

ELECTRONIC IDEAS

By Robert Hertzberg

A FAWCETT

75¢

HOW-TO BOOK

464



Electronic Ignition Analyzer

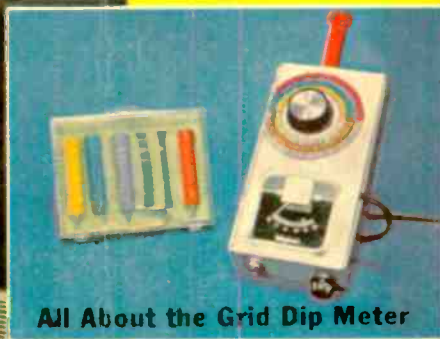

All About the Grid Dip Meter

Citizens Radio Service Round-Up

Ham Radio Interests All Ages



Small Meter Does Many Jobs

WHAT YOU SHOULD KNOW ABOUT KITS
LATEST TOOLS AND EQUIPMENT • TV TIPS
A REFRESHER COURSE IN ELECTRONICS

AMERICAN BASIC SCIENCE CLUB



Sensational LOW COST SCIENCE LAB

NOW over 110 fascinating projects with

SOUND ELECTRICITY HEAT ELECTRONICS LIGHT ATOMIC ENERGY

COMPLETE LABORATORY COMES IN 8 KITS, ONE A MONTH...
SUPPLIES ALL THE EQUIPMENT FOR ALL THE FOLLOWING:

A REAL SCIENCE COURSE
Developed with World Famous
SOUTHWEST RESEARCH INSTITUTE

The 8 manuals are expertly written,
clearly illustrated, excitingly different.

NO EXPERIENCE NECESSARY

You can complete every project and
**GAIN A VALUABLE SCIENCE BACK-
GROUND** that will **ENRICH YOUR LIFE**
and could **SHAPE YOUR FUTURE!**



Analyzing Glowing Gases
with the SPECTROSCOPE

Trouble Shooting with
the SIGNAL TRACER

PHOTOMICROGRAPH of a Fly's Wing
made with Microscope and Photo Lab
(Actual Size 5" diameter)

A VALUABLE SCIENCE LAB
Containing Parts by
RCA, MALLORY, PYRAMID,
STACKPOLE, TRIM and
other reliable manufacturers.
Retail Value of Parts Alone is
over FIFTY DOLLARS

**MEMBERS ARE
ENTHUSIASTIC!**

I wish I could provide each of my Physics
students with all of your enjoyable kits.
You are doing a wonderful job.

Your course is very enjoyable and
educational for all ages. I would
not sell mine for twice the price.

Francis Pitzer
13 Friendship Dr.
Tivoli, New York

Allen T. Ayers, Physics Dept.
Jamestown High School
Jamestown, New York

FREE! These 6 Auxiliary Textbooks

FOR SAFETY!

Circuits are low voltage
supplied by isolation
transformer that
comes with
first kit.



ELECTRICAL EXPERIMENTS

Educational fun with Electro-Magnets,
Transformer, Galvanometer, Rheo-
stoid, Relay, Voltmeter, Wheatstone
Bridge, and other electric equipment.

PHOTOELECTRIC EYE

Photoelectric Cell, Exciter lamp —
and Electronic Relay. Everything you
need to control motors, bells, alarms,
and do other light beam experiments.

CODE PRACTICE SET

Signal Oscillator, Key and Flasher
— the complete outfit to learn to
receive and transmit the Morse Code
— the first step to a Ham License.

RADIO SERVICE EQUIPMENT

All the parts to build your own
Radio Signal Tracer and a Probe
Light Continuity Tester. Both pieces
are invaluable in radio servicing.

PHOTOGRAPHY LAB

Completes dark room equipment:
Printer—Enlarger—Electronic Tissue
— Safe Light— Developing Trays and
supply of paper and chemicals.

SPECTROSCOPE

Fascinating optical instrument used
to identify and analyze substances
by observing the spectrum of their
flame. Spectrum charts are included.

ULTRAVIOLET LAMP

Produce dazzling color effects with
invisible "black light". Used extensively
for crime detection, mineralogy
and science. Fluorescent Ink, Crayon
and Tracer Powder are included.

RADIO RECEIVER

Three Tube Short Wave (80 Meter) and
Standard Broadcast Receiver. Sensitive
Regenerative Circuit uses regular 115
volt AC. Complete with Head Set.

MICROPHONE

A sensitive carbon-button micro-
phone that greatly amplifies unex-
pected noise. Also adaptable for
use with your radio transmitter.

STROBE LIGHT

A variable pulse neon lamp.
"Freezes" motion of rapidly vibrat-
ing or rotating objects for close
study and checking frequencies, RPM.

SOUND EXPERIMENTS

Laboratory demonstration of sound
waves, resonance and pitch. Includes
Variable Frequency Oscillator,
Sonometer and Ripple Tank.

SLIDE PROJECTOR

Takes 16mm and 35mm slides, sharp
focusing, convection cooled, G.E.
Projection Lamp included. Also ad-
aptable as a Projection Microscope.

ATOMIC RADIATION EXPM.

A variety of projects using Spin-
tharoscope and sensitive Electroscope.
Sample sources of radioactive Uran-
ium Ore and Radium are included.

HEAT EXPERIMENTS

Study the Molecular Theory of heat
using 2 Thermometer, Thermostat,
3 Foot Gas Thermometer and special
microscope arrangement that shows
the effect of Molecular Movement.

DC POWER SUPPLY

Power Transformer, Vacuum Tube
Rectifier and 20-30 mfd. Capacitor
Filter Circuit. Converts home AC to
the DC required for Electronic Circuits.

ELECTRONIC EXPERIMENTS

Explore functions of vacuum tubes
and other electronic components.
Build an Electronic Switch—Ampli-
fier, and other experimental circuits.

BROADCAST TRANSMITTER

Sends clear transmissions of both
code and voice to nearby radios.
Can be used with your microphone,
record player, or audio oscillator.

TELESCOPE

A mounted astronomical Telescope.
High quality ground lenses enable
you to examine details of the
moon's surface and distant objects.

MICROSCOPE

High and low power, precision
ground Lenses, Substage Light and
Polarizer. Adaptable for photomicro-
graphy in connection with Photo Lab.

ATOMIC CLOUD CHAMBER

See illuminated tracks of speeding
nuclear particles emanating from ra-
dioactive Alpha source and mysteri-
ous cosmic rays from outer space.

WEATHER STATION

Ancient Barometer, Cup Anemometer
that electronically measures wind
speed, Sting Psychrometer, Humidity
Gauge, Cloud Speed Indicator,
Cloud Chart and Weather Map.

ALL THE EQUIPMENT FOR ALL THE ABOVE—only \$29.50

SEND **\$2.00** WITH COUPON ONLY PAY **\$3.45** ONLY (ONE A MONTH FOR 8 MONTHS) **FREE**

SOLDERING
IRON
with second
Kit

Your Satisfaction or Your Money Back... AND
you may cancel at any time without obligation.

These "no risk" assurances because we know you will be...

SURPRISED! AMAZED! DELIGHTED!

AMERICAN BASIC SCIENCE CLUB
Dept. P-E, 501 E. Crockett, San Antonio 6, Texas

Start sending me A.B.S.C.'s Science Labs. in eight kits, one
each month. If not satisfied on inspection of first kit I may
return it for immediate refund. (I choose the plan checked.)
[] I enclose \$2.00 and will pay \$3.45 plus COD postage on
arrival of each kit. I may cancel unshipped kits at any time.
[] I enclose \$29.50, full payment, Postage Paid, for all 8 kits. I
may cancel any time and get full refund on unshipped kits.

NAME _____

STREET _____

CITY _____ STATE _____

MAIL COUPON TODAY

AMERICAN BASIC SCIENCE CLUB, Inc. San Antonio, Texas

ON LAND·IN THE AIR *and* ON THE SEA..

BIG MONEY

awaits
**TRAINED
 TECHNICIANS**
in
**TELEVISION·RADIO·
 ELECTRONICS·RADAR**

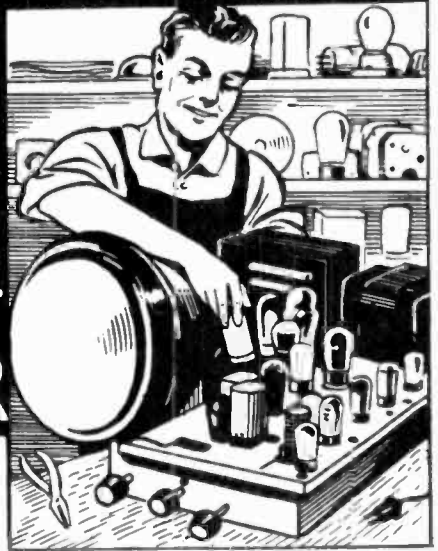

EARN *As You Learn*

Christy Shop-Method Home Training makes you a more valuable and desirable technician, assures you of more money, faster progress and greater success. This practical step-by-step training makes everything interesting and easy, makes learning fun. You don't have to leave home or quit your job to learn this simple, easy way. A few hours of your spare time each week soon prepares you for earning while learning and later for a big-pay job or profitable business of your own in this fabulous, fast-growing new industry. 3 new books contain complete information. Describe the course and many opportunities in this fantastic new field. Send for your 3 free books today!

The Only Complete Course!

C.T.S. training covers every phase of this fascinating new subject. You get this comprehensive training starting with your first lesson. You learn Radar, Sonar, Television, Radio and Electronics in C.T.S.'s Complete course. This broader knowledge and greater understanding means more jobs and higher pay for you. Why be satisfied with less? You learn faster and better with Christy Shop-Method Home Training. It gives you all the training you need in a clear, simple, easy-to-understand way.

Big pay, interesting work, immediate success, await those thoroughly trained in all branches of electronics. And the C.T.S. Master Shop-Method Home Training Course is the only complete course in Radar, Sonar, Television, Radio and Electronics.

19 TRAINING INSTRUMENTS INCLUDED

In a few months you learn what used to take years of hard work to master, reach your goal sooner and are better prepared to make maximum progress. Send for complete information today!

CHRISTY TRADES SCHOOL

Dept. T-274,

3214 W. Lawrence Ave., Chicago 25, Ill.

MAIL COUPON TODAY!

CHRISTY TRADES SCHOOL

Dept. T-274, 3214 W. Lawrence Ave., Chicago 25, Ill.

Gentlemen:

Please send me, without cost or obligation, two FREE Lessons and the new 24-page illustrated book telling all about the C.T.S. Master Shop-Method Home Training Course in Radar, Sonar, Television, Radio and Electronics, and the many opportunities this new field offers.

Name Age

Address

City State



The Angel Record Club



5741. Prokofiev: CINDERELLA. The ballet's enchanting music. Robert Irving conducts the Royal Philharmonic. \$4.98; Stereo \$5.98.



782. THE SCOTS GUARDS. The Regimental Band and Massed Pipes in pulsating marches, reels, strathspeys. \$4.98.



5700. SOVIET ARMY CHORUS & BAND. 200 thundering male voices sing Russian folk ballads and army songs. \$4.98; Stereo \$5.98.



5769. LOLLIPOPS. Sir Thomas Beecham conducts 8 delightful "musical sweet-meats" by Beethoven, Debussy, Mozart, others. \$4.98; Stereo \$5.98.



747. CALLAS PORTRAYS PUCCINI HEROINES. Favorite arias from operas Manon Lescaut, Turbidity, Bohème, Tosca, etc. \$4.98.



725. Dvorak: SYMPHONY NO. 5 ("New World"). Constantin Silvestri conducts the Orchestre national de la Radiodiffusion. \$4.98.



750. VIENNA ON PARADE. Julius Herrmann conducts the Deutschermeister Band, with soloists and choir, in gay waltzes, folk songs, operetta favorites. \$4.98.



5751. Sibelius: SYMPHONY NO. 2. Powerfully played by the Philharmonia Orchestra, Paul Kletzki conducting. \$4.98; Stereo \$5.98.



5733. Prokofiev: SYMPHONY NO. 5. A stunning rendition of a heroic work by Thomas Schippers with the Philharmonic Orch. \$4.98.



720. ROMEO AND JULIET. POLOVTSIAN DANCES, NIGHT ON BALD MOUNTAIN. 3 great works by Tchaikovsky, Borodin, Moussorgsky. \$4.98.



5734. Tchaikovsky: SYMPHONY NO. 4. A superb performance by Constantin Silvestri and the Philharmonia Orch. \$4.98; Stereo \$5.98.



726. MOZART: 4 HORN CONCERTOS. Virtuoso pieces flawlessly performed by Dennis Brain with the Philharmonia Orchestra. \$4.98.



720. BRAHMS: SYMPHONY NO. 4. His final symphony, played by the Philharmonia Orchestra, conducted by Herbert Von Karajan. \$4.98.



748. SCHUBERT SONGS. Dietrich Fischer-Dieskau sings 8 charming Schubert songs, from the gay and buoyant to the deeply tragic. \$4.98.



729. Arrau: PIANO CONCERTO; Schumann: PIANO CONCERTO. Brilliantly played by Claudio Arrau and the Philharmonia Orch. \$4.98.



749. VERDI OPERA CHORUSES. La Scala in favorites from Traviata, Aida, Otello, Ernani, I Lombardi, Nabucco. \$4.98.



724. NUTCRACKER SUITE; WATER MUSIC SUITE. Two favorite works by Herbert Von Karajan conducting the Philharmonia Orchestra. \$4.98.



737. Khatchaturian: VIOLIN CONCERTO. David Oistrakh plays, the composer conducts, in a dazzling, unforgettable performance. \$4.98.



5746. Tchaikovsky: VIOLIN CONCERTO; Mendelssohn: VIOLIN CONCERTO. Christian Ferras with the Philharmonia Orch. \$4.98; Stereo \$5.98.



726. WAGNER OPERA SELECTIONS. The Berlin Philharmonic plays Tannhauser, The Flying Dutchman, Gotterdammerung. \$4.98.

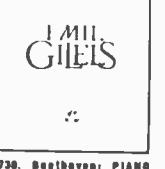

5730. Beethoven: PIANO CONCERTO NO. 4. Russia's famed Emil Gilels is soloist with the Philharmonia Orch. \$4.98; Stereo \$5.98.



743. Stravinsky: PETROUCHKA. The complete score of the famous ballet. Efram Kurtz conducts the Philharmonia Orchestra. \$4.98.



745. Chopin: 6 MAZURKAS; 3 POLONAISES. Witold Malcuzynski at the piano in fiery renditions of 11 notable works. \$4.98.



**Take 4 Albums
— pay only 99¢
on this offer**



725. BEETHOVEN'S APPRENTICE; LA VALSE. Suite from THE THREE CORNED HATS. "CLASSICAL" SYMPHONY 4. Exciting great works \$4.98.

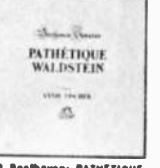

740. Beethoven: PATMETHIQUE and WALDSTEIN SONATAS. Hungarian pianist Anne Fischer plays two distinguished works. \$4.98.



720. Berlioz: SYMPHONIE FANTASTIQUE. A striking interpretation by Herbert Von Karajan and the Philharmonia Orchestra. \$4.98.



5777. FIRE-BIRD; CHILDEEN'S DANCES; ANOTHER GOOSE SUITE. 3 exciting works by Stravinsky, Bizet, Ravel. \$4.98; Stereo \$5.98.

If you collect records, you know the Angel label denotes music for the connoisseur. It is where you find the world's great artists, flawlessly reproduced at the height of their artistry. Now—through the Angel Record Club—you may acquire these extraordinary albums at impressive cash savings.

Invites You to ...

CHOOSE ANY FOUR ANGEL ALBUMS

pay ONLY 99¢

PLUS A SMALL CHARGE FOR POSTAGE, PACKING AND MAILING



"In masterful use of reproduction, Angel holds the lead." - NEWSWEEK

27 varied Angel albums are described on the opposite page. You may choose any 4—a total retail value of \$19.92—and pay only 99¢ (plus a small charge for postage, packing and mailing), under the Angel Record Club trial membership terms spelled out at the right. Mail the coupon today and see for yourself why the Saturday Review says of Angel Records: "It is hard to say which is the greater miracle, the performance or the recording."

... when you become a member of the Angel Record Club and agree to buy as few as six future recordings at the usual retail price during the next twelve months.

ANGEL RECORD CLUB

Dept. 2029, Scranton 5, Pennsylvania

Please accept my application for membership. These are the 4 albums I choose (RETAIL VALUE UP TO \$19.92).

WRITE ALBUM NUMBER IN BOXES:

--	--	--	--

All you will bill me is 99¢ plus a small charge for postage, packing and mailing.

I agree to buy 6 records during the next 12 months from over 100 to be offered (at the rate of at least one every other month) at the usual retail price of \$4.98, plus a small charge for postage, packing and mailing within seven days after I receive each album. After these purchases I may cancel my membership. Or, if I remain a member, I will select a BONUS ALBUM each time I purchase two records. Each month you will send me a description of the new Recommended Angel Selection, plus a range of alternate selections. If I want an alternate selection, or no record at all that month, I will notify you on the form always provided.

STEREO: Check here if you own a STEREO record player and agree to buy your six future selections in stereo which the Club sells for \$1.00 more than monaural. Then the four records you have chosen marked "S" will be sent to you in STEREO with a bill for only \$1.00 more (Total: \$1.99). BONUS ALBUMS and future selections will also be in stereo. NOTE: Stereo records can be played only on stereo equipment.

NO-RISK GUARANTEE: If not delighted, I will return these four albums within seven days and my membership and all charges will be cancelled without further obligation.

PRINT NAME.....

ADDRESS

CITY.....ZONE.....STATE.....

SEND NO MONEY. We will bill you. (Membership limited to one per household.) Slightly higher in Canada. Angel Record Club of Canada, 1184 Castlefield Ave., Toronto 19, Ontario

If you wish to join through an ANGEL record dealer authorized to solicit club subscriptions, write his name and address in margin. PRE-11

ELECTRONIC IDEAS

By Robert Hertzberg

A FAWCETT BOOK • NUMBER 464
LARRY EISINGER • EDITOR-IN-CHIEF
GEORGE TILTON • MANAGING EDITOR
SILVIO LEMBO • ART EDITOR

W. H. Fawcett, Jr. President
Roger Fawcett General Manager
Gordon Fawcett Secretary-Treasurer
Roscoe Fawcett Circulation Director
Ralph Daigh Editorial Director
James B. Boynton Advertising Director
Al Allard Art Director
Ralph Mattison Associate Art Director
George H. Carl Production Director

RAY GILL EDITOR
Phyllis Trieb Editorial Assistant
Susan B. Cole Editorial Assistant

Staff Artists

NICK CARLUCCI ASSOCIATE ART EDITOR
Harold E. Price • Michael Gaynor
Larry Flanagan • Howard Katz
John S. Selvaggio • George Zymarakis
Bob Vatter • Michael deLucia

Phyllis J. Bendremer Production Editor
Benita Rockwood Assistant Production Editor

ELECTRONIC IDEAS, by Robert Hertzberg, Fawcett Book 464, is published by Fawcett Publications, Inc., Greenwich, Connecticut. Editorial and advertising Offices: 67 West 44th Street, New York 36, New York. General Offices: Fawcett Building, Greenwich, Connecticut. Printed in U.S.A. Copyright 1960 by Fawcett Publications, Inc.

COVER PHOTOGRAPHS BY GRAYSON TEWKSBURY

Member of Magazine Publishers Association, Inc. 

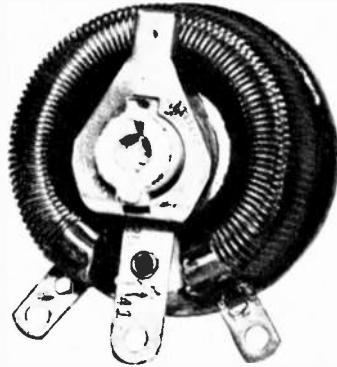
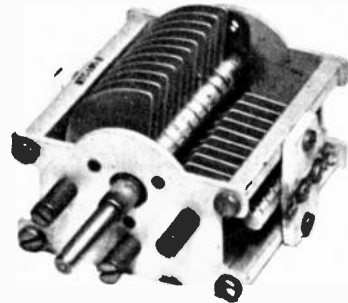

HOW TO BREAK INTO RADIO-TV-ELECTRONICS

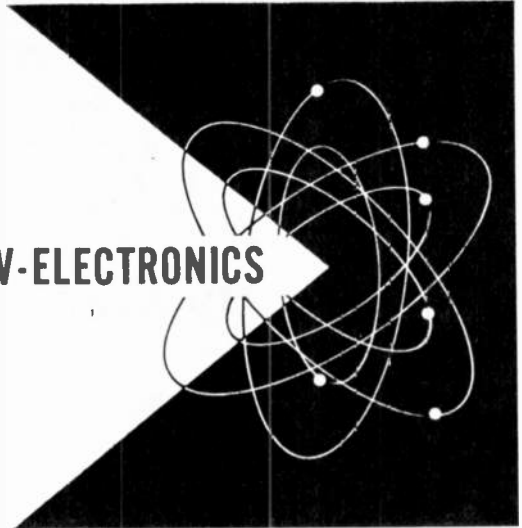

A good paying career in Radio-TV-Electronics may be closer than you think—regardless of your age, education or present job experience.

You know about the tremendous demand for radio-TV and electronics technicians. But something perhaps you didn't know is how easy it is to get the training that will qualify you for this vital work, and how quickly you can advance.

From the very beginning you will find that your I.C.S. course is preparing you thoroughly—at your own pace—for an exciting new career. I.C.S. Radio-TV-Electronics courses make electronic fundamentals clear, easy to follow. You get *personalized* guidance from people who know—and can tell you—what it takes to succeed along every step of the way.

The I.C.S. method makes it possible to learn while you earn. You study at home—in your spare time. Everything you learn is practical, usable. Your mastery of Radio-TV-Electronics assures you of top

pay and real job security in one of today's fastest growing fields.

So if you would like to break into Radio-TV-Electronics—your first step is to send for your **FREE I.C.S. Career Kit**. There's no obligation... and there's a whole new future to gain.

Send coupon below for your **free I.C.S. Career Kit!**

- 1 "How to Succeed" career guide
- 2 "Career Catalog" of job opportunities in your field of interest
- 3 "Sample Lesson" (math) to demonstrate the famous I.C.S. method



For Real Job Security—Get an I.C.S. Diploma!

I.C.S., Scranton 15, Penna.

Accredited Member,
National Home Study Council

INTERNATIONAL CORRESPONDENCE SCHOOLS



BOX 45015L, SCRANTON 15, PENNA.

In Hawaii reply P.O. Box 418, Honolulu

(Partial list of courses)

Without cost or obligation, send me "How to Succeed" and the opportunity booklet about the field BEFORE which I have marked X (plus sample lesson):

RADIO TELEVISION ELECTRONICS

- General Electronics Tech.
- Industrial Electronics
- Practical Radio-TV Eng'g
- Practical Telephony
- Radio-TV Servicing

BUSINESS

- Cost Accounting
- Managing a Small Business
- Purchasing Agent

DRAFTING

- Electrical Drafting

HIGH SCHOOL

- High School Diploma
- Good English
- High School Mathematics

ELECTRICAL

- Electrical Engineering
- Elec. Engr. Technician
- Elec. Light and Power
- Practical Electrician
- Professional Engineer (Elec.)

LEADERSHIP

- Industrial Foremanship
- Industrial Supervision
- Personnel-Labor Relations
- Supervision

Name _____ Age _____ Home Address _____

City _____ Zone _____ State _____ Working Hours _____ A.M. to _____ P.M. _____

Occupation _____ Canadian residents send coupon to International Correspondence Schools, Canadian, Ltd., Montreal, Canada. . . . Special low monthly tuition rates to members of the U. S. Armed Forces.

CONTENTS

Kinks	8	Know Your Components	82
Electrons in Motion	10	A Meter That Thinks for Itself	92
Citizens Radio Service Round-Up	24	Movable Radio Table	97
C. B. Converter for Your Car Radio	30	A Straight Steer on Stereo	98
Storage Battery Flashlight	33	Car Radio Care	106
Simple Power Transistor Circuits	34	Boxed Speaker	109
Transistorized Relay Circuits	38	Ham Radio in the Car	110
Electronic Ignition Analyzer	42	Grip-Dip Meter	120
The Nuvistor	46	Monitor Your Keying	130
So You're Going to Build a Kit!	50	TV Tips	134
Printed Circuit De-Soldering	58	No-Stoop Tuning	136
The Third Hand	62	Substitution Boxes	138
Keep It Clean!	66	Ham Radio Interests All Ages	140
Small Meter Does Many Jobs	68	Radio Interference	142
Clock Radio Works Anywhere	74		





Now! Work Over
300 PRACTICAL PROJECTS with these PARTS AT HOME!



to help You learn
ELECTRONICS
RADIO - TELEVISION - RADAR

NOW . . . at home in your spare time you can get the very kind of training and subsequent Employment Service you need to get started toward real earnings in one of today's brightest opportunity fields—TELEVISION-RADIO-ELECTRONICS. Now that Electronics is entering so many new fields, here is a chance of a lifetime to prepare to cash in on its remarkable growth.

DeVry Tech's amazingly practical home method enables you to set up your own HOME LABORATORY. You spend minimum time to get maximum knowledge from over 300 practical projects, using the same type of basic equipment used in our modern Chicago and Toronto Training Centers!

DeVry Tech Provides EVERYTHING YOU NEED . . .

—to help you master TV-ELECTRONICS. In addition to the home laboratory and easy-to-read lessons, you even use HOME MOVIES—an exclusive DeVry Tech advantage. You watch hidden actions . . . see electrons on the march. Movies help you to learn faster . . . easier . . . better.

LABORATORY TRAINING

Full time day and evening training programs in our modern Chicago and Toronto Laboratories are also available. MAIL COUPON TODAY for facts.



BUILD and KEEP Valuable TEST EQUIPMENT

As part of your training, you build and keep a fine Jewel-Bearing Vacuum Tube VOLTMETER and a 5-inch COLOR OSCILLOSCOPE—both high quality, needed test instruments.

EFFECTIVE EMPLOYMENT SERVICE

Get the same Employment Service that has helped so many DeVry Tech graduates get started in this fast-growing field.



"One of North America's Foremost Electronics Training Centers"

Accredited Member of National Home Study Council



DeVRY TECHNICAL INSTITUTE
CHICAGO 41, ILLINOIS

EARN WHILE YOU LEARN

DeVry Tech's practical training helps you toward spare time income servicing Radio and Television sets.

✓ CHECK These Exciting Job Opportunities:



21 INCH
Build and keep this BIG DeVry Eng. needed TV set—easily converted to U.H.F. DeVry offers another home training, but without the TV set.)

- TV-Radio Broadcast Technician
- Color Television Specialist
- Radar Operator
- Laboratory Technician
- Airline Radio Man
- Computer Specialist
- Quality Control Manager
- Your Own Sales & Service Shop
- . . . PLUS MANY OTHERS

MAIL COUPON TODAY!

DEVRY TECHNICAL INSTITUTE
4141 Belmont Ave., Chicago 41, Ill., Dept. PRE-Q

Please give me your FREE booklet, "Electronics in Space Travel," and tell me how I may prepare to enter one or more branches of Electronics.

Name _____ Age _____
PLEASE PRINT

Street _____ Apt. _____

City _____ Zone _____ State _____

2045 Canadian residents address: DeVry Tech of Canada, Ltd.
970 Lawrence Avenue West, Toronto, Ontario



Electronics in SPACE TRAVEL

Kinks

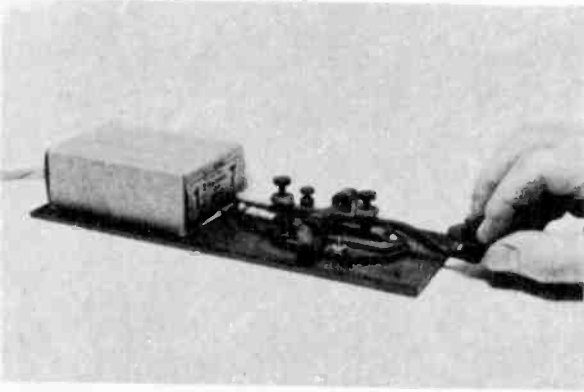

PRACTICE KEY MUST BE ANCHORED. Telegraph key should not wobble when used for code practice. Mount key on long, narrow piece of hardboard. Use countersunk flathead machine screws, from the underside. Weigh down the far end with box of screws. Key is firm, but taken up instantly.

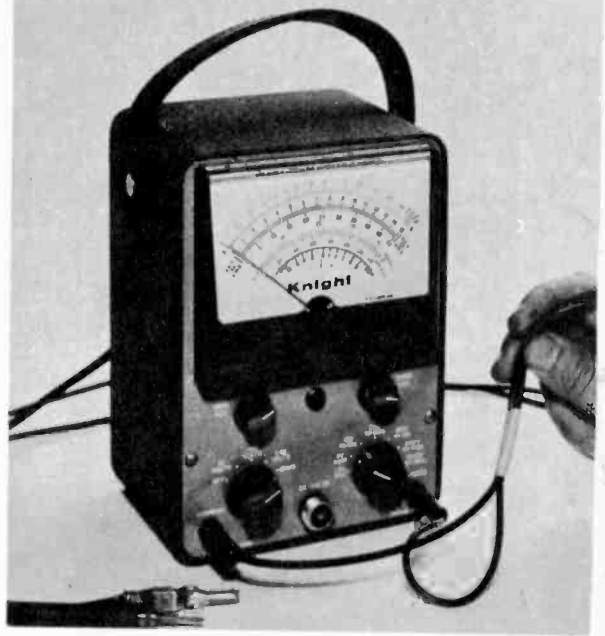

TAPED LEADS WON'T STRAY. Flexible test leads of volt-ohmmeter and vacuum-tube voltmeters are always used in pairs. Tape them together about six inches from ends that plug into the front panel of instrument to keep together. This will assure both of them are available and usable at all times.

LACQUER SPRAY PROTECTS MIKE. Ham operators and users of mikes clutch them tightly; to keep the perspiration from dulling finish, which may also cause rusting, lacquer it. Wipe mike down with slightly damp cloth, dry well, then spray with lacquer. Aim can so that the lacquer will not hit the mouth of the mike or more effectively, cover it with a disc of paper cut to fit snugly.



CLIP SECURES PHONE RECORDS. Many portable record players have no space to carry records. Safe place is the turntable itself. Stack the discs on spindle, with thin pieces of paper or cardboard to protect the groove surfaces and secure them firmly with a stiff paper clamp to the shaft. This way, you can easily carry your records from place to place without worrying about scratches.



I'd like to give this to my fellow men... while I am still able to help!

I am printing my message in a magazine. It may come to the attention of thousands of eyes. But of all those thousands, only a few will have the vision to understand. Many may read; but of a thousand only you may have the intuition, the sensitivity, to understand that what I am writing may be intended for you—may be the tide that shapes your destiny, which, taken at the crest, carries you to levels of independence beyond the dreams of avarice.

Don't misunderstand me. There is no mysticism in this. I am not speaking of occult things; of innumerable laws of nature that will sweep you to success without effort on your part. That sort of talk is *rubbish!* And anyone who tries to tell you that you can *think* your way to riches without effort is a false friend. I am too much of a realist for that. And I hope you are.

I hope you are the kind of man—if you have read this far—who knows that anything worthwhile has to be *earned!* I hope you have learned that there is no reward without effort. If you have learned this, then you may be ready to take the next step in the development of your karma—you may be ready to learn and use the secret I have to impart.

I Have All The Money I Need

In my own life I have gone beyond the need of money. I have it. I have gone beyond the need of gain. I have two businesses that pay me an income well above any amount I have need for. And, in addition, I have the satisfaction—the deep satisfaction—of knowing that I have put more than three hundred other men in businesses of their own. Since I have no need for money, the greatest satisfaction I get from life, is sharing my secret: of personal independence with others—seeing them achieve the same heights of happiness that have come into my own life.

Please don't misunderstand this statement. I am not a philanthropist. I believe that charity is something that no proud man will accept. I have never seen a man who was worth his salt who would accept

I was young once, as you may be—today I am older. Not too old to enjoy the fruits of my work, but older in the sense of being wiser. And once I was poor, desperately poor. Today almost any man can stretch his income to make ends meet. Today, there are few who hunger for bread and shelter. But in my youth I knew the pinch of poverty; the emptiness of hunger; the cold stare of the creditor who would not take excuses for money. Today, all that is past. And behind my city house, my

summer home, my Cadillacs, my Winter-long vacations and my sense of independence—behind all the wealth of cash and deep inner satisfaction that I enjoy—there is one simple secret. It is this secret that I would like to impart to you. If you are satisfied with a humdrum life of service to another master, turn this page now—read no more. If you are interested in a fuller life, free from bosses, free from worries, free from fears, read further. This message may be meant for you.

By Victor B. Mason

something for nothing. I have never met a highly successful man whom the world respected who did not sacrifice something to gain his position. And, unless you are willing to make at least half the effort, I'm not interested in giving you a "leg up" to the achievement of your goal. Frankly, I'm going to charge you something for the secret I give you. Not a lot—but enough to make me believe that you are a little above the fellows who merely "wish" for success and are not willing to sacrifice something to get it.

A Fascinating and Peculiar Business

I have a business that is peculiar—one of my businesses. The unusual thing about it is that it is needed in every little community throughout this country. But it is a business that will never be invaded by the "big fellows". It has to be handled on a local basis. No giant octopus can ever gobble up the whole thing. No big combine is ever going to destroy it. It is essentially a "one man" business that can be operated without outside help. It is a business that is good summer and winter. It is a business that is growing each year. And, it is a business that can be started on an investment so small that it is within the reach of anyone who has a television set. But it has nothing to do with television.

This business has another peculiarity. It can be started at home in spare time. No risk to present job. No risk to present income. And no need to let anyone else know you are "on your own". It can be run as a spare time business for extra money. Or, as it grows to the point where it is paying more than your present salary, it can be expanded into a full time business—overnight. It can give you a sense of personal independence that will free you forever from the fear of lay-off, loss of job, depressions, or economic reverses.

Are You Mechanically Inclined?

While the operation of this business is partly automatic, it won't run itself. If you are to use it as a stepping stone to independence, you must be able to work with your hands, use such tools as hammer and screw driver, and enjoy getting into a pair of blue jeans and rolling up your sleeves. But two hours a day of manual work will keep your "factory" running 24 hours turn-

ing out a product that has a steady and rapid sale in every community. A half dollar spent for raw materials can bring you six dollars in cash—six times a day.

In this message I'm not going to try to tell you the entire story. There is not enough space on this page. And, I am not going to ask you to spend a penny now to learn the secret. I'll send you all the information, free. If you are interested in becoming independent, in becoming your own boss, in knowing the sweet fruits of success as I know them, send me your name. That's all. Just your name. I won't ask you for a penny. I'll send you all the information about one of the most fascinating businesses you can imagine. With these facts, you will make your own investigation. You will check up on conditions in your neighborhood. You will weigh and analyze the whole proposition. Then, and then only, if you decide to take the next step, I'll allow you to invest \$15.00. And even then, if you decide that your fifteen dollars has been badly invested I'll return it to you. Don't hesitate to send your name. I have no salesmen. I will merely write you a long letter and send you complete facts about the business I have found to be so successful. After that, you make the decisions.

Does Happiness Hang on Your Decision?

Don't put this off. It may be a coincidence that you are reading these words right now. Or, it may be a matter that is more deeply connected with your destiny than either of us can say. There is only one thing certain: If you have read this far you are interested in the kind of independence I enjoy. And if that is true, then you must take the next step. No coupon on this advertisement. If you don't think enough of your future happiness and prosperity to write your name on a postcard and mail it to me, forget the whole thing. But if you think there is a destiny that shapes men's lives, send your name now. What I send you may convince you of the truth of this proverb. And what I send you will not cost a penny, now or at any other time.

VICTOR B. MASON
1512 Jarvis Ave., Suite M-206-M
CHICAGO 26, ILLINOIS

Electrons in Motion

Here is a short basic electronics refresher course.

Simple setup shows how magnetic induction starts electrons moving in coil of wire. A straight bar magnet is pulled quickly through the center of a bobbin (the winding from a discarded starting relay of a car). The voltmeter shows a pulse of current. Now see top photo, pg. 14.

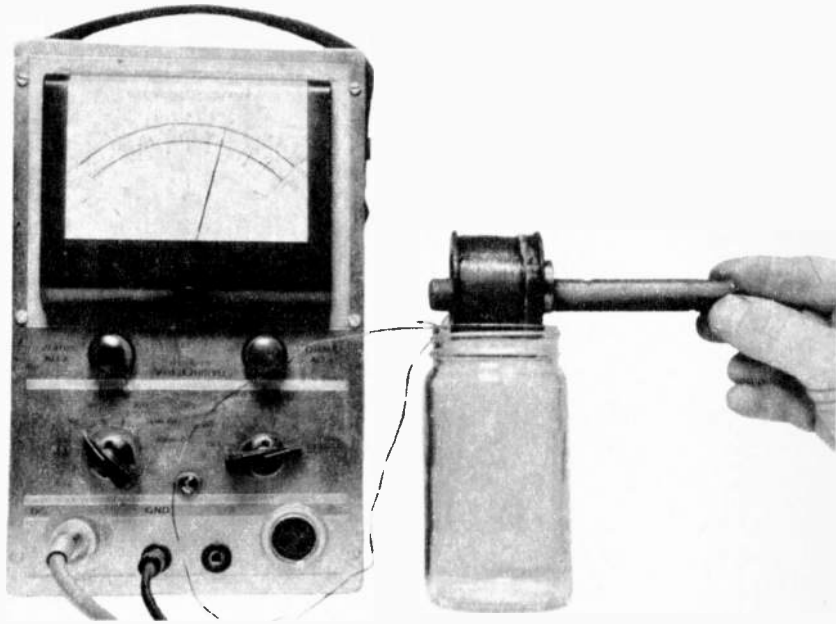

THE NATURE of electricity has been a puzzle to scientists for hundreds of years. For a long time it was firmly believed that "current" flowed from one side of a battery or generator, arbitrarily called the "positive," through the external circuit, and back to the other side of the battery, called the "negative." This theory suffered a serious setback with the development of the vacuum tube in the first two decades of the 20th century. For in this remarkable device, which ushered in what we now regard as the electronic age, there was visible, physical, indisputable evidence that whatever mysterious "current" flowed through the circuit flowed in exactly the *other* direction.

The ease with which this directional effect can be demonstrated both confused and confounded the electrical experts of the World War I period. Consider figures (page 18) which are the same except for versed polarities of the plate battery. The only purpose of the filament battery is to heat the filament of the tube to incandescence, just as if the latter were an ordinary electric light. (As a matter of fact, the radio vacuum tube evolved directly from one of Thomas Edison's original bulbs!)

With the plate battery connected as in Figure 1, the ammeter in the circuit shows absolutely no sign of current flow. You might say that this is to be expected, since the filament and the plate of the tube are well separated inside the evacuated bulb

and therefore act as an open switch. However, if the battery is reversed as in Figure 2, so that the plate is now so-called positive in relation to the filament, instead of negative, the ammeter shows a very definite and unmistakable flow of current. Why isn't the tube now acting as an open switch?

Turning off the filament battery alone, with the plate battery still connected as in Figure 2, kills the flow of current completely. Merely reducing the temperature of the filament, by means of a simple variable resistor in the filament circuit, reduces the plate current without actually cutting it off. Obviously, then, something is coming out of the filament, something that crosses the vacuum and jumps to the plate only when the latter is positive in relation to the filament. When the plate is negative, that "something" is repelled.

It has long been known that "unlike" charges of electricity tend to attract each other, and "like" charges to repel each other. It is reasonable to assume, therefore, that the radiation from the hot filament is essentially of negative nature. Its susceptibility to polarity can further be demonstrated by the hookup of Figure 3, which shows a vacuum tube containing *three* electrodes, the third being an open grid of fine wire placed directly between the filament and the plate. (This is the classic "audion" of Dr. Lee deForest, probably the greatest electrical invention to date.)

F.C.C. COMMERCIAL OPERATOR LICENSE

Training... for Jobs in Electronics

F.C.C. LICENSE—THE KEY TO BETTER JOBS

An F.C.C. *commercial* (not amateur) license is your ticket to higher pay and more interesting employment. This license is Federal Government evidence of your qualifications in electronics. Employers are eager to hire *licensed* technicians.

WHICH LICENSE FOR WHICH JOB?

The **THIRD CLASS** radiotelephone license is of value primarily in that it qualifies you to take the second class examination. The scope of authority covered by a third class license is extremely limited.

The **SECOND CLASS** radiotelephone license qualifies you to install, maintain and operate most all radiotelephone equipment except commercial broadcast station equipment.

The **FIRST CLASS** radiotelephone license qualifies you to install, maintain and operate every type of radiotelephone equipment (except amateur) including all radio and television stations in the United States, its territories and possessions. This is the highest class of radiotelephone license available.

GRANTHAM TRAINING PREPARES YOU

The Grantham Communications Electronics Course prepares you for a **FIRST CLASS** F.C.C. license, and it does this by **TEACHING** you electronics. Each point is covered simply and in detail, with emphasis on making the subject easy to understand. The organization of the subject matter is such that you progress, step-by-step, to your specific objective—a first class F.C.C. license.

CORRESPONDENCE OR RESIDENCE CLASSES

Grantham training is available by correspondence or in resident classes. Either way, you are trained quickly and well. Write, or mail the coupon below, to any division of Grantham School of Electronics. Our free booklet will be sent to you immediately.

HERE'S PROOF...

that Grantham students prepare for F.C.C. examinations in a minimum of time. Here is a list of a few of our recent graduates, the class of license they got, and how long it took them:

Name	Address	License	Weeks
Richard M. Wilhoit	2104 Santa Paula, Las Vegas, Nev.	1st	12
Larry R. Perrine	7 Normandy Place, Champaign, Ill.	1st	15
Marion Woolsey	3248 Warwick, Kansas City, Mo.	1st	12
Harold W. Johnson	3070 Hermosa Ave., Los Angeles, Calif.	1st	15
Ralph Frederick Beloner	2126 Grand, Joplin, Mo.	1st	12
N. B. Billie, II	110 So. Race St., Statesville, N. C.	1st	12
Dean A. Darling	403 S. Chase Ave., Columbus 4, Ohio	1st	12
Gerald L. Chopp	318 Audubon Road, Kohler, Wis.	1st	12

FOUR COMPLETE SCHOOLS: To better serve our many students throughout the entire country, Grantham School of Electronics maintains four complete Divisions—located in Hollywood, Calif., Seattle, Wash., Kansas City, Mo., and Washington, D.C. All Divisions of Grantham School of Electronics offer the same rapid courses in F.C.C. license preparation, either by home study or in resident classes.

Get your First Class Commercial F.C.C. License in 12 weeks by training at

Grantham School OF ELECTRONICS

for **FREE** Booklet **CLIP COUPON** and mail in envelope or paste on postal card.

HOLLYWOOD
CALIF.

1505 N. Western Ave.
Hollywood 27, Calif.
(Phone: HO 7-7227)

SEATTLE
WASH.

408 Marion Street
Seattle 4, Wash.
(Phone: MA 2-7227)

KANSAS CITY
MO.

3123 Gilham Road
Kansas City 9, Mo.
(Phone: JE 1-6320)

WASHINGTON
D. C.

821-19th Street, N.W.
Washington 6, D. C.
(Phone: ST 3-3614)

MAIL COUPON NOW



To: GRANTHAM SCHOOL OF ELECTRONICS

1505 N. Western • 408 Marion • 3123 Gilham Rd. • 821-19th, NW
Hollywood • Seattle • Kansas City • Washington

Please send me your free booklet telling how I can get my commercial F.C.C. license quickly. I understand there is no obligation and no salesman will call.

Name _____ Age _____

Address _____

City _____ State _____

I am interested in: Home Study, Resident Classes p-1

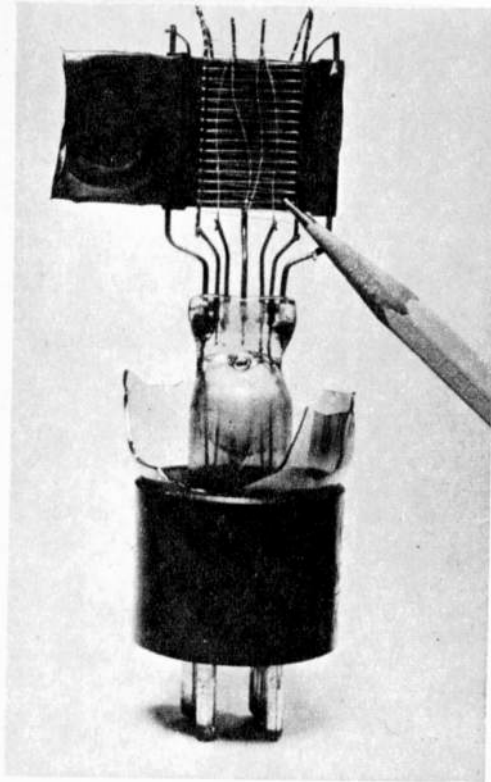

The three-element triode tube is shown in photo, above. The thin M shaped wire is the filament, surrounding it is the open mesh grid, and on the outside is the metal plate. The elements are supported by stiff wires set in the glass stem.

The lines of force that are extended from a magnet are invisible, but their existence and shape are given definite form when iron filings are used to demonstrate the field around the magnet. Note the whiskery formation around the ends.

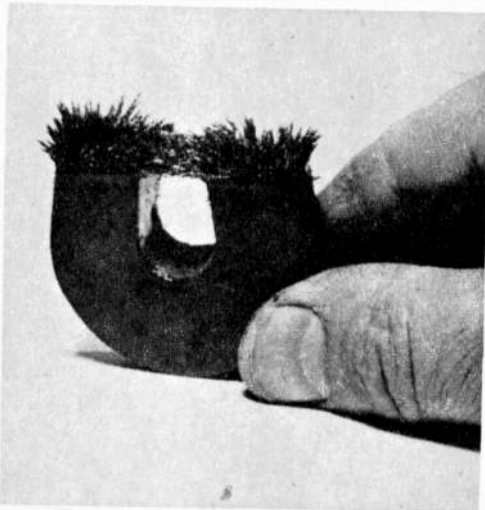

With the posts marked "grid battery" left open, a certain current, usually of the order of several milliamperes (*milliamperere* is 1/1000 of one ampere), shows on the ammeter.

If a battery is now connected to the grid posts with its positive side to the grid and its negative to the common return point of the filament and the ammeter, the plate current shoots up remarkably. The positive grid, being closer to the filament than the plate is, apparently accelerates the flow of the negative "something" from the filament. Being of open construction, the grid does not present any appreciable physical barrier to the flow.

If the grid battery is reversed so that the grid electrode becomes negative in relation to the filament, the flow of plate current is reduced. If the grid is made sufficiently negative, the plate current can be reduced to zero.

Small changes in grid voltage produce comparatively large changes in plate current. The three-element tube is thus an extremely sensitive control device and an amplifier.

The particles that boil out of the filament are "electrons." Present-day scientists agree pretty generally that electricity can be defined simply as *electrons in motion*.

COMPOSITION OF MATTER

What are electrons? It might be better to ask the broader question, "What is matter?" According to current theory, the atom, the smallest subdivision of an element capable of existence by itself, consists of a central nucleus surrounded by one or more electrons. The nucleus is thought to contain protons and neutrons. In ordinary materials, the electrons whirl around the nucleus and stay within the atom. Their attraction is thought to be due to unlike electric charges on them. To distinguish between them, electrons are regarded as negative, probably because the electron tube showed that they could be made to move to a plate having what was always known as a positive effect; the protons are regarded as positive. The neutrons within the nucleus apparently do not have any electric effect, and get their name from the word *neutral*.

In an atom not subjected to outside influences, the electrons orbit peacefully around their nucleus. The theoretical energy of their movement is enormous, but it isn't noticeable when the atom is in its normal state of balance. However, some curious things happen when certain influ-

NOW!
at a price
you can afford!

MAKE MORE MONEY in TELEVISION RADIO-ELECTRONICS

**BETTER...MORE COMPLETE...LOWER COST...
WITH NATIONAL SCHOOLS SHOP-METHOD
HOME TRAINING!**

BETTER... Training that is proved and tested in Resident School shops and laboratories, by a School that is the **OLDEST** and **LARGEST** of its kind in the world.

MORE COMPLETE... You learn **ALL PHASES** of *Television-Radio-Electronics*.

LOWER COST... Other schools make several courses out of the material in our **ONE MASTER COURSE**... and you pay more for less training than you get in our course at **ONE LOW TUITION!**



These two **FREE** books will show you how!

You get all information by mail... You make your own decision... at home! **NO SALESMAN WILL CALL**

TOP PAY... UNLIMITED OPPORTUNITIES LIFETIME SECURITY CAN BE YOURS!

You are needed in the Television, Radio, and Electronics industry! Trained technicians are in growing demand at excellent pay—in **ALL PHASES**, including Servicing, Manufacturing, Broadcasting and Communications, Automation, Radar, Government Missile Projects.

NATIONAL SCHOOLS SHOP-METHOD HOME TRAINING, with newly added lessons and equipment, trains you in your spare time at home, for these unlimited opportunities, including many technical jobs leading to supervisory positions.

YOU LEARN BY BUILDING EQUIPMENT WITH KITS AND PARTS WE SEND YOU. Your National Schools course includes thorough *Practical* training—**YOU LEARN BY DOING!** We send you complete standard equipment of professional quality for building various experimental and test units. You advance step by step, perform more than 100 experiments, and you build a complete TV set from the ground up, that is yours to keep! A big, new TV picture tube is included at no extra charge.

EARN AS YOU LEARN. We'll show you how to earn extra money right from the start. Many of our students pay for their course—and more—while studying. So can you!

LESSONS AND INSTRUCTION MATERIAL ARE UP-TO-DATE, PRACTICAL, INTERESTING. Every National Schools Shop-Method lesson is made easy to understand by numerous illustrations and diagrams. All instruction material has been developed and tested in our own Resident School Shops, Laboratories and Studios.

SEND FOR INFORMATION TODAY... it can mean the difference between **SUCCESS** and failure for you! Send for your **FREE BOOK** "Your Future in Television-Radio-Electronics" and **FREE Sample Lesson.** Do it **TODAY**, while you are thinking about your future. It doesn't cost you anything to investigate!

GET THE BENEFITS OF OUR OVER 50 YEARS EXPERIENCE

Approved for GI Training



NATIONAL TECHNICAL SCHOOLS
Los Angeles 37, Calif.

YOU GET...

- 19 Big Kits—**YOURS TO KEEP!**
- Friendly Instruction and Guidance
- Job Placement Service
- Unlimited Consultation
- Diploma—Recognized by Industry
- **EVERYTHING YOU NEED FOR SUCCESS!**

SHOP-METHOD HOME TRAINING COVERS ALL PHASES OF INDUSTRY

1. Television, including Color TV
2. Radio AM & FM
3. Electronics for Guided Missiles
4. Sound Recording and Hi-Fidelity
5. FCC License
6. Automation and Computers
7. Radar & Micro-Waves
8. Broadcasting and Communications

RESIDENT TRAINING AT LOS ANGELES

If you wish to take your training in our Resident School at Los Angeles, the world's TV capital, start **NOW** in our big, modern Shops, Labs and Radio-TV Studios. Here you work with latest Electronic equipment... professionally installed... finest, most complete facilities offered by any school. Expert friendly instructors. Personal attention. Graduate Employment Service. Help in finding home near school... and part time job while you learn. Check box in coupon for full information.

NATIONAL TECHNICAL SCHOOLS

WORLD-WIDE TRAINING SINCE 1905

MAIL NOW TO

NATIONAL TECHNICAL SCHOOLS, Dept. R6E-110
4000 S. FIGUEROA ST. LOS ANGELES 37, CALIF.

Rush free TV-Radio "Opportunity" Book and sample lesson. No salesman will call.

NAME _____ AGE _____
ADDRESS _____
CITY _____ ZONE _____ STATE _____

Check if interested **ONLY** in Resident School training at Los Angeles
VETERANS Give date of Discharge _____

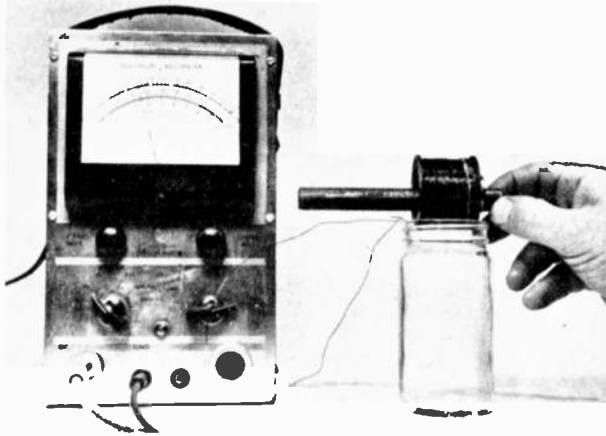

Push a magnet through an iron wound coil, as in photo above, note the voltmeter shows current in opposite direction. If magnet is pushed back and forth twice a second a slow alternating current is generated; needle swings back and forth, too.

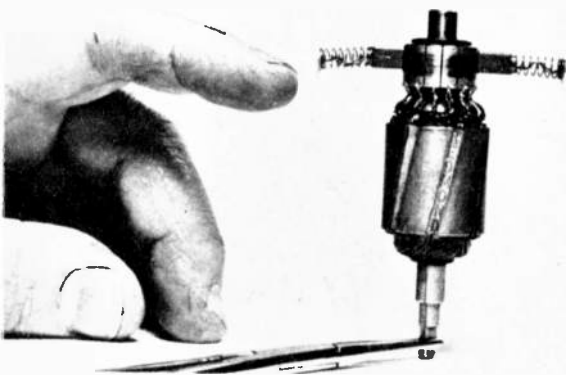

This is a close-up of the armature of a small DC generator. Coils of wire are wound in the angled slots of iron core. These are connected to the parallel copper slugs on the commutator, at top end of shaft. Carbon brushes press against shaft and make contact and contacts on coil at a time. The armature is the rotating member of generator.

In the generator, below, which is partly assembled, the armature is within field coils and commutator end is exposed. Small carbon brushes fit in insulated sleeves in the end of generator case and press in against the segments of the commutator.

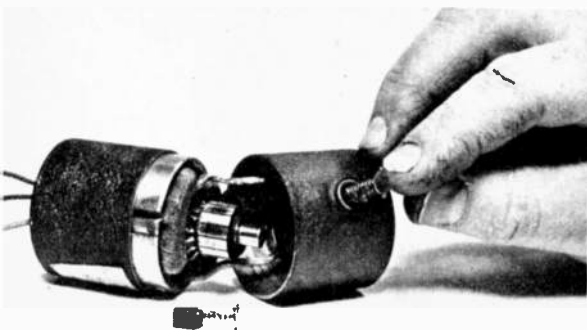

ences are applied, as you will soon see.

Consider magnetic influences. You know what a magnet is. It's a piece of steel, often U-shaped, and it is able to attract and hold pieces of steel and iron (photo page 8). Iron (of which steel is a refined form) is the only common material having strong inherent magnetic properties. Copper, aluminum, zinc and brass are common metals that are completely nonmagnetic. Science knows virtually nothing about magnetism except its external effects.

ELECTROMAGNETIC INDUCTION

Copper in itself is inert to magnetism. However, if a simple steel magnet is moved quickly inside a coil of copper wire whose ends are connected to a sensitive voltmeter, as on page 6 and this page, the meter needle moves sharply in one direction, showing that electricity has been generated; *electricity*, that is, a movement of electrons. When the magnet is drawn out of the coil, as on this page, the voltmeter shows a current flow in the other direction.

If the magnet is held stationary and the coil is moved over it, exactly the same current is generated.

This magnetic induction action is the heart of the entire electric-energy industry, yet to this day no one can explain it in detail. All we can guess is that the invisible external "field" of the magnet somehow disturbs the balance between the protons and the electrons of the copper atoms, and allows some of the electrons to break loose and chase each other around the closed metallic circuit of the coil of wire, the meter and the wires connecting the wire and the meter. The movement of electrons makes the wire alive electrically.

It is important to note two important facts:

1) Electricity is generated (that is, electrons made to move) only as long as the magnet and the wire are in motion relative to each other. The instant this motion stops, the movement of electrons stops, too, and the wire returns to its former condition of balance.

2) Electricity does not actually "flow" out of the wires, as water does from a pipe. The electrons nudge each other through the closed circuits of ordinary appliances, machines, etc., without escaping. They merely circulate and circulate, and their useful outward effects are due only to the energy of their motion. An electric generator can run for a hundred years, and the wire in it will weigh just as much at the end of that period as it did at the beginning. Does this mean that we get something for nothing? Absolutely not. We have only ex-

the experts say
your BEST BUY
 is **EICO**...

EICO, 3300 N. Blvd., L.I.C. 1, N. Y. PE10-60
 Show me HOW TO SAVE 50% on 10 models of top-quality: HI-FI TEST INSTRUMENTS
 "HAM" GEAR. Send FREE Stereo HI-FI Guide. Send FREE Short Course for Novice License. Send FREE Catalog & name of neighborhood EICO dealer.

Name _____
 Address _____
 City _____ Zone _____ State _____

ADD 5% IN THE WEST

...in
STEREO and MONO HI-FI



STEREO Dual Amplifier-Preamp HF81
 Kit \$69.95.
 Wired \$109.95.
 "Excellent" — SATURDAY REVIEW: HI-FI MUSIC AT HOME.



NEW! STEREO-Mono Player/Automatic Changer complete with dual stereo cartridge and "Magnadaptor".
 \$49.75 incl. F.E.T.



FM Tuner HFT90
 Kit \$39.95*.
 Wired \$65.95*.
 Cover \$3.95.
 "One of the best buys" AUDIOCRAFT



STEREO Dual Preamp HF85
 Kit \$39.95.
 Wired \$64.95.
 "Extreme flexibility" — HI-FI REVIEW
 a bargain!



Mono Power Amplifiers (60, 50, 35, 30, 22, 14-Watt; use 2 for Stereo)
 from Kit \$23.50.
 Wired \$41.50.

"Less Cover, Kit \$39.95, F.E.T. incl.

AM Tuner HFT94
 Kit \$39.95. Wired \$65.95, incl. Cover & F.E.T.



STEREO Dual Power Amplifiers: New 100W HF89: Kit \$99.50. Wired \$139.50.
 70W HF87: Kit \$74.95. Wired \$114.95.
 28W HF86: Kit \$43.95. Wired \$74.95



Mono Integrated Amplifiers (50, 30, 20, 12-Watt; use 2 for Stereo)
 from Kit \$34.95.
 Wired \$57.95.



2-Way Bookshelf Speaker System HFS1 complete with factory-built cabinet:
 Kit \$39.95
 Wired \$47.95



NEW! COMPLETE STEREO DUAL AMPLIFIER AF-4
 Kit \$38.95
 Wired \$64.95

TRUE HI-FI quality to drive hi efficiency speakers to concert volume.

...and in
TEST INSTRUMENTS



New Power & Bias Supply for Transistorized Eqpt. #1020*
 Kit \$19.95
 Wired \$27.95
 * Patent Pending



Miniaturized Multi-Signal Tracer #145A
 Kit \$19.95.
 Wired \$28.95.



Vacuum Tube Voltmeter #221
 Kit \$25.95.
 Wired \$39.95.



Peak-to-Peak VTVM #232 & Uni-Probe
 Kit \$29.95.
 Wired \$49.95.



New TUBE & CRT FIL. Tester #612
 Kit \$3.95.
 Wired \$5.95.
 Fast-checks radio/TV tubes, pilot lamps, etc.



1000 Ohms/Volt V.O.M. #536
 Kit \$12.90.
 Wired \$14.90.



5" Push-Pull Scope #425
 Kit \$44.95
 Wired \$79.95.



DC-5 MC Scope #460
 Kit \$79.95.
 Wired \$129.50.

Tube Tester #625
 Kit \$34.95.
 Wired \$49.95.



RF Signal Generator #324
 Kit \$26.95.
 Wired \$39.95.



Series/Parallel R-C Combination Box #1140
 Kit \$13.95. Wired \$19.95
 1350 Combinations!



6V & 12V Battery Eliminator & Charger #1050
 Kit \$29.95. Wired \$38.95.
 Extra-filtered for transistor eqpt. #1060
 Kit \$38.95. Wired \$47.95



R-C Bridge & R-C-L Comparator #950B
 Kit \$19.95.
 Wired \$29.95.

Most EICO dealers offer budget terms.

IN STOCK! Compare, take them home — right "off the shelf" — from 2000 neighborhood dealers. Over 2 MILLION EICO instruments in use throughout the world.

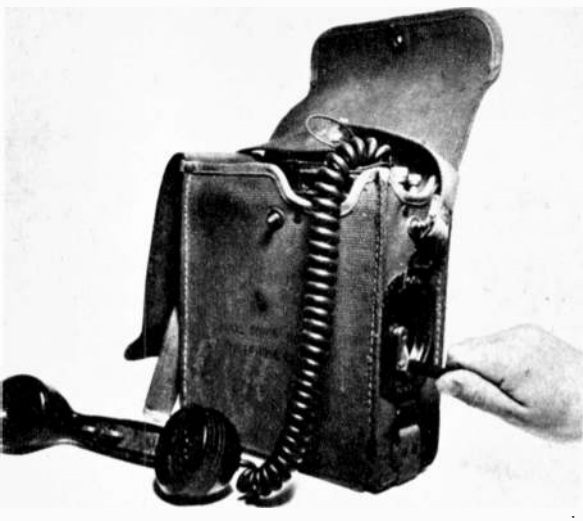

Above is an Army field telephone which has a hand crank which operates a magneto generator. This sends AC over line ringing bell at other end.



Two pennies in a very weak solution of sulphuric acid make simple primary battery. Note that the reading on the meter is only one half of a volt.

changed the mechanical energy of the generator driving force for the electrical energy of the driven electrons.

Magnetism produces electricity in wires. Very oddly, this same electricity produces magnetism in or around the wires themselves, despite the fact that they are not magnetic to begin with. The magnetic field around a straight wire is rather weak, but if the wire is coiled up the field becomes more concentrated. It grows still stronger if the coil is wound on a core of iron. An assembly of this kind is called an electromagnet. It exists in hundreds of forms in devices ranging from doorbells to television sets.

Probably 99.9% of all the electrical energy used in the world is generated by electromagnetic means. In large generators found in central power houses, the primary magnet is actually a large electromagnet energized by an external source of direct current. This rotates inside a series of fixed coils of wire. As the magnetic field sweeps through the latter, it sets up current in them, first in one direction and then in the other, as the rotation continues. This is called alternating current, or AC, because of its periodic reversing.

In automobiles a generator of direct rather than alternating current is needed for battery charging. The primary magnetic source is the outside frame or stator of the machine, made of mild steel that is slightly magnetized. Over it is a winding of wire, called the "field." The rotating member, called the "armature," has wire

on an iron cylinder. The wire consists of a series of individual loops, terminating at diametrically opposite copper slugs on the end of the shaft. These slugs are the "commutator"; against them bears a pair of carbon brushes. The field is connected to the armature, through the brushes. As the generator starts to turn, the armature wires cut through the residual magnetism of the field, and immediately they develop a voltage. Because of the switching action of the commutator, this generated voltage is all in one direction; it is, in effect, direct current. Flowing through the field, this current strengthens the field magnetism, and the generated current in the armature becomes stronger. Various methods are in use for regulating the field excitation so that the current output of the generator stays within prescribed limits.

Some small DC generators use field magnets made of special magnetic alloys, such as Alnico, which produce powerful fields without assistance from the armature. Permanent magnets are also used extensively in hand-cranked AC generators which function as sources of ringing current in country telephone systems and in military phones.

BATTERY SOURCES

Electronic disturbance in atoms is encouraged by many chemical processes. Faint currents can be obtained by immersing pieces of almost any two dissimilar metals in a corrosive solution of some kind.

**Courses in Radio and
Electronic Fundamentals –
TV Servicing – Color TV –
Electronics for
Automation –
Transistors**



RCA Institutes, one of the leading technical institutes in the United States devoted exclusively to electronics, offers the finest training-at-home. The very name "RCA" means dependability, integrity, and scientific advance. Practical work with your very first lesson. Pay as you learn. *No monthly installment payments.* You pay for your next study group only when you order it. Remember, in electronics, the more you know the higher you go! Licensed by the New York State Education Dept.



RCA INSTITUTES, INC.,
A Service of Radio Corporation of America
350 West Fourth Street, New York 14, N. Y.

**The Most Trusted Name
in Electronics**

Resident School Courses in Los Angeles and New York City offer comprehensive training in Television and Electronics. Day and Evening classes. Free Placement Service. Catalog free on request.

SEND FOR THIS FREE 64-PAGE BOOK TODAY!

RCA INSTITUTES, INC., Home Study School Dept. ED-NO
350 West Fourth Street, New York 14, N. Y.

Please rush me your FREE illustrated 64-page book describing your electronic training programs. No obligation. No salesman will call.

Name _____ Age _____
 Address _____ (please print)
 City _____ Zone _____ State _____

Korean Vets: Enter discharge date.
 Canadian:—Take advantage of these same RCA Institutes courses at no additional cost. No postage, no customs, no delay. Send coupon to: RCA Victor Company, Ltd., 5581 Royalmount Ave., Montreal 9, Quebec

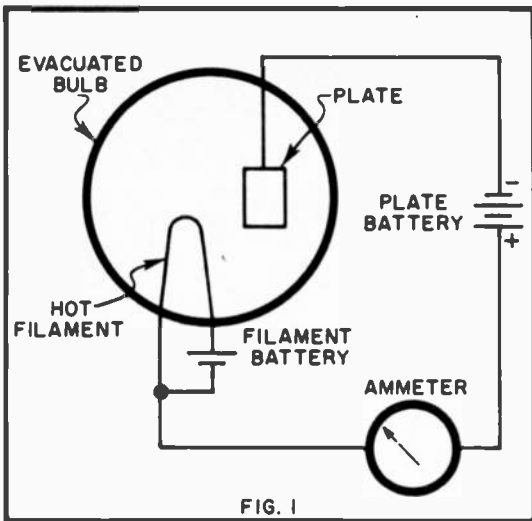

FIG. 1

Shown in the diagram above is a hookup of basic two-element vacuum tube. When the plate current is negative with respect to the filament, the plate current will not flow through the circuit.

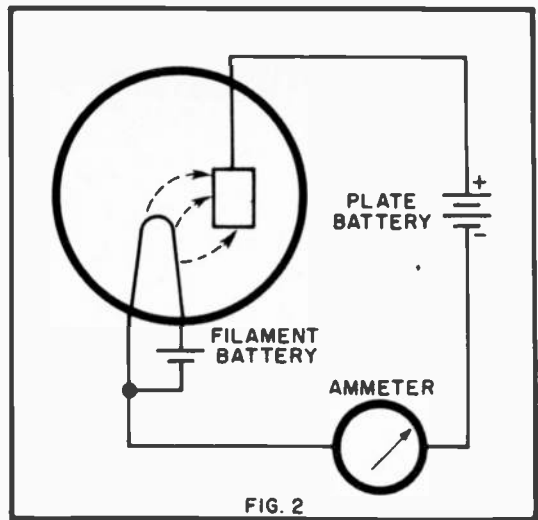

FIG. 2

When the plate of the tube is changed to positive, the ammeter shows that plate current is flowing. This is represented by the electron flow from the filament to plate (note dotted lines and arrows).

This combination constitutes a primary battery. The energy that moves electrons through the connected circuit comes from the disintegration of the chemical themselves. A very real little battery can be made in a few minutes by suspending one copper penny and one zinc penny in a glass of tap water to which have been added two or three drops of sulphuric acid borrowed from a car storage battery. As set up on page 16, this single cell registers a good $\frac{1}{2}$ volt on a meter.

The common "dry batteries" that are sold by the million for use in flashlights, portable radios, etc., are not really dry, but close to it. See page 19. In these batteries, the zinc container is one of the active plates. The other electrode is a thick carbon rod set through the center. The "electrolyte," the chemical that reacts with the plates to liberate electrons from them, is soaked into gauze or paper that lies against the inner surface of the zinc shell. Between the electrolyte and the carbon rod is a cushion of a black substance, called the "depolarizer," whose job is to absorb certain gases that form after periods of prolonged use.

The electrolyte eventually eats its way through the zinc, signalling the end of the battery's life. A side effect may be bloating. Many a good flashlight is ruined because exhausted batteries are left in it.

The car storage battery was mentioned earlier. Actually, there is no such thing as a "storage" battery; more properly, it is a

"secondary" battery. A car battery does not "store" electricity. It uses plates of lead compounds and a sulphuric acid electrolyte. When direct current from an outside source (for example, the DC generator driven by the car's engine) is allowed to flow through it, it "charges"; by this process the character of the lead plates changes and the concentration of the acid is increased. When the charging device is disconnected, the plates and the electrolyte function as a primary battery, and produce heavy current. As the battery is used, the plates change in chemical composition but are not consumed, and the acid becomes diluted. It is now said to be "discharged," and must be put through a charging cycle. In an automobile this is done automatically by a voltage-sensitive regulator. A good battery lasts for years through thousands of charge-and-discharge cycles if the acid level is maintained.

Again we do not obtain something for nothing. The battery is charged by the generator driven by the engine, which must be fed gasoline, which costs money!

OTHER ELECTRONIC "FUELS"

Generators furnish large, steady currents, and batteries give medium, intermittent current. There are other energy fuels of relatively low efficiency that are, nevertheless, both interesting and useful. Light is one of them. Light is considered a form of wave motion in space. Faint as it is, this motion is enough to dislodge electrons

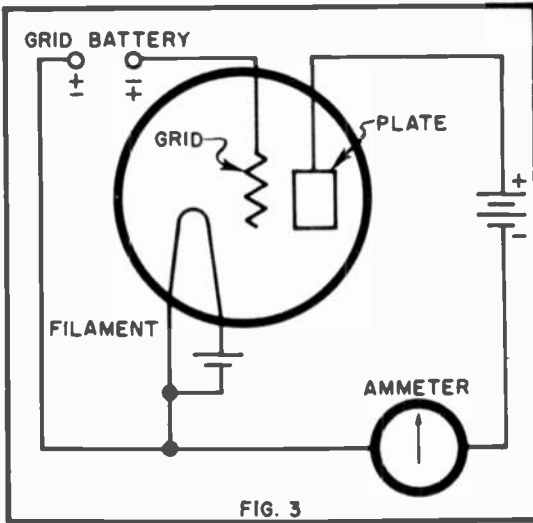

In the three-element vacuum-tube, above, the grid controls plate current when the plate voltage is fixed. Positive grid voltage increases the plate current; negative grid voltage decreases current.

in "photoelectric" materials. A popular plaything for electronic experimenters is the "sun battery," which is nothing more than a small photoelectric cell. It is also used extensively in satellites to power radio transmitters and telemetering equipment and to charge storage batteries that cut into service during periods of darkness. It is illustrated on page 20.

Photo cells make talking movies possible, and they are widely used in exposure meters. Such meters consist merely of a P.E. cell connected to a sensitive meter. Weak light liberates only a few electrons from the cell, so the meter needle moves only a little; strong light makes the needle jump. The meter itself is calibrated in terms of shutter speeds and diaphragm openings.

THERMAL EFFECTS

In physics, heat is commonly defined as the vibratory motion of the molecules, atoms and electrons that constitute matter. Since electricity was previously defined as the movement of electrons shaken out of atoms, it appears that heat might produce electricity. It does, under certain circumstances, but as was the case with light the efficiency is very poor; that is, a lot of heat produces only a little current and then only with a few materials. A heat-sensitive device is called a "thermocouple," and consists usually of strips of two dissimilar metals in close contact.

Thermocouples find application in high-



A number 6 dry cell, cutaway view, is in photo above. Pencil points to center carbon electrode surrounded by depolarizer chemical. On inside of zinc container is cloth soaked with electrolyte.



Pencil points to where the electrolyte has eaten through the zinc shell. This means that the battery is completely exhausted or is very close to being exhausted and will have to be replaced soon.

temperature thermometers and in fire-alarm systems.

Thermocouple action is not to be confused with the electron-emitting filament of the radio tube. Burning white hot, the wire does lose some electrons, but if left alone they tend to cluster closely around the wire and to form a dense negative "space charge." It is only when the plate or the grid of the tube is made very positive that they break out of this cloud and bombard the plate like so many hot rocks.

CONDUCTORS AND NONCONDUCTORS

A material in which electrons circulate freely is called a "conductor," and is said to have a low resistance. A material which is unresponsive electronically is a "non-conductor" or an "insulator," and is said to have very high resistance. In between are materials that are fair to poor conductors. The common metals are generally good conductors, as are liquid chemicals. Inert materials such as wood, paper, glass, cotton, wool and plastics are very good insulators.

Copper is universally used as a conductor because it is ductile, solders easily and has low resistance. With copper assigned the resistivity figure of 1.00, the compara-

tive resistivity of other common metals is as follows:

Silver	94
Brass	3.57
Iron	5.65
Aluminum	1.70
Tin	7.70

The resistance of most metals is not fixed, but increases with rising temperatures. This is surprising in view of thermocouple action, in which some heat liberates some electrons. Possibly the explanation is that enough heat strengthens the hold of the nucleus more than it loosens the electrons. At ordinary temperatures encountered by humans, the increase is not very important, but at high temperatures it becomes significant. As an example, it is interesting to measure the resistance of an ordinary 100-watt lamp, as on page 22. The meter shows this to be 10 ohms. Assume that the lamp is to be used on 110 volts. Applying Ohm's Law, which deals with the relationship of current, voltage, resistance and power in electrical circuits, we find that 10 ohms at 110 volts would pass a current of 11 amperes, which would represent a power of 1210 watts, not a mere 100 watts!

What actually happens is this: When

A photoelectric cell known as a sun battery is so small that when covered by fingers (see photo below), the light is cut off. The battery can produce no electricity and therefore the meter does not read.

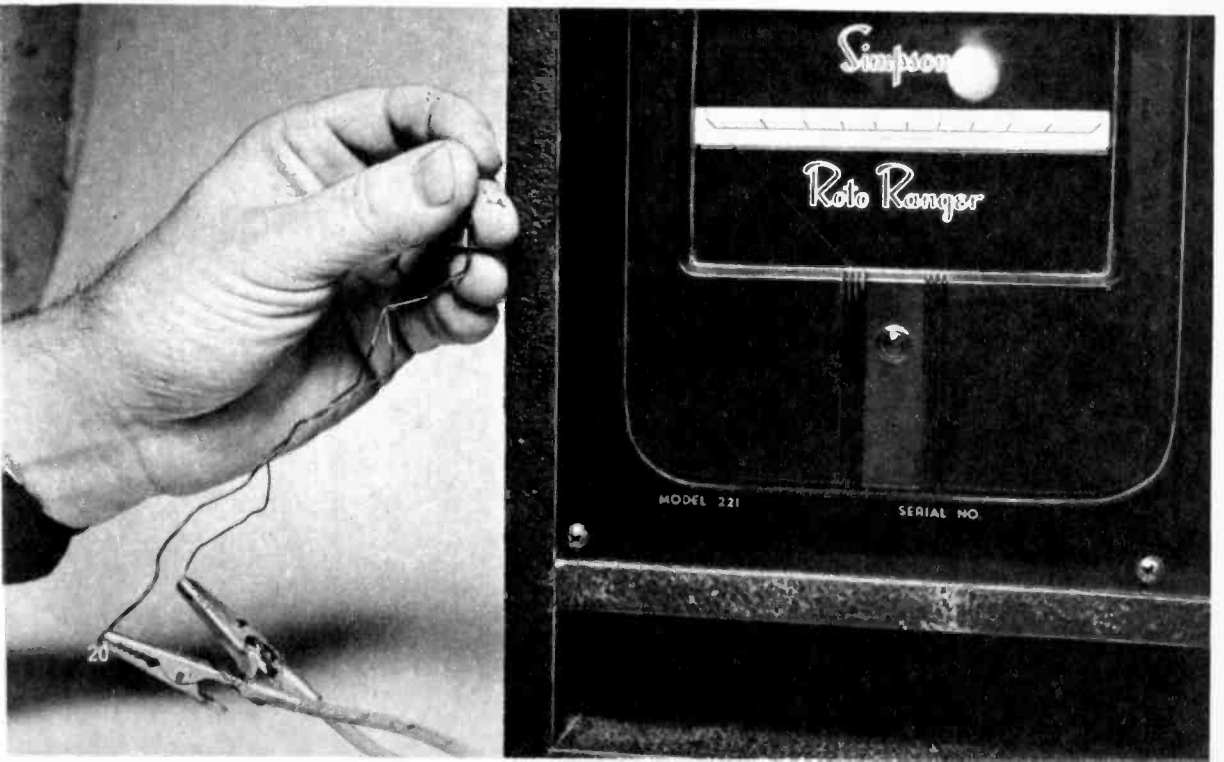

the lamp is turned on, its starting resistance is 10 ohms. The initial rush of electrons is so heavy that there is hardly room for all of them in the thin filament. They rub against each other and against the wire, and the friction heats up the wire. Its resistance goes up, so the current goes down. In a fraction of a second the filament assumes its operating resistance of 121 ohms and it passes its normal current of a little less than one ampere. At this current the filament burns at normal brilliance. If the resistance did not rise from 10 to 121 ohms, the current of 11 amperes would burn out the wire almost instantly.

The friction of electrons in motion through a conductor is very real. If large currents are forced through inadequate conductors, an appreciable amount of energy is consumed just in the pushing process, and this is lost to the appliance or device in use. This wire loss can be figured directly from the resistance of the wire and the current. What makes it so important in electronic equipment is the sad fact that it goes up with the *square* of the current. For example, the power loss in a wire resistance of 2 ohms with a current of 2 amperes is 8 watts, but with a doubled current of 4 amperes the loss rises to 32 watts! This means that more coal or oil

When the photoelectric cell is exposed to photo-flood lamp, it is activated, a current is then produced. The meter reads more than one milli-ampere, if you look carefully at the photo below.



must be burned at the power house to make more steam to keep the turbines turning the generators.

If heat increases wire resistance, does cold decrease it? Yes, if the drop in temperature is very great. The cold apparently loosens the grip of the nucleus on the electrons, and the latter are so cold that they're glad to move around. It has been calculated that at absolute zero temperature a movement of electrons, once started, will continue by itself. This isn't yet free perpetual motion, as getting down to zero is quite an undertaking by itself.

HIGH-VOLTAGE EFFECTS

Voltage is the measure of the pushing effect behind a movement of electrons. When very high voltage is applied to a non-conductor, the pressure of the electrons can strain the insulating material; that is, actually put it under physical stress. If the voltage is high enough or the material thin enough, the latter can readily rupture. Bolts of lightning, which run probably to billions of volts, are known to reduce large trees to toothpicks and to split entire buildings in half.

Air is one of the best of insulating mediums and one of the most difficult to break down, but there are times when it is de-

Widely used by photographer, the exposure meter contains this photoelectric cell which is then connected to an ammeter that is calibrated to read in photographic terms for the photographer.



The resistance of a cold lamp is very low. It is measured by an ohmmeter, right. Resistance value goes up about ten times when filament heats up.

In the ordinary automobile spark plug, thick porcelain insulation is over the center electrode forcing the high voltage from the ignition coil to the bottom tip and across the air gap to grounded arm.



The photograph below shows a chassis view of a typical television receiver. Note that the finger is pointing to the "yoke" which contains both the horizontal deflection and vertical deflection coils.

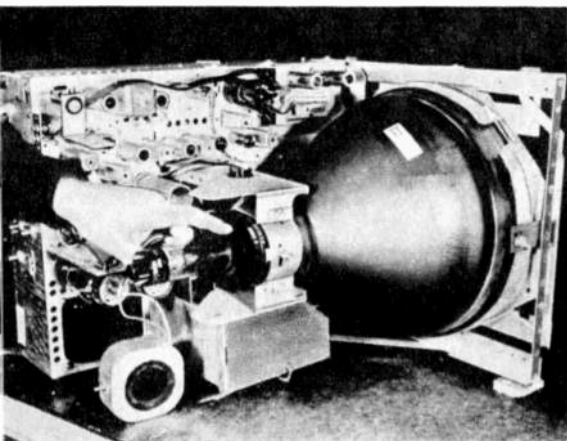

sirable to do so. Prime examples in everyday life are the ignition systems of automobiles and oil-fired furnaces. It takes about 10,000 volts to push electrons across an air gap of slightly less than $\frac{1}{4}$ inch; the breakdown takes the form of a bright, stinging spark, easily capable of igniting the vapor of gasoline or fuel oil. One of the reasons it is important to keep spark plugs in a car clean is that accumulations of dirt on the insulating body can offer far less resistance than the open gap itself and can drain off the high voltage impulses from the ignition coil before they even reach the gap.

At high voltages, electrons sometimes actually burst loose from their conductors without jumping to any nearby object and they join the air immediately surrounding the wires. The act of adding electrons to a gas (or removing some) is called "ionization." Around power lines on clear, dry nights, the effect is clearly visible as a blue haze, called "corona." It is also noticeable in television sets, in the area occupied by the rectifier tube associated with the picture tube. Some fantastically high voltages are encountered in TV circuits; 7000 to 10,000 is common, and values to 20,000 and 25,000 are not hard to find.

CONTROL OF ELECTRON BEAMS

In conventional radio tubes such as the triode of Figure 3 and numerous variations thereof, the only purpose of the positive charge on the plate and the varying positive-negative charge on the grid is to direct electrons to the plate. Charges obtained from batteries or other voltage sources and applied directly to the tube electrodes are

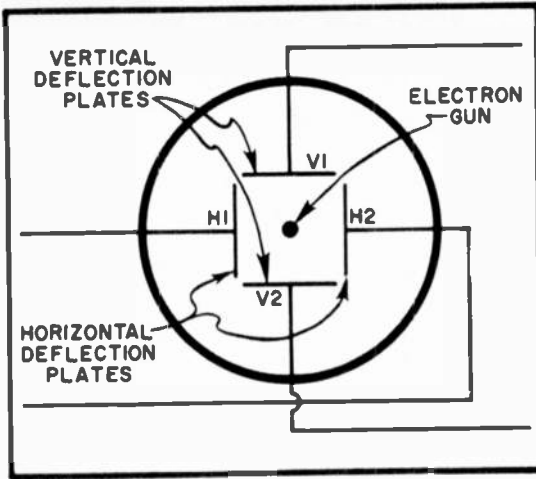

The diagram above is a simplified end view of a basic cathode-ray tube. It shows the right-angle placement of both horizontal and vertical deflection plates and the position of the electron gun.

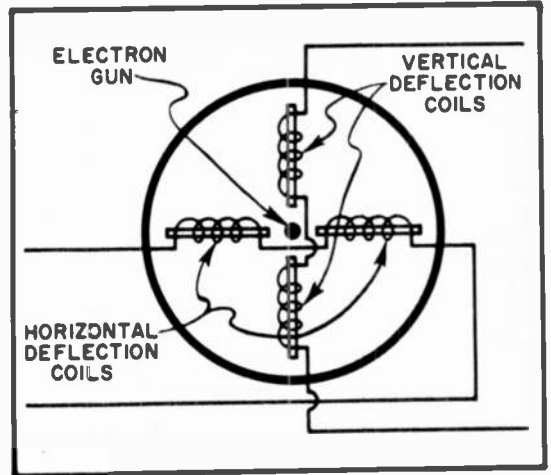

The electromagnetic deflection coils which are shown in this diagram, above, are used with a television picture tube to give the most accurate control that is possible of electron beam.

called "electrostatic" or sometimes simply "electric." Because electrons have very little mass, they respond almost instantaneously to changes in electrostatic charges.

Within a common glass tube or "envelope" there may be a single electron source or "gun" and a number of electrodes of different shapes arranged geometrically so that some of them pull the electrons out of the gun in a straight line while others cause the beam to wiggle somewhat in the manner of water from a spray-type garden nozzle. The most notable application is found in the cathode-ray oscilloscope.

In the C.R. tube the electron gun is in the slender neck of a long, pear-shaped envelope. Near the gun are several open electrodes carrying fairly high voltage charges, whose job is to accelerate and focus a sharp beam of electrons toward the inner surface of the flat or slightly bulging face of the tube. This surface is coated with complex chemicals that glow quickly and brightly when electrons impinge on them. Along the neck of the tube are two sets of metal plates, arranged in an open square, through which the electron beam passes on its way to the chemical screen. If we could look directly through the latter, as in diagrams, we would see only the edges of the plates. The two parallel horizontal members are called the *vertical* deflection plates, and the two parallel vertical members are the *horizontal* deflection plates. These designations are not contradictory.

If the deflection plates have no charges of any kind on them, the sharply focused electron beam hits the center of the screen and causes a tiny, bright dot to appear there. If plate V1 is made positive in rela-

tion to V2, it attracts the negative electrons and makes the spot assume a new position vertically toward V1. The extent of the displacement depends on the actual voltage on V1. If the polarity is reversed and V2 made positive in relation to V1, the spot appears closer to V2.

In exactly the same manner, DC charges applied to H1 and H2 move the dot to the left or right, depending on polarities.

Now, what happens if electrostatic charges are applied to both sets of plates at the same time? The electron beam is the victim of a voltage tug of war. The spot appears off center, depending on the relative voltages on the deflection plates.

If the charges on the plates are alternating and not direct current, the beam dances around nimbly. Instead of producing only a fixed dot, it traces a series of lines.

A curious thing about electrons in motion in a vacuum is that they are influenced just as strongly by magnetic fields as by electric charges. If the flat plates of left diagram are replaced by simple electromagnets, as in right diagram, horizontal and vertical deflection is accomplished in exactly the same manner. Physically, the coils take the form of a double yoke of many turns of fine wire, placed over the neck of the tube on the outside. Glass being a non-magnetic material, it freely passes the magnetic lines of force.

The familiar television picture tube (see page 22) is a cathode-ray oscilloscope tube with powerful magnetic deflection. Some small picture tubes have been made with electrostatic deflection, but for the general requirements of video reception the magnetic method is more flexible. •

Citizens Radio Service Round-Up

Here is a rundown on what's available in this interesting field.

IN SEPTEMBER OF 1958 the Federal Communications Commission issued a seemingly unimportant revision of one of its obscure rules, concerning the Citizens Radio Service, and it thereby touched off the wildest boom in the electronics field since the advent of television. The revision simply made available to the Citizens Radio Service a band of frequencies in the 27-megacycle ("eleven-meter") region previously assigned to ham radio use. What was so exciting about this?

We have to go back a bit to 1947, when the FCC established the Citizens Radio Service on a regular basis. At that time, the only frequencies assigned to it were in the 460-470 megacycle band. Citizens could obtain examination-free licenses just by applying for them, and then engage in personal two-way communication. The catch

Placed on the top of a filing cabinet, at just the right height for use standing up, a citizens band transceiver is a valuable addition to small business office. This is Knight-Kit Model C-11.

was that the 460-mc band was (and still is) very tricky, and that no simple, inexpensive equipment for this frequency was on the market or could be made by individual experimenters. Interesting and alluring as it sounded, "Citizens Band" ("CB") just didn't click. Later, the single frequency of 27.255 mc was allotted for control purposes only, not for two-way communications, and this did prove popular with builders of radio-controlled model airplanes.

CB REQUIREMENTS

The 27-mc band is as different from the 460-mc channel as a bicycle is from a sports car. It had been used by hams for years and its characteristics were well understood. Furthermore, and this is the spark that ignited the boom, it was an extremely simple matter to revamp ham gear to make it meet the FCC's requirements of frequency stability and power limitation in the transmitting end. The transmitter frequency tolerance is .005%, easily obtainable with common quartz crystals costing little. The maximum power is 5 watts, a

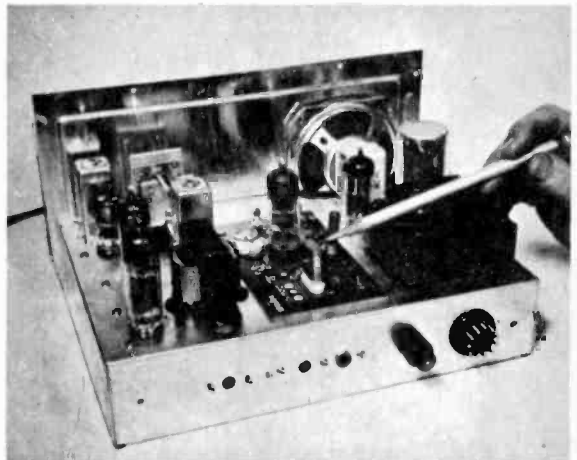

Inside chassis view of the Knight-Kit C-11 citizens band transceiver. Pencil points to frequency-determining plug-in crystal on printed-circuit board. This five-tube unit, no larger than a common table-type radio receiver, is easily assembled from a kit, even by a rank amateur.

very modest value obtainable with inexpensive receiver-type components. This restriction on power proved an advantage rather than a disadvantage, because it automatically made all CB equipment practical for use in cars and boats, on motorcycles and tractors, in airplanes, and in all sorts of vehicles in which a storage battery is the primary source of electrical energy.

Equipment manufacturers, and especially the producers of kits, were quick to recognize the 1958 ruling as a good thing. They hit the market initially with simple "transceivers," which were successful immediately. In a transceiver the same major components are used for both transmitting and receiving, at an obvious saving in cost, space, weight and wiring. The receiver section in the lowest-priced CB units is of the super-regenerative type, which requires no tricky alignment or other adjustment. As construction projects, CB kits are virtually foolproof, and have great appeal to the country's vast army of do-it-yourselfers. The details of a typical transceiver are shown in the accompanying illustrations.

The super-regen circuit has the disadvantage, in relation to the more complicated superheterodyne, of being somewhat broad in tuning and noisy in operation, but for many CB purposes this is not serious.

Within a year of the opening of the 27-mc

band, the FCC received about 65,000 license applications. New ones continue to pile in at the rate of several thousand a month. For a while it took from six to eight weeks to process a "ticket," but this delay is being whittled down rapidly.

CB TOO EASY?

There was and still is some feeling among communications experts that the FCC has made CB radio a little too easy. People who knew absolutely nothing about radio rushed on the air with CB units, and then became indignant when they discovered that this "free" band is indeed free, free to thousands of users all talking at once. In clear and unmistakable language the FCC warned all CB licensees that the service was set up to provide radio communication only on the same basis as a party-line telephone, that interference was to be expected, and that users must exercise patience and cooperation.

In spite of some flagrant abuse of CB, the service is proving of inestimable value in scores of fields. The new band was opened just when the small-boat industry was booming, and of course for marine use a CB unit can be and often is a real saver of lives and property. On the farm, on construction projects, in delivery and repair businesses of many kinds, for personal communication between physicians and their offices, for liaison between sports

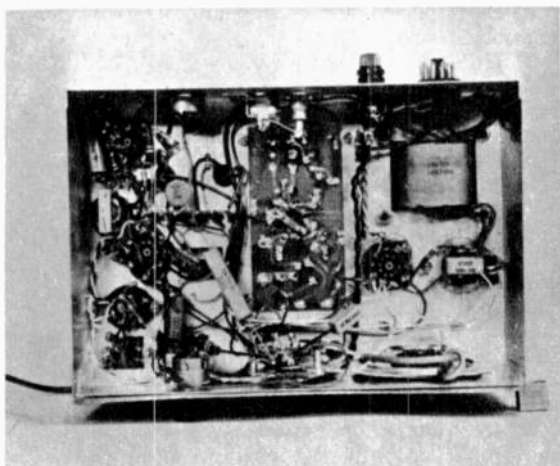

A bottom view of C-11 transceiver, showing all wiring in place. Printed-circuit board, in center, is assembled and soldered separately and then dropped into position in cutout in chassis. Little or no previous experience in electronics is necessary to put this Knight-Kit together.

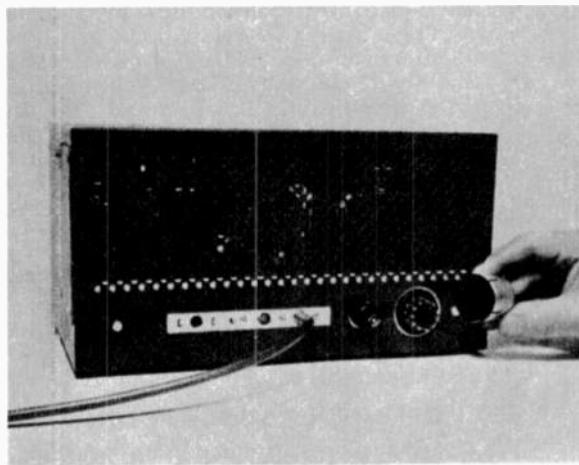

Back view of C-11 transceiver, complete in its case. Antenna lead is running off to left. AC power cord, or connection from battery power supply unit in a vehicle, is fitted to octal plug at right end of chassis. This kit costs \$40: mike, one crystal, AC power supply included.

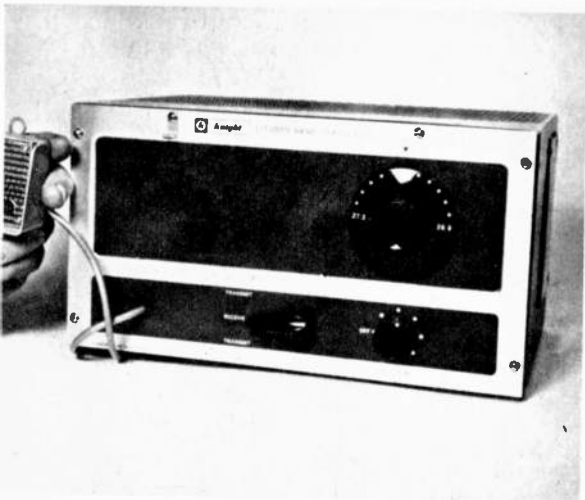

Photo, left, shows simplicity of C-11 transceiver. Single black dial is for receiver tuning, below it is volume control switch. Complete schematic diagram is shown at right. Five tubes do equivalent work of eight. Control switch S1-A-B-C-D is shown in receive position; V-3B and V-4A function as amplifiers of signals from the super-regenerative detector V-3A, and loudspeaker reproduces them. In the transmit position of the switch, V-3B and V-4A act as speech amplifiers for the microphone output, the loudspeaker voice coil is opened and the tapped primary of the output transformer T-2 acts as an auto-transformer to voice-modulate the power amplifier stage V-1B of the transmitter.

parties in the field, for control of road events, for auxiliary police and fire communication . . . direct voice radio communication via the CB is a wonderful thing.

With licenses free for the asking from the FCC and lots of good equipment available at low prices, the Citizens Radio Service was bound to attract some bad actors. The worst offenders, whom the FCC is gradually weeding out, are the morons who are too lazy or too stupid to qualify for regular ham licenses (which are easy enough in themselves) and who use ham lingo and improper ham operating practices in the citizens band. This is very definitely contrary to both the spirit and the wording of the FCC regulations, and lays the offenders open to Federal prosecution. What many CB users do not realize is that while their licenses are free and easy, in accepting them they come under the authority of the FCC as vested in that agency by the Communications Act of 1934. The technical regulation of radio communication has always been an extremely serious matter, not only of national but of international scope, and no one in his right mind will tangle with Federal agents on this score. Continued violations of the rules will result merely in revocation of licenses and loss of all operating privileges.

CB OPERATING SUGGESTIONS

Aside from the "no hamming" warning, which licensed hams themselves strongly endorse, here are some other important "don'ts":

- 1) Don't put a citizens radio transmitter on the air unless you have a message which you need to send.
- 2) Don't "broadcast" music or entertain-

ment of any kind. When some people see a microphone they are overcome with the impulse to emulate Frank Sinatra or Dinah Shore. Artistically, their efforts are often hideous, and legally they put the station owner in jeopardy.

3) Don't sell your services. Your CB station must not be used for hire.

4) Don't use the citizens band in connection with activities which are classified as improper by Federal, state or local laws. A group of "bookies" in one area had their very useful CB licenses taken away when state authorities pointed out that their business was illegal.

5) Don't use the CB as the control circuit in another service.

6) Don't talk to stations other than CB stations. While the 27-mc band is no longer assigned to United States hams, it is still being used by some foreign amateurs. When atmospheric conditions are favorable, signals on this band can sometimes "skip" very long distances, and it is a temptation to call foreigners or to answer calls from them. The whole purpose of limiting CB transmitters to five watts, as against 1,000 watts for licensed ham stations, is to restrict communication to short distances. Local interference is bad enough without the extra burden of unnecessary and illegal ham contacts.

Off-frequency operation is reported as bad by FCC monitoring stations, and citations in large numbers are being issued against the violators. Part of this trouble is probably due to the sale of unsuitable military surplus crystals by unscrupulous dealers. Don't take any crystal unless it comes from a reputable firm and is clearly marked as having a tolerance of .005%.

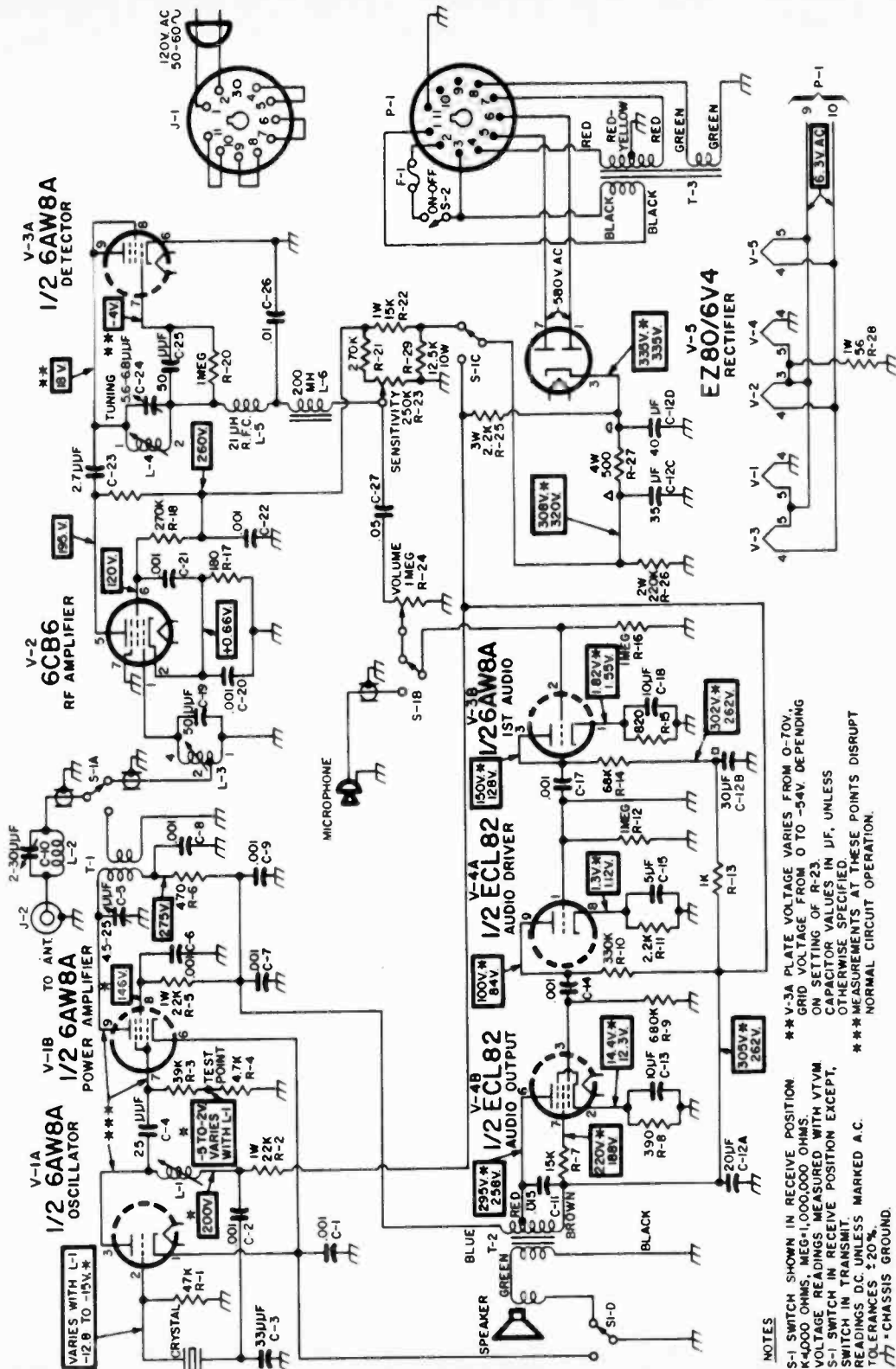

NOTES

S-1 SWITCH SHOWN IN RECEIVE POSITION
 K-4000 OHMS, MEG-1,000,000 OHMS.
 VOLTAGE READINGS MEASURED WITH VTVM
 S-1 SWITCH IN RECEIVE POSITION EXCEPT,
 * SWITCH IN TRANSMIT.
 READINGS D UNLESS MARKED A.C.
 TOLERANCES ±20%.
 /// = CHASSIS GROUND.

CB FREQUENCY ASSIGNMENTS

On the matter of frequency, it might be well to mention here that the citizens band is not merely an open chunk of air space, like a ham channel, but consists of 22 specific frequencies, as follows: (All figures in megacycles).

26.965	27.035	27.115	27.185
26.975	27.055	27.125	27.205
26.985	27.065	27.135	27.215
27.005	27.075	27.155	27.225
27.015	27.085	27.165	
27.025	27.105	27.175	

One little joker in these assignments is the little-suspected existence of many industrial, scientific and particularly medical devices on 27.12 mc. These create weird noises that often make the vicinity of 27.12 mc unusable for CB voice communication.

Most small transceivers are fitted with crystals for a single frequency, which the customer is expected to specify. If he doesn't, the dealer or manufacturer throws in one of what he has the most of! Some of the more advanced units offer a selection of two or several frequencies. As a matter of fact, a CB licensee may use *any* of the 22 frequencies, and switch from one to another as his equipment permits.

For personal communication between a car and the home, a single frequency is adequate. A business firm, on the other hand, might find it expedient to use different frequencies for different purposes. For example, the base station at a construction site might have a four-frequency transmitter and receiver: one for contact with trucks, a second for surveying parties, a third for blasting teams, and the fourth for a supply dump. The field units would work only on their own frequencies, and therefore would not be bothered with conversations that do not concern them.

Some advertisements for CB equipment mention 23 channels. Of these 22 are assigned exclusively for voice radio. The other one is 27.255 mc, for control purposes, as mentioned previously.

REDUCED POWER TRANSMITTERS

The maximum allowable power for the usual CB station, known as Class D in FCC terminology, is five watts. There is nothing to prevent a licensee from using less power if he wants to. Very low-power transceivers, more or less duplicating the appearance of the famous "handie-talkies" of World War II and using transistors and dry batteries, are gradually appearing on the market. They are a trifle on the ex-

pensive side, but they are worth their cost for certain specialized applications.

VERY LOW POWER DEVICES

In some radio catalogs mention is made of radio transmitters for which no FCC license of any kind is required, not even the free-for-the-asking ticket of the citizens service. This equipment is legitimate, but it is intended for very short distance communication. Furthermore, there are two important technical limitations: 1) The power must not exceed 1/10 watt; 2) The antenna must consist of a single element that does not exceed five feet in length. These transmitters are known as "low power communication devices," and are assigned the same frequencies used in the regular Citizens Band service. Pocket-size, battery-operated transistor transmitters of this type are used mostly as "wireless microphones" by entertainers, public speakers, etc. The range is usually short, sometimes as little as a hundred feet, but this is more than enough when a sensitive receiver is employed.

Actually, license-free low-power communication devices are almost as old as broadcasting itself, the once-popular "phonograph oscillator" being the prime example. This is permitted to operate in the regular AM band, so that its signals can be picked up by a regular broadcast receiver and reproduced by the latter as home-brewed phonograph music. Kits for such "home broadcasters" are still sold.



Knight-Kit Model C-27, more advanced unit, uses highly sensitive and selective superheterodyne receiving circuits. Latter has "squench" feature, which keeps loudspeaker quiet during standby periods, yet permits incoming signals to be heard instantly. Equipment functions like an intercom.

They must be used with great care to prevent signals from appearing as unwanted programs in someone else's receiver.

ON-THE-AIR PROCEDURE

Accustomed to the effortless operation of the conventional telephone, users of CB equipment find radiotelephony a bit awkward at first. The main control they must master is the press-to-talk or push-to-talk switch, which is located either on the front panel of the set or on the hand microphone. This switch is spring-loaded in such a manner that the equipment is in the receive position when it is left alone. When you want to transmit, you hold down the handle or button.

To let the person at the other end know that you are finished and that you expect him to reply, it is advisable to use a definite ending signal. In military, aeronautical, commercial and ham practice the word "Over" is pretty much standard.

When you are finished with your message and will not transmit again, at least for the time being, end by saying "Out." This is very important on the busy, shared frequencies of the CB, as other people may be waiting for you to get off.

The serial number appearing on the license is your call sign or identity on the air. The FCC regulations require you to use it at the beginning and the end of communication, and at least once every ten minutes if a transmission lasts more than ten minutes which is most unlikely.

PHONETIC ALPHABETS

Because it is often difficult to distinguish sound-alike letters through noise and interference, it is common practice in radiotelephony to use a phonetic alphabet. Here are three; take your pick:

Letter	Old Military	New Aero	ARRL
A	Able	Alfa	Adam
B	Baker	Bravo	Baker
C	Charlie	Cocoa	Charlie
D	Dog	Delta	David
E	Easy	Echo	Edward
F	Fox	Foxtrot	Frank
G	George	Golf	George
H	How	Hotel	Henry
I	Item	India	Ida
J	Jig	Juliet	John
K	King	Kilo	King
L	Love	Lima	Lewis
M	Mike	Metro	Mary
N	Nan	Nectar	Nancy
O	Oboe	Oscar	Otto
P	Peter	Papa	Peter
Q	Queen	Quebec	Queen
R	Roger	Romeo	Robert
S	Sugar	Sierra	Susan
T	Tare	Tango	Thomas
U	Uncle	Union	Union
V	Victor	Victor	Victor
W	William	Whiskey	William
X	Xray	Extra	Xray
Y	Yoke	Yankee	Young
Z	Zebra	Zulu	Zebra

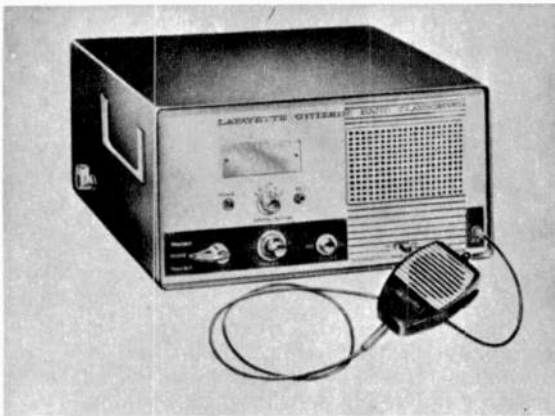

This Lafayette Citizens Band Transceiver offers five crystal-controlled transmitting frequencies at the flip of the center switch. Receiver section is of superhet type, with 3 watts audio output. Coax output connector at left end of cabinet. Model HE-15; about \$60 (one crystal), extras at \$3.

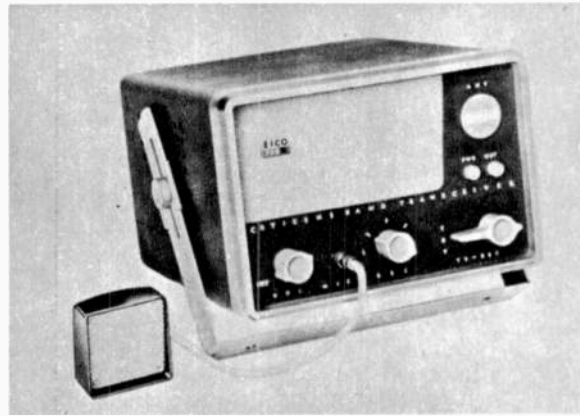

Available in kit and factory-assembled form, the Eico transceiver comprises tunable superheterodyne receiver section and single-channel, crystal-controlled transmitter section. Loudspeaker is built in; crystal-type microphone plugs into the front panel. More information available from Eico.

C. B. Converter for Your Car Radio

Party-line snooping (human interest at its best) is now available to you with the simple installation of the converter shown here.

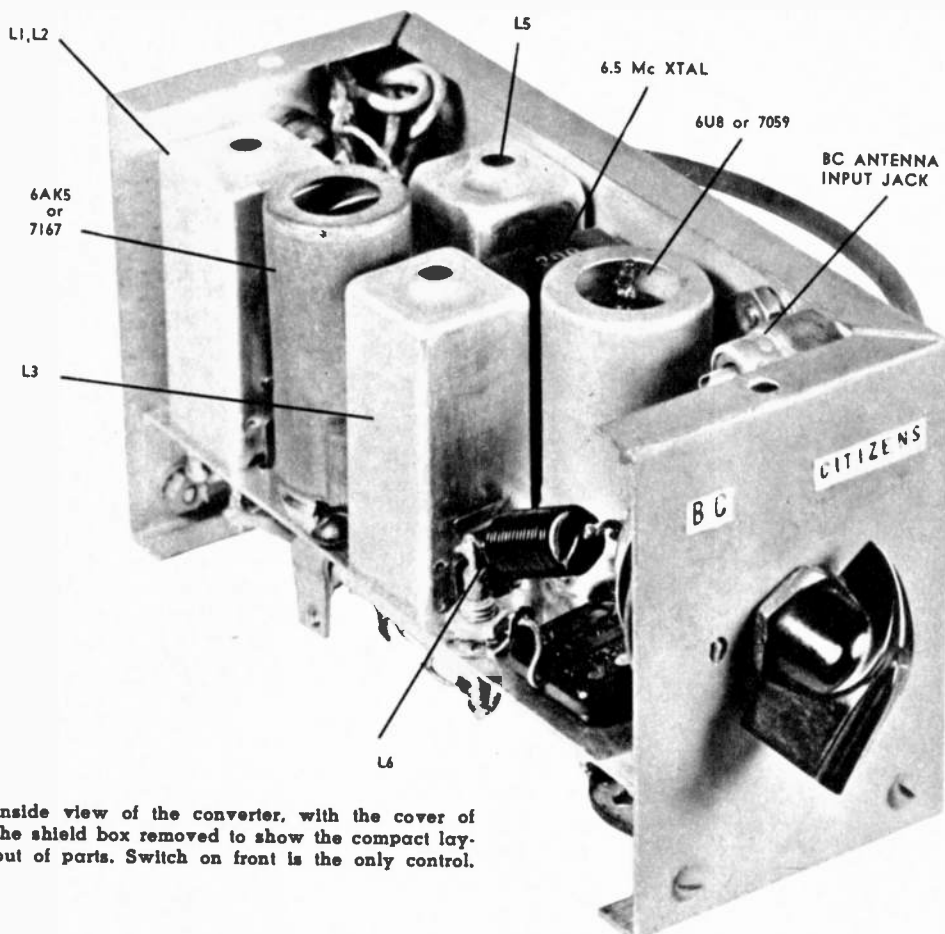

Inside view of the converter, with the cover of the shield box removed to show the compact layout of parts. Switch on front is the only control.

THE CONCEPT of using a converter ahead of a standard broadcast receiver for short-wave reception is not new; nor are the advantages to be gained, such as adaptation of existing equipment with little or no modification. With the opening of the "11-meter band" for "citizens radio communication," an 11-meter converter for automobile broadcast receivers would be a desirable and inexpensive approach to obtaining mobile citizens band receiver.

The converter described herein was originally designed for mobile use on 10-meters, where it proved to be exceptionally stable and sensitive. Its modification for 11-meter service is a natural adaptation of the circuit. The only changes required are insertion of a different crystal and retuning the coils. There is no significant change in performance in making these slight modifications on the original model.

This unit was designed by W. K. Boots, a field engineer in the Receiving Tube Operations Department, of Sylvania Electric Products, Inc., Emporium, Penna., and was described by him in a recent issue of the Technical Section of the firm's "Sylvania News."

In operation, the converter itself does not require adjustment. Station selection is accomplished by tuning the broadcast receiver dial, thus permitting push-button channel selection with receivers so equipped. A 6500 kc crystal provides direct logging on the broadcast band, i.e., 26.965 Mc tunes at 965 on the dial, etc. This method differs slightly from conventional superheterodyne systems in that the intermediate frequency (broadcast band) is variable; however, it retains the image rejection features of double conversion.

The circuit is conventional in that it uses a 6AK5 for the broad-band RF amplifier and a 6U8 for the oscillator-mixer. The oscillator employs a quartz crystal which is operated on the fundamental frequency to provide good frequency stability. The fourth harmonic of the crystal frequency is resonated in the 6U8 triode section plate circuit. Oscillator signal injection to the mixer grid is automatically provided by the built-in tube-lead and socket capacitances between the triode section plate and the adjacent 6U8 pentode section control grid. A satisfactory 6500 kc crystal, mounted in an FT-243 or smaller holder, may be obtained from various crystal suppliers or on the surplus market.

If so desired, the types 7167 and 7059, which have 12-volt heaters and are designed for dependable heater operation in mobile communication equipment, can be used in place of the 6AK5 and 6U8. Also, the plate and screen voltages may be obtained from the receiver power supply, provided it will accommodate the additional load, or an auxiliary pack capable of delivering 125 volts at 15 to 20 milliamperes.

The strong-signal handling capabilities of such a converter could be improved by adding AVC bias to the RF stage. Since this necessitates digging into the receiver wiring, this feature is generally not included for a "connect-on" converter. However, a manual "local-distance" switch, S_2 is incorporated in the converter.

Construction of the converter is not critical. Considerable leeway is permissible in the parts layout, as well as in the choice of components. The unit is housed in a Bud Minibox, measuring 2x3x5 inches, which was modified to include a shelf. The com-

Under view: the various capacitors and resistors are connected directly by their own pigtail leads.

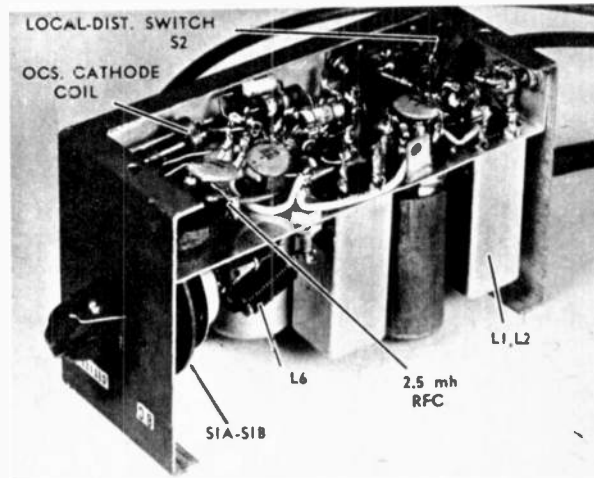

ponent placement shown in the photographs proved to be desirable especially from the standpoint of wiring ease.

The RF, mixer and oscillator coil forms, L_2 , L_3 and L_5 , complete with shield cans were salvaged from an old 40 mc television IF strip and easily modified for 27 mc operation according to the following:

Coil Data

- L_1 , L_2 , L_3 , L_5 — $\frac{5}{8}$ " diam. slug-tuned shielded forms
- L_1 —3 turns #20 e close-spaced, wound over grounded end of L_2
- L_2 , L_3 , L_5 —20 turns #30 e close-spaced
- L_4 —20 turns #28 e close-spaced on $\frac{1}{4}$ " diam.
- L_6 —10 turns #20 e close-spaced on $\frac{1}{4}$ " diam.

The builder can minimize undesirable stray coupling and thereby insure foolproof operation by adhering to standard wiring methods; i.e., use short leads and common grounds for each stage.

Alignment of the converter is straightforward. The oscillator plate circuit, L_5 , is tuned for maximum signal injection (4th harmonic of the crystal) to the mixer grid. A VTVM is helpful for this adjustment; a reading of approximately two volts dc developed at the mixer grid is adequate for good performance. Other methods will also serve, such as adjusting the triode plate inductance, L_4 , for maximum indication on the S-meter of a communications receiver,

Wiring of citizens band converter is quite simple. Separate CB antenna is connected permanently to L1, upper left corner. Regular car antenna goes to "BC INPUT," upper right corner. When switch section S1A connects the converter to the "RCVR ANT. INPUT," section S1B (p. 27) also turns on the heater supply.

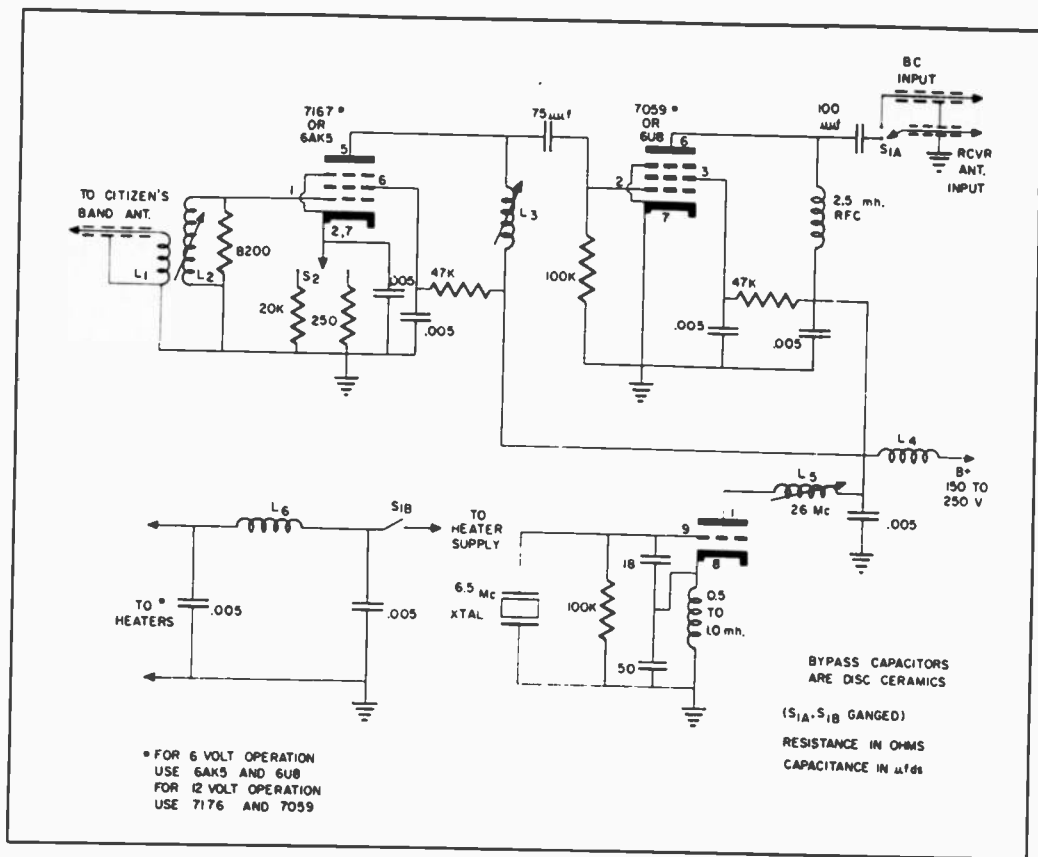

or absorption-type wavemeter tuned to the fourth harmonic of the crystal.

With the converter output coupled to the antenna input of a broadcast receiver, optimum tuning for the mixer grid circuit can most readily be accomplished with the aid of a signal generator. Simply connect the signal generator output to the converter antenna input and set the dial to about 27 megacycles. Keep in mind that the broadcast receiver must be tuned to about 1000 kilocycles in order to receive the 27 mc signal with a 6500 kc crystal in the converter. Adjust the mixer grid inductance, L_4 , for maximum output from the broadcast receiver, using as weak a signal from the signal generator as practicable. This is necessary for proper alignment of the mixer free from "flattening" effects caused by AVC action in the receiver. The RF stage tuning is not critical since it is purposely broad-banded.

It is recommended that the antenna input transformer, L_3 , be adjusted for maximum performance with the converter connected to the antenna system with which it will be used. "On-the-air" signals serve well for this adjustment; tuning for maximum noise can also provide satisfactory performance.

While the converter described is intended primarily for use with automotive broadcast receivers, it will perform equally as well in fixed installations with "any" broadcast receiver. It should be noted, however, that full use of its preselection capabilities cannot be achieved unless adequate receiver input shielding is employed. While an auto radio meets this requirement, home radios may not. If the home radio with which the converter is to be used employs a loop antenna, a switch must be provided to disconnect the loop when the converter is in use. •

Storage Battery Flashlight

Latest engineering feat is
lifetime use from your batteries.

THERE'S A BRIGHT future ahead for the good old family flashlight, the one kept in a dresser drawer, on a hook next to the furnace or in the glove compartment of the car. The Sonotone Corporation, of Elmsford, N. Y., which is well known for its hearing aids, has developed a unique flashlight battery that can be recharged overnight and that will outlast hundreds of ordinary dry cells.

Physically, this new battery is exactly the size of two standard "D" cells. Electrically, it is quite different from the lead-and-acid batteries of automobiles; it is of the sintered-plate, nickle-cadmium type, and is completely sealed. ("Sintering" is a process of producing a coherent, solid mass by heating but without melting the ingredients.) In the same case with the battery proper is a permanently-connected rectifier-charger. When the battery is exhausted, the cap is removed, and the cartridge is plugged into 115-volt AC outlet.

This 2½-volt power pack has some interesting and unusual characteristics. If exhausted, it can be left that way indefinitely without deteriorating, yet it can be brought back to full vigor with an overnight charge. If left on charge accidentally for longer periods, even for months, it suffers no damage! It is unaffected by any temperatures encountered normally by

To restore exhausted battery, simply plug into 115-volt outlet and allow to charge up overnight.



Battery cap unscrews to reveal two power-outlet prongs which are part of the charging circuit.

man; it can be charged and discharged in cold down to 40 degrees below zero and in heat up to 160 degrees. The voltage remains constant for over 90% of the useful discharge period.

Actually, this sealed battery was developed originally for use in space satellites, to provide a reliable source of energy for various electronic sensing devices. The flashlight version is perhaps the most spectacular consumer application. Sonotone makes a total of twelve different sizes, ranging from a button only ¾ inch in diameter and ¼ inch thick to a half-pound cylinder 3½ by 1¾ inches. •

This rechargeable battery will fit into any of the flashlights that take two standard "D" cells.



Simple Power Transistor Circuits

Experimenters will find these practical arrangements very interesting.

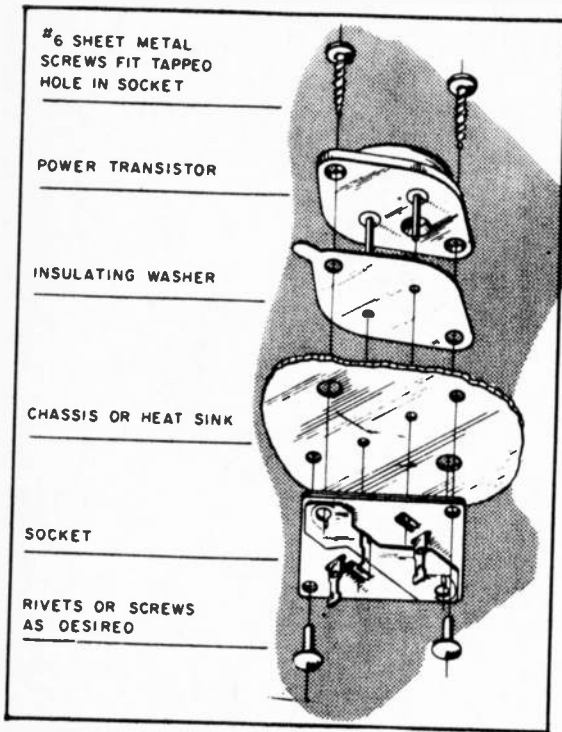

FIG. 1

POWER TRANSISTOR. Costing only \$1.35, the Motorola 2N554 power transistor is an ideal plaything for the electronic experimenter who wants to familiarize himself with modern transistor circuitry. Here are some practical arrangements worked out by Motorola engineers. Since these are all audio-frequency or control circuits, physical placement of components is not critical, and "breadboard" type assembly is entirely satisfactory.

The 2N554 is rated at 10 watts collector dissipation, with a maximum collector current of 3 amperes. Means for getting rid of the heat is essential. This is generally obtained by bolting the base of the transistor to a metal chassis, metal cabinet, or a plain piece of metal. Parallel connected transistors can be mounted on the same metal member, provided an area of about 5 square inches is allowed for each. Avoid enclosing power transistors in small boxes; if this type of construction is desirable for reasons of physical protection, provide plenty of ventilation.

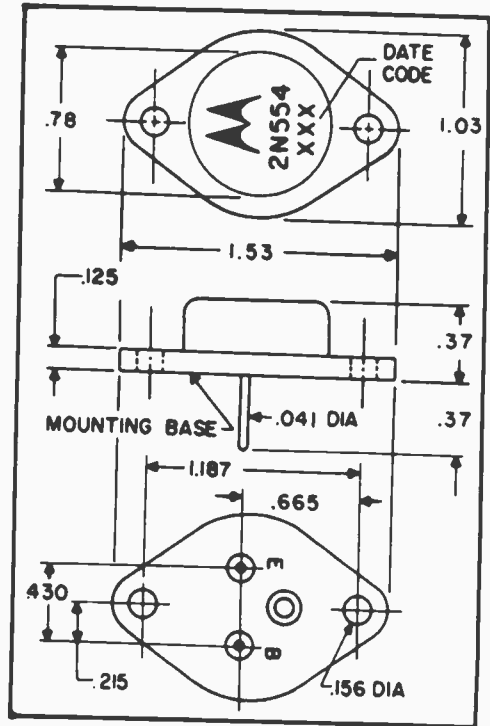

FIG. 2

The recommended method of mounting the 2N554 to obtain the maximum heat protection is shown in Fig. 1. The dimensional details of the 2N554 are shown in Fig. 2. This transistor is much larger than the pea-sized ones used for radio-frequency purposes. "E" is the emitter lug, and "B" is the base lug. The metal case of the unit is the collector connection.

Remember that the collector element of the 2N554 is connected to the case. This means that in some applications the latter must be insulated from the metal chassis by insulating washers.

For detailed characteristics of the 2N554, see chart.

Push-Pull Audio Amplifier, Class AB. This amplifier is capable of a power output of 5 watts with 10% or less total distortion. (See Fig. 3.) The power gain is approximately 20 db, and the current required from the power source varies from approximately 200 milliamperes at no signal, to about 1 ampere at full signal input. Typical use is in portable record players.

MAXIMUM RATINGS

Collector Current	5 amps
Collector Dissipation at 80°C mtg. base temp. Derate 1.0 watt/°C rise	10 watts
Collector Junction Temperature	90°C

ELECTRICAL CHARACTERISTICS, TYPICAL

General	
Collector Cutoff Current, I_{cbo} $V_{cb} = -2V$	50 μA
Emitter Cutoff Current, I_{ebo} $V_{eb} = -10V$	40 μA
Collector Saturation Voltage, $V_{ce(sat)}$ $I_c = 3A, I_e = 300mA$	0.6 volts
Collector Breakdown Voltage, V_{ce} $I_c = 100mA, I_e = 0$	43 volts

ELECTRICAL CHARACTERISTICS

Common Emitter	Min.	Typ.	Unit
Power Gain ($\pm 0.5db$), $P_o = 2$ watts, G_r $V_{ce} = -12V, I_c = -0.5A, f_c = 1kc$ $R_s = 10$ ohms, $R_L = 26.6$ ohms	20	34	db
Total Harmonic Distortion under same conditions at power gain	-	7	%
Beta Cutoff Frequency, F_{β} $V_{ce} = -12V, I_c = 0.5A, f_c = 1kc$	-	8	kc
Small Signal Forward Current Gain, h_{fe} $V_{ce} = -12V, I_c = 0.5A, f_c = 1kc$	-	30	-
Small Signal Input Impedance h_{ie} $V_{ce} = -12V, I_c = 0.5A, f_c = 1kc$	-	12	ohms

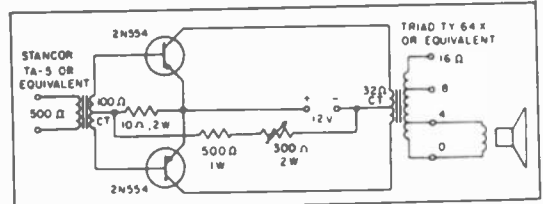

FIG. 3

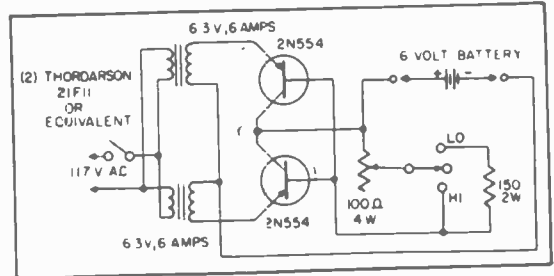

FIG. 4A

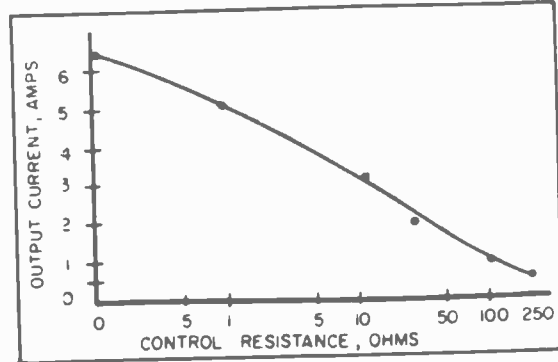

FIG. 4B

De Luxe Battery Charger or Model Power Supply. This circuit (see Figures 4A and 4B) provides a full-wave rectifier utilizing 2N554 transistors with a base current control resistor which smoothly varies the output power over wide ranges of current and voltage. Into low-impedance loads, such as storage batteries undergoing charge, the current may be varied from 1/2 ampere or less as a "trickle" charge to 6 amperes for faster charging. Higher voltages may be obtained with larger voltage output transformers, and higher currents by using two or more 2N554's in parallel on each side of the center tap.

In Fig. 4A, two separate transformers of the filament lighting type are connected to act as a single unit with center-tapped secondary. In Fig. 4B, the curve shows the smooth variation of output current exercised by the 100-ohm variable resistor in the output circuit of the charger.

Filtering of the rectified output current is not needed for battery charging. For other purposes, where smooth DC is re-

quired, use a 1,000 mf capacitor, rated between 12 and 50 volts, across the output. This sounds like a big unit, but because of its low voltage rating, it is quite small and costs only about \$1.50.

Realistic Control of Model Electric Trains. Very realistic starting, coasting and braking effects are obtained in a model train system by the automatic R-C time delay control consisting of the 150 mf capacitor and the various resistors. (See Fig. 5.) The voltage applied to the track will change smoothly between any of the switch positions. When entering "stop" position, No. 7 on the switch, the train makes a coasting stop. Faster braking is given by positions 8 and 9. Resistors R1, R2 and R3 can be changed to produce different braking speeds. Power supply should be well filtered; addition of C1 is recommended.

Direct Current to Direct Current Converter. Obtaining high voltage for the operation of mobile receivers and transmitters in cars, boats, etc., has long been a problem. Dynamotors are heavy and rela-

tively inefficient, vibrators short-lived and unreliable. An entirely different technique, using transistors, produces simple, reliable, lightweight units. As in this circuit (see Fig. 6), the transistors function as oscillators at a low audio frequency; their output voltage, stepped up by a transformer, is rectified in a bridge circuit. Very little filtering is needed.

Current in and out are as follows:

Input			Output		
Volts	Amps	Watts	Volt	Amps	Watts
6	1.5	9	125	.06	7.5
12	1.5	18	250	.06	15

The conversion efficiency is 83%, far better than that possible with older methods.

Some of the transformers made for circuits of this type may be phased wrong. If

oscillation is not obtained immediately, reverse the base leads marked B1, B2. The 1N1566's are Motorola high-voltage silicon diode rectifiers. Good heat sinking of the transistors is important because of the power they handle.

Regulated Power Supply With Low Ripple. This supply will deliver a continuously variable output voltage at currents up to 4 amperes. (See Fig. 7B.) Maximum available output voltage is dependent on VR, the voltage reference for the supply. Motorola engineers recommend that VR be either a 12- or 13-volt zener diode. This is preferable to a battery because it will not require replacement.

The AC ripple on the output will vary from 10 to 80 milliamperes, depending on the load. However, a factor of 3 reduction in ripple can be obtained by including C2,

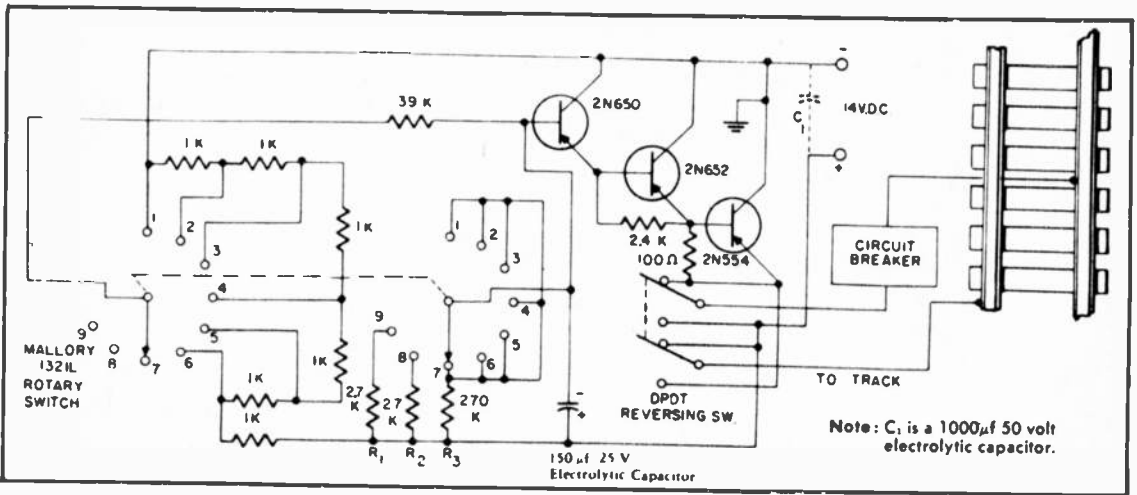

FIG. 5

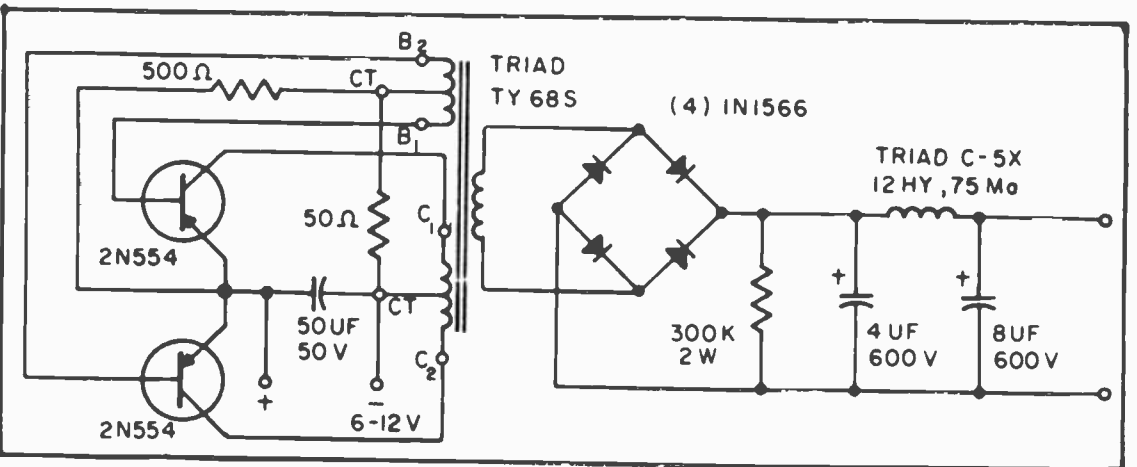

FIG. 6

a 500 mf, 25-volt capacitor, (dotted lines).

The circuit is called an "emitter follower regulator," in which Q3 and Q4 act as a variable resistor in series with the load. The internal impedance of the regulator is approximately $\frac{1}{2}$ ohm. A regulation curve is shown. (See Fig. 7A.) Note how little the voltage changes from no load to full load. The transistors Q3 and Q4 need especially good heat sinks, as they dissipate up to 60 watts. Q1 and Q2 dissipate about 1 watt each, need smaller sinks.

Toy Electronic Organ Makes Music. In this circuit (see Fig. 8), a simple audio oscillator, using a 2N653 transistor, is tuned over one octave of the musical scale from Middle C by fixed capacitors thrown in by simple key switches. Bass switch lowers scale about an octave. Battery can consist of five flashlight cells, in "C" or "D" size. •

FIG. 7A

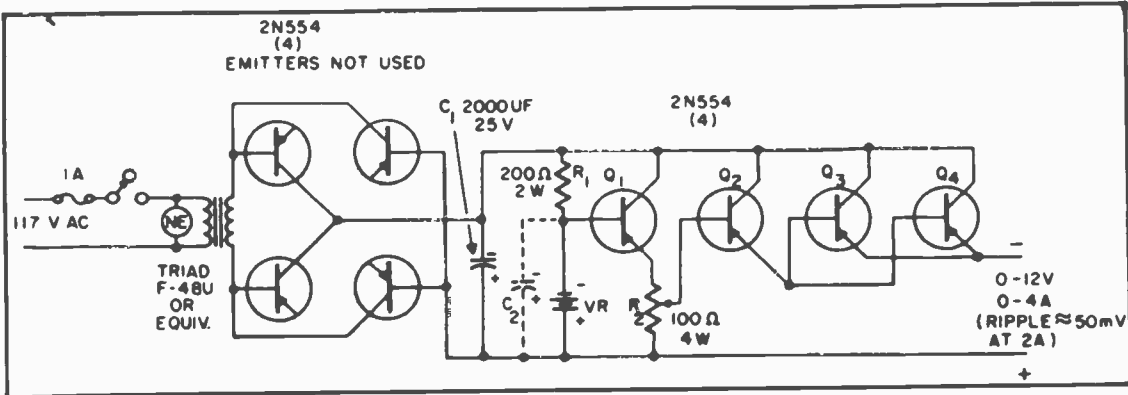
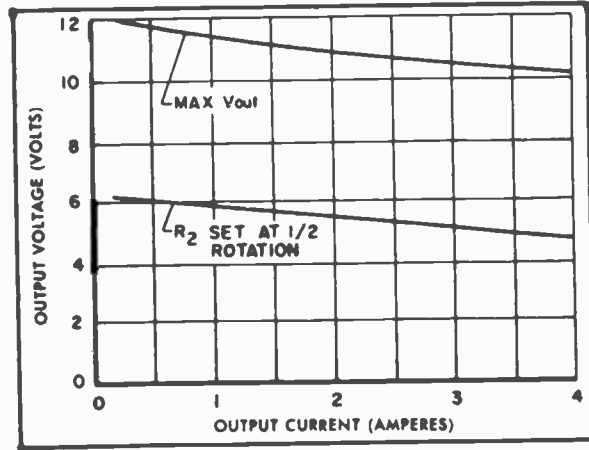

FIG. 7B

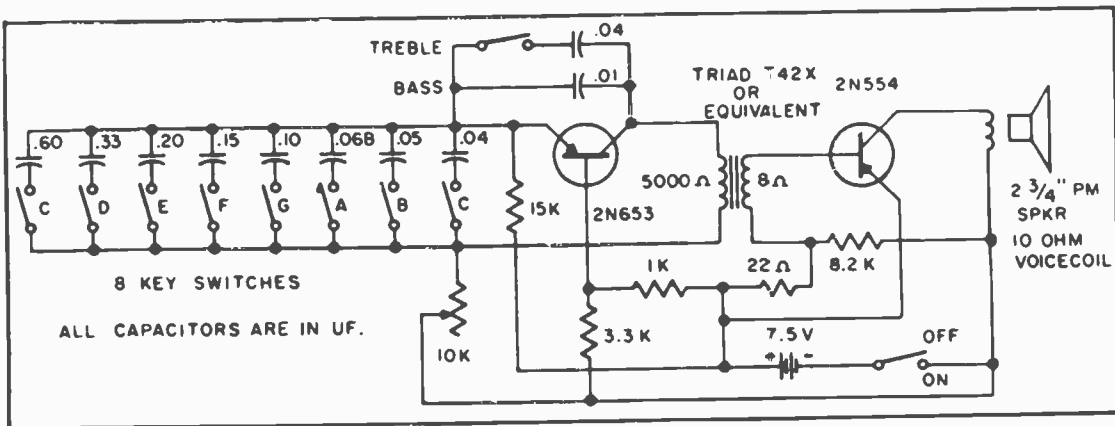
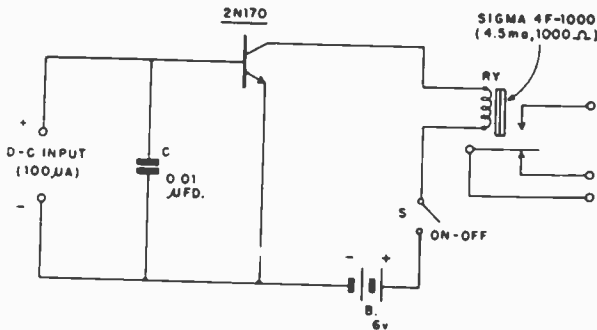

FIG. 8

Transistorized Relay Circuits

Engineering Department, Aerovox Corporation

Transistors have removed many of the problems of relay sensitizing. Their requirements are small, have long life, need simple circuitry.



D-C CIRCUIT WITH MILLIAMPERE RELAY

FIGURE 1

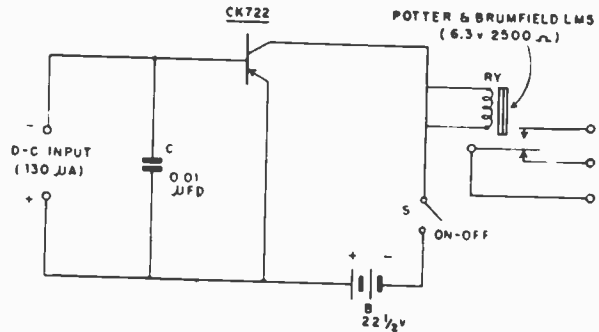

D-C CIRCUIT WITH "PLATE CIRCUIT" RELAY

FIGURE 2

SENSITIVE DC relays which operate on control currents of a few microamperes usually are of the D'Arsonval (rotating-coil, meter-movement) type. Their construction is similar to that of a microammeter. They are high-priced, often delicate, and sometimes depend upon a permanent-magnetic stationary contact to pull the moving contact "home," thus making a reset operation necessary to open the contacts. Formerly, the only way to sensitize a more rugged, less expensive relay so that it could be operated on tiny currents was to precede it with a tube-type DC amplifier. But this necessitated a power supply for plate and filament voltages, and the resulting standby-current (and power) requirement had to be taken into account. Furthermore, the reliability of such a combination is poor because of tube and power failures. Battery power could not be employed economically.

The transistor has removed many of the problems of relay sensitizing. Since the transistor basically is a current amplifier, it is readily applied to DC relay circuits. Its standby power requirements are negligible and it can be operated economically from a single, small, inexpensive battery. Its life is unlimited, its circuitry simple, it is ready

for fast operation (requiring no warmup whatever), and the amplifiers in which it is used may be made small and compact.

This article describes a number of circuits for transistorized relays which have been tested by Aerovox engineers. Complete operating data are given so that the reader can set up any one of the circuits at will. These arrangements do not exhaust the possibilities but are typical of certain classes of applications. In addition to being useful, as shown, they will suggest other modes of use.

DC RELAY CIRCUITS

Figures 1 to 6 illustrate basic amplifier-type DC relay circuits. In each of these arrangements, direct current amplification is provided by a transistorized circuit ahead of the mechanical relay. (Figure 6 dispenses with the relay.) The variety of circuits given will enable the designer or technician to select the one best suited to an individual application. The common-emitter configuration is employed in each instance, for maximum current gain. The specified operating current and input resistance will vary somewhat with individual transistors.

Figure 1 shows a simple, single-transis-

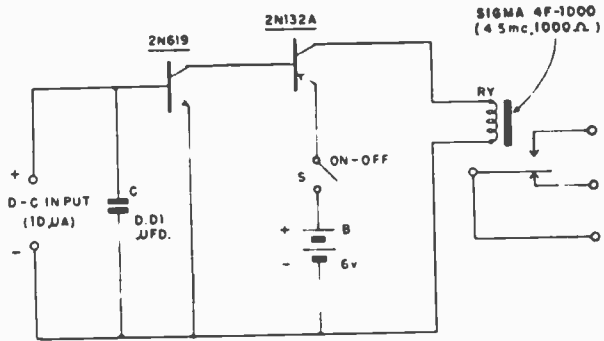

ULTRA-SENSITIVE D-C CIRCUIT
FIGURE 3

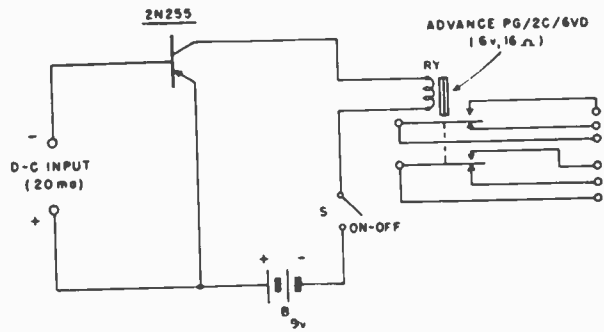

D-C POWER TRANSISTOR CIRCUIT
FIGURE 4

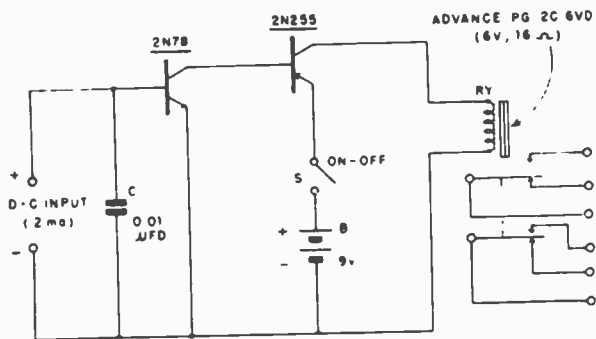

SENSITIVE HEAVY-DUTY D-C CIRCUIT
FIGURE 5

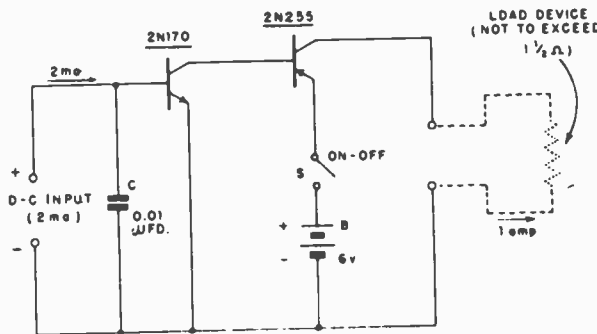

DIRECT USE OF POWER TRANSISTOR AS D-C RELAY
FIGURE 6

tor circuit employing an inexpensive NPN transistor (2N170). An input current of 100 microamperes will close the relay. The latter is a 1000-ohm, 4.5-milliampere unit. (Sigma 4F-1000). The input resistance of the amplifier is approximately 5000 ohms. Bypass capacitor C serves to remove any AC or RF component which may be present in the input current. Standby current from the 6-volt battery, B, when switch S is closed but no input current is applied to the circuit, is 60 microamperes. If a CK574 transistor is substituted for the 2N170, an input current of only 20 microamperes will close the relay. However, the CK754 is a PNP unit, and its use will require reversing the polarity of Battery B and the two DC input terminals.

Figure 2 shows a similar circuit for operation of a somewhat heavier, tube-plate-type relay. Here, RY is a 6.3-ma, 2500-ohm unit (Potter & Brumfield LM5). Some designers will have such relays on hand from previous vacuum-tube systems. An inexpensive PNP transistor (CK722) is employed. The relay will close with an amplifier input current of 130 microamperes. The input resistance of the amplifier is approximately 4000 ohms. Standby current from the 22½-volt battery, B, when

switch S is closed but no input current is applied to the circuit, is 72 microamperes.

The ultrasensitive circuit in Figure 3 is recommended for operation at very low current levels. Here, a 2-stage direct-coupled amplifier supplies the high gain needed to close the 4.5-ma, 1000-ohm relay, RY (Sigma 4F-1000), from an input current of only 10 microamperes. Standby current from the 6-volt battery B is of the order of 100 microamperes. The NPN input transistor (2N619) receives its positive collector voltage from battery B through the internal base-emitter path of the PNP output transistor (2N132A). The collector output current of the 2N619 therefore flows through the base-emitter path of the 2N132A, this arrangement requiring no coupling resistors.

It is clear that the zero-signal static collector current of the 2N619 likewise flows through the input path of the 2N132A and, being amplified by the second transistor, will raise the static current flowing through the relay. For this reason, a silicon transistor is specified for the input stage because of the extremely low leakage current of such a transistor and the good high-temperature characteristics of this unit. This is done with full realization that silicon

transistors presently are high-priced (the 2N619 costing about five times the price of the 2N132A). However there is no alternative if the simplicity and compactness of this high-gain, direct-coupled amplifier are to be obtained.

Figure 4 shows the circuit of a power-transistor amplifier for operating a heavy relay, RY (Advance PG/2C/6VD). The latter is a 6-volt, 16-ohm unit requiring approximately 0.4 ampere for closure. The relay contacts will handle 15 amperes at 115 volts. An input current of only 20 milliamperes DC will actuate the relay. Standby current from the 9-volt battery B is approximately 1.5 milliamperes. The input resistance of the amplifier is approximately 1 ohm. The power transistor (2N255) must be operated with a suitable heat sink, for safe dissipation of the power of approximately 2½ watts. Assuming that the relay contacts will switch the full, maximum rated current of 15 amperes, this relay circuit will provide an over-all current gain of approximately 750.

When the current sensitivity (20 ma) of the high-power circuit must be increased, a low-level amplifier stage may be added, as shown in Figure 5. Unlike the arrangement given in Figure 3, however, a silicon transistor is not needed in the input stage, since normal leakage current drift in the 2N78 germanium input transistor will not result in sufficient increase in the relay standby current to be detrimental. An input current of only 2 ma to the input transistor (2N78) will result in relay closure. The relay is an Advance PG/2C/6VD unit requiring approximately 0.4 ampere of closing current. Standby current from the 9-volt battery, B, is 3 milliamperes in the absence of an input signal. Capacitor C serves to remove any AC or RF component which may be present in the input current. Assuming that the relay contacts will switch the full, maximum rated current of 15 amperes, this relay circuit will provide an over-all current gain of approximately 7500. In order to handle safely the power involved, the 2N255 power transistor must be provided with a suitable heat sink.

In the 2-stage circuit shown in Figure 6, the mechanical relay has been omitted entirely, the output power transistor (2N255) switching current in the load directly through its collector circuit. This arrangement will be suitable for use with load devices (such as heaters, solenoids, lamps, signal alarms, etc.) of resistance not exceeding 1 ohm. At higher load resistances, the output current change decreases.

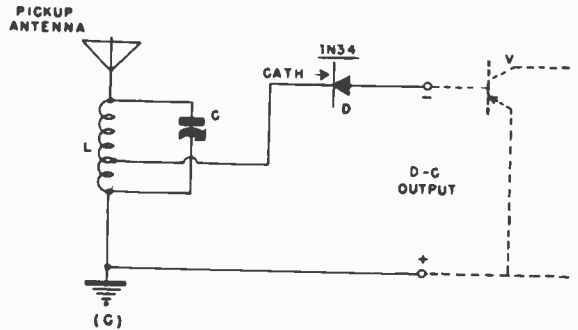
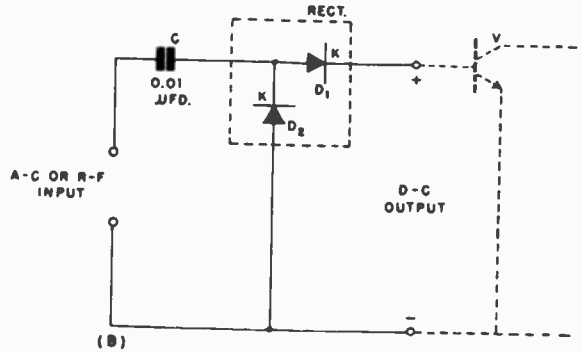
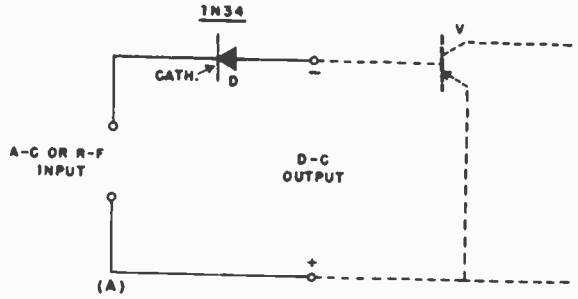

A-C AND R-F INPUT CIRCUITS

FIGURE 7

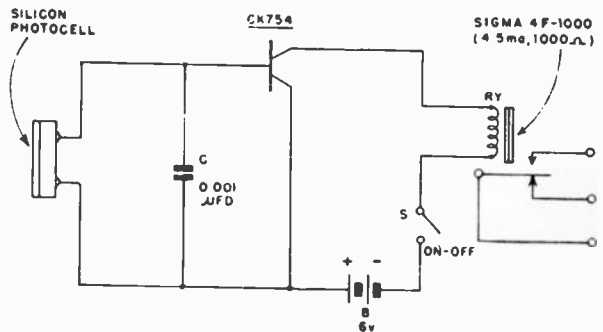

SENSITIVE, LIGHT-OPERATED RELAY

FIGURE 8

An input current of only 2 milliamperes to the 2N170 transistor will produce a current flow of 1 ampere through the load. Standby current from the 6-volt battery, B, is approximately 3 milliamperes. In order to handle safely the power involved, the 2N255 transistor must be provided with a suitable heat sink.

As in the circuits given in Figures 3 and 5, a direct-coupled arrangement is employed here, with the collector current change of the input transistor flowing through the internal base-emitter path of the output transistor directly. However, a silicon input transistor is not required (as was the case in Figure 3) since the amplification of the 2N170 leakage current by the 2N255 does not result in enough current to be significant in the external load.

AC AND RF CIRCUITS

The amplifier-relay circuits shown in Figures 1, 2, and 3 may be adapted to AC and RF use by connecting suitable rectifiers ahead of them. This is comparable to the process of rectifying AC for operation of a DC meter.

Figure 7 shows several circuits for accomplishing this conversion. In Figure 7 (A), a general-purpose germanium diode, D, is connected in series with the input transistor, V, of the relay amplifier circuit. The diode is poled here to supply a negative output to the base of the PNP transistor. If the input transistor is an NPN type, the diode must be reversed to supply a positive output to the base.

The simple circuit just described is satisfactory only when there is no d-c component in the AC or RF signal. Such direct current reaching the input transistor would cause a spurious signal in the amplifier output circuit and might erroneously close the relay. The circuit shown in Figure 7 (B) provide d-c isolation by means of the blocking capacitor, C. In this instance, however, an additional diode, D₂, is required for the reverse half-cycle of the signal component. The two diodes, D₁ and D₂, are shown as a unit within dotted lines and designated RECT, for the reason that 2-unit meter rectifiers are obtainable in this configuration and are useful efficiently up to about 5 kc. For higher-frequency operation, a pair of general-purpose germanium diodes should be connected as shown in Figure 7 (C). The diodes are poled in this illustration so that the d-c output is positive to the base of the NPN input transistor, V, of the relay amplifier. If, instead, a PNP transistor is employed, both diodes must be reversed to supply a

negative output to the base. Study diagram.

Figure 7 (C) shows an RF circuit for tuning in a desired RF signal which is to actuate the relay. The inductance of coil L and the capacitance of tuning capacitor C are chosen for resonance at the frequency of desired signal. For impedance matching, the tap to which diode D is connected is placed between $\frac{1}{4}$ and $\frac{1}{3}$ of the way up from the ground end of the coil. The diode is poled to deliver a negative DC output to the base of the PNP input transistor, V. If, instead, an NPN transistor is employed, the diode must be reversed to supply a positive output to the base.

While a bypass capacitor should be connected across the DC output terminals of each rectifier circuit, it is not shown in Figure 7, since such a capacitor already is present in each of the circuits to which one of these rectifiers might be connected. (See capacitor C in Figures 1, 2, and 3.)

LIGHT-OPERATED RELAY

In Figure 8, the DC input signal for the transistorized amplifier is obtained from an illuminated, self-generating photocell. A silicon photocell (such as International Rectifier Corporation Type Sa5-M or Hoffman S-1A) is employed for high output. Similarly, a high-gain transistor (CK754) is used. (This transistor has a maximum short-circuit current gain, β , of 300). This combination results in high sensitivity, light from a regulation-size flashlight at a distance of more than 30 feet being sufficient to close the 4.5-ma, 1000-ohm relay, RY (Sigma 4F-1000) in the collector circuit of the single transistor.

Standby current from the 6-volt battery, B, is approximately 200 microamperes when the photocell is darkened.

FURTHER POSSIBILITIES

The practical circuits given in this article show some of the ways of using transistor circuits in relay applications. New semiconductor devices and circuits will increase the scope of application. For example, heavy currents can be handled by the new *solid-state thyatron*, a transistor-like power-switching device which might be employed in a circuit of the general type shown in Figure 6.

Another possibility is the use of flip-flop circuits, which have the ability to remain in a conducting state once they are switched on by a signal pulse and thus simulate electronically the latching relay. Still other possibilities are circuits simulating multipole, multiposition relays in which mechanical relay is dispensed with. *

The Electronic Ignition Analyzer

Here's the equipment you need for a positive ignition check.

How's the ignition system of that Triumph TR3 functioning? Stepping on accelerator is one way of finding out, but a real "picture" is obtained on Heath ignition analyzer, shown here in use.

ONE OF THE MOST UNUSUAL electronic "gadgets" of recent years is the ignition analyzer. Essentially, this is a cathode-ray oscilloscope, specially designed to show the wave forms of the voltages in the primary and secondary circuits of an automobile's electrical system.

The instrument that particularly interests the current generation of sports-car enthusiasts, hot-rodders and professional mechanics is the Heath job, for the simple reason that it costs only \$60 as a do-it-yourself kit and \$100 in factory assembled form. The only other scope-type analyzer on the market, marketed only through automotive channels, sells for about \$400. Being adept with tools, most car hobbyists have little difficulty with the kit even if their experience in electronic construction is limited.

Unhappily, the scope ignition analyzer is something of a disappointment to many users, through no fault of its own. It is not a measuring device, like an ammeter, vacuum gauge, thermometer, air gauge, or gas gauge. It is an *indicator*, and what it shows can only be interpreted on the basis of the owner's practice and experience with it. An almost exactly parallel instru-



ment is the doctor's stethoscope. A layman can listen to his heart beat and hear a series of thumping noises that might just as well emanate from a leaky water pump; a doctor listening to the same sounds can form a pretty accurate opinion of the patient's cardiac condition.

Fortunately, it is fairly easy to acquire skill with an analyzer. The time to practice is when a car is new or known to be in good order.

Put deliberate faults into the ignition system, and see what happens. For example: disconnect the condenser inside the distributor; remove one or two wires from spark plugs (*danger, high voltage . . . shut off engine first!*), short one or two spark-plug wires to the engine block, put in a couple of old, fouled plugs, try excessively close and open adjustments of the contact points in the distributor, put in old and pitted points or a worn distributor arm, try different settings of the spark advance. The resulting patterns may or may not correspond with the ideal patterns shown in the instruction book, some of which are reproduced here to give you an idea of what to expect. Record the wiggles on the screen, either in your mind's eye or on paper.

Appearance of normal pattern for one cylinder. Complete ignition cycle is as follows: Point A: Instant when distributor breaker points open and spark starts. Segment A-B: Duration of spark discharge. Segment B-C: Coil condenser zone. This shows dissipation of energy remaining in the coil primary when the spark goes out. Point C: The breaker points close again. Segment C-A: This is the "dwell time," when the breaker points are closed and the battery current flows through the primary of the ignition coil. Point A: Breaker points open, next cylinder fires. Scope can be calibrated to read dwell time in terms of degrees for engines of various numbers of cylinders.



Above: These are the "probes" of the analyzer. The two insulated clips, in top left corner, go to the battery circuit. Cylindrical clips, which are split lengthwise, go to high tension leads.

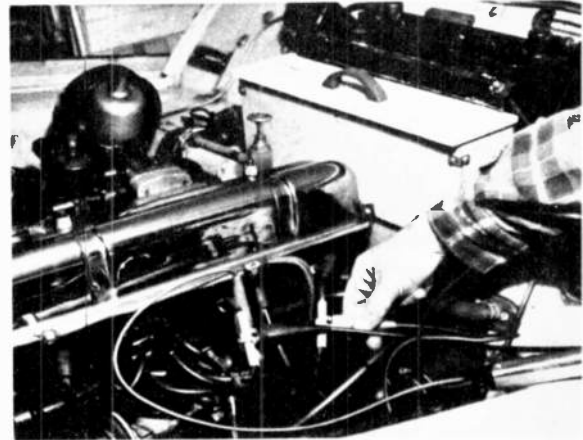

Probes go around the distributor and spark plug leads without making actual contact with wires inside. Capacitance effect between wire and probe is enough to transfer some spark energy to scope.

PRIMARY

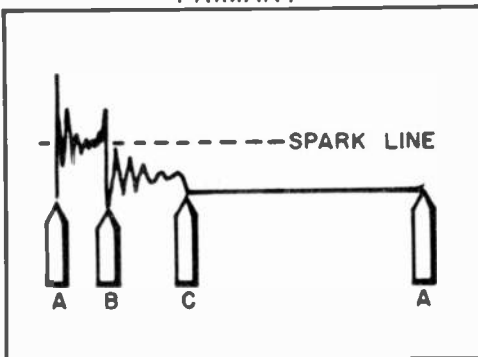

SECONDARY

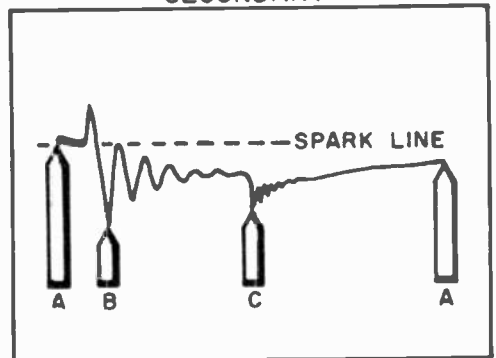



Photograph: The front panel appearance of the ignition analyzer resembles that of a standard oscilloscope. The operation of the various controls can be mastered with a little diligent practice.

"Is an ignition analyzer really worth buying?" Put it this way: If you own a conventional automobile and drive it the national average of about nine or ten thousand miles a year, and it starts and runs without hitch, the answer is "No." For what the instrument costs you can get all the "tune-ups" you will need.

However, if you own a high-grade sports car, particularly one of those snazzy foreign jobs with a small-displacement, high-speed engine, and you take pride in keeping it tuned to a fine pitch, you'll certainly find an analyzer a productive, intriguing investment, and you'll surely hook it up every time you lift the hood to fiddle in the engine compartment. Your main problem will be to keep other sports-car nuts from borrowing it from you. In this connection here's a suggestion: Let the local sports-car club buy an analyzer with club funds, and then allow members to use it on a rotating basis. If the club treasury is a bit low (the usual condition of club treasuries!), a "rental" fee of a dollar a week end will help amortize instrument's cost. •

PRIMARY

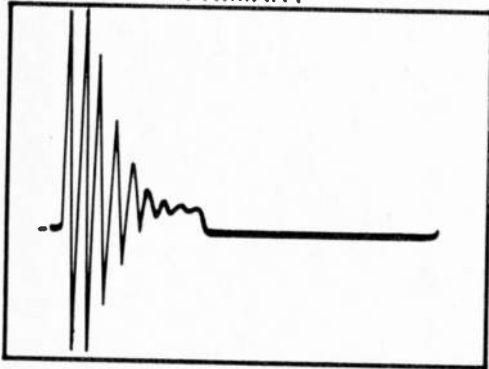

SECONDARY

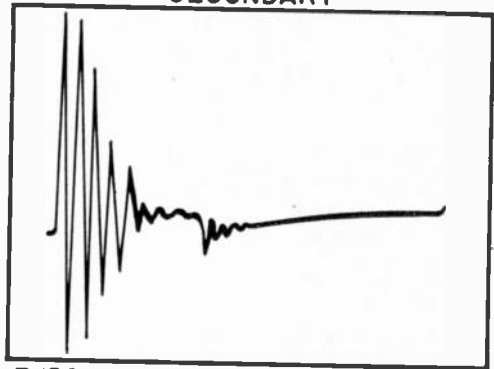

**ENERGY NOT RELEASED THROUGH SPARK GAP
OPEN SECONDARY CIRCUIT.**

If section A-B is missing, as in patterns above, there is no spark at all. This may be fault of loose plug wire, broken plug, or weak coil. However, if spark line is lower and of longer duration than the other, as in patterns below, current has found easier path. This may indicate too small a gap in the spark plug, making gap from distributor rotor arm to contact point the one spark gap in circuit.

PRIMARY

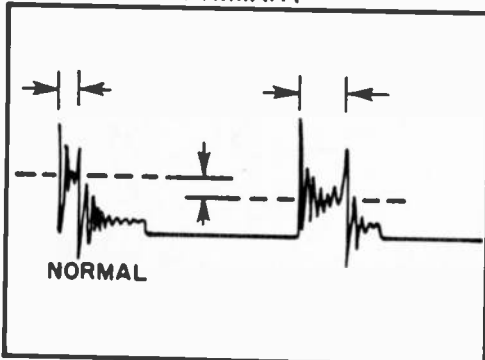

SECONDARY

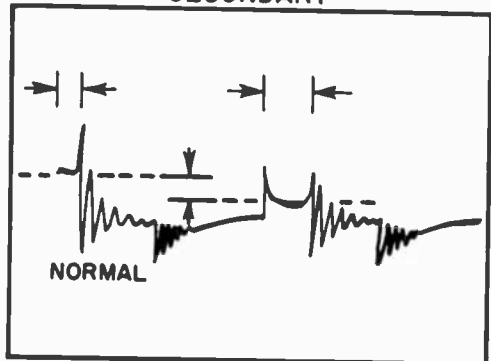

**COMPARE INTERVALS: NOTE LONG, LOW SPARK LINES.
SHORTED PLUG, WIRE OR DEFECTIVE DISTRIBUTOR CAP.**

PRIMARY

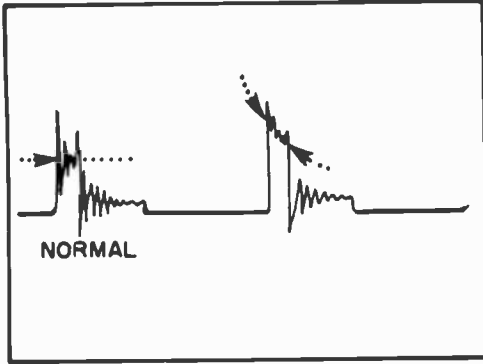

SECONDARY

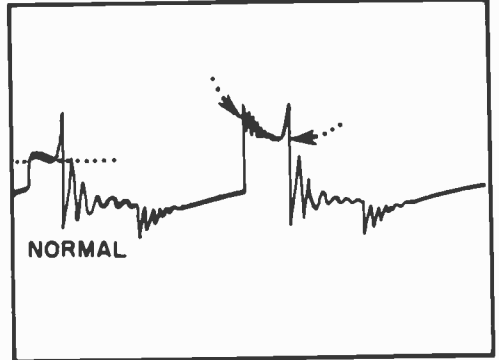

COMPARE SPARK LINES.
HIGH RESISTANCE IN SECONDARY CIRCUIT.

High resistance in plug wire is represented by pronounced bending of spark line. Check tightness of fit of wires at both plug terminals and in contact holes in distributor cap. Spark trace can be used to test reserve voltage of coil (see patterns below). Disconnect one spark plug wire. If spark zone peak is twice as high as in normal pattern, the coil has adequate reserve and may be considered OK.

PRIMARY

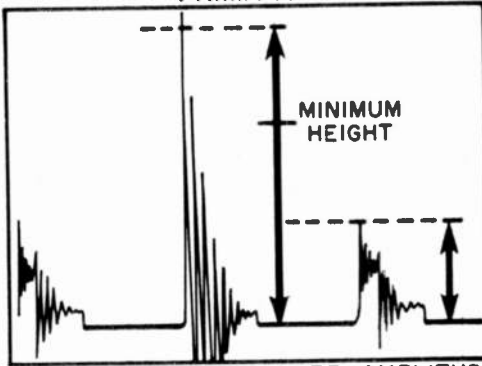

SECONDARY

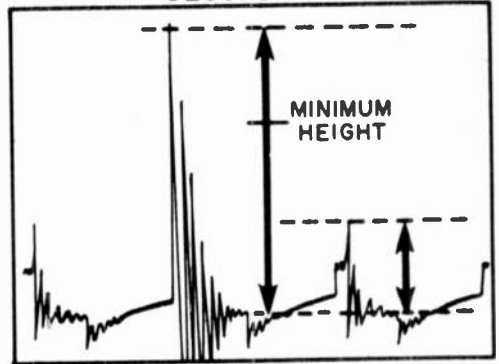

NOTE: AMPLITUDE OF OPEN PLUG PEAK IS MORE THAN TWICE NORMAL PATTERN HEIGHT. THIS COIL HAS ADEQUATE RESERVE.

The coil-condenser zone is affected by many factors. A bad coil can be traced by one of the several patterns shown below. A bad condenser may reduce the wiggles to almost a straight line without affecting the "points close" point. A low primary supply voltage will reduce the amplitude of the oscillations, resulting in a discharge similar to that of a bad coil. Before replacing the coil, measure the voltage being delivered to it, with the engine off or at normal idle. A "six-volt" battery in good condition should show close to 6.6 volts, and a "twelve-volt" battery close to 13 volts. Corrosion of wires and connections, especially in areas bordering on salt water, can greatly reduce effectiveness of neglected electrical system. Check ignition coil with special care if car uses 6-cell battery.

PRIMARY

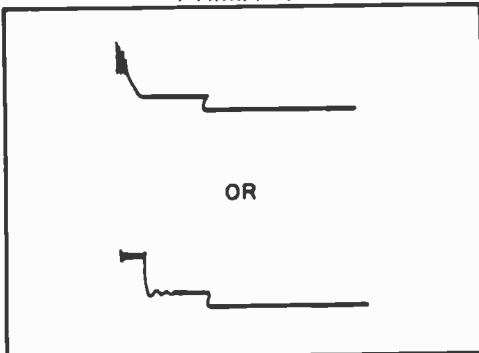

SECONDARY

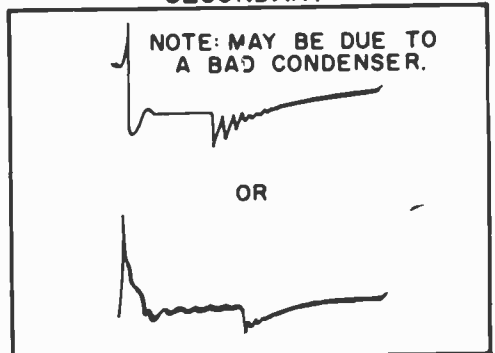

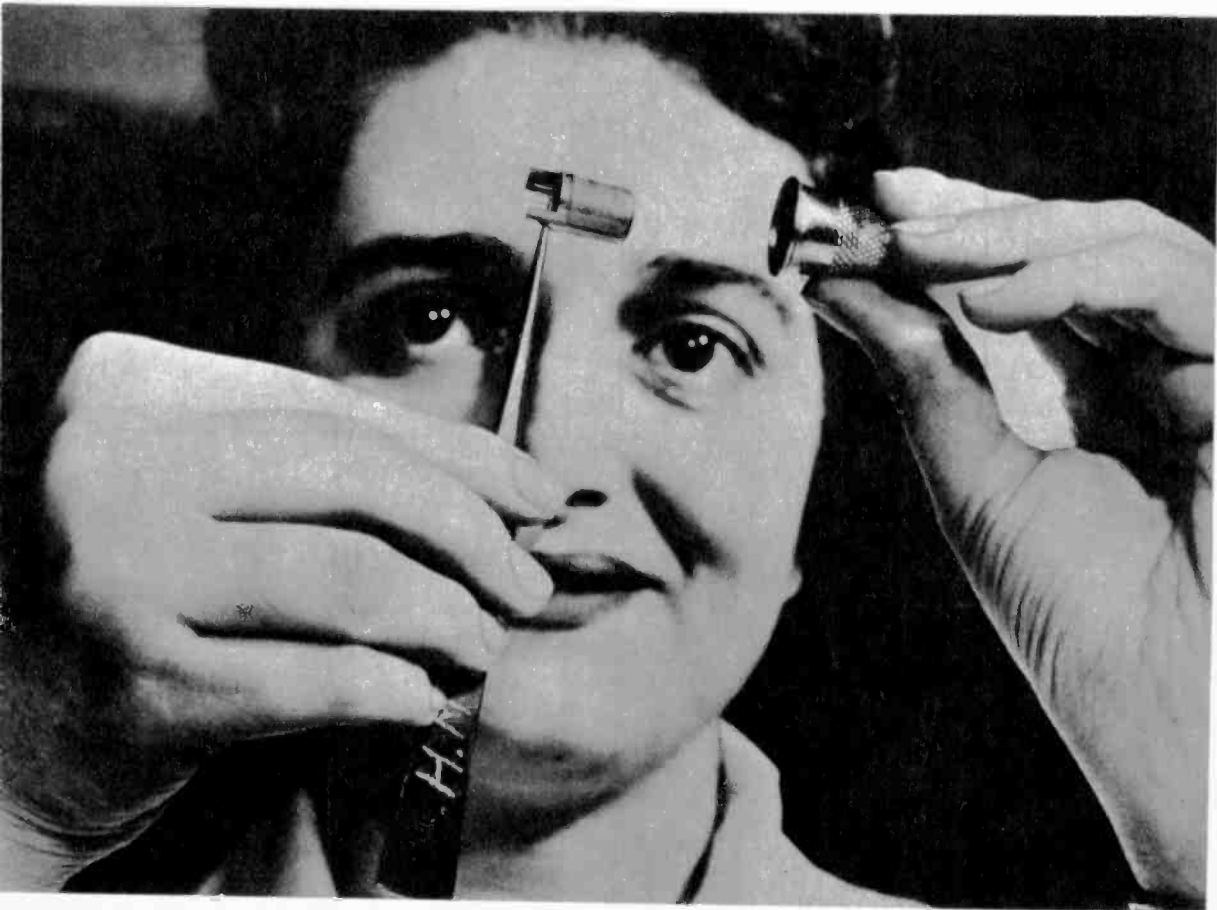

This is newest vacuum tube and not a transistor that the young lady is about to put into the thimble.

The Nuvistor

Midget tube does good job in circuit, replacing larger counterpart.

A REVOLUTIONARY DEVELOPMENT in electron tube design, hailed by engineers as a significant advance in electron tube history, was announced recently by the Radio Corporation of America.

"Development of the new design represents a major breakthrough in tube size, performance, power drain, and reliability," said D. Y. Smith, Vice-President and General Manager, RCA Electron Tube Division. "It opens the way to mass production of high-performance, thimble-size tubes having improved ruggedness, reliability and efficiency."

Called "Nuvistors," the new tubes will lead to important electronic developments in such instruments as television sets, communications receivers, and computers, as well as making possible more compact and efficient electronic equipment for use in

defense and industry, Mr. Smith added.

The name is based on the words "nueva" meaning new and "vista" meaning prospect. Hence, the "new look" or "Nuvistor."

"Electron tubes," Mr. Smith said, "have by no means reached the limit of their low-cost, high-performance capabilities. Through the study of new materials, new processes and new techniques, our engineers foresee the practicality of even smaller tubes having power consumption reduced to one twentieth the power required for conventional tubes. They anticipate that receiving tubes of Nuvistor design can have useful lifetimes of tens or even hundreds of thousands of hours."

In demonstrations for the technical press, RCA showed a completely "nuvistorized" tuner unit of a television set requiring only a fraction of the plate voltage needed by

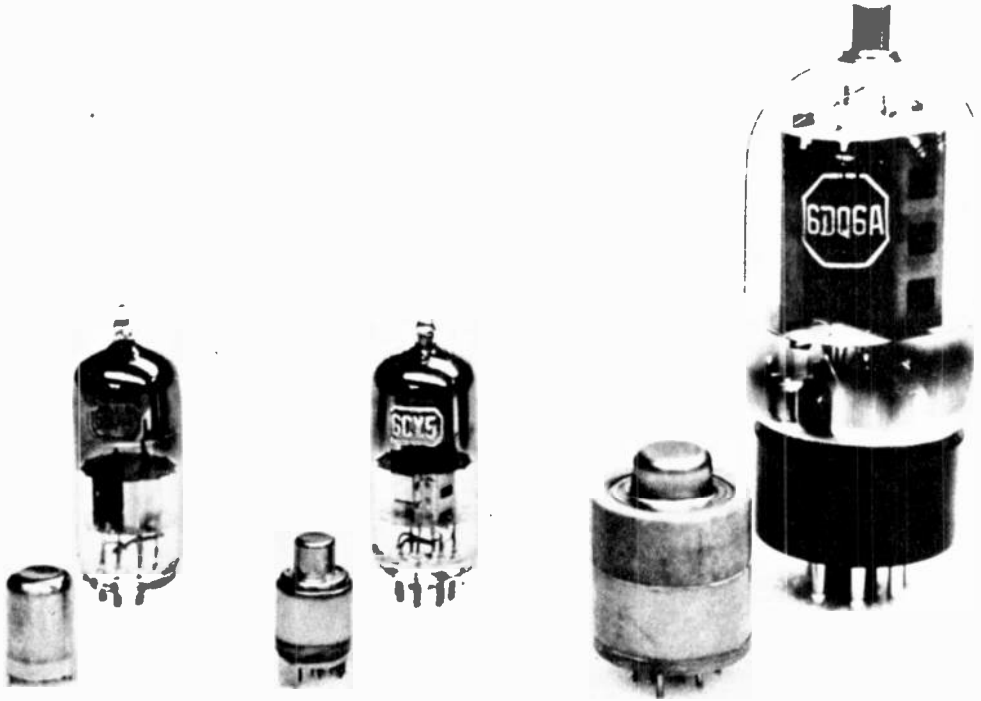

How's this trick for the newest in tube design: in back row are three conventional vacuum tubes of type found in television and radio receivers; in front are the Nuvistor counterparts which are much smaller and lighter. From left to right: a small signal triode, a small-signal tetrode, and a beam power tube.

conventional tuners. This experimental tuner reduces the over-all volume of conventional tube TV tuner units by approximately one third.

The ruggedness of the Nuvistor design was displayed in several torture and endurance tests. The tiny tube continued to function normally in an electronic circuit when placed alternately in the heating coils of a special furnace (660 degrees Fahrenheit) and in liquid nitrogen (320 degrees below zero F.). In another demonstration, the new tubes were shown operating continuously in both the special furnace and in liquid nitrogen. Operation of the Nuvistor tubes was not disturbed by a guillotine-type device which repeatedly subjected them to severe mechanical blows.

Mr. Smith pointed out that these experi-

ments, as well as other rigorously controlled laboratory tests, illustrate the high-temperature capabilities of Nuvistor tubes as well as their reliable performance under conditions of severe shock and continuous vibration.

"We believe these features, plus the tube's compactness and high efficiency, will make the Nuvistor tube design ideal for many types of military and airborne electronic systems. Modern jets, guided missiles, and military vehicles all require sturdy, rugged, and compact electronic components capable of reliable, efficient performance.

"Because the tiny tubes have improved electrical and thermal characteristics as well as improved reliability, we believe the Nuvistor will find a ready market in the television industry. The small-signal triode

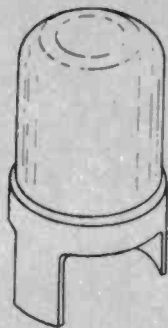

METAL ENVELOPE



PLATE



GRID



CATHODE



CATHODE SUPPORT SLEEVE



HEATER



PLATE FLANGE



GRID FLANGE



CATHODE FLANGE

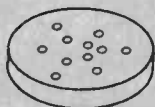

BASE WAFER

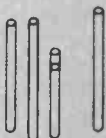

LEADS



BRAZING RING

The conventional tube used in TV tuners is shown here held in hand in order to compare it with the thimble size Nuvisitors which are being used in an experimental tuner built in RCA laboratories.

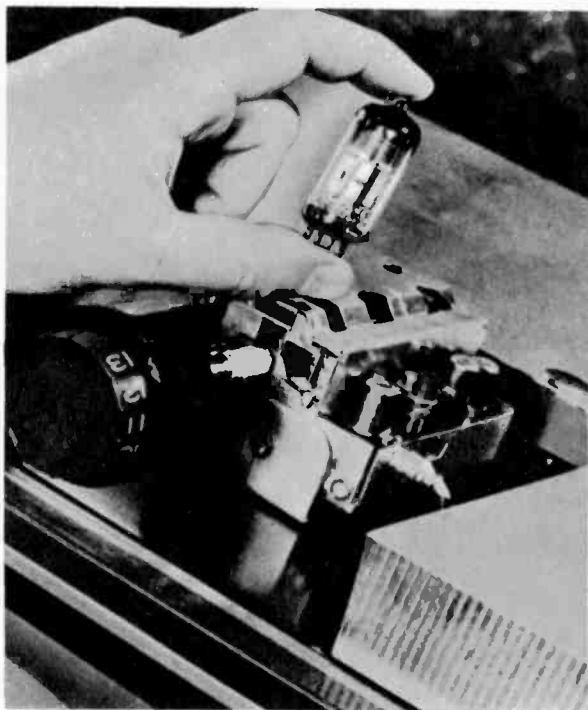

and the small-signal tetrode, already well along in advanced development, will be of particular interest for TV tuner designs and intermediate-frequency amplifiers in view of their small size and excellent electrical characteristics. The beam power tube is especially well suited for audio output and horizontal-deflection applications in television sets."

Nuvisor tubes are also expected to offer many advantages for high-speed data-processing equipment.

"The new small, high-efficiency triodes and tetrodes will find wide use in the logic and computing circuits of electronic computers. The power tetrode, capable of high peak current at low plate voltage, offers advantages for memory-core-driver applications, an important operation in which information is stored for later use.

"Furthermore, we envisage that the beam power tube could be utilized in series voltage regulators, low-power transmitters, servo amplifiers, and high-power

Sketch shows a phantom view of tube complete, except for the outer shell. The elements that comprise the Nuvistor are very solidly supported.

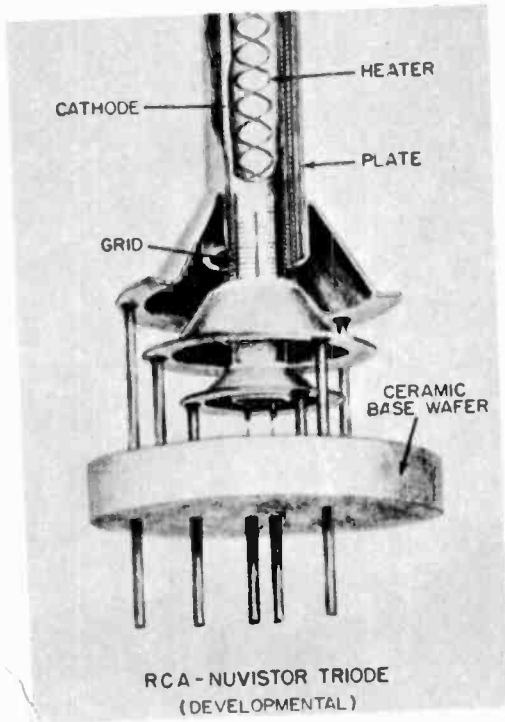

The small scale dimension of the Nuvistor makes it necessary for assemblers to use powerful microscopes in putting this newest tube together.



sound systems for a wide variety of industrial applications.

Explaining the pertinent features of the Nuvistor's unique construction, Mr. Smith said:

"For ruggedness, we start with a strong ceramic base-wafer as a platform and erect an array of tube electrode assemblies on it. Each assembly is held rigidly in place by a tripod-like structure. Nuvistor tubes are made of ceramic materials and strong metals such as steel, molybdenum and tungsten.

"The electrodes are strongly supported from one end in a cantilever fashion, a method employed for bridge-building in which trusses are extended from piers. This construction feature eliminates the need for mica support discs or spacers. All the electrodes are small, light cylinders. They are able to withstand a high degree of shock or vibration because of their shape and low mass."

Mr. Smith cited the following advantages

of the Nuvistor construction: (1) cylindrical symmetry and cantilever construction permit the use of accurate jigs for assembly; (2) brazing of assembly in accurate jigs produces a strain-free structure; (3) micas are completely eliminated; (4) high-temperature processing results in super-clean structure; (5) indexing lugs permit safe and easy insertion into tube socket; (6) tubes can operate in high temperatures; and (7) the tubes use no glass which might shatter under shock.

RCA's announcement of the Nuvistor carefully avoided any reference to transistors. However, the implication of a challenge to the latter is unmistakable. Introduced only in 1948, the transistor has admittedly made enormous strides, but many of its boosters have gone a little overboard in predicting that it would completely replace the time-proved vacuum tube. They both have their places in electronic engineering, and they complement and supplement each other. •

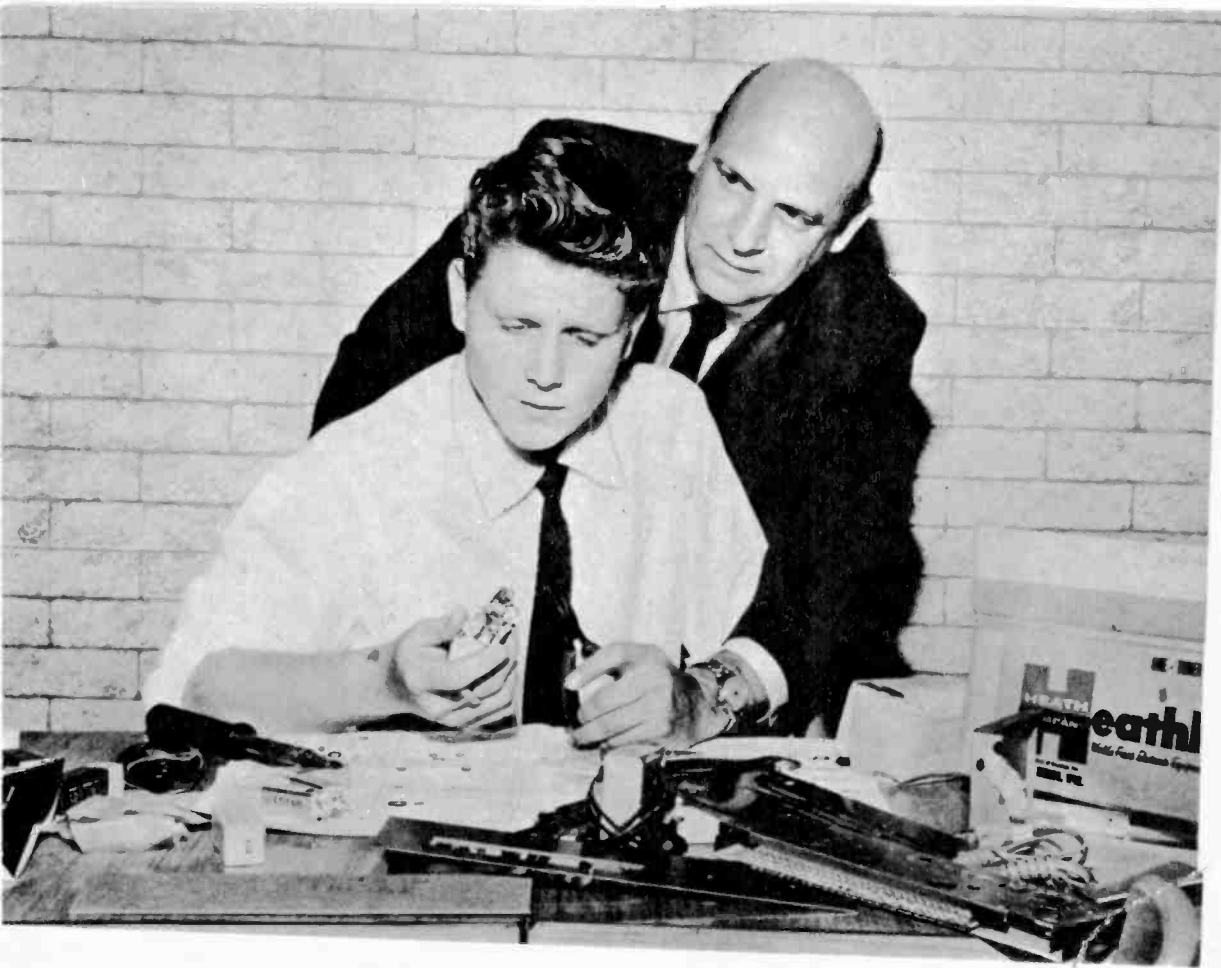

So You're Going to Build a Kit!

Some suggestions about tools and techniques that you might find useful and time-saving.

BUILDING ELECTRONIC EQUIPMENT from prepared kits is interesting, instructive, relaxing and money-saving. I know a doctor, an ardent ham operator himself, who prescribes kit assembly as a form of therapy for certain patients. The treatment works, the only trouble now being that they sometimes return for help on circuit matters rather than for medical advice!

By furnishing pre-punched panels and chassis, all components, tested circuits and step-by-step instructions, kit manufacturers have removed the drudgery and uncertainty from do-it-yourself construction. However, it isn't all apple-pie easy, and

lots of important things are left unsaid in many of the instruction manuals. For one thing, adequate and proper tools are neither provided nor suggested.

A "basic" tool kit sold specifically for kit assembly purposes consists merely of a soldering iron, two pairs of pliers and two screwdrivers. By straining yourself, you could get along with these, but you can cut an assembly and wiring job about in half with the aid of a few more small, inexpensive but extremely useful tools.

Once a kit arrives, you're anxious to get at it. Go ahead, but go slowly. Double-check each operation. Study the next six pages for practical hints. •

They're learning something and having fun at the same time: TV-movie star Jackie Coogan and son Anthony.



First step is to sort out all the parts of a kit into flat, open receptacles of any kind, for quick identification. Use cigar boxes, cutlery holders, stocking boxes, etc., and leave them on a table that won't be needed for a while. Here are parts of a Heath Op-1 Professional Oscilloscope.

Do you have everything you really need? Best way to find out, and at the same time to acquaint yourself with all the parts, is to check them one by one against the parts list in the instruction book.

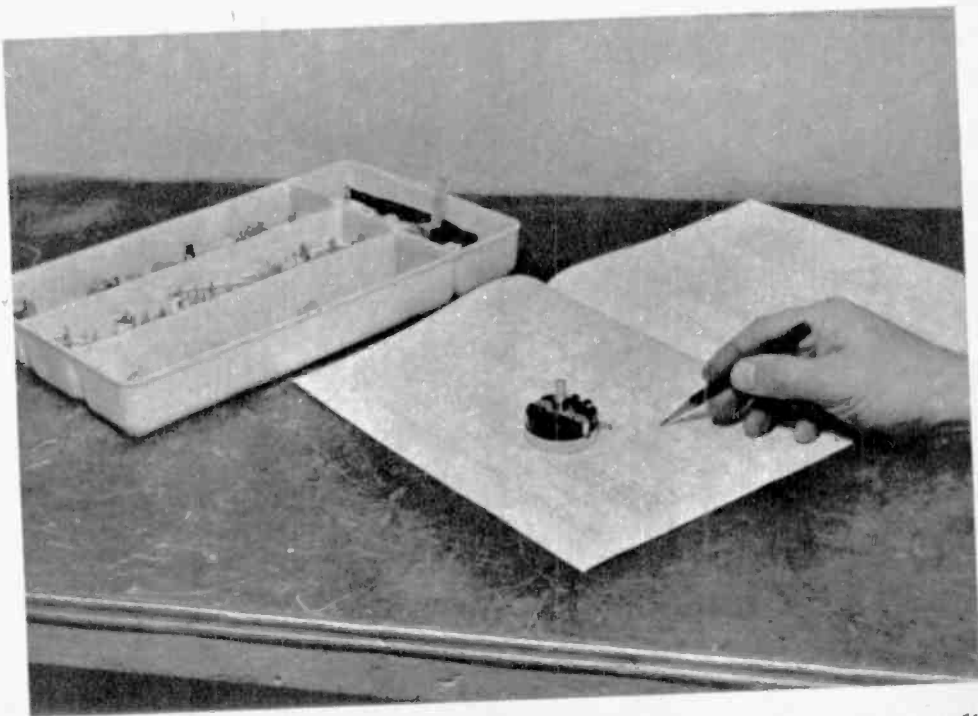

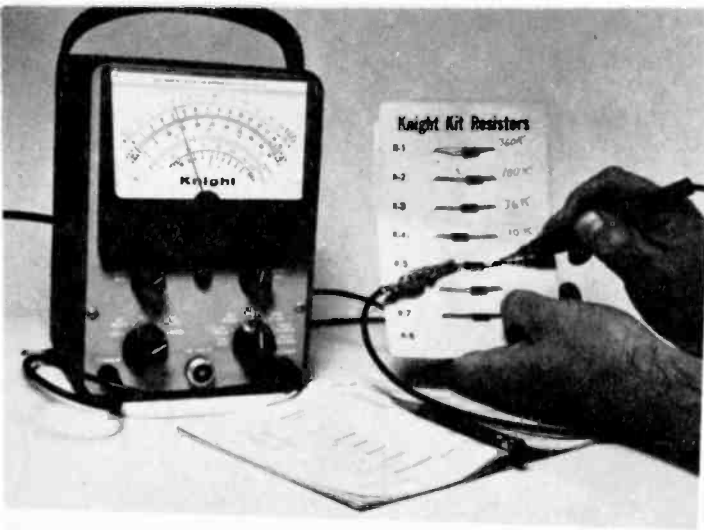

Small resistors, used in large numbers in many kits, can be confusing because of similarity of their color markings. Good idea to verify their values with a VOM or VTVM, and mark them on card.

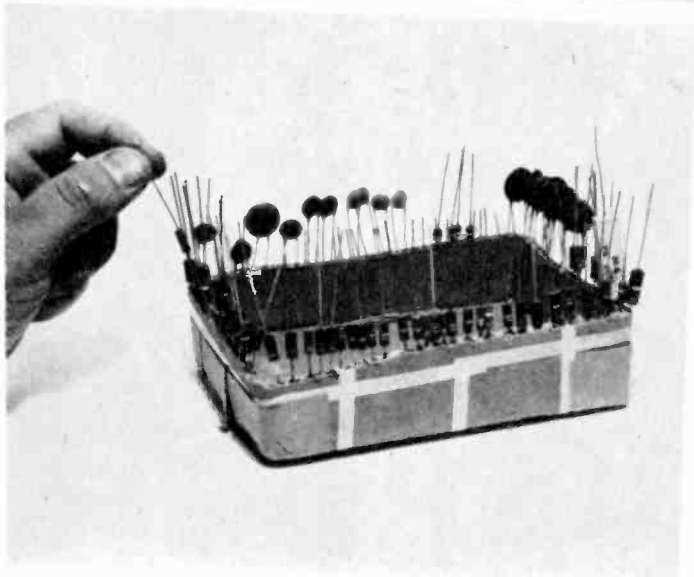

If resistors and small capacitors are loose in kit, they are a nuisance to handle and sort out. Cut off the top of a small corrugated box. Straighten wire leads of the components, arrange them in sequence according to values, and stick them into the edge openings in this manner. Now you can pick any resistor or capacitor without having to untangle a great big mess of them.

If kit includes blow-ups of working drawings, you can staple or tape them to pieces of plywood or Masonite, wallboard, cardboard from a carton, etc. Now they can be propped up on the workbench, and they are easy to study. After the kit is finished, drawings make unique decorations in den, shop.

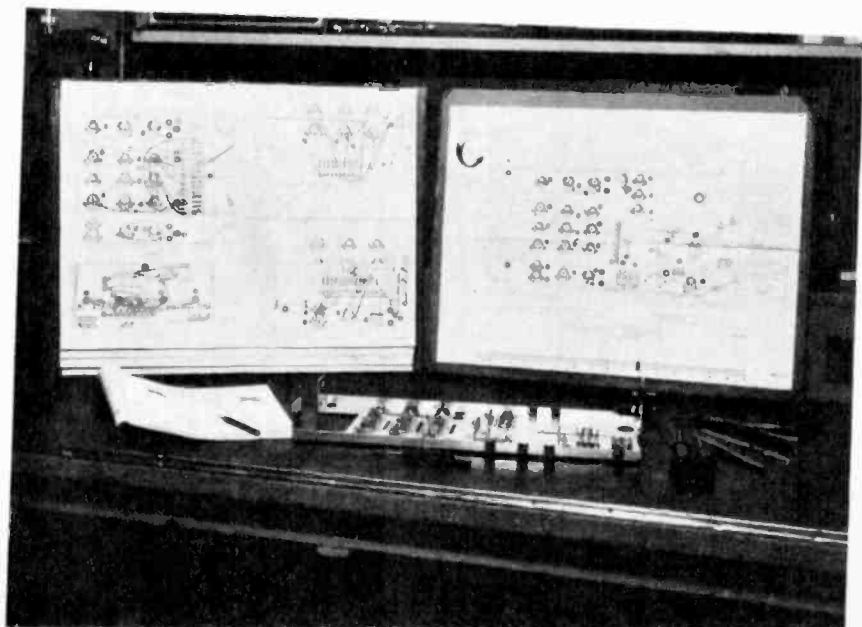

Right: The importance of good light, well placed, cannot be overemphasized. Components such as transistors, resistors, disc capacitors, etc., are very small and must be positioned with care.

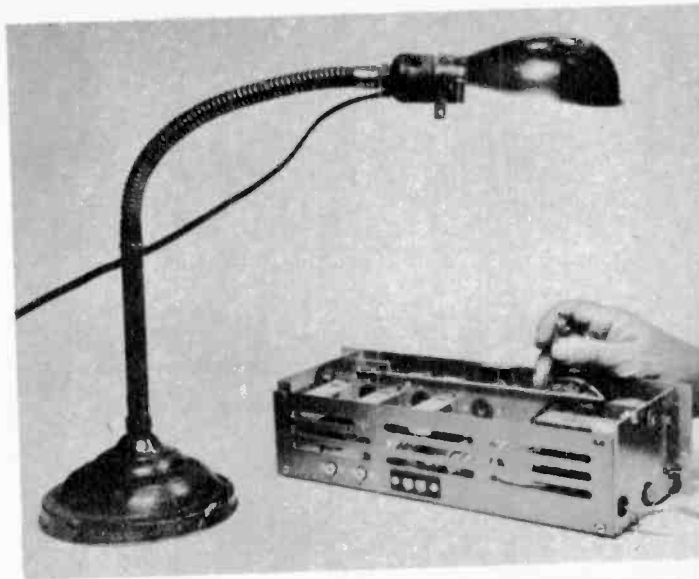

It will be much easier to identify parts when wiring if they are clearly marked. Use same symbols found in the diagrams and mark chassis with a grease crayon.

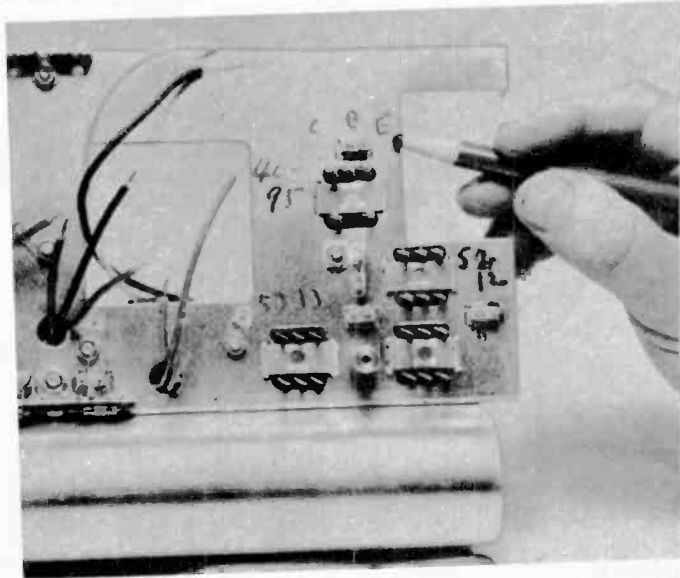

Instructions call for cutting numerous pieces of wire to length. A long wooden ruler is therefore necessary. Add about $\frac{1}{4}$ inch to all wires for precautionary measure.

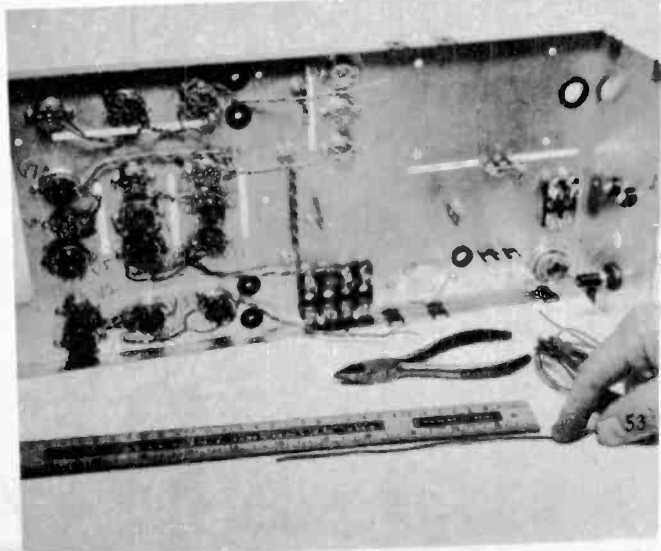

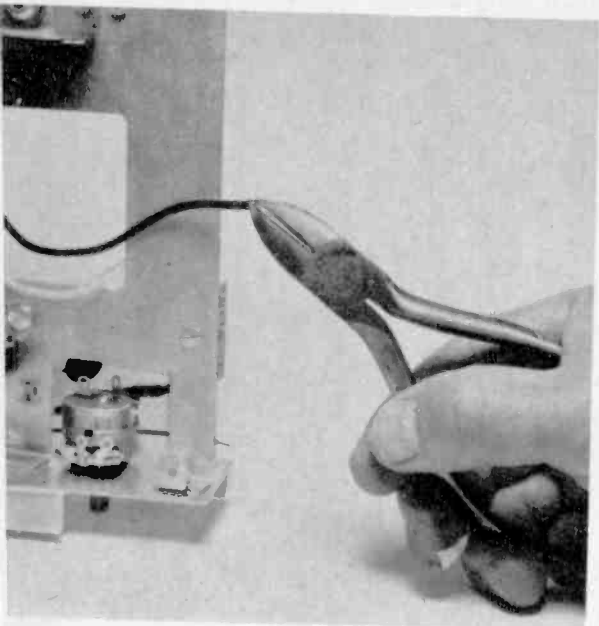

Diagonal side-cutting plier is the basic tool for trimming wires to length. Buy the very best one you can obtain. If used only for cutting and not for holding or squeezing, it will last a lifetime.

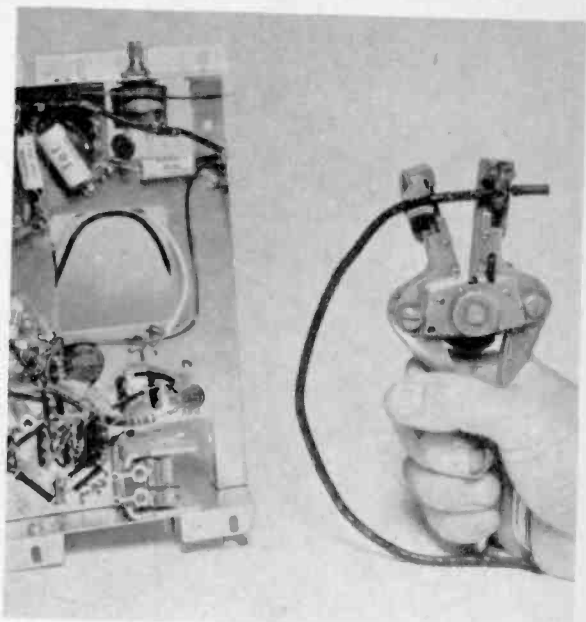

Trim insulation from wires with a common knife? Nonsense! That's old-fashioned, dangerous, time-consuming. Wire-stripping tool does the job better and faster, saves cut fingers and nicked wires.

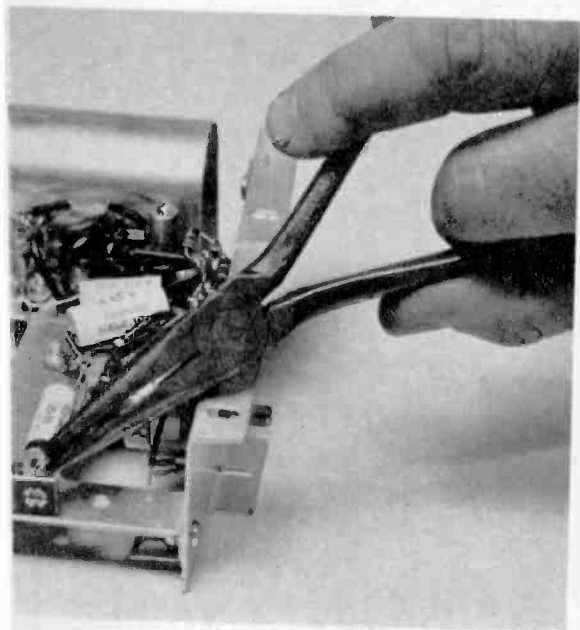

Long-nose pliers are indispensable for closing wire leads around terminal lugs, light bending of thin metal, holding parts for soldering, etc. Do NOT use them as wrench for nuts or screws.

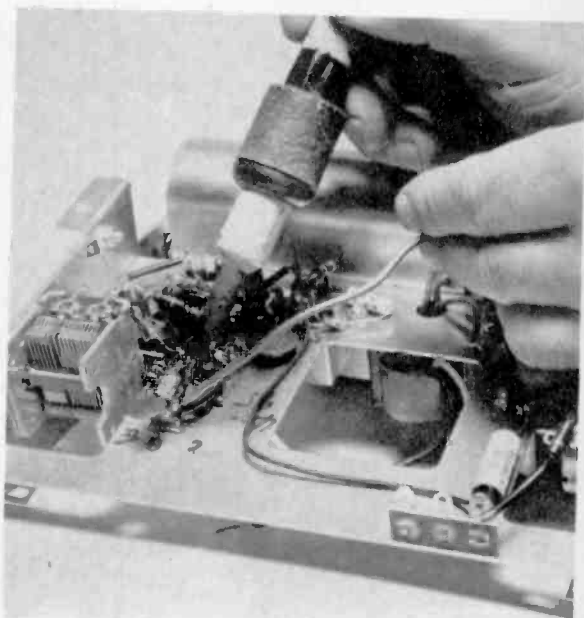

One medium and one small soldering iron are needed for most wiring. For close work on transistor sets (such as this Heath portable receiver), 1/8-inch tip is essential. Keep spare tips on hand.

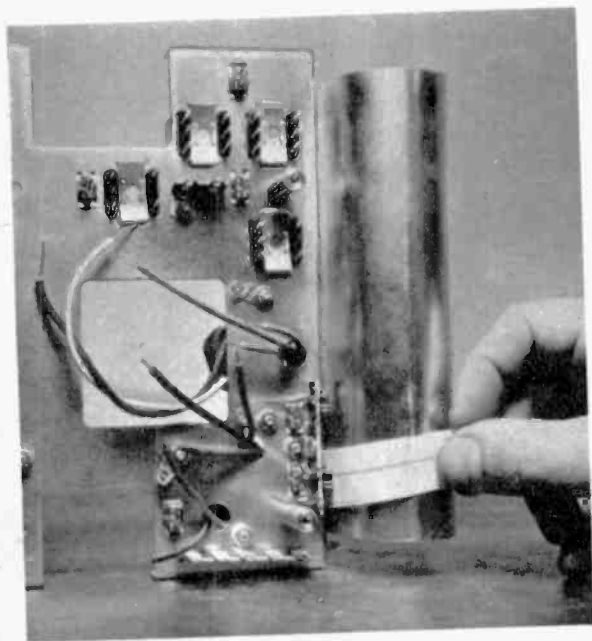

Assembly of small parts in some chassis is very tight. It is highly advisable to check clearances by slipping strips of paper between all close-by surfaces. Bend parts carefully, avoid "grounding."



Meticulously check off each step in the instruction book as you complete it and verify it. Then you can stop work at any point and pick it up the next time without fear of overlooking something.

Try to pick up a tiny lock washer or setscrew with your big fingers, and you'll then appreciate the importance of a pair of good tweezers. Borrow from your wife, or buy a new pair.

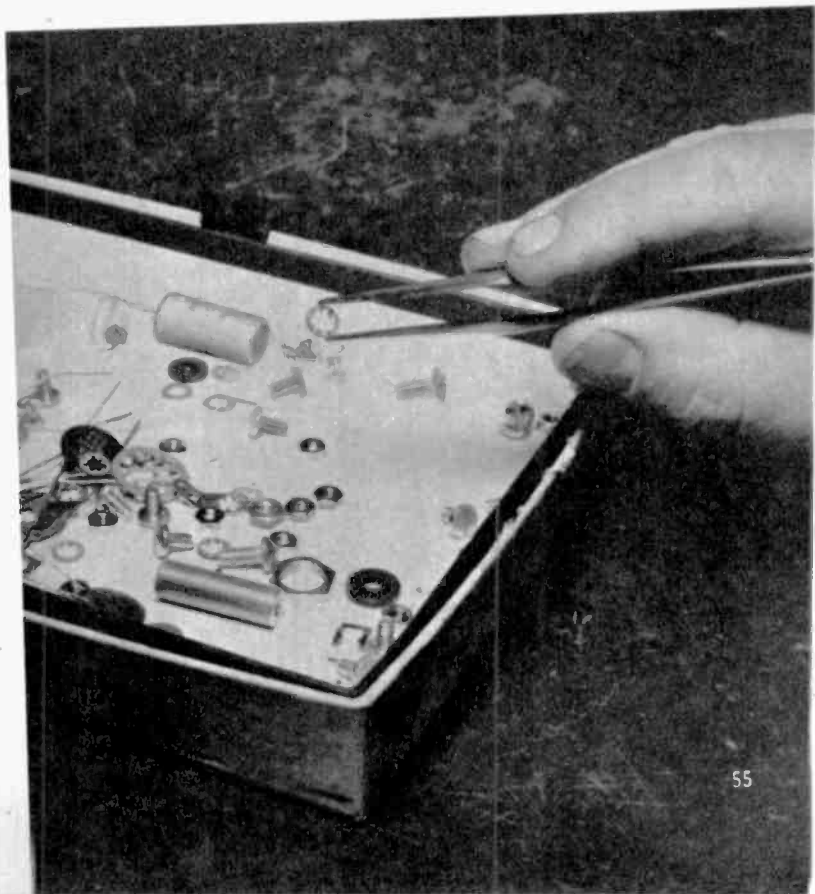

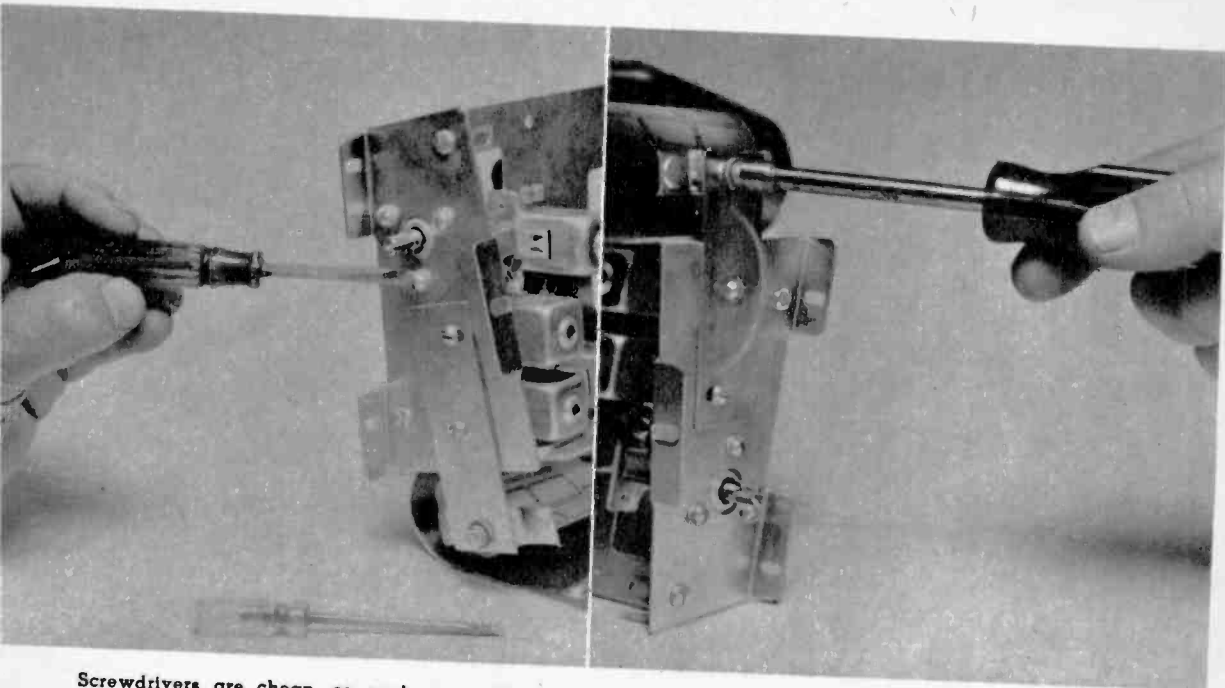

Screwdrivers are cheap, so equip yourself with sizes to fit the various screws furnished with the kit. You'll need at least three: for setscrews, for 6/32 screws, and for 8/32, 10/24, 10/32 screws.

Nut driver is by far fastest and most convenient way of tightening nut-and-screw combinations. Most commonly used size is 1/4 inch, for hex nuts supplied for 6/32 screws; 5/16-inch is useful too.

Below: The mounting studs of volume controls, switches, jacks, etc., use hex nuts usually 1/2 or 9/16 inch across. For tightening these, use fixed or adjustable jaw wrench borrowed from tool kit of car; or, even better, buy nut drivers ("socket wrenches") to lessen the danger of scratching the front panel.

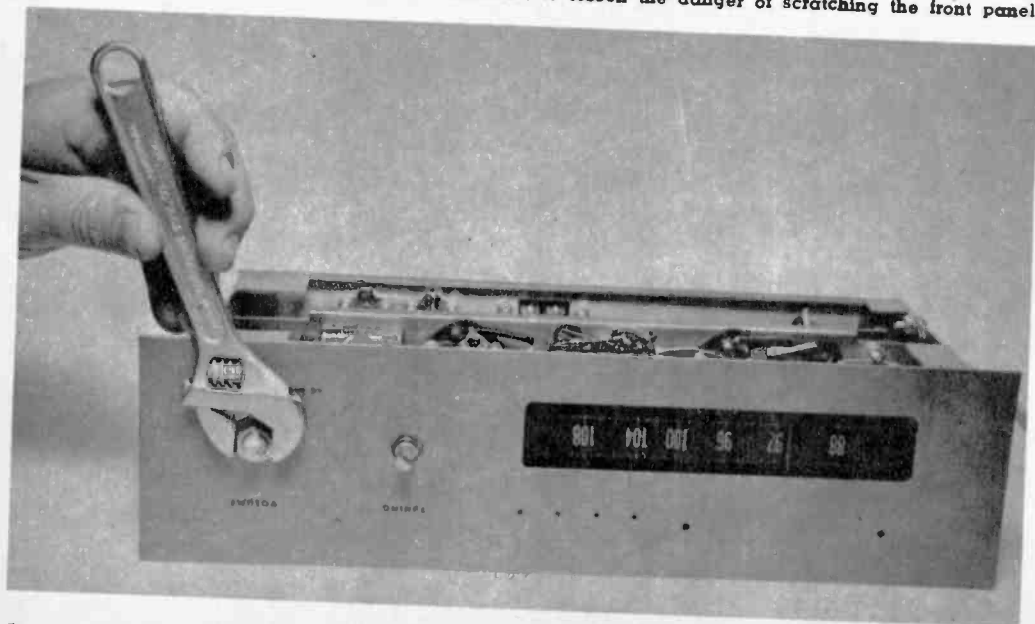

Right: A magnifying glass can be of tremendous help when you are working on printed-circuit boards or other tightly packed assemblies. The glass can reveal any breaks in lines, solder spillover, etc., not always visible to the eye alone. A stamp magnifier is better than nothing, but for a really good, close look a glass that is at least three inches in diameter is recommended for comfort.

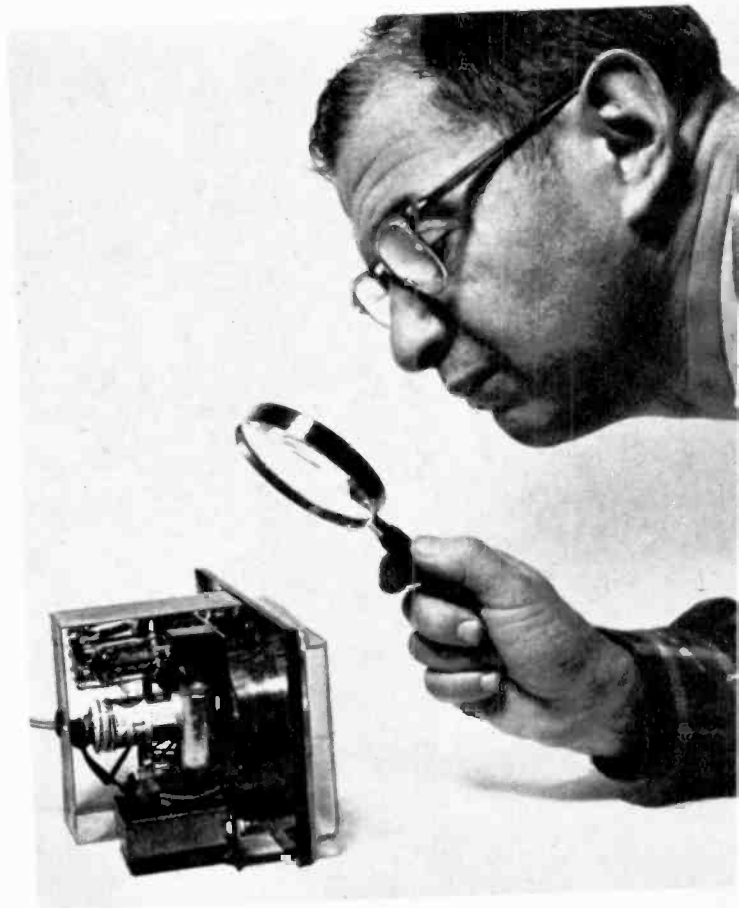

The first time you yawn, or rub your eyes, pull out soldering iron plug, throw a sheet over the worktable and go to bed. Otherwise, you'll start seeing blue for violet on resistors, and .001 instead of .01 on capacitors. Give in and win!

(Note: And for additional hints on assembly and wiring practice, see sections entitled "Keep It Clean" and "The Third Hand," elsewhere.)

Printed Circuit De-Soldering

Specially shaped copper tips facilitate the removal of components having multiple lugs.

CONVENTIONAL HAND TOOLS are quite satisfactory for assembling and soldering components onto printed-circuit boards. However, when that inevitable moment arrives when it is necessary to remove a snugly mounted part such as a tube socket or an electrolytic capacitor, which has several lugs soldered flush with the

surface of the board, the technician or experimenter suddenly realizes that he has a real problem on his hands.

Consider an ordinary "miniature" tube socket having seven or nine lugs. During the original assembly job, the lugs were pressed simultaneously into the matching holes in the board and soldered one by one

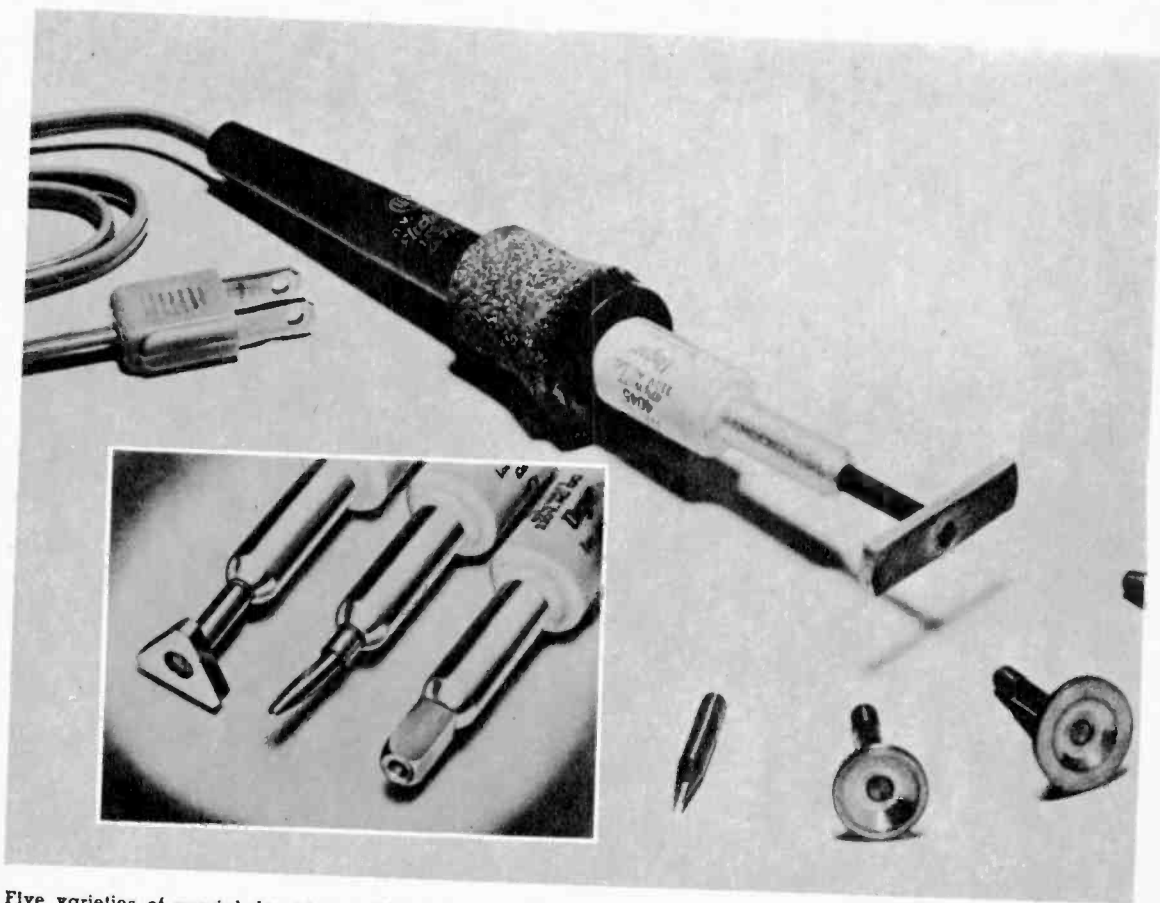

Five varieties of special desoldering "tiplets" made by Ungar Electric Tools, Inc., of Los Angeles. The threaded shanks fit the neck of the soldering iron. In the foreground, right, is a straight slotted tip; next to it, cup tiplets $\frac{3}{8}$ ", $\frac{3}{4}$ " and 1" in diameter. In the iron is a bar, $1\frac{1}{2}$ " by $\frac{3}{8}$ ". Shown in insert are three more tiplets for printed-circuit board desoldering. Triangular member is designed for electrolytic capacitor leads arranged in triangular fashion. Offset slotted tip is useful for straightening, holding or pulling wires close to board surface. Cube tiplet, right, has center clearance hole for protruding lugs.

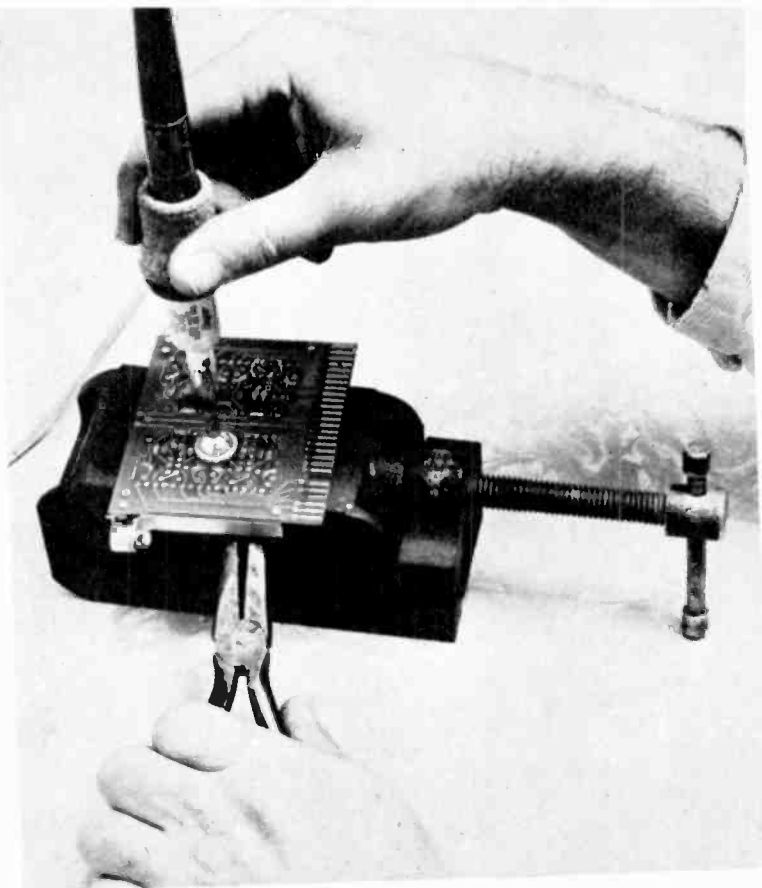

Removing an entire tube socket from a printed circuit is easy if you use a cup tiple. The board is supported in a vise. Socket body is gripped from the top side with long-nose pliers. As tiple melts solder on all lugs at the same time, sockets can be pulled off very smoothly.



Multiple in-line terminals yield quickly to the heat of the bar tip. This view is phantomized to show the component on the top side of the printed circuit board.



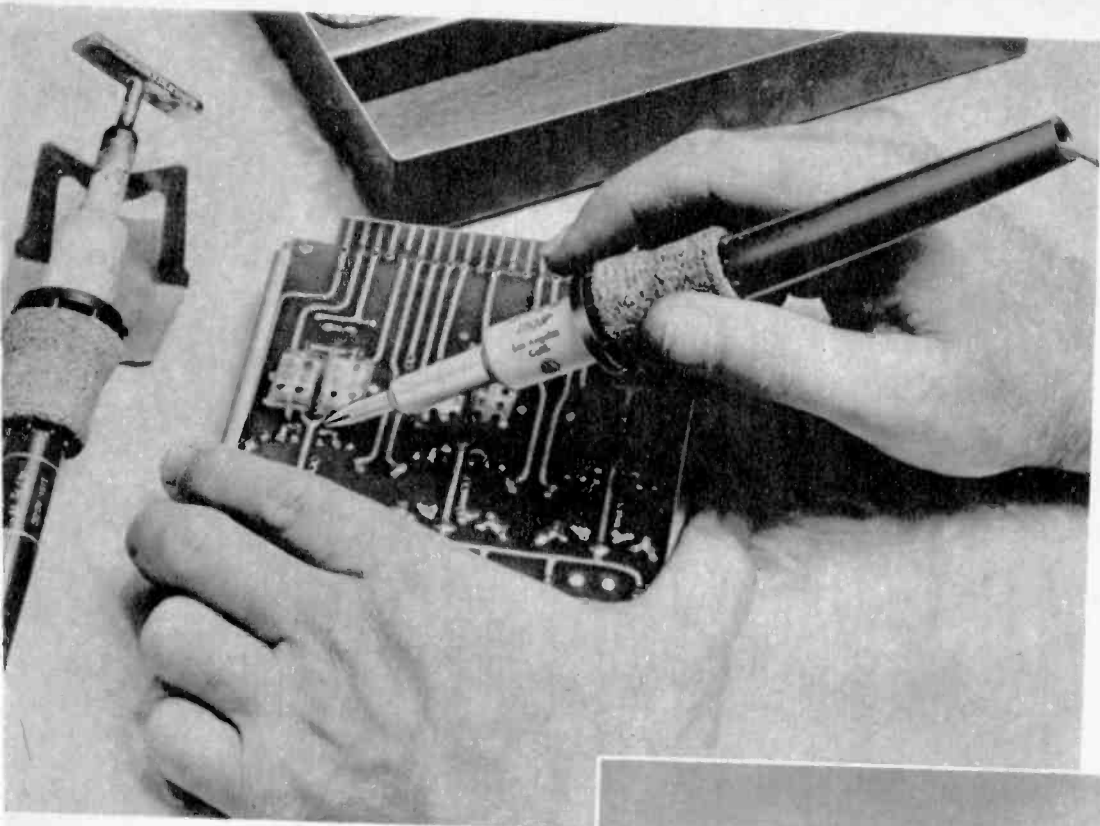

With a slotted tiplet placed over the wire lead, solder at the joint will melt very quickly; a half twist of the tool and the lead comes out. In this photo (above) a small capacitor is being changed.



Problem: removing single small resistor from a crowded board without damaging neighboring resistors or transistors. Slender slotted tiplet does the job in about three seconds, and without pliers.

to the respective metal lines on the board. If you try to reverse the process, you find that it is extremely difficult, and often impossible, to open all the solder bonds with an ordinary iron applied to one lug at a time. In fact, if you tug at the socket a little to loosen some of the more stubborn lugs you are likely to break them off or cause damage to the lines.

What is obviously needed is a series of specially shaped soldering tips that could heat all lugs of a component *at the same time*, and thus permit it to be wiggled a trifle and pulled free while the solder at all the lugs is in the same molten condition. Some service technicians have attempted to make their own, but the job calls for machine tools not usually found in electronic labs or shops.

Happily, the Ungar people, whose screw-in type pencil soldering irons are found in practically every radioman's tool kit, have come to the rescue with a set of

ingenious little "tiplets" of very low cost. There are three sizes of cup shaped tips, for various sizes of tube sockets and IF transformers; a triangular piece, for electrolytic capacitor lugs; a rectangular bar, for components such as resistors mounted in a straight line; a cube tiplet, with a hole through the center, for individual pins or wires in very cramped spots; and a simple slotted tip for handling individual wires. The accompanying photographs show how they cure many de-soldering headaches.

The slotted tip is useful for initial soldering as well as de-soldering. By feeding the solder through the slot, rather than to the very end of the tip as is the usual practice, you can confine the molten metal to the immediate area of the connection and prevent it from spilling over to adjacent lines. This is an important advantage with printed boards having very closely spaced lines. The tip also can be used for twisting wires into or out of position. •

A break in a printed circuit line? Bridge with bead of solder, laid down like this with slotted tiplet. A trick that saves many a damaged board!

The slotted tip is very useful in making and removing the connections in most conventional electronic equipment as well as on printed boards.

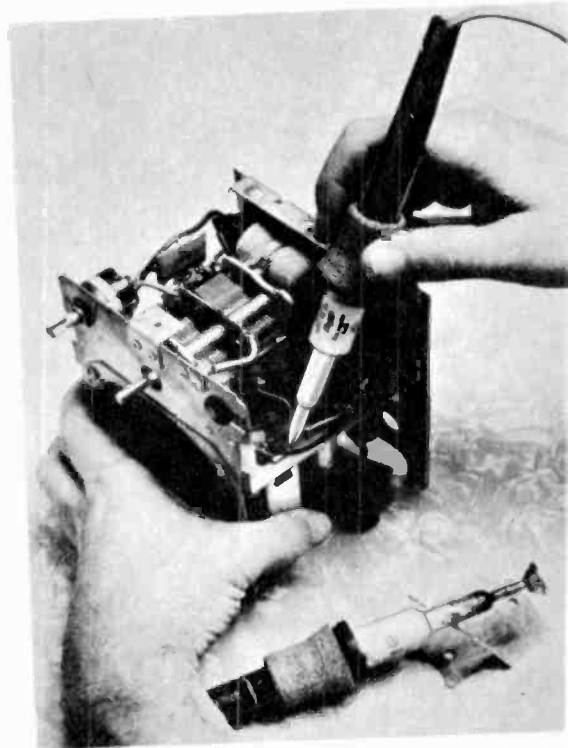

Combinations of tiny disc capacitors and carbon resistors are widely used in electronic circuits. There is a trick to soldering the leads close to the bodies without damaging anything. Shown at the right is a photograph of an ordinary paper clamp being used to act as an effective "heat sink" to drain off some of the heat from the iron lead.



The Third Hand

These excellent tools are so handy that they will become a part of you.

"If I only had a third hand I could finish this project in half the time it's taking!"

Every worker in the field of electronics has probably voiced this remark at one time or another. The need for a "third hand" is particularly urgent in soldering operations. One hand is required for holding the solder, the other for the iron, and this often leaves the joint or connection dangling without control.

With the increasing use of transistors, an artificial third hand is important for another purpose: to act as a "heat sink." A heat sink is any body of metal held against the leads or body of a transistor (or of any other heat-sensitive component, for that matter) to absorb some of the heat of a soldering iron and to allow only enough to

pass to the leads to melt in the solder. The instructions that accompany transistors often call for a pair of pliers "in contact with the wires." This is a good trick if you can do it, inasmuch as pliers stay closed against the wires only if you squeeze the handles, and this in turn means dropping either the solder or the iron.

Obviously, the third hand, to be practical, must be self-locking. Radio jobbers now sell a variety of special tools of this type. They are inexpensive, easy to use, and save not only time and temper but many a ruined component and not a few burned fingers.

There are also some very common objects you're likely to find around the house that serve excellently as third hands. The paper clamp shown in the above

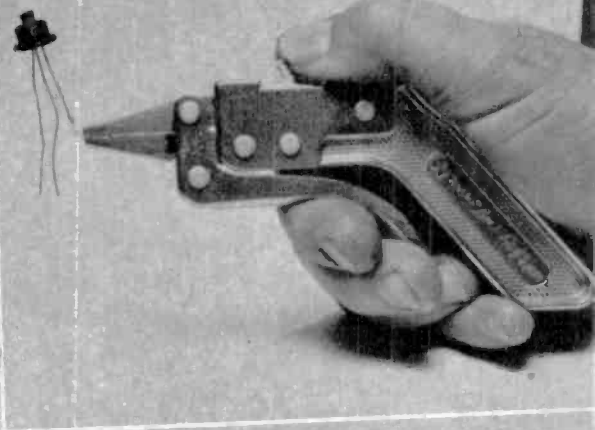
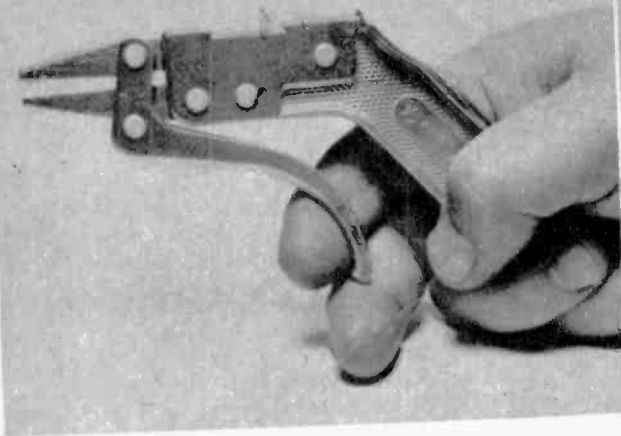

It looks like a gun, but it's much more useful than one! This is a very ingenious "third hand," called the Lock-GriPlier. The jaws are spring-loaded and normally are open. The lower one is riveted to the body, and the upper one is hinged. To close jaws temporarily, merely squeeze "trigger" and hold it; relax your grip and they open. Little projection along the top of the body (it looks like a gun sight) is the locking key. With the jaws closed, as in the picture immediately below, you simply push it forward, and the tool is solidly locked. Thumb key backward, the next photo to the right, and the jaws pop open. The inner surfaces of the jaws are serrated in two directions, and take a firm grip on thin, round wires such as transistor leads. The Lock-GriPlier is made by X-Acto, Inc., whose knives and other special tools have been used by generations of model builders.

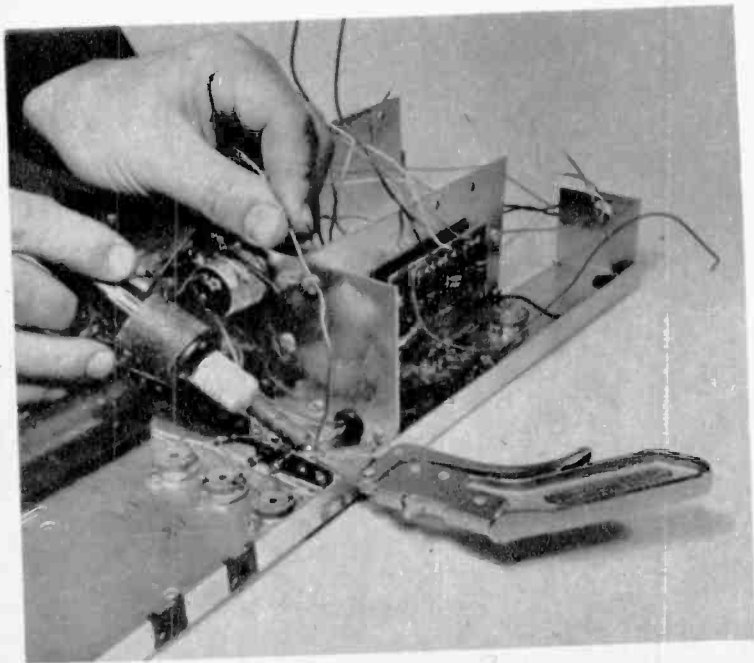
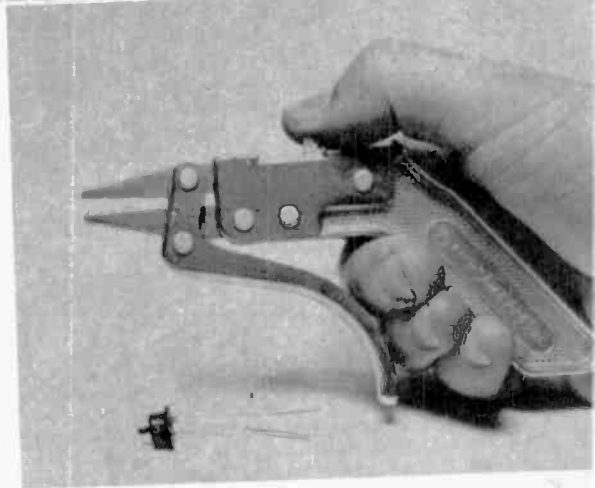

As a heat sink, the Lock-GriPlier will pay for itself on the very first job. It attaches itself firmly to the wire, soldering lugs, terminals, etc., and its relatively massive jaws will take up any excessive heat that might otherwise cause very serious damage to the components which are being soldered. This locking action is also very useful for holding springy wires firmly in position for soldering even when the heat-sink action is not the important problem.



Pivoted near ends, jaws of this inexpensive tool are spring-loaded to be closed normally. To open the jaws to grip objects easily, squeeze handles. This tool makes a generally useful third hand. It is also a very good heat sink.

Ordinary spring-action clothes pins are fine third hands when firm holding action is needed with heat-sinking. For example: to hold two wires together, and to keep them parallel for soldering to make a joint with the minimum bulk around joint as is shown in the photograph below.

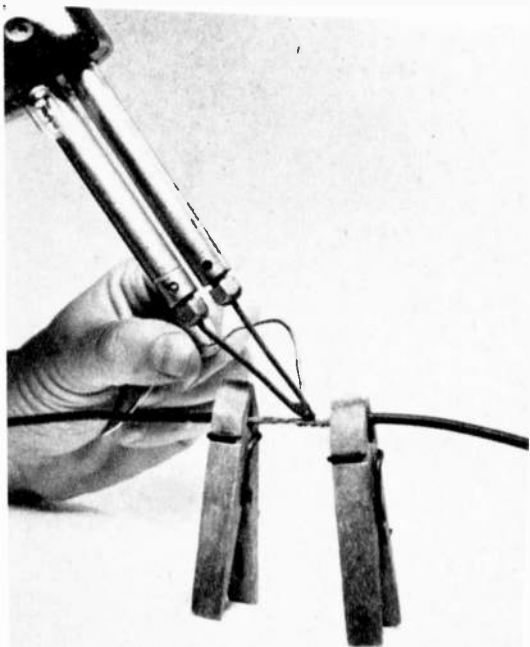

picture is a good example. It has broad jaws, a powerful spring, and a large area of iron to soak up excess heat. With light parts such as the capacitor and resistor combination, it is self-standing. It can also be steadied in a vise, or it can be stuck in the guts of a chassis to hold components.

When only holding properties are needed, and not heat absorption, ordinary paper clips, rubber bands, string and sticky tape of various kinds often serve as emergency expedients.

Sometimes it is necessary to support a heavy unit such as a transformer in an awkward position, in defiance of the laws of gravity, while mounting hardware is being assembled. This might call for a fourth hand as well as a third; C-clamps often can be pressed into service.

Third hands intended primarily for soldering jobs are also very useful for holding and retrieving very small parts, particularly lock washers and soldering lugs. These have an annoying habit of falling off a screw just as the nut is about to be put on. •

Ordinary tweezers are all right for picking up things, but a locking pair makes an extremely versatile third hand for small parts. A button sliding through slots in the handles makes the jaws tighten up. This tool is made by Walsco. You can get this tool in many different sizes.

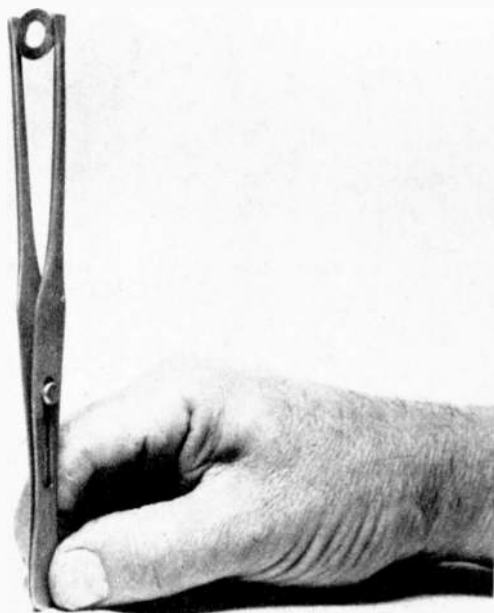

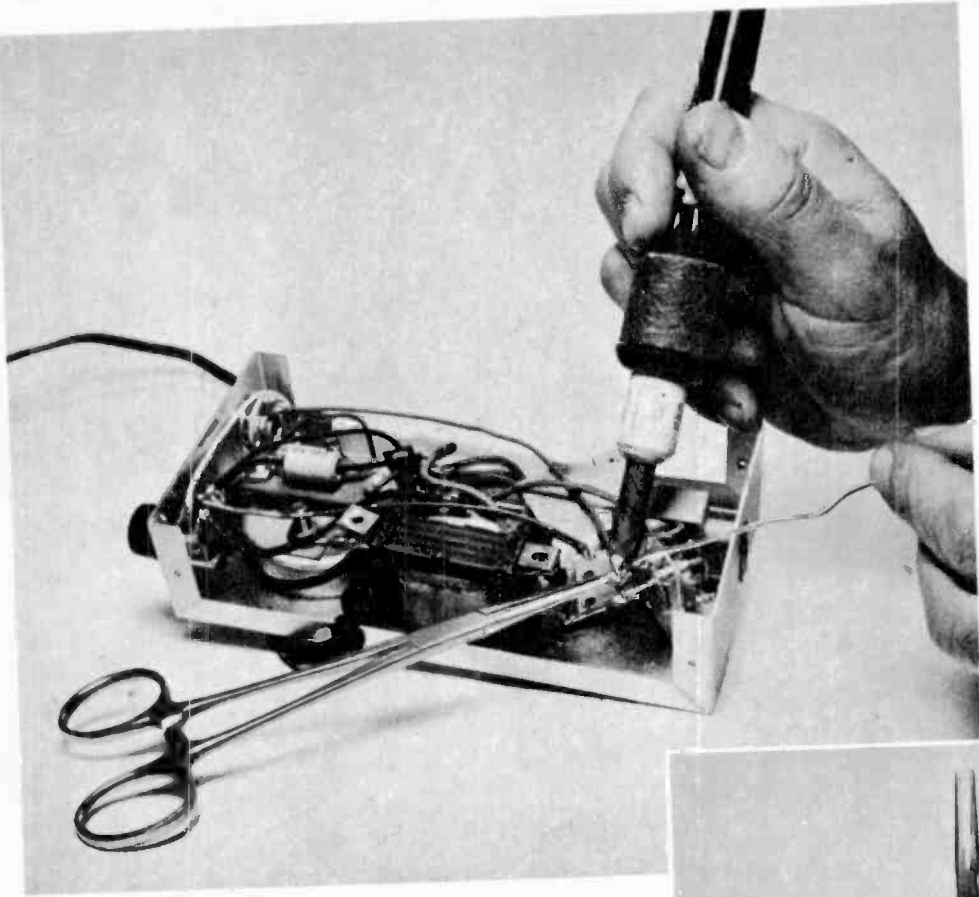

The third hand shown in these photographs is the Xcelite "Seizer." Precision made of fine stainless steel, with a very accurately machined jaw. It looks like a surgical tool, which is precisely what it is. The positive locking action is furnished solely by V-shaped teeth on the little extension from the handles. Above: The Seizer is especially good as a heat sink for the delicate parts which do not offer very much gripping surface. The jaws hold firmly on wires as thin as human hairs. The center photo shows the tool open. The picture at the bottom of the page shows the jaws locked on a 4/48 nut, which is difficult to hold with the fingers because it is so small. Long and slender, the Seizer is almost invaluable as a tool for both installing and removing wires and any other small hardware in this type rats' nest chassis.

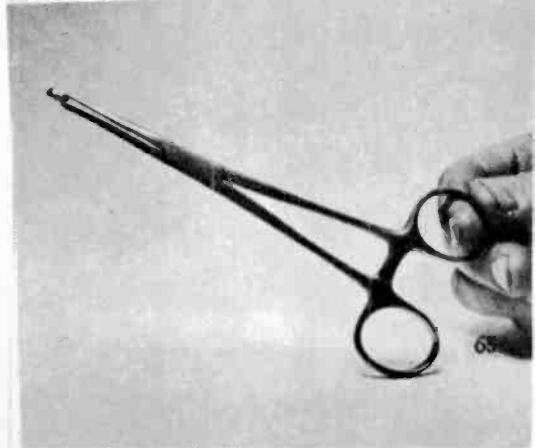
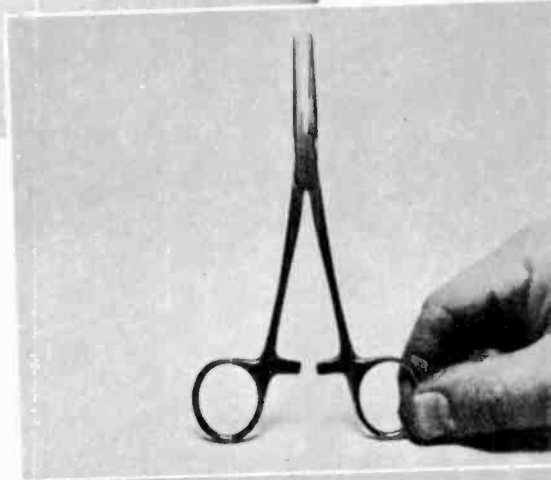

Keep It Clean!

Here are some ideas on the care of the most precious tool you own—the soldering iron.

Before using each time, examine the tip closely for signs of pitting. With a very fine file, smooth the surface carefully on all faces, using light strokes. Also scrape the body of the tip with the edge of the file to remove any scale. As the iron warms up, apply rosin-core solder, which will flow over the clean tip and "tin" it with a layer of clean, bright metal. Additional light filing is usually necessary after a couple of hours of continuous use. Pencil-type iron with screw-in tip is shown in the photo.



"Tip" of gun type soldering iron is loop of copper wire. This corrodes with use, and needs occasional touching-up with a file. Wire is soft and bends readily, so don't press too hard with file on tip.



Between filings, a hot iron requires frequent cleaning to remove excess flux and light scale. Useful for the purpose is a brass-wire brush of the kind sold for the cleaning of suede shoes. A couple of quick swipes of the tip against the bristles does wonders for any soldering tool.

KEEP IT CLEAN! There in three words you have the secret of successful soldering. If all builders of electronic equipment followed this terse advice, they would have little or no trouble with the wiring of receivers, transmitters, test instruments, hi-fi amplifiers, etc.

All soldering "irons" actually have tips of rather soft copper. As the metal heats, it gradually combines with the oxygen in the air and burns up, at the same time becoming dirty and scaly. Molten solder will not adhere to the dirty surface, and the copper will refuse to "tin." With prolonged

use, the tips become pitted. Frequent filing, with a fine-toothed file, is therefore imperative. The accompanying photos show some simple and effective ways of keeping an iron in top operating order.

Warning! Some of the screw-in tips provided with irons of the handy "pencil" type are made of iron, and are intended for leather and wood burning, not for soldering. Rosin-core solder applied to an iron tip merely forms beads that roll off like drops of water on a waxed surface. When buying a new tool or tips for an old one, be sure to specify copper. •



Another good cleaning agent is ball of steel wool in shallow container. Push iron (above photo) into it, twirl quickly, and tip comes out like new.



Drawing tip of iron across folded rag is an easy way of keeping the tip clean. Do with a quick, careful motion, to prevent the rag from burning.

A new idea in soldering: A shallow tray contains a special sponge kept wet with water. It's the Ungar "Kleen-Tip." Wipe iron across sponge to restore bright "tinning" without danger of contaminating copper. Contact with sponge is brief.

These "knights of the soldering iron" get pleasure out of working on Knight-Kit short-wave receiver with clean, well-tinned iron. Man-sized 100-watt tool has tapered tip that puts solder into tight as well as open joints. Result: good "clean" reception.



Small Meter Does Many Jobs

Handy gadget comes in kit form,
is easy to build and fun to use.

For DC voltage checking in radio chassis, technique is to ground negative test lead by means of alligator clip and to touch positive probe to points where voltage should be present. Long, insulated handle of probe protects against shocks.

BY FAR THE MOST USEFUL test instrument used by experimenters, amateurs, engineers, service men and other electronic workers in every category is the volt-ohmmeter, usually called the "VOM." It consists basically of a sensitive direct-current ammeter (short for "ampere meter"), which is made to read various ranges of DC current and voltage by the addition of resistors of various values connected in parallel or in series with it. For AC voltage measurement, a small rectifier is included in the circuit to change the AC to DC. As an ohmmeter, for the measurement of resistance and for checking the continuity of components or wiring, the meter is connected in series with a small battery; it shows a reading in proportion to the resistance inserted between the meter proper and the battery.

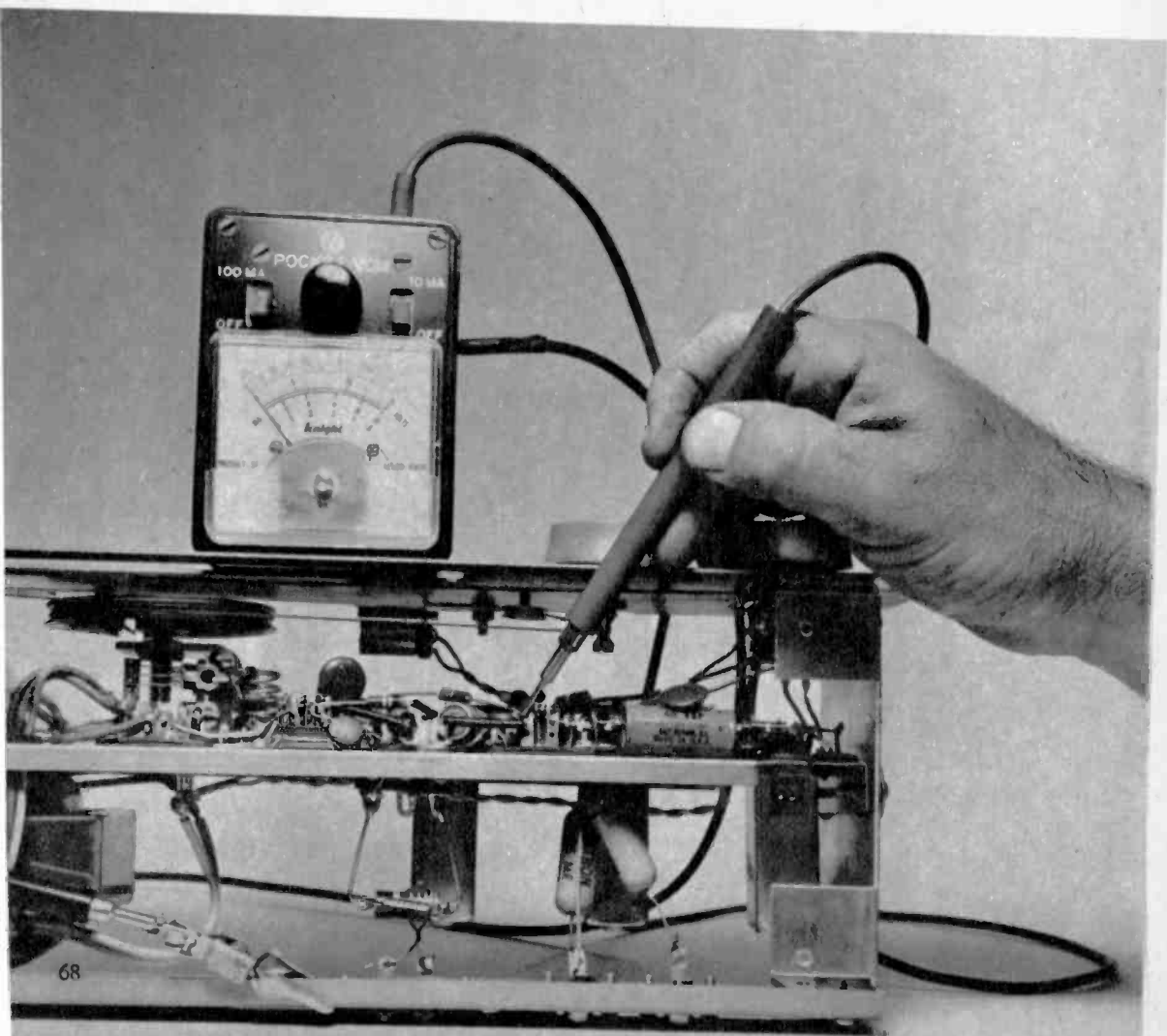

A more sensitive and advanced form of VOM is the vacuum-tube voltmeter, or "VTVM." This uses a tube to amplify the voltages undergoing measurement.

Basic VOM's and VTVM's, in kit form for easy assembly, cost between about \$25 and \$30. However, it is entirely possible for economy-minded people to enjoy most of the features of these meters for much less: \$10, to be specific. This is the price of the Knight-Kit "2½ Pocket VOM," an excellent little instrument that I have found useful and convenient for many everyday jobs of electrical-circuit investigation.

It would be unreasonable, of course, to expect a \$10 product to equal a \$30 product in characteristics. Nevertheless, this handy meter (and it is just a handful) will more than serve the requirements of most beginners in electronics. Furthermore, it

makes a fine supplementary tool for the man who already owns a fine bench type meter and doesn't like the idea of using it for what might be called rough work.

The "2½" in the name designates the size of the meter face in inches. The entire VOM measures only 2⅞ by 4 by 2 inches overall and weighs about nine ounces, and it really can be carried in a pocket.

The schematic diagram shows how the multiple functions of the VOM are brought into play. The double circles marked J1 through J12 are pin jacks mounted around the top and sides of the instrument case; into these are plugged the small ends of two test leads or "probes," the other ends of which are touched or connected to the circuit or part under test. For DC voltage measurement, probably the meter's most frequent application, the negative probe

Tubes can be checked for filament burn-out in a few seconds with test leads in resistance jacks on meter. Good filament reads a little above zero ohms; open filament doesn't budge needle.



Transistor portables depend on batteries for all energy. Voltage check with Pocket VOM, with the set turned on, should be performed fairly frequently.

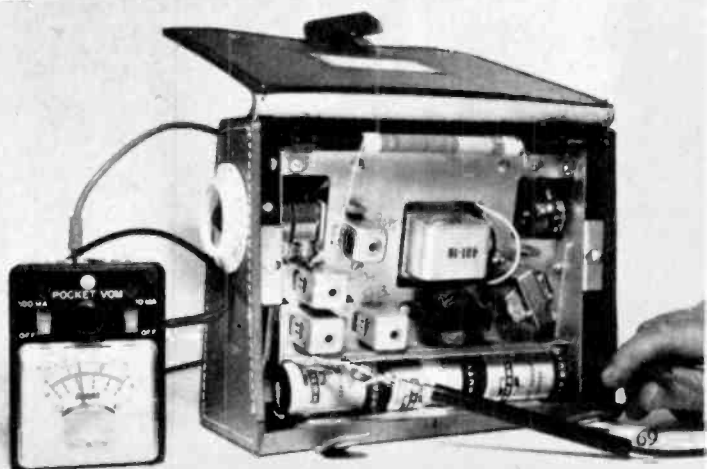

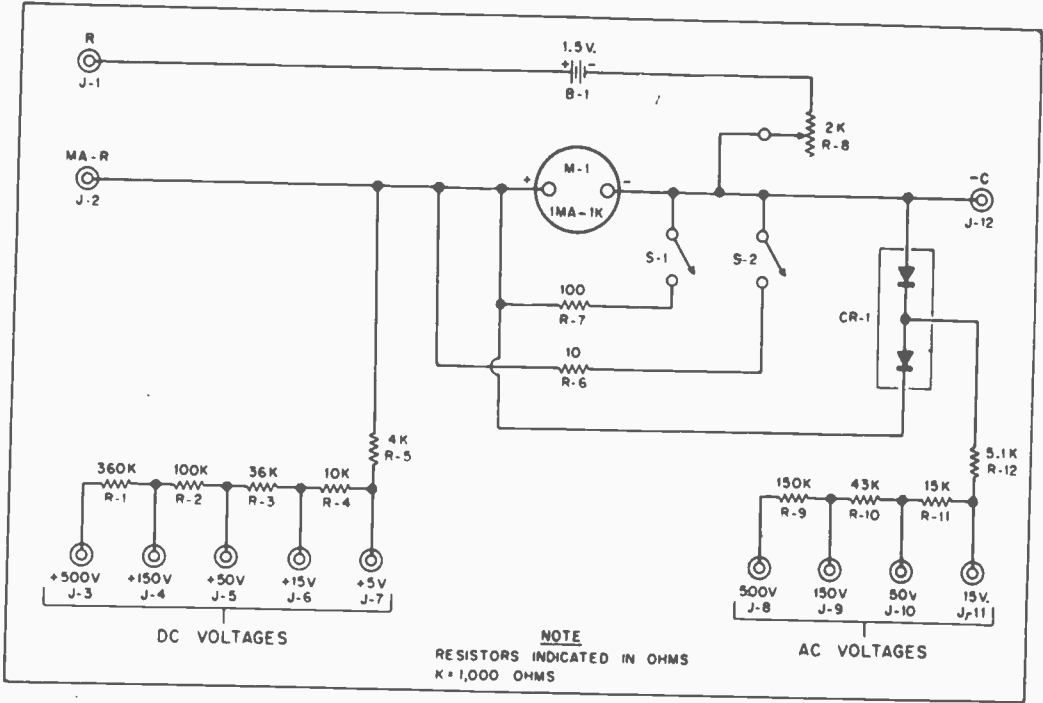

The schematic diagram above shows the very simple internal connections of the Pocket VOM. The battery B-1 is used for resistance measurements. As it ages, the value of the rheostat R-8 is reduced so as to permit the meter to be "zeroed" when the test jacks J-1 and J-2 are short circuited. CR-1 is an AC rectifier. The switches S-1 and S-2, seen in the center of diagram, are located on front panel.

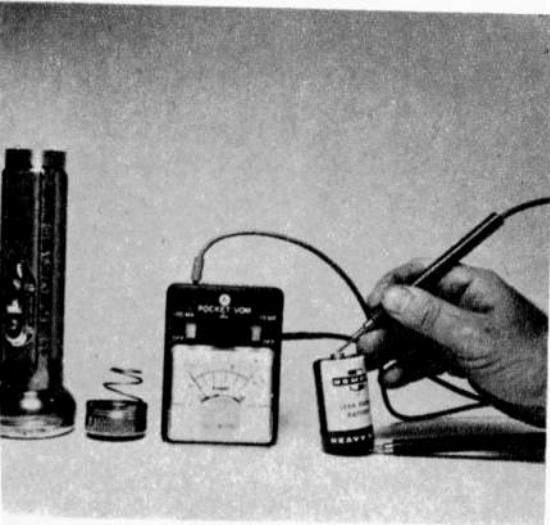

Flashlight batteries can expire unexpectedly. A voltmeter test reveals trouble quickly. New cell measures 1.5 volts; will give light at 1.2 volts. When it reads nothing, it's ready for trash can.

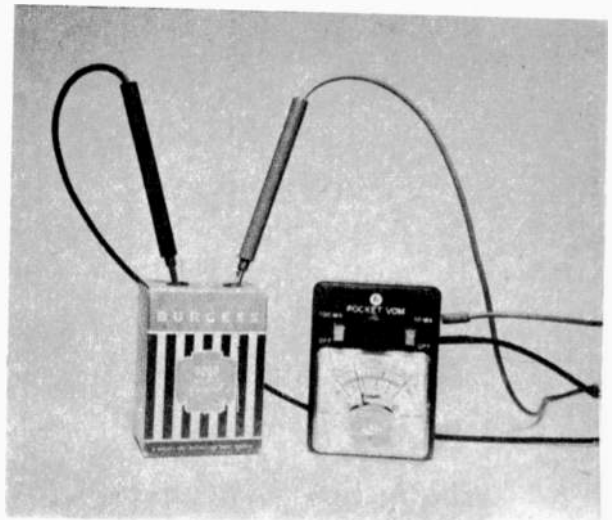

This 300-volt "B" battery came out of an electronic photoflash unit that hadn't been used in more than a year. The lamp wouldn't flash, and with reason: Meter reads only about 160 volts.

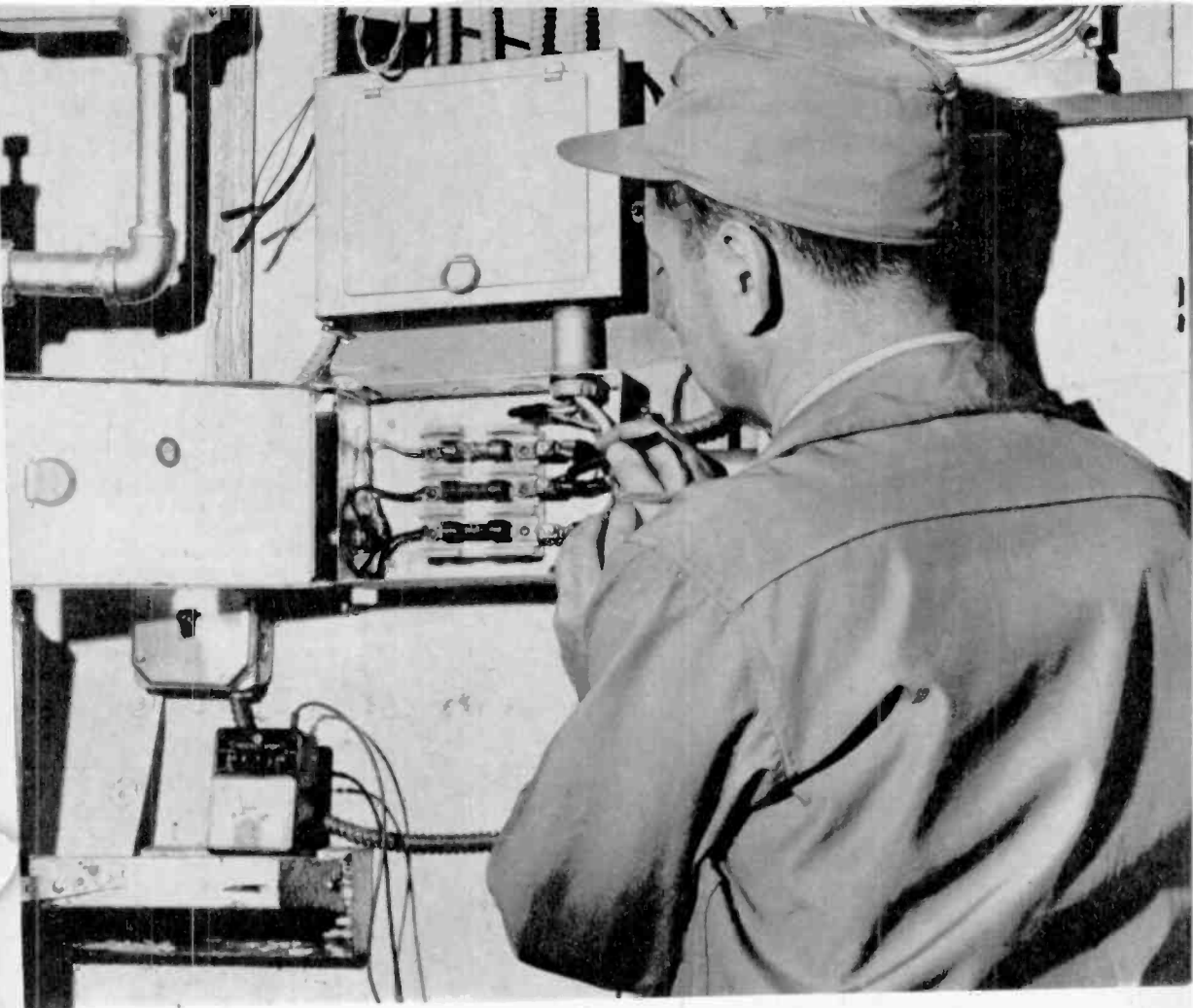

Trouble in the house power lines? With the Pocket VOM set for 150 or 500 volts AC you can readily tell if your circuits are dead or alive, and the voltages on them. A continuity check with the meter tells in an instant the condition of fuses. They may not look burned out, yet are.

Some household electrical appliances (those using high-speed motors), develop dangerous "grounds" between internal wires and outside metal case. Set Pocket VOM for resistance measurement. Turn appliance on, connect leads between frame and prongs of plug. Grounding shows as reading on meter. see photo.





Pocket VOM is ideal for trouble-shooting in a car's electrical system. It checks voltages of battery and charging generator, wiring continuity, fuse condition, and unwanted "grounds" to vehicle's framework.

goes to J-12 (upper right section of diagram); the positive probe goes to J-3, J-4, J-5, J-6 or J-7, depending on the range of voltage expected.

The meter itself, M-1, deflects full scale with a current of one milliamper through it. The values of the series multiplier resistors R-1, R-2, R-3, R-4 and R-5 have been chosen so that the voltages marked along the row of jacks produce a maximum of one milliamp in the meter and therefore full scale deflection. For example, with the 4,000-ohm resistor R-5 between J-7 and the meter, five volts applied to J-7 and J-12 pushes the meter needle to the top; $2\frac{1}{2}$ volts moves it only half way, and the other voltages between zero and five move it proportionately.

The meter face actually is marked with three scales, reading 0-5, 0-10 and 0-15. The 0-10 scale is used only for current measurements, as will be described later. For 5-volt and 15-volt measurements, the 0-5 and 0-15 scales are read directly. For

50-volt measurement, the 0-5 scale figures are multiplied by 10; for 500-volt purposes, the same scale is multiplied by 100. For 150-volt readings, the 0-15 scale is multiplied by 10.

Four AC voltage ranges are similarly available between J-12 and jacks J-8, J-9, J-10 and J-11. CR-1 is the rectifier that permits only one-way current passage to the meter.

I compared these DC and AC voltage scales against an expensive VOM, and found them surprisingly close; quite accurate enough for 95% of the measuring one is likely to do in radio receivers, transmitters and high-fidelity amplifiers.

For continuity and resistance checking, the test leads are plugged into jacks J-1 and J-2, their ends touched together, and the rheostat R-8 adjusted so that the meter reads zero. Any resistance inserted between the probes will then make the meter read a lower value. The top scale, in red to distinguish it from the others, is cali-

Parts of Knight-Kit Pocket VOM are few. The assembly should take about fifteen minutes, the wiring another forty-five.

The pencil points to the multiplier and shunt resistors, soldered directly to the tip jacks on case of meter. At the left is the panel assembly. A single penlite battery, for resistance measurement, is clamped to the back of the meter body, as shown here.

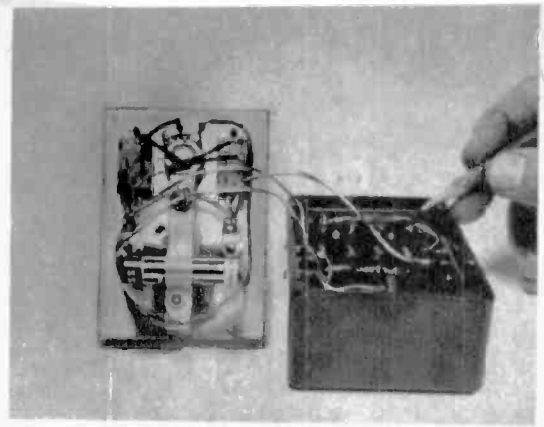

brated to read from 0 to 30,000 ohms. The first scale division up from 0 is 100 ohms, so low values between 100 and a dead short circuit can only be approximated. There is a small range of movement between 30,000 and infinity, or open circuit, at least enough to show that the resistor or circuit under test is more than 30,000 ohms but not entirely open.

With the test leads connected to J-2 and J-12, the meter functions as a milliammeter. If switches S-1 and S-2 are left open, the 0-10 scale is used, with the readings divided by 10; that is, the decimal point is moved one place to the left and the full-scale deflection is one milliamp. With switch S-1 alone closed, the 100-ohm resistor R-7 is shunted across the meter, and the needle now reads to 10 milliamps on the 0-10 scale. With switch S-2 alone closed, the 10-ohm shunt resistor R-6 is added to the circuit, and the meter now reads on the 0-10 scale multiplied by 10, for a maximum current of 100 milliamps. •

Highly useful accessory for negative test probe is an alligator clip. Connected to one side of circuit or part under test, this leaves one hand free while the other holds the positive probe.

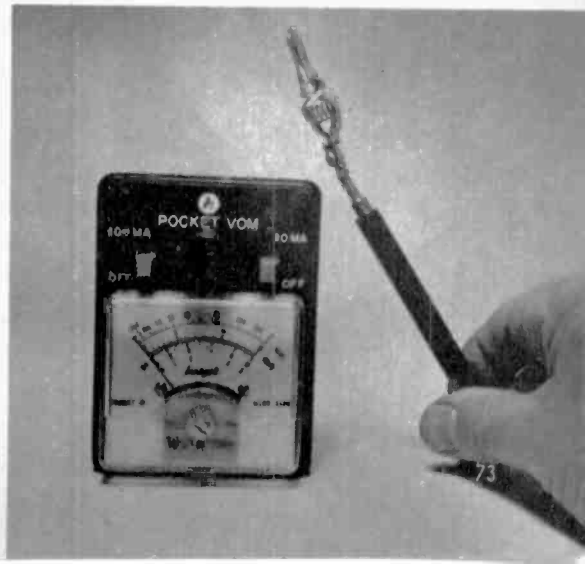

Clock Radio Works Anywhere

About the size of a thick book, the clock-radio is an easy handful to carry. In its two-tone plastic case, it measures only 8 inches wide, 7½ inches deep, and 3½ inches high. Small knob at extreme left is "lull-to-sleep" control; next one is the on-off switch. The tuning knob is at far right.

VERY QUICKLY after its introduction a few years ago, the transistor brought about a complete revolution in the design and construction of portable radio receivers. This was a natural development, in view of the transistor's ability to work satisfactorily with small low-voltage dry batteries.

While the energy source is no problem in sets intended for interior use in homes, offices, shops, etc., battery-operated transistor receivers now are gradually pushing AC-operated table-model tube receivers into the background. Being completely self-contained and comparatively light and compact, these "cordless" sets are proving unexpectedly convenient and advantageous for everyday reception of AM broadcasting stations.

An important feature of transistorized receivers is their 100% safety factor. Not connected at all to the potentially dangerous house power line, and working on battery voltages between about six and nine, they are absolutely harmless to young and

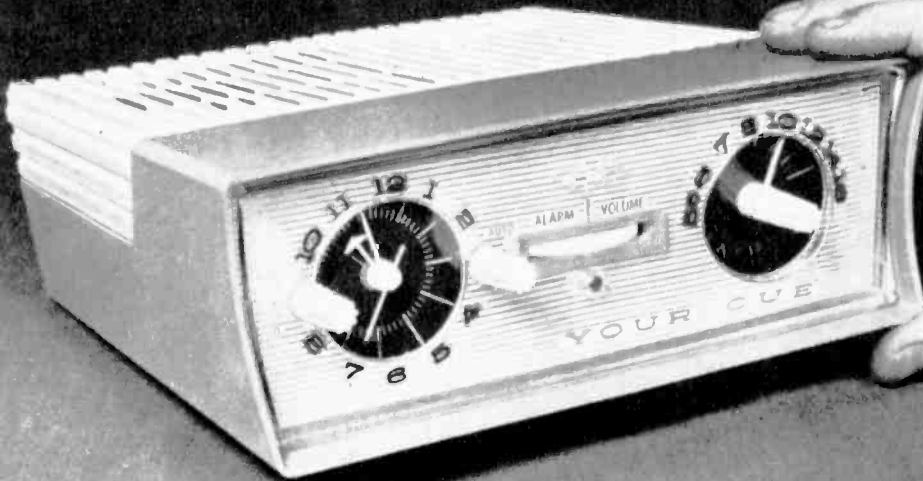

old alike. (It is a matter of sad record that the common "AC-DC" hot-chassis radio has killed and injured many innocent victims.) With complete impunity, you can use a transistor job in the bathroom, the kitchen, the laundry, or any other wet area.

There's a difference between the transistor "portable" and the transistor "cordless." The former is usually built down to minimum size for ease of carrying. Its necessarily small loudspeaker (actually smaller than some standard earphones) is tinny and squawky and the reproduction is often barely intelligible. The latter can contain a respectable speaker, as large as 4 by 6 inches, and its audio quality is therefore far superior.

Small transistors are still somewhat limited as to power-handling capacity. Fortunately, however, very little electrical power in the audio section of a receiver produces considerable sound from the loudspeaker. A typical set has a rated audio output of about $\frac{1}{4}$ watt. This doesn't look like much compared with the 10, 20 and 30

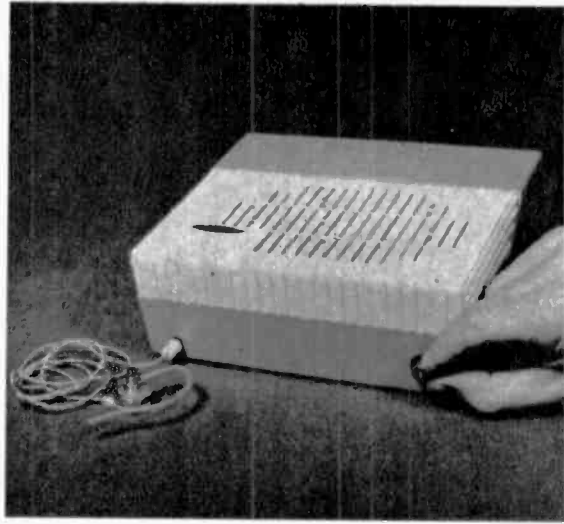

At the back of the receiver, left, is miniature jack for the connection of an earphone for "private" listening. At the right is the clock alarm-set knob.



An invaluable bedside companion, transistor clock-radio provides news, weather and music, tells the time, acts as an automatic alarm clock. It can be kept in a table drawer when not needed.

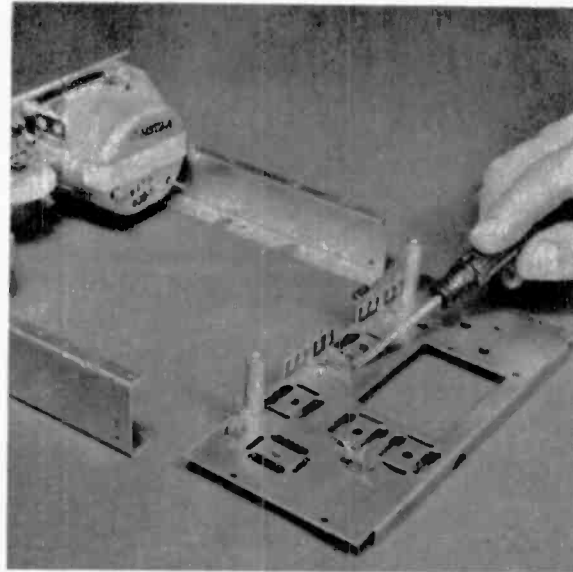

Initial assembly of clock-radio from kit. Tuning capacitor, clock and volume control have been fastened to the front panel, along with side supports for flat chassis, as shown in foreground.

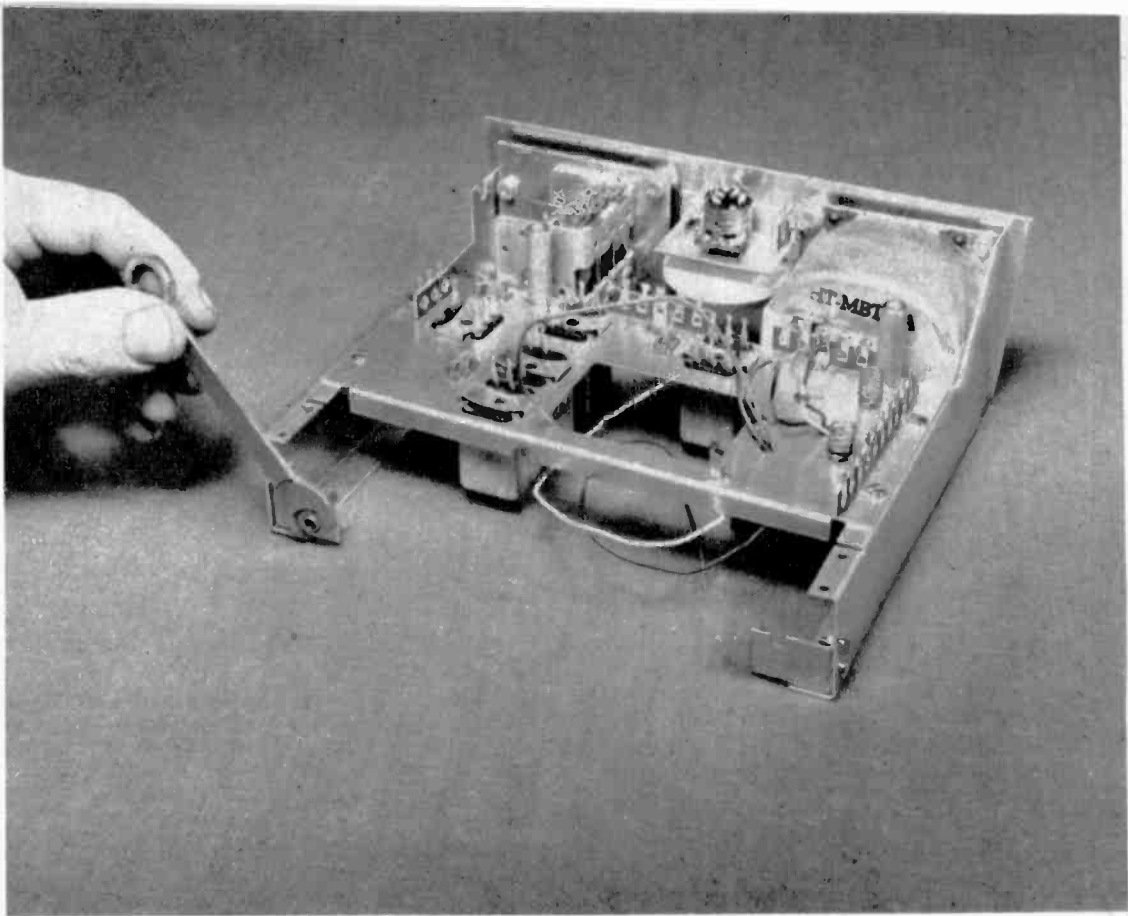

Below: complete schematic diagram of Heathkit Clock Radio. Signals picked up by rod antenna (far upper left) are tuned by first section of three-gang capacitor, indicated by dashed lines, and fed to base of 2N544 transistor, acting as RF amplifier. Output of latter, from collector element, goes to RF coil TD 52-30, tuned by second section of capacitor. RF signal induced in secondary terminals 6 and 1 goes to oscillator-mixer transistor 2N374. Oscillator coil TG 40-199 is tuned by third section of the aforementioned three-gang capacitor to frequency 455 kilocycles higher than incoming, amplified signal.

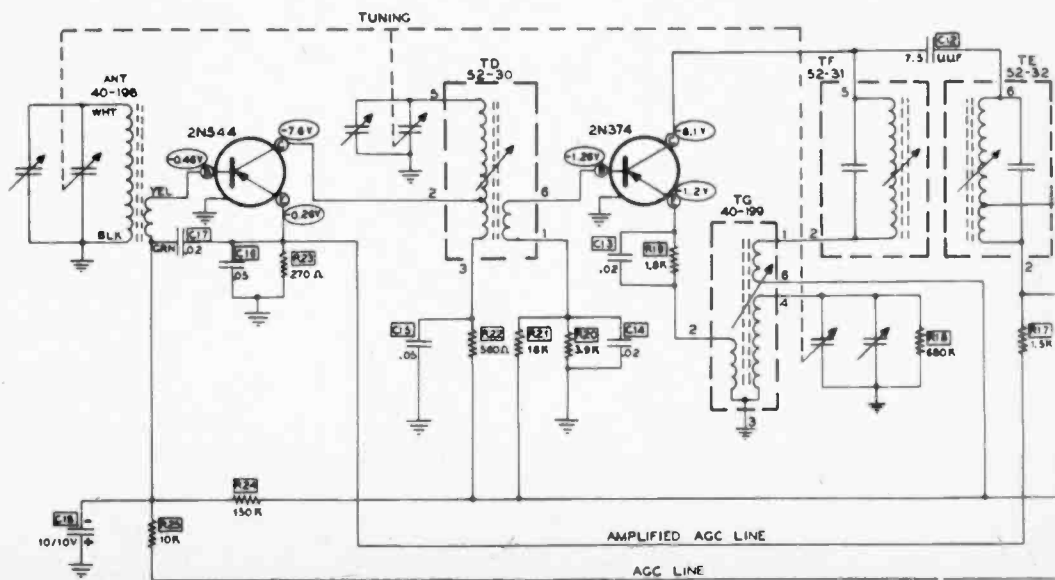

IF transformers, transistor sockets and terminal strips have been mounted on chassis, which in turn is positioned on side supports. Earphone jack is being tightened with small erd wrench. Blank space (rear) is for battery holder.

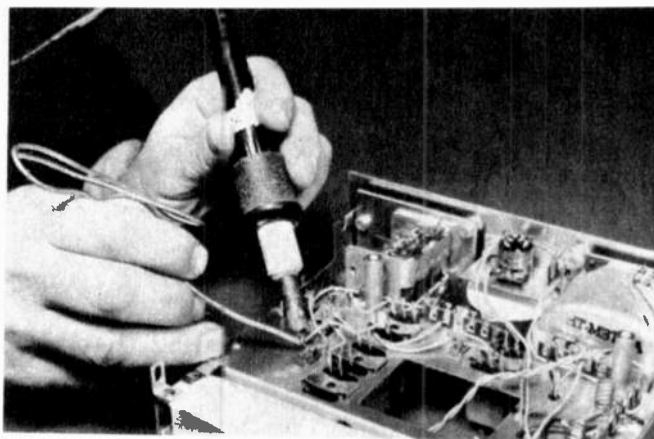

White plastic battery holder has been added to rear of chassis, and half the wiring is in. Pencil-type iron is being used to solder wire to tiny transistor socket. Opening is for loudspeaker to be added.

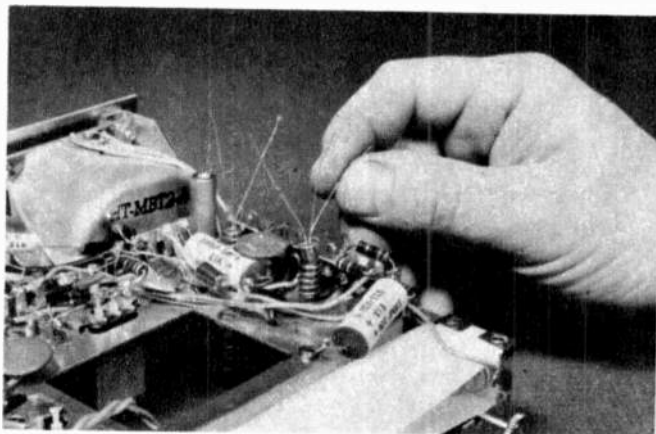

Close-up of right end of chassis, showing two power transistors in coil-spring "heat sinks." Long leads will go to the lugs on the terminal strip.

Difference between this signal and the oscillator output comes out of the 2N374 as a 455-kc signal, which goes through the IF amplifying stage consisting of IF coils TF 52-31 and TF 52-33. The latter contains diode rectifier, which acts as second detector and recovers audio modulation from the signal. This is amplified by transistor 2N408, feeding push-pull output stage of two more 2N408s. Alarm-volume switch is a DPST unit on the shaft of the volume control R11. In closed or "volume" position, the amplifier functions normally. For "alarm," use the top right 2N408 feeds tone to speaker.

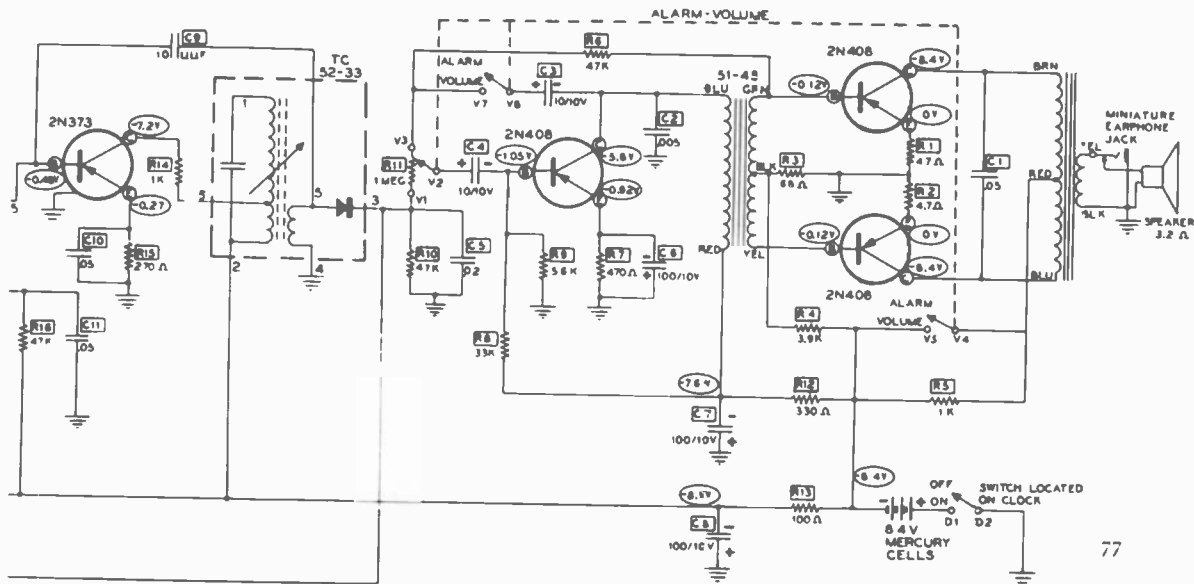

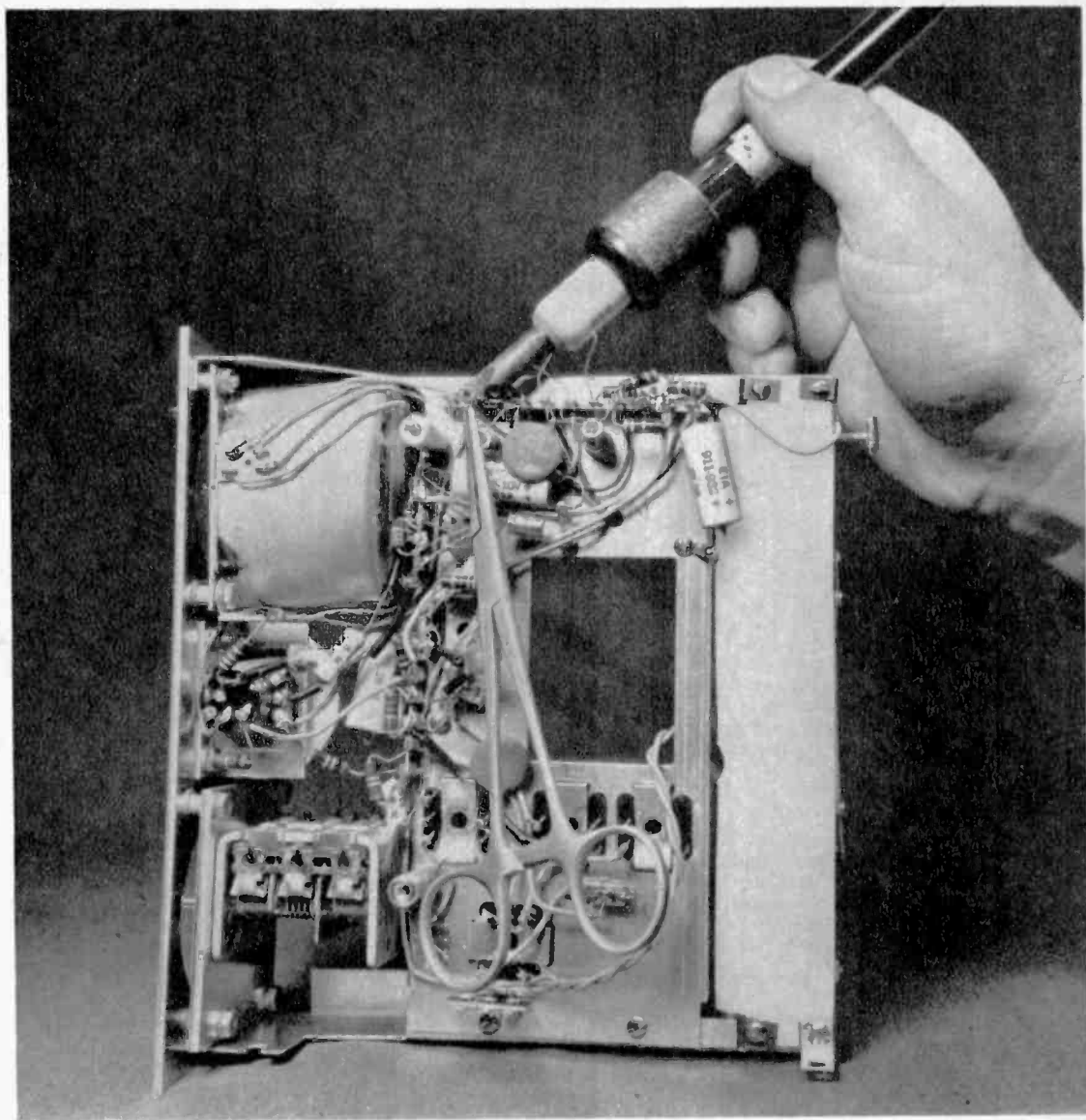

watt figures of hi-fi equipment, but it's enough to make a small loudspeaker rattle in its frame.

Their small size and circuit simplicity also make transistor receivers ideal do-it-yourself construction projects. An excellent example is the Heathkit Model TCR-1, the letters representing "Transistor Clock Radio." The built-in clock, operating off its own battery in the same manner as electric clocks in automobiles, provides not only accurate time but also automatic control of

the radio proper in the manner of an alarm clock.

Circuitwise, the set uses six transistors in a regular superheterodyne circuit, with rod antenna, tuned RF stage, and 300-milliwatt push-pull audio output to a 4 by 6 inch speaker. It is energized by six penlite-size cells. The life expectancy of conventional flashlight type dry batteries is 100 to 150 hours; of mercury cells of the same size, 250 to 500 hours. The latter cost about four times as much as the former,

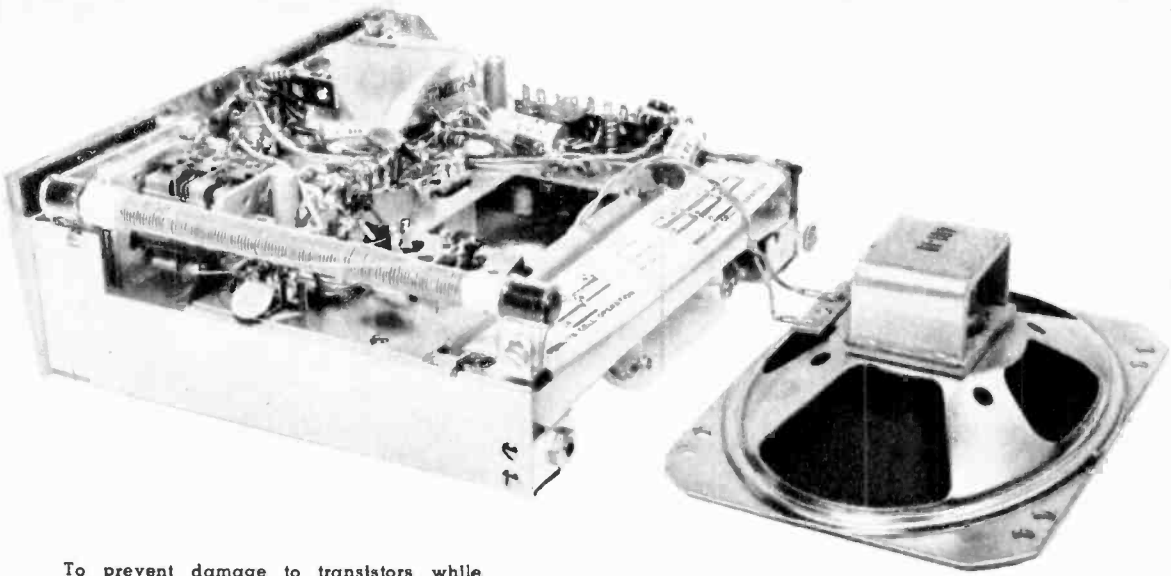

To prevent damage to transistors while their leads are being soldered to lugs on terminal strip, wires are gripped by self-locking "Seizer," which acts as heat sink.

The receiver is now completely wired, but the loudspeaker has not yet been mounted. The loop-stick antenna is long helically-wound rod along left edge of the chassis.



The loudspeaker sits on chassis studs, in a horizontal, face-up position. The top of the receiver cabinet is slotted to permit the very best projection of the sound.

give more uniform and dependable voltage, and are a better investment in the long run.

Dry batteries last longest if they are idled frequently, even if only for a few minutes at a time. A good habit is to snap off the radio switch during commercials, when carrying the set from room to room, when answering the telephone, etc. Since transistors require no warming-up, a program can be turned back on immediately.

As a kit project, this clock-radio is quite

simple and can be tackled by anyone who doesn't have more than two thumbs. Mechanical assembly is straightforward nut-and-bolt. As is the case with most transistorized equipment, some of the small components such as resistors and disc capacitors are in cramped positions and require delicate soldering and the use of heat sinks. (See the section of this book entitled "The Third Hand.") With a slender tip in a pencil-type soldering iron, the work can be done without difficulty.



The receiver is powered by six penlite batteries, which fit in two rows in the plastic holder under the loudspeaker. The clock is powered by a separate cell, located in the bottom of the holder.

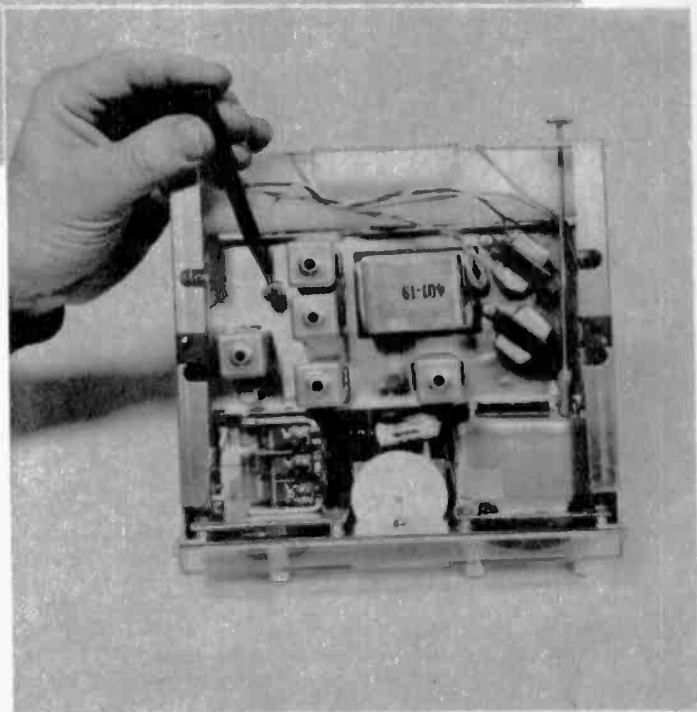

A bottom view of the chassis of a completed receiver. The pencil points to one of three RF transistors. The white disc, lower center, is volume control.

The three transistors in the RF and IF circuits fit in sockets; the three in the audio amplifier stages are soldered into the wiring by their own leads.

The only familiar home-radio feature missing from this receiver (and from all transistor sets, for that matter) is the pilot light. It is omitted for the simple reason that it would take four or five times as much current as the entire radio circuits themselves, and it would exhaust the small batteries in very quick order. You just have to remember to turn the set off when it's no longer wanted.

The accompanying series of photographs shows the TCR-1 from start to finish. Gratifyingly, it produced loud signals the first time it was turned on. It produced more of them after it was properly aligned. The word "alignment" seems to scare some people, but it needn't. The RF and IF

coils are factory-adjusted quite close to their correct settings, and require only minor twiddling to peak them for maximum performance. A special plastic aligning tool, which looks like a large toothpick, is included in the kit for the purpose. Of the three small trimmers on the three-section tuning capacitor, only the oscillator (center unit) is critical. The routine is merely to set the dial to the frequency of any local station and to adjust the oscillator trimmer until that station comes through strongly. A fraction of a turn on the trimmer screw, one way or the other, does the trick.

The clock mechanism can be set to turn the radio circuit on at any predetermined time. You can be awakened by music from a station tuned in the night before, or by a steady tone generated in the audio circuits of the receiver. •

One important step in the alignment of the circuits is shown in the photo at right: adjustment of IF transformer is made by using the special plastic tool which is one included in this kit.

Screwdriver adjustment of oscillator trimmer capacitor is critical, but takes only few seconds. Plentiful signals on broadcast band permit complete alignment without need for signal generator.

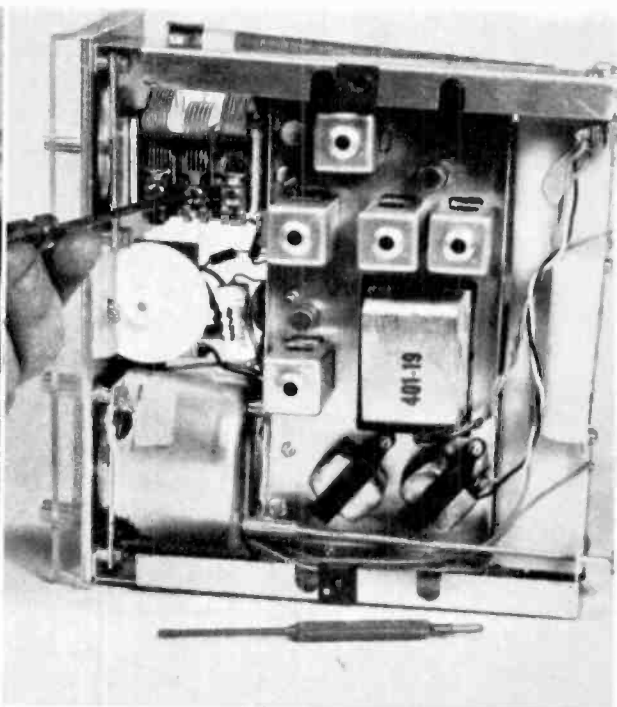
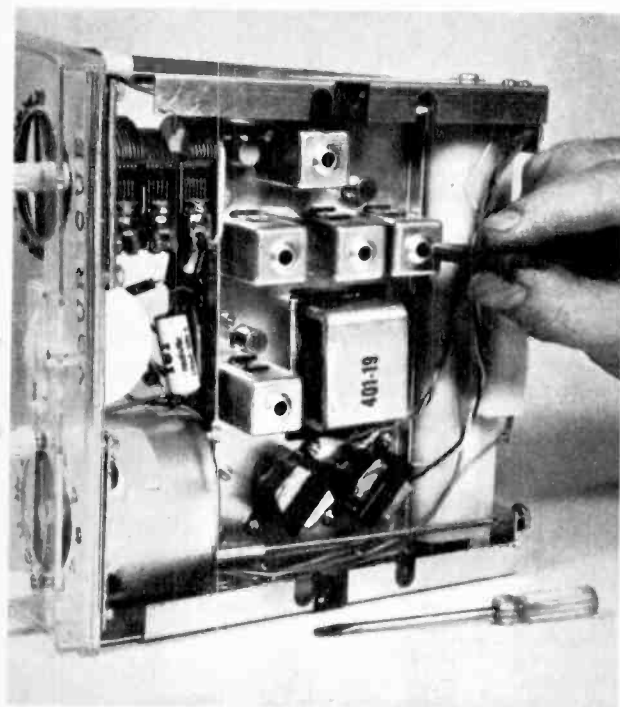

Know Your Components

It is important to get to know the basic differences and uses of parts that are needed for your various electronic projects.

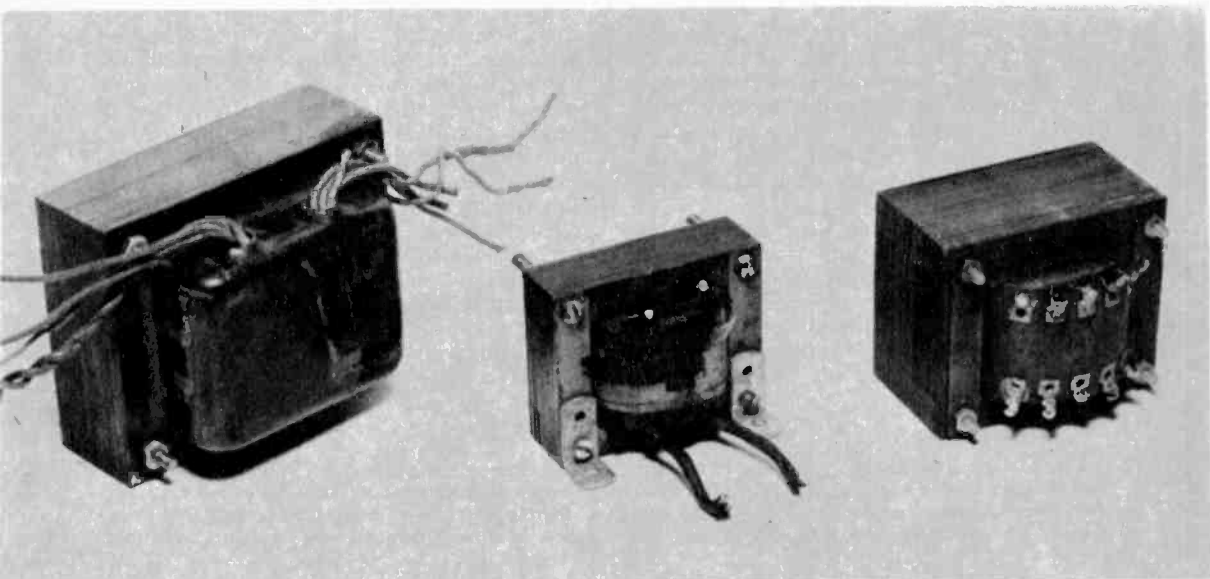

TRANSFORMERS

POWER AND AUDIO transformers are the heaviest individual components found in electronic equipment. They consist essentially of a laminated core of thin sheets of very soft iron, over which are placed two or more windings of insulated copper wire. Because of the magnetic interaction of the coils, alternating current sent through one of them induces alternating current in the other or others. The winding carrying the original AC is called the primary; the windings in which the new AC appear are called the secondaries.

The secondary voltage depends not only on the primary voltage but also on the direct and simple ratio of primary-to-secondary turns. There is virtually no limit as to the step-up and step-down actions; furthermore, it is easy to obtain a variety of secondary voltages with a single primary on the common core.

The popular gun-type soldering iron is the ultimate in step-down transformers. The secondary consists of *one turn*, which takes the form of the bars to which the

copper soldering loop is fastened. High-voltage transformers used in television receivers and transmitters of many kinds have secondaries of thousands of turns.

Some people are puzzled by power-line transformers having a 1:1 ratio, which are listed in all parts catalogs.

"Why use a transformer at all if the primary and secondary voltages are the same?" they ask.

The answer is simple. These are isolation transformers, whose purpose is to separate the grounded power line from the electrically "hot" chassis of certain electronic equipment of the so-called AC-DC type. They are literally lifesavers.

A transformer is not limited to one primary. For some special audio applications two or more primaries can feed that many signals to a common secondary for simultaneous amplification.

Nor are transformers restricted to AC. They work almost as well on interrupted DC. The classical example of a "DC transformer" is the ignition coil of a car.

Split shells of case, right, act as heat radiators and protect transformer which has 115-volt primary, two low-voltage secondaries for tube filaments, one high-voltage winding.

On opposite page, three common types of transformers. Left, cased, multisecondary power transformer. Center, uncased audio output. Right, uncased power transformer with lugs.

Transformer core consists of E-shaped laminations of thin iron. These are inserted alternately from left and right into winding assembly, clamped by bolts through the holes.

The photo of wound core at the right shows how the various windings are placed around stiff center piece of rectangular cross section, and doped and taped to keep them in place.

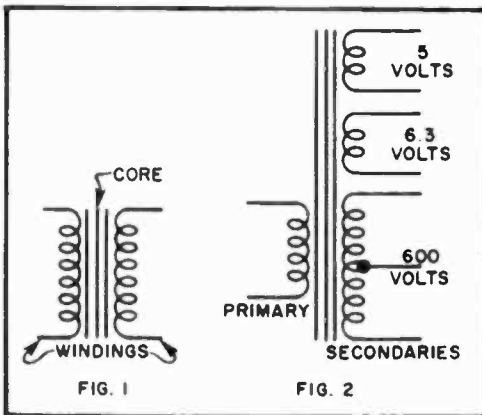
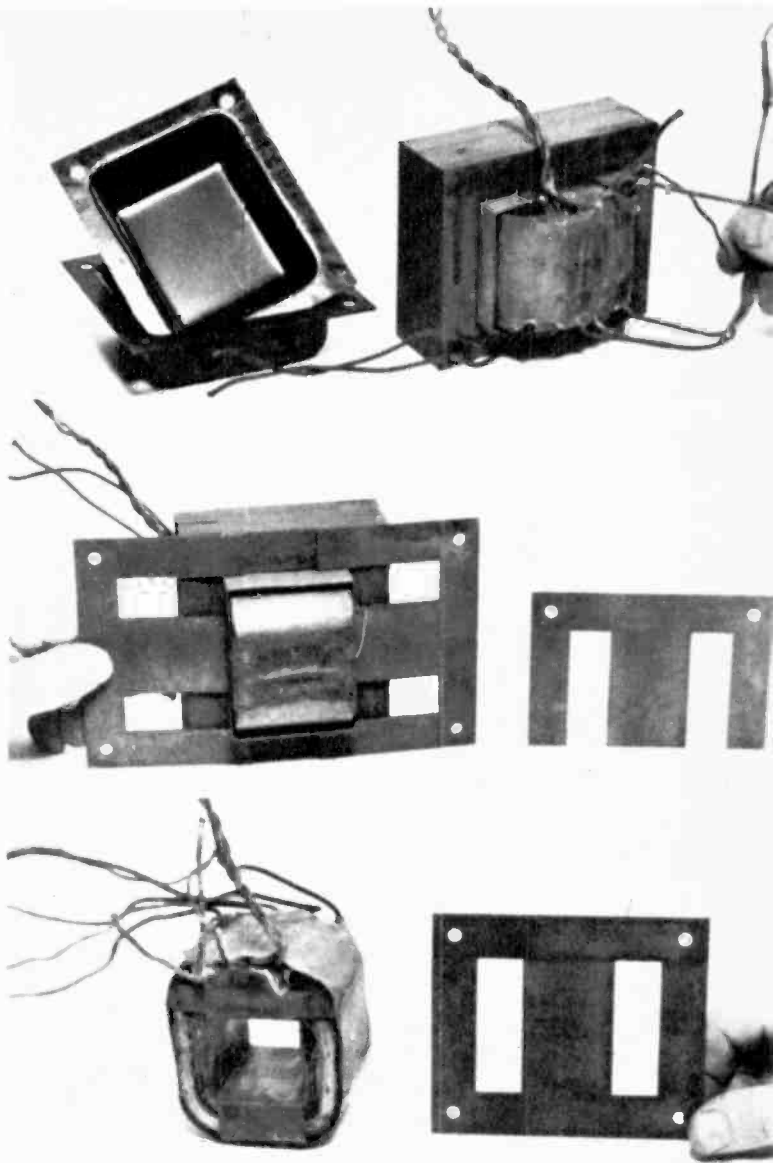

Close-up of transformer winding assembly, photo below. Fig. 1 is schematic of basic two-winding transformer. Fig. 2: receiver with three secondaries.

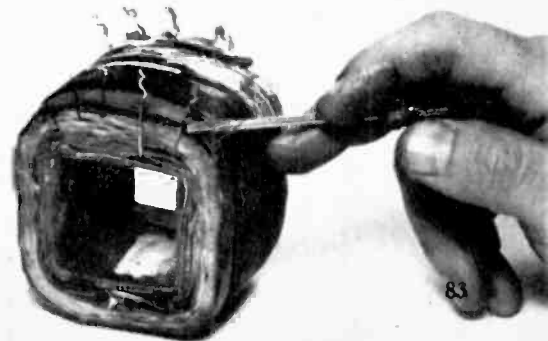

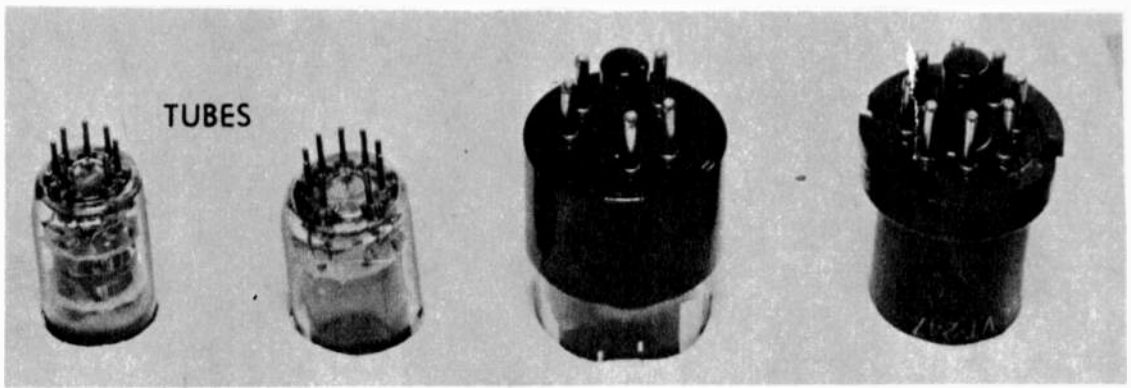

Left to right: Bases of a seven-pin tube, nine-pin, an octal with only five pins used, and a full octal.

THERE ARE NOW several thousand different tube types on the market, and keeping track of them can be a career all in itself. The ones commonly found in entertainment and communications equipment can be classified roughly according to their base construction: seven-pin miniature, nine-pin miniature, and octal. All tubes of the first two types are made entirely of glass, and their connector pins are molded directly into the flat bases. The octal base (octal meaning eight pins) is a separate unit, into which either a glass or metal tube shell is sealed.

In the so-called miniatures, all seven or nine pins always are present.

The outer shell of a tube is called the *envelope*. The very basic two-element tube or *diode* contains a filament and a plate, and is a simple half-wave rectifier of AC. The

incandescent filament is the direct source of electrons, which flow to the plate when the latter is positive in relation to the filament. In most tubes the filament is used only to heat a *cathode*, a small cylinder surrounding the hot wire. This cathode is the source of electrons.

Add a grid of open wires between the cathode (or filament) and the plate of a diode and you have a *triode*.

Two grids with a cathode and a plate make a four-element tube, or *tetrode*; three grids, a five-element tube, or *pentode*.

There are many multifunction tubes, combining the equivalent of two or more tubes in a common envelope. It is usual to find duo-diodes, duo-triodes, a diode with a triode, a triode with a tetrode or pentode, etc. What limits combinations is number of base pins used.

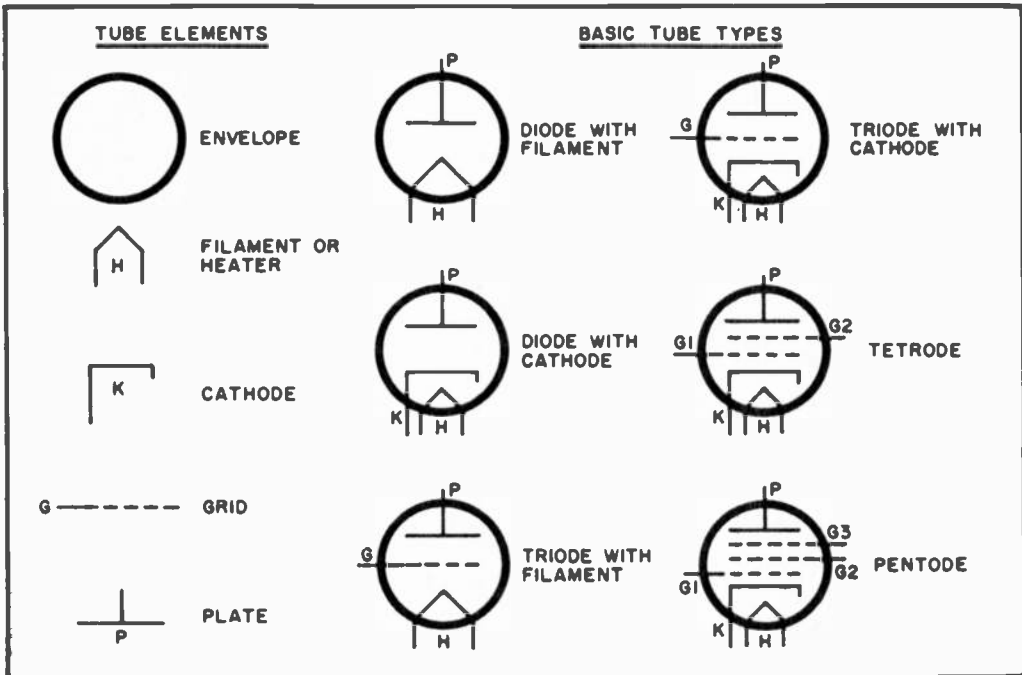

IF TRANSFORMERS

INTERMEDIATE-FREQUENCY amplifying transformers, better known as "IF's," differ from power and audio transformers in that they consist only of two small coils of fine wire placed an inch or less apart on a short piece of fiber or cardboard tubing.

In an older type, there is no magnetic core, and the magnetic lines of force of the primary simply pass through air to engage the wire on the secondary. The coils are tuned to a selected frequency, which can range between 50 and 1,500 kilocycles, depending on the receiver circuit, by means of small, flat trimmer capacitors, which have slotted screws for adjustment.

In the newer type of IF transformer, each winding has a tiny fixed capacitor connected across it. Tuning is accomplished (and magnetic coupling increased) by two round "slugs" of a powdered iron composition, one for each winding, arranged to slide inside the tubing on which the windings are mounted. When the slugs are close to the coils, the effective inductance of the latter is increased; when pulled away, the inductance is decreased. The slugs look like little pistons, and are supported by threaded brass shanks passing out through the bodies of the transformers. Turning these shanks in and out permits extremely fine and precise tuning.

Photo below, left, is a close-up of slug-tuned IF transformer, with a slug pulled about half way out of the mounting tube. Then it is shown below on the right after it has been removed from the IF. The black slug looks like a small piston. At mounting tube's left is the assembled transformer.

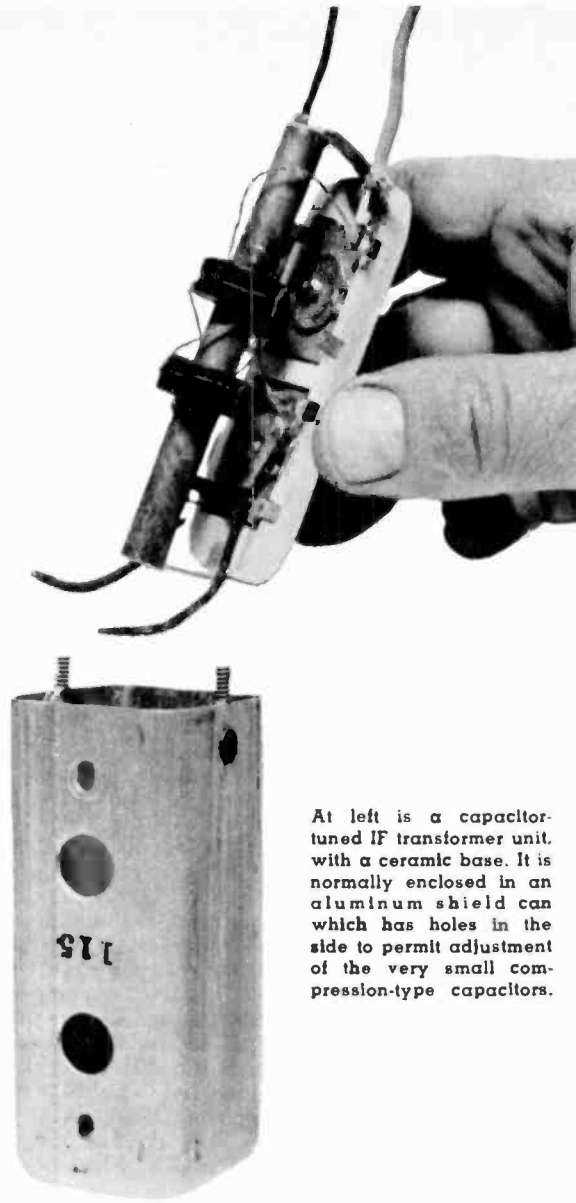

At left is a capacitor-tuned IF transformer unit, with a ceramic base. It is normally enclosed in an aluminum shield can which has holes in the side to permit adjustment of the very small compression-type capacitors.

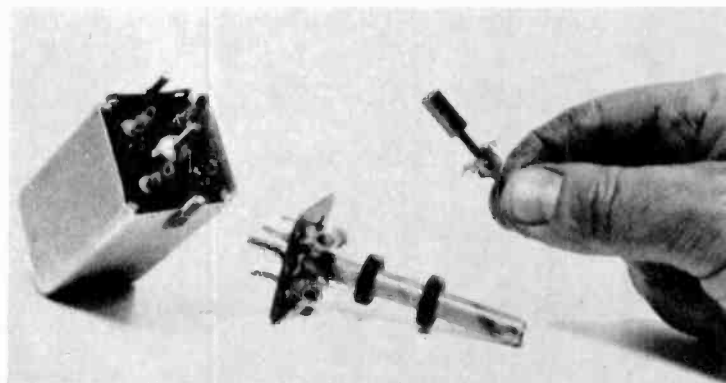
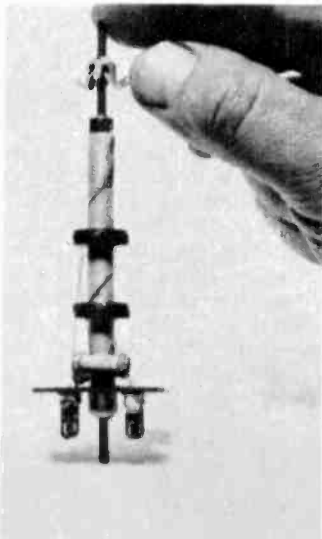

FIXED CAPACITORS

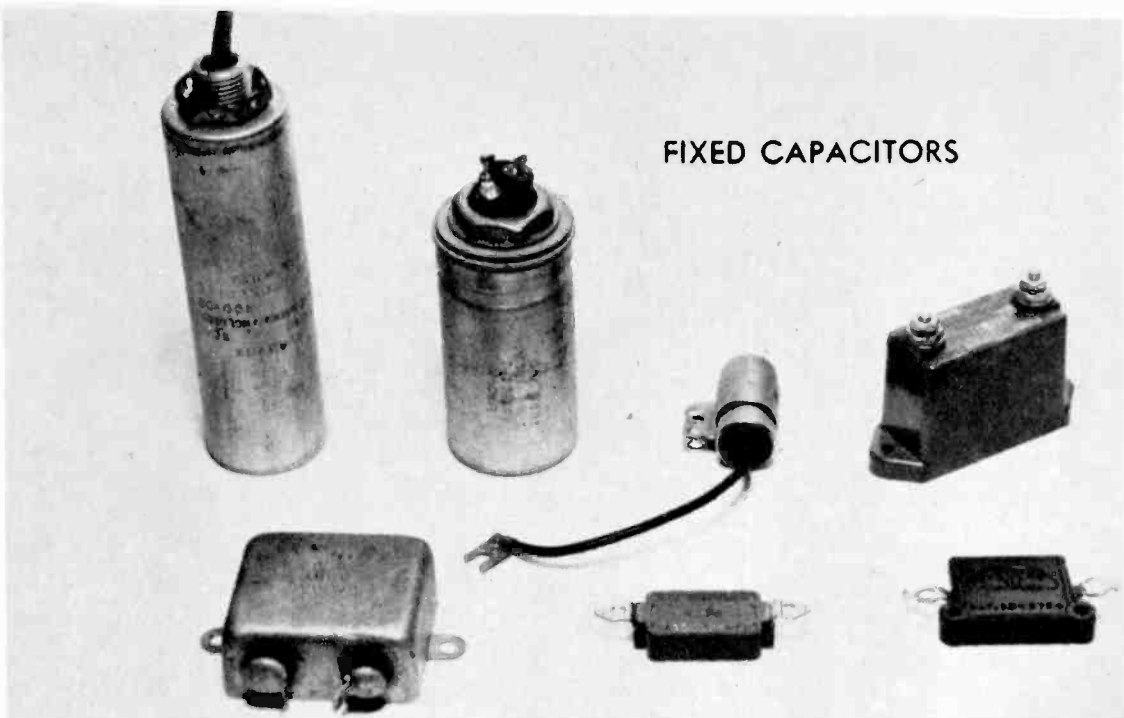

Typical fixed capacitors. Left to right: electrolytic with flexible leads; electrolytic with terminal lugs; tubular paper with grounded case; transmitting mica. Bottom: paper capacitor; micas of receiving type.

FIXED CAPACITORS consist of thin metal foil plates separated by thin layers of insulating material called the *dielectric*. They are classified according to the dielectric as *paper*, *mica* and *electrolytic* capacitors. In the first type, the foil and the paper are rolled tightly together and then sealed in a cardboard or metal container. In the second type, individual square or rectangles of metal foil and mica are stacked like a sandwich, and then encased in Bakelite or some other sealing plastic. In the third type, the dielectric is a chemical film deposited on foil plates by a chemical mixture. The latter is usually in the form of a paste soaked into gauze or blotter paper placed between the foils.

The greater the area of the plates and the

thinner the dielectric, the higher the capacitance. Electrolytics have the highest capacitance in proportion to size because the chemically-formed dielectric is extremely thin. However, the thinner the dielectric the more easily is it punctured by excessive voltage. For the same capacitance value, then, high-voltage capacitors are naturally larger than low-voltage units.

Electrolytics actually last longer if they are used, rather than kept idle, because the application of voltage maintains the electrochemical action. In time, however, the chemicals are consumed or dry up, and the plates become in effect short circuited. Replacement of electrolytic filter capacitors in radio receivers is a common servicing job.

VARIABLE CAPACITORS

IN ELECTRONIC communications equipment of many kinds, variable capacitors have the job of tuning the circuits to a wide range of frequencies. They exist in hundreds of sizes and shapes, but they share a basic construction. They consist of two sets of stiff metal plates, usually of semicircular or oval shape, arranged so that they mesh parallel without touching. Capacitance is minimum when the plates are open; maximum when meshed.

As with fixed capacitors, the actual capacitance of a variable depends on the effective area of the plates and the thickness of the dielectric. Since the latter is air, its "thickness" is the spacing of the plates. Air is a very good insulator, and the spacing in receiving-type capacitors can be made very close because the signal voltages in receiver circuits are very low. Transmitter variables have wide spacing to discourage voltage flashovers.

Left to right: Wide-spaced transmitting variable; small single section with ceramic end plates front and back; close spaced unit with single front plate; two-section, iron frame capacitor commonly used in radio receivers; and the tiny thimble-sized "trimmer" is at the far right.

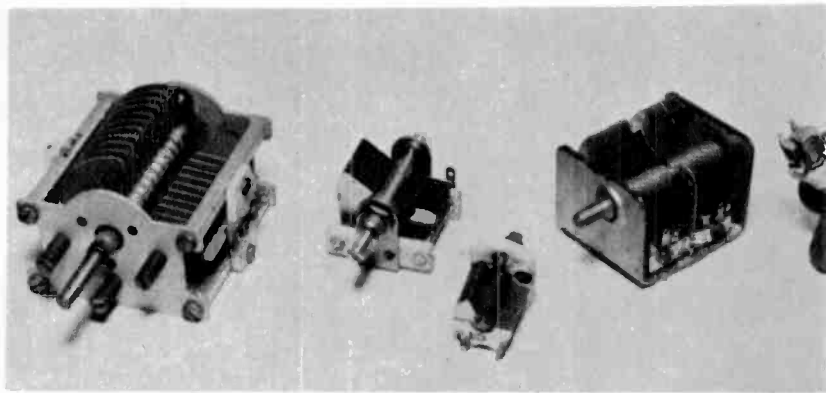

All this metal foil and paper came out of a small paper capacitor such as the one at the right. Two strips of foil are staggered over the paper that separates them and protrudes beyond its sides. After the roll-up is completed, the foil sticking out of ends is flattened to form terminals.

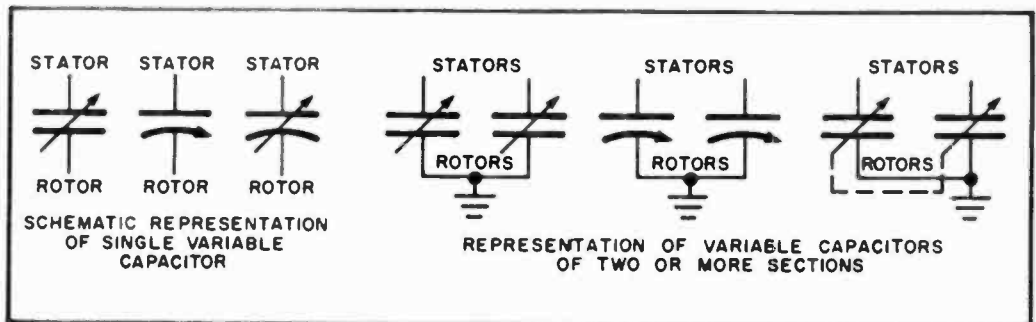
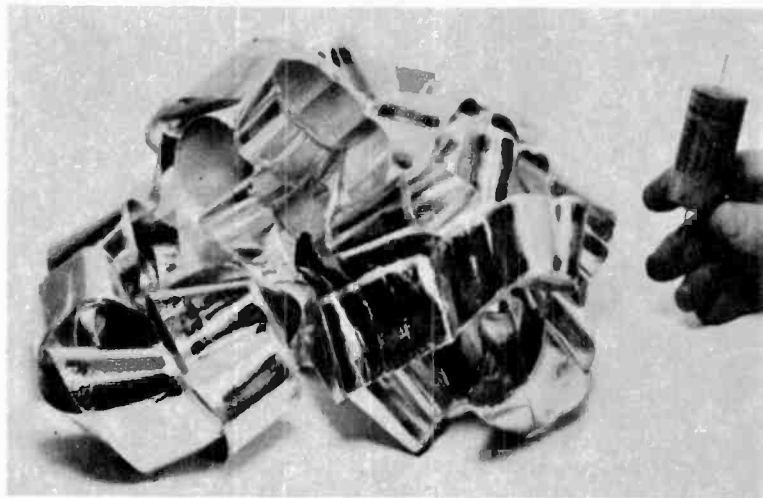

In practically all variable capacitors the rotor plate assembly is part of the mounting frame, so the rotor is automatically grounded when a capacitor is fastened to a metal chassis. The stator plates are insulated by ceramic or plastic blocks.

Both receivers and transmitters use many multiple variables having two, three and even four sections with a single rotor shaft. The sections are often of different capacitances.

By far the majority of variable capacitors now on the market are made with aluminum plates; a few have brass. In medium and large size units the supporting frame is iron, sometimes aluminum, and the rotor shaft has bearings at both ends. In smaller variables there may be only a single ceramic front plate, to which both the rotor and stator assemblies are fastened. Very small variables of a few plates are often called "trimmers."

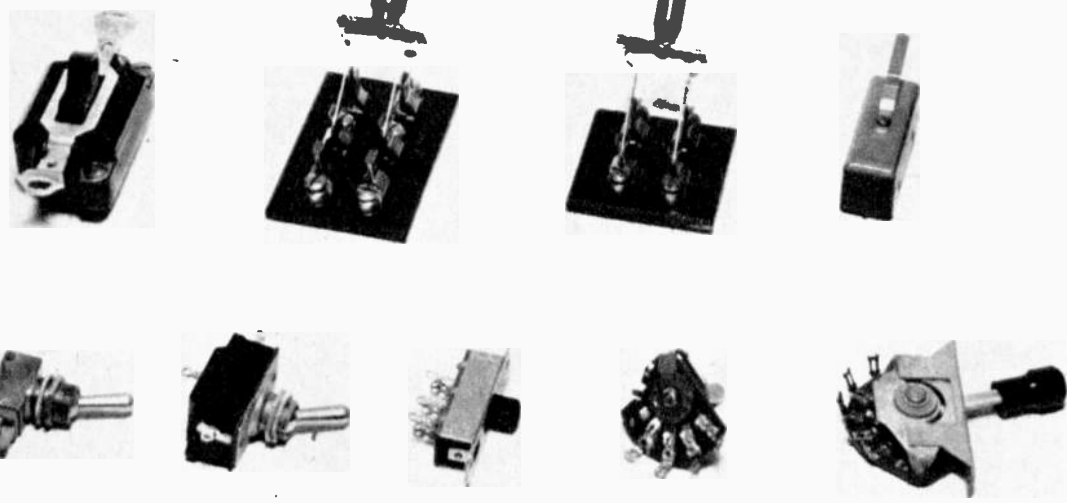

SWITCHES

Top row, left to right: SPST power switch; DPDT knife; DPST knife; SPST normally-closed microswitch. Bottom: SPST toggle; SPDT toggle; DPDT spring-loaded intercom; three-position rotary; lever rotary.

SWITCH FUNCTIONS are designated by the number of movable poles or arms and the positions they can assume. Thus, a basic switch used for turning lights on and off has one pole that touches against one contact, and it is called a "single pole single throw switch." This is invariably abbreviated to SPST. If the pole can move to either of two contacts, it becomes single pole double throw, or SPDT.

A switch with two arms and one pair of contacts is double pole single throw, or DPST; with two pairs of contacts it becomes DPDT. Switches of the DPDT type are widely used for a variety of control purposes. Adding another pole gives us triple pole, either single or double throw, or TPST, TPDT.

Most double throw switches are so constructed that the arms are always against one contact or contacts, depending on the position of the switch handle. An important variation is represented by switches with a "center off" position. Some single throw switches are spring-loaded so that they are normally closed rather than open, and stay open only as long as manual pressure is maintained on their handles. Similarly spring-loaded switches having multiple poles, positions, are special-purpose.

There is practically no limit to the number of arms and contacts that can be combined in switches of the rotary type. These can be further "ganged" or coupled into very complicated assemblies. An example is selector switch in television receivers.

TYPICAL SWITCH COMBINATIONS

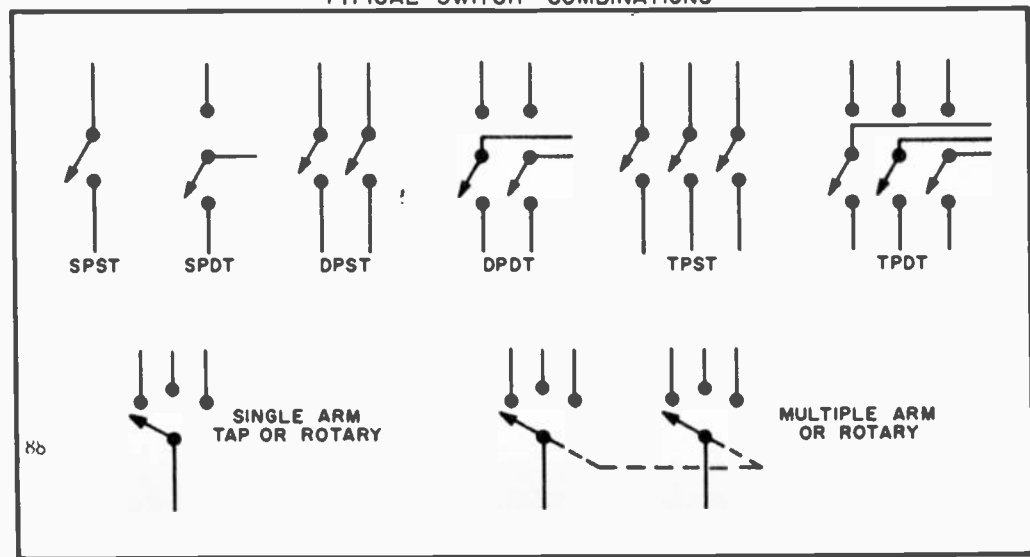

RESISTORS

FIXED AND VARIABLE resistors provide a means of controlling electron flow in circuits of all kinds.

Very small fixed resistors are made usually of carbon deposited on a nonconductive base of cylindrical shape. A thin layer has relatively high resistance; a thick one, relatively low resistance. An elaborate color code is used to indicate values, as the bodies are too small to take printed numbers.

Resistors that are required to dissipate a fair amount of heat are wound with special resistance wire on a ceramic form. A high-temperature protective coating of some sort is baked over the wire. Some wire wounds have fixed taps along their length; others have movable sliders that

make contact with an exposed strip of wire. Fixed resistors run all the way from a fraction of an ohm to several million ohms.

Rotary type variable resistors in many forms are valuable for fine control of voltages. In the small sizes the center rotating arm moves against an open ring of carbon-covered or impregnated material. In larger sizes the resistance element is wire wound. When both ends of the element as well as the movable arm are used in a circuit, a variable resistor is called a *potentiometer* (more usually, just *pot*). When only one end and the arm are used, it is called a *rheostat*. Pots are often ganged in piggyback fashion, and have switches attached to the shafts to go "on" from the extreme left setting.

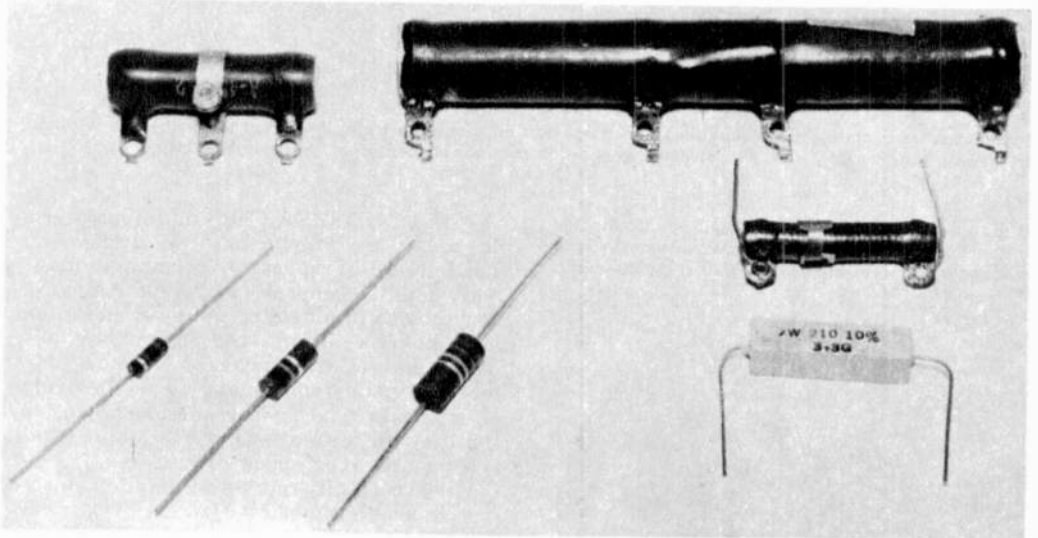

Three small carbon type resistors are shown in lower left corner. Other resistors are wire wound.

Shown in photo below, left to right: Heavy duty wire-wound potentiometer; light duty wire wound; small volume-control type pot with the cover removed; then an identical volume-control pot but with the cover.



LOUDSPEAKERS

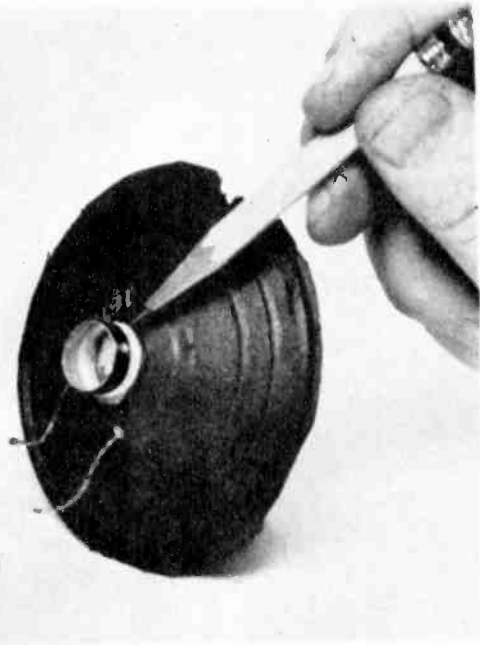
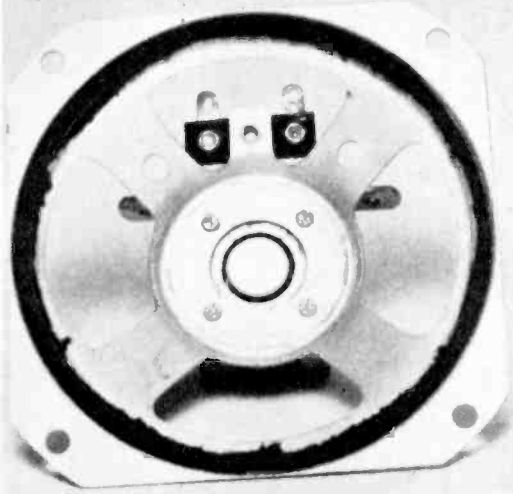

Paper cone of a standard PM speaker has been torn off mounting frame to reveal the voice coil winding (at pencil point). This coil fits closely over end of magnet, center of the speaker frame at the left.

In the photograph below, the pencil point indicates to the small but powerful Alnico magnet which is mounted in the end frame of the loudspeaker.



THE LOUDSPEAKERS in universal use today are known as "PM dynamics". The letters PM represent "permanent magnet". This is generally a bar of Alnico, a very powerful magnetic material, mounted in a box-like frame that forms the exposed end of the speaker. You have to tear the paper cone away from the body of a speaker, as in the photo shown, to see that the round end of the magnet has a thin clearance space around it.

Very carefully centered in this space is a short, lightweight cardboard cylinder which is cemented to the apex of the paper cone and carries a single layer of fine wire. Flexible leads from the ends of the latter are brought out through the back of the cone to the terminal lugs of the speaker.

The winding is called the "voice coil" because it carries amplified current representing voice or music signals (or other forms of electroacoustical intelligence). Passing through the coil, the current sets up a fluctuating magnetic field around it. This field interacts with the fixed field of the PM, causing the voice coil to be attracted or repelled axially along the magnet. Since the cone is attached to the voice coil, it vibrates back and forth in the same manner, and its broad surfaces set up sound waves to the front and to the rear.

RF CHOKES

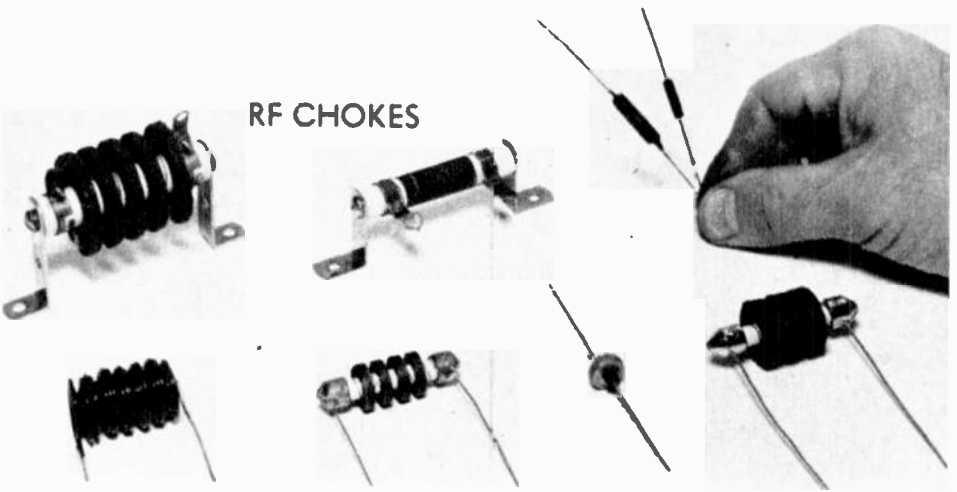

Shown in the photo above are some representative RF chokes of the single-layer and multiple "ple" types.

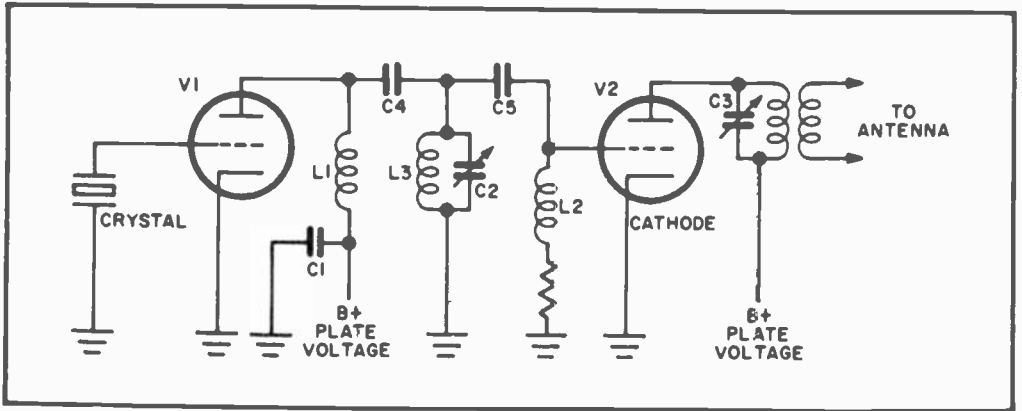

COILS OF WIRE (that is, "inductors") have the property of opposing the flow of alternating current. The magnitude of the effect depends on two interlocking factors: the numbers of turns of wire, and the frequency of the AC. Coils intended to impede the flow of low-frequency AC, from 60-cycle power to about 15,000-cycle hi-fi sound, are called *audio* or *AF chokes*; for the higher radio frequencies, they are *RF chokes*. Only RF chokes are discussed here.

A coil consisting of a dozen or so turns of wire on a form $\frac{1}{4}$ inch in diameter offers no appreciable impeding effect, or *impedance*, to audio current or even to signals in the broadcast range of 550 to 1600 kilocycles. However, at the much higher frequencies used for television it can be almost as complete a block as an open switch.

RF chokes are available in many sizes and shapes. They are vital in controlling the passage of currents of different frequencies in a single circuit. Two typical applications are shown in the diagram on this page, of a basic two-tube transmitter,

the type used by amateur operators. V1 might be any triode tube operating as a crystal oscillator. RF generated here passes readily through capacitor C4 to the plate tuning circuit L3-C2, and through C5 to the grid of the power amplifier tube V2. The RF choke L1 has virtually no limiting effect on the DC voltage needed for the proper operation of V1, but its dimensions are such that it offers high impedance to the generated RF energy, which is thus forced to go to L3-C2, where it belongs. If the B plus went directly to the plate of V1, the RF energy would be short circuited in the plate voltage supply circuit.

Similarly, choke L2 completes the grid-cathode circuit of V2, and forces the RF signal to enter the grid for amplification by this tube. L4-C3 is the plate tuning circuit of V2.

The fixed capacitor C4 blocks the dangerously high DC of V1 from getting to the exposed tuning controls of L3-C2 and to the grid of V2. Capacitor C5 isolates the DC grid-bias circuit of V2 and saves it from being short-circuited by the very low resistance of L3. •

A Meter That Thinks for Itself

Automatic range selector in new AC VTVM responds to all voltages from low to high.

YOU'RE EXPERIMENTING with a new stereo amplifier. An audio generator is feeding a steady 400-cycle signal to the input, and you're trying to track this through the various stages to determine if the latter are amplifying the way they should. One point in the circuit arouses your suspicions, and you decide to measure the AC voltage there. You don't know how much to expect; it might be .1 volt or 10 volts.

You pick up the test leads of a certain new voltmeter, clip the ground wire to the amplifier chassis, and start to touch the hot lead to the circuit point.

"Hey, wait a minute!" If an interested

observer were alongside, this is what he would probably shout. "How about setting the range switch? You're likely to knock the needle galley west if you don't."

But there is no range switch on this meter. As you actually touch the test lead to the circuit point, the meter starts acting like a pinball machine. A motor inside whirls, relays click, little red lights flash on the front panel, the meter needle wiggles. In about two seconds the racket stops, one light stays on, and there is a steady reading on the meter. The light is marked "1.0," which means you're on the 1-volt scale; the needle is at .6, so that's your voltage!

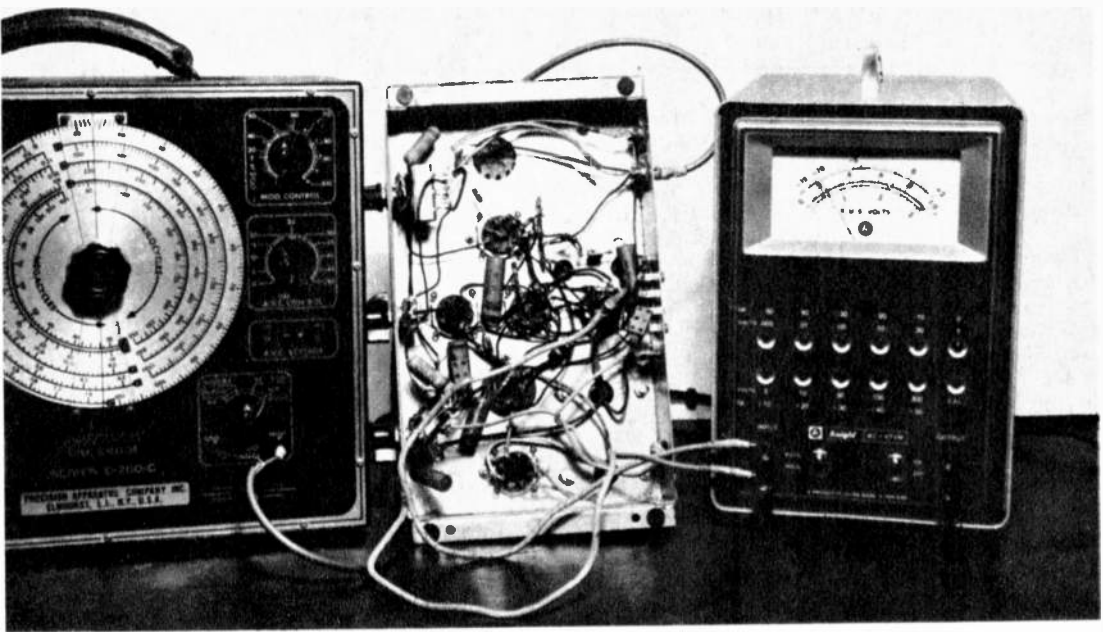

The AC VTVM, on the right, in a typical application for the measurement of voltages in an audio amplifier, center. Test signal is provided by 400-cycle section of signal generator, left. Pilot lights which show range automatically selected by meter, are in two rows under the meter face. Terminals at lower right marked OUTPUT permit external use of amplifier section of the meter alone.

With the front panel removed from the Knight-Kit AC VTVM, the twelve pilot lights become accessible. Black hoods or sleeves shown below unit merely concentrate light to bull's-eyes on panel.

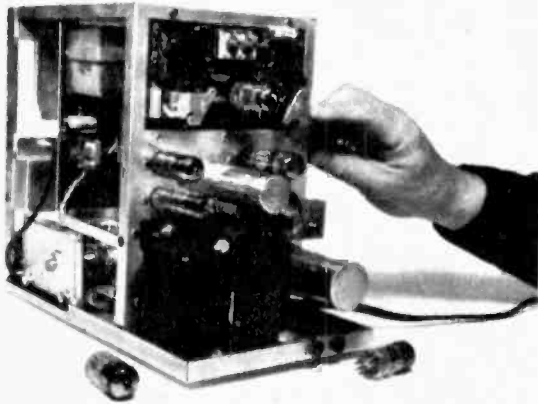

Back view of the AC VTVM. Along the bottom is power supply. Printed circuit board, top, holds the trigger section. Two tip jacks at rear apron furnish 6.3 volts AC for calibration purposes.

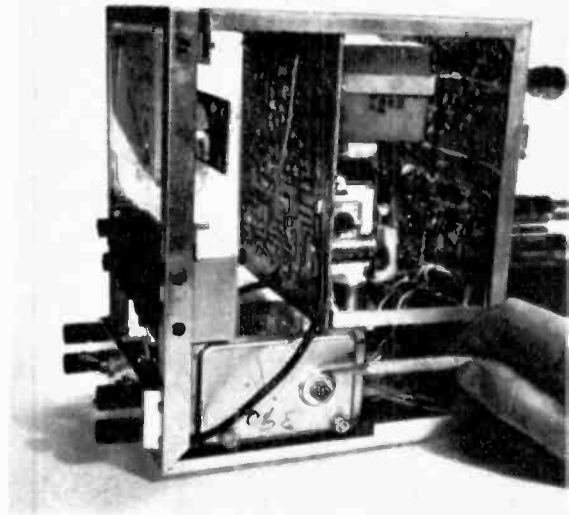

Right side view shows the special motor-drive mechanism (at the point of the pencil), and two vertically mounted printed circuit boards. The inner board contains the amplifier components.

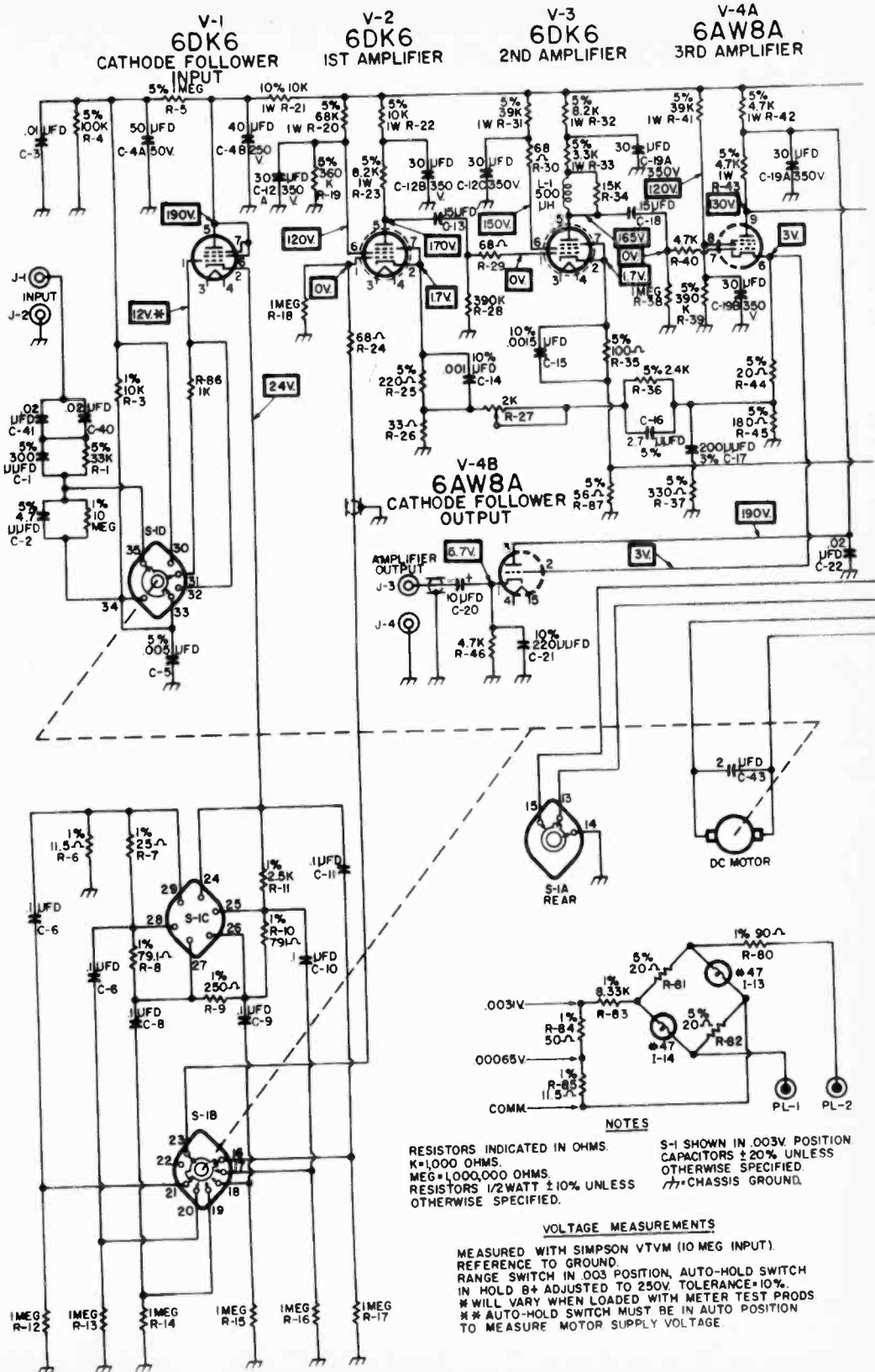

NOTES

RESISTORS INDICATED IN OHMS.
 K=1,000 OHMS.
 MEG=1,000,000 OHMS.
 RESISTORS 1/2 WATT ± 10% UNLESS OTHERWISE SPECIFIED.

S-1 SHOWN IN .003V POSITION
 CAPACITORS ± 20% UNLESS OTHERWISE SPECIFIED
 ⚡ CHASSIS GROUND.

VOLTAGE MEASUREMENTS

MEASURED WITH SIMPSON VTVM (10 MEG INPUT).
 REFERENCE TO GROUND.
 RANGE SWITCH IN .003 POSITION, AUTO-HOLD SWITCH IN HOLD B+ ADJUSTED TO 250V TOLERANCE 10%.
 * WILL VARY WHEN LOADED WITH METER TEST PRODS
 ** AUTO-HOLD SWITCH MUST BE IN AUTO POSITION TO MEASURE MOTOR SUPPLY VOLTAGE

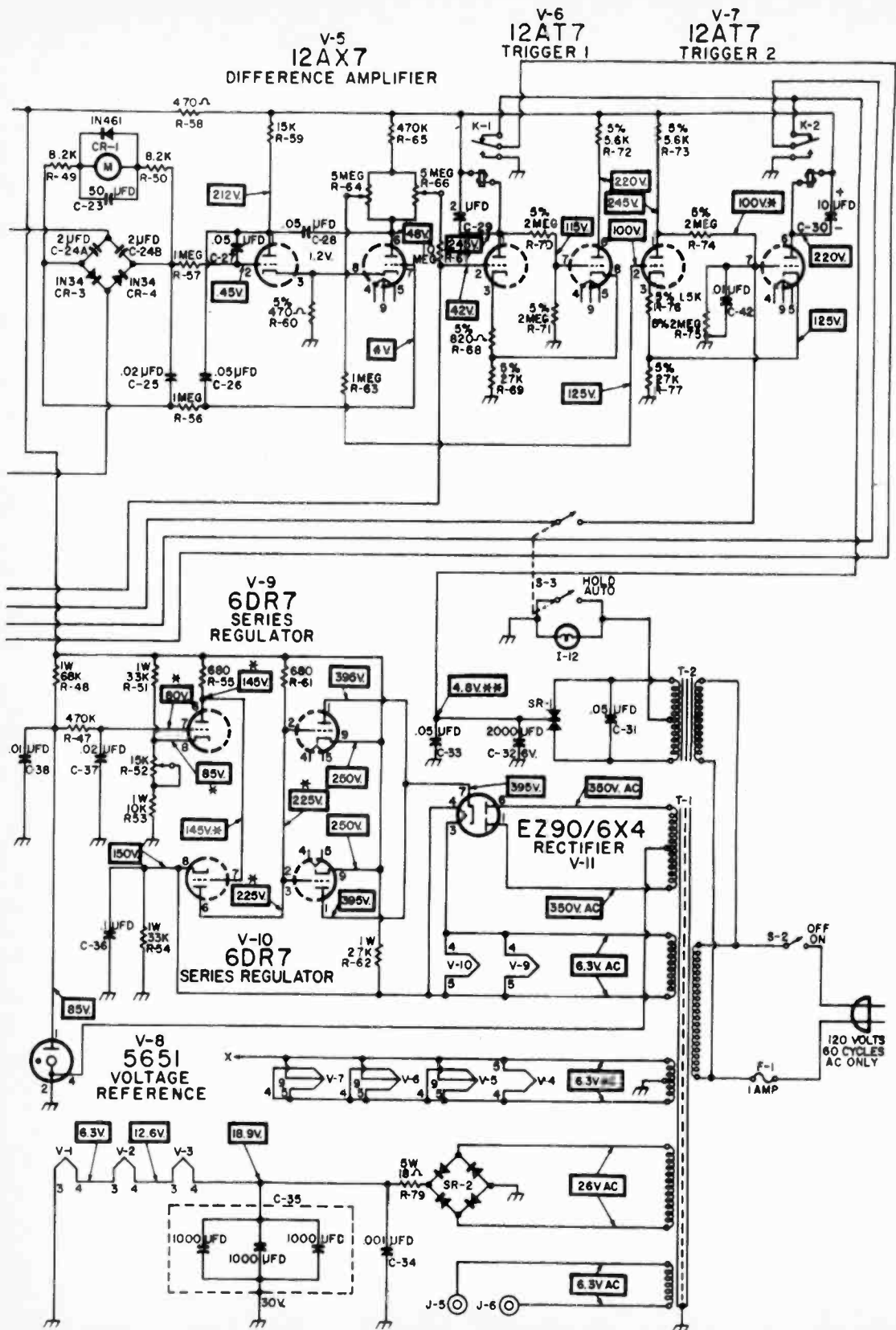

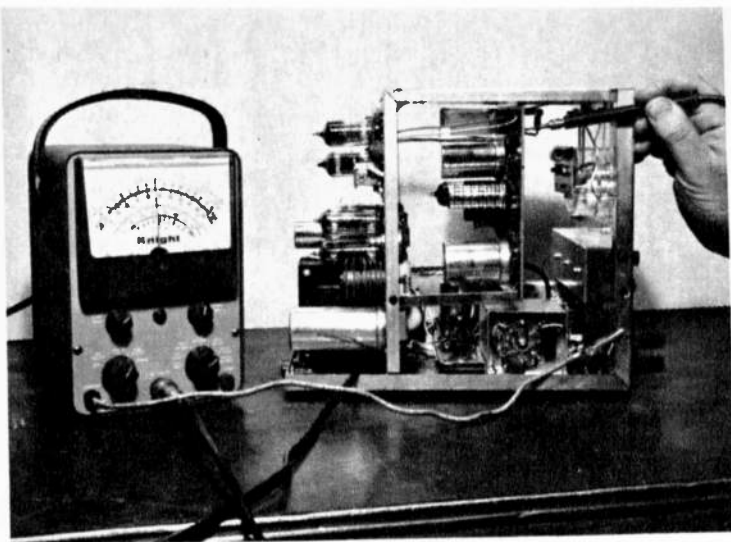

The adjustment of DC plate voltage of amplifiers to 250 volts is an important preliminary step. Actually, it should take you only a very few seconds. In this view, one section of the motor-driven range switch is clearly visible in the open box at the bottom right edge of the chassis.

Is this automatic instrument the meter of the future? Not at all; it exists right now as a regular Knight-Kit that you can put together yourself in a week of evenings. It is known simply as the Knight AC VTVM, and it is easily the most interesting and most unusual piece of test equipment to appear on the market in a long time.

Intended for measurement of AC only, the meter achieves extremely high sensitivity through the use of a three-stage amplifier preceding the meter movement itself. The full-scale reading at the lowest setting of the automatic range selector is only .003 volt (3 millivolts, or 3/1000 of one volt); at the low end of this range readings in the area of .0005 volt show quite clearly. There are eleven ranges altogether, with 300 volts the maximum reading. These voltage ranges are complemented by eleven decibel ranges. Actually there are only three scales on the face of the meter, and these are multiplied by various factors in the usual manner to give the real readings.

The frequency range runs all the way from 20 cycles to 2.5 megacycles, and the input impedance is 10 megohms, so the instrument is valuable for a wide variety of applications, such as audio, radio, intermediate and video circuits. The amplifier circuit can be used by itself.

The meter appears to be of special interest to audiophiles because it can probe practically any part of a hi-fi circuit without disturbing its operating condition.

The trigger circuits that actuate the automatic range selector are rather tricky. An explanation of the full functioning of the meter is in the instruction book that comes with the kit, and is very interesting if checked against schematic diagram.

The DC filament section supplies the

input section and the first two tubes in the amplifier section with DC filament voltage. This voltage is supplied by T-1 and the full wave bridge rectifier SR-2. The high sensitivity of the input and amplifier sections requires DC filaments to eliminate any trace of hum.

The power used in the DC motor section is supplied by transformer T-2 and SR-1. The center tap of T-2 is grounded through S-3, the AUTO-HOLD switch, when the switch is in the AUTO position. When the switch is in the HOLD position, the calibrate light is placed in the motor circuit, rendering the motor inoperative.

The full-wave rectifier SR-1 delivers a positive voltage to the motor control relays on the trigger circuit board. In the normal operating position each relay passes this voltage to a separate terminal of the motor, effectively shorting the motor terminals. While the motors are shorted, additional torque on the motor shaft is produced by dynamic braking of the motor. When a relay is energized, it removes the power from one terminal of the motor and connects this terminal to ground, activating the motor.

AUTHOR'S EVALUATION

Containing eleven tubes and a motor-drive switching mechanism, the Knight-Kit AC VTVM is not a job for a beginner, but it certainly presents no difficulties to a man who appreciates its features and who therefore must be an experienced electronics technician or engineer. The kit is well worked out, with much of the "wiring" already in place on two printed circuit boards. The instruction book and its accompanying stage-by-stage drawings are excellent. I recommend this to anyone who feels he is ready for it. •



Ugh! Loaded with receivers and transmitters, this ham operating table proved much too heavy for moving.

Movable Radio Table

Here's how to make a "mobile" unit out of your heavy equipment.

YOU START with a receiver and a loud-speaker. Then you add a transmitter or two, a second receiver, an oscilloscope, perhaps a couple of meters. Very soon your radio table is loaded with several hundred pounds of iron and copper. When you try to move it, to make changes in connections at the back, you find you can't budge it without the help of at least one strong assistant. If your radio shack has a carpeted floor the situation is even worse, because then the table can't be pushed at all, but must be lifted.

Anticipate the growth of your equipment

by fixing up your table with ball-bearing casters. Use the largest size the legs will accommodate. For relatively thin legs you will probably have to use socket-type casters, which fit into holes bored about two inches deep through the end grain. For heavier legs use plate-type casters.

Casters naturally add a bit of height to the table. A table slightly higher than normal is actually more comfortable for standing-up experimenting with equipment. If you spend more time in a sitting position, you may saw off an inch or two from the legs before mounting the casters. •

Two-inch diameter plate casters were screwed to the legs. Job took only about fifteen minutes.

Now table swings away from wall easily and changes in back connections can be made quickly.

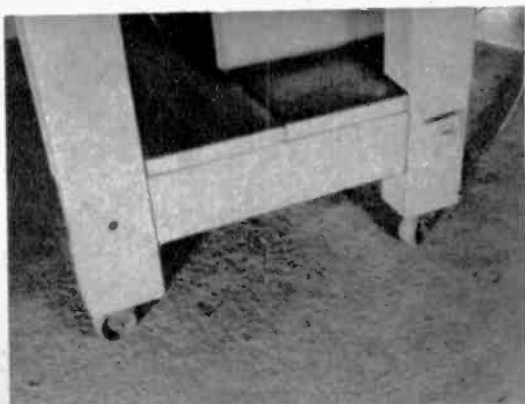

A Straight Steer on Stereo

For a stereo system made from components and kits that sounds terrific and yet blends with your room decor, read this story . . .



THE ELECTRONIC development of the 1950's that caused the most confusion in the mind of the general public was, undoubtedly, stereophonic sound.

Unlike the related term "high fidelity," which pretty much explains itself, "stereophonic" needs to be spelled out in simpler words. "Stereo" is derived from the Greek word meaning "solid", so stereophonic sound is solid sound.

All electromechanical reproduction of sound through radio broadcasting, phonograph records or magnetized tape is an illusion. The higher the quality of the technical equipment all along the line, from microphone to loudspeaker, the higher the

apparent fidelity of the reproduction and the greater the illusion that the performers are in the same room with the listeners. In conventional systems, now known as "monophonic", the original sound is gathered by a single microphone and transmitted over a single broadcasting channel, or recorded as a single physical track on a plastic record or as a single magnetized track on magnetically-sensitive paper tape. In the home, the sound is received and amplified by a single-channel radio receiver and reproduced through a single loud speaker (or a multiple-unit speaker actually operating as a single speaker); or it is reproduced directly



In this bold design by David Eugene Bell, of Macy's New York, the stereo equipment is not concealed but in itself forms an important part of the room's furnishings. Speakers are well separated to the extreme left and right. The large center cabinet holds the tuner, amplifier, turntable, record collection, etc.

To show that technical equipment need not conflict with room decor, the Institute of High Fidelity Manufacturers commissioned a number of interior decorators to design compatible layouts. Here is an interesting room by Hector Grant. The stereo components have been incorporated ingeniously into the coffee table in front of the main sofa, where the owners would sit normally to listen to the loud speakers. The latter are directly across the room, at the extreme left, in floor cabinets that also support a pair of triangular bookcases. In this manner, maximum stereo effectiveness is obtained within the room.

This diagram shows just about everything that can be attached to a stereo amplifier. The "multiplex adapter" in the lower right corner is for the future. Multiplexing is a still-experimental means of obtaining two true stereo channels, for radio broadcasting, over a single FM station. Several multiplex methods have been proposed, but none have been standardized by the FCC. Input and output terminals in this diagram are those of a Paco SA-40 amplifier. You can adapt this to your particular needs.

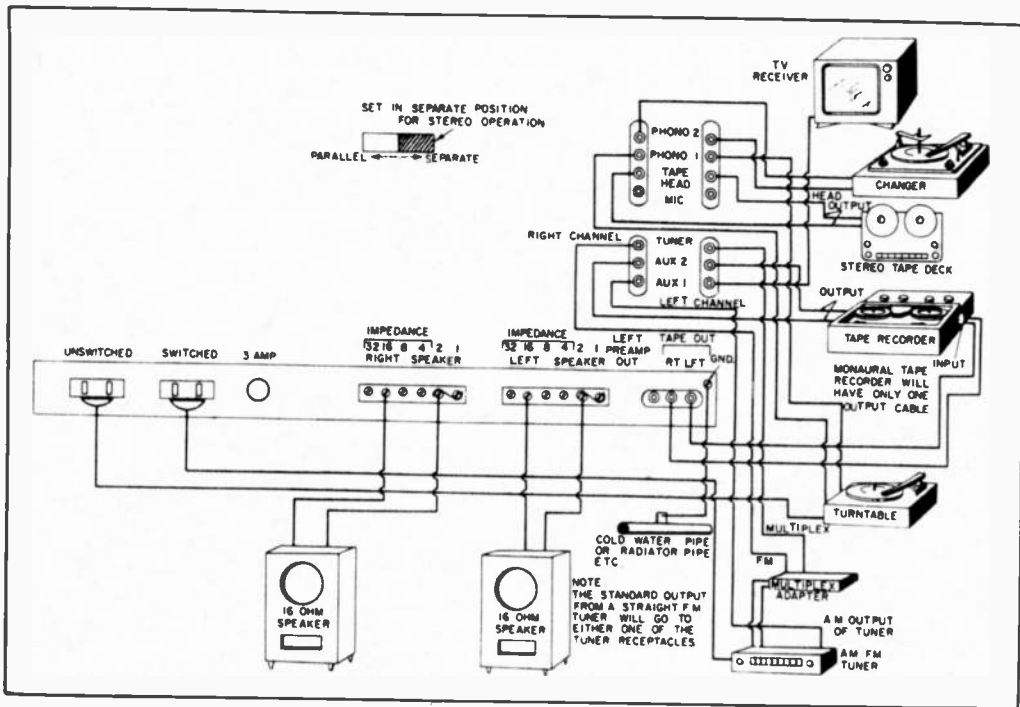

through an amplifier-speaker combination. If you pay enough for the components, you have a "high-fidelity" system, and you can enjoy some mighty good music from it.

WHAT STEREO IS

In a stereo system, advantage is taken of the fact that people have two ears and that they can distinguish between sounds coming from different directions without turning their heads. Stereo is thus merely hi-fi multiplied by two.

At the broadcasting or recording end, two microphones are placed near the performers so that one catches the sounds coming generally from the left and the other from the right. The output from one mikes goes to one transmitter or to one track on a record or tape; the output from the other mike goes to a completely separate second transmitter or onto a second recording track. At the reproducing end in the home, there must be two radio receivers, two identical amplifiers, and two identical loudspeakers; or in the case of

recordings, a dual cartridge or magnetic head that responds to both recorded tracks and, again two amplifiers and two speakers.

If the speakers are properly placed in relation to the listeners, or vice versa, so that the left ear hears mainly what comes from the left speaker and the right ear the right speaker, and if the two ears hear equally well, and further if the program material really lends itself to stereo handling, the overall reproduction is nothing less than sensational. The sound really sounds "solid."

Currently, stereo is most successful in the form of phonograph recordings. The record industry had the good sense a few years ago to agree on a standard method of double-groove cutting of discs, and this has enabled manufacturers of related equipment to produce components that work with each other interchangeably.

STEREO TAPE

Stereo tape has suffered from a lack of industry-wide standardization. There are

Modest but highly effective stereo installation in student's room. Turntable and records are on desk for convenience. Dual-channel amplifier (Paco Model SA-40) is on first shelf. Two loudspeakers are neatly balanced on shelves over closet doors.



Stereo amplifier in kit form is interesting and rewarding project. This is Paco Model SA-40. Power transformer, extreme left, is bolted in place in factory, to protect component in shipping. All other parts mounted by builder. Assembly is simple.

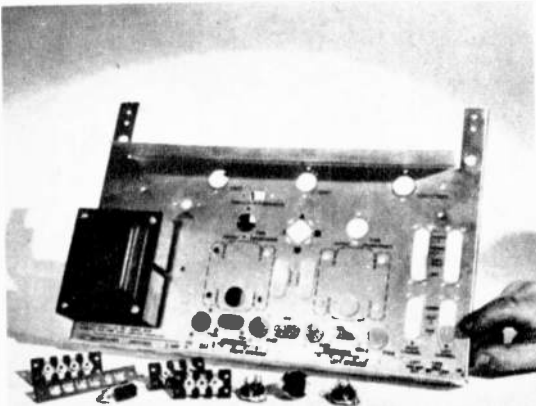

two-track tapes at $7\frac{1}{2}$ inches-per-second speed, new "standard" reels using four tracks at the same speed; and four-track tape cartridges at half this speed. It will probably take a little time before this situation clears up.

Stereo by radio is experimental, regional and interesting, but altogether not nearly as satisfactory as stereo by disc or tape. The illusion of a stereo effect is created by transmitting a program simultaneously over separate AM and FM stations, and reproducing it in the home on separate AM and FM receivers. The expression "illusion of a stereo effect" is a double qualification, and must be used because this type of broadcasting is not true stereo. It could be if each station transmitted only the pickup of one microphone, as in stereo recording. However, if it did this, the programs as reproduced on conventional receivers on the individual channels would sound incomplete. The stereo effect is probably produced by a slight difference in the arrival time, at the receiving point, of the two signals from two separate radio transmitters of markedly different type operating on widely separated frequencies.

GOOD DISCS ARE IMPORTANT

Regardless of what technical or human factors are involved, stereo reproduction can be no better than the original stereo recording. The market is loaded with cheap discs labeled "stereo" but containing phony music re-recorded from old monophonic originals. The smartest idea is to buy only the records of the recognized companies that are known to do their own recording. In stereo work the placement of the microphones and the mixing of their pickup is a job of great delicacy, and requires the services of engineers who are also musicians or musicians who are also engineers.

The spread-out, room-filling effect of stereo is most successful with spread-out, room-filling original music. This means that stereo is best with orchestras or other large groups of performers. It offers little advantage over half-price single-channel hi-fi with soloists or very small groups of performers. Some stereo discs become unintentionally funny when the two channels are separated too far. For example, with a solo singer under one mike and his or her piano accompanist under the second one perhaps fifteen or twenty feet away, the respective vocal and instrumental renditions can readily sound like two radio programs interfering with each other.

There are many special stereo demonstration records intended to show the

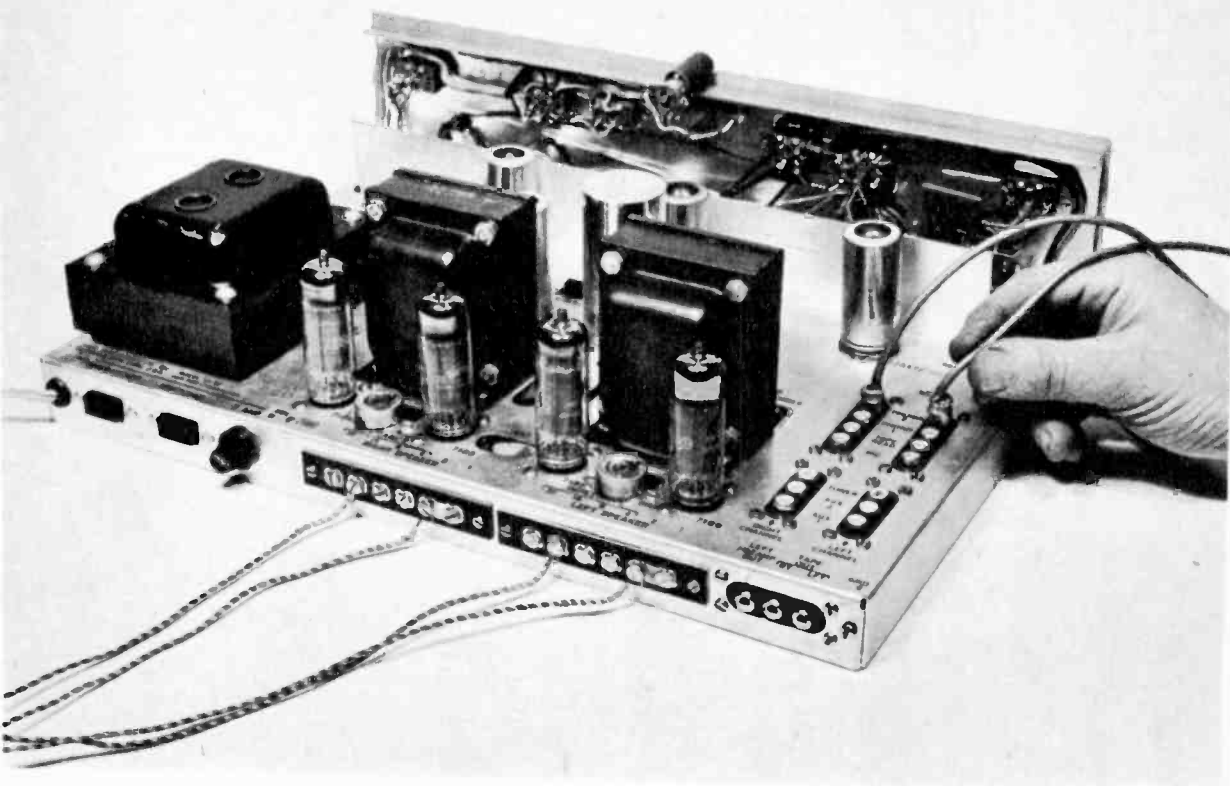

Rear view of completed Paco Model SA-40 stereo amplifier, taken out of its cabinet. Two pairs of wires in the foreground go to separate loudspeakers; two shielded wires at right are from two sections of the special stereo cartridge in the phonograph tone arm. Note that there are connections which have also been provided for a radio tuner, a microphone, a tape head and other signal sources.

startling realism of a properly balanced stereo system. Some contain just good music; others concentrate on tricky effects that are good for an evening's entertainment. Favorites among newcomers to stereo are records of Ping-pong games, so well transcribed that you unconsciously turn your head from side to side to follow the ball as it bounces from one end of the table to the other; of trains approaching from a distance, pulling into a station, and then departing; of planes that dive-bomb you out of your seat.

THE HUMAN ELEMENT

When conventional hi-fi became popular, many people, particularly older folks,

discovered to their distress that they were partially tone deaf (that is, they couldn't hear the very low or the very high frequencies, mostly), and that they therefore got little or no benefit from good systems. Some listeners are now learning, from trying to listen to stereo, that their ears are considerably off balance. They can compensate for this condition, partially anyway, by playing with the volume controls and the tone controls of the individual amplifier channels. Any off-average settings of these controls will, of course, reduce or nullify the stereo effect for listeners having different hearing characteristics. The ears, however, will "learn" to listen stereophonically in time

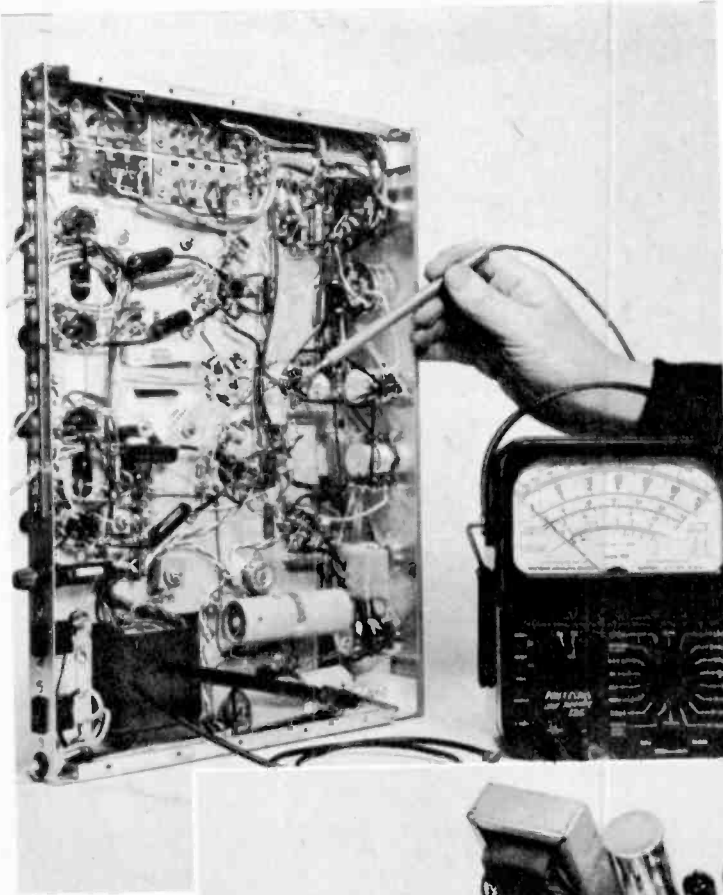

Typical voltage check-out on Paco SA-40 stereo amplifier. Photo at left shows a view which is intended also to show open, single-layer wiring on the underside of the shallow chassis.

The Paco ST-45 duplex AM-FM tuner shown in photo below matches the SA-40 stereo amplifier in size. The AM section is on the left, the FM section shown at the right. The only thing the sections share in common, besides the chassis, is the power supply line. The long black object being held in the rear is loop-stick antenna for AM reception.

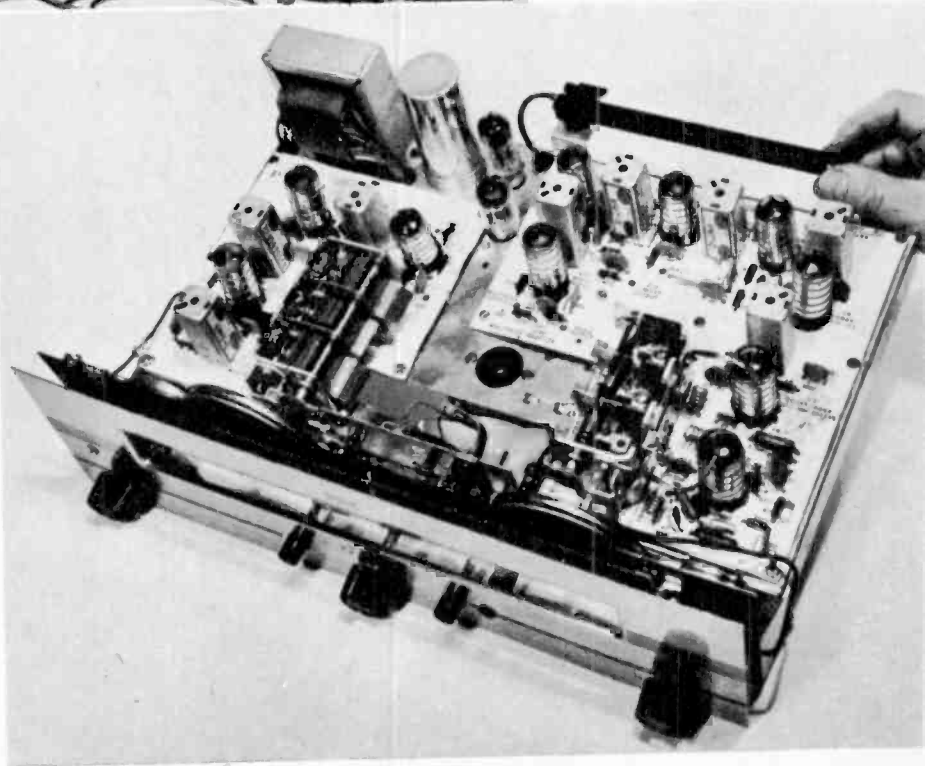



Paco SA-40 stereo amplifier is being bench tested before it is set up. Demonstration record, at left on Glasser-Steers turntable, is signal source (photo above).

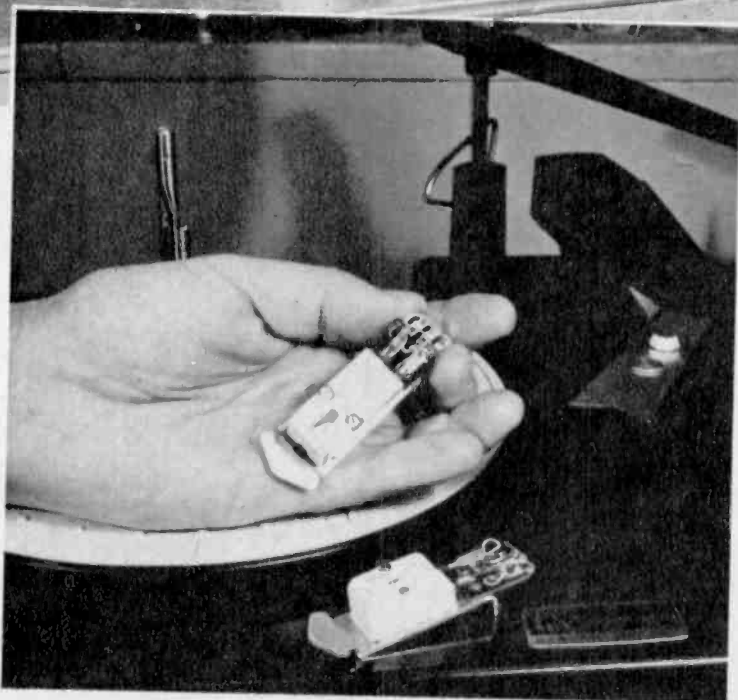

Shown in the photo at the left is a stereo cartridge for a record player, which fits into the palm of the hand. It is differentiated from the single monophonic cartridge on the player table by its four connections. The cartridges can be interchanged in a minute.

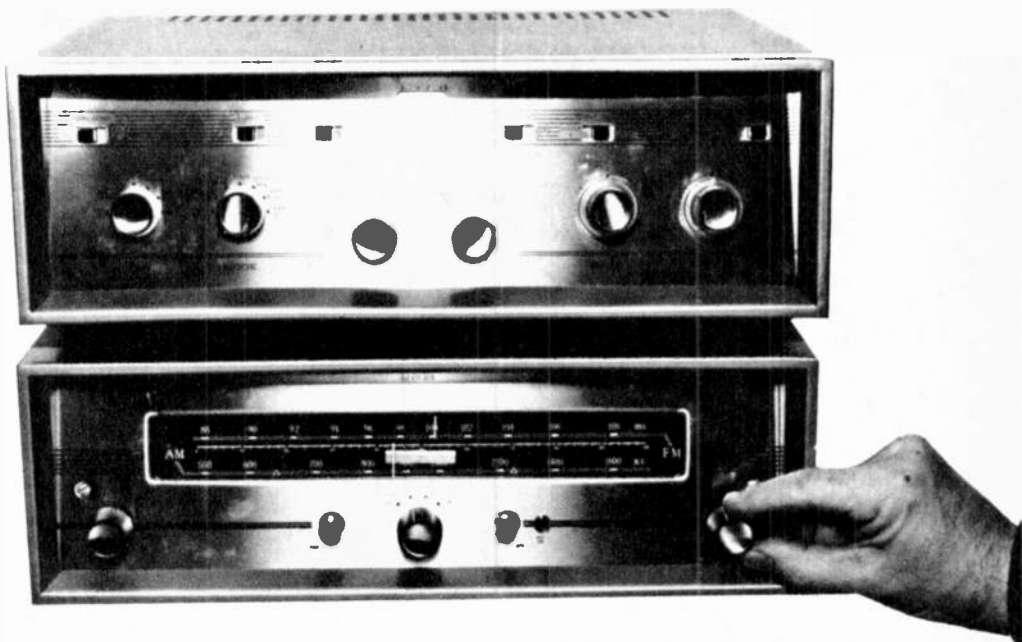

Vertical stacking is a very popular mounting arrangement for AM-FM tuner and matching amplifier. The amplifier should always be on top, as in this illustration, because it runs much hotter than the tuner and thus needs unobstructed venting upward. (Paco ST-45 tuner and SA-40 stereo amplifier.)

ROOM ACOUSTICS

It is well known that the total effectiveness of any sound-reproducing system depends heavily on the size, shape, proportions and decor of the room in which it is used. With ordinary hi-fi it is fairly easy to find a location for the loudspeaker that doesn't require a complete reshuffling of the furniture. The music, especially if it is loud (and who ever heard a soft hi-fi installation?) spreads around and sounds good even in other rooms. Stereo is much more critical in these respects. You have to place the speakers and fix the listening positions in relation to them so that the sounds from the separate units arrive at your ears with the same relative timing with which they were recorded. There's no stereo effect down the hall or in the next room; it's good, high-quality music, but the time-and-space illusion is absent.

It follows, of course, that either amplifier section of a stereo system can be used in conventional manner for monophonic records, tape, or radio. In fact, it isn't even necessary to change the stereo cartridge for a monophonic record; it works fine. It also follows, in the other direction, that a good, existing high-grade monophonic system can be converted readily to stereo; merely duplicate it and replace monophonic cartridge in record player with a stereo type.

DC-IT-YOURSELF COMPONENTS

In setting up an entirely new stereo system, it is advisable, of course, to take advantage of the design idea of incorporating the entire double amplifiers on a single chassis. This saves space, simplifies wiring and facilitates adjustments. There are also double receivers on a single chassis, one section for AM and the other for FM, which play simultaneously. These are not to be confused with AM-FM tuners in which only one side can be used at a time. In the new versions the AM and FM dials represent two independent tuners, which can be operated at the same time through two independent amplifiers for a radio-stereo effect as described previously. Tune the same program on AM and FM for this.

For the many people who like to "roll their own", stereo equipment is easy. There are many excellent kits and semi-kits on the market. A single-chassis stereo amplifier is much less work than the equivalent in two separate amplifiers. Representative units checked out personally by the author are the Paco Model SA-40 preamplifier-amplifier and its matching Model ST-45 duplex tuner, shown in some of the accompanying photographs. These are exceptionally simple to assemble and hook up, the wiring being spread out comfortably over the bottom of a broad but shallow chassis. •



Above is shown a typical four-prong vibrator from an auto radio. It looks like a tube. These prongs should be kept clean by an occasional (bi-monthly) scraping with knife or screwdriver.

Tubes removed from auto set are of "miniature" glass type. The pins are thin, and must be kept straight and clean. Remove and re-insert these tubes with a straight motion; do NOT twist them.

Car Radio Care

A few simple jobs of preventive maintenance will keep the radio in your automobile sounding like new and providing longer service.

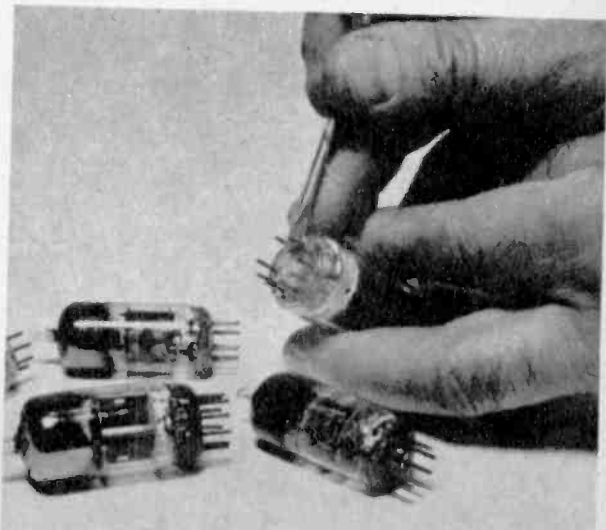

ONE of the most neglected pieces of electronic equipment in common use is the auto radio receiver. Generally, this is a very strong assembly, built to withstand vibration and jarring shocks. In fact, its very ruggedness is what makes an owner take its presence for granted . . . until one day it produces only silence when turned on. Fortunately, its usefulness can be extended appreciably by a few simple acts of preventive maintenance.

Of all the elements in an auto set that wear out with time, the one most likely to fail is the "vibrator." This is a sort of overgrown buzzer whose function is to interrupt the low voltage direct current of the vehicle's storage battery at a rapid rate and to give it some of the characteristics of alternating current. The interrupted current is passed through a step-up transformer and then rectified to form high voltage direct current for the proper operation of the tubes in the receiver.

There is continuous and heavy sparking at the contact points of a vibrator when the set is on. Eventually, it is not unlikely for the points to weld together. This creates the equivalent of a short circuit in the six- or twelve-volt battery circuit, and causes the fuse in the battery circuit to the receiver to blow out. It is extremely rare for auto sets to blow their fuses for any other reason.

In a car that has been driven normally for about eighteen months or more, the vibrator is working on borrowed time. It is a smart idea to replace it with a new one, and to keep the old one in the tool box or glove compartment as an emergency spare. Replacements cost from about \$1.50 to \$5.00.

It is best to keep all the sections of your telescoping antenna clean by wiping them with a dry rag. You should not lubricate. It's unnecessary.

In appearance, vibrators closely resemble large-metal type tubes and fit into regular tube sockets. They can be distinguished from metal tubes (which are always finished in black) by their dull cadmium or zinc color. They are plugged in and removed with a straight motion, never with twisting.

The main job in replacing a vibrator is to get at the radio chassis itself. This means pushing back the front seat and pulling yourself on your back under the dashboard. A flashlight or a portable extension light is, of course, helpful. To facilitate inspection and servicing, practically all auto sets are built with drop-down bottom covers. These are secured with wing nuts or self-tapping screws. It usually is necessary only to loosen the latter to permit the cover to drop off. The vibrator and the tubes are then readily accessible. Their socket positions are usually shown on a small diagram pasted to the inside of the cover.

It is also advisable to remove the tubes, again by pulling straight down, and to clean and straighten the pins. Replacing them then establishes new and better contact between the pins and the spring clips in the sockets. Not infrequently the simple act of pushing the tubes and the vibrator in and out of their sockets a couple of times breaks up corrosion at the contacts and restores a noisy set to quiet operation.

There is always the possibility, naturally, that receiver failure can be due to nothing more than a defective tube. Complete burn-out of the heater is easily determined by a continuity check with an ohmmeter; a tube checker will show up other defects.

Antenna base might loosen because of vibration or from the drying out of rubber mounting washer. Tighten carefully, with only a little pressure.

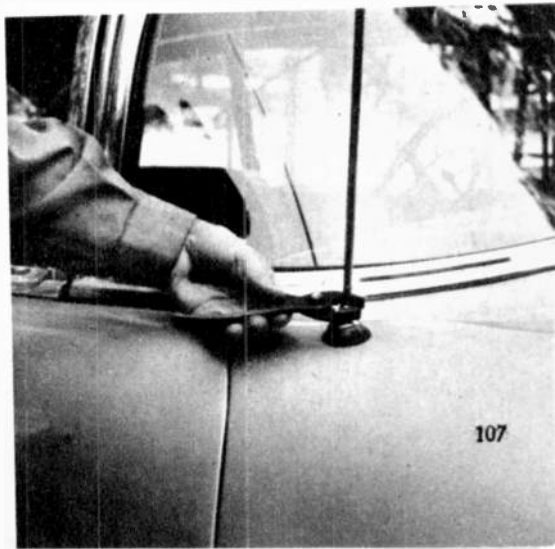

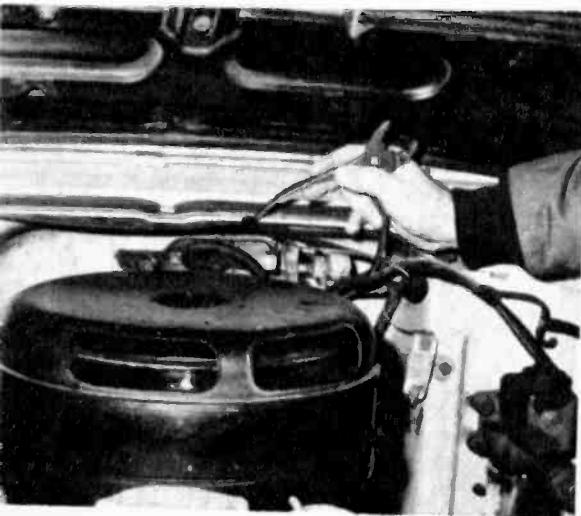

Look for metal-finger grounding contacts screwed to upper edge of engine compartment. They should make good connection with the back edge of the hood. Clean with an emery cloth or a fine file.

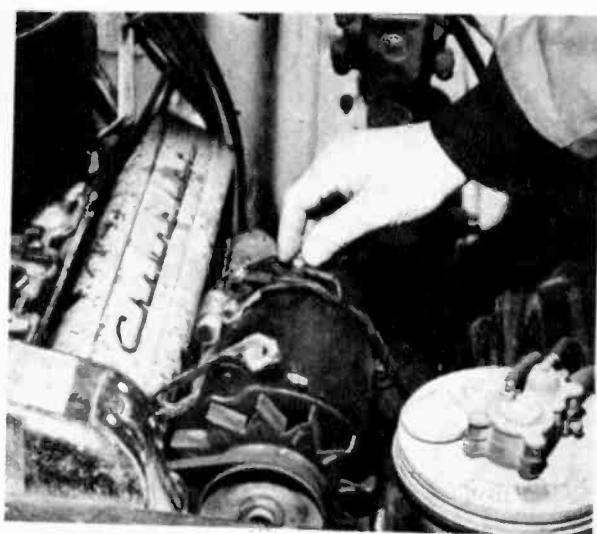

Check all connections on charging generator and cutout for tightness. If it's accessible, examine commutator for excessive sparking, correct it by applying fine sandpaper while engine is running.

If a receiver is perfectly quiet, with the car stationary and the engine shut off, and noisy when the car is running, obviously the noise originates somewhere in the vehicle. Irregular, grinding noise usually results from loose or dirty connections in various places. Start with the antenna. Extend it to its full length and clean it with a dry rag. The amount of black muck that works into the telescoping sections is often astonishing. Do NOT lubricate the sections with oil, gun grease or petroleum jelly, all of which are rather good insulators. No lubrication is necessary; the tighter the bond between the sections, the better the electrical connection.

Check the base fitting of the antenna for tightness. A half turn on the large hex mounting nut is all that is usually needed. On the inside of the car, trace the flexible cable from the antenna to the set and also check this for tightness. The receiver end of the cable has a push-in plug; twist or remove and re-insert it, to make new, clean contact.

Very few people seem to know that virtually all cars of recent manufacture have special little spring fingers along the top edge of the engine compartment, intended to make good electrical connection with the matching edge of the hood when the latter is closed. As long as they remain clean, these contacts maintain the proper "grounding" of the hood in relation to the rest of the body, the engine and the chassis. As they accumulate a mixture of oil vapor from the engine and dirt from the road, the contacts can lose their effectiveness, and the result is often a slight but annoying grating noise in the radio set. Look for

these inconspicuous springs, and keep them bright and clean.

Real electrical interference, created by the car's ignition and charging systems, is eliminated quite effectively by resistor-type high-voltage leads from the distributor to the spark plugs and by a simple bypass capacitor across the commutator of the generator. These expedients are factory-installed in most cars, and require no attention. However, it is advisable to examine the generator for excessive sparking at the commutator, as this sparking might generate interference noise.

In some cars the generator is readily accessible, and the copper segments of the commutator can be cleaned in a minute with a thin strip of fine sandpaper taped around the end of a stick. Let the engine idle, press the stick in lightly, and blow out the loosened carbon deposits. The carbon brushes in most generators outlast the cars and rarely need replacement.

The pilot light that illuminates the face of the tuning dial is much more likely to burn out than most of the tubes. While a replacement costs only pennies, the job of putting it in usually requires the removal of the entire receiver from the dashboard.

The chassis is mounted to the dashboard by the same studs bearing the volume and tuning controls. If the knobs are pulled off, the large hex fastening nuts become visible. Some sets have an additional brace to a nearby point on the underside of the dashboard, secured by a wing nut or screw. To free chassis completely for removal, pull out antenna lead, remove loudspeaker plug and separate sections of fuse holder in the "hot" lead that goes to battery circuit. •

Boxed Speaker

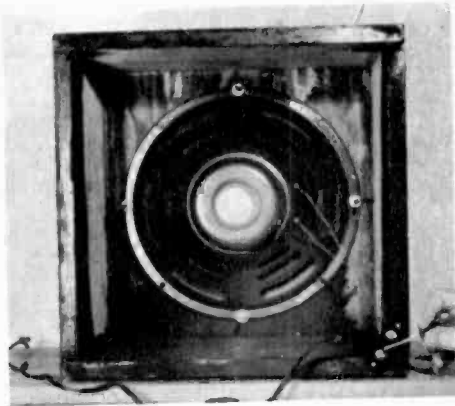

Discarded TV speaker in screened box gives very fine results with communications receiver.

BEFORE throwing out a discarded radio or television receiver, save the loud-speaker if its cone appears to be intact. Mounted in a simple wooden enclosure, it is excellent for use with communications receivers, most of which do not have built-in speakers, and for general experimental work in a home electronics shop.

The "enclosure" can be merely a square box, preferably of rigid wood such as $\frac{3}{4}$ -inch thick, 8- to 10-inch wide shelving, or 5- or 6-ply plywood. Nailed and glued

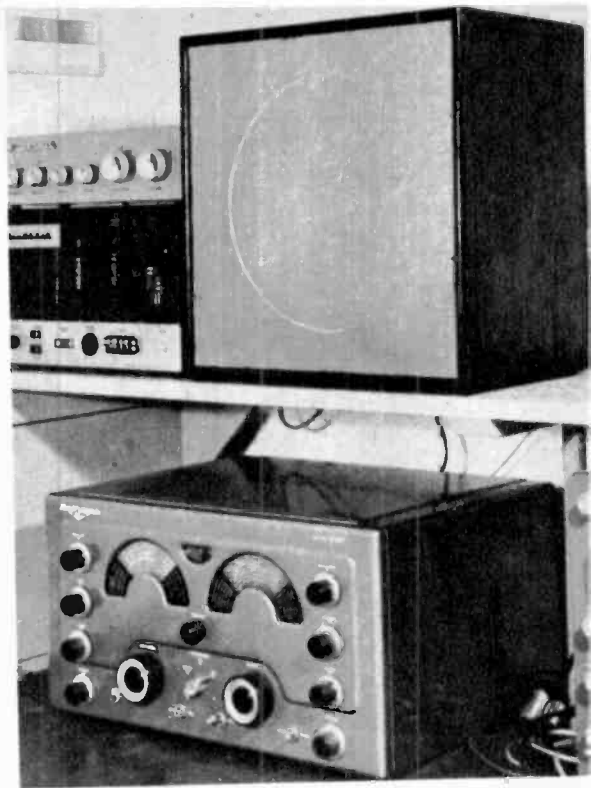

Voice-coil leads of speaker are brought out to terminal strip mounted on back edge of box.

butt joints are adequate, as there is no real physical strain on them. The speaker itself is bolted from the inside to a hole in the front panel of suitable diameter.

To protect the cone and to give the speaker a finished appearance, cover the front with ordinary window screening, held down with thin half-round molding. Paint to match receiver.

Box dimensions are not critical. Provide at least three inches of space between the speaker rim and the inside of the box.

Hammer Fixes Pliers

TOOLS are important when making or repairing equipment for hi-fi or other electronic devices. To keep tools in the best working order, repair them when they need it.

The most useful tool you own is a pair of pliers. They may loosen in the center. To tighten, lay on an anvil, hammer on center nut until it is tightened. •

Tighten pliers by hammering on center nut, but don't overdo it. They may become too tight to open.

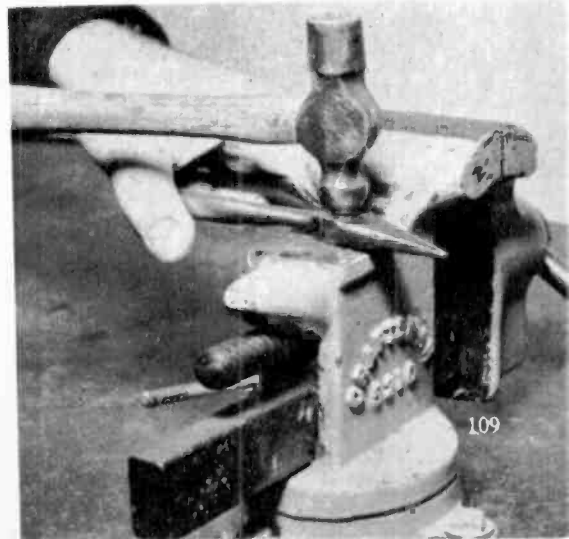



A complete "ham shack" on the driver's seat! Actual installation of the Heath Cheyenne transmitter and Comanche receiver in a 1960 Ford. Units are secured in a base mount, which in turn rests on a plywood board. Sponge rubber pads protect upholstery. Note loudspeaker on transmission hump, under dashboard. Since it is not bolted down, but rests by its own weight on seat, this mobile unit can be removed, shifted, reconnected, etc., in a few minutes.

Simple piece of plywood acts as sub-support for Heath AK-6 base mount for mobile transmitter and receiver. U-shaped channel (left) comes with mount; it is held to plywood with several short screws. The wood strip (right) is $\frac{3}{4} \times \frac{3}{4}$ inch, with a $\frac{1}{8}$ -inch slot.

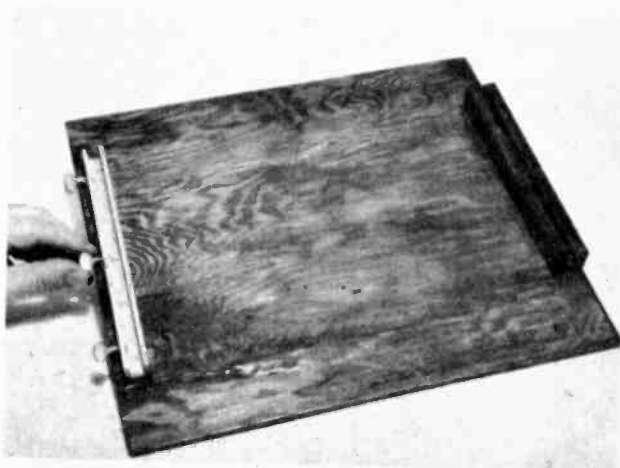

Ham Radio in the Car

Units work safely and economically on vehicle's electrical system.

THE BIG PROBLEM in the design of transmitting and receiving equipment for mobile use has always been the limited current capacity of the vehicle's battery-charger combination. It's very well to make a two-way communications unit that requires from 40 to 80 amperes of DC, (actual, not imaginary figures!) but what good is it if the charging generator is rated at 25 amperes, starts cooking at 35 amperes, and burns up at 50?

Some manufacturers of mobile ham gear are notoriously coy about mentioning how much juice it needs. In an elaborate brochure describing the technical features of a certain beautiful transmitter-receiver combination, the primary current drain is the one detail that is missing. Many purchasers of mobile stations have been forced to remove the generators and voltage regulators that came with their cars and to replace them with much larger units of the type used in taxis and police cars. This is a fairly simple job mechanically, but it costs plenty.

The word "mobile" does not mean "automobile," although it includes it. There are large numbers of ham installations in small boats and a few in private planes, and in

these vehicles it is much more necessary to preserve and protect the electrical system than in a car.

Merely putting in a larger storage battery is not the answer. In practically all mobile service it is necessary to keep the engine running at a fast idle when the car is stationary, so that the heavy current for the equipment, and for the transmitter in particular, comes mostly from the generator. Work the equipment on the battery alone for an hour or so and you're lucky if the latter kicks over the engine for starting.

Instead of building up a two-way unit from the signal standpoint first and worrying about the power requirements afterward, it would appear to be much more sensible to fix the primary current drain at some reasonable maximum, within the ratings of standard generators, and to design the transmitter to give out as much signal as is possible under the circumstances. The receiver presents no difficulties because it requires very little energy, and besides, the switching arrangement of practically all mobile equipment is such that the receiver plate voltage is switched off when the transmitter goes on.

The Cheyenne transmitter and Comanche receiver bolted together and fastened in vertical position on Heath AK-6 base mount. Rear lip of base fits in slotted wood piece. Front lip is raised on U-shaped bracket to leave space for connecting cables.

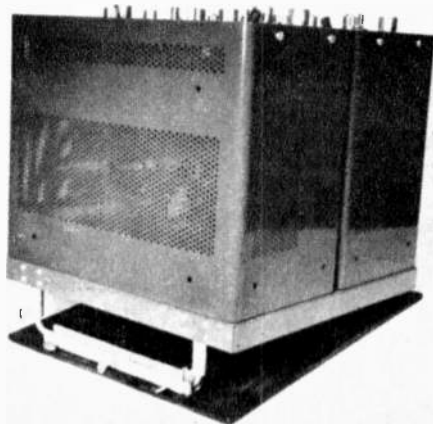

Well-anchored spring base for mobile antenna on car is a necessity. This type of clamp-on bumper mount obviates hole-cutting in body. Single small hole needed to pass coaxial antenna feeder to inside is made in splash apron or floor of trunk.



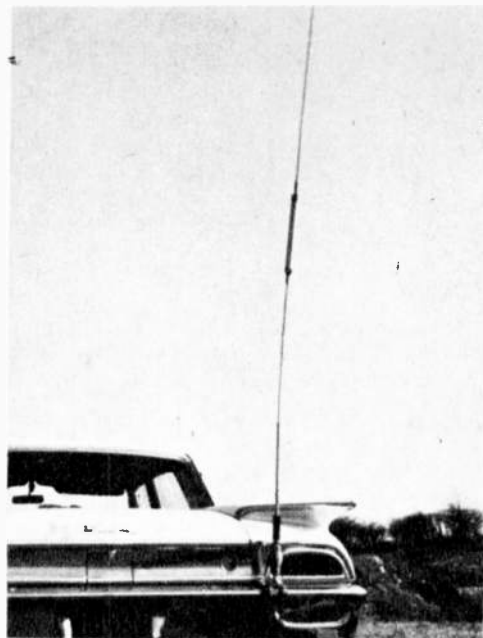

Heath RM-1 antenna, left, above, with adjustable center loading coil, enables owner of mobile equipment to work on 10, 15, 20, 40 and 80 meter bands and to take advantage of "open" conditions as they occur. Moseley MA-3 mobile whip, above right, is three-band antenna, for 10, 15 and 20 meters. The loading coils at the base and in the center are fixed. Investigate both models before you buy.

The limited-current approach was used by the Heath people when they decided to produce mobile gear in their usual kit form. The generators found in most cars having six-cell batteries are rated at 25 amperes. Since the ignition system alone requires up to about 5 amperes, the radio load was set at 20 amperes. If the headlights are on at the same time the total current exceeds 25 amperes, but what saves the generator is the intermittent nature of the transmitter load.

As shown in the accompanying photos, the new equipment takes the form of four integrated units: the "Comanche" receiver,

the "Cheyenne" transmitter, a transistor power supply, MP-1, for 12-volt DC sources, and a utility AC power supply, UT-1, for fixed station use. Accessories include a small loudspeaker, a crystal mike and an all-band antenna.

Identical in size and front-panel appearance, the receiver and the transmitter each measure 12½ inches wide, 6½ inches high and 10 inches deep. These dimensions are a bit on the generous side. Depending, of course, on the individual car, the units can be hung side by side under the dash, or they can be stacked vertically and mounted over the transmission hump on a special

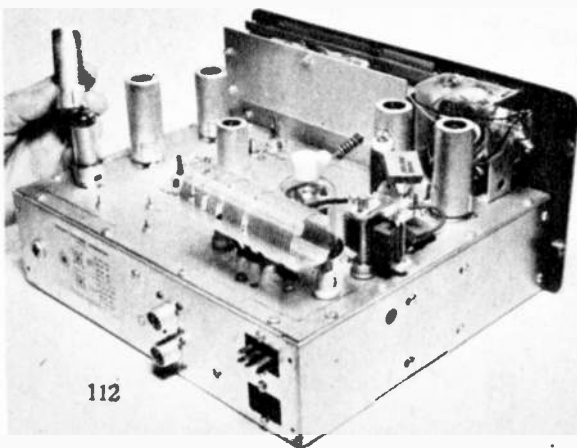

Inside chassis view of Cheyenne mobile transmitter. The 6146 power amplifier tube is sunk partially in large hole in chassis behind large open-wire tuning coil, foreground. Coax fittings on back apron are for antenna leads; 6-prong connectors for power supply.

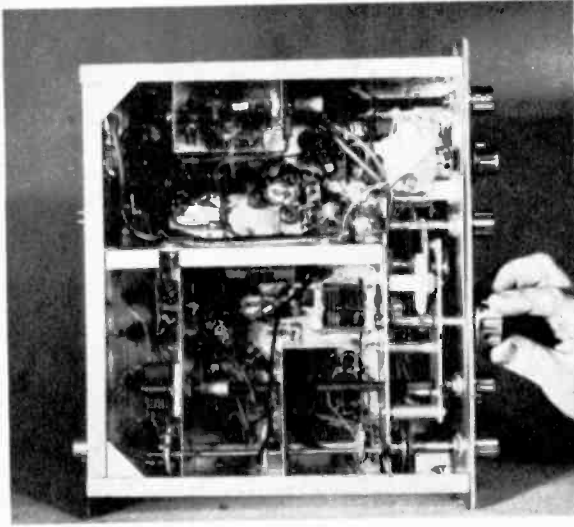

Underside of Comanche receiver chassis, shown in the photo above, is well filled. There is little margin for error in assembling and wiring this five-band set. So be sure to do it right the first time!

base made for the purpose. In this position the controls are conveniently accessible to both the driver and a passenger on the front seat. Of course, the equipment also blocks the driver to the right, and he must get into the car by the left door. This isn't as bad as it sounds when you consider that owners of Thunderbirds and some other fancy sports cars have to do the same thing even *without* mobile ham gear in them. (In these cars the transmission hump or tunnel is as high as the individual seats on either side.)

In my own car, a 1960 Ford, I found that there wasn't quite enough room on the transmission hump for the Comanche-Cheyenne combination, so I merely put it on the seat next to me. To protect the upholstery, I made a simple plywood sub-base, for the iron base to which the units are fastened, and put sponge rubber seat

Heath MP-1 transistor power supply, below, furnishes all the high voltage DC needed for both the Cheyenne and the Comanche. Transistors are surface-mounted on chassis for heat dissipation.

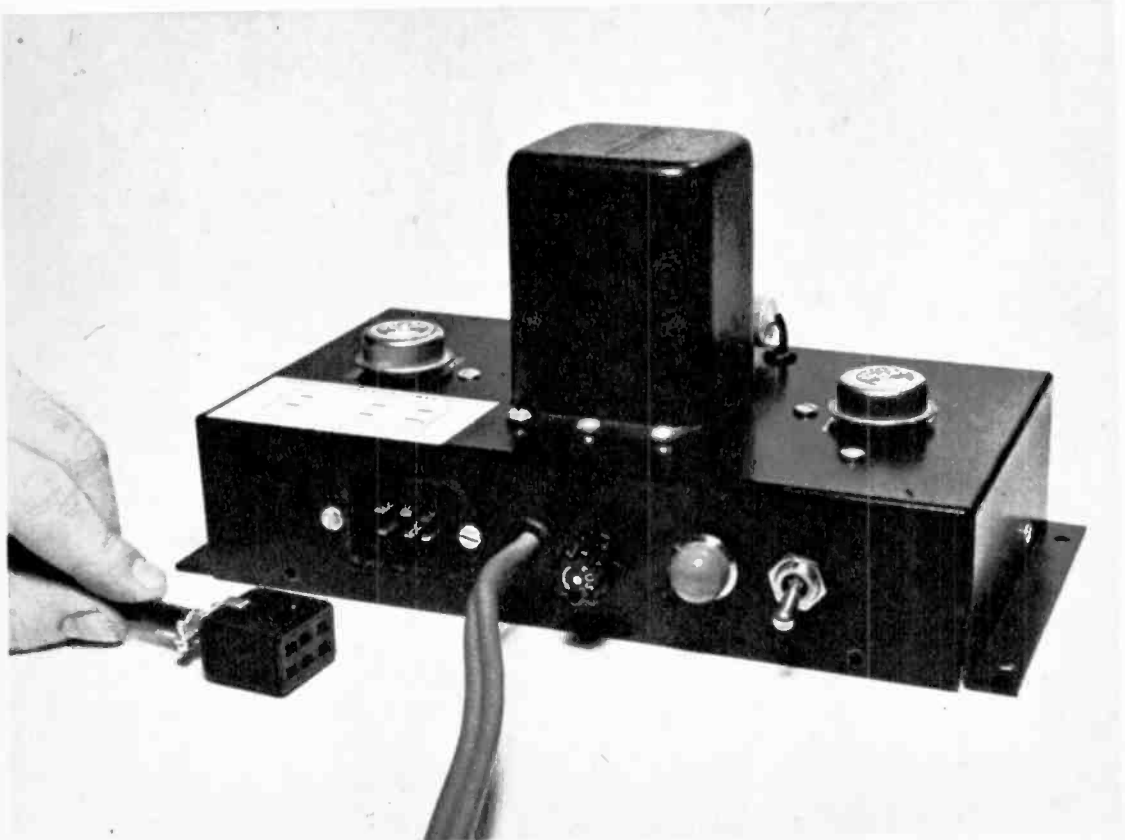

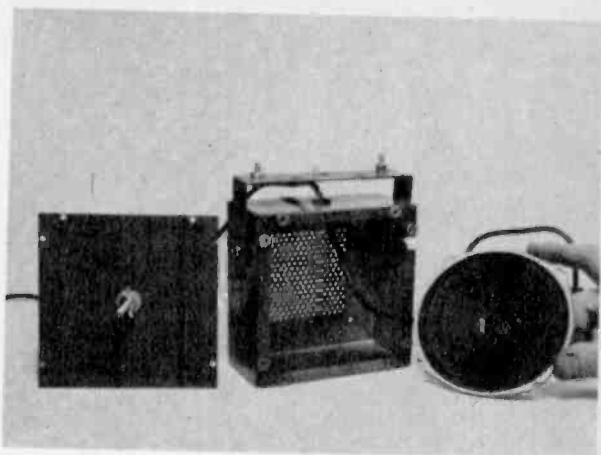
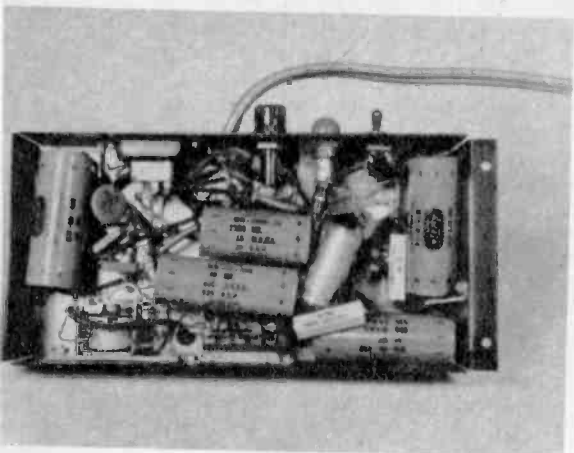

Large filter capacitors dominate underside of chassis of MP-1 power supply. Waterproof 4-inch speaker in metal case, above right, is Heath accessory. It can be mounted under the dash or on the fire wall.

The Cheyenne and Comanche "mobile" units constitute a very handsome fixed station as well when used with the Heath UT-1 AC power supply. This compact but complete little "shack" will provide endless hours of thrilling two-way communication, on either voice or CW (radiotelegraph). Note important accessories: clock, log book, pencil and paper, microphone (included with Cheyenne kit), radio key.



pads under and behind the assembly. This arrangement has worked out very advantageously. I can install or remove the whole business in about three minutes, since it is not bolted down. I can also place it on the back seat, where a passenger can operate it without bothering the driver.

Transferring the stacked assembly from the car to a motel or hotel room, or the home shack, along with the AC power supply and a window antenna, is a simple job that requires only some muscle. The gross weight is about 65 pounds.

CIRCUIT ARRANGEMENTS

The transmitter has a built-in variable frequency oscillator and is band switching over the 10, 15, 20, 40 and 80 meter bands. The tube sequence is: 6AU6 VFO, 6CL6 buffer, 5763 driver, 6146 final amplifier,

12AX7 speech amplifier, 6DE7 carrier-control modulator, and OA2 voltage regulator. Power levels up to about 90 watts input on modulation peaks are obtained.

The receiver is a full five-band super-heterodyne having excellent sensitivity, selectivity and stability.

Circuit details of both units are shown in the complete schematic diagrams, reproduced on these pages.

As kits, the Cheyenne and the Comanche are worked up with the thoroughness that has made Heath famous. However, it must be stated in all fairness to prospective builders that these projects are definitely not for beginners. The mechanical assembly alone, especially of the dial mechanisms, is somewhat tricky. With five-band coverage, the components

The actual connections of a Cheyenne-Comanche combination used as a fixed station. Coax cable from antenna from upper right, to top coax connector on transmitter. Short coax loop between transmitter (top) and receiver (bottom), for antenna changeover. Cable from AC power unit (on table, right) to transmitter. Short jumper cable from transmitter to receiver, to carry power to latter. Loudspeaker to jack, right end of receiver apron. Microphone plugs into jack in side of transmitter. Radio key, not shown in this view, plugs into jack at left end of transmitter apron. Whole setup can be taken apart or put together in less time than it takes to describe it. This is also a great advantage when it is used in the car.

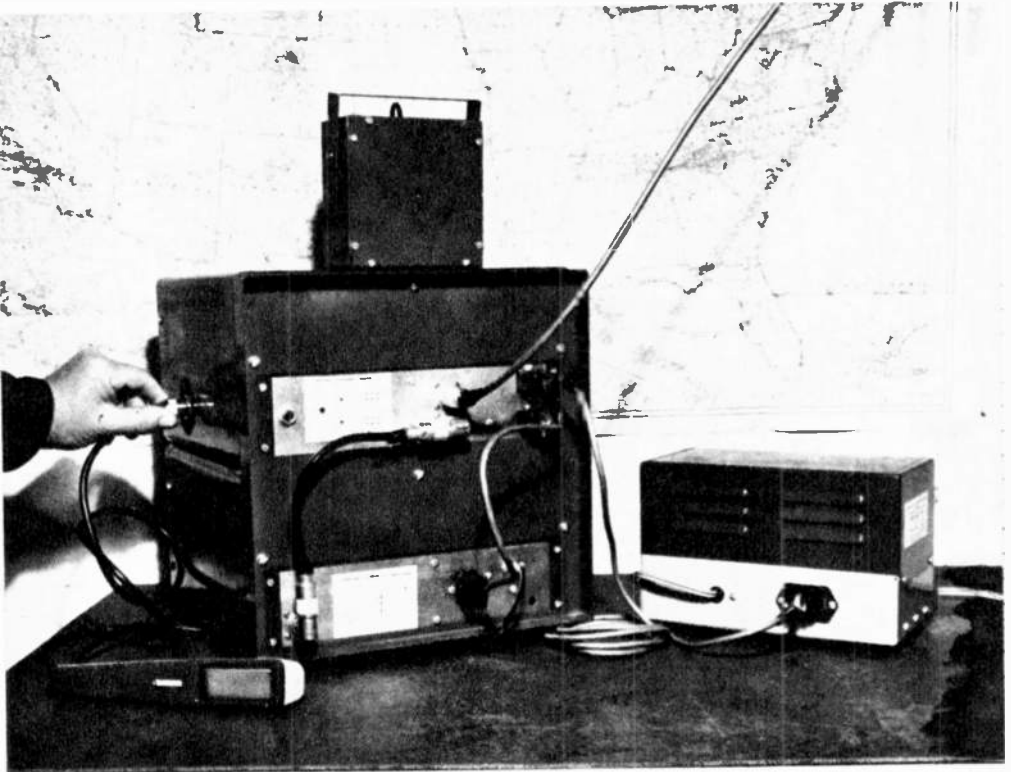

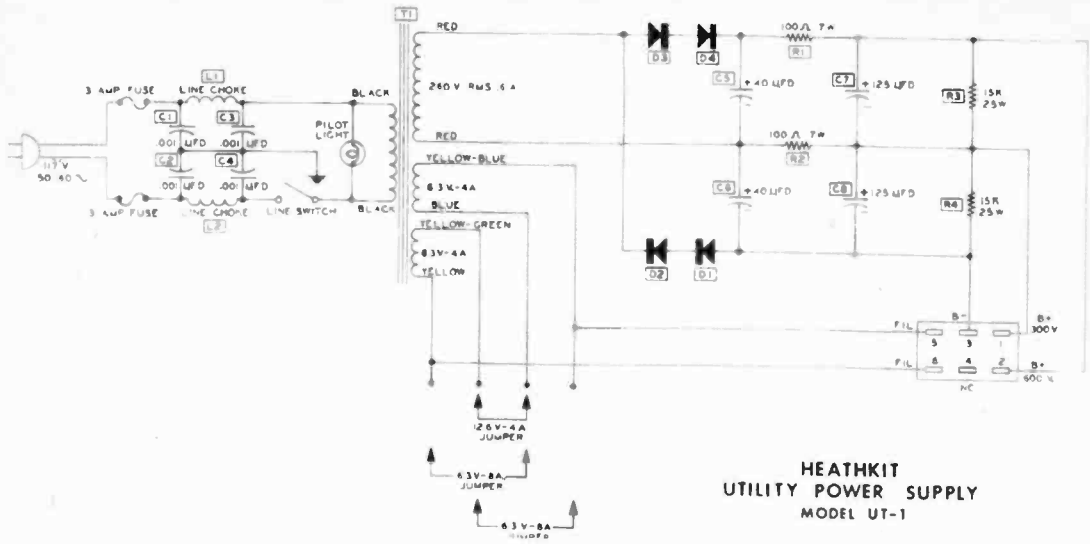

The cover is off to show power transformer (center) filter capacitors (left) and bleeder resistor (right).



are numerous and the wiring tight, and both the transmitter and the receiver must be aligned and calibrated from scratch. These jobs are not difficult . . . in fact they are interesting and challenging . . . but they should be undertaken only by hams with appreciable experience in kit construction.

Neither the transmitter nor the receiver contains its own power supply. They are intended for use with the separate MP-1 supply, a compact little unit you can knock together in an evening. This embodies two 2N442 transistors which act as electronic switches to interrupt the DC of the generator-battery source and to permit transformer action in the manner of AC. Four diode rectifiers in a voltage doubling circuit, with heavy filtering, furnish 600 volts DC at about 150 milliamperes and 300 volts at 100 ma. The supply is turned on by means of the on-off switch on the

receiver, and the high voltages are controlled by a relay in the transmitter. This relay is actuated by a push-to-talk switch on the hand microphone.

With the receiver on full, the transmitter filaments on, and the mike switch off, the whip antenna on the vehicle is connected through the relay in the transmitter to the receiver, and the latter works in normal fashion. The total current drain in this condition is about 9 amperes. When mike switch is pushed to activate transmitter, total drain goes up to 19-20 amperes.

Heath has a five-band whip antenna, the RM-1, as an optional accessory. This uses an adjustable center loading coil which can be set accurately for each band.

With the UT-1 AC power supply, the Cheyenne and the Comanche make an extremely compact, attractive fixed station. Left in their mobile mount but placed upright, they occupy very little table space. •

Under view of Heath UT-1 AC power supply. Pencil points to compact, efficient silicon rectifiers.

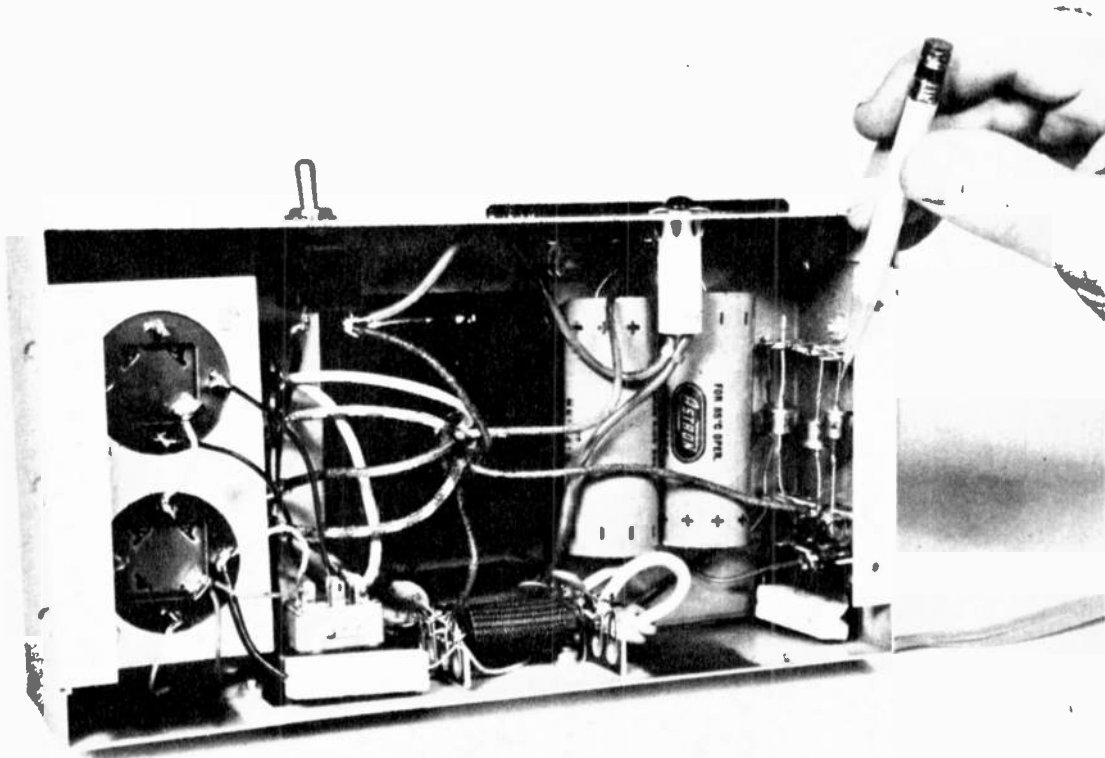

The Grid-Dip Meter

NEXT to a good volt-ohmmeter or a vacuum tube voltmeter, probably the most useful test instrument around a ham shack or electronics shop is a "grid-dip meter," popularly called a "grid dipper."

In the form in which it is widely sold as either a kit or a factory-assembled unit, a grid dipper is basically a simple one-tube variable frequency oscillator with a sensitive DC microammeter in the grid return circuit to show the relative power of the generated RF energy. A wide frequency range is made possible by the use of plug-in coils, which are tuned by a variable capacitor. The coils are generally slender and long, from about $\frac{1}{2}$ to 1 inch in diameter and 2 to 4 inches long, and they are always exposed at one end of the case of the instrument.

In its primary application for determining the frequency or range of frequency of a resonant circuit (typically, the combination of a tuning coil and a tuning capacitor in a transmitter), the coil of the grid dipper is brought near the coil of the circuit under test. The latter itself is not energized; that is, power is off. As the tuning control of the dipper is turned, a point is reached at which the grid meter drops sharply. As the point

is passed, the needle resumes its normal reading. This dip occurs when the two circuits are tuned to the same frequency; the unknown circuit simply "sucks out" some of the energy generated in the grid dipper, causing the meter to dip and thus giving the instrument its name.

Of course, a measuring device, to be of value, must be calibrated. In factory-made meters this is done by the manufacturer. With dippers assembled from kits, the initial calibration represented by the dial scales is only approximate. Fortunately, this can be corrected to a high degree of accuracy merely by "zero beating" the dipper against standard-frequency stations that transmit practically around the clock on the short waves.

The latter operation represents another important use of the grid dipper. Once the scales are calibrated, the meter becomes a very valuable marker generator, either for determining the exact frequency of a station being heard on a receiver or for pre-setting the latter so that a station of known frequency can be located on the dial and tuned in easily.

With a pair of earphones connected to it, a grid dipper becomes a sensitive one-tube

Two popular AC grid-dip meters. Left: Eico Model 710, in kit or assembled. Right: Knight-Kit Model G-30.

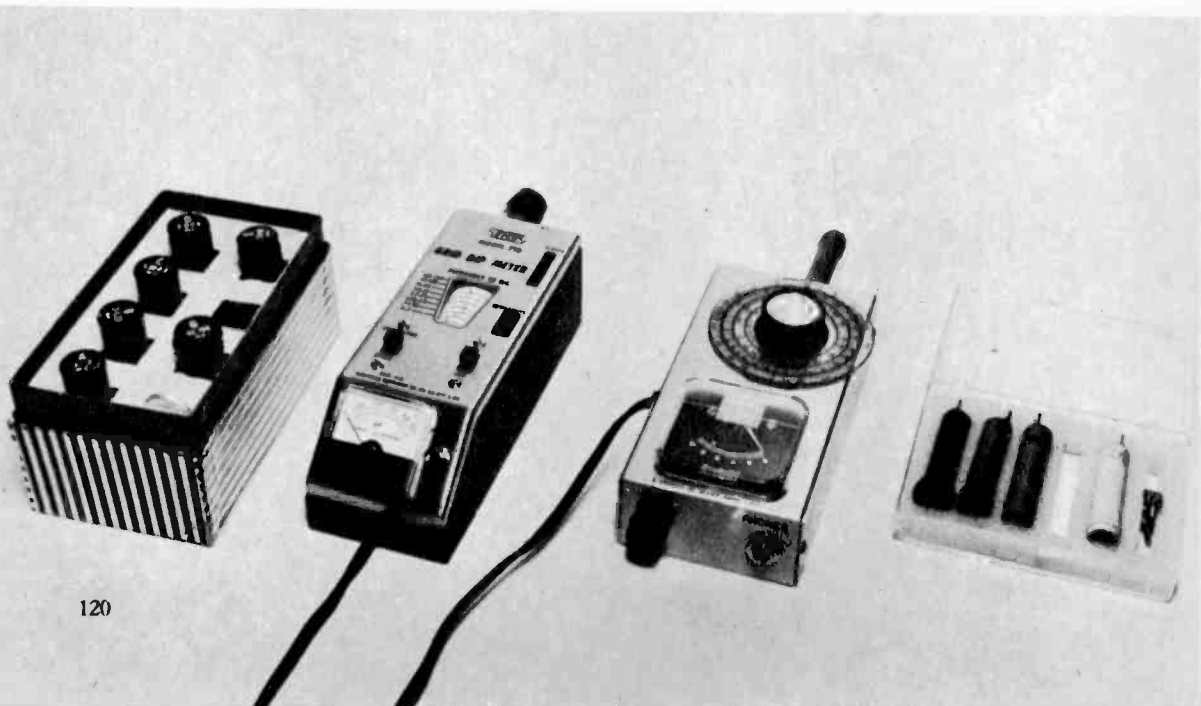

The Magazine That's Right Up Your Alley **ELECTRONICS ILLUSTRATED**

Take advantage of this

SPECIAL INTRODUCTORY OFFER

12 Monthly Issues Only \$2.78*

E. I. sells for 35c per Copy or
\$4 per yearly subscription



**ELECTRONICS
ILLUSTRATED**

ELECTRONICS ILLUSTRATED shows you how to buy, how to use and how to build: hi-fi, short wave and ham equipment, transistor radios and projects for your home and hobby.

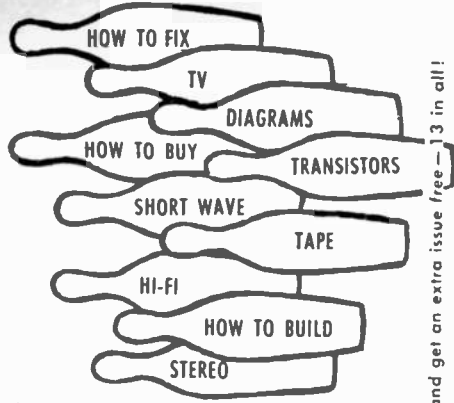

MAIL THIS CARD TODAY

+Enclose remittance with order and get an extra issue free — 13 in all!

Yes!

Set up my 12 issues of **ELECTRONICS ILLUSTRATED** for only \$2.78* (this saves me \$1.22 over the yearly subscription price)

*1 enclose \$2.78 entitling me to 13 issues

Bill me later

Name

..... please print

Address

City.....Zone.....State.....

B U S I N E S S R E P L Y M A I L

No Postage Stamp Necessary if Mailed in the United States

**FIRST CLASS
PERMIT NO. 80
Greenwich, Conn.**

POSTAGE WILL BE PAID BY

ELECTRONICS ILLUSTRATED

**FAWCETT BUILDING
GREENWICH, CONN.**

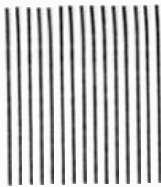

**See
Reverse Side
For a Real
Money-Saving
BARGAIN
On
America's Favorite
Electronics
Magazine**

In this actual operating setup, the calibration of an Eico grid dipper is being checked against that of a Hallicrafters SX-101 hiband communications receiver, which has an accurate built-in crystal standard. The grid dipper itself can then be used as a standard for setting other receivers, transmitters, oscillator circuits, etc., to any predetermined frequency. There is no actual connection between the dipper and the receiver; the latter picks up direct radiation from the dipper's coll.



In the grid-dip oscillator made by James Millen Manufacturing Company, Malden, Mass., the indicating meter is at a convenient angle for viewing. The plug-in coils are fully enclosed in plastic to protect them. This oscillator comes only in assembled form, not in a kit.

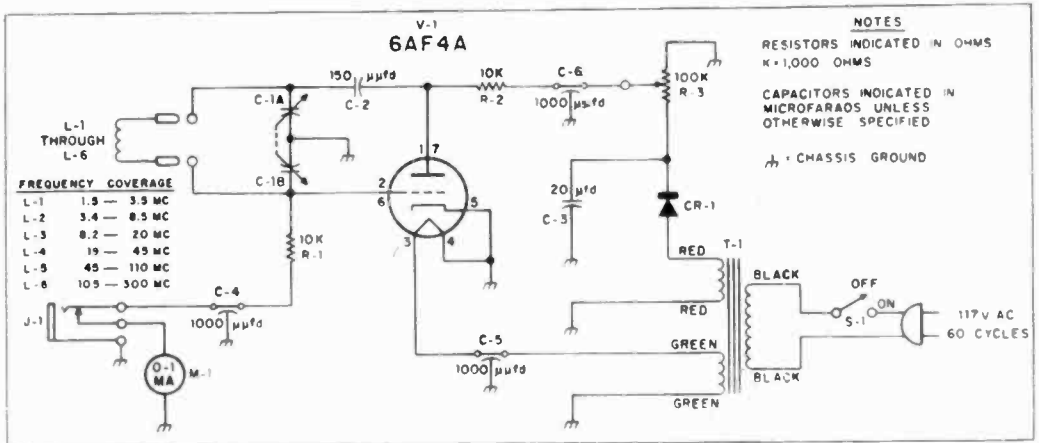
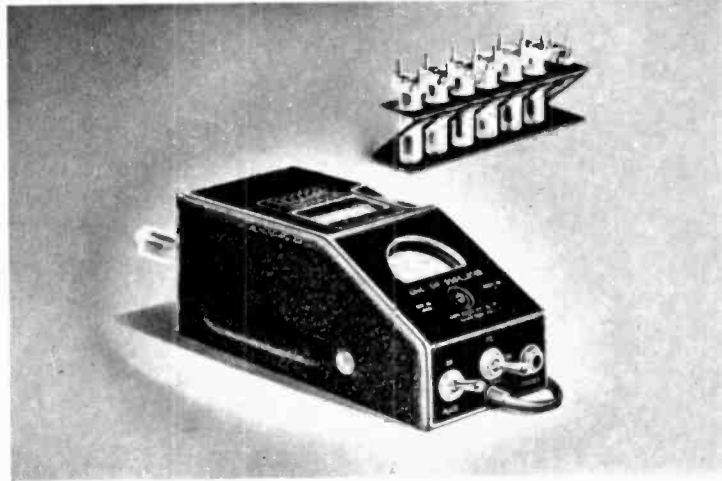

Schematic diagram of the Knightkit grid dipper. DC for plate of 6AF4A oscillator tube is furnished by rectifier CR-1 and filter capacitor C-3, off secondary of power transformer T-1. Coils plug in at left marked "L-1 Through L-6"; earphones into jack J-1. Potentiometer R-3 is sensitivity control. Study carefully

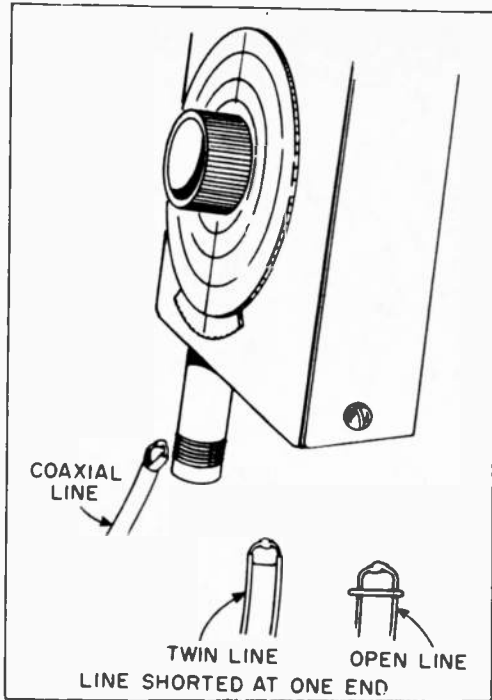

For determining resonant frequency of antenna at feeder end, latter is closed temporarily and then coupled to end of grid dipper probe coil.

oscillating-detector receiver. Placed near a source of unmodulated RF energy, such as the oscillator circuits of transmitters and superheterodyne receivers, it produces a series of whistles or squeals as it is tuned close to the frequency of the unknown signal. Tuned *more* closely so that there is absolute silence between two adjacent squeal settings of the dial, the grid dipper is then working on exactly the same frequency as the signal, and the value of the latter can be ready from the dipper's dial. This tuning process is called "zero beating."

With its plate voltage cut off, a grid dipper functions as an absorption-type frequency meter. The tube works as a simple diode rectifier. When the probe coil of the dipper is brought near a live source of RF energy and the variable capacitor is turned back and forth, resonance between the dipper and the source is indicated by a sharp *upward* movement of the meter. This application is generally limited to transmitters rated at a minimum of several watts. In the oscillator circuits of receivers the energy level is too low to bridge the air gap between the oscillator elements and the pick-up coil of the grid dipper.

In no application is a grid dipper ever connected directly to the equipment it is checking. Such a hookup would either disturb the calibration of the dipper itself or prevent either or both circuits from

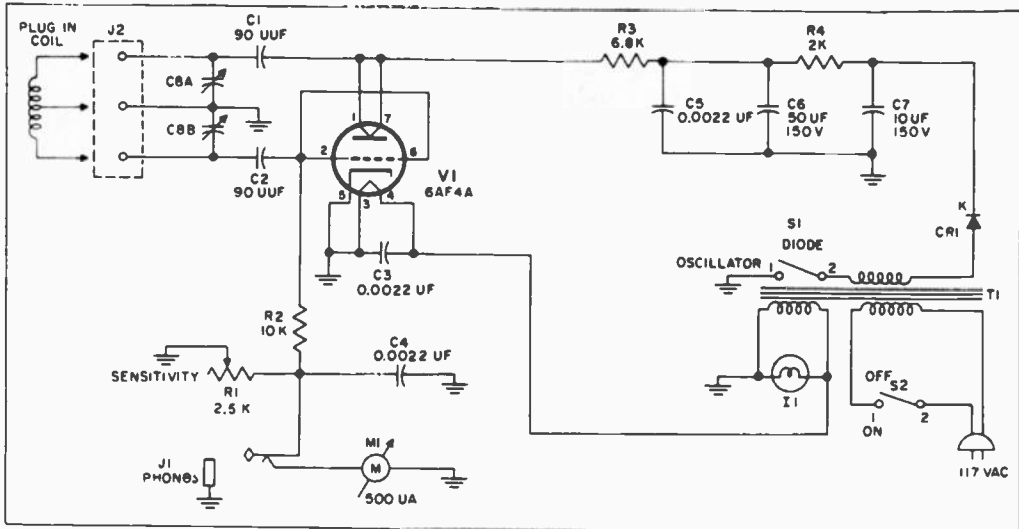

Schematic diagram of Eico Model 710 grid dip meter. S1 is plate voltage switch; I1, pilot light, CR1, rectifier.

In the construction of ham transmitters, the frequency range of an experimental combination of a coil and a capacitor is not always known in advance. It can be determined in a few seconds with this setup, showing a Knight-Kit grid dipper in actual operation. The plug-in coil of dipper is inductively coupled to large "tank" coil, but does not make direct electrical contact. Read the article for complete details.

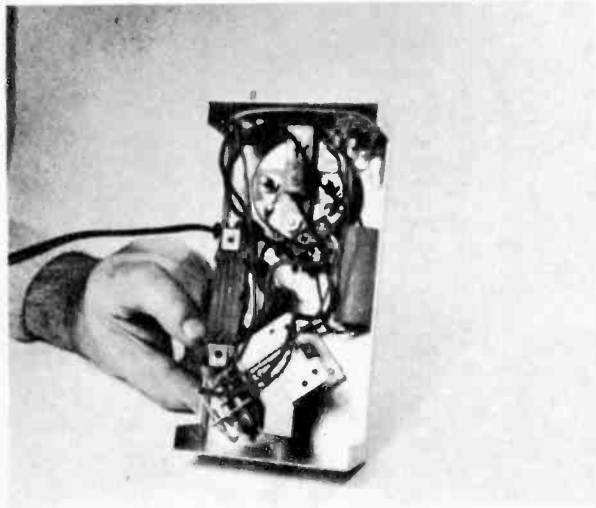
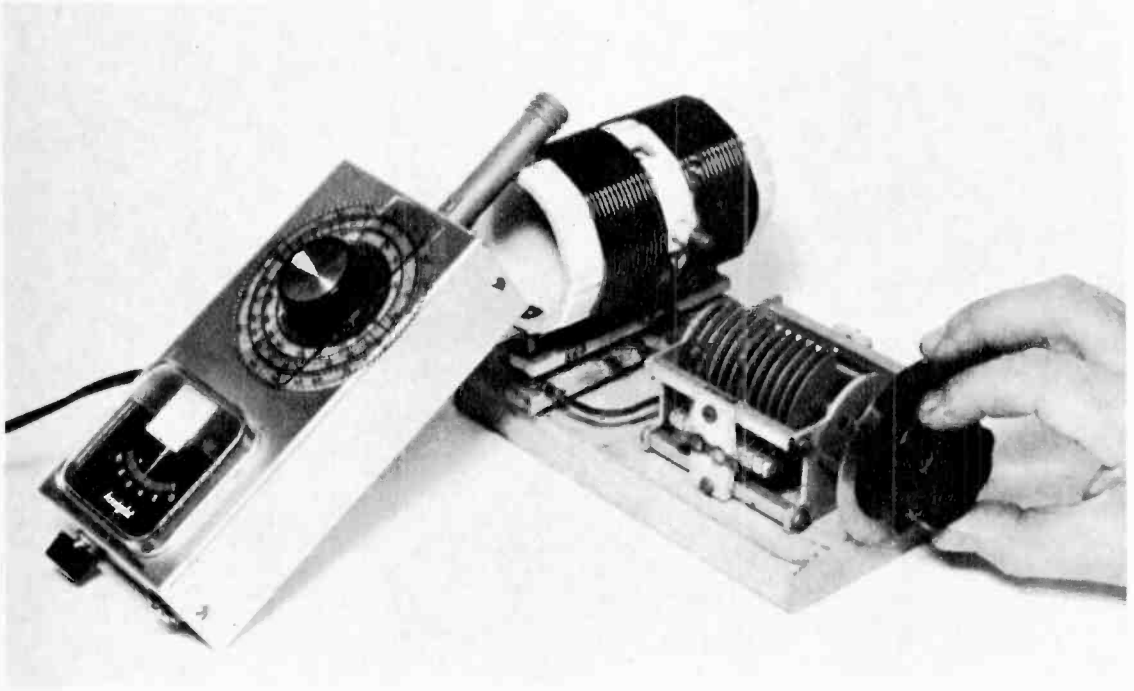

Inside view of Knight-Kit grid-dip meter. Parts are few, wiring simple. Finger is on transformer.

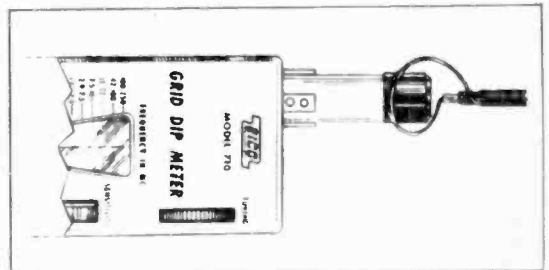
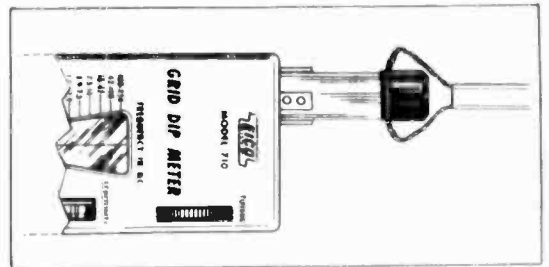

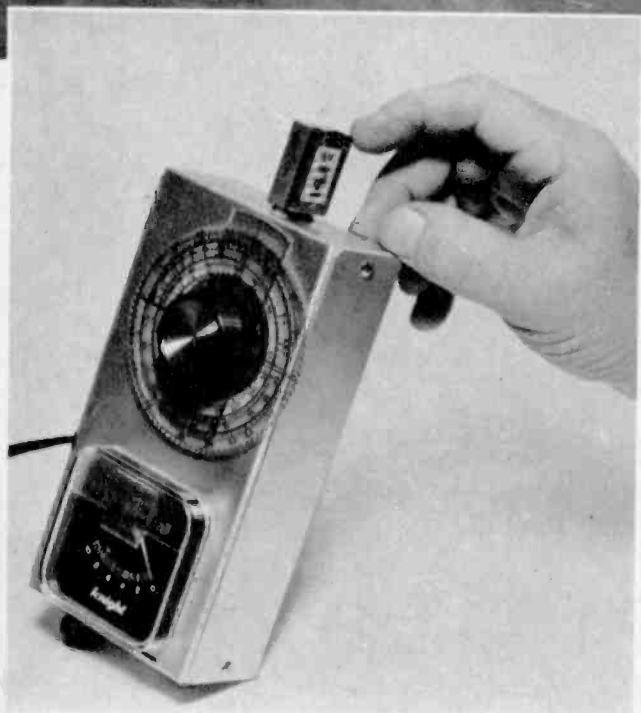
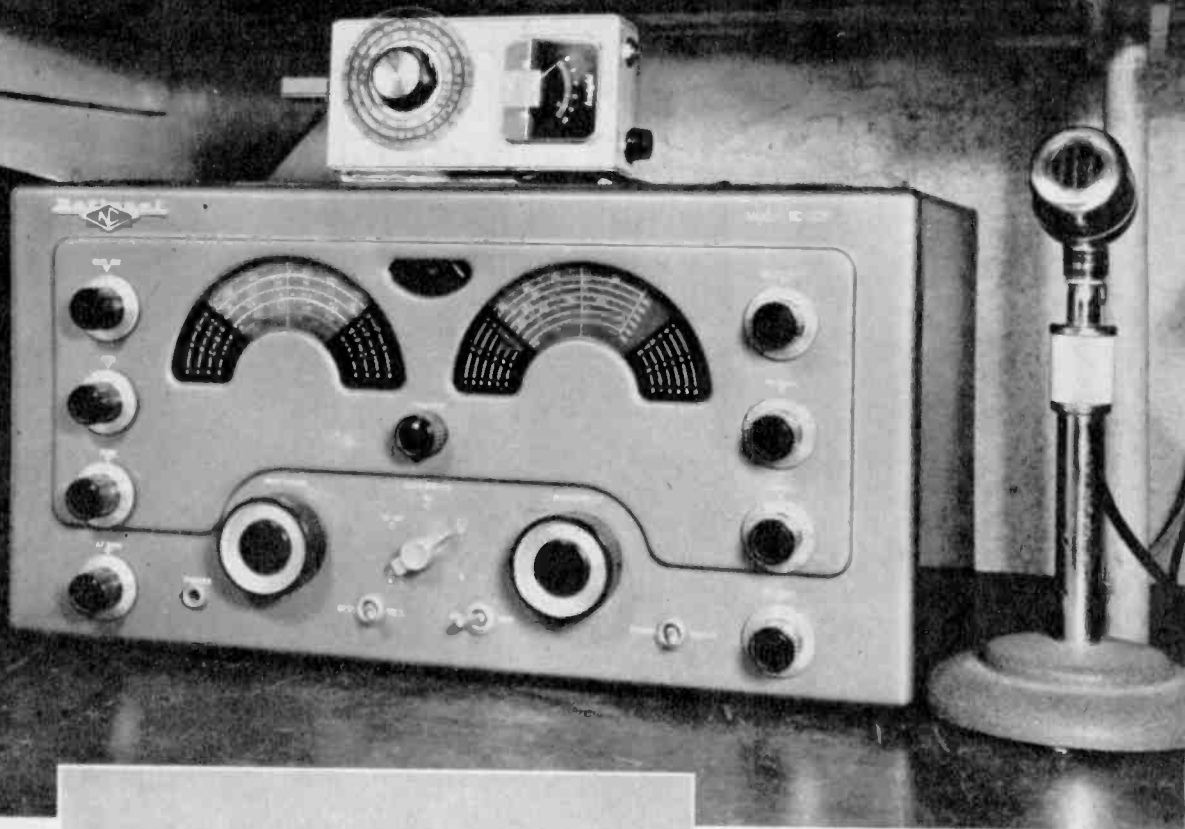

Above: The Knight-Kit grid-dip meter as an outboard frequency standard in conjunction with a National NC-183D all-wave receiver. Crystal is plugged into coil socket at left end of case. Dipper is connected to AC line, but not to receiver, which picks up RF radiation from wiring in the dipper. Crystal gives quick markers for accurate setting of receiver dials. Below: Shown here is how a standard crystal plugs into the coil socket of the Knight-Kit dipper. The dial is not used on this meter.

This straight in-line arrangement, shown in the diagram at the right, is the recommended method of coupling to an unknown circuit.

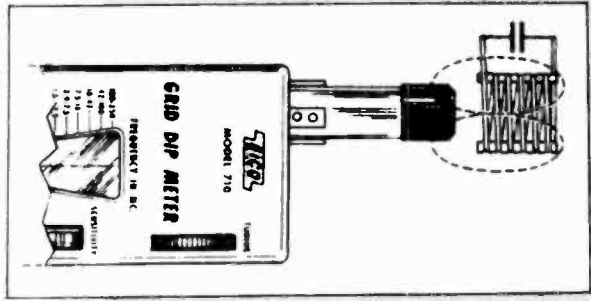

Whenever a single-turn high-frequency coil is used in the dipper, the latter may have to be turned in the direction shown for pickup.

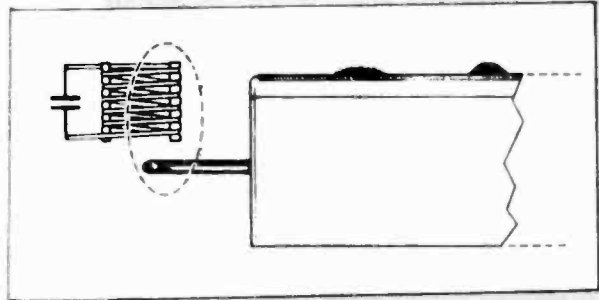

Where parts in a chassis are crowded and not too accessible, this alternate method of coupling may be used (follow the diagram).

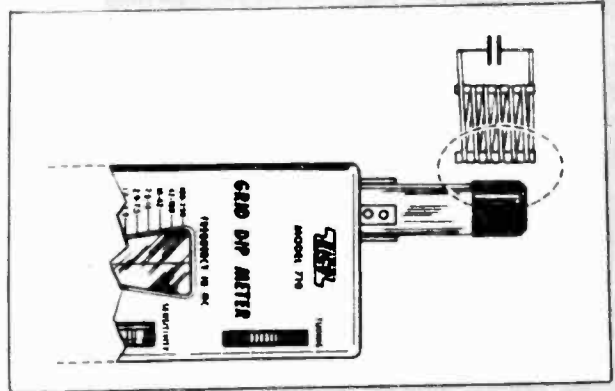

Another method of coupling to an inaccessible resonant circuit is to couple loosely two loops of wire as sketched here at right.

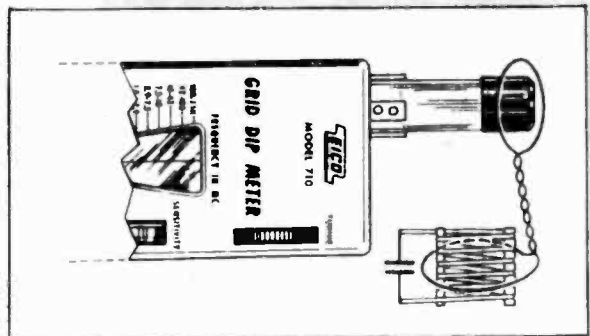

The Most Versatile All-Purpose Multi-Range Tester Ever Designed!

Superior's New Model 79

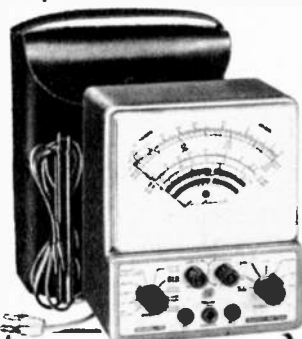

Model 79—Super Meter
 Total Price \$38.50
 Terms: \$8.30 after 10 day trial, then \$6.00 monthly for 5 months if satisfactory. Otherwise return, no explanation necessary.

but in addition includes those services which are "musts" for properly servicing the ever-increasing number of new components used in all phases of today's electronic production. For example with the Model 79 SUPER-METER you can measure the quality of selenium and silicon rectifiers and all types of diodes—components which have come into common use only within the past five years, and because this latest SUPER-METER necessarily required extra meter scale, SICO used its new full-view 6-inch meter.

SUPER METER -WITH NEW 6" FULL-VIEW METER

A Combination VOLT-OHM MILLIAMMETER

Plus CAPACITY, REACTANCE, INDUCTANCE, AND DECIBEL MEASUREMENTS

Also Tests SELENIUM AND SILICON RECTIFIERS, SILICON AND GERMANIUM DIODES.

The Model 79 represents 20 years of continuous experience in the design and production of SUPER-METERS, an exclusive SICO development. In 1938 Superior Instruments Co. designed its first SUPER-METER, Model 1150. In 1940 it followed with Model 1250 and in succeeding years with others including Models 670 and 670-A. All were basically V.O.M.'s with extra services provided to meet changing requirements.

Now, Model 79, the latest SUPER-METER includes not only every circuit improvement perfected in 20 years of specialization, which are "musts" for properly servicing the ever-increasing number of new components used in all phases of today's electronic production. For example with the Model 79 SUPER-METER you can measure the quality of selenium and silicon rectifiers and all types of diodes—components which have come into common use only within the past five years, and because this latest SUPER-METER necessarily required extra meter scale, SICO used its new full-view 6-inch meter.

• D.C. VOLTS: 0 to 7.5/15/75/150/750/1,500.
 • A.C. VOLTS: 0 to 15/30/150/300/1,500/3,000.
 • D.C. CURRENT: 0 to 1.5/15/150 Ma. 0 to 1.5/15 Amperes.
 • RESISTANCE: 0 to 1,000/100,000 Ohms. 0 to 10 Megohms.
 • CAPACITY: .001 to 1 Mfd. 1 to 50 Mfd.
 • REACTANCE: 50 to 2,500 Ohms. 2,500 Ohms to 2.5 Megohms.
 • INDUCTANCE: .15 to 7 Henries. 7 to 7,000 Henries.
 • DECIBELS: -6 to +18, +14 to +38, +34 to +58.

The following components are all tested for QUALITY at appropriate test potentials. Two separate BAD-GOOD scales on the meter are used for direct readings.

• All Electrolytic Condensers from 1 Mfd. to 1000 Mfd.
 • All Selenium Rectifiers.
 • All Germanium Diodes.
 • All Silicon Rectifiers.
 • All Silicon Diodes.

Model 79 comes complete with operating instructions and test leads. Use it on the bench—use it on calls. Only

\$38⁵⁰

Superior's New Model 82A

A truly do-it-yourself type

TUBE TESTER

TEST ANY TUBE IN 10 SECONDS FLAT!

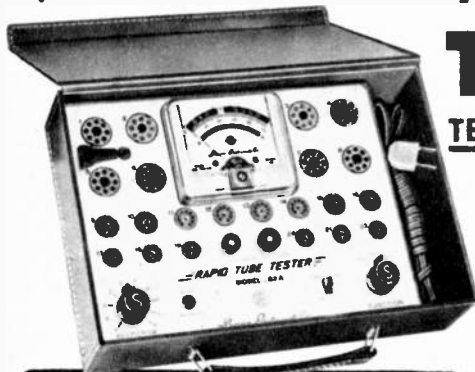

Model 82A—TUBE TESTER . . . Total Price \$36.50—Terms: \$6.50 after 10 day trial, then \$6.00 monthly for 5 months if satisfactory. Otherwise return, no explanation necessary.

FEATURES:

- Tests over 600 tube types.
- Tests OZ4 and other gas-filled tubes.
- Employs new 4" meter with sealed air-damping chamber resulting in accurate vibrationless readings.
- Use of 22 sockets permits testing all popular tube types and prevents possible obsolescence.
- Dual Scale meter permits testing of low current tubes.
- 7 and 9 pin straighteners mounted on panel.
- All sections of multi-element tubes tested simultaneously.
- Ultra-sensitive leakage test circuit will indicate leakage up to 5 megohms.

- ① Turn the filament selector switch to position specified.
- ② Insert tube into a numbered socket as designated on our chart (over 600 types included).
- ③ Press down the quality button—

THAT'S ALL!

Read emission quality direct on "BAD-GOOD" meter scale.

Production of this Model was delayed a full year pending careful study by Superior's engineering staff of this new method of testing tubes. Don't let the low price mislead you! We claim Model 82A will outperform similar looking units which sell for much more—and as proof, we offer to ship it on our examine before you buy policy.

Model 82A comes housed in handsome, portable Saddle-Stitched Texon case. Only
 (Picture Tube Adapter available for \$5.50 additional)

\$36⁵⁰

EXAMINE BEFORE YOU BUY!
USE APPROVAL FORM ON NEXT PAGE

Superior's New Model 70 UTILITY TESTER®

FOR REPAIRING ALL ELECTRICAL APPLIANCES MOTORS·AUTOMOBILES·TV TUBES

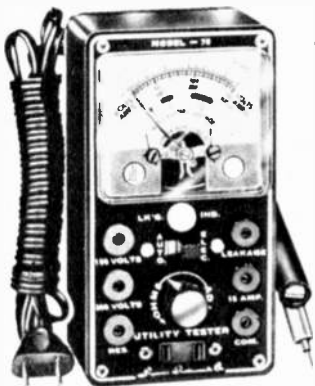

As an electrical trouble shooter the Model 70:

- Will test Toasters, Irons, Broilers, Heating Pads, Clocks, Fans, Vacuum Cleaners, Refrigerators, Lamps, Fluorescents, Switches, Thermostats, etc.
- Will test all TV tubes for open filaments, inter-element shorts, burned out tubes, etc.
- Measures A.C. and D.C. Voltages, A.C. and D.C. Current, Resistances, Leakage, etc.
- Will measure current consumption while the appliance under test is in operation.
- Incorporates a sensitive direct-reading resistance range which will measure all resistances commonly used in electrical appliances, motors, etc.
- Leakage detecting circuit will indicate continuity from zero ohms to 5 megohms (5,000,000 ohms).

As an Automotive Tester the Model 70 will test:

- Both 6 Volt and 12 Volt Storage Batteries • Generators • Starters • Distributors • Ignition Coils • Regulators • Relays • Circuit Breakers • Cigarette Lighters • Stop Lights • Condensers • Directional Signal Systems • All Lamps and Bulbs • Fuses • Heating Systems • Horns • Also will locate poor grounds, breaks in wiring, poor connections, etc.

IT'S SO EASY!!



With tester's cord in outlet, current consumption of appliance is read direct on meter when line cord is connected to receptacle on panel. This typical iron takes 7 amperes (Good)



Small electric fan motor indicates 50 ohms (normal resistance).



Control circuits of most furnaces use 24 volts obtained from step-down transformer. Here's how to check room thermostat to see if wires to it are alive.



Manual supplied with Model 70 shows meter needle should move to right when test leads are connected to pins 3 and 4 of this 6AU8 tube. Procedure for testing all tubes used in TV are detailed in manual.

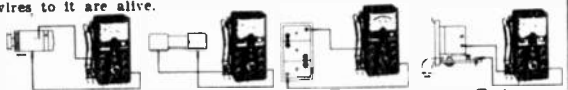

Test Generators Test Auto Fuses Test Storage Batteries Test Circuit Breakers

READ THIS!

READ THIS!

READ THIS!

You don't pay for the Model 70 until AFTER you have examined it in the privacy of your home! Model 70 is

SHIPPED ON APPROVAL

NO MONEY WITH ORDER — NO C. O. D.

Try any of the instruments on this or the facing page for 10 days before you buy. If completely satisfied then send down payment and pay balance as indicated on coupon. No Interest or Finance Charges Added! If not completely satisfied return unit to us, no explanation necessary.

MOSS ELECTRONIC, INC.

Dept. D 814, 3849 Tenth Ave., New York 34, N. Y.
Please send me the units checked on approval. If completely satisfied I will pay on the terms specified with no interest or finance charges added. Otherwise, I will return after a 10 day trial positively cancelling all further obligations.

Name.....
Address.....
City.....Zone.....State.....
All prices net, F.O.B., N. Y. C.

- Model 70 Total Price \$15.85 \$3.85 within 10 days. Balance \$4.00 monthly for 3 months.
- Model 82A Total Price \$36.50 \$6.50 within 10 days. Balance \$6.00 monthly for 5 months.
- Include Model 82A Picture Tube Adapter at \$5.50
- Model 79 Total Price \$38.50 \$8.50 within 10 days. Balance \$6.00 monthly for 5 months.



INCLUDED FREE!!

This 64-page book—practically a condensed course in electricity. Learn by doing.

Just read the following partial list of contents:

- What is electricity? • Simplified version of Ohms Law • What is wattage? • Simplified wattage charts • How to measure voltage, current, resistance and leakage • How to test all electrical appliances and motors using a simplified trouble-shooting technique
- How to test all TV tubes also simple procedure for determining which specific tube (or tubes) is causing the trouble.
- How to trace trouble in the electrical circuits and parts in automobiles and trucks.

Model 70 comes complete with above book and test leads. Only ...

15⁸⁵

functioning normally. The coupling must essentially be electromagnetic, and as loose as possible. If the dipper and the unknown-circuit coils are too close, the suck-out effect invariably causes one of the oscillator circuits to stop oscillating. The general technique is to approach slowly with the dipper in hand and to keep swinging the tuning control back and forth until the meter needle moves.

No connection is needed even when a dipper is used as a marker generator with a receiver. Most receivers are so sensitive that they respond very strongly to the space radiation of RF energy from the exposed coil of the dipper.

In at least one dipper, now on the market (the Knight-Kit Model G-30), the receptacle for the plug-in coils is actually a crystal socket with .486-inch pin spacing. Very conveniently, this permits the use of standard crystals as frequency markers. The regular tuning dial, of course, is ignored. Crystals are very cheap these days, and it pays to buy a handful of them.

A crystal-controlled dipper makes an especially useful adjunct for a communications receiver that does not have a built-in calibrator. Surprisingly, many receivers do not, although one is sometimes available as an accessory that must be connected

into the set's wiring. The external dipper is much less bother, since it only has to be plugged into an AC outlet. A single crystal can often "mark" several bands. For ham purposes, for instance, a crystal having its fundamental frequency at 3500 kilocycles also usually has a lively harmonic at 7000 kc and a weak but discernible one at 14 megacycles. A 7-megacycle crystal is good also for 14 and 28 megacycles.

A dipper has many applications with ham antennas. For example: measuring resonant frequencies, adjusting tuning "stubs" and feed lines, measuring characteristic impedance, adjusting parasitic beams, etc. It is rather easy to obtain false or misleading readings in this work, because of the influence of nearby bodies on antennas and their feed lines and also because of tricky harmonic effects. Quite a bit of double-checking and study of local operating conditions are imperative.

Grid dipper plug-in coils being small and cheap, frequency coverage is no problem. One meter goes from 1.5 to 300 megacycles with six coils; another from 400 kilocycles to 250 megacycles with eight coils. To reduce possible calibration errors, the coils of all dippers, including the kit models, are furnished already wound. •

Under most circumstances, single-turn loop in the end of twin-lead or coaxial feeder of ham antenna must be pretty close to the pickup coil of the grid dipper. However, as shown below, actual operating setup shows that a good indication is sometimes obtained with loose coupling of almost an inch.

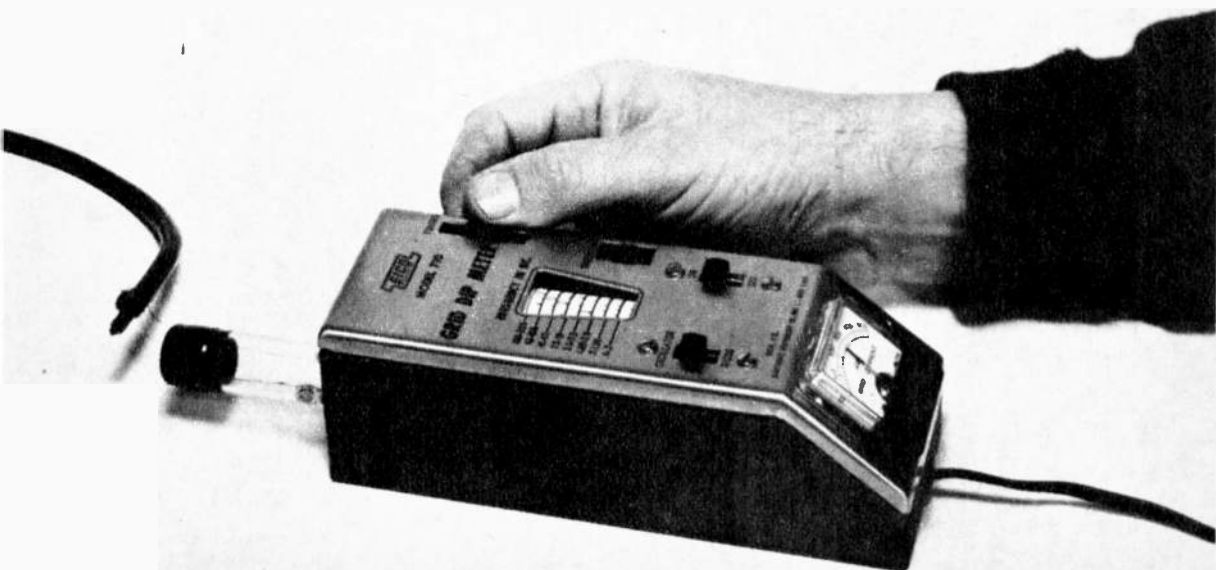

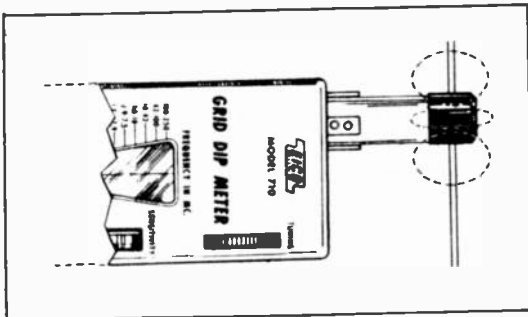

A straight wire has some magnetic field around it. Coupling with pickup coil usually gives a reading.

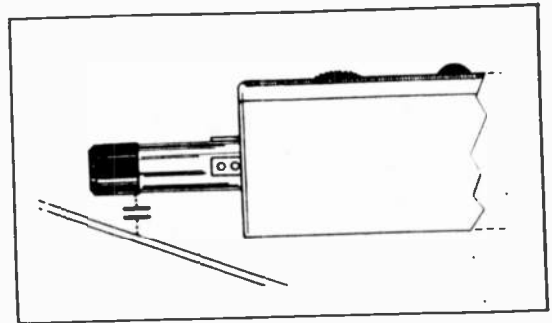

There's always some capacitive effect between wire and dipper's coil. This helps transfer RF juice.

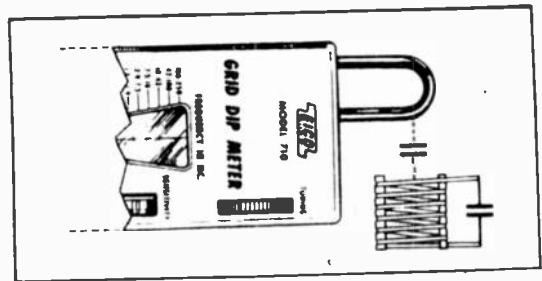

At vhf capacitive effect is used between hairpin loop of dipper and circuit under test (see right).

This diagram shows how grid-dip meter is used as RF oscillator in connection with a standing-wave-ratio bridge and a volt-ohmmeter, to determine characteristic impedance of short-wave transmitting antenna.

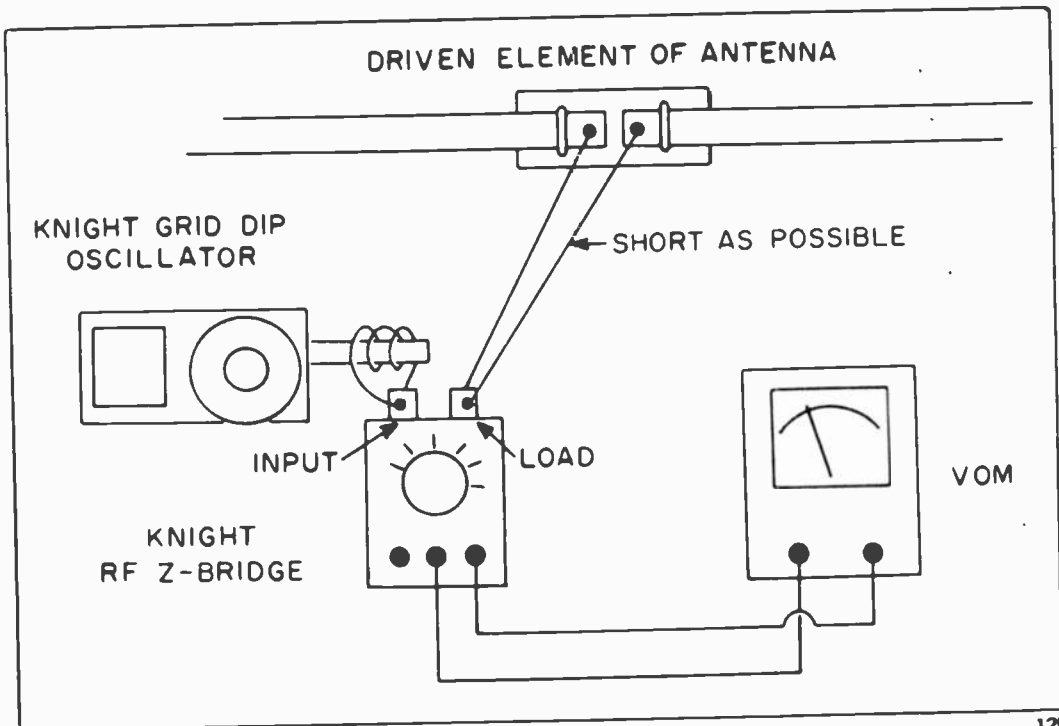

Monitor Your Keying

For greater efficiency in clarity and comprehension, "listen in" on your own key.

MANY EXPENSIVE ham transmitters lack a small feature that would contribute greatly to good CW operating: a source of side-tone to enable the operator to hear his own keying. Without this monitoring facility, it is difficult to verify the accuracy of dots and dashes made with a straight key, and it is impossible with a

semiautomatic key. Many users of the latter just don't realize that an extra dot here or there changes E to I, to H, H to 5, D to B, etc. Much of the speedy sending on the ham bands is hardly more than hash.

Since it is much easier to work DX stations by CW than by voice, it behooves CW men to add a monitor of some kind to their

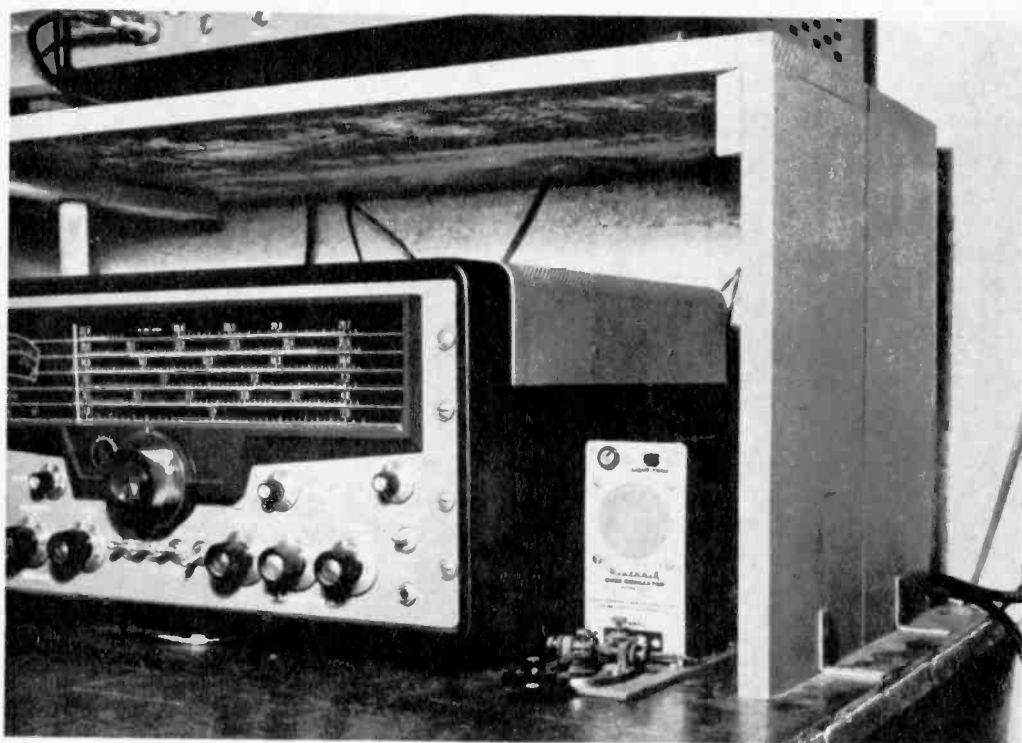

Monitor unit on operating table of an active ham station, next to SX-101 receiver; HT-32 transmitter is directly above. Weight of components keeps base well anchored, no need to screw down.

Front view close-up of assembled monitor, which uses Heathkit transistor code oscillator. Base is smooth hardboard, $3\frac{1}{2}$ by 10 by $\frac{1}{8}$ inches. Parts are mounted with flathead machine screws; in countersunk holes through bottom of base; the base hugs table surface nicely and looks neat.



BUILD 20 RADIO

CIRCUITS AT HOME

with the New
PROGRESSIVE RADIO "EDU-KIT"

only
\$26⁹⁵

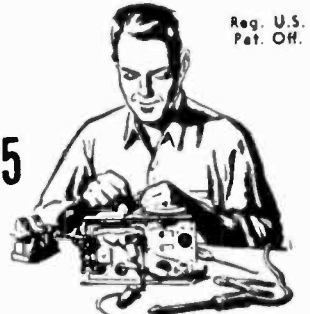

Reg. U.S.
Pat. Off.

A Practical Home Radio Course

Now Includes

- ★ 12 RECEIVERS
- ★ 3 TRANSMITTERS
- ★ SQ. WAVE GENERATOR
- ★ SIGNAL TRACER
- ★ AMPLIFIER
- ★ SIGNAL INJECTOR
- ★ CODE OSCILLATOR

- ★ No Knowledge of Radio Necessary
- ★ No Additional Parts or Tools Needed
- ★ EXCELLENT BACKGROUND FOR TV
- ★ School Inquiries Invited
- ★ Sold in 79 Countries

YOU DON'T HAVE TO SPEND HUNDREDS OF DOLLARS FOR A RADIO COURSE

The "Edu-Kit" offers you an outstanding PRACTICAL HOME RADIO COURSE at a rock-bottom price. Our Kit is designed to train Radio & Electronics Technicians, making use of the most modern methods of home training. You will learn radio theory, construction practice and servicing. THIS IS A COMPLETE RADIO COURSE IN EVERY DETAIL.

You will learn how to build radios, using regular schematics; how to wire and solder in a professional manner; how to service radios. You will learn how to operate them. You will receive an excellent background for television, Hi-Fi, and Electronics.

You will learn the basic principles of radio. You will construct, study and work with RF and AF amplifiers and oscillators, detectors, rectifiers, test equipment. You will learn and practice trouble-shooting using the Progressive Signal Tracer, Progressive Signal Injector, Progressive Dynamic Radio & Electronics Tester, Square Wave Generator and the accompanying instructional material.

You will receive training for the Novice, Technician and General Classes of F.C.C. Radio Amateur Licenses. You will build 20 Receiver, Transmitter, Square Wave Generator, Code Oscillator, Signal Tracer and Signal Injector circuits, and learn how to operate them.

Absolutely no previous knowledge of radio or science is required. The "Edu-Kit" is the product of many years of teaching and engineering experience. The price of the complete kit is \$26.95. The Signal Tracer alone is worth more than the price of the entire Kit.

THE KIT FOR EVERYONE

You do not need the slightest background in radio or science. Whether you are interested in Radio & Electronics because you want an interesting hobby, a well paying business or a job with a future, you will find the "Edu-Kit" a worth-while investment. Many thousands of individuals of all

ages and backgrounds have successfully used the "Edu-Kit" in more than 79 countries of the world. The "Edu-Kit" has been carefully designed, step by step, so that you cannot make a mistake. The "Edu-Kit" allows you to teach yourself at your own rate. No instructor is necessary.

PROGRESSIVE TEACHING METHOD

The Progressive Radio "Edu-Kit" is the foremost educational radio kit in the world, and is universally accepted as the standard in the field of electronics training. The "Edu-Kit" uses the modern educational principle of "Learn by Doing." Therefore you construct, learn schematics, study theory, practice trouble-shooting—all in a closely integrated program designed to provide an easily-learned, thorough and interesting background in radio.

You begin by examining the various radio parts of the "Edu-Kit." You then learn the function, theory and wiring of these parts. Then you build a simple radio. With this first set you will enjoy listening to regular broadcast stations, learn theory, practice testing and trouble-shooting. Then you build a more advanced radio, learn more advanced theory and techniques. Gradually, in a progressive manner, and at your own rate, you will find yourself constructing more advanced multi-tube radio circuits, and doing work like a professional Radio Technician.

Included in the "Edu-Kit" course are twenty Receiver, Transmitter, Code Oscillator, Signal Tracer, Square Wave Generator and Signal Injector circuits. These are not unprofessional "breadboard" experiments, but genuine radio circuits, constructed by means of professional wiring and soldering on metal chassis, plus the new method of radio construction known as "Printed Circuitry." These circuits operate on your regular AC or DC house current.

THE "EDU-KIT" IS COMPLETE

You will receive all parts and instructions necessary to build 20 different radio and electronics circuits, each guaranteed to operate. Our Kits contain tubes, tube sockets, variable, electrolytic, mica, ceramic and paper dielectric condensers, resistors, 1/2" strips, coils, hardware, tubing, punched metal chassis, Instruction Manuals, hook-up wire, solder, selenium rectifiers, volume controls and switches, etc.

In addition, you receive Printed Circuit materials, including Printed Circuit chassis, special tube sockets and instructions. You also receive a useful set of tools, a professional electric soldering iron, and a self-powered Dynamic Radio and Electronics Tester. The "Edu-Kit" also includes Code instructions and the Progressive Code Oscillator. In addition to F.C.C.-type Questions and Answers for Radio Amateur License training. You will also receive lessons for servicing with the Progressive Signal Tracer and the Progressive Signal Injector, a High Fidelity Guide and a Quiz Book. You receive Membership in Radio-TV Club, Certificate of Merit and Discount Privileges. You receive all parts, tools, instructions, etc. Everything is yours to keep.

PRINTED CIRCUITRY

At no increase in price, the "Edu-Kit" now includes Printed Circuitry. You build a Printed Circuit Signal Injector, a unique servicing instrument that can detect many Radio and TV troubles. This revolutionary new technique of radio construction is now becoming popular in commercial radio and TV sets. A Printed Circuit is a special insulated chassis on which has been deposited a conducting material which takes the place of wiring. The various parts are merely plugged in and soldered to terminals.

Printed Circuitry is the basis of modern Automation Electronics. A knowledge of this subject is a necessity today for anyone interested in Electronics.

FREE EXTRAS

● SET OF TOOLS

- SOLDERING IRON
- ELECTRONICS TESTER
- PLIERS-CUTTERS
- ALIGNMENT TOOL
- WRENCH SET
- VALUABLE DISCOUNT CARD
- CERTIFICATE OF MERIT
- TESTER INSTRUCTION MANUAL
- HIGH FIDELITY GUIDE & QUIZZES
- TELEVISION BOOK & RADIO TROUBLE-SHOOTING BOOK
- MEMBERSHIP IN RADIO-TV CLUB
- CONSULTATION SERVICE & FCC AMATEUR LICENSE TRAINING
- PRINTED CIRCUITRY

SERVICING LESSONS

You will learn trouble-shooting and servicing in a progressive manner. You will practice repairs on the sets that you construct. You will learn symptoms and causes of trouble home, portable and car radios. You will learn how to use the professional Signal Tracer, the unique Signal Injector and the dynamic Radio & Electronics Tester. While you are learning in this practical way, you will be able to do many a repair job for your friends and neighbors, and charge fees which will far exceed the price of the "Edu-Kit." Our Consultation Service will help you with any technical problems you may have.

J. Statitis, of 25 Poplar Pl., Waterbury, Conn., writes: "I have repaired several sets for my friends, and made money. The "Edu-Kit" paid for itself; I was ready to spend \$40 for a Course, but I found your ad and sent for your Kit."

FROM OUR MAIL BAG

Ben Valerio, P. O. Box 21, Magna, Utah: "The Edu-Kits are wonderful. Here I am sending you the questions and also the answers for them. I have been in Radio for the last seven years, but like to work with Radio Kits, and like to build Radio Testing Equipment. I enjoyed every minute I worked with the different kits; the Signal Tracer works fine. Also like to let you know that I feel proud of becoming a member of your Radio-TV Club."

Robert L. Shuff, 1534 Monroe Ave., Huntington, W. Va.: "Thought I would drop you a few lines to say that I received my Edu-Kit, and was really amazed that such a bargain can be had at such a low price. I have already started repairing radios and phonographs. My friends were really surprised to see me get into the swing of it so quickly. The trouble-shooting tester that comes with the Kit is really swell, and finds the trouble, if there is any, to be found."

UNCONDITIONAL MONEY-BACK GUARANTEE

ORDER DIRECT FROM AD—RECEIVE FREE BONUS RESISTOR AND CONDENSER KITS WORTH \$7

- Send "Edu-Kit" postpaid. I enclose full payment of \$26.95
- Send "Edu-Kit" C.O.D. I will pay \$26.95 plus postage.
- Rush me FREE descriptive literature concerning "Edu-Kit."

Name

Address

PROGRESSIVE "EDU-KITS" INC.

1186 Broadway, Dept. 504MM, Hewlett, N. Y.

transmitters. Fortunately, this is a rather simple job and can be accomplished with external units. All that is needed is a code-practice oscillator of some sort and a low-voltage AC relay having two poles. The battery-powered transistor oscillators now available in both kit and assembled form are ideal for the purpose, being small, self-contained and loud. Vast quantities of surplus relays are on the market, and it is only necessary to select one with a coil designed for any voltage between about 5 and 7.

The wiring is shown in Figure 1. The source of AC for the relay is the "accessory" socket found on the back of practi-

cally all communication receivers. Pressing the key energizes the relay, causing the contacts to close simultaneously. One set closes the keying circuit of the transmitter, the other turns on the oscillator.

With the transmitter turned off, the assembly still functions as a code-practice oscillator and can be used for instruction purposes without being disconnected.

The use of a relay for keying offers an incidental advantage: it eliminates all danger of accidental shock at the metal body of the key. In some transmitters, one side of the key is "hot" in relation to ground when the key is in the up position, and it can give a nasty bite. •

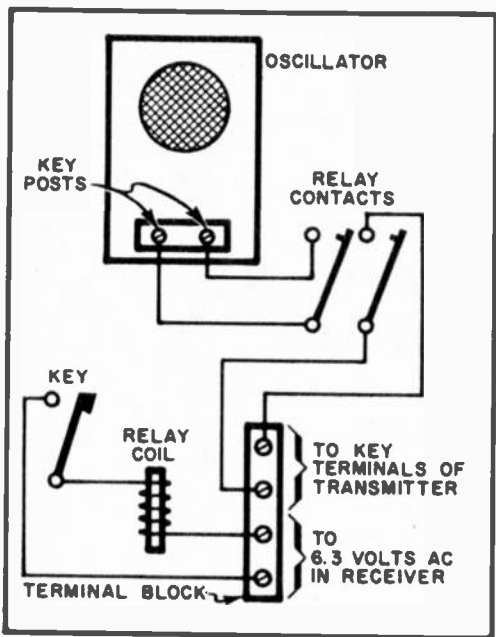

Double-pole relay is mounted between oscillator and four-terminal connector block. Block is raised on base by short collars or piles of washers.

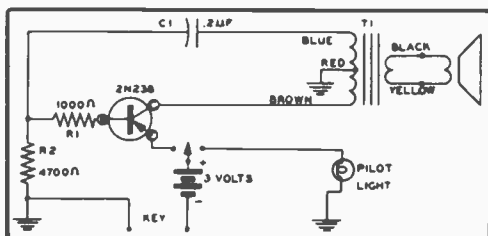

Schematic diagram of the Heathkit code oscillator, which uses a single 2N238 transistor powered by flashlight batteries in series. The "pilot light" is intended for blinker practice, and can be ignored or removed; the SPDT switch connected to the positive side of the battery can then be moved to the left, to the emitter connection of the transistor. No on-off switch is needed as the oscillator draws current only when it's keyed.

The wiring of the keying monitor is very simple. Just follow the diagram at the left accurately.

Heathkit oscillator, inside view. Pencil points to single transistor, mounted on loudspeaker frame. Flashlight batteries should last a year.

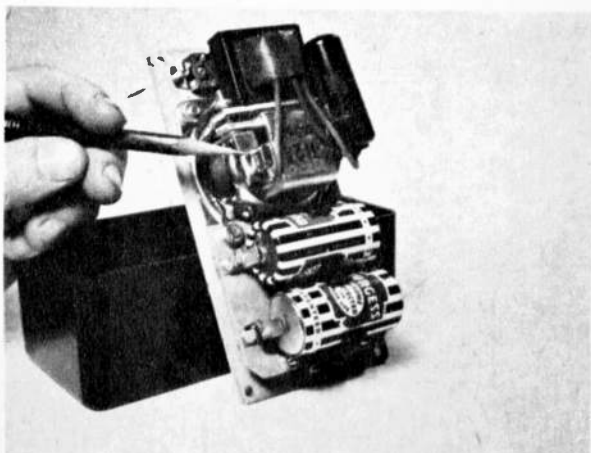
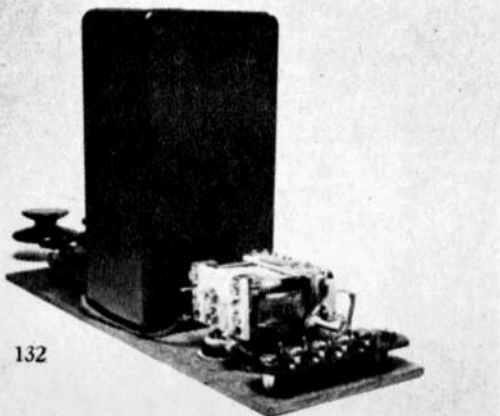

Here's all you need to build HEATHKIT® HI-FI

... these tools and **NO EXPERIENCE**

We say "NO ELECTRONIC EXPERIENCE NEEDED" . . . and we mean it.

Recognized by leading consumer research organizations as the best in the field of kit construction manuals, the Heathkit step at a time instructions leave absolutely nothing to question. Giant size pictorial

diagrams and everyday, non-technical language make every Heathkit easy for anyone to build. No electronic or soldering

experience is required; the Heathkit manuals teach you the right way to do a professional job the first time.

No matter what your field of interest, building a Heathkit will be one of your most exciting, rewarding experiences.

And you'll save 50% or more on the world's finest electronic equipment. Send today for your *free* Heathkit catalog—or see your nearest authorized Heathkit dealer.

EVERYTHING FOR STEREO



AMPLIFIERS



TUNERS



CHANGERS

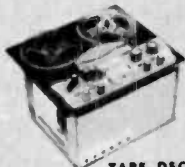

TAPE DECKS

Mail the coupon Today!



HEATH COMPANY

A DIVISION OF
DAYSTROM, INCORPORATED

Benton Harbor 7, Michigan

Please send the latest Free Heathkit Catalog.

NAME _____

ADDRESS _____

CITY _____ ZONE _____ STATE _____

TV Tips



Above is "horizontal hold" control; it determines lateral stability and is located in back. Left, horizontal hold when unlocked. New horizontal oscillator is needed!

HOLD THAT HORIZONTAL! In television receivers, the tubes that contribute most to the stability and smoothness of the pictures are those marked "horizontal oscillator" and "horizontal output." A fairly certain sign that either is beginning to weaken from prolonged use is a tendency of the picture to tear apart crazily, usually when the channel selector is turned from one setting to another.

Before removing the back of the receiver and replacing the tubes, see if you can restore the picture by a minor adjustment of the control marked "horizontal hold" or "horizontal frequency." This may be on the back of the set, on the bottom rear apron of the chassis, or, less often, on the front of the set behind a little trap door. If this doesn't help, in nine cases out of ten a couple of new tubes will do the trick. Let them warm up for about ten minutes, and then readjust the horizontal control.

MARK THOSE TUBES

When examining your TV chassis for the first time, look especially for a tube socket layout or diagram. This may be printed on the back of the removable safety cover or cemented somewhere inside the set. It is an important and valuable document, because the sockets themselves are rarely identified by the tube types they are intended to take.

Since well over 90% of all television set "breakdowns" are due to nothing more than tube failure, and can be fixed quickly by simple tube replacement, it pays to know what goes where. With the line cord removed from the wall outlet, carefully

pull out one tube at a time and note if its type number is distinguishable. The markings on glass tubes tend to burn off, and there is no easy way of re-marking the smooth surface. Therefore, be careful not to mix tubes up. With tubes having metal bodies or plastic bases, however, it is a simple matter to scratch in their type numbers with a nail or scribe.

USE FOR BUILT-IN ANTENNA

The "built-in" antenna in most small table model and portable TV sets is usually nothing more than a pair of thin wires stapled or taped to the inside of the cabinet or the inner surface of the back safety cover. Because of its limited size it does not provide much signal pickup on the lower channels, from 7 down to 2, but in some locations it works fine on the top channels, 11, 12 and 13, and gives fair results on the UHF stations.

It may be fruitful to try using the built-in antenna in conjunction with an outside antenna or a pair of "rabbit ears" sitting on the cabinet. Merely connect the two antennas to the same terminals on the back of the set. Improved reception with fewer ghosts might be obtained, or poorer reception with more ghosts! There's no harm in experimenting, so go to it.

TRANSMISSION TROUBLES

Some of the troubles that develop in TV receivers are not the fault of the latter themselves, but are due to difficulties in the TV transmission. Resist the temptation to reach for your toolbox, and many times they will disappear. •

“All personnel . . .
 clear the firing area . . .
 stand by for
 countdown . . .
 minus 10 . . .
 . . . 9 . . . 8
 7 . . . 6 . . .
 . . . 5 . . . 4 . . .
 3 . . . 2 . . .
 . . . 1 . . .”

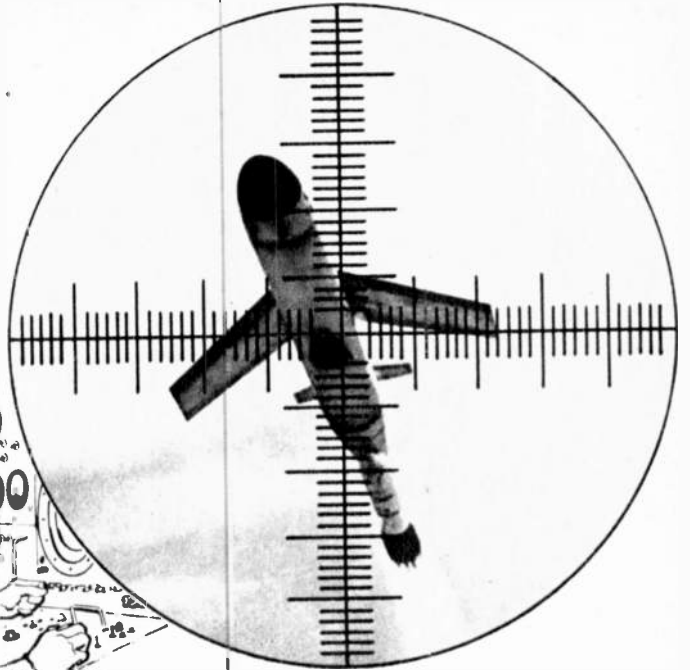
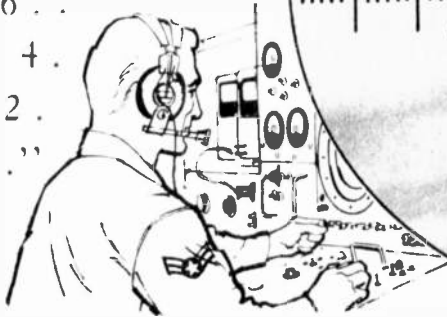

YOU MAY HANDLE A SITUATION LIKE THIS...

If you measure up to the Aerospace Team

A man in this situation requires cool judgment and an aptitude for advanced technical training. This is the kind of man who can measure up to the qualifications of the U. S. Air Force. He is the kind of man who can build a career in the Aerospace Age that will be meaningful and rewarding.

Are you that man? As a trained and experienced Air Force technical specialist, you

will have the opportunity to work with the intricate equipment of the Aerospace Age—the age of air and space travel. You will enjoy steady advancement and solid security. And you will be superbly prepared for the future.

If you would like to learn more about the many unique advantages that go with a career in Air Force blue, fill in and mail this coupon today.

U.S. AIR FORCE

There's a place for tomorrow's leaders on the Aerospace Team

PASTE COUPON ON POSTCARD AND MAIL TO:

Airman Information, Dept. MPE011, Box 7608, Washington 4, D. C.

Please send me more information on my opportunities in the U.S. Air Force. I am between the ages of 17-34 and reside in U.S.A. or possessions.

Name _____

Address _____

City _____

Zone _____

County _____

State _____

No-Stoop Tuning Made Easy

Here are a few bits of high-frequency logic to improve your rig.



PRACTICALLY ALL short-wave receivers and other specialized communications units are built with right-angle front panels. This means that an adult of average size must hunch his shoulders and bend over (photo above) in order to see the dials and controls. If the equipment is propped up along its front edges (photo top left, facing page), the operator can sit comfortably in a relaxed position. Experiment with books to obtain the best angle; then cut wooden blocks for permanent support. Incidental feature of this arrangement is extra storage space on table.

SHORT AERIAL—LONG DISTANCE

One of the remarkable characteristics of the short waves is their ability to penetrate the most improbable places and to make themselves heard in receivers using antennas of very small dimensions. While it is true that the most dependable results are obtained with high, exposed aerials, it is extremely interesting to observe that international reception is often possible with nothing more than a paper clip for an antenna, and at that with the receiver six feet

below ground level in a finished basement!

Opened to a length of six inches and connected directly to the aerial post of the set (see middle photo, facing page), this paper clip brought in amateur stations and foreign broadcasters up to 3,000 miles away. With a "long" antenna, a common wire coat hanger straightened out to about five feet, stations in South Africa and the Near East were heard readily in a Long Island town bordering New York City.

BEWARE OF LEAKAGE PATHS

Some very mysterious troubles in TV sets are often due to "leakage paths" between terminals or connections that are supposed to be thoroughly insulated from each other. These paths are usually accumulations of soot and dirt. They look harmless, but they can be of relatively low resistance and can easily cause circuit malfunctioning. To convince yourself of this, make a few soft pencil lines on a piece of paper (photo at right) and connect a VTVM to them. Resistance reading may be between $\frac{1}{2}$ and several megohms, which are very appreciable values. •



Here is a really uplifting thought: Put blocks under front section of units for easier tuning.

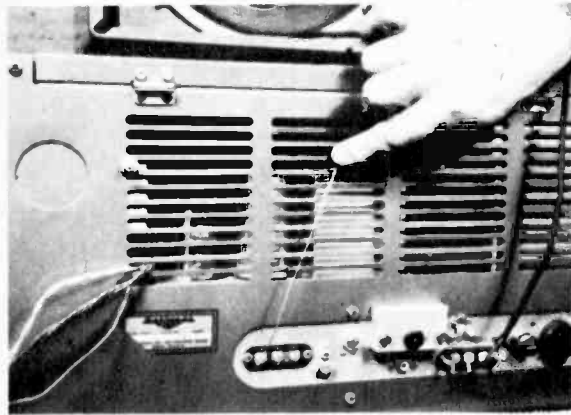

Short-wave reception can be had with little more than a paper clip (opened out) as shown in photo.

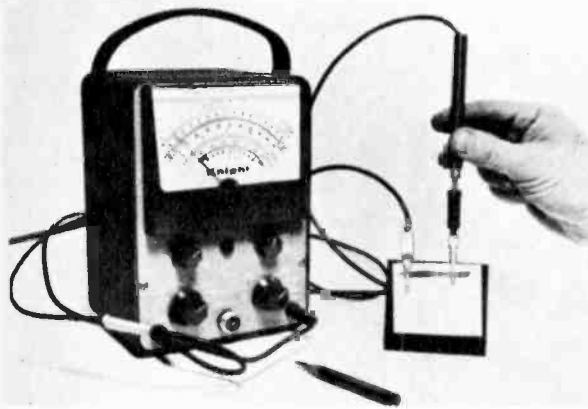

Accumulations of soot and dirt can be definite leakage paths in sets. Pencil mark proves point.

BUILD THE BEST ELECTRONIC EQUIPMENT



It's fun to build years-ahead money-saving

knight-kits®

A PRODUCT OF ALLIED RADIO

featured in the

ALLIED

Big 444-Page 1961

ELECTRONICS CATALOG

free

build-your-own...
it's easy...it's fun

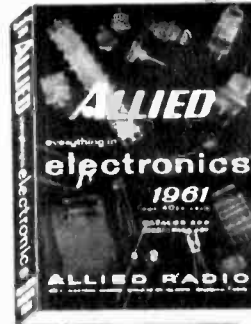

BIG SAVINGS



KITS FOR ANY NEED
Hi-Fi
Hobby
Instrument
Amateur

See the exciting 1961 line of KNIGHT-KITS—available only from ALLIED. They're lowest in cost, convenience-engineered for easiest assembly, outstanding for performance—the only kits offered with Free Inspection Privilege. Send today for the 1961 ALLIED Catalog—select your KNIGHT-KITS—and...

SAVE ON EVERYTHING IN ELECTRONICS

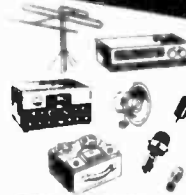

Get more for your money in: Stereo hi-fi systems and components • Recorders and tape • Amateur station equipment • Citizen's 2-way radio • TV tubes, antennas, accessories & test instruments • Electronic parts, tubes, transistors, tools • Send today for your FREE 444-page 1961 ALLIED Catalog!

only \$2 down
on orders up to \$50

FREE
catalog

ALLIED RADIO

ALLIED RADIO, Dept. 135-1
100 N. Western Ave., Chicago 80, Ill.

Rush FREE 1961 ALLIED Catalog.

Name _____

Address _____

City _____ Zone _____ State _____

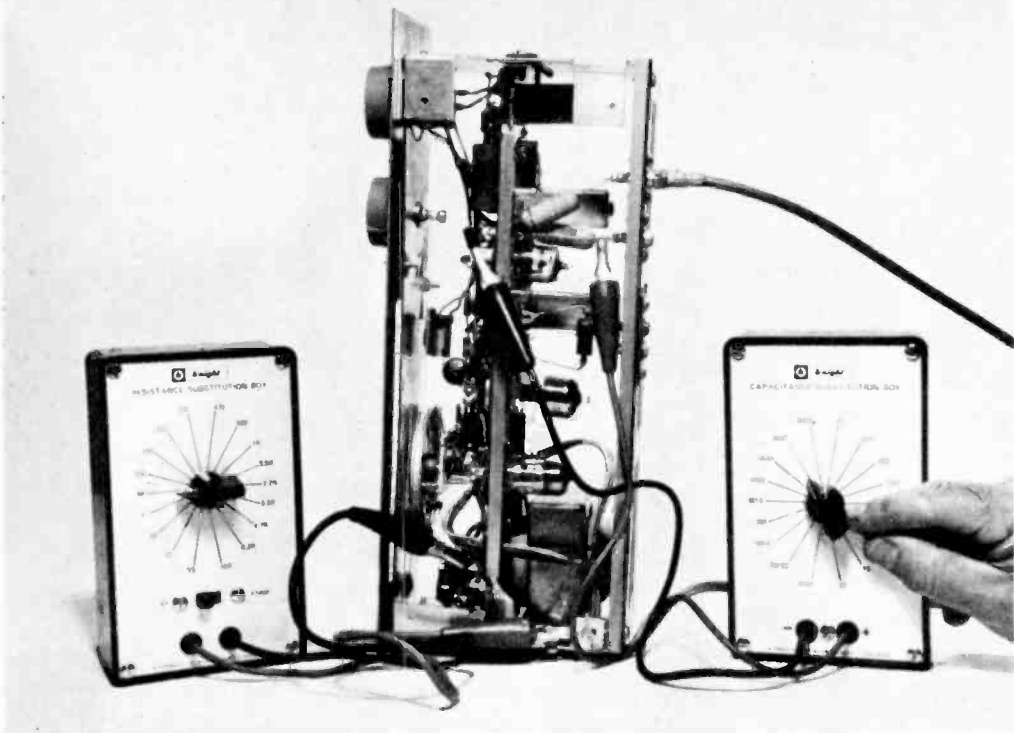

Typical application of resistance and capacitance substitution boxes: determining best values of the tone-control elements in a hi-fi tuner. The boxes shown: Knight-Kit units with attached clip-on leads.

Substitution Boxes

Inexpensive device produces RC combinations which save you time.

YOU ARE experimenting with a new hi-fi amplifier or repairing an old radio receiver, and you are not quite sure of the value of a small resistor or capacitor needed in a certain circuit. You rummage through your accumulation of spare parts and spend a lot of time just identifying resistors and capacitors. Then you waste more time soldering and unsoldering leads into wiring.

After a couple of frustrating experiences of this kind, you are ripe for "substitution boxes." These are nothing more than collections of resistors and capacitors, tied to multiposition switches. A single pair of test leads from each box goes to the circuit position; you turn the switch, and in a matter of seconds you have the equipment working properly.

Representative boxes are shown here. The capacitance unit contains 18 capacitors, from .0001 mf to .22 mf. Two flexible test leads, 15 inches long, are attached permanently. They have alligator clips at

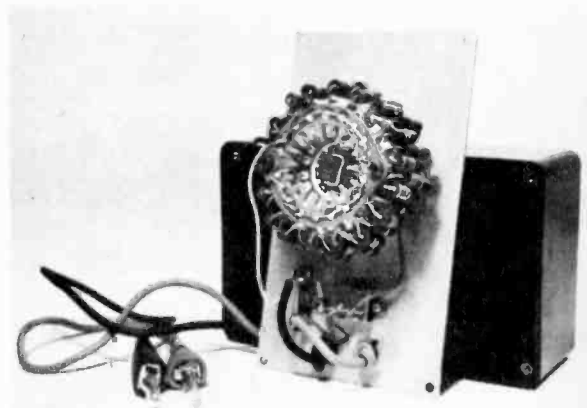

Inside of Knight-Kit Resistance Substitution Box. Three dozen resistors are clustered closely around two-layer, 18-position rotary switch. Note how test leads are knotted on inside to prevent pull-through.

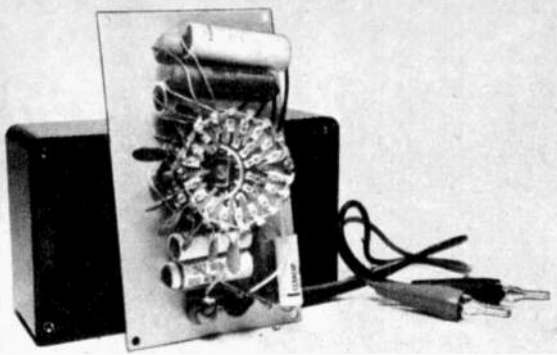

Capacitors are of varying sizes and shapes. Eighteen connect to switch lugs by pigtail wires.

their ends, for quick hookups. The capacitors from .0001 mf through .1 mf are rated at 600 volts; the .15 and .22 mf sizes at 400 volts. These values are well within the normal range of voltages found in the home.

The resistance box is even more versatile, providing a total of 36 values in two ranges: 15 to 10,000 ohms, and 15,000 to 10 million ohms. The selector switch has 18 positions, and is supplemented by a smaller two-position slide switch. In the latter's "X1" setting, the panel markings are read directly; 15, 22, 33, 47 ohms, and so on. In the "X1000" setting, the markings are merely multiplied by 1000; thus the 15 mark indicates 15,000 ohms, the 22 mark 22,000 ohms, etc. The resistors are all one watt. The attached test leads are the same as those on the capacitance box. •

Diagram of capacitance box. The switch is an 18-position rotary, selects one capacitor at a time.

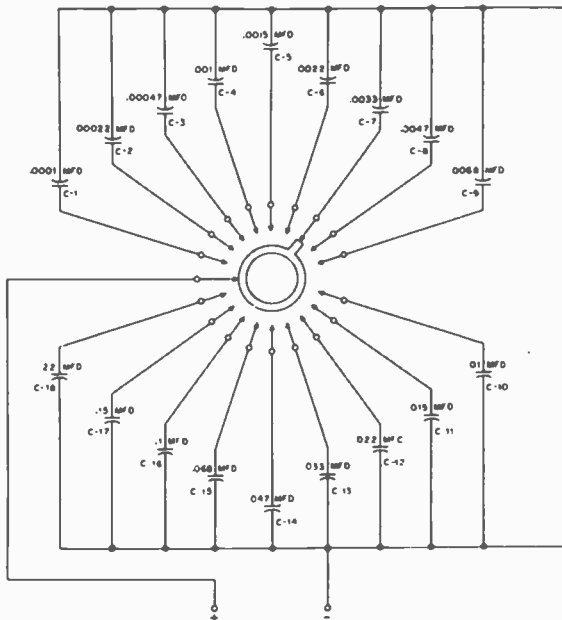

Free Trial Guarantees you can

FIX ANY TV FAST!

.. or pay not one cent!

**NO EXPERIENCE
OR HIGHER MATH NECESSARY!**

Let 10 days' free use of this book prove—at our expense you can install and repair any TV set like an expert. You'll be amazed how easy it is to spot most troubles by eye and ear alone—how the clear, step-by-step instructions and illustrations reduce even the most complicated problems to simple a-t-r-o. Quickly and easily, with this manual to guide you, you can turn your up-to-the-minute knowledge into plenty of spare-time cash or be your own boss in a profitable business.

In this new edition you get: The latest circuits—Troubleshooting techniques—Transistorized TV sets—Remote control tuning—Troubleshooting printed wiring—Module type construction—Packaged circuits—Newest servicing hints—Latest information on color TV and test equipment... every new advancement plus the basic know-how you need to put any set back in perfect working order.

Mr. C. W. Morris of Charleston, W. Va., says: "I have paid as much as \$200.00 for courses that haven't given me the clear understanding this book has."



**All New!
3rd
Revised
Edition**

**TRANSISTORIZED TV
COLOR SETS
PRINTED CIRCUITS
DEFLECTION
METHODS
DC RESTORATION
ANTENNAS
POWER SUPPLIES
SYNCHRONIZATION**

—10-DAY TRIAL COUPON—MAIL TODAY—

PRENTICE-HALL, INC., Dept. 6708-P2
Englewood Cliffs, New Jersey

Please send me for 10 days' FREE EXAMINATION a copy of TELEVISION SERVICING. In 10 days I will either send you \$7.15 plus a few cents for postage and shipping or return the book and owe nothing.

Name

Address

City

Zone..... State.....

SAVE! Refund and same return privilege guaranteed.

TV ON THE BLINK?

Learn how you can fix almost all TV breakdowns quickly and easily using professional trouble-shooting techniques. Hundreds of money saving, step-by-step repair hints, pictures and diagrams.

PROFESSIONAL TV REPAIR SECRETS

75 cents
On sale at
your favorite
newsstand

FB #435



Mail orders to: FAWCETT BOOKS, Dept. 464, Greenwich, Conn. Add 10 cents per copy to cover mailing. Sorry, no Canadian orders



Ham Radio Interests All Ages

There is no age limit for "Hams"—nor is there any limit to the fun and adventure of long distance communications with other Hams.

THE Federal Communications Commission receives frequent inquiries about the "youngest" and "oldest" amateur radio operators. Such questions cannot be answered precisely because hams now hold more than 200,000 licenses, their records are voluminous and in a constant state of flux, they encompass six classes of operators ranging from beginners to old-timers, and, of course, the ages of the licensees do not remain static. However, some indication of the age range of amateurs is shown in the following examples, by no means complete, gleaned from the Commission's records:

Though blind from birth, John M. Fearon qualified for a general-class license. the

most difficult one, in 1952 when he was only seven years old. In that same year, Leonard Ross, of the same age, became a novice licensee. Not to be outdone, a seven-year-old girl, Sharon L. Perkins, received her novice ticket the following year. In the early days of the FCC, eight-year-old Jean Hudson made history by passing the operator test. In 1956, still another girl, Elizabeth A. Deck, obtained a technician-class license at the age of nine. Eleven-year-olds were further represented when Thomas B. Davis and Lynch Morgan passed their exams in 1950 and 1952, respectively. Teen-age hams are too numerous to identify.

Age extremes were typified when Robert Clute and Dr. Joseph Van Becelaere were

among the first to pass the novice tests in 1951. Bobby was 8 and the doctor was 86!

These cases prove there is no age limitation in amateur radio. However, the "average" age is estimated to be about 34 years.

Amateur radio provides an appropriate outlet for electronic-minded individuals to pursue an interesting and instructive hobby, says the FCC. At the same time, it is a means for self-improvement, for it furnishes training and experience for those who plan to enter the rapidly expanding field of telecommunications.

The parents of a boy or a girl interested in ham radio have little cause to worry about where their children spend their spare time. The youngsters are either at home engrossed with their own equipment or helping fellow hams set up a new rig or antenna. The only problem is the thoughtlessness of overzealous persons who go on the air without the benefit of an amateur license. His presence on the airwaves is quickly detected and traced. The law is strict about illegal radio because it can interfere with services used in safeguarding life and property.

Amateur radio is a particular boon to the physically handicapped, the FCC says further. The ability to communicate with old friends and to make new acquaintances over the air bolsters the morale of the disabled and means closer touch with happiness in the outside world. The room in which a patient occupies a bed or a wheelchair no longer seems to be a place of confinement if he or she has the seven-league boots provided by the medium of amateur radio. Even people in iron lungs are able to enjoy hamming.

While not waiving operator requirements, the Commission has always given special consideration to the conditions under which amateur examinations are given to the physically handicapped. A blind person, for instance, is permitted to take code tests in Braille, the reading system used by the sightless. A deaf person may be able to qualify in the code with a hearing aid, or by feeling the vibrations of a buzzer, or by some other means.

When an applicant is shown by a physician's certificate to be unable to appear at a designated examination point because of protracted disability, the Commission's rules enable him to take the test at home under the supervision of voluntary examiners. When their workload permits, FCC field engineering representatives sometimes are able to visit these applicants to give examinations for the general-class license, which, under the rules, cannot be done by voluntary examiners.



SPECIAL OFFER

25¢

Hear these authentic recordings of dramatic events from

"The Amazing World of Short Wave Listening"

narrated by Alex Dreier, Radio-TV "Man on the Go"

- President's voice from outer space!
- Actual capture of a desperate criminal!
- Radio amateur at Little America!
- Ships at sea... aircraft in action!

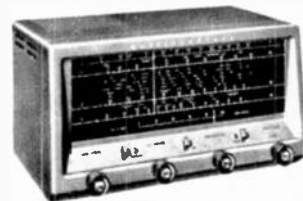

S-38E receiver
\$59.95

3 short wave bands plus standard broadcast. Built-in speaker, headset output.

MAIL COUPON TODAY!

hallicrafters
DEPT. 37, CHICAGO 11, ILL.

Gentlemen: Please rush by return mail my recording, "The Amazing World of Short Wave Listening." I enclose 25¢.

NAME _____

ADDRESS _____

CITY _____ STATE _____

Tracking Down Radio Interference

A loose wire, an annoyed neighbor or unshielded installations may be responsible for interference—FCC detectives are always busy.

TRACKING AND ELIMINATING sources of serious interference to radio communication has become one of the major tasks of the FCC Field Engineering and Monitoring Bureau. Disruption of radio service is often caused by electronic devices not employed for communication purposes. Following are examples:

Aviation interests complained that interference was blocking reception on two of their frequencies. FCC monitoring stations established that it came from the vicinity of Helena, Ark. A mobile unit from the FCC New Orleans field office was able to trace it to an improperly shielded industrial heater in a factory making water skis. The management promptly provided more adequate shielding.

The Houston airport experienced interference on an aeronautical frequency. But here the FCC engineers located the trouble in the airport's own radio shop.

Residents near Santa Rosa, Calif., were plagued with TV interference. FCC engineers and cooperating electric company "trouble shooters" found that it was caused by faulty controls for ventilating the brooder house of a local chicken ranch. The owners replaced the defective devices.

An industrial heater in a plywood manufacturing plant near Medford, Oreg., was found to be interfering with a radio company experimental station at Burbank, Calif. The disturbing radiation was suppressed with further shielding.

A loud intermittent buzzing heard by a Pennsylvania college on a frequency used for satellite tracking purposes was traced to a substation of the local power company. The latter quickly replaced a defective switch.

INTERFERENCE CAN ALSO COME from defective receivers: A "popping" sound which blacked out TV reception over a four-block area in Denver was first blamed by a set owner on neighborhood amateur radio operation. Investigation showed that it came from the complainant's own TV receiver. It had been "souped up" with higher voltage to take care of a larger picture tube, with resultant breakdown of equipment. The abashed owner agreed to remedy his set to satisfy his neighbors.

When a California family went on vaca-

tion it forgot to turn off the household broadcast receiver. Not only that, but something went wrong with the neglected set. Possibly because of loneliness, it started to retransmit the programs of a local broadcast station. It did so in a manner to play havoc with reception by land mobile radiotelephone stations up to 33 miles away. Insertion of a new tube and a turn of the "off" knob eliminated the trouble.

DEFECTIVE TRANSMITTERS likewise cause headaches: The Air Force complained that a spurious signal was blotting out its communication over a certain frequency in the eastern part of the country. The FCC traced it to an Air Force facility at Oklahoma City, where the defective transmitter was repaired.

Investigation of a complaint by a Navy radio station near the nation's capital resulted in it being advised that the interference was due to faulty apparatus at one of its own installations.

An experimental radio station of a university in Puerto Rico was discovered invading the amateur frequency band and failing to use its identifying call signal. The station corrected both deficiencies.

MUCH TIME AND EFFORT is devoted to closing down unlicensed radio operation: "SOS" signals heard off the California coast were found to come from two teenagers who did not know that the surplus "Gibson Girl" transmitters they had purchased automatically sent out the distress call when they tinkered with them. At the boys' request, FCC engineers made the sets inoperative, and the store withdrew such equipment from public sale.

Interference to amateur operation revealed that members of a military reserve unit in Texas were using their official walkie-talkies for private use. One reservist "walkie-talkied" the transfer of groceries from the stockroom to the supermarket in which he was employed. Another employed his set to cover a golf tournament. Upon warning, "Operation Walkie-talkie" was discontinued.

Complaint by viewers about degraded reception of an Oregon TV translator station brought discovery that a local community antenna TV system was operating

a transmitter to jam the translator station channel. Prosecution has been recommended.

"My engine has conked out. I have landed but can't walk out. Send a copter to pick me up!" This message was responsible for useless air search efforts in Alaska. A 12-year-old boy finally confessed that, while "playing jet pilot" in an unattended private plane, he had so used the transmitter.

Six FCC field engineers were given citations and cash awards for their work in locating a transmitter, hidden in a national forest, which was sending hoax signals on a space satellite frequency. The false signals temporarily confused scientists in this country and elsewhere. Working night and day, the FCC field men ran down the illegal transmitter. As a result, its three operators were arrested and fined.

Also among the 130 unlicensed transmitters uncovered during one year was one utilized by a fish cannery to contact its boats in Puget Sound, Wash. Another involved conversion of a phonograph oscillator into a transmitter by boys at an Idaho university to serenade the girls in a sorority house across the street. Still another was employed for an outdoor lecture by a man who claimed to have already made a journey to the moon on a space ship. Another man confessed faking papers in order to use a dead man's amateur license.

INTERNATIONAL COOPERATION resolves many cases of long-distance interference: A New York international radio carrier complained that its reception in Germany was subjected to annoying signals. Evidence gathered by the FCC confirmed that a station in India was at fault, and that country took remedial action.

A West Germany monitoring station requested assistance in identifying a foreign radio station whose weather bulletins had strayed onto the German airwaves. FCC observations located the offender in the far distant Fiji Islands.

Interference to an aeronautical station at Cleveland, Ohio, was traced to a Portuguese station in the Cape Verde Islands, some 3,000 miles away.

The Commission furnishes many direction-finding assists to ships and planes in distress. One of these involved a plane with 105 persons on board which had navigational equipment trouble while flying between California and Hawaii. A distress call from a vessel off its course in the Pacific near San Francisco brought FCC

NOW—Get this expert SELF-TRAINING in RADIO SERVICING

by ABRAHAM MARCUS

co-author of famous "Elements of Radio" which has sold over 800,000 copies!

Here is every detail you need to know about radio repair, replacement, and readjustment. Easy-to-understand, step-by-step self-training handbook shows you how to locate and remedy defects quickly.

Covers: Transistor Radio; Hi-Fi Amplifiers and Receivers; Hybrid Automobile Receivers; A-M and F-M Receivers; 3-Way Portable Receivers; Semi-Conductors; Power Supplies operated from AC, DC Batteries, Motor-Generators, etc.; Tells you the HOW and WHY of: Electron Tubes (Diode, Triode, Pentode, Beam Power, Thyatron, Phototube, Cathode Ray, etc.); Rectifier Circuits (Half-wave, Full-wave, Bridge, Voltage-Doubler, etc.); Detector Circuits (Diode, Triode, Regenerative, Superregenerative, Infinite-Impedance, etc.); Amplifier Circuits (Audio, Radio, I-F, Video, D-C, etc.); Oscillator Circuits (Harley, Colpitts, Crystal, Transatron, Multi-vibrator, Sweep-circuit, etc.); Control Circuits (Volume, AVC, DAVC, Tone, Noise-Suppression, Automatic Tuning, Automatic Frequency Control, etc.); Explains how to use testing instruments such as: meter, vacuum-tube voltmeters, ohmmeters, bridges, multimeters, signal generators, tube checkers, cathode-ray oscilloscopes, etc. Over 100 pages and 69 illustrations in this section alone!



All in one big volume—easy to read. 16 Big Chapters. 121 Sections. 400 "Show-Now" Diagrams. 848 pages of practical radio instruction.

Get this authoritative radio repair handbook today! Coupon below brings you "Radio Servicing" on FREE trial for 10 days. Mail it NOW.

PRENTICE-HALL, Inc., Dept. 5708-P2
Englewood Cliffs, N. J.

Send me for 10 DAYS' FREE TRIAL, "Radio Servicing" by Abraham Marcus. I will return it in ten days and pay nothing—or keep it and send \$1.95 down (plus postage) and \$2 monthly for 3 months.

Name

Address

City State

() SAVE! Send \$7.95 WITH COUPON—we pay postage.

here's help...



75 Cents

FB 462

Able assisted by Joseph Marshall and Norman Crowhurst, Author Don Hoefler shows you how to select your original hi-fi system, improve it, or convert to stereo most economically.

AT YOUR FAVORITE NEWSSTAND

To order direct, send 75 cents plus 10 cents per copy for mailing to FAWCETT BOOKS, Dept. 464, Greenwich, Connecticut. No Canadian orders.

bearings which enabled the Coast Guard to locate the ship and render assistance.

Enforcement of a new law which requires small boats (those carrying more than six passengers for hire) to be equipped with radiotelephone as a safety measure is an added chore for the FCC field engineering staff. One fishing boat master paid a \$450 fine for such a violation. Also, various fishing vessel masters have been fined up to \$500 each for violating another Federal law by using "too salty" language over marine radiotelephone.

The interference problem has become such that the Commission field force, because of its many other duties, must concentrate on interference cases which have serious impact on radio communication services. However, various groups cooperate by resolving routine complaints in the field. More than 500 local committees handle TV complaints.

By means of engineering measurements with equipment in mobile TV enforcement vehicles and test cars, Commission engineers check technical performance of radio and TV stations. Such measurements disclose conditions resulting in distorted music or voice or in failure of stations to deliver a signal of sufficient strength to provide a distance coverage in keeping with the station's licensed power.

The American Radio Relay League has formally commended the Field Engineering and Monitoring Bureau "for its assistance and cooperation rendered amateurs." That the amateurs, for their part, have internal woes is indicated by a letter from the wife of one which requested the Commission to revoke her husband's ham

license "since it has been interfering with his family life."

Sixty families in three New York City apartment houses were annoyed by both radio and TV interference. Pooling their observations, they noted that the trouble always started when a certain tenant returned home. An FCC engineer then determined that the source was in the suspect's apartment. Friendly entry with a police officer found the man using an old sparking-commutator motor. He said he did so to retaliate against a neighbor whose refrigerator, he thought, was ruining his AM reception. He desisted upon warning, whereupon broadcast reception returned to normal for everybody concerned.

Investigation of the use of radio to flash horse racing results caused the arrest at a Florida race track of one man who had a miniature transmitter built into his clothing. Detection of such a clandestine operation is made more difficult by the fact that the equipment is well hidden and the user gives no visible evidence other than seeming to talk to himself—as so many people do in the excitement of watching a race. Interception of the actual transmission is the best evidence.

An Air Force base in Colorado complained of interruptions to its air-to-ground communication. FCC engineers found it to be due to radiation from an old type radio-controlled garage-door opener at a nearby private residence where the garage doors were labeled "His" and "Hers." The difficulty was removed by he and she installing a remote control system that could be licensed in the Citizens Radio Service. •

Warehouse filled with electronic surplus material. If used illegally, it can cause radio interference.





JOB COUNSELORS ADVISE LEARN ELECTRONICS



PRACTICE WITH
17" TV RECEIVER



PRACTICE WITH
LOW POWER TRANSMITTER

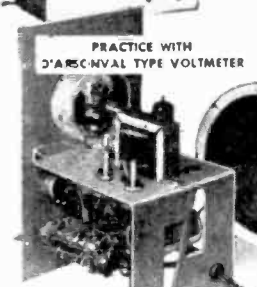

PRACTICE WITH ULTRA
HIGH FREQUENCY OSCILLATOR

SPECIAL TRAINING KITS NO EXTRA COST

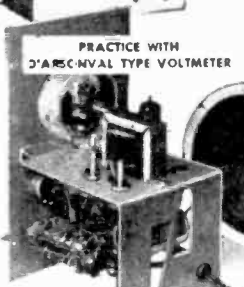

PRACTICE WITH
D'ARSONVAL TYPE VOLTMETER

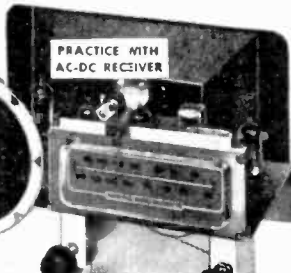

PRACTICE WITH
AC-DC RECEIVER

NEW Home Study Course in **ELECTRONICS** Principles-Practices-Maintenance **NOW READY**

This is the Electronic Age. Electronic equipment is already being used to count and control flow of liquids, solids, gases. Electronics is employed to search for oil, make surveys, control traffic, machine complex parts and in atomic installations. Military uses of Electronics are great and expanding rapidly. In business, Automation with Electronics plays an important part, prepares payrolls, calculates engineering formulas.

Learn More to Earn More

Now, to meet the growing demand for trained Electronic Technicians NRI has developed a comprehensive, complete course in Electronics Principles, Practices, Maintenance. This training stresses fundamentals. It is a course specially prepared for beginners and for Technicians. You get both theory and practical experience in an interesting, exciting way.

Ten Special Training Kits Give Practical Experience

You get practical experience with Thyratron Tube circuits, Multivibrators, build a D'Arsonval type Vacuum Tube Voltmeter (Kit 2); work and experiment with pentode tubes, selenium resistors, oscillators, transistors, magnetic amplifiers; and get practical experience in telemetry circuits as used in earth satellites, digital and analog computers (Kit 9).

NRI Oldest, Largest School  **SEE OTHER SIDE**

Wishing for success won't bring success. You must act. Get FREE 64-page Catalog from America's oldest and largest home study Electronic-Radio-Television school. It gives facts, opportunities in Industrial and Military Electronics careers, also shows what you learn, tells about NRI's other courses in Radio Television Servicing and Radio Television Communications. Monthly payments plan. Mail Postage Free Card for 64-page Catalog. **NATIONAL RADIO INSTITUTE**, Dept. DMB9, Washington, 16, D. C.



**POSTAGE FREE CARD
MAIL NOW**

FIRST CLASS
Permit No. 20-R
(Sec. 34.9, P. L. & R.)
Washington, D.C.

BUSINESS REPLY CARD
No Postage Stamp Necessary if Mailed in the United States

POSTAGE WILL BE PAID BY

National Radio Institute

3939 Wisconsin Avenue

Washington 16, D.C.



Learn RADIO, TELEVISION

AND ELECTRONICS

by Practicing at Home in Your Spare Time

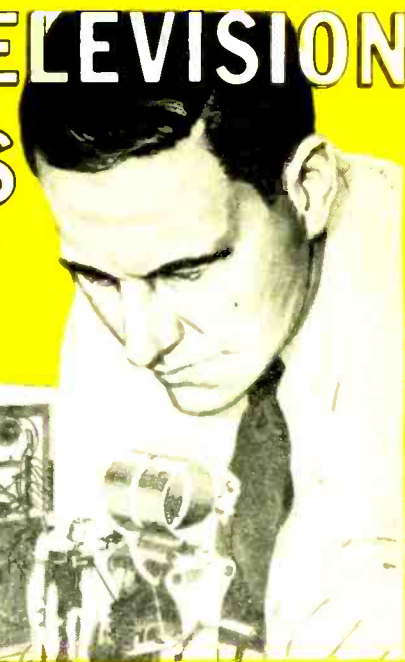

At No Extra Cost you get specially developed Electronic Training Kits for practical experience. Shop and laboratory practice at home make learning easier, interesting, faster. You do not need a high school diploma or previous experience.

Increasing Demand for Trained Men

This is the Electronics age. Men with Electronic know-how are in demand. They enjoy high pay and growing opportunities for advancement. Satellites, Radar, Automation in Industry, Missiles, Rockets, Planes, Stereo, TV, Radio, Two Way Communications for transportation are a few of the fantastic developments in the fast growing Electronics industry. If you are not completely satisfied with your work, if you are doubtful about your future, investigate Electronics.



High Pay, Prestige, Bright Future

What branch of Electronics interests you? Thousands of successful NRI graduates prove that NRI's learn-by-practice method is the way to success. You start in your chosen career way ahead of the man who only learns from books. You do not need to give up your job. You do not need to go away to school. You learn at home, get practical knowledge from training kits NRI provides.

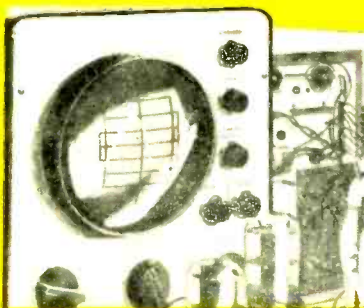

NRI Has Trained Thousands for Success



"I get over twice the salary I made before enrolling NRI training gave me a thorough understanding." H. ATKINSON, Austin, Tex.



"Now in charge of sound effects for CBC NRI opened doors to greater opportunity for me." E. TUOHK, Toronto, Ontario



"Averaged \$150 a month spare time before I graduated. Now have my own full time business." F. W. COX, Hollywood, Cal.

NEW COURSE IN ELECTRONICS TURN PAGE

Cut Out and Mail—No Stamp Needed

64-PAGE CATALOG FREE

No Salesman will call. (Please PRINT)

Name _____ Age _____

Address _____

City _____ Zone _____ State _____

OLDEST & LARGEST HOME STUDY RADIO-TV SCHOOL
National Radio Institute
 Dept. OMB9, WASHINGTON, 16, D. C.
 ACCREDITED MEMBER NATIONAL HOME STUDY COUNCIL

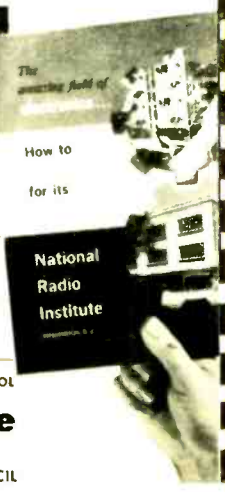

Train With the Leader

NRI is the world's oldest and largest home study Electronics school. You benefit from the experience NRI has gained from training men for 45 years. NRI offers you proven courses of home study in Electronics; Principles, Practices and Maintenance; Radio Television Communications—Radio Television Servicing.

Start Soon, Earn More

Soon after enrolling NRI shows you how to apply your knowledge to earn extra money doing Electronic repairs or servicing Radio and Television sets for friends and neighbors. Take the first step toward success now. Find out what NRI offers you. Mail the postage-free card. No obligation. Cost of NRI training is low.



Monthly payment plan available. NATIONAL RADIO INSTITUTE, Dept. OMB9, Washington 16, D. C.