

# BUDGET Electronics

by the EDITORS of ELEMENTARY ELECTRONICS

© 02040

1980 EDITION \$1.75

## DOLLAR-SAVING PROJECTS

- ✓ Low-Cost Test Bench
- ✓ Budget Remote Control
- ✓ Bargain Power Supplies
- ✓ Radios that Run for Free

## BE YOUR OWN APPLIANCE REPAIRMAN

- Restore Antique Radios
- Service Auto Stereo
- Silence Static
- Be a Parts-Buying Whiz

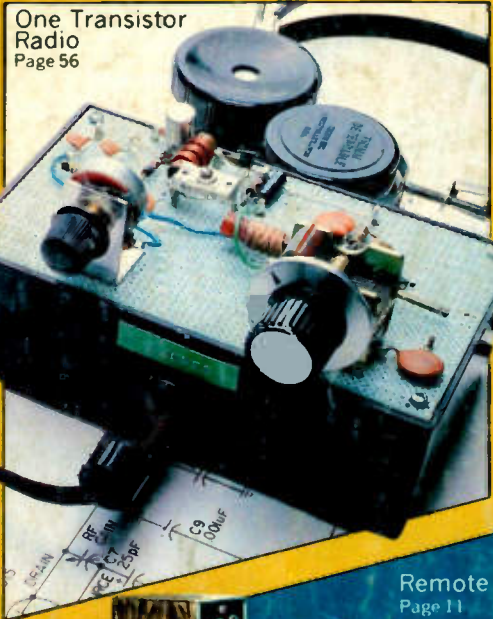

One Transistor Radio Page 56



Signal Tracer Page 63



Remote Controller, Page 11



Capacitor Checker Page 58

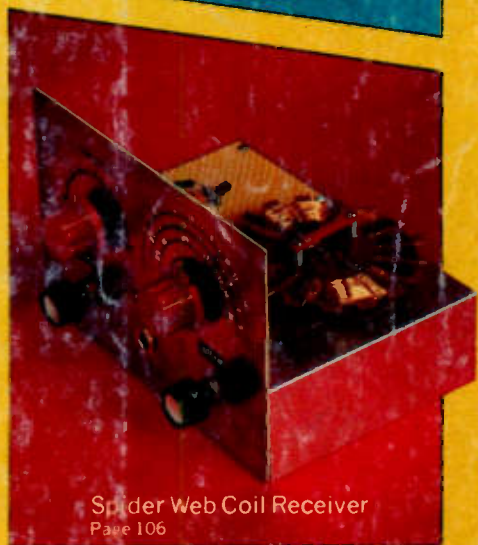

Spider Web Coil Receiver Page 106



# NEW!

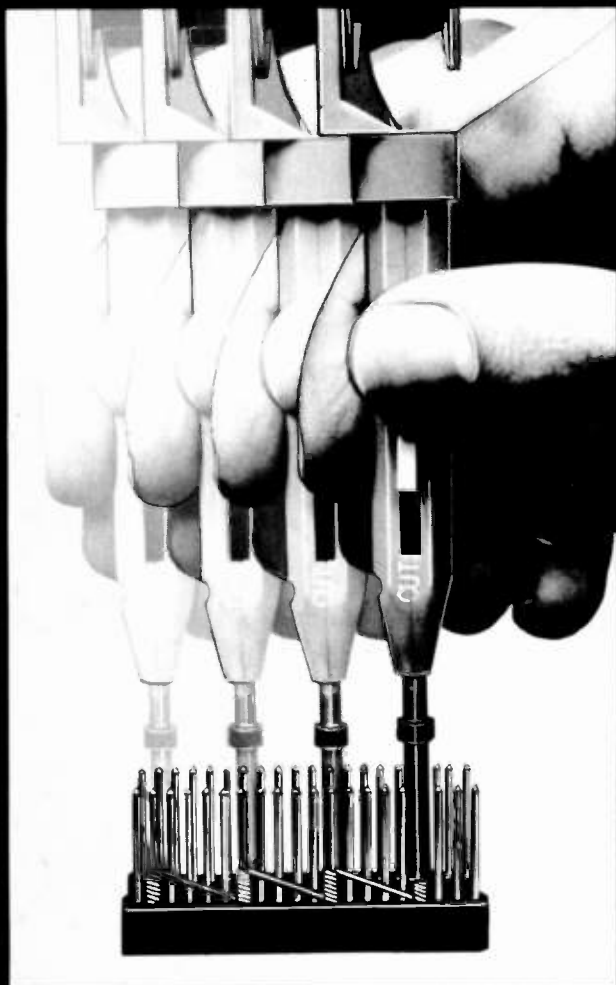

WHY CUT?  
WHY STRIP?  
WHY SLIT?

WHY NOT...



# JUST WRAP™



U.S.A.  
FOREIGN  
PATENTS  
PENDING

- AWG 30 Wire
- .025" Square Posts
- Daisy Chain or Point To Point
- No Stripping or Slitting Required
- ....JUST WRAP™....
- Built In Cut Off
- Easy Loading of Wire
- Available Wire Colors:  
Blue, White, Red & Yellow

**\*\$14<sup>95</sup>**

 JUST WRAP TOOL WITH ONE 50 FT. ROLL OF WIRE		
COLOR	PART NO.	U.S. LIST PRICE
BLUE	JW-1-B	\$14.95
WHITE	JW-1-W	14.95
YELLOW	JW-1-Y	14.95
RED	JW-1-R	14.95
 REPLACEMENT ROLL OF WIRE 50 FT.		
BLUE	R-JW-B	2.98
WHITE	R-JW-W	2.98
YELLOW	R-JW-Y	2.98
RED	R-JW-R	2.98

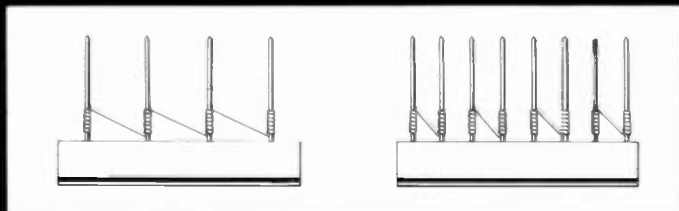

DAISY CHAIN

POINT TO POINT



MACHINE & TOOL CORPORATION 3455 CONNER ST., BRONX, N.Y. 10475 (212) 994-6600/TELEX 125091

\*MINIMUM BILLING \$25.00 / AD SHIPPING CHARGE \$2.00 / NEW YORK CITY / STATE RESIDENTS ADD APPLICABLE TAX.

# New from NRI! 25" color TV that DIAGONAL tunes by computer, programs an entire evening's entertainment.

**Just part of NRI's training in servicing TV, stereo systems, video tape and disc players, car and portable radios.**

Only NRI home training prepares you so thoroughly for the next great leap forward in TV and audio... digital systems. Already, top-of-the-line TVs feature digital tuning, computer programming is appearing, and new digital audio recording equipment is about to go on the market.

NRI is the only home study school to give you the actual "hands-on" training you need to handle servicing problems on tomorrow's electronic equipment. Because only NRI includes this designed-for-learning, 25" diagonal color TV with electronic tuning, built-in digital clock, and computer programmer as part of your training. With this advanced feature, you can pre-program an entire evening's entertainment... even key lock it in to control children's viewing.

### **Exclusive Designed-for-learning Concept**

The color TV you build as part of NRI's Master Course looks, operates, and performs like the very finest commercial sets. But behind that pretty picture is a unique designed-for-learning chassis. As you assemble it, you perform meaningful experiments. You even introduce defects, troubleshoot and correct them as you would in actual practice. And you end up with a magnificent, big-picture TV with advanced features.

### **Also Build Stereo, Test Instruments**

That's just a start. You demonstrate basic principles on the unique NRI Discovery Lab,<sup>®</sup> then apply them as you assemble a fine AM/FM stereo, complete with speakers. You also learn as you build your own test instruments, including a 5" triggered sweep oscilloscope, CMOS digital frequency counter, color bar generator, and transistorized volt-ohm meter. Use them for learning, use them for earning as a full- or part-time TV, audio, and video systems technician.

### **Complete, Effective Training Includes Video Systems**

You need no previous experience of any kind. Starting with the basics, exclusive "bite-size" lessons cover subjects thoroughly, clearly, and concisely. "Hands-on" experiments reinforce theory for better comprehension and retention. And your personal NRI instructor is always available for advice and help. You'll be prepared to work with stereo systems, car radios, record and tape players, transistor



radios, short-wave receivers, PA systems, musical instrument amplifiers, electronic TV games, even video tape recorders and tape or disc video playbacks.

### **Send for Free Detailed Catalog... No Salesman Will Call**

Mail the postage-paid card today for our free 100-page catalog with color photos of all kits and equipment, complete lesson plans, convenient time payment plans, and information on other electronics courses. You'll also find out about NRI's new Computer Technology Course that includes your personal microcomputer. Or Complete Communications with 2-meter transceiver. If card has been removed, write to:



**NRI Schools**  
McGraw-Hill Continuing  
Education Center  
3939 Wisconsin Ave.  
Washington, D.C. 20016

# BUDGET Electronics

CONTENTS

1980 EDITION

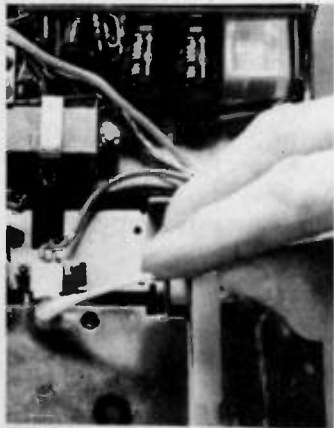

## BE A BUDGET DO-IT-YOURSELFER

- 13 Restoring Antique Radios
- 15 Pitch Fix
- 20 7 Steps to Auto Cassette Repair
- 32 Budget Installs a Roof Antenna
- 34 10 Car Radio Repair Tips
- 47 The Fine Art of Buying Parts
- 54 Solderless Breadboarding
- 76 Budget Installs an Attic Fan
- 80 Love That Lettering
- 103 Stop Static

*You can save a bundle when you put in and repair appliances yourself. These articles show you how to do it, with style.*

## LOW-COST RADIO ADD-ONS

- 24 Horizontal Dipole Antennas
- 64 SWL's Super Calibrator
- 69 Shortwave Supercharger
- 82 Budget Checks the B&W Window Antenna
- 91 Put New Life in that Old Car Radio

*Make a real hot-rod out of your old table radio. Accessories like these soup up shortwave sets, AMers, get dials straight, and bring signals in.*

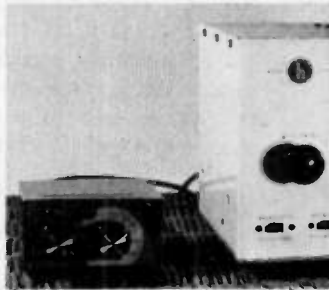

## 10 BUDGET CONSTRUCTION PROJECTS

- 9 Rain Gauge
- 11 Remote Controller
- 43 Passive Mixer
- 44 5 Volts/3 Amps for Digital Projects
- 45 The Junk Box Special
- 87 Space Cushion Timer
- 89 Control That Tape
- 96 Washer Watcher
- 97 CB Power Mate
- 109 Light Jinn

*Projects like these don't grow on trees —though you'll think they do when you see how little the parts they use cost.*

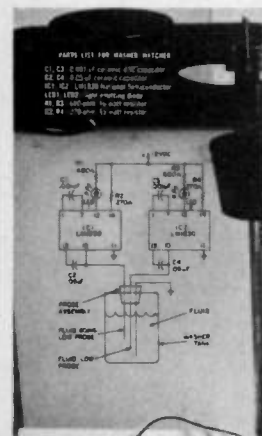

## REGULAR DEPARTMENTS

3 New Products

5 Ask Hank, He Knows

115 Literature Library

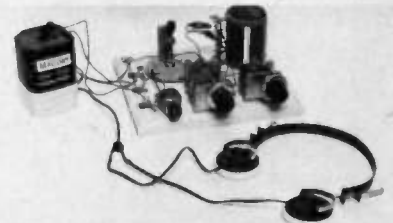

## BUDGET RECEIVERS

- 7 Classic Crystal
- 29 Grand Pa's Whisker
- 56 Signal Snare
- 65 Sub-Basement Radio
- 73 Solar Swinger
- 83 Crystal Detectors
- 106 Spider Web Receiver
- 112 See-Through  
Crystal Receiver

*These receiver projects capture both past and present circuit technology, and do it with ease on a real shoestring budget.*

## ECONOMY TEST EQUIPMENT

- 28 Budget Checks the  
B&K DP-50 Logic Probe
- 38 Building a Budget Test Bench
- 58 High-Amp Meters
- 59 Count Capacita
- 63 Signal Tracer
- 71 Budget Checks  
the Heath Vectorscope
- 94 Chip Clip
- 101 Signal Chaser

*Put together a low-cost lab with kits and projects that are easy on your pocketbook, but hard on bad circuits.*



# New Products

## Handles Big Chips

New Model MOS-2428 Dip Inserter by OK Machine handles all MOS, CMOS and regular 24 and 28 pin ICs and aligns bentout pins. Simply rock the IC on the straightening saddle to align pins. Press

CIRCLE 37  
ON READER SERVICE  
COUPON

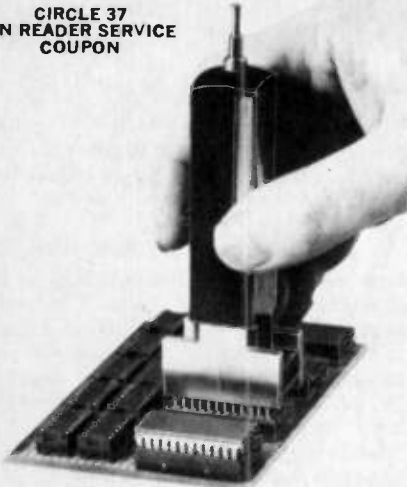

tool over IC to pick up, then simply place the tool onto the socket and depress the plunger for instant and accurate insertion. Features heavy chrome plating throughout for reliable static dissipation and terminal lug for attachment of ground strap. Priced at \$7.95, the MOS-2428 IC Insertion Tool is available from your local electronics distributor or directly from OK Machine and Tool Corporation, 3455 Conner Street, Bronx, New York 10475.

## Mini-Disk Systems for TRS-80

Percom Data has expanded its line of "add-on" mini-disk data storage systems for the Radio Shack TRS-80 micro-computer to include both 40 and 77-track drives. One, two, and three-drive systems can be supplied with either 40-track TFD-100 drives or 77-track TFD-200 drives. The big advantage of 40-track drives is that both sides of the mini-disks may be used for data storage. The capa-

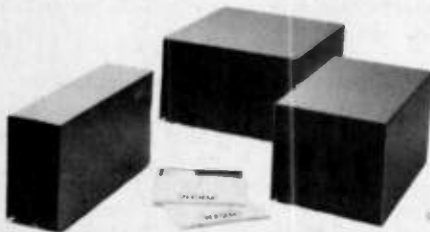

CIRCLE 36 ON READER SERVICE COUPON

bility of the TFD-100 units to accommodate so-called "flippy" mini-disks increases disk storage capacity to almost 205K bytes compared to only 90K bytes for the usual single sided 35-track units.

A 77-track TFD-200 stores up to 197K bytes, and a three-drive system provides 591K bytes of on-line storage. The 77-track mini-disks are single-sided. With each disk system sold, Percom supplies a PATCH PAK #1 mini-disk which includes programs to patch TRSDOS, the TRS-80 disk operating system, for 40 and 77-track operation. Prices range from \$399 for the single-drive, 40-track TFD-100 to \$2025 for the 3-drive, 77-track TFD-200. Get all the facts first by writing to Percom Data Company, 211 N. Kirby, Garland, TX 75042. (The Tandy Corporation and Radio Shack have no relationship to Percom Data Company).

## Automatic Memory Dialer

Now you can dial frequently called or emergency telephone numbers at the touch of a single button with Radio Shack's new DuoFone-32 Automatic Memory Dialer. The automatic dialer saves time and eliminates misdialing, especially on emergency numbers. It also increases efficiency in offices and homes by eliminating the time required to look up and dial numbers. The DuoFone-32 can store up to 32 different telephone numbers of up to 14 digits each. This allows instant one-button dialing of long-distance numbers even on phone sys-



CIRCLE 32 ON READER SERVICE COUPON

tems using an access digit or dial "9" for an outside line feature. The DuoFone-32 includes a built-in LED digital clock and timer that indicates elapsed time up to one hour. It can be used on single line phones only, either dial or push-button types. Operates on 120 VAC and three "AA" batteries for auxiliary power to prevent the loss of stored numbers in the event of a power failure or if the unit is moved to another location. The new DuoFone-32 Automatic Memory Dialer is available from participating Radio Shack stores and dealers for \$99.95.

## Padded Grille Compact Speaker

A new compact speaker with a padded grille has been added to RCA's line of AutoSound products. Measuring just 4 3/8-

## THE STAFF

Associate Publisher & Editor-in-Chief

**Julian S. Martin**

Managing Editor

**Alan H. Rose, K2RHK**

Technical Editor

**Gordon Sell, KBDA1464**

Associate Editor

**Lee Lensky, KA2DKT**

Citizens Band Editor

**Kathi Martin, KGK3916**

Editorial Assistant

**Cynthia McClean, KBKF3780**

Workbench Editor

**Hank Scott**

Art Director

**Ralph Rubino**

Associate Art Director

**David Pindar**

Assistant Art Director

**Michael Vessio**

Cover Art Director

**Irving Bernstein**

Art Assistants

**Della Nobbs**

**Susan Mahler**

Advertising Director

**Ralph Vega**

Production Director

**Carl Bartee**

Production Manager

**Carole Dixon**

Production Assistant

**Edith Muesing**

Newsstand Circulation

Director

**Don Gabree**

Subscription Circulation Director

**Robert V. Enlow**

Subscription Circulation Manager

**Eugene S. Slawson**

Marketing Director

**James C. Weakley**

President and Publisher

**Joel Davis**

Vice President and

General Manager

**Leonard F. Pinto**

Vice President and Treasurer

**Victor C. Stable, KBP0681**

BUDGET ELECTRONICS is published annually by Davis Publications, Inc. Editorial and business offices: 360 Lexington Avenue, New York, New York 10017. Advertising offices: East Coast: 380 Lexington Ave., New York, New York 10017. 212-557-9100; Midwest: 520 N. Michigan Ave., Chicago, Illinois 60611, 312-527-0330; West Coast: J. E. Publisher's Rep. Co., 8732 Sunset Blvd.—Fourth Floor, Los Angeles, California 90069, 213-659-3810. EDITORIAL CONTRIBUTIONS must be accompanied by return postage and will be handled with reasonable care; however publisher assumes no responsibility for return or safety of manuscripts, artwork, or photographs. All contributions should be addressed to the Editor-in-Chief, BUDGET ELECTRONICS, 360 Lexington Avenue, New York, New York 10017. Copyright 1979 by Davis Publications, Inc.

# New Products

inches in diameter, and requiring only 1½-inches rear clearance, RCA's model 12R409 speaker set can fit readily in many car models and areas that cannot accommodate larger size speakers. Its textured black finish blends unobtrusively with all car interiors. The padded grilles snap on for easy installation. Technical specifications are: 4-ohm voice coil impedance, 90 to 13,000 Hz frequency response, and 10 watts maxi-



**CIRCLE 33  
ON READER SERVICE  
COUPON**

mum input (music). Suggested list price for the 12R409 stereo speaker is \$14.30. Additional information is available from RCA AutoSound Distributors, or contact RCA Distributor and Special Products Division, Deptford, NJ 08096.

## Direct-Drive Automatic Turntable

The Sansui Model SR-5090 2-speed turntable has all the conveniences of automatic operation plus the precision of direct drive. The SR-5090 has a single knob control for completely automatic operation, including power turn-off at the end of play, with the tonearm returned to its rest position. It has repeat control with 1 to 5 repeat plays and an option for endless play. Automatic play can be interrupted at any time and the unit can also be operated manually. The electronically controlled drive system uses a high-torque 20-pole, 30-slot brushless DC servo motor. Wow and flutter are down to 0.038%, rumble is better than 67 dB and SNR is better than 57 dB. The edge of the 12½-inch alu-



**CIRCLE 40 ON READER SERVICE COUPON**

minum alloy diecast platter has strobe patterns which, with its built-in strobe light, permits a visual check of rota-

tional speed. The statically balanced S-shaped tonearm, utilizing a two-point pivot support, has a zinc-alloy diecast arm base. The SR-5090 automatic direct-drive turntable is supplied with a dustcover and base. Suggested retail price is \$280 including base, dustcover and a 45 rpm spindle adaptor. For further information, write to Sansui Electronics Corporation, 55-11 Queens Blvd., Woodside, NY 11377.

## Project Probe Case

Continental Specialties Corporation offers the molded grey plastic case, complete with hardware, that is used in their logic probe kit. This case, model CTP-1, called the Probe Case, is offered at a suggested U.S. resale price of \$4.95. The case itself measures 5.8 x 1.0 x 0.7-inches. Included with it are a 36-inch two-wire power cord with a molded-on strain relief clamp and attached alligator clips; a 1½-inch nickel-plated screw-in probe tip; a mating tapped hex probe tip connector; assembly screws and a perf board precut to size. The Probe Case CTP-1, is suggested for housing signal injectors, logic probes, small counters, voltage probes, resistance probes, con-

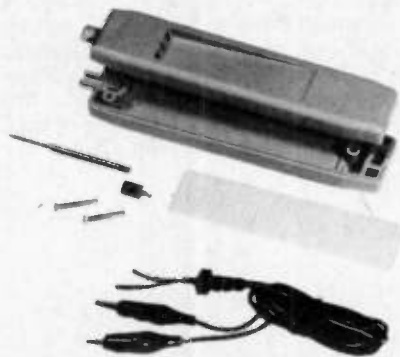

**CIRCLE 39 ON READER SERVICE COUPON**

tinuity checks and more. For additional information or the name of your local distributor, call Continental Specialties Corporation toll-free at 1-800-243-6077, or write to them at 70 Fulton Terrace, New Haven, CT 06509.

## Eliminate Record Static

Permostat, a totally new and uniquely formulated fluid, which with just one application completely eliminates record static electricity indefinitely—without any degradation in sound quality, surface noise, or frequency response. Phonograph records are pressed in vinyl, a highly insulating material that is extremely easy to charge up by the frictional contact which takes place when records are removed from jacket sleeves or wiped with cleaning devices. Static electricity attracts undesirable airborne dust particles and holds them like a magnet inside the record groove, causing audible crackles and pops. The Permostat record preservative kit contains a 3 fluid ounce bottle of Permostat, pump sprayer, record buffer, instruction sheet

and record identification tabs. Each Permostat kit provides protection for 25 records (both sides). The kit is priced at \$19.95, (refill kits are available at

**CIRCLE 55  
ON READER SERVICE  
COUPON**



\$15.95) and is on sale at hi-fi outlets across the nation. Write to Stanton Magnetics, Inc., Terminal Drive, Plainview, NY 11803 for more info.

## Air Compressor for Hobbyists

Now available from Radio Shack is the multi-purpose Archer "Mini" air compressor, which, although small enough to fit in the palm of your hand, is said to deliver up to 60 lbs of air pressure to inflate tires, rafts, air mattresses, balls and sporting equipment. The "mini" air compressor plugs into the cigarette lighter socket in any 12 VDC positive or negative ground system car, truck, boat or recreational vehicle. Compact size allows convenient storage in console, glovebox or trunk. The compressor has factory sealed bearings that never need lubricating. It comes complete with 10-foot air hose, cigarette lighter plug, inflator accessories and attachments for most air valves. The

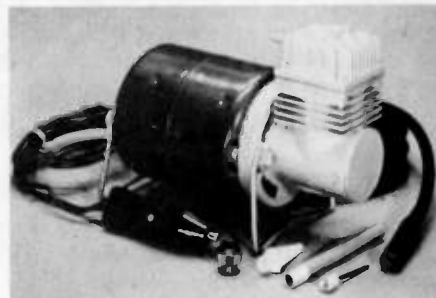

**CIRCLE 32 ON READER SERVICE COUPON**

Archer "Mini" Air Compressor, available from participating Radio Shack stores and dealers, nationwide, is priced at \$39.95.

## 5-Function Volt-Ohm Milliammeter

Only 4½-inches long, a new volt-ohm-meter from VIZ Mfg. fits comfortably in the hand for convenient on-the-job use. Housed in an ABS high-impact case, the instrument is ideal for engineers, technicians and hobbyists. Known as the Model WV-561B VOM, the instrument can be used to measure DC and AC volts up to 250 V, resistance up to 500,000 Ohms, current up to 250 mA and decibels from -20 to +22. Each function has three

*(Continued on page 114)*

# Build the REAL THING – Yourself!

Get top mileage from your own craft skills



**367. ROBIN** is a versatile skiff that can be used for hunting or fishing, as a yacht club tender, or a work boat. It is rugged, yet its plywood construction makes it easy to build; no special jig or tools are needed. It can take a motor of 7-10 hp. L.O.A., 12'; beam, 5'1". **\$5.00**



**75. KINGFISHER** is a modern version of the Scandinavian pram developed hundreds of years ago. It rows easily, sails well, and propels nicely with a small outboard motor. Its 90 lb. weight and small size make it ideal to carry-top; construction is plywood. L.O.A., 9'; beam, 4'. **\$5.00**



**245. CAT'S PAW** catamaran provides a stable base for a lot of sail area to make for fast sailing. And she's easy to build because of her straight-sided hulls, flat sheer, and straight bow and stern. It's an ideal boat in which to learn sailing. L.O.A., 12', beam, 6'2"; sail area, 85 sq. ft. **\$6.00**



**343. MINIMOST** is an 8' outboard sports hydro you can build in just 15 hours, and at a cost of less than \$25 for materials. Its advanced underhull design makes speeds in the 30 mph range possible with a 10 hp motor. L.O.A., 8'. **\$5.00**  
Full-size pattern set 344 **\$15.00**

## Make it with Craft Prints and save hundreds of \$\$!

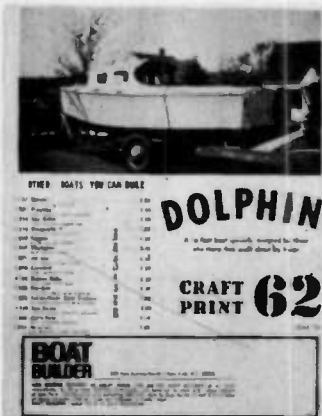

**62. DOLPHIN** is small and light enough to be transported anywhere by trailer, yet it will accommodate two persons for extended cruising or a party of four on day trips. Plywood is used throughout, and the hull is designed to get the most from modest power. L.O.A., 16'; beam, 5'9". **\$5.00**



**356. TABU** gets up on plane, just like an outboard, to provide speeds up to four times higher than those possible with a conventional hull of the same size. Hull is of plywood, covered with resin and Dynel cloth. L.O.A., 16'; beam, 4'8"; draft, centerboard down, 2'6"; sail area, 165 sq. ft. **\$5.00**



**371. JAMAICAN** is a sailing surfboard of unique construction. Fiberglass and Dynel cloth are stretched and stapled in place over a wooden framework, then resin is applied. No special building jigs or forms are needed. Foamed-in-place polyurethane adds stiffness. L.O.A., 12'; beam, 3'. **\$5.00**



**36. CHUM** is a speedy little runabout that can be built as a single cockpit or double cockpit model. Use a light-weight engine of no more than 100 hp for top performance. Construction is of marine plywood over hardwood frames. Decks are of mahogany-faced plywood. L.O.A., 15'6" **\$5.00**

COMPLETE AND MAIL TODAY

Boat Builder, 380 Lexington Ave., N.Y., NY 10017

BE-80

Enclosed is \_\_\_\_\_. Please add 50¢ for postage and handling. Send me the Craft Print(s) I have checked below:

- |  |  |   |
|--|--|---|
| <input type="checkbox"/> #367 \$5.00 Add 50¢ | <input type="checkbox"/> #75 \$5.00 Add 50¢  | <input type="checkbox"/> #343 \$5.00 Add 50¢                      |
| <input type="checkbox"/> #245 \$6.00 Add 50¢ | <input type="checkbox"/> #356 \$5.00 Add 50¢ | <input type="checkbox"/> #344 \$15 full-size pattern set. Add 50¢ |
| <input type="checkbox"/> #62 \$5.00 Add 50¢  | <input type="checkbox"/> #36 \$5.00 Add 50¢  |   |
| <input type="checkbox"/> #371 \$5.00 Add 50¢ |  |   |

SATISFACTION GUARANTEED.

Name \_\_\_\_\_  
Address \_\_\_\_\_  
City \_\_\_\_\_ State \_\_\_\_\_ Zip \_\_\_\_\_

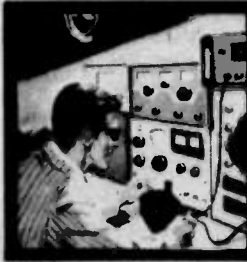

**Ask Hank,  
He Knows!**

Got a question or a problem with a project—ask Hank! Please remember that Hank's column is limited to answering specific electronic project questions that you send to him. Personal replies cannot be made. Sorry, he isn't offering a circuit design service. Write to:

**Hank Scott, Workshop Editor  
BUDGET ELECTRONICS  
380 Lexington Avenue  
New York, NY 10017**

**Down with the Leader**

*My telephone answering device chewed up its original cassette. After cleaning the machine, it works fine but I always miss the first few seconds of the first call. How come?*

—F.S., La Jolla, CA

If you purchase an ordinary blank cassette, you'll miss the early part of the first telephone call on your home phone recorder due to the length of non-recordable tape leader. Either buy a cassette with no

leader (intended for your machine) or open a cassette and shorten the leader so recording tape appears at the felt pads after the cassette is fully wound.

**Mic Tricks**

*I visited a professional recording studio and heard some of the engineers talking about the "proximity effect" of a particular microphone. What were they talking about?*

—L.B., Memphis, TN

The proximity effect is a phenomenon that occurs with all mics, but is most noticeable with dynamic types. As a singer gets closer to the mic, the apparent bass response goes up. A good vocalist would sing softly, holding the mic close to the mouth, to exaggerate the bass and give a warmer sound. Then, to raise excitement in the voice, hold the microphone further back and sing louder. There will be less bass in the voice, but more penetrating quality. Classical guitars can also take advantage of the proximity effect to get a warmer recorded sound.

**Audio-Load**

*I used several wire-wound resistors to simulate an eight-ohm, 250-watt load for amplifier tests. I know there is an inductance in these resistors. How can I compute the correct value of capacitance to cancel the inductance?*

—L.R., New Ulm, MN

You will be able to experimentally determine the correct capacitance for any one frequency, but it would not be effective throughout the testing range of audio frequencies. I suggest you resort to composition-type resistors.

**Plug It In**

*Why don't the hi-fi manufacturers use phone plugs instead of those nail-busting phono plugs?*

—D.J., Cambridge Springs, PA

Count the number of phono jacks on the rear panel of an AM/FM receiver with several phono and tape interconnections. Imagine the internal space and rear apron space wasted by phone jacks compared to the mini-space required for phono jacks. Besides, phono jacks are cheaper and function just as well.

**Resistor Values**

*Every time I design a circuit I find out that the resistor values I need are unavailable. Sure I can put different values together in series or parallel but it's a*

*pain in the power supply and involves too many trips back and forth to the electronics parts store. Do you have a list of the so-called standard resistor values so I can save time and gas?*

—N. S., Plainedge, NY

Here it is—any good-sized electronics supply house should be able to fill your shopping list. You won't, however, find all of these on the "blister pack" rack; they may be behind the counter—ask! All the values shown on the chart should be available in 5% tolerances, while the bold-faced values are also available in 10% tolerances.

Ohms	Ohms	Ohms	Ohms	Megs.
1.0	33	1000	33000	0.75
1.1	36	1100	36000	0.82
1.2	39	1200	39000	0.91
1.3	43	1300	43000	1.0
1.5	47	1500	47000	1.1
1.6	51	1600	51000	1.2
1.8	56	1800	56000	1.3
2.0	62	2000	62000	1.5
2.2	68	2200	68000	1.6
2.4	75	2400	75000	1.8
2.7	82	2700	82000	2.0
3.0	91	3000	91000	2.2
3.3	100	3300		2.4
3.6	110	3600	Megs.	2.7
3.9	120	3900		3.0
4.3	130	4300	0.1	3.3
4.7	150	4700	0.11	3.6
5.1	160	5100	0.12	3.9
5.6	180	5600	0.13	4.3
6.2	200	6200	0.15	4.7
6.8	220	6800	0.16	5.1
7.5	240	7500	0.18	5.6
8.2	270	8200	0.20	6.2
9.1	300	9100	0.22	6.8
10	330	10000	0.24	7.5
11	360	11000	0.27	8.2
12	390	12000	0.30	9.1
13	430	13000	0.33	10.0
15	470	15000	0.36	11.0
16	510	16000	0.39	12.0
18	560	18000	0.43	13.0
20	620	20000	0.47	15.0
22	680	22000	0.51	16.0
24	750	24000	0.56	18.0
27	820	27000	0.62	20.0
30	910	30000	0.68	22.0

**Little Echos**

*What is the difference between ambience and reverberation? I think they are one and the same.*

—D.L., Roselle Park, NJ

Reverberation is the reflection of sound from walls and/or ceilings, or simply, echo. It can be created artificially by electronics and mechanical devices to imitate the effect of large halls. Ambience is the distinctive acoustical environment unique to the concert hall or recording studio. It's unique sound signature consists of multiple sound reflections (reverberations) from all the surfaces in the hall. You could say that the sum of many selected reverberations can be used to compose the ambience of a hall or studio. In fact, this is being done today and is available on the consumer market at reasonable prices. To answer your question; no, they are not the same!

**Don't be a heart breaker**

**Stop smoking.**

The American Heart Association  
WE'RE FIGHTING FOR YOUR LIFE

SEE AD ON INSIDE BACK COVER

**ELEMENTARY ELECTRONICS**  
P.O. Box 2630  
Greenwich, CT 06835

Yes. Enter my subscription—6 issues for ONLY \$3.98.

Payment enclosed.  Bill me.  
(Outside U.S.A. and possessions \$5.00)

Name \_\_\_\_\_

Address \_\_\_\_\_

City \_\_\_\_\_

State \_\_\_\_\_ Zip \_\_\_\_\_

Please allow 6 to 8 weeks for delivery of your first copy. H91054



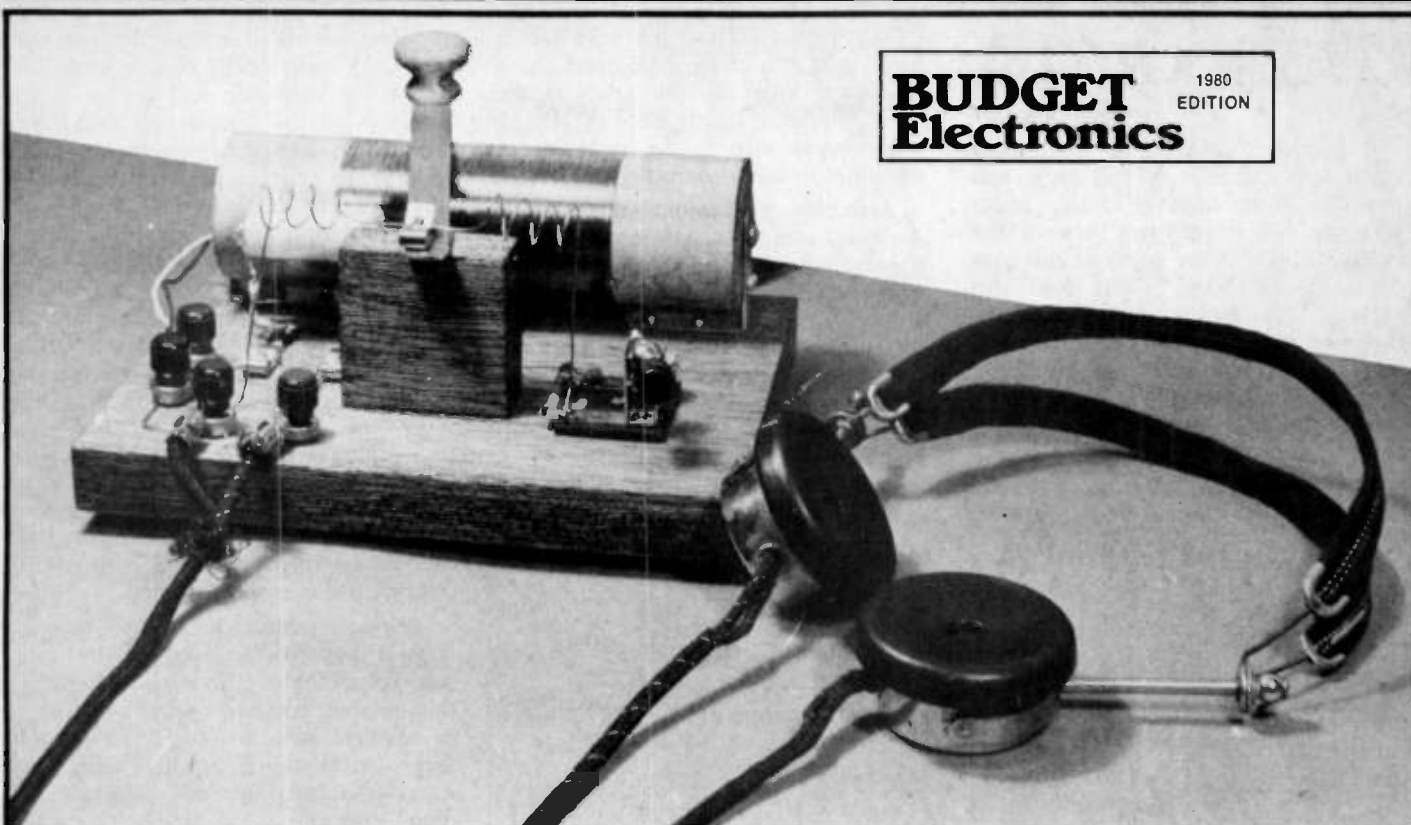

# CLASSIC CRYSTAL

A low-cost crystal set that will enrich any collection.

by George Campbell

**Y**OU CAN RELIVE THOSE EARLY days of broadcasting by building this authentic reproduction of a crystal radio from the early part of this century. This afternoon's project uses the same components, mostly hand-built, that your grandfather used to use, and costs less than \$10 to build.

The heart of this receiver is an authentic crystal detector, using a natural galena crystal and a cat-whisker. It is available by mail order (see parts list for ordering information). The coil and the condenser are also handmade, using original techniques from the early '20s.

*Old-Style Components.* Begin by lay-

ing out the wood base according to the drawing. You may use any wood you choose, as long as it's dry and well-seasoned. Drill  $3/32$ -inch pilot holes for the screws and  $5/32$ -inch holes for the binding posts. Counterdrill the binding post holes  $3/4$ -inches deep with a  $1/4$ -inch bit. Glue the slider support block to the base, then give the entire base two coats of shellac, the original finish for most of those old-time sets.

While the base dries, make the coil and condenser. The coil is wound on 4 inches of a 7-inch section of a rolling pin. Remove the handle from one end and withdraw the iron rod that passes through the rolling pin. Cut the rolling pin to length, and put the nylon bearing from the unused end of the pin in the hole in the 7-inch section.

Drill  $1/16$ -inch holes completely through the wood,  $1\frac{1}{2}$  inches from each end. Use the original rod from the pin as an axle, and carefully wind a single, smooth layer of No. 26, coated copper magnet wire between the holes. The coil must be tight, with no overlaps. Pass the wire ends through the pre-drilled holes to anchor the coil, then give it two coats of shellac.

Next, cut the parts of the condenser as shown in the diagram. On a hard surface, stack the strips together, beginning with the Kraft paper, then waxed paper, then foil, waxed paper, foil, waxed paper, and Kraft paper.

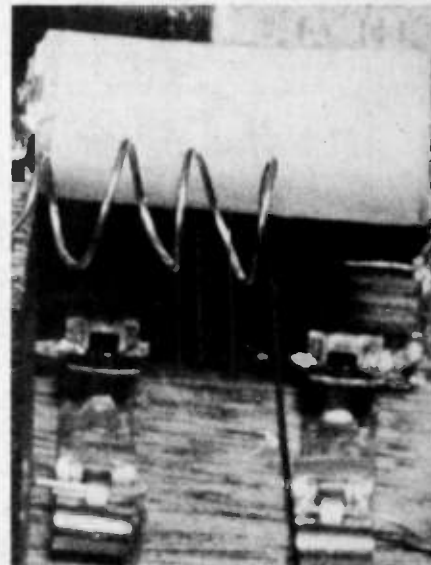

The roll-your-own capacitor is made of metal foil and paper—just like the old days.

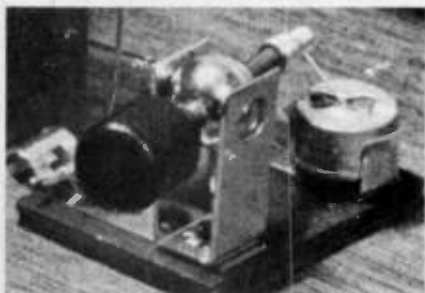

The crystal/whisker act as a rectifier diode to detect audio from the tuned LC circuit.

# CLASSIC CRYSTAL

The L-shaped ends of the foil should be at opposite ends of the stack, and protrude from opposite sides. Make sure the foil is centered between the layers, then bind the edges of the condenser together up to the foil with masking tape. Roll the bundle up tightly. Cover the completed condenser with masking tape and crush the protruding foil into wire-like leads.

Make the slider from a 1/8- by 1/2-inch brass strip, 6 inches long. Round the

corners with a file and drill a 5/32-inch pivot hole, 1 inch from one end and a 3/16-inch hole for the knob at the other. Solder a 3-inch piece of No. 12 bare copper wire to the underside of the slider to make contact with the coil.

**Assembly.** Mount all components on the base, using No. 5 x 1/2 inch brass, round-head wood screws. Place a fiber washer under the tuning slide pivot to reduce friction. Locate the tuning coil so that the holes in the nylon bushings line up with the top holes in the brass L-brackets. Use a No. 8 wood screw here. Attach the rubber feet to the bottom of the base.

Wire the receiver according to the drawing, using No. 20 copper wire. Remove the insulation and shellac from the top of the tuning coil with fine sandpaper, and bend the tuning slide slightly to provide good contact with the bare wire of the coil.

To use your crystal set, connect the antenna binding post to a good antenna (one side of a TV lead-in works well). The ground post must be connected to a good ground, such as a cold water pipe. The headphones used with this set must be the high impedance type. Normal stereo headsets will not work with this primitive receiver. If you wish, you can attach the center conductor of a shielded cable to binding post J3, the shield to J4, and plug the other end into an amplifier to provide loudspeaker reception and easier listening.

Locate a sensitive spot on the galena crystal by slowly dragging the cat-whisker spring over its surface with the tuning slide centered on the coil. Once a sensitive spot is found, you should hear a local station clearly. Tuning this receiver takes time and patience, so don't give up.

Don't be surprised if you hear more than one station at once. Crystal sets are not very selective. However, careful adjustment of the tuning slide should separate stations reasonably well. And who knows? One day you may even hear a voice from the past. ■

## Capacitor Construction

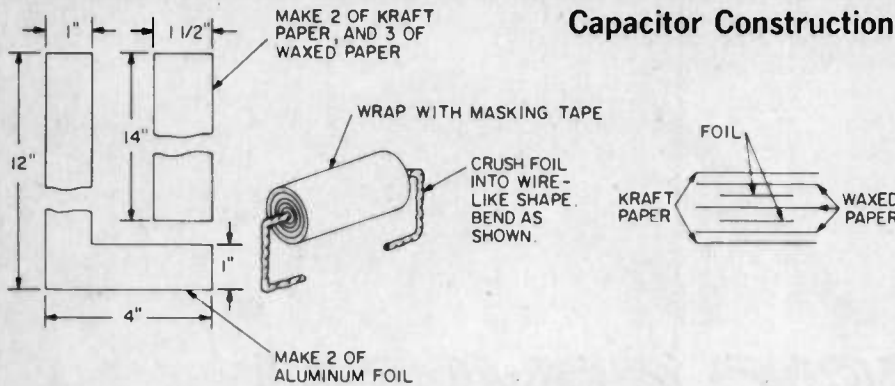

To build the capacitor (C1) cut strips of aluminum foil, kraft paper, and wax paper according to the patterns above. Then interleave the strips as shown above, with the L-shaped ends of foil at opposite ends of the bundle, facing in opposite directions. Bind the edges with masking tape and roll the bundle tightly. Test it with a VOM; if the meter moves and then goes back to infinite resistance then C1 is OK. If not, rebuild C1.

## Parts Placement

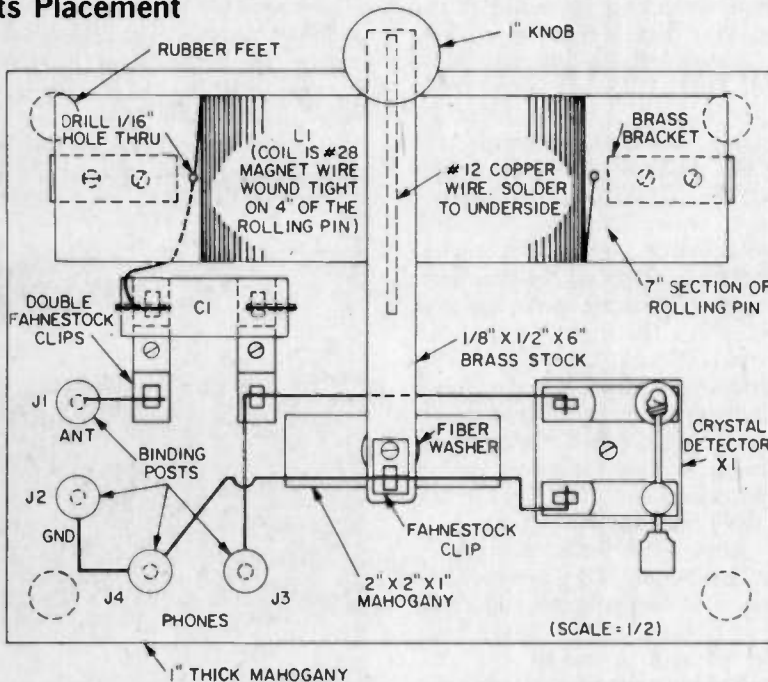

This parts' location diagram shows the relative positions of all the parts. It is drawn to half-scale, so multiply any distance by two to get the full-scale measurements. The wire connections are the bold lines. Wind the coil for four inches along the rolling pin. The non-functional coils on each side of the wiper in the photograph are for decoration.

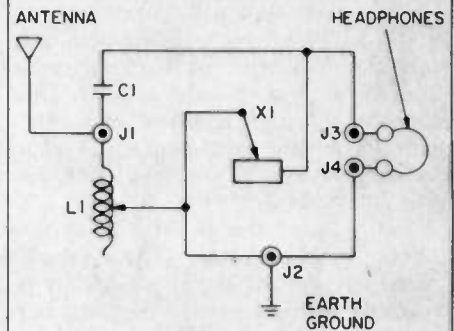

## PARTS LIST FOR CRYSTAL SET REPLICA

- C1—capacitor (see diagram)
- J1, J2, J3, J4—binding posts
- L1—tuning coil (see text and diagram)
- X1—Crystal detector, available from: Johnson Smith Company, 35075 Automation Drive, Mt. Clemens, MI 48043. Order catalog No. 6590. Enclose \$1.95 plus \$0.60 for postage and handling. Allow 3 weeks for delivery.
- Misc.—6 x 8-inch wooden base, 2 x 2 x 1-inch wood slider support block, aluminum foil, wax paper, kraft paper, 150 feet No. 26 coated, copper magnet wire, 3 feet No. 20 copper wire, 3 inches No. 12 copper wire, wooden rolling pin, 2 No. 18 double Fahnestock clips, 1 No. 18 single Fahnestock clip, 1/8 x 1/2 x 6-inch brass strip, fiber washer, rubber feet, wooden knob, two 1 1/2-inch brass "L"-brackets, assorted brass round-head wood screws.

# The Electronic Rain Gauge

by Bob Powers

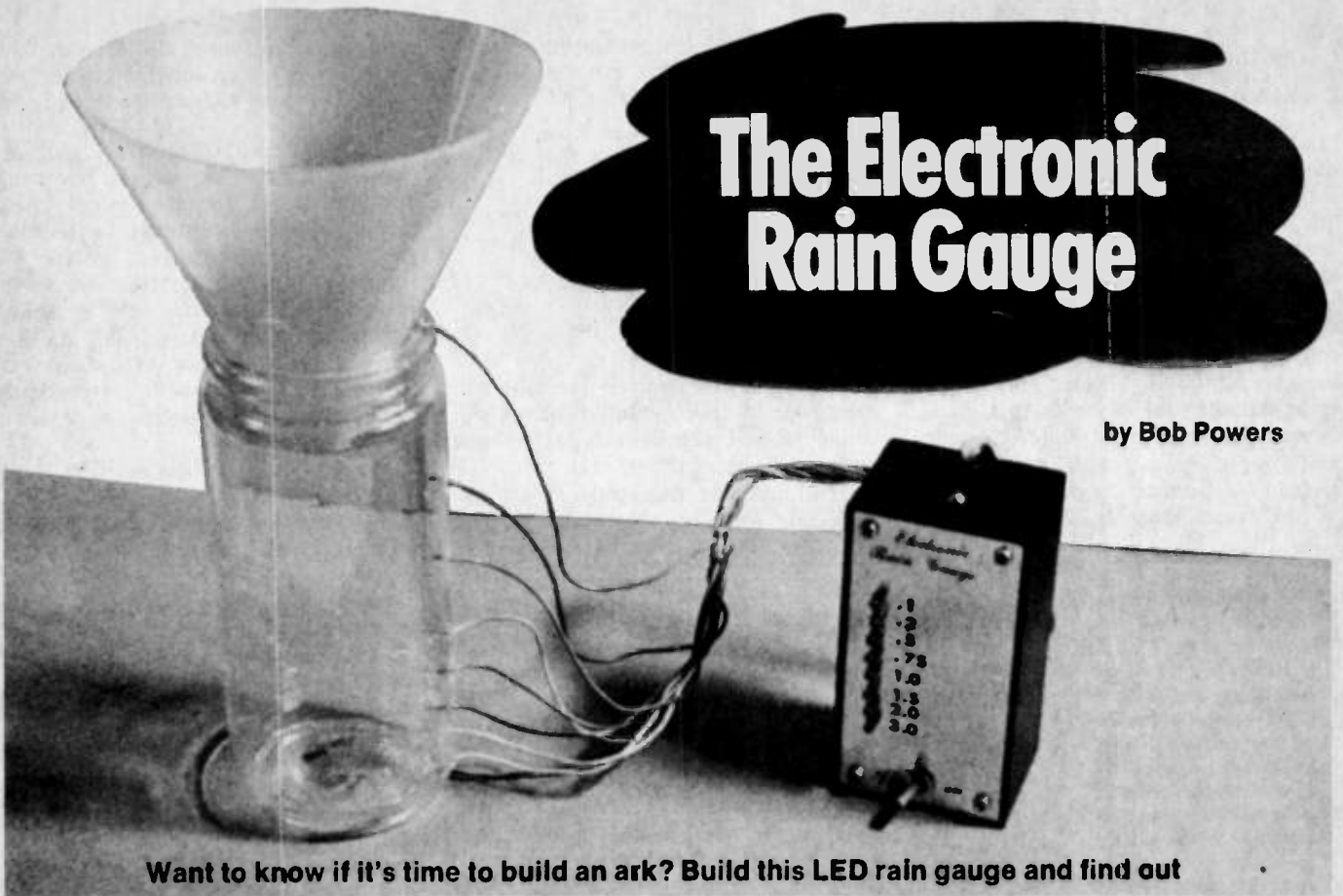

Want to know if it's time to build an ark? Build this LED rain gauge and find out

**W**HO KNOWS HOW MUCH rain has fallen during any period of time? The *Electronic Rain Gauge* knows, and will tell you at a glance! This neat little unit will quickly tell you how much rain has fallen during any period of time, overnight for example. You won't have to wait for some giggly weatherman to tell you the precipitation over a 24-hour period either. *The Electronic Rain Gauge* will tell you with its' eight-LED readout.

Unlike old-fashioned rain gauges assembly is fast. The entire project cost is about \$5 if you shop wisely, and best of all, you won't get soaked while using it either!

**How the System Works.** The project

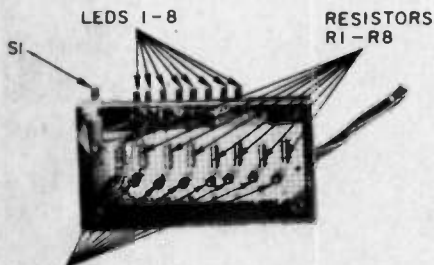

TRANSISTORS Q1-Q8

Construction of the LED raingauge is a snap. Just eight LEDs, eight transistors and eight resistors does the trick. Use perfboard construction and a mini-box, and you can't go wrong. Two AA penlight batteries should last you through a summer of cloudbursts.

consists of two parts: A cabinet that houses all of the circuitry including the LED display, and a water retaining bottle (with a funnel) that will hold the rain to be measured.

A ground wire, mounted on the bottom of the bottle, represents a negative potential that can turn on (bias) each of the transistors, Q1-Q8, through their respective sensing wires. When rain water bridges the gap, the ground wire and, for example, the 0.1 inch sensing wire (connected to the base of Q1) is turned on, and LED1 glows, showing that 0.1 inches of rain has fallen. The resistance of water is very high here, (20,000 to 100,000 ohms typically) but it takes little negative potential to turn each of the eight transistors on.

Note that each sensing wire connects to the base of a transistor, which it controls. The length of the sensing wires can be of any convenient length. For example, you can have the cabinet with the circuitry and LED readout inside of your house, and the water retaining bottle outside for a real custom installation!

**Circuit Assembly.** To house the circuitry, choose a cabinet small enough to make the project compact, yet large enough to house all of the circuitry and LEDs. Since there are few parts, a neat layout on a small piece of perfboard would be your best bet. Point to

point wiring, using short lengths of wire would be best with the perfboard arrangement.

Mount the LEDs on the front of the cabinet where they will be easily visible. If you mount the LEDs on a metal face, make sure that the LED leads do not short on the metal facing. Drill a hole in the top or side of the cabinet large enough to allow the 8 sensing wires and the ground wire to pass through. The sensing wires can be of any gauge, but use solid, not stranded, wire. It would be a good idea to use color coded wire for the sensing wires so you can tell more easily where each wire will go when you install them into the water retaining bottle. The sensing wires can be any length that you wish, but if you use a really appreciable length, then use the thickest gauge of wire practical.

**Rain Collector Setup.** The water retainer bottle will catch rain directed into it and hold it for continuous measurement. You will need to drill eight holes for the sensing wires to go into, at their respective levels. One additional hole, flush with the bottom of the bottle, will also be necessary for the ground wire.

The water retainer can be almost any plastic or metal container but it should have straight sides (the same diameter from top to bottom). You will also

# Rain Gauge

need a funnel to help collect the rain drops. You could use the container just as it is but little rain would get into the relatively small opening and it would be rare that the water depth ever exceeded a small fraction of an inch.

If you use a funnel that is twice the diameter of the container you will collect four inches of water in the tube for every inch that falls. This is because doubling the diameter of a circle increases its area by a factor of four, and four times as much rain is collected. You need to determine the ratio of the funnel area to the area of a

cross-section of the measuring tube.

To do this you can use the attached chart or use the following formula:

$$\left(\frac{\text{Diameter of Funnel}}{\text{Diameter of Tube}}\right)^2 = \text{Height Ratio}$$

For example: a 5.75-inch funnel feeding a 1.66-inch tube would have a height ratio of:

$$\left(\frac{5.75}{1.66}\right)^2 = 11.9983 \text{ or } 12$$

So, 12 inches of water in the tube will equal one inch of rainfall, 6 inches will equal a half-inch and 3 inches will equal a quarter-inch of rain.

Drill holes in the bottle at the appropriate locations. Note that if you

use the same funnel and tube as mentioned above, that tube will need to be three feet long to measure three inches of rain.

Strip at least 1/2-inch of insulation off the ends of the sensing wires and push them through their proper holes so all of the non-insulated wire sticks inside the bottle level with its hole. Put a drop of super glue right where the insulation of each wire butts up against its proper hole. This will hold the wire snug and also prevent water from leaking out. Be careful not to get any of the super glue on the non-insulated part of the wire.

Strip at least 1 1/2-inches of insulation off the ground wire, and install it like the others in its hole at the bottom of the bottle. Make sure it sits flat on the bottom of the bottle.

**Operation.** When the glue is dry on the water retaining bottle, fill it with water to make sure that it doesn't leak. If it's watertight, you can then test the whole system out. If there aren't any dark clouds around to help you, you can fill the bottle slowly with tap water. Run water in slowly and as each sensing wire is submerged, its respective LED should glow.

If no water is in the water retaining bottle, none of the LEDs will glow, and thus no current from the batteries is drawn. Leaving the unit on with the bottle empty does not drain your batteries. So there you have it. You'll be nice and dry whenever the next time arrives that you need to know, or are just curious, how much rain has fallen in the next storm or drizzle.

The numbers up the left side represent the diameter of the funnel in inches and the numbers along the bottom represent the diameter of the retaining tube in inches. A six-inch funnel on a three-inch tube will have a height ratio of 4.0 where four inches of water in the retaining tube would represent one inch of rain. If a one-inch tube had a 12-inch funnel that tube would need to be 144 inches high to measure one inch of rain collection.

DIAMETER OF FUNNEL	12	144	64	36	23.04	16	11.76	9.0
	11	121	53.77	30.25	19.36	13.44	9.88	7.56
	10	100	44.44	25	16	11.1	8.16	6.25
	9	81	36	20.25	12.96	9.0	6.61	5.06
	8	64	28.44	16	10.24	7.111	5.22	4.0
	7	49	21.78	12.25	7.84	5.44	4.0	3.06
	6	36	16	9.0	5.76	4.0	2.94	2.25
	5	25	11.1	6.25	4.0	2.77	2.04	1.56
4	16	7.11	4.0	2.6	1.78	1.3	1.0	
3	9.0	4.0	2.25	1.44	1.0	0.73	0.56	
		1	1.5	2	2.5	3	3.5	4
		DIAMETER OF TUBE						

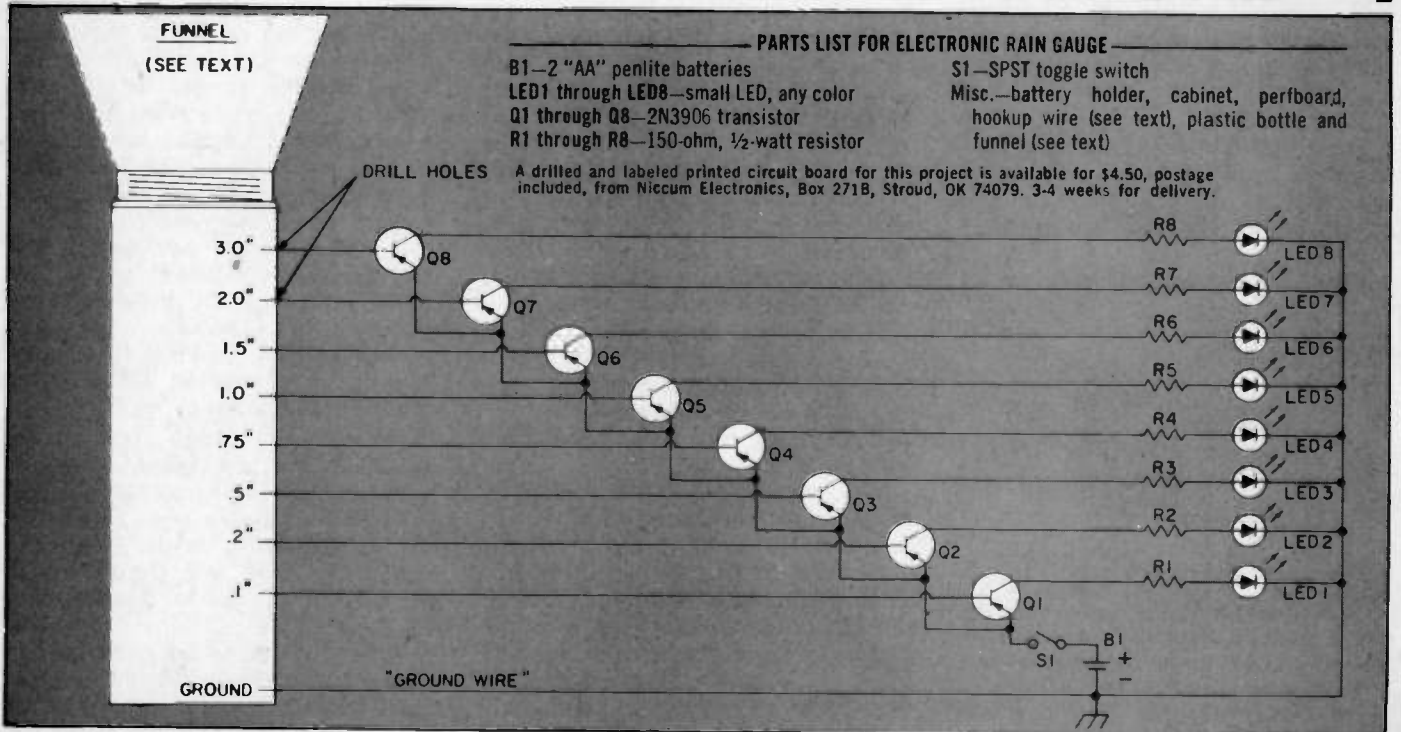

# REMOTE CONTROL

We all know how annoying TV commercials (and some programs) can be. Some times you would love to be able to flick off their loud, abrasive chatter until the show comes back on, but you are watching TV to relax not to jump up and down every ten minutes. With this simple remote control unit you can turn the sound on and off with the blink of a flashlight.

All you do is aim a flashlight at a small box sitting on top of the TV. When the unit receives the first flash of light the sound is turned off and an indicator light comes on (verifying your signal). When you want the sound back another flash of the light and the sound is restored.

There are a number of good reasons for using a flashlight as the transmitter. First, of course, it is simple and inexpensive. Also it allows the receiver to be simple, and hence easy to build and trouble-shoot. Naturally this system requires the operator to have a free line-of-sight to the TV, but a viewer always has that. Further the unit responds to any number of flashlights.

**How It Works.** The circuit operates as follows. The signal light is received by a photo-transistor (P1) recessed behind the front panel. A photo-transistor is a transistor where the base signal is effectively provided by a light source, the brighter the light the more it turns on. In this circuit, the photo-transistor is used as one leg of a voltage divider. When the light strikes P1 the voltage across it drops. This "falling edge" is amplified by Q1 and then used to trigger the monostable multivibrator (IC1).

This device (IC1) is often called a "one shot" because it outputs one pulse of uniform width each time the input goes high or low (depending on how it's connected up). The length of this pulse is set by C2 and R5, in this case about .5 sec. The "one shot" here is acting as a buffer, taking the rough signal from the flashlight and converting it into a nice, clean, clock pulse for the flip-flop (IC2).

The flip-flop is used here as a memory to keep track of whether the TV sound is on or off. One property of the J-K flip-flop is that if both J and K inputs are held high (5v), the output will "toggle" with each clock pulse. In other words if the output is low, it will go high with the first clock pulse and then low again with the next clock etc. This is just the kind of action we need. When the output of IC2 goes high it will turn the sound off and hold it off until it gets another clock pulse. To accomplish this the output of the flip-flop is used to drive the relay con-

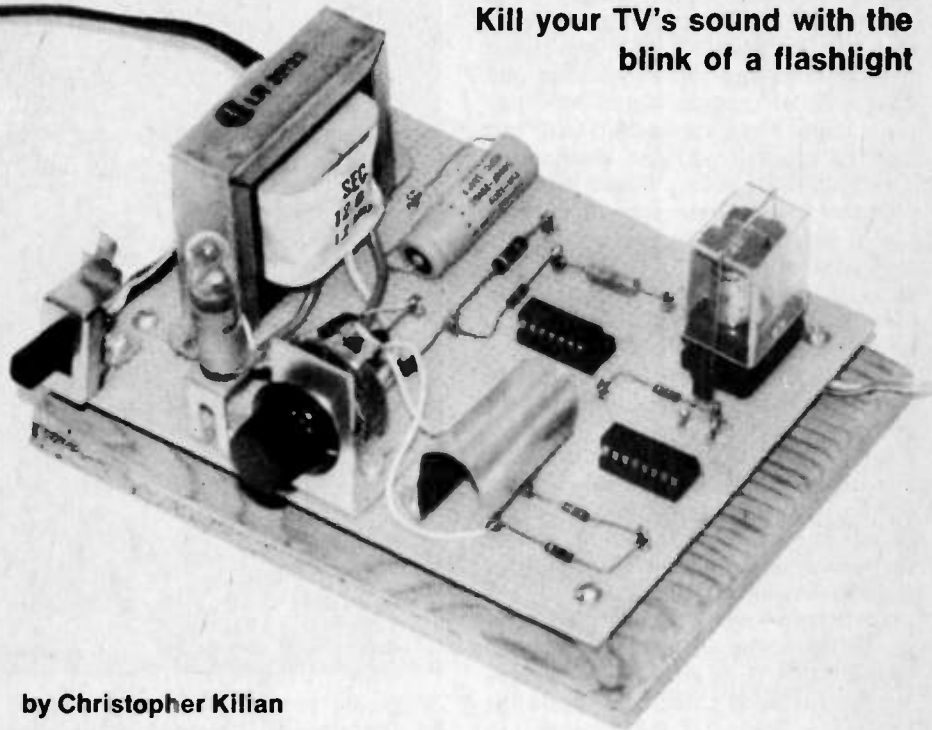

Kill your TV's sound with the blink of a flashlight

by Christopher Kilian

trol transistor Q2. When IC2 goes high, the transistor turns on providing a path for the relay coil current to ground, thus energizing the relay.

Note the diode D3 across the relay coil. This is necessary as it provides a safe path for the built-up energy in the coil to dissipate when the relay is de-energized. Without the diode high voltage spikes occur which quite probably would cause false triggering in other parts of the circuit. The relay performs two functions. The first set of contacts (normally closed) controls the sound by opening the TV speaker circuit. The other set of contacts (normally open) controls the indicator light which is powered by the 12.6 VAC from the transformer. The function of this light is more important than you might think as it gives the operator a positive indication of what state the unit is in. (It's not always obvious from program material.)

The power supply is simple and straightforward. The 110 VAC is run thru a power switch into a 12.6 fla-

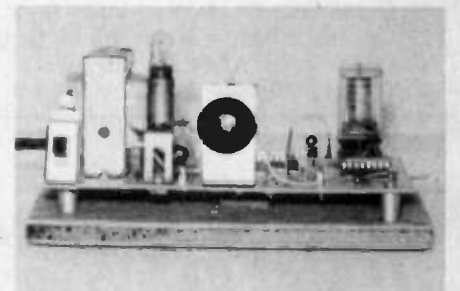

Install a light shield over the photo-transistor so that the unit will not be triggered by anything other than the flashlight beam. Installing the project inside a light proof case with only a small hole in front of the photo-transistor will make the unit even more effective. With a little bit of imagination this controller could be adapted to almost any device you can think of

ment transformer. The 12.6 VAC is rectified by a full-wave rectifier using the center tap with D1 and D2, then smoothed by C1. This unregulated voltage is adequate for the relay coil, but not for the ICs, so the 6-V zener

# REMOTE

is employed to provide a regulated 6-V for these components.

**Construction.** Probably the easiest way to construct the circuit is on a 4½-in. by 6-in. perforated circuit board using push-in terminals for connection points. Start by laying in the transformer, relay and IC sockets. If you use a board with 0.1 in. centers the IC socket pins should stick right through and can be secured with two small screws. Mounting the transformer and relay will, of course, require enlarging some holes. Next, the push-in terminals may be inserted and the components soldered into place. Note that the photo-transistor is mounted directly on top of Q1, facing the front. It should be as far above Q1 as its leads will allow. For a professional looking job turn the board over and solder the interconnecting wires on the backplane.

The circuit can now be mounted in a case using stand-offs. Mount the power switch, potentiometer, and indicator on the front panel. Cut a one-inch hole directly in front of the photo-transistor to allow the flashlight beam in. Finally, it is best to enclose the whole unit to keep ambient light from activating the circuit.

**Installation and Checkout.** To complete the system a simple modification to the TV is required. Unplug the set, remove the back cover, and locate the two wires going to the speaker. As shown in the schematic, cut one of the wires and connect the two leads to a phone jack, which you mount in the side of the case. When the jack is correctly wired the sound will be normal

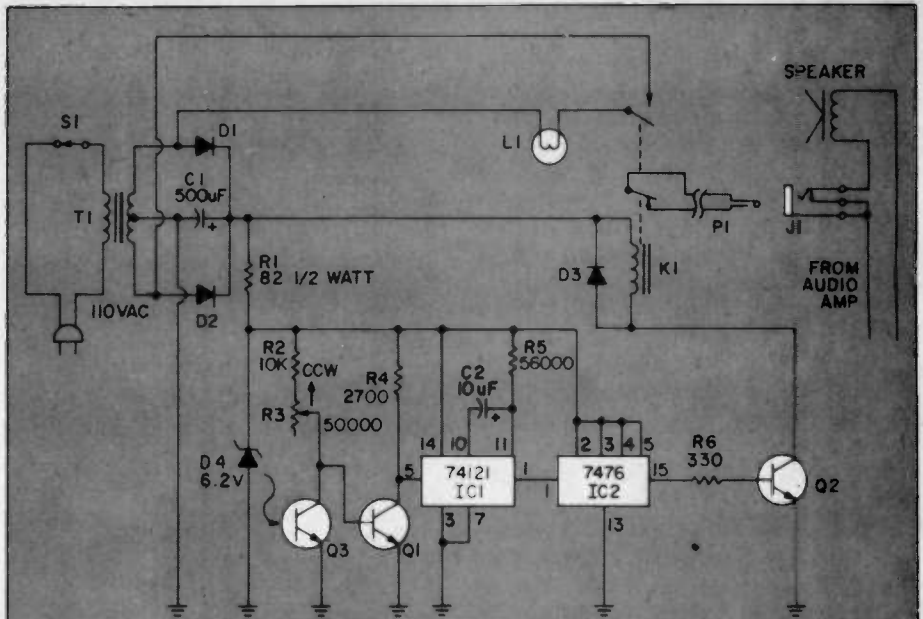

## PARTS LIST FOR REMOTE CONTROLLER

- |  |   |
|--|---|
| C1—500- $\mu$ F, 35-volt electrolytic capacitor              | or equiv.)  |
| C2—10- $\mu$ F, 35-volt electrolytic capacitor               | R1—82-ohm, ½-watt, 10% resistor   |
| D1, D2, D3—1N4003 diode                                      | R2—10,000, ¼-watt, 10% resistor   |
| D4—1N4735, 6.2-volt zener diode                              | R3—50,000-ohm, potentiometer  |
| IC1—74121 monostable multivibrator                           | R4—2,700-ohm, ¼-watt, 10% resistor  |
| IC2—7476 dual JK master/slave flip-flop                      | R5—56,000-ohm, ¼-watt, 10% resistor   |
| J1—closed circuit jack (Radio Shack 274-292, or equiv.)      | R6—330-ohm, ¼-watt, 10% resistor  |
| K1—12-volt DPDT relay  | S1—SPST switch  |
| L1—lamp assembly and 12-volt bulb                            | T1—12.6-volt center tap filament transformer  |
| P1—matching plug for jack J1 (Radio Shack 274-289 or equiv.) | Misc.—one 16-pin and one 14 pin IC socket, 4½-in. by 6-in. perfboard, cabinet, nuts, bolts, spacers, perfboard push-in terminals, sheet metal, knob, power cord, etc. |
| Q1, Q2—2N3904 transistor                                     |   |
| Q3—photo-transistor (Radio Shack 276-130                     |   |

when the control unit is not plugged in. But when it is plugged in the relay must be closed to complete the sound circuit.

Once the system is operational, some adjustment of the sensitivity potentiometer is necessary. Have someone op-

erate the flashlight from the viewing area while you adjust the pot. Find the point where the unit responds to the flashlight but not to room lights etc. Now sit back, knowing you have at least some power over Madison Avenue. ■

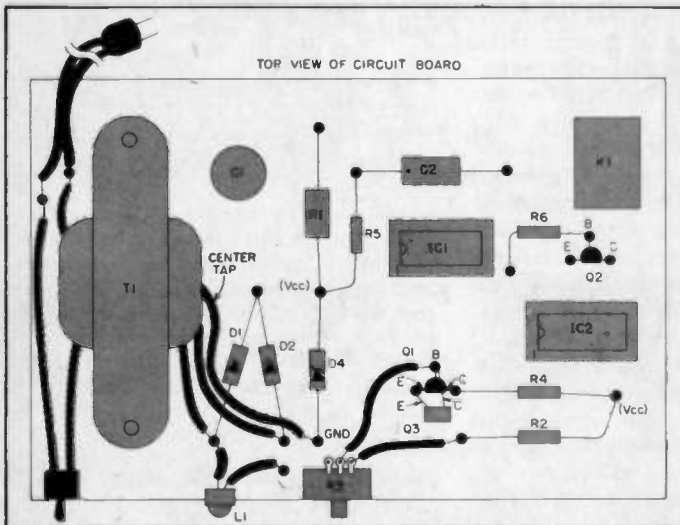

This top view of the circuit board shows how the photo transistor is mounted directly on transistor Q1's base and emitter leads.

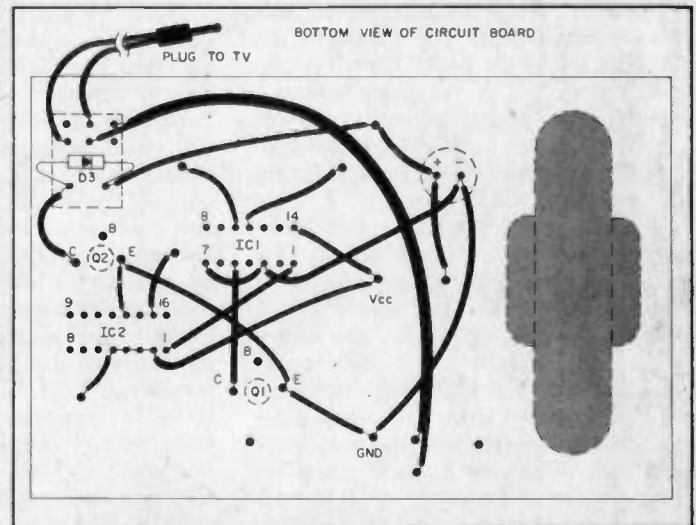

Point to point wiring and perfboard construction make this project a snap to put together. Take care hooking up the relay.



# RESTORING ANTIQUE RADIOS

by James A. Fred

Put that flea-market eyesore back in showroom shape

**S**OME TIME AGO I wrote a story for BUDGET ELECTRONICS telling where to find, how to buy, and how to sell old radios. Since then many readers have written to me asking just exactly how to go about restoring an old radio. There are several levels of restoration, and while one collector will be happy just to have his radio play many others want the set to look and play like it did the day it was shipped from the factory. In this story I will tell you how to refinish the cabinet and restore the radio to playing condition. If you want to stop at any point along the way that is your privilege.

**Break It Down.** First you must find a radio. The one I show you in this story is a five-tube Airline, (Montgomery Ward) wooden cabinet, table model, made around 1935. It cost \$1.50 at a farm auction. It did not play, but for this price I didn't expect it too.

The first thing to do is to remove the knobs, dial escutcheon, the back if it has one, and remove the chassis from the cabinet. The speaker may be fastened to the front panel or it may be chassis mounted. Remove the chassis, speaker, and any other item that may be attached to the cabinet. In-



This is how the radio looked before restoration. It is in quite good condition and the veneer is intact. If the radio you want to restore is badly damaged and the case is broken you might consult a book on restoring antique furniture for repair techniques.

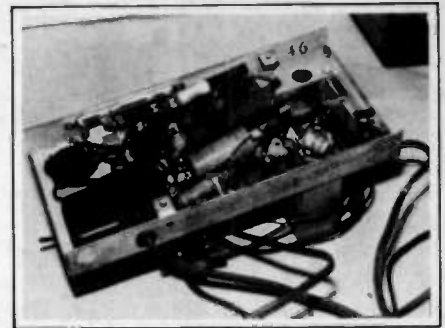

The chassis was in surprisingly good shape and all I had to do was replace the cracked line cord, a filter capacitor and all of the tubular capacitors (see text for details).

spect the speaker grill cloth and if it is so badly damaged that it will spoil the appearance of the restored radio throw it away. Set the chassis aside and restore the cabinet first.

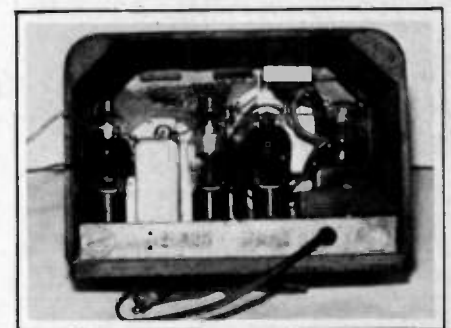

This is how the chassis looks now that the repairs and replacements have been made. Get out all the old spiderwebs and dust. Give the tubes a good wash, make sure they are dry before you fire up the old rig.

**Scrub It Down.** The cabinet should first be washed with a damp cloth and a mild detergent. Do not soak the cabinet, just scrub it, and rinse it. You will be surprised at the improvement

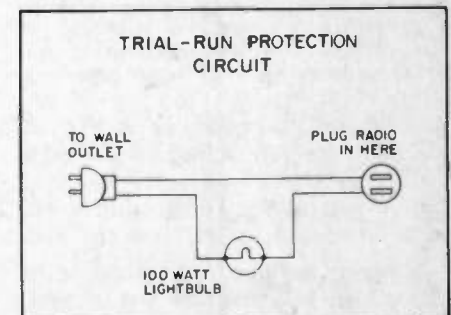

This circuit can keep your first trial-run from being a disaster, by protecting the radio from faulty transformer or capacitor.

this will make. If there are grooves cut through the veneer for decoration clean them with an old tooth brush. After the cabinet is clean look for scratches, cigarette burns, white rings left by wet glasses or other defects in the finish. If there are only a few scratches these can be touched up with stain, and a

# RADIO RESTORING

small brush, even iodine will cover scratches in some wood. You can also find color sticks in lumber yards to match the cabinet color. If you have a can of brown paste shoe polish you can touch up the cabinet and give it a wax job all at the same time. If you have never tried shoe polish, don't knock it. You can also buy colored Simoniz wax or perhaps you know of other products



There are lots of old plastic radios available at junk shops and flea markets throughout country. This was bought for \$1.50.

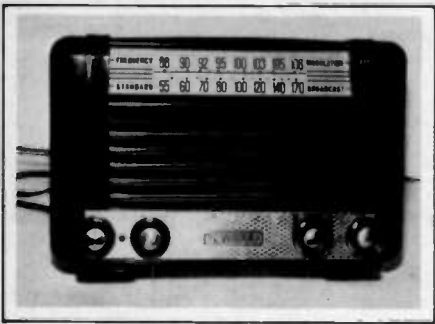

After washing cleaning and polishing the cabinet looks just like new, and it will fit in with the rest of your collection.

that will do a good job. After you touch up the scratches give the cabinet a good coat of paste wax and buff it with a soft cloth. This treatment will restore many of the cabinets you find.

**Stripping the Wood.** Now suppose the damage is worse than you first thought. You may want to do a complete refinishing job. The original finish usually consisted of a coat of shading stain and one or two coats of clear lacquer. If you want the natural color of the wood to come through you must remove the finish down to the bare wood. Always follow the directions on the can of paint stripper you are using. To remove the finish on our cabinet we used Treadway's Paint and Varnish Remover. You can purchase a complete Treadway's refinishing kit for \$9.95. It

includes remover, Tung oil finish, steel wool, brass brush, and instructions for use. Pour some of the remover into a bowl and dip the steel wool supplied into the remover. Now rub with the steel wool and the finish will begin to come off the cabinet. After the cabinet is stripped and washed clean sand it lightly with No. 220 Garnet paper or extra fine sandpaper. Wipe the cabinet with a tack rag to remove all traces of dust.

Now you are ready to put a new finish on the cabinet. You can use the Tung oil that comes with the Treadway

ventilated.

If the speaker grill cloth was ruined shop the fabric stores and Hi-Fi shops for a suitable replacement. Install the cloth in the cabinet, replace the speaker, and put back the escutcheon. Now you are ready to restore the radio electrically.

**Getting It Working.** About the first thing to do is to remove the tubes and clean out all the dust, dirt, and mice corrosion. A small air compressor is handy to blow out dust and dirt. If there is rust or corrosion on the chassis or other metal parts a small brass or

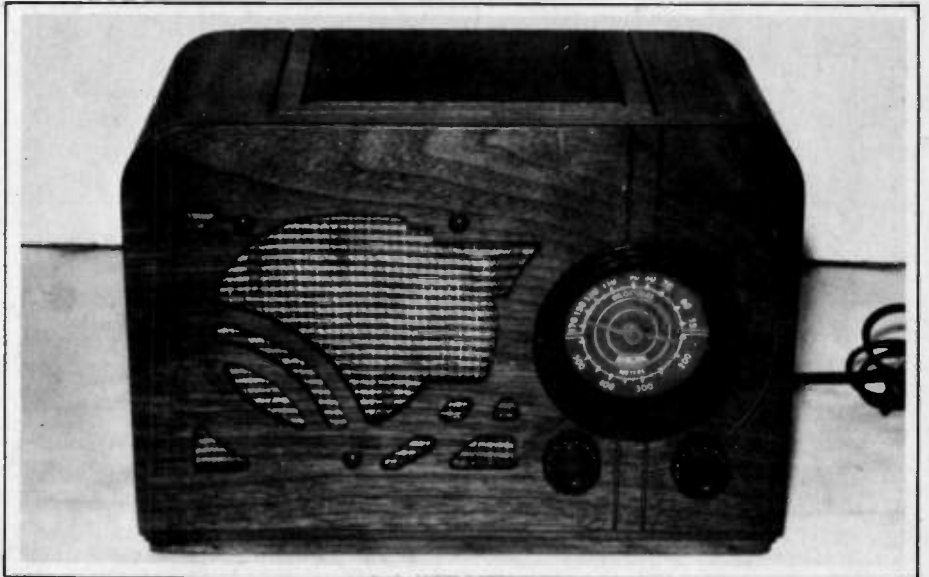

The finished product will be the pride of your showcase. With a like-new finish on the wood, a new speaker grill and a cleaned-up dial face its value is greatly increased.

## APPENDIX

Plastic cleaner and polish, small wire brushes, glass cutter and tools; Brookstone, 127 Vose Farm Road, Peterborough, NH, 03458.

Small brushes and tools; Consumers Bargain Corp., 109 Wheeler Ave., Pleasantville, NY 10570.

Tubes, parts and schematic drawings; Antique Radio Parts, P.O. Box 42,

Rossville, IN 46920. Also Puett Electronics, P.O. Box 28572, Dallas, TX 75228.

Power Supplies for old battery radios; G. B. Schneider, 6848 Commonwealth Blvd., Parma Heights, OH 44130.

Treadway's Paint and Varnish Remover; Treadway's Refinishing Products, P.O. Box 1, Lima, OH 45802.

kit or if you prefer a varnish finish you can put on several coats of your favorite varnish. If you are a highly-skilled refinisher you may spray on several coats of lacquer. If you want the cabinet to be a different color than the bare wood you must first stain it. There are many kinds of stain available, but I prefer a non-grain raising stain because it minimizes sanding. If the weather is warm work outside in a spot sheltered from the wind and sun. If you must work inside be sure the area is well

stainless steel wire brush is useful in removing it. A hand held motor tool with a round wire brush will also do a good job. You may want to paint the metal parts with chrome or aluminum paint to hide the damage. After the chassis is clean pay special attention to the line cord. If it has hardened, broken, frayed, or in any way is unsafe replace it. If the set is very old, i.e., made before 1930, it probably had a silk covered line cord. Most electric

(Continued on page 113)



# PITCH FIX

Salvage those old tape recordings with these low-cost tape-speed controllers

by Jorma Hyypia

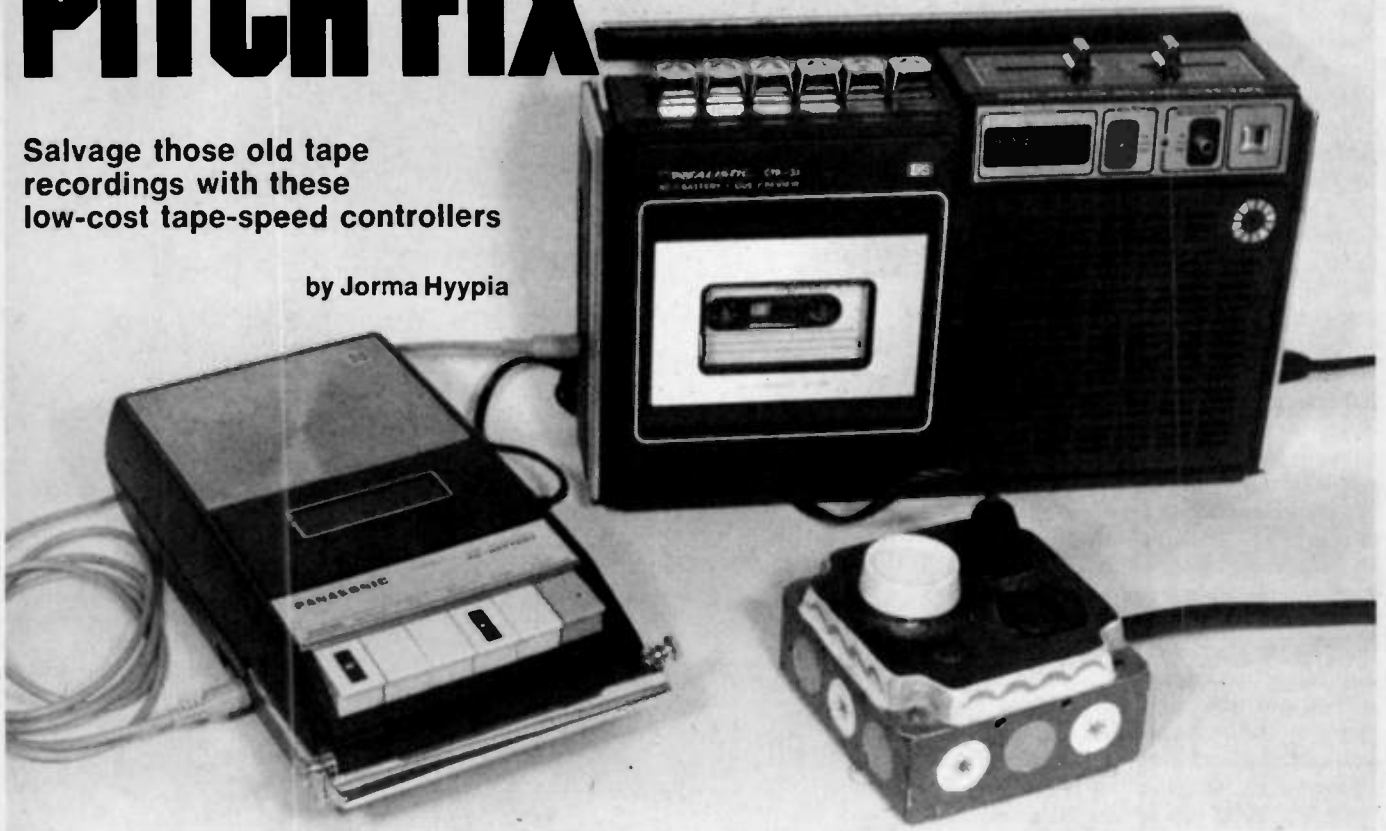

IT SOUNDS CRAZY, but you actually need *cheap* tape recording equipment to perform these interesting variable tape speed sound experiments. If you pride yourself on owning only the very best hi-fi tape equipment, disguise yourself and sneak into the local thrift shop to look around for a cheapy portable recorder that is in operable condition.

The tape tricks discussed in this article evolved from attempts to salvage a collection of unlistenable tapes recorded during a cross-country family camping trip some fifteen years ago. The original reel-to-reel portable recorder used during the trip suffered from extreme tape speed instability; my then eight-year-old son sounded like a basso profundo while my spouse came through like a neurotic chipmunk. The objective was to re-record the tapes while compensating for the errors in tape speed in order to recapture more natural voices and sound effects.

In addition to salvaging old tapes, the methods described here can be used to perform many entertaining and educational experiments involving *continuously* variable tape speed. One example: use a microphone to record insect sounds like cricket chirps, then play back at slower speeds to hear the inter-

esting sound patterns that human ears cannot decipher under normal conditions.

**The Good Pitch.** My old monaural tapes could be played back on our stereo deck by killing sound on one channel. But there seemed no way to vary the tape speed to compensate for the gosh awful sound except, perhaps, by building relatively complicated pulse- or frequency-varying circuitry to change the tape drive motor speed. As it turned out, there was a far simpler solution.

Unlike AC tape drive motors used in hi-fi equipment, the small DC motors in *some* inexpensive portable tape recorders can be controlled by means of voltage reduction. If you have a relatively good, portable recorder, it may have voltage regulating circuitry that will defeat what we are trying to do. What you need is an inexpensive recorder that does not have such regulation.

If the owner's manual that came with your recorder warns that weak batteries will affect tape speed, you are probably in business. There is a simple test you can make to be sure. Load the dry cells into the recorder and make sure the machine plays back the recorded tape in a normal fashion. Then

remove only *one* dry cell and use a short piece of wire to bridge the break in the battery circuit. If the recorder plays back at a slower speed, as evidenced by pitch reduction in the sound, your recorder is right for the job. If there is no change in sound quality, your recorder has voltage regulation and is unsuitable for this application.

To provide tape speed control when the recorder is powered by batteries, you need only remove the batteries and form them into an external pack so that you can add a suitable rheostat in series for voltage control. You may have trouble finding a rheostat having a maximum resistance of only 20 to 30 ohms. But not to worry! Make a liquid rheostat by suspending two clean, large nails (spikes) in a tumbler of water in which about a quarter teaspoon of table salt has been dissolved. Connect one lead from the battery pack to a nail, the other to the appropriate recorder battery terminal (watch polarity!); use another lead to connect the second nail to the other battery terminal in the recorder. Now dunk the nails in the salt solution and control the recorder tape speed by simply varying the distance between the two nails.

If your recorder can also be operated off 110-volts AC, and you plan more

# PITCH FIX

than casual experimentation, you can control the power input by means of a Variac or other suitable variable transformer. You can make your own control unit by mounting an ordinary light dimmer and duplex receptacle in a covered junction box as shown. Play it safe by using a three-conductor lead terminating in a grounding plug. You can use the dimmer unit to also control the intensity of table lamps, but don't try to slow down AC motors with it.

Make some preliminary tests to determine just how much you can slow down the tape speed while still getting enough juice through the circuitry to put a strong signal on the tape. Watch the take-up spool at very low speeds. If the take-up stalls while the capstan keeps pushing tape, you'll get a mess of tape wound around the capstan. It's no tragedy if you spot it soon enough; just disentangle the tape gently and manually roll it back into the cassette.

You can now play pre-recorded cassettes at slower than normal speeds. If you want speeded-up play, you must re-record the sound using the modified recorder set to run at less than normal tape speed, then play back at a faster tape speed.

**Super Salvaging.** If you have old tapes that exhibit off-pitch sounds, chances are that the original equipment had a too-slow tape speed because of weak batteries. Playing such tapes at normal speed raises the pitch to unnatural levels. Here's how to correct such tapes.

If the original material is on cassette tape, just play back with the speed-

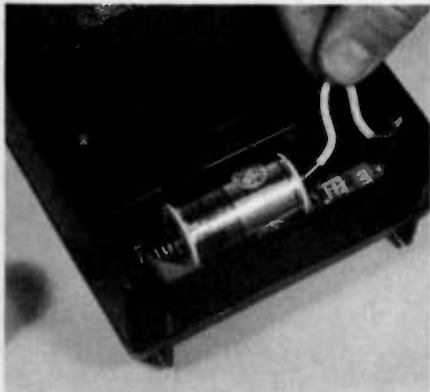

You need a recorder without an automatic voltage regulation circuit. Test for this by removing one of the dry cells and then bridging the gap with a piece of wire. If tape speed is slowed, you know you will be able to control the voltage by rheostat.

If you can find a rheostat with a maximum resistance 20 to 30-ohms, that will make a handy speed control for a recorder which is powered by dry cell batteries.

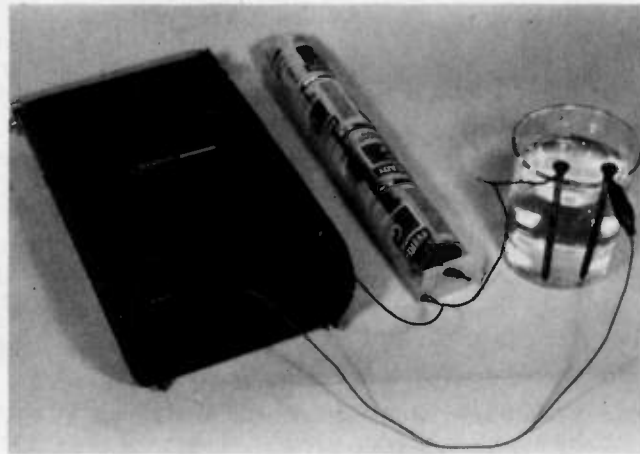
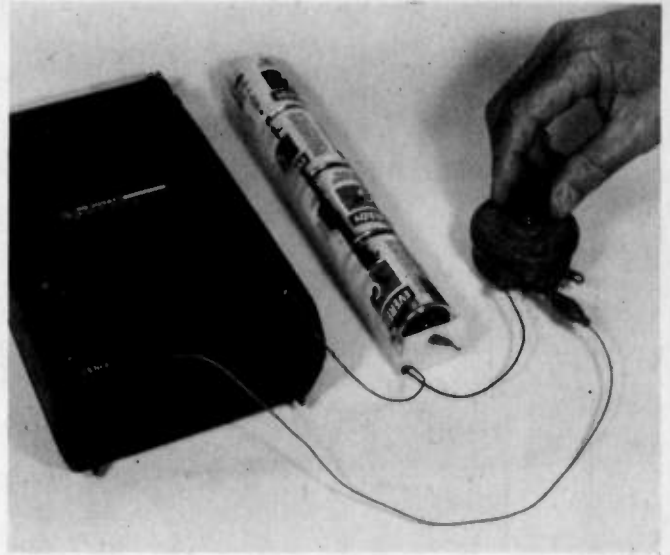

If you can't find a rheostat, make a liquid one. Suspend two large nails in a salt solution. You will be able to change voltage by varying the distance between the two metal nails.

controlled machine while re-recording with a second tape deck operating at normal speed. You obviously need to monitor the playback signal to properly adjust the playback during the re-recording process.

If the original material is on open reel tapes (as in my case), you must first make an exact duplicate on cassette tape without attempting any corrections. Then play the cassette duplicate at slower speed while re-recording the output with another machine operating at normal speed.

Here's one more tip to simplify the salvaging of tapes that exhibit off-pitch sounds only at intermittent intervals. When the sound is normal, operate both the playback and second tape recorder at normal speeds. When you notice that the pitch is changing, do *not* immediately stop the playback; instead, adjust the rheostat to obtain natural sound through your monitor speaker. Then back up both recorders to the point where the sound went sour and continue the transcription procedure using the adjusted tape speed until re-adjustment is once again required. ■



A light dimmer connected to a duplex receptacle, in a junction box, can be convenient voltage controller when the recorder is powered with 110-volt AC. Note grounding plug on three-conductor cord.

# What's so hard about building a Heathkit product?

nothing!

JUST PICK A KIT... ANY KIT  
Whether you're a beginner or an experienced kit builder, you'll find it's easier than you'd dreamed!

STEP-BY-STEP, CHECKING AS YOU GO — you can't go wrong when you do one step at a time and check your work!

GET STARTED

ALL THE PARTS ARE INCLUDED — even solder — so all you need are a soldering iron, wire cutter, pliers and a screwdriver!

THE EASY-TO-FOLLOW INSTRUCTIONS even show you how to solder perfect connections!

ALL FINISHED

ONE LAST CHECK that all the connections are made right, and you're ready to turn it on...

IT WORKS

AND TO THINK YOU BUILT IT YOURSELF! It's a great feeling. You saved money — you enjoyed it — and you ended up with a great, hand-crafted product!

You can start right now...fill in the coupon and mail it today!

Read about nearly 400 money-saving, easy-to-build electronic kits — stereo, color TV, clocks and weather instruments, auto and aircraft accessories, Amateur Radio Equipment, Personal Computer Systems and much more! Simply remove the card along the perforated line, fill in and mail today.



HEATH  
Schlumberger

Heath Company, Dept. 312-570  
Benton Harbor, MI 49022

Please send me my FREE Heathkit Catalog.  
I am not now receiving your catalogs.

Name \_\_\_\_\_

Address \_\_\_\_\_

City \_\_\_\_\_ State \_\_\_\_\_

CL-705 Zip \_\_\_\_\_

CIRCLE 1 ON READER SERVICE COUPON

**FREE**  
**HEATHKIT®**  
**CATALOG**

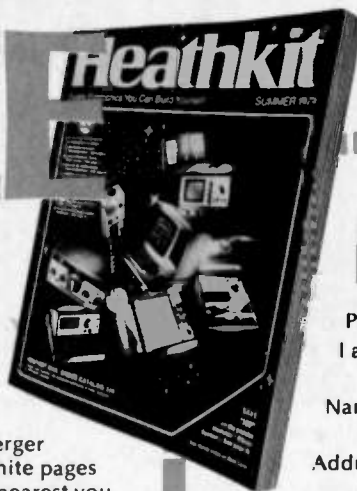

Heathkit products are displayed, sold and serviced fast-to-coast at Heathkit Electronic Centers (Units of Schlumberger Products Corporation). See the white pages in your phone book for the store nearest you.

If coupon is missing, write:  
Heath Company, Dept. 312-570  
Benton Harbor, MI 49022

**A**s with all types of electronic equipment these days, car stereo, or car-fi as it is now popularly called, as well as having become better and more sophisticated, is equally more complex. As a result, when they require some sort of repair, or, for that matter, even routine maintenance, many owners are finding it necessary to take them to the local service shop. With bench labor prices at a premium these days, a little do-it-yourself consumerism seems appropriate. While we are not advocating that you undertake major surgery on your unit, we feel that with a little knowledge (and some guts) you can apply routine maintenance to your tape player, and hopefully forestall larger labor costs later, as well as some smaller ones right now.

Of course, it is impossible to prescribe the specific remedies and maintenance courses for each and every

tape player on today's market. There are literally thousands of types! Below, you will find seven general tips that will apply to almost all conventional makes of cassette players. Don't be scared to unscrew the lid of your unit and have a look inside. It is highly unlikely that you can do any damage simply by looking. In many cases, the problem(s) will be evident immediately from a cursory inspection, and even if you feel that the task of repair is beyond your individual capabilities, at least you will be aware of what areas are affected by the malfunction, and what to look for on the repair bill. Hopefully, you won't be sold a bill of goods. If indeed you choose to take your cassette player to a shop for repair, don't ever be ashamed to ask for the return of all defective parts. If the bill doesn't make sense to you, ask questions! Remember, it's your money, and your music!

by Homer Davidson

# 7 STEPS TO AUTOMOBILE CASSETTE REPAIR

**I**t is absolutely essential that the tape head be kept clean for maximum performance. The gaps on the pickup surface are very small, and only the smallest amount of oxide from the tape surface will impair the sound quality if it is not removed from the head regularly. The symptoms of a dirty head are: Loss of high frequency sound, loss of volume, distortion, or loss of one or both channels entirely.

While some manufacturers of cassette tape have provided head-cleaning leaders on the beginning and end of each tape (such as Maxell), we suggest regular maintenance with a cotton swab and Freon or denatured alcohol. In cleaning the head, beware of getting the cleaning solution on any of the pinch rollers or plastic tape guides. Some cleaning fluids have the nasty habit of eating away at the synthetic materials used to make the rollers and guides. The guides and pinch roller surfaces may be effectively cleansed with solutions made specifically for the purpose. In many cases,

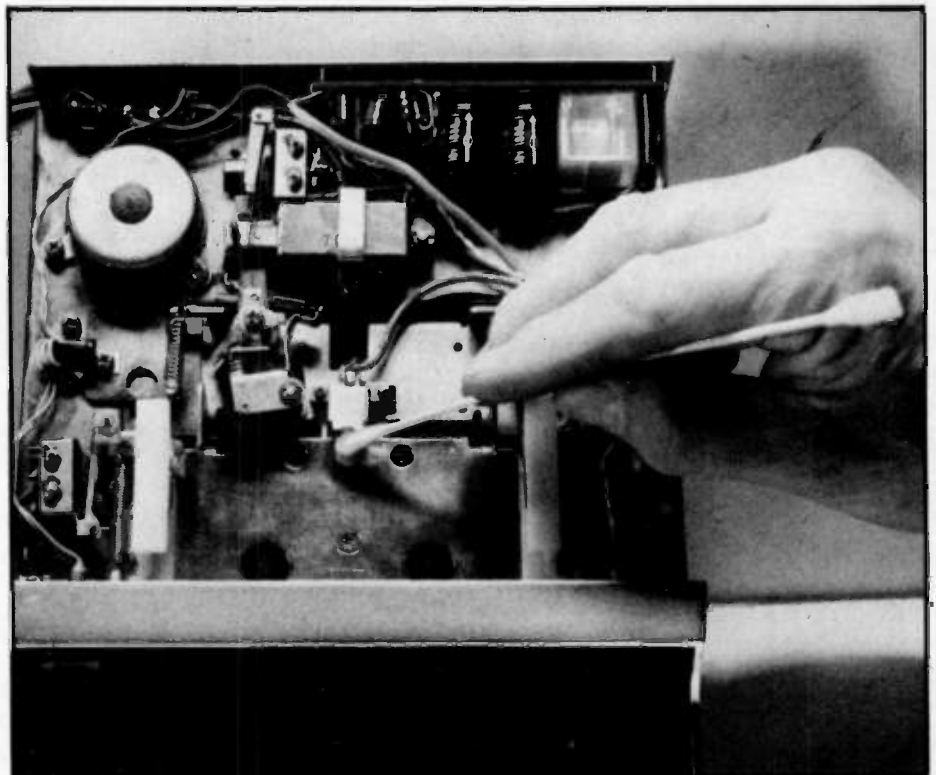

the owner's manual for your particular unit may recommend a particular brand or type of cleaner, and it is always safe to follow their recommendations.

Never use a pointed instrument, such as a pencil, to clean any surface—particularly the head—inside the machine, as even the slightest scratch on the head surface will damage tapes.

**2** Probably the worst problem with any tape player is when the tape drive develops an appetite for your tapes, and "eats" them.

This condition is usually caused by improper, or lack of, operation on the part of the takeup spindle. The takeup spindle is driven from the motor by

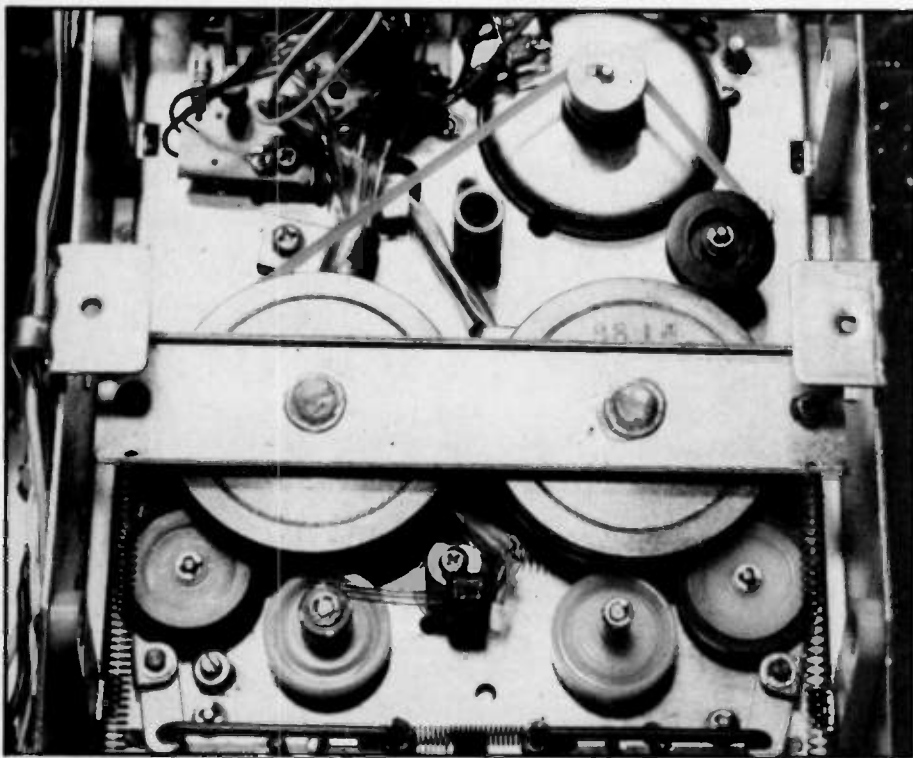

means of a separate belt and pulley system, and the same troubleshooting procedures used for the main tape drive (as described later) apply here. Check for loose or worn belts, or a binding pulley at the takeup spindle. With the belt to the spindle disconnected, turn the spindle by hand to make sure that it's moving freely.

Also, make sure that the pinch roller is making firm contact with the capstan, thereby pulling the tape from the cassette and feeding it to the takeup. Because the pinch roller is backed off from the capstan during rewind or fast forward operation, it is always possible that, over a period of extended use, the arm on which the pinch roller rides may have become bent, thereby not allowing the roller to come into firm contact with the capstan, and allowing the tape to feed out of the cassette with nowhere to go, even with the takeup spindle functioning normally. This can happen because the takeup spindle operates with very little torque to avoid stretching the tape between it and the pinch-roller/capstan.

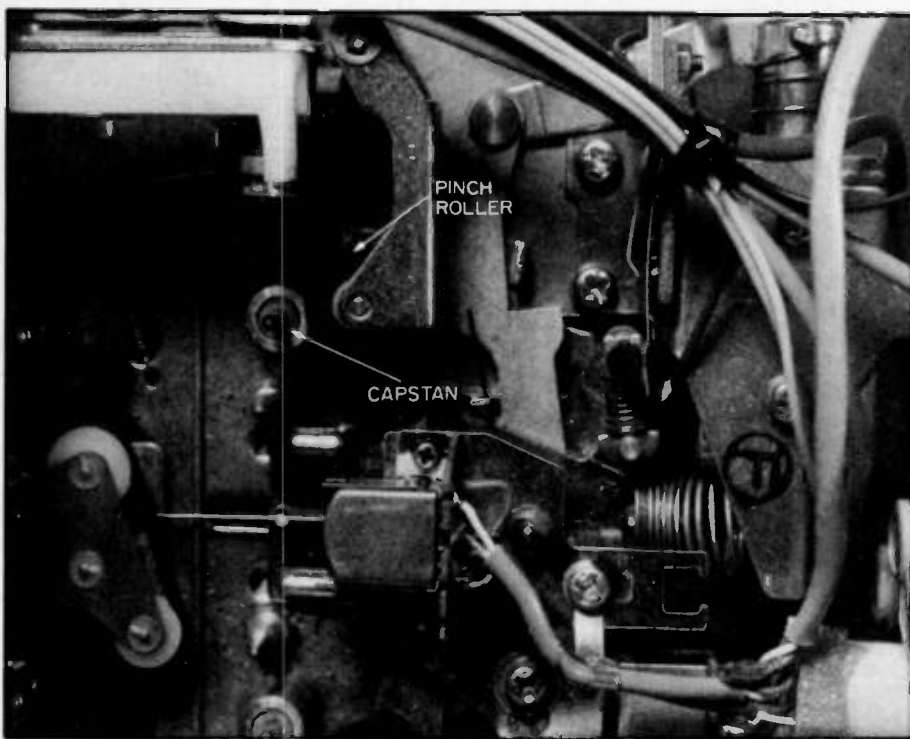

irreplaceable material on it, then the best thing to do is to play the tape back on a high quality home deck with dual capstan drive (these drives have more muscle to them, and can often alleviate the wow and flutter) and record it onto another, and hopefully higher-quality tape, on another machine.

If, however, the source of the problem is not in the tape(s), then you should strongly suspect the pinch roller. These are usually made of neoprene, and, as a result, have a somewhat lower resistance to dirt, grease, and oxide buildup than natural rubber, while being generally more resistant to wear.

The first step is to visually examine the roller for sign of dents, divots, and chipping. If any surface irregularity is apparent, including loss of roundness, then discard the roller and get a new one. If no irregularities appear, then a thorough cleansing of the surface is in order, even if no grime is visible.

If these procedures don't eliminate the problem, then go through all of the troubleshooting procedures we've outlined elsewhere for the tape drive, beginning with the motor, and working your way up to the capstan and pinch roller. Sometimes a slipping drive belt can cause wow and flutter as well as a bad pinch roller.

**3** Erratic tape speed, that is, the slowing down and speeding up of the tape at random, can usually be attributed to two factors: Defective tape, or a worn pinch roller. As we mentioned earlier, many inex-

pensive brands of tape lack the internal guides necessary for smooth winding of the tape, and, as a result, often produce irregularities in the playback. There is not much that can be done to remedy this. If the tape has

## CASSETTE REPAIR

**4** Stoppage of tape movement may be caused by any one of several components within the machine, and it is best to eliminate each one in order to save time on your troubleshooting and repairs.

The first thing to check is the fuse. If the fuse is shorted, this indicates a short circuit either in the wiring of the power leads to the tape deck or in the motor itself. Eliminate the external wiring as the problem first, as this is usually the source in nine out of ten cases.

Next, examine the wiring from the automatic start switch to the motor. Make sure that power is getting to the switch from the main power line of the tape player. Then, either by inserting a cassette or by closing the start switch manually, check to see that power is getting to the motor terminals. If power is being fed to the motor and it still will not turn, move the drive wheel that is attached directly to the end of the motor's shaft to insure that it is not jamming the motor. If it turns easily, then you can



**5** Tape drag, as opposed to complete tape stoppage, may be one of the hardest problems to diagnose because it's not absolute. If the tape is not moving at all, you can usually find something jammed or broken to account for it. With tape drag, the examination must be more precise and painstaking.

The first thing to examine is the drive belt which runs from the motor pulley to the flywheel or, if the flywheel is attached directly to the motor, from the motor/flywheel to the capstan. If the belt appears to be worn, replace it. If there is a shiny band on the flywheel, this is an indication that the belt is slipping and it should be replaced immediately. If you cannot obtain a direct replacement belt from the manufacturer, there are several kits available which allow you to custom-make a belt to the size needed.

If the belt is tight and in good condition, examine the capstan pulley, with the belt removed, to see if it is binding. If it is, first try lubrication with a bit of powdered graphite. If this method does not succeed, remove the pulley from the spindle and rub down the spindle with fine emery cloth. The capstan itself may be mounted on a spindle, and it will be necessary to

be certain that it's time to hunt up a new motor.

Should you discover that the motor is operating, but not moving the tape, visually inspect the drive system of belts and pulleys to see if any one of them is not moving with its drive belt, that is if the drive belt is moving, but the pulley it wraps around is not, or vice versa.

Frozen pulleys usually have to be

separated from their mounting spindles and, if they will not turn freely after cleaning and light lubrication of the contact surfaces, the spindle may have to be narrowed by rubbing with fine emery cloth to remove the built-up effects of metallic oxidation and/or warping due to heat. The lack of regular (annual) lubrication on these pulley contact surfaces increases friction which can warp the spindle.

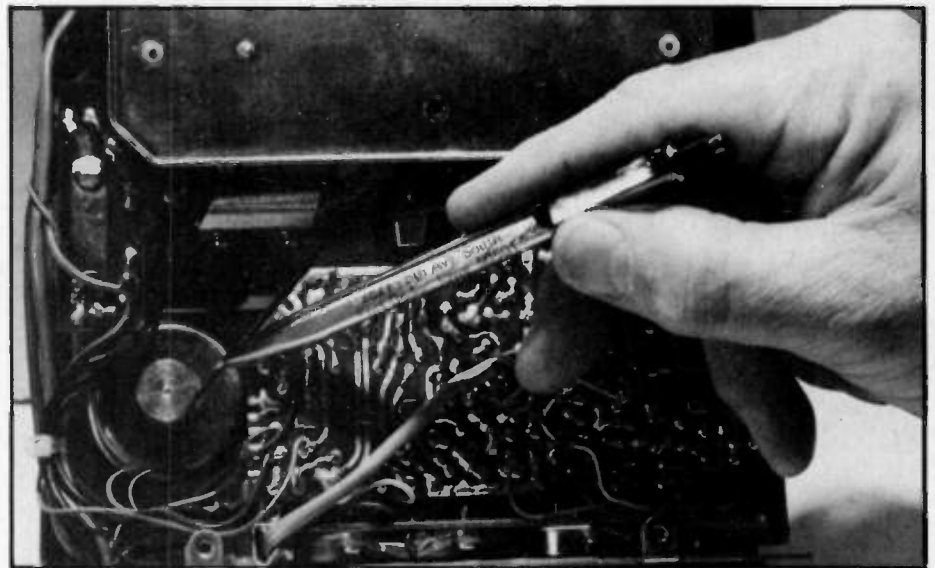
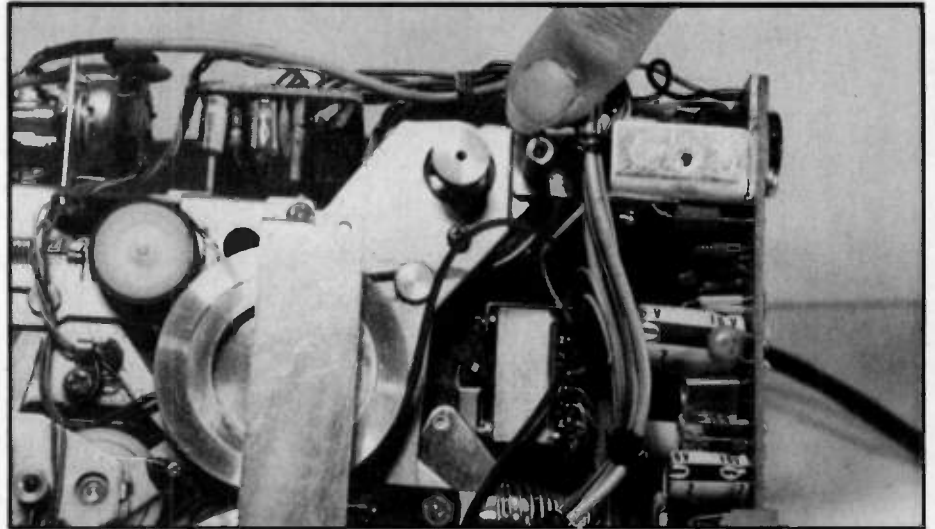

check its freedom of movement and apply the above procedure to it if it is found to be the source of excessive friction.

Remember, that if your machine has "eaten" a tape, there is likely to be some tape wrapped around the capstan. If this tape gets caught between the spindle and the capstan, it will serve to bind up the capstan, thus producing drag. As a general maintenance rule, if a tape gets eaten, you should open up the machine as soon as is

conveniently possible to remove the debris. Delaying this increases the chances of dragging or jamming, and the jamming always occurs when you least want it to happen.

Remember, that the less expensive the tape, the more likely the chance that the cassette itself may have a high level of drag built into it, due to the lack of internal tape guides, or to the lack of a lubricating compound in the base material of the tape. You get what you pay for in cassette tapes.

**6** Unfortunately, not all problems in your tape player are mechanical in nature. Even though today's electronic technology is vastly superior in terms of durability compared to that of even a few years ago, you may find yourself in the position of being minus one channel even with a clean head and proper tape alignment. In a case such as this, unless you have sufficient knowledge to troubleshoot an amplifier circuit, you would be best advised to refer the repair to an experienced and qualified shop, preferably one which is an authorized service center for your brand of machine. The manufacturer usually

includes a list of service centers for all areas of the U.S., and it is a safe bet to take it to one of them, if only because they are responsible to the manufacturer in case something should be botched on the repair.

Before taking the unit to a repair shop, there are some checks which you can perform quickly and easily, even without specialized knowledge:

Visually inspect the soldered leads to the tape head. If any appear to be loose, resolder them with a low-power (15-watt) iron. If the leads appear to be firmly soldered, you may wish to check the output leads to the speakers from the PC board. In many units,

there are interlock devices which are used to pass the leads through the cabinet, and these may sometimes become loosened from tugging during installation, and cause outages. Also, check the solder connections at the board for continuity.

If your unit incorporates a radio section, turn the radio on and see if both channels are working. If they are both functioning, then the problem is in the tape head and preamplifier, and not in the final amplifier. If this seems to be the case, then it would be a good idea to visually trace the wiring from the tape head to the PC board, and when reaching the PC board, to rock all of the components gently to see if there are any loose solder connections among them.

Sometimes, a defective tone or volume control can be the culprit, since the signals from the tape head are channeled through them. Rotate the controls through their entire arc. If the missing channel comes on at any point in the rotation, then you have found the defective component, and it should be replaced with an equivalent potentiometer.



and then moving back when the slack is taken up at the end of the side of tape.

From there, make sure that when the arm does move back, that the switch which it is connected to actuates the reversal mechanism. If it does not do this, check for loose wires at the switch, and trace the wires back to the solenoid which actually moves the mechanism. If power is reaching the solenoid, yet it refuses to work, check to make sure that the reverse mechanism is not jammed by moving it manually. If it moves freely, then replace the solenoid. The same goes for automatic eject units.

If your tape player is the type which is actuated by a cam and follower assembly, then there isn't much you can do, except to determine if the mechanism is being jammed, possibly by debris from an old tape. There are so many different types of mechanisms, that it is impossible to describe them all and suggest troubleshooting procedures. Use common sense. If the mechanism appears as so much spaghetti to you, then you're much better off letting a repair shop untangle the intricacies of it, rather than trying it yourself. You're more likely to do damage than good, and you'll end up with a king-sized repair bill and a headache as well. ■

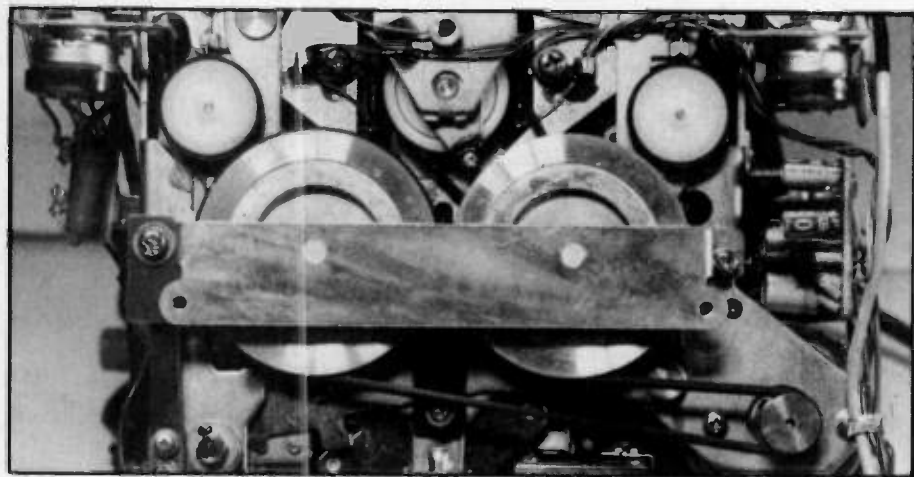
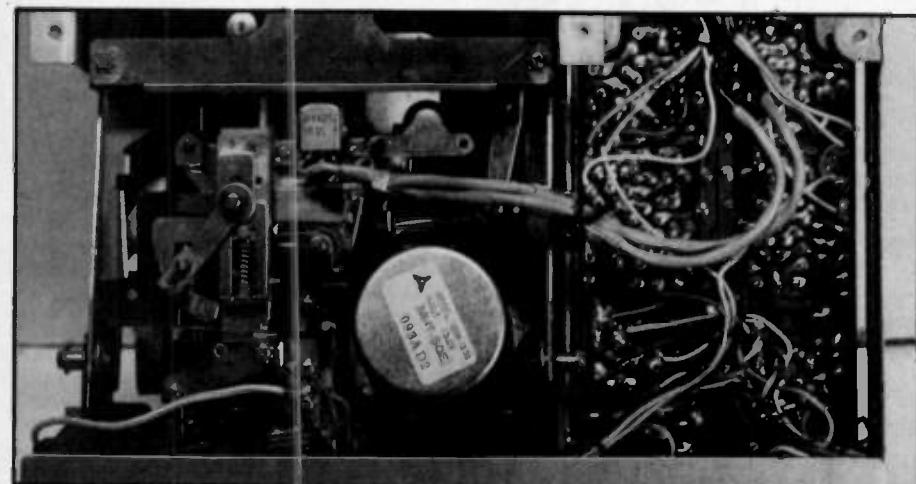

**7** Many of the newer cassette players incorporate an automatic reverse feature which eliminates the need for removing the tape from the machine in order to play the other side. These mechanisms take many forms, both electrical and mechanical, and it seems that each manufacturer has his own unique (and complicated) way of accomplishing automatic reverse. There are, however, some gen-

eral tips which we can pass along.

If your unit is the type which is actuated by a little arm which rides on the surface of the tape itself, and is actuated by increased tension at the end of the tape, then you should make certain that the arm moves freely back and forth. Also, make sure that the arm is sticking out far enough to make contact with the tape, depressing it slightly as the tape moves across it,

Get the most antenna  
for the least amount  
of money.

by Edward Noll W3FQJ

Author Ed Noll has written 33 books and hundreds of magazine articles on many electronics subjects. Among his titles are: 73 Dipole and Long-Wire Antennas, Radio Transmitter Principles and Projects, and The Radio Operator's License Handbook. We welcome him to the DAVIS ELECTRONICS GROUP and we expect that you will enjoy more of his contributions in the near future.

# THE VERSATILE HORIZONTAL DIPOLE

**T**HE HORIZONTAL DIPOLE is a simple, effective antenna. Antenna wire and accessories for its construction are inexpensive and readily available. It is of a length that makes for efficient use as a receptor of an incoming radio wave. When used as a transmitting antenna, it radiates efficiently and, at the same time, displays a proper impedance match to the output of the transmitter.

Dipoles are of critical length when used as transmitting antennae because of the need for proper match. Length and match insure ideal characteristics for reception as well. It is true that length and match are less critical if the antenna is to be used for receive only, because of the high sensitivity of modern receivers. For example, an antenna cut to length on one of the lower-frequency short-wave broadcast bands, will also receive well on other international broadcast bands. However, a dipole cut to length and properly oriented may be of considerable help in receiving some favorite, but weak station.

**Dipole Length.** The physical length of the antenna is related to the wavelength of the signal frequency to be received or transmitted. Frequency in megaHertz, and wavelength in meters are related as follows:

$$\text{Wavelength in Meters} = \frac{300}{\text{Frequency in MHz}}$$

For example, the wavelength of a 3.75 MHz signal frequency would be: Wavelength =  $\frac{300}{3.75} = 80$  meters

A dipole is a half-wavelength antenna and, therefore, its theoretical length would be one-half of this value, or 40-meters long. In practice, however, there are capacitive end-effects which cause a dipole that is cut to exactly the so-called "free-space" wavelength to be resonant on a lower frequency than the calculated value. In fact, to make the antenna an exact

"electrical" half-wavelength long, it is necessary to shorten the physical length by 5-percent. Hence the dipole length for 3.75 MHz resonance would be:

$$\text{Dipole Half-Wavelength} = 0.95 \times 40 = 38 \text{ meters}$$

Since the dipole antenna is fed at the center and separated into two quarter-wavelength segments as shown in Fig. 1, each side of the antenna would be 19 (38/2) meters long.

Physical antenna length for each quarter-wave segment of the dipole can be obtained by multiplying the 19 meters times the meters-to-feet conversion constant of 3.2808, obtaining a value of 62.34 feet.

A conversion from metric to linear length results in a very simple equation that can be used to determine the length of the quarter-wavelength segment of a dipole:

$$\text{Length in Feet} = \frac{234}{f(\text{MHz})}$$

**Table 1—Here are the dimensions for cutting half-wave dipoles for the various Amateur frequencies below 30 MHz. The number given represents one-half the total antenna length.**

FREQUENCY IN MHz	DIPOLE $\lambda/4$ IN FEET	FREQUENCY IN MHz	DIPOLE $\lambda/4$ IN FEET
160 METERS			
1.81	129.28	7.200	32.50
1.83	127.86	7.225	32.39
1.85	126.49	7.250	32.28
1.87	125.13	7.275	32.17
1.89	123.80	20 METERS	
1.91	122.51	14.025	16.69
1.93	121.24	14.050	16.66
1.95	120.00	14.075	16.63
1.97	118.78	14.100	16.60
1.99	117.59	14.125	16.57
80 METERS			
3.525	66.38	14.150	16.54
3.550	65.92	14.175	16.51
3.575	65.45	14.200	16.48
3.600	65.00	14.225	16.45
3.625	64.55	14.250	16.42
3.650	64.11	14.275	16.39
3.675	63.67	14.300	16.36
3.700	63.24	14.325	16.33
3.725	62.82	15 METERS	
3.750	62.40	21.05	11.12
3.775	61.99	21.10	11.09
3.800	61.58	21.15	11.06
3.825	61.18	21.20	11.04
3.850	60.78	21.25	11.01
3.875	60.39	21.30	11.98
3.900	60.00	21.35	10.96
3.925	59.62	21.40	10.94
3.950	59.24	10 METERS	
3.975	58.87	28.2	8.30
40 METERS			
7.025	33.31	28.4	8.24
7.050	33.19	28.6	8.18
7.075	33.07	28.8	8.13
7.100	32.96	29.0	8.07
7.125	32.84	29.2	8.01
7.150	32.73	29.4	7.96
7.175	32.61	29.6	7.91



A hand calculator is an aid if you wish to make your own antenna calculations.

**Dipole Dimension Charts.** Quarter-wave segment lengths for each of the Amateur bands, 10 through 160 Meters, are given in Table 1. For example, each quarter-wave segment of a dipole antenna cut to 14.2 MHz in the 20 Meter band should have a length of 16.48 feet. Table 4 gives dimensions for dipole quarter-wave segments for reception on the various shortwave broadcast bands. Dipole lengths for the various WWV frequencies are given in Table 3.

Lengths are given to a decimal part of one foot in the tables. In addition, Table 2 permits you to make an approximation in inches. In fact, when erecting an antenna for use with a transmitter, there are other variables, such as proximity to ground and metallic surfaces, as well as antenna element diameter, that influence the exact resonant frequency. Therefore, cutting an antenna within an inch or two of indicated value is satisfactory. For example, in cutting the dipole for 14.2 MHz use, a practical value is 16-feet, 6-inches. Note from Table 2 that the six-inch figure is appropriate for a decimal part falling between 0.55 and 0.65.

It has been my experience in cutting antennas, that it is preferable to cut elements somewhat on the long side, permitting you to trim down the antenna to a specific resonant frequency after initial tests have been made. Of course, antennas for receive-only use are not nearly so critical as to their length. Consequently, in Table 4, one dimension is given for operation over the specific shortwave broadcast band.

Of course, it should be stressed that an inch or two of length has a much more decided effect on the resonant frequency on a higher frequency Ama-

teur band as compared to a lower one. Thus, you should be more careful in cutting the dipole for 10 or 15 Meters, as compared to the cut for 80 or 160 Meters. For example, a differential of 3-inches on 10 Meters might result in a frequency change of approximately 1 megaHertz, while a similar differential on 80 Meters corresponds to a frequency shift of only 20-25 kiloHertz.

**Dipole Directivity.** The horizontal dipole is directional. As a transmitting antenna, it sends out maximum radio energy (radiation) in the two directions broadside (perpendicular) to the antenna wires (Fig. 2). As a receiving antenna, it displays maximum sensitivity to radio signals arriving from the same two directions. Radiation and sensitivity taper off at angles away from the perpendicular, declining to a minimum in the direction along the line (parallel) of the antenna wire. The response pattern of Fig. 2 is a theoretical one. The antenna does radiate energy at other angles and is sensitive to in-

coming signals as well. The extent of the differential depends upon a number of variables including type of antenna, proximity of ground, nearby metallic structures, propagation conditions, transmission line system, etc. It is a fact though, that maximum radiation and sensitivity occur perpendicular to the antenna wire and minimum in the direction of the antenna wire. The figure-eight pattern is itself rather broad, and it is only at angles near to the angle of the antenna wire that the response is sharply down.

In practice, then, it is a good idea, if possible, to erect the dipole antenna with an orientation that places it broadside to the direction toward which you wish to radiate maximum signal or display maximum sensitivity. If your intent is to minimize the pickup of an interfering signal, you should point the dipole antenna wire in that direction.

**Dipole Antenna Components.** Essential components of the dipole antenna are: antenna wire, dipole center connector, end insulators, support rope, transmission line, and other accessories as needed. The antenna wire can be the popular 7-strand, #22 type, which is common and inexpensive. When it can be found at low cost, our personal preference is for #14 or #16 solid, insulated wire. A good-quality, insulated wire gives you added safety and weather protection. Insulation in no way interferes with the radiation or pick-up of signal.

Available end insulators are usually made of porcelain and are 1.75 to 3-inches long. They are oval-shaped or rectangular, some having a ribbed construction. Two holes are provided, one for the antenna wire itself and the other for the support line. Support line can be nylon rope or strong plastic

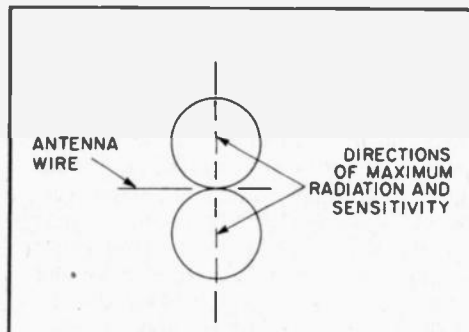

Figure 2—If you're interested in working a particular area with your dipole, then be sure to orient it properly. The maximum amount of RF is radiated perpendicular to the line of the antenna wire itself.

Table 2—Use this table to convert the decimal portion of the feet measurement given in Table 1, to inches. Always cut your antenna a bit longer at first. It's easier to trim it down than to add length later.

DECIMAL PART OF ONE FOOT	INCHES (APPROXIMATE)
0-.05	0
.05-.10	1
.10-.15	2
.15-.25	3
.25-.35	4
.35-.45	5
.45-.55	6
.55-.65	7
.65-.75	8
.75-.85	9
.85-.90	10
.90-.95	11
.95-1.0	12

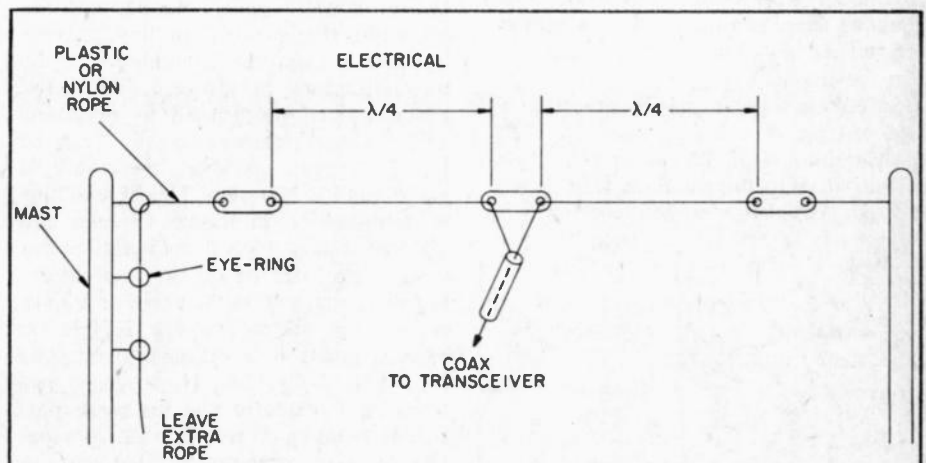

Figure 1—Here's the proper way to erect a dipole. Either or both ends may also be attached to the house or garage. Lead the coax away from the antenna at right angles.

# DIPOLE

clothes-line with a nonmetallic core. To make it easy to lower the antenna, for cleaning or experimentation, the support line at one end can be fed down through eye-bolts to ground level, as shown in Fig. 1.

A coax-to-dipole connector, Fig. 3, is the ideal method of linking the dipole antenna to the coaxial transmission line. This connector provides a durable and reasonably weather-proofed connection, providing for convenient connection and detachment of transmission line. An alternative plan is to use an end insulator at the center. The two conductors of the transmission line can be attached firmly, soldered and taped to the antenna wire on each side of the center insulator.

There are various support means for horizontal dipole antennas. The variety of TV-antenna hardware such as chimney, side-wall and roof mounts, permit easy attachment to a house or garage. Support itself can be a 5 or 10-foot section of TV mast. Free-standing and guyed masts are available for ground-mounted supports. A telescoping TV mast is versatile because of its ease of erection and let-down. Guying is required. Guy rings are spaced approximately every 10-feet along such a telescoping mast.

Use good quality coaxial line, either 50-ohm or 70-ohm. Preferred types are RG-58A/U (50 ohms) or RG-59A/U (70 ohms) for low power applications. RG-8A/U is recommended for higher-powered applications, and installations where a long feed line, from antenna to transmitter, is necessary.

**Erection of Dipole.** Plan your installation according to length, height, and directional orientation. You must consider the space required by the antenna, and where the line must be brought into the house.

Safety and performance are important criteria. For safety reasons, keep the antenna clear of power lines. Be certain that if the antenna falls when erected, or while under erection, it cannot fall across electrical wires.

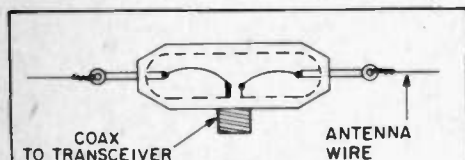

Figure 3—The best method for mating the antenna to the transmission line is a coax-to-dipole insulator/connector.

**Table 3—For receive-only operation, the dipole is still a very good choice. Here are the optimum lengths for broadband operation. Remember to orient the antenna for the area you wish to listen to specifically.**

BAND METERS	FREQUENCY IN MHZ	DIPOLE $\lambda/4$ IN FEET
120	2.3-2.495	97.5
90	3.2-3.4	70.9
75	3.8-4.0	60.0
60	4.75-5.06	46.8
49	5.95-6.2	38.36
41	7.1-7.3	32.5
31	9.5-9.775	24.4
25	11.7-11.975	19.8
19	15.1-15.45	15.3
16	17.7-17.9	13.15
13	21.45-21.75	10.8

Make certain that under no circumstances, can mast or wire come in contact with power lines if you lose control of the mast or antenna. Keeping clear of power lines also improves the antenna performance. You will pick up less power line noise on receive. On transmit, you will radiate the least signal into the power lines, minimizing loss and possible interference with home entertainment units such as television receivers and high-fidelity amplifiers.

Orient the antenna to best meet your needs. If you wish to radiate maximum signal east and west, orient the antenna wire north and south. In a built-up area, it is not always possible to find an ideal mounting situation. However, within reason, it is not necessary that the two antenna ends be the same exact height above ground. Neither must the two quarter-wave segments of the dipole be in an exact line. Stay as close as you can to the idealized situation, but don't worry if you must make limited departures. The antenna will still perform well if you are reasonable in the changes you make.

**Receive Only.** The same general considerations must be made in the erection of a receive-only antenna, with the exception that power handling capability and transmitter matching are no longer factors of concern. Thus the antenna need not be cut as precisely. The two-wire transmission line can be made of lamp cord or, preferably, a good quality 300-ohm TV ribbon line. A combination of dipole antenna and TV line makes a good combination for short-wave listening on the international broadcast and radio amateur bands. A receiving dipole cut for 35-feet on each segment is a reasonable antenna for all-band listening. However, if you want peak performance on some particular band, you can then cut a separate receiving antenna for that particular band. Orient this antenna with its figure-eight reaching out in the favored direction.

**Tuning With An SWR Meter.** An SWR meter connected between transmitter and transmission line, Fig. 4, can be used to measure the resonant frequency of a dipole. To go a step further, the antenna can now be trimmed or extended if it does not resonate to the desired frequency. The results can be observed by the SWR meter, as the antenna resonant frequency is moved up or down the band. Since it is easier to trim off rather than to add on wire length, cut the initial antenna wire longer than the specified value for the particular frequency, in order to catch up with any variables that might influence resonance. A practical example will demonstrate an acceptable procedure.

Assume an antenna is to be cut for 7150 kHz in the 40 Meter amateur band. Table 1 indicates a dipole length of 32.73 feet. This suggests a dipole length of 32-feet, 9-inches. Cut each dipole element to 33-feet, which would be for a resonant frequency of 7100 kHz. Erect the antenna on a temporary basis.

Measure the SWR every 25 kHz between 7025 and 7225. Set the readings down in a table form of frequency vs. SWR. Determine the precise frequency at which the SWR reading is minimum.

FREQUENCY IN MHZ	DIPOLE $\lambda/4$ IN FEET
2.5	93.6
5	46.8
10	23.4
15	15.6
20	11.7
25	9.36

Table 4—Here are the dimensions needed to cut a dipole for WWV time station frequencies. WWV is an excellent source for receiver frequency calibration as well as the correct time. WWV's transmitters can be heard world-wide, 24-hours every day.

f(mHz)	SWR
7.005	1.65:1
7.025	1.5:1
7.050	1.35:1
7.075	1.21:1
7.100	1.1:1
7.125	1.08:1
7.150	1.08:1
7.175	1.11:1
7.200	1.2:1
7.225	1.36:1
7.250	1.5:1
7.275	1.75:1
7.295	2.2:1

This would be the resonant frequency of the dipole. In our example, it was exactly 7050 kHz.

Inasmuch as the resonant frequency reading is low, you can now trim the antenna to attain the desired resonance. Be careful not to trim off too much. According to Table 1, each trimmed inch corresponds to a frequency change of approximately 20-25 kHz. In our example, we trimmed off six-inches, and increased the resonant frequency to 7141 kHz. If your SWR reading is low, and the resonant indication falls near to 7150, let well enough alone.

The plot of our experimental antenna is shown in Fig. 5. Note that even at the band edges, the SWR reading is reasonable. In the range between 7050 and 7250 kiloHertz, the SWR meter indicated almost ideal performance.

**Antenna Tuners at Work.** The primary function of an antenna tuner, Fig. 6, is to provide a proper match between your antenna system and transmitter. In so doing, your transmitter sees a proper load and is able to operate at the optimum conditions of its design. The tuner does not alter the performance of the antenna or the SWR on its transmission line. Rather, it makes certain that an improper SWR does not result in unfavorable operation or possible damage to your transmitter. Primarily it is a transmitter protector.

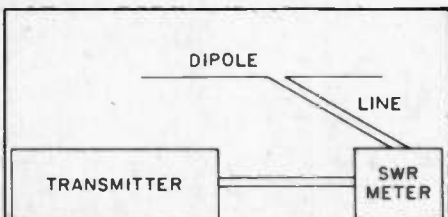
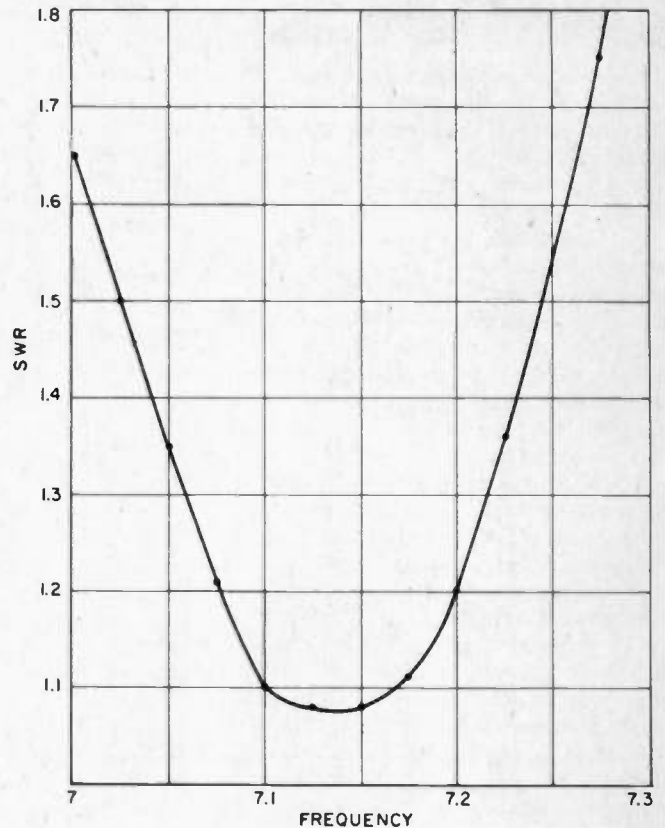

Figure 4—An SWR meter should be inserted in the transmission line between the transmitter and antenna for accuracy.

Figure 5—Table 5— At left is the table made from the SWR plot (right) of our experimental dipole for 40 Meters. Make a similar one for your antenna in order to determine the exact resonant frequency. It is shown at right as the lowest point in the curve. Even though the curve is rather steep, we managed to achieve an SWR under 2.0:1 for just about the entire band. This would normally be acceptable.



However, a tuner has a number of secondary benefits that enhance antenna system experimentation and permits the use of antenna systems that are not, in themselves, ideal for matching the standardized 50-ohm output of modern ham radio equipment. Again, it must be stressed that the tuner does not influence the performance of an antenna system. Rather, it acts as an interface between an antenna system and transmitter.

An additional secondary benefit is that it reduces harmonic and spurious signal radiation because it blocks the path between any such signals generated by your transmitter, and the radiating antenna. The tuner also rejects incoming signals that are on frequencies removed from the desired operating band. In effect, it reduces the sensitivity of the receiving system to image and other spurious frequency components.

A tuner makes the dimensioning of a horizontal dipole antenna less critical. It extends the frequency range of operation of the antenna that will provide an ideal match to the transmitter. For example, an 80 Meter dipole cut to 3750 kHz, will be made operable over the entire 80 Meter band from 3500-4000 kHz. The electrical performance of the antenna will not differ greatly from an antenna cut precisely

to some specific frequency on the band. Even though the SWR on the transmission line might be rather high at the band extremes, the transmitter itself will look into an optimum load.

**Conclusion.** The horizontal dipole is indeed a versatile antenna, giving good performance at low cost. It should be dimensioned properly, and should be used with an SWR meter to evaluate its performance. A tuner insures proper match between dipole antenna system and transmitter, and also extends the operating bandwidth of the dipole in terms of proper matching to the transmitter. Let the dipole start you off in your first experimental activities with antenna systems. ■

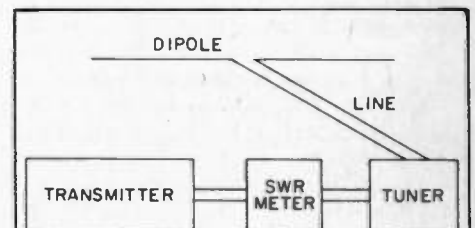

Figure 6—The antenna tuner allows the transmitter to work into an optimum load even if the dipole itself is not cut for the correct frequency. A tuner won't correct an inefficient antenna installation.

b/e  
checks  
out the...

# B&K Precision DP-50 Logic Probe

Save big money  
by doing your own  
digital troubleshooting

CIRCLE 35 ON  
READER SERVICE COUPON

**R**EMEMBER WHEN TROUBLESHOOTING meant dusting out the cobwebs and eyeballing the chassis for a burnt out tube, broken wire or a fried resistor. Or perhaps you date from a more recent era and are used to spraying coolant on suspicious transistors or checking power supply voltages with your pocket VOM. Well no matter what you are used to, it is time to recognize that we are solidly into the age of digital electronics. Our troubleshooting techniques have to be brought up to date with digital age equipment such as this B&K Precision DP-50 Logic Probe.

The key to digital troubleshooting is to know what is going on at each of the IC chip pins. If you know how to read an integrated circuit data sheet you can find out what voltage levels or pulse trains to expect where. Once you know what you are looking for you need something that will measure the logic levels. If you have a few hundred bucks to spare for an oscilloscope your troubles are over, but if you can't spare that kind of bread a logic probe might be just what you need.

"But," you are probably saying, "why should I buy a logic probe when my VOM will measure all the highs and lows I need?" And you are right—up to a point. A VOM is just fine for checking *static* and very low frequency logic levels, but what happens when

the pulse rate increases to more than a few hertz or you need to confirm the occurrence of a single short duration pulse. You won't know if the lack of meter movement is indicating a low or a pulse stream, and your logical deductions could be all wrong.

**Taking the Pulse.** This is where the DP-50 logic probe really starts to pay the bills. It has LEDs that give a positive indication of both high and low logic levels plus a third LED that lights when it detects a pulse stream as fast as 50 MHz. The DP-50 also has a switch selected circuit called a Pulse Catcher. This circuit detects single pulses and causes the LED to light and remain lit until the switch is reset. It

also has a pulse stretcher that enhances the indication for short duration pulses.

The DP-50 is compatible with TTL, DTL, RTL, HTL, MOS, CMOS and HiNIL (High Noise Immunity Logic). We checked it out on the bench and the LEDs all clicked on and off at just the right voltage levels. It has a 2-megohm input impedance, a voltage overload capacity of  $\pm 50$  VDC, and the hook-up leads are reverse polarity protected to 50 VDC. The DP-50 is powered directly from the tested circuit's Vcc and ground via a pair of long, alligator-clip tipped leads. The B&K Precision DP-50 retails for \$50. For more information circle number 35 on the Readers Service Coupon. ■

The compact size and light weight of the DP-50 lessens user fatigue, and increases accuracy in test procedures. Special memory feature stretches pulses for "true" in-function testing. Circle 35 on the reader service coupon.

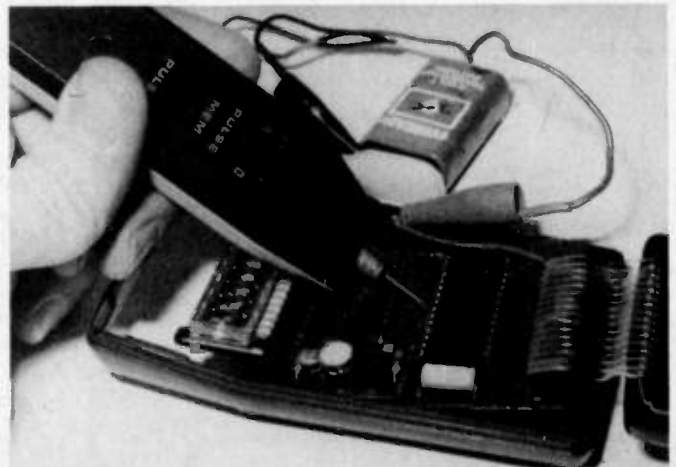

# GRANDPA'S WHISKER

Build a carborundum detector from the days of the not-so-ancient mariners

by Charles Green

IN THE BEGINNING OF this century, when radio was still called "wireless," the crystal set was used by most of the early radio pioneers. The simple "catwhisker" touching a piece of galena or silicon crystal, and a coil wound on an oatmeal box, formed a primitive yet effective radio receiver that stayed popular for many years. Even the later development of the vacuum tube could not entirely bury the crystal set; it still remained popular as a first set for many radio experimenters who later went on to more complicated electronic developments. Even today, the simple crystal set is still being built using modern germanium or silicon diodes in place of the moveable catwhisker and crystal.

Back in the old days, the popular galena and silicon crystals had a rival for the more specialized ship-to-shore communication work. It was the carborundum crystal detector. The carborundum

crystal detector did not require a light touch with the catwhisker, but instead required a heavy contact pressure. This heavy catwhisker pressure was more suitable for the early radio stations on ships. The lesser sensitivity of the carborundum detector was compensated by the crystal's ability to take stronger radio signal energy (such as leakage from nearby spark transmitters) without burning out, then the galena and silicon crystals could. What is really different about the carborundum detector, is the requirement for a bias battery. This bias battery is normally not used with galena and silicon crystals.

You can experiment with the carborundum detector by building our *Grandpa's Whisker*, which is patterned after the early crystal sets. The receiver uses a tapped coil and two variable capacitors (one capacitor tunes the antenna) to allow coverage of the entire

broadcast band and for maximum signal coupling to the detector. A separate assembly is provided for the carborundum detector and a control is mounted for convenient adjustment of bias battery voltage for maximum detector sensitivity. The receiver is built "breadboard style" on a 8½-inch by 7¼-inch by ¾-inch wood base which is similar to the style of construction used by early radio experimenters.

**The Receiver Circuit.** Signals from the antenna are fed through J1 and coupled through C1A-C1B to the parallel tuned circuit of L1-C2. C1A-C1B is in a series tuned circuit with L1, and serves to tune the antenna for maximum RF current flow. The resultant tuned signals are detected by D1 and the audio is fed through the R1 bypass C3 to J5-J6 and external headphones. R1 adjusts the D1 bias voltage from B1 and C4 is the RF bypass for the headphones.

**Carborundum.** Not a natural mineral like galena or silicon, carborundum is the name given to a compound of silicon carbide by its American inventor Edward Goodrich Acheson (a former assistant of Thomas Edison), Acheson was experimenting with a primitive electric furnace in 1891, when he fused a mixture of clay and powdered carbon. He found that the resultant crystals would cut glass similarly to a diamond (silicon carbide is next to a diamond in hardness), and he called his discovery Carborundum; thinking it was a substance composed of carbon and corundum (a crystallized form of alumina). Scientific analysis later showed it to be silicon carbide, but the designation Carborundum was kept as a trade name. Industrial usage of carborundum is primarily grinding compounds and grinding wheels.

Its use as a detector was discovered by experimenters around the beginning

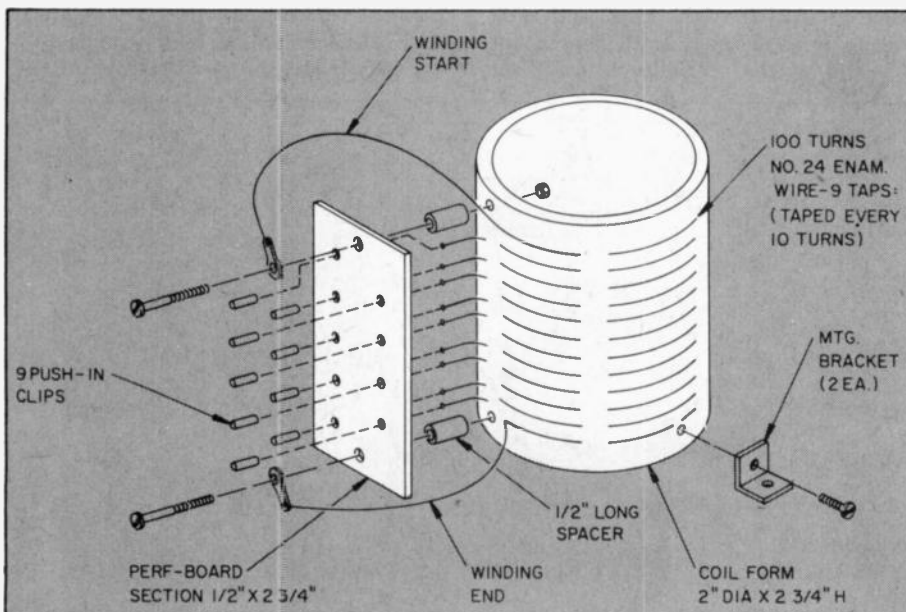
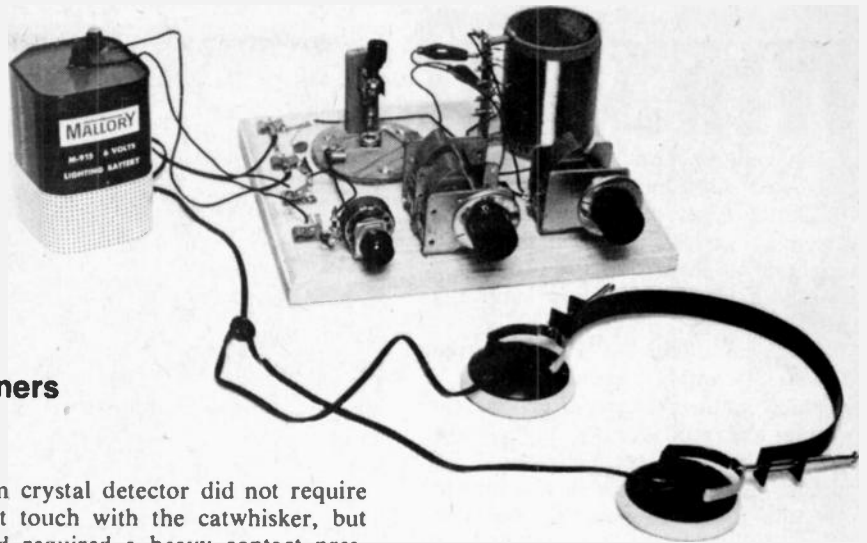

The tuning coil is wound on a cardboard mailing tube section for 100 turns of #24 enameled wire, tapped every ten turns. The taps should be stripped bare with sandpaper before soldering to the clips which are mounted on a section of perfboard. See the text.

# WHISKER

of this century who tried various minerals and substances in their search for better types of radio wave detectors; much as Edison tested many materials in his search for the proper material for his incandescent lamp filament.

A crystal diode has a high current flow with voltage applied so that it conducts in the forward direction (cat-whisker to crystal), and a very low current flow in the reverse direction. The amount of current flow in the forward direction depends upon the characteristics of the crystal material and the applied forward voltage. As shown in the Crystal Forward Conduction Curves graph, Germanium minimum voltage is approximately 0.3 V, Silicon is 0.6 V, and Carborundum is 3 V. (The high Carborundum voltage is the reason why a bias battery is necessary to move the threshold down so that the weak RF signal voltages can be detected.)

**Tuning Coil (L1) Construction.** Look at the drawing of the L1 construction details. The tuning coil is wound on a cardboard mailing tube section 2-inches in diameter and 2¾-inches long. Start winding approximately ¼-inch from the form edge with #24 enameled copper wire. Punch a small hole to feed the wire into the cardboard before you start winding, then wrap the wire around the edge of the form to hold it in place while winding; or, a section of plastic tape can be used to keep the wire from moving.

As shown in the drawing, the tuning

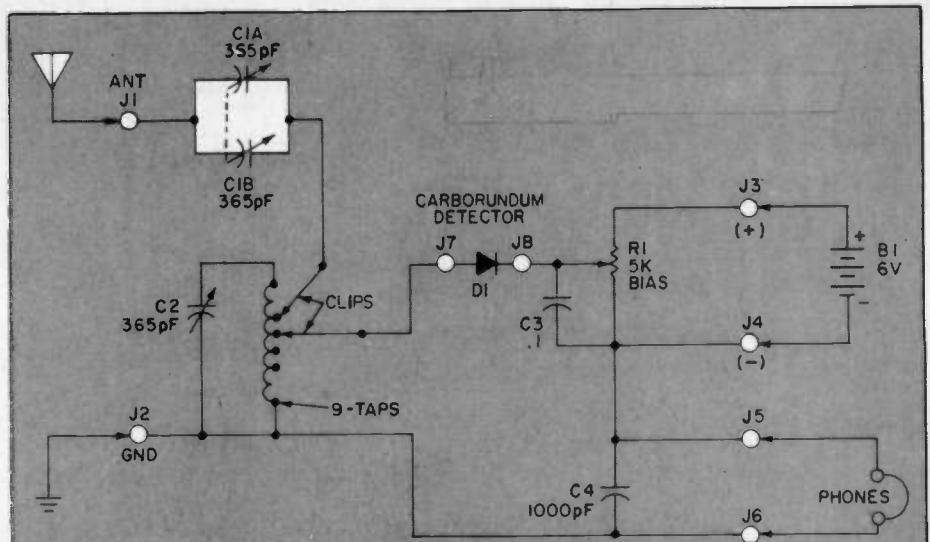

## PARTS LIST FOR GRANDPA'S WHISKER

- B1—6 V battery
- C1A-C1B—Dual 365-pF tuning capacitor (dual gang)
- C2—365-pF tuning capacitor (single gang)
- C3—0.1-uF capacitor
- C4—1000-pF capacitor
- D1—Carborundum Crystal (Modern Radio Labs, P.O. Box 1477, Garden Grove, CA 92642), and Crystal Detector Assembly (Philmore #7003 open type detector, or equiv.)
- J1-J8—Fahnestock Clips

- L1—See drawing and text
- R1—5,000-ohm potentiometer. (linear taper)
- MISC: 2000-ohm earphones, 2¾-in. x 2-in. dia. coil form, clips, #24 enam. wire, ½-in. long spacers, perfboard strip, push-in clips, solder lugs, mtg. brackets, wood sections for detector assembly, knobs, 8½-in. x 7¼-in. x ¾-in. wood base, hook-up wire, wood screws, headphones (2000-ohms), and a 1N34A germanium diode (or equiv.) for initial adjustment of the receiver.

coil is wound with 100 turns and is tapped every 10 turns. An easy way to make the taps is to twist the wire together for a half-inch and position the free end out. Then, when all of the taps have been made, used sandpaper to take the enamel off the tap-wire ends. At the end of the winding, punch another hole in the coil form and after cutting a three inch lead, thread the free end of the coil wire through the

hole and wrap it one turn around the coil form edge (or tape it in place).

Mount 9 push-in clips in a ½-inch by 2¼-inch perf board section and mount it on the coil form with machine screws and nuts and two ½-inch long spacers (as shown in the drawing). Then solder the coil taps to the push-in clips. Connect the coil start and end wire leads to solder lugs mounted on the perf-board screws. Punch two holes

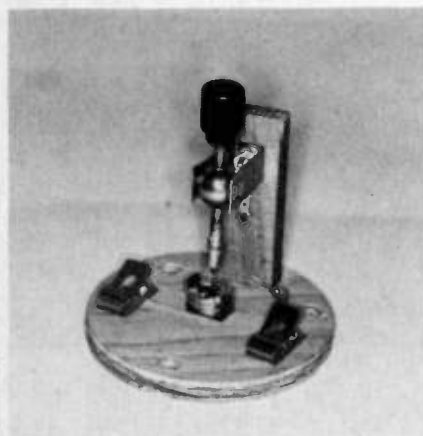

Most of the crystal detector assemblies you can turn up will be of the horizontal type. You will need a heavier pressure for the carborundum crystal, so convert the assemblage to a vertical format. None of the dimensions shown are all that critical.

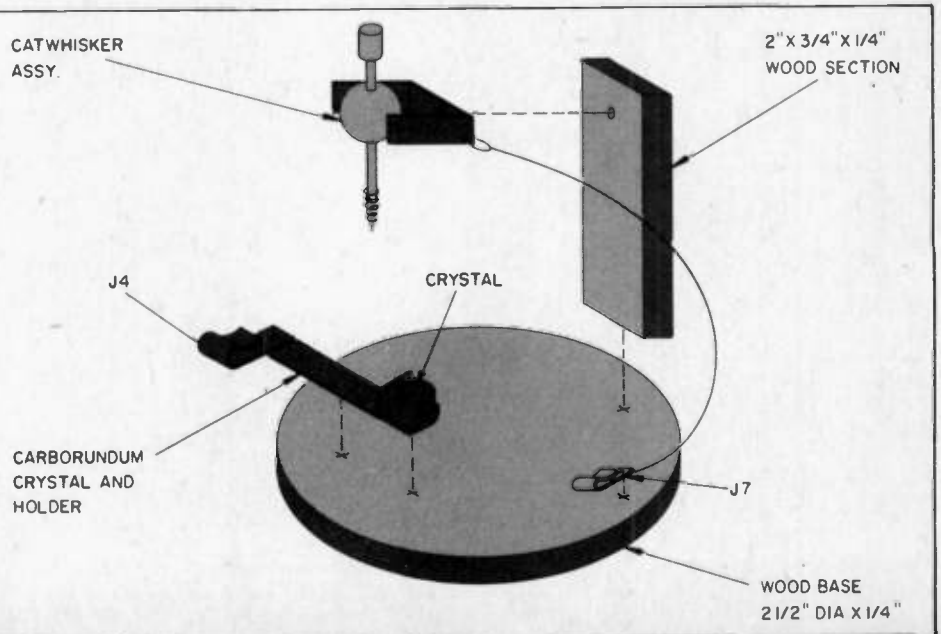

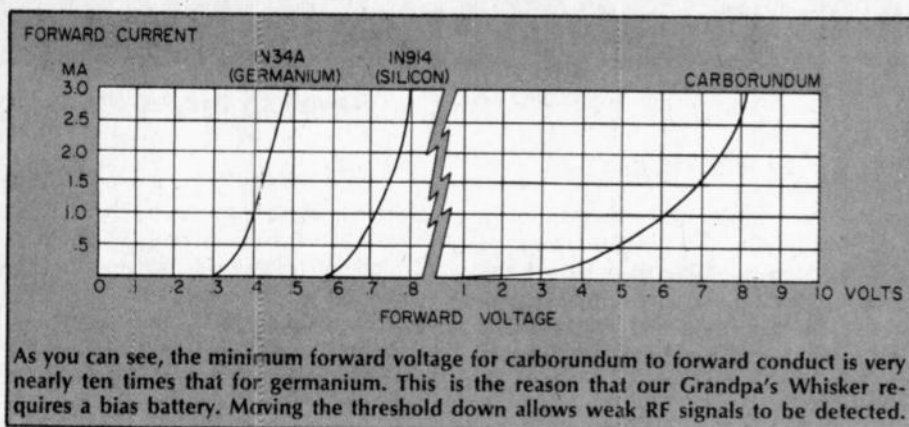

on opposite sides of the base of the coil form, mount two brackets, and the tuning coil is completed.

**Detector Assembly Construction.** Most of the crystal detector assemblies available nowadays are of a horizontal type; designed for fine adjustment of a galena crystal. The carborundum crystal requires a heavier catwhisker pressure than the galena crystal, so the detector assembly (as shown in the drawing) is constructed in a vertical configuration.

Begin construction by cutting a 2-inch x 3/4-inch x 1/4-inch wood section, and then gluing or using wood screws to fasten it to a 2 1/2-inch diameter x 1/4-inch high wood base. This wood base is readily available from art, or hobby, supply stores that stock wood plaques. Or, a suitable base can be cut out of a section of plywood. The dimensions of the detector assembly are not critical and should be modified as necessary to fit your particular crystal mount and catwhisker configuration. If necessary, the rivets holding the catwhisker mount to a metal strip can be

drilled or ground out, and then reassembled with a solder lug as shown in the drawing.

Mount the crystal holder on the base of the detector as shown in the drawing and photos, and then mount the catwhisker assembly on the vertical section with small wood screws, or machine screws and nuts. Make sure that the crystal holder screws do not protrude below the base bottom. Connect a lead between a solder lug on the catwhisker assembly and a terminal clip mounted on the base. If the crystal cup does not have an attached metal strip and terminal clip as in our model, it will be necessary to mount a solder lug with the cup and connect a lead to a terminal clip mounted on the base.

**Receiver Construction.** Most of the receiver components are mounted on a 8 1/2-in. x 7 1/4-in. x 3/4-in. wood base. The base dimensions are not critical and any size wood base can be used that will be large enough to mount the components as shown in the photos. The model wood base shown was obtained from an art supply store and was

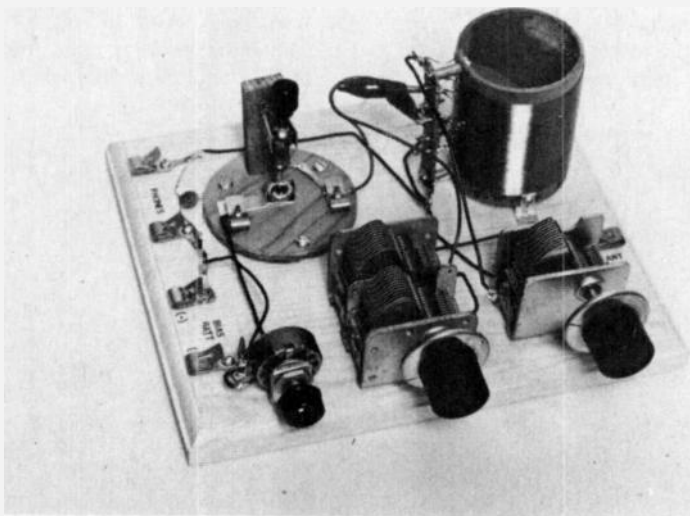

Grandpa's Whisker is a nostalgic look back at the days when a ship's radio lifeline to shore was dependent on no more than a coil, a battery, a catwhisker, and carborundum.

originally intended for use as a wood plaque. Small wood screws were used to hold most of the components on the base, except the variable capacitors C1A-C1B and C2 are mounted with machine screws in countersunk holes drilled through the base bottom. If the particular capacitors in your model do not have tapped bottom holes, metal brackets must be fabricated to fit either front or back capacitor mounting holes. The Bias Adjustment Control R1 is also mounted on the wood base with a metal bracket.

Begin construction by locating the component mounting holes on the wood base, and then mounting the parts as shown in the photos. Install solder lugs on all of the terminals J1 to J6 and also on the metal frames (rotors) of the variable capacitors C1A-C1B and C2. Install the detector assembly with three wood screws to the wood base and then install L1 positioned as shown in the photos (with the taps facing the detector assembly).

Wire the components as shown in the schematic diagram and position the wiring for short, direct connections. Install a clip on the lead to C1A-C1B and also on a lead to J7 of the Detector Assembly (the connection to the catwhisker). These clips will be connected to the coil taps during operation of the receiver. Install knobs on the variable capacitors and also on the Bias Adjustment Control, then mark the terminals with rub-on lettering or with small slips of typed, paper designations cemented on to the board.

**Operation.** All types of crystal set receivers require a good, outside antenna and a good ground for best results. If you are located near a high-power radio station, an inside antenna and a waterpipe ground will probably work. For distant stations, an outside antenna, 50 to 100 feet long will be necessary. Check the mail order houses for supplies and antenna kits.

The taps on L1 are provided to compensate for antenna loading as well as for the loading effect of the carborundum detector. The position of the clip leads on the coil taps must be determined by experiment as they will vary according to the length (loading) of your antenna and the frequency of the radio station being received. Inasmuch as the carborundum detector also requires adjustment (both in determining a sensitive crystal point and in the proper bias voltage adjustment), a saving in initial L1 tap set-up time can be achieved with the use of a fixed crystal diode (1N34A, or equivalent germanium type).

(Continued on page 116)

# Budget installs a...

Save big bucks by doing

by Jorma Hyypia

**D**O-IT-YOURSELF INSTALLATION of a high-quality TV antenna can be far less expensive than having the cheapest antenna on the market installed by a professional worker. The job is quick and easy, especially if you can work on a flat roof as shown here.

Some cities have exact regulations about the maximum allowable heights of TV antennas, so check with your local authorities or just keep your antenna at the same level as others in the neighborhood. If there are other antennas on the roof, avoid togetherness as much as possible; place your antenna as far from others as you can, and where it can be pointed toward major transmitter towers with least obstruction by other antennas, chimneys, large trees or other buildings.

If possible, locate the legs of your tower over roof joists (tap the roof and listen for a "solid" sound). Mark locations of the lag screw holes, then drill pilot holes. Test your drill bit on a piece of scrap wood to be sure the pilot holes won't be too large for a tight fit. Also, before drilling, use a plumb-bob to be certain that the tower stands straight. Add shims under one or two legs, if necessary, to correct any bad lean and to stabilize the tower on an uneven roof surface.

**Weatherproofing.** Paint the drilled holes and contact surfaces on both the roof and feet of the tower with roof patch compound obtained from a building supply or hardware store. Get the smallest can of compound sold; you don't need much.

Reposition the tower, then hand drive the lag screws part way into the holes;

tighten the screws only after all three have been driven in most of the way. To complete the weatherproofing job, paint the screw heads and feet of the tower with more roof-patch compound.

Before continuing with installation of the antenna, remove all unneeded materials, waste and tools from the roof, including boxes, cans, the old antenna and mast you might be replacing, and the power or hand drill you won't need anymore. You are less likely to damage the rather delicate new antenna during installation when working on a clean roof.

If you are working on a peaked roof, the antenna must be unpacked and assembled on the ground. But if you have a flat roof, remove the antenna from its box on the roof if there is plenty of free working space. You can use the box to stow the old antenna for easier removal from the rooftop.

Do not unfold the antenna elements until you are actually ready to proceed with the mounting. The elements are of seamed tubing that is quite rugged, unless you step on it or bang it hard against a chimney or other obstruction. The antenna will last for a long time under normal conditions, although wind action and roosting birds—especially large ones like vultures—will eventually cause damage.

Follow the printed directions that come with the antenna so that you unfold the elements in the proper order and make any other adjustments that may be required. Secure the antenna to the mast only after all elements have been unfolded and snapped into place. A good ratchet wrench makes the job

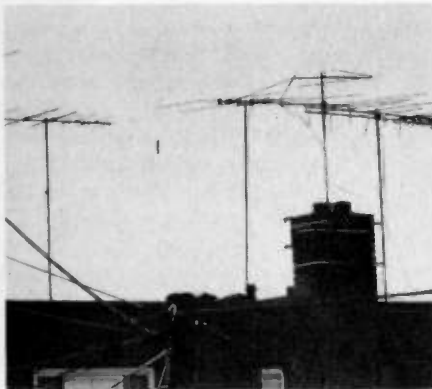

Avoid antenna crowding by installing it as far away from other antennas as possible.



Drill pilot holes for the lag screws and make sure the tower is straight and steady.



Use roof patch compound to prevent rain-water leakage through the pilot holes.



Drive home the lag screws by hand only after all three are most of the way in.



Put roofing compound over the tightened screws to keep them secure and leakproof.



A hard hat protects against falling antennas, roosting pigeons and satellites.



# ROOF ANTENNA

this simple job yourself

**DANGER!!** Keep all antennas clear of power lines!

of fastening the antenna to the mast easier. Avoid over-tightening the nuts and bolts.

**Caution!** Antenna elements are most often broken during this phase of installation, when the antenna is fastened to the mast but not yet installed on the tower. So handle the antenna/mast assembly carefully.

To obtain the best signal transmission from the antenna to your TV receiver, use 75-ohm coaxial cable. Use a matching transformer to match the antenna's 300-ohm impedance to the 75-ohm impedance of the coax line. This transformer is connected at the antenna. A small connector on an F-type transformer joins to a standard 75-ohm F-connector on a cable that can be purchased pre-assembled. A rubber boot on the antenna slips over the connector to minimize corrosion by snow, ice, rain and air pollutants. It is a good idea to coat the connector and nearby cable with silicone sealer. Tape the transformer to the mast or antenna main beam to prevent its movement by wind.

Black plastic electrical tape can be used to secure the coax cable to the mast. It's important to prevent the cable from moving about freely, thereby putting strain on the connections. Paint or spray lacquer on the connection terminals, on the antenna, to further minimize rust and other corrosion. Attention to such details is the secret of a no-trouble antenna installation.

Mount the antenna and mast on the tower, using shims between the mast and tower, if necessary, to get the mast vertical (check with a plumb bob or

carpenter's level if you have one, otherwise sight by eye from several different directions).

Feed the coax cable down to your TV set, using recommended stand-offs and a matching 75- to 300-ohm transformer at the TV set if the receiver does not have a 75-ohm input terminal. Try to keep the cable away from metal rain gutters, downspouts, power lines and other metallic or electrical obstructions. To complete the job properly, add a good lightning arrestor and earth ground, using heavy gauge aluminum wire sold for that purpose by radio/TV supply stores. A good ground protects your antenna, TV set, home and your family at very low extra cost.

**Warning!** If there are any power lines on or near the roof, do not allow the antenna, mast or tower to accidentally touch them. Hundreds of people have been electrocuted, in the past few years, by bumping antennas into power lines.

The last step is to aim the TV antenna at the TV transmitter tower. In this installation the alignment was easy because the transmitting tower was within view. Where the transmitting tower is not visible, adjust the antenna direction while someone else monitors the quality of the TV image. Do not assume that other TV antennas on the roof are necessarily aligned correctly; those near this installation were up to 30 degrees off! If you are very close to a transmitting tower, and the signal is strong enough to overload your TV receiver, it may be necessary to orient the antenna 180 degrees away from the transmitter direction. ■



For best results use 75-ohm coaxial cable and an impedance-matching transformer.

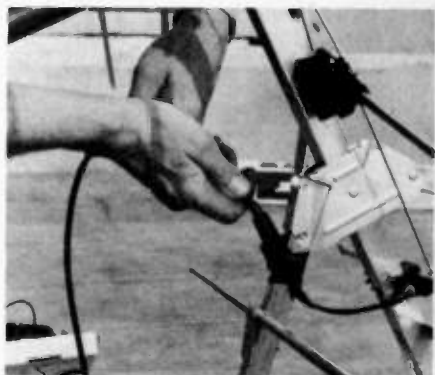

Seal all connections and secure the coax to the mast with plastic electrical tape.

CIRCLE 32 ON  
READER SERVICE  
COUPON



Aim the antenna at the TV transmission tower. Follow the directions in the text.



Unpack the antenna on the roof and unfold the elements only when you are ready.



Secure the antenna to the mast. Most damage to the elements occurs at this time.

# TEN

Ninety percent of auto radio repair problems don't require a trained technician with thousands of dollars worth of test equipment. Many car radio problems concern mechanical connections—a broken wire, loose capacitor or a broken dial cord—others are caused by defective power supplies or overheating parts. Whatever the problem it can almost always be fixed without taking it into a shop and running up a big bill—just learn these tricks-of-the-trade and get down to business.

An auto radio, however, can be very tricky to work on. Sometimes it includes FM as well as the standard AM, not to mention FM multiplex, 8-track, cassette and even CB. When all of this is jammed into a seven-inch wide package it can be pretty confusing to figure out what is what, so you don't want to make things harder than they need be.

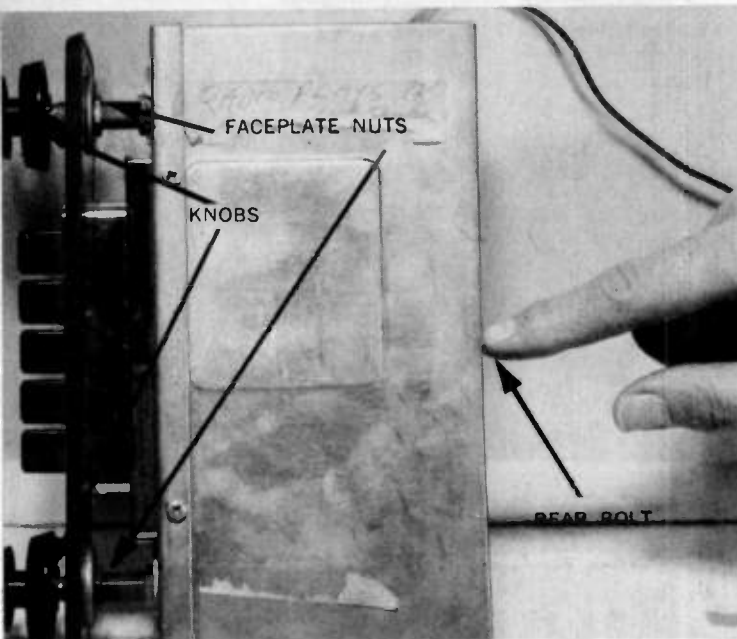
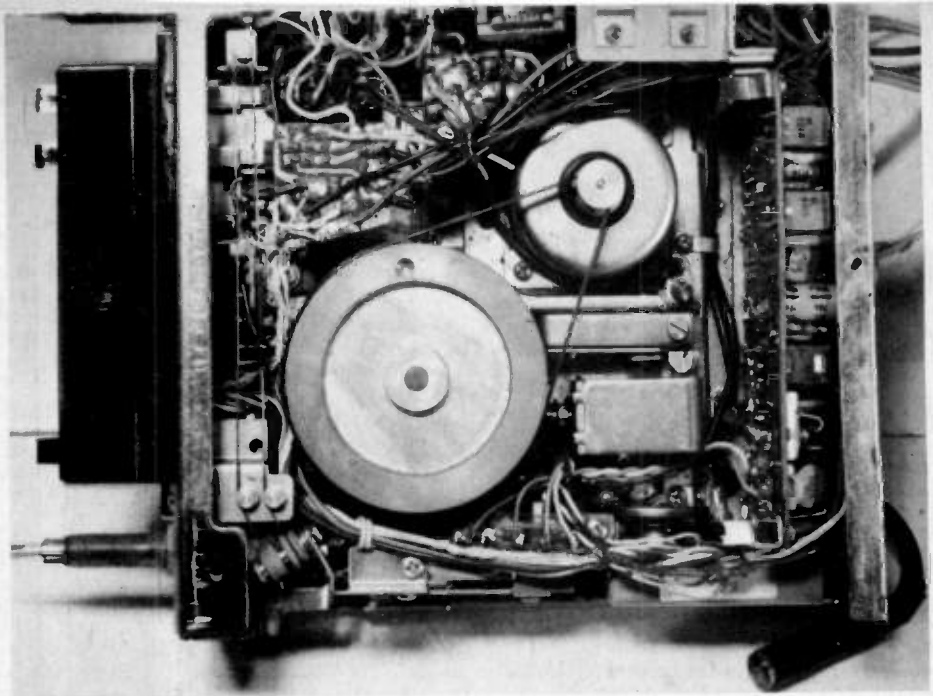

**2.** Doing without a dial light on a car radio is like fixing a flat tire with a dead flashlight after Friday night's football game. Most car radios must be pulled out to replace the dial light. Before removing the radio check to see if the pilot light may be wired to the dash light control switch. Trace two (black) wires leading to the fuse block or auto wiring harness. A defective plug or poor wiring connection may be the trouble.

After removing the radio, inspect the front dial assembly to locate the defective dial light. On some radios you unclip the dial light assembly from the radio chassis. Other models mount the dial light close to the bottom of the dial assembly. You may have to remove the whole front dial assembly to get at the dial light mounted behind a white plastic cover. Within some Japanese models, you may find a dial light with long wire leads.

Most American-made radios use a 12-volt bayonet dial light such as an 1891, 1892, 57 or 47. Foreign radios may have screw type bulbs which are sometimes difficult to obtain. They can be replaced with a bayonet type or one with leads. Since all dial lights are 12-volt types you can solder a bayonet bulb in place of a screw type. If not, replace it with one having a 12-volt flexible lead (like those found in tape players) and cement it in position with black silicone cement.

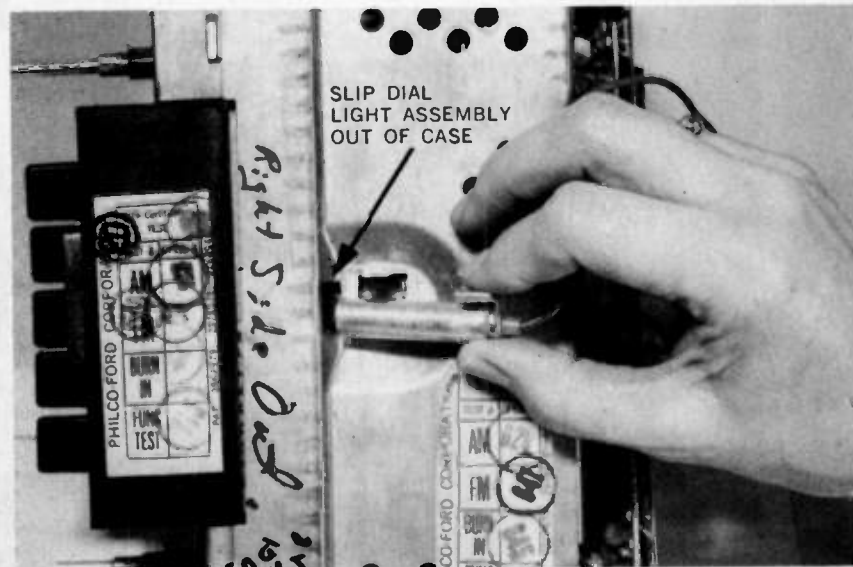

**1.** Before removing the radio make sure the troubles are definitely in the unit itself. You may have a blown fuse, defective speaker, antenna or bad wiring connections. First thing: locate and check the fuse. The fusebox is normally under the dash and to the left of the steering wheel. When a tape player is included in the radio you will find it in the plug or harness. If you can't find it trace the largest wire out of the radio and see where it goes. The color of the "A" lead wire may be black, red or blue.

A defective speaker may be causing the problem and the type of sound is a clue to the cause. If the music is intermittent then the speaker voice coil wires may be partially broken into. A dropped speaker cone will produce a tinny and mushy sound. Typically on loud volume certain vibrations may be caused by a torn or loose speaker cone. Excessive blatting music may result from a loose voice coil support. You should check the speaker for continuity with ohmmeter or a flash-light battery. When using a small battery just temporarily touch the speaker leads and listen for a clicking noise. If you don't get a new speaker.

Check the radio wiring for possible loose or broken connections. If the radio is a universal type, mounted under the dashboard, it's likely that the speaker and "A" lead connections are just twisted together. Remove the tape and solder all connections then retape with plastic tape. In case of stereo speakers, with one side intermittent or dead, inspect the speaker wiring to see if it is frayed.

An open or poor antenna connection may cause weak or noisy reception. If radio reception is very noisy, check the bond between antenna base and metal car body. Another source of car noise may be a broken shielded cable where the male plug enters the radio. With antennas molded into the front windshield check for a broken connection at the bottom of the windshield. Be real careful and don't pull on the antenna connection or you may end up replacing the whole windshield. If another auto antenna is handy simply plug it in and hold the base outside the car window. You would be surprised how many antenna problems are identified by this test.

# CAR RADIO REPAIR TIPS

by Homer L. Davidson

**3.** There are two different types of dial mechanisms found in an auto radio—mechanical and dial cord operations. The mechanical system employs a couple of worm and gear assemblies. The most common problem with mechanical tuning is slippage between the clutch and tuning coil assembly. Clutch tension may be adjusted with a set screw, or liquid rosin and phono-grip may be applied to prevent the clutch from slipping.

You should suspect a broken dial cord if the radio will tune in stations, but the dial pointer doesn't move. You will find two basic dial cord arrangements; a simple one with tuning shaft, two small pulleys and dial pointer; the other with additional small pulleys and dial cord spring. When a spring is not used to take-up the slack, most of the dial cord is wound around the tuning shaft. The small spring keeps the dial string taut around larger pulleys.

Do not attempt to tie a knot in the broken dial cord and make it do. Select a cord of medium or fine dial cord (found in most radio and TV supply houses). If a dial stringing schematic is not handy, draw a diagram the way you found the broken dial wound. Nine times out of ten you have come up with the right method. Remember, when the tuning coil cores are all the way into the coils, your dial pointer should rest at the low end of the dial. Another helpful method is to tie the end of the dial cord to the tuning drum and leave the dial spring to attach at the end of the line.

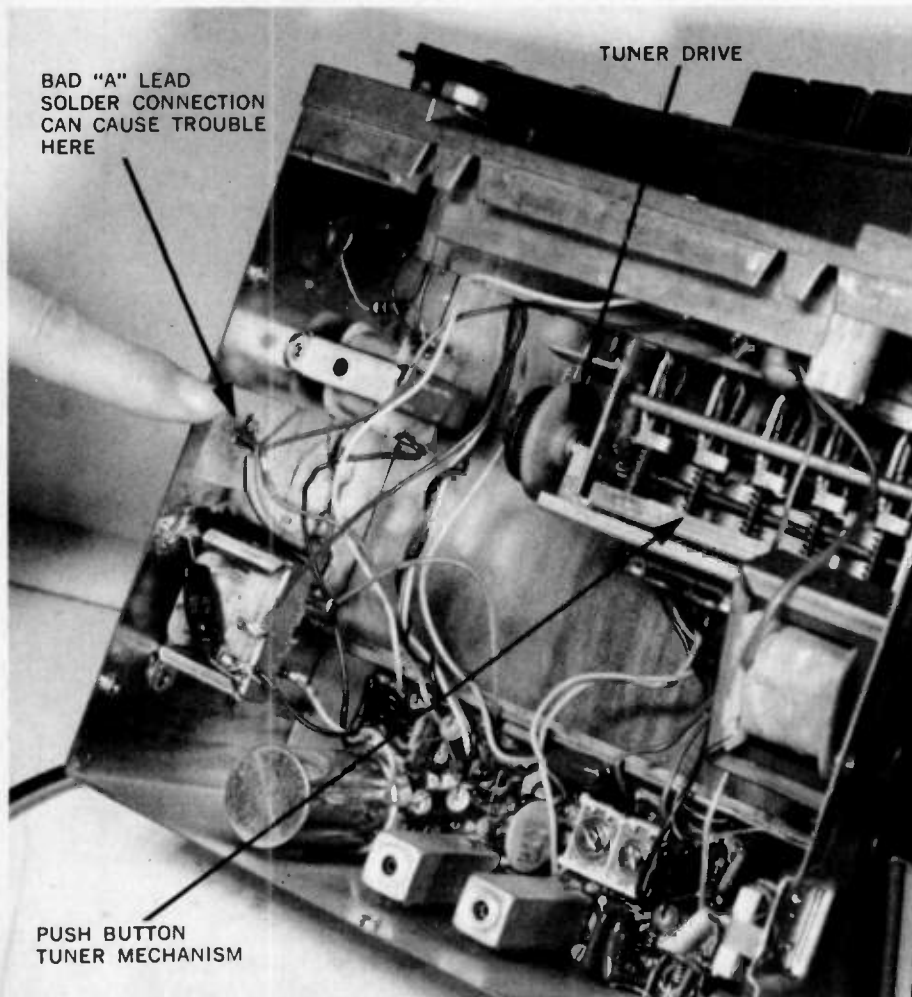
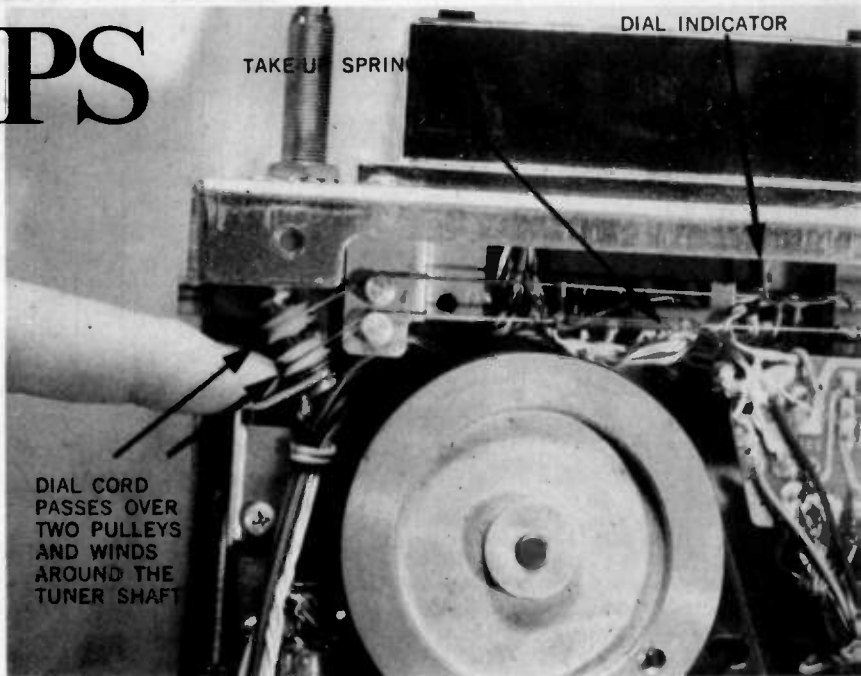

**4.** If your car radio won't produce a sound, look at the small fuse. Visually inspect the fuse holder and "A" lead. Most solid-state radios may pull from 1 to 5 amps.

Always replace the defective fuse with one of the same value. You will find this stamped in the metal edge of the fuse. If in doubt, check the correct radio fuse listed in your car manual. Most Japanese car radios will have a 1- or 2-amp fuse for protection. American manufactured auto radios are protected with a 3- or 5-amp fuse. Very large Japanese radios with tape players may be protected with a 3- or 5-amp fuse, while American made radios with tape players may be fused with a 10- or 20-amp fuse.

Trace the hot lead inside the radio to the spark plate and on-off switch. A poor or broken switch connection can put a radio completely out of action. If the dial light is on you know the switch is good. If not, clip a jumper around the switch connection and check for a 12-volt source at this point.

Substitute a new PM speaker. An open voice coil or poor speaker lead may cause problems. If the sound returns after speaker substitution you may want to check out the defective speaker. With the speaker still connected, push down on the cone of the speaker and see if the sound cuts in and out. A poor or broken voice coil lead may cause intermittent sound conditions. Disconnect the leads and check for continuity across the voice coil leads with the ohmmeter. If the PM speaker is defective, replace it with one of the same voice-coil impedance. You may encounter a 3, 2, 4, 8, 10 or 20-ohm speaker on a car radio. Replace a Japanese radio's speaker with an 8-ohm speaker.

When you turn on the radio switch and a click is heard on the speaker, you may assume that the power output transistor and power voltage are normal. An open or shorted power output transistor may not produce any sound on the speaker. If the output transistor becomes leaky you should at least hear hum or distortion on the speaker.

# REPAIR TIPS

**5.** Does your auto radio start to play only after it's been turned on for twenty minutes or so? Perhaps, it's real weak in volume and then comes on with a bang! These symptoms are caused by intermittent transistors. Since transistors are solid-state devices, cold or heat may make them become open or leaky. Sometimes after applying heat or cold spray the defective transistor will return to normal operation.

Problems caused by heat and cold usually occur in the RF oscillator and IF transistors. If the radio is cold and does not come on instantly, apply heat to the body of each transistor. Start at the RF transistor and apply heat for no more than a second or two. If left on too long you may damage the transistor. Then move on to the oscillator and IF transistors. Sometimes just moving the suspected transistor may cause it to "pop" on. Apply heat when the radio will not come on and coolant if the unit cuts out or becomes weak after it warms up.

Weak conditions may be caused by transistors, the antenna or bad capacitors. When you can hear every station on the dial but weakly, suspect a defective antenna system or RF transistor.

You have eliminated the antenna system as a possible problem if the same weak condition exists on the workbench. Go to the RF transistor and take voltage measurements. A very high collector and very low, or no, base voltage indicates the transistor is open. You may have the same condition if the emitter bias resistor opens up. Check for broken wires or replace it.

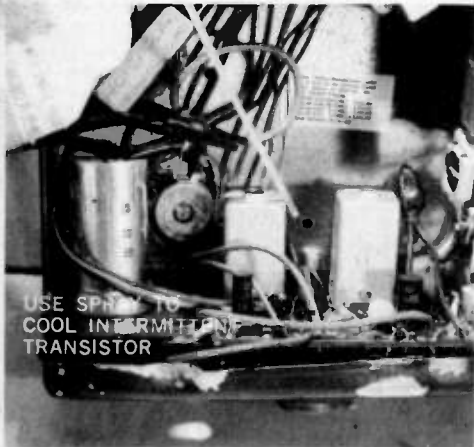

**6.** A coolant or cold spray is essential for locating intermittent transistors. Your radio may play for several hours before cutting down in volume or maybe it will only do it once a week. But, it always acts up while listening to your favorite song or football game.

You may waste hours and even weeks trying to locate an intermittent transistor if it only happens once a week or twice a day. Play it until it begins to really act up—like every hour or two. Then carefully remove it from the auto and connect it to the workbench. Of course, you must have a 12-volt DC source to operate the auto radio, or you may be able to extend the power leads from the auto to the radio and check it out on the front seat. Always, observe and connect each wire to its hookup.

Try to isolate the intermittent problem. Start at the volume control when the radio is in the intermittent state and notice if the audio section is functioning. Simply hold a screw-driver blade on the center tap of the volume control and you should hear a loud hum. If not, the audio section is intermittent. Then start at the driver transistor and work towards the front of the receiver. Spray each transistor at least three or four times. If the music begins to play you have located the defective transistor. Don't remove that transistor just yet. Let the radio go into the intermittent condition and spray it once more—to make sure the transistor is intermittent. You may also find coolant sprayed upon certain areas of the PC board will bring out those poor, soldered connections.

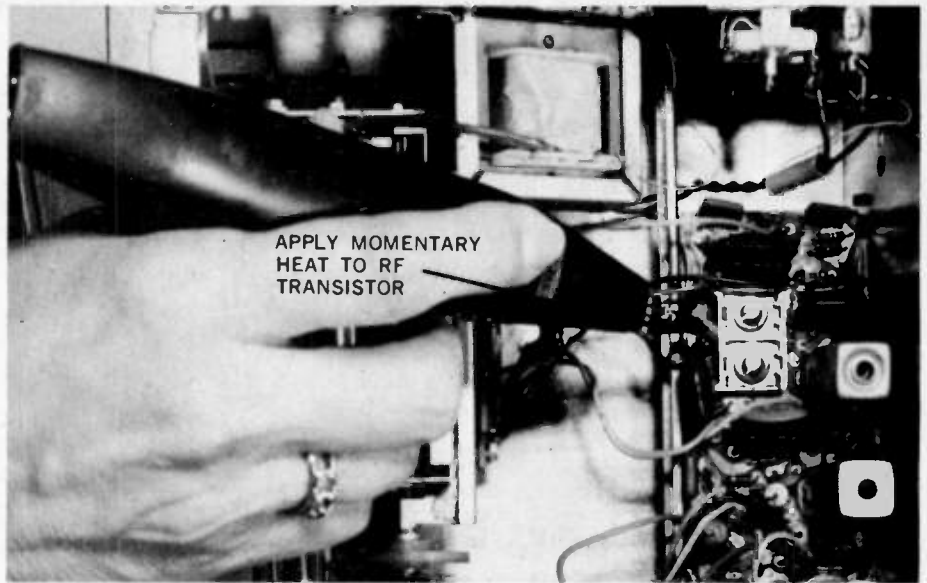

**7.** You may find one, two or possibly four power output transistors in your receiver. Within the AM radio you may locate one single or two push-pull power output transistors. Generally, four power output transistors are found in the AM-FM-MPX and tape player receivers. If your radio incorporates an eight-track tape player there are eight power output transistors. Just go slow and easy when replacing the defective output transistors.

After locating the defective output transistor check to see if the transistor and mounting screws are insulated from the heat sink with a piece of mica or plastic material. In a push-pull output circuit you may find one transistor insulated from the heat sink and the other mounted directly upon it. Sometimes a single output transistor may be mounted upon the heat sink and the heat sink is insulated away from the radio chassis. Remove only one transistor at a time if both output transistors are being replaced.

Replace the power output transistor with an identical unit. If a piece of mica insulation is found between the transistor and heat sink apply silicone grease to both sides of the insulation. You will find most output transistor replacements enclose an insulator in each package. Remove the old grease and dirt with alcohol and a cloth. Now firmly tighten down both mounting screws. Be careful, too much pressure may bite through the insulation and short out the transistor.

When mounting output transistors with only one mounting screw be sure the three terminals of the transistor go through the correct holes of the insulator. The terminals are then bent at a right angle and fitted into the transistor socket. Make sure the terminals are clear through the socket piece to make a good contact. In many cases these flat type transistors are soldered directly to the audio PC board. You may find this single-hole mounted transistor at the rear heat sink, on the chassis near the volume control or just inside of the front tuning panel.



**8.** With all those odd noises coming out of the speaker you may think a swarm of bees or mice are trapped inside the radio. Actually, all of these noises can be caused by an open filter capacitor in the power supply. Locate either a filter pack or a single filtering capacitor upon the radio chassis. To find out which one is defective, turn off the power and clip a new capacitor (1000 mfd) across the suspected one. This test will uncover an open capacitor.

When more than one filter capacitor is located in one container, shunt the clips to the tie point (+) and chassis ground. To test a single filtering capacitor, clip the new capacitor across those found upon the PC board. You may find two or three single filter capacitors on the board. Observe correct polarity (+) in testing and replacement. The negative terminal (outside metal case) connects to chassis ground. Clip the new capacitor across each suspected one until the noise stops being very bothersome.

If you locate a defective capacitor in a container with several other capacitors, replace the entire filter network. Replace the defective capacitor with one of the same capacitance and voltage value. If you cannot locate one of the same value, use one with a little higher capacitance and operating voltage.

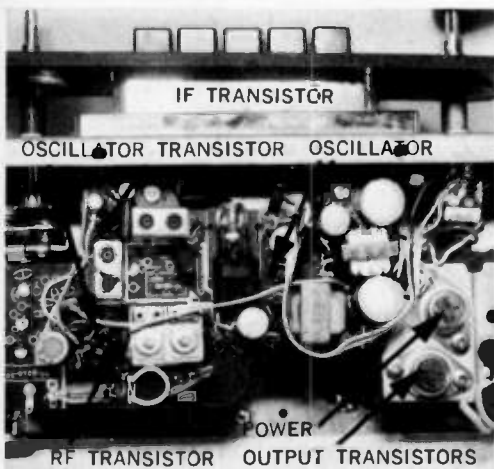

**10.** Suspect a defective oscillator transistor when one half of the tuning dial is alive. Usually the high end of the dial is dead but it may be either end. The oscillator transistor is located close to the tuning mechanism oscillator coil and padder capacitors. In some auto receivers it may be marked on the PC board. A transistor test may show that the transistor is good but will not oscillate across the whole broadcast band. Simply remove the transistor and install a new one.

One important thing to remember is to avoid the temptation to put a small screwdriver into the tuning coils and capacitors. It is improbable that you will be able to improve the radio's performance this way. You should never adjust these unless you have the proper test equipment and have been trained in its use. More radios go to the junk pile thanks to well-meaning coil and capacitor adjusters. Most of the time these adjustments are made at the factory and then sealed with wax so they can't vibrate out of tune.

**9.** Don't be too surprised if your car radio begins to sound like a small gasoline engine. The put-put noise you may hear in the speaker may be a sign that excessive motorboating is occurring in the RF, AF and power supply circuits. Go directly to the filter circuits of the power supply and shunt a large (1000 mfd) electrolytic capacitor across each one. Always, remember to turn off the receiver and clip the capacitor in place to prevent damage to other transistors. Also, observe correct capacity polarity. When the motorboating noise quits, you have located the defective filter capacitor.

If the filter capacitors in the power supply are not causing the motorboating action, shunt smaller electrolytic capacitors in the B+ and decoupling circuits. These (100- to 250-μF) capacitors may be found anywhere in the PC board. Also, check for defective bypass capacitors in the emitter circuits of RF and AF circuits for motorboating problems. Simply shunt a new one of the same value across the suspected capacitor.

Excessive motorboating may be caused by an audio output or AF transistor. Try to isolate the AF or driver transistor by shorting the base and emitter terminals together. Be careful to make sure you are on the right terminals. If motorboating ceases either the transistor is defective or the fault is in the preceding stage. Replace the audio output transistor if suspected of motorboating. Most of these audio output transistors are easily replaced since they are mounted to the heat-sink with a couple of screws.

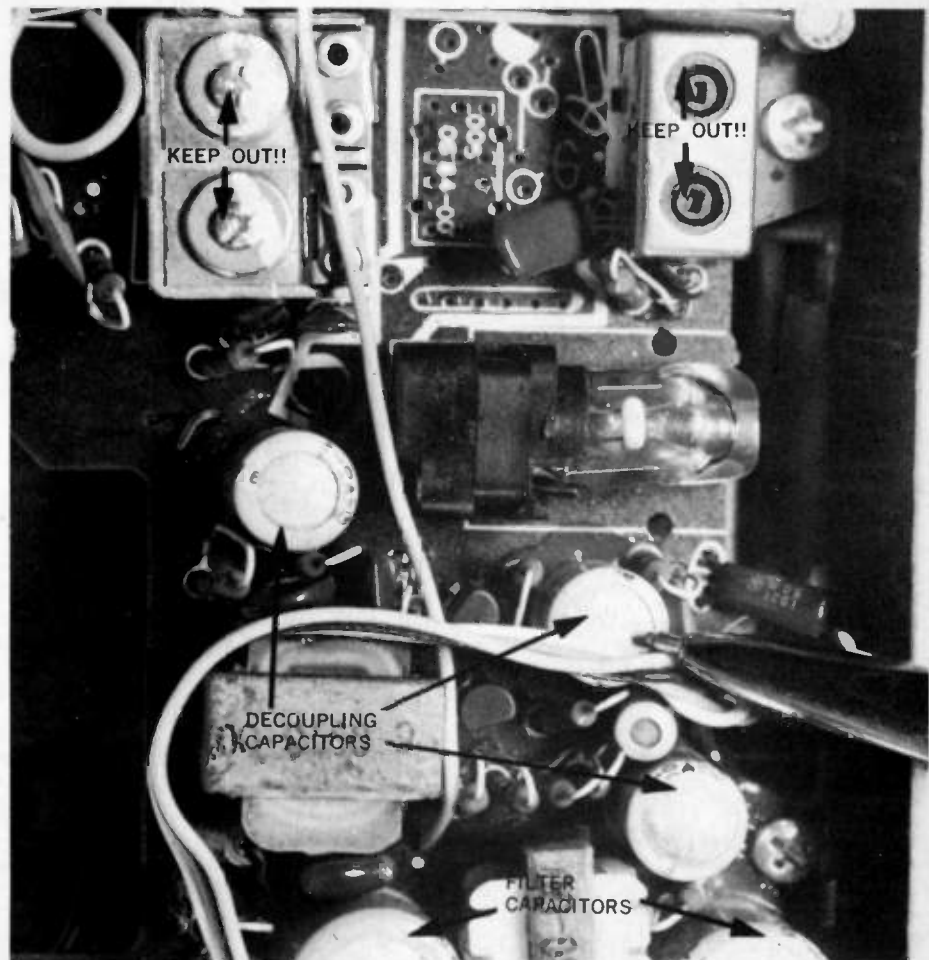

# BUILD A BUDGET

Heathkit's new instruments make

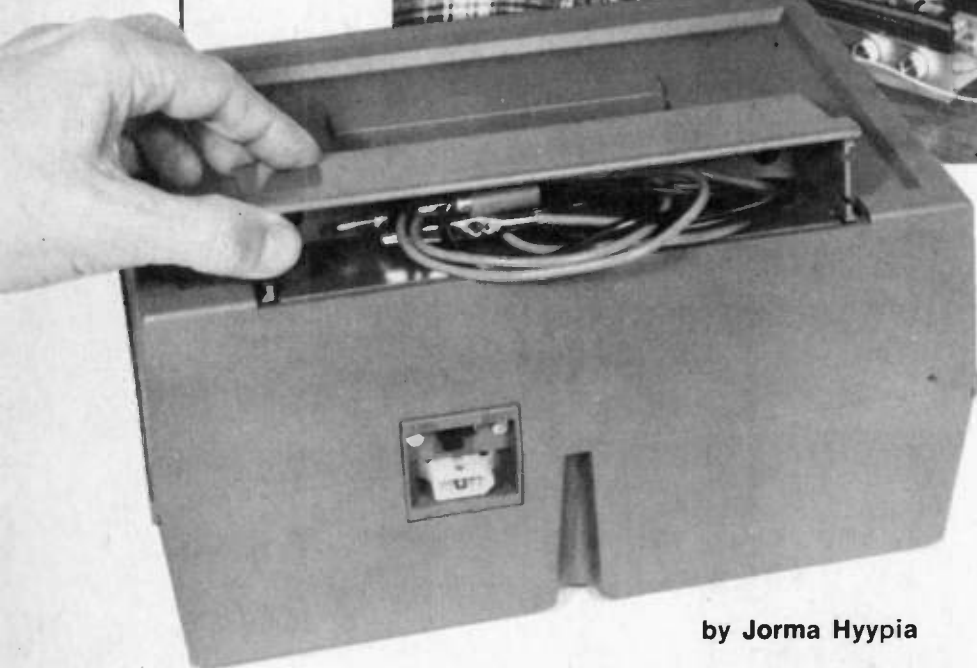

How often have you misplaced cables for an instrument, or tangled them all together? Each instrument has a handy storage space.

other reason than that it might be vital to troubleshooting possible construction errors you might make when building the other test instruments (although you should experience no problems if you follow Heath's peerless directions carefully). The Multimeter, of course, measures resistance, DC voltage, AC voltage and DC current.

What you should buy next depends largely on your intended uses for the equipment. I'd opt for the Signal Tracer (Model IT-5283) which is a real time-saver when tracking down a malfunctioning stage in a piece of audio equipment. The unit also functions as an *audible* voltmeter that is especially handy for tracing logic circuits because its sound tones vary in pitch as measured voltages change—more about that later.

Your third choice might be the Audio Oscillator (Model IG-5282) because it too is applicable to troubleshooting a broad variety of electronic gear, including radios and TV sets. It puts out both sine wave and square wave signals for checking stage gain, distortion, frequency response and harmonic distortion.

Consider the RF Oscillator (Model

by Jorma Hyypia

**A**S WE ACCUMULATE ever increasing numbers and varieties of electronic equipment in our homes, everything from kitchen appliances to elaborate hi-fi audio equipment and even hobby computers, we compound the basic problems of keeping everything in operating order without suffering budget-crushing repair bills. One answer is to do at least part of our own troubleshooting, leaving only the toughest jobs for professional repairmen.

**The Five Choices.** But for that you need reliable equipment as well as know-how. Many who would be willing—in fact eager—to learn how to

troubleshoot electronic and electrical equipment have not done so because of the high cost of test equipment, but that no longer need be a deterrent. Heath Company has come out with a much-needed line of basic test instruments and at truly affordable prices. Each of the five matched units described in this article costs only \$39.95, plus any applicable tax, in kit form. A handy, optional AC power pack costs \$27.95.

If you can't or don't want to buy *all* of the instruments at one time, start with the Multimeter (Model IM-5284) because it is basic to all kinds of troubleshooting. It is a "first" if for no

# TEST BENCH!!!

testing gear easy on the wallet.



The test instruments may be stacked any convenient way, in pairs as shown here or a stack. The plastic cases will interlock.

IG-5280) as your fourth acquisition, especially if you want to align AM radios and troubleshoot tuned stages of FM and TV receivers.

The RLC Bridge (Model IB-5281) measures the values of resistance, inductance and capacitance of electronic components. The instrument would be especially useful to electronics experimenters and hobbyists who have need to determine the electrical characteristics of "junk box" components that have missing or obliterated identifying marks and values.

Now let's take a closer look at each of these instruments to see what you would get for your money, and what you might do with each of them.

**Multimeter.** This instrument combines the functions of a high input-impedance voltmeter, an ohmmeter, and a milliammeter, with all measurements indicated by a large, 4½-inch meter with 100 degree movement.

Each function has four ranges. The DC voltmeter measures from zero to 1, 10, 100, and 1000 volts full scale with an accuracy of  $\pm 3\%$  of full scale; the input resistance is 10 megohms on all ranges. The AC voltmeter offers the same four voltage ranges, with an accu-

CIRCLE 1 ON  
READER SERVICE COUPON

racy of  $\pm 5\%$  of full scale. The input resistance is 1 megohm on all ranges, input capacitance is about 100 pF (40 pF on 1000 V range), and the frequency response is  $\pm 1$  dB from 10 Hz to 1 MHz (from low source impedance). The DC milliammeter reads from zero to 1, 10, 100, and 1000 Ma full scale with  $\pm 4\%$  accuracy of full scale. The resistance reading multipliers are 1, 100, 10K, and M. Ten ohms is at center scale, and the ohmmeter reads with  $\pm 3$  degrees of arc accuracy.

In addition to reading resistance of various electrical and electronic compo-

nents or component systems, the ohmmeter is very useful as a continuity tester to determine whether there is a complete path in a circuit through which electric current can flow. It can help you to quickly and easily find breaks in many household electrical devices such as electric irons, heating pads, waffle irons, lamps, extension cords, toasters and many other items. These of course are all "power off" tests, with the appliance disconnected from its normal power source.

The DC voltmeter can be used for such simple chores such as checking the batteries of a portable radio or

All the test instruments are easy and simple to assemble, even for the first-time kit builder. The instructions feature ultra-clear, step-by-step formats and illustrations.

## BUDGET BENCH!

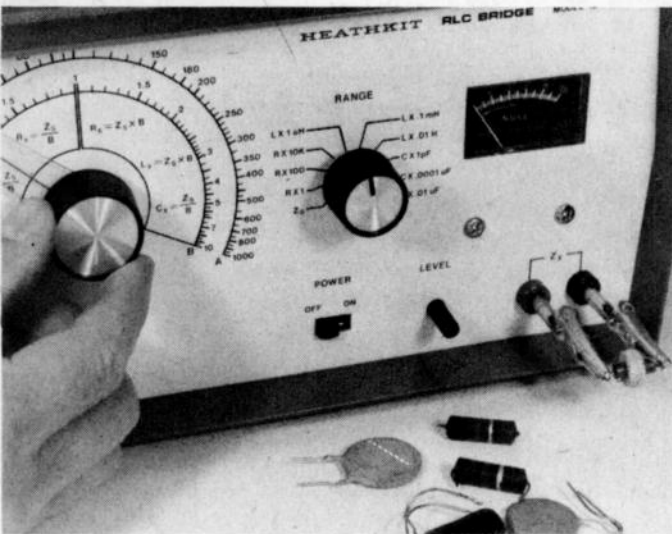

The RLC bridge is especially handy for those who must measure resistance, inductance and capacitance of junk box parts. This photo shows an unknown coil being measured for its inductance by simply clipping it to the alligator clips on the lower right corner of the RLC bridge's front-face panel.

other battery-powered device, testing automobile electrical circuits, or for more complicated jobs—such as comparing voltages in hi-fi audio equipment against manufacturer specifications during troubleshooting. The AC voltmeter might be used to find the fault in a doorbell circuit or any other AC-powered device, and to a limited degree is useful in audio troubleshooting. Of course all of these functions, including the milliammeter, are out-and-out necessities for those engaged in any kinds of general electronic hobby or experimental work.

**Signal Tracer.** This instrument is one of the most effective tools you can own for rapid troubleshooting in radio and TV circuits. It is basically a hi-gain amplifier having a diode-equipped probe which acts as an RF detector. A relaxation oscillator provides an audible volt/ohmmeter function. The instrument is of the "untuned" variety for simplicity of operation.

By setting the function switch to *Signal Tracer* position, and clipping the black lead to the chassis or ground circuit of the radio or TV under test, the probe can be used to trace a signal through various stages until a dead stage is found. You set the probe to RF detection initially, then switch to DC after the traced signal has gone through the detector. You can also use the instrument to spot intermittent or faulty volume controls or coupling capacitors. Bear in mind that the signal tracer will detect the presence as well as absence of a signal. For example, it's common practice to use a high capacity by-pass capacitor in the audio output circuit. If the capacitor is open, there will be a definite indication of a signal at the by-pass capacitor,

whereas a good capacitor would pass the signal to ground.

By placing the probe switch in the DC position, and the function switch in the *Audible V/Ohms* position, you have an "audible voltmeter" that will surely produce a "why didn't I discover this before" reaction the first time you use it. In this mode, the instrument not only reveals where in a circuit under test signals are present or absent, but also indicates, by changes in pitch of the audible tone, relative high and low voltages. As voltage increases (or resistance decreases) the frequency of the tone increases; and as the voltage decreases (or resistance increases) the frequency (pitch) of the tone goes down. The device responds to voltages from about  $-3$  to  $+20$  VDC, and to resistances from zero to 5 megohms.

The audible voltmeter is especially convenient when you would rather not have to take your eyes off the circuit under test to look at a dial or readout on a voltmeter or ohmmeter; you just listen! There's much less chance of a probe tip slipping to short-circuit delicate components.

In service work it is sometimes necessary to remove the chassis of a radio or TV from its cabinetry and disconnect the speaker. The Heathkit Signal Tracer can be used as a substitute speaker because the speaker is completely disconnected from the internal circuitry when the function switch is in the *Off/Spkr Sub* position. Speaker packs on the front panel make it easy to connect a radio or TV set to this speaker.

You'll find many off-beat uses for this versatile instrument. You can use it to check a phono turntable for any irregularity in mechanical operation, such as turntable wow or thump, or

any objectionable noise transmitted through the phono cartridge. You can also use it to test microphones and musical instrument pickups.

**Audio Generator.** The sine wave generating circuit in this instrument is a Wien-type oscillator. The frequency output is 10 Hz to 100 kHz in four ranges; the sine wave output voltage is 0 to 3 volts rms while the square wave output voltage is 0 to 3 volts peak.

Gain and distortion checks are probably the most common types of sine wave tests you will make using this generator; in either case, you can test a single amplifier stage separately, or the amplifier system as a whole. You simply connect the generator output to the input of the amplifier to be tested, feed a signal of known amplitude (voltage) into the amplifier, and measure what comes out by means of a voltmeter or oscilloscope to determine the voltage gain provided by the amplifier. Frequency response tests are made by determining the gain at various frequencies. To test for distortion, simply compare oscilloscope waveforms representing the generator output and how it looks after passing through the amplifier.

Square waves are very useful for testing amplifiers because one square wave can perform several tests simultaneously—simply because a square wave actually consists of many superimposed sine waves. By using a square wave, you can test a circuit at many different frequencies at the same time. The Heathkit manual explains how the frequency response of an amplifier, from 10 Hz to 100,000 Hz, can be checked by setting the square wave output to only two frequencies—100 Hz and 10kHz.

By observing, with the aid of an oscilloscope, changes in the shape of the input square wave after passage through the amplifier, you immediately see whether low-frequency response is good or bad, and whether some of the higher harmonics might be missing.

You can use the sine wave and square wave outputs of the generator at the same time without detrimental effects to either waveform. For example, when making stage gain measurements on an amplifier with an oscilloscope, connect the sine wave output of the generator to the input of the stage being measured, and the square wave output to the external sync connector of the oscilloscope. You then can measure a number of amplifier stages without readjusting the oscilloscope sync controls, regardless of how small or how large the signal happens to be.

There are many other applications for this versatile audio generator. It can



be used to measure the input impedance of an amplifier or other circuit, for example. Or it can be used as an audio signal source during signal tracing with the Heathkit Signal Tracer instrument. The electronics hobbyist who likes to build and experiment with all kinds of gadgets can surely find many other uses for this generator.

**RF Oscillator.** A Hartley oscillator is used to generate the basic RF frequency range from 310 kHz to 32 MHz in four bands, and separate oscillator circuitry is used to extend the output to 110 MHz in a fifth band. There's also an additional band of calibrated harmonics extending from 100 MHz to 220 MHz. The output voltage is about 100 mV (open circuit), and internal modulation is 1,000 Hz. For added convenience, there's also an audio frequency output signal of 1,000 Hz with an output voltage of 2 volts rms (open circuit).

It's possible to use this RF oscillator as an RF signal source for peak alignment of tuned circuits in some FM radios and tuners. But a better method of aligning FM equipment is by means of sweep alignment (for which you need a different type of generator); in that case this RF oscillator may be used as a marker generator.

Despite this limitation, there are many other useful applications for the oscillator. For example, the instrument is what you need to align any AM radio. The radio speaker itself, or a suitable voltmeter like the Heathkit Multimeter shown in this article, may be used as the output indicator. The voltmeter is preferable to the speaker because it will indicate smaller changes in the output signal. The Heathkit manual tells where to connect the voltmeter (different places depending on whether you use the AC or DC section of the meter) and in general how to go about aligning the radio.

The RF oscillator is also very valuable when using a "signal injection" method of troubleshooting weak or dead electronic devices including radio and TV receivers, hi-fi amplifiers and the like. In this method, a signal produced by the oscillator is coupled into various stages of the defective equipment, one stage at a time, until the defective stage is located. For example, to find the faulty stage of an AM receiver, the 1,000 Hz audio signal from the oscillator would first be connected to the base of the output transistor and then be moved back to the audio transistor. If normal sound is heard from the speaker in both cases, you'd switch to use of a modulated RF signal to check the remaining stages of the radio. Once the defective stage is located, a search for the individual defective component within that stage would be sought. Further tests using the 1,000 Hz audio signal, for example, might indicate that there's an open coupling capacitor between two amplifier stages.

**RLC Bridge.** The internal electronic configuration of the RLC bridge is basically the same as the familiar Wheatstone Bridge you studied in your

high school or college physics course except that a fixed, internal component standard ( $Z_s$ ) is used in place of the usual calibrated potentiometer. The standard, used in conjunction with a range switch, selects a suitable multiplication factor and a certain frequency appropriate to the component being tested.

When you insert an unknown component of value  $Z_x$  you balance it electrically against the same kind of reference component in the RLC bridge, then read the value of the unknown from the circular scales. The bridge uses an AC rather than DC source because capacitors and inductors cannot be tested with DC. The required AC is generated by a Wien bridge oscillator which provides three output frequencies (1000, 100 and 10 Hz) which the range switch selects.

To measure the inductance of a coil, just fasten it to alligator clips plugged into the  $Z_x$  jacks on the front panel, set the range switch at one of the three  $L$  positions, then turn the *balance* knob until the null meter indicates a minimum reading (which may not be zero). If no null can be obtained, switch to an  $L$  range that makes the meter responsive, then read the value of inductance from the appropriate balance scale.

The same procedure is used to measure resistance or capacitance, except that the range switch is turned to the appropriate  $R$  or  $C$  position.

It's also possible to compare the unknown component with an external standard plugged into the  $Z_s$  terminals on the front panel by setting the range switch in the  $Z_s$  position. This convenience can be used, for example, to quickly compare resistors to find

*(Continued on page 114)*

Heath's new line of test instruments are a handsome addition to any bench.

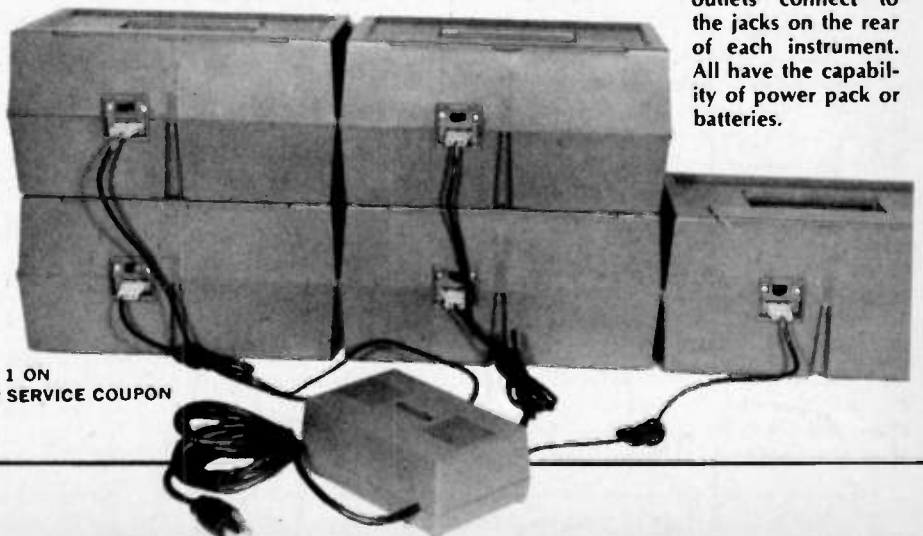
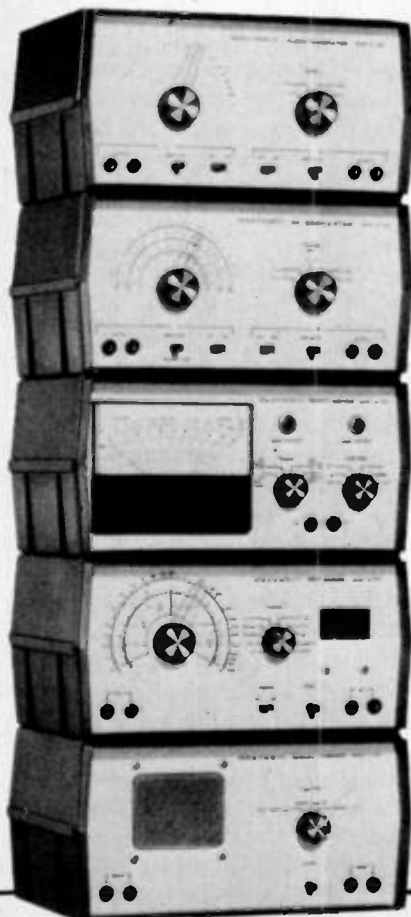

The power pack's five outlets connect to the jacks on the rear of each instrument. All have the capability of power pack or batteries.

CIRCLE 1 ON  
READER SERVICE COUPON

# BUDGET QUICKIE

## Guitar Tuning Aid

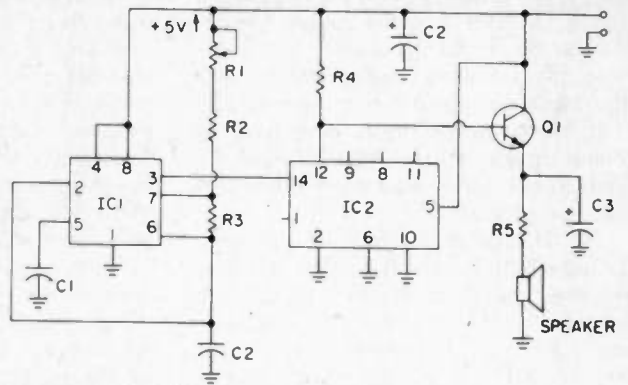

### PARTS LIST FOR GUITAR TUNING AID

- C1—0.1- $\mu$ F ceramic capacitor, 15 VDC
- C2—15- $\mu$ F electrolytic capacitor, 15 VDC
- C3—100- $\mu$ F electrolytic capacitor, 15 VDC
- IC1—555 timer
- IC2—7490 decade counter
- Q1—2N4401
- R1—50,000-ohm linear-taper potentiometer
- R2, R4—4,700-ohm,  $\frac{1}{2}$ -watt resistor
- R3—33,000-ohm,  $\frac{1}{2}$ -watt resistor
- R5—33-ohm,  $\frac{1}{2}$ -watt resistor
- SPKR—8-ohm PM type speaker

When you're into electronics, Calectro is into whatever you need — whether it's ideas, instructions, or a complete supply of parts

Calectro has projects designed for you: a "Project of the Month", conceived by the Calectro engineering department, along with detailed instructions and a list of all the Calectro parts you need to build it!



Calectro has parts and accessories: printed circuit materials, tools, meters, testing devices, equipment boxes, sockets, switches, IC's, transistors, rectifiers, lugs, fuses, bulbs, wire, connectors, terminals, jacks, transformers, and lots more — everything you need to complete your project. And you'll find more of the parts you want at your Calectro store than anywhere else.



Calectro has literature: the Calectro Handbook — a valuable guide and product reference for the experimenter, hobbyist, audiophile, technician, and student; plus handbooks on semiconductors, circuits, and more! Coming soon: a new Calectro Handbook, a compendium of popular project ideas.



Whatever you need in electronics, your Calectro distributor is your surest, finest source!

**Calectro**

Products of GC Electronics, Rockford, IL 61101

By taking advantage of the frequency stability of the 555 timer IC operating in an astable mode, an oscillator can be constructed which can be used as a tuning aid for the guitar. The first string of the guitar, E, produces a note with a frequency of 82.4 Hertz. The frequency of the oscillator is set to twice this value, 164.8 Hertz, and then followed by a divide-by-two stage to produce the desired frequency. The purpose of the divide-by-two stage is to guarantee that the waveform produced has a duty cycle of exactly 50%. This produces a note with no second harmonic distortion. The frequency of oscillation of the circuit is set by adjustment of R1. R2 and C2 also determine the frequency of oscillation but these components are fixed values and need no adjustment. The output of IC2 is fed to an emitter follower to provide current gain to drive a loudspeaker. C3 acts as a low-pass filter to attenuate harmonics and produce a more natural sounding note. The circuit is powered by a 5 volt supply, and this voltage *must* fall within the range of 4.75 to 5.25 volts for IC2 to operate.

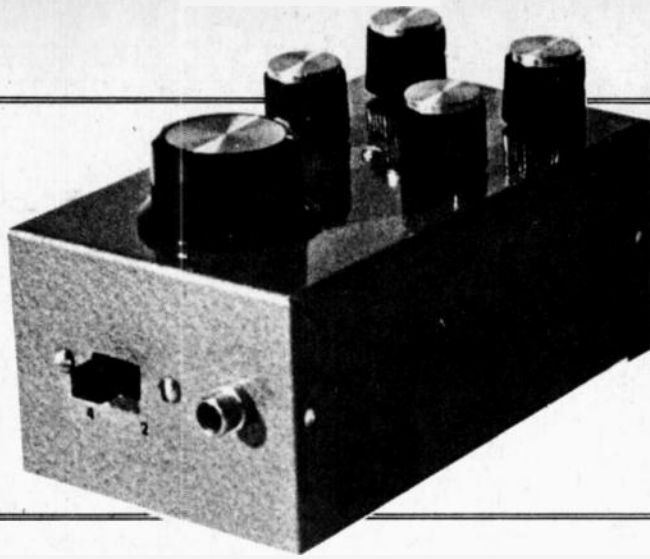

# PASSIVE MIXER

Mix music like a pro with this low-cost passive mixer.

by Walter Sikonowiz

□ One of the handiest accessories that an audio enthusiast can own is a mixer, a device to combine several channels of sound into one. Mixers are especially useful to the tape recorder, who mixes sounds from several sources so that they occupy a single track of his recording tape. For P.A. applications as well, a mixer is indispensable. Perhaps you too have wanted to try your hand at the creative effects possible with a mixer, but have been turned off by the high prices asked for these devices. Generally, commercial mixers provide other functions besides mixing (i.e., amplification, impedance-matching, filtering, sometimes reverberation, etc.), and it is the presence of these extra functions that causes the price to soar.

A bare mixer is an amazingly simple device that requires only passive components such as resistors and capacitors. Such a passive mixer is not only simple and cheap, but it is also free from the gremlins that haunt you whenever active elements are put into a device: distortion, hum and noise. If you can spare a few hours of your time plus less than ten dollars, you can easily duplicate the passive mixer presented here. In fact, if you shop wisely, you should spend considerably less than ten dollars.

From the schematic you can see that this is a four-channel mixer. Potentiometers R1, R2, R3 and R4 control the relative levels of the four channels, and potentiometer R9 acts as a master gain control. Resistors R5, R6, R7 and R8 tie the four input channels to the single output. The input impedance of each channel is 10,000 ohms, while the output impedance ranges as high as 40,000 ohms.

When switch S1 is closed you have full four-channel mixing capability. Should you need to mix only two channels, open S1. This will give you about

70 percent more output voltage, and this may come in handy when your inputs are low-level. Remember, a 70 percent increase in the input voltage to an amplifier approximately triples the power delivered by the amp to its load.

Construction of the mixer is non-critical, but a metal (aluminum) cabinet is recommended for shielding purposes. Such a shield will prevent the high resistances in the circuit from intercepting any unwanted electrical interference. The shield is denoted in the schematic by a dotted line that connects to system ground. Apart from providing a shield, you have a free hand in the mixer's construction.

One nice thing about a passive mixer is that you don't have to provide power,

so you can build it into another piece of equipment, such as an amplifier, without much fuss. On the other hand, because the device is passive, its gain must be less than or equal to one. We can illustrate that fact like this. If your input consists of four sources having 10-volt peak-to-peak amplitudes, the largest possible composite output signal will be less than 10 volts peak-to-peak.

Use of the mixer is fairly obvious; just hook it up and experiment. However, you should keep an eye on impedances. The impedance of any source should be less than 10,000 ohms in order to avoid loading by the mixer. At the opposite end, the mixer should drive a load whose impedance is greater than 100,000 ohms. Both of these rules may

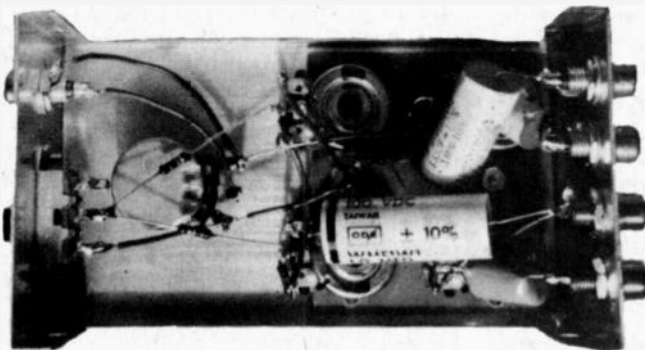

The passive mixer is a very simple device and it requires no complex or expensive parts. The unit pictured here is very obviously a junk box special. Note the two slightly different RCA jacks and the variety of capacitors used.

The concept of the mixer is simplicity in itself—the four inputs are individually controlled by the four variable resistors labeled 1 through 4 and the overall output is governed by the large variable resistor.

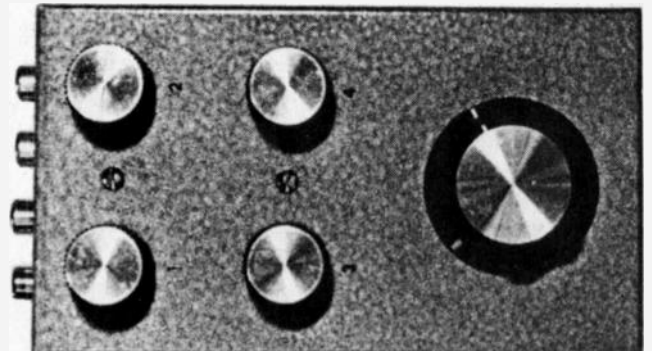

# MIXER

be violated, but at the expense of decreased output. However, you will find that neither of these rules is very restrictive. Low-impedance microphones, tuners, most preamplifiers and power amplifiers can all drive the mixer with ease. And so far as the load is concerned, most amplifiers and tape decks have high-impedance inputs that can be easily driven by the mixer. Note that since the mixer's output impedance is fairly high, it is wise to use a shielded coaxial output cable as well as shielded input cables. When building this project you might try putting all the inputs and outputs on the rear of the box and all the potentiometers and switches (you might like to add a switch to each input) on a nice looking front panel.

This wraps up the discussion on the mixer; the rest is up to you. After you've used this handy mixer for a while, you'll probably agree that the little money spent on this project was money well spent. ■

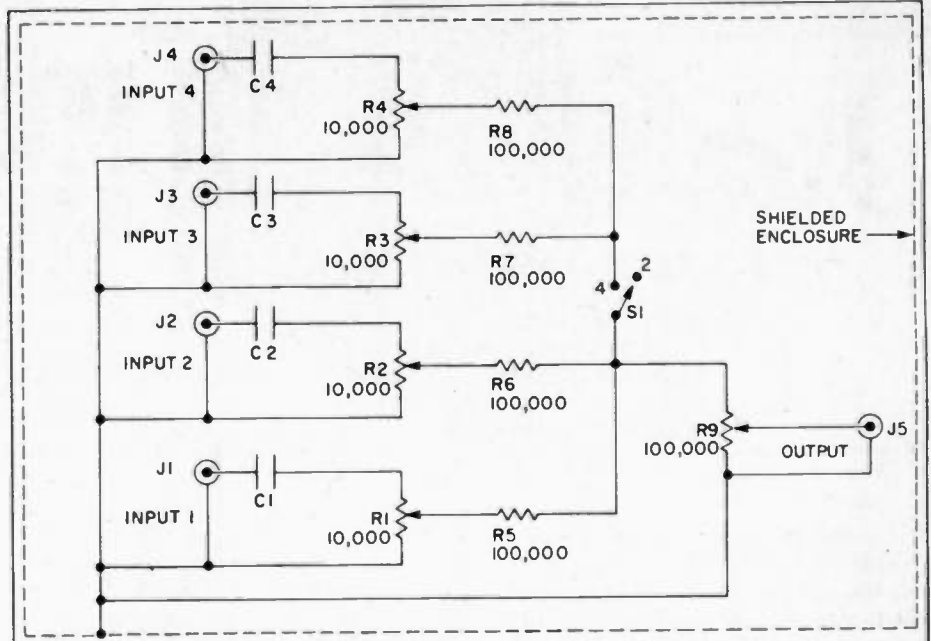

PARTS LIST FOR PASSIVE MIXER

- |   |   |
|---|---|
| C1, C2, C3, C4—1 uF., 250-Volt mylar capacitors | potentiometers                            |
| J1, J2, J3, J4, J5—Phono jacks                  | R5, R6, R7, R8—100,000-ohm, 1/2-watt, 10% |
| R1, R2, R3, R4—10,000-ohm audio-taper           | R9—100,000 audio-taper potentiometer      |
|   | S1—SPST slide switch                      |

## 5V/3A for Digital Projects

□ The 5-volt power supply is almost the universal power source for digital projects. Only problem is the 5 volts must be highly regulated, for a power line transient riding through the supply can zap a board full of ICs. This supply gives you full protection against transients, as well as providing tight regulation. The entire regulator is contained in IC1; no other components other than the filter capacitor and rectifier are needed. For full 5 ampere output IC1 requires a

heat sink of 30 square inches; but if you use a metal cabinet 3 x 4 x 5 inches or larger the cabinet itself serves as the heat sink. Since pin 3 on IC1 is grounded (to the cabinet), all you need is some silicon heat sink grease between the IC and the cabinet—no insulator.

Power transformer T1 must be rated for the maximum current you will use or need. If you want the full 5 amperes T1 must be rated 5 amperes. But if you will need less cur-

rent, say 2 amperes, T1 can be rated 2 amperes.

Rectifiers O1 through O2 are available with ratings up to 3 amperes in the standard coaxial mounting. For greater current capacity the rectifiers must be heat-sinked (electrically isolated) to the cabinet, or other sink. A 10-ampere bridge rectifier such as sold by Calectro and Radio Shack can be substituted, but make certain it is heat sunked to the chassis. ■

### PARTS LIST FOR 5V/3A FOR DIGITAL PROJECTS

- C1—3000-uF, 25 VDC electrolytic capacitor
- C2—0.1-uF Mylar capacitor
- C3—500-uF, 10 VDC electrolytic capacitor
- D1-D4—See text
- F1—1/4 ampere, 3AG
- IC1—5-volt regulator, LM223 or LM323
- S1—Spst slide or toggle switch
- T1— see text

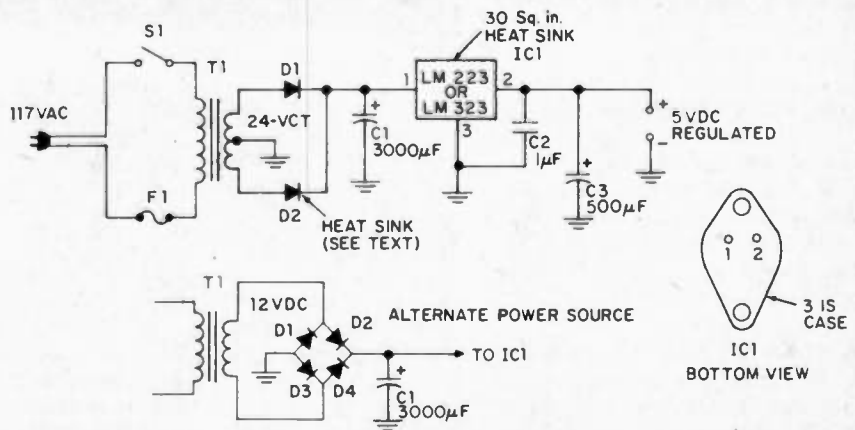

# THE JUNK BOX SPECIAL

Power your projects, spend pennies for parts.

by Herb Friedman

Between 555 timers, TTL, CMOS, opamps and run of the mill transistor projects, the average experimenter is often faced with the need for a regulated power supply with a range of about 5 to 15 volts—just to try out a breadboard project. If you've priced any regulated supplies lately you know they don't come cheap. Maybe, just maybe, you might get one for \$30 or \$35.

With a little careful shopping, a reasonably stocked junk box and one or two "brand new" components you can throw together a regulated supply costing less than \$10 that will handle most of your experimenter power supply requirements. One of these Junk Box Specials is shown in the photographs and schematic. The range of this model is 5 to 15 volts DC at currents up to 1 ampere. One of the common, 3-terminal regulators which are now flooding the surplus market provides everything in the way of regulation. Depending on the source, the regulator will cost you from \$1 to \$2.50; the higher prices often include an insulated mounting kit (worth about 25-cents).

5 to 15 volts from one 3-terminal regulator? Correct. If regulator IC1's collector terminal is connected to a voltage divider across the output—R1 and R2—the output voltage will be that at the junction plus the voltage rating of the regulator, which in this instance is 5 volts. So, when potentiometer R2 is adjusted so its wiper is grounded the power supply's output is that of the regulator, 5 volts—perfect for TTL projects. As R2 is advanced, increasing the resistance from IC1's collector to ground, the voltage output increases.

**Getting the parts.** There are plenty of parts around to build this supply for

under \$10. If you go out and round up "all new" components the cost is likely to go well over \$30, so forget about new parts. Power transformer T1 can be 18 volts at 1 ampere (or rated at higher current, though the supply's maximum output is 1 ampere), or 36 volts center-tapped at 1 ampere or more. Both the 18 volt and 36 volt transformers are glutting the surplus market. If you get an 18 volt transformer use the bridge rectifier shown in the schematic. If you get a 36 volt C.T. transformer use the full-wave recti-



fier shown below the schematic. The diode rectifiers SR1 through SR4, are type 1N4001, 1N4002, 1N4003, or 1N4004, which are also glutting the surplus market. Just to show you the savings possible, at the time this article is being prepared you can buy fifteen surplus 1N4001s for \$1. Just one single "general replacement" for the 1N4001 from a national supplier is selling for over 40-cents. Get the idea how to save costs on this project?

Capacitor C1 can be anything from 2000 to 4000 uF at 25 volts or higher. Look for an outfit selling surplus computer capacitors. If worse comes to worse you can get the value specified in the parts list in a Radio Shack store.

The 3-terminal, 5 volt regulator is another item easily found on the surplus market. With an adequate heat sink—such as the cabinet itself—the device can safely deliver 1 ampere. The unit shown in the photographs is a Motorola MC7805 (though you can substitute any similar type) obtained for \$2.50 from Circuit Specialists. We have seen similar devices from other manufacturers selling for \$1. The terminals B, C and E are indicated directly on the device or on the terminals—where they join the case. The collector (C) lead is connected to the IC's metal tab, and is normally grounded. Note that in this project, however, the collector terminal, and therefore the tab, is not grounded. You must use an insulated mounting kit consisting of a mica insulator and a shoulder washer. Place the insulator between the IC's body and the cabinet, or the tab and cabinet, and slip the shoulder washer into the opening (hole) in the body or tab. Pass the mounting screw from outside the cabinet through the mica washer, through the IC, and

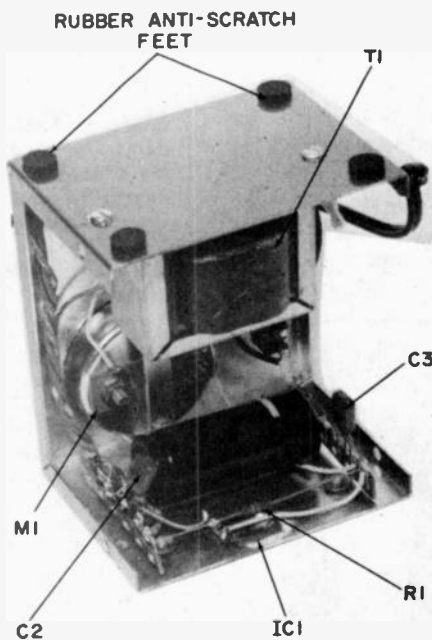

To prevent scratching your workbench apply rubber anti-scratch feet or bumpers on the bottom of the cabinet. They are available in most hardware and houseware stores.

# JUNK BOX

through the shoulder washer. Secure with a 1/4-inch (or smaller, not larger) nut hand-tightened against the shoulder washer. Before going any further check with an ohmmeter to be certain the collector terminal is insulated from the cabinet.

Connecting wires are soldered directly to IC1's terminal leads; use a heat sink such as an alligator clip on each terminal if you have a large (greater than 40 watts) iron. Since the layout is not important, we suggest the arrangement shown, with IC1 positioned between two mounting strips so R1 can span across the strips and be soldered to IC1's collector terminal.

Finally, we come to the meter, a device that has become slightly more expensive than a barrel of Arabian oil. Any meter that can indicate at least the range of 0 to 15 VDC is adequate. The EMICO 0-30 VDC meter shown in the photographs was selling in one local store for \$7.95, while we bought ours almost down the block as "surplus" for \$2.99. A good source for surplus meters is Fair Radio Sales. You might not end up with a meter case that looks

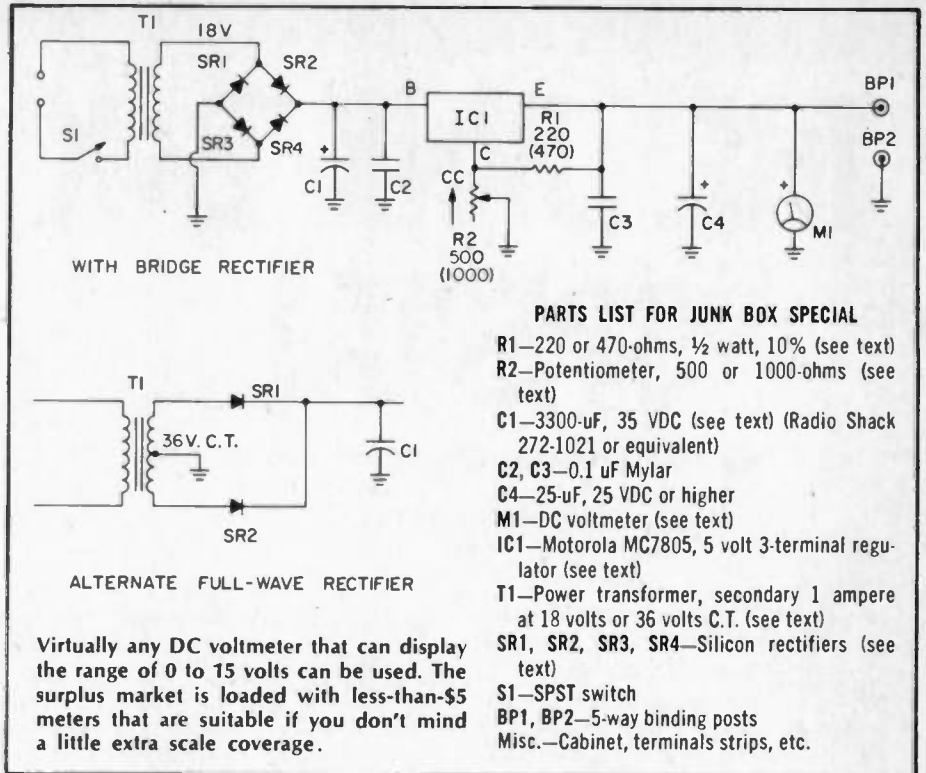

Virtually any DC voltmeter that can display the range of 0 to 15 volts can be used. The surplus market is loaded with less-than-\$5 meters that are suitable if you don't mind a little extra scale coverage.

suitable for NASA, but the output voltage doesn't care two hoots whether the meter is a modern \$25 dollar model or a surplus-special for a buck ninety-nine. Power switch S1 can be a separate

SPST as shown in our project, or it can be part of R2. But keep in mind that a separate S1 allows you to turn the supply on and off without affecting voltage control R2's adjustment.

Finally, we come to R1 and R2. You will note that the schematic shows two values for each. One value for each resistor is in brackets (parenthesis). You can use either set of values as long as they are matched. If R2 is 500 ohms R1 is 220 ohms; if R2 is 1000 ohms R1 is 470 ohms. The reason we show both sets of values is because 500 and 1000 ohm potentiometers appear on the surplus market from time to time, but usually not together. This way, you can use whatever is available at low cost.

**CHECKOUT.** Set potentiometer R2 so the wiper shorts to the end connected to IC1's collector terminal, thereby connecting the collector directly to ground.

(Continued on page 114)

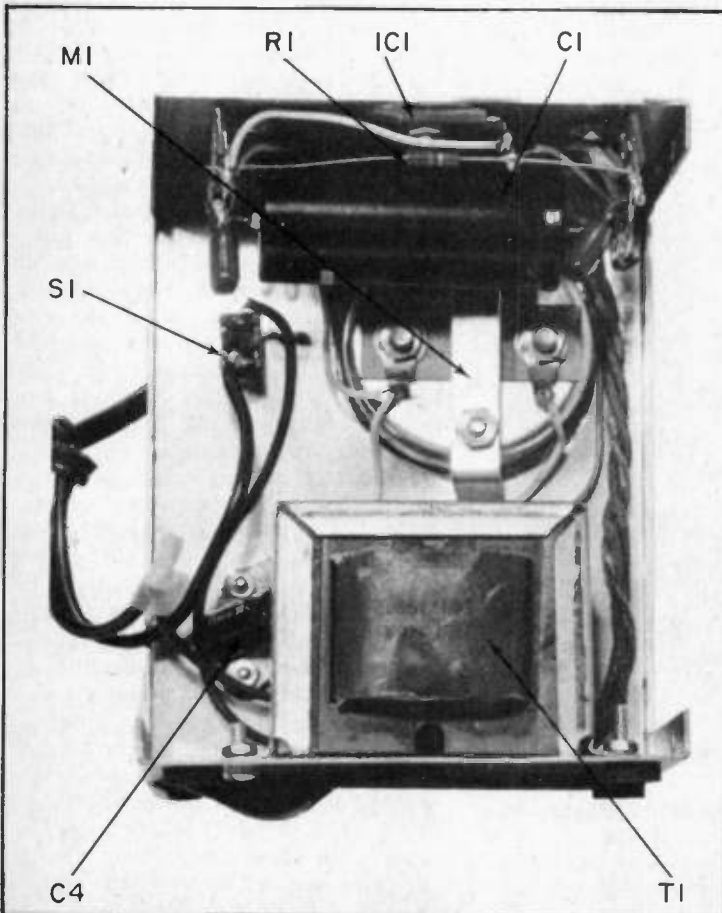

If you've had experience with assembly in tight quarters, you can shoe-horn the power supply into a standard 3 x 4 x 5-inch Mini-box. If your soldering iron is so big it burns adjacent wires when you make a connection, use a larger size cabinet.

In order to handle a full ampere, the IC regulator must be heat sunk to the cabinet. Make certain the collector and its attached sink tab (the back of the package) is insulated from the cabinet. Use silicon grease to insure heat transfer from the IC to the cabinet.

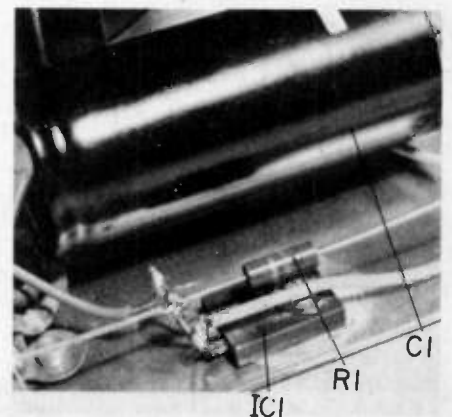



# The Fine Art of Buying Electronic Parts

by Walter Sikowicz

An inflation fighter's guide to buying components

products, such as integrated circuits, and little else. Because of specialization, these companies can afford to have very complete inventories of selected merchandise. Furthermore, although you might expect a specialist to slap you with a fat fee, in most cases just the opposite will happen; you'll save money.

Who are these specialists? They are the mail-order businesses that advertise in the back pages of *ELEMENTARY ELECTRONICS* (as well as other publications). Some of these companies restrict themselves to new merchandise, which they sell at very agreeable rates because of low overhead. Others sell only surplus, that is, unused components obtained from manufacturers willing to sacrifice some inventory for ready cash. A component's appearance on the surplus market can be caused by a multitude of economic factors which are unfortunate for the manufacturer, but a windfall for you, the buyer.

**New or Surplus?** How can you tell whether merchandise is brand new or unused surplus? In many instances, the catalog will tell you. If not, there is one sure indication: If the merchandise is being sold for a fraction of the retail price you would expect to pay, it's surplus. Three firms that deal exclusively in surplus are Delta Electronics (PO Box 2, 7 Oakland St., Amesbury, Massachusetts, 01913), B&F Enterprises (119 Foster St., Peabody, Massachusetts, 01960), and John Meshna

**A**SK A GROUP of electronics enthusiasts what the single most difficult part of project building is, and more often than not the reply will be, "Buying the #\$\$%&\* parts." Such an attitude is not unwarranted because, try as you may, you will never find one distributor capable of supplying all the parts you need. Even so, there is no reason for the incredible amount of difficulty experienced by some people.

If you're planning to build a particular group of projects at once or in a series, then it may be of help to plan in advance, and only have to make one or two parts orders by mail, or the same number of trips to the local parts stores. Buying in larger groups can also cut costs, because some houses give discounts for purchases of the same part in excess of five pieces. Your savings can

really add up if you exercise some prudence in shopping.

**The Big Four.** You start by collecting catalogs; the more the better. Ten will get you by, but twenty is not too large a figure. Begin with the Big 4: Burstein-Applebee (3199 Mercier St., Kansas City, Missouri, 64111), Radio Shack (everywhere), Allied (401 E. 8th St., Fort Worth, Texas, 76102), and Lafayette Electronics (PO Box 428, Syosset, New York, 11791). These are the general practitioners of electronics; they dispense a little of everything.

**The Specialists.** Once Ohm's Syndrome takes hold, however, and your sales resistance rises in the face of inflation (and limited selection), it's time to see a specialist. This might be any one of several firms selling certain

# Parts

Inc. (PO Box 62, E. Lynn, Massachusetts, 01904). Others, like Poly Paks (PO Box 942, South Lynnfield, Mass., 01940), or Herbach & Rademan (401 E. Erie Ave., Philadelphia, Penn., 19134), offer a mixture of surplus and brand new stock. Regardless of whether the merchandise is new or surplus, all firms offer some guarantee of satisfaction.

In order to get better acquainted with the various suppliers, let's survey the market item-by-item. In the following paragraphs, whenever a specific company is mentioned in connection with a component, it is only because that firm is particularly strong in a certain area. Some degree of overlapping does exist among all firms, however, so don't assume that any one supplier is being recommended to the exclusion of all others.

**Integrated Circuits.** Although human life is based on the chemistry of carbon, it is the chemistry of silicon that now forms the basis for our business and industry, thanks to the integrated circuit. Because of their tremendous importance, integrated circuits are sold by almost every electronics supplier, big or small. You'll find that the Big 4 have quite respectable IC inventories, but prices are relatively high, and selection is not complete. Jameco Electronics (1021 Howard St., San Carlos, Calif., 94070), and Ancrona Corp. (PO Box 2208, Culver City, Calif., 90230) feature perhaps the widest selections of ICs; linear, TTL, CMOS, DTL, ECL, LSI and so forth. Jade Computer Products also offers a good selection of ICs in their catalog.

Circuit Specialists (PO Box 3047, Scottsdale, Ariz., 85257) is a nice company to do business with, since they require no minimum-size order. In addition to a wide range of the standard ICs, Circuit Specialists carries special numbers from RCA, Motorola, and

You can buy bulk components at next-to-nothing prices if you buy untested, surplus parts. Poly Paks is a popular bulk supplier and two of their packs are shown here. Most of the parts are useable.

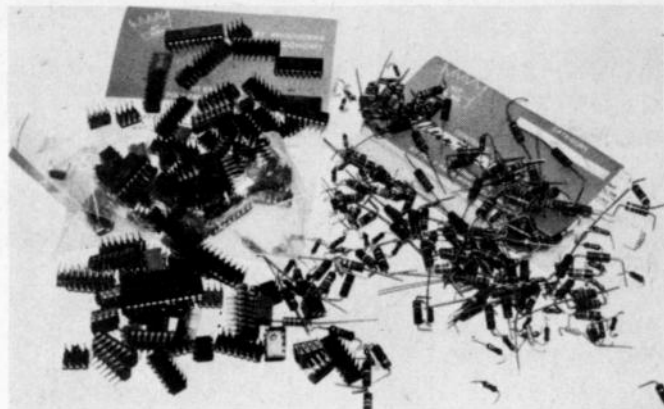

Mostek. Digi-Key (PO Box 677, Thief River Falls, Minn., 56701) also features a wide assortment, including some circuits difficult to find elsewhere. Last, but not least, there is Solid State Sales (PO Box 74A, Somerville, Mass., 02143). Although this company's selection may be a trifle smaller than some, its service is like the fabled "greased lightning."

Occasionally, you are going to receive a dud. When this happens, it's best not to go berserk. A calm request for a replacement is usually accommodated very quickly. After all, these companies want your continued business in the future. As a precautionary measure, you might consider ordering two of each IC. The chances of getting one dud are so small that the probability of receiving two duds simultaneously is infinitesimal. You can use the extra IC, if it is good, in a future project.

Occasionally, the inevitable happens, and you will find yourself with an inoperative circuit. If you have any reason to suspect the IC as the culprit, either from poor handling technique, or from having eliminated any other possible causes, a spare IC will cure many late-night headaches caused by projects that have no good reason *not* to work. Try the new IC before you burn the schematic!

**Discrete Semiconductors.** This category is an exceptionally broad one. Included are: bipolar transistors, FETs,

SCRs, diodes, UJTs and so on. As in the case of ICs, almost everyone sells some discrete semiconductors, but few vendors stock each part number. Before giving up an elusive part, try either Hanifin Electronics Corp. (P.O. Box 188, Bridgeport, PA 19405), or the Ancrona Corp. These two firms have perhaps the most extensive listings of discretes.

Most suppliers offer special discounts to encourage volume buying of parts. This appeals directly to the squirrelish instincts of the electronics hobbyist, but be careful. Just like that greedy little tree-dweller, you will probably horde more than you can ever use. If you must stockpile parts, do it sensibly. Choose those discrete components that are most frequently used: 2N3906 PNPs, 2N3904 NPNs, 1N914 switching diodes, 1N4003 rectifiers and so forth. Avoid the high-wattage zener diodes now appearing in surplus. Today, integrated circuits have supplanted zeners as regulators at all but the lowest power levels.

**Resistors.** Buying from one of the larger retailers, you can expect to pay around 10 cents a piece for carbon-composition resistors. Compare that with the typical 4-cent selling price from the specialist firms, and the choice of a supplier is obvious. Resistors are one class of component that can be sensibly stockpiled. Buy half-watters with a 5% tolerance. They cost only a bit more than 10% resistors

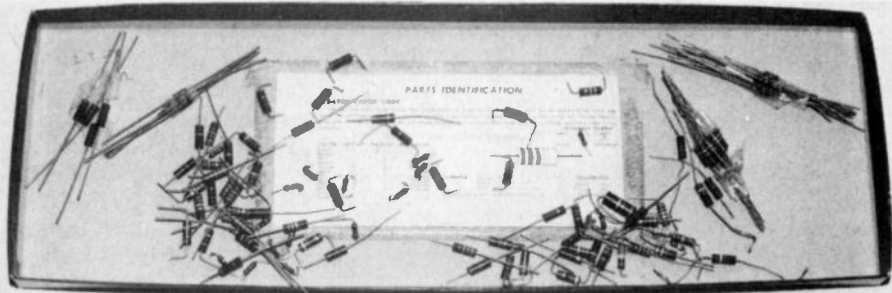

Since a great many people have trouble remembering the color code, a useful aid to sorting surplus resistors is an old tie box with the color code marked inside the lid.

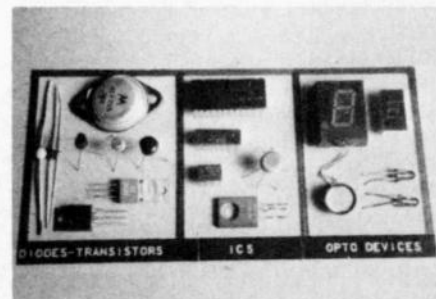

Try to build up a supply of transistors, diodes, ICs and electro-optical devices.



## ADDRESSES OF PARTS SUPPLIERS:

Ace Electronics, 5400 Mitchelldale  
Houston, TX 77092

Active Electronics Sales Corp.  
12 Merser Rd., Natick, MA 01701

ALdelco, 228 E. Babylon Tpk.  
Merrick, N.Y. 11566

Allied Electronics, 401 E. 8th St.  
Forth Worth, TX 76102

Ancrona Corp., P.O. Box 2208  
Culver City, CA 90230

B&F Enterprises, 119 Foster St.  
Peabody, MA 01960

Bullet Electronics, P.O. Box 1944  
Dallas, TX 75219

Burstein-Applebee, 3199 Merceir St.  
Kansas City, MO 64111

Calectro Products of GC Electronics  
Rockford, IL 61101

Chaney Electronics, P.O. Box 27038  
Denver, CO 80227

Circuit Specialists, P.O. Box 3047  
Scottsdale, AZ 85257

Delta Electronics, P.O. Box 2  
7 Oakland St., Amesbury, MA 01913

Diamondback Electronics Co.  
P.O. Box 194, Spring Valley, IL 61362

Digi-Key, P.O. Box 677  
Thief River Falls, MN 56701

Digital Research Corp.  
P.O. Box 401247B, Garland, TX 75010

Electronics Distributors, Inc.  
4900 N. Elston  
Chicago, IL 60630

ETCO Electronics, 521 Fifth Ave.  
New York, NY 10017

Formula International, Inc.  
12603 Crenshaw Blvd.  
Hawthorne, CA 90250

Fuji-Svea, P.O. Box 3375  
Torrance, CA 90510

Hanifin Electronics, P.O. Box 188  
Bridgeport, PA 19405

Herbach and Rademan, 401 E. Erie Ave.  
Philadelphia, PA 19134

HobbyWorld, 19355 Business  
Center Dr., Northridge, CA 19324

Integrated Electronics  
540 Weddell Dr., Sunnysvale, CA 94086

International Electronics Unlimited  
Village Square P.O. Box 449  
Carmel Valley, CA 93924

Jade Computer Products  
5351 W. 144th St.  
Lawndale, CA 90260

Jameco Electronics, 1021 Howard St.  
San Carlos, CA 94070

John Meshna, Inc., P.O. Box 62  
East Lynn, MA 01904

Lafayette Electronics, P.O. Box 428  
Syosset, NY 11791

Mouser Electronics,  
11511 Woodside Ave.  
Lakeside, CA 92040

New Tone Electronics, P.O. Box 1738  
Bloomfield, NJ 07003

Olson Electronics, 260 S. Forge St.  
Akron, OH 44327

Optoelectronics  
5821 N.E. 14th Avenue  
Fort Lauderdale, FL 33334

Poly Paks, P.O. Box 942  
South Lynnfield, MA 01904

Quest, P.O. Box 4430  
Santa Clara, CA 95054

Radio Hut, P.O. Box 401247  
Dallas, TX 75238

Radio Shack Consult your local  
phone book

Ramsey Electronics, P.O. Box 4072  
Rochester, NY 14610

Signal Transformer Co.,  
500 Bayview Ave.  
Inwood, NY 11696

Solid State Sales, P.O. Box 74A  
Somerville, MA 02143

Steven Products, P.O. Box 698  
Melville, NY 11746

Surplus Electronics Corp.  
7294 N.W. 54th St., Miami, FL 33166

and save you the trouble of stocking two tolerances.

Most construction projects are designed to utilize resistors with a tolerance of 10%, unless specified otherwise in the parts list.

Power resistors, with ratings from 5 to 100 watts, are available from the surplus dealers at incredible prices. Buy a small assortment. Power supplies and audio amps often need dummy loads during checkout, and for such purposes these high-power resistors are ideal. If you do not have exactly the right resistance at hand, use serial and parallel combinations whose net resistance is the desired value.

Don't forget those high-class resistors, the metal-film precision units with tolerances of 1% or better. You can get these from the larger retailers, but at 60 cents to one dollar apiece (often with a ten-piece minimum order) who needs them? Actually, for certain ultra-stable or low-noise circuits, precision resistors are mandatory. Active filters, accurate voltage dividers, and analog-computer circuits are but a few examples. When you really need precision resistors, Hanifin Electronics can sup-

ply them at about 15 cents each. But because Hanifin is an industrial supplier, do not send in a 75¢ order; fifteen dollars worth is a realistic minimum. Since Hanifin offers lots of goodies besides resistors, you should have no trouble putting together a good-sized order.

**Capacitors.** The best all-around capacitor that money can buy is the polystyrene type. It also happens to be one of the cheapest, a fortunate coincidence. Polystyrenes are available in the range from 5 pF to 0.5-uF, but above .01-uF, they begin to get bulky and expensive. Your best and most complete sources for these capacitors are Burstein-Applebee and Allied (addresses supplied previously). Standard tolerances are 5% (super for a capacitor), with 2.5% and 1% available at higher prices.

In the range from 0.01-uF to 1-uF, you are best off with mylar (polyester) capacitors. (Mylars are available outside this range, too.) Standard tolerances are 20% and 10%. A great many firms carry mylar capacitors.

Above 1-uF, most capacitors are aluminum electrolytics, which are polar-

ized devices. One of their most important functions is filtering, particularly in AC power supplies. Tolerances tend to be relatively loose since applications rarely call for very precise electrolytic capacitors. Capacitances as high as 40,000-uF and beyond are available.

The aluminum electrolytic has a more sophisticated cousin, the tantalum capacitor, which is commonly available in capacitances as high as several hundred microfarads. Relative to the aluminum electrolytic, the tantalum features tighter tolerances (10% typically), lower leakage, and smaller size for equivalent capacitance. As a result, tantalums are preferred over aluminum electrolytics in timing applications. Both electrolytic types are stocked by many distributors.

Surplus capacitors are available, with perhaps the best source being Poly Paks (see above), at least in terms of variety. If you do buy surplus capacitors, play it safe and check each one on a capacitance meter. Ceramic bypass capacitors for digital logic are available very cheaply as surplus, and so too are mylars. On the other hand,

# Parts

be very cautious when buying surplus aluminum electrolytic capacitors. They have a limited shelf life, and once they dry out, they are useless. Most dealers are scrupulous enough not to do this to you, but you can end up with a relic of the 1950's that looks more like an artillery shell than a capacitor. Choose carefully.

**Potentiometers.** New pots cost about the same no matter where you buy them. Imported units may sell for less, but cheap materials yield an inferior device, one that is often difficult to turn because of high-friction bearings. While imports are excellent for experimenting, it always pays in the long run to use top-quality pots in your projects.

Surplus pots can save you a lot of money, but read the fine print closely. Pay attention to shaft length. Some units are intended for screwdriver adjustment and have short, slotted shafts which cannot accept a knob. In addition, watch out for strange tapers, such as "reverse logarithmic." Pots specified as having either "linear" or "audio" tapers are the ones most usually called for in projects.

You will find that only linear and audio taper potentiometers are called for in the circuits described in 101 Electronics Projects.

For some reason, wirewound pots seem to abound in surplus. These are fine for low-frequency work, often at high power. But wirewounds have poor resolution and should never be used in a circuit where very precise adjustments must be made. For the bulk of your experimenting, standard carbon-composition pots are your best choice.

Slide pots are a great convenience in audio work, especially if you are building a mixer or music synthesizer. Many outlets carry them, but most units have too short a path of travel (1¼ inches) to be really useful. Slide pots with twice the adjustment range are preferable, and they can be purchased at reasonable cost from Mouser Electronics (11511 Woodside Ave., Lakeside, Calif., 92040).

**Relays.** These may well share the fate of the dodo, thanks to fast and reliable solid-state switchers like triacs, SCRs and transistors. Industrial control systems that once bristled with relays and cam-actuated microswitches now rely on digital logic and thyristors. Even Ma Bell, at one time the patron saint of relay manufacturers, now uses electronic switching to route calls. The result of all this phasing-out is a sur-

The best way to build up your parts inventory is to salvage useable components from junked pieces of electronics gear. Transformers, switches, potentiometers, crystals and coils are always handy to have.

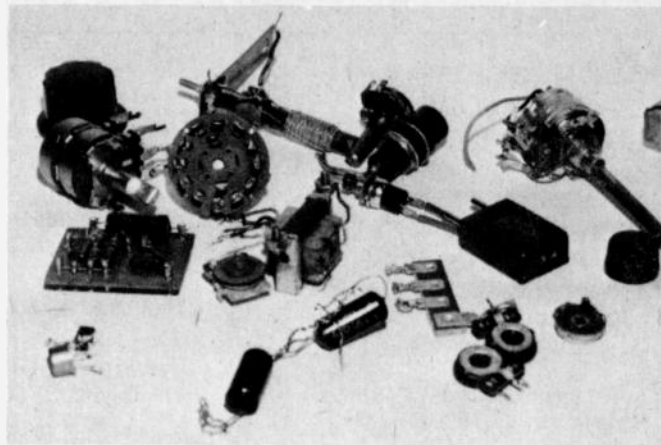

plus market chock full of relays at bargain prices.

Despite the decline in its commercial popularity, the relay still possesses some admirable qualities, such as excellent driver/load isolation and minimal temperature sensitivity. Furthermore, it happens to be one of the easiest devices for the beginner to understand and use. All things considered, it makes sense to take advantage of the surplus bargains now, while they last.

**Power Transformers.** Here is another item carried by almost every supplier, but inventories are generally limited in scope. When your application demands just the right transformer, it pays to be able to order directly from the manufacturer. Signal Transformer Co. (500 Bayview Ave., Inwood, N.Y., 11696) offers a wide array of transformers, from tiny, PC-mount devices to mammoth, kilowatt isolation transformers. Other makers also offer diverse selections, but some may not encourage direct mail ordering.

Undoubtedly the most economical way of securing a transformer is through a surplus dealer like Delta. Many kinds of transformers end up as surplus, and with just a little luck you can find one to suit your purposes. Discounts greater than 75% off list are common, so the money you save may be substantial. This is especially true if you are planning to construct something big such as a high-powered audio amplifier. Transformers from some of the best amps ever to shake a loudspeaker end up as surplus, victims of design changes and competition.

**PC Supplies.** There is no surplus material worth mentioning in this category, so let's focus on new merchandise. The simplest PC methods involve placement of a pattern directly on copper-clad board. These are fine in the beginning, but for serious experimenters, photographic techniques are a must. Not only do photographic methods yield neater copper traces and a

greater density of components on your board, they also allow any number of boards to be produced from a single piece of artwork.

Photographic PC processing can best be learned from one of the kits offered by various manufacturers. You do not need expensive equipment like a camera or enlarger. All necessary materials and instructions come in the kit. These PC kits may employ either negative or positive photographic processes, which differ from one another principally in the method used to prepare a board's artwork. Positive methods are perhaps easier for a beginner to visualize, but negative kits seem to be equally popular. Most suppliers carry at least one brand of PC kit, if not more. Choose one that fits your needs and budget. You'll find the professional-looking results to be well worth the extra effort.

Although only the tip of the iceberg has been exposed here, you should have a pretty good idea of how to find supplies by now. To obtain copies of the catalogs you want, write directly to the companies mentioned in the text. Note that our coverage has been by no means exhaustive. Undoubtedly other worthwhile catalogs are available, so hunt carefully through the back pages, too. Remember, all companies stock much more merchandise than they can economically include in a single magazine advertisement.

Now that you have a pretty fair idea on how to purchase the parts you'll need for the projects you plan to build, sit down and compile a master parts list. As you do this, you'll probably start to see the same parts cropping up time and time again. To avoid unnecessary duplicity, only buy a part twice (or more) if the project it is being used for is one of a permanent nature. If you're going to tear it down, you can use its parts for another project at a later time. ■

# The chances are excellent that... You have a talent other people are willing to pay for!

You're "handy" around your house, have the ability to fix things, and "make them work right"... that's why there may be a rewarding career for you in Electronics.

## A career in Electronics?

Absolutely. Because you're interested in *things*. How they work. Why they work. How to take them apart and put them back together. Plus . . . you've got a head for detail work.

## Your chances are excellent

With the right kind of *specialized* technical training, you can have a challenging, financially rewarding future waiting for you in Electronics. Think of the career opportunities . . . computers, aerospace, 2-way radio communications, radio/TV broadcasting, medical electronics, to name just a few.

And, surprisingly, you don't need a college degree!

All you need to do to qualify for one of these exciting career fields is to build upon the technical aptitude you already have . . . just put your hands and your head to work with a CIE Electronics career course.

## You learn by doing

The CIE method of instruction is the refinement of over 40 years of Electronics, independent home-study experience. It works. And you don't need *any* prior electronics experience. A CIE *career* course can take you from ground zero right up to training in Lasers, Microminiaturization, Radar, Analog Computers, and various applications in Communications.

In some CIE courses, you'll perform "hands-on" experiments and tests with your own CIE Personal Training Laboratory. And, if TV technology and digital Electronics are your main interest, you can select from several courses that involve working with and



troubleshooting a TV. (And the TV is yours to keep, too!) This combination of "head and hands" learning *locks in* your understanding of the crucial principles you'll use on the job in your new career. But, don't kid yourself . . .

Electronics is not an "easy" science and CIE courses are not "snaps." Subject matter is technical, thorough, and challenging. It has to be. We're training you for a *career*. So the presentation of ideas is logical, written in easy-to-understand language . . . you progress step by step, at your own pace.

## CIE Education by mail

There is no need to "go back to the classroom" with CIE. Because you learn at *home* or wherever else is convenient. You keep your present job and income. No cross-town commutes. *You* decide when and where *you* study best.

Your eventual success . . . at CIE and in your electronics career . . . will be determined by your own motivation and self-discipline. *You can* do it. And CIE can show you how.



Patterns shown on TV and oscilloscope screens are simulated.

## Put your talent to full use

We believe that you may be a "natural" for electronics, and we'd like to tell you more about potential career fields and our school. We'll be glad to send you our complete package of FREE career information if you'll send in the card or call the toll-free number. For your convenience, we'll try to have a school representative contact you to review various educational programs and assist in course selection. As soon as we receive your request, we'll mail you our school catalog, complete G.I.

Bill details, and special information on government FCC License preparation.

**CIE** Cleveland Institute of Electronics, Inc.  
1776 East 17th Street, Cleveland, Ohio 44114  
Accredited Member National Home Study Council

For your free information package mail the postage paid card or:

CALL TOLL FREE 800/321-2155  
(Except in Alaska or Hawaii)

In Ohio, CALL...800/362-2105

Ask for Pat Crandall at CIE.

No charge. No obligation.

# Solderless Breadboarding

The neat, easy, quick way to go for the experimenter.

by Paul Kaufman

**T**HERE ARE A LOT OF WAYS to put electronic circuits together, among them point-to-point wiring on a chassis with sockets and terminal strips, perf-boards and printed-circuit boards, to name the most familiar conventional methods, all of them depending heavily on soldering. But over the last few years, assembling and testing circuits on *solderless* breadboards has become increasingly popular. And little wonder, because this technique offers hobbyists and professionals alike a way to save considerable amounts of time, as well as saving sizeable amounts of money, since parts can be used and reused over and over again.

**More Work in Less Time.** To the electronics professional, engineering and technician time is a valuable resource, and it's really no different for electronics enthusiasts who spend late weekday hours or entire weekends experimenting with new circuits. But how, exactly, is the time spent? With solder in one hand and a soldering iron or gun in the other, which should really be no surprise, when you think about it, since even a simple amplifier can have well over a dozen connections. Add the fact that today's projects, with their 14-, 16-, 24- and 40-pin ICs, multiple LEDs, plus the usual assortment of transistors, capacitors, resistors, potentiometer, etc., are often considerably more sophisticated, and your newest labor of love can involve a lot of manual labor.

**A Better Way.** In their search for a better way to assemble circuits, a number of engineers and technicians came up with crude solderless breadboarding systems, using such ingredients as alligator clips, springs, fahnestock clips perforated masonite, and the like. These were awkward and often unreliable, particularly when multiple connections were necessary at a given point in the circuit. Happily, like semiconductor technology, solderless breadboarding technology has come a long way since the early days. Precision and versatility have increased, while prices have decreased to the point that the many advantages of solderless breadboarding are now easily affordable by even the most budget-conscious electronics buff. Today, complete solderless breadboarding sockets carry manufacturer's recommended retail prices as low as \$2.50.

With solderless breadboarding, connecting, disconnecting and reconnecting components and leads is nearly as fast and easy as plugging a conventional AC line cord into a wall socket. Just about the only preparation necessary is to strip the insulation from hookup wires, because no connectors are required. Leads from all types of components (ICs, transistors, resistors, capacitors, etc.) plug in directly, and interconnect just as easily.

We're getting ahead of ourselves. A better way to understand the way solderless breadboarding sockets function is to remember the old days before transistors, when electron tubes plugged into chassis to make things work. Manufacturers of breadboarding sockets have taken this basic idea and extended it. Instead of round sockets, holes are placed in a rectangular grid, spaced at regular intervals, corresponding to the spacing of standard components, such as ICs. And instead of terminating in soldering lugs, the lugs beneath these holes are interconnected in larger or smaller groups. Smaller groups (usually five or so), used to connect a few component leads together, are called "terminals." Larger groups, often of 25, 40 or more, which are used to connect large numbers of leads to a single point in the circuit (such as supply voltage, ground or common signal paths), are called "buses." By using these terminals and buses, circuits can be easily and quickly assembled in as little as one-tenth the time of conventional wiring techniques. Let's see why.

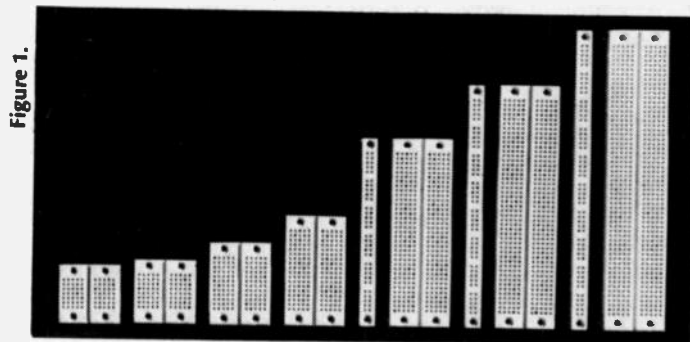

Figure 1.

Figures 1 and 2 illustrate typical solderless breadboarding sockets and bus strips used to build and test electronic circuits. As you can see from Figure 3, these can be combined together and "grown" to accommodate virtually any size circuit, using a variety of components

Leads from all components, including DIP (dual-inline

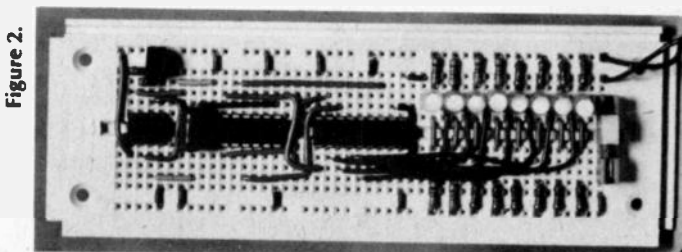

Figure 2.

package) integrated circuits, are inserted directly into the sockets, and interconnections are accomplished with short lengths of #22-30 AWG solid hookup wire, stripped of insulation at either end. The result is a neat, compact layout that can be used for testing, or actually built into a housing or mounted on a baseplate and used as a completed project. Changes are no problem either. Changing a wire from one lead or another typically takes less than 10 seconds even if the socket is crowded with components.

**Adding up the Advantages.** By now, if you're like most experimenters who've been exposed to solderless breadboarding for the first time, you're probably already interested in trying this fun way to build circuits for yourself, just on the basis of the time you'll save. But speed isn't the only nice thing about solderless breadboarding. Here are some of the other major advantages.

You can translate circuits directly from schematic or pictorial diagrams directly to working circuits. There's almost never a need to come up with a separate wiring diagram or go through other intermediate steps. And if you're designing a circuit yourself, you can go from rough sketch right to assembled unit, to check your ideas in minutes. Once you're finished, you can easily translate the working circuit back into a schematic, too.

These are two of the most underrated factors in designing and building circuits. On a solderless breadboard, all components are right there in front of you, so it's hard to miswire a circuit. It's also easy to change component values or connections, especially if you're improving or otherwise modifying a circuit. Component values and parts designations are right there in front of you. And it's rare that you have to move any components to get at others.

Want to add a stage? Feed one circuit into another? Compare two different ways to do things, side-by-side? With modular solderless breadboarding, it's easy. Just keep adding sockets or bus strips as you need them!

Quality breadboarding sockets and bus strips have molded-in mounting holes that let you put them anywhere you need them; on a chassis, the surface of a cabinet or workbench. You name it! Be sure the sockets have insulated backing, to prevent shorting if you mount them on metal, or your circuits will be *short-lived!*

**Utilize Your Junkbox.** Even components with larger leads can be connected to solderless breadboards by using short lengths of hookup wire soldered to their terminals. And since the better solderless sockets are made of materials that withstand 100°C or more, you can even use heat-dissipating devices in close proximity to the sockets without fear of damage. You can even solder to components while they are still connected to the sockets. Note: consult manufacturers' specifications before you do, though.

For many experimenters, particularly those with tight budgets (and who hasn't one these days?), solderless breadboarding offers one more advantage that outweighs all the rest. Instead of giving components a lead-length "haircut" each time you use them, components are intact, so you can use them over and over again. And, because there's no soldering involved, there's no chance of accidentally overheating a delicate diode or expensive IC chip with an accidental touch of the soldering iron. Instead of shrinking your junkbox with each new project you build, your junkbox grows. So you can spend that hard-earned money on *new* components, and build a larger variety of new projects!

**When, Where and How.** Quality solderless breadboarding systems are compatible with a wide range of circuit types, including digital, and analog audio, all the way up to video

Figure 3.

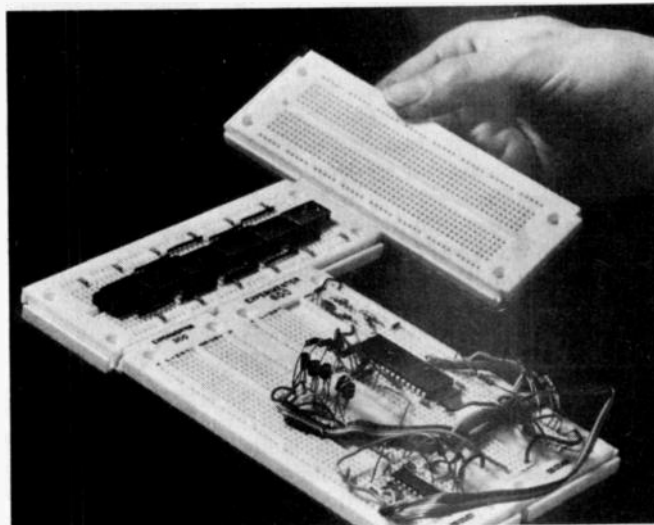

and RF, if proper wiring practices are followed. Capacity between adjacent terminals should be less than 10 pF, which gives you the ability to work up to about 20 MHz, for most applications. Virtually any type of component can be used, though with components having very small diameter leads, stranded leads, or leads larger than .033-inch diameter, you should solder a small length of #22 hookup wire to them, using spaghetti or electrical tape where necessary, to prevent shorts.

**Wiring and Hookup Hints.** While most of the points raised below are good basic wiring practices, it especially pays to keep them in mind when using solderless breadboards, because the speed and ease with which your circuits go together may tempt you to overlook some of them.

Leads in general should be as short as possible, particularly with high-frequency circuits. Keep component leads and jumpers as direct as possible, since excessive leads can add inductance or stray capacitance to circuits, sometimes producing unwanted oscillation. Neat lead layout, lead bending, etc., also makes components easier to insert, and helps you trace the circuit for later diagramming, debugging, etc.

To jump two or more tie-points, you'll need short lengths of wire. Almost any #22-30 solid hookup wire will do. Strip insulation a bit more than  $\frac{3}{8}$  inch from each end, to allow for insertion and bending, and be careful not to nick the wire when stripping it. When estimating jumper length, allow a total of a bit more than  $\frac{3}{4}$  inch (for the  $\frac{3}{8}$  inch-plus of bare wire you'll need at each end), plus any extra wire required for bending, to make a neat layout. And don't throw those jumpers away! They can be re-used again and again, so store them on an unused portion of your socket, or in a plastic box.

When laying out circuits, allow several rows of tie-points between components, especially ICs. This will give you plenty of maneuvering room to add extra components, run wires, etc., as well as yielding a more open, neater layout.

One of the nice things about solderless breadboarding is that you can lay out a circuit just the way it's drawn on a schematic, with supply buses at the top, signal buses in the middle, and ground buses at the bottom. With high-frequency circuits, be sure those ground buses are handy, since you'll want to run bypass capacitors with short leads directly to them. And speaking of bypassing, remember that leads to and from the socket can sometimes pick up stray signals, so you might want to bypass power lines to ground right where they connect. ■

**A**N AMPLIFIER STAGE that is used at two widely separated frequencies (such as RF and audio) is called a reflex amplifier. This type of amplifier circuit was used in the early days of radio because of its economical use of the then expensive vacuum tubes. Later, during the depression period of 1934 to 1937, reflex circuits were used in small home radios. When transistors first became popular, two transistor radios were manufactured in Japan and sold here for very small prices. These transistor circuits employed reflex amplifiers, usually in a TRF type of receiver with a crystal diode detector. One transistor was employed as a reflex RF amplifier and first audio stage, and the second transistor was used as the audio power amplifier.

You can experiment with the reflex circuit by building our simple one-Transistor Reflex Receiver project. The circuit employs a j-FET as a tuned RF amplifier and also as a stage of audio (after the signal is detected by a germanium diode). The circuit is laid out breadboard style for easy construction.

**The Reflex Action.** The reflex circuit is a system in which an amplifying device (transistor or vacuum tube) is made to function at both RF (or IF) and audio frequencies. As commonly used, the signal is amplified by the device, detected, and the resultant audio signal fed back into the same device for further amplification. Such a circuit has two inputs (one for each type of signal frequency) and two outputs, with filtering necessary to split the two sets of signals.

Look at the signal flow block diagram of the one-Transistor Reflex Receiver project. This is a diagram of a typical reflex circuit. Signals are amplified at RF frequencies and then fed through a signal splitter to a crystal diode detector. The detected output is filtered and coupled back through the tuned circuit to the amplifier, where the signal is now at audio frequencies. The audio frequencies are amplified and fed through the signal splitter to the low pass filter and to the headphones.

As shown in the block diagram and the schematic, radio signals are coupled through J1 and C1 to the tuned circuit of C3/L1/and to the gate of the field-effect transistor (j-FET) Q2. C2 places the bottom end of L1 and the rotor of C3 at RF ground. R3 supplies the bias for Q2, and C8 is the RF/AF bypass capacitor. R1 functions as the Q1 gate DC return and audio input load. The amplified RF signals from the drain of Q1 are coupled through C9 to R5 and detector D1. C7 is connected in shunt with the RF out-



# SIGNAL SNARE

## An easy-to-build one-transistor reflex receiver

put of Q1 and is used to adjust the RF gain of the j-FET.

The detected audio signal is fed through the RC filter composed of R4, C5, and C6 to the volume control R2. The audio is then coupled through C4 to the junction of R1, C2, L1, and C3. C2 presents a low impedance to RF, but has a high impedance to audio. L1 has a high impedance to RF, but has a low impedance to audio. The two types of signals (RF and audio) are therefore applied directly to the gate of Q1, each being amplified therein.

The amplified audio signal at the drain of Q1 is coupled through L2 to the J2 headphone jack. L2 serves as both a component of the low-pass filter (L2/C10) and as an RF load for the signal splitting action of C9 to D1. L2 is chosen to have a high value of reactance over the broadcast band and serves to broadly tune the D1 detector circuit over the range of 550 kHz to 1500 kHz.

The DC power for the circuit is supplied by an external 6-volt battery (or

DC power supply), and C11 serves as an audio filter for the power input.

**Construction.** The receiver, as shown in the photos, is built on a 6-inch long by 3 3/4-inch wide by 2-inch high plastic box with a perf-board section installed on top. Most of the components are mounted on the perfboard with push-in solder terminals. The input and output connectors, J1 and J2, are mounted on the front and rear of the box. The 6-volt battery, or power supply, is connected via two leads fed through a hole in the rear of the box. The tuning capacitor C3 is mounted directly on the perfboard with machine screws, and the volume control R2 is mounted on a small bracket made from sheet aluminum that is also installed on the perfboard.

Begin construction by cutting a perf-board section to size to fit the top of the box. Locate corner holes to fit the threaded molded screw retaining extrusions located inside the top corners of the box. Mount C3 on the perfboard in the location shown in the photo of

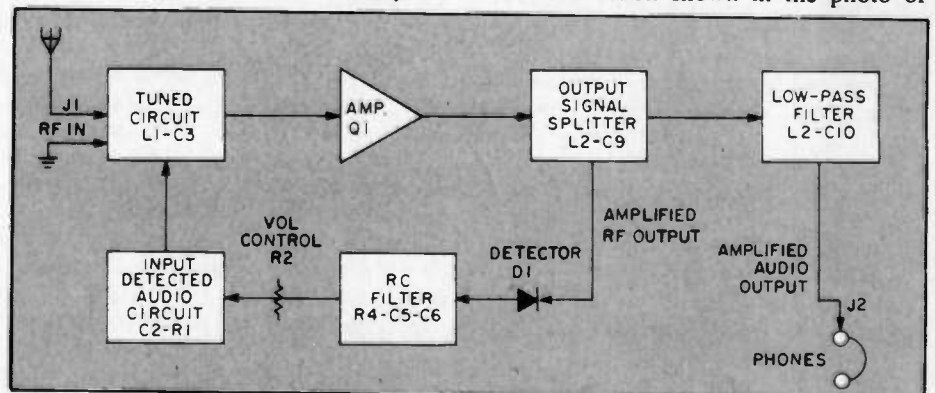

This block diagram shows how the signal is amplified as AF and RF, then split and fed back to the tuned LC circuit. The low pass filter separates the amplified audio signal.

the top of the receiver. The capacitor used in our model had threaded holes in the bottom for easy mounting with machine screws and washers to lift up the stator insulating panels from contact with the board surface. If your capacitor does not have these mounting holes, the capacitor can also be mounted by a small bracket cut from sheet aluminum to fit front mounting holes. Cut a bracket to fit R2 and mount it on the front of the perfboard in the general location shown in the photos. Use an internal toothed lock washer between the R2 mounting nut and the bracket surface to prevent accidental movement of the volume control.

Mount the remainder of the components on the perfboard with push-in solder terminals in the locations shown in the top of the board photo. The locations are critical, so follow the layout of our receiver model. Install a solder lug on the frame of the tuning capacitor C3 for connection to the rotor. Wire the board components as shown in the schematic and keep the connecting leads as short and direct as possible. L1 is mounted with two push-in terminals soldered to the coil connecting lugs.

Install the headphone jack J2 on the box front and the antenna/ground jack, J1, on the rear of the box as shown in the photos. Cut a hole in the rear of the box for the battery leads and complete the wiring of the perfboard with the interconnecting leads to the box components. Install lugs on the battery leads to fit your battery terminals. The leads on our model extended approximately 10 inches from the box, but the lead lengths are not critical and can be any convenient length to fit your particular installation. To minimize accidental breakage, the battery leads should be stranded wire (preferably color coded; red for positive and black for negative).

**Testing Your Reflex.** For best results, an outdoor antenna and a good ground should be connected to J1 (center connector to the antenna and the outer shell to ground). Inasmuch as the Reflex Receiver project only uses a simple tuned circuit, you may have some problems with overloading on strong local stations. C1 value can be changed to adjust the antenna loading; small capacitance (3 to 20 pF) for light loading and better selectivity, and larger capacitance (25 pF to 47 pF) for heavier loading, higher sensitivity, but lesser selectivity.

Before connecting up the receiver project to the battery, check the wiring and then adjust the RF Gain control, C7, to maximum capacity (minimum

The author used perfboard mounted on a plastic box as chassis for the signal snare. Push-in solder terminals make construction a snap. The input/output jacks are all mounted on box under the board.

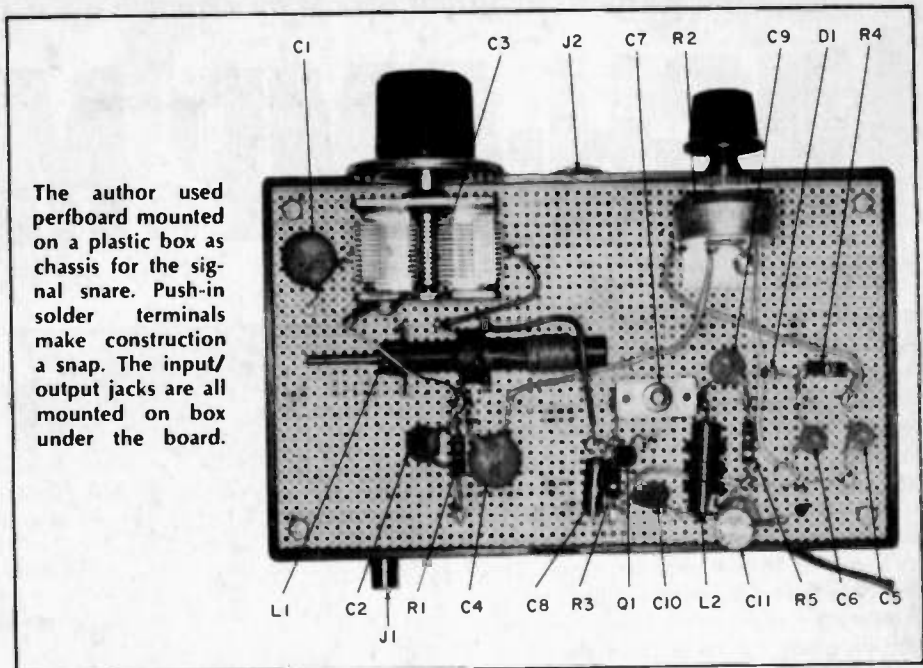

RF Gain). Set the volume control R2 full counter-clockwise (for minimum audio gain). Check the lead polarity before connecting the 6-volt battery to the receiver, then plug in the headphones (2000-ohm type).

Tune the broadcast band with C3 while adjusting R2 for a comfortable audio volume. Adjust L1 for best band coverage for your particular location.

Tune the slug in for more inductance. Adjust C7 for increased RF sensitivity over the band, and if oscillation occurs, adjust for maximum capacity (just short of the oscillation point).

Check the RF amplifier action in the reflex circuit by tuning in a weak station and then connecting a 500 pF capacitor (approximate value) between the antenna and ground. (Continued on page 114)

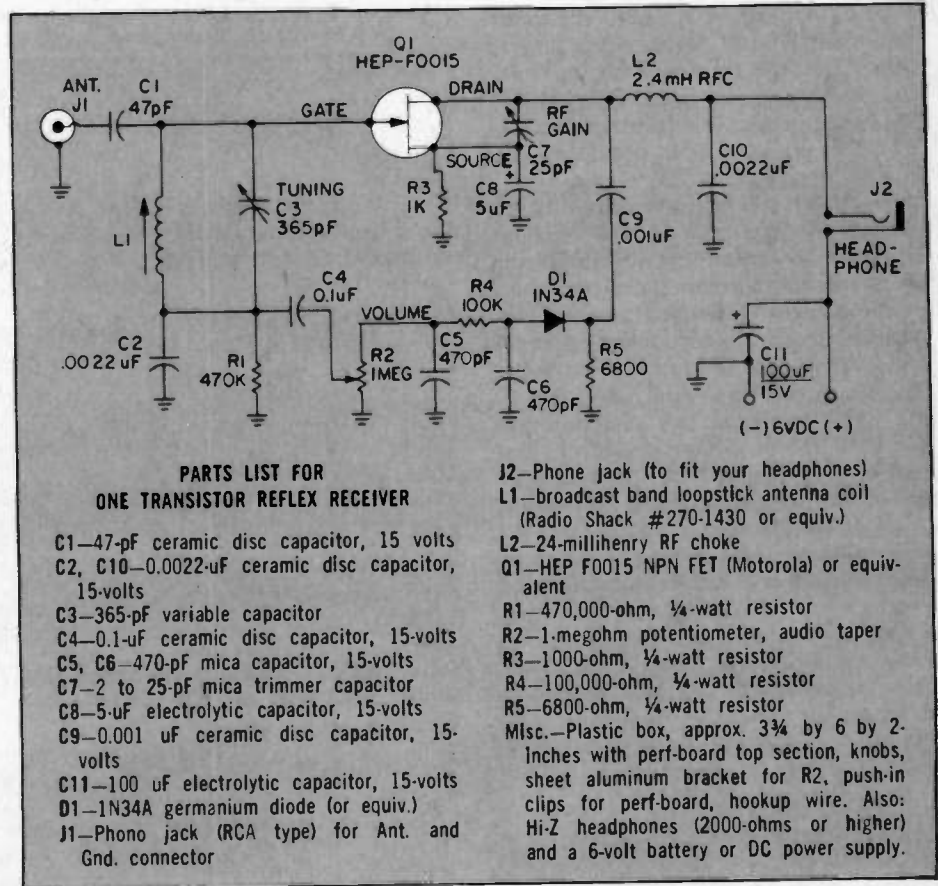

Keep up with current events by expanding your meter's amp-ability

# HIGH-AMP METERS

by Jeff Jones

**W**ITH THE RISING COST of test equipment it is advantageous to be able to perform several operations with one meter. For instance a DC milliammeter can be converted to read higher values of current by adding a shunt to bypass the bulk of the current around the delicate meter. By following a few simple steps a milliammeter can be converted to read 10 to 20 amps or more. The first step is to determine the internal resistance of the meter. From this you can calculate the shunt resistance needed and the type of material to be used.

To find the internal resistance of the meter, construct the test circuit illustrated here. The 4700 ohm resistor is used to limit current and serves no other purpose. Start with the power supply set to zero volts, leaving S2 open and S1 closed. Slowly increase the current flow by varying R3 until the meter needle moves to full-scale deflection. Without touching the setting of R3, close S2 and adjust R2 until the meter reads half of full scale. According to Ohm's Law the resistance of the meter and of R2 are now equal. Open switch S2 and measure the resistance across R2. This value will be equal to the internal resistance of the meter.

**Shunt.** Precise shunt resistance is important for accurate current readings and must be chosen carefully. With the shunt connected across the meter, most of the current is diverted past the meter. This is the theory behind a small meter being able to read high currents. The shunt can be a wire, steel or copper bar, or almost any material that will offer the proper resistance. To determine the needed shunt resistance we will consider an example. If we want a 0 to 10 milliammeter to be able to read full-scale for a current of 10 amps. Therefore 10 mA will flow through the meter when 9.990 Amps are diverted through the shunt. If the meter resistance was 100 ohms, using Ohm's Law the voltage across this parallel circuit is found by using the following equation:

$$\begin{aligned}
 E &= (\text{Current}) \times (\text{Resistance}) \\
 &= (0.01 \text{ amps}) \times (100 \text{ ohms}) \\
 &= 1 \text{ volt}
 \end{aligned}$$

Using the calculated voltage and

$$\begin{aligned}
 \text{Resistance} &= \frac{\text{Voltage}}{\text{Current}} \\
 &= \frac{1 \text{ Volt}}{9.990 \text{ Amps}} \\
 &= .1001 \text{ Ohms}
 \end{aligned}$$

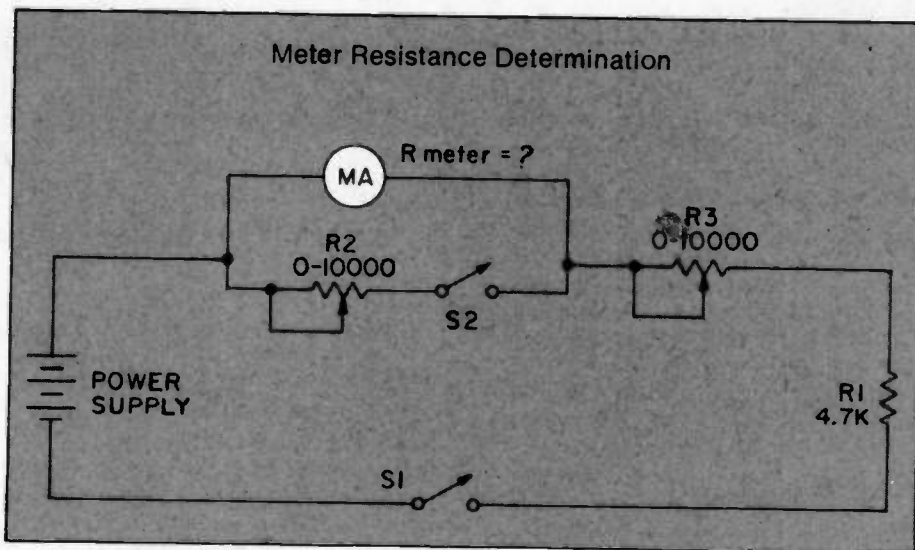

To determine the internal resistance of a meter construct a circuit like the one illustrated above. If you don't have the parts in your junk box then check an electronics surplus outlet.

A shunt resistor bypasses the bulk of the current around the meter while allowing a regulated amount to pass through the meter's coil and give an accurate reading. A shunt can be a resistor or a measured length of wire. Make sure it will handle the current.

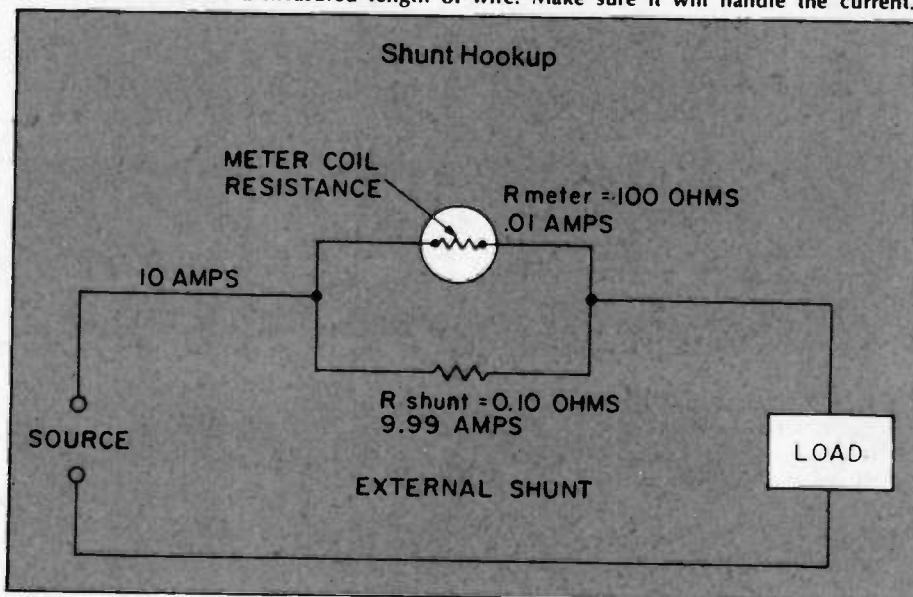

solving Ohm's Law for resistance the proper shunt can be found. This derivation is shown below:

In this case the milliammeter would be capable of giving a readout directly in amperes.

By following these few simple steps you will greatly expand the versatility of your test equipment. It will increase your ability to handle a greater variety of test and trouble shooting situations. ■



# COUNT CAPACITA



## Bring Your Junk Box Capacitors Back From The Dead!

by Walter Sikonowiz

**M**AYBE YOUR JUNK BOX looks like a haunted mansion? Full of mystery and intrigue? Do you sometimes wonder just what values all those surplus or unlabeled capacitors really are? All the VOMs, frequency meters, power meters, FETVOMs and tachometers in the world aren't going to help you here. What you need is a visit from the Count—Count Capacita—our own toothsome capacitance meter.

You can use this capacitance meter to separate good capacitors from bad ones in your junk box. In addition, if you ever have to repair a television or radio, Count Capacita will quickly put the bite on a defective capacitor, thus saving you the expense of a repair bill in the process. Last, but certainly not least, the Count will enable you to purchase surplus capacitors, and this is where you can really save money.

Surplus capacitors are sold at discount rates, usually by mail-order dealers and for several reasons. First, suppose an audio manufacturer decides to completely phase-out his old capacitively coupled amps in favor of direct-coupled designs. His inventory of new and perfectly good capacitors is now useless to him, so he disposes of the lot on the surplus market. You can take advantage of the savings—often more than 75%—if you know the Count.

With our meter, you can spot the mislabelled or out-of-tolerance units, identify unmarked devices, and eliminate the occasional defective unit. If you do much experimenting, your savings may soon pay for your capacitance meter.

**Transylvanian Circuitry.** Let's begin discussion of this particular circuit with the block diagram. The circuit is driven by a free-running oscillator that generates short-duration, negative-going pulses. These pulses are spaced by a time interval  $T_2$ . Now,  $T_2$  is controlled by the capacitor under test. Specifically,  $T_2$  is equal to  $k_1 C$ , where  $k_1$  is just a constant of proportionality. At the monostable's output, there is a rectangular waveform that is high for a time  $T_2$ , and low for a

time equal to  $(1 - T_2)$ . This waveform is then time-averaged to yield a meter current equal to  $(k_2 T_2) / T_1$ , where  $k_2$  is another constant of proportionality. Since  $T_2$  is equal to  $k_1 C$ , it follows that meter current  $I_m$  must also equal  $(k_1 k_2 C) / T_1$ . Therefore, there is a direct relationship between meter deflection and capacitance; by choosing the right values for  $k_1$ ,  $k_2$  and  $T_1$ , you get a capacitance readout.

The Count's various constants have been chosen to allow a useful measurement range that spans from less than 100 picofarads to 5000 nanofarads (5 microfarads). In case you are unfamiliar with the above nomenclature, one microfarad is one-millionth of a farad, the standard unit

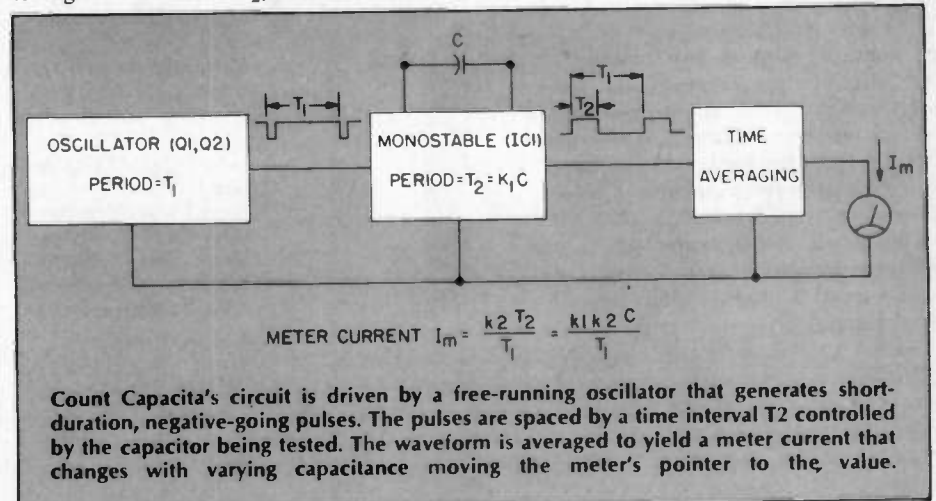

# CAPACITA

of capacitance. It takes a thousand picofarads to equal one nanofarad, and a thousand nanofarads to equal one microfarad. The scales on this meter measure capacitance in terms of picofarads and nanofarads; with the above information, you should be able to easily convert between units when necessary.

Let's now consider the schematic diagram. Assume that switch S2 is in its *battery* position and that S3 is pressed down. Battery current will flow into meter M1 through resistor R2, and M1's deflection will indicate whether or not the batteries are good. Fresh batteries will provide a meter indication of about "45"; batteries should be changed when the indication drops below "33", or thereabouts. Now, flip S2 mentally back to its *capacitance* position, and let's proceed with the rest of the circuit.

Battery current flows through resistor R1 to yield a regulated 6.2-volt supply potential across zener diode D1. Capacitors C1 and C2 bypass the supply and stabilize the circuit. The free-running oscillator is composed of unijunction transistor Q1 plus associated components. Timing capacitor C5 is charged through R13 and R14, or R15 and R16, depending on the setting of range switch S1. When the voltage on C5 reaches a specific level, Q1's emitter breaks down to a low impedance, thus discharging C5 through resistor R11. When the capacitor has been discharged to a sufficiently low level, Q1 ceases to conduct, and C5 once again

begins to charge. This charging and discharging of C5 proceeds alternately, causing a voltage spike to appear across R11 each time C5 discharges. Transistor Q2 inverts and amplifies the pulse, which is applied to the inputs (pins 2 and 4) of monostable IC1.

The monostable's period is determined by the capacitor under test in conjunction with a resistor—either R5, R6, R7 or R8—selected by range switch S1. In operation, the capacitor being tested first gets connected across a pair of binding posts, and then S3 is pressed to take a reading. You will note that these binding posts are polarized, with BP1 being positive and BP2 (which connects to ground) being negative. This is an important consideration with polarized capacitors such as aluminum and tantalum electrolytics; the capacitor's positive terminal must connect to BP1. Reverse connection is harmful to such capacitors, so be careful. The standard non-polarized capacitors—mica, paper, mylar, polystyrene, ceramic and glass—may be connected across the binding posts in either direction.

Diode D2 functions to provide a quick discharge of the capacitor under test when S3 is released. Monostable IC1's output, pin 3, drives meter M1 through R3. Averaging of the pulses is accomplished by capacitor C3 across M1. Finally, diode D3 ensures that no current is emitted from IC1's output when it drops low (to about a tenth of a volt).

Since this is not a temperamental circuit, though the Count is a bit batty you should have few problems with its construction. One point that you should bear in mind, however, is that the binding posts must connect to

the rest of the circuitry via short and direct wires spaced at least an inch apart. This minimizes stray capacitance between the binding posts and maintains good accuracy on the lowest range (pf. X 10).

As specified in the parts list, resistors R2 and R3 must have 5% tolerances. Likewise, the tolerances of R5, R6, R7 and R8 must be at least 5 percent. If you desire, 1% precision resistors could be used for R5 through R8. This will improve accuracy somewhat on the four lowest ranges, but it will also be more expensive. You won't be needing hair-splitting precision, so 5%-tolerance resistors should be quite adequate here.

Although it might seem more difficult at first, printed-circuit construction is far and away the most convenient method of assembly. For your convenience, a PC foil pattern is provided elsewhere in this article, and it may be used in conjunction with a printed-circuit kit from any of the electronics retailers. An equally effective construction method involves the use of perf-board. Either technique is capable of turning out a small, neat circuit board.

When wiring the circuit, be careful to install all polarized devices in the correct orientation. This applies to all the semiconductors, meter M1, the batteries, and electrolytic capacitors C1 and C3. Basing diagrams for all the semiconductors may be found elsewhere in the article. Lead identification

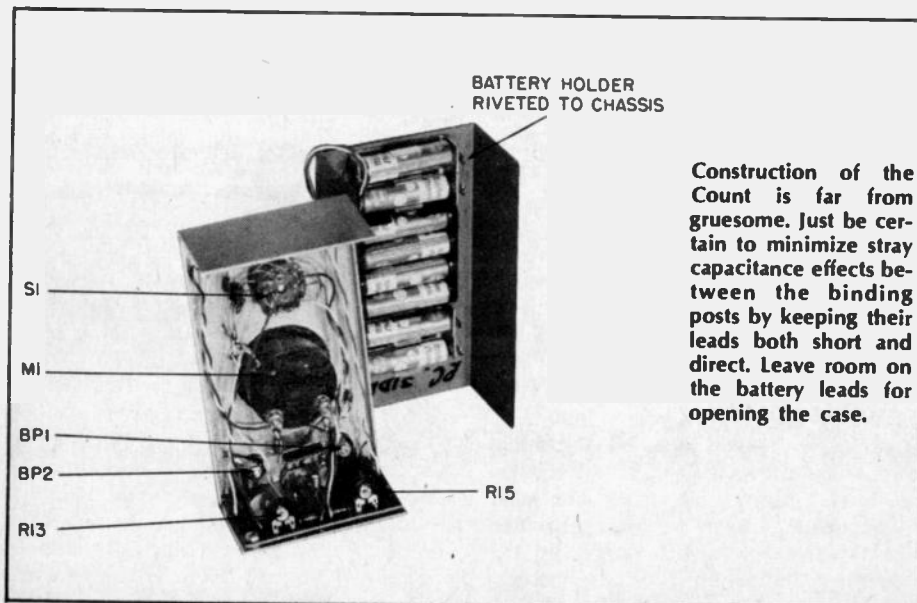

Construction of the Count is far from gruesome. Just be certain to minimize stray capacitance effects between the binding posts by keeping their leads both short and direct. Leave room on the battery leads for opening the case.

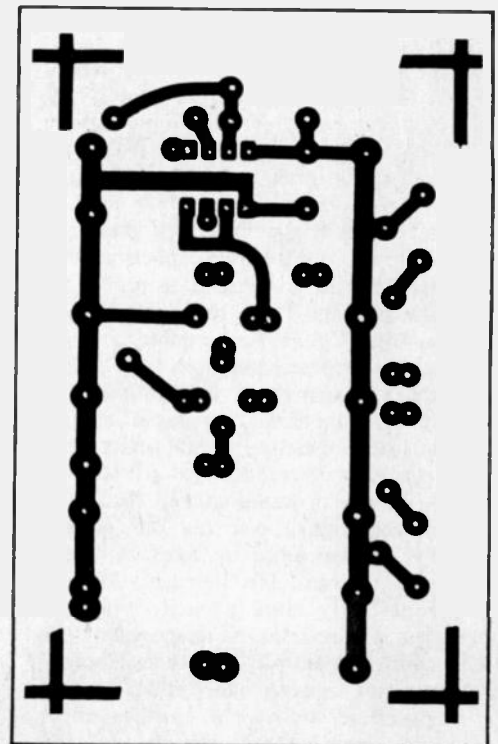

Here's your PC board template to bring the Count home to roost. Use either photo-etch materials or just use a resist marking pen.

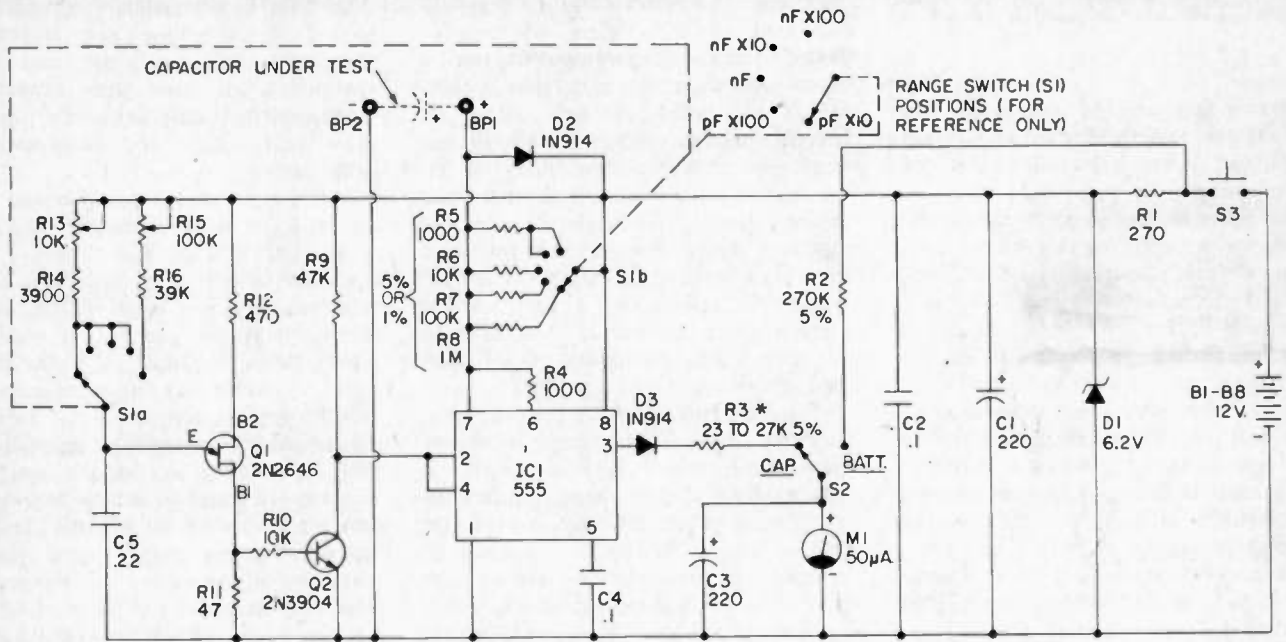

\* SELECT A LOWER VALUE RESISTOR IF NEEDED TO OBTAIN

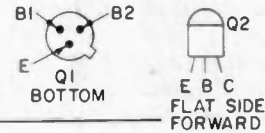

### COUNT CAPACITA PARTS LIST

- B1-B8—1.5 VDC AA-cells, connected in series
- BP1, BP2—binding posts
- C1, C3—220- $\mu$ F, 16-volt electrolytic capacitor
- C2, C4—.1- $\mu$ F ceramic capacitor
- C5—.22- $\mu$ F, 10% tolerance, mylar capacitor
- D1—1N753A Zener diode, 1/2-watt at 6.2-volt
- D2, D3—1N914 diode
- IC1—555 timer
- M1—0-50 microamp meter (Radio Shack 22-051 or equiv.—see text)
- Q1—2N2646 unijunction transistor
- Q2—2N3904 NPN transistor

ALL RESISTORS ARE 10% TOLERANCE, 1/2-WATT UNLESS NOTED

- R1—270-ohm resistor
- R2—270,000-ohm resistor, 5% tolerance
- R3—27,000-ohm resistor, 5% tolerance
- R4—1000-ohm resistor
- R5—1000-ohm resistor, 5% tolerance or 1% if desired
- R6—10,000-ohm resistor, 5% tolerance or 1% if desired
- R7—100,000-ohm resistor, 5% tolerance or 1% if desired
- R8—1-Megohm resistor, 5% tolerance or 1% if desired
- R9—47,000-ohm resistor
- R10—10,000-ohm resistor
- R11—47-ohm resistor
- R12—470-ohm resistor
- R13—10,000-ohm trimmer potentiometer
- R14—3900-ohm resistor
- R15—100,000-ohm trimmer potentiometer
- R16—39,000-ohm resistor
- S1—rotary switch, 5-position, double-pole
- S2—SPDT toggle switch
- S3—SPST pushbutton switch

- Misc.—battery holders; knobs; cabinet (LMB #C-R 632, from Circuit Specialists, Box 3047, Scottsdale, Arizona 85257); wire; press-on lettering; etc.

for transistor Q1 applies *specifically* to a 2N2646. If you use a Radio Shack RS2029 for Q1, note that it uses a different lead orientation, which is clearly illustrated on the package in which it is sold. Though their lead orientations are different, these two transistors are electrically equivalent and interchangeable.

Although it is not absolutely necessary, the use of a socket is advisable for IC1, especially if you haven't had much experience soldering integrated circuits. The socket, as well as most of the other components in the parts list, is available at Radio Shack. Two of the components, S1 and the case, may be purchased by mail from Circuit Specialists (see the parts list for their address). Circuit Specialists carry a tremendous assortment of electronic devices, and they cater to the experi-

menter by not imposing a large handling charge on small orders. You can obtain their catalog by writing to the address in the parts list.

**Under the Lid.** During construction, do not substitute for meter M1 unless the device you intend to use has a full-scale sensitivity of 50 microamps and an internal resistance of about 1500 ohms. As usual, you should make all connections with a 25-watt iron and resin-core solder. When wiring S1, make sure that the rotor of S1b engages R8 in the fully CCW position, and R5 in the CW position. Also, S1a's rotor must contact R16 when fully clockwise, and R14 in all other positions. You may then label S1 according to the diagrams provided here, with the lowest range in the extreme CCW position. Finally, be certain to label BP1 with a "+" and BP2

with a "-".

When construction is complete, there are two calibration adjustments that must be made. In order to make these adjustments, you will need two accurate reference capacitors. The first, which will be used to calibrate the highest range, should have a value between 2 and 5 microfarads—the higher the better. Commonly available capacitors in this range are generally mylar or electrolytic. The mylar is your best choice; pick a unit with the tightest tolerance you can find. In this capacitance range, that means about  $\pm 10\%$ —sometimes better. If you must go with an electrolytic, choose a tantalum device and avoid the aluminum electrolytics, which tend to be leaky and have poor tolerances. Common tolerances for tantalums run about  $\pm 20\%$ , so you can see why the mylar is the better

# CAPACITA

choice.

For calibration of the lower four ranges you will need another reference capacitor; since calibration can take place on any of the four ranges, you have some leeway in your choice of a calibration capacitor for these lower ranges. One especially good choice is a 5000 picofarad polystyrene capacitor, available from just about all of the large electronics retailers. This particular capacitor is cheap but precise ( $\pm 5\%$  tolerance). The steps that follow will use this capacitor, but remember that you can use any capacitor as long as it is accurate and its nominal capacitance falls at the high end of one of the scales.

Begin calibration of the lower ranges by connecting the 5000 picofarad polystyrene capacitor to BP1 and BP2. Set trimmer R13 to the midpoint of its range of adjustment. Make sure that S2 is in its *capacitance* position, and that range switch S1 is set to PF. X 100. Press S3 and adjust trimmer R13 for a full-scale indication of "50" on M1. This completes calibration of all four lower ranges.

Calibration of the top range is similar to the above. Hook up your capacitor, and set R15 to its midpoint. Make sure that S2 is set to *capacitance*, and that S1 is fully clockwise. Press S3 and adjust trimmer R15 until your meter indication corresponds to your capacitor's marking. This finishes the cali-

bration.

Use of Count Capacita is fairly obvious; nevertheless, here are a few odds and ends that you might find helpful: The maximum voltage appearing across any capacitor under test is about 4.2 volts, which is well below the rated working voltage of almost any capacitor that you are likely to encounter. Because battery current drain is intermittent and moderate, the cells will last a long time—possibly for years. However, it might be a good idea to replace batteries once a year, even if they indicate more than "33", in order to prevent the possibility of a battery leak inside your meter.

Whenever you make a measurement, start on a range high enough to accommodate the capacitor being tested. If you have no idea of the capacitor's approximate value, always start on the highest range. Should a capacitor be opened up internally, it will provide a reading of zero on all scales.

If the capacitor is leaky, its measured capacitance will be considerably larger than the value stamped on its case. This is because capacitor leakage is equivalent to having a resistor in parallel with the capacitor. This leakage resistance siphons off capacitor current, so the capacitor takes longer to charge, and monostable IC1's output stays high for a longer time. The result is an erroneously high capacitance reading. By the same token, you can expect an internally shorted capacitor to pin the meter's needle on all scales, since a short is, in effect, just a case of complete leakage.

Now, let's return to an important

topic that was introduced earlier; stray capacitance between the binding posts. The construction details already presented should help to keep strays at a minimum; however, you can never completely eliminate stray capacitance or the errors it may cause. Fortunately, it is very simple to compensate for such errors.

After your meter is calibrated, turn to the most sensitive range: Picofarads x 10. This is where the effects of stray capacitance will show up. Without any external capacitor between the binding posts, press the pushbutton and note meter M1's indication. On the prototype, a reading of 30 picofarads was obtained. This represents the value of the stray capacitance in parallel with any capacitor under test. It also represents the amount by which any capacitance reading will be in error. To compensate, simply subtract the residual capacitance from any given meter reading. For example, a reading of 480 pf. on the prototype meter would be corrected to 450 pf. (480 pf. minus 30 pf.). Such corrections are significant and necessary only on the most sensitive scale. Finally, since stray capacitance can obviously affect accuracy on the most sensitive scale, it is preferable that you *not* calibrate there, but on one of the higher scales, as outlined previously.

So, on the next dark night, why not sit yourself down and, to the strains of some Transylvanian music, acquaint yourself with the inner workings of our Count Capacita? You have nothing to lose but your fear—fear of choosing the wrong capacitor!

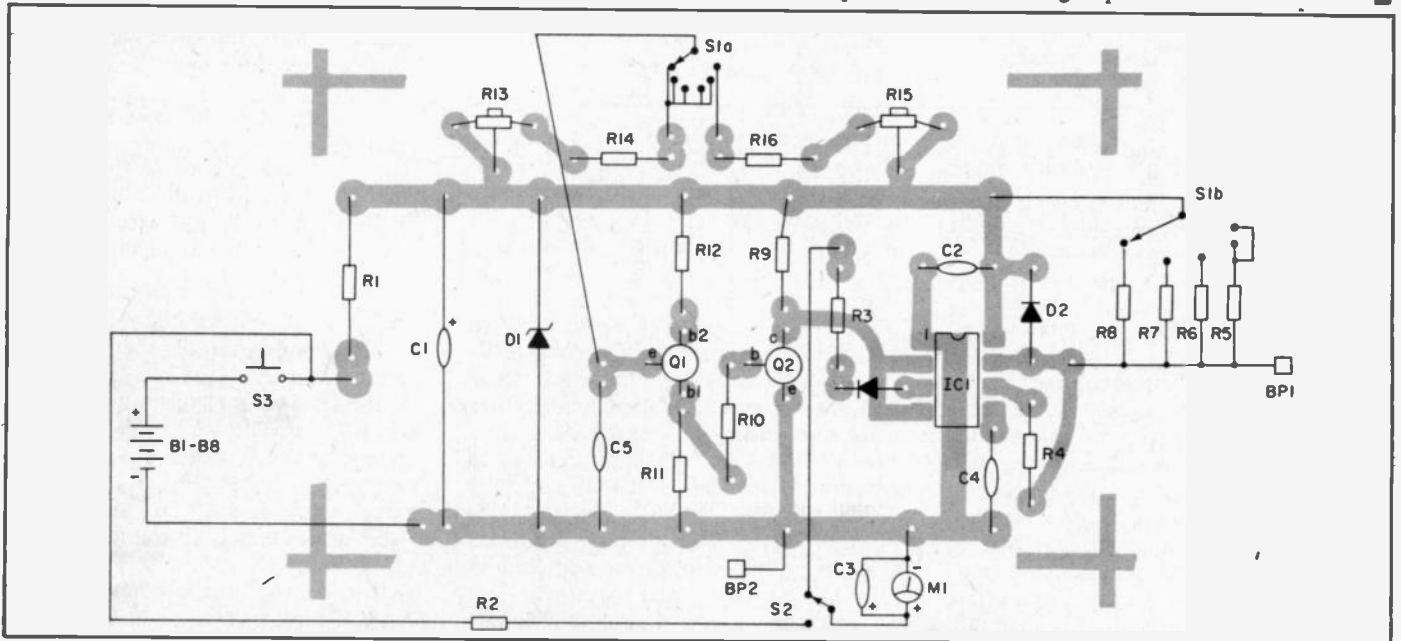

Take your mind off those eerie noises from off the moors by building our sanguine Count. Here's where the components lie. The Count will bring back to life all of those once-useless, unmarked capacitors once doomed to a junkbox graveyard!

# THE SIMPLE SIGNAL TRACER



**R**emember that AM pocket radio your cousin gave you last year? How about the one the bank gave you last week when you opened up a new account? Most electronic experimenters end up with one such useless radio at some time, and that spare radio can be converted into a piece of test equipment that will be an invaluable aid to your workbench; a signal tracer.

In AF and RF circuits, even after you have taken voltage measurements and begun to suspect certain components, it really helps to be able to *hear* what's there. The signal tracer can be used to probe the area in such cases and can also be used as a simple amp/speaker system.

This project will outperform the inexpensive tracers on the market, which cost about \$15. If you already have a spare AM radio, you can complete this project for 3 to 4 dollars. If you don't have a spare radio already, some sharp shopping should nab you one for about two or three dollars. Either way, you'll enjoy a considerable savings over the store-bought tracer, as well as better performance.

**How It's Done.** Every radio has two sections in it: An RF (Radio Frequency) section and an AF (Audio Frequency) section. The RF section yanks the radio signals from the air and demodulates them to recover the audio signals that are being broadcast. The AF section then amplifies these weak audio signals to a volume that we can hear.

What we'll do then, is to tap in just before the volume control (The volume control works by sending a varying signal to the AF section that has been produced by the RF section. The variation is the volume control setting.) So the volume control will control the loudness of the input signal that you put in when you're tracing.

Referring to the schematic, in the AF mode of operation, the signal input goes through C1, which blocks any DC coming from the circuit under test, but couples the signal to the radio's ampli-

fier input. For tracing RF signals, D1 and C2 couple and demodulate the RF signal that is being traced.

**Construction.** Remove the back cover of your radio, and locate the volume control potentiometer. Remove the small screw that is holding the volume control dial to the potentiometer's shaft, and remove the dial so that you can clearly see the three "lugs" (or pins) on the volume control potentiometer.

Now, it's necessary to find the lug that carries in the signal from the RF section of the radio. You can eliminate the center lug. Next, take an ohmmeter and clip its ground lead to the negative battery wire. Take the positive ohmmeter lead and touch it alternately to the two remaining lugs of the volume control potentiometer. The lug that, when touched reads no resistance (0-ohms), can be eliminated, as the remaining lug (the third one) is the one you'll need to operate on for the modification.

Now, take a sharp knife or cutting tool, and cut the foil on the PC board that runs to this lug on the potentiom-

With the chassis removed from the case, the connections to the radio's printed circuit board are visible. The input wire running from S1 to the volume control's input lug, as well as the ground wire from jack J1, are the only two hard-wired connections necessary.

## A pocket radio dies so that others may **live**

By Bob Powers

eter so that there is no longer any connection there. This cuts off the signal from the radio's RF section so that it won't be heard. Now, solder a three-to-four-inch piece of insulated wire to the disconnected lug. Solder a similar length of wire to the point on the PC board where the battery's negative lead is attached.

Connect the wire from the lug of the potentiometer to the center lug of switch S1. Follow the schematic, and wire capacitor C1 to one side of switch S1, and to the tip connector on jack J1. In a similar manner, connect diode D1 and capacitor C2 to the other side of switch S1, and to the tip connection point on jack J1. Observe the polarity of D1, and use a heat sink when soldering it. Next, connect the sleeve connector of J1 to the wire from the negative side of the battery that you installed earlier. Finally, drill two mounting holes in the radio's case to accommodate J1 and S1. Be sure to mount them where there is no possibility of their connecting lugs coming in contact with the PC board. This is usually best done near the battery compartment.

Finally, solder different colored wires (red for the center connector, black for the sleeve connector) to P1, and attach an alligator clip to the black lead, and a probe tip to the red wire. A paperclip wrapped with electrical tape will make a functional probe tip.

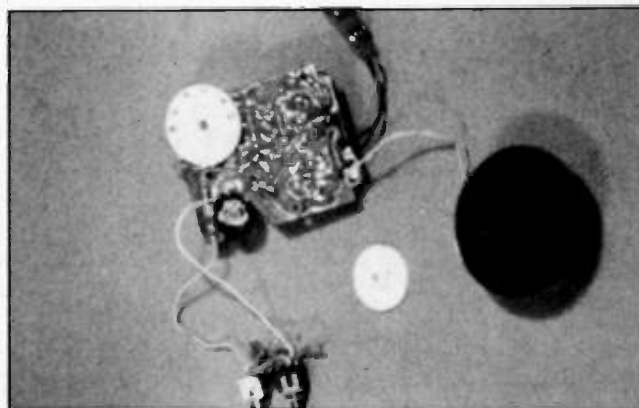

# TRACER

**Use.** Turn on the tracer, as you would regularly turn on the radio, and set the volume up half-way. Now insert the plug with the input leads into jack J1. Connect a signal source to the tracer's input leads and listen for it.

With its RF circuitry, you can listen to modulated RF signals when switch S1 is in the RF position. The normal procedure is to connect the tracer's ground (-) input lead to the ground of the unit under test, and connect the positive tracer lead in a radio frequency circuit somewhere before the "detector."

Books on troubleshooting can give you many tips on how to best utilize a signal tracer and with only a little practice, you can start beating down the high cost of professional service, and maybe even make a little money by fixing your friends' and family's electronic gear!

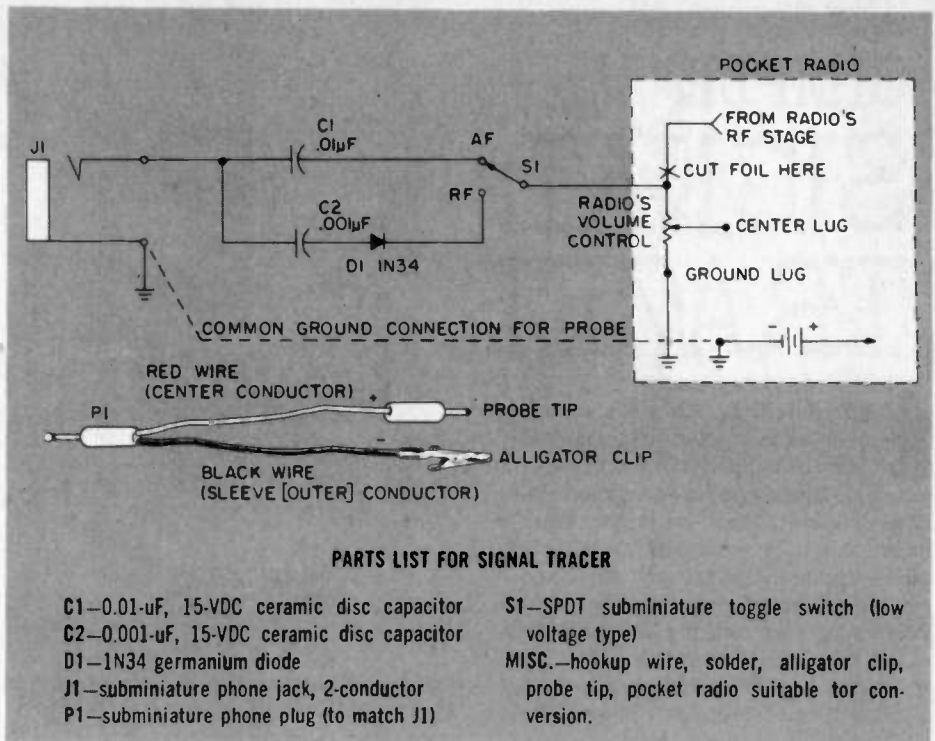

# SWL's Super Calibrator

□ Providing WWV referenced outputs at 1 MHz, 100 kHz, 10 kHz and 1 kHz, this super calibrator looks quite difficult to assemble, but if you lay it out for a printed circuit board you'll find it's one of the easiest projects to build and get working.

IC1 serves as both the oscillator and buffer amplifier. Another buffer amplifier is used for the output amplifier (terminals 11, 12 and 13), IC1's output at pin 8 is a buffered 1 MHz. ICs 2, 3 and 4 are *divide by 10*

*frequency dividers* providing outputs of 100 kHz, 10 kHz and 1 kHz. Since all outputs are square waveform, all output signals are rich in harmonics and so can be used to calibrate receiver dials to well above 60 MHz for the 1 MHz output and to at least 30 MHz for the 100 kHz and 10 kHz outputs. The 1 kHz harmonics can range up to 30 MHz depending on your receiver's sensitivity. The calibrator's output at jack J1 can be connected directly to the receiver's an-

tenna input terminals without affecting the calibrator's output frequency.

The unit is set to zero-beat with WWV with trimmer capacitor C4. It can be assembled in any type of cabinet, but a PC board is specifically recommended for circuit stability.

Power must come from a 5-volt regulated source and we recommend the LM340 5-volt three-terminal regulator for this project. Make certain capacitor C1 is installed as close as possible to IC1 pin 14.

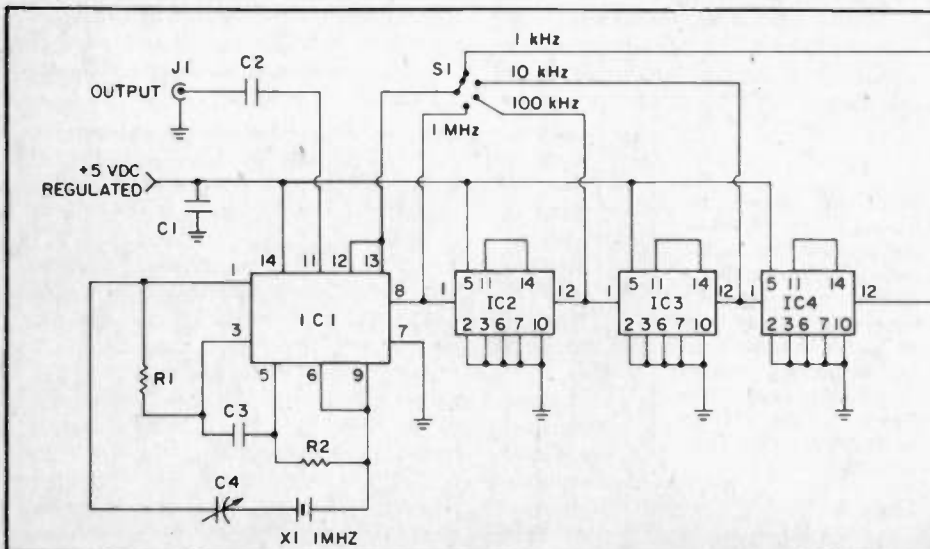

- PARTS LIST FOR  
SWL'S SUPER CALIBRATOR**
- R1, R2—220-ohms, ½-watt, 10%, resistor
  - C1, C2, C3—0.01-µF, 10-VDC or higher, capacitor
  - C4—5-50-pF trimmer capacitor
  - X1—1-MHz crystal, Calectro J4-1900 or equiv.
  - IC1—Integrated circuit type SN7400
  - IC2, IC3, IC4—Integrated circuit type SN7490
  - S1—SP4T switch
  - J1—Output jack (phono type suggested)



# SUB-BASEMENT RADIO

## EXPERIMENTER'S DELUXE FET/IC VLF RECEIVER

**J**UST AS MANY of the "cliff dwellers" in modern multi-story apartment buildings have little-known basements and sub-basements, the radio spectrum has a "basement" LF (low frequency) band and a mysterious "sub-basement" VLF (very low frequency) band, little known to many electronics hobbyists and experimenters. The LF band goes from 300 kHz down to 30 kHz, and the VLF band from 30 kHz down to 3 kHz.

The lower portion of the LF band, from about 60 kHz to the upper portion of the VLF band (about 18 kHz), is used by the National Bureau of Standards to transmit coded, standard-frequency signals (similar to WWV). Special receivers are used for proper reception of these signals, which automatically adjust electronic laboratory generators to coincide with the standard frequencies. The U.S. Navy has found that the VLF band signals will penetrate into salt water and has established giant high powered transmitting stations that communicate with submerged submarines anywhere in the world.

Other nations maintain transmitting stations in the LF/VLF region for scientific and navigational purposes. These

stations are subject to changes in frequency, power, and time of broadcast since there is still considerable experimentation. The stations usually transmit their call signs in CW at periodic intervals for identification.

Receivers for the LF/VLF "basement" transmissions are usually quite complex, but you can sample the activity in this portion of the rf spectrum with our simplified receiver project which covers the most popular portion of the bands from 20 to 50 kHz. This frequency coverage can be changed by using different values of inductances than specified in our plans. Plans are also included for a VLF-style loop antenna to be used with the receiver instead of the usual outdoor dipole antenna used in the higher frequencies. Inasmuch as VLF wavelengths are many miles long, a half wave antenna dipole is impractical at these frequencies.

The receiver uses two ICs and three FETs in a simplified regen detector circuit with a two-stage rf amplifier. Good audio volume is provided for earphone reception, and the receiver is housed in a compact metal utility box. Perforated board style construction is used for

ease in building the receiver.

**The Circuit.** Very low frequency signals picked up by the loop antenna are fed through coax cable to the input of IC1, the rf amplifier stage. The amplified signals are fed through C3 to the coil L1 and the second rf amplifier stage, IC2. L1 and the input capacity of IC2 act as a broadly tuned circuit for VLF signals: R2 controls the rf amplification.

Capacitor C6 couples the amplified rf signals to the oscillating detector stage of FET Q1. These signals are tuned by L2 and the S1 switch-selected capacitors of C8 to C18. Variable capacitor C7A/B acts as a fine tuning control for the VLF signals, and R5 controls the oscillation point and, therefore, the sensitivity of the detector stage.

The detected audio signals are fed through the low pass filter R7/C20 and coupling capacitor C21, to the audio gain control R8 and audio amplifier stage Q2. The amplified audio signals are coupled via the L3/C23 peak filter to the second audio amplifier stage of FET Q3. The peak filter is tuned to approximately 800 Hz to provide better receiver selectivity of the

# SUB-BASEMENT RADIO

VLF signals. The amplified signals are fed from the drain circuit of Q3 to J2 and can drive high impedance ear-phones (2000-ohm type).

Field effect transistors Q2 and Q3 form the audio amplifier stages. Q3 is a P-channel FET and therefore requires a relatively negative potential on its "drain" terminal. This is accomplished by grounding the drain through the earphone and returning the "source"

to the positive power supply terminal.

**Construction.** Coils L1 and L2 are made from miniature transistor audio transformers by removing the laminated iron core. We used 10,000-ohm to 2,000-ohm center-tapped transformers for the coils in our receiver. The connections are made to the 2,000-ohm center-tapped winding only; the leads to the 10,000-ohm winding should be cut off close to the coil form. Coil L3 is a 1,000-ohm CT to 8-ohm miniature output transformer and is used with its iron core intact. The 1,000-ohm wind-

ing is used (no connection is made to the center tap), and the 8-ohm and center tap leads should be cut off close to the coil form.

The receiver operation is at low rf frequencies, but the wiring of the receiver should still be carefully done. For best results, follow our component layout as shown in the photos. Your best way to start construction is to cut a 4¼ x 7¾-in. section of perf board and install it approximately halfway up the LMB-146 aluminum box. We used two ¼-in. lengths of sheet aluminum

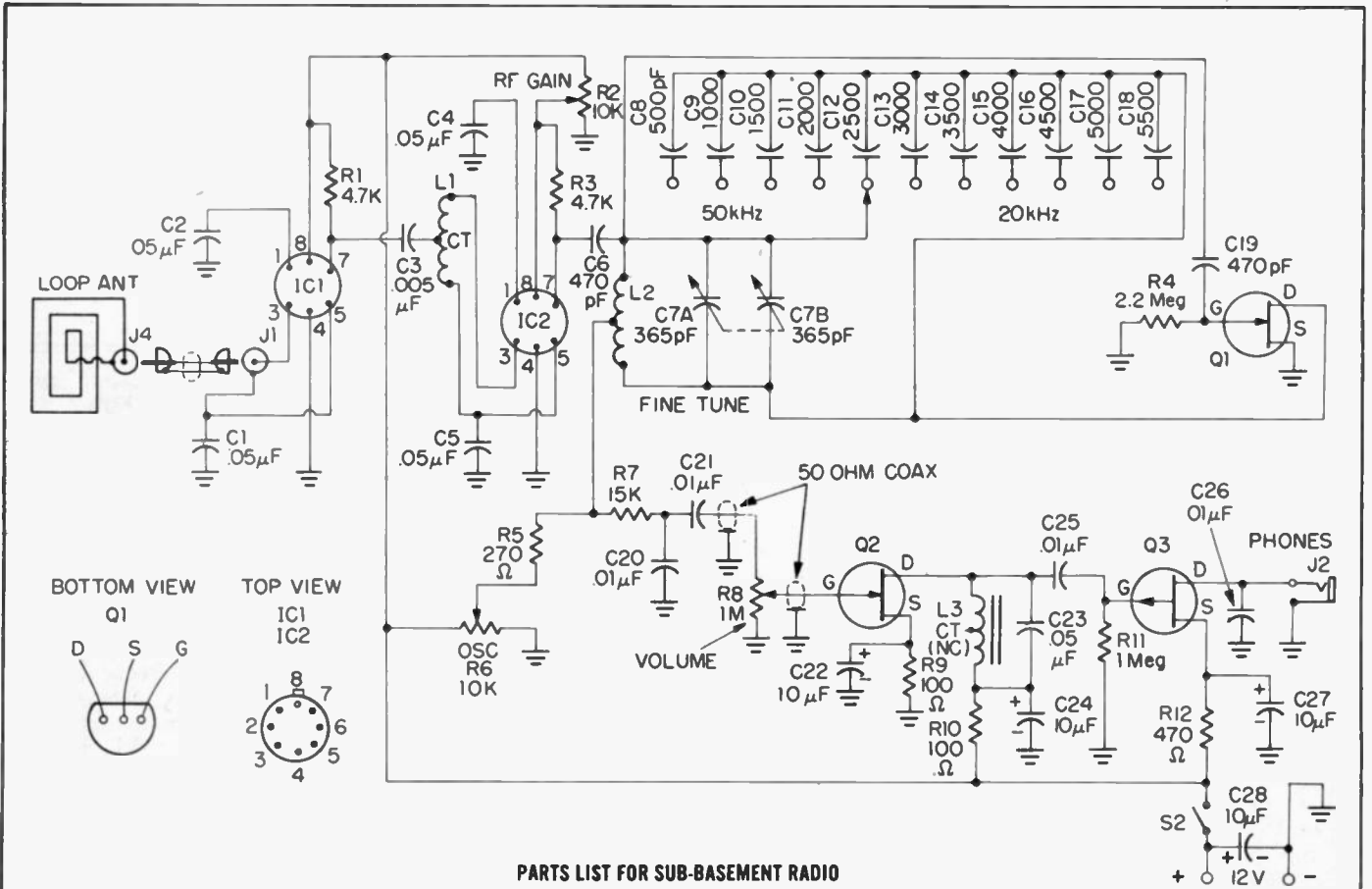

PARTS LIST FOR SUB-BASEMENT RADIO

C1, C2, C4, C5, C23—0.05-uF capacitor, 12-VDC or better

C3—0.05-uF capacitor, 12-VDC or better

C6, C19—470-pF capacitor

C7A/B—dual-gang 365-pF variable capacitor (TRW 273 or equiv.)

Note—A dual-gang 365-pF variable capacitor may be difficult to obtain. You can go the same route as pioneer radio builders by using two single-gang 365-pF variable capacitors and operate them in tandem (turn each knob the same amount).

All capacitors 15-VDC or better

C8—500-pF (see text for all capacitors, C8 to C18)

C9—1000-pF

C10—1500-pF

C11—2000-pF

C12—2500-pF

C13—3000-pF

C14—3500-pF

C15—4000-pF

C16—4500-pF

C17—5000-pF

C18—5500-pF

C20, C21, C25, C26—0.01-uF capacitor

C22, C24, C27, C28—10-uF electrolytic capacitor, 16-VDC

IC1, IC2—703-type integrated circuit

J1, J3—insulated phono jack, RCA type (see text)

J2—two-conductor phone jack

L1, L2—inductors made from small 10k to 2k audio driver transformers

L3—inductor made from small 1k to 8-ohm audio output transformer (see text)

Q1—N-channel FET, HEP-802 (Motorola)

Q2—N-channel FET HEP-F0015

Q3—P-channel FET HEP-F1035

R1, R3—4700-ohm, ½-watt resistor

R2, R6—10,000-ohm potentiometer, linear taper

R4—2.2 meg, ½-watt resistor

R5—270-ohm, ½-watt resistor

R7—15,000-ohm, ½-watt resistor

R8—1 meg potentiometer, audio taper

R9, R10—100-ohm, ½-watt resistor

R11—1 meg, ½-watt resistor

R12—4700-ohm, ½-watt resistor

S1—single pole, 11 position rotary switch (Calectro E2-161 or equiv.)

Note: values for bias resistors R9 and R12 may be changed for optimum performance.

Misc.—aluminum cabinet 8-in. x 6-in. x 4½-in. (Author used LMB 146), perf board, push-in clips, 50-ohm coaxial cable, knobs, hook-up wire, No. 28 enameled wire, plastic tape, solder, etc.



bent into brackets with sides approximately  $\frac{1}{4}$  x  $\frac{1}{2}$ -in. ( $\frac{1}{2}$ -in. side mounted to the box wall, and the  $\frac{1}{4}$ -in. side mounted to the perf board). Additional lengths of  $\frac{1}{4}$ -in. wide sheet metal stiffeners were added to the side of the perf board to increase the rigidity of the board. This may not be necessary in your unit.

**More Mechanics.** Locate C7A/B on the front panel as shown in the photos, and then cut a  $\frac{1}{2}$ -in. or larger hole for the shaft. This will allow the frame of C7A/B to be mounted to the perf board and allow the shaft to protrude through the front panel without touching the metal panel. Note that the shaft *must* be insulated from the panel, or it will short the B+ at the detector circuit. If necessary, you can use an insulated coupling for the shaft. Make sure that you use a plastic tuning knob to minimize the possibility of short circuits.

Locate and install the remainder of the front and side panel controls and components as shown in the photos. Make sure that you install serrated washers between the control bushings and the inside of the panels to prevent accidental disturbance of the position of the controls. Also, use insulating washers for J1 to keep the jack body from electrical contact with the box panel and electrical ground.

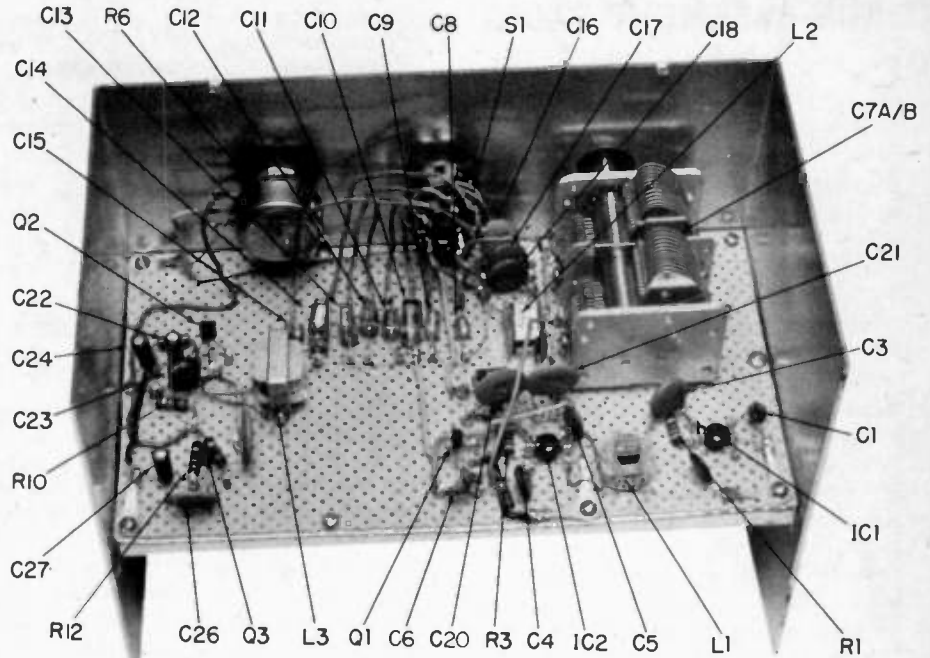

These are the major parts locations for the perf board. Note dual-gang cap C7A/B.

Most of the components on the perf board are connected to push-in clips. Keep the component leads as short as possible and group them around their particular IC or FET as shown in the photos. Wire the components as indicated in the schematic drawing and position the leads as shown in the

board photo.

Coil forms L1 and L2 can be either cemented to the top of the perf board, or (as in our unit) held with an application of hot plastic glue from an electric glue gun. Use short lengths of coax or shielded wire to connect R8 to the perf board components as shown in the

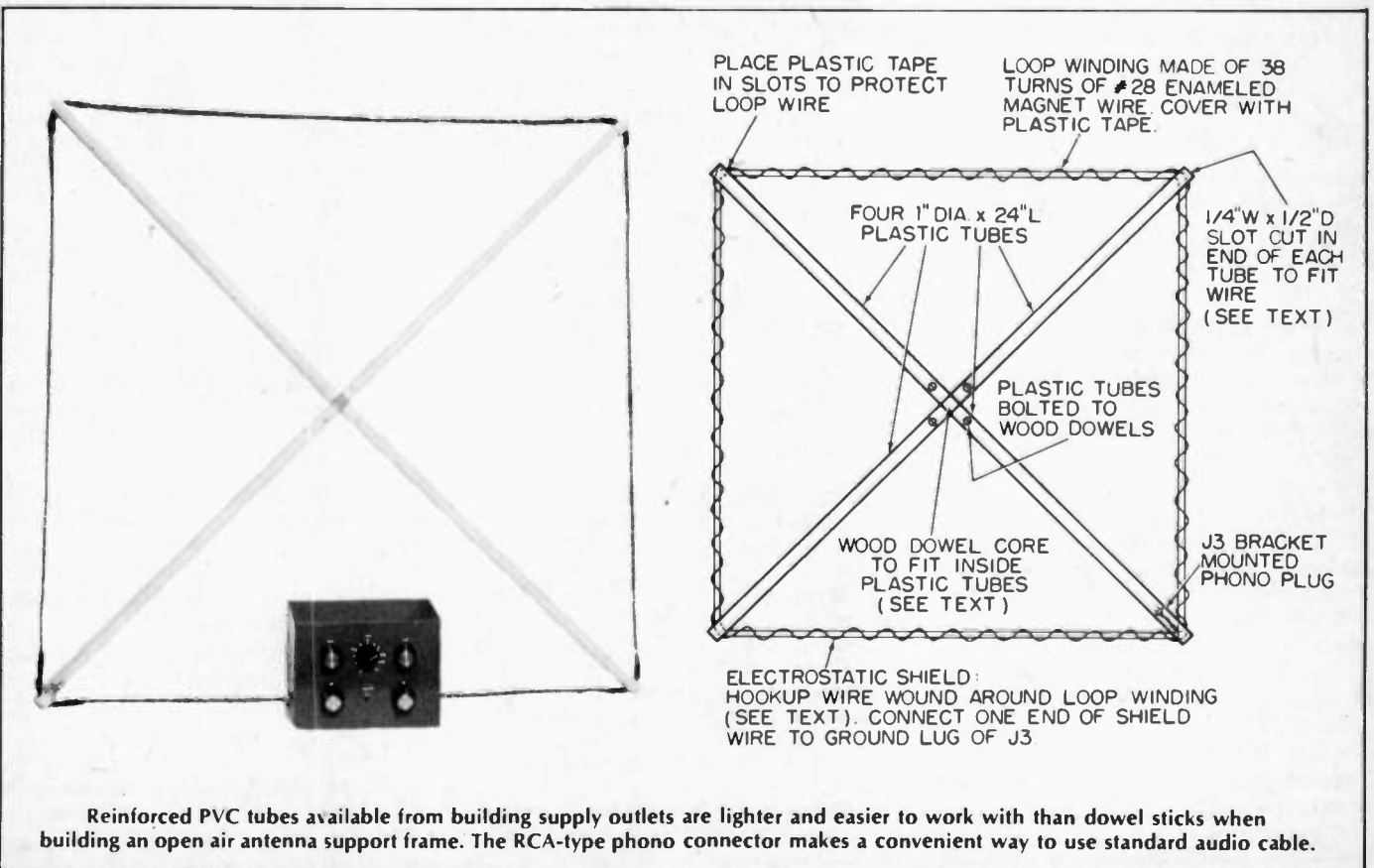

## SUB-BASEMENT RADIO

photo. Connect ground lugs at the board corners and on the C7A/B mounting screws for the necessary electrical circuit connections.

Capacitors C8 to C18 should have as accurate a capacity value as possible (select them on a capacitor bridge if possible), and they can be either ceramic or polystyrene types. Mount them with short leads around S1 and connect them with straight direct leads to the S1 lugs. If necessary, you can parallel capacitors to make up the required capacity values. Connect the remainder of the front and side panel controls and jacks to the board circuits, and position the leads as shown in the photos.



The front panel control knob "osc" sets the regenerative feedback point of the detector FET Q1 (it sets the audible "plop" point!). That "tune" knob is actually a fine-tune of the bandswitch-like "kHz" (course) control.

cut a 1/4-in. x 1/2-in. deep slot on one end of each tube. Then mount the tubes to the wood dowel core with the slotted ends outward and parallel to allow the loop antenna wires to be wound around the ends as shown in the drawing.

Place plastic tape in the tube slots to prevent the wire from being abraded, and wind the loop with 38 turns of #28 enameled magnet wire, and cover the wires with a layer of plastic tape. Connect the loop leads to a phono jack (J4) mounted on the end of one of the plastic tubes.

To minimize noise pickup, wind an electrostatic shield composed of a spiral winding of hookup wire around the antenna loop. Leave about 1-in. spacing between the electrostatic shield wire turns, and connect one end of the wire to the "low" side (shell) of J4. The other end of the electrostatic shield wire should be taped so that it will not cause any accidental short circuits.

A length of good quality phono or coax can be used to connect the loop antenna to the receiver. Make sure that the "low" sides of P4 and J1 are con-

nected together (the outside shells of the jacks).

**Range and Panel Markings.** We used rub-on decals for the panel markings for our receiver model, but neatly drawn pen and ink markings on white tape can be used as well.

The receiver does not require any calibration for exploratory operation on the VLF band, and you can designate the approximate frequency of the S1 kHz switch as follows: 20 kHz (C18=5500 pF), 25 kHz (C15=4000 pF), 30 kHz (C13=3000 pF), 35 kHz (C10=1500 pF), 40 kHz (C9=1000 pF), 45 kHz (C8=500 pF).

For more accurate calibration with the transformers you used for L1 and L2, connect an audio oscillator to J1 through an isolating audio transformer.

**Testing and Operation.** The loop antenna can be suspended with a length of cord from one of the plastic tubes for easy rotation and operation indoors. Or the loop can be placed on a wooden chair for temporary operation. Note, however, that the loop should be away from AC appliances for best performance.

Set all controls to the extreme counter-clockwise position, and connect the receiver to a 12 volt DC power supply or battery. Connect the loop antenna to J1 with either coax or a length of good quality phono cable, and plug in a set of high impedance earphones at J2.

Adjust the *audio gain* (R8), *rf gain* (R2) and *fine tune* (C7A/B) controls to mid-range. Adjust the *osc* control (R5) clockwise until the detector circuit (Q1) is oscillating. There will be a "click" or "plopping" sound in your earphones when the detector stage first falls into an oscillating condition. Keep adjusting the *osc* control (R5) near this point for best sensitivity when tuning for signals. Adjust R8 and R2 for best reception of signals.

Adjust the *fine tuning* control (C7A/B) for each setting of S1 as you listen in on the VLF band from 20 kHz to 50 kHz. Reposition the loop antenna as necessary for best reception of signals. Practice is required to obtain the proper "feel" for operating the receiver controls. You can also try different loop antenna assemblies with different turns of wire for best results in VLF reception over different portions of the band. You can experiment with the tuning range by changing the values of L1 and L2.

Remember, this is an experimenter's project exploring the little-known, little-tuned very low frequencies. It's a good first-step project into VLF; why not "kick in" right now!

CENTER SLOTS  
CUT IN TWO 5-IN.  
WOOD DOWELS

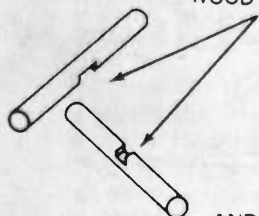

AND CEMENTED  
TOGETHER TO  
FORM LOOP CORE

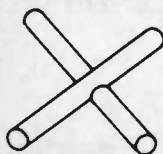

Dowel sticks for this assembly are available from lumber yards, hardware store and hobby shops. Notch with a wood chisel or a keyhole saw or whittle with a pocket knife.

**The Loop Antenna.** As shown in the drawing, the loop antenna is composed of four 1-in. diameter x 24-in. long plastic tubes. We used polyvinyl chloride (PVC) tubes that can be obtained from a building supply store. Or any type of plastic tube can be used as well. The plastic tubes are fitted over a wood-dowel center core as shown in the drawing, and the loop antenna wires are wound over the slots in the tube ends.

Begin construction of the loop antenna by cutting center slots in two 5-in. long wood dowels (of a diameter to fit snugly into the plastic tubes), and cement them together as shown in the drawing. Wood screws can be used in place of cement, or hot glue from an electric glue gun can be used as we did in our model.

Cut the plastic tubes to size and then

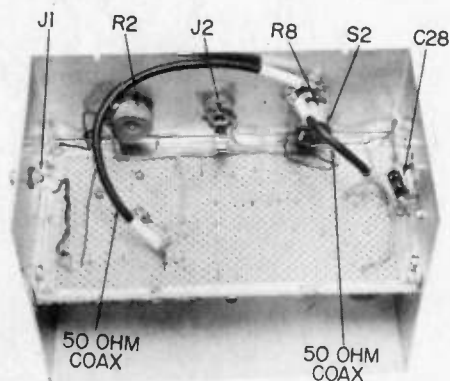

Experimenters should use a short length of 50-ohm coaxial cable for vol. control R8 connections (mini-type RG-174U or RG-58 U).

**S**OME BIG CHANGES are on the way for the SWL, especially in the upper shortwave bands from the 25-meter band on up to 30 MHz and beyond. The Sun is now entering one of its periods of increased sunspot activity after a 20-year period of relative calm. This will make short range communications unreliable and long range DX an everyday affair. Signals from stations just down the road will be, literally, lost in outer space, and wishy washy signals from outer nowhere will come booming



# SHORTWAVE SUPERCHARGER

Turn your old SW clunker into a high-band hot-rod.

into your listening post like they were right next door.

Under these conditions many old and some not-so-old shortwave receivers will need a bit of help when they try to work the high bands. Their circuits tend to get a little frazzled. As a matter of fact, almost any SWL would appreciate a bit of a signal boost now and then. It might just

make the difference between a very good DX catch and a record breaking DX discovery.

If you decide you want a DX boost or you need to increase the versatility of your old set then you should build this Shortwave Supercharger.

This unit will boost selectively the RF signal by 20-30 dB and it will compensate for many deficiencies of your set.

It will not only improve the gain of the shortwave receiver but will also improve its selectivity and the image frequency rejection. Simple, single conversion superhet SW sets have the annoying tendency of receiving spurious signals separated by twice the IF frequency from the desired signal. For example if you tune to 20 MHz you may also receive  $20 + (2 \times 0.455) = 20.910$  MHz (image frequency) signal which will interfere with the 20 MHz signal. In addition you will be able to pull in many SW stations you didn't even know existed. With 10- to 15-feet of wire behind your sofa as an antenna you may receive stations as distant as Australia or mainland China.

**How does it work.** The circuit is based on an inexpensive integrated circuit manufactured by Motorola and its HEP subsidiary. Its innards consist of three transistors, a diode and four resistors which together form an excellent automatic gain controlled (AGC) radio frequency amplifier. To build the circuit with separate discrete components would cost a bundle and the result would not be as good. The incoming RF signal is coupled with a few turns of wire to the coil L1. The tuned parallel-resonant circuit consisting of L1 and C1 selects the wanted signal by rejecting adjacent frequencies and feeds the sig-

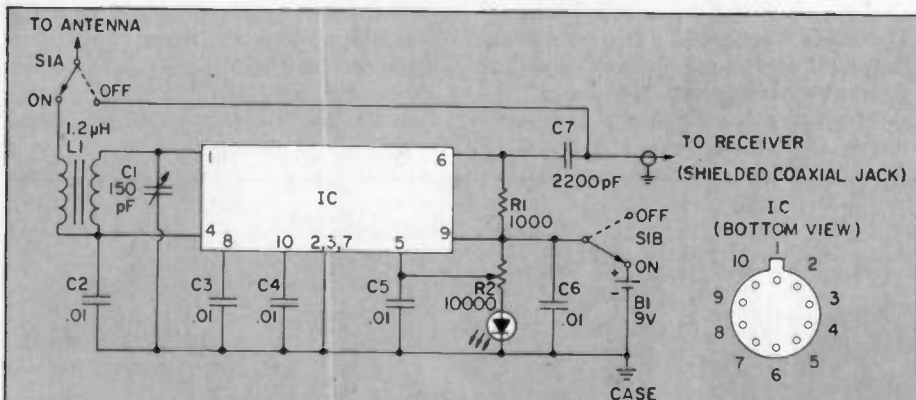

PARTS LIST FOR SHORTWAVE SUPERCHARGER

- B1—9V transistor radio battery
- C1—150-pF variable capacitor
- C2, C3, C4, C5, C6—0.01 uF capacitor
- C7—2200-pF capacitor
- R1—1000-ohm 1/4-watt resistor
- R2—10,000-ohm variable resistor
- IC—Motorola MC1550, HEP 590 or HEP C6091

- LED—Red LED indicator
- L1—Miller 4502, 1.1-1.5-microhenry coil (for winding your own, see text), for antenna connection use 3 turns of wire wound tightly around the coil.
- S1—DPDT switch
- Misc.—case, knobs, jacks for shielded cable

# Super Charger

nal to pin 1 of the integrated circuit. The amplified signal leaves the IC on pin 6. The AGC input on pin 5 is used to control the gain of the amplifier when you turn potentiometer R2.

**Construction.** This is a radio frequency project which requires a neat soldering job and short connections. However, if you do a half-decent job the supercharger should fulfill your expectations. The author used point-to-point wiring on a perf board. If you have some experience with PC boards you might use the layout shown here. The Super-

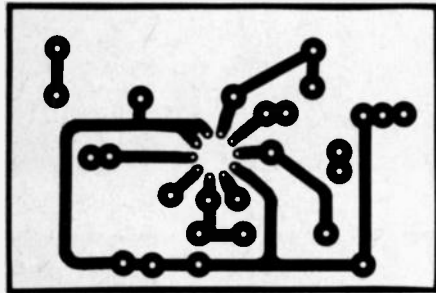

Use this full-size circuit-board template to build your Shortwave Supercharger. You can find etching materials at a radio shop.

charger with the indicated component values will cover approximately 10-30 MHz. Using different values for L1 or C1 will change this range, though the ratio of minimum to maximum frequency will remain 1:3. Doubling the capacitor or inductance value lowers the frequency by 1.41 and lowering either value increases the frequency by the same factor. If you want to substitute some parts, or wind your own coil or use a different capacitor, the circuit is quite flexible in this respect. For example you may want to replace the 150 pF capacitor C1 used by the author since this is often difficult to find. Use instead the oscillator half of the stand-

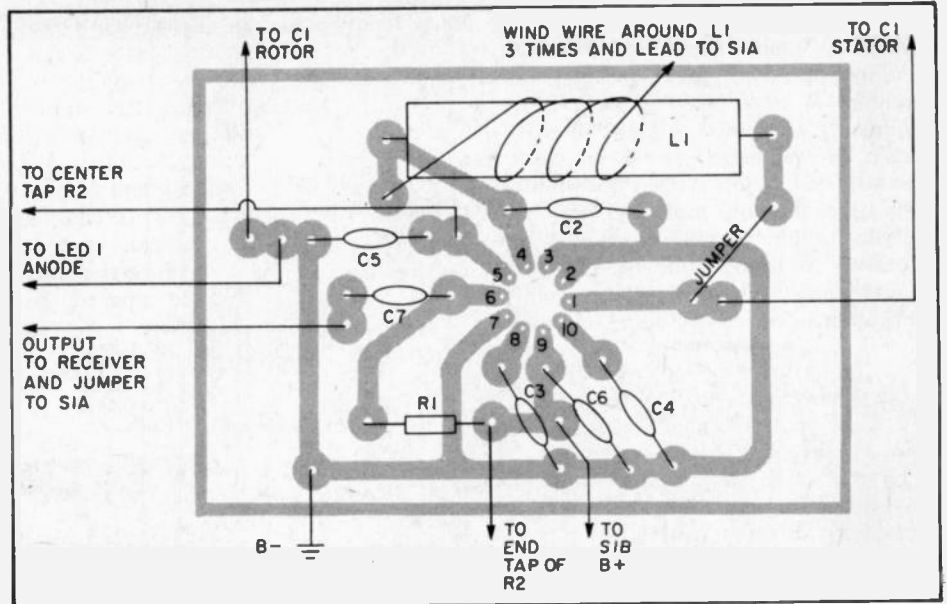

This part's location overlay is twice the actual size in order to make the positioning clearer. If you use a loop different than specified in the parts list you may want to modify the appropriate spacing on the printed circuit board. Don't forget to wrap the L1-to-antenna wire around the loop stick three times. You might install an integrated circuit socket on the printed circuit board to simplify installation and repair.

ard AM tuning capacitor from any pocket transistor radio. Instead of the coil mentioned in the parts list you might try to wind 15-20 turns of insulated copper wire on a pencil.

Mount the Shortwave Supercharger inside a metal case which you can find in most electronic supply stores. Use shielded cable between the supercharger and your receiver otherwise the connecting wire will behave like an antenna and some of the features of your supercharger will be lost. The final job is to make a dial. You can calibrate it with your shortwave receiver by tuning C1 to optimum reception.

If you find that the circuit "whistles" at certain frequencies (this may easily happen if you do not use a PC board or your connections are too long), the simplest cure is to thread a few small ferrite cores through pins 1 and 4 of the

IC. Such cores can be purchased from many electronic surplus dealers.

**Operation.** Tune your receiver to the desired frequency and then tune C1 till you can hear maximum signal or noise, if no station is present. Returning your receiver with the fine tuning knob should require no readjustment of the supercharger. You can use R2 as your volume control or leave it in some intermediate position and use the volume control of the receiver. For strong signals you may want to turn R2 back to prevent overloading the receiver with the corresponding increase in the background noise.

Once you get it working, start digging deeper into the higher shortwave frequencies. There is a lot going on out there and with the increased sunspot activity and a Shortwave Supercharger you can't go wrong. ■

The author's prototype, shown here, used perf-board and point-to-point construction. You may build your Shortwave Supercharger using this technique or by making a printed circuit board and soldering on all the parts. The author added a small LED power indicator to prevent dead batteries if left on.

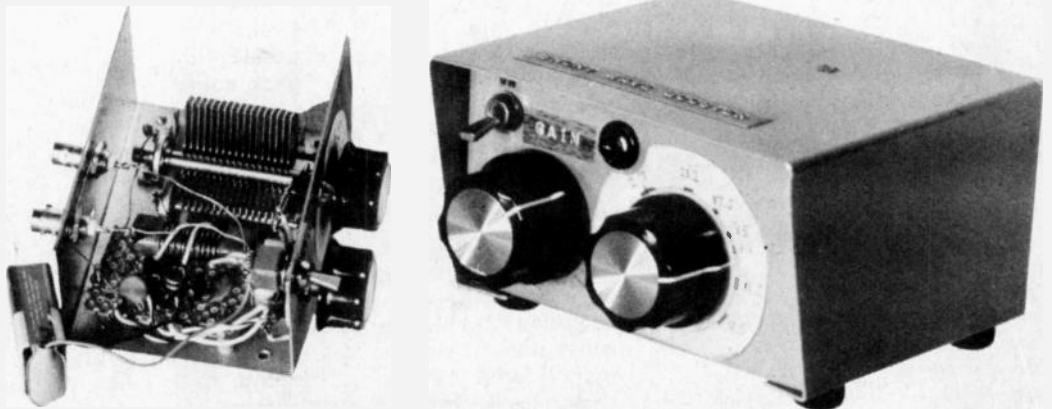

□ WHETHER YOU SERVICE your own color and/or black-and-white television equipment because you truly enjoy electronic troubleshooting, or because you are primarily interested in holding down spiraling professional TV repair costs, you need more sophisticated test equipment than your battered, but faithful old VOM. Basically, you must have a generator capable of producing a broad variety of test signals to reveal what's right or wrong in complicated TV circuitry. One of the most versatile instruments you are likely to find for either home or pro-shop TV repair is Heath's model IO-4101 Vectorscope. Not the least remarkable feature is the modest price of \$179.95.

First, a word of caution. Although you should have no difficulty assembling the kit if you follow Heath's typically excellent assembly instructions to the letter, give a thought to how ready you are to actually use the instrument. The Vectorscope is *not* a magic solution to all TV problems in the hands of one whose only acquaintance with TV equipment is through channel-selector buttons. To use the Vectorscope, you must already know a fair amount about the inner workings of a TV set, or be prepared to spend much time and effort educating yourself in such knowledge.

**Super Test Set.** This all-solid-state instrument generates all the stable crystal-controlled test signals needed to produce color and convergence patterns required to adjust color circuitry and tri-gun convergence systems. Twelve patterns, including dots, crosshatch, horizontal and vertical lines, gray scale, and color bars are available in either the standard 9 by 9 display or an exclusive Heath 3 by 3 format. A clear raster for purity adjustments can also be produced.

The Vectorscope is much more than a typical pattern generator because it includes its own cathode-ray-tube display that shows a characteristic waveform for each type of color TV receiver. The petal-pattern or "Daisy" display waveform is a voltage representation of all ten color bars, an exact representation of the chroma signal being fed to the guns of the CRT in the TV receiver. It can reveal a missing, or weak color, and show the correct setting of the burst phase transformer, reactance coil, oscillator coil and band-pass controls. The color demodulation angle may also be checked."

Crystal-controlled horizontal and vertical sync pulses are incorporated into the Vectorscope output signals to provide necessary blanking and to lock the various patterns firmly on the TV

screen. Sync signals are also available at a front panel jack, for servicing sync circuits without video, or sets having separate video and sync demodulator phase adjustments. There's RF output for channels 2 through 6, and an RF level control varies the RF output for checking relative sensitivity and to prevent overloading the RF and IF circuits of the receiver. A switched, crystal-controlled 4.5 MHz sound carrier aids in fine tuning the Vectorscope to the receiver channel frequency.

A video signal is available for

the 3.56 MHz oscillator. Be sure that any TV receiver you use as monitor during these adjustments is in good working condition because a malfunctioning set can lead to endless confusion.

Two methods are provided for checking the video output signals. The first method utilizes an oscilloscope. The clarity and details of the patterns are directly related to the bandwidth and triggering of the oscilloscope used. This is the procedure to use if you have a scope. A chart shows how to set os-

## Budget assembles the...



CIRCLE 1 ON READER SERVICE COUPON

# Heath VECTORSCOPE

**Budget TV tester does almost everything but change tubes**

troubleshooting video circuits; it's adjustable with a level control. The chroma signal is also adjustable for amplitude and is used to check color hue and sync with different signal levels. Front panel switches are provided to turn the individual red, blue, and/or green beam currents on or off during convergence checks.

**Generator Tests and Adjustments** are needed, after assembly, to put the Vectorscope itself into proper operating condition. A black-and-white TV receiver may be used for all adjustments except for the color bar displays, the vector displays, and the adjustment of

oscilloscope controls and what waveform characteristics to expect for various display settings such as purity, dots, crosshatch, horizontal and vertical lines.

If an oscilloscope is not available, you'll have to connect the Vectorscope to the video detector and sync detector output of a TV receiver. Heath doesn't hold your hand at this point, or attempt to tell you where to find these detectors in your TV set; it's assumed that you already know your way around inside a TV set. Instead of observing waveforms, as with the oscilloscope, you now compare TV screen patterns with a set of drawings of normal patterns.

# VECTORSCOPE

**Vector Display Adjustment.** A four-wire cable coming from the Vectorscope terminates in four alligator clips. Three have insulation-piercing needles built into the jaws which make quick and easy connections to chroma leads going to your TV receiver's picture tube. You have to know how to identify these normally color-coded chroma leads. The fourth alligator clip, without needles, goes to chassis ground.

You also need to know whether the chroma signal in your TV receiver is fed to the cathodes or grids of the CRT, and then set a switch at the rear of the Vectorscope to either "Cath" or "Grid," as the case may be. The luminance (black-and-white) signal must be bypassed to ground on receivers that have their chroma signals applied to the cathodes of the picture tube. If there is no service switch in the receiver that grounds the luminance signal, the signal must be bypassed by insertion of an electrolytic capacitor between the center lug of the contrast control and chassis ground.

The channel, chroma and RF controls on the Vectorscope are used to create the proper petal ("Daisy") pattern as shown in photographs in the Heath manual; the shape depends on whether the receiver is grid-fed or cathode-fed, and on whether you are using the 9 by 9 or 3 by 3 format. Don't overlook the important fact that the size and shape of the petal pattern is also influenced by the color, tint and horizontal hold controls of the TV receiver. Although you will have pre-set the focus and astigmatism, pull off the knobs on the Vectorscope's horizontal and vertical position controls to get at the hollow shafts, and use a small screwdriver to touch up the petal pattern if it seems too fuzzy. However, don't expect to get razor-sharp edges on the petals.

To further emphasize the fact that

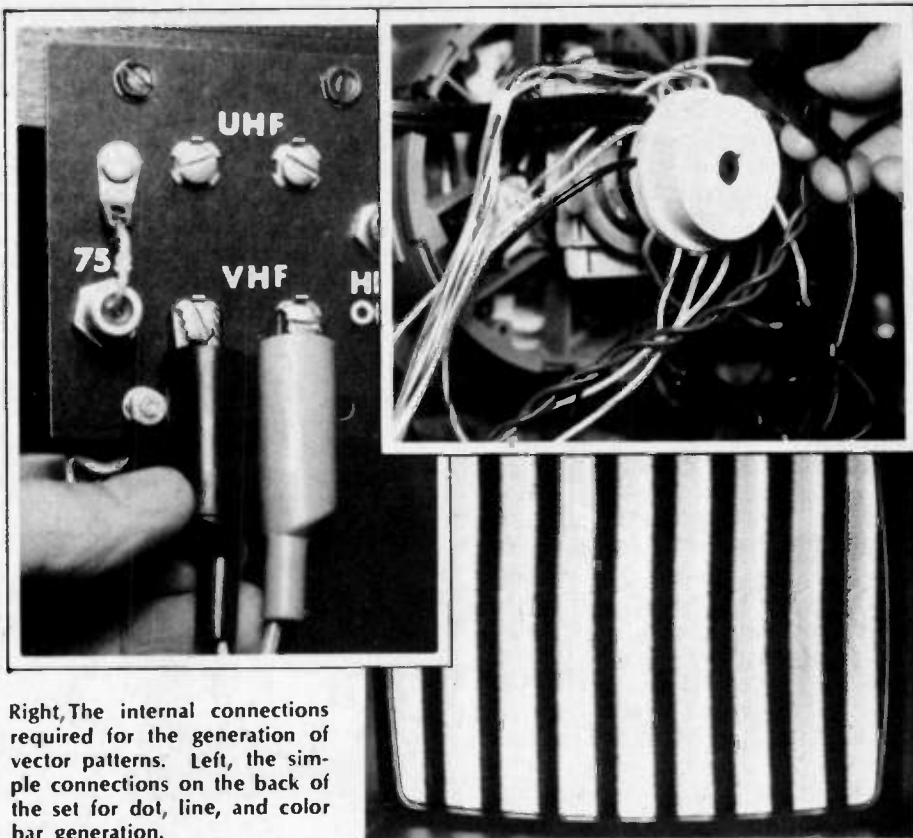

Right, The internal connections required for the generation of vector patterns. Left, the simple connections on the back of the set for dot, line, and color bar generation.

you must have basic knowledge about TV circuitry, we mention in passing that adjustment of the vector display also calls for disabling the burst amplifier by removal of a transistor or tube, depending on the type of TV receiver used. And you must know how to adjust the reactance coil for the most stable color picture.

**Using the Vectorscope.** To effectively and properly use the Vectorscope, you must know the correct pattern display of an aligned TV receiver. Use manufacturer specifications if they are available. Otherwise hook the Vectorscope to a properly functioning receiver, and misadjust each coil carefully as you observe its effects on the pattern on the TV screen or Vectorscope CRT. Attach a "tape flag" to the alignment tool so that you can return the coil to its

proper setting before going on to the next one. If you have more than one TV receiver available, try the tests on all of them and note any small differences in the displays.

Color guns in TV receivers that apply chroma signals to the grids can be turned on or off with the gun switches on the front panel of the Vectorscope. If the chroma signals are applied to the cathodes, the guns can be turned off by turning down the screen (drive) controls, using the actual procedure that pertains to the type of TV receiver under test.

The Heath manual tells how to use the Vectorscope to perform standard adjustments of TV receivers, but you may wish to obtain a good color TV servicing book for additional information, especially to understand how to judge receiver performance by observations of variations in the color bars of your particular set.

**Summing Up.** Clearly, the Heath Vectorscope is an extremely versatile tool that can help squeeze out every last bit of performance inherent in the design and construction of your color or black-and-white TV receiver. But it can do that only if the instrument is used knowledgeably. If you take time to become truly familiar with your Vectorscope's Daisy and other patterns, you'll be in clover for the rest of your TV troubleshooting days. ■

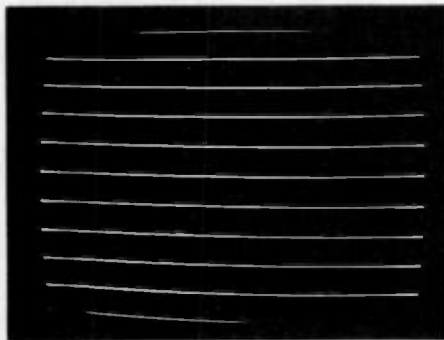
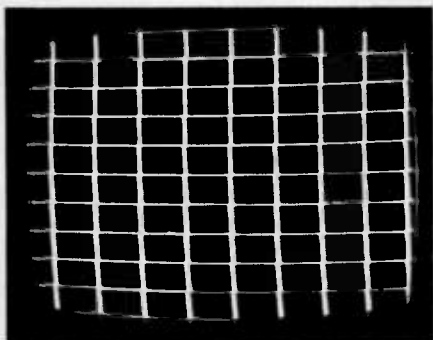

The lefthand TV screen shows the pattern used for convergence and linearity adjustments. The right screen is for vertical linearity and pincushion adjustment. Both use a 9-by-9 setting.

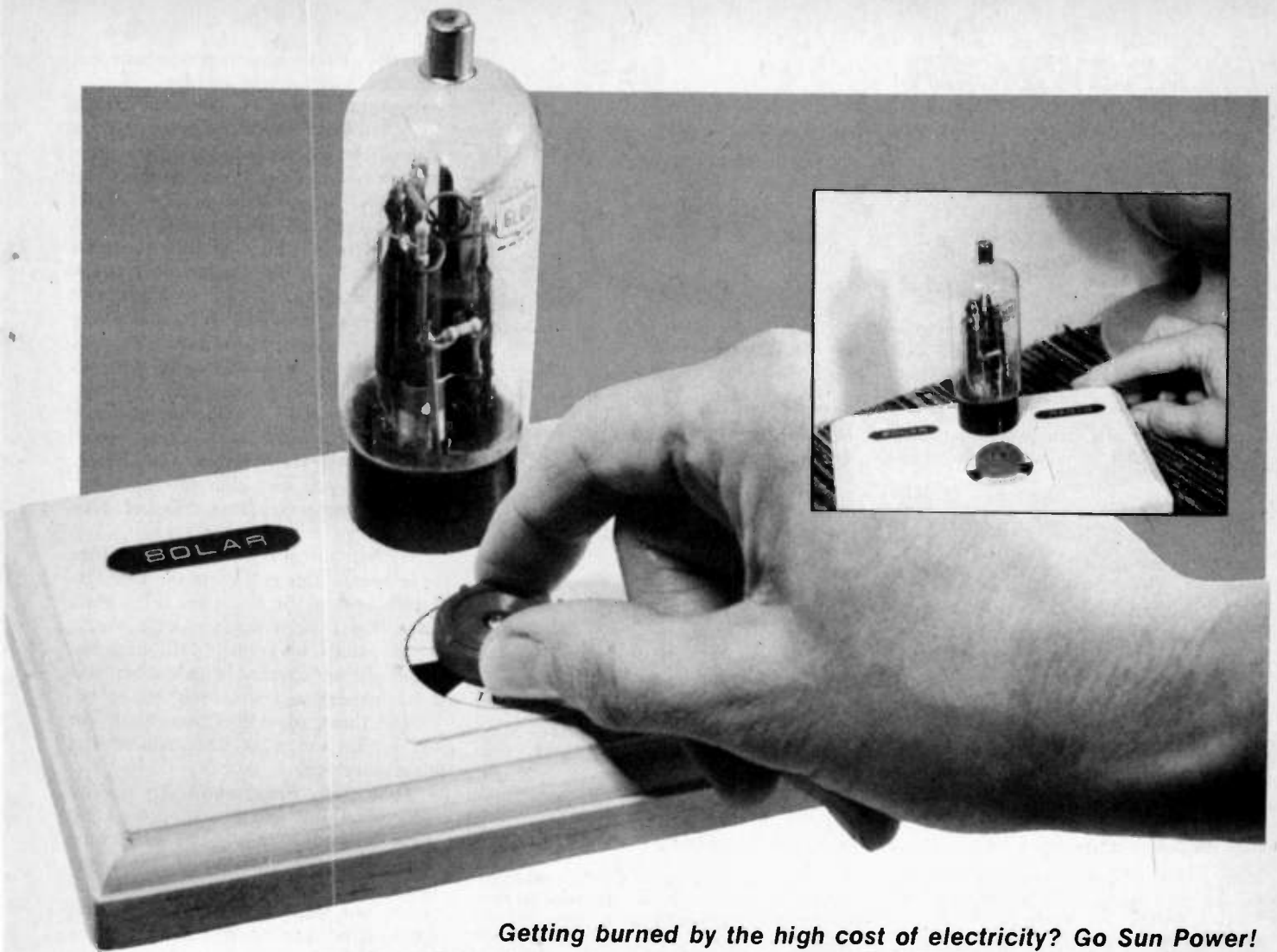

Getting burned by the high cost of electricity? Go Sun Power!

# SOLAR SWINGER

Homer L. Davidson

**H**AVE YOU EVER seen a model ship inside a bottle? The next logical step is to build a small radio inside of a radio or TV vacuum tube! We call it the *Solar Swinger* and it has no on/off switch, batteries or power supply. If you want to turn the Solar Swinger off, just place a cap or hood over the tube. You may want to let it play all the time—it doesn't hurt a thing. No need to worry about batteries running down, for the little radio is solar powered. It will operate in the sun, shaded daylight or under a desk lamp in the evening. Of course, the radio won't blast your ear drums with music, but you can listen to local AM broadcast stations with ease.

**Tube Preparation.** Select a defective radio or TV tube with a bakelite base. The larger the glass tube, the greater building area for the small radio components. An antique radio tube is ideal, but not necessary. If you can't find one in the junk box, check with your local

Radio-TV shop—they may throw out several hundred of these old tubes every year.

There are many old power output tubes available, such as 6L6G, 6C6G and 5U4G. Don't select a 6BK4 type as you cannot remove the top metal anode from inside the glass envelope. You may use a large tube (6LQ6) with a glass base and then mount it on top of a black tube base. Pickup five or six old tubes to practice on.

Before attempting to remove the bakelite base from the tube, let air into the bottom of it. All radio and TV tubes operate with an internal vacuum—the air having been pumped out. A small glass seal is located at the bottom of the tube.

*Always wear a pair of gloves when working around glass or warm components.*

Now you want to let air back inside the tube. Break off the black bakelite center key locator between the tube side the tube. Break off the black bakelite center key located between the tube

prongs. You should see the pointed glass seal. Take a pair of long nose pliers and break off the glass tip. You may hear a rush of air, or see a couple of white areas form near the bottom of the tube envelope.

To prevent glass pieces or excess solder from falling on the floor or work bench, do all of the glass preparation inside of a large pasteboard box.

Next remove the soldering iron tip from a 150 or 250 watt soldering gun. Take a six-inch piece of number 14 copper wire, (you can remove the insulation from a piece of number 14 romex or a single conductor electrical wire for this purpose) and form a loop shaped soldering element. Wrap the bare wire around the base of the tube next to the bakelite base area and insert about one inch into the gun tip and bend over. Tighten down the soldering iron nuts—real tight. After cutting a couple of glass bases you may want to snug up the soldering iron nuts for a greater transfer of heat. Keep the copper loop close to the gun tips so

# SOLAR SWINGER



Break off the black tube-locator pin and the glass tip with some long nose pliers.

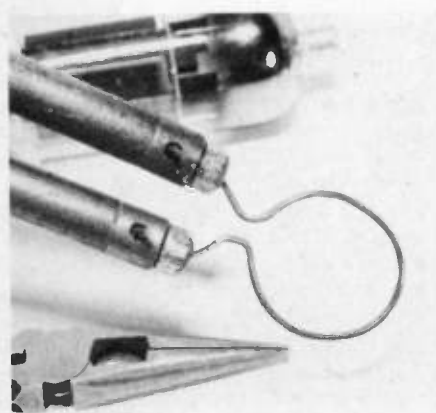

Form a loop of copper wire that fits snug around the tube and into a soldering gun.



Put the loop over the part of the tube you wish to cut and hold the tube firmly. Wear gloves to keep from burning yourself on the hot glass. Next apply heat to the loop and rotate the tube until the glass cracks.

the loop will heat up faster. Pinch it close together, and snug, clear around the tube with a pair of long nose pliers. You have now constructed a copper wire loop to replace the soldering iron tip.

Slip the wire loop over the end of the tube base and press the loop together at the ends—but not so close as

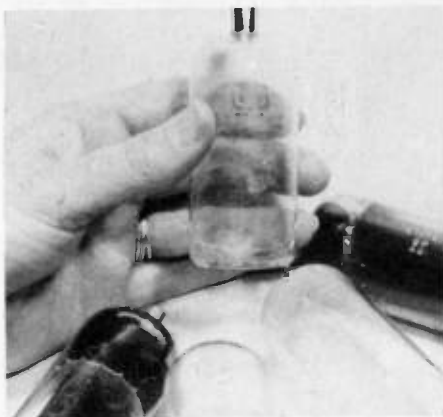

Note the clean easy cuts this technique produces. Make sure you have a back-up tube.

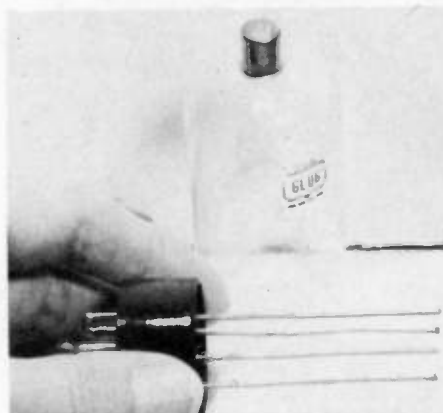

The four copper support wires are soldered into the pin bases. The components are soldered and glued to these supports.

to touch. Now hold the tube in the left hand and soldering gun in the right. Very slowly turn the vacuum tube inside the heated loop. Within a few minutes you will hear the glass crack and break in a perfect cut at the base of the tube. Some glass tubes take longer to break than others. In the meantime you may smell a hot bakelite odor from the wire loop, which is normal. Often the glass will crack clear around and just a tap on the end of the bakelite base separates the two pieces.

If you have selected a tube with a metal cap on top, turn the inside components until the connecting wire breaks off. Be careful not to break the remaining glass envelope, which is very brittle. It's best to cut off the wires connecting the tube elements to the base with a small pair of side cutters. In case the tube elements and mica insulators will not pull through the small opening, use a pocket knife to cut out sections of the insulators. You may have to crush or remove the tube elements in sections. Again, proceed slowly to prevent breaking the glass envelope. If you break or crack the tube

envelope, start on another one—one out of three is not a bad average.

If you choose a TV tube with a glass base (6LQ6), press the copper loop around the prongs and against the glass bottom of the tube. Break off the small glass seal between the prongs and let air into the tube. Heat up the soldering gun and rotate the tube until the glass cracks in a round circle. Now break and crush the glass base with the wire tube prongs into little pieces. Be very careful in removing the tube elements, they must be reduced in size until all parts fit through the small opening. You may want to cut and remove each element piece individually until all parts are removed from the tube envelope. Later on, you can glue this glass envelope over a separate bakelite tube base.

It's best to cut out three or four tube envelopes. After removing the tube elements, choose the best one. If the glass edge is a little irregular, don't worry; when placed upon the black base the area will be covered with rubber silicone cement and will look like it belonged there all along. Now wash out the white and dark areas inside the glass envelope.

**Tube Base Preparation.** To remove the remaining glass and connecting wires from the tube base, each tube prong must be unsoldered. Hold the tube base upright and over a pasteboard box. Apply heat from the soldering iron against each prong. Let the excess solder begin to boil and then fling the tube base downward and the excess solder will fall into the bottom of the pasteboard box. Use this method on each tube prong a couple of times to remove all of the solder. After the excess solder has been removed, pull the connecting wires out of the tube base area. You may have to break the glass in several pieces to remove some stubborn connections. Clean out the excess glass cement with a pocket knife and place the tube base with the glass envelope for safe keeping.

**Tube Base Construction.** Cut four pieces three inches long, of number 14 or smaller copper wire. These four support wires will become tie-in circuit and mounting supports for the small components. You may use any stiff wire for these supports as long as the wire itself can be soldered. Number 14 copper wire will just fit inside the tube pins and solder should be fed up from the bottom terminal. Also, you may solder the wire supports from the top side, down inside the tube base. Place support wires in terminals 1, 2, 6 and 8. Look at the bottom of the bakelite socket and start with Pin #1, to the



left of the center pin. (Although the tube locator pin is broken off you still can see where it was located.)

After all support wires are soldered into position, clean excess solder from each wire with a pocket knife. Scrape off rosin and excess solder down inside the base, next to the support wires.

Place a 6-32  $\frac{3}{4}$  inch machine screw and washer in the center hole of the tube socket. Slip a nut on the outside of the screw to hold it in position until the socket can be bolted to the wooden base. Temporarily, slip the glass envelope over the support wires to see if they will clear the top area. You may use longer support wires if the glass envelope is a lot longer in length. This may help string out the parts and keep them from shorting against each other. A cut glass envelope from a 5U4GT tube runs about three inches long.

A tube's pin terminal connections (bottom view) are shown. Remember the tie-wire supports are reversed when the tube socket is upright. Scratch a line straight up from the tube locator pin, along the side of the socket, with a pocket knife. Now place a piece of masking tape around it and mark the support wires. You can now solder to your heart's desire. The four supports will be used for component tie points and they are marked upon the sche-

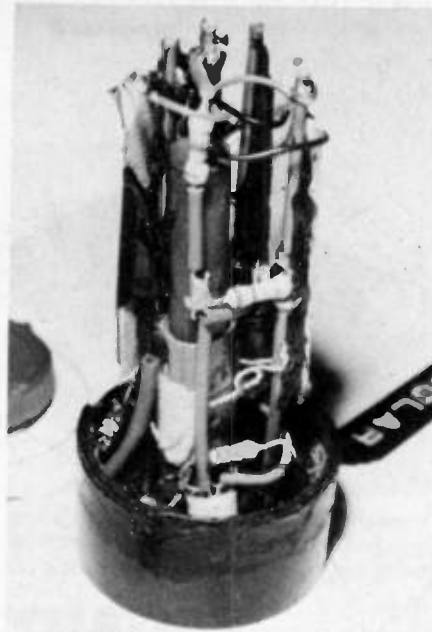

The photo cells are mounted on two sides of the frame. The loop stick fits neatly in the middle of all the components. The transistors are in the base of the tube. Wire support number 8 is used only as a wiring tie-point for the small components. All other support terminals will be tied into the circuit after the tube socket is bolted to the wooden base.

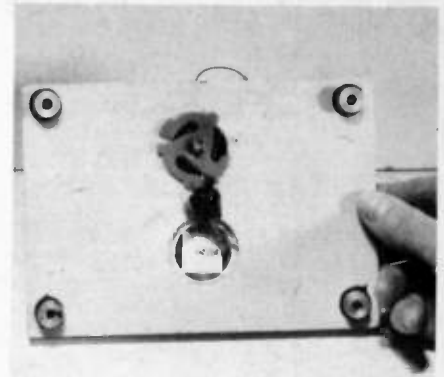

The only wood work needed is to make two large holes in the base. One for the tube and one for the tuning capacitor. A bolt through the base holds the tube in place.

**Wiring in the Parts.** Mount the antenna coil (L1) in the center of the support wires since it is the largest component. Solder the top wire to pin 2 and the bottom terminal to pin 1. Leave it loose until all parts are soldered and then use a dab of silicone cement to hold it in place. Solder the collector terminal of Q1 and negative terminal of C2 to support wire number 2. Keep the leads fairly short and place a pair of long nose pliers next to the transistor body as a heat sink. The emitter terminals from each transistor will tie to terminal support number 1.

Now solder in all small components to their correct support wire terminals. Place a piece of spaghetti over the collector wire of Q2 and solder into pin terminal 4, if it is long enough. If not, lengthen the terminal wire with a piece of hookup wire. Connect the small diode between the coil tap (L1) and the base terminal of Q1. Slip a piece of spaghetti over the wiring to prevent touching of other components.

Mount the solar cells last—inside the tube area. Be careful to observe correct wire polarity. The positive terminal will solder to terminal 1 and the negative wire to 6. After all wiring has been completed inside the tube socket, double check each component and tie wire before bolting to the wooden base. Now tack the antenna coil (L1) and solar cell into position with a dab of silicone cement.

**Base Layout.** You may pick up a wooden base mounting plate at any novelty or hobby store. Ours was 6 $\frac{3}{4}$  by 4 $\frac{1}{2}$  and cost .99 cents. They may come in many sizes and shapes with a higher or lower price tag. Mark the parts layout on the bottom side of the wooden base. The tube socket may be mounted 1 $\frac{1}{2}$ " from the rear and in the center of the base plate. Place a

(Continued on page 116)

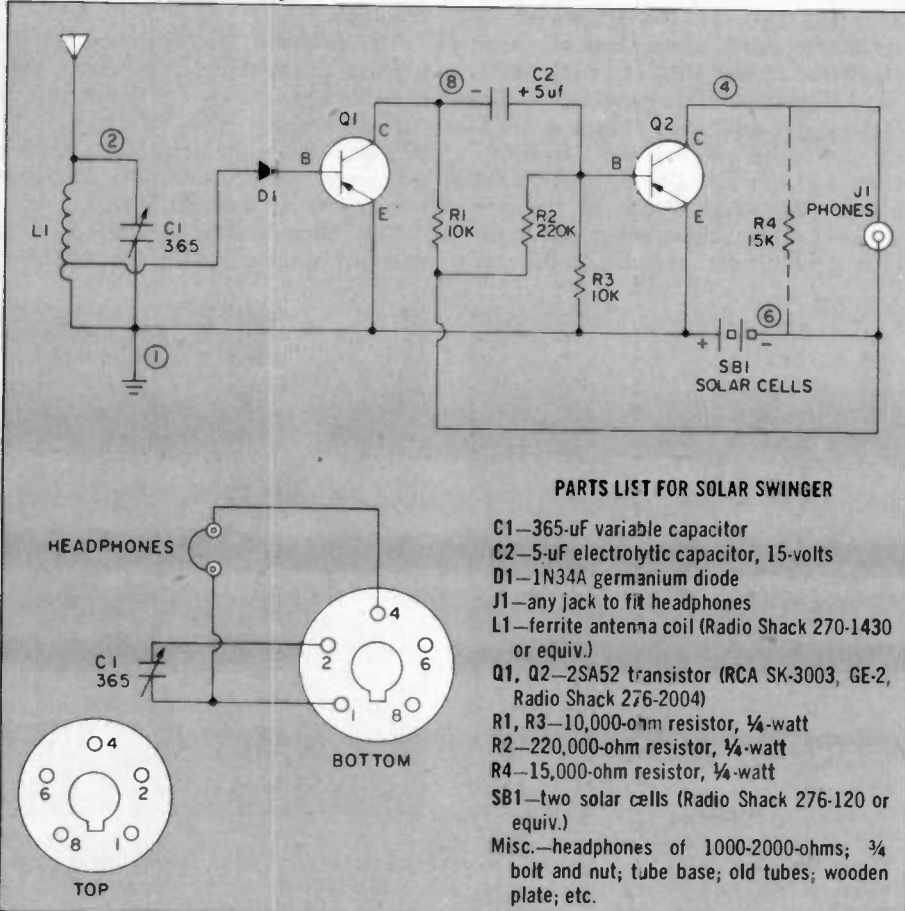

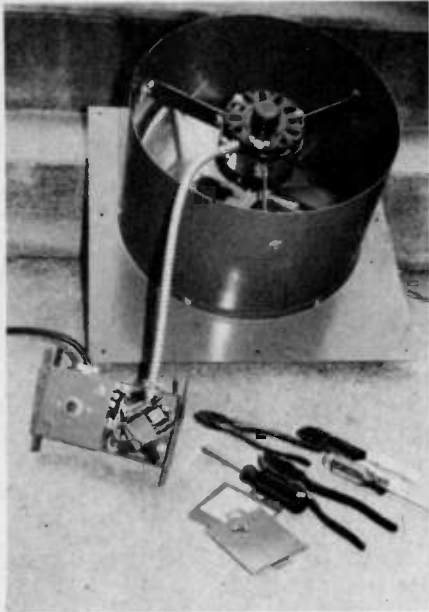

Here we see the thermostat wired to the fan motor. The high-temperature protective unit turns the fan off in case of a fire.

**Y**OU CAN CUT the cost of air conditioning dramatically, or in some cases get along very nicely without air conditioning of any kind, just by installing an attic fan to reduce under-roof heat build-up which can reach 140 degrees or more. Typically, when the attic temperature is at this high level, an air conditioner must operate constantly just to maintain a 72-degree comfort level in the living quarters below this blanket of heat. Install a fan, and that attic temperature could drop to as low as 95 degrees under the same summer heat-wave conditions! Only intermittent air conditioner operation would be required to maintain the same 72-degree in-house temperature.

Installation of an attic fan is a relatively simple do-it-yourself job that usually requires only cutting a hole in the gable or roof of the house, installing the fan unit, and making simple electrical connections. Even when the fan must be placed in a more "difficult" location—as in an air shaft of the kind shown in this article—installation poses no special problems.

**Fans For All Seasons.** Attic fan manufacturers offer many different models to answer all possible needs. The unit shown here is a NuTone fan, Model WF-57, which moves 2090 cubic feet of air per minute and can effect ten complete air changes per hour in an attic having a volume of 12,540 cubic feet. You may not need a fan as powerful as this, so start your project by estimating the volume of your attic area, then choose a fan that is strong enough

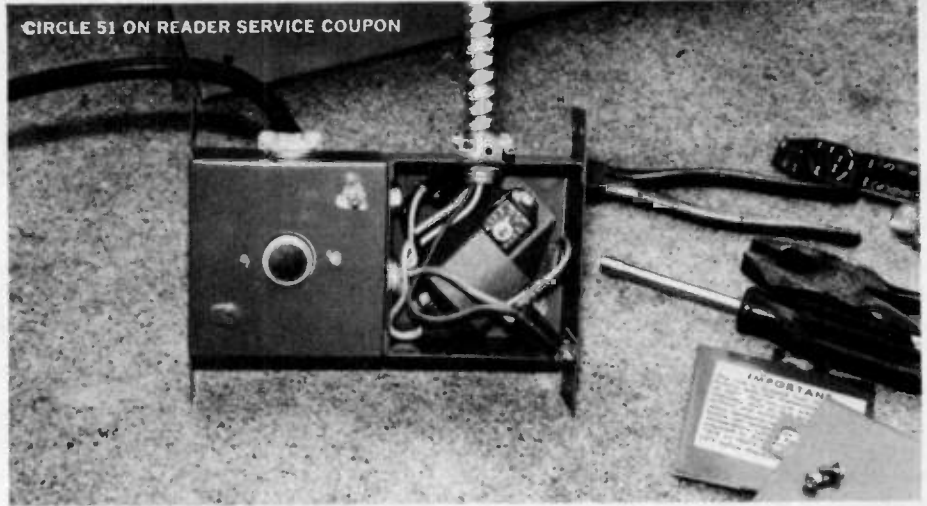

Normally, the two thermal detectors are mounted near each other, but separately. In this installation the modules were physically joined in order to make mounting in the cramped space easier. Both boxes, of course, can and are closed by means of metal plates.

# INSTALL AN ATTIC FAN

by Jorma Hyypia

to change the air ten times per hour. NuTone, for example, has two other gable-mounting units that are rated at 1550 and 650 cubic feet per minute respectively. Also offered are roof-type fans rated at 730, 1020 and 1250 CFM.

Specification sheets provided by fan makers give additional information including motor horsepowers (typically from 1/15 to 1/5 H.P.), sizes of fan blades (16-inch diameter in the unit shown), general construction and materials, overall sizes, and size of the wall

or roof cutout required. Look for a unit made of zinc coated steel and aluminum for long service without corrosion problems.

The powerful, deluxe model WF-57 features an automatic thermostat that is factory-preset for 110°, but that is user-adjustable from 70° to 160°F. Whenever the attic temperature reaches the preset temperature, the fan goes into operation automatically.

The thermostat is contained in a standard 4-inch square junction box



Don't let stray nails or fragments lie about on the roof. If you step on one, then there goes your roofing materials!



When we came to an obstructing stud, we used a keyhole saw to remove it, but you could use just about any small saw.



Position the cardboard template to mark the size and position of the desired cutout. Use a saber saw, or drill holes on the line.



The cardboard template is pulled free and we see the drilled holes. A hammer and chisel finally freed the outlined disc.



A stud and interior plaster had to be removed. We hammered away splinters and used an old drill bit to do the remainder.

## AND COOL THE LOW-COST WAY

that is mounted near the fan. From this box you run a power cable to an On/Off switch in your living quarters. You can eliminate the automatic control if you wish, but in any case we strongly recommend that you install an optional heat sensor that turns the fan off if attic temperatures go *too high*. This would happen in the event of a fire—the one time you would definitely *not* want the fan to blow air through your attic! The heat sensor is simply wired in series with the automatic control, if used, and

the master switch in your living quarters.

These fans operate off regular 120-volt, 60 Hz house current, and draw so little current that you can safely connect to any normal house branch that is not already grossly overloaded with electrical appliances. If all your electrical circuits are in heavy use, it might pay to run a separate branch circuit from your circuit breaker board to power the fan. The one-fifth horsepower motor shown turns quietly on its

ball-bearing mountings at 1050 RPM, and features automatic reset thermal protection.

**Cutting In The Fan.** Wall and roof cutouts range from 11 inches to 17¾ inches square for gable models and from 11 inches to 14½ inches in diameter for roof models. As shown here, you can mount the gable-type fan into a circular rather than square hole if you prefer. In this illustration the round opening was preferable because it required removal of less wall surface.

Be sure that the fan of your choice is adequately protected from inclement weather, especially heavy rains, and from cold winds during winter months. Model WF-57 has an automatic louver that closes when the fan is not in use, and opens whenever the unit is activated. Other types of rain baffles are used on roof-style fans. Incidentally, if yours is a relatively small attic—say 5,000 cubic feet—you can obtain a fan that mounts directly *behind an existing attic louver*, so no holes need to be cut into either the gable or roof. NuTones Model GF-56 is an example of this type of unit.

And bear in mind that if you install a louvered fan into a cutout in a gable wall having a regular ventilating louver, that original house louver must be blocked off to prevent a kind of "short circuit" of air flow that would greatly reduce the efficiency of the fan. You want air to enter the attic through louvers that are as far removed from the fan as possible.

Chances are that your installation

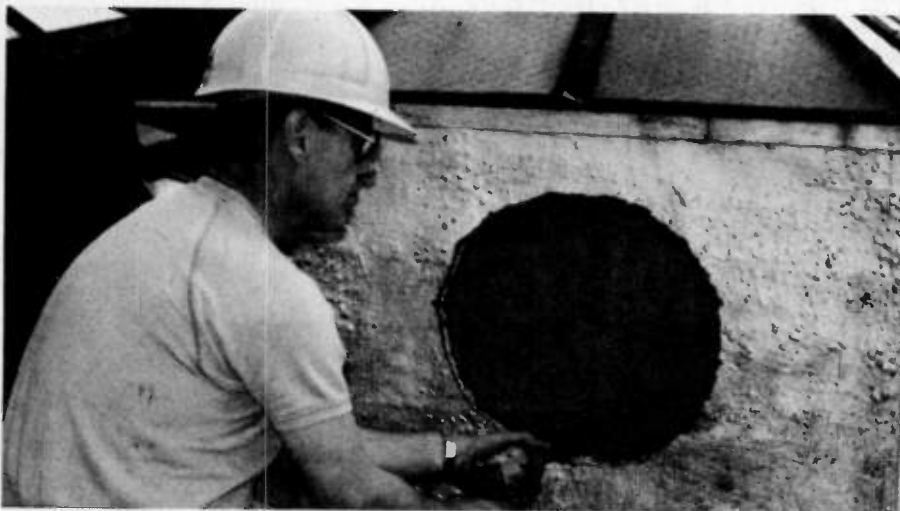

Use a circular rasp to smooth down any rough edges. Make certain you have taken away enough previously that this part of the job isn't harder for you than it should be! The rasp will take care of the final touch, just make sure you get the proper rasp.

# ATTIC FAN

job will be much easier than that encountered during the fan project shown here. To cut a hole into this air shaft meant going through an outer wall, then a tough inner wall consisting of plaster on wire lath. In a more typical gable installation there is no inner wall to complicate matters. Moreover, you can do some hole-shaping and electrical wiring more easily from inside the attic, than if you must install these same components in an air shaft.

The step-by-step photographs are in



The fan fits! However, thermostats must be secured to the inside of the air duct and a wood frame made to support the fan.

the main self-explanatory. You start by selecting the best location for the fan, making sure there's nothing behind the spot (electrical cables or plumbing) that could cause major problems. Cut the hole, using whatever available tools are best for the particular conditions. Bear in mind our repeated caution to promptly sweep up nails and other trash that could damage a flat rooftop if left underfoot; get careless, and your fan unit may be completely water-tight while your roof starts leaking!

Provide whatever kind of framing is recommended by the manufacturer of your fan. In this case only a simple wooden frame was needed to interface the fan unit and air shaft wall. Just be sure to thoroughly caulk or otherwise

weatherproof all joints. You can add additional rain protection—as was done by this installer—if you wish; just be sure that any added baffles do not obstruct free air flow.

**Wiring The Attic Fantastic.** As the diagram shows, wiring is about as simple as any electrical job you might do around the house. Basically, be sure that all wiring is made so that it com-

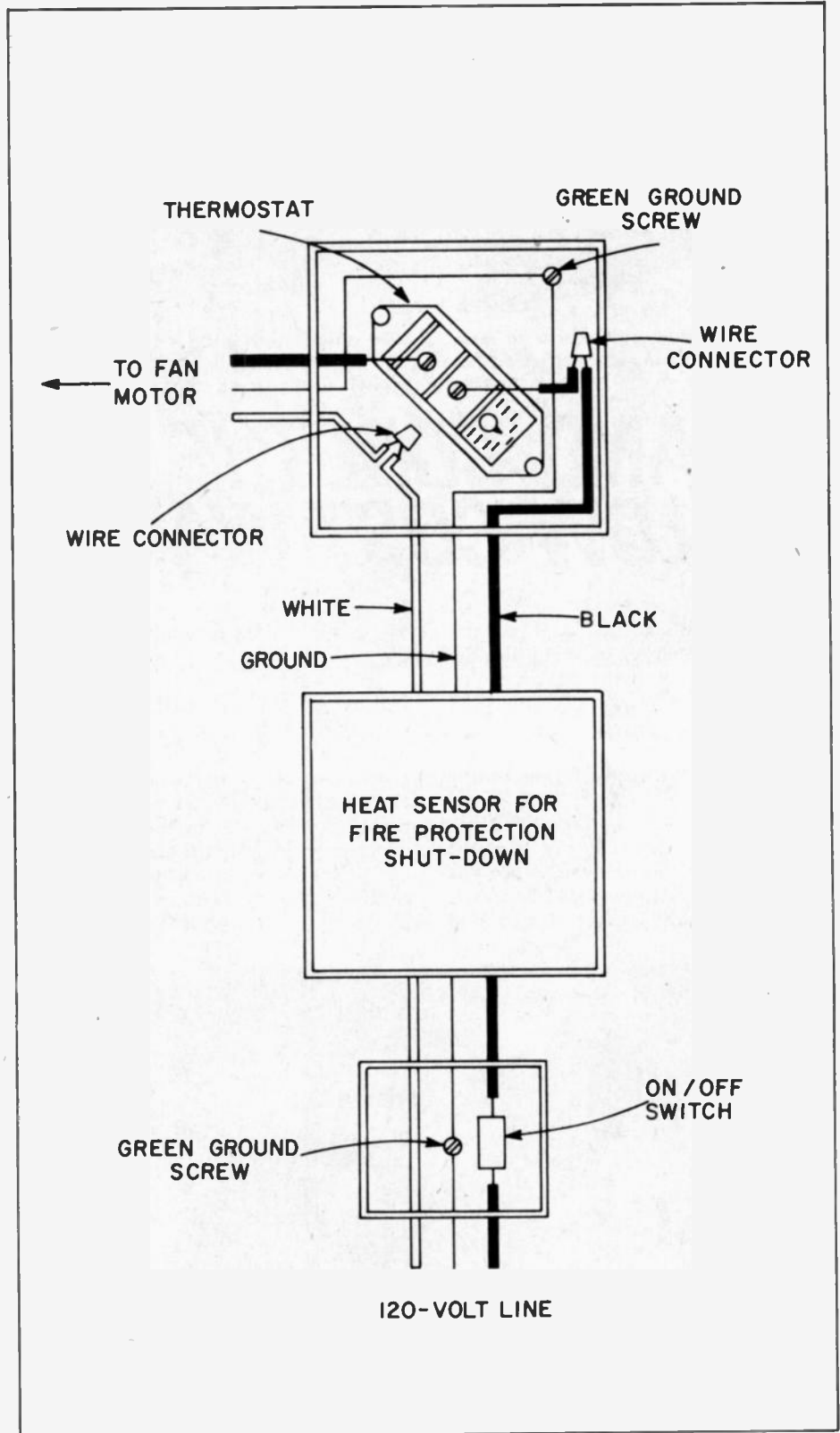

Follow this basic plan for hooking up your own attic fan and budget-cool your hot summer days. Note the heat sensor between the fan and the 120-volt line on/off switch; this is a most important part. If it senses too high a temperature—a fire—off goes the fan!

plies with local codes (or you might have trouble with insurance claims in the event of a fire), and ground the fan and switches as indicated.

The thermostat can be damaged easily, so remove it from the junction box if you nail the box to studding; if you mount with screws, removal of the

thermostat is not necessary.

Study the wiring diagram to see how easily the connections are made. The black wire coming from the fan motor goes to one terminal of the thermostat, and a short length of black-insulated wire is added to the second terminal to permit connection of the power cable black wire by means of a wire nut. The white wire coming from the motor is also connected to the power cable by a wire nut; note that the white wire is *not* attached to the thermostat. The third (ground) conductors coming from the motor and in the power cable are both attached to the green ground screw inside the thermostat box.

Some folk just run the power cable to a switch in the living quarters of the house, and then to a regular AC power

CIRCLE 51 ON READER SERVICE COUPON

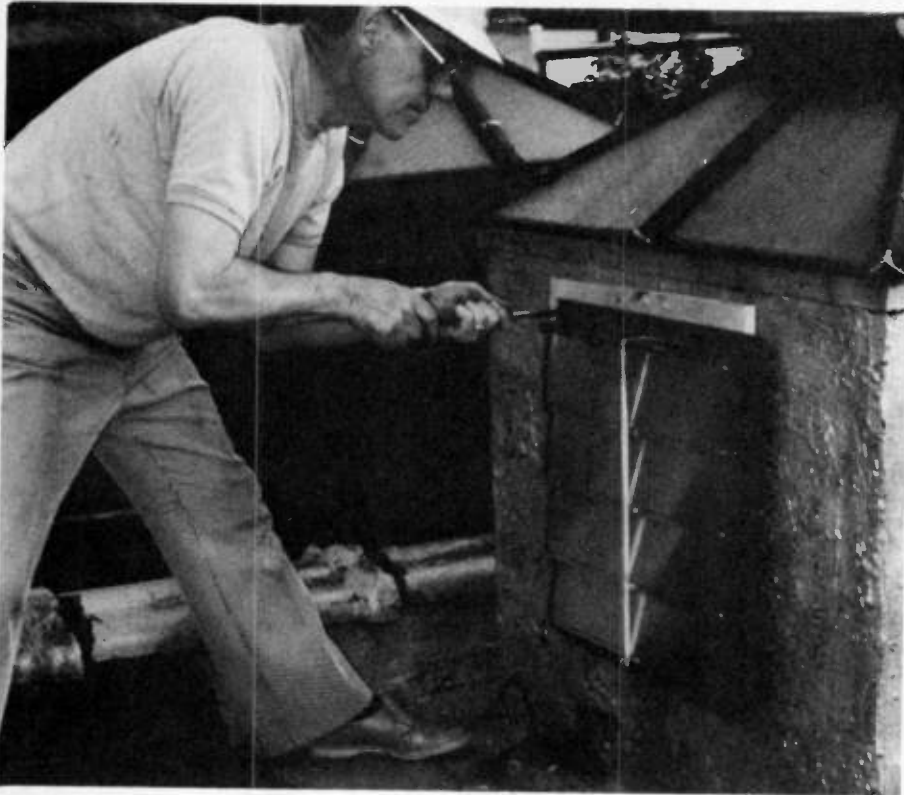

A pre-cut frame made of 3/4-inch thick wood is slipped behind the fan and secured to the wall with 2-inch long, No. 8 wood screws. The frame strengthens the wall. Now is a good time to remember a previous hint—remove all that trash off the roofing!



Check the operation of the self-opening louvers. Be sure that they do not bind, scrape or stick. Remove any bits of material that might cause sticking, after all you want to make certain they open everytime. Who wants to go on the roof more than they have to?



A rain shield prevents water leaks. Slope the top and paint the outer surface with roof patch material to seal all watertight.

supply. We *strongly* feel that this is penny-pinching foolishness and urge that you spend a few more bucks for the optional heat sensor that will turn the fan off in case you have a fire in the attic. The unit comes with wiring instructions.

Before making your first test, recheck all wiring to make sure that black-insulated conductors connect only with other black conductors all the way from the power source, through the switch box and sensor units, to the motor. Similarly, white wires should connect only with other white wires. Also be sure that you have a continuous ground line from the motor, through the sensor and switch units, to the box from which you take the required AC power ■



1. Why not build projects you can be proud of, in appearance as well as circuit design? It is neither difficult nor expensive as you'll note when you follow this unit on a step-by-step journey from a blank, machined panel to real artistic beauty.



2. You will need spray and brush-on protective coating, plastic tape, various types of rub-on lettering and designs, and a burnishing tool (the white cylinder) to effect the transfer of the letters from the carrier sheet to a project's front panel.

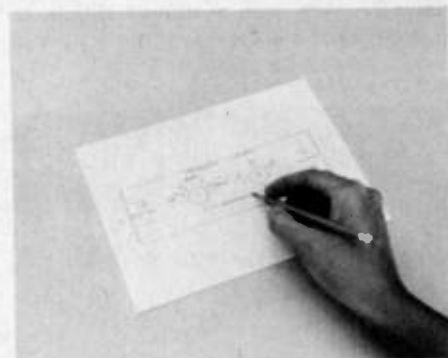

3. You can't fashion it if you have never seen it before—at least seen it on paper. First, make a sketch and work on the arrangement until you are quite satisfied with it. Using the quadrule paper, as pictured here, makes the job easier.

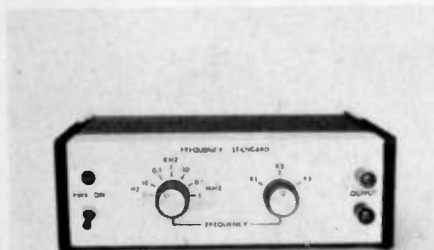

14. And now—the finished project, a delight to the eye! Once you try this method on one of your projects you'll never go back to ugly again. You don't have to be an artist, and it does not add much to the cost. Electronics can be beautiful!

**W**HEN YOU GIVE birth to an electronic project, don't send it into the world illiterate. As shown in this article, it's easy to apply lettering and designs to give your projects a professional appearance, as well as for functional reasons. This is accomplished by using a product called *rub-on lettering* (or *dry-transfer lettering*), which consists of letters, numbers, or designs with an adhesive on their back side so that they can be affixed to a panel or other surface. The letters come attached to the back of a transparent plastic *carrier sheet*, from which they are transferred to the panel by rubbing or *burnishing*. Follow the photos to see how it is done. The process may seem complicated at first, but with a little experience you will find that the steps go quickly.

Rub-on lettering is available in various sizes and colors (black and white are the most common). Sets may contain complete words, individual letters or numbers, or a combination of these. Sets consisting of index marks and other

# LOVE THAT

Press-on decals will turn

by Randall

designs for rotary switches and dials are also available.

A small set, which should see the average hobbyist through half a dozen projects or more, costs only about two dollars. Your local electronics store probably carries rub-on lettering and related supplies, if not, try the suppliers listed at the end of this article. Rub-on lettering is also available from art, graphic arts, and office supply stores. Although the type they carry is intended primarily for other purposes, it can be used for electronic projects.

In addition to the lettering and a few household items (cellophane or plastic

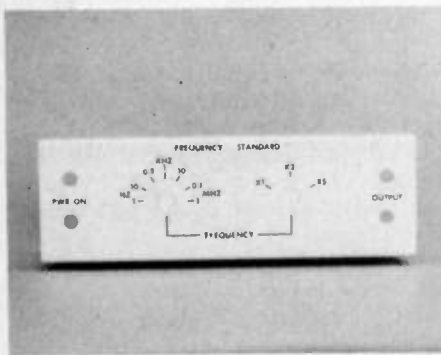

13. Here you see what the panel looks like after the lettering has been completed but before the parts have been mounted. It already has a clean, professional look, more like something out of an assembly-line factory than from your workbench!



12. You can also buy spray overcoating as pictured here. Spray is more even than the brush-on, but the brush-on can be applied thicker. This method too requires that you carefully check for the compatibility of the overcoat with both letters and panel.

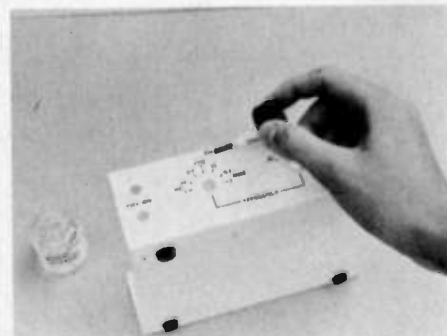

11. You'll want to protect that final panel, and there are two methods you can use. Here we show the brush-on method of overcoating. First, check on a scrap or hidden area for compatibility with both rub-on lettering and the panel finish.

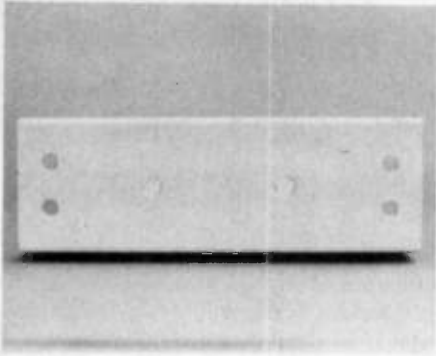

4. Once you know where it is all going to be at, you can begin to machine the panel. Follow your quadrille-paper layout carefully and don't make last minute, poorly planned changes! Then make certain the panel is clean and dry and free of any imperfection.

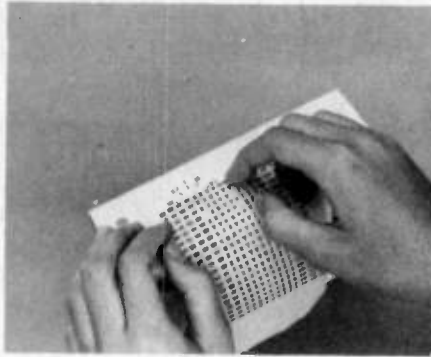

5. Locate the desired letter (or word, or design) on the carrier sheet, place it in position on the panel and press the sheet against the panel. The back of the sheet is tacky so it will not easily slip. Here we have already applied some of the letters.

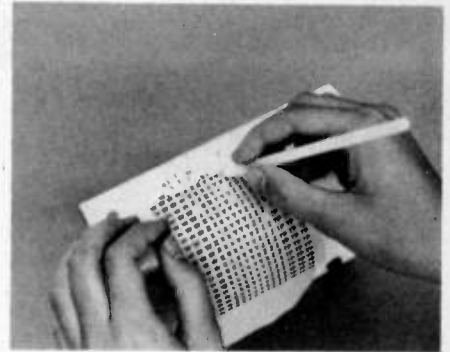

6. Transfer the letter to the panel by use of the burnishing tool. Rub over the letter several times, increasing the pressure each time until the transfer is complete. As you do this a slight change in the letter's appearance verifies transfer is working.

# LETTERING

projects into works of art

Kirschman

tape, ruler, paper, etc.), you will need a blunt-pointed tool to burnish the letters into place. Tools for this purpose can be obtained where art supplies are sold, or you may be able to find something around the house that will serve the purpose. However, a pencil or ball-point pen tends to be too sharp, and may also obscure the lettering. The burnishing tool shown in the photos was made from 1/4-inch diameter plastic rod sanded round on one end and tapered and rounded to about 1/8-inch diameter on the other end. It could also have been made from a wood dowel.

The panel or other surface to which

you intend to apply the lettering should be clean and dry. Any oil, grease, dirt, or moisture will hinder adhesion of the lettering. Soap and water can be used for cleaning, except on bare aluminum. Rinse and dry the panel thoroughly; after wiping off excess water, use a heater or warm oven to dry. Solvents can also be used for cleaning; test first for compatibility with the finish. *Do not* use a heater or oven with solvents. To clean bare aluminum, solvents can be used, or chemical preparations for this purpose are available from paint and hardware stores. After cleaning do not touch the areas where you will apply the lettering.

If you use solvents or other chemicals be sure to follow the manufacturer's directions and particularly observe the appropriate safety precautions. Spend a little extra time and effort to be safe and minimize the possibility of injury.

After you have applied the lettering, you will probably want to protect it  
(Continued on page 114)

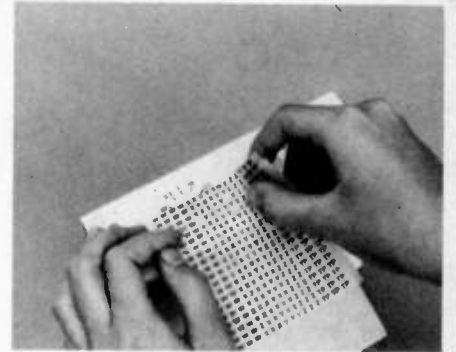

7. Peel the carrier sheet away from the panel, starting from one end and holding the other end in position against the panel. Check that the letter has completely transferred. If it has not, all you have to do is lay the sheet back down and burnish over.

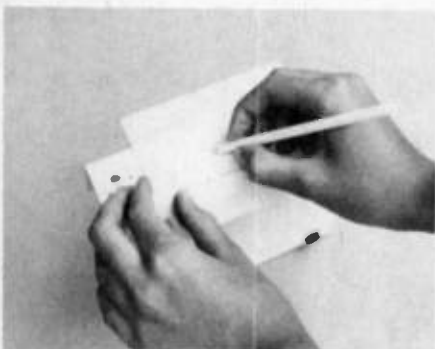

10. Once all lettering is applied, and you are satisfied with it, burnish one more time. Use a backing sheet of slick paper, so the lettering will not stick to the backing sheet, and go over the whole panel. Use the blunt end of the burnishing rod.

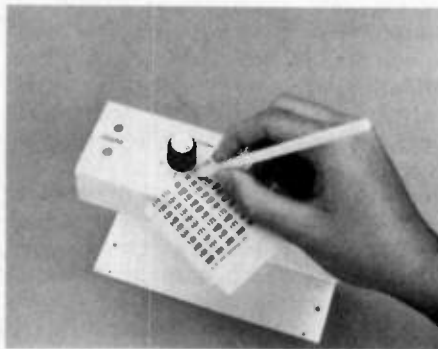

9. Positioning index marks is done by temporarily mounting both a switch and its knob. Turn the knob to each position and align the mark with the pointer. As you see here, the number "1" makes a good index mark, certain other letters may be used.

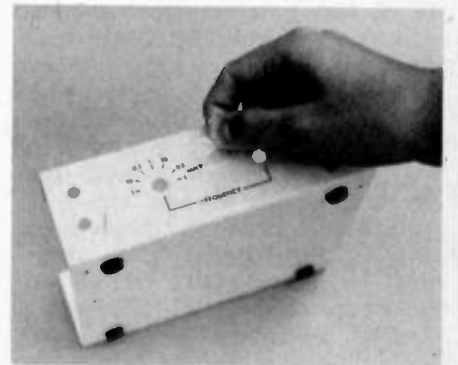

8. Make a mistake? It's no disaster. To remove an error, press ordinary cellophane or plastic tape over the offending letter and then simply lift it off. This may be repeated if needed, until all is clear. An eraser may also be used.

# Budget checks out the...B&W 370-10 Window-mount antenna

CIRCLE 52  
ON READER  
SERVICE COUPON

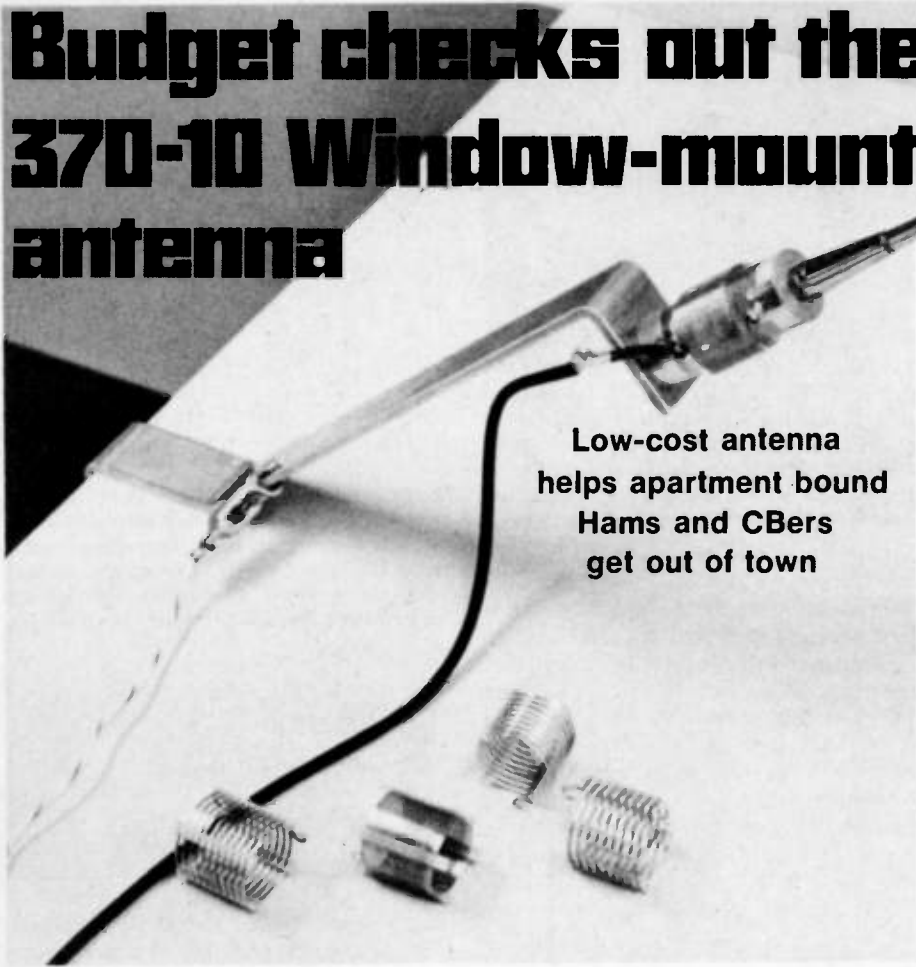

**Low-cost antenna  
helps apartment bound  
Hams and CBers  
get out of town**

**T**HERE ARE MANY Radio Amateurs and CBers who have acres of land on which to string antennas, and have never given a thought to the plight of the poor city-bound Operator. Well, luckily, Barker & Williamson has. Their newly improved Model 370-10 antenna makes it possible for many an apartment-stranded Ham or CBER to get on the air with a decent signal, and start working the world. The 370-10 is designed to work out of city apartments, town houses, and also trailers, boats, hotels and other locations where a permanent antenna is not feasible. All you need is a window, a radio transceiver, and a few minutes' time.

**Anyone Can do It.** The Barker & Williamson 370-10 comes in a compact little package complete with a very heavy-duty window clamp, a substantial plexiglass coil mount insulator, a collapsible whip, a hank of RG-58 coax feed line, a roll of heavy hookup wire for the counterpoise, and a handful of hardware—as well as air-wound inductors for the 10, 15, 20, 40-meter and CB bands. Assembly and installation take just a few minutes. The hardest part is attaching a suitable coax fitting for your particular transceiver—not ex-

actly a major undertaking. The coil and whip extend at a forty-five degree angle from the clamp part of the bracket, so the antenna can be mounted on either a vertical or horizontal plane.

**Tune-Up Tips.** Once the antenna is in place, tune-up is simple and very neat. Following proper antenna practice, Barker & Williamson provides a counterpoise—which is really a one-quarter wavelength piece of wire—to act effectively as a ground plane for the one-quarter wavelength whip, which really needs one. The user simply rolls up whatever isn't needed from the thirty-three feet of wire, leaving the proper length attached to the mounting bracket. Sometimes moving the counterpoise around helps a bit in lowering the standing wave ratio. The whip, of course, uses loading coils for each of the lower bands. They require no adjustment, and changing them is a snap. There's a shorting strap for 6 and 2-meter operation, and the whip is retracted (to 54-inches from its full 57-inches) on 2-meters.

**Does it Work? Yes, Sir!** The antenna was tested on each band, except 6-meters. In almost all respects it performed as well as claimed by the manu-

facturer. We first went on the air on 20-meters CW, calling a CQ (general call) on this crowded band. Immediately, a station in Indiana (about 800 miles from this location) answered, and reported strong signals and solid copy. Similar responses were had on each of the other bands. Operation is especially good on the higher bands such as 15 and 10-meters, where the radiating efficiency is at its highest for a short antenna. We were not always able to get the standing wave ratio down to the 1.1 to 1 Barker & Williamson claims, but we were always able to come close. You might find, if you're using a transmitter with a solid-state final stage (as virtually all CBERs are) that a small antenna tuner will sometimes make your transmitter a little happier in loading. Barker & Williamson rates the 370-10 at 360-watts transmitter input—we used 100-watts of transmitter output, and everything worked perfectly.

For cramped space applications, temporary installations, and for emergency use when permanent antennas have been damaged, this antenna is hard to beat. And for its price, \$32.50, it's a real bargain. Barker & Williamson, Inc. is located at 10 Canal Street, Bristol, PA 19007. For more information, circle number 52 on the Reader Service Coupon. ■

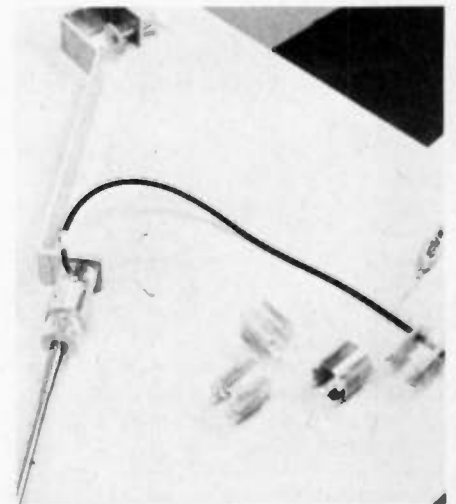

The 370-10 comes with all you'll need for mounting and operation. For more information, circle 52 on reader service coupon.



# Crystal detectors and how they work

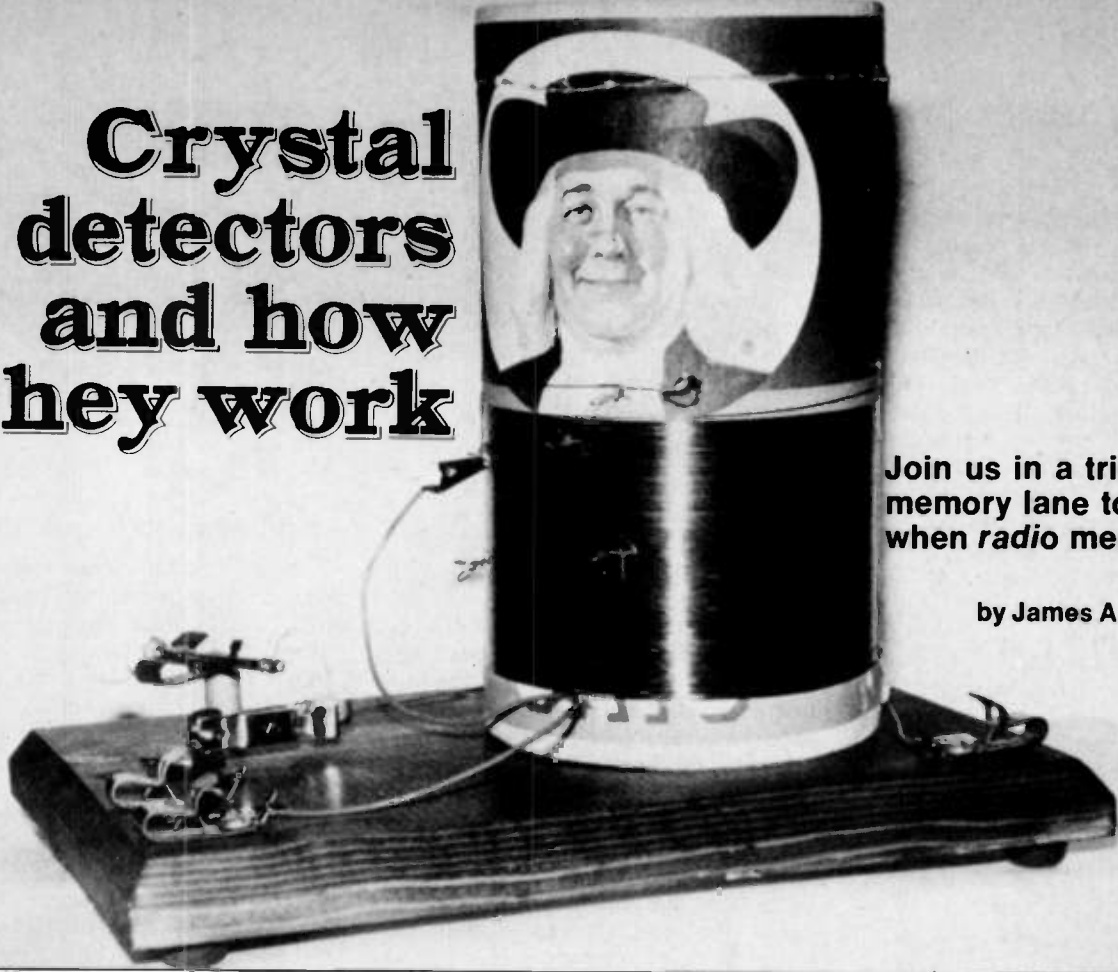

Join us in a trip down memory lane to the time when *radio* meant *crystal*

by James A. Fred

**R**ADIO WOULD NOT BE POSSIBLE without a means of detecting the signals. Detection of a signal refers to the separation of the audible signal from the radio frequency carrier signal. Over the years since 1873, many kinds of detectors have been used. The first really sensitive and stable detector was the mineral detector of Dr. Greenleaf Whittier Pickard. Utilizing the research of Professor Braun which showed the "unilateral" conductivity of certain minerals such as Pyrite and Galena, Dr. Pickard developed the crystal detector. During the developmental process, Pickard found over 250 different minerals that would detect radio signals when used in conjunction with metal contacts. He actually tested over 31,000 combinations, finding many hundreds of useful pairings.

**Early Development.** The crystal detector developed by Dr. Pickard between 1902 and 1906 was the first truly sensitive and fairly stable detector. The crystal detector was more sensitive than the Fleming Valve (diode) and even the deForest Audion (triode). As testimony to that fact, many radio operators kept a crystal detector on standby for their vacuum tube receivers. The one drawback to any detector, including the crystal detector, is that they do not amplify signals, but merely detect the signals received.

**Ups and Downs.** This lack of amplification requires that every possible step be taken to provide the highest level of signal to the receiver. The antenna gathers in the radio signals and the higher it is and the longer it is (to a point) the stronger the signal is. Of course in this day and age there has to be a limit to the height and length of the antenna. These limits will vary with where you live and how far you are from radio stations. For use with the crystal radio we are about to describe, your antenna should be from 10 to 25-foot high, and from 50 to 100-foot long.

Lack of caution in erecting antennas has caused some fatal accidents, so we urge that you use care when making your installation. No antenna should cross, go under, or even be erected *near* power lines, or even telephone lines. Keep your antenna in the clear. Not only will this prevent an accident, but it will help avoid picking up power line noises that could drown out the radio signals.

A good ground is next in importance, since the ground completes the antenna circuit. Usually a connection to a cold water pipe is considered an acceptable ground, but today this is not always true. The pipe could have a plastic section, or could be separated from the earth by a meter or other device. A better ground can be obtained by driv-

ing a copper-plated rod at least six-feet long into moist soil. Try to avoid sandy or dry soil, as it makes a poor ground. Don't drive the rod under the eaves of the house, because the rain will not moisten the ground there. The old-time radio experimenters sprinkled a few crystals of copper sulphate around the upper section of the ground rod. The copper salts would improve the soil conditions and make a better ground. Use a good ground clamp to attach your ground lead-in or better yet solder it to the ground rod.

**The Human Connection.** With further respect to the fact that crystal detectors do not amplify, and that every possible way to improve the strength of the received signal must be taken advantage of, the need for a set of the most sensitive headphones available must be recognized. You cannot use crystal headphones or the low-impedance (4 to 16-ohms) dynamic phones found on today's market. Most of the mail order radio parts catalogs will list 2000-ohm headphones, which are the ones you should buy. If you can find 4000 to 8000-ohm units, you will hear an even stronger signal on your crystal radio.

While the preceding tells us what to do to receive the best signal possible, we have not discussed the crystal detector itself. If a crystal detector is examined, it will be found to be merely a

# Crystal detectors

stand that holds the mineral in place with electrical contacts probing the mineral. Most minerals are mounted in a metal cup filled with a low melting-point metal, called Woods metal. The low melting-point prevents damage to the mineral crystal, which could cause it to lose its sensitivity. The adjustable electrical contact probing the mineral is called a "Cat Whisker," since it is a fine, springy wire. These two contacts to the mineral form a junction that permits electrical current to flow in one direction, or, as Pickard called it, "unilateral conductivity." This is a form of rectifier diode, and its action detects the audible signal which operates the headphones and permits us to hear the program material.

Now that we have all the necessary background for building and using crystal detectors, let's build a simple Cat Whisker crystal set which requires no parts beyond the wire and crystal, which we in jest have called the "No Parts Crystal Set."

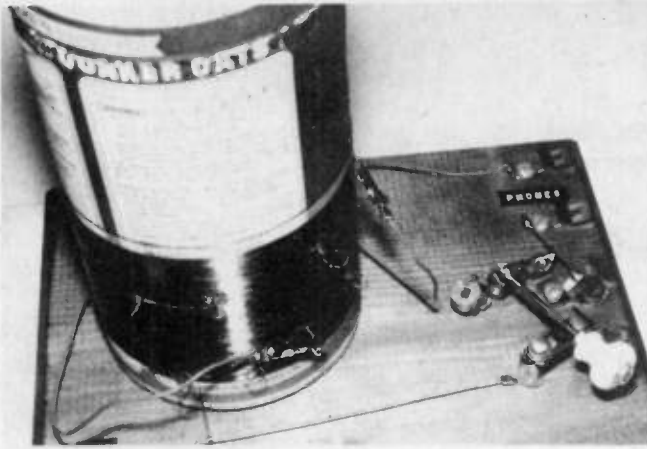

You can't make a simpler, or less expensive BCB receiver than this one. Even the coil winding isn't terribly critical, but the value we selected gave the best result.

**Construction.** You can build your crystal receiver on a piece of pine board, just as the oldtimers did. If you follow our layout, you won't need any fancy hardware, and in fact, you can use the exact same materials which were used years ago to build the first sets. Don't laugh! They actually worked, as you will see.

First, mount 4 terminals. You can use Fahnestock clips, or make your own with four wood screws and washers on them. Run the antenna wire, etc. between the washers and tighten the screws. Build your crystal detector stand at the right-hand side of the board. Use the small battery clip to hold the mounted crystal, and attach this battery clip

to the board with a small angle bracket. Connect this to one headphone terminal. Take a 3-inch piece of wire, strip away the insulation, and mount it about 1½-inches from the mounted crystal. Form a cat whisker with this wire so that it touches the surface of the crystal. If you want to go first-class, you can buy a complete, mounted detector, but this is not necessary. Connect this catwhisker to the ground terminal on your board.

Wind your coil on the empty oatmeal box, making a tap every 10 turns. You will need a total of 120 turns to cover the broadcast band, since this set does

*(Continued on page 118)*

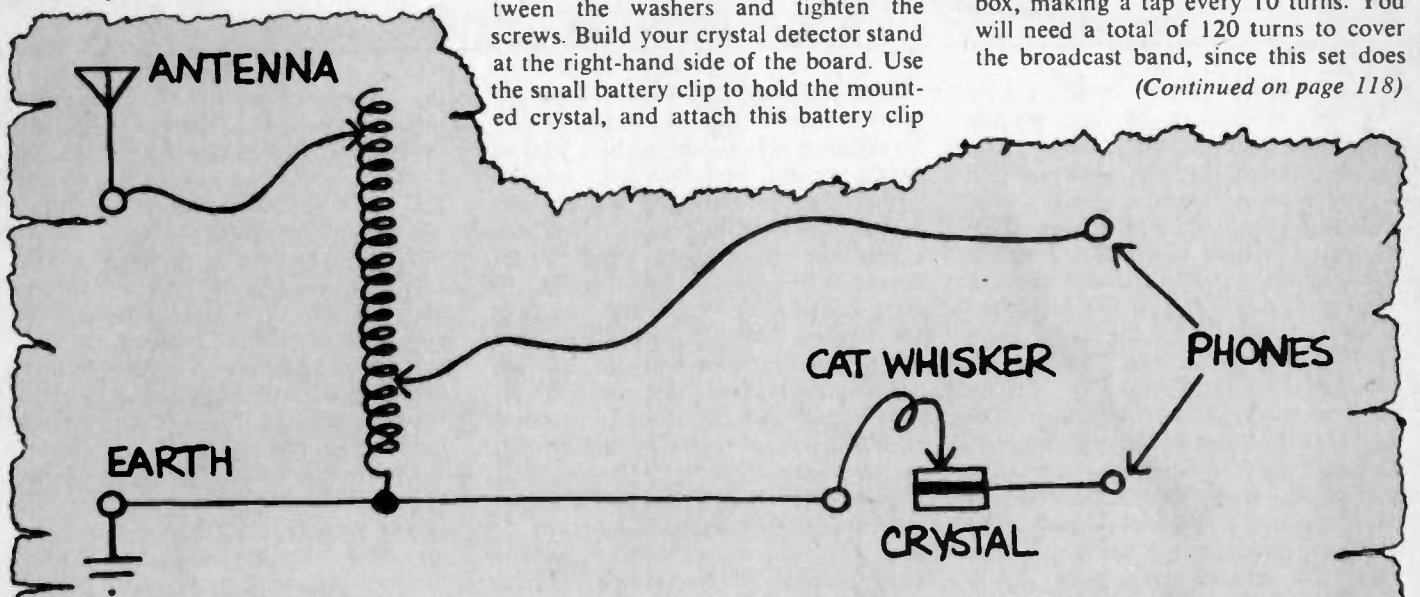

## Materials

One Oatmeal Box (empty)

Four Fahnestock Clips

One Mounted Crystal

One Spring Clip (to hold crystal)

Two Small Alligator Clips

One Cat Whisker and Holder  
(not from a neighbor's cat)

Hookup Wire, Solder, Wooden Base

130 feet of #22 Enameled Wire

This "authentic" schematic was found in Grandfather's trunk in the attic, wrapped around a stack of Grandmother's love letters. Gramps was never too much of a sentimentalist anyway, except when it came to radio. For good, clean fun in his day, radio couldn't be beat.

This tailgating gauge helps you to keep your distance.

# Space Cushion Timer

by Thomas R. Fox



**M**OST OF US WHO DRIVE the highways these days have become witness, at one time or another, to the gruesome sight of a high speed, rear-end collision. With today's cars becoming smaller and lighter, the only way the auto makers can provide a margin of collision safety for the occupants is to design the cars to crumple on impact, thus absorbing the shock and hopefully leaving the passengers uninjured.

The drawback to this method is that while you and your loved ones may manage to avoid serious injury, your car is likely to be suited for use as nothing more than junkyard scenery.

**The Principle.** To help you avoid these unpleasant consequences, we suggest you build the Space Cushion Timer. This device works on the "two-second rule." The rule simply says that if a two-second interval is kept between

cars at all speeds, ample braking distance will be provided for safe stops. In practice, you would fix a landmark at the side of the road, such as a light pole. When the car in front of yours passes the pole, two seconds should elapse before your car reaches that same spot. With our timer, you merely trip the touch plate, and 2.1 seconds later, a pleasant tone sounds. If you're at the landmark, then you are a safe dis-

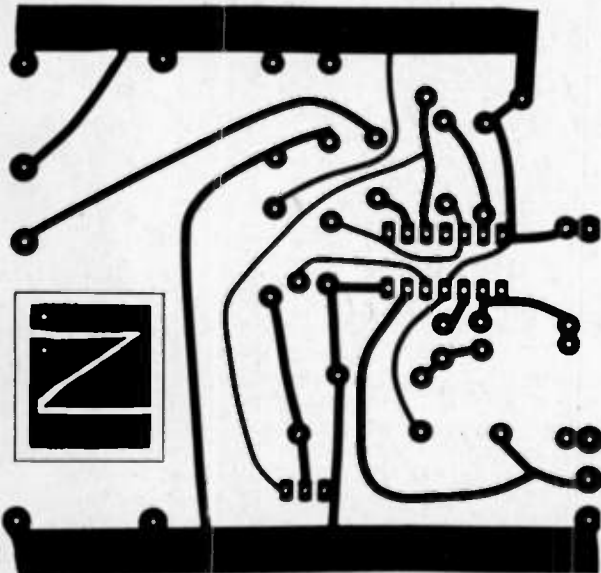

Separate the template for the touchplate and make an individual printed circuit board for it. Make both PC boards very carefully.

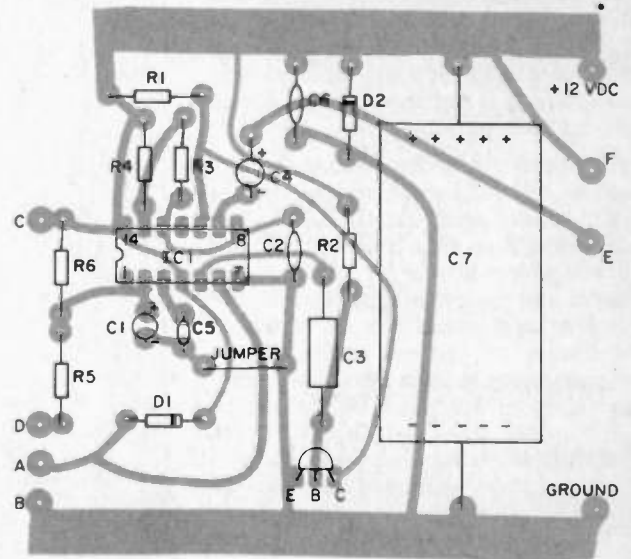

The components all mount on the side opposite the foil pattern. Be sure to double check the polarities of electrolytic capacitors.

# Space Timer

tance behind. If not, then adjust your speed accordingly.

**Construction.** Best results will be obtained by constructing the timer on a PC board. We have provided a template which you can use for etching your own board. All components, except for the speaker, switches, and the touch plate, are mounted on the PC board. The polarity protection circuit may be wired point-to-point on a small chunk of perfboard, and mounted on or near the car's fuse box, in order to save space within the timer's cabinet.

Instead of using a cabinet, especially if your car has a bit of room behind the dash, you may wish to mount the timer's PC board right inside, and have the touch plate and the switches mounted flush on the dash, in order to give the project that "built-in" look.

**How it Works.** IC1 consists of two 555 timers, one operating in a monostable mode, and the other in an astable mode. The monostable multivibrator is triggered when your finger contacts the touch plate. It has a pulse length of 2.1 seconds when S1 is in the *normal*, or closed position, and about 5.2 seconds in the *poor*, or open position. The output of Q1, which serves as a differentiator/inverter, shaping the pulse into a positive sawtooth, with a duration of 0.25 seconds. The reshaped pulse is then fed to the *reset* side of the astable oscillator which operates at 600 Hz. This oscillator will only produce an output when the *reset* input is held above ground potential (minimum of 0.4 volts). Therefore the oscillator will produce a 600-Hz tone for 0.25 seconds, which is fed into the speaker as the audible warning.

**Operation.** After connecting the protection circuit to the fuse box and the timer, you're ready for the safest driving you've ever done. Consult the table for the proper setting for the road conditions and the prevailing speed of traffic. The *look-ahead* feature of switch S3 allows you to set a considerably greater safety margin for conservative driving. You may wish to clip the table from the page and fasten it to the underside of your sun visor where it will be handy when you need it. **Remember!** The Space Cushion Timer will not prevent accidents if you don't use it, and even when you do use it, it's not intended as a substitute for seat belts and common sense. ■

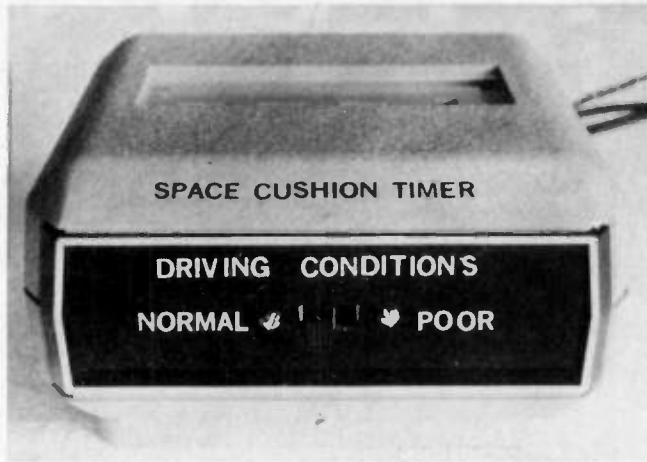

While almost any case can be used for the space cushion timer, this Radio Shack clock case seems ideal. This unit can be mounted at almost any convenient spot on the dashboard of your car.

## Rationale For Two Seconds Following Distance

Car Speed	Feet Car Will Travel In 1 Second	At 1 Car Length For Each 10 M.P.H. You Will Be (based on 20 ft. vehicle)	2 Second Safety Rule You Will Be
30 =	44.4	60 ft. back	88.8 ft. back
40 =	58.6	80 ft. back	117.2 ft. back
50 =	73.3	100 ft. back	146.6 ft. back
60 =	88.0	120 ft. back	176.0 ft. back

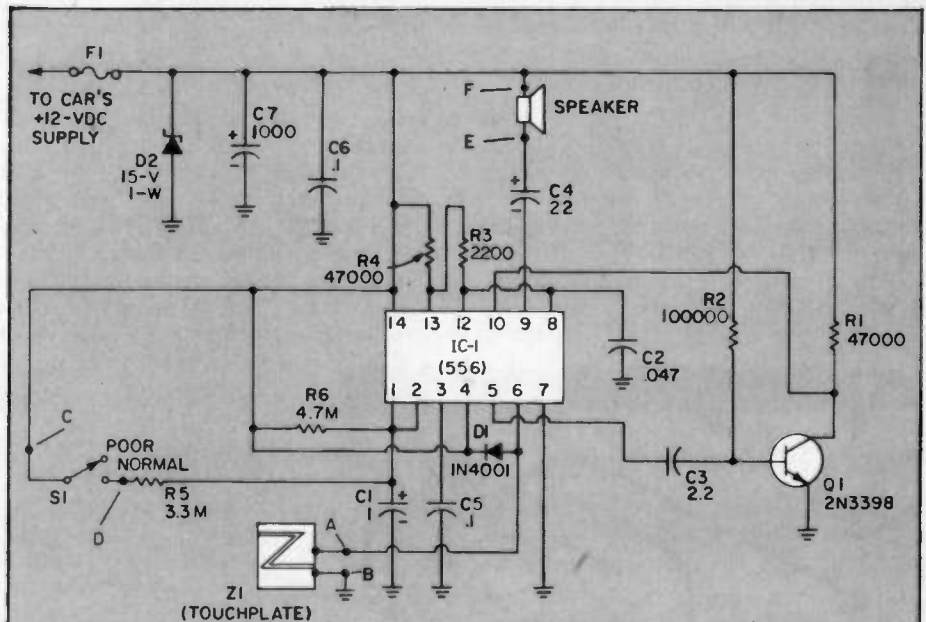

## PARTS LIST FOR SPACE CUSHION TIMER

- |  |   |
|--|---|
| C1—2.2- $\mu$ F tantalum capacitor, 25-volt or greater         | IC1—556 dual 555 timer                                    |
| C2—0.047- $\mu$ F ceramic disc capacitor, 25-volts             | Q1—2N3398 NPN transistor or equivalent                    |
| C3—2.2- $\mu$ F non-polarized electrolytic capacitor, 25-volts | R1, R4—47,000-ohm, 1/4-watt resistor                      |
| C4—22- $\mu$ F electrolytic capacitor, 25-volts                | R2—100,000-ohm, 1/4-watt resistor                         |
| C5, C6—0.1- $\mu$ F ceramic disc capacitor, 25-volts           | R3—2,200-ohm, 1/4-watt resistor                           |
| C7—1,000- $\mu$ F electrolytic capacitor, 25-volts             | R5—3,300,000-ohm, 1/4-watt resistor                       |
| D1—1N4001 diode  | R6—4,700,000-ohm, 1/4-watt resistor                       |
| D2—1N4744 zener diode, 15-volts                                | S1,—sub-miniature SPST slide switch                       |
| F1—0.25-amp quick-acting fuse                                  | SPKR—8-ohm miniature speaker                              |
|  | Z1—touch plate (requires 1 square inch of PC board stock) |
|  | Misc.—cabinet, perfboard, hookup wire, etc.               |

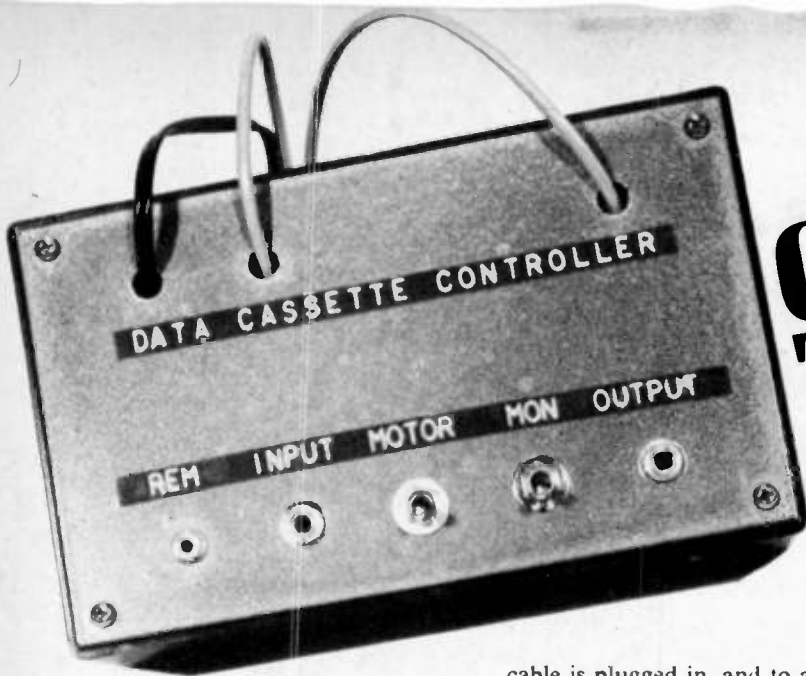

# CONTROL THAT TAPE

Keep in charge of your computer with this one-evening project.

by Herb Friedman

**T**HOUGH THE COMMON CASSETTE recorder, used as the data storage system for many hobby and personal computers, is both inexpensive and reliable, it is also a pain-in-the-RAM. Most computers control the starting and stopping of a recorder's motor via a control cable and plug from the computer's recorder interface to a jack on the side of the recorder. It is impossible to run the recorder manually. You must pull out the remote control plug if you want to rewind the tape, or do anything else to the tape, such as skipping forward to other data, or to a "clear" section of tape for additional data recording. Then you must reinstall the remote control to return the recorders' on-off operation back to computer control.

Another problem with most cassette installations is that you can't hear what's going on. Is the tape really feeding data to the computer? Is the computer really feeding data to the cassette? If we had a dollar for the times many of us hit the LOAD key—only to realize minutes later there was no feed to the computer—we could probably afford a disk system. Surely, we could afford a disk if we also had a buck for every time we dumped from the computer only to discover too late the recorder wasn't in the record mode, or there was no dump when we thought there was.

Though many personal computers provide some form of bell, whistle, or terminal indication that the computer is loading or dumping, it's most convenient to hear what's going on.

For something like ten dollars and a short evening's work you can build a *Personal Computer Tape Controller* that allows you to manually control the recorder's motor and functions even when the computer's remote control

cable is plugged in, and to also monitor loads and dumps.

The monitor hookup depends on the particular model cassette recorder you use. The audio feed from the recorder to the computer is generally taken from the monitor jack of the recorder, which is an output for an external speaker or earphone that disconnects the recorder's internal speaker when a patch cord is plugged in. Most inexpensive recorders also provide a monitor jack output for the record signal even though the speaker is turned off. By bridging a small speaker across the connection to the monitor jack it's possible to hear the signal feed to and from the computer. You might have other problems with load and dump, but by hearing the signals you'll at least know there actually is a computer signal going in and out of

the recorder.

The complete controller is amazing: No power supply, ICs, transistors, batteries, or LEDs! A few jacks, switches, a small speaker and some patch cords are all that's needed. (We could have done it the hard way with a few ICs and transistors, but why waste money on unnecessary parts.)

The only critical area is the cabinet, or the front panel on which the jacks are installed. It must be made of plastic or some other insulator. Many computers are sensitive to ground loops between a recorder's input and output jacks, and for this reason there must be no common connection between the two in the controller. Similarly, the remote motor control jack (J3) must also often be electrically insulated from J1 and J2's common connection. By mounting



The Tape Controller connects between the computer's record interface and the cassette recorder, allowing monitoring of both the record and playback signal(s), as well as providing forward and reverse control without pulling the remote control patch cord.

# TAPE CONTROL

all three jacks on a plastic panel or cabinet the whole ground loop problem is avoided and the controller is truly universal.

The speaker can generally be any 8 or 16-ohm miniature type 1.5 inches or larger. It is cemented with "airplane" or "model" cement directly to the panel—its muffled sound will be adequate for monitoring.

Resistor R1 is used only if you want to lower the speaker volume (which is often unnecessary because of the muffling). Experiment with ½-watt values from about 15-ohms upwards until you get the desired sound level. While you could install a potentiometer (about 50 or 100-ohms) to provide a variable volume adjustment, such is not an easy value to locate at your local parts distributor, and the slight extra convenience isn't worth the extra cost.

Jacks J1, J2 and J3 match the existing plugs on the connections from your computer's recorder interface, and plugs P1, P2, and P3 should be identical with the interface plugs. As a general rule, J1, J2, P1, and P2 carry the audio signals and are the miniature type. J3, and P3, which are the recorder's remote

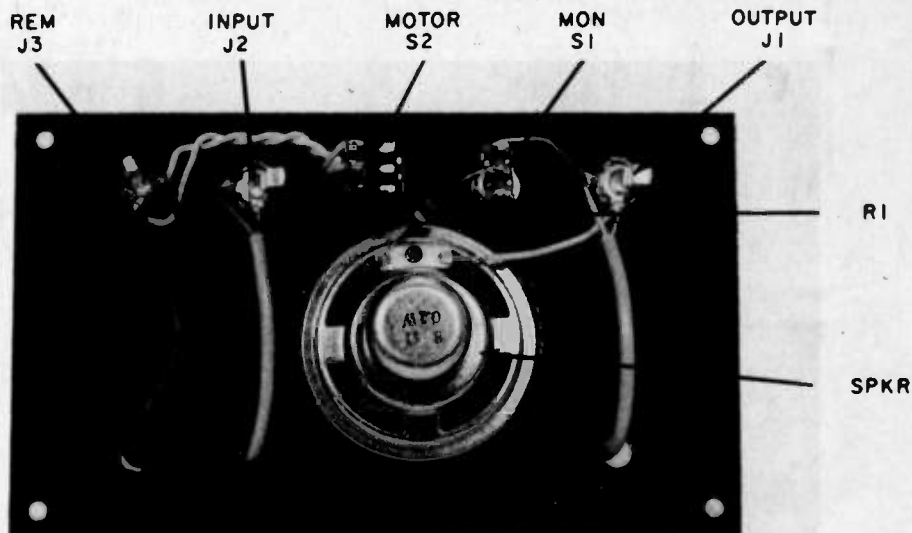

Construction of this tape controller couldn't be more straight-forward. There's no power supply, ICs, transistors, batteries or LEDs! However, there is one critical area—the front panel. The jacks installed thereon must be electrically isolated from each other. This is because many computers are sensitive to ground loops between a recorder's input and output jacks so the controller must not make a connection between the two. The best bet is to just avoid the entire problem from the beginning. Use a plastic panel/cabinet!

control, are the sub-miniature type.

**Using The Controller.** Connect the wires from your computer or computer interface to J1, J2, and J3. Connect P1, P2 and P3 to your cassette recorder. To operate the cassette recorder manu-

ally, set S2 to *manual* (closed), thereby shorting the recorder's remote control circuit. When you want the computer to start and/or stop the recorder, set S2 to the *open* position. (When S2 is closed it's the same as if you had pulled out the remote control plug from the recorder's *remote* jack.)

To monitor either the output from, or input to, the recorder, close S1. If you find the monitor sound disturbing after the load or dump starts simply open S1; it has no effect on the load or dump. If your computer requires the load start on the recording's *marking tone* to avoid a "garbage" entry at the point where the marking tone commences, close S1 so you can monitor the recorder output, close S2 so you can operate the recorder manually and *play* the tape until you hear the start of the marking tone, then open S2 as soon as you hear the tone. This returns cassette control back to the computer. You can now commence the load without fear of "garbage" caused by the start of the marking tone.

(Note. This controller is intended for recording systems that utilize audio tones to represent data, such as the so-called Kansas City, or Byte/Manchester systems. It is not intended for recording magnetic impulses, such as NRZ, which generally provide an input/output monitor as part of the recorder.)

Be in control of your computer by building this little device. We think you'll agree it will be one of your most useful computer accessories. ■

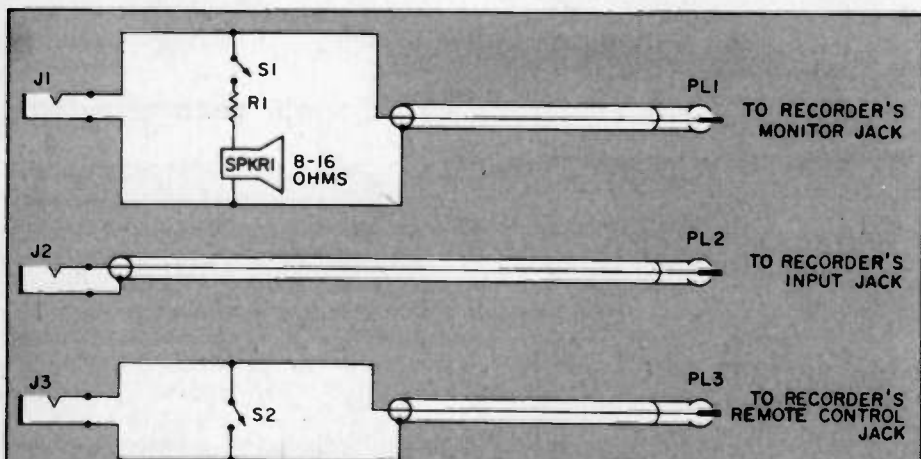

## PARTS LIST FOR TAPE CONTROLLER

J1, J2—Miniature jack, see text.  
 J3—Sub-miniature jack, see text.  
 P1, P2, P3—Plugs to mate with J1, J2, J3. See text.  
 SPKR—8 or 16-ohm miniature speaker, see text.

S1, S2—SPST switch  
 R1—50 to 100-ohm resistor, ½-watt, see text.  
 Misc.—Cabinet or panel made of plastic or other insulator; wire, etc.

Speaker SPKR 1 can be anything from 1.5-inches and larger. It can even be smaller if you happen to stumble across one of those surplus mini-speakers that still sell for about 50-cents. The speaker is cemented to the front panel with silicon rubber (RTV) adhesive, or "airplane" or model cement. Do not try to use one of the new instant-drying cements such as Krazy-glue—they won't stick to the speaker's fiber "front." The switches shown have more terminals than needed for SPST. They are "surplus," selling for much less than a "new" SPST switch. Use whatever you can get most cheaply.

# Put NEW LIFE Into That OLD CAR RADIO

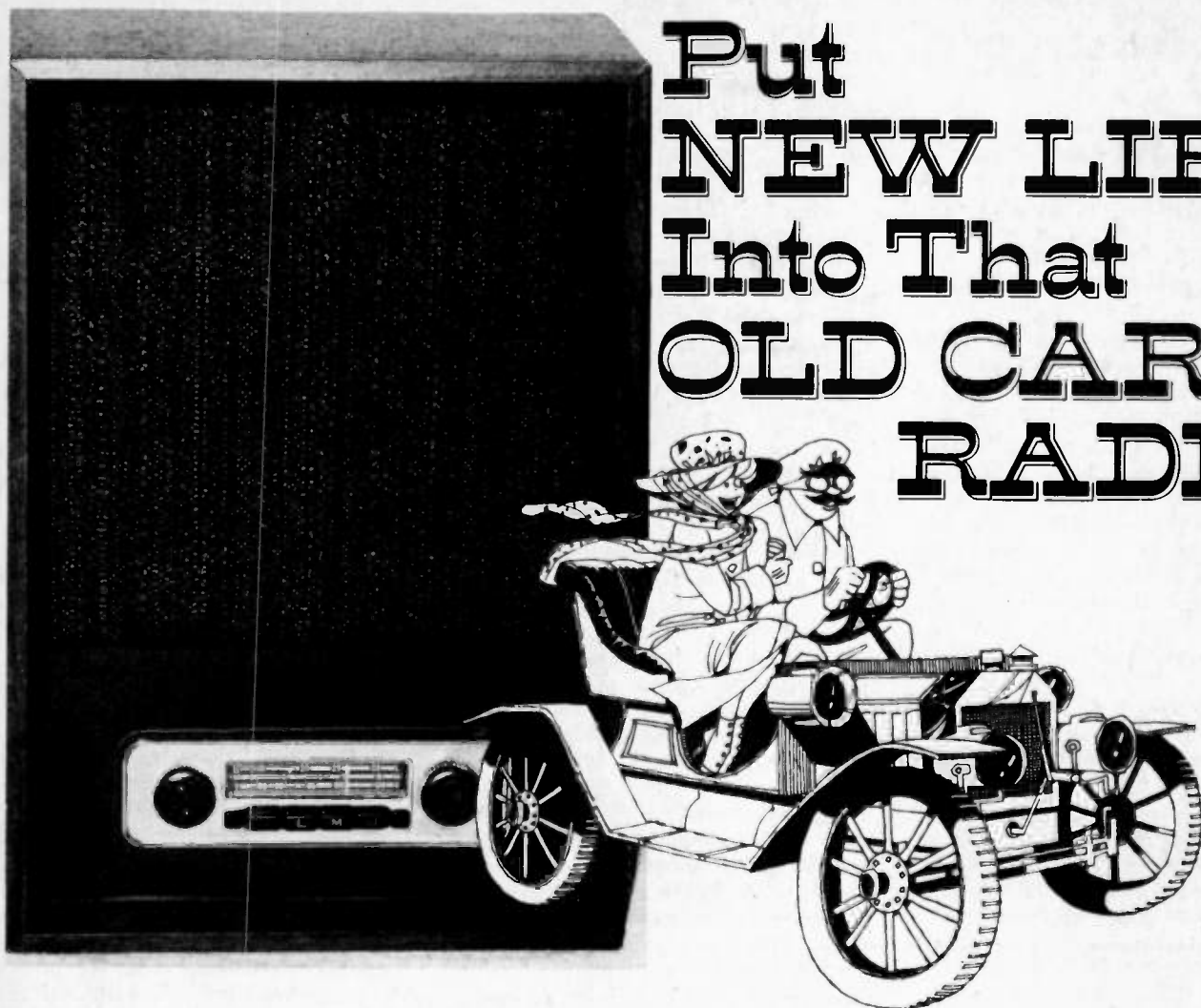

With a loudspeaker and a simple power supply your old car radio will become a high-quality home receiver. Good for DXing, too.

□ For years now Americans have bought 10 million or so new cars every year, and most of those cars have radios in them when new. As a result millions of used cars are sold by their original owners each year. Now the price a car dealer will pay, or allow you on a used car is a combination of the so-called "book" value, which he gets from a little blue book, and of the bargaining. He doesn't care whether your used car has a radio or not, and many people, knowing this, take out the car radio before trading in the old bus on a new one. The result is that there are hundreds of thousands of used car radios lying around in garages, attics and cellar storehouses, waiting to be thrown out some year in the annual spring cleaning.

Most of these radios are perfectly good, but won't be used because it's usually too much trouble to install them in a car other than the one they were

originally set up for.

But there's no reason such sets can't be put to work as house radios, especially since they will almost always work better than most table model radios, and even most console sets you can buy today. Their tone is as good or better than most home sets—obviously we're not comparing them with high fidelity component sets, which cost many times more than regular table or console radios. Their selectivity and sensitivity is also better than that of most home sets because they have an RF (radio frequency) amplifier stage ahead of the converter stage, and most home sets don't bother with an RF amplifier stage which car sets need.

**Going for AM DX?** DX fans can have a ball with converted car radios. The sensitivity and selectivity of most car sets, when combined with a good outside antenna can get you AM stations from all over the country. Here in Cali-

fornia I've been able to get stations like KOMA, Oklahoma City, WLS Chicago, and many others regularly, at night. For more on AM DXing see *ELEMENTARY ELECTRONICS* Sept./Oct. 1976 "The Secrets of Split-Frequency DX." White's Radio Log, regularly published in our sister publication, *COMMUNICATIONS WORLD*, is an excellent source of info on the super DXing you can do on AM radio.

**Car Radios Are Better.** The typical car radio was built to perform in one of the toughest environments—your car. The set has to work with a ridiculously small antenna, and yet get distant stations. It also must have enough volume to overcome road noise and tone quality to offset the shortcomings of the small, poorly baffled speakers found in most cars. And to top it off, the car radio must perform well over a wide temperature range.

Conversion is easy and inexpensive.

# NEW LIFE

All you have to do is add a power supply, antenna, and a good speaker to a car set and you are in business! So if you have an old car radio, or know where you can get one, don't pass it up. You won't know how good radio can be until you convert a car set to home use.

**First Get Your Radio.** What car radios are best for conversion? Just about any old car radio can be converted to home use, provided it's a *transistor set*. Tube sets will be too old, and more important to us, they use much too much current (to heat up the tube filaments) to be practical for conversion to home use.

You can use an AM-only set, or an FM/AM set. If it's a really recent car radio it may be one which has a four- or eight-track tape player built in, and with a stereo radio section. If it has a tape player you'll have to use a heavier power supply than if it's just a radio receiver, but that's the only other restrictions (besides no tube sets).

Of course the car radio should be a 12-volt unit. 6-volt car radios haven't been made for quite a while, though it's possible you might happen across one. And don't convert one of those fancy car radios which has "signal seeking" (sometimes called "Wonder Bar," because you just touch a little bar to activate it). These sets have a motor inside the set to drive the tuning mechanism and the tuning dial. The motor draws several amperes of current, and would require a heavy power supply costing much too much. In addition, these automatic-tuning units are likely to get out of whack, and they're not easy to repair. In fact many car radios have been consigned to the junk box just because the auto tune failed and it was too expensive to repair.

And another thing. Try to use a radio which has all its knobs and the dial plate. It'll save you the trouble of scrounging around to find matching knobs and a dial escutcheon plate later. However, if you happen to already have a good car radio—for example, one with separate bass and treble tone controls, don't let the absence of knobs

hold you back. They *are* available at some specialized stores. And you *can* make up a new escutcheon plate from a piece of scrap aluminum.

**Check It Out First.** Before you convert the car radio to home operation, be sure it's working OK, or is worth repairing. To do this make up an antenna as shown in the diagram, and connect it and a speaker (just about any speaker will do) and a power supply to the radio as shown.

Hook up a 12-volt battery or battery eliminator to the radio, being careful to hook the positive (red) side, usually marked +, to the "hot" lead of the radio. The negative (ground, or common) nearly always goes to the case of the radio. Check the markings first to be sure.

Adjust the antenna trimmer capacitor to get maximum sensitivity. This is done by setting the tuning dial to a weak station around the high end of the dial (1400 kHz is ideal) and adjusting trimmer C2 for maximum volume. The setting of C2 will be different when you connect the final antenna to the set, later. Measure the current drawn by the radio. Most solid state sets draw ½ amp or less—if it draws much more than this we suggest you use a commercial power supply such as those made for CB radios and tape players. Almost any store-bought power supply will work fine in most cases. Make sure that the radio works properly. Clean it off and wipe the dial glass clean. Spray

the volume/tone controls with a good control cleaner, and remove the dial lamp. This will save power and allow the power supply to run cooler.

**Making the Conversion.** Start by building the power supply shown unless you buy one. If you use the commercial power pack mentioned, skip this section. I built my supply on a 4-in. x 3½-in. piece of U-shaped aluminum. The components, with the exception of transformer T1 are all mounted on the sides of the "U", which are about 1½-in. high. You can build yours in the same way, or mount the parts in a commercial chassis instead. Or you can mount the power supply on the top or back of the radio. But just be sure if you do this that you can install the radio in a cabinet. Install the components and wire them up, being careful of the connections of IC1, a voltage regulator. The case is ground so you don't have to isolate the case from the chassis. When you complete the component wiring, add leads at least three feet long so that the power supply may be easily attached to the radio.

You have an option at this point as to how you connect the AC power switch. You may use a separate unit as I did with the second radio shown, or open up the set and use the existing switch. If you choose this method, be sure to carefully remove the existing wires and solder them together. Then connect the AC wires from the power supply. Connect up the ground and 12-volt positive wires to complete the job. Check the radio out again with speaker and antenna. If all's well, install the radio.

**Selecting a Loudspeaker.** You can generally use any of a wide variety of loudspeakers with a car radio. The smaller speakers supplied with car sets are four or five inches in diameter, while the better ones, which usually have much better tone, are oval-shaped units either 4-in. x 6-in., or 6-in. x 9-in.

You can use one of these, if the impedance is correct, or you can go to a small high fidelity speaker for even better tone. First you should carefully examine the radio to see if it uses a special-impedance speaker. For many years most car sets used 3.2-ohm speakers. This is the nominal value if there

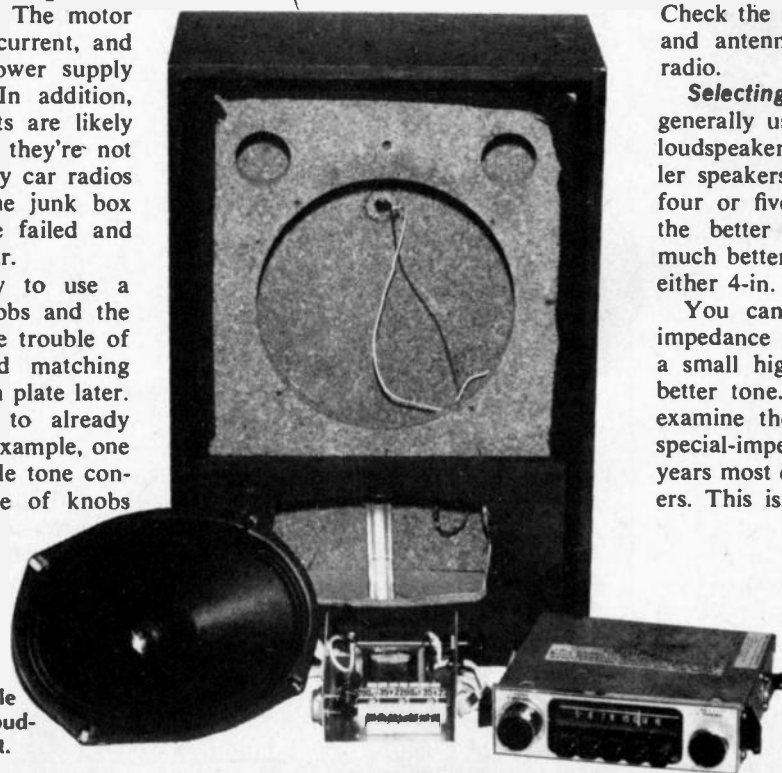

Car radios may be converted for home use using any convenient enclosure, a simple power supply, and a better loudspeaker, as shown at the right.



is no special indication. Many of today's sets use higher impedances, however, such as 10, 20, or even 40 ohms. If the set you're converting is so marked, you can use any one of the multi-impedance speakers listed in the Parts List. If it's not specially marked, use any speaker of 3.2, 4, or 8 ohms. Choose the largest speaker, with the heaviest magnet (and costing the most, generally) for the best tone.

**Installation.** This is where you get to exercise your creative talents. There are many different places you can mount your converted car radio. You can go my route and install it in a speaker cabinet. This worked great because reject cabinets were available from a local speaker company for \$1.00 each. I installed both radios in reject cabinets. I bought speakers to match the cut-outs (8 inches in both cases). Then I added grille cloth to cover the speaker

area and installed it. If you do this you will find the going very easy as most of the work has been done for you by the cabinet manufacturer.

Some other places you can put your radio are in a room divider or end table. Or how about the wall in your kitchen? What about under a shelf in a cabinet? The choice is up to you. If you have room for the radio only, you can locate the speaker somewhere else.

**Operation.** After you have installed the radio, power supply, and speaker, connect the antenna. Place C2 in a convenient spot where you can get at it. Then turn on the radio and tune in a weak station around 1400 KHz on the dial. Adjust C2 for maximum volume. The antenna lead may be stapled around the back of the cabinet. If you've converted an AM/FM set you might wind several turns of the antenna around the AC cord for better reception. The lead

may also have to be carefully positioned for best results on FM. This was necessary for the two radios that are seen here. That's all there's to it! Sit back and enjoy your new radio. You'll be amazed at the performance; it will far outstrip the radio receivers you buy in the drugstores, and the AM sections of all but the best stereo sets, too!

#### If You Don't Have A Car Radio.

If you don't have one, a good place to get car radios is from junk yards and used car dealers. Better yet, check out flea markets, garage sales, and other similar places. You'll generally be able to bargain and get a set for a lower price from the former sources. You shouldn't have to pay over \$10.00 for a set. You might get a radio that needs repairs and cut the price even farther. I bought several broken radios for fifty cents each, fixed them, converted them and gave them away as gifts! ■

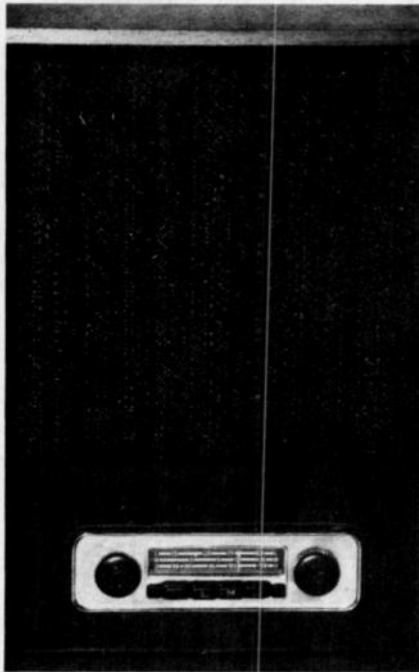

Another loudspeaker cabinet (cost: \$1.00!) houses this converted car radio. Sounds great!

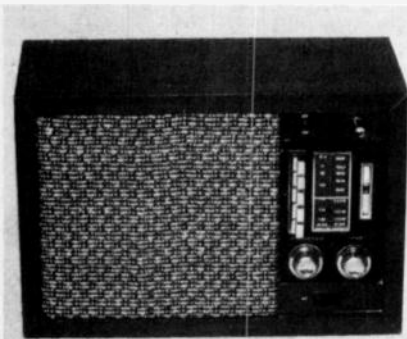

Out of a VW and into a reject speaker cabinet goes this car radio. AM, FM, and short-wave.

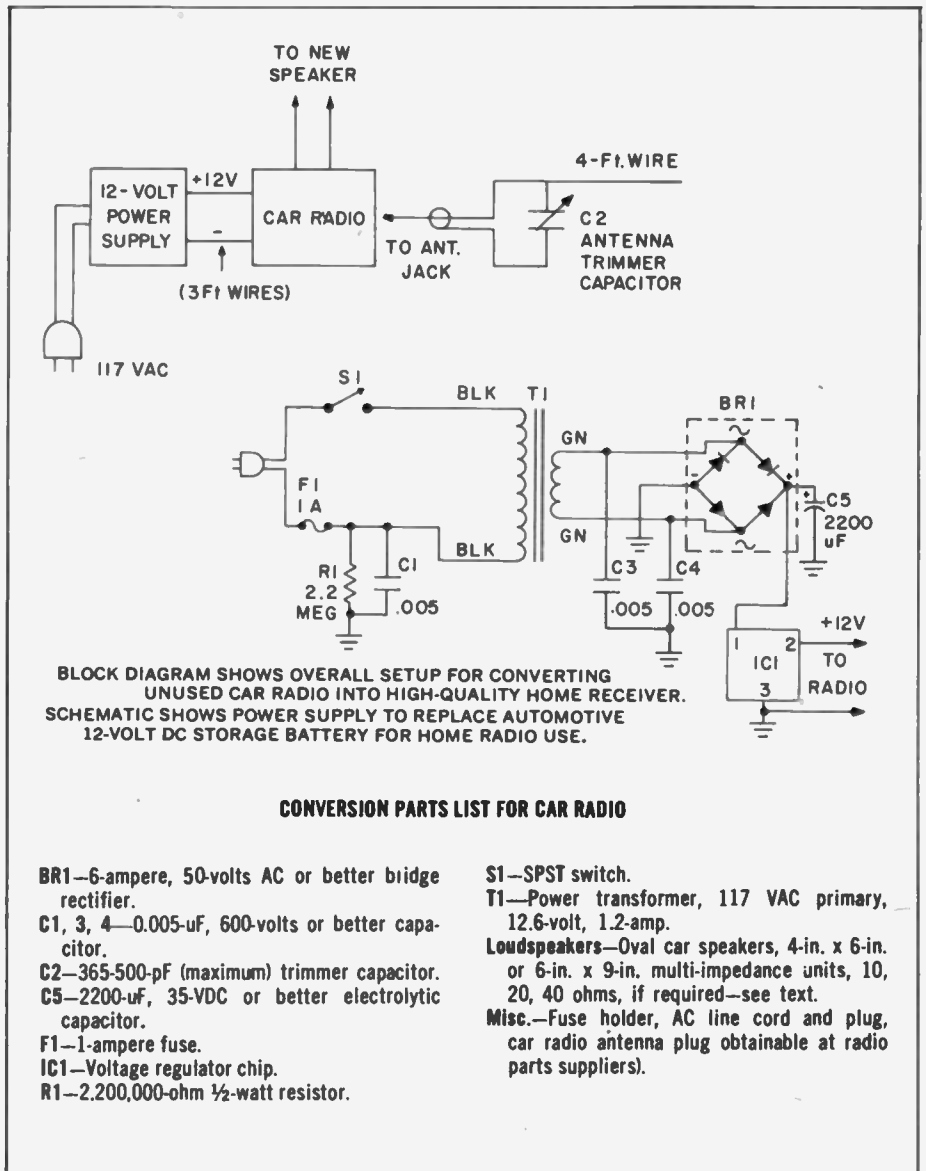

# chip-clip

IC testing got you flipping? Don't give up, try Clip-Chipping!

by James Gupton

□ The dual-inline-package (DIP) integrated circuit (IC) is not a really new electronics device; it's been around for more than ten years. While it was the microprocessor and mini-computer revolution that focused attention on this device, even those of us not involved in computers use ICs. For example, tape decks, radios, and television receivers now use them. Unfortunately, ICs are not infallible, and do on occasion breakdown. Due to the compact size of the IC, working space between devices is scant, to say the least. The need for an IC tester becomes apparent when one tries to follow a schematic diagram, manhandle two snake-like probes, and keep one eye on a meter and the other on an IC pin at the same time. That's where our deluxe *Chip-Clip* becomes a necessity.

Most frequently, repairmen come across digital ICs. In digital logic circuits there are only two input and output values (called states), low or high, corresponding to off or on. Most digital logic ICs use a voltage of +5 volts DC for the high state and 0 volts for the low state. We use the low or high voltage to turn off or on a light emitting diode (LED) and let a number of LEDs tell us what the present state is at every IC pin simultaneously. *Chip-Clip* will close on the small, tightly spaced

is high on either or both NAND outputs, there are eight close-quarter voltage measurements that you must make. Imagine how difficult it would be to keep your meter probe in the right spot without wandering and shorting between pins! We have also diagrammed the 7404 hex inverter logic IC. Here we have not two logic devices but six independent inverting circuits. In operation, if a high voltage appears on the input pin, the output drops to a low voltage. Should the input go low, the output goes high. By taking advantage of the high and low voltage states, we can observe the on or off condition of the LEDs and see the status of all six inverters simultaneously. Here, too, the *Clip-Chip* will prove an invaluable aid.

**Building the *Chip-Clip*.** The foundation of the *Chip Clip* is the standard 14 pin or 16 pin IC test clip available at any Radio Shack store or from any number of electronic mail order firms. To the IC test clip we add subminiature LEDs and a current limiting resistor between each logic test-clip pin and the IC ground pin. As mentioned previously, when low voltage is present on the IC pin, the LED does not light. When +5 volts appears on the logic input pin, the LED turns on. In addition, *Chip-Clip* has a different color

LED on the Vcc connection (pin 14 or 16) to confirm the presence of Vcc IC pins without shorting adjacent pins. Equally important, it can be attached to an IC when there is only a quarter of an inch of space between circuit components.

To further illustrate the utility of our *Chip-Clip*, let's take a look at two types of logic ICs. We have illustrated a 7420, quad input, positive, NAND gate. It actually contains two separate four-input NAND gates, one on each side of the DIP. In either circuit, the output voltage will be high if a low voltage appears on any of the four input pins. When all four input voltages are high, the output voltage goes low. Therefore, to find out why the output voltage. The contrasting LED color prevents confusing Vcc indication with a logic indication.

The assembly drawing illustrates the necessary connections for the 14 pin *Chip-Clip*. If you are building a 16 pin unit, two additional LEDs and resistors are needed for the two extra test points. The IC ground changes to pin 8 and Vcc input changes to pin 16. The additional LEDs are connected to pins 7 and 15. No other changes are necessary.

The ground pin is connected to a common ground wire loop. It consists of two rectangular loops fashioned from 20 gauge solid wire. One of these loops is placed around each edge of the test clip one-half inch down from the top of the plastic. Four 0.028 holes are drilled to anchor the ground bus to the test clip. Since there is one ground bus loop on each half of the test clip, they must be connected together with a short piece of #20 flexible stranded wire to allow free movement of the test clip's sections and enable the test clip to clamp onto the IC DIP pins.

On the 14 pin test clips, six 150 ohm, quarter watt resistors are soldered to the ground bus loop on each side of the test clip and are positioned vertical-

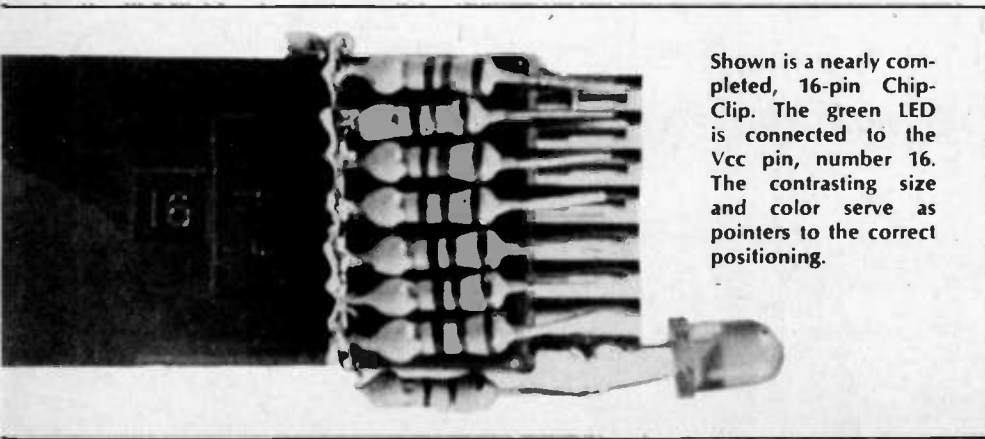
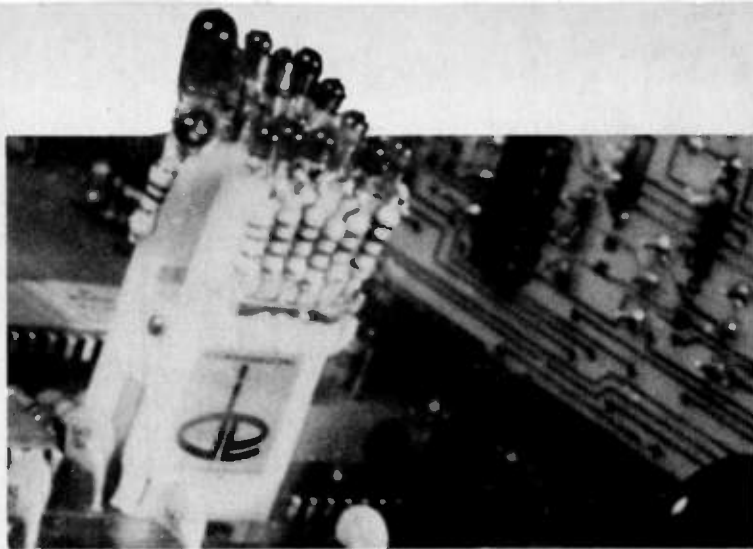

Shown is a nearly completed, 16-pin *Chip-Clip*. The green LED is connected to the Vcc pin, number 16. The contrasting size and color serve as pointers to the correct positioning.

ly. The body of the resistors should not stand above the top of Chip-Clip's frame and the resistor leads should be trimmed to the level of the metering pins. The resistor for the Vcc pin is positioned at the same level as the rest of the resistors but instead of being positioned on the side of the test clip, it is placed at the end of the clip next to the Vcc pin.

**Finishing Touches** Installing the LEDs is only a matter of soldering the cathode LED lead to a resistor and the anode lead to one of the test clip's metering pins. The cathode lead can be identified by its notch or flat side. Remember, no LED goes to the test clip's pin 7 on a 14 pin Chip-Clip, or pin 8 on a 16 pin one. All other test clip metering pins have a LED and resistor attached. It should be noted that the specified LEDs have a forward voltage rating of 1.6 volts d.c. and a maximum current rating of 20 mA. For voltages greater than 5 volts at Vcc, a new value of current limiting resistance must be used. (See accompanying box.)

**Determining Limiting Resistance**

The simplest way to determine the value of current limiting resistance for any value Vcc is by the formula:

$$R = \frac{V_{cc} - 1.6}{.020}$$

Vcc = voltage greater than + 5 volts.  
 1.6 = forward voltage of LED  
 .020 = maximum LED current  
 R = the new resistance

While almost any size LED can be used, the subminiature LED is recommended because of the limited space across the side of the IC test clip. In the author's model, a green emitting LED, jumbo size, was used to indicate the presence of Vcc voltages. The contrasting color prevents mistaking the lit LED as a logic function and serves as a pointer to the correct positioning of the test clip on the IC under test since the Vcc indicator is on pin 14 or 16.

**Final Checkout.** There are two things to be sure of. Be certain that the LEDs polarities are observed. Also, identify pins 1 and 14 on the 14 pin test clip or 1 and 16 on the 16 pin test clip and always be sure that these numbers always point towards the IC identifying notch, dot, or indenture on the top of the IC case. Final note, while these logic status test clips have been designed only for logic type ICs, it may be possible to employ them for other 14 or 16 pin ICs providing your schematic diagram confirms pins 7 or 8 as ground and pins 14 or 16 as Vcc. If in doubt, *don't use the Chip-Clip.*

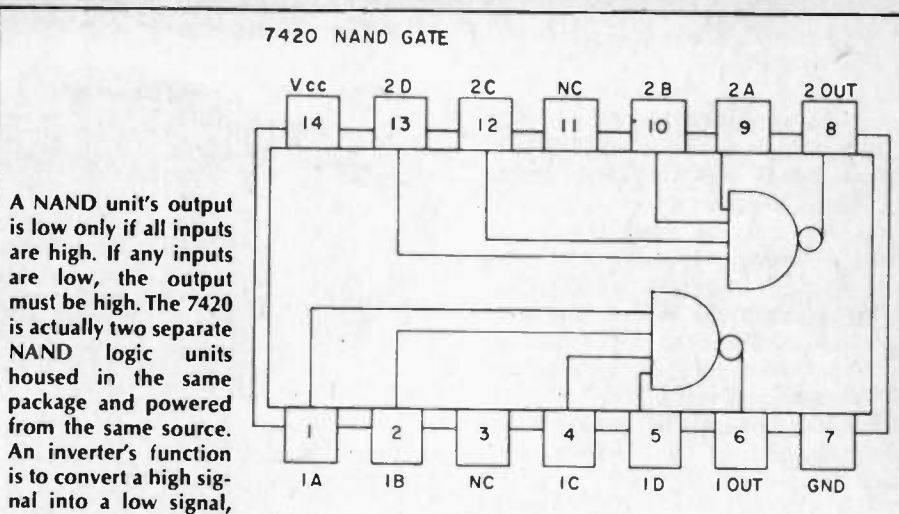

A NAND unit's output is low only if all inputs are high. If any inputs are low, the output must be high. The 7420 is actually two separate NAND logic units housed in the same package and powered from the same source. An inverter's function is to convert a high signal into a low signal, or vice-versa. The 7404 Hex inverter contains six independent units. Like the 7420, the only interfaces are common packages and Vcc inputs.

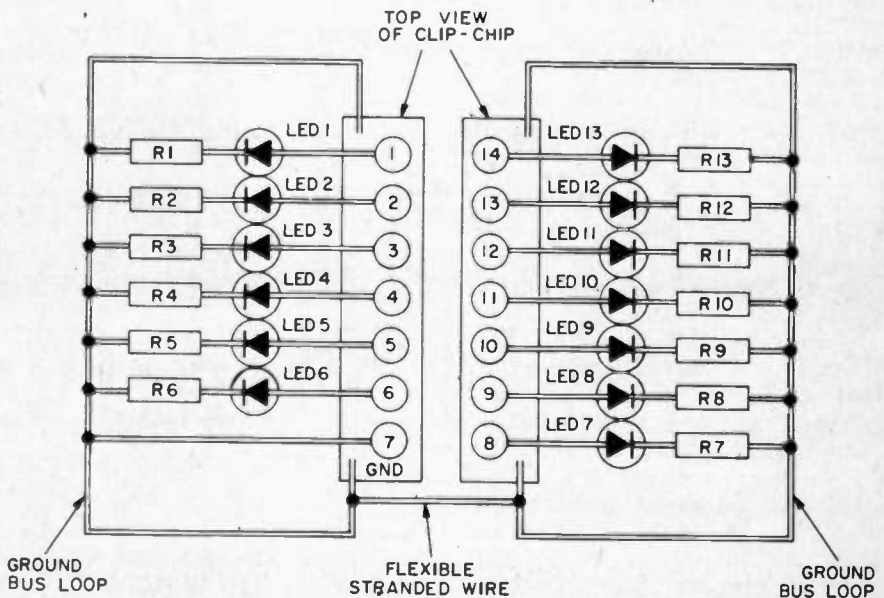
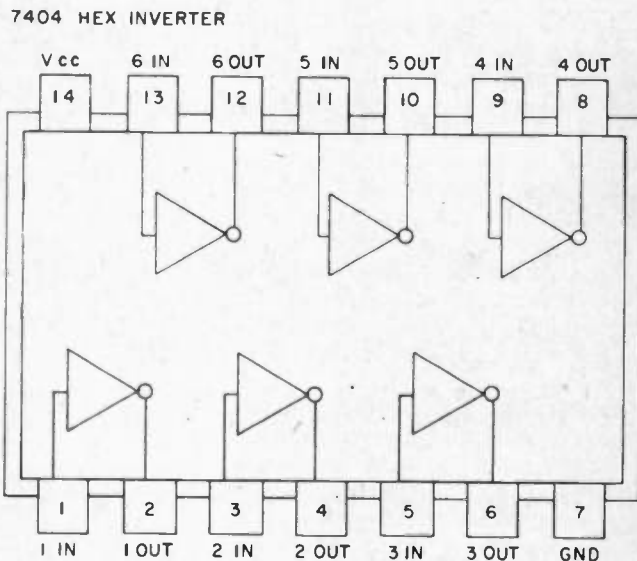

**Composite wiring-component placement drawing for 14 pin Chip-Clip.** The LEDs are shown connected to the test clip's metering pins. They are attached to the current limiting resistors which are in turn all fastened to the ground bus loops. The ground bus loops must be firmly anchored to the test clip. Flexible wire connects both loops electrically making them into a common ground wire loop which is wired to pin 7.

**E**VER HAD THE ANNOYING experience of having the car in front of yours on the highway begin to kick up dirty water on your windshield, and when you went for the washer button, nothing happened? Well, chin up, bunkie, the Washer Watcher is just for you. It not only warns you when the tank is empty, it warns you when you're nearing refill time, *before* it's too late. This handy device can also be an engine saver for those of you who have water-injected turbocharger setups on your car.

The heart of the unit is National Semiconductor's LM1830 fluid detector, which responds to the conductivity of fluids across its probe leads.

**How It Works.** The LM1830 generates an AC oscillator signal (in order to prevent electrolytic coating of the probes, thereby reducing their efficiency) which is coupled to the probes by a 0.05- $\mu$ F capacitor. When the conductive fluid in the tank reaches a low enough level, the resistance between the probes rises past the 13,000-ohm reference level (set internally within the IC), and the oscillator signal is coupled to the amplifier segment of the IC. The amplified 6,000 Hz signal is then fed to an LED which indicates the low fluid condition.

**Construction.** The circuit can be assembled quickly and easily on solderless breadboard stock. We used Continental Specialties Corp.'s Experimenter 350. Component layout is not critical, but you can use the layout shown in the photograph if you're not feeling terribly creative.

The probe assembly in our model was made by drilling three holes in a triangular pattern in a large rubber stopper. After doing this, insert the metal probes (we used knitting needles). Measure the diameter of the narrow end of the stopper, and then cut a hole in the top of the fluid reservoir just slightly larger than the stopper's narrowest diameter, thus allowing a snug fit. Solder a wire to each probe, and connect them to the appropriate pins on the IC. Do not cement the probes into position on the stopper yet, because you still have to calibrate.

**Calibration and Operation.** The longest probe, which connects to a ground anywhere in the engine compartment that's handy, should be pushed down through the stopper so that it's just touching the bottom of the reservoir.

The "refill" probe may be inserted to any length, depending upon how much margin you wish to have between the first and last warnings.

Remember, water varies from area to area, and the type of solvent you use in

by Martin Weinstein  
WB8LBV

#### PARTS LIST FOR WASHER WATCHER

- C1, C3—0.001- $\mu$ F ceramic disc capacitor
- C2, C4—0.05- $\mu$ F ceramic capacitor
- IC1, IC2—LM1830 National Semiconductor
- LED1, LED2—light emitting diode
- R1, R3—680-ohm, 1/2-watt resistor
- R2, R4—270-ohm, 1/2-watt resistor

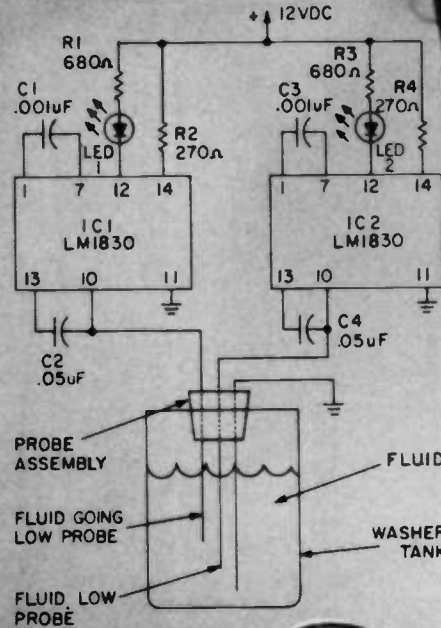

# WINDSHIELD WASHER WATCHER

You'll never get caught high and dry again

your washer reservoir, and the resulting mixture, can affect the calibration. Before you cement the probes and stopper in place, check the operation of the unit by referencing the warning lights with visual observations. Try to keep the solvent/water mixture the same each time you refill, in order to keep the unit calibrated.

When you're satisfied with the unit's calibration, cement the probes into the stopper, both on the top and bottom, and then cement the stopper into the hole in the reservoir. Silicon bathtub sealer should do the job very nicely. The next time you take a trip, let the Washer Watcher take some of the grief out of driving for you. ■

# CB Power Mate for Maxi-Output

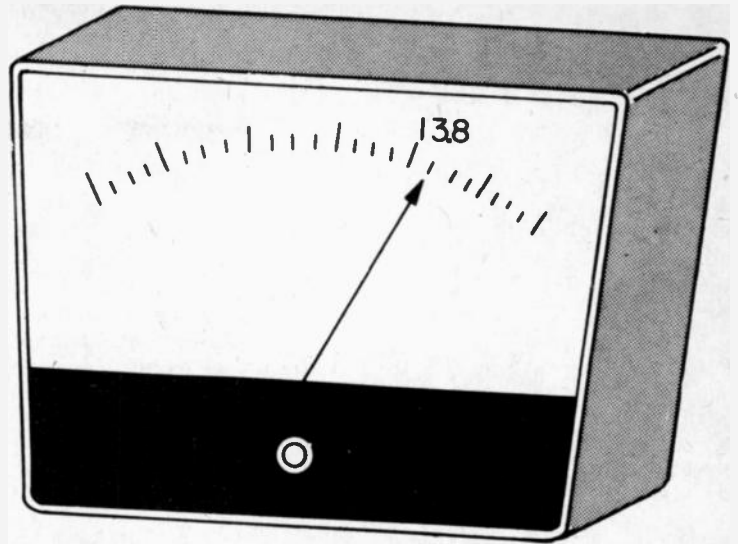

Here's the partner to power your mobile CB rig at home to its maximum capability—four watts RF output.

By Herb Friedman, W2ZLF

**S**O YOU'VE JUST upgraded your Citizen's Band setup with a shiny new transceiver specified to give you four watts out—the legal maximum—or perhaps, if you've converted to the more efficient SSB (single sideband) operation, as many progressive CBers are doing these days, 12 watts, P.E.P. You've paid a couple of hundred dollars for this new equipment and are going to use it at home as your base station—even though it could be operated mobile, in your car, from its 12-volt system.

You hook it up to the 12-volt DC power supply you used at home with your old, lower-powered rig and it

seems to work fairly well. You contact a few nearby CBers easily enough. But it doesn't seem to be getting out much farther than your earlier transceiver, which has considerably lower power output. What's wrong? Where did the power go?

You're probably not feeding the new set the 13.8 volts it was designed to get from the electrical system of your car when the generator is running, charging the battery, as well as powering the rest of the electrical system in addition to accessories like a mobile transceiver.

The 117-volt AC to 12-volt DC power supply you used with the earlier transceiver may have supplied it with

current at 12 volts, but it can't provide the 13.8 volts, at higher current, which your new set needs to put its rated power on the air.

To be sure, check the actual power supply voltage you're feeding to the CB set.

**What Voltage?** To check the actual output of your old power supply, get out your voltmeter and measure the voltage being fed to your transceiver. It probably reads around 12 volts (maybe a bit more when the transceiver isn't turned on). You turn the CB set on to *Receive* and get a good solid 12 volts (or maybe as high as 13). So far so good. Now switch the set to *Transmit*.

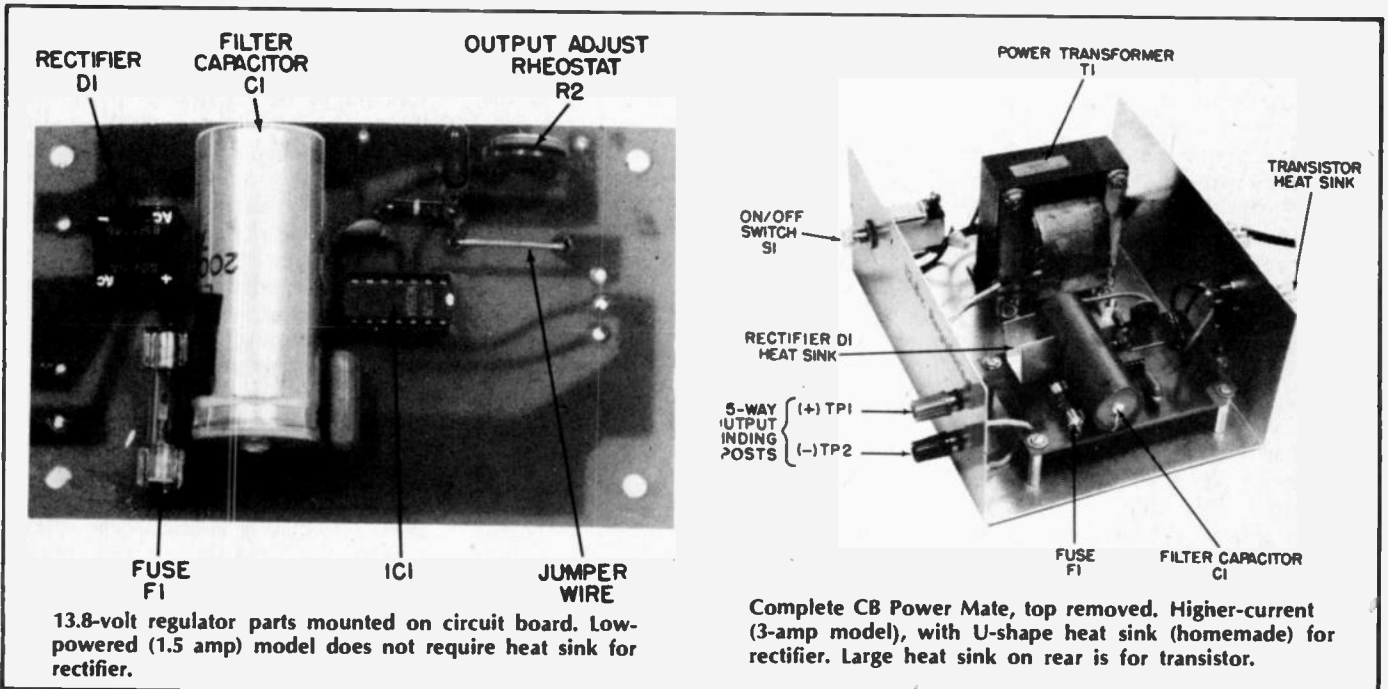

13.8-volt regulator parts mounted on circuit board. Low-powered (1.5 amp) model does not require heat sink for rectifier.

Complete CB Power Mate, top removed. Higher-current (3-amp model), with U-shape heat sink (homemade) for rectifier. Large heat sink on rear is for transistor.

# Power Mate

The input power voltage drops to around 10 volts! Turn it off.

That power supply might have been OK with a lower-powered unit, but it just doesn't make it with this higher-powered job. The four watts of transmitting output you paid for when you bought this new rig is only 2.5 to 3 watts now. This is because your power supply hasn't got the output voltage

The difference between 12.0 and 13.8 volts amounts to 15% less transmitter power. If the supply puts out only 10 or 11 volts when it's under a heavier-than-usual load the loss can be as high as 25 percent. It could be a lot less. If that power supply's output regulation is so poor that it puts out only eight or nine volts with your new CB transceiver the transmitter might not work at all.

To insure maximum performance from your mobile transceiver when powering it with AC house current, you must use a 13.8 volt regulated power

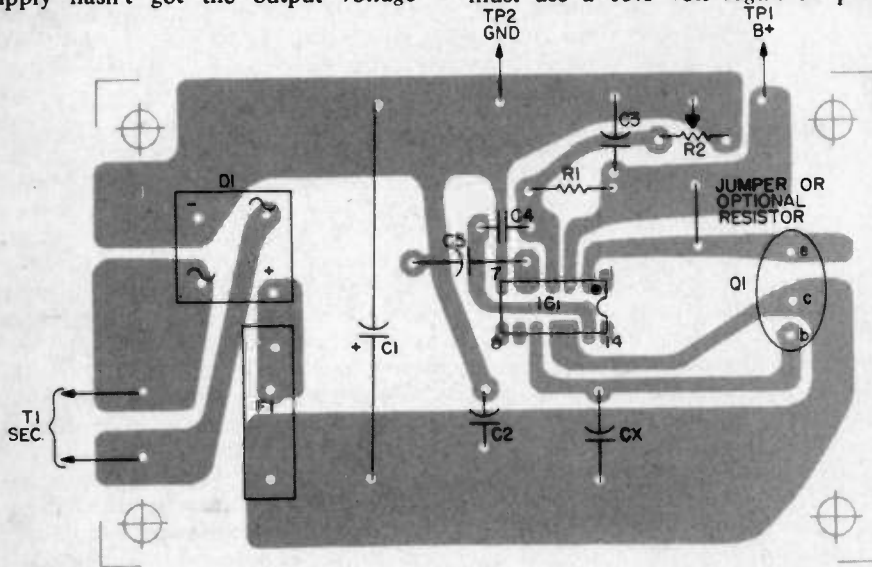

You can make it easily from kit purchased at electronic parts stores. Positions of parts shown actually are located on back side of board. See full size template in story. Copper foil side of board is shown down.

regulation it needs—the ability to put out constant voltage, within its specified limits, regardless of variations in the required current. In addition, your mobile transceiver was designed to work from a DC power supply of 13.8 volts; when the car is running that's what it gets, to charge the battery. (Ever notice how the lights are dimmer when you run them without the motor turning over? That's the difference between 13.8 and 12 volts (or even less, if your battery is on low charge or about to conk out with a weak cell).

**It's Only 1.8 Volts.** "So what's 1.8 volts?" some people may ask. "Most electronic components are manufactured to a tolerance of 10%, and we see that most schematics have their voltages specified  $\pm 20\%$ ."

Won't most equipment and circuits operate over a wide range of voltages from their power supplies? Yes, they will often operate, in many cases quite well, but not power output circuits. They just won't deliver the specified output. Equipment which draws substantial current can only produce its rated output when it gets power at the voltage specified by the design engineers.

supply. Regulation provides exactly 13.8 volts under a wide variety of loads—from full load to no load—and also compensates for AC line voltage fluctuations if they occur.

Although a regulated supply can cost from \$50 to \$100, you can build the *CB Power Mate*, as shown in the photographs for about \$20 to \$25 (or even less if you're good at scrounging parts

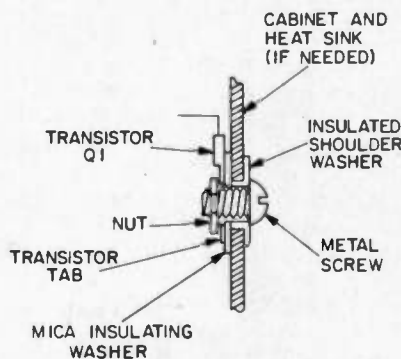

How to mount transistor to dissipate heat into metal cabinet (and external heat sink, in 3-amp model). Use silicone grease on both sides of insulating mica washer. Tape over screw head (outside case) to protect against external short.

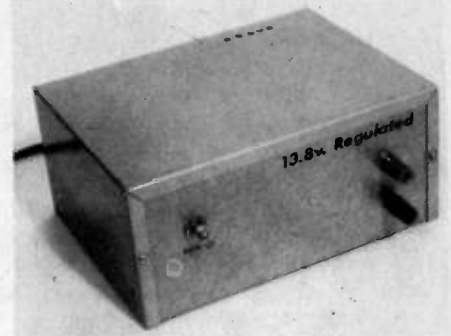

Front view of CB Power Mate shows On/Off switch, red (+) and black (-) power output binding posts. Rear view of higher-powered version has finned heat sink to dissipate heat from regulating transistor. Quarter-inch holes on top of unit are for ventilation.

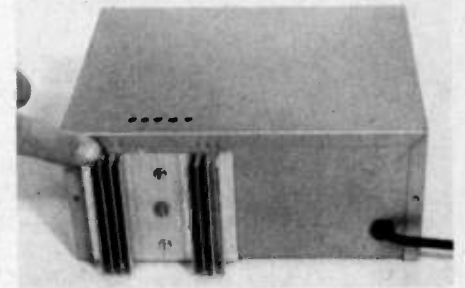

or have a junkbox of used components). The same supply can be used as an AC-to-DC power source for high power walkie-talkies (one-watt or more output) which require exactly 12 volts, because this supply can be adjusted at the flick of a finger to any mobile power voltage—even six volts. Your regulated supply can be built to handle any current needed, up to three amperes. The current capacity is determined by the output of the power transformer, T1, and filter capacitor C1, the two most costly items in this project. Thus you can save money by building only the current capacity you actually need.

**How It Works.** The first section of the CB Power Mate (the 117-volt step-down transformer T1, the rectifier, and the large capacitor, C1) supplies *unregulated* current at between 15 and 35 volts, depending on the number of turns in the secondary of T1. The rest of the supply is the regulator section. The size of the voltage drop across the regulator depends on the resistance of transistor Q1, which varies according to its base bias. The bias is controlled by the action of the IC, which gets its commands from the voltage applied to pin 4. This voltage is taken from the junction of R1 (1800 ohms) and R2 (500-ohm rheostat), which are a voltage divider across the power supply output. Initially R2 is set to provide the desired volt-

age—13.8 or whatever—at the emitter of Q1 (the supply output).

When the load (the transmitter) starts to draw more current, the voltage at the power supply output begins to drop. This lowers the voltage at IC pin 4. The IC then applies a higher (more positive) voltage to the base of Q1 (IC pin 10). Since the transistor is an NPN, the positive-going base signal lowers Q1's collector-emitter resistance, increasing the collector current and raising the voltage at the emitter (power supply output). When a change in load draws less current, tending to raise the supply voltage, this increase is sensed by the voltage divider, which now applies a lower (more negative; less positive) voltage to IC pin 4. This in-

creases Q1's collector resistance, lowering the voltage at the supply output.

This all takes place almost instantly, so the output voltage remains steady, at the value at which it was originally set. This happens even though the transmitter current (the load) is changing all the time.

**Two Versions Can Be Built.** The schematic diagram shows the supply for loads up to three amperes at 13.8 volts. For lighter loads, up to 1.5 amperes (still 13.8 volts) capacitor Cx is not needed, and the power transformer can be a lighter, less expensive one. In addition, capacitor C1 can be rated at 25 VDC, instead of the 35 or more required for the higher-powered version. Also, the smaller power supply doesn't

need heat sinks for the bridge rectifier and the series transistor (also called a "pass transistor") because all the current used by the transceiver passes through it.

**Check the Voltage.** First you should find out what the power requirement of your transceiver is when you are transmitting. It will usually be one amp or more (*receiving* will take much less current). It may be as high as 2.5 amps. Once you know how much current your transceiver needs, you'll know whether to build the model which supplies up to 1.5 amps or the three-amp one. Now take the parts list and check your junk box for parts you can use.

**Construction.** The heart of the CB Power Mate is the regulator, which consists of integrated circuit IC1, series regulating transistor Q1 (which is controlled by IC1), and their associated resistors and capacitors. C1 is the main filter capacitor, which initially smooths the varying DC supplied by the bridge rectifier from the AC output of the power transformer secondary.

The printed circuit board, which you can easily make with a kit from any parts distributor, has been designed to work in either the 3-amp model or the 1.5-amp unit. The photograph, showing the board with its components mounted, is of the lower-powered one. The completed supply pictured is the higher-powered unit. You can see that the assembled boards for both versions are almost identical. One difference is that the 3-amp supply (completed unit) has a piece of U-shaped aluminum you can bend to make the heat sink for the bridge rectifier. This is not needed for the lower-current supply. The photograph of the completed unit also shows the fins of the large heat sink for the transistor mounted on the back of the box behind the transistor. This heat sink isn't needed in the 1.5-amp power supply.

Fuse F1 is a fast-acting type which protects the bridge rectifier and the power transformer from blowing out if you should make a wiring error or short-circuit the output. The fuse listed will blow out before the components, so don't use any other kind of fuse, even if it has the correct current rating (three or five amps). Use only type AGX, not slow-blo or 3 AG. Try to get a fuse-holding clip made for soldering to the printed circuit board. That kind is easier to install than those which mount with screws.

Solder the pins of the 14-pin IC socket to the board, but don't insert the IC into its socket until the socket has cooled off. Heat can ruin an IC or a tran-

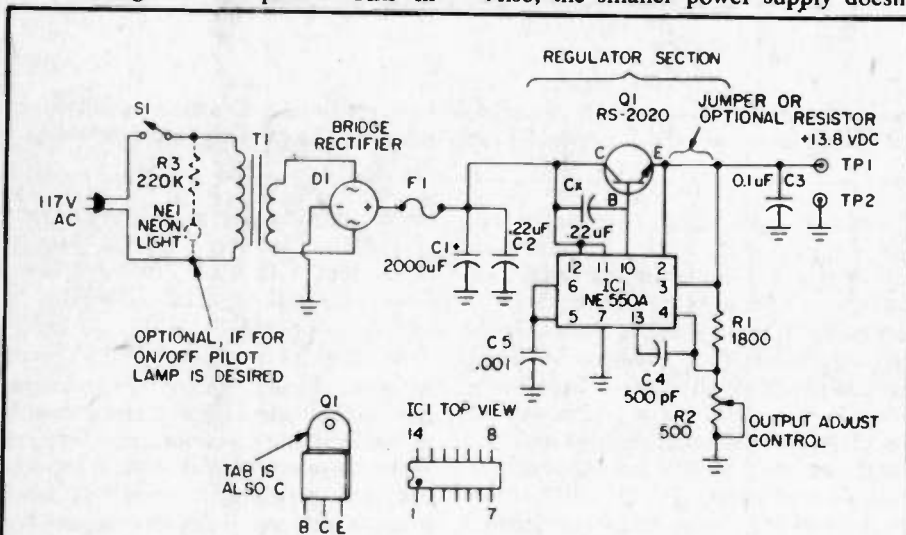

Ultra-simple circuit delivers regulated output.

#### PARTS LIST FOR CB POWER MATE (3-AMPERE MODEL)

- C1—2000-uf, 35-VDC electrolytic capacitor
- C2—0.22-uf, 100-VDC capacitor
- C3—0.1-uf, 100-VDC capacitor
- C4—500-pF, 100-VDC capacitor
- C5—.001-uf, 100 VDC capacitor
- D1—Bridge rectifier diode package, 6-amp rating, 100 PIV (peak inverse volts)
- F1—Fast-acting fuse, 5-A rating
- IC1—Voltage regulator integrated circuit, NE550 (DIP package, Hamilton Avnet, 364 Brookes Drive, Hazlewood, MO 63042. NE550 or equiv.)
- Q1—NPN silicon transistor (Radio Shack RS-2020 or equiv.)
- R1—1800-ohm, ½-watt resistor
- R2—1000-ohm printed circuit (end mounting) potentiometer
- S1—SPST power switch, 120 VAC. If self-illuminating switch with built-in neon light is desired, use Radio Shack 275-671 or equiv.)
- T1—Power transformer, 117-120 VAC primary, no center tap needed. Secondary 18 to 21 VAC at three amperes (Allied Radio 705-0133 or equiv.)

TP1, TP2—Binding posts, 5-way, one red, one black

Misc.—Printed circuit board materials, or perf board; fuse clip for mounting on PC board; heat sink for transistor Q1; heat sink compound (Radio Shack silicone grease 276-1372 or equiv.); IC socket for integrated circuit IC1 (Radio Shack RS276-027 or equiv.); scrap aluminum piece approx. 1-in. x 3-in. x ¼-in. thick; standoffs (aluminum) four, ½-in. for mounting pc. board (Radio Shack 270-1394 or equiv.) with machine screws, nuts, and lock-washers.

#### PARTS LIST FOR CB POWER MATE (1.5-AMPERE MODEL)

Use all same parts as above, except for the following changes:

- C1—Same, or use 25-VDC rating, which costs less
  - C2—Cx is not needed
  - F1—As above, except 3-ampere rating
  - T1—As above, except 12.6 to 16 VAC, at 1.5 amperes (Allied Radio 705-0121, or equiv.)
- Heat sink for transistor not needed  
Scrap aluminum for heat sink not needed

# Power Mate

sistor. Also be sure to hold each transistor lead with a pair of long-nose pliers as a heat sink when you solder to the transistor leads.

For the high-current CB Power Mate the bridge rectifier has a hole in the center to which you can secure the homemade heat sink. To make this, take a piece of scrap aluminum the width of the sink or larger and bend it in a U-shape with the ends sticking up in the air about an inch. Secure the sink to the rectifier with a #6 screw, a lockwasher between the screw and the rectifier, and a lockwasher and a nut on top of the heat sink. (The screw feeds in from the terminal or lead side of the rectifier.)

Also, for the high-current Power Mate the transistor uses the special heat sink with fins on the back of the cabinet (as shown in the picture). Q1 is installed the same way for both models. Drill a 1/4-in. hole through the sink and the cabinet. Bend Q1's leads outward, away from its mounting tab. Using a mica insulator from a power rectifier (preferably) or a power transistor mounting kit, coat both sides of the mica with silicone heat sink grease. Position the insulator over the hole in the cabinet and place an insulated shoulder washer (from a 5-way binding post) in the cabinet hole, from outside the cabinet. Pass a #6 screw through the sink, the cabinet, and the mica insulator.

Then install Q1, a lockwasher, and a nut. Tighten the screw slightly more than hand tight. Check with an ohmmeter to be sure there's no short between the tab of Q1 and the cabinet. You should read infinity—no connection. If you have a short (one ohm or less) look for an improperly-seated shoulder washer or for a metal chip from the drilling.

**Final Assembly.** Before final assembly, with the parts *not* mounted in the box, drill a row of five 1/4-in. holes in the cabinet directly over Q1, and five more holes in the lower left of the cabinet, near the transformer. These will provide adequate ventilation. Then put a small piece of tape over the head of the screw which secures the transistor, to prevent a (possible) external short.

Complete all wiring before installing the IC. Plug it into its socket so that pin 1, which has a dot molded next to it, faces the edge of the printed circuit board farthest away from the rectifier. Pin 1 should be toward the wires going to the board from the transistor. Install the fuse in its clips, set the rheostat,

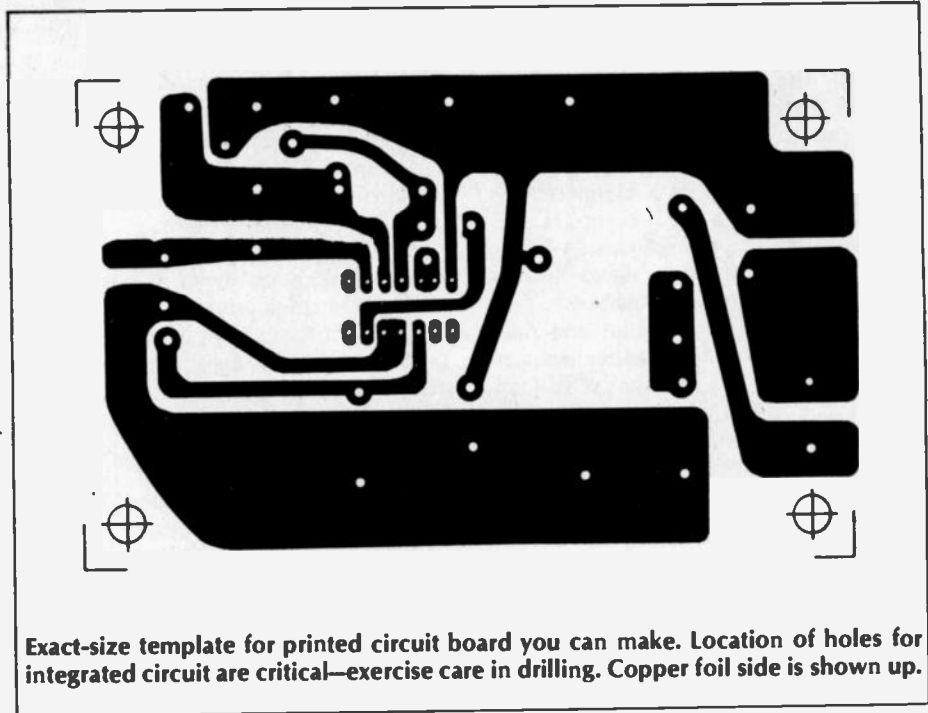

Exact-size template for printed circuit board you can make. Location of holes for integrated circuit are critical—exercise care in drilling. Copper foil side is shown up.

R2, to its mid-position, and connect the voltmeter to the output of the power supply (the binding posts). Plug in the CB Power Mate's AC cord and observe the meter. It should rise to some value and stay there. If it wanders, or rises and falls back down to zero, disconnect the AC power and check for a wiring error. If the voltmeter remains steady, adjust R2 very slowly for the desired voltage, 13.8 volts (or 12, or whatever depending on the set you are going to power with it). That's it—your CB Power Mate is ready to use.

**Optional Protection.** If you want to build-in the *maximum current limiting* (to make sure the supply will turn off if a short suddenly appears outside it), you can substitute a resistor for the jumper on top of the board. To figure the value of the resistor, follow these steps:

1. Find the value in ohms of the resistor, which we will call "R." The formula is:  $R = \frac{0.6}{X}$  where "X" is the current the transceiver draws when transmitting.

2. If the current is 2 amps, then the formula gives us:  $R = \frac{0.6}{2} = 0.3$

3. Now we must find the power rating of the resistor. Power is  $W = I^2R$ , where I is the current. Since we know that R is 0.3 ohms, and that the current is 2 amps, we get:  $W = 2 \times 2 \times 0.3$  or  $W = 4 \times 0.3 = 1.2$  watts. For safety we double the rating, giving us 2.4 watts.

4. So, we need a 0.3 ohm, 2.4 watts

(or more, since that exact wattage isn't available). The nearest larger wattage rating should be used. Two 0.6 ohm, 2-watt resistors in parallel would do nicely.

**In Use.** Now plug your CB Power Mate in, connect the positive and negative leads of the 13.8-volt power supply to the Plus and Ground connections on your transceiver, and start contacting your fellow CBers . . . with the maximum legal power which you paid for with your new set. Why not get it?

Of course the CB Power Mate is only needed in your home. In your car the transceiver will be getting the 13.8 volts it needs, if that electrical system is operating correctly.

**Caution:** Don't try to use the CB Power Mate at settings higher than 13.8 volts with a transceiver which requires that voltage. Trying to increase a transmitter's RF power output that way will probably result in blowing out components in the transceiver, because many transceivers are designed to just accept 13.8 volts, with not much safety factor above that. Be sure the Power Mate is set for exactly 13.8 volts before you turn on the transceiver, not any higher.

If you're not certain that your voltmeter is reading DC volts accurately, you can calibrate it very closely by using several new flashlight cells (not nicads—just ordinary, good condition—tested in flashlight—batteries). These cells, in good condition, put out exactly 1.56 volts each. Four cells in series should read 6.24 volts.  $8 \times 1.56 V = 12.48 V$ . Or you can get 13.94 V from nine cells. ■



# SIGNAL CHASER

Save on repair dollars with this pennywise project.

by Martin Weinstein  
WB8LBV

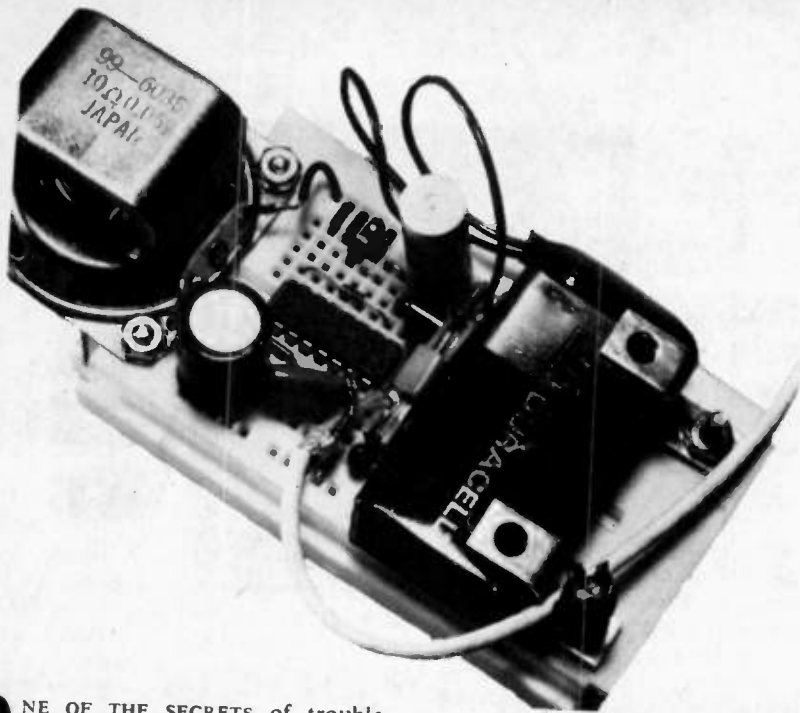

**O**NE OF THE SECRETS of troubleshooting is to start at those circuit areas where there is no trouble, then to back your way through the circuit until you've reached the point where it isn't working. The same trick can work frontwards, letting you trace a signal through a circuit until you reach the point where it disappears.

Here's a handy aid for troubleshooting in the frontwards fashion, a signal tracer with a great deal of input sensitivity called Signal Chaser.

**Built-in Demodulator.** An ordinary amplifier could help you find signals in the AF (audio frequency) range, but the Signal Chaser can do more. D1, a 1N914 diode, acts as a demodulator, much like the diode in a simple crystal-set-style radio, to demodulate AM (amplitude modulated), RF and IF signals directly to audio (or whatever the carrier is modulated with). On FM and PM (frequency modulated and phase modulated) signals, the diode acts as a slope detector, giving a suitable, if low-fidelity, audio output.

**High Impedance Input.** The one feature of this circuit that really makes it shine when compared to most signal tracers is its high impedance input. The input impedance of the Signal Chaser is close to 10-Megohms. This is due to the use of a JFET (Junction Field Effect Transistor) for Q1. Q1, a Siliconix 2N5458 or similar P-channel JFET, is configured as a high-to-low impedance converter with an input impedance determined mostly by the value of R2, 10-Megohms. Capacitor C1 blocks DC but passes AF, RF and IF signals. Resistor R1 limits the input current to Q1.

A high input impedance means that for a given signal voltage, very little

current is drawn by the Signal Chaser. This means that under almost all conditions, the Signal Chaser cannot load down the circuit you are troubleshooting.

**Speaker Size Output.** The output of Q1 alone would be enough to drive a high impedance earphone, but keeping one in your ear while busy probing a suspect circuit can be, to say the least, inconvenient.

Instead, the output of Q1 (after demodulation) is coupled to the input of IC1, an LM380N audio amplifier. IC1 provides enough drive to power even

low-impedance speakers, around 8-ohms, to a good, healthy volume.

Capacitor C5 provides DC decoupling between the speaker and the output of IC1.

**Breadboard-Easy Construction.** The entire circuit can be built up on a small solderless breadboard like the one shown (a Continental Specialties Corporation "Experimenter Socket," model EXP350, about \$5.50) almost in less time than it takes to tell about it.

I've used three tricks here I would especially like to share. For one, I used a pair of zig-zag mounting brack-

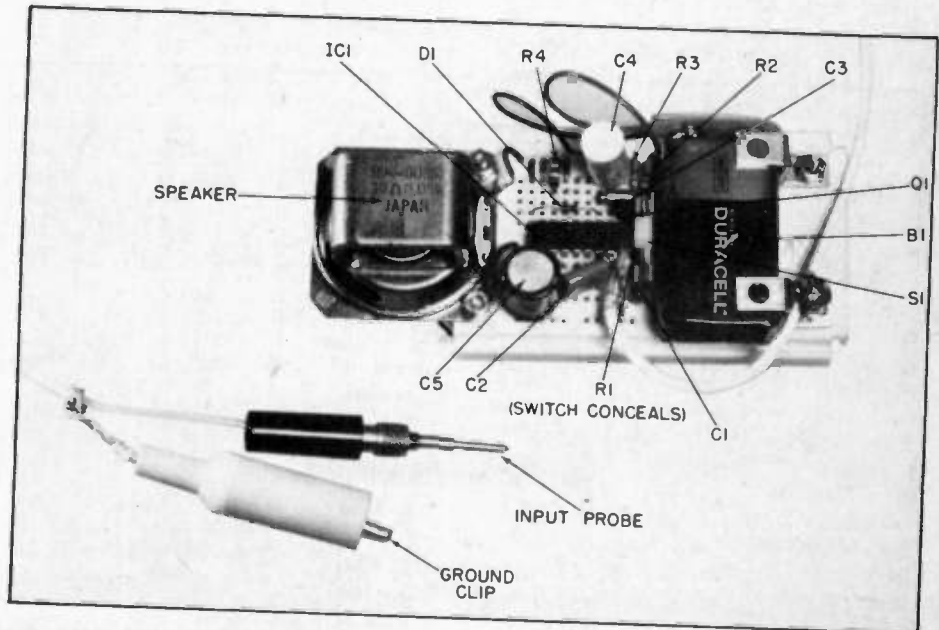

Our Signal Chaser was built using a solderless breadboard and, as you can see, it made for a neat component arrangement. If you follow this photo, be certain you don't forget about R1, which connects to the Gate of Q1 and to C1—it's really there, it's just hard to make out in the picture! Signal Chaser should go together quite quickly, so if you start it after lunch you should be chasing your first signals before the dinner bell.

# CHASER

ets (from the local Radio Shack) as battery hold-down clips. The mounting holes in the CSC EXP350 helped make this especially easy. At the far side of the breadboard, the mounting holes there happened to match exactly the holes on a small speaker I had on hand, and I was quick to take advantage of it. My third trick was to solder stiff wire (resistor leads I cut off some of the resistors in the circuit) to the breadboard end of the shielded probe cable. You may also want to use "headers," available from several sources and many parts stores for under a dollar a strip.

The rest of the assembly is fairly straightforward. Follow the lead of my layout, as shown in the photograph, when you lay out your own Signal Chaser—whether on solderless breadboard, a PC board or whatever method you use.

**Understanding Solderless Breadboards.** In case you haven't tried solderless breadboards before, you may not know how easy they are to work with. The holes in the face of the breadboard are arranged on .1" centers (1/10th of an inch apart), which happens to be the lead spacing on standard DIP (dual inline package) integrated circuits and most other modern components.

The center channel (.3" wide) is just right for IC's to straddle. On each side

Signal Chaser has a high impedance input that is close to 10-Megohms. It will draw very little current and so will not usually load down the circuit under test.

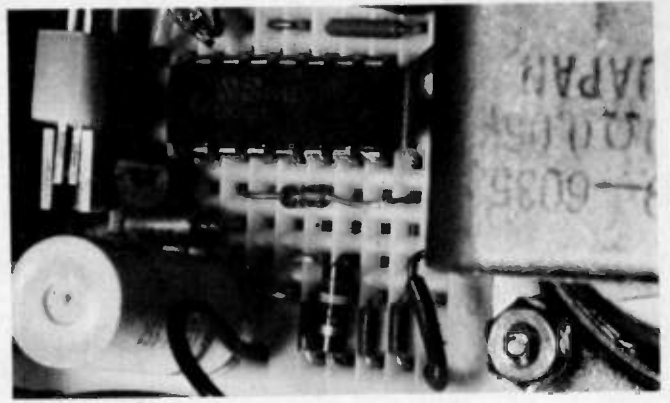

of the center channel are groups of five holes (columns, if you view the breadboard as widest on the horizontal, with the center channel running left to right). Behind each group of five holes is a spring clip with slits between the hole positions to allow a lead inserted into any one hole to be grasped firmly and independently, and interconnected with anything grasped at any other position in the group.

Each five-position terminal can be interconnected with any other by simply using hookup-wire jumpers.

The separate rows (at the top and bottom) are connected across their entire lengths and can be used for power or signal busses. I use them to carry the battery plus and minus lines.

**Using the Signal Chaser.** For most run-of-the-mill signal tracing, clip the probe cable shield to a circuit ground near the area you're testing and touch the probe to each side of the signal

path near each active or passive device in the signal path. Start at the front end and work your way to the output, if you like—but skipping a few stages on the chance they'll work can also help you localize a problem.

The high impedance of the Signal Chaser input means high sensitivity, which lends it to some useful applications.

You can attach a coil of wire or a magnetic tape head to the input to inductively probe circuits and devices. You can "listen" to the magnetic stripe on the back of your credit cards, amplify a telephone conversation or pick off the signal on your transmitter's modulation transformer.

Or attach a photocell to the input and listen to the sounds of light bulbs, LED readouts, the sun, street lights and then some.

Signal Chaser—not only a good introduction to solderless breadboarding, but once it's built you may find it to be one of the handiest gadgets in your electronic bag of tricks-of-the-trade. Have fun and chase those signals—and those problems—down!

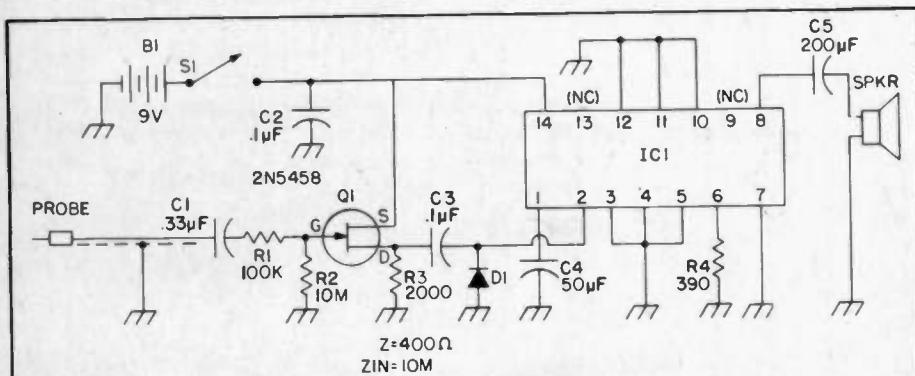

## PARTS LIST FOR SIGNAL CHASER

B1—9-VDC battery  
 C1—.33-uF capacitor  
 C2—.1-uF capacitor  
 C3—.1-uF capacitor  
 C4—50-uF capacitor  
 C5—200-uF capacitor  
 D1—1N914 diode  
 IC1—LM380N audio amplifier  
 Q1—2N5458 JFET (Junction Field Effect Transistor)

R1—100,000-ohm resistor, 1/4-watt  
 R2—10-Megohm resistor, 1/4-watt  
 R3—2000-ohm resistor, 1/4-watt  
 R4—390-ohm resistor, 1/4-watt  
 S1—SPST switch  
 SPKR—8-10-ohm speaker  
 MISC—Breadboard (Continental Specialties model EXP350 or similar) or other method such as PC board; probe; insulated clip; battery holder/clip; wire; etc.

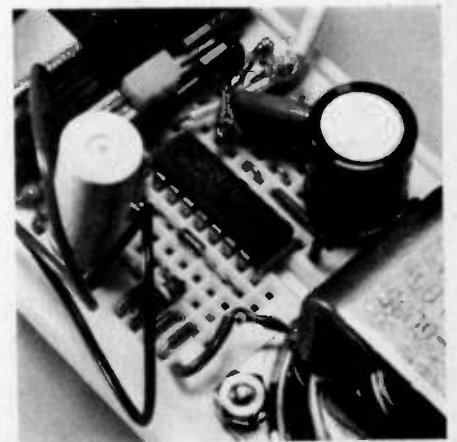

Solderless breadboard materials is arranged with the holes about 1/10 inch apart. As you can see, this just fits the spacing of the IC's leads and of most modern components.

# STOP STATIC

Some low-cost cures for some expensive sounding sounds

**P**ROJECT-BUILDING is supposed to be, and generally is, a challenging and entertaining adventure. Yet, there are times when it can turn out to be a miserable disappointment, all because of a pesky little gremlin known as electronic noise. To the electronic engineer, noise is a catch-all term that refers to any signal appearing someplace where it does not belong. Even if you have constructed just a few projects, chances are that you have been introduced to noise, whether you realized it or not. While noise cannot be eradicated completely, it can be effectively minimized once you understand its origins. In most instances, the key to a noise-free project lies in good construction practice, so let's examine some of the techniques used by skilled project builders.

When dealing with electrical interference, it is helpful to define two classes of devices: noise sources and noise receivers. Noise originates at some source and appears in another electronic circuit, the receiver. Almost anything can be a noise source. Some of the more common ones are automobile alternators, arcing motors, the ever-present 60-Hz power line, high-voltage or high-current electronic circuits, and digital logic. Similarly, almost any electronic circuit can be a receiver, although high-gain, low-level, high-impedance stages are often the most susceptible. While the source and receiver may belong to two different pieces of equipment, they may just as well be different stages of a single piece of equipment.

**Coupling.** In order to transfer energy from the source to the receiver, some form of coupling must exist. The two important modes of coupling consist of an electromagnetic field or a common ground impedance between the two circuits in question. Consideration of an electromagnetic field is usually broken down into two subclasses:

electric-field coupling and magnetic-field coupling. A high-voltage, low-current circuit radiates energy chiefly through an electric field, whereas high-current, low-voltage circuitry radiates predominantly through a magnetic field. Most noise sources radiate through both fields, but it is easier to deal with one field at a time.

Let's begin with electric-field coupling, also known as capacitive coupling. In Figure 1 we have voltage source  $V_1$ , with internal impedance  $R_{G1}$ , driving a load,  $R_L$ . This voltage generator might be anything—a transistor, op-amp, logic gate, or even an alternator; the exact nature of the source is unimportant. Nearby, we have a second voltage generator,  $V_2$ , with an internal impedance of  $R_{G2}$ . An amplifier, with input impedance equal to  $R_{IN}$ , is supposed to amplify  $V_2$ . However, electric-field coupling between the two circuits exists through stray capacitance  $C$ . Now,  $C$ 's capacitance will be very small. As an example, consider that the capacitance between two closely spaced

#22 wires amounts to less than 40-pF per foot of wire. Despite the small magnitude of capacitance  $C$ , however, it can result in the appearance of a noise voltage,  $V_N$ , across the amp's input impedance. We are in trouble if  $V_N$  is a significant fraction of  $V_2$ 's magnitude, and the situation is hopeless if  $V_N$  equals or exceeds  $V_2$ .

To see what determines the size of noise voltage  $V_N$ , note that current from generator  $V_1$  can flow in a complete loop: first through  $R_{G1}$ , then through  $C$ , and finally through  $R_{G2}$  and  $R_{IN}$  back to source  $V_1$ . Since  $R_{G2}$  is effectively in parallel with  $R_{IN}$ , and since  $V_N$  is developed across this parallel resistance combination, we are interested in the equivalent parallel resistance, which we abbreviate as  $R_{G2}/R_{IN}$ . Basically, what we have here is a voltage divider— $R_{G1}$ ,  $C$ , and  $R_{G2}/R_{IN}$ —across  $V_1$ . The noise voltage caused by  $V_1$  will be increased by the following factors: 1) an increase in the magnitude of  $V_1$ ; 2) an increase in the frequency of  $V_1$ , since  $C$ 's impedance

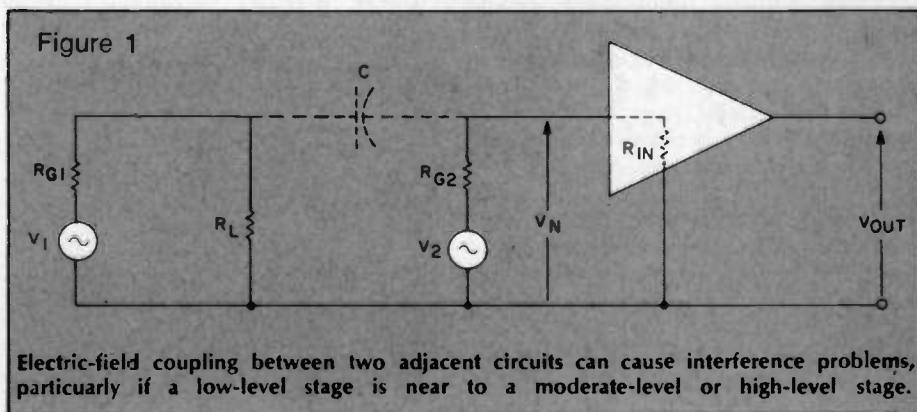

# STOP STATIC

drops at higher frequencies; 3) a decrease in source-to-receiver distance, because this increases  $C$ ; and 4) an increase in the equivalent parallel resistance,  $R_{G2}/R_{IN}$ .

**Voltage and Frequency.** It is apparent that high-voltage, high-frequency circuits are the most troublesome noise sources, as far as the electric field is concerned. Digital logic is one of the most common examples of this type of circuitry. Signal swings are large—between five and fifteen volts usually. Furthermore, even though the repetition rate of the pulses or square waves involved may be low, these signals still have a high harmonic content. For example, pulses with a 5-nano-second rise-time have significant harmonic energy right up to 30 MHz, even if the repetition rate is much less than that.

At the receiving end, the most noise-susceptible circuits will have high impedances and operate at low levels (that is, with small  $V_2$ ). This latter factor, low levels, is very often accompanied by high gain. Common examples of such noise-sensitive circuits are: high-gain FET preamps, low-level analog comparators, and op-amps with large feedback resistors.

Assuming that you cannot change the design of the source and receiver circuits, the only practical method of reducing noise from an electric field is to minimize the coupling capacitance. Separation of the two stages helps; at least an inch or two should intervene between the circuits. Separation beyond this distance will reduce pickup still more, but the noise level does not drop as quickly as it does over the first inch or so.

**Shielding.** More effective than separation is the use of metallic shield when pickup is severe. In Figure 2, the two possible methods for shielding are diagrammed. Figure 2A shows a conductive metal shield, grounded to source common, that completely encloses source  $V_1$ . Electric-field coupling between source  $V_1$  and the shield is symbolized by capacitor  $C_1$ . Outside the shield, another stray capacitance,  $C_2$ , exists between the shield and the equivalent parallel resistance,  $R_{G2}/R_{IN}$ . (The rest of the amplifier has been deleted because, so far as we are concerned here, its only important characteristic is  $R_{IN}$ .) An electric field exists within the shielded enclosure; however, the field outside the shield is zero every-

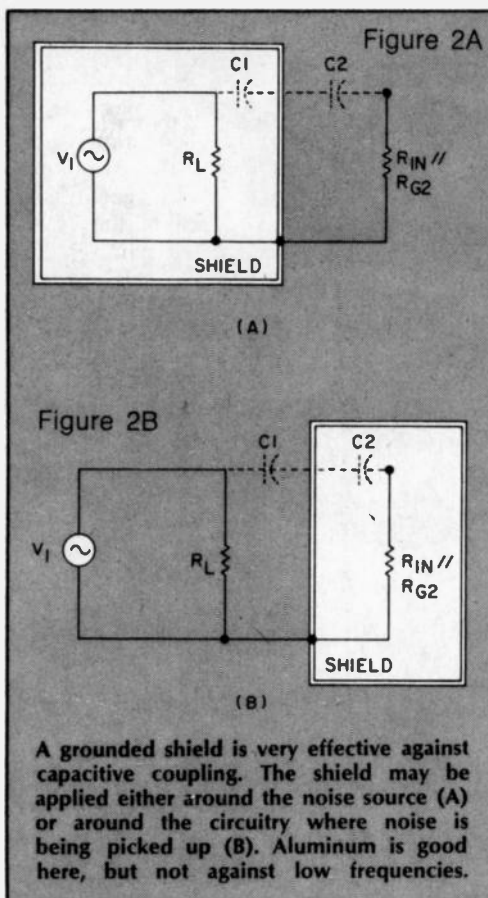

A grounded shield is very effective against capacitive coupling. The shield may be applied either around the noise source (A) or around the circuitry where noise is being picked up (B). Aluminum is good here, but not against low frequencies.

where. This comes about because, at least ideally, the entire surface of the shield remains at ground potential. Since the external field is zero, no energy is transferred across stray capacitance  $C_2$ .

In part B of Figure 2, the grounded metallic shield envelops the receiver. Energy transfer occurs between source  $V_1$  and the grounded shield via  $C_1$ . The field within the shield is zero since the shield is at ground potential. As a result, no noise is picked up by the receiver.

Any metallic sheet makes a good electric shield. Aluminum, a common cabinet material, is excellent at all frequencies. A shield may be placed

between two stages of a single piece of equipment. On the other hand, a grounded metallic cabinet constitutes a shield between a particular piece of equipment and all noise sources in the outside world. The only precaution necessary when shielding is that the shield must be in electrical contact with the circuit's ground. Note that this does not necessarily mean an earth ground, such as a pipe in the soil. Connection to circuit common is all that is ever required.

At this point, you are probably wondering what happens if the source and receiver circuits do not share a common ground connection. We can treat this coupling by means of two stray capacitances, as shown in Figure 3. You should be able to see for yourself that the previously discussed shielding methods still apply. A shield around either circuit, connected to that circuit's ground potential, is all that is required.

Before leaving the electric-field case, let's note that wires may also need shielding if they connect to possible receivers or sources. When wires exit a particular piece of equipment, they may be protected by shielded cable. Likewise, shielded cable may be used within a single piece of equipment when interstage noise coupling is a problem. Often, however, you can obtain the benefits of a partial shield by simply routing wires close to the grounded chassis. The electric field near the chassis/shield is minimal, so any pickup by wires is likely to be small. As a final precaution, keep wiring to low-level circuitry separated from high-level wiring.

**Inductance.** Now, let's turn to the magnetic field and Figure 4. The most important aspect of this is that there are two current loops, a source loop and a receiver loop. In the source loop, generator  $V_1$  drives a current  $I_1$  through load  $R_L$ . The current flow is, in turn, responsible for a magnetic field that exists in the vicinity of the source

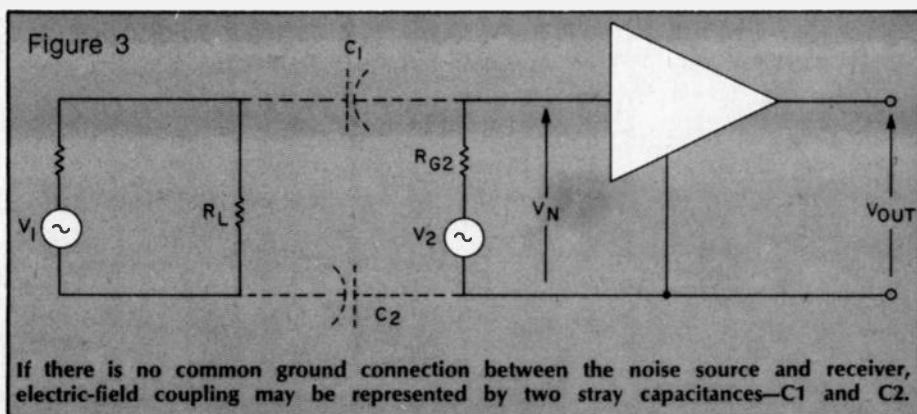

If there is no common ground connection between the noise source and receiver, electric-field coupling may be represented by two stray capacitances— $C_1$  and  $C_2$ .

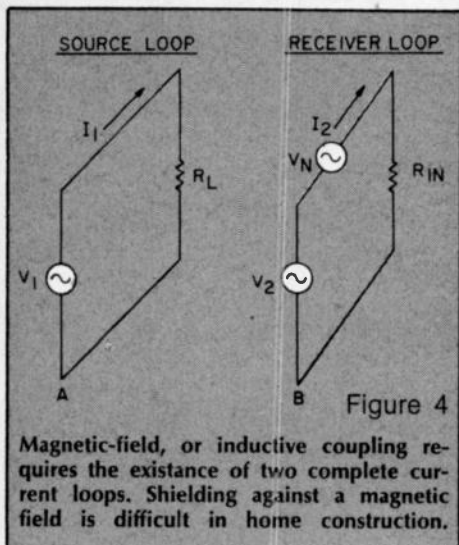

loop.

The receiver loop consists of generator  $V_2$  driving a stage with input impedance  $R_{IN}$ . (Note that no internal resistances are indicated for the voltage generators since such impedances have a negligible effect here.) In addition, a noise voltage,  $V_N$ , which is due to source  $V_1$ , appears in series with  $V_2$ . If  $V_N$  is not negligible compared with  $V_2$ , then we must find ways of minimizing the noise pickup.

What we have in Figure 4 is a simple transformer, which suggests why magnetic coupling is also known as inductive coupling. Alternating current  $I_1$  generates a changing magnetic field that induces a voltage in any loop it intersects. As Figure 4 shows, the two current loops may be completely isolated. However, points A and B could be connected with no change in the induced noise voltage. Therefore, as was the case with the electric field, we must consider coupling between stages of the same device, or between stages of two separate devices.

Let's examine the factors that cause increased noise coupling: 1) an increase in the magnitude of  $I_1$ ; 2) a decrease in the separation of the two loops; 3) an increase in the frequency of  $I_1$ ; 4) orienting the loops so that their planes are parallel; and 5) an increase in the area of the receiver loop. From the above, several methods of noise reduction are suggested. First, separate the two loops; in particular, keep high-current stages away from low-level stages. Second, minimize receiver loop area. This applies especially to the wiring associated with a receiver stage. All wires to a jack, a switch, or a potentiometer should be twisted together, thus minimizing pickup loop area. Third, try to minimize the source loop's magnetic field. This is

most conveniently done by using twisted wired again. To see why this is effective, imagine taking the source loop, stretching it, then twisting the wires together. The currents in the twisted pair flow in opposite directions, and because twisting keeps the two wires in close proximity, the magnetic field of one wire cancels that of the other. Even better than twisted pair, especially at high frequencies, is coaxial cable; for most hobbyist requirements, however, a twisted pair is sufficient to reduce magnetic radiation. Finally, changing the orientation of the source with respect to the receiver often helps. Consider, for example, the magnetic radiation from a power transformer. You may carefully twist the leads, but you cannot do anything about the magnetic flux from the transformer coils. Usually, however, some mounting orientation of the transformer will result in minimized pickup in your noise-sensitive stage.

Comparing magnetic coupling with electric coupling, one thing you may have noticed is that the impedance of the receiver has no effect on its susceptibility to inductive coupling. Also, you may have wondered whether a shield would be as effective against a magnetic field as it is against an electric field. The answer is no. Aluminum, which is so effective as an electric shield, begins to be effective against magnetic fields only at higher frequencies (above 100 kHz). At the important frequency of 60 Hz, aluminum is use-

shielding.

**Wiring Problems.** So far we've dealt with stray pickup from a more or less familiar viewpoint—familiar at least in the sense that whenever noise problems occur, the first thing to be blamed is some mysterious, invisible field. Very often, however, the trouble is the handiwork of a more mundane villain: your circuit's electrical wiring.

Figure 5 shows a serial power distribution system, the most common way of delivering power to the various stages of a piece of equipment. Two power leads run from the supply to one stage, and then from there to the next stage, and so on. Such a scheme is simple and generally practical, except when you have the situation shown in Figure 5. Here we have a low-level source,  $V_s$ , driving a high-gain amp stage, with resistor  $R$  and inductor  $L$  representing the resistance and inductance of the interconnecting ground lead. Current  $I_1$  from the high-current stage and current  $I_2$  from the switching stage both flow through the power bus—in particular, through  $R$  and  $L$ . Since the amp responds to the potential difference between its input and ground leads, any voltage developed across  $R$  and  $L$  due to  $I_1$  and  $I_2$  appears in series with  $V_s$ , and this noise voltage  $V_N$  gets amplified right along with  $V_s$ .

Now, let's suppose  $R$  and  $L$  represent a piece of #22 wire. One foot of #22 has a resistance of 16.14 milliohms, and if  $I_1$  is a direct current of about 61 milliamps, then  $V_N$  equals

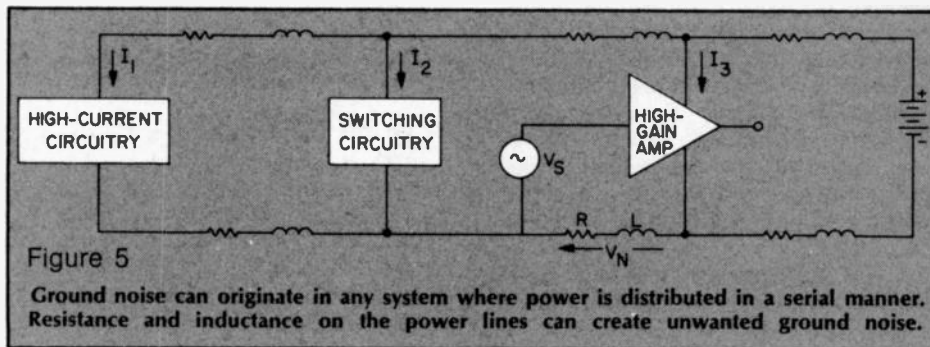

less. In order to obtain better magnetic shielding, your shield must be a ferromagnetic substance, such as steel. Because it is harder to machine than aluminum, steel is rarely used by hobbyists, even though its magnetic-shielding properties are superior to those of aluminum. At 60 Hz, however, even steel is only partially effective (shielding effectiveness increases with frequency). Special magnetic alloys, such as mu-metal, are necessary at low frequencies. All things considered, magnetic shielding is more difficult than electric

1 millivolt. This is small, but certainly significant if  $V_s$  is also on the order of millivolts. At high frequencies, the impedance of inductance  $L$  increases to become the dominant factor, and this gives us even more trouble. For example, a foot of #22 wire has a 4-ohm impedance at 1 MHz, and a whopping 40 ohms at 10 MHz. Needless to say, high-current and high-frequency stages (and this includes our old friend, digital logic) can wreak havoc on low-level circuits.

(Continued on page 114)



Lure hard-to-get DX like grandad used to do with this hot receiver

# Spider Web Receiver

**I**N THE OLD DAYS OF RADIO, back when grandpa was building his first one tube radio, the spiderweb coil was the "cat's pajamas." This type of tuning coil was very popular with the home-constructors, and with good reason; the spiderweb coil is a high Q type, wound with interleaved turns for minimum residual capacity. Many of the old timers made long distance reception commonplace with this type of tuning coil in their radios.

The spiderweb coil is a type of coil in which the wire is wound on a flat form so that the radius of successive turns increases from the center outward. You can experiment with this type of coil by building our receiver model which combines the old spiderweb coil with present day solid state circuitry. The receiver covers from 550 kHz to 14 MHz, with three plug-in spiderweb coils in a FET regenerative-detector circuit. A stage of audio is included with a pnp transistor directly coupled for good headphone volume.

**The Spiderweb Coil Receiver Circuit.** Signals from the antenna are coupled through J1 and C1 to L1 and the tuning capacitor C3. The bandsread capacitor C2 is used to fine-tune crowded SW bands and the resultant signals are fed via C4 to the gate-leak R2 and the gate of FET Q1. The RF signals are detected and amplified by Q1 and a portion of the RF is fed back into L1 from the source circuit of Q1. This feedback RF is detected and further

amplified by Q1. The regen control R1 varies the amount of RF feed-back to L1.

The detected audio signals in the drain circuit of Q1 are coupled through T1 to the AF Gain control R5 and to the audio amplifier circuit of Q2. The amplified signals are direct-coupled via the collector circuit of the pnp transistor Q2 through J4 to external high

impedance phones. DC power for the circuits is supplied by an external 6 volt battery. Bias current for the Q2 base circuit is supplied by the R6-R7 divider circuit, and R8-C7 acts as the interstage decoupling network to minimize audio feedback between the stages via the DC power bus.

Three plug in coils are used for L1, each one covering a different band of

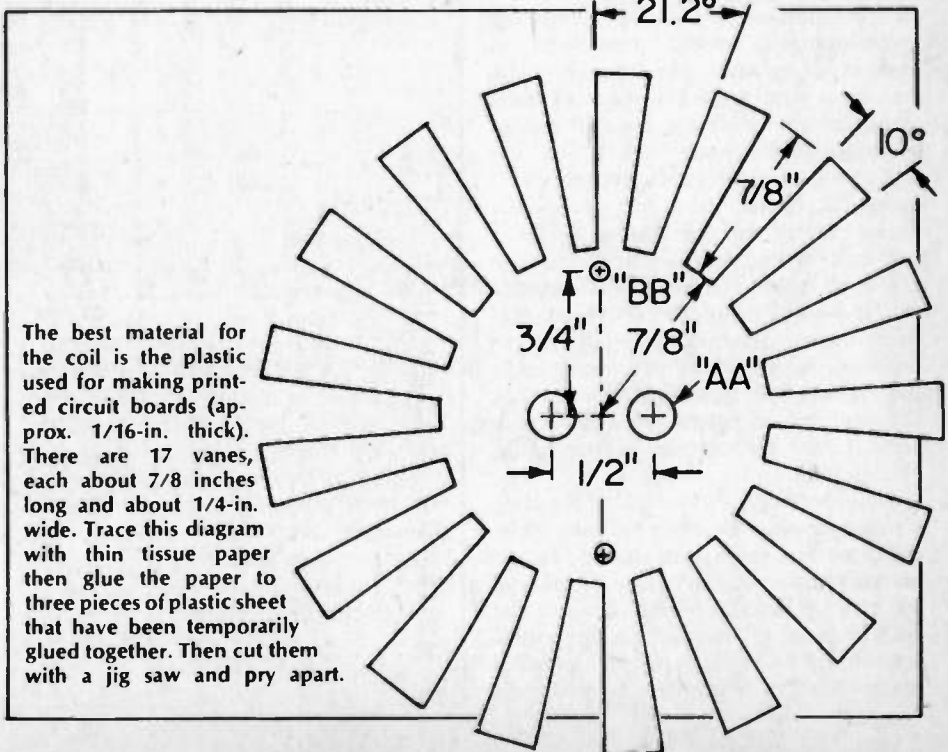

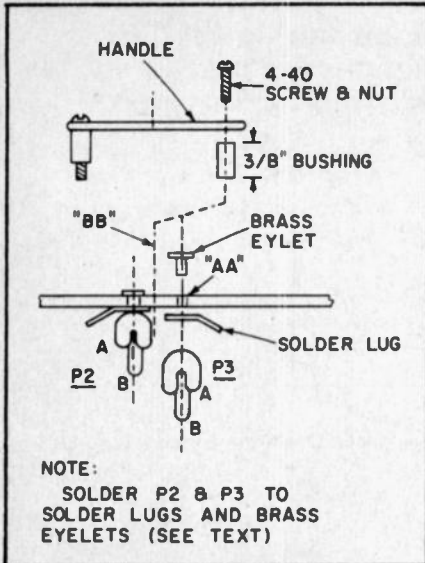

Solder the phono plugs to each spiderweb by using small brass eyelets as rivets. A handle will simplify plugging-in.

frequencies. L1 A tunes from 7 MHz to 14 MHz, L1 B tunes from 1.7 MHz to 5 MHz, and L1 C tunes from .55 MHz to 1.6 MHz.

**Spiderweb Coil Construction.** Look at the drawing of the spiderweb coil form. There are seventeen "vanes," 7/8-inch long and approximately 1/4-inch wide, positioned around the perimeter of a 1 1/2-inch disc. A good quality plastic should be used for the coil form; the coil forms shown in the receiver model photo are made from the type of plastic sheet used for printed circuit boards (approx. 1/16-inch thick).

The easiest way to start construction of the coil forms, is to trace the outline of the spiderweb coil form drawing and temporarily cement the tracing onto a sheet of plastic. Then cut out the coil form with a hack saw. If desired, three sheets of plastic can be temporarily cemented together with rubber cement and the coil forms for all three bands can be cut out at the same time. After cutting out the forms, carefully pry apart the spiderweb coils.

Brass eyelets (available at notions counters in department stores) are soldered to lugs and P2-P3 as shown in the drawing. Carefully drill holes to fit the eyelets, positioned 1/2-inch apart, for each of the three spiderweb coil forms, and mount the phono plugs (P2-P3).

Refer to the Spiderweb Coil Winding Table and wind the coils with the turns indicated for each band. Start winding on the inside of each coil form and wind to the outside of the form. Allow enough wire at each end of the coil to solder to P3A-B as shown in the schematic. After winding the coil make the

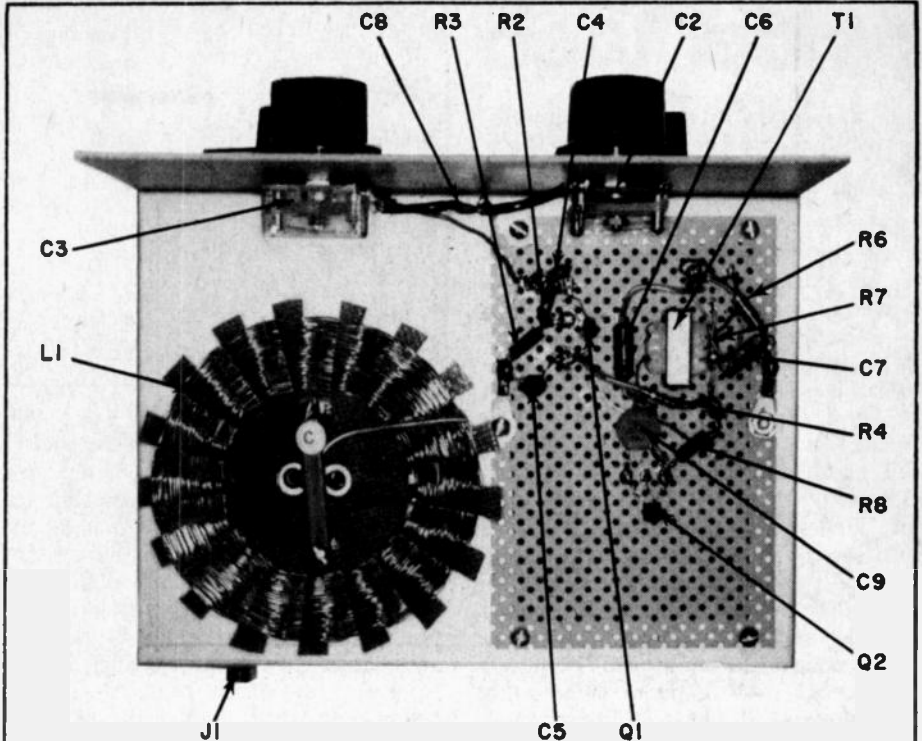

This layout shows how best to locate the spiderweb coil to leave room for the perf-board. Note capacitor C8 which is used to help achieve the desired bandwidth.

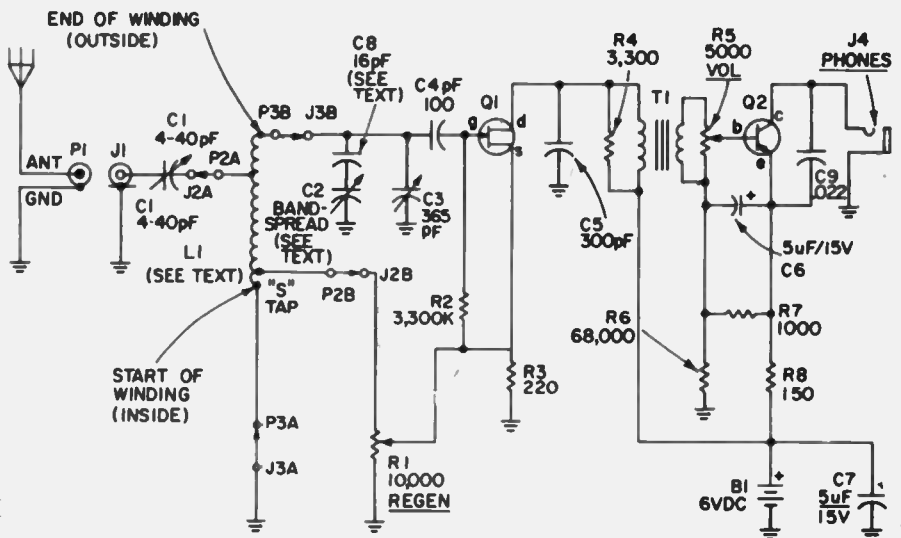

#### PARTS LIST FOR SPIDERWEB RECEIVER

- C1—4 to 40 pF midget mica trimmer (ARCO 422 or equiv.)
- C2—Bandspread capacitor (modified C3, see text)
- C3—365 pF subminiature variable capacitor (Radio Shack 272-1341)
- C4—100 pF capacitor
- C5—300 pF capacitor
- C6, C7—5uF/15 VDC Miniature electrolytic capacitor
- C8—16 pF capacitor (see text)
- C9—.022 uF capacitor
- J1, J2, J3—Phone jacks
- J4—Phone jack
- L1—See Coil Table and text
- P1, P2, P3—Phono plugs (see text)
- Q1—FET (NPN), Motorola HEP-F0015, or equiv.)

- Q2—Transistor (PNP), Motorola HEP-57 or HEP-S0019 (or equiv.)
  - R1—10,000-ohm linear taper potentiometer
  - R2—3,300,000-ohm resistor, 1/4-watt
  - R3—220-ohm resistor, 1/4-watt
  - R4—3,300-ohm resistor, 1/4-watt
  - R5—5,000-ohm audio tape potentiometer
  - R6—68,000-ohm resistor, 1/4-watt
  - R7—10,000-ohm resistor, 1/4-watt
  - R8—150-ohm resistor, 1/4-watt
  - T1—Audio transformer; PRI: 10,000-ohms, SEC: 2,000-ohm (Calectro D1-722 or equiv.)
- Misc: 5 by 7 by 2-in. aluminum chassis, 5 by 7-in. copper clad board (for front panel), sheet plastic for L1 form (see text), knobs. 3 by 4 1/2-in. perf board, two lug solder strip (to mount C1) 6 brass eyelets.

# Spider Web

taps as indicated in the table; carefully scrape the enamel off the wire for a good soldered connection to the tap leads to P2A-B.

**Receiver Construction.** Most of the receiver components are mounted on a 3- by 4½-inch perf board section installed on a cut-out portion of a 5-by-7-by 2-inch aluminum chassis. As shown in the photos, the perf board is installed on one half of the top of the chassis to leave enough room for the plug-in spiderweb coils. The tuning capacitor C3 and the bandspread capacitor C2 are mounted on a 5- by 7-inch section of copper-clad printed circuit board used as the front panel. A similar section of sheet aluminum would also be suitable for the front panel. The panel is held by the mounting nuts of the regen control R1, audio gain (volume) control R5, and the phone jack J4 that are mounted in holes drilled through the front of the chassis and the lower half of the panel.

Begin construction of the receiver by cutting the perf board section to size and then temporarily positioning it upon the top of the chassis. Lightly draw the outline of the board on the top of the chassis, then remove the board and layout the chassis cut-out within the board outline. The cut-out section on the model shown is approximately 2½ by 4-inches. Drill holes near the inside corners of the cut-out section and use the holes to start a hack saw or jewelers saw. After the chassis section is cut-out, drill six mounting holes for the perf board edges. Install the perf board on the chassis with small machine screws and nuts.

Locate and install the board components with perf board clips. Do not install Q1 at this time to minimize any possible damage to the FET; solder Q1 into the circuit when all of the other components have been connected. Temporarily place an alligator clip across the source and gate leads (shorting them together) while soldering the FET in place. Cut the leads of all of the components to allow short, direct connections and to prevent any of the leads from accidentally coming in contact. Make sure that you remove the alligator clip from the FET after soldering. For best results follow the component layout of the model shown in the photo. T1 is mounted by drilling holes in the perf board to fit the mounting tabs and then bending them over for a snug fit under the board. Position the three ground lugs on three of the board

SPIDERWEB COIL WINDING TABLE				
	WIRE SIZE	TOTAL TURNS	ANT TAP (P2A)	"S" TAP (P2B)
BAND A 7 MHz to 14 MHz	#18 Enam.	4	½-Turn from end	1-turn from start
BAND B 1.7 MHz to 5 MHz	#24 Enam.	17	1½-turns from end	2-turns from start
BAND C .55 MHz to 1.6 MHz.	#28 Enam.	52	10-turns from end	1-turn from start

mounting screws, as shown in the photo.

Cut holes in the center of the remaining portion of the chassis top to fit J2 and J3. Space the two jacks to fit the plugs P2 and P3 mounted on the plug-in spiderweb coils. A dual jack was used on the model shown in the photo. But, it may be easier to use separate jacks for easier spacing in the front and rear of the chassis to fit the components to be installed; R1, R5 and J4 on the front and J1, C1 and the rubber grommet for the DC power leads on the rear chassis. C1 is mounted on a two lug terminal strip with a small access hole drilled in the chassis to allow adjustment.

**Bandspread Capacitor Construction.** The bandspread capacitor C2 is a modified tuning capacitor that originally had a 365-mmf capacity. The model in the photo utilizes a Radio Shack miniature type with plastic dielectric. In this particular make of capacitor, the stator blades are made from thin sheet metal and are fastened with only one screw and nut. Carefully remove the end nut (after removing the plastic outer cover) and pry out the stator blades one by one with small pliers, until only one blade is left. Replace the nut and tighten it. Check with an ohmmeter to see if the blade is shorted to the rotor blade assembly. If so, remove the nut and readjust the stator blade. The rotor blades should be able to rotate freely as the shaft is turned.

**Front Panel.** Mount the panel on to the front of the chassis by drilling the appropriate holes and securing it with the mounting nuts of the panel controls. After the panel is mounted with the copper clad surface facing outward, locate and drill the holes for C2 and C3. Install the two variable capacitors and then connect them to the circuit board with short leads. C8 is mounted between the stator of C2 and the stator of C3. The exact value of C8 is best determined by experiment after the receiver is operational for the desired bandspread. A good starting value is 16

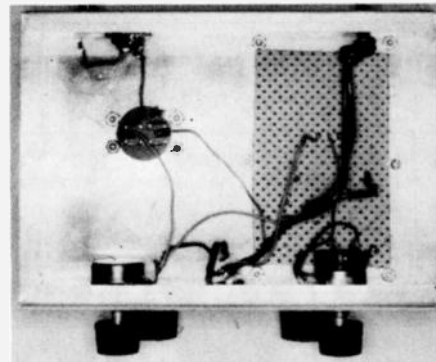

This bottom view of the receiver shows the jacks for the spiderweb and how they are hooked up to the antenna. Note how the perfboard is secured to the chassis.

mmf (as on the model shown in the photo).

**Completing Construction.** Complete the construction of the receiver by wiring the underchassis components. Make sure that the leads to J2 and J3 are as short and direct as possible; position these leads up and away from the chassis bottom. Connect the DC power leads to the circuit and mark them with the proper polarity. Or, a red lead can be used for positive and a black lead for negative polarity. Make a knot in the power leads before putting them through the rubber grommet on the rear of the chassis.

Install knobs on the shafts of the front panel controls. If necessary, cut the shafts of the controls for a uniform appearance. Cement a 1-in. length of Number 18 wire on the rear of the C3 knob. Or, a shaped section of clear plastic with a black line drawn down the center can also be used for a pointer.

**Dial Calibration.** The front panel dials are marked with rub-on lettering positioned on three concentric India-ink lines for the C3 dial, and one inked line for C2. Begin dial calibration by plugging in the "C" Band (Broadcast Band) coil and connecting earphones and a six

(Continued on page 118)



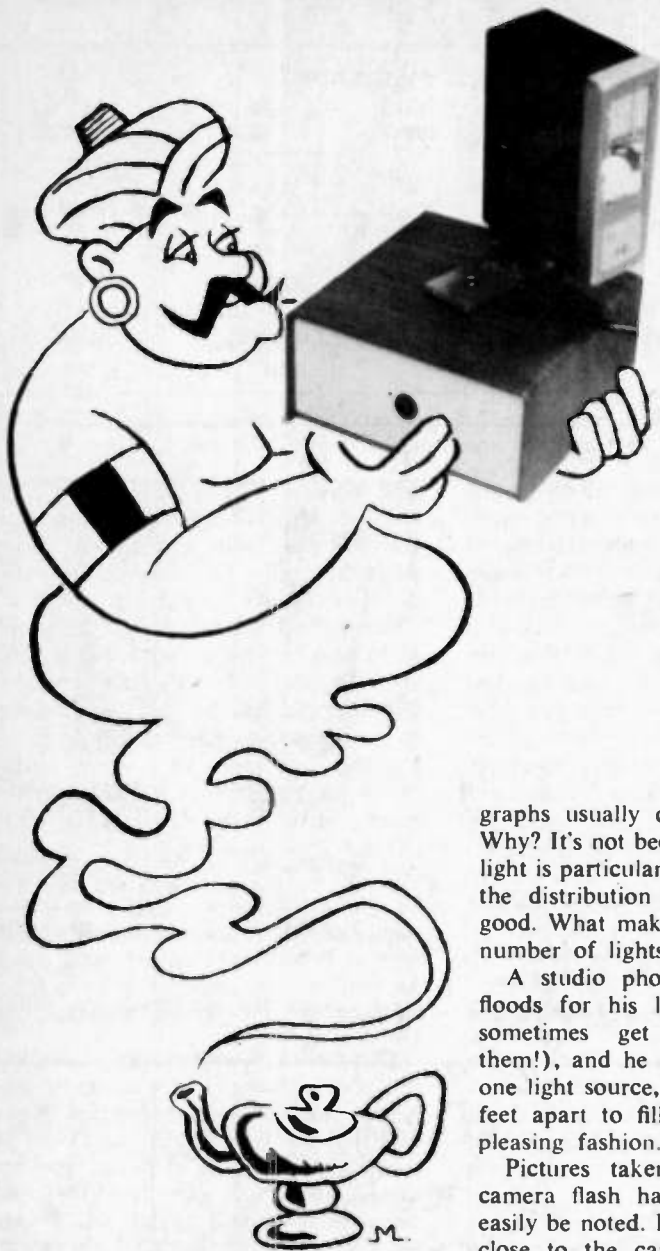

# LET LIGHT/JINN SERVE UP SNAPPIER SNAPSHOTS

This cable-free slave flash uses only two resistors, one LASCR, one choke, and an optional diode bridge.

by C. R. Lewart

graphs usually come out second best. Why? It's not because the quality of the light is particularly inferior, but because the distribution of that light isn't as good. What makes the difference is the number of lights used.

A studio photographer uses photofloods for his lighting (those models sometimes get awfully hot under them!), and he always uses more than one light source, spaced at least several feet apart to fill in the shadows in a pleasing fashion.

Pictures taken with a single, on-camera flash have defects which can easily be noted. If you have subjects up close to the camera they often look washed-out or overexposed, and the shadows are usually harsh and too contrasty, particularly if the subject is near a wall or other large background. Automatic flash units, coming into wider

use now, can control some of these problems partially. But the automatic flash can't fill in the shadows it creates. Using bounce flash (aiming the flash at a white ceiling) provides more even illumination, although most on-camera flash units can't readily be aimed at the ceiling. And with bounce flash you must open the lens diaphragm to compensate for the lower overall light level. This decreases the depth of field, which can be another problem. Furthermore, bounce flash with color film can put the color of the ceiling or wall, if not white, into the subjects' faces. All in all, taking flash pictures with a single flash is something you'll learn to avoid wherever possible.

Adding just one more flash, if it's properly placed, will give you shadowless pictures, with greater depth, more modeling of subject's features, and

**G**REATLY IMPROVE your flash pictures by using the flashgun on your camera to control one or more "slave" flashes by means of our Light/Jinn—a magical genie which has no cables to the master flash, but triggers from the light of the camera flash—at your command. You can use two or more Light/Jinns at the same time, but the greatest improvement in your flash pictures will come with the addition of the first Light/Jinn to your regular on-camera flash. The time delay between the master and slave flashes is on the order of 1 millisecond (1/1000 sec) so that you can take pictures at the shortest exposure times your camera permits.

**Multiple Flash is Better.** If you compare most ordinary flash pictures to other shots taken with photofloods (high intensity incandescent lamps, such as are often used for motion pictures, as well as for professional still pictures) the single flashgun-illuminated photo-

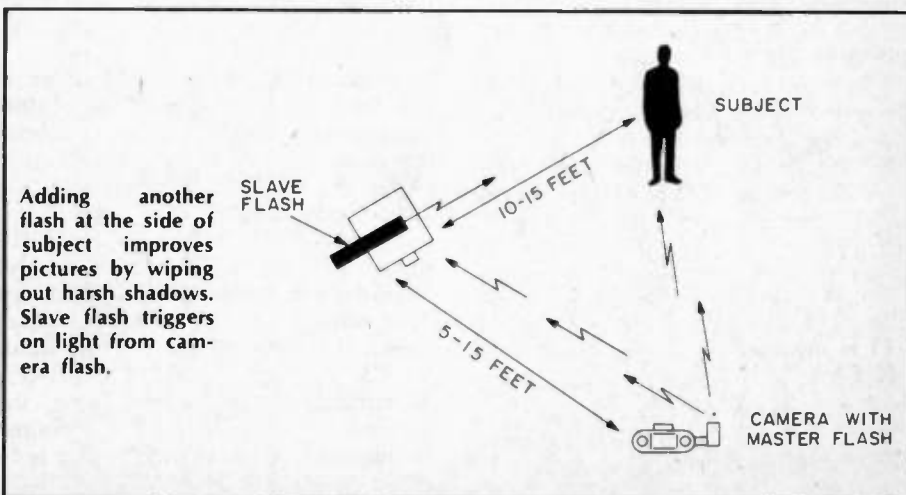

# LIGHT/JINN

clearer details. Or, in other words, your pictures will be a lot closer to studio photographs.

**Better Flash Shots.** To take such pictures you need one more flash unit and some way to support it, and of course some way to make it fire at the same time as the main flash. The first flash unit mounts in the usual way on the camera (or slightly off it, with an extending bar), while the second flash, which now becomes the "main" light (the primary source of illumination), is placed near the subject and interconnected to flash at the same time as the first flash, in synchronism with the shutter opening.

The usual way to synchronize the two flashes with the shutter is to use a long connecting cord—if your camera or first flash has a receptacle for it (most do not).

**Get Rid of Cables.** Long cords can lead to problems. They can come loose at either end or both; they can be tripped over; and their length is either too long for most shots, or not long enough for some. But these problems can all be eliminated if you use a flash connected to the main unit by *light!* That's right. You can use the light from the first flash to set off the second one. It takes less than a millisecond (1/1000 of a second) for the second flash to fire. Since you'll be using a 125th or 250th of a second shutter opening, the camera will think both flashes go off at the same time, and the effect is exactly as though they do.

The project is simple to build and inexpensive—the basic parts cost less than \$5. Light/Jinn requires no power source; it "borrows" its energy from the flashgun it operates. It also is an improvement over many previously-described similar circuits, because Light/Jinn will not be triggered by even a strong beam of ambient light falling on its sensor. Only another flashgun, or direct sunlight can trigger it. In addition this project will familiarize you with one of the most modern optical semiconductor devices, the *Light Activated Silicon-Controlled Rectifier*, or LASCER for short. The unique properties of this device can lead you to other electro-optical projects which also can be built simply and inexpensively.

**What Is An LASCER?** Its tongue-twisting name, Light Activated Silicon Controlled Rectifier, explains its function. It is an SCR (silicon controlled recti-

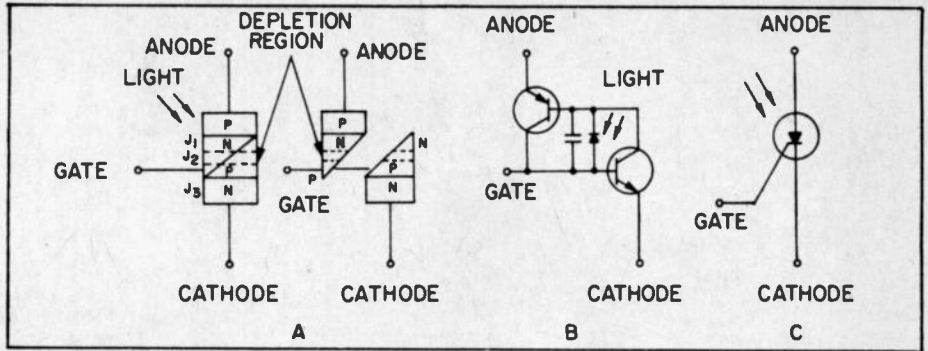

Operation of the LASCER (light-activated silicon-controlled rectifier) is shown above. It's equivalent to combined NPN and PNP transistors, as shown in A and B, above.

fier) operated by light falling on its sensitive area. The LASCER is the brain of our project, the understanding of which, though not essential for successful completion of the project, should nevertheless interest you.

Refer to the three small drawings (above the schematic diagram) marked A, B, and C, for a description of how the LASCER works. With positive voltage applied to the anode, junctions J1 and J3 are forward-biased, and they will conduct if sufficient free charge is present. Junction J2 is reverse-biased however, and it blocks current flow. Light entering the silicon creates free hole-electron pairs in the vicinity of the J2 depletion region which are then swept across J2. As light increases the current in the reverse-biased diode

will increase. The current gains of the NPN- and PNP-equivalent transistors also increase with current. At some point the current gain exceeds unity and the LASCER starts conducting.

**Slave Flash Circuit.** The LASCER is sensitive both to visible and invisible light, and will normally trigger at as low as 200 foot-candles. To limit its response so it responds only to another flash, we put the inductance of a small audio choke L1, and resistor R1 between the gate and cathode terminals of the LASCER. This novel approach prevents the LASCER from being triggered even by strong ambient light. For steady ambient light the inductance of the transformer behaves like a very small resistor and prevents the LASCER from firing by bleeding the charge generated by

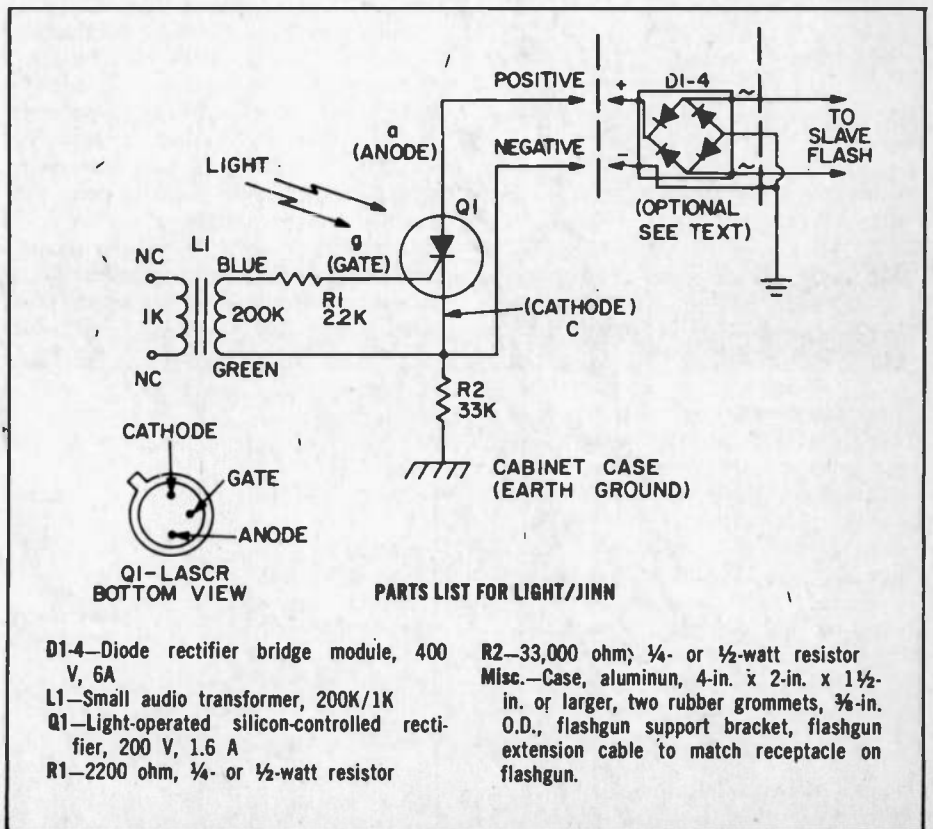

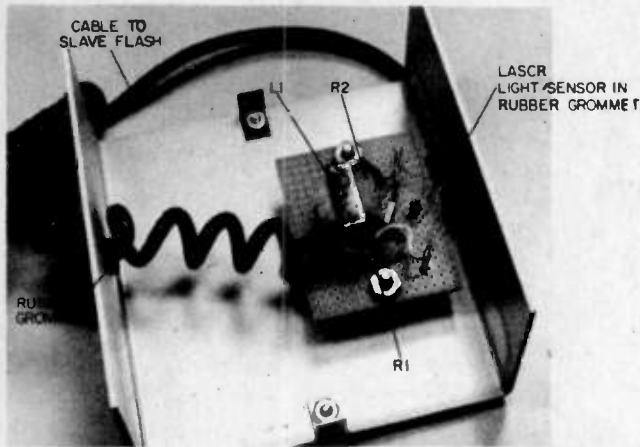

Light/Jinn with cover removed showing all the parts except optional diode bridge rectifier. Top cover has flash mount.

light directly to ground (the cathode). A sudden burst of light coming from an electronic or other flash makes the inductance of the transformer appear as a high resistance which causes the LASCR to conduct, triggering Light/Jinn. Finally, resistor R2 connects the circuit to the cabinet and lowers the

ordinary audio transformer and leaving the secondary unconnected.

**Construction.** Although the actual components of the simple circuit for Light/Jinn take very little space we selected a good-sized box (4-in. deep by 4½-in. wide by 2-in. high) to provide a substantial stand for the slave flash. A flash gun mounting shoe and flash gun extension cable can be obtained in most photo supply stores. Mount the flashgun shoe on top of the cabinet. Cut off and throw away the male jack on the flash gun extension cable and strip the two wires leading to the female jack. If the flash gun you are planning to use for Light/Jinn has a "hot" shoe you will not need the extension cable. You should now determine which wire is positive. In most, but not all, flash guns the positive is the one which leads to the inner part of the jack (the center lead). If you plan to use Light/Jinn with a slave flash whose polarity you do not know, add the bridge rectifier (labeled "optional") at the right hand of the schematic. Then the polarity does not matter.

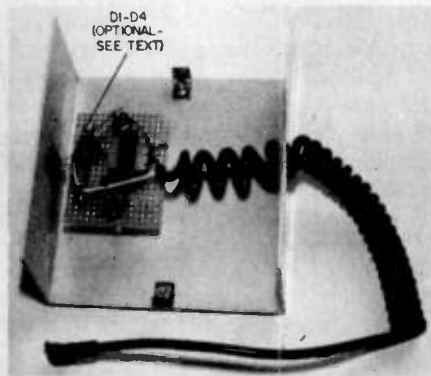

This photograph shows the unit including the diode bridge rectifier, which is needed if Light/Jinn will be used with flash units whose polarity is unknown.

possibility of flashes caused by static electricity.

An inexpensive audio frequency choke is most readily obtained by using an

**Using Light/Jinn.** Mount the second flash unit on Light/Jinn, connect it to the cable extension, and charge the gun from its built-in batteries (or AC). It

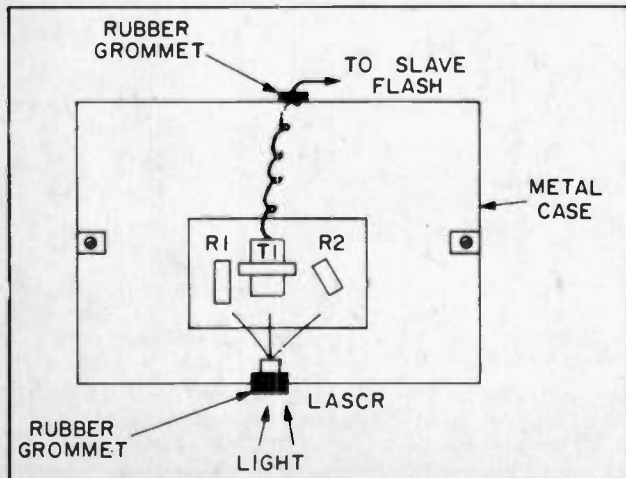

Drawing at left shows there is much spare space in the metal enclosure. This is because the box must be large enough to provide a substantial mounting base for the flash unit.

may flash once or twice by itself, but then it should stabilize. If it keeps going off spontaneously check the circuit for mistakes. If the wiring looks OK you may have to try another LASCR. This is because they have different sensitivities, and some trigger more easily than others.

For the best pictures set Light/Jinn five to ten feet to one side of the subject, with the sensor (LASCR mounted in rubber grommet) pointing directly at your camera, and Light/Jinn's flash unit pointing directly at the subject. Make sure that neither the slave flash nor its reflections are in the picture. Test the setting by looking in the camera viewer and releasing the master flash before taking a picture. If Light/Jinn does not go off, point the LASCR at the camera or move it closer. Light/Jinn can be set 10-15 feet away from the camera depending on the strength and direction of the master flash. If your camera has various flash settings (X, M, F) use the setting recommended for the master flash (X for electronic flash, M or F for flash bulbs).

The key to success in multiple flash photography is correct placement of the flash units. If you follow the basic rules for good studio photography you'll be able to take much improved flash photographs. The basic studio setup calls for just two lamps. In our setup the basic, on-camera flash becomes the "fill" light, and the second, added flash unit becomes the main light source. This is often called the *key* light, and its placement is critical to the production of a good photograph.

The key (off-camera) flash must be mounted on a chair, tripod, or something similar, such as a chair back or bookcase. If all else fails have a friend hold it for you. Putting this light high, and off to one side, about 45 degrees, will provide both depth and modeling. The on-camera flash, being much further away from the subject than the key flash, will be much weaker, and need not be considered when figuring the correct camera aperture.

Since the key light is the only one that matters (in figuring the exposure) the calculation is quite straightforward. You just divide the number of feet from the key flash to the subject into the flash guide number. This gives the approximate *f* stop for the key flash mounted on Light/Jinn.

**Caution.** A charging flashgun may develop as high as 200 Volts, so keep the cabinet closed when the circuit is in operation. Also, do not get the flash gun close to your eyes, because when it is charged it may go off accidentally due to static electricity pulses. ■

# Build the SEE-THROUGH CRYSTAL RADIO RECEIVER

by Art Trauffer

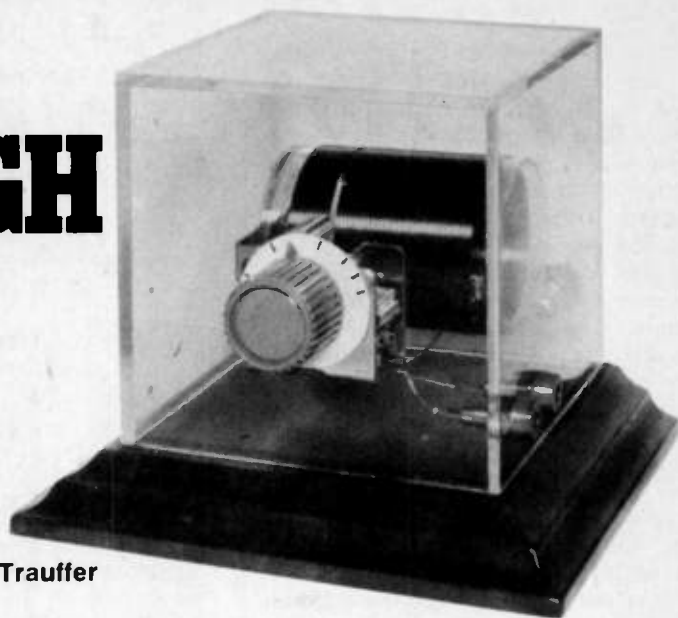

□ Have you ever wanted to recreate those old days of listening to AM radio on a crystal set and headphones? No tubes, no batteries, no hum, no nothing but pure clean sound drifting out of the ether into your headset? If you have the yen to get a crystal set which has the advantage of using a crystal diode instead of the old unreliable cats-whisker and galena crystal, this radio is the one for you to build. In addition to being about as good a power-supplyless AM receiver as you can make, it's also a pleasure to look at.

It closely resembles the beautiful glass-enclosed radio receivers that were custom-built by manufacturers for display in radio exhibitions in the 1920's. Manufacturers of radio receiver kits mounted and wired their kits in glass cabinets so the visitors could see the "works" from all angles instead of lifting the lid to look inside. Those glass cabinet radios are now rare collectors

items.

This crystal radio also saves you the work and expense of making a wood cabinet, and it is low-loss for radio frequencies because the cabinet and coil form are made of styrene plastic which is a good dielectric material. The cabinet is simply a clear plastic 4-in. square photo display cube, and the coil form is a clear plastic pill container about 2-in. in diameter.

**Circuit Description.** The simple schematic diagram shows a time-tested hookup which is still widely used, but it's improved here by connecting one side of the crystal diode to a tap on the secondary, L2. This greatly increases the receiver's selectivity and helps you separate the powerful local stations.

**Making the Coil.** To make coils L1 and L2 the four ends of the coils are anchored in small holes drilled through the wall of the plastic container and spotted with Duco cement. You can also

make small holes by pushing a hot sewing needle through the plastic. To make the tap on the coil, simply twist a small loop in the coil and spot it with Duco cement. Scrape the enamel insulation off the loop, and solder to it.

**Build Your Own or Ours.** The plastic cube makes a very attractive enclosure, as you can see in the photographs. However, the parts layout isn't at all critical, and you can breadboard this radio any way you want, so long as it's wired correctly. If you want to have a beautiful-looking radio you can show off you'll follow the model I made which is shown in the photographs.

**Mounting The Parts.** The photograph shows how the parts mount inside the plastic box. The coil form is mounted to the rear of variable capacitor C1 by means of a brass angle-bracket. Use lockwashers wherever needed to hold the screws, binding posts, and phone tip jacks securely to the plastic material.

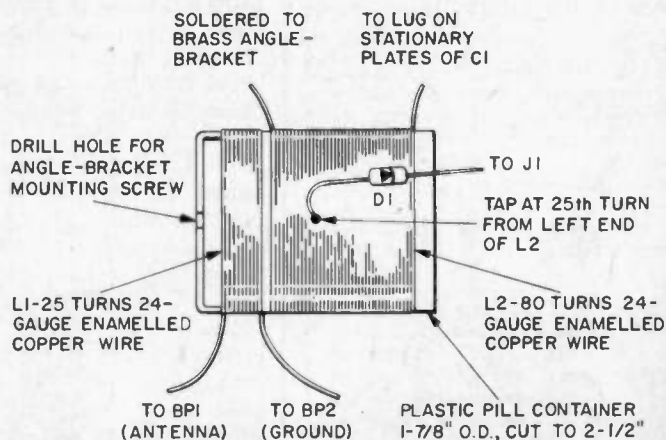
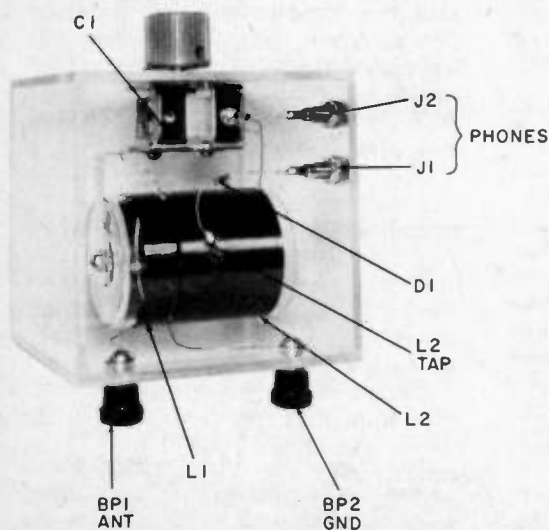

Apart from getting hold of the parts, construction of the See-Through Crystal Set should take you less than two hours in all. You can use any kind of box you want, but the lucite box shown will make it into a real showpiece.

When assembling and wiring this receiver be careful not to scratch the plastic, and keep the soldering iron well away from the plastic. If you use rosin core solder, protect the plastic by covering it with pieces of paper taped in place to keep the rosin from splattering on the plastic.

The completed crystal radio is mounted on a fancy walnut base purchased from a woodworking shop. The plastic box is secured to the wood base by spotting the four corners of the bottom of the box with Duco cement. The dial for the pointer knob is simply a small disc of white double-weight paper held to the plastic box with a spot of Duco cement. Make pencil marks at the places where your local stations come in.

Use of a pair of sensitive high-impedance magnetic or crystal earphones, a good connection to a cold water pipe, and a long outdoor antenna (for best results, put up a long single-wire, random-length antenna.) With a simple crystal set it becomes particularly important that the antenna-ground system be the best possible. Remember, unlike its bigger cousin, the superheterodyne, the crystal set does not have rf amplifiers and other circuitry to help it pull in all those signals floating around out there in the ether. ■

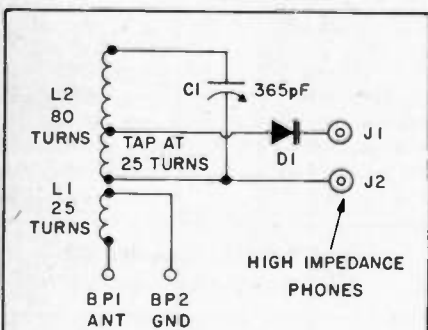

#### PARTS LIST FOR CRYSTAL RADIO

- BP1, 2—Binding posts for antenna and ground connections; may be any convenient type
- C1—365-pF variable tuning capacitor, single-gang.
- D1—Small-signal, general purpose diode, similar to 1N34.
- J1, 2—Jacks for headphones (dependent on phone(s) selected).
- Misc.—Headphone(s), high impedance. May be crystal or magnetic, or small earphone as supplied with transistor radios and portable tape machines; plastic photo display cube, approx. 4-in. each dimension; plastic pill container, 1 7/8-in. diameter, for use as coil form; 1/4-lb. 24-gauge enamelled copper magnet wire (Radio Shack 278-004 or equiv.); brass mounting strip, assorted screws, nuts and lockwashers.

## Restore Antiques

(Continued from page 14)

shops in larger cities carry this wire in stock for use in rewiring antique table or floor lamps, otherwise use a brown plastic linecord unless the radio cabinet is white in which case a white linecord looks best.

Next check all the tubes if you have access to a tube checker; otherwise check the filaments with an ohmmeter. Wash them carefully and put them back into the proper sockets. Connect a 100-watt lamp in series with the radio and wall outlet, (see circuit) and plug in the radio. Why do I recommend this step? Simply because the set may have a short in it, if so the lamp will burn brightly and you will not burn up a power transformer or other part. If the light bulb does burn brightly pull the rectifier tube, if the set has a power transformer, and if the lamp doesn't dim the transformer is probably shorted or a filter capacitor is shorted. If the light bulb burns dimly then you can plug the radio line cord directly into the wall outlet.

**Filter Caps.** Listen for hum in the speaker, a barely audible hum is good, a loud hum like a buzz saw is bad, if you have a loud hum, replace the filter capacitors. They will either be in a round aluminum or cardboard tube about 1 inch in diameter and 3 inches long with a red, blue, and black wire coming out the end, mounted under the chassis; or an aluminum or copper can about 1 1/4 inches in diameter and 4 inches long, mounted on top of the chassis with three or more wires or 1 threaded stud on the bottom. If the radio is from the 1930's you had better replace the filter capacitors as a form of insurance against early failure. Other small capacitors should be replaced since most cardboard tube capacitors have leakage resistance and will cause the radio to play poorly or not at all. While you are under the chassis look for burned resistors, wire with hardened or broken insulation etc. Use capacitors with the same capacity and with the same or higher working voltage.

Now when you plug in the radio you should hear a faint hum in the speaker. When you rotate the volume control you should not hear a loud click, static, etc., but only a rushing noise as you turn the control clockwise. If you do get a loud static noise the volume control is noisy or worn out. The only permanent repair is to replace the control. If you want to try cleaning it, buy a can of contact cleaner

at a radio parts store and follow their directions. If your radio has no built in loop antenna you will need about 50 feet of wire connected to the antenna lead to pick up stations.

**Speaker Repair.** One more problem may be the speaker. Look for holes and loose seams in the cone, especially in the center around the voice coil or around the edge where the cone is cemented to the metal basket. Recement the cone or small holes in the cone, larger holes or tears can be repaired with speaker cement and strips torn from a paper towel. Speaker cement can be purchased at Radio Shack stores. If the sound is distorted or raspy you may have dirt or iron filings in the space between the voice coil and pole piece. This is difficult to repair and you may need a new speaker.

By now your radio should be working quite nicely unless you have a rare fault in some component. If it is you can put it back into its cabinet. If you have replaced the grill cloth, put the speaker back, and mounted the dial escutcheon, you can put the chassis back in place. Install the knobs, after polishing them, and replace the back if there is one. Now turn the radio on, sit back and enjoy the real old fashioned tone of a tube type radio.

**Antique Plastic.** What? you say you have looked all over and cannot find a wooden cabinet radio to restore. All you could find were sets with plastic cabinets covered with dirt, paint spots, grease, and scratches all over the cabinet, well I'll tell you what to do. Buy the oldest plastic cabinet radio you can find and practice on it and one of these days you will find a wooden cabinet radio. First remove the knobs, back, radio chassis and speaker. Carefully wash the cabinet and dial glass. Use warm water and a dish washing detergent, then rinse and wipe dry. Washing should remove dirt, grease, etc. but will leave paint spots. Your fingernail or alcohol will usually remove the paint. After washing the cabinet will probably still be dull and dingy looking so a plastic cleaner and polish should be used to restore the original luster. The best polish and cleaner I've found is Meguiar's Mirror Glaze, Plastic Cleaner and Plastic Polish. They are sold by Mirror Bright Polish Co., Inc., Irvine, CA 92664. A catalog source is listed in the appendix.

We have tried to give you the overall picture of what is involved in restoring a small table model radio so you will have a set you will be proud to show to your friends and neighbors. A lot of these small wooden radios are still available so look around. ■

## Stop Static

(Continued from page 105)

What can be done? First, current spikes from digital logic may be reduced by bypassing ICs with .1-mfd. ceramic capacitors. These capacitors are applied as closely as possible to the power pins of the various IC packages. Another scheme that is successful at frequencies below 1 MHz is the use of a parallel power distribution system, as shown in Figure 6. Since  $I_1$  and  $I_2$  cannot flow in R or L, they produce no troublesome noise. In order for this

system to work well, however, the power supply must have a low impedance and use very short wires.

Now, in most instances, you don't need to worry about how to distribute power in a project; all the interconnections are established on the author's PC board, and you just copy that layout. This eliminates a lot of trial and error, and makes your life that much simpler in the process. Using a PC board, and following the construction practices that we've discussed here, you should be able to turn out a perfect project every time.

When different types of circuits are sharing a single power source in a parallel distribution system, ground noise is often totally eliminated. The arrangement isolates the various circuit components from their neighbor's power sources. The power source should have low impedance and be connected to points A and B by very short wires.

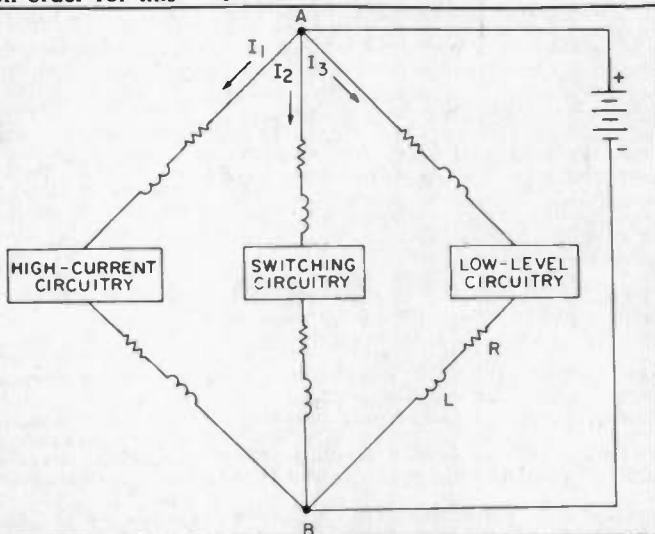

## Signal Snare

(Continued from page 57)

tween the drain of Q1 and ground. The station signal should diminish. This indicates that the RF reflex portion of the circuit is operating correctly. The capacitor shunts the RF to ground, but does not affect the audio amplification as it has a high impedance to the audio frequencies.

Check the audio amplifier portion of the reflex circuit by tuning in a station and then removing the headphones from J2. Temporarily connect a 100-ohm, 1/2-watt resistor in place of the headphones to J2. Connect the headphones with a pair of clip leads across the output of D1 (across C6), and compare the signal level with the previous level at J2. The level at D1 should be lower than that of J2 to verify that the audio is being amplified by Q1.

## Budget Bench

(Continued from page 41)

matched pairs for use in circuits where normal value variations would not be acceptable.

The bridge has a resistance range of 10 ohms to 10 megohms, an inductance range of 10 $\mu$ H to 10H, and a capacitance range of 10pF to 10 $\mu$ F.

**AC Power Supply.** All of these 5280 series Heathkit test instruments can be battery powered, which is a real convenience when you need a portable unit for testing auto electrical systems. But for truly convenient test-bench use, there's no denying the very real con-

venience of an AC power pack that eliminates the need of most batteries.

The Heathkit Model IPA-5280-1 AC Power Supply is specially designed to power all of the 5280 series equipment, *without the need to unplug one equipment to power another.* The unit has five separate output cords so that all test equipment can be plugged in simultaneously for instant action. The power pack operates from 110 or 220 VAC outlets without rewiring.

It features full wave rectification, capacitor filtering and dual integrated circuit regulators to insure correct voltage output of +9 and -9 VDC  $\pm$ 9%. The maximum output current is 100 milliamperes.

## Junk Box Special

(Continued from page 46)

If you wired R2 correctly it should be full counterclockwise. Then set S1 to on. The meter should rise instantly to 5 volts DC. As R2 is adjusted clockwise the output voltage should increase to 15 VDC or slightly higher. If R2 can adjust the output voltage only over the range of approximately 12 to 15 VDC, or 12 to 15+ VDC, IC1 is defective, or has been damaged.

## New Products

(Continued from page 4)

ranges which are easily selectable by means of a rotary panel switch with three color coded function indications. Sensitivity is 2000 ohms-per-volt and accuracy is 3% DC and 4% AC. The



CIRCLE 34  
ON READER SERVICE  
COUPON

instrument comes complete with battery (for resistance function) and standard banana plug test leads. VIZ, the manufacturer, offers one-year parts and labor warranty. The VOM sells for \$19.95. For additional information, contact VIZ Mfg. Co., 335 E. Price St., Philadelphia, PA 19144.

## Love That Lettering

(Continued from page 81)

with a brush-on spray coating. It's best to use products made for this specific purpose, which should be available from the same sources as the rub-on lettering. Ordinary lacquers, clear fingernail polish, etc., are likely to damage the lettering. Always make a test beforehand or you may end up with a mess.

Here are some additional suggestions:

- 1) Read the instructions (if any) that accompany the lettering set.
- 2) If this is your first experience with rub-on lettering, practice on scrap material first to get the feel of it.
- 3) To align rows of letters or words, tape a strip of paper to the panel about 1/16-inch below where the row will go.

# LITERATURE LIBRARY

389. You can't buy a bargain unless you know about III *Fair Radio Sales'* latest electronics surplus catalog is packed with government and commercial buys.

388. SWLs need Gilfer's Shortwave Mail Order Catalog for economy one-stop armchair shopping. From From top-notch rigs to reporting pads, Gilfer supplies all your hobby needs.

372. Olson continues to amaze hobbyists with their jammed packed 48-page newspaper catalog. It's a bargain buyer's bonanza.

327. *Avanti's* new brochure compares the quality difference between an *Avanti Racer 27* base loaded mobile antenna and a typical imported base loaded antenna.

362. A new catalog crunched full of military, commercial and industrial surplus electronics for every hobbyist is offered by *B&F Industries*. 44 pages of bargains you've got to see!

366. *Poly Paks* has a special section on solar powered products in their latest catalogue. As a special bonus, they are offering free of charge either two \$1.29 items or one \$2.49 item with any \$20 shipment.

384. The entire line of *B&K Precision* test instruments comes in a condensed catalog. Scopes, testers, counters, generators, etc., for every hobbyist's bench are illustrated.

310. *NCE (Newman Computer Exchange)* has just issued their Spring/Summer 1979 "Mini-Micro" catalog, and it's full of hard-to-find equipment. Money-saving offers are listed on such items as all Data General and LSI-11 equipment.

322. A new 20-page, full-color TRS-80 Microcomputer Catalog has just been issued by *Radio Shack*. The catalog includes complete, current information on the TRS-80 Microcomputer, its peripherals and accessories with plain-language descriptions, application ideas and detailed specifications.

386. If you're looking for books on computers, calculators, and games, then get *BITS, Inc* catalog. It includes novel items.

335. The latest edition of the *TAB BOOKS* catalog describes over 450 books on CB, electronics, broadcasting, do-it-yourself, hobby, radio, TV, hi-fi, and CB and TV servicing.

338. "Break Break," a booklet which came into existence at the request of hundreds of CBers, contains real life stories of incidents taking place on America's highways and byways. Compiled by the *Shakespeare Company*, it is available on a first come, first serve basis.

345. For CBers from *Hy-Gain Electronics Corp.* there is a 50-page, 4-color catalog (base, mobile and marine transceivers, antennas, and accessories). Colorful literature illustrating two models of monitor-scanners is also available.

393. A brand new 60-page catalog listing *Simpson Electric Company's* complete line of stock analog and digital panel meters, meter relays, controllers and test instruments has just come out. Other new products are listed also.

385. Amateur Radio buffs and beginners will want the latest *Ham Radio Communications Bookstore* catalog. It's packed with items for the Ham.

373. 48-page "Electronic Things and Ideas Book" from *ETCO* has the gadgets and goodies not found in stores and elsewhere.

382. Buys by the dozens in *Long's Electronics* super "Ham Radio Buyer's Guide." Good reading if you're in the market for a complete station or spare fuses.

383. If you're a radio communicator, either ham, SWL, scanner buff or CBer, you'll want a copy of *Harrison Radio's* "Communications Catalog 1979." Just what the shack book shelf needs.

380. If your projects call for transistors and FETS, linear and digital ICs, or special solid-state parts, then look into *Adva Electronics'* mini-catalog for rock bottom prices.

301. Get into the swing of microcomputer and microprocessor technology with *CREI's* new Program 680. New 56 page catalog describes all programs of electronics advancement.

302. Giant savings are what *Burstein Applebee* has in store in their latest mail order catalog. Everything from CB test equipment to name brand audio wares are advertised. Telephone accessories and pocket calculators too!

305. A new 4-page directional beam CB antenna brochure is available from *Shakespeare*. Gives complete specs and polarization radiation patterns for their new fiberglass directional antennas.

371. Your computer system needn't cost a fortune. *Southwest Technical Products* offers their 6800 computer complete at \$395 with features that cost you extra with many other systems. Peripheral bargains are included here.

374. *Radatron's* Catalog 1006 lists many projects from a self-contained portable lab station for an electricity-electronics course to many texts, lab manuals, and applied activities.

306. *Antenna Specialists* has a new 32-page CB and monitor antenna catalog, a new amateur antenna catalog, and a complete accessory catalog.

307. *Allas* calls their 210X and 215X the perfect amateur mobile rigs. Their 6-page, full-color detailed spec sheet tells all. Yours for the asking.

330. There are nearly 400 electronics kits in *Heath's* new catalog. Virtually every do-it-yourself interest is included—TV, radios, stereo and 4-channel, hi-fi, hobby computers, etc.

392. The opening of the new Software of the Month Club has been announced by *Creative Discount Software*, which is giving out membership enrollment applications now. The Club plans to have separate branches for users of the Apple II, TRS-80, Ohio Scientific, Exity, Pet and CP/M based systems.

312. *E.D.I. (Electronic Distributors, Inc.)* carries everything from semi-conductors to transformer/relays to video cameras. In prices ranging from 19¢ to \$500, products appear from over 125 electronic parts manufacturers. The catalog is updated 3 times a year.

313. Get all the facts on *Progressive Edu-Kits* Home Radio Course. Build 20 radios and electronic circuits; parts, tools, and instructions included.

390. *Whitehouse & Co.*, your "hard to find parts specialist," offers over a dozen parts and kits in their latest catalogue, featuring an entire section on gunnplexers for Amateur Radio buffs.

318. *GC Electronics* offers an "Electronic Chemical Handbook" for engineers and technicians. It is a "problem solver" with detailed descriptions, uses and applications of 160 chemicals compiled for electronic production and packaging. They are used for all types of electronic equipment.

320. *Edmund Scientific's* new catalog contains over 4500 products that embrace many sciences and fields.

321. *Cornell Electronics'* "Imperial Thrift Tag Sale" Catalog features TV and radio tubes. You can also find almost anything in electronics.

328. If you are into audio, ham radio, project building, telephones, CB or any electronics hobby you'll want *McGee's* latest catalog of parts and gadgets. Hard to find parts fill each page, so get a copy of the catalog from *McGee* today!

329. *Semiconductor Supermart* is a new 1979 catalog listing project builders' parts, popular CB gear, and test equipment. It features semiconductors—all from *Circuit Specialists*.

333. Get the new free catalog from *Howard W. Sams*. It describes 100's of books for hobbyists and technicians—books on projects, basic electronics and related subjects.

354. A government FCC License can help you qualify for a career in electronics. Send for Information from *Cleveland Institute of Electronics*.

355. New for CBers from *Anixter-Mark* is a colorful 4-page brochure detailing their line of base station and mobile antennas, including 6 models of the famous Mark Heliwhip.

391. A new software products catalog for the Apple II Computer has just been issued by *Charles Mann & Associates*. The booklet contains business accounting, accounts receivable, inventory, BASIC teaching and other special purpose business applications.

359. *Electronics Book Club* has literature on how to get up to 3 electronics books (retailing at \$58.70) for only 99 cents each... plus a sample Club News package.

364. If you're a component buyer or specifier, you'll want this catalog of surplus bargains: industrial, military, and commercial electronic parts, all from *Allied Action*.

365. *Electronic Supermarket* has a new catalog of almost everything in the field—transformers, semi-conductors, tv parts, stereos, speakers, P.C. boards, phones, wire and cable, tools, motors.

375. *CompuColor Corp.* has a personal computer system with an 8-color integral display, a typewriter-like keyboard, and a mass storage device. Programs are ideal for checkbook and income tax figuring.

377. We can't enumerate all the products in *John Meshna, Jr.'s* catalog of surplus electronic parts: power supplies; computer keyboards; kits for alarms, clocks, speakers, and more.

378. *Delta Electronics* is a complete parts source for electronics experimenters. Discrete parts, modules, boards, subassemblies and complete gadgets. Get *Delta's* 120-page catalog today.

311. *Midland Communications'* line of base, mobile and hand-held CB equipment, marine transceivers, scanning monitors, plus a sampling of accessories are covered in a colorful 18-page brochure.

316. Get the *Hustler* brochure illustrating their complete line of CB and monitor radio antennas.

**BUDGET ELECTRONICS**  
Box 1849, G.P.O.  
New York, NY 10001

**1980 EDITION**  
Void After January 6, 1980

Please arrange to have the literature whose numbers I have circled below sent to me as soon as possible. I am enclosing 50¢ for each group of 10 to cover handling. (No stamps, please.) Allow 4-6 weeks for delivery.

301	302	305	306	307	310	311	312	313	316	318	320
321	322	327	328	329	330	333	335	338	345	354	355
359	362	364	365	366	371	372	373	374	375	377	378
380	382	383	384	385	386	388	389	390	391	392	393

300  Enter my subscription to **ELEMENTARY ELECTRONICS** for 9 issues at \$5.97.  
Check enclosed. Add \$1.53 for Canada and all other countries. H91047

NAME (print clearly)

ADDRESS

CITY

STATE

ZIP

## Solar Swinger

(Continued from page 75)

work cloth under the wooden base to protect the soft wood from scratches and dents.

Cut a 1½" hole about ¼" deep for the tube base. The ¼" indentation will take a large pasteboard washer to bolt the tube socket into position. Finish drilling out the 1-inch hole for the tube prongs to fit comfortably inside. Depending upon the size of the tuning capacitor, lay it upon the bottom area and drill a large hole to enclose the whole body. Do not drill clear through the board but leave about ¼" at the top side for the mounting area of the tuning capacitor.

The tuning capacitor and the headphones are the only components mounted outside of the tube envelope. A small ¼" hole is drilled in the center and at the rear of the base towards the tube socket. The headphone and antenna wires will feed through this area to the tube socket pins. Cut a groove into the wood area between the capacitor and tube socket hole. The capacitor's two small connecting wires will lay flat in this groove.

If needed, sand down the top of the wooden base area with fine sandpaper. Stain, varnish or spray paint the top side. Choose a light color spray paint, such as white or yellow, to give

the base and component parts a contrasting appearance. Spray on at least three coats of paint and let it dry between each coat to produce a slick, enamel appearance. Let the wood base dry overnight.

**Final Touchup.** After the base appears dry mount the variable capacitor and connect two pieces of hookup wire from it to tie into the tube socket. Next, mount the small tube socket. Temporarily, place a piece of masking tape over the socket and wooden base plate. Lay the base upside down (over a shoebox) to wire up the remaining components. Feed the earphone cable through the rear hole and connect to terminals 4 and 6 of the tube socket. Feed a short piece of hookup wire through the same hole to serve as an external antenna connection. Solder this wire to terminal 2. Now solder the capacitor's two wires to terminals 2 and 1. Once again, check over the entire wiring procedure. Solar Swinger should be ready to roll (and rock).

Connect the antenna wire to the outside antenna—or you can try to pick up local stations with a 12-ft. piece of wire laying around the baseboard of a wall. You should be able to pick up local stations at each end of the broadcast band. If a ferrite, adjustable antenna coil is used, adjust the core until the stations are loudest at each end of the band. Turn Solar Swinger's solar cell toward the sunlight or operate under a table lamp.

After all adjustments are made, spread silicone cement over the tuning capacitor wires. Cut out a large pasteboard or plastic washer and place it over the tube pins. Use the ¾-inch machine screw and bolt the tube socket into position. To keep the earphone wires from pulling out, apply silicone cement in the small hole. Place four rubber grommets or metal spacers on each corner for feet, and cement in place. Let the radio lay upside down until the silicone cement sets up.

The glass envelope should be mounted last and glued to the tube base with black silicone cement. Place a thin layer of rubber cement around the top, just inside the tube base. Hold the envelope in a straight upright position and set it down in the fresh cement. Now apply rubber silicone cement to the outside of the glass and base area. Wipe off all surplus with a paper towel and make a neat joint with your fingers.

Many of our Solar Swinger's parts may be found in the junk box. In fact, low priced transistors are used in the directly coupled audio circuit. If you are starting out cold and purchasing all new parts, you may pick up a 2 transistor AM radio kit from Radio-Shack (#28-214) for \$6.95. Most all the parts needed for the Solar Swinger can be robbed from this kit.

Solar Swinger—a great conversation piece and a sunny savings over the high cost of batteries! ■

## Grandpa's Whisker

(Continued from page 31)

**CAUTION.** Make sure that the battery is disconnected for this initial adjustment.

Connect an antenna to J1, a ground to J2, and a pair of high-impedance headphones to J5 and J6. A pair of 2000-ohm phones was used with our model; do not use low impedance headphones (8, or 16 ohm stereo types). Do not connect the 6-volt battery at this time.

Make sure that the catwhisker is not touching the crystal or the crystal cup (open circuit to the carborundum crystal), and then connect the crystal diode across J7 and J8 (the polarity is not important; it will work either way). Connect both of the clip leads (lead to J8 and lead to C1A-C1B) to L1 coil taps; any of the mid-coil taps will do for an initial start. Set C1A-C1B to mid-capacity range and then tune C2

until you hear a radio station in the headphones. Readjust the setting of C1A-C1B for best headphone volume. Then readjust each one of the clip leads for best headphone volume of the received radio station. All of the adjustments and coil tap settings will interact, and will require careful retuning of both C1A-C1B and C2 for best results.

When a radio station is tuned in for best headphone volume, carefully disconnect the germanium crystal diode from J7 and J8 without disturbing the tuning capacitor settings or the positions of the L1 tap connections. Then place a carborundum crystal in the detector assembly and connect the 6-volt battery to J4 (negative lead) and J3 (positive lead). Adjust the catwhisker until it touches the carborundum surface and then set the bias control R1 to mid-range.

Carefully adjust the catwhisker for a sensitive spot on the crystal surface at the same time adjusting R1 for best volume of received signal. If this seems like a lot of trouble to hear a radio station, remember the radio pioneers

around the turn of the century would spend considerable time with equipment even cruder than Grandpa's Whisker in order to capture the elusive wireless signals. After a station is found with the carborundum detector, it may be possible to achieve a bit more received volume by readjusting the coil taps and tuning capacitors.

You can experiment with different types of silicon and germanium crystals as well as other materials with this circuit; but remember, do not use the battery unless it is with a carborundum crystal. The battery will burn out the more conventional germanium and silicon crystals. You can also try chips of carborundum broken off of sharpening stones, etc. and held with melted solder or lead. Or you can also try packing the crystals with sections of crumpled aluminum or lead foil in place of the melted lead bodies. The received crystal set volume will vary according to the type of crystal used; generally germanium will be loudest, and silicon a bit less, and the carborundum crystal will usually be lower in volume. ■



# Classified MARKET PLACE

**BUDGET ELECTRONICS—PUBLISHED ANNUALLY.** The rate per word for Classified Ads is \$1.00 each insertion, minimum ad \$15.00 payable in advance. Capitalized words 40¢ per word additional. To be included in next issue, write to R.S. Wayner, DAVIS PUBLICATIONS, INC., 380 Lexington Ave., NY 10017.

## ADDITIONAL INCOME

BECOME COMMISSION MAILER. How? Write: Grams, DPBX 99371, Tacoma, WA 98499.

MAKE 2 to 3 TIMES your COST on hundreds of products, gift items, novelties, toys, carded merchandise, 1001 others. \$2.00 brings giant catalog, refundable on first order. GEORGE BUCKLEY, 18603 NE 164th Street, BRUSH PRAIRIE, WA 98606.

HOW to earn at home addressing envelopes. Rush stamp to Ferrell, P.O. Box 37290, Jacksonville, FL 32205.

## AUTOMOBILES & MIDGETS

NEW Car Free Yearly! Details! Supercar, Box 28101, St. Louis, Missouri 63119.

## BLUEPRINTS, PATTERNS & PLANS

LINEAR AMPLIFIERS 100 or 200 watt, 2-30 MHz. Omnipolarized ANTENNA. 300 MHz COUNTER. Modulation BOOSTER-VOX. Plans \$3.00 each, \$10.00/all. Catalog of others! PANAXIS, Box 130-GB10, Paradise, CA 95969.

## BUSINESS OPPORTUNITIES

CABLE FM BROADCAST STATION. Investment/experience unnecessary. Home operation possible. Excellent income reported! Free details. CAFM, Box 130-B10, Paradise, CA 95969.

100% PROFIT Bronzing Baby Shoes. Free Literature. NBC, Box 1904-DC, Sebring, FL 33870.

STAY HOME! EARN BIG MONEY addressing envelopes. Genuine offer 10¢. Lindco, 3636-DA, Peterson, Chicago 80659.

MAILORDER opportunity! Start profitable home business without experience or capital. Write for free book and details. No obligation. Gil Turk, Dept. 45, Montvale, NJ 07645.

MAKE \$1.00 Each Addressing Envelopes. We pay postage. No Limit. Beginner's Kit \$2.00. Colossi, Box 318-D, Brooklyn, NY 11204.

\$480 Weekly Possible. Amazing New Mailing Program. Details. Rasmussen DP109, 1747N, 450E, Ogden, Utah 84404.

BUSINESS AND FINANCING CONSULTANTS NEEDED! Earn large commissions. Most thorough training anywhere. Inquire: Pyramid Management Group, Inc., 500 West Central—Suite 200, Mount Prospect, IL 60056.

\$350 Weekly Mailing Letters. Free Details. Bronxville House, Box 311-D, Bronxville, NY 10708.

\$500.00 WEEKLY MAILING CIRCULARS! NEW GUARANTEED PROGRAM! FREE PROOF: McMahon, Box 909-D, Niagara Falls, NY 14303.

FANTASTIC PROFITS Mailing Circulars. Write: McGuire, Box 91054-D, Tacoma, WA 98491.

HOMEWORKERS!!! Stuff Envelopes. Make Big Money. Rush stamped addressed envelope. C.R.L., P.O. Box 51, Chino Valley, AZ 86323.

EARN EXTRA MONEY: 21 ways by mail. Send \$1.00. J&J Gifts, Box 19699B, Los Angeles, California 90019.

FREE Details. Excellent Home Mailing Offer. Robinson, Box 415, New Hartford, NY 13413.

FREE DETAILS—Make money writing and selling simple information. Falconer, Box 20102-D, Indianapolis, Indiana 46220.

30¢ PER ENVELOPE stuffed with circular. Garry Manz, Mt. Kemble Lake, Morristown, NJ 07960.

PROFITABLE Wholesale Business. Over 1500 fast selling specialty products. Start without capital. Free details. Specialty, 14617 NW Seventh Avenue, Miami, Florida 33168.

## BUSINESS OPPORTUNITIES—Cont'd

\$534.00 WEEKLY working three hours daily at home. \$356.00 weekly working two hours daily. \$178.00 weekly working one hour. Start immediately. Paid daily (advance)—\$106.80, \$71.20 or \$35.60. WRITTEN EARNINGS GUARANTEE. FREE Bulletin/Application. FAS, Postal Unit 13703-G, San Antonio, Texas 78213.

FREE!! Mailorder Circulars, Supplies, Professional Setup. Information: Publishers, 4887-M Trail, Salt Lake City, Utah 84120.

UNBELIEVABLE MONEY. \$9.00 profit from \$10.00 orders. Rush 25¢ for details. R. Nibbs, 915 Industrial Bank Bldg-0, Providence, RI 02903.

CIRCULAR Mailers needed. Work from home. Earn hundreds \$\$\$ weekly. Details: Department 25-11, Box 1060, Orangepark, FL 32073.

FREE REPORT!! MAILORDER—400% PROFIT Selling Moneymaking Books/Information. Publishers, #126-D Homcresta., Brooklyn, 11229.

\$2000 Monthly mailing circulars. Free details. American, 1108 Colonial, Inkster, Michigan 48141.

\$58.90 daily pay. \$353.88 weekly. Homework. Immediate income. Earnings guarantee certificate. Free report/Application. AAHIP, Unit 29309-H, Medonesta, Texas 78229.

BIG MONEY in MAILORDER!! Professional Reveals Secrets. Details: Stamped, addressed envelope and 25¢. Dennis Kelley, Dept. 21, 1116 Pine St., Corbin, KY 40701.

\$500.00 WEEKLY STUFFING ENVELOPES. FREE details! Send addressed stamped envelope, Enterprise, P.O. Box 5-D, Salem, Ohio 44460.

UNBELIEVABLE MONEY. \$9.00 profit from \$10.00 orders. Rush 25¢ for details. R. Nibbs, 915 Industrial Bank Bldg-0, Providence, RI 02903.

\$350 WEEKLY Mailing Letters. FREE DETAILS. Donco, 428 East 81, #2D-C1, New York, NY 10028.

## BUY IT WHOLESALE

SAVE MONEY! Buy Low Cost Items. (5) Wholesale Catalogs \$5.00. New York Directory. Close-Out Directory \$2.00. 1001 Things Free Directory \$2.00. All for \$10.00. Winchester Enterprises Inc. 2807/SS Hargrave Street, Phila., PA 19136.

## EDUCATION & INSTRUCTION

BECOME ENGINEER, DJ. Start your own radio station, receive FCC license, equipment, records. Free details. "Broadcasting," Box 130-GB10, Paradise, CA 95969.

UNIVERSITY DEGREES BY MAIL! Bachelors, Masters, Ph.D.s. Free revealing details. Counseling, Box 389-BE-10, Tustin, CA 92680.

COLLEGE degree by mail, via resume. Education, 256D South Robertson, Beverly Hills, CA 90211.

DO YOU NOW "How to Write a Classified Ad That Pulls?" Instructive booklet tells how. Also includes a certificate worth \$2.00 toward a classified ad in any of our publications. For your copy send \$1.50 (plus 25¢ postage) to R. S. Wayner, Davis Publications, Inc., Dept. CL, 380 Lexington Ave., New York, NY 10017.

COLLEGE DEGREES for Life & Work Experiences. Bachelors, Masters, Doctoral Programs. Free information, write American International University, 150 South Los Robles Dept. AU-10, Pasadena, CA 91101. Call toll-free 1-800-423-4166.

## GIFTS THAT PLEASE

FREE GIFT catalog! UNIQUE gifts from around the world. Gifts, Box 11588-BE, Spokane, WA 99211.

FREE Gift Catalog. R & T, P.O. Box 130 Ryder St. Sta., 1165 East 54th St., Brooklyn, New York 11234.

## HI-FI EQUIPMENT

SAVE 50% BUILD YOUR OWN SPEAKER SYSTEM. Write McGee Radio Electronics, 1901 McGee Street, Kansas City, MO 64108.

## HYPNOTISM

FREE Fascinating Hypnosis Information! Startling! DLHM, Box 487, Anaheim, CA 92805.

## INVENTIONS WANTED

INVENTORS: Free information on offering your invention for sale. Kessler Sales Corporation, C-278, Fremont, Ohio 43420.

INVENTIONS, patents, wanted cash, royalty. Auto, electro-mechanical, mechanical devices. Housewares, etc. We develop, finance, manufacture and market from an idea to perfected product. Free evaluation and brochure. Request Kit DP, Pixonix Corporation, 250 West 57th Street, New York, New York 10019.

## LOANS BY MAIL

GET cash grants—from Government. (Never repay.) Also, cash loans available. All ages eligible. Complete information. \$2 (refundable). Surplus funds-DG, 1629 K. St. NW, #502, Washington, DC 20009.

BORROW \$25,000 "OVERNIGHT." Any purpose. Keep indefinitely! Free Report! Success Research, Box 29263-SX, Indianapolis, IN 46229.

## MAIL ORDER OPPORTUNITIES

SHOP BY MAIL and save 40% on over 2500 gift items for Christmas. Send \$2.00 for catalog to House of Palmer's Gift World, Dept. M1079, 4522 Alameda Drive, Fremont, CA 94536.

## MEMORY IMPROVEMENT

INSTANT MEMORY . . . NEW WAY TO REMEMBER. No memorization. Release your PHOTOGRAPHIC memory. Stop forgetting! FREE information. Institute of Advanced Thinking, 845DP Via-Lapas, Pacific Palisades, CA 90272.

## MISCELLANEOUS

ENTER CANADA'S FABULOUS LOTTERY. Details: Joe Davis, #15-5763 Oak, Vancouver, Canada V6M 2V7.

LOTTERY OF LOTTERIES! Tax Free. Application \$2.00. Capitol Enterprises, P.O. Box 774, "D," Appleton, WI 54912.

GASOLINE MILEAGE INCREASED 50%+, horsepower 5-10% by our simplified re-tuning methods. DETAILS FREE! Techneering, Box 12191DP, Norfolk, VA 23502.

FABULOUS Gems for Jewelry. Investment. Gemcutter to You. Save! Taylor's, 113-MP Martin, Indian Harbor Beach, FL 32937.

SAVE TO 90% WEEKLY on groceries!! Guaranteed!! Information: Rush self addressed stamped envelope plus 25¢! Martens Ent., 1046 Greenwood Ct., Rm7DPO, Oshkosh, WI 54901.

## MONEYMAKING OPPORTUNITIES

HOMEWORKERS Needed! \$400 weekly addressing, mailing. Ideal for students. Box 1874, Htd., CT 06144.

\$300 WEEKLY SPARE TIME—Mailing Saleletters. Details. Thomas, Dept.-D, Box 11773, Charlotte, NC 28220.

EASY HOMEWORK PLAN. Stuff circulars. Big \$\$\$ Write: A&I, 5343-A Diamond Hts., San Francisco, CA 94131.

## For Greater Classified Savings... Results... and Profits...

Place your ad in one of our SPECIAL COMBINATIONS: Combo #1, Combo #2, or Combo #3. Each combination is designed to give you the largest audience available. For further information write to R. S. Wayner, Classified Ad Manager, Davis Publications, Inc., 380 Lexington Ave., N.Y., N.Y. 10017.

## Classified Continued

### MONEYMAKING OPPORTUNITIES—Cont'd

**MAKE YOUR CLASSIFIED AD PAY.** Get "How to Write A Classified Ad That Pulls" Includes certificate worth \$2.00 toward a classified ad in this publication. Send \$1.50 (plus 25¢ for postage) to R. S. Wayner, Davis Publications Inc., Dept. CL, 380 Lexington Ave., New York, NY 10017.

**STUFF-MAIL ENVELOPES!** \$250.00 Profit per thousand possible! Offer details. Rush stamped addressed envelope: Worldwide-A 460, X15940, Fort Lauderdale, FL 33318.

**THREE** Hundred and Seventy dollars Weekly Guaranteed for envelopes you mail. Postage paid Free. Write: J. P., P.O. Box three sixty two-G, Durant, OK 74701.

**\$350 WEEKLY** Mailing Letters. FREE Details. Karmchell, 628F5 Cherry, Albany, GA 31701.

**RICH!** 20 Ways by Mail. Report 50¢, sase. Tailleir, Box 62, Hyde Park, NY 12538.

"INSIDE secrets to success" will show you how to become RICH, AWARE, SUCCESSFUL—free "SURVIVAL—today and tomorrow." \$3.95 to Jace Green Company, 403-B Fourth Avenue, Redwood City, CA 94063.

**\$500 Cash;** stuff 1000 envelopes! Guaranteed Rate. Information: Rexson 25-12, Box 1060, Orange Park, FL 32073.

**EARN \$1,700 Weekly!** Start Immediately! Write: Day, Box 89-CM, Licking, Missouri 65542.

**STUFF-mail envelopes!** \$500.00 profit per thousand Guaranteed. Free Brochures. Lewis Enterprises, P.O. Box 1175-B, Pinellas Park, FL 33565.

**MAKE EXTRA MONEY** in your spare time. Report tells how. Send \$2: Spectron Company, Dept. 3, 420 East 111th St., Suite 2908, New York, NY 10029.

**\$500.00 WEEKLY STUFFING ENVELOPES,** start immediately, details 25¢. Enterprise, P.O. Box 5-D, Salem, Ohio 44460.

### PENPALS

**FREE** service ages 16 and above. For information: Friends Worldwide, CP-95/F Anjou, Montreal, Canada H1K 4G2.

### PERSONAL

**SINGLE?** Widowed? Divorced? Nationwide Introductions! Identity, Box 315-DC, Royal Oak, MI 48068.

**JAPANESE Girls** Make Wonderful Wives. Let us introduce you to an unspoiled Oriental Beauty. \$2 application brings photos, descriptions. Japan International, Box 156 DC, Carnelian Bay, CA 95711.

**JAPANESE introductions!** Girls' photographs, descriptions brochure, details, \$1.00 INTER-PACIFIC, Box 304-SC, Birmingham, MI 48012.

**THERE IS NO CHARGE FOR THE ZIP CODE** USE IT IN YOUR CLASSIFIED AD.

**UNIVERSITY DEGREES BY MAIL!** Bachelors, Masters, Ph.D.s . . . Free revealing details. Counseling, Box 389-DP10, Tustin, CA 92680.

**FREE: 1,000 LADIES PHOTOS.** World's largest Matrimonial Catalog. Postage/Handling \$1.00. Inter-contact, Box 12, Toronto, Canada M4A 2M8.

**BEAUTIFUL MEXICAN GIRLS!** Correspondence, Photos, details free! "Latinas," Box 1716-DE, Chula Vista, CA 92010.

**SINGLE?** Meet sincere, beautiful people—like YOU Very low fees, Call DATELINE toll-free: 800-451-3245.

**BEAUTIFUL Mexican-Oriental girls** Needing American Boy-Friends. Free Details, "Actual" photos. World, Box 3876-DC, San Diego, CA 92103.

**TRADITIONAL, home-loving ladies** seeking marriage. Rainbow, Box 62B, Stehekin, WA 98852.

### PHOTOGRAPHY—PHOTO FINISHING & SUPPLIES

**SAVE HUNDREDS OF DOLLARS!!!** Make your own S&M Densitometer. Send \$3.00 for details, drawings and instructions. A must for successful photography in your darkroom. Order direct: S&M Instruments, Dept. BE-10, 380 Lexington Avenue, N.Y., NY 10017.

### RECORDS & SOUND EQUIPMENT

**FREE** Promotional albums, concert tickets, stereos, etc. Information: Barry Publications, 477 82nd Street, Brooklyn, NY 11209.

### START YOUR OWN BUSINESS

**EARN \$555 at home!** FREE information! Write: HOW, Dept. 105, Box 717, Glendora, CA 91740.

**117 services** anyone can sell by mail. Details 25¢. Emjay Sales, 224 N. Fig, Escondido, CA 92025.

## Crystal Detectors

(Continued from page 84)

not use a variable capacitor for tuning. You make the taps while winding the coil, by twisting the wire, at the proper turn, to form a small loop of about 1/4 to 1/2-inch in diameter. Wind your coil so that connections can be made to the wire at each end of the coil.

Now, use a little cement on the coil around each tap to strengthen it. When the cement is dry, use fine sand paper to clean away the insulation, so a bare copper loop will be exposed. Fasten your coil form to the board with cement, or with thumb tacks thru the bottom of the box. Connect the wire at the bottom of the coil to the ground lead that runs between the cat whisker and the ground terminal on the board.

Next, prepare two short lengths of wire (about 10-inches long). Solder one end of one wire to the antenna terminal and solder a small alligator clip to the other end. Take the other piece of wire and solder it to the headphone terminal, and then solder the other alligator clip to the other end of this wire.

**Operation.** Now your set is finished and the fun begins. Connect an antenna

and ground to the terminals, and connect your headphones to the other two terminals. You will use the two small alligator clips to tune your set. Clip the one from the headphone terminal to a tap near the upper end of the coil, and the one from the antenna terminal to a tap near the lower end of the coil. Move the end of the cat whisker over the galena crystal until you find a sensitive spot where you can hear a station. Now move the alligator clips up and down the coil to get maximum volume. You will be surprised at the clarity and tone of the signal. You see, a crystal detector doesn't amplify, so it doesn't distort the signal.

This is truly a basic crystal set. It has but one tuned circuit, therefore it is *not* selective. In fact, if you live near several strong broadcast stations, you may hear more than one signal at a time. While not intended to be the centerpiece of your home's sound system, you have learned, by building it, crystal theory and some of the history of radio development during the early part of the century.

As you listen to your crystal receiver, you will get a feeling of satisfaction akin to the thrill the experimenter of the early 1920's got when he built his first crystal set.

## Spiderweb Receiver

(Continued from page 108)

volt battery to the receiver. Set the Bandsread capacitor C2 to minimize capacity and the Tuning Capacitor C3 to maximum capacity. Connect a signal generator to J1 and then calibrate the dial with the generator. Adjust the AF Gain R5 and R1 as necessary for a good received signal. Make sure that the signal generator output is kept low enough to prevent overloading of the receiver. Begin with a modulated signal generator frequency of 550 kHz and mark the receiver dial accordingly. Proceed up the dial to 1600 kHz and mark the scale at convenient points. Then replace the "C" with the "B" plug-in coil and calibrate the scale from 1.7 to 5 MHz with the signal generator. Also, calibrate the "A" plug-in coil with a generator from 7 to 14 MHz. If a signal generator is not available, you can calibrate the bands with markings noted from received radio stations of known frequency. The Bandsread dial is not calibrated, but, a set of points can be marked over the range of C2 to aid in tuning the dial.

**Operation.** For best results a good

antenna and ground are required. Also high impedance earphones (2000 ohms or more) are needed. If a DC power supply is used in place of the 6 volt battery, make sure that the supply does not have any hum in the output as this will affect the receiver sensitivity. Tune C3 for a received station, while at the same time adjusting the Regen control R1 for a whistle. If the station is AM, back off R1 until the station is received clearly. If the received station is CW, adjust R1 for a convenient "beat note." Many strong side-band stations can also be received by experimentally tuning R1 and C2 for best reception. Adjust the AF Gain control for good earphone volume. Adjust C1 for best reception for each coil. The position of the "S" tap can be experimented with (moving up or down on L1) for best regeneration over the band. Also, try several FET's as Q1 for maximum sensitivity over the higher SW frequencies. ■

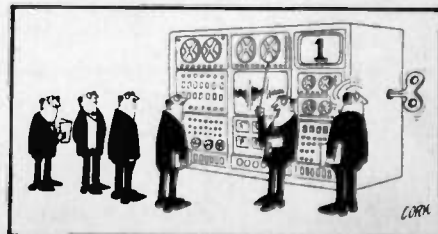

# Lab Test Elementary Electronics For Yourself

## Get switched on

it gives you the complete, ground-floor lowdown on a variety of important electronics subjects. For example—Understanding Transistors . . . How Radio Receivers Pull in Signals . . . Cathode Ray Tubes Explained . . . How Capacitors Work . . . Using Magnetism in Electronics. And more!

In case you're not all that familiar with us, we're not a publication for electrical engineers and other wizards. No way. ELEMENTARY ELECTRONICS is expressly for people who like to build their own projects and gadgets—and maybe get a little knee-deep in tape, solder and wire clippings in the process.

In fact, we have a sneaking suspicion that our readers like us because they think we're just as bug-eyed and down-right crazy over great new project ideas as they are. And I guess they're right!

E/E thinks of you who dig electronics as the last of a special breed. It's more than just the "do-it-yourself" angle—it's also the spirit of adventure. In this pre-packaged, deodorized world, building your own stereo system, shortwave receiver, darkroom timer or CB outfit is like constructing a fine-tuned little universe all your own. And when it all works perfectly—it really takes you to another world.

**ELEMENTARY ELECTRONICS** knows the kinds of projects you like—and we bring 'em to you by the truckload!

Ever hanker to build a sharp-looking digital clock radio? Or to hook up an electronic game to your TV? Or an easy-to-build photometer that makes perfect picture enlargements? Or a space-age Lite-Com so you and the family can talk to each other on a light beam? We've got it all to get you started.

**WHEN IT COMES TO REPAIRS** E/E can save you time, trouble and a pile of money!

Has your sound system gone blooey just when the party's going great? Do you shudder when your friendly neighborhood electrician hands you the bill? E/E can help.

Of course, we can't make you a master electrician overnight. But we can show you the fundamentals of repair plus maintenance tips.

**IF YOU'RE NEW TO ELECTRONICS** YOU GET A "BASIC COURSE"!

That's right! It's a regular feature. And

### ENJOY GREAT ARTICLES LIKE THESE

- How to Build Your Own Transformer
- How to Select the Right Shortwave Receiver
- The Burgeoning World of Microcomputers
- Quickdraw Rickshaw—The Electric Car that Really Gets Around
- What's Really Wrong with FM Radio?
- How to Power-Up Your Antique Radio
- The Vanishing Vacuum Tube
- How to Customize Your CB Antenna
- Those Incredible TV Sets of the Future
- Listening in on the Forgotten Continent
- DXing Endangered Species
- Sandbagging—CB Fun Without a License
- The World's Worst Hi-Fi Components

**TRY A FEW ISSUES AND EVALUATE OUR...**

► **HOW-TO-DO-IT HELP.** Tips and pointers that add up to money saved. For example—tuning up your tape player . . . all about radios . . . whys and hows of turntables . . . care and feeding of speakers.

► **NO-NONSENSE TESTS.** The scoop on Pioneer's TP-900 FM stereo car radio . . . How well does GE's NiCad charger pep up your pooped batteries? . . . What's your best bet in video games? Plus help in making buying decisions.



► **EXCITING DISCOVERIES.** Whatever your particular interest in electronics, you'll be entering a world of discovery in the pages of ELEMENTARY ELECTRONICS.

**ELEMENTARY ELECTRONICS** is regularly \$6.95 for 6 issues (one year).

But with this special introductory offer you can enjoy a full year for only \$3.98.

**ORDER TODAY!**

See page 6 for Extra Coupon to the excitement and satisfaction of

**ELEMENTARY ELECTRONICS**  
P.O. Box 2630, Greenwich, CT 06835

Yes. Enter my subscription—6 issues for ONLY \$3.98.  
 Payment enclosed.  Bill me.  
(Outside U.S.A. and possessions \$5.00)

Name \_\_\_\_\_

Address \_\_\_\_\_

City \_\_\_\_\_

State \_\_\_\_\_

Zip \_\_\_\_\_

Please allow 6 to 8 weeks for delivery of your first copy.

H91054



**"PLUG IN"**

# BUILD 20 RADIO AND ELECTRONICS CIRCUITS

Reg. U. S. Pat. Off.



Training Electronics Technicians Since 1946

## PROGRESSIVE HOME RADIO-T.V. COURSE

### Now Includes

- ★ 12 RECEIVERS
- ★ 3 TRANSMITTERS
- ★ SQ. WAVE GENERATOR
- ★ SIGNAL TRACER
- ★ AMPLIFIER
- ★ SIGNAL INJECTOR
- ★ CODE OSCILLATOR
- ★ No Knowledge of Radio Necessary
- ★ No Additional Parts or Tools Needed
- ★ Solid State Circuits
- ★ Vacuum Tube Circuits

### YOU DON'T HAVE TO SPEND HUNDREDS OF DOLLARS FOR A RADIO COURSE

The "Edu-Kit" offers you an outstanding PRACTICAL HOME RADIO COURSE at a rock-bottom price. Our Kit is designed to train Radio & Electronics Technicians, making use of the most modern methods of home training. You will learn radio theory, construction practice and servicing. THIS IS A COMPLETE RADIO COURSE IN EVERY DETAIL. You will learn how to build radios, using regular schematics; how to wire and solder in a professional manner; how to service radios. You will work with the standard type of punched metal chassis as well as the latest development of Printed Circuit chassis. You will learn the basic principles of radio. You will construct, study and work with RF and AF amplifiers and oscillators, detectors, rectifiers, test equipment. You will learn and practice code, using the Progressive Code Oscillator. You will learn and practice trouble-shooting, using the Progressive Signal Tracer, Progressive Signal Injector, Progressive Dynamic Radio & Electronics Tester, Square Wave Generator and the accompanying instructional material. You will receive training for the Novice, Technician and General Classes of F.C.C. Radio Amateur Licenses. You will build Receiver, Transmitter, Square Wave Generator, Code Oscillator, Signal Tracer and Signal Injector circuits, and learn how to operate them. You will receive an excellent background for television, Hi-Fi and Electronics. Absolutely no previous knowledge of radio or science is required. The "Edu-Kit" is the product of many years of teaching and engineering experience. The "Edu-Kit" will provide you with a basic education in Electronics and Radio, worth many times the low price you pay. The Signal Tracer alone is worth more than the price of the kit.

### THE KIT FOR EVERYONE

You do not need the slightest background in radio or science. Whether you are interested in Radio & Electronics because you want an interesting hobby, a well paying business or a job with a future, you will find the "Edu-Kit" a worth-while investment. Many thousands of individuals of all ages and backgrounds have successfully used the "Edu-Kit" in more than 79 countries of the world. The "Edu-Kit" has been carefully designed, step by step, so that you cannot make a mistake. The "Edu-Kit" allows you to teach yourself at your own rate. No instructor is necessary.

### PROGRESSIVE TEACHING METHOD

The Progressive Radio "Edu-Kit" is the foremost educational radio kit in the world, and is universally accepted as the standard in the field of electronics training. The "Edu-Kit" uses the modern educational principle of "Learn by Doing." Therefore you construct, learn schematics, study theory, practice trouble shooting—all in a closely integrated program designed to provide an easily-learned, thorough and interesting background in radio. You begin by examining the various radio parts of the "Edu-Kit." You then learn the function, theory and wiring of these parts. Then you build a simple radio. With this first set you will enjoy listening to regular broadcast stations, learn theory, practice testing and trouble-shooting. Then you build a more advanced radio, learn more advanced theory and techniques. Gradually, in a progressive manner, and at your own rate, you will find yourself constructing more advanced multi-tube radio circuits, and doing work like a professional Radio Technician. Included in the "Edu-Kit" course are Receiver, Transmitter, Code Oscillator, Signal Tracer, Square Wave Generator and Signal Injector Circuits. These are not unprofessional "breadboard" experiments, but genuine radio circuits, constructed by means of professional wiring and soldering on metal chassis, plus the new method of radio construction known as "Printed Circuitry." These circuits operate on your regular AC or DC house current.

### THE "EDU-KIT" IS COMPLETE

You will receive all parts and instructions necessary to build twenty different radio and electronics circuits, each guaranteed to operate. Our Kits contain tubes, tube sockets, variable, electrolytic, mica, ceramic and paper dielectric condensers, resistors, tie strips, hardware, tubing, punched metal chassis, Instruction Manuals, hook-up wire, solder, selenium rectifiers, coils, volume controls, switches, solid state devices, etc. In addition, you receive Printed Circuit materials, including Printed Circuit chassis, special tube sockets, hardware and instructions. You also receive a useful set of tools, a professional electric soldering iron, and a self-powered Dynamic Radio and Electronics Tester. The "Edu-Kit" also includes Code Instructions and the Progressive Code Oscillator, in addition to F.C.C. Radio Amateur License training. You will also receive lessons for servicing with the Progressive Signal Tracer and the Progressive Signal Injector, a High Fidelity Guide and a Quiz Book. You receive Membership in Radio-TV Club, Free Consultation Service, Certificate of Merit and Discount Privileges. You receive all parts, tools, instructions, etc. Everything is yours to keep.

### FREE EXTRAS

- SET OF TOOLS
- SOLDERING IRON
- ELECTRONICS TESTER
- PLIERS-CUTTERS
- VALUABLE DISCOUNT CARD
- CERTIFICATE OF MERIT
- TESTER INSTRUCTION MANUAL
- HIGH FIDELITY GUIDE • QUIZZES
- TELEVISION BOOK • RADIO TROUBLE-SHOOTING BOOK
- MEMBERSHIP IN RADIO-TV CLUB: CONSULTATION SERVICE • FCC AMATEUR LICENSE TRAINING • PRINTED CIRCUITRY

### SERVICING LESSONS

You will learn trouble-shooting and servicing in a progressive manner. You will practice repairs on the sets that you construct. You will learn symptoms and causes of trouble in home, portable and car radios. You will learn how to use the professional Signal Tracer, the unique Signal Injector and the dynamic Radio & Electronics Tester. While you are learning in this practical way, you will be able to do many a repair job for your friends and neighbors, and charge fees, which will far exceed the price of the "Edu-Kit." Our Consultation Service will help you with any technical problems you may have.

### FROM OUR MAIL BAG

Ben Valerio, P. O. Box 21, Magna, Utah: "The Edu-Kits are wonderful. Here I am sending you the questions and also the answers for them. I have been in Radio for the last seven years, but like to work with Radio Kits, and like to build Radio Testing Equipment. I enjoyed every minute I worked with the different kits: the Signal Tracer works fine. Also like to let you know that I feel proud of becoming a member of your Radio-TV Club."

Robert L. Shuff, 1534 Monroe Ave., Huntington, W. Va.: "Thought I would drop you a few lines to say that I received my Edu-Kit, and was really amazed that such a bargain can be had at such a low price. I have already started repairing radios and phonographs. My friends were really surprised to see me get into the swing of it so quickly. The Trouble-shooting Tester that comes with the Kit is really swell, and finds the trouble, if there is any to be found."

### SOLID STATE

Today an electronics technician or hobbyist requires a knowledge of solid state, as well as vacuum tube circuitry. The "Edu-Kit" course teaches both. You will build vacuum tube, 100% solid state and combination ("hybrid") circuits.

### PRINTED CIRCUITRY

At no increase in price, the "Edu-Kit" now includes Printed Circuitry. You build a Printed Circuit Signal Injector, a unique servicing instrument that can detect many Radio and TV troubles. This revolutionary new technique of radio construction is now becoming popular in commercial radio and TV sets. A Printed Circuit is a special insulated chassis on which has been deposited a conducting material which takes the place of wiring. The various parts are merely plugged in and soldered to terminals. Printed Circuitry is the basis of modern Automation Electronics. A knowledge of this subject is a necessity today for anyone interested in Electronics.

Progressive "Edu-Kits" Inc., 1189 Broadway, Dept. 505-GT Hewlett, N.Y. 11557

Please rush me free literature describing the Progressive Radio-TV Course with Edu-Kits. No Salesman will call.

NAME .....

ADDRESS .....

CITY & STATE ..... ZIP .....

**PROGRESSIVE "EDU-KITS" INC.**  
1189 Broadway, Dept. 505-GT Hewlett, N.Y. 11557