

# RADIO & TV

# HINTS

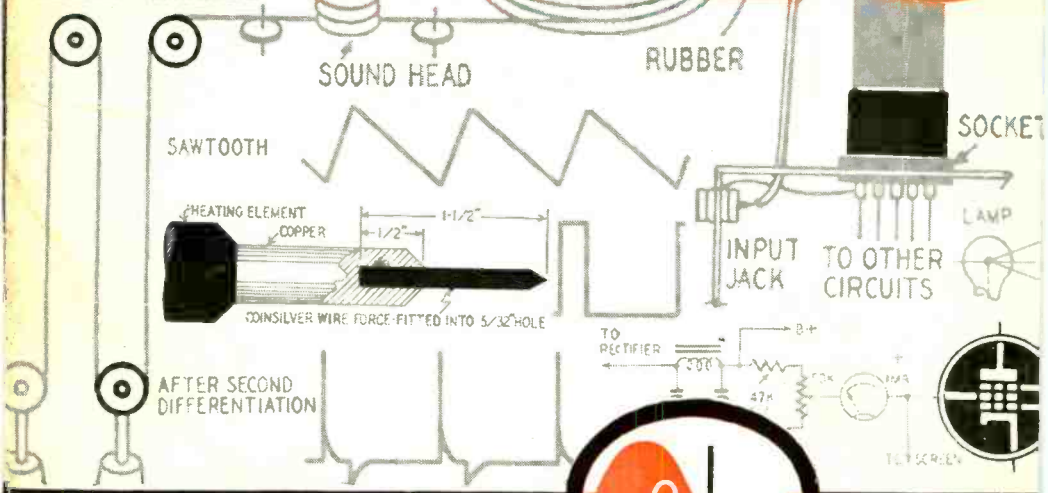



# RADIO & TV HINTS

*edited by*

**MARTIN CLIFFORD**

*Formerly Associate Supervisor, Pierce School of Radio and Television, New York, N. Y.  
Senior Instructor, Radio-Television Training Association, New York, N. Y.*

*in cooperation with*

The Editors of RADIO-ELECTRONICS Magazine



Gernsback Library No. 47

PUBLISHED BY  
Gernsback Library, Inc.  
New York, N. Y.

**COPYRIGHT, 1952**  
**BY HUGO GERNSBACK**

**All Rights Reserved**

**First Printing—November 1952**

**Second Printing—June 1954**

**Third Printing—August 1958**

**Fourth Printing—July 1959**

# Introduction

**S**CROUNGE around the work bench of a service technician, or a ham, remove the accumulated clutter of speakers and half-built amplifiers in an audio lab, or push aside the slipstick and eyeglasses on an engineer's desk and you'll find yourself a gimmick.

This is a gimmick book. A gimmick may be just an idea, or a piece of wire shaped into a tool, or an electronic stunt that is so obvious that it just hasn't occurred to you as yet. The rubber on the end of your pencil started life as a gimmick. A pencil clip is a gimmick. An amplifier tube used as a rectifier is a gimmick. So is a bicycle spoke used as a dial stringing tool. And so is a piece of two-wire transmission line used as a precision fixed capacitor. A gimmick is a kink, a circuit, a tool—all used in a novel, unique, new way. Get the idea?

Radio & TV Hints contains numerous kinks and shortcuts taken directly from the actual day-by-day experience of more than hundreds of service technicians, radio amateurs, audio fans, experimenters, and engineers. Some of the ideas dreamed up by these electronics groups were strictly for show; unique, clever, and not worth the room they took up. Such hints were carefully filed away and forgotten. The hints and kinks in this book are practical, are in actual use, and can be put to work by you. They do not represent the very last word in electronic know-how, since it is highly possible to improve upon and expand their use. We urge you to do so.

Radio & TV Hints is not intended as a reference book to be consulted only once in a great while. It belongs right on your work bench or test bench, as much a part of your equipment as your soldering iron and scope. The benefit you will get from this book will be in direct proportion to the amount of time that you spend in reading it. Remember also that this is not intended as a radio theory book. We assume that you are busy with some form of electronics and have acquired a background such that you can put this book to its best use.

We've made a deliberate attempt to reach as many different electronic groups as possible. If you are a ham, then the section on radio amateurs is definitely for

you. If you like audio, high-fidelity or otherwise, use the chapter on audio. However, just because a particular kink appears in a particular chapter does not mean that its use is confined and restricted to that one application. Browse through the book constantly. You will find many ideas suited to your own electronic needs—ideas that may be used directly or with modifications.

If this book saves you some hours of time, or if it shows you how to do a job that was a stickler, or gives you some needed service suggestions—in short, if it has saved you as much as one hour and one unnecessary drop of perspiration, then it will have fulfilled its purpose.

Martin Clifford

# Section 1

## Test Instruments

### Capacitor Decade Box

A capacitor decade box having a range of  $10\ \mu\text{mf}$  to more than  $0.1\ \mu\text{f}$  can be made from 16 capacitors and eight toggle or slide-type s.p.d.t. switches connected as shown in the diagram, Fig. 101. It is advisable to use capacitors having a 600 volt rating. The

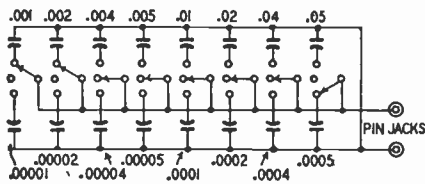

Fig. 101. Wide-range capacitor decade box.

switches should have a "dead" or off position so capacitors not in use are out of the circuit. The decade box is set at  $.0035\ \mu\text{f}$  in the diagram. The range of the decade box can be extended by using more capacitors and switches.

### Capacitor Values

Often capacitors in the junkbox or

in a receiver are not marked. To find the value of any capacitor, use a relaxation oscillator to compare it with units of known value.

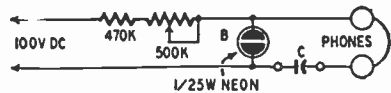

Fig. 102. R-C capacitor tester.

A simple relaxation oscillator is shown in Fig. 102. Adjust the potentiometer for a low-frequency tone with the unknown capacitor connected as C. Then substitute various known values for C until the same tone is heard. The unknown capacitor will then be approximately equal to the known one.

Although electrolytics are usually clearly marked, the capacitance can be quite different from that marked on the capacitor. When checking electrolytics against a standard capacitor, make sure that you observe the proper polarity when connecting the electrolytic to be tested.

## Handy Substitution Box

A combination capacitor substitution box and headphone adapter for a.f. signal tracing is a handy piece of equipment to have on your workbench. This unit consists of 11 fixed capacitors which may be connected to circuits under test and two blocking capacitors which are inserted in series with the phone leads when the selector switch is turned to position 12. You can use the capacitor values shown in the drawing

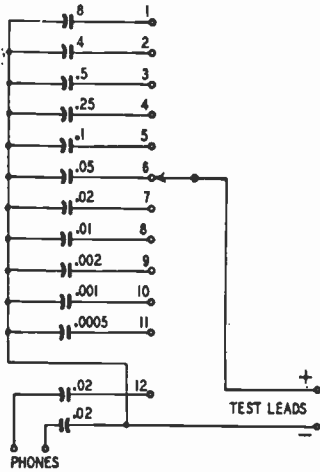

Fig. 103. Substitution box-phone adapter.

(Fig. 103) or values most often encountered in your work.

To use the unit as an audio signal tracer, set the selector switch on position 12, plug in the headphones, and use; connect the test prods to the circuit under test.

## Capacitor Substitution Box

This capacitor substitution box is very useful in TV and radio servicing. Using only 21 capacitors and an equal number of s.p.s.t. switches in the cir-

cuit shown in Fig. 104, you can cover the equivalent of 54 different capacitors arranged in the form of a decade

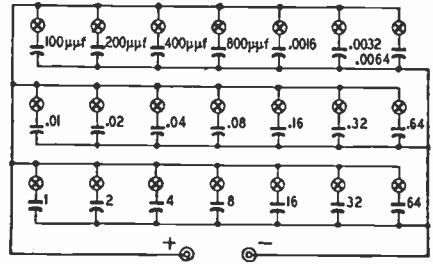

Fig. 104. Capacitor substitution box.

box. This capacitor box substitutes for approximately 262,656 individual capacitors. The components are mounted in a 4 × 5 × 9-inch metal box with switches and terminals on the front. Connections are made so stray capacitance is minimized.

## Capacitor Checker

This circuit can be used to check the quality and approximate capacitance of the most common values of electrolytic and paper capacitors. The circuit consists of a relaxation-type oscillator transformer-coupled to an audio amplifier and speaker or a pair of headphones.

With the values indicated in Fig. 105,

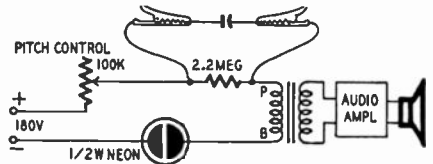

Fig. 105. Electrolytic capacitor tester.

the neon tube will oscillate readily with good capacitors having values as low as approximately .005  $\mu$ f. Capacitor val-



ues are determined by comparing the tone produced by the unit under test with that of a standard capacitor. If the capacitor is open, the lamp will not oscillate and no sound will be heard. A shorted capacitor will cause the lamp to glow continuously.

The capacitors are connected to the unit by flexible leads fitted with alligator clips. Since the alligator clips go to the 180-volt bus, insulate them with tape or flexible rubber insulators.

### Testing Capacitors

You will find this circuit (Fig. 106) handy and accurate for checking *low-voltage* electrolytic capacitors for leakage. In it, the capacitor to be checked

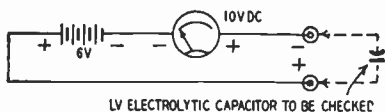

Fig. 106. Electrolytic leakage tester.

is connected in series with a 6-volt battery and a 10-volt d.c. meter. On a good capacitor, the meter will read zero or close to it. Discard the capacitor if the meter shows more than 2 volts. The units can be checked for capacitance on a standard capacitance checker.

### Simple Test for Meters

When it is necessary to test an ammeter or voltmeter for burnout, and no battery or other voltage source is available, proceed as follows: In the case of an ammeter, disconnect any shunts connected across the meter coil, whether inside or outside the case. Then, shake

the meter sharply and note the pointer deflection. Place a short circuit across the meter terminals. With a voltmeter, be sure to get the short directly across the coil, leaving out any internal or external multipliers. After this is done, shake the meter as before and again note the pointer movement. If the meter coil is good, the deflection will be much less than before. This reduction is caused by electromagnetic damping by currents induced in the coil when the pointer swings. These currents flow through the coil and across the short-circuited terminals. However, if the coil is burned out or otherwise open-circuited, these currents cannot flow, and thus there is no reduction in deflection.

### Stabilizing the V.T.V.M.

Many commercial and home-made vacuum-tube voltmeters show a shift in the zero point when the range is shifted. Particularly noticeable on the

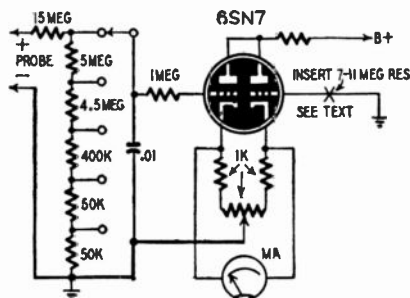

Fig. 107. Method for stabilizing the v.t.v.m.

lowest range, this effect is caused by grid current flowing through the voltage divider which usually has a resistance of 10 megohms or more. Because the grid resistance is different for each

range, the grid voltage will change accordingly and the zero will shift.

Some balanced vacuum-tube voltmeters are arranged to have the grid resistance constant. This is an improvement, but does not entirely eliminate the trouble because most circuits do not have a compensating resistor in the grid circuit of the balancing tube.

A typical unbalanced v.t.v.m. is shown in Fig. 107. Zero shift will be negligible if a suitable resistor is inserted at X in the grid return of the balancing tube. The value of this resistor will be approximately equal to the resistance between grid and ground of the active stage on the lowest range.

This resistance usually being moderately smaller than the 15-megohm probe resistance, the optimum value is likely to be slightly more than 7 megohms. This resistance is not critical, and 7 to 11 megohms should work nicely.

### Extending Range of V.T.V.M.

The range and utility of an electronic voltohmmeter can be extended by adding two banana jacks and a s.p.d.t. switch. Mount the switch and jacks on the panel and connect them as

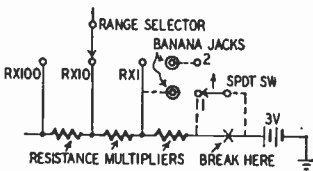

Fig. 108. Increasing usefulness of v.t.v.m.

shown in Fig. 108. Operation is normal when the s.p.d.t. switch is in position 1. To increase the resistance

range of the meter, set the range selector to  $R \times 1$ , throw the s.p.d.t. switch to position 2, then insert a suitable precision multiplier resistor in the jacks.

Care must be taken when using a soldering iron near the precision resistors in the ohmmeter, because overheating them is likely to change their values permanently.

Two resistors can be matched by connecting one across the ohmmeter test leads and plugging the other into the jacks. They are equal when the needle rests in the center of the scale, having previously been zeroed with the jacks open.

The precise value of a resistor can be ascertained by connecting it to the resistance test leads and connecting a decade resistor box to the jacks. The unknown resistor is equal to the setting of the decade when the needle is centered. The accuracy will be as great as that of the decade resistors.

### V.T.V.M. Hint

Many v.t.v.m.'s use a pin jack for one of the connecting leads. If the pin jack has a habit of working its way loose, coat the pin jack with a thin film of solder. Solder is soft enough to allow the pin jack to make a force fit.

### Voltage Divider Design

The design of a divider for a v.t.v.m. is not difficult but it may become confusing unless a system is followed.

First list the desired voltage ranges in column A, starting with the lowest range. See Fig. 109. Next fill out column B, writing down the total divider

resistance at the top. Under this are numbers which are inversely proportional to the corresponding voltage ranges. For example, if the next range is 5 times as large, the corresponding column B number is  $\frac{1}{5}$  the preceding one.

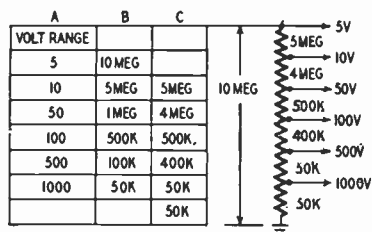

Fig. 109. Voltage divider for v.t.v.m.

When the first two columns are finished, start column C. The numbers in this column are the differences between consecutive numbers in column B. When column C is finished it gives the individual divider resistances in megohms from the hot terminal to ground.

### V.T.V.M. Mount

If you prefer to work standing, a block of wood having a V-shaped notch will hold your v.t.v.m. so that you can take readings without getting a stretched neck. A piece of rubber under the V-block will keep it from sliding around.

### Polarity-Reversing Switch

The polarity-reversing switch shown in Fig. 110 is simple and easily made. It consists of a slide or toggle type d.p.d.t. switch and a pair of jacks on an insulated panel or on the top of a small box. The flexible leads which connect to the switch arms (see diagram in

Fig. 110) are fitted with tips which fit the jacks on the multimeter.

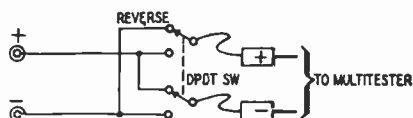

Fig. 110. Reversing switch for multimeter.

jacks on the polarity reverser fit the tips of the test leads.

To use the unit, plug the flexible leads into the jacks on the multimeter and plug the test leads into the jacks on the switch panel. When measuring negative voltages, all that is necessary is to flip the switch instead of transferring the leads at the multimeter.

The polarity-reversing switch need not be external to your v.t.v.m. or multimeter. If there is sufficient room, this switch can be mounted on the front panel of your test instrument.

### Unique Crystal Probe

Many owners of vacuum-tube voltmeters have constructed a.c.-r.f. test probes for their instruments, using 1N34 crystal diodes. These probe circuits are peak-operated and are of the shunt-diode type.

The probe circuit shown in Fig. 111 is unusual in that it has an a.f.-r.f. voltage-quadrupler arrangement. Voltage stepup is obtained without a transformer. The d.c. output voltage of this probe is equal to approximately 5.66 times the r.m.s. value of the input voltage. This results in a much increased meter sensitivity. For example, the full-scale deflection on the 0-3-volt d.c. range of the v.t. voltmeter will indicate an a.f. or r.f. input voltage of

only 0.53 volt r.m.s. when this probe is used.

Although the voltage-quadrupling probe uses four 1N34 crystals and four 0.01- $\mu\text{f}$  postage-stamp mica capacitors, it may be built into a small-sized container. The crystal polarities indicated in the schematic must be followed exactly or the circuit will not multiply correctly.

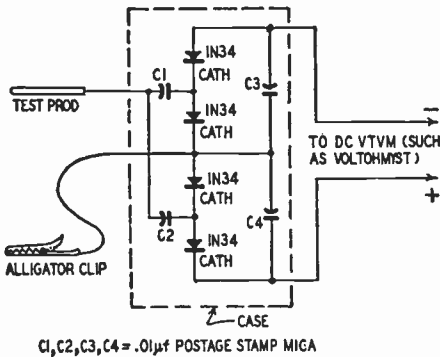

Fig. 111. Voltage-quadrupler crystal probe.

It is advisable to make an individual voltage calibration after the probe has been completed and plugged into the d.c. vacuum-tube voltmeter, since the rectification efficiency of production-lot crystals varies and the 5.66 multiplication factor might not hold exactly for a particular quartet of crystals.

### Hear Your Oscillogram

An oscilloscope is a highly useful instrument. However, when working on a radio receiver or audio amplifier, it is often difficult to interpret the oscillograms, because the signals which they represent are intended for the ear instead of the eye. When using an actual signal for servicing, it is difficult to tell

whether the waveforms are normal or not. The solution is to connect a head-phone jack in the vertical deflection circuit of the oscilloscope, enabling the waveform to be heard as well as seen.

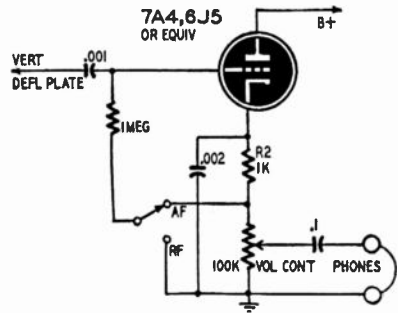

Fig. 112. Method for adding phones to scope.

Such a direct connection is useful only for audio-frequency signals. The circuit shown in Fig. 112 is capable of making audible audio-frequency signals, and the modulation on r.f. signals.

Its operation is simple. Throwing the switch to the AF position connects the tube as a cathode follower, while the RF position connects the tube as an infinite-impedance detector. The input is through the .001- $\mu\text{f}$  capacitor to the vertical deflection plate or the output of the vertical amplifier, thus getting plenty of signal. The output is controlled by the potentiometer which also acts as the tube load resistor. The oscilloscope circuit should be checked to make sure that the signal take-off point is not at a dangerously high potential. The .001- $\mu\text{f}$  coupling capacitor must have a voltage rating high enough to withstand the peak potential at the point of signal takeoff.

This circuit makes it possible to use the ears to detect troubles such as dis-

tortion, noise, or hum, difficult to detect from oscillograms, especially when they are slight. Then, a close examination of the oscillogram of the defective signal can be used to determine the electronic nature of the defect.

### Scope Preamplifier

Although designed for use with Sylvania 131 and 132 oscilloscopes, experimenters and service technicians will find the preamplifier of Fig. 113 a useful addition to conventional scopes of almost any make. Having a gain of approximately 30, it makes many traces viewable which do not show up well on the scope alone.

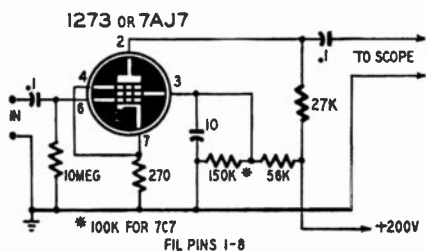

Fig. 113. Circuit for increasing scope gain.

The frequency response is  $\pm 10\%$  from 10 cycles to 70 kc (1,000 cycles reference), down not more than  $15\%$  at 90 kc or  $25\%$  at 145 kc.

The 1273 is a nonmicrophonic pentode having physical and electrical characteristics of the 7AJ7. A 7AJ7 or 7C7 may be used. The 150,000-ohm resistor must be changed to 100,000 ohms when the 7C7 is used.

### Longer Life for Meters

The life and accuracy of the sensi-

tive movement of a 20,000-ohms-per-volt multimeter can be prolonged by keeping the function switch set to a.c. VOLTS whenever the meter is being carried on outside jobs. Setting the meter to read a.c. voltage damps the meter movement by shunting it with the low resistance of the instrument rectifier. This damping action greatly reduces pivot wear caused by bouncing while in transit. This fact can be verified by setting the meter to d.c. VOLTS and giving it a quick jerk. The meter will swing wildly upscale. Try an a.c. range and note how much the needle is damped.

The meter can also be protected against vibration and sudden jolts by setting the function switch to a high current range. This damps the movement by loading it with the current shunts. This method is not recommended. The meter will burn out if you forget to switch the meter before measuring voltage.

### Precision Resistors

When winding precision resistors by hand, the usual procedure is to solder the resistance wire to the terminals and then check the resistance on a bridge. Thermoelectric effects will cause erroneous readings as long as the soldered joints are slightly warm. Instead of waiting for the joints to reach room temperature, use the following procedure when winding resistors:

Cut the resistance wire slightly longer than necessary and then cut it in the middle. The ends of the halves are permanently fastened to the terminals and the inside ends of the wires are

then soldered together. The resistance is reduced to precisely the desired value by lengthening the soldered joint as shown in Fig. 114. With this type of

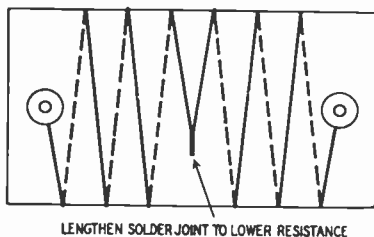

Fig. 114. Eliminating thermoelectric effect.

construction, the thermoelectric effects are equal and opposite so they cancel.

If the resistance wire is difficult to solder, try wrapping the joint tightly with No. 30 tinned copper wire before soldering.

### Voltmeter as a Precision Resistor

The common multirange voltmeter is a source of precision resistors which can be used for calibration work without removing them from the voltmeter. When the multimeter is switched to read d.c. volts, the circuit consists of a simple series arrangement of meter and multiplier resistor as shown in Fig. 115. This series circuit

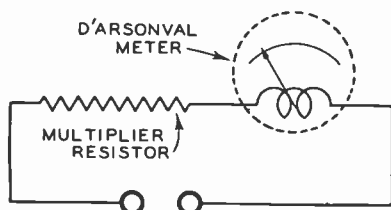

Fig. 115. Voltmeter as precision resistor.

is connected to the test leads for convenient use. The total resistance of the

series circuit is determined by the voltage range and the meter sensitivity. It can be computed by multiplying the voltage range by the ohms-per-volt rating of the multimeter. For instance, if the sensitivity is 1,000 ohms per volt and the 30-volt range is used, the resistance is 1,000 times 30 or 30,000 ohms. This will be accurate to  $\pm 1\%$  for the average instrument. If two multimeters are available, they may be connected in series or parallel to increase the combinations of resistors.

Pay no attention to any reading that may occur on the meter unless, of course, it goes off scale.

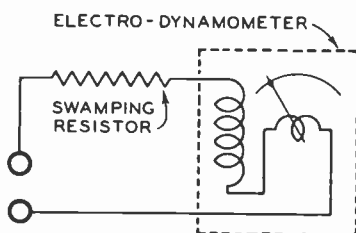

Fig. 116. Electro-dynamometer as precision resistor.

This method may be used on a.c. work without any damage to the meter since it cannot follow the cyclic fluctuations of the alternating current.

A laboratory electro-dynamometer voltmeter has an accurate, temperature-compensated, swamping resistor in series with the meter coils, as in Fig. 116. This resistor is in the order of a few thousand ohms for a 150-volt meter. Usually the meter carries the resistance value on the data nameplate. The meter will read on d.c. or a.c., and can indicate when a safe current value has been reached when it is used for resistance purposes.

Because the resistance value given for both meters includes the resistance of the meter coils, no correction need be made.

A vacuum-tube voltmeter is not suitable for this use since it operates on a different principle.

When using a meter as a precision resistor, always make a few calculations beforehand to find the voltage that will be placed across the meter and multiplier. Be sure it is not greater than the maximum reading of the scale you plan to use.

### Extending Voltmeter Range

Many owners of multimeters sometimes have to measure voltages higher than their meters ordinarily will handle. A simple way to extend meter range is to use a test prod with a multiplier resistor built into it. A standard  $\frac{1}{2}$ -watt resistor can be inserted in the handle of most test prods.

All the information necessary for choosing the correct resistance value is the sensitivity of the meter in ohms per volt, usually given in the manufacturer's instruction book. If the meter has a sensitivity of 1,000 ohms per volt, for example (this is usual), and you want to extend the 300-volt range to read 600 volts, multiply the difference between the old and desired full-scale readings ( $600 - 300 = 300$ ) by 1,000 ( $300 \times 1,000 = 300,000$ ). For best accuracy, the 300,000-ohm resistor used should have a tolerance of no more than  $\pm 1\%$ . To make the original 300-volt range read 900 volts, use a 600,000-ohm resistor; and so on.

If you choose even multiples of the

existing meter scales, you can read the higher values simply by multiplying. For instance, if the 300,000-ohm resistor is used with the 300-volt scale to read a maximum of 600 volts, just multiply any reading by 2. For 900 volts maximum, multiply by 3.

If you use multipliers to read voltages around 1,000 or more, be sure to get a high-voltage probe, one with sufficient insulation to protect you from arc-overs and breakdowns.

### Electronic Flasher

The simple electronic flasher shown in Fig. 117 can be used as a flashing

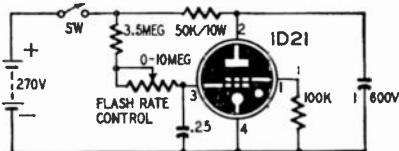

Fig. 117. Circuit of portable stroboscope.

danger signal or as a portable stroboscope for timing and checking rotating and reciprocating mechanical parts. Operating voltage is supplied by a power supply capable of delivering 270 volts d.c.

An R-C network consisting of approximately 13 megohms in series with a 0.25- $\mu$ f capacitor is connected in parallel with the plate and cathode of the 1D21 Strobotron and the 270-volt supply. The starter anode of the tube is connected to the positive side of the capacitor. When the switch is closed, the 0.25- $\mu$ f capacitor starts to charge through the series resistance. When the charge across the capacitor reaches approximately 60 volts, the starter anode ionizes the gas in the tube and causes

the 1- $\mu$ f capacitor to discharge through the plate-cathode circuit to produce the bright neon-red flash. The flash repeats at a rate controlled by the setting of the 10-megohm potentiometer.

### CRO as Stroboscope

A cathode-ray oscilloscope can be used as a stroboscope to "stop" motion. The only requirement is that it must have a short-persistence screen.

Disconnect the saw-tooth generator from the deflection circuits and connect it to the Z-axis input (the electrode which controls the intensity of the pattern). With the sweep generator operating at a low frequency, adjust the brightness control so that the spot appears on the screen only at the peak of the saw-tooth wave. Then apply external signals to the deflection plates to get as large a light pattern as possible. The frequency of the external signals should be high compared to that of the sweep generator.

### Unusual Scope Applications

If your scope has a ruled grid in front of the C-R tube, you can use it for comparing the strength of permanent magnets, or as an electroscoper.

If a negatively charged body is brought close to the ruled plate while the horizontal sweep is on, the trace will open in the center. The separation will depend on the settings of the intensity and focus controls and on the potential of the charged body. For best results, keep the intensity control turned down and bring the charged body to the exact center of the screen. If the plate becomes charged, run up

the intensity control for a moment and then return it to its original position.

To compare the strength of permanent magnets, turn on the horizontal sweep and adjust the focus and intensity controls to the desired level. Place the horseshoe magnet against the plate with its sides parallel to the face of the tube. The pole faces should be just under the horizontal center line and on the vertical center line. The beam should be deflected upward; if not, turn the magnet over. The distance through which the beam is deflected is a measure of the magnet's strength.

### Camera Shutter Timer

If your oscilloscope has a calibrated driven sweep, use it in conjunction with a photoelectric cell to check the speed of your camera shutter. A typical setup is shown in Fig. 118. The

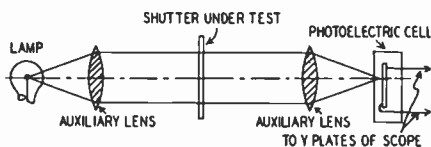

Fig. 118. Setup for checking shutter speed.

auxiliary lens is not needed if the camera is focused on the lamp and the emissive surface of the cell is in the plane of the film.

When the shutter is tripped, the cell generates a pulse which triggers the sweep on the scope. Applied to the Y plates of the scope, the pulse bends the horizontal trace in a vertical direction. A typical trace for a radial shutter is shown in Fig. 119a and a focal plane shutter in Fig. 119b. Because the sweep is linear, the length of the sweep can



be measured with a rule and compared with the length of the shutter trace.

A camera with a fast lens and high-speed film is used to photograph the trace on the cathode-ray tube. It may

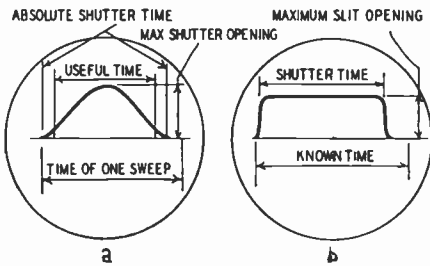

Fig. 119. Typical trace for radial and focal plane shutter.

be possible to record the trace by fastening a piece of high-speed pack or cut film to the face of the cathode-ray tube. Keep the intensity control turned off until a moment before the shutter is snapped; then turn it down immediately after the exposure.

The sweep oscillator should be adjusted so that the duration of one sweep is longer than the assumed speed of the shutter; thus the shutter opens and closes during the sweep interval. Use 20- and 200-cycle sweeps when testing 1/25- and 1/250-second shutters.

### Pulses from a CRO

Next time you need a sawtooth or pulse generator don't overlook your oscilloscope as a source. A sawtooth generator feeds the horizontal plates D1, D2. These plates are accessible through terminals usually located at the rear of the scope. Frequency is determined by the sweep-frequency control.

When the deflection circuit is balanced to ground, the output may be taken off in three different ways. Leads directly to D1 and D2 provide an unbalanced output. Grounded output is available by connecting one lead to ground (of the scope) and the other to one of the terminals. Polarity is reversed by interchanging terminals D1 and D2.

The sawtooth may be converted to a pulse by differentiation networks. One stage converts it to a rectangular wave. A second stage results in a sharp, rapidly decaying pulse. Fig. 120a shows the waveforms and Fig. 120b the differentiating network.

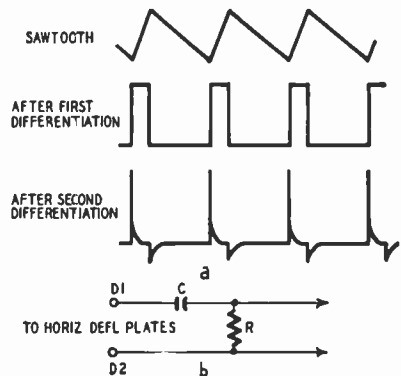

Fig. 120. Making use of scope pulses. Note the effect on the waveform after repeated differentiation.

The time constant ( $RC$ ) of the differentiation network should be small relative to the period of the sawtooth or pulse wave. For proper differentiation  $R$  should be small in comparison with  $X_c$ . However, if  $R$  is made too low, a weak pulse will result. For medium frequencies  $R$  may be 25,000 ohms and  $C$  may be .002  $\mu\text{f}$ .

## Wattmeter Substitute

Useful and easy to build, the wattmeter shown in Fig. 121 will check the power consumed by radios, TV sets, and various a.c. appliances. Short circuits and overloads can be detected by comparing the meter reading with the manufacturer's rating on the device. Most service technicians do not have

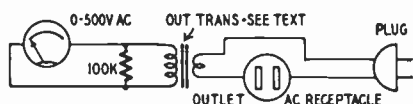

Fig. 121. Voltmeter converted to wattmeter.

an a.c. ammeter but they do have a reliable a.c. voltmeter which can be used.

Select a husky output transformer which has a secondary consisting of few turns of heavy wire or use one having a tapped secondary. Connect an a.c. receptacle and line cord in series with the secondary and shunt the primary with a 100,000-ohm resistor and a 500- or 1,000-volt a.c. meter. The resistor is to prevent arcing across the primary.

When a set or other appliance is plugged into the outlet, the meter will show a voltage which can be converted to watts. Plug different size lamps into the receptacle and record the voltage and wattage ratings. Use the tap on the transformer which makes the meter read nearest 100 volts with a 100-watt lamp. When a number of checks have been made, record the data on a chart or graph.

To check a radio or TV set, plug it into the wattmeter and let its tubes come to operating temperature. Convert the meter reading to watts and

compare this figure with the manufacturer's wattage rating. Shorted filter or bypass capacitors in a receiver or amplifier will cause a noticeable increase in wattage. Open transformers, resistors, etc., will cause the wattage to be low. Excessive current in a motor will probably be caused by shorted turns in a winding or by an excessive load.

## Wattage Checker

Sometimes it is desirable to know how much current a receiver or other appliance draws from the a.c. line. A quick check on line current will often show up a partial short in a filter capacitor or power transformer. Since most multimeters do not have provisions for measuring alternating current, you can use this adapter unit in conjunction with the a.c. voltage range of the meter. The adapter is shown in the diagram Fig. 122.

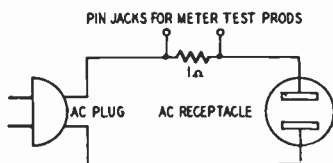

Fig. 122. Circuit for checking wattage drain.

The adapter is simply a 1-ohm wire-wound resistor inserted in series with one side of the power line. Either side of the power line can be used. Pin jacks are provided so a meter can be connected to measure the voltage drop across the resistor. By using a 1-ohm resistor, an a.c. voltmeter scale can be read directly in amperes without using charts or calibration tables. To find the

wattage drain simply square the meter reading since watts equals  $E^2/R$ .

The wattage rating of the resistor is determined by the receiver current drain. A 10-watt resistor will handle a little more than 3 amperes. The reactance of a 1-ohm wire-wound resistor at 60 cycles may be neglected.

### Locator for Open Heaters

An open heater in a series string is easy to locate with a tester made by connecting a set of test prods to a 10-watt, 115-volt lamp. Touch the prods to the heater pins of each tube. The lamp lights when it is across the open heater. You can also use your multi-meter or v.t.v.m. in the same manner.

### Intermittent-Heater Checker

Intermittent heaters in a.c.-d.c. sets are hard to locate and have caused many service technicians to waste lots of time hunting for them. This little gadget will enable you to locate intermittent heaters in a comparatively short time.

Get a spare tube socket and wire the

filament or heater terminals in series with a 117-volt lamp. A 25-watt size will do the job for testing most tubes used in a.c.-d.c. sets. Check the wattage of the lamp to be sure that the drop across the tube will not exceed its normal voltage rating.

The lamp will remain lighted as long as there is continuity through the tube socket. An intermittent heater will cause the lamp to go off and on or flicker. It's a good idea to make up a test set of spare tube sockets for different types of tubes.

### A.F. and I.F. Signal Tracer

The simple signal tracer shown in Fig. 123 has two tuned channels for tracing signals and aligning broadcast receiver i.f.'s, and an input circuit for tracing and probing in audio circuits. The tuned stages consist of two 6SK7 amplifiers with 175- and 456-kc i.f. transformers in their plate circuits. The secondary of either transformer can be switched to the detector diodes of the 6SQ7 detector and first a.f. amplifier.

After aligning the tracer's trans.

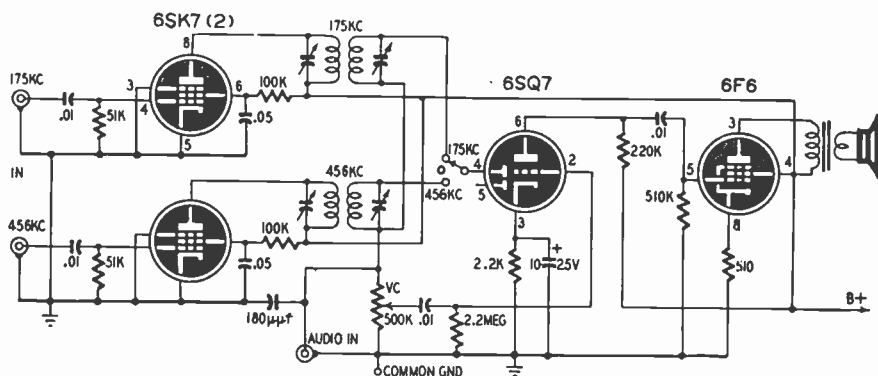

Fig. 123. This circuit can be used for tracing a.f. and i.f. troubles.

formers with an accurate signal generator, it can be used to trace a signal from the mixer plate to the second detector in receivers using 175- or 456-kc i.f.'s. Smaller receivers can be aligned without using a signal generator. Switch the tracer to the proper i.f. and connect its input to the i.f. output of the set. Adjust the set's i.f. trimmers for maximum output from the tracer's speaker. Plug a shielded lead into the audio jack for audio-signal tracing.

### Thermal Shunt

While studying the effect of heat on the value of resistors and other components used in electronic equipment, the Telecommunication Research Establishment, a branch of Britain's Ministry of Supply, found that small composition resistors can be ruined by heat when using standard soldering techniques. The heat from the soldering iron may cause the value of the

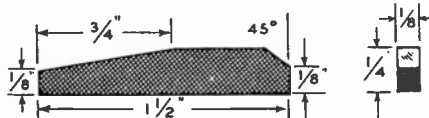

Fig. 124a. Dimensions of thermal shunt.

resistor to increase or decrease by 20% or more. The body temperature of the resistor should be restricted to 100° C and preferably 50° C if permanent change in the initial value is to be avoided. In most cases, the temperature rise does not reach the critical value when the length of lead between the body and soldered joint is at least 1/2 inch.

Leads 1/2 inch long are prohibitive in

most miniature apparatus, so a *thermal shunt* was developed to dissipate the unwanted heat and prevent it from reaching the body of the component. The shunt consists of a crocodile clip with copper bars 1/8 inch thick, 1/4 inch wide, and 1 1/2 inches long sweated to



Fig. 124b. Appearance of completed shunt.

its jaws. The shunt is clamped to the resistor lead so it is at least 1/16 inch from the body of the resistor and from the soldering lug. It should be left in

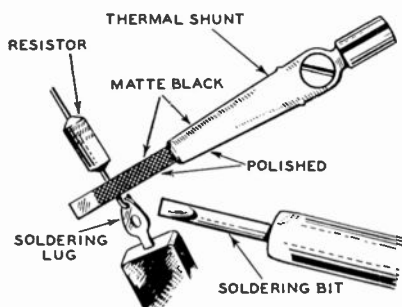

Fig. 124c. Illustration shows how the thermal shunt is put to use.

this position for at least 15 seconds after the iron is removed from the joint.

The construction of the shunt is shown in Fig. 124a, b, and method of using it is shown in Fig. 124c. The surface next to the resistor should be finished with a flat black paint. The opposite side should be polished so heat will be radiated away from the resistor. The faces of the thermal shunt (faces making contact with the resistor lead) should be bright, unpainted copper.

## Resistance Boards

This resistance board is a time-saver in the shop. Use 10-watt resistors and mount them on a board with five terminals and a jumper wire. Type a list

Value	Terminals
54 ohms	1 and 2345
57 "	1 " 234
62 "	1 " 235
67 "	1 " 23
73 "	1 " 245
80 "	1 " 24
89 "	1 " 25
100 "	1 " 2
114 "	1 " 345
133 "	1 " 34
160 "	1 " 35
200 "	1 " 3
214 "	2 " 345
233 "	2 " 34
260 "	2 " 35
273 "	3 " 245
280 "	3 " 24
289 "	3 " 25
300 "	2 " 3
367 "	2 " 45
400 "	1 " 4
462 "	4 " 235
467 "	4 " 23
489 "	4 " 25
500 "	2 " 4
560 "	4 " 35
600 "	3 " 4
800 "	1 " 5
857 "	5 " 234
866 "	5 " 23
880 "	5 " 24
900 "	2 " 5
933 "	5 " 34
1000 "	3 " 5
1200 "	4 " 5

of values and terminals on a 4 x 6" index card and mount it in a celluloid holder right on the board.

The accompanying diagram, Fig. 125, is self-explanatory and a complete table of values is given for one of the boards. This "post-office" circuit gives numerous values.

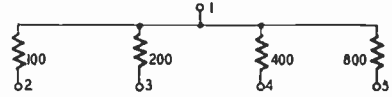

Fig. 125. Resistance-board circuit diagram.

For example—if 280 ohms are needed, connect one lead to terminal 3 and the other lead to terminals 2 and 4.

Right column of terminals means that those numbered terminals must all be tied together to form one lead.

## Inductance Measurements

Multimeters having capacitance scales can be used to measure the inductance of small, low-resistance inductors. Adjust the meter to read capacitance in microfarads, place the inductor between the test leads, then record the meter reading. Measure the d.c. resistance of the inductor. The inductance in henries is found by solving the equation

$$L = \frac{\sqrt{X^2 - R^2}}{377}$$

where X is the 60-cycle reactance of the capacitance indicated on the meter, and R is the d.c. resistance of the inductor. The number 377 is  $2\pi$  times the frequency of 60 cycles.

For example, assume that a choke

has a d.c. resistance of 50 ohms and the meter reads 8  $\mu\text{f}$ . Referring to a capacitive reactance chart, we find that the 60-cycle reactance of an 8- $\mu\text{f}$  capacitor is 340 ohms. Substituting in the equation,

$$L = \frac{\sqrt{340^2 - 50^2}}{377} = \frac{336}{377} = 0.89 \text{ henry.}$$

### Simple Stroboscope

A stroboscope for studying rotary or reciprocating motion can be made from a few inexpensive parts which can probably be found on the average experimenter's workbench. It draws negligible power and can be operated from dry batteries or any supply delivering 120 to 250 volts d.c. See Fig. 126.

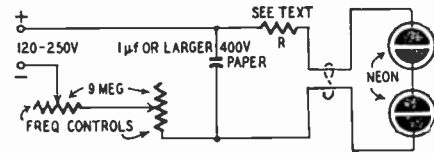

Fig. 126. Relaxation oscillator used as a stroboscope.

The circuit is basically a variable-frequency relaxation oscillator using neon tubes. These are mounted on the end of a length of 2-conductor cable so their light can be concentrated on the object in motion. A high resistance is required for a wide range, so use two 9-megohm variable resistors in series. Two controls in series provide a sort of vernier action which makes it easier to adjust the stroboscope to the desired frequency. Two 10-megohm units will work just as well and will probably be easier to acquire. Resistor R protects the neon lamps. Refer to manufacturer's data for its resistance.

### Rectifier Tester

This circuit, Fig. 127, is a handy tester for selenium rectifiers. To operate: connect the rectifier to the rectifier pin jacks. Be sure to observe the proper polarity. Turn on the power

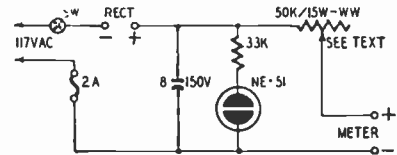

Fig. 127. Selenium rectifier tester.

momentarily and watch the NE-51 neon lamp. If both electrodes glow, turn off the power at once because this indicates that the rectifier is shorted. A shorted rectifier may damage the filter capacitor if power is left on. If the lamp does not glow, the rectifier is open. If only one electrode glows, connect a d.c. milliammeter to the METER terminals and adjust the 50,000-ohm control for the rated current drain through the rectifier to test for excessive heating. Be sure that the meter polarity is correct and that its full-scale rating is higher than the current rating of the rectifier under test. If possible, use a meter having shunts and a selector switch. This will enable you to check selenium rectifiers having a wide range of current-carrying ability.

### Pilot Light Tester

The tester shown in Fig. 128 does away with the tedious process of juggling test leads when testing pilot lamps with an ohmmeter. Use a 1.5-ma meter, 1,000-ohm resistor, and a 1.5-volt flashlight battery. Other me-

ters can be used by selecting a battery and resistor which will cause the meter to read full scale when the lamp socket is shorted. A good lamp will cause the meter to deflect to nearly full scale.

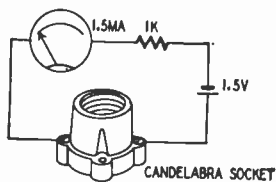

Fig. 128. Setup for checking pilot lights.

Separate screw and bayonet sockets can be wired in parallel or you can use a candelabra socket of the type used for 117-volt pilot and Christmas tree lamps. This type of socket will take screw- and bayonet-type pilot lamps.

### Handy Tester

Practically every experimenter has a power supply which he keeps in the workshop for testing receiver circuits, experimenting, etc. To increase the

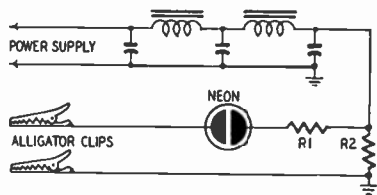

Fig. 129. Capacitor and continuity tester.

utility of this power supply, wire a small neon light in series with the 250-volt terminal and arrange a pair of alligator clips in series with the neon lamp and the power supply. See Fig. 129.

This makes an admirable capacitor tester, and an equally good continuity

tester, because it is extremely sensitive.

Use a  $\frac{1}{4}$ -watt neon lamp and a 60,000 ohm resistor (R1) for protection against short circuits; R2 is the bleeder resistor of the power pack and has a value of 100,000 ohms,  $\frac{1}{2}$  watt. The coils and capacitors shown symbolize the filter in the power supply.

A good capacitor, when connected in the circuit, will cause the glow lamp to flash once. A leaky capacitor will cause it to flash intermittently. An open capacitor will cause no flash.

### Calibrating Oscillators

By using a simple experimental setup described in elementary physics text-books, you can accurately calibrate

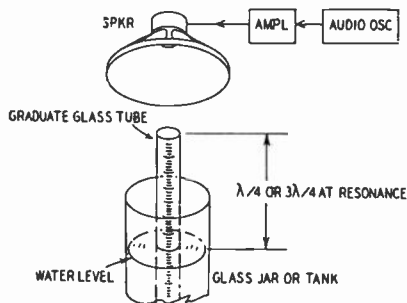

Fig. 130. Oscillator calibration setup.

audio oscillators without oscilloscopes or other complex measuring equipment. The calibrating equipment (see Fig. 130) consists of an audio amplifier and speaker having fairly good frequency response and an open-ended glass tube 1 to  $1\frac{1}{2}$  inch in diameter, calibrated in fractions of an inch, and somewhat longer than one-quarter wavelength at the lowest frequency to be checked.

This calibration method is based on the fact that the sound level increases

when a musical note produced by a tuning fork or similar instrument is closely coupled to a column of air one-quarter or three-quarters wavelength long at the same frequency. The frequency of the note is equal to the velocity of sound (in air) in feet per second divided by its wavelength in feet.

One-quarter wavelength is found by lowering a calibrated glass tube in water as shown in the setup until the sound level reaches a peak.

The velocity of sound is 1,090 feet per second at 0° C and increases 2 feet per second for each degree of increase in temperature. To find the velocity of sound in air ( $V$ ) at any temperature  $T$  above 0° C, use the formula:  $V = 1,090 + (2 \times T)$ .

With the oscillator and amplifier operating and the speaker close to the top of the tube, slide the tube in and out of the water until resonance is indicated by a sharp increase in sound level. Read the tube length in inches, multiply by 4 to find wavelength in inches, then divide by 12 to convert to wavelength ( $L$ ) in feet.

Frequency in c.p.s. equals  $V/L$ , where  $V$  is velocity at room temperature and  $L$  is wavelength in feet. For example: If the room temperature is 20° C and there is 6 inches between the water level and the top of the tube at resonance, the corrected velocity is  $1,090 + (2 \times 20)$  or 1,130 ft./sec.,  $L$  is  $6 \times 4/12$  or 2 feet, and  $F$  is  $1,130/2$  or 565 c.p.s.

### Output Indicator

A sensitive output indicator for use

when aligning receivers can be constructed with a minimum of time and parts. As shown in Fig. 131, it consists of a small PM speaker and output transformer mounted on a small base which can be placed close to the speaker in the set being aligned. Maximum sensitivity will be obtained when the test speaker and the receiver speaker are parallel, and close to each other.



Fig. 131. Output indicator for alignment.

Connect a low-range v.t.v.m. to the terminals and use it as the output indicator. With the meter set to the 0.25-volt a.c. range, the signal from the signal generator can be turned low enough to prevent the set's a.v.c. from operating and broadening the output peaks.

### Steady Tone Generator

Stable a.f. or ultrasonic signals for test and control purposes can be generated by heterodyning signals from two crystal-controlled oscillators. Any conventional oscillator can be used. Feed the outputs into the grid circuit of an a.f. amplifier and the difference frequency will appear at the plate.

### Signal Generator Hint

Most signal generators use a coaxial cable output lead connected to the generator by means of a coaxial male and female connector. Sometimes the center points of the two connectors do not make contact, resulting in zero output, even if the generator and its



cable are in good working order. A drop of solder on the center point of either the male or female connector will correct this trouble.

### Simple D.C. Amplifier

Electron-ray indicator tubes are useful as signal indicators in some applications but they are sometimes unsatisfactory when a distinct, easy-to-see indication is required. A sensitive indicator is the d.c. amplifier and neon lamp arrangement shown in Fig. 132. The amplifier may be a 6C5 or similar

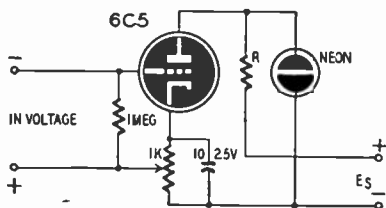

Fig. 132. Sensitive d.c. amplifier indicator.

tube. The plate load resistor must be determined experimentally after the neon lamp is installed.

### Substitution Block

The gadget in Fig. 133 is as handy as it is simple to construct. It is lots easier to use than a decade box. The component leads are clamped firmly to Fahnestock clips on a heavy wooden

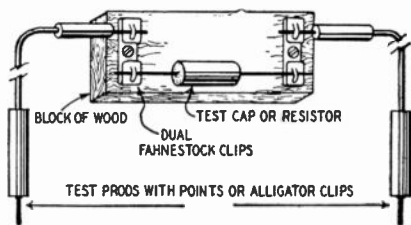

Fig. 133. Experimental substitution block.

block, so there is little danger of short-circuits or an accidental shock. If test leads are fitted with alligator clips, the setup can be used when trying different components in experimental circuits. Any capacitor, resistor, or other two-terminal device can then be inserted for test or substitution.

If experimentation or new circuitry is your hobby, make up a set of these blocks. They're wonderful time savers.

# Section 2

## Tools

### Solder Removing Idea

Removing solder from components which you want to salvage can often be a tiresome job. A cheap, one-inch paint brush can be a big help. Just heat the joint with the iron until the solder melts and then quickly remove the solder with the brush.

### Insulated Tool Handles

Some service technicians like to cover the handles of diagonal cutters, needle-nose pliers, etc. with friction tape for better gripping and insulating purposes. Three- to four-inch lengths of rubber tubing will do the same job and will overcome the disadvantage of using tape that will unravel.

### Convenient Pick-up Tool

Nuts, screws, and other hardware often fall into the deep recesses of a chassis out of the reach of needle-nose pliers. Sometimes this hardware can

be picked up with a magnetized screwdriver. If the screwdriver is not strong enough, rub the blade vigorously with an Alnico magnet. The hardware, of course, must be a magnetic material.

### Handy Tools for Servicing

Every service technician needs certain special test instruments and tools, but a little ingenuity converts many ordinary items to valuable radio-repair implements. Here are some ideas used by a practical repairman. Add these to your own storehouse of ideas.

Start with a trip to your local department store to pick up a pair of kitchen tongs. If you've ever tried to pull a red-hot metal tube out of its socket for replacement (and what service technician or experimenter hasn't), you will appreciate the cool comfort of removing the tube with the tongs. It's as good as a regular tube puller but costs less.

Everyone knows that all you need to scribe out markings on radio chassis and panels is a piece of metal with a sharp point; and you must have thought often that a phonograph needle would be ideal if there were only some way to hold it. Why not use an old crystal cartridge?

Suppress your embarrassment and buy one of those small hair-curling kits at the dime store, one with those convenient split, metal, rubber-tipped curlers. Clip them to chassis to keep the chassis from falling over or use them to anchor test leads to chassis or terminals.

Ever find yourself needing two hands for a job, when one of them is already holding a hot soldering iron—and not a stray ashtray in sight to rest it on? The book says you should have a regular iron holder; maybe it's hiding from you. Take a tip and keep a few of the large, old-style tube shields around the bench instead of in the junk box. They're fine iron holders!

A  $4\frac{1}{2}$ -inch chrome reflector—you can find them at the camera store—keeps light out of your eyes and adds many lumens to the brightness of your probe lamp. Slip the upper part of the probe through the hole in the reflector and tighten the fit with tape.

No good repairman has holes in his pocket knowingly; but what he doesn't know may hurt him, especially if he carries small screwdrivers or alignment tools in the pocket. A metal toothbrush carrier carries the tools neatly and requires a much bigger hole for loss.

When you want to concentrate a stream of liquid, you use a funnel.

Why not do the same when you want a little spot of light for a delicate job? Tape the funnel over a flashlight lens.

A piece of asbestos paper may easily be worth several times its weight in burned capacitors and insulation. Before you stick your soldering iron in a tight place, cover the surrounding components with the asbestos.

A radioman without an ice pick is like a painter without a brush. Use it to line up chassis holes with those in the cabinet, pick bits of solder out of unlikely places, strip shield braid from microphone cable, poke holes through solder-filled terminals—you could exhaust a ball-point pen writing down all its virtues!

There are lots of tight places where you have to strip off insulation. When there isn't room to pull it off, you have to slice. When you try your jack-knife, you wish you had a surgeon's scalpel. Next best is a modelmaker's knife. Of course you can use a discarded razor blade, but the modelmaker's knife can really get into those tight corners.

### Unusual Service Tool

A handy tool for your radio service bench consists of a bicycle spoke—or

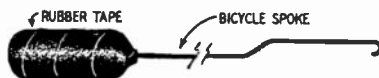

Fig. 201. Unique dial-stringing tool.

any wire of similar diameter and length—with one end bent as shown in Fig. 201 and the other end heavily wrapped with rubber tape to form a handle. It can be used for tapping tubes and other

components, stringing dial cords, and for testing connections for intermit-tents.

### Wire Stripper

A pair of pocket fingernail clippers can be used as a wire stripper. Clamp the wire in the jaws and pull. If the pointed end of the depresser is filed off, it can be used as a small screwdriver.

### Use for Socket Punches

Many people do not know that screw-type tube-socket punches (such as the Greenlee and others) will also work with Presdwood, Bakelite, and hard rubber. You will have to drill the usual  $\frac{3}{8}$ " pilot hole, then use the socket punch just as though you were going to work on metal.

### Cleaning Tool

Here is an interesting and useful tool which makes cleaning inaccessible parts, such as band switches and variable capacitors, much easier. Remove the head from an old vibrator-type electric shaver and attach a short fiber stick to the vibrating driver. The fiber is at right angles to the shaver so that when the shaver motor is turned on it vibrates lengthwise. A piece of cotton is glued to the other end of the fiber stick.

To use the gadget, dip the cotton in carbon tetrachloride, start the shaver, and apply the cotton to the dirty part. The vibration will make the cotton wipe off the dirt.

### Soldering Iron Regulator

A handy stand and automatic heat

regulator for a soldering iron can be made from a small chassis, a flush-mounting duplex outlet, a small tin can, and a surplus Fenwall Thermo-switch. The switch is tacked to the inside of the can with silver solder or a solder having a higher melting point than that normally used. The switch and outlets are wired as shown in the diagram, Fig. 202. A neon-type night light is plugged in one side of the outlet as a tell-tale.

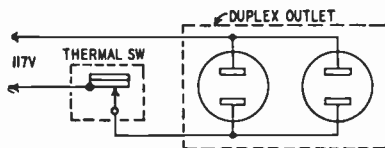

Fig. 202. Soldering iron heat regulator.

The switch has a wide range. It works best when set to cut off the current just below the melting point of radio solder. This adjustment is made with the iron inside the stand and next to the switch.

### Spray Gun Cleans Radios

An old insect spray gun is useful for cleaning dust out of radio chassis and from between capacitor plates. Be sure there is no liquid in the gun, then point it at the chassis and pump. It beats lungpower by a mile and has the additional advantage of keeping dirt out of your eyes.

Also try using the spray gun for getting surface dust from the optical components (mirrors and lenses) of projection television receivers.

### Soldering Iron Holder

An ordinary binder clip, obtainable

at almost any stationery store, is very handy as an iron holder for outside jobs. It can be clipped to the iron and left in place, unless working space is small. It is also useful for holding small parts when a small vise does not happen to be at hand.

### Probe Light

The average room light often is not so placed as to enable the serviceman to see into obscure places under the chassis. To illuminate these spots, remove the tip from a pencil-type soldering iron and screw in a 117-volt, candleabra-base lamp in its place. The arrangement is completely insulated, with no danger of shorts or shocks.

### Battery Connectors

The next time you need connectors or a 6-volt storage battery when servicing an automobile radio, try the sliders from a 50-watt adjustable resistor. These sliders are inexpensive and fit the terminals on most vehicular storage batteries.

Another connector useful for the workbench is made by drilling  $3/16$ -inch holes about  $1/2$  inch into each post. Tap in 8-32 screws and saw off their heads. Then screw on nuts from ordinary dry cells, making very convenient terminals.

Before putting on the connectors clean the battery terminals with a wire brush. The terminals will clean fairly easily since they are made of lead. After putting on the connectors, put on a thin coating of vaseline to prevent corrosion. Connectors should always be heavy enough to carry the

maximum current drain to be put on the storage battery.

### Improved Soldering Iron

A short length of silver wire can very easily improve the heating ability of a small pencil-type soldering iron. Since silver is a much better conductor of heat than is copper, a soldering iron with a silver tip is more efficient than one with a conventional tip. Furthermore, a silver tip does not corrode or oxidize as badly as does a copper one and consequently does not require re-tinning as often.

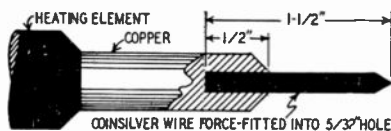

Fig. 203. Improvement in soldering iron.

To make the silver tip, drill a hole approximately  $5/32$  inch in diameter about  $1/2$  inch deep into one end of the copper. Then force-fit a short length of coin-silver wire of the same diameter into the hole, allowing about 1 inch to protrude. File a point onto the end of the wire and the job is done. The drawing in Fig. 203 shows construction details.

A tight force-fit is most important. If the wire fits loosely, the heat will not be transferred efficiently and most of the advantages of the silver will be nullified.

### Workbench Kink

Fasten a small but powerful permanent magnet to the wall behind your work-bench. Whenever working from

a diagram or from sheets of notes, place the papers against the magnet and then lay a small piece of magnetic metal on top of them. Thus you will have a magnetic clip board which will not damage the papers while keeping them out of the way where they will not become soiled, burned or torn.

To keep the magnet strong, protect it from heat. Do not drop it and avoid using it as a tool.

### Dial Stringing Aid

Use small strips of Scotch tape to hold dial strings on pulleys when restringing elaborate dial drive mechanisms. They will prevent the string from jumping off the pulleys before the tension is applied by the springs.

The tape is also useful in holding the strings in place while the springs are being adjusted for greater tension. This eliminates a complete restringing job.

### Handy Dial Stringing Tools

A number of gadgets have been devised as aids to dial stringing; how-

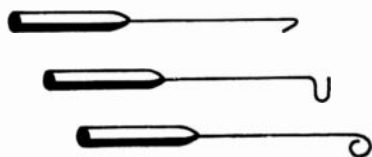

Fig. 204. Tools for stringing dial cord.

ever, you may find that more than one such instrument is needed for working in close places which cannot be reached with the fingers alone or with the ordinary tools found in a workshop.

The three instruments shown in the

drawings in Fig. 204 have been evolved by constant usage. Made of stiff wire, bent to shape and fitted into wooden handles, they are just the tools needed during most dial-stringing operations. Fit the wire into a hole drilled in the handle. Fasten with cement and secure with tape.

### Handy Trouble Light

Some Christmas-tree lights have candelabra-type sockets with small clips fastened to them. When fitted with a suitable line cord and a 115-volt pilot lamp, these make handy trouble lights for illuminating dark corners of a chassis. If the leads are fitted with insulated clips, power can be taken from the set under test. A miniature screw-type pilot light assembly can be used in the same manner. In this case, the power comes from a filament winding on the set.

### Useful Jeweler's Tool

A small jeweler's eyeglass, known as a loupe, is useful for locating broken ends of a fine wire coil, examining a phonograph needle for wear, and many other fine jobs. A four-power glass with a 2-inch focal length is good, and its cost is not high.

### Handy TV Servicing Tool

A  $\frac{1}{4}$ -inch nut driver or Spintite wrench is required to remove the cover of the high-voltage cage in most TV sets. Why not convert yours for use as a high-voltage indicator as well? Take a  $\frac{1}{4}$ -inch hex nut driver and soften its plastic handle in hot water so the bit can be pulled out. Solder one terminal

of a small neon lamp (NE-2 or similar) to the handle end of the bit. Drill the hole in the handle deep enough to accommodate the lamp on the end of the bit. Reheat the handle and insert the bit back in place.

The next time you suspect trouble in a high-voltage supply, use the wrench to remove the cover, then probe with the bit. Presence of high voltage is indicated by a glow in the neon lamp.

### Drilling Thin-Wall Tubing

It is difficult to start a drill into soft thin-wall tubing without using a center punch which is very likely to deform the tubing. You can solve this problem by modifying a cheap pair of gas pliers to serve as a guide for the drill.

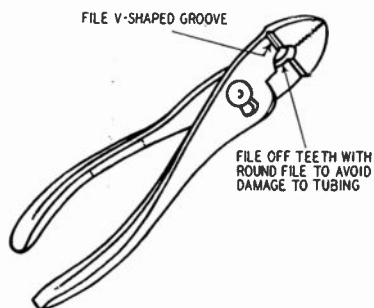

Fig. 205. Drilling into soft-wall tubing made easy by modification of pliers.

The serrations are filed or ground off the inside of the jaws and a V-groove is filed down one side as shown in Fig. 205.

To use the tool, grip the tubing lightly with the groove centered over the spot where the hole is to be drilled. The groove is a guide for starting the drill. Remove the tool as soon as the hole is started.

You won't need to hold the gas

pliers shut by hand if you snap a rubber band around the ends of the plier handles.

### Handy Tool for Coax

A Gillette office knife is a handy item to keep around the shop or shack. This rugged knife is constructed like a scalpel and its replaceable blades are razor sharp. Its full-size handle fits the palm so you can apply enough force to make a clean cut in or through coax—even RG-8/U. If you have previous experience at cutting RG-8/U, you will appreciate the clean cuts which can be obtained.

The knife can be purchased at most stationery and office-supply stores for about a dollar, and replaceable blades are only a few cents each.

The knife is also suitable for stripping insulation, when necessary, from wires located in hard to get at places in the chassis.

### Alignment Tool

Don't throw away those plastic mixing sticks that come with a Tom Collins or similar thirst quencher. File down one end and you will have a nice alignment tool plus a reminder of happy days.

### Pick-up Tool

A wooden rod about  $\frac{1}{4}$  inch in diameter and having a blob of wax firmly stuck on the end is very useful for picking up small parts in inaccessible places or starting nuts in cramped quarters.

### Nail File Uses

An ordinary fingernail file can be

used as a tool in radio and television servicing. The radioman who does not have one of these in his kit is overlooking a useful instrument.

Here are some of its uses:

First—As a probe. Loose wires are detected by wiggling them with the file.

Second—Enamel-insulated wire can easily be cleaned by running it between the edge of the file and your finger.

Third—The end may be ground down and used as a screwdriver.

Fourth—Filing of contact points or cleaning tube points, wires, etc., is easily done.

You can use such a tool without modifications, or make it easier to use by putting a handle on it. The simplest handle is some tape around the unused end of the nail file. A more professional handle can be made by heating the unused end of the file and then pushing it into a piece of plastic rod.

### Cord and Antenna Reel

Many old radio sets use a hank antenna which must be unrolled when the

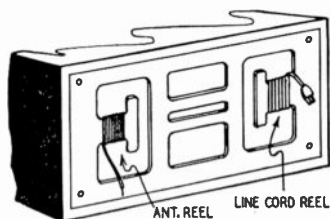

Fig. 206. Line cord and antenna reel.

set is in use. When the set is moved the antenna and line cord always seem to get entangled. To simplify the moving job both antenna and cord are usually rolled up into a ball and shoved into

the rear of the set. Straightening out the resulting mess is like trying to unscramble an egg. Try making a rear cover of heavy cardboard or plywood with two small reels cut out as part of the design. The antenna and cord can then be wound up separately and kept apart. The drawing in Fig. 206 shows how it is done.

Another technique, suitable for keeping the antenna out of the way when moving the set, is to mount two wood screws along the rear edge of the cabinet. The antenna wire is then looped back and forth between the wood screws. While this may seem applicable only to wooden cabinets, the idea can be used on plastic cabinets as well by drilling and tapping for machine screws along the rear of the cabinet.

### Plastic Parts Boxes

Plastic boxes sold by hardware and five-and-ten-cent stores make neat chassis and cabinets for small code oscillators, amplifiers, and similar devices. The partitioned containers are handy to have around for storing resistors, capacitors, and other small components. But be sure to select *fire-resistant* or *noninflammable* plastic! A short circuit, a hot soldering iron, or a carelessly dropped cigarette can easily start a fire if the box is made of a highly inflammable plastic.

### Handy Adapter for Testing

Many modern electronic devices are made so compactly that it is almost impossible to reach some parts of the circuit with standard alligator clips. You



can overcome these difficulties by making a simple gadget which works as well.

The adapter is made from a contact out of a molded-plate octal socket. Remove the whole contact and make a narrow slit in the eye. Slip it over the end of a test prod or piece of insulated bus bar. When metering circuits, signal tracing, signal injecting, etc., slip the eye over the circuit lead and give the

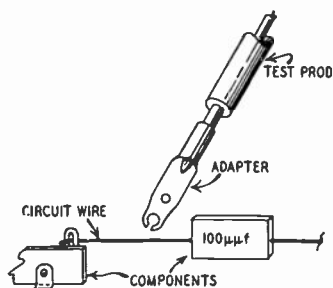

Fig. 207. Socket pin as prod adapter.

prod a half-turn to hold it in place. The illustration in Fig. 207 shows how the adapter is used.

### Color Scheme

In using the so-called Spintites, a serviceman usually has to dig through his tool box to select the proper size. There are invariably eight drivers to a set. The only identification one has is a small stamp on the handle denoting the size. Overcome this difficulty by dipping the handles in lacquer, using various colors. Red, yellow, and black may be used for the more popular sizes as the colors are dominant; other colors may be selected to dip the remainder. After becoming accustomed to the color scheme, much time may be saved in reaching for the proper size at a glance.

If you color the Spintites using the standard resistor color code, you will find it easier to pick the Spintite you want at a glance and easier to replace the tool in its proper place in the rack.

### Useful Test Probe

Much of your daily work in an electronic laboratory or in a service shop is with test leads and probes for making circuit measurements. For this work, you can make several probes like the one shown in the drawing in Fig. 208.

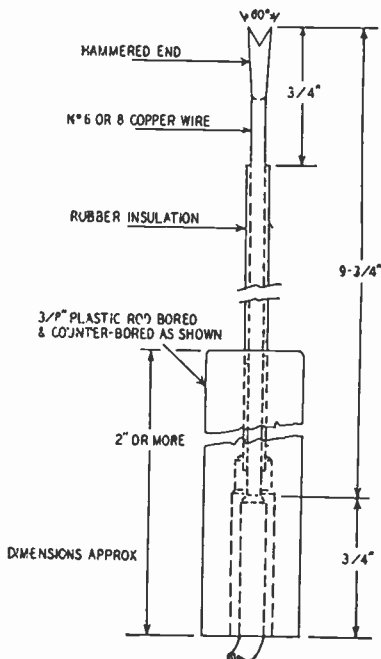

Fig. 208. Useful, handy test probe.

Remove approximately  $\frac{3}{8}$  inch of insulation from one end of a 10-in. piece of No. 8 rubber-covered wire and then hammer and file the end to the shape shown. Solder the other end of the lead to a brass jack designed to

its normal length and diameter making a snug-fitting insulating sleeve which leaves only the business end of the clip exposed. The finished lead is shown in the drawing at c.

Leads tipped in this manner will prove useful for connecting signal tracers, test oscillators, output meters, scopes, and other devices to the circuits under test while leaving both hands free for circuit adjustments.

### Handy Test-Lead Switching

We often see radio and TV service benches cluttered with snarls of test leads dangling from a number of different test instruments. You can eliminate this by using one set of test leads and a 2-circuit rotary switch having at least as many positions as there are test instruments. The negative test lead connects to the arm of one switch section and the positive lead to the other. The negative or ground leads from the various instruments connect to the taps on the section of the switch connected to the negative test lead, and the positive or hot leads connect to taps on the remaining section of the switch.

One service technician has seven instruments connected in this way to an 8-position switch. The unused position disconnects the test leads from all instruments. This system saves wear and tear on test leads, but it does not work out well when two instruments are needed at the same time.

### Twin-Lead Test Leads

Excellent non-kinking test leads for almost any purpose can be made from a 3-foot length of 300-ohm twin-lead. Split the lead at each end for two or three inches and make a hole with a paper punch at the end of the split to prevent further tearing. Terminate the conductors with spade lugs, phone tips, or whatever other connectors or probes are desired.

You can easily polarize the test leads by putting a drop of red nail polish on one lead at both ends to identify it as positive. The holes punched near the ends can be used to slide the lead over a nail on the wall, keeping the test lead out of your way until you need to use it.

Sets of these leads in various lengths are a great convenience.

# Section 3

## Television

### Solving the Antenna Problem

When a large increase in rent was asked by the landlord in return for permission to erect an outdoor TV antenna, one set owner tried all sorts of indoor TV antennas with poor results. Finally, a piece of 300-ohm ribbon line was run up to the floor above where a friendly tenant had an outdoor antenna. The ribbon line was run parallel to the friend's lead-in and taped to it. There was no electrical connection between them or to the antenna. The two sets worked fine with no ill effects on the picture on either receiver.

A service technician can waste a lot of time on a set which is apparently O.K. but will not produce a stable picture on any channel. Before going into such a set, always check the antenna. If stations are on the air, make a temporary antenna from 300-ohm line and connect it to the set. If the set performs with fair results, check the lead-

in and connections to the original antenna until you locate the fault.

### Coaxial Antenna Plugs

Care in soldering the antenna plug to coaxial cables will minimize service

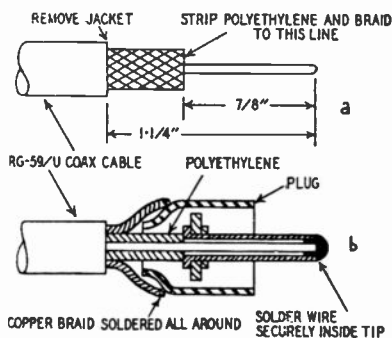

Fig. 301. Assembly of coaxial plugs.

call-backs and signal losses. First remove the vinyl jacket, copper braid, and polyethylene insulation as shown at a in Fig. 301. Be careful not to nick the braid or center conductor. Solder the connections as shown at b. Line

up the cable with the body of the plug, then use a hot iron for soldering. Work rapidly to avoid excessive heat which will damage the polyethylene insulation and increase leakage and possibility of short circuit between the conductors. Check the plug for shorts with an ohmmeter.

### Good Low-Band Antenna

In some locations, television channels 2 and 5 are weak and 4 is strong. Being unable to find an antenna which would give optimum performance on these channels, one experimenter developed a three-element Yagi that does the trick.

The folded dipole and reflector were cut and spaced for channel 2. The director was cut for channel 5 and spaced  $1/10$  wavelength (of channel 5) in front of the folded dipole.

### Simplified TV Installation

When installing a TV antenna on his home, a service technician found it impossible to anchor the lead-in at the correct points on the outside wall. The antenna being mounted on an unused chimney, he decided to bring the transmission line down by the most direct route—straight down the chimney. The lead-in came out through a flue in the basement and was then run along the floor joists and passed through a hole directly under the TV set.

In other installations, the lead-in can be brought out of any convenient fireplace or flue not in use. This method not only simplifies installations, but it also protects the lead-in from damage by heavy ice and snow.

### Finding Lead-in Break

Long TV lead-ins often develop close-gap breaks which affect the performance of the receiver. Since the wire usually breaks while leaving the insulation intact, it is often more economical to replace the line than to spend the time required to locate the breaks by carefully going over every inch of line.

Breaks are easy to locate if you put a standard a.c. line plug on one end of the line and a socket and 115-volt bulb on the other. See Fig. 302. When you

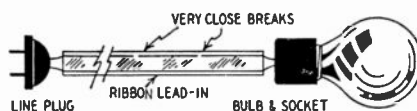

Fig. 302. Use light bulb and male plug for location of twin-lead break.

insert the plug into the power line, the current will jump across the gaps and develop enough heat to burn the plastic insulation. The break can then be spotted by inspection. The breaks should be cleaned, soldered, and taped to restore normal service.

### V.H.F. Antenna Terminals

After a few months exposure to the elements, terminals on TV and other v.h.f. antennas usually are so badly corroded that they cannot be loosened. To eliminate this trouble and to avoid high-resistance connections, coat all terminals, nuts, and bolts with battery-terminal sealing compound. This protects the terminals against weathering and the coating is easy to strip off when necessary. It can be purchased at most automotive supply stores.

Coating antenna terminals with

Glyptal or nail lacquer will also supply protection against corrosion.

### V-Beam for DX

A simple but excellent antenna for TV fringe reception (if you have the necessary space) is the V-beam shown in Fig. 303. It has very high gain and sharp directivity. The V contains 70 half-wave elements, all working and all beam-forming. The dimensions shown are for channel 13.

The booster at the antenna end is needed because the antenna has an

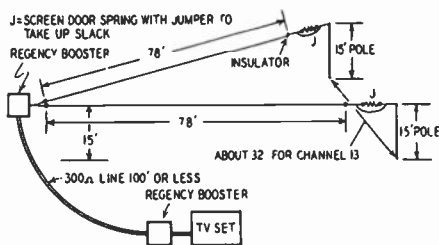

Fig. 303. V-beam for long-range TV.

impedance of 800 ohms, and the signal would get lost on a 300-ohm line. A Regency booster is specified because it uses 6J6 tubes in a circuit that is very efficient on channel 13. Most other boosters use 6AK5's which have a higher internal noise level and the boosters do not have much gain on the high channel 13.

Orienting the 78-foot legs is simple. Lay one wire on the ground, and stretch the other in the general direction of the transmitter to be received. Walk the far end of the stretched wire back and forth. Two definite signal peaks will appear, with almost complete lack of signal between these two points. These maximum points are where the two

15-foot antenna masts are to be located.

The 78-foot length is used because a shorter one will give less gain while a longer one will cause time-delay effects. A 150-foot length would tend to cross two picture elements. This delay is independent of frequency, so the antenna can be used just as well with any channel. However, the separation of the legs does depend on the frequency, but the exact separation is not critical because the booster is tightly coupled to the antenna. Tuning the booster changes the effective separation of the legs.

### TV Antenna Installations

TV antenna installations in fringe-areas can be simplified by using a detailed road map of your vicinity, a compass, and a radiation pattern of the antenna you plan to use. Mark the locations of all nearby TV stations on the map. Center the radiation pattern over the spot where the antenna is to be installed. You will be able to see exactly where the major lobes lie in respect to the different stations.

This system has been used to locate the source of reflections and has proved helpful in bringing in a weak channel. If the antenna you select does not have lobes which point toward all stations, try the pattern of another type of antenna.

Radiation patterns for various types of TV antennas can be obtained from manufacturers or from their catalogs and sales literature.

### Carrying TV Masts

If you are wondering how to get that

length of TV mast or light wooden pole home without scratching the family car, try a set of the rubber suction cups and web straps used for carrying skis and fishing poles. You can purchase a set from an automobile appliance dealer for less than a single touch-up job would cost.

### Interference Elimination

TV and FM receiving antennas frequently take on a heavy charge of static electricity which produces interference as it leaks off in a corona discharge. This can be eliminated by placing plastic beads or a coating of tar on the ends of the antenna elements and other sharp projections on the assembly.

### Ignition Noise in TV Sets

Ignition noise can be reduced by any one or all of these steps:

1. Relocate the antenna lead-in away from the street side of the house.
2. Connect two  $50\text{-}\mu\mu\text{f}$  capacitors in series with the antenna line and a center-tapped coil as shown in Fig. 304.

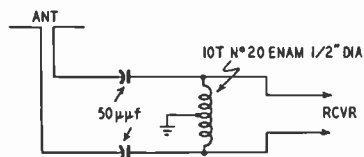

Fig. 304. Circuit for reduction of ignition noise pickup.

The coil should have about 10 turns of No. 20 enamelled wire on a  $\frac{1}{2}$ -inch form.

3. Unbalanced input to the r.f. tuner results in greater noise factor. Exchanging the antenna coil or the entire

tuner for a new one may help to clear up this trouble.

### New Uses for Glyptal

If your twin-lead transmission line must be lengthened, add on the new length of line in the usual manner by stripping, tinning, and soldering the ends. Since the joined wires will no longer be covered by plastic, they can become corroded or may possibly short. Cover the exposed parts with Glyptal, whether the new connection is indoors or outdoors. You can unsolder through the Glyptal if you later change your mind about the connection.

Glyptal is also useful for eliminating corona in high-voltage supplies. Cover bare wires, exposed solder connections, sharp points, or increase the breakdown insulation of covered wires by painting the Glyptal right over the insulation.

### Novel Antenna Mount

This method of mounting TV, FM, and lightweight amateur beams does not require straps, turnbuckles, guys, or other hardware normally used to mount antennas. Furthermore, the antenna can be taken down in a few seconds without using tools.

Select a length of iron pipe which has an inside diameter equal to or slightly larger than the outside diameter of the antenna mast. Drill several holes through the pipe, each large enough to pass a toggle bolt. Place the pipe against the chimney or wall, and mark the location of each hole. Drill holes through the wall or chimney. Bolt the pipe to the surface with toggle bolts; then insert the mast in the pipe.

Drill the first hole at least a foot below the top of the pipe to give the mast ample supporting surface. Or possibly saw a slot in the mast so that it will slide down past the toggle bolts, thus affording additional support.

### TV Isolation Amplifier

The unit shown in Fig. 305 was designed to permit two TV receivers to be operated from a common TV antenna without interaction between them. Unlike matching pads which

unbalanced transmission line. When using balanced input, reversing the antenna leads may improve reception. The grid of the second stage gets its signal from the cathode of the first through a 47-ohm resistor. The output terminals are designed for two TV sets having 72-ohm antenna input terminals. If either set has a 300-ohm antenna circuit, insert a 150-ohm resistor at point X in the grounded side of the amplifier output lead.

The power supply is isolated from the a.c. line by two 6.3-volt filament transformers connected back-to-back. A small half-wave power transformer may be used instead.

### Tool for Coax Cable

A standard copper-tubing cutter, available at most hardware stores for less than a dollar, is a handy tool for preparing coaxial cable to receive fittings. In using the tool, the first step is to twirl the cutter around the jacket, cutting through it to the outer braid.

After removing the jacket, cut through the outer braid and remove it. The cable can now be finished with a pocket knife and the fitting can be installed in a professional manner.

### TV Antenna Phasing Unit

In many TV installations, the location and type of antenna and the length and type of transmission line may produce a mismatch which will cause ghosts. To solve this problem and to prevent complaints, use the tubeless phasing unit shown in the diagram, Fig. 306. By shunting the noninductive potentiometer across the line and

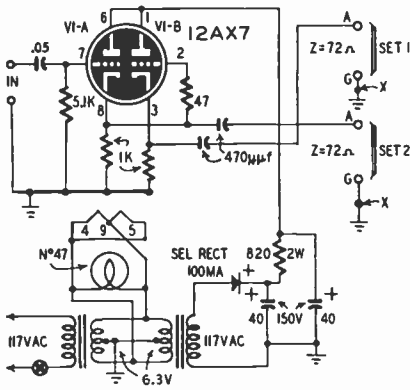

Fig. 305. This circuit permits operation of two TV sets from one antenna.

are generally used for this purpose and which cause a signal drop, this unit provides appreciable boost in the signal to both sets. It has a built-in a.c. power supply which can be connected across the primary of the transformer in the set so the on-off switch of the receiver controls both units.

The circuit consists of a 12AX7 twin triode, chosen for its high amplification factor and plate resistance. The grid of the input section is fed through a .05- $\mu$ f capacitor from a balanced or

grounding its arm through a 330-ohm resistor, you can vary the over-all impedance to a point where it matches the receiver and eliminates the troubles caused by a mismatch of this type.

The action of the control is to load

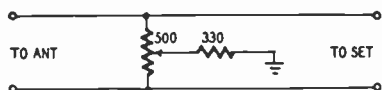

Fig. 306. Ghosts can be minimized by using this impedance-matching network.

one side of the line, permitting the other to balance out and present an even load to the input of the set.

### Curing Lead-in Noise

Video and audio static was severe in a TV installation located only 25 feet from a busy street. The antenna was a conventional job fed with 300-ohm line. Moving the antenna to the back of the building to a point farthest removed from the street failed to cure the trouble.

The trouble was finally cleared up by using 72-ohm coaxial line with a 33-inch section of 150-ohm line between the line and antenna and a similar section between line and the receiver.

### High-Voltage Meter Adapter

Most TV receiver manufacturers warn the service technician not to attempt to measure the pulse voltages on the plates of the horizontal output and high-voltage rectifier tubes. Sometimes it is expedient to do this to check the condition of the high-voltage transformer. For this purpose you can use a v.t.v.m. adapter constructed as shown in the diagram, Fig. 307.

The 1B3-GT, battery, and filter capacitor should be mounted in a wooden or plastic box to prevent leakage. The push-button switch should be insulated for high voltage. The voltmeter should have a sensitivity of at least 20,000 ohms per volt. Its range should be high enough to measure the normal anode voltage on the cathode-ray tube.

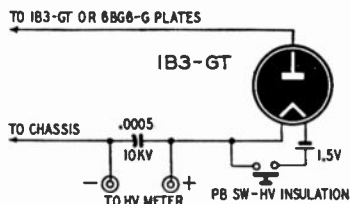

Fig. 307. Adapter circuit for measuring pulse voltages on plates of horizontal output tube and high-voltage rectifier.

If your voltmeter does not have a high enough range, increase it through the use of a voltage-multiplier resistor. You can calculate the value of this resistor or obtain the information from the manufacturer of your particular voltmeter. The value of resistance will be determined by the value of the voltage you wish to measure and the current required for full-scale deflection of the meter.

### Soldering Shield Braid

Tinning, or soldering a wire to the shield braid of coaxial cable will cause the underlying plastic to melt and can result in a short between the center conductor and the outer braid. Prevent this by putting a piece of metal sleeving under the braid at the soldering point. Remove the sleeving after



the soldered connection has been made. If you find it difficult to get the metal under the braid, push the braid back slightly and it will expand enough to allow the sleeving to be used.

### Simple Audio Connector for TV

Here is a simple method of connecting the sound signal of a TV set to the audio amplifier of a radio or to a phono amplifier. Many different circuits are possible, some using switches, others relays, but the simplest solution is the one shown here.

Fig. 308 shows the main features of

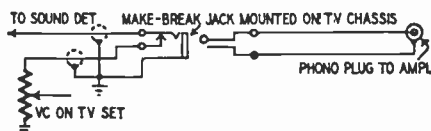

Fig. 308. Connecting TV sound to audio amplifier.

this circuit. To make sure the TV sound is piped to the amplifier only when desired and to avoid an extra switch, the jack used is of the make-break type. When the plug is not inserted, the sound signal travels from the output of the detector through the contacts on the jack to the volume control on the TV set and thence to the TV receiver audio section. When the plug is inserted, this connection is broken and the TV volume control has no effect. Instead the volume and tone can be adjusted at the console amplifier.

To simplify this further, the plug is wired to a cable at the other end of which a phono plug is connected. Most console radios have a phono jack into which the TV sound can be connected. All leads should be shielded cable and

all shields soldered to the chassis. Some TV receivers use no power transformer and one side of the a.c. line goes to the chassis. In this case the ground connections should be made through a .1- $\mu$ f capacitor.

The jack can be mounted on the chassis by drilling a  $\frac{3}{8}$ -inch hole, or it can be mounted on the rear cover of the TV set.

### 60-Cycle Distortion in TV Sets

A strong 60-cycle signal in video or horizontal-sweep circuits may cause a heavy horizontal bar across the screen, wavelike-distortion at the sides of the raster, or both. This trouble is easily identified and simple to localize. A trouble which is often deceptive and difficult to diagnose occurs when just a small amount of 60-cycle voltage finds its way into the video or sweep circuits. The result is a slight distortion or interference pattern in the picture. During some programs, the distortion is motionless and is likely to pass unnoticed. On others, it may move vertically and be very annoying to viewers.

The interference pattern is stationary when its frequency and that of the set's vertical oscillator are exactly the same, as is the case when the TV sync generator is locked in with the 60-cycle power source supplying the TV set. Thus the interference is usually motionless on local programs. However, when the local station broadcasts programs originating at a distant point, as is the case with many network programs, the frequencies of the vertical oscillator and the interference will be slightly

different and the distortion will drift vertically.

Whenever you receive a complaint of distortion or interference of this type, be sure to check the set on a network program and examine the picture carefully for a faint horizontal bar and slight bending at the sides of the raster. The sources of this trouble are the same as when the interference is much more severe but it may be more difficult to localize. The hum may be caused by heater-to-cathode leakage in the picture tube, d.c. restorer, video amplifier, video detector, picture i.f., or tuner stages. It can usually be tracked down with a scope, with an r.f. detector probe added for the stages ahead of the video detector. It may also be due to insufficient filtering in the B-supply circuits to these stages, or to capacitive or inductive coupling between signal and heater leads. A speaker field coil can cause similar troubles, and occasionally the antenna lead-in wires may pick up strong 60-cycle fields from power lines or machinery.

### Intermittent H-V Supplies

Failure of a 1B3-GT high-voltage

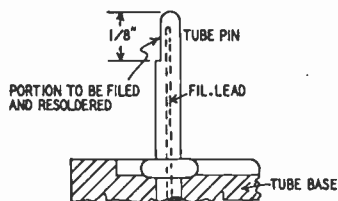

Fig. 309. Poor pin connections can cause intermittent in high voltage.

all. Failure of a rectifier tube in voltage-multiplier circuits will result in defocusing and increased size of the picture.

Failure of the 1B3-GT rectifiers can often be traced to poorly soldered connections between the filament leads and the tube base pins. These tubes can be repaired and returned to service by filing pins 2 and 7 as shown in Fig. 309 and resoldering them with noncorrosive solder which is allowed to flow freely to insure a good connection.

### Servicing TV Intermittents

Many compactly-built TV receivers develop intermittents only after the set has heated up during several hours of operation. The intermittents seldom appear when the set is taken out of the cabinet for servicing because the added ventilation prevents the temperature from rising to the point where intermittents begin.

A practical solution to the problem is to use a home hair dryer to blow a stream of warm air on the suspected parts, thus simulating an in-the-cabinet condition.

### Tool for TV Servicing

Particularly useful for TV servicing is this tool (shown in Fig. 310) made from a thin fiber or plastic rod and a

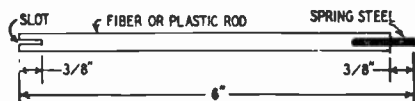

Fig. 310. TV alignment and probing tool.

rectifier in half-wave circuits will result in a dim picture or no picture at

small piece of spring steel which may be cut from a spring out of an old lock or

clock. Cut the rod approximately 6 inches long as shown in the drawing. Square the ends of the steel and force it tightly into one end of the rod so only  $\frac{3}{8}$  inch projects. This makes a handy screwdriver-type aligning tool. The blade is so small that it has little or no effect on tuned circuits. The insulated rod minimizes hand-capacitance effects.

Double the usefulness of the rod by cutting a slot  $\frac{3}{8}$  inch deep in the other end. When checking for intermittent or noisy joints and components, simply slip the slotted end over various leads and twist gently. The slot will fit over leads only  $\frac{3}{8}$  inch long—a feat impossible with the bare fingers. There is no danger of short circuits, shock, or damaging components.

### TV Channel Indicator

Some TV sets have only a small dot as the indicator on the channel-selector knob. This makes it difficult to tell which channel is tuned in when viewing from a distance in a dimly lit room.

To solve this problem, use a piece of cardboard as a pointer. With the rear circumference of the knob as a guide, trace the outline on the cardboard, then add a small projection for the pointer. After trimming around the outline and punching out the center for the control shaft, cement the pointer to the back of the knob so it is directly behind the small indicator dot.

### Beam Killer

The circuit modification shown in Fig. 311 prevents formation of the intense spot of light that appears in the center of many TV screens immediately

after the set is turned off. In most TV sets the picture tube first anode is supplied from some point in the power supply proper. The diagram shows how a popular RCA circuit can be modified so the first anode is supplied directly from the arm of the height control which usually obtains its voltage from the damper-boost circuit. If the original circuit has a resistor in series with the first anode, remove it.

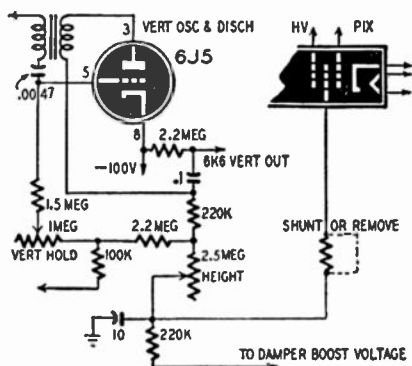

Fig. 311. Circuit modification for suppressing a beam after TV set is turned off.

This circuit also aids in eliminating the brown spot seen on kinescope screens after some use. Although the circuit shown is applied to the 630-type set, there is no reason why it cannot be applied in other receivers.

Take care when adding this circuit to sets having large picture tubes, because the boosted voltage may exceed the maximum voltage which may be applied to grid 2. If the voltage exceeds 400, use a voltage divider.

### Curing TV Breakdowns

Many TV receiver breakdowns are due to excessive heat generated in the boxed-in high-voltage cage. In fact,

you could cook a meal on top of some sets.

A simple but effective solution to this problem is a small fan inside the cabinet, that goes on and off with the TV set, to circulate the air. This prevents many breakdowns because of the much lower ambient temperature in which the parts have to operate.

An excellent compact unit that will fit in any set is a phonograph synchronous motor with a 4-blade fan, commonly used by amateurs for cooling transmitting tubes. Make sure to face the fan to blow the air to the back of the set and out the cabinet. These can be purchased from almost any radio supply house at small cost.

A drop of oil on the fan bearings will keep motor noise down to a very low level. The fan will also be much quieter if a rubber pad is placed between the fan base mounting plate and the cabinet.

### Retrace Elimination

The vertical retrace-elimination cir-

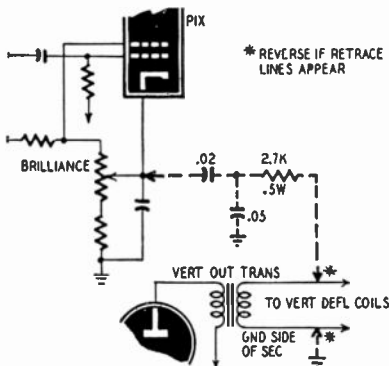

Fig. 312. Retrace line elimination circuit.

cuit shown in Fig. 312 is adaptable to many TV receivers. The portion of the

schematic in broken lines represents the additions to be made to the present circuit.

### C-R Tube Precautions

Be sure to discharge the high-voltage anode on all C-R tubes being removed from or going into receivers. Use a heavy insulated lead to short the anode to the chassis or to the tube coating. These tubes hold a heavy charge for a long time—one good shock can cause you to do lots of damage.

### Retrace Blanking Kinks

This is a method of applying vertical retrace blanking to some sets without pulling the chassis. On the Zenith G2952R and similar models, simply

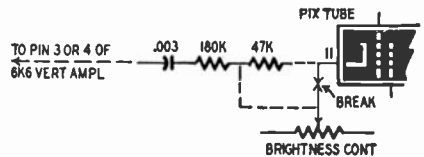

Fig. 313. Vertical retrace blanking circuit.

connect a 180,000-ohm resistor from the picture tube cathode (pin 11) to pin 9 of the dummy Phonevision plug on the rear of the chassis. A .002- $\mu$ f capacitor is connected between this pin and the plate of the vertical output stage. The vertical signal is tapped off at this point and applied to the cathode of the picture tube to blank the retrace lines.

The diagram in Fig. 313 shows the details of a similar modification made on Emerson 571 and 606 models. The .003- $\mu$ f capacitor and the 47,000- and 180,000-ohm resistors are assembled on

a small terminal strip. The lead between the picture-tube cathode and the brightness control is broken near the socket and the leads from the ends of the 47,000-ohm resistor are connected as shown by the dashed lines. The lead from the free end of the .003- $\mu$ f capacitor is connected to either pin 3 or pin 4 of the 6K6 vertical amplifier tube. There is d.c. on this lead, so make sure that it does not short to the chassis.

### Servicing TV Sets

When servicing a TV set, be sure to check the 5U4-G rectifier socket before turning the set on end or on its side to get at the under side of the chassis. Pins 1 and 4 must be in the vertical plane or the filament is likely to sag and short to the plate, thus causing the tube to blow out.

### Receiving FM on TV Sets

If you are using a split-channel TV set which has a turret-type tuner, it is quite possible that you can modify it so you can receive a few of the local FM broadcast stations. (This idea will not work with intercarrier receivers.) Channel 6 must be vacant in your locality.

You simply adjust the channel 6 oscillator-tuning slug until you receive FM stations in the low-frequency half of the band. The printed-circuit tuner can be adjusted to bring in stations between 88 and about 94 mc. The Standard Coil tuner can be adjusted to bring in stations a few megacycles higher. The fine-tuning control can be used to tune in stations adjacent

to the one on which the oscillator is centered.

The mixer and antenna circuits are not tuned to the FM band, so this trick works best for local stations.

### Handy Servicing Light

Time after time, service technicians run into TV sets which have flat, wafer-type miniature sockets mounted

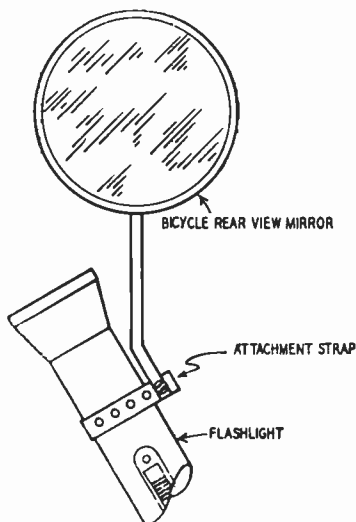

Fig. 314. Handy light-mirror combination.

behind i.f. cans, capacitors, transformers, and other components where they cannot be seen without pulling the chassis. Taking the tubes out for checking isn't so bad, but getting them back into the sockets can be a time-consuming, frustrating job. The same problem also arises frequently in seating alignment tool tips in tiny tuning slug slots.

Avoid such experiences by using the flashlight-mirror combination shown in Fig. 314. A bicycle rearview mirror is

fitted to the barrel of the flashlight with a metal strap clamp. With this arrangement, you can throw light into the socket and see the reflection clearly in the mirror. The swivel on the mirror permits it to be set at the most convenient angle.

### Slug-Tuned Coils

Constructors, experimenters, and service technicians often run into trouble on TV sets having slug-tuned coils. The slotted screw which adjusts the core is either so tight that the slot breaks or it is located in a place where it is difficult to get at to make adjustments. Solve this problem by screwing a nut onto the top of the screw and soldering it in place. This will allow you to use an insulated wrench or neutralizing tool instead of a screwdriver.

### Kit Assembly Hints

Follow these rules when constructing TV sets and other equipment from kits:

1. When controls are mounted on the chassis instead of the panel, mount them for a trial fit. This will enable you to ream the holes, and make other adjustments before wiring.

2. Use panel bushings when switches and potentiometers are mounted some distance back of the panel. A rigid shaft makes operation easier and prolongs the life of the component.

3. Capacitors having the same electrical ratings come in many shapes and sizes. Be sure that all parts will fit into the space provided for them before soldering in the first one.

4. Check the color coding and ratings of components against the parts list.

Sometimes it is easy to mistake a red dot or stripe for a brown or orange one.

5. Always take inventory before starting to build.

6. Always check components before mounting and wiring them into place. Resistors and capacitors have been known to be incorrectly color coded.

7. Always fuse your kit. Use the right size fuse.

8. When you first turn the kit on, keep an eye on the rectifier plates. If they glow red you've got yourself a short circuit.

9. Don't dive in as soon as the kit arrives. Read and reread the instructions, then take it easy!

### Ribbon-Line Capacitor

Small but fairly precise values of capacitance are often required in the

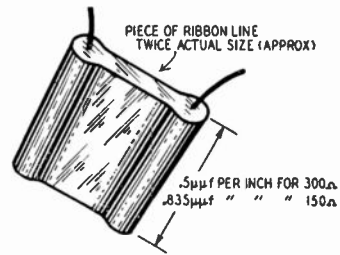

Fig. 315. Don't throw away scrap twin lead. Sections make handy capacitors.

construction of TV boosters and other v.h.f. and u.h.f. equipment. Small capacitors having high voltage ratings can be made from sections of ribbon-type transmission line as shown in Fig. 315. The average 300-ohm ribbon has a capacitance of approximately  $0.5 \mu\text{mf}$  per inch, and 1 inch of 150-ohm ribbon has a capacitance of about

0.835  $\mu\text{f}$ . The required capacitance can be obtained by cutting the line to the required length. For precise work, cut the line a little long and prune it the exact value required.

Keep your ribbon-line capacitor as flat as possible. Even a quarter-turn adds lots of inductance at high frequencies.

### TV Chassis Support

When servicing TV sets, it is often necessary to stand the chassis on end to expose the wiring underneath. When the picture tube and deflection yoke are mounted on the chassis, the assembly is very top-heavy, making it difficult to keep the chassis in a position convenient for under-chassis servicing.

Solve this problem by using stiff wire hooks suspended by adjustable straps fastened to the ceiling or a shelf above the workbench. The chassis can be safely supported in any convenient position by engaging the hooks at the top end. This system permits the assembly to be pivoted when making adjustments on both the top and under sides of the chassis.

### Troubleshooting TV Sets

Troubleshooting a TV receiver by isolating individual stages is difficult when the tube heaters are in series-connected strings. Solve this problem by saving all defective tubes which have good heaters. Snip off all except the heater pins and use these tubes to replace the good tube in the stage to be disabled. Be sure to mark each dummy tube with its heater voltage and current so you can select the correct substitute

for the tube as you put the dummies in the set.

### TV Interlock Adapter

It is often difficult to obtain the special interlock plugs used on Philco, Zenith, and some other makes of TV sets. A simple solution to the problem is to drill holes in the center of the slots on a standard plastic cube tap fitted with an extension cord long enough to reach a convenient receptacle. If a polarized connector is needed drill one hole with a No. 19 drill and the other with a No. 26. Use a No. 19 drill for

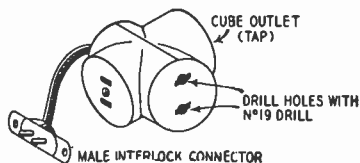

Fig. 316. TV interlock cube adapter.

both if polarity is not important. The holes in the slot are the correct size to fit over the prongs of the male half of the connector.

You can connect the modified tap to a standard male chassis interlock connector with a few feet of cord (see Fig. 316). Plug the adapter into the female connector on the cabinet back and fit the tap over the terminals of the male half of the interlock. The soldering iron, trouble light, or extension cord can be plugged into the other slots on the tap.

### 630-Type TV Sets

Replacing the 6K6-GT vertical output tube with type 6V6 or 6V6-GT in 630-type television receivers, or re-

ceivers with similar circuit design, will provide increased picture height with good vertical linearity. This change is especially applicable to sets that have been converted from 10- to 12- or 16-inch picture tubes. No other modification is required for expanded height.

Readjust the vertical linearity control after making this change.

### **Use for Weak Rectifiers**

Don't throw away those weak 5U4's, 5Y3's, and similar rectifier tubes which you remove from TV receivers. The next time you have a set with an intermittent B-plus short in it, stick in one of these weak tubes and save the new replacement until after the short has been located and eliminated.



# Section 4

## Radio Servicing

### A Tip on Soldering Irons

Soldering-iron tips will last almost indefinitely without corroding or pitting if coated with a layer of silver solder. Your local plumber will do the job for a nominal fee, but you can do it yourself by heating the tip in the flame of a gas burner or blowtorch and then applying silver solder. The coating will not melt or corrode in ordinary use because its melting point is much higher than that of standard solders used for ordinary electrical soldering and metal work.

### Plating Soldering Irons

Another method of plating a soldering iron is to plate the tip of the iron with Cool-Amp, a silver plating powder which can be applied to any clean copper surface with a damp cloth. This powder is also useful in improving the contact between heavy copper conductors which are clamped or bolted together.

### Soldering Hints

If you are annoyed by stray drops of solder sticking to a chassis which you are wiring, try rubbing the areas likely to be so damaged with a wax crayon or piece of candle before starting.

If, on the other hand, you have trouble making rosin core solder stick to a chassis, try Kester or some other brand of aluminum solder.

### Soldering Litz Wire

To remove the enamel from very fine wire so that solder will stick to it, dip the wire in liquid cement solvent. After a few seconds, scrape off the softened enamel with a fingernail, then solder.

### Removing Excess Solder

Replacing resistors, capacitors, and other components in electronic devices is often made difficult by excess solder on the terminals of sockets, switches, and mounting lugs. To remove excess

solder, try holding a piece of heavy bus bar on the terminal and flowing the solder onto it.

### Improving Soldering Irons

Sometimes while soldering a heavy joint on a chassis, you will find that your soldering iron is not producing enough heat to do a good job. Removing the tip and knocking off the rust may not help. To provide a more efficient transfer of heat between the tip and barrel, reverse the tip, lightly file the part which goes into the barrel, then tin it thoroughly. When the tip is replaced correctly, the iron will supply enough heat for jobs which could not be done before the tip was cleaned and tinned.

### Saving Soldering Irons

There is a way to prevent soldering iron tips from corroding and pitting when the iron is left on for long periods.

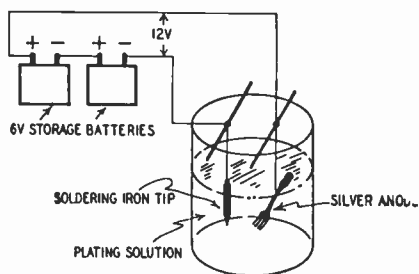

Fig. 401. Silver plating soldering-iron tips.

Dissolve one ounce of potassium silver cyanide in a pint of water in a small plating tank or crock. Using the copper tip as the cathode and any silver object such as an old knife or fork

as the anode, deposit a fairly heavy coating of silver on the tip. Use the circuit shown in Fig. 401 and allow the current to flow over night. This will not discharge the average battery because the current quickly tapers from a 300-ma rate to approximately 5 ma steady state.

A quick wipe with a clean cloth will remove any residue which may form on the iron. It should not be necessary to re-tin the iron after its initial tinning.

**TAKE CARE!** Cyanides are **DEADLY POISONS** and must be handled carefully. All operations should be carried out in a well-ventilated room or out of doors. Use rubber gloves in handling the solution and plating equipment. **WASH** the tank, anode, and work in running water.

### Handy Solder Supply

Forgetting to take along a supply of solder when going on a service call or running out of solder just when you need it most, can be prevented by wrapping a foot or two of wire solder around one end of the soldering-iron cord. Here, it will be out of the way, yet always available when needed.

### Flux Saver

Most radio service technicians have a can of soldering paste on the workbench for those tough soldering jobs. A brand new can of flux is always a pleasure to use because it is nice and clean. But it doesn't take long for the flux to become contaminated with dirt and small pieces of wire and solder because it seems that most technicians

are always *too* busy to replace the cover when the job is completed.

A simple solution to the problem is to cut a slit in the side of the cover (see Fig. 402) so it can be left on the can in the raised position. This allows solder to be inserted to pick up flux and

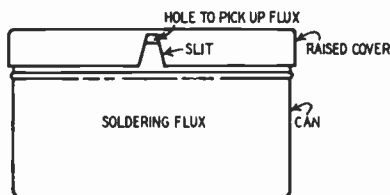

Fig. 402. Keeping soldering flux clean.

transfer it to the work. Besides keeping out dirt, the slit prevents picking up too much paste. Too much paste can do more harm than good. It produces a messy job and is often the cause of leakage, noisy contacts, intermittents, and other troubles.

### Soldering Paste Holder

Test leads, tools, and components are often smeared with soldering paste from an open container on the work bench. To prevent this from happening, fasten a needle cup with spring cover to the bench and put the soldering paste in it. The lid stays closed and protects both paste and tools.

### Soldering-Iron Tips

It is a good idea to have a number of different-sized and-shaped tips for your soldering iron to take care of fine and coarse jobs and to get into otherwise inaccessible places.

A small depression, large enough to hold a drop of solder, in one surface of

the iron is useful for transferring solder to hard-to-reach connections.

Soldering-iron tips are often held in place by means of a set screw. Remove the screw once in a while or else it may bind in permanently, making it impossible to remove a worn down tip.

Some service technicians insist that tinning only one of the faces of a tip makes for a more efficient transfer of heat from tip to work and results in easier, cleaner soldering.

### B-Supply Uses Old Tubes

The next time you start to hook up an experimental power supply and find that you don't have a suitable rectifier, look around and see if you can find a 25L6, 35L6-GT, 50B5, or similar output tube that is weak or not being used. The circuit in Fig. 403 shows how these

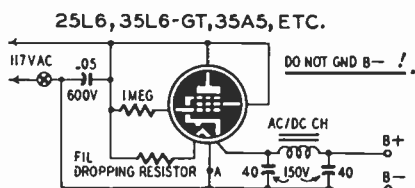

Fig. 403. Use weak output tubes as rectifiers.

tubes can be connected as half-wave rectifiers. The filament-dropping resistor should be selected to supply the correct voltage to the heater or heaters. Other tubes can be connected in series and inserted at A on the diagram.

### Faded Tube Numbers

The tube type number is often printed on the side of the glass type tubes and through frequent handling, the number soon becomes unreadable.

Overcome the handicap by dipping the glass portion of the tube in ammonia and allowing it to dry. The numbers then stand out clearly. Powdered ammonia may also be used by spreading it on the surface of the tube and then dipping into warm water and allowing it to dry.

Another neat idea is to rub the tube through your hair a number of times, with the tube number facing your scalp. The natural oil in your hair will make the tube numbers visible.

Some service technicians claim that putting a tube in the refrigerator for several hours is sure to do the trick.

### Birdies in A.C.-D.C. Sets

Squeals and birdies may sometimes be eliminated from compact a.c.-d.c. sets by replacing the i.f. tube. The old tube may pass a tube checker and can be used in another set.

### Interference Eliminator

Replacing the cloth cover of the speaker grill of an auto radio with a well-grounded copper screen often eliminates ignition noise and similar interference which may enter the set through the speaker opening. This practice is equally useful in other models having the speaker mounted in the receiver cabinet.

### I.F. Interference

Harmonics of marine and commercial stations operating on the low-frequency side of the broadcast band can fall within the i.f. range of superheterodyne receivers. These signals are often

picked up by the antenna. If so, you can eliminate them by inserting one or more tuned traps in the antenna circuit of the set as shown in Fig. 404.

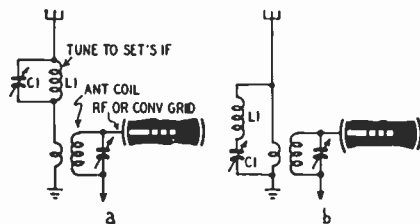

Fig. 404. I.F. interference eliminator.

The drawing at a shows a parallel-tuned trap, and the drawing at b shows one which is series-tuned. If the interference is severe or is from two stations, it may be necessary to use both types of traps. In any case, the traps should tune to the i.f. range of your set. L1 and C1 may be one winding and tuning capacitor from a standard i.f. transformer.

### Defective Tubes are Useful

Frequently service technicians are called on to repair a small a.c.-d.c. set in which the trouble is a burned-out tube as indicated by the complaint, "the set won't light."

To quickly locate the tube with the open filament, make a collection of different types of tubes which have good filaments but are otherwise defective. Snip off all the pins except those for the heater. Now, when you get a set to repair, you can quickly find the defective tube by substituting a dummy.

You will also find dummy tubes handy substitutes for line-dropping resistors in experimental a.c.-d.c. circuits.

For example, a code oscillator using a 35Z5-GT and 50L6-GT does not need to have a resistor in series with the heaters if you wire in an extra socket and insert a dummy 35Z5-GT.

### Noisy A.C.-D.C. Sets

Several compact midget sets have shown up with noisy, microphonic 35Z5's. It seems that vibration from the speaker causes the coating to flake off the cathode, thus making the emission unstable and erratic.

New 35Z5's are only a temporary cure because the trouble returns in a short time. For a permanent cure, use rubber grommets to shock-mount the rectifier socket on the chassis.

### Open Rectifier Tubes

Don't be too hasty in replacing a 35Z5-GT or similar tube when you

other tubes from the string then plug in a new 35Z5-GT. With the line switch on (but with the set *not* connected to the line), use an ohmmeter across the line plug to check for a short. This precaution requires only a few seconds and will save many new tubes.

### Curing Converter Troubles

Sluggishness and drift on shortwave bands are common complaints against converters and shortwave receivers using 6A8 converter tubes. In such cases, try substituting a 6K8. The set or converter will have more pep, and drift will be lessened or eliminated. Corresponding tube elements connect to the same pins, so no wiring changes are necessary when making this tube substitution.

### Tube Substitutions

When a 6H6 goes bad and a replacement is not immediately available, check the circuit. If only one diode is used or if both diodes are connected in parallel, a 6C5, 6J5, or 6P5 can be used as a replacement.

Connect one jumper between pins 3 and 5 and another between pins 4 and 8 on the base of the triode. The jumpers make it possible to use any of these triodes as replacements.

The replacement triodes may be those which would normally be discarded because of microphonism or grid-to-plate shorts.

### Excessive Line Voltage

If you live in an area where the line voltage is unusually high, a.c.-d.c. sets

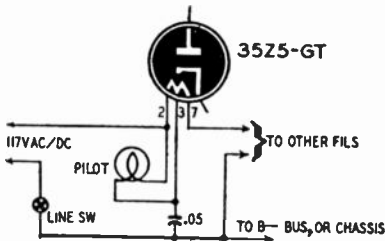

Fig. 405. Investigate the cause of an open 35Z5-GT filament before replacing the tube.

find the heater tap is open. Some receivers have a line filter capacitor connected to the center-tap as shown in Fig. 405. If this capacitor is shorted, it will burn out one section of the heater as fast as you can plug in new tubes.

You can check this capacitor without pulling the chassis. Remove one of the

will probably have frequent tube burn-outs. To reduce trouble from this source replace the output or rectifier tubes with equivalent higher-voltage heater types. A 45Z5-GT can be used, for instance, as a replacement for a 35Z5-GT or a 50L6-GT can be used to replace a 35L6-GT.

If the line voltage is *too low*, reverse the procedure.

Note the tube substitution and the reason for it on a service tag and glue it to the back of the set. This information may prove useful to you and to other technicians who may have to service the receiver in the future.

Do not assume that the line voltage is high on the basis of a single voltage measurement. Some residential sections, feeding off the same power lines that service industrial areas, experience wide fluctuations in line voltage. The above hint is excellent in areas in which the line voltage is consistently low or high.

### Salvaging Broken Tubes

Constructors and experimenters often have on hand a few octal-based tubes

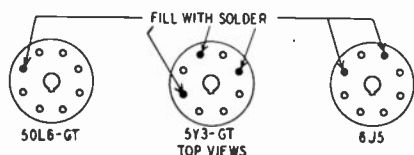

Fig. 406. Use tubes with broken keyways.

which are practically useless because the key has broken off the base.

If the tubes have one or more pins missing from the base, fill the unused holes in the socket with solder. This permits the tubes to be seated correctly

in the socket. The drawings in Fig. 406 show top views of sockets prepared for 50L6-GT, 5Y3-GT, and 6J5 tubes.

### Checking Auto-Radio Fuses

Visual inspection of auto-radio fuses will not always tell you if they are bad, because some of them blow out at one end instead of in the center. Test the fuse with a low-range ohmmeter because just a few ohms of resistance in the fuse will allow a good vibrator to operate but will not supply proper heater voltages.

### Vibrator Failure

New vibrators and those which have not been used for a long time often fail to start on d.c. because of oxidization of the contacts. The usual method of clearing up this trouble is to connect a 50-watt lamp in series with the vibrator and run it on 117 volts a.c. for a few minutes.

You will find it more convenient to plug the unit into a tube tester and operate it on 12 volts a.c. from the filament transformer. If the tube tester does not have a flexible switching arrangement, test leads fitted with banana plugs can be inserted in the filament pins of a 4- or 6-prong socket and the other ends clipped to the vibrator pins.

This method does not harm the tester. Usually a few seconds of running on a.c. is all that is needed to remove the oxidization. When the hum of the vibrator changes to an unsteady buzz, this is an indication that the contacts have cleaned up and that the vibrator will start without trouble on d.c.

## Quick Test for Auto Sets

The vibrator transformer of a battery-operated receiver or amplifier can be checked quickly and simply with a 6.3-volt filament transformer and an a.c. voltmeter. Remove the vibrator and plug the filament leads into the correct holes on the vibrator socket. Measure the voltage between ground and each plate pin on the rectifier socket. The voltage should be equal between each plate pin and ground; however, some transformers work satisfactorily with a 15-20-volt variation across the halves of the secondary.

## Troubleshooting Auto Radios

When an auto radio has a bad vibrator and a replacement is not immediately available, checking the rest of

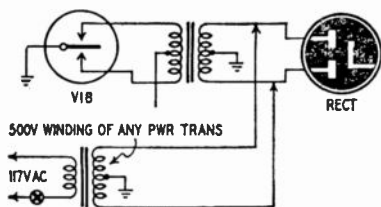

Fig. 407. Don't put that auto radio away because you haven't a replacement vibrator. Use this stunt instead.

the circuits must wait until a vibrator is obtained. To save time in repairing the set or preparing an estimate, remove the vibrator and connect the set to the 6-volt supply or storage battery. Using a standard 500-volt, center-tapped power transformer, apply 250 volts to each plate of the rectifier tube as shown in the diagram in Fig. 407. This method can be used for a dead vibrator or open power transformer.

## Auto Radio Kink

Sometimes it is desirable to do preliminary troubleshooting before removing a defective auto receiver. It is not necessary to bring out the portable signal generator. Simply remove the cover from the hash filter in the power supply section of the set. Use a capacitor to couple the vibrator hash into the suspected circuit or component under test. The coupling capacitor should be large enough to pass the hash and have a working voltage rating high enough to protect parts and tubes from d.c.

This system will prove useful in isolating an intermittent stage and for signal tracing by the signal-injection method. Do not attempt to use it to align r.f. or i.f. stages because the output of the vibrator is a wide-band signal which is not constant in amplitude or in frequency. Consequently, such signals are useful only for simple signal tracing.

## Noise in Auto Sets

Stubborn cases of ignition noise may be caused by leakage between the antenna and the body of the car. A deposit of metal salts, caused by corrosion of the brass in the antenna, forms under the insulating washer. This leakage is too high to be measured with an ordinary ohmmeter. The noise can be cleared up by removing the antenna and cleaning its base and insulator.

In cases where noise is being picked up through the 6-volt supply—noise comes in with the antenna disconnected—one simple remedy is to run the hot lead from the set direct to the

battery. Keep this lead dressed close to the body of the car.

### Fuse for Receivers

A fuse to protect the rectifier tube and power transformer in case of shorts in the high-voltage supply is worth while in all receivers and is almost a necessity in experimental equipment where there is the added risk of overloads.

The easiest fuse to install and replace is a simple pilot lamp. The 150-ma screw type is best in most equipment but an ordinary flashlight bulb will give

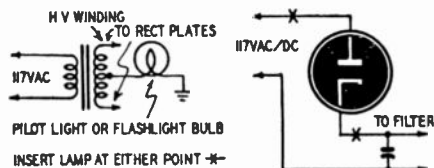

Fig. 408. Flashlight bulb used as a fuse.

sufficient protection. Simply wire the socket in series with the center tap of the high-voltage winding of the power transformer or in series with the plate or cathode of the rectifier in a transformerless receiver. The 150-ma pilot lamp is also useful as a rough indicator of amount of current flow. If the lamp lights to full brilliance the load is taking 150 ma. Do not worry if the lamp does not light at all. The load current taken out of the power supply may not be enough to light the lamp. The drawings in Fig. 408 show where the bulbs may be inserted.

### Overload Protection

By installing an overload switch in series with the a.c. line to your work-

bench, you can save many a.c.-d.c. sets from possible damage through short circuits to ground or test instruments. One service technician used a switch made for an Easy washing machine. This switch can be purchased from appliance supply stores for a few dollars. It breaks the power as soon as the overload occurs. Power is restored by merely throwing the switch.

### Repairing Fuse Connectors

When repairing auto radios, you may often find that the fuse connector has been disconnected and the insulated sleeve has been lost. If a new one is not immediately available, make a new one of the same size from a piece of spaghetti tubing. Insert the fuse into the sleeve before putting it in the connector. This gadget works well. There is no danger of shorts between the connector and the body of the car itself.

### Flashing Pilot Lamp

Many sets and amplifiers have a pilot lamp connected between one side of the

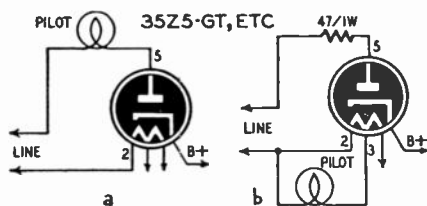

Fig. 409. Elimination of flashing pilot lamps.

line and the plate of a 35Z5-GT, 35W4, or similar rectifier as shown at a in Fig. 409. If the set is turned off and turned back on while the rectifier is still warm, the pilot lamp will flash very brightly and may burn out. This



condition can be eliminated by connecting the pilot lamp across the tapped heater and connecting a 47-ohm, 1-watt resistor in series with the plate as shown at b.

### Pilot-Light Saver

A.c.-d.c. receivers have the bad habit of burning out pilot lights connected in series with the filaments because of the high initial current through them when the set is first turned on. To make the lights last longer, connect a 50-ohm, 10-watt resistor directly across each one. This has the additional advantage of allowing the set to continue playing when the light does burn out.

### Blinking Pilot Lamps

Pilot lamps which blink intermittently in a.c.-d.c. sets can be caused by an intermittent heater in one of the tubes. Locate the faulty tube by connecting a fast-acting a.c. voltmeter across each heater until you come to one which causes the meter to rise above normal when the pilot is off. Replace this tube.

### Heater-to-Cathode Leakage

Modulation hum caused by heater-to-cathode leakage can be checked simply by opening the cathode return of the suspected stage. If the tube is good, the cathode potential will approach the supply voltage and the set will be inoperative. However, if there is leakage between heater and cathode, the tube will continue to conduct and the hum will grow louder or remain at its previous level. The high cathode voltage will probably cause the heater and cathode to short if the tube is leaky.

This method may not work too well in sets having the filament transformer isolated from ground. It should do the trick in cases where the center tap or one side of the filament winding is grounded.

### Curing Modulation Hum

When hum in receivers and amplifiers is not produced by faulty filtering, stray a.c. fields, and other common faults, it may be caused by heater-to-cathode leakage in one or more of the tubes.

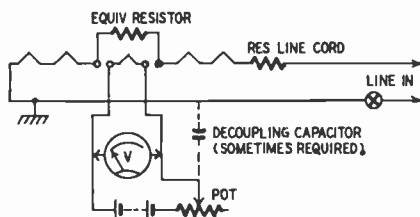

Fig. 410. Heater-to-cathode leakage causes hum.

The easiest method of locating the bad tube is by substitution. However, this method is not too reliable unless two or more of each type tube are available.

Another method is to disconnect the tube heater from its a.c. supply and use a battery to heat it. The battery should deliver the required voltage and current. A rheostat and voltmeter can be used to adjust the voltage to the correct value. Try this on each tube until the hum disappears. This tube should then be replaced by one of the same type hand-picked for hum-free service.

Fig. 410 shows the connections for a.c.-d.c. type sets having series filament

strings. In such sets, the heater string must be completed by a resistor equal to the "hot" resistance of the heater it replaces. The resistance is equal to the heater voltage divided by the heater current in amperes. Fig. 411 shows the connections for making the test on a.c. sets.

If instability is experienced during—or because of—this test, bypass one side of the heater to chassis or B-minus. Use a .001- $\mu\text{f}$  capacitor for r.f. circuits and a .01- $\mu\text{f}$  unit for a.f. circuits.

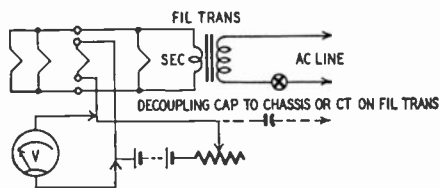

Fig. 411. Checking modulation hum in a.c. receivers.

If the hum is strong, start testing tubes at the front end of the set or amplifier. If it is weak, start at the output stage. Do not overlook the rectifier tube. It can cause this trouble just as easily as the others can. Be extremely careful when testing rectifier tubes.

This method is especially effective in checking high-resistance leaks between cathode and filament of the power tube in series-filament receivers. The leakage may be so slight as to be undetectable on any tube tester but be very noticeable when it has the whole voltage of the filament string across it.

### Servicing 3-Way Sets

Many of us tend to underestimate

the value of a variable-voltage line transformer when servicing three-way portables. One of these sets had stopped playing while being operated on the power line. It didn't play until the 1R5 oscillator tube was replaced. The set was returned to its owner after allowing it to play normally for a few hours. The next day, the set came back with the same complaint. It had stopped playing during the day and had been left turned on and plugged into the line. It started to play again in the middle of the night and woke up the whole family.

Plugging the set into the output of a variable-voltage line transformer, it was found that the set would not start to operate until the line voltage reached 120 and would cut out again when the voltage dropped to about 115.

The trouble was cleared up by substituting a 75-ma selenium rectifier for the 50-ma unit in the set. Apparently the original did not pass enough current at normal line voltages, although its forward and backward resistances checked o.k. on an ohmmeter.

### Tunable Hum

Tunable hum in a.c.-d.c. receivers whose grounds are not connected directly to the chassis can often be traced to the a.v.c. bypass capacitor. If this capacitor is connected to the chassis, unsolder it and hook it to the circuit ground.

### Hum Reduction

Hum can be reduced at the output of R-C filters simply by connecting a resistor R between the rectifier cathode

and the output of the filter, as shown in Fig. 412. R should equal approximately 10 times the total resistance in the filter.

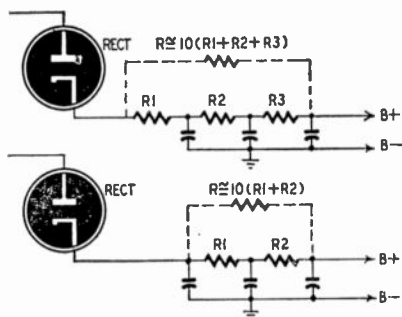

Fig. 412. Easy modification of the filter in transformerless power supplies will give good hum reduction.

When R-C filters are used in B-supplies, the ripple voltage across the output capacitor is out of phase with the ripple voltage at the cathode of the rectifier. Resistor R delivers to the output capacitor ripple voltage which bucks out some of the ripple which passes through the filter. The combination of ripple voltages being less than the ripple voltage without R, the hum level is reduced.

A variable resistor may be used to find the best value for R. Adjust it to the point of least hum, measure it with an ohmmeter and replace with a fixed resistor.

### Protecting Line Cords

Soldering-iron line cords tend to fray where they enter the iron and also at the plug. Consecutive turns of waxed lacing-twine wrapped around these areas will keep the damage from starting.

### Polarizing Line Cords

Many a.c.-d.c. receivers and phono amplifiers are wired with one side of the line connected to the chassis. This presents a serious shock hazard when the user touches the chassis or other metal part if the ungrounded side of the line is connected to the chassis. Because most line plugs are not polarized, the user is never certain that the line cord will be plugged in correctly once it has been removed from its receptacle.

To avoid this trouble, plug in the set and turn it on. Take a small 117-volt lamp and connect one side to a radiator, cold water pipe, or outside ground wire; then touch the other lead to the chassis. If the lamp lights, the chassis is hot and the line plug must be reversed. When the correct polarity is found, apply a coat of paint to one half of the plug and to the correspond-

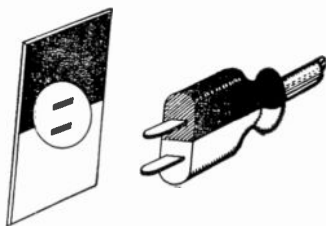

Fig. 413. Use paint to polarize plugs.

ing half of the receptacle as shown in Fig. 413. The set will always be polarized correctly when the plug is inserted so its painted side faces the painted surface on the receptacle.

### Antenna for FM

To install a built-in antenna on FM receivers and tuners simply replace

the standard line cord with a flexible, rubber-covered, three-wire cord. Connect two of the conductors to the power supply and line plug. One end of the third wire connects to the antenna terminal, and the other end is cut to approximately 6 feet and taped.

If a three-conductor cable is not available, take a 6-foot length of insulated wire and tape it to the power cord with cellophane tape.

The third wire has some direct pickup plus additional pickup through capacitive coupling to the line. The system is used by some commercial receivers. This type of antenna can be used with AM sets as well, if the signals override the static on the line.

### Home Made FM Antenna

The FM antenna shown in Fig. 414 was constructed from a piece of 2 x 4

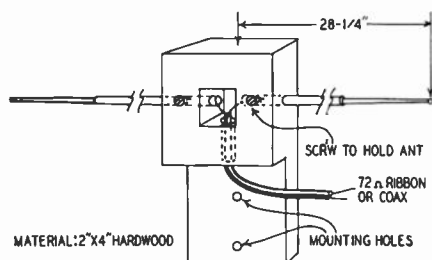

Fig. 414. A telescoping auto antenna, a scrap block of wood (hard rubber, plastic, etc.) and you have an FM antenna.

hardwood and the lower sections of two telescoping auto antennas. The center of the wooden block is drilled or sawed out for connecting the 72-ohm ribbon line or coax. The transmission line can be anchored to the block to prevent strain on the soldered connections at the dipole.

### Oscillation

If an i.f. stage using metal tubes persists in oscillating, scrape some of the paint from each of the metal tubes and run a wire from the bare metal to the chassis. If the oscillation stops when this is done to a particular tube, then the #1 pin (the shield pin) is not connected to the metal shell of the tube, or else the #1 pin is either ungrounded or poorly grounded.

### Poor Sensitivity

Sensitivity can be poor in sets having tapped oscillator coils, like that shown

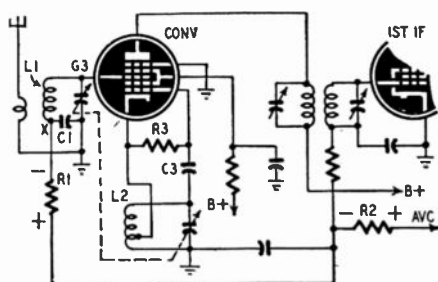

Fig. 415. Excessive local oscillation can cause poor sensitivity.

in Fig. 415, even when all voltages are correct and alignment is perfect. Connect a v.t.v.m. between B-minus and point X, the ground side of the mixer or antenna coil. A small negative voltage may be indicated. If this voltage is reduced greatly when the oscillator section of the tuning gang is shorted, the oscillator is *too strong*.

The full oscillator voltage appears across L2. The signal grid G3 is grounded for r.f. through L1 and C1. Therefore a part of the oscillator voltage is between G3 and the cathode. When positive peaks of the oscillator

voltage are greater than the delayed a.v.c., if any, G3 acts as a diode plate. The rectified oscillator current flows to ground through R1, R2, and the remainder of the a.v.c. network to produce a negative voltage in series with the a.v.c. voltage. The sum of these voltages is sufficient to seriously reduce the gain of the stages connected to the a.v.c. line. (Tune to a no-signal spot.)

The remedy is to reduce the value of the oscillator grid leak R3 until the trouble is cleared up. Sometimes a new converter tube will do the trick.

### Increasing Sensitivity in A.C.-D.C. Receivers

Small table model a.c.-d.c. radios usually use loop antennas. While adequate for nearby stations, they seldom have sufficient sensitivity for satisfactory reception in rural areas.

The obvious solution is to use an outside antenna to increase the signal pickup. Usually an attempt to attach an outside aerial to the loop antenna results in the receiver starting to oscillate and squeal. Coupling the outside antenna to the receiver through a capacitor produces the same result.

One method which you can use to couple an outside antenna to the receiver loop antenna is: With the outside antenna located as desired, take the free end of the antenna wire and wind several turns completely around the loop antenna. This effectively transformer-couples the outside antenna to the set with the loop acting as the secondary. Four or five turns usually proves adequate. A little experimenting will easily indicate the

optimum number of turns. Grounding the free end of the antenna winding may give added gain.

An a.c.-d.c. receiver so modified has much greater sensitivity and a better signal-to-noise ratio than a similar receiver using only the loop antenna.

### Substitute for Old I.F.'s

Occasionally, a set lands on the service bench with an open i.f. transformer

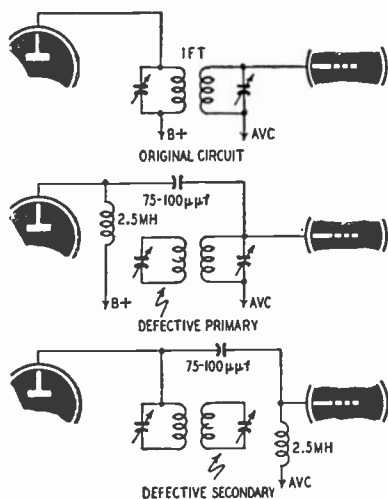

Fig. 416. You don't have to throw away defective i.f.'s if you use these ideas.

and the age and general run-down condition of the set do not justify the cost of a new replacement.

The circuit can be converted to use impedance-capacitance coupling as shown in Fig. 416. An r.f. choke of about 2.5 mh is substituted for the open or shorted winding and the signal is carried over to the next stage through a mica capacitor of about 75 or 100  $\mu\mu\text{f}$ . The choke can be used to replace a defective primary or secondary.

The modified circuit will not be quite as efficient as the original, so take care to align the i.f. and r.f. circuits precisely.

To make sure that the unused portion of the i.f. transformer does not cause any trouble, short it with a piece of wire soldered across it.

### Improving Image Rejection

Many sets which use external antennas have poor image rejection on the broadcast band. The region between 550 and 800 kc is often filled with heterodynes and garbled speech. A simple remedy for this is to insert a 2.5-mh r.f. choke in series between the antenna lead and the top of the primary of the antenna coil. If the set has short-wave bands, install a switch to cut out the choke because it will attenuate signals in the short-wave range. On band-switching receivers, install the choke between the broadcast antenna coil and the band-switch.

### Killing Birdies and Oscillation

To determine the source of oscillation in a receiver, tune the set for a good beat note or birdie. Use a metal tool such as a screwdriver to probe around the grid and plate leads of the r.f., mixer, and i.f. stages until there is an abrupt change in the audio note. Verify your findings by detuning the suspected circuit. This will also change the frequency of the beat. Check the alignment, shielding, lead dress, bypass capacitors, and decoupling networks for causes of oscillation. Do not overlook possible coupling between a loop antenna and the mixer or i.f. stages.

### Intermittents

One cause of intermittents is ground lugs riveted to the chassis. These sometimes loosen up enough to cause resistance. To fix them permanently, solder them securely to the chassis.

### To Repair Intermittents

#### DO—

1. Obtain all possible information from customer.
2. Avoid jarring set until trouble appears.
3. Check tubes for intermittent shorts and noise.
4. Check capacitors by probing and tapping them gently.
5. Check resistors by tapping at connections.
6. Check wiring, terminals, etc., in same way.
7. Check tube sockets, particularly the rectifier, for arcing.
8. Play set for several hours if doubtful.

#### DON'T—

1. Jar set until trouble is found.
2. Treat components roughly.
3. Repair open filter capacitor by bridging with good unit. Remove defective capacitor.
4. Replace one section of a filter capacitor and leave others in place. Replace all.
5. Take anything for granted.

### Adapter for Tuning Shafts

Many automobile radios have volume, tone, and tuning controls equipped with special fittings designed

to be operated through slotted-end flexible shafts. This type of control is difficult to adjust when the control shafts are removed while the set is being serviced.

Use thin-nose crocodile clips to simplify adjusting the controls. The drawing in Fig. 417 shows the type of fitting

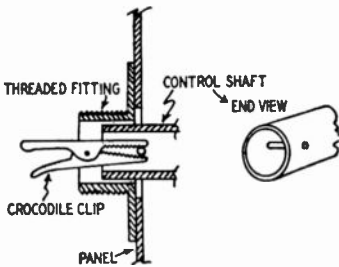

Fig. 417. Substitute for flexible control shaft.

and the use of the clip as an extension shaft.

### Oscillator Circuit Kink

When wiring in the grid leak of a superhet oscillator or converter, do not ground the bottom end of the resistor; bring it to a tie point and connect a resistor of 500 to 1,000 ohms between that point and ground. You now have a test point for checking oscillator grid current without breaking the circuit to insert the meter. The added resistance is large enough to prevent it from affecting the meter reading, yet so small it will not affect circuit operation.

### Checking Dead Receivers

A tunable signal tracer is handy for checking the performance of the pre-selector and oscillator of a dead receiver. Tune the receiver to the frequency of a strong local station, then

tune the signal tracer to the receiver's intermediate frequency. If the front end is O.K., the station will be heard from the tracer when its r.f. probe is brought near the oscillator tube or chassis.

If you are not sure of the receiver's i.f., tune the tracer between 115 and 500 kc until the signal comes through.

### Tracking Superhets

Some inexpensive sets do not have low-frequency padders or adjustable slugs on the oscillator coil. To improve tracking, construct a wire loop slightly larger than the circumference of the oscillator coil. Place the loop over the coil and ground one side to the chassis. For tracking, vary the inductance of the coil over narrow limits by adjusting the coupling between loop and coil.

### Difficult I.F. Alignment

If you cannot peak the i.f.'s in some of the new inverted-chassis models, look for wax around the trimmers on the i.f. transformers. This trouble usually occurs in small, poorly ventilated sets. The wax melts and runs down into the trimmers, making it impossible to align the set. Replace the transformers with wax-free units to avoid a repeat of this difficulty.

Trouble with wax can also occur on slug-tuned i.f.'s. Receiver heat causes the wax to melt and solidify in a blob inside the coil form. Trying to force the slug will break either the slug or its screw. Best cure is to remove the slug and ream inside of coil form with long-blade pocket knife.

## Note to Constructors

After completing a successful radio or electronic project, make a note of all operating voltages and currents. Should the unit become defective, a comparison of operating voltages will help localize the defect. The same method can be applied to commercial equipment where these measurements are not given in a manual. The information may be kept in a notebook or attached to the chassis.

If you record operating characteristics, repairs can be made with simpler equipment than would be required if voltage and current measurements were unavailable.

Another stunt is to record operating data on a large index card and slip same into low-cost cellophane protective holder available at all stationery stores.

## Improving Tuning Eyes

To increase the sensitivity of 6E5's and similar electron-ray tuning indica-

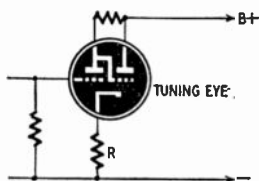

Fig. 420. Cathode resistor improves tuning eye sensitivity.

tors, insert a resistor R in the cathode circuit of the tube. See Fig. 420. When a negative voltage is applied to the grid, the triode plate current drops while the target current increases. The increase in target current is much greater than the decrease in plate current so the total cathode current in-

creases. The increase in cathode current through R biases the grid more negative, thus increasing the sensitivity of the tube and making the shadow angle smaller for a given grid voltage.

The value of R will probably be between 5,000 and 10,000 ohms, depending on the type of tube. The exact value should be determined by experiment. If R is too large, the tube may oscillate and limit its usefulness as an indicator.

## Eliminating Ignition Noise

To cure stubborn cases of ignition noise in auto radios, construct a three- or four-turn, 2-inch loop, using insulated, unshielded wire. Connect this loop in series with the antenna lead-in with shielded wire. Move this noise-pickup coil close to potential sources of noise. Orient the coil for maximum noise cancellation; then fasten the coil in this position.

## Anchoring Radio Parts

The conventional method of mounting such components as extractor fuse posts, spring-mounted sockets, grommets, etc., may permit them to be turned enough to break the leads or cause a short circuit. This may be prevented by applying a cement such as EC-847 (Minnesota Mining & Mfg. Co.) to the components which must be anchored securely.

This cement can be used to make outdoor PA equipment water- and weatherproof. Apply a coat of the cement to junctions between cables and plugs and to other joints where water and moisture may enter.



## Pest-Proofing Receivers

Many cases of radio failure are caused by mice who eat away the wax coating sometimes used on coils and capacitors. As a preventive measure, cut brass or galvanized screen wire to fit the back and possibly the bottom of the set. Solder a  $\frac{1}{8}$ -inch border around the edge of the screen and mount it over the rear of the cabinet.

This method can be used to good advantage in mobile communications equipment and standard auto receivers. Some speakers have a thin grille cloth over the back of the speaker case and others have no protection at all. In areas where dirt daubers are plentiful, these pests will build their mud huts in a speaker or control head and ruin it in a short time.

Always protect the speaker by enclosing it in metal screen wire. Prevent them from entering control heads by taping the small holes and then coating the tape with service cement.

## Tightening Dial Cords

A number of suggestions have been advanced for tightening dial cords so they won't slip. A simple method is to loosen one end of the cord, twist it a number of times, then replace it. Twisting shortens the cord, thus causing it to exert greater pull on the spring throughout the drive mechanism.

## Home Broadcaster

See Fig. 421 for the way to convert a standard superhet receiver into a home broadcaster. Disconnect the primary of the output transformer from the

output tube. Ground one end and connect the other end to the arm of the volume control or to the grid of the first a.f. amplifier. Connect the secondary of an ordinary interstage audio transformer in series with the oscillator plate or the anode grid of the converter tube. Insert the primary of the transformer between B-plus and the plate of the power amplifier stage.

With this setup, the speaker becomes a microphone. Set the dial of the

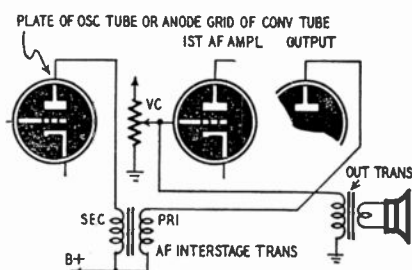

Fig. 421. Home broadcaster superhet.

broadcaster approximately 456 kc (assuming a 456-kc i.f.) below the frequency of the receiver used with it.

## Battery Receivers

If a battery-operated receiver always stops operating before the batteries reach the end of their useful life, try adding a few turns to the tickler winding on the oscillator coil. The increase in feedback voltage will insure oscillation at lower voltages.

## Safety with A.C.-D.C. Sets

Here is a sure-fire method of making certain that you do not get a shock while servicing a.c.-d.c. equipment. Cover one end of your workbench with sheet metal and connect it to ground

through a large neon lamp. Service all transformerless equipment on this section of the bench. If the neon lamp lights when the line cord is inserted, the chassis is hot. Do not touch the chassis until you have reversed the plug. It is a good idea to mount the indicator lamp close to the power outlet where you will be sure to see it when you plug in the set.

### Line Filters in A.C. Sets

Many a.c. receivers have filter capacitors—usually about  $0.1 \mu\text{f}$ —connected from the chassis to one or both sides of the a.c. power line. Although these capacitors are effective in removing stray line noises, they have the disadvantage of reducing the line-isolating capabilities of the power transformer. The current passed by these capacitors is not sufficient to damage any of the set's components but it can give you a healthy jolt if you happen to get between the chassis and a good ground. You can avoid it by removing one capacitor and connecting the other across the line.

### Cleaning Variable Capacitors

Many of the younger service technicians use carbon tet, compressed air, and other gimmicks to remove dust, metal filings, etc. from between the plates of tuning capacitors. When it comes to stubborn cases which do not respond to these treatments, the youngsters would do well to borrow a trick from an old-timer.

Disconnect the leads from the tuning capacitor, apply 800–1,000 volts a.c. across the plates, and slowly turn the

rotor through its range. Arcing in the narrow air gap will quickly burn out any foreign material.

The secondary of an old power transformer is a convenient source of voltage. Connect a 200-ohm, 25-watt resistor or a 25-watt, 115-volt bulb in series with the primary and one side of the power line. This limits the current and keeps the transformer from burning out. When the bulb starts to light, leave the rotor set at this point until the condition clears up as indicated by the lamp going out. Use well-insulated leads and test clips to connect the transformer across the capacitor.

### Transformer Turns Ratio

The turns ratio of a transformer can be found by measuring its voltage step-up ratio, which is the same as the turns ratio. Fig. 422 is a typical setup. Apply

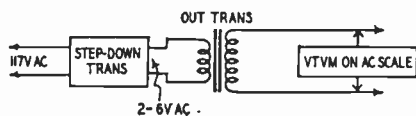

Fig. 422. Finding transformer turns ratio.

a small known voltage to the primary and measure the stepped-up voltage across the secondary. Dividing the secondary voltage by the a.c. voltage applied to the primary gives the turns ratio. As an example, if 2 volts is applied to the voice-coil winding of an output transformer and 60 volts is read across the plate winding, the turns ratio would be 30 to 1. (It is preferable to use a small value of a.c. voltage on the voice-coil winding to prevent overheating.)

If you don't like to fool around with

the line voltage, or if you feel that you may burn out the coil, use the audio modulation voltage of your signal generator. Most signal generators have an attenuator so that you can control the amount of audio test voltage. If your generator does not have a variable audio-frequency control, then the audio frequency is 400 cycles per second. This is satisfactory for performing the test.

### Extending Battery Leads

Servicing farm and portable battery radios can be hard on your nerves when the batteries are connected to the chassis through a short cable which does not permit them to be moved out of your way. Avoid this trouble by making 2-, 3-, or even 4-foot extension leads for the batteries most commonly used. Remove the socket or receptacle from an old battery. Mount it on one end of the extension cable and a male battery plug on the other. This makes it easy to shove the batteries to one side where they won't crowd the working area. Male and female snap-on connectors are used to make leads for batteries used in personal portables.

### Removing Old Capacitors

When installing new power-supply filter capacitors in a receiver, it is very bad practice to leave the old ones in place. They may eventually break down and short. Remove or disconnect them.

Removal of certain types of capacitors benefits the service technician in other ways. Old aluminum cans, for instance, are useful around the shops

as r.f. probes, tube shields, night-light shades, and ballast housings.

### Using Radio as Tuner

Many music lovers now have high-fidelity amplifiers which they use for

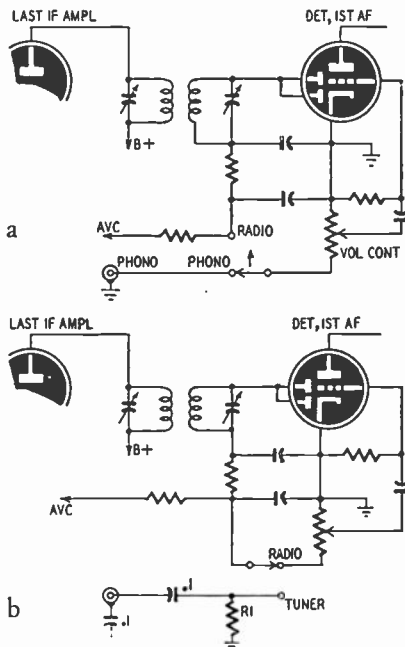

Fig. 423. Radio can be used as tuner.

phonograph reproduction. For radio reception, many of them have to be content with the poorer quality reproduction from the single-ended audio system and midget speaker used in many AM and FM radios. If the set has a phono input jack and switch, it is a simple matter to rewire the input circuit to the a.f. amplifier section so the set can be used as a tuner or straight radio simply by throwing a switch.

The drawing at a in Fig. 423 shows the detector, first audio, and phono

input circuits of a typical receiver. The diagram at b shows how the arm of the PHONO-RADIO switch is removed from the hot side of the volume control and connected to a point on the detector load. Resistor R1 must be added to complete the detector load when the switch is in the TUNER position. The value of R1 should be the same as that of the volume control.

### Crystal Tuner

The AM tuner in Fig. 424 performs well on the broadcast band when used

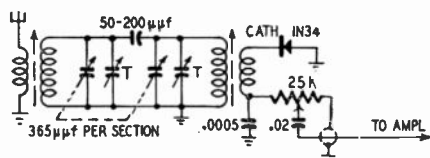

Fig. 424. Selective crystal-tuner circuit.

with a high-fidelity amplifier and reproducing system. Because it has a crystal diode detector, and does not use vacuum-tube amplifiers, it does not require a power supply. The bandpass circuit consists of two slug-tuned, broadcast-band, antenna coils connected back-to-back through a coupling capacitor which may be between 50 to 200  $\mu\text{mf}$ . The secondary windings are tuned by a two-gang, 365- $\mu\text{mf}$  tuning capacitor.

The tuner is aligned at the high end of the band with the 3-30- $\mu\text{mf}$  trimmers and at the low end with the core slugs. The tracking is almost perfect with most coils. Some may require that a few turns be taken off one of the tuned windings.

Using the two antenna coils back-to-back gives this little tubeless tuner

sufficient selectivity for use on the broadcast band, and the tuner output on local stations is enough to drive a high-gain audio amplifier.

### Slow Fade on Old Sets

A slow fade in older models, particularly Philcos, can often be traced to corroded terminals on the tube sockets. Clean and bend them to restore positive pressure on the tube pins. If the socket has been subjected to heat, its fiber may be weakened. The socket should then be replaced.

### Common Ground

When a number of leads are to be grounded, a neater and more efficient job is made by using a common post consisting of soldering lugs mounted in staggered positions on a screw grounded to the chassis. The lugs will remain securely anchored if the top and bottom lugs are the inside star washer type.

### Increasing Electrolytic Life

Electrolytics mounted close to rectifier tubes have their life shortened by the heat. If the electrolytic is a top-of-the-chassis type, drop an unused tube shield over the electrolytic. The tube shield will act as a heat baffle.

### Battery Portable Distortion

Severe distortion on battery and a.c. operation can sometimes be traced to corroded batteries. The same type of trouble can occur on any number of battery sets. It is a good idea to check

the batteries by substitution before you start replacing tubes and coupling capacitors.

### Capacitor Ground Leads

Many molded tubular capacitors have no mark to indicate which lead is connected to the outer foil. To determine which is which, connect the capacitor across the input of an audio amplifier and place your finger on the capacitor at the end from which the grounded lead emerges. Then reverse the capacitor connections and repeat the test.

When your finger induces the least hum, the grounded lead is the one connected to the foil.

### Dial Pointers

To make a new pointer for a dial which has lost its original one, straighten a 12-inch length of solid tinned copper wire by fastening one end of it to a nail or screw on the bench and pulling on the other end with pliers until it breaks. Cut a piece the needed length, and fasten it to the dial shaft.

This is an excellent way to straighten wire for any purpose.

### Replacing Rubber Washers

Many of the older receivers use rubber washers in friction-type dial mechanisms. When the rubber rots with age or deteriorates because of oil spilled on it, replacement washers are seldom available.

If unable to obtain replacement washers for a dial drive, make them by cutting circles (see drawing in Fig. 425) from the bulb of a medicine drop-

per of the type which is built into the tops of eyewash and nose-drop bottles. The rubber used in these droppers is of good quality, has fine grain and is of a convenient size.

If the washers do not fit snugly on the dial shaft, build up the shaft with layers of friction tape before slipping the washer on it. Clean the mechanism

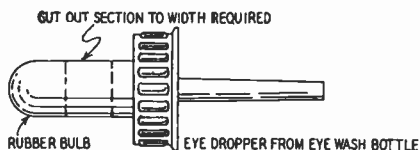

Fig. 425. Bulb from eye dropper is source of supply for rubber washers.

with carbon tet to make sure that there is no oily residue to contaminate the rubber.

### Electrical Wiring Hint

Solder all splices and connections and avoid solderless connectors when installing power and light wiring on or near radio and TV service benches or sensitive electrical and electronic instruments.

A solderless connector is not likely to cause power loss, but oxidation and corrosion may result in small transient currents in the joint. Such currents can cause noise and spurious responses in sensitive equipment connected to the line.

### Save Old Rectifiers

Don't discard defective selenium rectifiers after removing them from a circuit. Lay them aside until you have time to dismantle them. One brand of rectifier contains nine metal washers,

two fiber washers, two grounding straps or lugs, one 3/16 x 1-inch eyelet, and one 1/4 x 1-inch paper coil form. Keep these parts in your spare-parts box. They will come in handy sooner than you think.

### Stripped Screw Holes

Some sets have backs fastened to the cabinet with wood screws. The screw holes are usually stripped after the back has been removed and replaced a few times. A good remedy for stripped wood-screw holes is to slip a piece of small-diameter rosin-core solder into the hole and replace the original screw in the ordinary manner.

This will in most cases hold more securely than the original hole and will eliminate the possibility of splitting the wood with a larger screw.

### Shielding Kink

Shielded wiring is often needed in certain parts of electronic circuits to eliminate hum pick-up, feedback, stray coupling, etc. When circuit performance indicates that additional shielding is needed, remove the leads one at a time and replace them with shielded braid until the trouble disappears.

In such cases, you can quickly locate the lead which requires shielding by wrapping tin-foil tightly around the leads suspected of causing the trouble and connecting one end of the foil to ground. If this makeshift shielding improves the performance, it can be replaced with a piece of shielding braid.

### Improving A.C.-D.C. Filters

A high residual hum level is one of

the undesirable characteristics of most inexpensive a.c.-d.c. radios and phonographs. If the set has an electromagnetic speaker, the 60- or 120-cycle component in the d.c. feeding the speaker field coil will produce hum in the output. If there is ripple on the d.c. line feeding the plate of the output tube, it will produce a pulsating magnetic field which may affect the field of a PM speaker, which is usually placed close to the output tube.

Note that in either case the hum is caused by d.c. ripple rather than a.c. pickup from the power line or heater string. Hum of this type can be greatly reduced or eliminated by attenuating the ripple component of the d.c. supply.

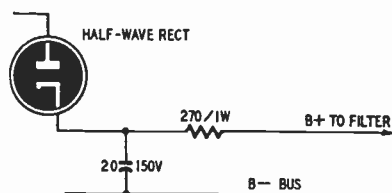

Fig. 426. R-C filter helps cut down hum.

The simplest method of doing this is to install a simple R-C filter right at the cathode of the rectifier—ahead of any other filter components. A typical R-C filter is shown in Fig. 426. The filter should consist of the largest capacitance which can be used without raising the peak voltage or current to dangerous proportions and the highest resistance which can be employed without causing a noticeable reduction in the d.c. supply voltage at the output of the filter.

The values which produce the most effective filtering in most cases are 20  $\mu\text{f}$  and 270 ohms. Adding a simple

filter of this type will greatly decrease the hum level of almost all a.c.-d.c. sets—even new ones.

### Cabinet Repairs

Small scratches on radio cabinets are easily covered with any of the scratch removers on the market, but a deep scratch or dig is a real problem. Commercial scratch removers simply stain the flaw, often leaving a very noticeable scar in the finish.

An undetectable repair can be made with stick shellac in a few minutes and without the need of any great skill. Select a stick of shellac which matches the finish. Hold it an inch or so above the scratch and touch it with the tip of a hot soldering iron. Melt off enough shellac to cover the scratch completely. Hold the iron over the repair just close enough to make the shellac melt and run. Be careful not to let the iron touch either the shellac or the cabinet, nor blister the good finish around the repair.

Allow a few seconds for the shellac to harden. With a sharp knife blade held parallel to the surface chip off the top of the new shellac until it is nearly flush. Dress it down to a smooth finish with very fine sand paper dipped in oil. Linseed oil or light machine oil will do. It is important to scrape the shellac nearly flush before sanding otherwise a lump will be left. Too much sanding will remove finish adjacent to the repair.

Kits of stick shellac in several colors and shades may be purchased from most radio parts jobbers and from mail-order houses.

### Adding Headphones

Every now and then a service technician will get a request to add headphones to a receiver. In the circuit shown in Fig. 427, the jack is wired so the speaker is cut out when the phones are plugged in. The phone jack can be installed in the plate or grid circuit of the output tube. The volume will be somewhat greater when the phones are inserted in the plate circuit as shown at a, but the volume obtained with the circuit at b is usually adequate for most purposes.

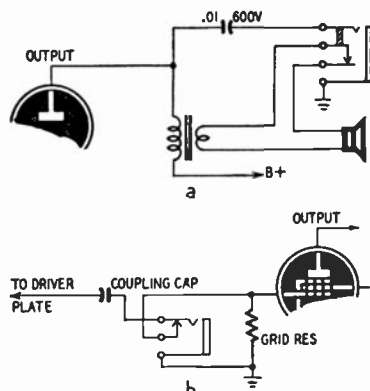

Fig. 427. Two ways to connect headphones to a radio or TV receiver.

These circuits can be used for most sets having single-ended output stages. If the receiver is an a.c.-d.c. model, a .006- $\mu$ f, 600-volt capacitor should be used between the frame of the jack and ground.

### Polishing Clear Plastic

Scratches may be removed from plastic meter faces, dials, and other transparent plastics easily. Simply rub Bon-Ami briskly over scratch and finish

with a fine buffer. Polish with Glass Wax to obtain original luster.

### Resistor Wattage Chart

Economical construction of electronic equipment requires that resistors

tively. The resistance values are in the left-hand column and the current in milliamperes is across the top. Wattage ratings are found at the intersections of the resistance and current columns. Wattages are adequate and the safety factor runs as high as 20%. Wherever possible, wire in resistors away from other heat sources such as tubes, transformers and hot resistors. Mount resistors close to louvers or chassis openings. If the resistor, whether carbon or metal, is completely insulated, mount flush against the chassis. A good conductor, the chassis will draw heat from the resistor, permitting it to work well within its wattage rating and increasing its useful life.

RESISTOR WATTAGE CHART									
Resistance (ohms)	Current (ma.)								
	2	4	6	9	14	20	28	40	60
100								1/2	1/2
250									1/2
500									1/2
1K				1/2	1/2				1/2
2.5K		1/2							1/2
5K	1/2								1/2
10K									1/2
25K									1/2
50K									1/2
100K									1/2
250K									1/2
500K									1/2
1 meg.									1/2

have a minimum, but adequate, wattage rating. Determining the power dissipated in a resistor is simple, but can be laborious when calculations must be made for each resistor in the circuit.

To avoid future calculations of this use this chart which shows the wattage of resistors when the current through them is known. The current and resistance ranges are 2 to 60 ma and 100 ohms to 1 megohm, respec-

If the resistance is not given on the chart, use the next larger values of resistance and current.

The chart is correct for use with carbon resistors; for wire-wound resistors it will be safer to double the wattage rating shown.

Minimum wattage rating in the chart is 1/2 watt. Blank spaces in wattage column above and below the number 1/2 represent 1/2 watt. Disregard all blank spaces under the number 20.



# Section 5

## Audio

### Volume Control Tool

Here is a simple method of removing the C-rings or retaining collars, used in rotary switches, potentiometers, and volume controls, without gouging a hunk out of your thumb.

Drill a small hole in the shaft close to the retaining ring as shown in Fig. 501. Slide a prying tool under the

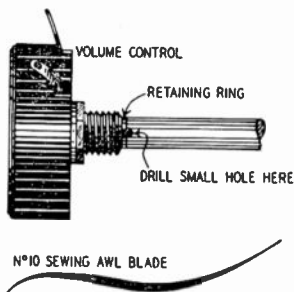

Fig. 501. Tool for removing C-rings.

ring and lift it out. A shoemaker's No. 10 sewing awl blade is an ideal tool for the job. Its shape and sharp point also make it a handy tool for cleaning up soldering lugs and socket pins.

### Repairing Volume Controls

This tool, like the one described in the foregoing paragraph, can be used for removing retaining rings used on switches, volume controls, etc.

Take two beer-can openers and grind the points down so they are very thin. Insert the points of the openers into the gap in the C-ring. Apply slight pressure on the handles and the washer slips off.

These tools are very handy to have around the workbench. When you are not using them to repair controls, you can always use them for their original purpose.

### Quieter Volume Controls

Standard replacement volume controls have been shrinking in physical size for the past several years. While these controls have a low enough noise level for replacement use in radios, they are noisy in low-level stages of amplifiers and equalizers. Here are some

ways to substantially reduce this noise.

A large part of volume-control noise is a result of the grid not having any return to ground when the contact passes over an eroded or dirty portion of the control. This is the case in Fig. 502a. By adding a resistor R2 between

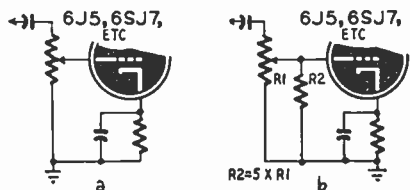

Fig. 502. Having a grid return to ground gives quieter volume control operation.

grid and ground, a d.c. return for the grid is insured at all times. This resistor should have a resistance about five times the volume-control resistance R1. See Fig. 502b.

Fig. 503 is the basic tone-control circuit used in many tuners and radios. Only two terminals of the bass control are usually wired into the circuit. After a few months the control becomes more noisy. The simple cure is to ground the third terminal as shown by the dashed lines. This establishes a grid return

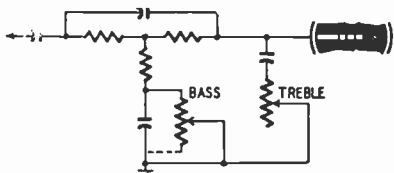

Fig. 503. Bass control circuit gives smoother operation if potentiometer is grounded as shown.

through the potentiometer regardless of variable arm contact irregularities.

The procedure is simple, yet it is a sure cure for this cause of control noise.

## Making Special Controls

Nonstandard shafts have been used on volume and tone controls on a number of receivers. On some sets, the dial string runs around a pulley which is centered on the volume control shaft and held in place by retaining rings. On others, the control shaft may be turned to two diameters for operating an indicator or to fit a special knob. Such controls are annoying to service technicians, particularly when replacements for the control are no longer available.

Some types of control shafts can be turned down without a lathe. A breast drill is locked in a bench vise so its handle and chuck are free to turn. Put the control shaft in the chuck and tighten it. Turn the drill with one hand while the other holds a pair of gas pliers which are used as a cutting tool. The depth of the cut is regulated by the pressure on the pliers. If it is necessary to notch the shaft for a retaining ring, cutting pliers can be used for this purpose.

This type of turning is limited to the soft metals used for shafts on many controls. Precision turning cannot be done by this method, but it will serve when other tools are not available. The process does not harm the pliers because they are made of metal much harder than most control shafts.

## Novel Tone Control

A 2.5-megohm tone control tapped at 500,000 ohms makes an elaborate tone control as shown in Fig. 504.

When the arm of the potentiometer is at the top, the high frequencies pre-

dominate, going directly to the following grid through the 500  $\mu\text{mf}$  capacitor. The 2-megohm section of the control effectively blocks the low frequencies. The response is normal when the arm is at the tap position, and the lows are boosted when the arm is near the bottom.

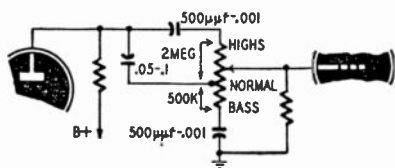

Fig. 504. Interesting tone-control circuit.

You may use two 500- $\mu\text{mf}$  and one .05- $\mu\text{f}$  capacitor or two .001- and one 0.1- $\mu\text{f}$  capacitor. Use the values which give the most pleasing performance.

### Hum Reducing Kink

Sometimes, you may find that hum in an audio amplifier is originating in a push-pull driver or output stage which uses directly heated tube types such as the 45, 47, 2A3, 6A3, 6B4-G, and 6B5. In this case, try transposing the filament leads of *one* tube and use the connection which gives the least hum. This connection is the one which makes the hum voltages in phase in the plate circuits so they cancel.

### Hum Detector

It is often important to know whether or not a potentiometer on an amplifier chassis is free of magnetic fields. To determine this, wind a small choke of about 100 turns on a core made of a thin iron nail. Connect the two leads from the choke to the amplifier input,

or connect one to the grid of the first a.f. amplifier tube and the other to ground (in a receiver). Hold the choke on the spot being tested. If any hum is present, it will be heard in the loudspeaker.

This method can also be applied to oscilloscope construction when it is necessary to locate and eliminate electro-magnetic fields which may distort the pattern on the cathode-ray tube.

### Tone Control Circuit

This tone control is a modification of one which was used in some prewar Airline receivers. It consists of separate high- and low-pass filters which work

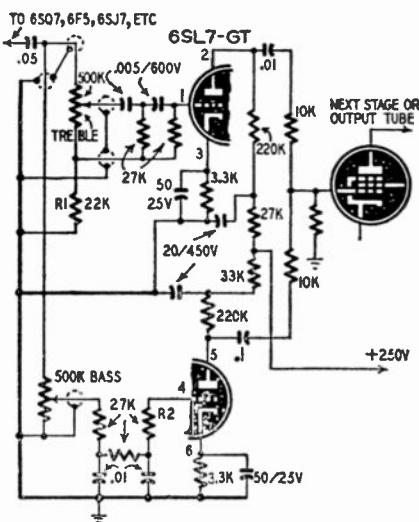

Fig. 505. Modified tone-control circuit.

into the grids of the triodes of a 6SL7-GT mixer tube.

Resistor R1 determines the amount of mid-range frequencies which are passed when the bass and treble controls are turned down. R2, shown as

27,000 ohms in the circuit diagram, Fig. 505, may be as high as 68,000 ohms or may be left out of the circuit entirely. If it is left out, bass notes will override the highs on an average recording. If it is 68,000 ohms, the high will predominate. Experiment with other values if you wish.

Do not try to leave the 6SL7-GT out of the circuit. It is needed to compensate for losses in the tone-control networks.

### Minimizing Hum

Placing a metal plate across the open bottom of an audio amplifier chassis will often help in getting rid of the last bit of hum.

### Spotting PA Microphones

The public-address or remote broadcast operator frequently encounters a setup in which he must control the levels of a number of mikes, and pickups, and other devices. While the same situation exists in the studio, even an excellent operator occasionally cuts in the wrong mike on a remote job, because he is not familiar with the controls and mike locations in the temporary layout. Embarrassment may be prevented and a smoother program will result if each mike or other source is positively identified with its respective gain control.

Place a small dot of colored paint on or near each gain-control knob, a different color being used for each control. Each mike, pickup, etc., is marked with a color matching that of its control. The color labels should be temporary so

that each new layout can be "tailored" to suit the circumstances.

An excellent material for such labeling is colored cellulose tape, which may be purchased in most office-supply stores. A strip of tape of the proper color wrapped around a mike stand, or a small square of tape stuck on the top of a phono pickup will be easily visible in a hurry.

Such a marking system is also convenient in similar fields, such as stage lighting, sound effects, experimental electronic work, and others requiring rapid association of controls.

### Emergency PA Hookup

On an emergency PA installation, it became necessary to feed two ampli-

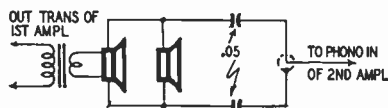

Fig. 506. Effective way to operate two audio amplifiers from one microphone.

fiers from a single microphone. No mixer panel being available, the input of one amplifier was connected across the output of the other through blocking capacitors connected as shown in Fig. 506.

The voltage across the low-impedance speakers averages a volt or two. After passing through the capacitors, it is equal approximately to the output of a good crystal pickup.

### Simple Filter for Scratchy Records

It is easy to construct and install a filter which will make scratchy records sound much better. It consists of a coil

and capacitor connected in series across the pickup leads. Almost any small choke will do—a shielded r.f. choke is excellent. Try small capacitors of different values until you find one which

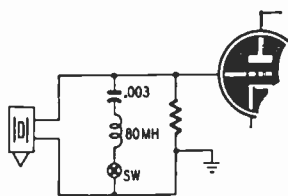

Fig. 507. Easy-to-make scratch filter.

gives the greatest reduction in scratch with the least reduction in volume. If your coil is around 80 to 100 mh, try a .003- $\mu$ f capacitor and work up and down from there. Use large steps at first, and gradually work down to smaller ones.

The filter attenuates some of the highs, so it is advisable to wire in a switch as shown in Fig. 507. Avoid hum pickup by keeping the leads short and well away from a.c. leads.

### Equalizer for V-R Pickups

It is not necessary to use the 6SC7 preamplifier-equalizer with variable-reluctance pickups when connecting

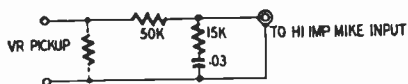

Fig. 508. R-C equalizer circuit.

them to conventional public-address amplifiers if you use the simple equalizer circuit shown in Fig. 508.

The response with the equalizer is substantially flat. A slight bass boost can be had by replacing the .03- $\mu$ f capacitor with a .02- $\mu$ f unit. A slight

high-frequency roll-off can be obtained by shunting the pickup with a resistance of 5,000 to 10,000 ohms.

The equalizer components should be placed in a shield can and connected to the amplifier and pickup through low-capacitance, shielded cable.

### Modifying G-E Preamp

G-E recommends 6,800 to 15,000 ohms as the input resistor in preamplifiers for variable-reluctance pickups. While increasing the high-frequency response, the higher value reproduces scratch on old or poor records. Replace this fixed resistor

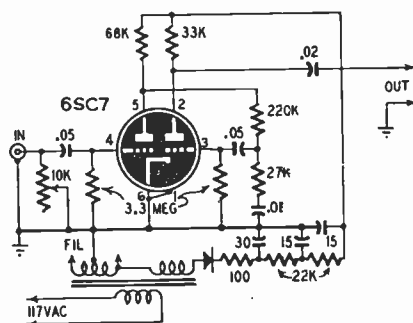

Fig. 509. Preamplifier modification for variable-reluctance pickups.

with a 10-15,000-ohm potentiometer connected as shown in Fig. 509. This control can be adjusted to suppress scratch on old records or reduce the boosted highs on high-fidelity recordings.

### Small Audio Chokes

Single headphone units sometimes can be substituted for plate chokes in low-level audio circuits. The diaphragm can be left in place or removed if it makes too much noise. Do not

the slack and keep the wire tight so it drives at a constant speed. The sound head works into a suitable amplifier. Almost any length of wire can be accommodated by adding more pulleys and weights.

### Novel Crossover Network

The circuit shown in Fig. 514 is an acceptable substitute for the more expensive dividing or crossover networks used with most high-fidelity reproducing systems. It is particularly useful in small receivers which do not have

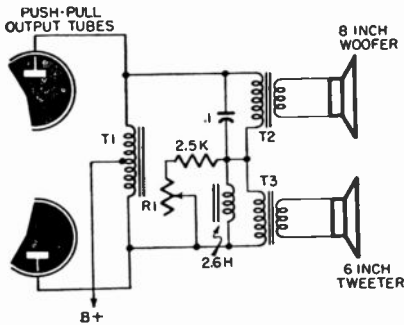

Fig. 514. Easy, quick way to get a crossover network for high and low speakers.

sufficient baffling to warrant the expense of a more elaborate system. The crossover frequency is approximately 400 cycles.

T1 is the regular output transformer of the receiver or amplifier. Its secondary is not used. T2 and T3 are small output transformers. The primary impedance of each is equal to the plate-to-plate load impedance of the output tubes. R1 serves as a tone control by cutting the highs fed to the tweeter. You can use a 500,000-ohm unit, but probably a lower value will work better.

### Simple Audio Pickup

Radio programs may be piped from a receiver to any recorder, amplifier, or public address system through inductive coupling between the output transformer of the set and a magnetic contact microphone connected to the amplifier. Tests have shown the strongest field to be at the top of the transformer. The mike may be suspended within 3 inches of the top of the transformer or mounted directly atop the transformer if it is cushioned with a thin layer of rubber or cork.

### Novel A.F. Tone Source

A simple nonelectronic tone generator which produces a sine-wave output at frequencies from nearly zero to approximately 2,000 cycles can be made by driving an ordinary 110-volt synchronous clock motor as a generator. Any small variable-speed motor can be used to drive it. The frequency is varied by adjusting a rheostat in series with the supply to the driving motor. The sine-wave output is taken from the input leads to the clock motor.

The output voltage varies with the make and model of the motor. One experimenter uses a 250-volt Sangamo motor which delivers 13 volts peak into a high-impedance load such as an oscilloscope or the grid of an amplifier tube.

### Audio Construction Tip

When constructing high-gain audio amplifiers and similar equipment, it is desirable to keep the grid of the input stage isolated from the other circuits

to minimize hum and feedback. It is easy to isolate the control grid and input circuit of double-ended tubes such as the 6J7 and 6F5 but the usual construction methods do not take full advantage of the tube. The usual arrangement is shown in Fig. 515a. The

to drill a few  $\frac{1}{4}$ -inch holes in the chassis above the tube to allow for air circulation and heat dissipation.

### Fixed Bias Supply

Hearing-aid batteries are a handy source of bias voltage for audio amplifiers. They weigh less and require much less space than the line-operated supplies they replace. Because of their low internal resistance, voltage regulation is just about perfect for all practical purposes.

They are available in 15-, 22.5-, 30-, 33-, and 45-volt sizes making it possible to use one or more to come within 5 to 10% of the required grid voltage. Always mount batteries in the coolest part of the chassis because heat considerably shortens their useful life.

### Audio Mixing System

If you are an audio fan and want to avoid using a channel-selector switch on

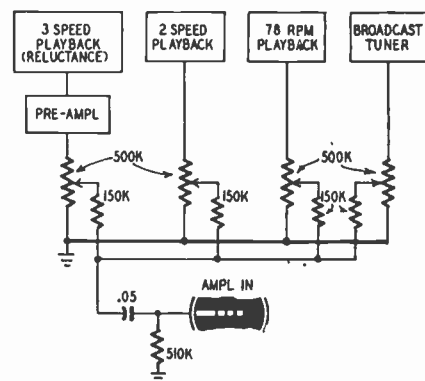

Fig. 516. Audio mixer without switches.

grid lead is comparatively long and must be well shielded to avoid hum and feedback. A suitable shield on the grid lead increases the input capacitance of the circuit and can cause loss of highs.

A better layout is shown in Fig. 515b. The tube is mounted under the chassis in a partition shield which effectively isolates the tube and its input circuit from the circuits on the rest of the chassis. With this arrangement the grid lead can be short and unshielded, thus decreasing stray capacitance and increasing high-frequency response.

Take the usual precautions necessary in low-level amplifiers—placing the tube and shield away from the magnetic fields of power transformers and filter chokes as well as the output transformer and its leads.

Replacing the tube is a little more difficult than when the conventional mounting is used, but since replacements are infrequent, the inconvenience is of little consequence. It is advisable

your amplifier because of the clicks and pops which usually occur when a switch is thrown, use the mixer circuit shown in Fig. 516.

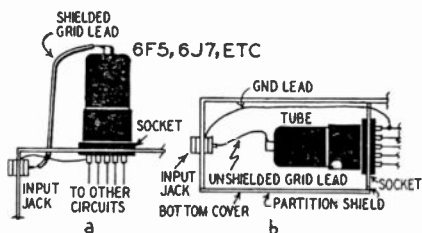

Fig. 515. Mount for high-gain preamplifier.

Replace the volume control at the input of the amplifier with a 510,000-ohm resistor. Couple the amplifier to individual 500,000-ohm volume controls through 150,000-ohm isolating resistors. These resistors introduce some loss into the individual circuits, but they will enable you to set the unused controls in any position without noticeably changing the level of the particular channel in use.

### Tuner for PA Amplifier

Many PA amplifiers can be used to receive signals from strong local stations with the addition of a broadcast coil, tuning capacitor, mica capacitor,

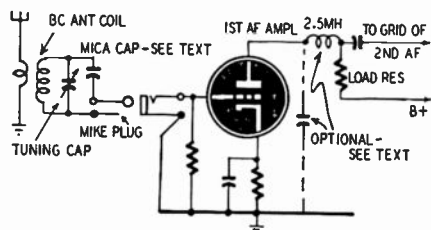

Fig. 517. Amplifier tube as detector.

and a microphone plug, connected as shown in Fig. 517. In this system, the first stage of the amplifier becomes a grid-leak detector. The mica capacitor should have a high a.f. and low r.f. reactance compared to the resistance of the grid resistor in the first a.f. stage of the amplifier. Experiment with values between 50 and 250  $\mu\text{mf}$  for best results.

The tuner may be improved by connecting a 2.5-mh r.f. choke and plate bypass capacitor as shown. The capacitor should be between .001 and .002  $\mu\text{f}$  for triode amplifiers and 250 to 500  $\mu\text{mf}$  where the first stage is a pentode.

### Audio Amplifier Hint

If oscillations do not respond to the usual remedies in a high-gain amplifier which does *not* have inverse feedback, try reversing the leads to the primary of the output transformer. If the amplifier has a push-pull output stage, reverse the plate connections to the output transformer and keep these leads isolated as much as possible from grid and plate leads of preceding stages. Shielding these may be necessary.

### Fastening Tone Arms

Most service technicians have their pet ways of anchoring a pickup arm to a record changer so it will not bounce around and damage the needle or upset delicate adjustments while the instrument is being carried to or from the service shop.

A good method is to punch  $\frac{1}{4}$ -inch holes through the opposite sides of a tube carton. The carton is placed over the pickup and lowered over the center post of the changer until the post projects through the carton. The carton insert or facial tissue can be used to stuff the carton where necessary.

### 3-Way Speaker Baffle

The baffles shown in Fig. 518 use 3-, 6-, and 8-inch speakers to handle the high, medium, and low notes respectively.

The base of the baffle is a heavy box, 12 inches high, 28 inches wide, and 12 inches deep. Holes 7, 5, and 2 inches in diameter are drilled in the top for mounting the speakers. The resonant columns are cut from heavy 8-inch



cardboard tubing like that used for shipping rugs. The top of each column is plugged with a wooden disc having a

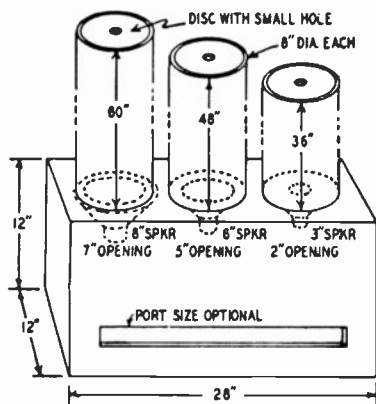

Fig. 518. Unusual three-speaker baffle.

1-inch hole in the center. The port size is optional. Port size in the sketch is  $2 \times 18$  inches.

### Improving Audio Fidelity

If you want to improve the response of an audio amplifier without purchasing an expensive high-fidelity output transformer, you'll probably find that two inexpensive transformers will meet your needs. In an actual test, an amplifier, having a response of 200 to 8,000 cycles with a single output transformer was made flat within 2 db from 50 to 12,000 cycles merely by using two output transformers in series as shown in Fig. 519.

The upper limit of the frequency range of an output transformer is determined by the distributed capacitance of the primary winding. This capacitance being high in inexpensive transformers, appears as a low capacitive-reactance shunt across the primary, and

signals above approximately 8,000 cycles are attenuated. Using two transformers in series halves the distributed capacitance, doubles the capacitive reactance, and extends the upper limits of the response curve.

The low-frequency response is also improved through the use of two transformers. The primary inductances add to produce twice the inductance of a single winding. The higher inductance increases the inductive reactance shunting the primary and lowers the point at which the lows begin to fall off. In this way you can save the cost of a transformer having a high-inductance primary and a heavy iron core and still get a good response.

The transformers preferably should be of the same type. Each—if used alone—should match the output tube to the speaker.

Although this method of improving fidelity can be a great help, always re-

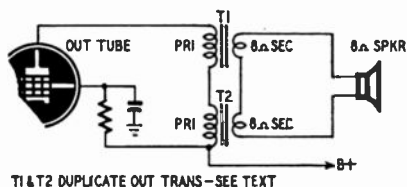

Fig. 519. Idea for improving audio response.

member that the response of a system is no better than that of its components. The input to the amplifier, whether it be from a tuner, phono pickup, or microphone, should have high fidelity. The speaker should faithfully reproduce the audio signals fed into it.

At first glance, it may seem strange that two identical transformers connected in series will match the same source and load as either of them alone.

This is true because the impedance ratio does not change when they are connected in series.

Assume that a transformer is to match a 4,000-ohm load to an 8-ohm speaker. The transformer turns ratio should equal the square root of  $Z_s/Z_p$ , where  $Z_p$  is the impedance of the primary (4,000 ohms) and  $Z_s$  is the secondary impedance (8 ohms). The turns ratio is  $\sqrt{500}$  or 22.4 to 1.

If we assume that the voice coil winding of T1 or T2 has one turn, then the primary will have 22.4 turns. When the transformers are connected in series as shown in the diagram, the number of turns in the effective primaries and secondaries are doubled so that there are now two turns on the secondary and 44.8 on the primary. Although the number of turns on both windings has been doubled, the impedance ratio remains constant.

This method may increase fidelity but will not minimize distortion caused by core saturation.

### Brush for Speaker Cement

Some makes of speaker cement do not have a brush or applicator built into the bottle cap. Consequently, the brush always gets hard and must be discarded. Prevent this by drilling the bottle cap to pass the handle of a small metal-handled glue brush. Solder the handle solidly to the cap with an airtight joint. The tip of the brush will not harden because it is immersed in cement when not in use.

### Protecting Speaker Cones

Most service technicians have acci-

dentally punctured a speaker cone at one time or another while working on a set or carting it to or from the shop. Although such accidents are rare, there is always a chance that it will happen on your next servicing job. A simple protective cover such as the one in Fig. 520 will prevent this and make it less likely to drop bits of solder, metal filings, and dirt between the voice coil and pole piece.

For speakers from 4 to 8 inches in diameter, cut a 10-inch disc from  $\frac{1}{4}$ -inch plywood or similar material. Draw two lines at right angles through the

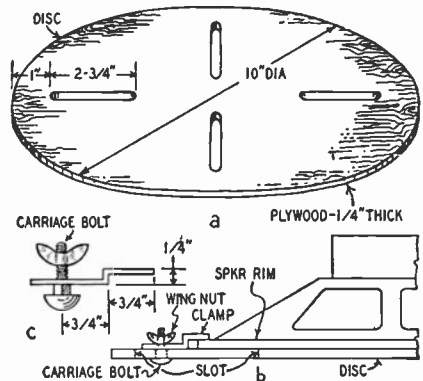

Fig. 520. Kink to protect speaker cones.

center. With these lines as centers, begin 1 inch from the rim and cut four slots  $2\frac{3}{4}$  inches long as at a in the figure. They should be just wide enough to pass the square shank on the head of a small carriage bolt. When you finish the slots the disc will look like a lathe faceplate. Make four clamps from strap iron (see b in the drawing) and drill holes to pass the shafts of the bolts.

The disc is fastened to the front of the speaker by four small Z-shaped clamps slipped over the shafts of the

bolts and held against the rim of the speaker with the wing nuts. The slots grip the shanks of the bolts and prevent them from turning while the nuts are being tightened. (See drawing at c.)

For speakers ranging between 8 and 15 inches in diameter, cut the disc at least 17 inches in diameter. The slots should be approximately  $4\frac{3}{4}$  inches long and should start about  $\frac{3}{4}$  inch from the rim.

### Speaker Installation Kink

A number of home, portable, and auto radios have the speakers mounted some distance from the chassis and are connected to it through flexible leads soldered at both ends. The speaker leads must be unsoldered or the speaker removed from its mounting whenever the chassis is pulled.

It is a good practice to solder a phono jack firmly to one of the voice coil terminals on the speaker frame and replace the speaker leads with shielded wire and a phone plug whenever a set of this type comes in for repairs or a replacement speaker.

The cost of this modification is absorbed in a saving of labor during future jobs on the set.

### Phasing Loudspeakers

When a number of speakers are mounted on a common baffle or close to each other, it is necessary that they be phased or connected so that they work as one unit. Before connecting each speaker, momentarily connect a 1.5-volt dry cell across the voice coil. Note the polarity of the battery and the direction the cone moves.

If matching transformers are used with the speakers, connect a high-resistance voltmeter across the secondary. Touch the leads of a 22.5-volt battery to the primary and note which direction the meter reads. In either case, connect the speakers so the cone movements or meter deflections are in the same direction.

### Checking Rubbing Speakers

It is often difficult to locate the source of distortion or scatching sounds

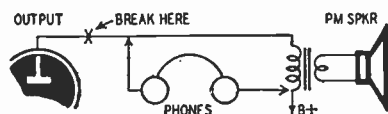

Fig. 521. Checking rubbing voice coils.

which occur when an amplifier or radio is played at high volume. The trouble may be in the amplifier or it may be a rubbing voice coil in the speaker. Here is a sure-fire method of detecting a rubbing voice coil. Try it the next time you have reason to suspect the speaker.

With the set disconnected from the line, disconnect the plate lead to the output tube and connect a pair of high-impedance headphones across the primary of the output transformer as shown in Fig. 521. Press slightly on the cone while wearing the phones. A rasping sound indicates a rubbing voice coil. The voltage step-up in the transformer and the use of phones provides a sensitive test.

### Metal Filings in Speakers

Those stubborn metal filings that be-

come lodged in the magnet gap of a loudspeaker can be removed efficiently and quickly with a piece of gummed masking tape, such as is used by painters and draftsmen. Insert the tape and rub it around against the sides of the gap. The gummed surface will remove even the smallest particles with ease. Larger filings can be chased up to the top of the gap with the edge of the tape and then picked off with a little pressure against the gummed surface.

A blast of compressed air into the gap or through a hole at the rear of the magnet pot will bring to light

filings that would later work their way into the gap.

A tack cloth, used by painters to remove dust from surfaces to be painted, will also work just as well.

### **Speaker Servicing Kink**

Before drilling a hole on or near a loudspeaker, coat the area with a layer of service cement at least 2 inches in diameter. Drill the hole before the cement dries. The cement will catch and hold any chips and prevent them from entering the gap between the loudspeaker's pole piece and voice coil.

# Section 6

## Amateur

### Checking Crystals

The frequency of an unmarked crystal can be found by the following method. Connect the crystal in series between a signal generator and a vacuum-tube voltmeter. Set the v.t.v.m. to the 3-volt, a.c. range, and tune the generator slowly. The meter reading will be very low until the resonant frequency of the crystal is reached. The meter will then kick up very sharply.

You can get readings of as much as 2 volts with very active crystals, but 1 volt is more usual. Reading the dial of the generator will tell the frequency; for greater accuracy, check frequency with a frequency meter.

### Using 160-Meter Crystals

If you have any crystals from the old 160-meter band, you can probably put them to work on 6 meters if they are between 1852 and 2,000 kc. Most of these crystals will oscillate on their

third harmonic without any special multiplier or feedback circuits. Thus, you can hit 6 meters by using a simple oscillator followed by two low-power triplers.

### Adapter for Crystals

Many of the prewar transmitting crystals were mounted in holders which

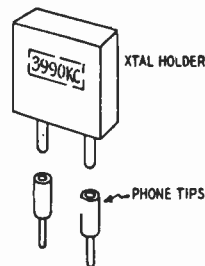

Fig. 601. Phone tips for crystal holder.

fitted into the old five-prong sockets. Thus the pins are too large to fit into an octal socket or one of the newer type crystal sockets. Use these crystals in standard sockets by using ordinary

phone tips as adapters as shown in Fig. 601. The pins on the holder fit tightly into the open ends of the phone tips, and the small ends of the tips fit snugly into the holes in the modern octal and standard crystal sockets.

### Crystal Absorption Meter

Because of its high  $Q$ , a crystal makes a very selective absorption meter. The crystal can absorb a considerable amount of r.f. energy from a nearby tank coil. One terminal of the crystal may be grounded and the other left free. Alternatively, the crystal may be coupled to the circuit through a small capacitor. In either case, the r.f. energy dips sharply as the circuit is tuned to the frequency of the crystal.

Fig. 602 shows how a crystal is used

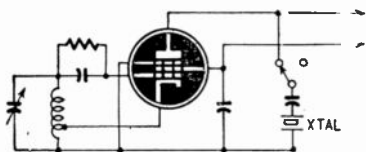

Fig. 602. Circuit to crystal check v.f.o.

to check the calibration of a v.f.o. As the tank is tuned through crystal resonance, there is an abrupt loss of excitation to the following stages. A grid or plate meter in the final will indicate when this occurs. If two or three crystals are available, it is easy to calibrate the v.f.o. at several points without using a crystal standard and a receiver or more elaborate calibrating equipment.

### Harmonic Crystal Oscillators

Several of the commonly used harmonic-type crystal oscillators have a

tuned circuit in series with the cathode return. This tuned circuit must be shorted to prevent damaging the crystal when fundamental output is desired. Forgetting to short this coil often results in damaging the crystal.

You can minimize this danger by making the circuit connections shown in Fig. 603. A lead from the oscillator

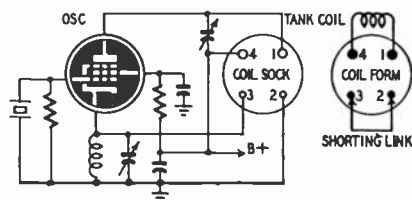

Fig. 603. Idea to protect crystals in harmonic crystal oscillator.

cathode is run to one of two unused terminals on the socket for the plug-in plate coil. The other unused terminal is grounded. A jumper is connected between corresponding pins on the plug-in coil used for *fundamental output*. Now the cathode coil is automatically shorted out when the fundamental tank coil is plugged in. This trick is useful only when all the available crystals are in the same band.

### Link Coupling to Beam

Link coupling is an efficient way to transfer r.f. from one stage of a transmitter to another. It works equally well in transferring r.f. from the transmitter to the radiator of a beam antenna. It has certain advantages over most matching systems. It's easy to adjust; one person can do it within a few minutes, there is no guess work, and you get more r.f. into the radiator.

To feed a 10-meter beam, you simply

construct a 10-meter tank circuit, wind a 1-turn link around the center of its coil, and mount the whole thing on the beam next to the radiator. The link connects across the center of the split radiator and the transmission line—any type will do—across the tank coil. Of course, you will want to enclose the unit in a weather-proof wooden box.

Adjustment is simple. Before you install the unit, place it near your transmitter final amplifier and resonate it wave-meter-fashion to the transmitter frequency. Keep this setting and install the unit on your beam. Then retune the final amplifier. It's a

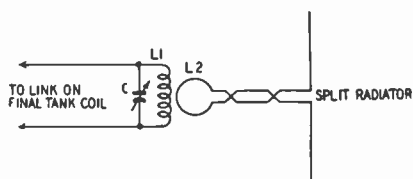

Fig. 604. Link coupling of sky wire to final means easier adjustment, more output.

good idea to recheck the tuning of the link-coupling unit by holding a neon bulb on the radiator a few feet from center and tuning for maximum brilliancy. Last of all, recheck your final.

The drawing in Fig. 604 shows the coupling unit for a 10-meter beam. L1 is six turns of  $\frac{1}{4}$ -inch copper tubing wound with an inside diameter of 2 inches. L2 is a single turn of No. 12 rubber-covered wire wound tightly around the center of L1. The ends of L2 are twisted together to form a short link to the center of the radiator. C is a 50- $\mu\text{mf}$  variable capacitor. A midget receiving-type unit will do for medium power. O<sub>1</sub> high-power rigs,

use a capacitor with sufficient spacing to prevent arc-over in damp weather.

### 40-Meter M Antenna

While experimenting with antennas, a folded dipole was put up as a receiving

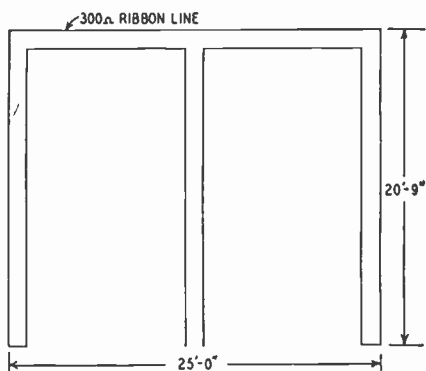

Fig. 605. Use 300-ohm ribbon line as a 40-meter antenna.

antenna in the attic where it would not be too close to the transmitting antenna. One night after trying many calls and just not getting out, this folded dipole was hooked up to the transmitter and the results were surprising.

The antenna in the attic had to be

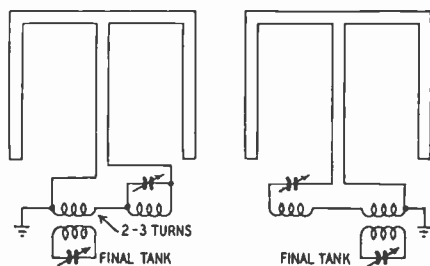

Fig. 606. Coupling M antenna to tank.

put up in an M shape because of the lack of space. An antenna may be bent to fit a restricted space if the bend does

not exceed  $\frac{1}{8}$  wavelength at each end.

In this case the bend was more than that. According to the books this reduces the efficiency of the antenna, and having it in the attic doesn't help any. Nevertheless, this antenna outperformed any other antenna.

Dimensions for the antenna for the 40-meter band are shown in Fig. 605. Made of 300-ohm ribbon line, it may be suspended in any convenient way. The feeder can be any suitable length and should be coupled to the final tank with a tuned and grounded coupling coil. The tuning may be either series or parallel as shown in Fig. 606.

The dimensions given should give good performance on the 40-meter band, and, once tuned, will cover the band.

### Long-Wire Antenna

The disadvantage of carrying a 40-80-meter transmitter in a car is that you frequently must erect a long-wire antenna. To simplify erecting and taking down the antenna use a deep-sea fishing rod and reel.

Wind a good length of strong fishing line on the reel first. Then tie the end of a 134-foot length of phosphor bronze (surplus) antenna wire to the end of the line and wind on the reel.

On arrival at a location, dismount the reel from the rod and tie the rod to the side of the car. Pass the end of the wire through the top guide of the rod, through subsequent guides, and into the car window. Then, walking backward, carry the reel, letting the wire pay out.

Eventually the wire will be all un-

reeled and you can tie the fish line to a tree. The line acts as an end insulator. To fold up and move on, reverse the process.

### Automatic Antenna Match

Tuned loops, open and shorted stubs, Q-bars, and delta- and T-match systems have been devised for matching transmission lines to antennas to provide a low standing-wave ratio. With these systems, the frequency range is limited to narrow bands and the antenna cannot be operated efficiently on harmonics without making adjustments on the matching system.

This system is devised to match

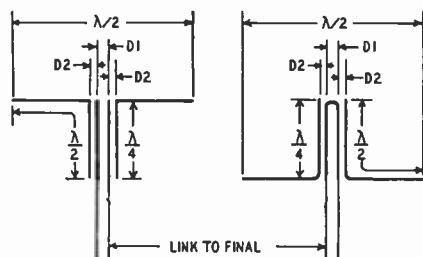

Fig. 607. Hint for getting impedance match between antenna and transmission line.

almost any balanced line to antennas having high or very low radiation resistances. It is suitable for feeding rhombics, V-beams, folded dipoles, all-channel TV antennas, stacked arrays, and many other types of antennas requiring 2-wire feed lines. An antenna cut for 80 meters will work equally well on 40, 20, and other harmonics. The only difference is in the radiation patterns.

Two methods of applying the automatic match are shown in Fig. 607. D1 is equal to the spacing between con-



ductors of the transmission line, and D2 is just enough spacing to prevent voltage breakdown. In receiving and low-power transmitting antennas, D2 may be the insulation of two wires taped together. For transmitters of 500 or 1,000 watts, D2 may be approximately  $\frac{3}{8}$  inch. You can use 72-ohm coaxial cable for the quarter-wave section. The inner conductors are connected to the antenna and the outer conductors connected to the transmission line. In this case, D2 is the spacing between the conductors of the coax, and D1 is adjusted so the outer conductors present the same impedance as the transmission line. In other tests, the matching section consists of No. 12 wires taped together with  $\frac{3}{4}$ -inch spacing between pairs to match 300-ohm ribbon. For other open-wire lines, the matching sections should be made of wire having the same diameter and spacing as the transmission line.

This system has been used to feed antennas having up to six reflectors. The only necessary adjustment was trimming the radiator and matching section. Rhombic and V-beam antennas are matched by cutting two legs long enough to include an additional one-quarter wavelength at the lowest usable frequency.

The standing wave ratio of an antenna cut for 200 mc dropped from 3 : 1 at 150 mc to 1 : 1 at 200, then rose to 1.6 : 1 at 250 mc. This shows that antennas cut for the lowest frequency can be used at higher frequencies.

### Transmitter Meter Plug

Metering a multistage transmitter is

usually done with a rotary tap switch or by plugging the meter into panel jacks connected in the various circuits. The first method is convenient; but since the meter leads are usually soldered to the switch, the meter can not be used for other purposes. The plug-and-jack scheme is more flexible because it permits the meter to be used elsewhere; but it can be dangerous to

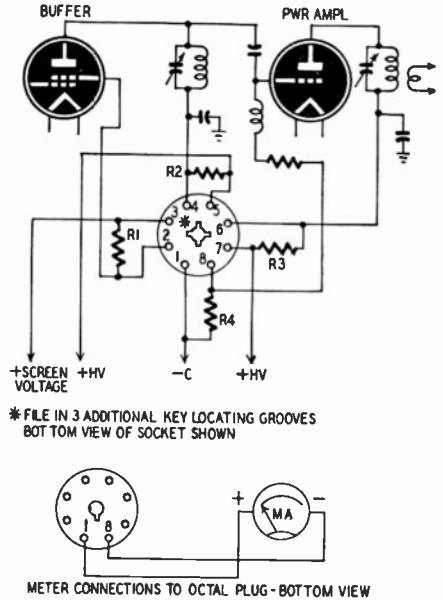

Fig. 608. Plug system for metering a multistage transmitter.

the user, particularly where higher voltages are encountered and the jacks are above ground.

However, with equipment no more elaborate than an octal plug or an old tube base and a slightly modified Bakelite octal socket, it is possible to make a milliammeter switching plug-in arrangement that is foolproof, electrically safe, convenient, and universally usable.

Carefully file three additional locating grooves in the Bakelite octal socket, as shown in Fig. 608. Since there are now four of these grooves in the socket, the octal plug may be plugged in in four different ways; to provide a maximum of four circuits into which the meter can be switched. If more circuits are desired, a second socket can be used to supplement the first.

Then solder the meter leads, which can be of any convenient length, to the octal plug. One good way is to connect the meter positive lead to pin 1 and the negative lead to pin 8. That completes the meter plug.

The modified socket may be wired into a typical circuit as shown in the diagram. Resistors R1, R2, R3, and R4 are shunting resistors which have a negligible effect on the operation of the meter or the circuit. They may be from 20 to 100 ohms in value. The higher resistances are used in low current circuits, and the lower resistances in high current circuits. The actual resistance value is not critical and 47- or 68-ohm, 2-watt carbon resistors will do very well. An alternative method is to use a 1-ma meter and make R1, R2, R3, and R4 appropriate shunting resistances to extend the range of the meter to the best value for the particular circuit in which it is to be used. When the meter is across R1, R2, R3, and R4, it reads buffer screen, buffer plate, power amplifier plate, and power amplifier grid currents, respectively, when the plug is rotated in a clockwise manner.

Using the meter switching plug is quite simple. Just rotate the plug to the desired locating groove and plug it

in. The meter will then measure the current in that circuit.

## Testing Transmitting Tubes

Only very large commercial tube users have equipment to test transmitting tubes. However, a simple and satisfactory check can be made as follows.

Detune the final or multiplier circuit in which the tube is being used, noting the plate current. This current rises at either side of resonance. With a new tube the rise will be much higher than with a much-used tube. Emission drops with use; therefore the rise is more limited in a tube that needs replacement.

If the operator takes periodic off-resonance readings, he can judge the condition of his tubes. No circuit should be left detuned longer than necessary, of course.

## Transmitting-Tube Check

You can tell when your transmitting tubes are going sour if you will make a note of the plate-current readings of new tubes for a given load and plate voltage with the transmitter operating normally. When a tube starts to lose emission, the plate current will begin to drop off from its former fixed value and its output will be less. Class B modulators are checked by watching for a decrease in the static plate current. A gassy tube will cause a higher-than-normal plate-current reading.

## Simple S-Meter Circuit

An S-meter can be added to the aver-

age superheterodyne receiver merely by adding three resistors and a 1-ma d.c. meter. Two 47,000-ohm resistors and a 50,000-ohm potentiometer are connected as a bleeder across the voltage supply. The meter is connected between the arm of the pot and the screen grid of an i.f. tube controlled by the a.v.c. voltage. The circuit is shown in Fig. 609.

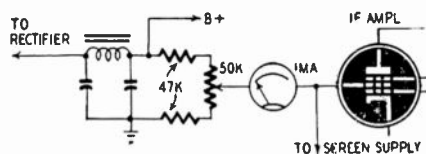

Fig. 609. Modification for adding S-meter circuit to receiver.

The arm of the pot is adjusted until the meter zeros with the r.f. gain control on full and the antenna terminals shorted. If the meter is too sensitive, a variable resistor may be shunted across it.

### Bandspread Capacitors

If you are building a communications receiver and are wondering what to use as a bandspread capacitor, try using an FM tuning capacitor. These have capacitance ranges which are just right for bandspreading. They are available in two- and three-gang types which are less expensive than other ganged capacitors of similar size and construction.

### Mobile Mike Case

In mobile or portable ham work it is often convenient to have both hands free instead of having to hold a microphone. A very handy way to achieve this is to buy one of the old hearing-

aid cases available at many surplus stores. There is a place in them for a crystal or magnetic microphone, which, if not already in the case, can be bought from Sonotone for 69¢.

You can even make a preamplifier which fits into the hearing-aid case with the microphone. Output is enough to permit use of the unit with a mobile transmitter originally designed for a carbon mike.

### Simple Bandsread Tuning

This modification was made in a receiver covering the 550 to 1600-kc broadcast and 5 to 18-mc short-wave bands. Tuning was so critical on 14 mc that it was almost impossible to separate the stations until a small bandspread tuning capacitor was inserted in the oscillator circuit. The capacitor was first connected in parallel with the oscillator section of the main tuning gang, but considerably more spread was

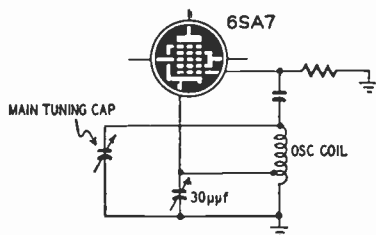

Fig. 610. Get good bandsread by connecting tuning capacitor as shown.

obtained by connecting it between ground and the cathode tap on the coil as shown in Fig. 610. The capacitor was installed close to the oscillator coil and a flexible coupling added to bring the control shaft through the front panel on the set.

## ARC-5 Conversion

Some hams use ARC-5 and SCR-274-N command transmitters on two bands by switching out the ganged power-amplifier tuning capacitor and using the padder to tune the plate circuit to the second harmonic of the oscillator. The slotted shaft on the padder is hard to get at.

A fellow ham developed this simple

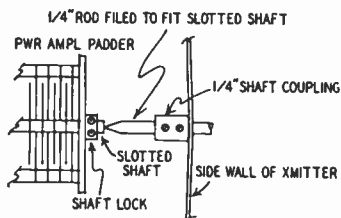

Fig. 611. Coupling extension shaft to padder.

method of coupling an extension shaft to the padder: A 3- or 4-inch piece of  $\frac{1}{4}$ -inch shafting is tapered at one end so it fits into the end of the slotted capacitor shaft. Insert this end of the shaft through the hole provided for screwdriver adjustments, then slip a  $\frac{1}{4}$ -inch coupling over it. Force the shaft into the slot, then slide the coupling against the transmitter wall and tighten it so the wall is forced slightly outward. The springiness in the wall holds the shaft in the slot. Place a knob on the shaft to complete the job. Fig. 611 shows this modification.

## Simple Keying Monitor

If you use low-impedance phones on your receiver, a low-cost keying monitor can be made by connecting a germanium diode across the phone leads

at the receiver. R.f. picked up by the phone leads and circuit wiring in the receiver is rectified and will appear in the phones as hum which is easy to copy.

Connecting the diode across the phones does not affect the volume of received signals.

## Setting Slotted Controls

Transmitters, amplifiers, TV receivers, and numerous other electronic devices often have potentiometers or variable capacitors with slotted shafts for screwdriver adjustments. These controls are frequently under the chassis or behind a panel where the slots are difficult to find and even more difficult to keep the screwdriver in.

Adjusting slotted controls is simpler when a  $\frac{1}{4}$ -inch metal or insulated coupler is placed over the end of the shaft as shown in Fig. 612a. The drawing, Fig. 612b, shows how a standard shaft can be converted for screwdriver adjustments. The shaft is fitted

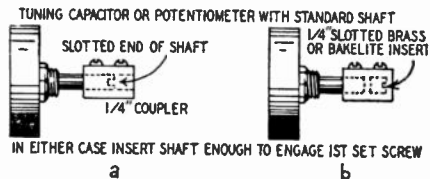

Fig. 612. These ideas will eliminate fumbling around trying to get a screwdriver into a slotted control.

with a coupler and a short piece of  $\frac{1}{4}$ -inch shaft which has been slotted for a screwdriver. If the control shaft is hot and must be insulated for safety, use an insulated coupler and a fiber insert.

## Capacity Relay

The electronic relay control circuit shown in Fig. 613 is simple to construct and economical to operate. It

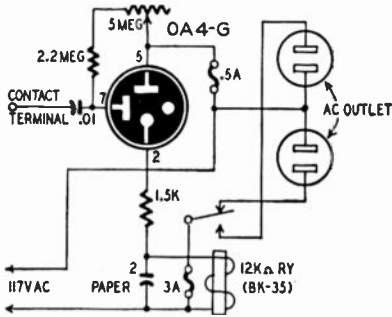

Fig. 613. Electronic relay control.

does not draw current from the line until it is triggered by an object touching the contact terminal. It can be used as an intruder alarm, annunciator, or safety control for industrial machinery.

The relay should operate when a grounded object touches the contact terminal. If it does not, reverse the line plug in its socket.

The relay used is a surplus BK-35 which has a resistance of approximately 12,000 ohms. Other sensitive relays closing at about 1 ma can be used, but it will probably be necessary to change the values of the sensitivity-control potentiometer and the resistor in the cathode circuit. You can increase sensitivity of some relays by loosening the armature spring.

## Kink for D.C. Relays

In small broadcast stations d.c. relays are often operated by microphone switches on the control console. Using such an arrangement, every time a mike is turned off, the VU meter will

kick and a click heard in the audio system. This is probably caused by the inductive kickback current in the relay coil. Clear up the trouble by shunting a .05- $\mu$ f capacitor across the coil of each relay.

## Self-Locking Photo Relay

Some photoelectric relays close an external circuit when light falls on the phototube and open the circuit when light fails. By adding a few simple parts, the external circuit can be locked on until opened manually. Locking-type relays or internal circuit changes are not required.

Mount a 6-watt, 117-volt lamp on or near the control unit and reflect its light into the phototube with a small mirror as shown in Fig. 614. Connect

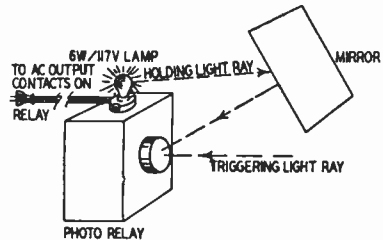

Fig. 614. Light from small lamp can be triggered to keep relay locked for a long time.

the lamp to the a.c. output contacts in parallel with the external circuit. When a light pulse falls on the phototube, the external circuit is closed and the 6-watt lamp comes on. Its light will be reflected into the phototube so the relay remains closed. Turn off the 6-watt lamp to open the external circuit or to restore the relay to momentary-type operation.

## Curing Sticky Relays

If a relay is noisy or will not break cleanly, place a small strip of masking tape between the armature and the pole piece. Scotch tape can be used as a substitute, but friction tape is not suitable because it is sticky on both sides.

## Panel Lettering

Designations can easily be printed on radio panels with a rubber stamp outfit, obtainable at most stationery stores. The choice of stamp pad ink is important. Volger's opaque ink, available in several colors, and special stamp pad are excellent for marking dark panels; mistakes can be wiped off with a rag moistened with benzene.

## Powering Surplus Relays

Surplus high-resistance relays have become fairly common as antenna-changeover relays, and in other low-power applications. However, it is

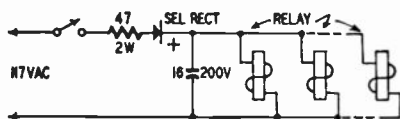

Fig. 615. Power supply for relays.

difficult to obtain a suitable d.c. voltage to operate them.

One common type of relay suitable for low-power antenna switching has a resistance of 8,000 to 10,000 ohms and requires a "make" current of about 10 ma. The voltage may be obtained from a simple selenium rectifier circuit. Two advantages of this circuit are that the relay operation is independent of

transmitter-receiver voltages, and that no warm-up time is required.

The hook-up shown in Fig. 615 is a half-wave rectifier having a single-section capacitor input filter. The relay windings act as both filter choke and load. The voltage developed across the relays is high enough to give good, positive action. No ground troubles are involved since the relay winding and terminals are isolated from each other. Five or six relays may be operated in parallel with a rectifier of suitable current rating before the voltage becomes too low for dependable action. A capacitor of the size shown or larger should be used to avoid any possibilities of chatter.

## Wrinkle Finishes

Although the wrinkle-finish enamel used on radio equipment is extremely durable, it will gradually chip, scuff, and wear thin under hard usage. A good way of restoring the original finish is to brush over the scuffed surface with a quick-drying lacquer of the same color. Use a minimum of lacquer on the brush, brush hard, and spread the lacquer as thinly as possible. This thin layer of lacquer will preserve the wrinkle finish and restore the original appearance or something very near it.

## Touch Up Scratched Parts

When black panels, smooth or crackle-finished, are scratched, try this trick.

Rub a piece of black wax crayon over the scratch with a circular motion. Dip a piece of soft cloth in linseed oil and rub over the spot, using the same

circular motion. Finish the job by rubbing with a polish cloth. If you get too much oil on the surface, remove the excess with a little turpentine on a rag. This method of removing scratches can be applied to other colors by using wax crayons of matching colors.

### Scratch Removing Process

Scratches in plastic escutcheons and radio cabinets and on refrigerators can be removed by the following process:

1. Remove scratch by sanding with wet No. 400 (wet or dry) type sandpaper. Use a free, easy, circular motion and finish with light feathering strokes. Use lots of water.

2. Clean the sanded area thoroughly by swabbing with wet cotton, then dry with another piece of cotton.

3. Apply a polishing agent such as Simonize Kleener, Johnson's Carnu, or Wright's Silver Cream, and rub in rapid, vigorous, circular strokes. It will take several minutes to obtain satisfactory results.

4. Remove all traces of cleaner by

swabbing with wet cotton. If the results are satisfactory, dry completely and buff the entire surface with clean, dry cotton.

### Marking Metal Panels

It is easy to make attractive, permanent, legible labels on aluminum, galvanized iron, copper, and other bright metals. Remove dirt and grease from the surface with carbon tetrachloride, then use a medium pen and a good grade of India ink for the markings. Take your time and make the lettering as neat as possible. You will be proud of the job when it's finished. When the ink is dry, apply a thin coat of lacquer or clear nail polish to preserve the lettering.

It is a good idea to mark the tube number next to the socket on all your equipment. This makes troubleshooting easier and you can be sure of returning the tubes to the correct sockets when you remove them for testing.

# Section 7

## Miscellaneous

### Safety and Electric Tools

Portable electric saws, drills, sanders, hedge clippers, and other devices which we use every day are potential killers when we do not take steps to protect ourselves against electrical shock. Most of these appliances have an extra wire protruding from the rear of the line plug. This is a ground wire which is attached to the metal frame of the motor or housing of the equipment. It is a good idea to check this connection with a low-range ohmmeter. The wire is included as a safety measure to protect the operator if one of the power leads should short to the frame.

Never operate such equipment without first grounding the third lead. Solder it to a length of heavy flexible lead which terminates in a large battery clip for connecting to a convenient water pipe or electrical conduit, or a short length of metal rod pointed at one end so it can be pushed into the earth. If the appliance does not have a

ground wire, install one. The third wire can be connected to the metal body of the device and taped to the outside of the power cord.

For safety in the household, connect a good ground lead to the motor on the wife's washing machine, ironer, electric mixer, and any other appliance which she uses while standing on a concrete floor or when working near the kitchen sink or wash basin.

### Masking Tape for Layouts

Apply masking tape to your panels and chassis before making your layouts. It adheres readily to wood, metal, and bakelite and protects the finish from the usual accidental scratches and scars.

To prepare a panel or chassis for marking, do not put scribe marks on the bare metal. Cover the chassis with wrapping paper and hold the paper in place with masking or scotch tape. You can drill right through any marks



made on the paper without removing the paper until all required holes have been drilled. Then countersink all holes underneath chassis to remove burrs.

Some technicians prefer covering a chassis with layout fluid, a technique that makes scribe marks stand out clearly. This method does not protect the chassis from being scratched or marked.

### Novel Demagnetizer

Watches, small tools, and small pieces of ferrous metal can be demagnetized with a Weller soldering iron. Plug in the iron, hold it near the item to be demagnetized, and pull the trigger. The field around the tip is strong enough to do the job very effectively.

### Nonskid Cabinet Feet

The flat parallel-conductor line cord of the type widely used on receivers and lamps can be used to make nonskid feet for wooden radio cabinets. Cut the line to the desired length and attach it to the bottom of the cabinet with thin, flat-head wire nails. Drive the nail head through the insulation so it flattens against the wire inside the cord. With the nail head below the surface of the insulation, there is no danger of it scratching the surface supporting the set.

### Preselector from T.R.F. Set

Old t.r.f. broadcast radios which have been dismissed from active service can be used as preselectors for broadcast dx. (Also for short wave if the set has a short-wave switch.) One experi-

menter used a set which had two 6K7's in the r.f. stages and a 6F6 in the audio. The .01- $\mu\text{f}$  capacitor which went from the plate of the detector to the grid of the 6F6 was removed, and a 100- $\mu\mu\text{f}$  mica capacitor was soldered from the plate of the 6K7 detector to a tie lug. A shielded wire was brought from the tie lug and attached to the antenna post of a broadcast set. The shield was grounded in the t.r.f. preselector and near the antenna of the broadcast set to which it was attached. Both these sets had transformer-type power supplies. If two a.c.-d.c. sets are to be hooked together, polarity must be observed. No feedback was noticed with the sets in their cabinets. If feedback is present, it may be necessary to put wire screen inside the cabinet of the preselector.

With the preselector in operation after midnight when there is little congestion on the band, the results were astounding. Stations all over the country never before heard came in with good signals.

### Arc Suppressor

Special precautions must be taken to suppress arcing at the contacts of small

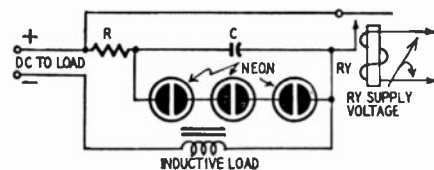

Fig. 701. Use neon lamps for suppression of sparking at relay contacts.

relays which handle direct current into a highly inductive load. The arcing, caused by a high induced voltage which

is developed when the circuit is broken, pits the contacts and shortens the useful life of the relay. The usual suppressor circuit consists of a resistor and capacitor in series across the contacts. The capacitor absorbs the induced e.m.f. and the resistor retards the flow of discharge current from the capacitor when the contacts close.

In many cases, the inductive load stores up more energy than can be absorbed by the capacitor, so there is sufficient energy left to arc across the contacts. Increasing the size of the capacitor may cause the contacts to weld together.

These difficulties can be overcome by connecting several neon lamps in series across the capacitor as shown in Fig. 701. R and C are components of the standard arc suppressor. The sum of the ignition voltages of the individual lamps—without any external resistance—should be greater than the load voltage.

With this circuit, the lamps ignite and shunt the high self-induced voltage around the capacitor and contacts. The capacitor absorbs the surge energy until the voltage builds up enough to break down the lamps.

### Using Knife Switches

In many applications requiring a single-throw knife switch, it is better to use a double-throw unit. The double-throw switch has a positive off position, keeping the blade in place so that the circuit may not close accidentally.

### Garage-Door Opener

A garage-door opener is easy to con-

struct and operate. Designed for standard hinged doors, it does not require complicated motor-driven mechanisms.

The control is a simple spark gap transmitter operating off an old Model-T spark coil that feeds a spark gap between two metal plates. See Fig. 702a.

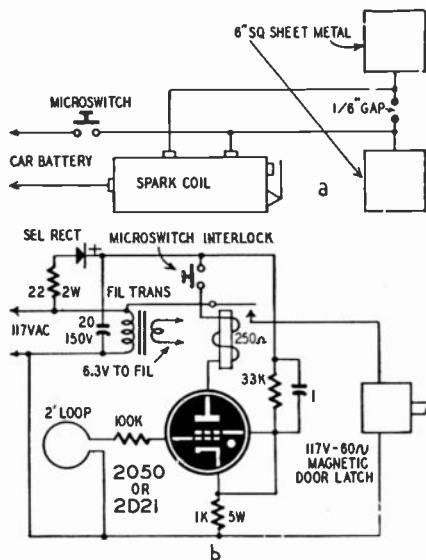

Fig. 702. Circuit for opening garage doors.

The setup is similar to Hertz's original. The unit is not powerful enough to cause troublesome interference, but it will operate the simple receiver at a range of 10 feet.

The receiver, mounted on the garage door, consists of a single-turn loop antenna feeding the signal to a single thyratron which closes a relay after an impulse. The receiver is shown in Fig. 702b.

The relay operates a standard magnetic door latch. A 20-pound weight, attached to the doors through a pulley, causes them to swing open as soon as they are unlocked. With this system,

no motors, springs, or worm gears are required. Closing the doors lifts the weight and resets the latch.

Because d.c. is used on the thyatron, a microswitch is in series with the plate lead to open the circuit when the doors open. This switch is closed when the doors are shut, and open when they are open. The 1.0- $\mu\text{f}$  capacitor between B-plus and cathode prevents transient voltages from firing the tube when the plate switch is closed.

### Printed-Circuit Grounds

Most amplifier builders have, at one time or another, spent hours tracking down hum or feedback which was eventually traced to a ground loop in a high-gain stage. Because it is often difficult to run all grounds to one point in the low-level stage, avoid ground loops by using printed-circuit grounds.

Cover the underside of the chassis with a piece of insulating paper, then drill through it and mount all components. All grounds are painted on this sheet with regular silver paint used in making or repairing printed circuits.

When connections are to be made, cut out a tab, lift it up, paint it with a heavy coat of silver, then squeeze a soldering lug onto it and let it dry. Solder connections to the lug.

If the spot selected for a common ground is not satisfactory, it can be moved to another.

### Converter Tubes as Amplifiers

Converter tubes which are no longer useful or serviceable as such, can often be used as voltage amplifiers in exper-

imental circuits. The control grids of the oscillator and mixer sections are paralleled as are the mixer plate and the oscillator anode. The circuit in

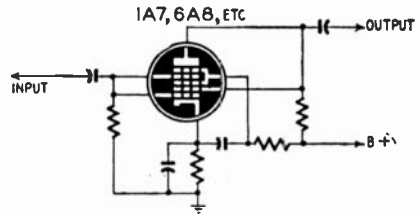

Fig. 703. A weak converter tube might still work as an amplifier.

Fig. 703 shows how a typical converter can be connected as an amplifier. The screen and cathode dropping resistors and bypass capacitors may or may not be needed.

### Buying Experimental Parts

Be sure to select units having terminal lugs rather than flexible leads when purchasing audio or power transformers, filter chokes, electrolytic capacitors, radio- and intermediate-frequency coils, and other parts commonly used in radio and electronic circuits. Leads are almost invariably cut to the correct length for the first project and are usually too short for the next one. Components with terminal lugs are harder to mount because mounting hole spacing is critical but you will find that they last longer in experimental service.

### Emergency Vibrator Transformer

Standard power transformers can be used as vibrator transformers for emergency or experimental work if they have a center-tapped 5- or 6-volt heater

winding. Simply connect the filament winding as you would the primary of a standard vibrator transformer. A typical circuit is shown in Fig. 704.

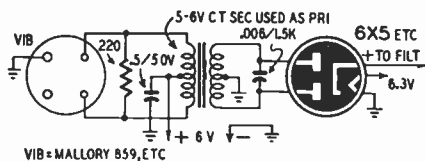

Fig. 704. Auto radio servicing suggestion.

The output voltage will be nearer normal and the power losses will be lower if you select a transformer having two high-current 6-volt windings. They need not be center-tapped. Connect the windings in series-aiding and use their junction as the center-tap.

### Measuring Inductance

If you use this circuit arrangement for measuring the inductance of audio-frequency chokes and transformers, you need no longer pass up a good-looking surplus choke or transformer just because its value isn't given.

Connect the circuit as shown in Fig. 705. The input is connected to a

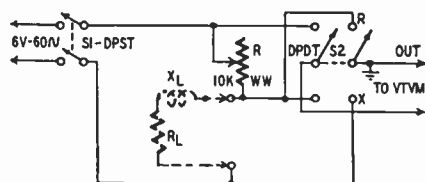

Fig. 705. The measurement of inductance.

source of approximately 6 volts at 60 cycles through S1. This voltage appears across resistor R and the unknown inductance in series. The 10-volt range of an a.c. v.t.v.m. is connected across

the output terminals. S2 is then flipped rapidly back and forth while R is adjusted until the meter reading does not change as the switch is thrown between the two positions. The voltage drops across R and the coil are equal so the impedance of the coil equals R.

Open S1, switch the meter to the ohms range, and record the resistance readings with S2 in the R and X positions. The inductance of the coil is now calculated from the formula

$$L \text{ (in henries)} = \frac{\sqrt{R^2 - R_L^2}}{377}$$

where R is the impedance of the coil and  $R_L$  is the d.c. resistance of the coil.

You can measure the capacitance of large paper and mica capacitors by using the same setup. In this case, the resistance of the capacitor will be very high and can be ignored. The capacitance in microfarads equals 1,000,000 divided by 377R.

### Threading Rods

Short lengths of threaded brass, copper, and fiber rods are often needed in experimental work. If you do not have a die which will do the job, you can often use a steel nut of the proper size and with a clean-cut thread. With the unthreaded rod held tightly in a vise, you can, by applying considerable pressure, screw the nut onto the rod. When the nut is backed off, it will leave a perfect thread.

It helps to file or grind a conical end on the rod so the nut can be slipped over it, making the cut easy to start. Another trick is to select a nut one size larger than normal and cut a slot

through one side with a hacksaw. Slip the nut over the rod, then grip the nut tightly in a vise so that the pressure closes the gap, causing the threads to bite into the rod.

### Saving Plate Bypass Capacitors

Most manufacturers return the power amplifier plate bypass capacitor to the cathode or to ground. This practice puts high audio voltages across the capacitor and makes it necessary to use high-voltage units. Many receivers use 600-volt capacitors in this application. Even these break down and cause serious damage to the set.

Try lifting the lower end of the capacitor off the cathode or ground and connecting it between the plate and screen grid. The voltage across the capacitor will be much lower and it is less likely to break down.

The bypassing action will remain just as effective as before, since the bypassed screen is ground for audio frequencies.

### Sound-on-Light Beam

An electron-ray tuning indicator may be used instead of a Kerr cell in transmitting sound over light beams for demonstration purposes. A 6U5, preferably new, is perhaps the best tube to use. With a 300-volt plate supply and -10 volts fixed bias, the brightness is more than enough for short distances. The grid of the tube is connected to the output of a preamplifier through a coupling capacitor. A good photoelectric cell connected to a high-gain amplifier will give good reproduction at the receiving end.

### Handy Solder Holder

Discarded cellulose-tape dispensers make handy holders for wire-type solders. They are lighter and require less space than the usual  $\frac{1}{2}$ - or 1-pound

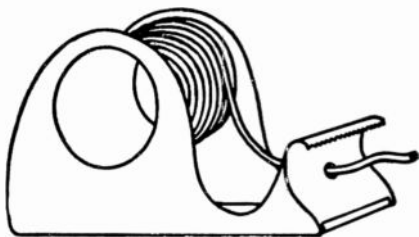

Fig. 706. Handy holder for wire solder.

spools. Simply wind a length of solder around the empty tape reel and pull the free end through the hole in the end as shown in Fig. 706.

### Protecting Instrument Panels

The panels of kits and home-made receivers, transmitters, test equipment,

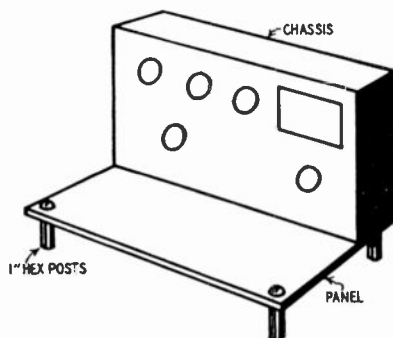

Fig. 707. Protect panel from scratches.

etc. are likely to be scratched or damaged during wiring, assembly, or repair operations. To avoid this, fasten 1-inch long hexagonal posts to the corners of the panel as shown in the drawing in Fig. 707. The posts act as legs

and prevent the panel from being scratched by metal filings or a rough surface on the workbench.

### Stable Oscillator

The stability of a heavily loaded, modulated, tuned-plate tuned-grid oscillator may be greatly improved by installing a carefully chosen cathode biasing resistor. Moving the grid-leak and its bypass capacitor from the normal position to the grounded end of

3 mc. The basic circuit of the modulated oscillator is shown in the diagram in Fig. 708. It may be used as a phono oscillator, home broadcaster, or carrier-current transmitter. The tuning range depends on the inductance of the coils and the values of the variable capacitors. Power output may be raised by using heavier tubes and raising the power input to the oscillator plate and modulator. For phonograph and home broadcast use, antenna length and power input should be held to a minimum, to avoid illegal radiation.

### A Visual Alarm for Hard-of-Hearing

One member of our household is somewhat hard-of-hearing, although not enough so to be considered really deaf. On numerous occasions he is left to hold the fort alone for an evening as general custodian and baby sitter. While not a professional, he enjoys the family TV receiver in true sitter style. Now this is where a problem arises. With the receiver volume at a fairly high level, the telephone bell is not sufficiently loud to attract the sitter's attention if he is absorbed in a TV program. This difficulty caused several evenings of anxiety when a call home produced no response.

Some kind of signal or alarm with more attention-getting power was needed. We considered using a mike, amplifier, and speaker which would make the sound of the phone bell much louder. The baby sitter would hear it, but so would the baby! Some other method would have to be used.

A little thought brought up the idea of using a light as the signal. The fol-

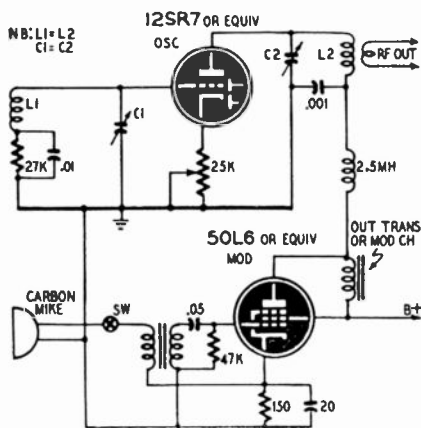

Fig. 708. Methods for improving oscillator stability.

the grid coil provides more constant output over the tuning range when the cathode biasing resistor is correctly adjusted. A variable potentiometer is recommended. When it is adjusted for best modulation quality, and antenna loading is optimum, the band-width and audio quality of the modulated oscillator compares favorably with a well-designed AM transmitter running the same power input.

When loaded with a dummy antenna, the oscillator performed well on the broadcast band as well as on 2 and

lowing system was developed quick'y. A microphone picks up the sound of the telephone bell and an electronic circuit operates a relay, which in turn flashes a light near the TV screen. It works every time.

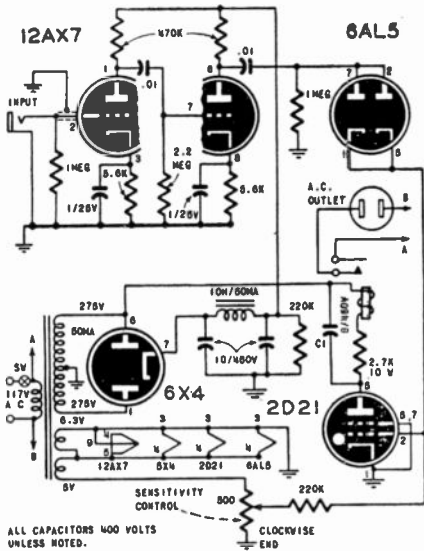

Fig. 709. Telephone-operated electronic flasher circuit.

The control unit shown in Fig. 709 is built in a conventional chassis to be mounted in a wooden cabinet. A two-stage resistance-coupled amplifier raises the voltage from the microphone to a level of 20 volts or more (depending on the mike output). The amplifier output is rectified by the 6AL5, producing a positive voltage at the cathodes. This positive potential is present only when sound is being picked up by the mike.

### An Interesting Mixer Circuit

Needing a mixer having special characteristics, we thought of a combina-

tion of two cathode followers, tying the cathodes together to deliver the modulated output voltage. The circuit shown in Fig. 710 was tried and worked nicely at once. A 6J6 tube was used, but equally good results were obtained with 6SN7-GT and 6F8-G tubes. The scheme is extremely simple and involves no critical parts.

A radio-frequency choke RFC is required to provide a low impedance path for the audio component. The choke must be chosen in accordance with the r.f. range of the mixer.

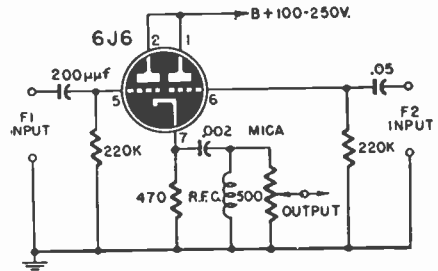

Fig. 710. This mixer circuit is easy to build, is not critical, and requires no adjustment.

This circuit features several outstanding advantages:

- 1—Very low input capacity. As a cathode follower, the amplification of the tube is less than unity, and there is no Miller effect.
- 2—High input impedance. The grid resistors are of 0.2 to 2 megohms.
- 3—Low output impedance. A good characteristic for signal generators.
- 4—High stability. The B-voltage can vary widely without any change in modulation quality. Resistors and capacitors are in no way critical.
- 5—Economy. Minimum of components.

## Neat Breadboard Layouts

The appearance of breadboard layouts suffers and sometimes dangerous short circuits occur because of loose, dangling leads. To remedy these conditions, tack all long leads to the breadboard with an office stapler. Staples are cheap and easy to remove and are therefore ideal for use in experimental work where the wiring is often changed.

## Temporary Connectors

Small steel springs are very useful on the experimenter's bench for making temporary connections between wires. The ends of the two pieces (or more) of wire can be inserted between the coils. If the spring is close-wound, it will grasp the wires tightly.

The connections can be insulated quickly by slipping a small length of rubber tubing over the spring.

## Cutting Machine Screws

If you ever need to reduce the size of a machine screw by sawing or cutting it, be sure that the nut is on the screw (toward the head end) before starting. When the cutting job is finished, removal of the nut gives a die-like action, straightening any screw threads that may have been bent by the sawing or cutting operation.

## Wireless Intercom

Unable to remain in his service shop at all times, the owner rigged up a wireless intercom which enabled him to listen in when anyone entered the store.

A battery-operated set was used as a transmitter. The primary of its output

transformer was disconnected from the output tube and one lead was connected to the arm of the volume control and the other to ground. Another output transformer was installed with its primary in the output circuit and its secondary connected between ground and the grid cap of the 1A7 mixer-oscillator. A short antenna was connected to the 1A7 plate through a small capacitor. This set was then tuned to a spot on the low-frequency end of the broadcast band. A standard receiver upstairs was tuned to the oscillator frequency of the transmitter.

The speaker on the transmitter picks up sounds in the store and feeds them to the a.f. circuit where they are amplified and used to modulate the 1A7.

Adjust the transmitter so its signal falls on a quiet spot on the band. Keep the antenna as short as possible for good results, and above all, don't try for distance records with this unit or the FCC may have a few things to say about your running a radio station without a license.

## Saving 1.4-Volt Tubes

In cases where tubes are blown in a 3-way receiver, it is advisable to check the voltage and current on the filament string with the tubes removed from their sockets. First add the filament voltages of all tubes in the series-connected string, then divide the total by the filament current in amperes. The resultant gives the equivalent resistance of the filament circuit.

Obtain a resistor having the same value as the equivalent resistance. Plug its leads into the filament con-



nectors of one of the sockets in the string. Plug short lengths of hookup wire into the filament connectors on the remaining sockets in the string. Now, with the set adjusted for a.c.-d.c. operation, you can check the voltage and current in the filament string without running the risk of blowing out a set of 1.4-volt tubes.

### Chassis Punching

You can save a lot of energy and time if you use this method the next time you use a Greenlee or Pioneer type socket punch. After drilling the pilot hole, assemble the punch in the usual manner, but make sure that the cap-screw head is on the outside of the chassis. Fasten the screw head in a vise and tighten the punch with your fingers. Now, all you have to do is turn the chassis clockwise until the hole is punched. After the hole has been punched, the chassis can be lifted off so the socket punch can be disassembled while still in the vise.

This procedure is particularly useful

when a number of identical holes must be punched. You don't have to remove the screw or the die from the vise until you have completed the job.

### Soldering Aid

Although many gadgets have been devised to substitute for an extra hand while soldering loose radio components, you will find that you can still do a good job with your fingers. Furthermore, you won't misplace them just when you need them most.

Wind some solder around the index finger, letting the end protrude about 2 inches. Grasp the component to be soldered or tinned between the thumb and middle finger, manipulating the solder with the index finger, and, with the soldering iron in the other hand, you're in business.

Incidentally, if you don't have the time or patience to coat the tip of your soldering iron with silver solder, the iron will tin easier and hold it longer if you use a very coarse file rather than a fine one for dressing the bit.

# Index . . .

<b>A</b>		<b>Crystal:</b>	
Adapter for testing, handy . . . . .	30	Absorption meter . . . . .	90
Adapter for tuning shafts . . . . .	62	Adapter . . . . .	89
A f and i.f. signal tracer . . . . .	17	Probe . . . . .	9
Alignment tool . . . . .	29	Tuner . . . . .	70
Amateur . . . . .	89	Crystals, 160-meter . . . . .	89
Amplifier, d.c. . . . .	23	Crystals, checking . . . . .	89
<b>Antenna:</b>		<b>D</b>	
For FM . . . . .	59	Demagnetizer . . . . .	101
Homemade FM . . . . .	60	<b>Dial:</b>	
Long-wire . . . . .	92	Cords, tightening . . . . .	67
Low-band . . . . .	36	Pointer . . . . .	71
Match, automatic . . . . .	92	Stringing aid . . . . .	28
Mount . . . . .	38	Stringing tools . . . . .	70
ARC-5 conversion . . . . .	96	<b>Distortion:</b>	
Arc suppressor . . . . .	101	In battery portable . . . . .	70
<b>Audio</b>		In TV, 60-cycle . . . . .	41
Chokes, small . . . . .	75	Drilling thin-wall tubing . . . . .	29
Connector for TV . . . . .	41	<b>E</b>	
Construction . . . . .	82	Electrical wiring . . . . .	71
Fidelity, improving . . . . .	85	Electrolytic life, increasing . . . . .	70
Mixing system . . . . .	83	Electronic flasher . . . . .	13
Tone source . . . . .	82	Equalizer for V-R pickups . . . . .	79
<b>Auto radio:</b>		Experimental parts, buying . . . . .	103
Fuses . . . . .	54	<b>F</b>	
Interference . . . . .	52	Fading . . . . .	70
Noise in . . . . .	55	Filter, cause of shorted . . . . .	65
Quick test for . . . . .	55	Filter, scratch . . . . .	78
Trouble-shooting . . . . .	55	Filters, a.c.-d.c. . . . .	72
<b>B</b>		Flux saver . . . . .	50
Bandspread capacitors . . . . .	95	FM on TV sets, receiving . . . . .	45
Bandspread tuning . . . . .	95	Fuse connectors, repairing . . . . .	56
Bass boost . . . . .	81	Fuse for receivers . . . . .	56
Battery connectors . . . . .	27	<b>G</b>	
Battery leads, extending . . . . .	69	Garage-door opener . . . . .	100
Battery receivers . . . . .	67	G-E preamplifier, modifying . . . . .	72
Beam killer . . . . .	43	Glyptal . . . . .	39
Bias supply . . . . .	83	Ground, common . . . . .	78
Birdies . . . . .	62	<b>H</b>	
Birdies in a.c.-d.c. sets . . . . .	52	Harmonic crystal oscillators . . . . .	90
Braid cutter . . . . .	33	Heat in TV sets . . . . .	43
Breadboard layouts . . . . .	108	Heater-cathode leakage . . . . .	57
Brush for speaker cement . . . . .	86	Heaters, locator for open . . . . .	17
<b>C</b>		Heterodyning . . . . .	64
Cabinet repairs . . . . .	73	High voltage indicator . . . . .	28
Calibrating oscillators . . . . .	21	High-voltage meter adapter . . . . .	40
Camera shutter timer . . . . .	14	Home broadcaster . . . . .	67
<b>Capacitor:</b>		<b>Hum:</b>	
Checker . . . . .	6	Detector . . . . .	77
Decade box . . . . .	5	Generator . . . . .	64
Ground leads . . . . .	71	Reduction of . . . . .	58, 78
Substitution box . . . . .	6	Tunable . . . . .	58
Tester . . . . .	21	<b>I</b>	
Values . . . . .	5	Ignition noise, elimination of . . . . .	66
Capacitors, testing . . . . .	7	Image rejection, improving . . . . .	62
Capacity relay . . . . .	97	Inductance measurements . . . . .	79, 104
Cleaning tool . . . . .	26	Instrument panels, protecting . . . . .	105
Color scheme for Spintites . . . . .	31	Intercom, wireless . . . . .	108
Connectors, temporary . . . . .	108	Interference, elimination of . . . . .	38
Converter troubles . . . . .	53		
Converter tubes as amplifiers . . . . .	103		
Cord and antenna reel . . . . .	30		
C-R tube precautions . . . . .	44		
CRO as stroboscope . . . . .	14		
Crossover network . . . . .	82		

Intermediate Frequency:			
Alignment . . . . .	63	Probe light . . . . .	27
Interference . . . . .	52	Pulses from a CRO . . . . .	15
Substitute for . . . . .	61	R	
Intermittent heater checker . . . . .	17	Radio as tuner, using . . . . .	69
Intermittent h-v supplies . . . . .	42	Radio servicing . . . . .	49
Intermittents . . . . .	62	Record player requirements . . . . .	80
J		Rectifier:	
Jeweler's tool . . . . .	28	Tester . . . . .	20
K		Tubes, open . . . . .	53
Keying monitor . . . . .	96	Weak, use for . . . . .	48
Kit assembly hints . . . . .	42	Relays:	
Knife switches, using . . . . .	106	Curing sticky . . . . .	98
L		D.c. . . . .	97
Lead-in:		Powering surplus . . . . .	98
Break . . . . .	36	Resistance boards . . . . .	19
Noise . . . . .	40	Retrace blanking kinks . . . . .	44
Line:		Ribbon-line capacitor . . . . .	46
Cords, protecting . . . . .	59	Rubber washers, replacing . . . . .	71
Filters . . . . .	68	S	
Voltage, excessive . . . . .	53	Safety . . . . .	100
Link coupling to beam . . . . .	90	Safety with a.c.-d.c. sets . . . . .	67
Loudspeaker:		Scope:	
Baffle . . . . .	84	Applications . . . . .	14
Cones, protection of . . . . .	86	Preamplifier . . . . .	11
Installation . . . . .	87	Scratch-removins,ng process . . . . .	96
Metal filings in . . . . .	87	Scratched pane touch-up for . . . . .	98
Phasing of . . . . .	87	Screw holes, stripped . . . . .	72
Servicing . . . . .	88	Sensitivity:	
M		Increasing in a.c.-d.c. receivers . . . . .	61
M-antenna, 40-meter . . . . .	91	Poor . . . . .	60
Machine screws, cutting . . . . .	108	Servicing light . . . . .	45
Marking tabs . . . . .	64	Shielding . . . . .	72
Masking tape for layouts . . . . .	100	Signal generator connectors . . . . .	22
Meters:		Slotted controls, setting of . . . . .	96
Longer life for . . . . .	11	Slug-tuned coils . . . . .	46
Simple test for . . . . .	7	Slug-tuned push-buttons . . . . .	65
Microphone case, mobile . . . . .	95	S-meter circuit . . . . .	94
Mixer circuit . . . . .	107	Socket punches . . . . .	26
Modulation hum . . . . .	57	Solder:	
N		Holder . . . . .	105
Nail file uses . . . . .	29	Removing excess . . . . .	24, 29
Noise in auto sets . . . . .	55	Supply, handy . . . . .	50
Noisy a.c.-d.c. sets . . . . .	53	Soldering iron:	
Nonskid cabinet feet . . . . .	101	Holder . . . . .	26
O		Improved . . . . .	27, 50
Oscillation . . . . .	62	Regulator . . . . .	26
Oscillator, stable . . . . .	106	Tips . . . . .	49, 51
Output indicator . . . . .	22	Soldering Litz wire . . . . .	49
Output transformer checks . . . . .	80	Soldering paste holder . . . . .	51
Overload protection . . . . .	56	Soldering shield braid . . . . .	40
P		Sound-on-light beam . . . . .	105
PA hookup, emergency . . . . .	78	Spray gun cleans radios . . . . .	26
PA microphones . . . . .	78	Stroboscope, simple . . . . .	20
Panel lettering . . . . .	98	Substitution block . . . . .	23
Panel, marking metal . . . . .	99	Substitution box, handy . . . . .	6
Pest-proofing receiver . . . . .	67	Superhets, tracking of . . . . .	63
Phasing loudspeakers . . . . .	87	T	
Photo relay, self-locking . . . . .	97	Television . . . . .	35
Pickup tool . . . . .	24, 29	Test instruments . . . . .	5
Pilot lamp:		Test-lead clip, push-on . . . . .	33
Flashing . . . . .	56, 57	Test-lead, switching . . . . .	34
Saver . . . . .	57	Test leads, handling of . . . . .	32
Tester . . . . .	20	Test probe . . . . .	31
Plastic parts boxes . . . . .	30	Thermal shunt . . . . .	18
Plastic, polishing . . . . .	73	Threading rods . . . . .	104
Plate bypass capacitors, saving . . . . .	105	Three-way sets . . . . .	58
Plating soldering irons . . . . .	49	Tone arms, fastening . . . . .	84
Polarity reversing switch . . . . .	9	Tone control . . . . .	76, 77
Power supplies, improving . . . . .	65	Tone generator, steady . . . . .	22
Power supply for portables . . . . .	65	Tool for coax . . . . .	29, 39
Preselector from t.r.f. set . . . . .	101	Tool handles, insulated . . . . .	24
Printed-circuit grounds . . . . .	103	Tools . . . . .	24
		Transformer:	
		Lead marking . . . . .	64
		Turns ratio . . . . .	68
		Transmitter meter plug . . . . .	93
		Transmitting tubes, testing . . . . .	94
		Trouble light . . . . .	28
		Tubes:	
		Defective, use for . . . . .	51
		Faded numbers on . . . . .	5

Salvaging broken . . . . .	54	Vibrator transformer, emergency . . . . .	103
Substitutions for . . . . .	53	Visual alarm for hard-of-hearing . . . . .	106
Tuner for PA amplifier . . . . .	84	Voltage divider design . . . . .	8
Tuning eyes, improving . . . . .	66	Voltmeter as a precision resistor . . . . .	12
TV (see Television):		Voltmeter range, extending . . . . .	13
Antenna installation . . . . .	37	Volume controls:	
Antenna phasing unit . . . . .	39	Quieter . . . . .	75
Beam killer . . . . .	43	Repairing . . . . .	55
Channel indicator . . . . .	43	Tool for . . . . .	77
Chassis support . . . . .	47	V.t.v.m.:	
Installation . . . . .	36	Extending range of . . . . .	8
Interlock adapter . . . . .	47	Mount . . . . .	9
Intermittents . . . . .	42	Pin jack . . . . .	8
Isolation amplifier . . . . .	39	Stabilization of . . . . .	7
Masts, carrying . . . . .	37		
Servicing tool . . . . .	42	W	
Twin-lead test leads . . . . .	34	Wattage chart, resistor . . . . .	74
V		Wattage checker . . . . .	16
Variable capacitors, cleaning . . . . .	68	Wattmeter substitute . . . . .	16
V-Beam for dx . . . . .	37	Welder gun, new use for . . . . .	64
Vertical output tube . . . . .	47	Wire recording, endless . . . . .	81
V.h.f. antenna terminals . . . . .	36	Wire stripper . . . . .	26
Vibrator failure . . . . .	54	Workbench magnet . . . . .	27
		Wrinkle finishes . . . . .	98



# Other GERNSBACK LIBRARY Books

- 44—**BASIC RADIO COURSE.** 26 chapters on radio theory. Describes the action of radio circuits in a quick-to-grasp manner. Hard cloth cover. 176 pages. \$2.25
- 45—**RADIO TUBE FUNDAMENTALS.** The first low-priced book to give a complete understanding of radio tubes. 96 pages. \$1.00
- 48—**HIGH FIDELITY.** Audio design, construction, measurement, techniques. Complete section on building amplifiers. 128 pages. \$1.50
- 49—**RADIO AND TV TEST INSTRUMENTS.** Build 22 instruments: Picture Tube Circuit Analyzer, Picture Tube Tester, Three-Inch Scope, Portable Marker Generator, etc. 128 pages. \$1.50
- 50—**TV REPAIR TECHNIQUES.** How to service TV in the home, overcome high-voltage troubles, picture-tube circuit difficulties, cure TVI, intercarrier buzz, brightness troubles, etc. 128 pages. \$1.50
- 52—**THE OSCILLOSCOPE.** Waveforms, sweep systems, typical scopes, alignment techniques, tests, measurements, experiments. 192 pages. \$2.25
- 53—**RADIO-CONTROL HANDBOOK—**For hobbyists interested in radio control for planes, boats, trucks, tractors, etc. Practical construction ideas. 192 pages. \$2.25
- 54—**PROBES.** Describes crystal-demodulator; voltage-doubler; balanced; low capacitance; high-voltage; isolation and direct probes, including a transistorized type. 224 pages. \$2.50
- 55—**SWEEP & MARKER GENERATORS** for TV and Radio. Complete theory and use of sweep and marker generators. 224 pages. \$2.50
- 56—**HIGH FIDELITY CIRCUIT DESIGN.** Feedback, drivers, inverters, power supplies, attenuators, filters, equalizers, speaker systems. Hard cloth cover. 304 pages. \$5.95
- 57—**THE V.T.V.M.—**how it works—how to use it. Supplies full information on the theory and practical operation of the vacuum-tube voltmeter. 224 pages. \$2.50
- 58—**MAINTAINING HI-FI EQUIPMENT.** Service hi-fi systems. Chapters include: Hi-fi Standards; Test Instruments; Circuits; Diagnosis; Distortion; Bass and Treble Faults; Pick-ups; Styli; Turntables; Equalizers; Tuners; Adjustments. 224 pages. \$2.90
- 59—**SERVICING RECORD CHANGERS.** Excellent source of profit for the service technician. Detailed drawings show how to make repairs. Full servicing information. 224 pages. \$2.90
- 60—**RAPID TV REPAIR.** Alphabetical listing of hundreds of TV troubles — symptoms and specific information on repair. 224 pages. \$2.90
- 61—**TRANSISTOR TECHNIQUES.** How to work with and test transistors; how to make transistor measurements; also supplies practical building projects. 96 pages. \$1.50
- 62—**TV—IT'S A CINCH!** Snappy conversational style with hundreds and hundreds of drawings helps you breeze through TV. 224 pages. \$2.90
- 64—**UNDERSTANDING HI-FI CIRCUITS.** A new approach to audio. Explains how modern audio circuits work and what you can expect from them. 224 pages. \$2.90
- 65—**SERVICING COLOR TV.** How to repair color receivers. Illustrated with photos, drawings and troubleshooting charts. 224 pages. \$2.90
- 66—**BASIC AUDIO COURSE.** Fundamental audio concepts; describes microphones, equalizers, amplifiers, speakers, enclosures. 224 pages. \$2.75
- 67—**ELEMENTS OF TAPE RECORDER CIRCUITS.** Complete coverage of the electronic portion of tape recorders. For technician and audiophile. 224 pages. \$2.90
- 68—**TV AND RADIO TUBE TROUBLES.** Service TV and radio receivers by understanding tube troubles. Recognize symptoms quickly. 224 pages. \$2.90
- 69—**ELECTRONIC HOBBYISTS' HANDBOOK.** Scores of practical circuits for the hobbyist. Parts lists on construction projects. 160 pages. \$2.50
- 70—**ELECTRONIC PUZZLES AND GAMES.** Build and design them. Dozens of projects which need no special parts or tools. 128 pages. \$1.95
- 71—**AUDIO DESIGN HANDBOOK.** Practical design procedure. Each chapter covers a separate section of an audio system, from the preamp to the speaker. 224 pages. \$2.90
- 72—**OSCILLOSCOPE TECHNIQUES.** Derivation and interpretation of waveforms. Plot tubes and transistor characteristics on the scope. Hundreds of photographs of actual traces. 224 pages. \$2.90
- 73—**AUDIO MEASUREMENTS.** Covers test equipment and all phases of audio measurement from the basic amplifier to the microphone. 224 pages. \$2.90
- 74—**MODEL RADIO-CONTROL.** Every phase of radio-control for the hobbyist. Basic concepts, coders, transmitters, receivers, power control, servos, transistors. Theory and construction, 192 pages. \$2.65
- 75—**TRANSISTORS—THEORY and PRACTICE.** Revised, up-to-date, new material added. Covers semiconductor theory, equivalent circuits, amplifiers, oscillators. Includes tests and measurements. 160 pages. \$2.95
- 76—**SERVICING TRANSISTOR RADIOS.** Fundamentals, types of construction, testing, stage-by-stage servicing procedures, transistor interchangeability, data charts & glossary. 224 pages. \$2.90
- 77—**GUIDE TO MOBILE RADIO.** Handbook for technicians, sales engineers. Includes industrial and railroad radio, selective and remote systems, maintenance and licensing. 160 pages. \$2.85
- 78—**RAPID RADIO REPAIR.** Fix radios quickly and easily. Separate sections deal with receiver types, servicing techniques, troubles, including many valuable charts. Alphabetically arranged for quick reference. 224 pages. \$2.90
- 79—**DESIGNING & BUILDING HI-FI FURNITURE.** Fundamentals of design, woods, tools, professional finishing, polishing and retouching, furniture styles, placement, construction and repair. Specifically written for use with hi-fi systems. 224 pages. \$2.90