



**PRINTED
CIRCUITS**

Morris Moses

contents

chapter 1 DEVELOPMENT OF THE ART page 7

Early history. Important commercial developments. Radios and printed circuits. Printed-circuit components. Pocket radios. Reflexed superhets. Communications receivers. Television applications. Hearing aids. Industrial electronic uses. Amplifiers in control circuits. Printed-circuit strain gauges. Musical devices. The electronic organ. Advantages of printed circuits and sub-miniaturization. Printed-circuit motor. Micro-miniaturization.

chapter 2 TECHNIQUES AND MATERIALS page 17

Painting. Surface preparation for painted circuits. Putting on the paints. Conductive and resistive paints. Magnetic paints and pastes. Spraying or metalizing. Imprinted-circuit inlays. Spray milling. Stamped wiring. Encapsulation and potting. Soldering methods. Dip-soldering technique. Spot and jig soldering. Solder masking techniques. Soldering troubles. Solder characteristics. Flux considerations. Special soldering techniques. Indium-based solders for glass to metals. Etched circuits. Photographic etch-resist methods. Glue-type photosensitive resists. Etching the home-made plate. Etchants. Etchant handling techniques. Negative masking. Mechanical methods of etch resists. Silk-screen methods. Making your own silk screens. Toughening and waterproofing the screen stencil. Exposure problems with presensitized material. Tape resists. Paint resists. Writing-implement resists. Circuit layouts and design.

chapter 3 COMPONENT SELECTION AND APPLICATION page 51

Resistance components. Making your own painted resistors. Subminiature carbon resistors. Selection of subminiature wire-wound resistors. Deposited film resistors. Flexible resistors. Miniature variable resistors. Capacitors for printed-circuit and subminiature use. Ceramic capacitors. Metalized paper capacitors. Mica capacitors. Electrolytics. Tantalum capacitors. Variable capacitors. Making your own printed and etched capacitors. Subminiaturization and inductors. Inductive components. Rf inductors. Loop antennas. Matched-coil kits. Glass inductors (metalized). Making your own printed-circuit inductances. Q values of inductances. Use of magnetic materials. Rf coil forms—winding your own coils. Cores. Hardware and special wiring. Punchboards. Stitched wiring boards. Pre-etched test boards. Sockets. Connectors. Terminals. Flea clips. Component holders. Battery holders. Shields and heat sinks. Individual plugs.

chapter 4 BATTERIES AND POWER SOURCES page 121

Classification of batteries. Flashlight cells. Air cells. Mercury cells. Construction features of the mercury cell. Using the mercury cell. Primary-cell sizes and terminations. Size and voltages of dry batteries. Secondary cells. Silver-zinc cells. Nickel-cadmium cells. Recharging nickel-cadmium cells. Silver-cadmium cells. Using B-batteries. B-battery conservation. Testing batteries. Recharging dry cells.

chapter 5 REPAIR OF PRINTED-CIRCUIT AND SUBMINIATURE ASSEMBLIES page 135

Possible troubles and diagnosis. Pitfalls in printed-circuit servicing. Tools. Replacing components. Complete replacement of component. Replacing foil. Repairing cracked boards. Tube-socket repairs. Replacement of sockets. Replacing transformers, inductors and if's. Replacing controls. Special desoldering methods. Test instruments. In-circuit component tester. Subminiature tube tester. Simple transistor checker.

chapter 6 PRACTICAL ASSEMBLIES AND TECHNIQUES page 159

One-transistor radio. Testing the one-transistor set. One-tube radio-control receiver. Chronograph neon timer. Printed-circuit maze. Rain detector. Field-strength meter. Printed-circuit amplifier. Photoelectric light meter. Light-beam relay. Circuits using Ampecs. Printed-circuit audio oscillators. High-frequency crystal-controlled transmitter. Phonograph pickup. Printed-circuit switches. Printed-circuit cables. Stamped wiring. Potting.

chapter 7 ADVANCED APPLICATIONS page 197

Rf oscillator. 6-meter converter. Checking the 6-meter converter. Two-tube wristwatch AM transmitter. "Lipstick" transmitter. Adjustable frequency and pulse-width multivibrator. Printed-circuit radio-control receivers. Lorenz two-tube receiver. Little Gem duo-diode receiver. Gazistor receiver. B-supply (transistor converter).

INDEX page 221

introduction

THIS is a book on the "how-to-do-it" of printed circuits and miniature equipment, and has been written especially for the radio ham, TV and radio service technician, and garage and basement experimenter. Practical techniques and methods have been presented wherever possible.

The space and nuclear age has brought with it a tremendous demand for smaller and smaller circuit packages. As the information-handling requirements grew, room for equipment disappeared at a startling and discouraging rate. New techniques had to be found to compress a lot of hardware into embarrassingly meager volumes.

Two techniques resulting from electronic "circuit shrinking" have been the printed circuit and the miniature or subminiature component. The bulky thickness and three-dimensional character of conventional wiring are giving away to a flat—nearly "2-D" look—capable of being mass-produced by machines at production rates of thousands of circuits an hour. Components have been scaled down, and, in many cases, completely redesigned with new materials to give more ohms, millihenries and microfarads per cubic inch.

The process of learning is such that no book is the work of any one individual. Therefore, the author wishes to extend his thanks to the many firms and persons who have cooperated so generously; particularly to the following: Ace Radio Controls, Aerovox Corp., Allied Radio, Bruno-New York Industries, Centralab, Eastman Kodak Co., Electronic Industries, *Fortune Magazine*, Gulton Industries, Hansen Electronic Industries, International Crystal Manufacturing Co., Kester Solder Co., Lepage's, Methode Manu-

facturing Co., Micro Circuits Co., Photocircuits Corp., RADIO-ELECTRONICS, *Tele-Tech* Magazine, Ungar Electric Tools, Inc., Walsco Electronics Mfg. Corp., Westbury Electronics, and Yardney Laboratories.

Thanks are also due Mrs. Rose Sell who typed the manuscript, and to Mr. Bennett Carter for his valuable photographic advice.

Electronics is fast becoming one of the key scientific arts. Wall-hung TV sets no thicker than a picture frame, cigarette-sized pocket radios, and matchbox-sized recorders are but a few of the marvels which will be made possible with printed circuits and miniature components.

MORRIS G. MOSES
W8UVC

development of the art

PRINTED circuits and subminiature electronic equipment were not in widespread use until the advent of World War II. War needs built an enormous demand for reduction in size of electronic assemblies of all types. One notable example was the "proximity-fuze shell," which exploded when it came within a certain distance of an object. The vast quantities of shells required stimulated research on new high-volume mass-production techniques in electronic circuitry. The combined talent of engineers at the National Bureau of Standards and at the Centralab Division of Globe-Union Corp. brought about a very effective solution to the problem in the form of ceramic-based conducting circuits. From this early commercial-military development have stemmed innumerable advances in the art of printed circuitry and subminiaturization.

Although the work of the Centralab Co. was the first large-scale application, several foreign developments are worth mentioning. As early as 1941 and 1942, Dr. Paul Eisler, working in England, applied for patents which involved the use of conventional printing techniques and photoengraving in electronics manufacture. One of these used etch-resistant ink as a printing medium. The idea was to print the desired circuit on a metal foil and immerse the foil thus printed in an etchant which attacked all areas of the foil except those protected by the ink. Unfortunately, Dr. Eisler's work was mostly on a small scale and was not fully understood and exploited until the US Army Signal Corps became aware of it in 1946. Evidence of early printed-circuit work crops

up in reports of the Joint Intelligence Objectives Agency, which investigated technical developments along these lines in Germany during and at the end of World War II. Various isolated

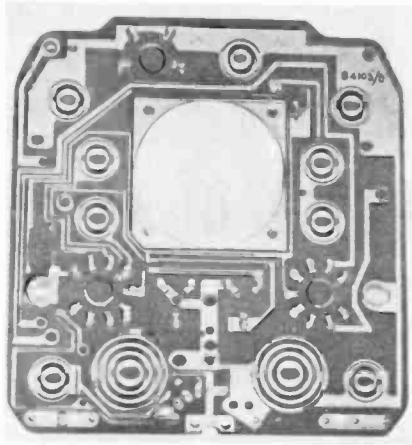
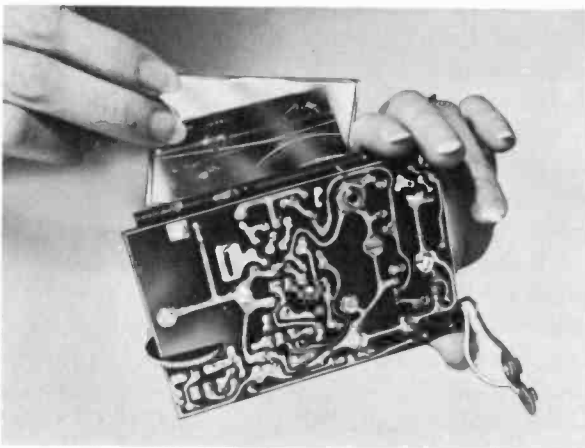

Fig. 101. Circuit plate used in an early British two-tube ac-dc receiver. (Courtesy Sargrove Electronics, Ltd.)

techniques which might have inspired the current methods can be found in the patent literature, and among these is the Parolini patent granted in England about 1927 for the "production of electrically insulating plates with a series of connections."

Fig. 102. Complete assembly (less case) for pocket portable receiver.



Important commercial developments

Perhaps the greatest advances in commercial printed-circuit and subminiaturization techniques are those concerned with mass-consumed goods. These encompass both domestic products such as used around the home and industrial equipment. The home products include radios, television sets, hearing aids, electronic music devices and automotive accessories. Industrial uses range from controls of all sorts to testing equipment such as the vacuum-tube voltmeter and cathode-ray oscilloscope.

Radios and printed circuits

One of the earliest mass-produced radio receivers employing ideas which later became useful in printed circuits and subminiaturization work was invented by J. A. Sargrove of England. A

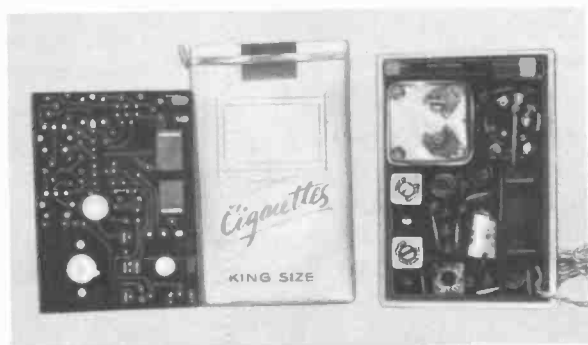

Fig. 103. This miniature radio is smaller than a pack of cigarettes.

circuit plate for this unit is shown in Fig. 101. Produced in 1947, the radios were literally stamped out on a production line that required only two or three people to attend it. The capacitors on these plates were made by spraying zinc over concave indentations in the plastic base. Capacitances of 100 to 500 μf were produced by corrugating the indentations, which gave a larger surface area. Plastic plates inserted at one end of the machine came out 20 seconds later, fully fabricated. Metal sockets for tubes and inductive components were inserted automatically and held permanently to the base plate by riveting and soldering. The finished plates were automatically tested and, if two plates in a row were defective, the machine shut down until repairs were made. The receiver was a two-tube unit designed for use in Asia and, somewhat like Eisler, Sargrove was a little bit ahead of the times.

From Sargrove's first attempts have come many practical mod-

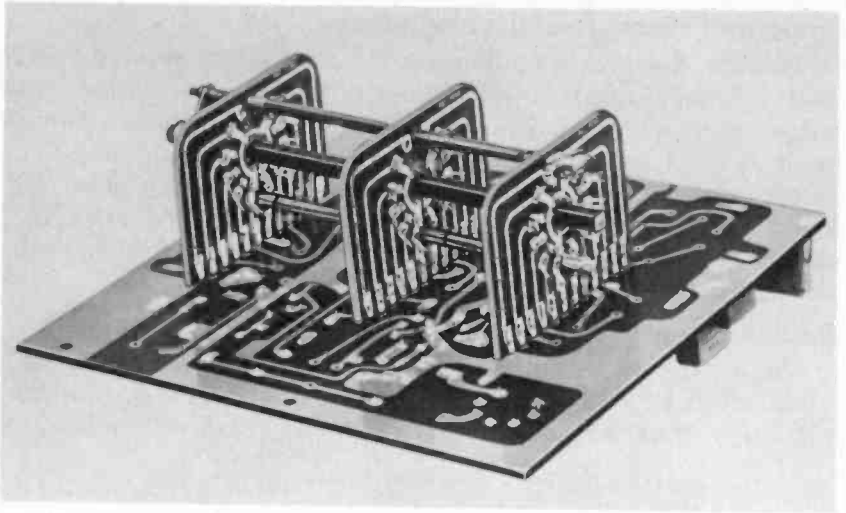
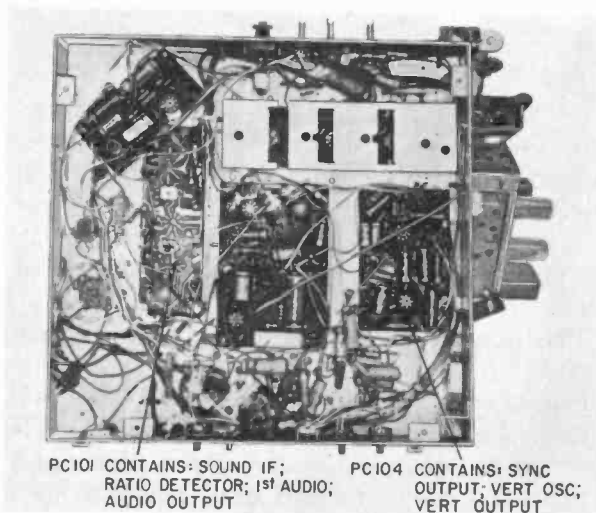

Fig. 104. *A printed circuit bandswitch used in an all band receiver. (Courtesy Allied Radio Corp.)*

ern receivers. Pocket radios such as the one shown in Fig. 102 have become common as a result of printed circuits and subminiaturization. This receiver has a loudspeaker output. Still more remarkable is the unit shown in Fig. 103, smaller than a king-size pack of cigarettes. Its circuit is a reflexed superhet



PC101 CONTAINS: SOUND IF;
RATIO DETECTOR; 1st AUDIO;
AUDIO OUTPUT

PC104 CONTAINS: SYNC
OUTPUT; VERT OSC;
VERT OUTPUT

Fig. 105. *Printed circuit plates find wide use in television. This set combines conventional wiring techniques with the use of printed circuitry. (Courtesy RCA.)*

using four transistors and two diodes to provide a converter, two if stages, avc and avc-detector combination, and audio output to a magnetic earphone. The entire unit weighs 5 ounces.

The art of printed circuitry has been extended into the field of communications receivers (Fig. 104). Printed circuits have made possible auto radios which can be removed from the dash-board and used as portables.

Subminiaturization of radio devices has also been given tremendous impetus by the improved techniques in transistor production.

Television applications

Printed circuits have also helped shrink the TV set down to where present-day 17- and 21-inch receivers occupy less volume than the early 5-inch sets. Fig. 105 shows the use of printed circuits in TV set construction. Front-end tuners and if stages have been some of the most common sections of TV receivers to

Fig. 106. Almost all of the circuitry of the hearing aid (bottom) is combined in a single ceramic unit. Step by step construction of the amplifier is shown in the upper portion of the photo. (Courtesy Centralab Corp.)

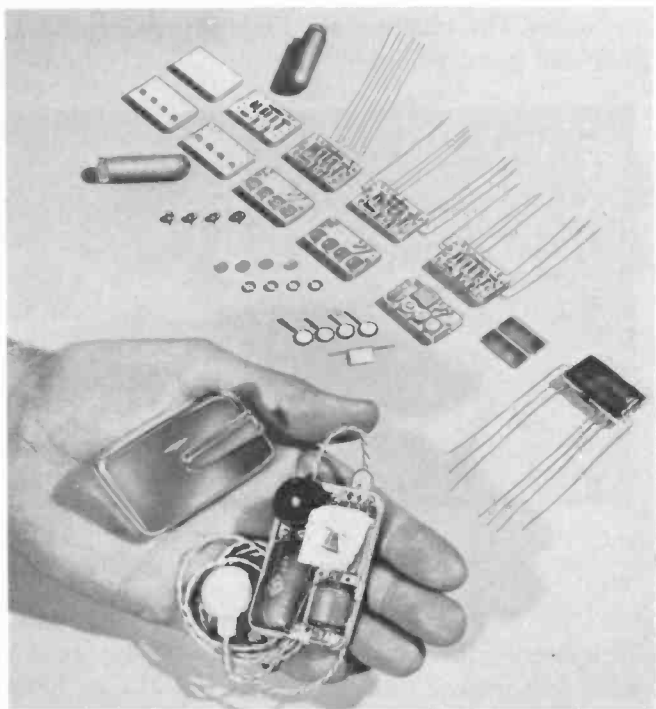

employ this technique, entire if strips having been built up this way. Modular construction, described in Chapter 3, has been utilized in some sets to make maintenance easier.

Hearing aids

Before the advent of the modern hearing aid, batteries had to be carried separately in bulky cloth "aprons" worn on various parts of the body, or else as a cumbersome battery-pack in one pocket. The older hearing aids also required a cord from the battery to the amplifier and another cord connecting the amplifier to the earpiece. These units commonly ran to 5 and 6 inches on a side and over 1 inch thick.

One of the earliest firms to experiment with printed-circuit and subminiaturization techniques in the hearing-aid field was the Allen-Howe Electronics Corp. In cooperation with Centralab, it developed several designs based on a few fundamental amplifier circuits. After much experimental testing, the ceramic circuit plate (Fig. 106) was developed that became the complete audio amplifier—heart of the hearing-aid chassis. This was the beginning of the end for scattered components which formerly were soldered in place by tedious hand work and elaborate mechanical assembly methods. The chassis was built up to include a volume control plate and battery holder.

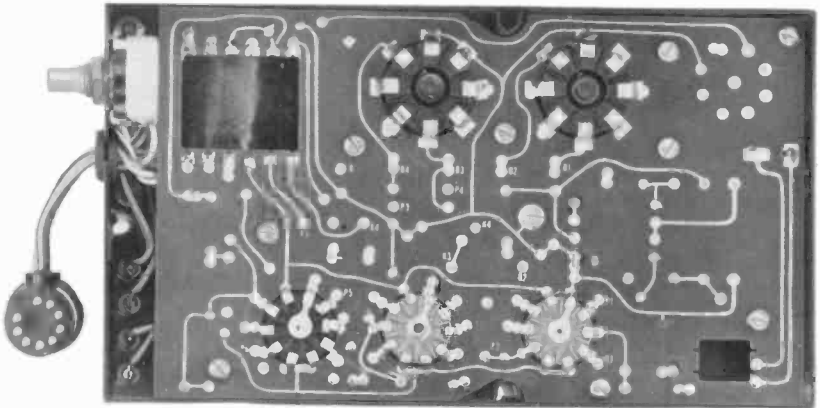

Fig. 107. Bottom view of a printed-circuit industrial amplifier. (Bristol Co.)

An added advantage of printed-circuit hearing aids is that smaller high-energy-low-volume batteries can be used to make lighter, less-conspicuous devices, and give longer battery life.

Present-day repair work on hearing aids often amounts to no more than replacing a single printed-circuit plate in a few minutes' time. Here again the transistor helped shrink a product to incredibly small size.

Today, through the use of transistors, printed circuits and subminiaturized components, it is possible to manufacture hearing aids the size of book matches, and even units which are self-



Fig. 108. A control unit used in conjunction with test instruments. The characteristics of a test setup are changed simply by substituting a different unit. (Swartwout Electronics Co.)

contained and will fit into the ear! Single-stage amplifiers the size of pencil erasers and a four-stage transistor audio amplifier not much larger in volume than a cigarette are described in later chapters.

Industrial electronics uses

Printed circuits have found their way into amplifiers used in control circuits, test instruments and computers. An example of

industrial printed circuitry is the amplifier chassis shown in Fig. 107. One of the common uses is where the range or input conditions of an instrument have to be changed quickly by inexperienced personnel. One instrument company has made up various forms of controllers based on this idea. If the characteristics of the process require a change in the mode of control, the operator merely substitutes a new printed-circuit board (Fig. 108).

Fig. 109 shows examples of printed-circuit strain gauges. Gauges like these have been made about the size of a match head. They are cemented to mechanical parts such as building beams, automobile axles and motor shafts. By measuring the resistance of the gauge under stress, load and strain can be determined. The fine wire patterns are made possible by photoetching methods.

Switching devices of all kinds have been made using this ap-

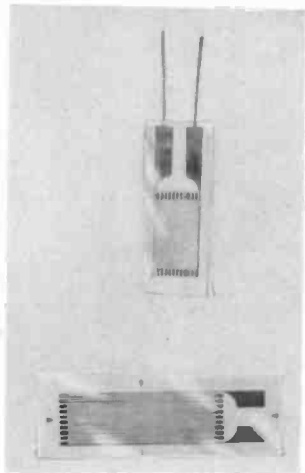

Fig. 109. These simple strain gauges find wide industrial application. They are easily attached to parts being tested.

proach. Printed-circuit commutators are easier to manufacture and require less hand-assembly work.

Musical devices

The basic building block in an electric organ is the tone generator, usually some form of oscillator. Because of the repeated circuitry found in electronic organs, printed-circuit techniques naturally lend themselves to such applications. Another fundamental circuit in electronic organ manufacture is the modulator, and several articles have appeared in popular magazines on the use of printed circuits in this connection. One of the nicer features of organ building is that relatively few components are needed

in the basic building-block circuits, and printed circuitry minimizes the time required to manufacture and wire the basic units.

Advantages of printed circuits and subminiaturization

These new techniques offer many advantages:

1. Reduced cost in wiring.
2. Adaptability to both large and small quantity production.
3. Savings in space and weight.
4. Reproducibility—uniformity from one unit to the next.
5. Ease of testing and replacement.

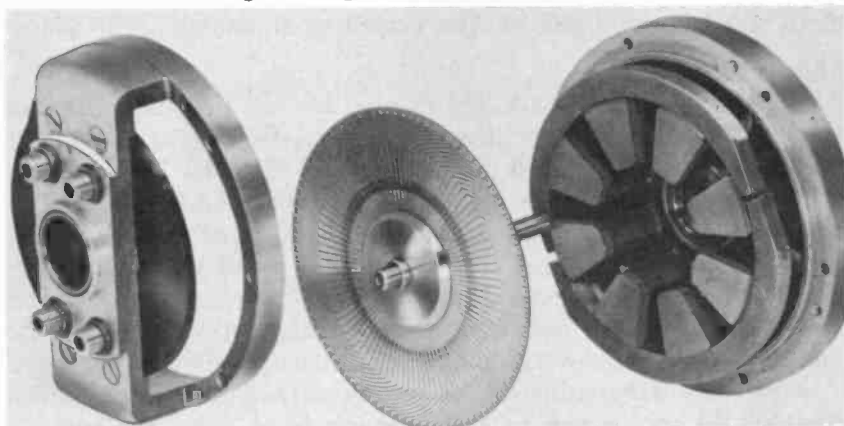

Fig. 110. This printed-circuit motor has been disassembled to show the armature. (Photo courtesy Photocircuits Corp.)

From just looking at a printed-circuit board you can see that a tremendous amount of wiring labor is saved—the savings have been estimated to be as high as 35% to 60%. Wiring labor normally includes cable harnessing, wire stripping, and physically lacing the wires into place prior to soldering.

Space and weight savings often run as high as 100% over similar items using conventional wiring. If the sides of an assembly are reduced by one-half, the volume is reduced by one-eighth. Assuming uniform density throughout, the weight would also be cut by a factor of 8. Even with nonuniform density, the saving in weight is normally three or four times that of conventional devices.

Because the circuit has been laid out in advance on a master that has been checked and corrected, there is less chance for human error on individual chassis. If parts have to be positioned in certain locations, such as rf or high-gain audio circuits (notorious for feedback troubles), the printed circuit usually offers a

better chance of fixing the location more accurately from chassis to chassis. Overall dimensions of the printed-circuit package can be held to closer tolerances than the wired type of unit in which hand labor is variable from person to person. Interchangeable plug-in units have a better chance of fitting if they are made in printed-circuit or module form.

Another advantage is that printed-circuit connections can be paralleled in manufacture with a set of lines made expressly for testing. This provides the service technician with easier access to the circuit, which might otherwise be difficult, if not impossible, due to wiring put on after certain components are in place.

The future

Mushrooming in growth, the printed-circuits field has supplied the electronics industry with some unusual developments. One of these is the printed circuit motor shown in Fig. 110. The unit has a printed-circuit armature made from a two sided-laminate. The armature disc rides between magnets. Brushes of silver-graphite are spring loaded against the armature. Two of the advantages claimed for such a motor design are smooth torque output and relatively spark-free commutation. The magnetic circuit of the motor consists of several alnico permanent magnets arranged around the outside edge of the printed circuit rotor disc. Variations of the motor can be made which have "stepping action," very similar to a telephone stepping switch. Such printed-circuit motors hold great promise for more power in smaller, lighter-weight packages.

Another development is the *micro*-miniaturization program which has been under way for a few years now. Recent announcements by RCA and the U.S. Army Signal Corps indicate component densities of 300,000 to 600,000 per cubic foot! This is a far cry from the present average of 100 to 500 components in a similar volume. The components are housed on modules which are ceramic wafers about 3/10 of an inch square and less than 1/64-inch thick. A side development of this technique is the photo-etched transistor which would be made as one small flat sandwich, doing away with height-consuming electrodes. This would ultimately provide a transistor that would be about 1/4 the size of a postage stamp, and probably only three to four times as thick.

techniques and materials

THERE are many methods of producing "printed circuits," or what most people think of as circuits, without the need for regular point-to-point wiring. One is a simple technique in which the conductors are "painted" on the insulating material in a manner similar to ordinary house-painting. Another depends upon spraying hot metal in the form of a "vapor" onto the insulating background. Still another produces circuits by electroplating or reverse-electroplating—material is actually "plated off" the insulator instead of on to it. Die stamping, in which a metallic wiring pattern is cut out of a solid-conductor background, has been used for making printed-circuit antennas. In addition to these more popular methods, auxiliary techniques such as potting or encapsulating allow the circuit to be cast into rigid molds for mechanical protection. Soldering techniques are also very important in the art of printed circuits because poor solder or poor flux can ruin an entire chassis.

Techniques such as metalizing require specialized equipment and are mentioned only as background information for the technician. Imprinted circuit inlays are close cousins to the foil techniques described in Chapter 5.

Painting

Painted printed circuits are easy to make on both an experimental and production scale. Conductive materials such as copper, silver and carbon are ground into fine particles and dispersed in solvents. The resulting paints are then brushed or

sprayed onto the objects to be coated. In some cases, the paints are air-drying and require no additional source of heat. In others, it is necessary to apply the paint to the "base" material and then fire the painted coating in a manner similar to pottery glazing. One ounce of silver is enough to paint several square inches of conductive surface and can easily produce many multi-tube circuit chassis. The pigment for resistors is mainly carbon black, although colloidal graphite is also used. Flake graphite can be used for brush painting mixtures while carbon black and colloidal graphite are more adaptable to spraying and silk-screening. A binder—linseed oil, cottonseed oil, lacquers or silicate—holds the pigment together in the solvent. Some forms of printed-circuit paints contain reducing agents, such as formaldehyde, which are used to convert the salts of the metal to the pure metal at low temperatures. Silver oxide and silver nitrate are two agents used to produce pure silver.

A solvent adjusts the viscosity of the paint. Some of the more common ones are acetone, various alcohols, ethyl acetate and amyl acetate. Sometimes solvents which attack the base material are used to improve adhesion of the conductive coating to the base; for example, toluene on polystyrene. Toluene, a relative of benzene, "etches" the surface of the polystyrene and allows the silver or other paint to obtain a firm grip on the base.

Some typical silver and carbon paint formulas are given in Tables 2-1 and 2-2.

Table 2-1. Typical Silver Paint Formulas

<i>base-plate material</i>	<i>pigment</i>	<i>binder</i>	<i>solvent</i>	<i>processing temperature</i>
ceramic	65% silver powder	13% cellulose resin; 12% low-softening-point glass	10% acetates or cellulose derivatives	842°-1,440°F
glass	65% silver powder	same as above	same as above	840°-1,440°F
thermo-setting plastic	70% silver powder	20% cellulose resin, methacrylate resin, phenolic resins	10% acetates, ketones, cellulose solvents	77°-347°F
thermo-plastic	70% silver powder	20% methacrylate resin, polystyrene resin	10% ketones, benzene, toluene, ethylene dichloride	77°-347°F

Note: All percentages are by weight.

Courtesy National Bureau of Standards

Surface preparation for painted circuits

The insulated surface on which the conductive paint is laid down has to be prepared in many cases. In the case of plastic bases such as Lucite or Plexiglas, a light sanding with fine sand-



Fig. 201. *Painting a printed circuit.* (Courtesy Micro-Circuits Co.)

paper (180 grit) will do the job. The unpainted parts of the base material must be protected with heavy masking tape. Glass surfaces can be etched with commercial etching pastes such as Etchall or else hydrofluoric acid can be used. *When using hydro-*

Table 2-2. Typical Carbon Paint Formulas

resistance (ohms)	thickness (inches)	pigment	binder	solvent	processing temperature
1,000	.003	38% graphite	62% silicone resin	—	527°F
2,000	.003	3% carbon black 27% graphite	70% silicone resin	—	527°F
5,000	.003	4% carbon black 19% graphite	77% silicone resin	—	527°F
25,000	.003	12% carbon black 38% graphite	17% phenolic resin	33% phenolic resin solvent	347°F
25,000 to 50,000	.0015 to .003	4% carbon black	74% silicone resin	22% benzene	527°F
45,000 to 10 megohms	.001 to .004	12% carbon black 27% graphite	20% crystal- lite	12% toluene 29% ethylene dichloride	122°F

All values are for resistors approximately 1/10-inch wide by 4/10-inch long.

Note: All percentages are by weight.

Courtesy National Bureau of Standards

fluoric acid, protect your eyes and hands from the acid fumes. After roughening the surface, scrub it perfectly clean. Dirt will weaken the bonding between the paint and the base material. Ordinary detergents work very well in this respect, but they should be followed with several water rinses.

Putting on the paints

The painting of printed circuits is shown in Fig. 201. Brushing is the commonest method for small-lot runs; an ordinary camel's hair or sable brush can be utilized. Use even strokes and take care to avoid air bubbles and excessive paint buildup. Stir the paint occasionally to prevent settling or thickening. Adjust paint viscosity by thinning with solvent or else allowing the paint to evaporate, depending on the results desired.

Stencil techniques can also be used, and stencils prepared as described later in this chapter will hold up for several dozen or even several hundred runs. Another method for applying the inks or paints is to use an ordinary printing press. The ink plate of the press is coated with conductive or resistive paint. The pattern of the electronic circuit is made up as a form of "type" and put into the press where the regular type is usually set. The base material to be printed is laid on the plate where the paper usually goes, and the press is then operated. Repeated printings will build up the coating thickness, giving a wide variety of conductance or resistance values. Silk-screen techniques can be used very successfully for large production runs when tolerances have to be held more closely than can be done with hand-painting methods.

Conductive and resistive paints

The most common use for these materials is to paint conductive circuit lines on an electronic circuit board. Some of the less obvious uses include:

1. Measuring a break or tear in a surface by coating the surface with conductive paints and stretching or abrading the surface while the coating is in series with an ohmmeter.
2. Strain-gauge devices for weighing various objects. A layer of conductive paint acts like a varying resistance when the coated member is stressed, and the relation between stress and resistance can often be found experimentally.
3. Moisture-detection devices similar to the rain-gauge detector described in a subsequent chapter.
4. A substitute for a broken metallic part or a working model of a complex metallic part. By shaping the part from wood or

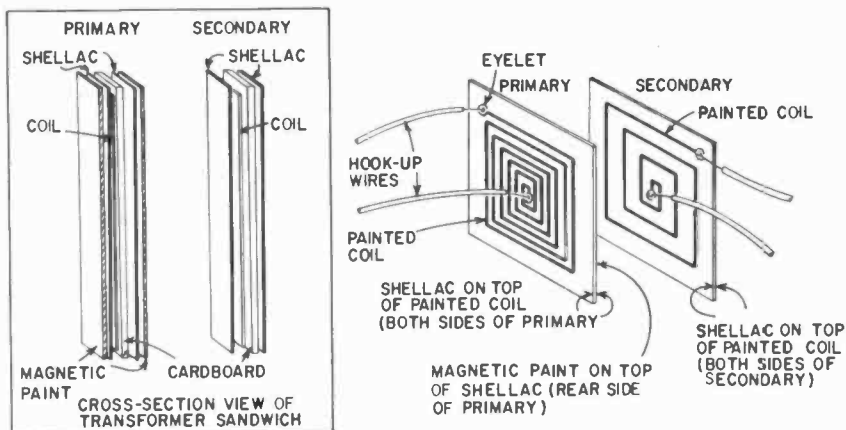

Fig. 202. Construction details of a printed-circuit transformer.

plastic and then coating it with conductive paint, it is possible to make a very inexpensive model. Dipole antennas have been made this way, using wooden dowels coated with conductive silver paint.

5. Measurement of surface and volume resistance. Small dots or lines of conductive paint can be used as electrodes for point-to-point volume and area resistance measurements.

6. Silver conductive paints have been used for electromagnetic and electrostatic shields in TV tubes. These paints have also been used to dissipate static which builds up on windshields and phonograph pickups.

7. By painting carbon resistances around a glass beaker, the resulting element can be used to boil water in the beaker or else heat water to a given temperature, using a thermostat to control the resistance-paint heater. The chapter on components has design information for computing the wattage of resistors using painted-circuit materials.

8. By coating a vibrating object with conductive paint and making it part of a capacitor, the vibration of the object can be measured as a function of capacitance changes.

9. Areas of conductive paint are brushed on box tops and other moving objects so that when the box or object passes certain points on an assembly line, solenoids triggered off by the coatings kick the objects to one side or perform predetermined operations on the boxes. These paints can be put on coded wheels and used as programming timers.

Magnetic paints and pastes

Miniature transformers can be made by using magnetic paints and pastes composed of metallic pigments dissolved in binders. These pigments are mainly iron-base materials and can be applied over coils and wires to increase inductance and coupling and also to control magnetic leakage. A transformer can be made as shown in Fig. 202 by placing one coil on each side of the base material and building up with alternate layers of shellac, like laminations in a regular transformer. A thermoplastic version of these magnetic materials is available for casting special core shapes.

Spraying or metalizing

Although the metalizing process has been used since 1935 by electrical manufacturers, it has been applied to printed-circuit work only since the mid-1940's. The basic idea of the process is to spray molten metal onto a base plate, using a stencil to produce the desired pattern. The process is too complicated for the average experimenter.

Imprinted-circuit inlays

The main feature of this technique is that all of the circuit conductors are cut out of a solid sheet of copper or silver and then attached to the base material by fusing with heat. Dies are used to cut out the conductor pattern, two dies being required for a circuit having a pattern on both sides of the insulator base. The dies are mounted in a heated embossing press, and the time and temperature of pressing controlled closely for proper operating results. Practical methods using brass shim stock for making switches are given in chapter 6.

Spray milling

The most famous application of this technique was in the Sargrove broadcast receiver (Chapter 1). The spray-milling process was a technique conceived for mass production of small ac-operated broadcast receivers. Two plastic base panels with preformed holes and indentations were fed into automatic machines in which the panels were sand-blasted and then sprayed with zinc. The excess wire was then milled so that the remaining zinc formed wires, capacitors and inductors in the depressions. At another stage, carbon (graphite-dispersion) resistors were sprayed on through stencils, and hardware, such as the tube and electrolytic capacitor sockets, was put on. The units were tested automatically and coated with protective resins to keep out dirt

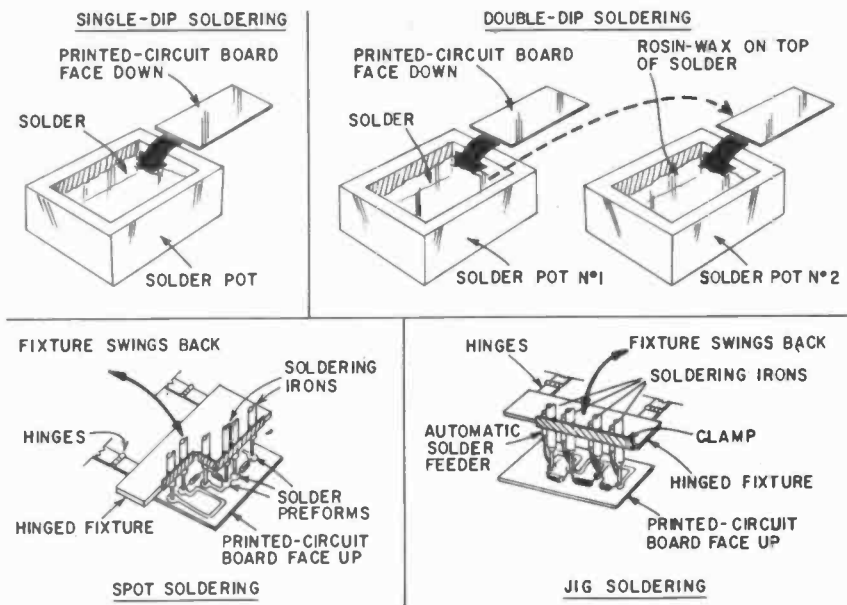

Fig. 203. Dip-, spot- and jig-soldering methods.

and moisture. The circuit wiring and spray-milled components were determined by whatever grooves were molded in the base panels. Inductors were formed by spirals, and capacitors by leaving thin grids in the panels during fabrication and spraying metal on each side of a grid to form a dielectric combination.

Stamped wiring

The basic idea in the die-stamping printed-circuit technique is to form a series of bus bars on an insulating base and then proceed to interconnect these bus bars to produce a circuit.

One variation is to run one set of bus-bar conductors horizontally on one side of the base board and to run the other set of bus-bars on the other side at right angles to the first set. Crossovers are made by simply putting eyelets or pins through the right junctions. Another technique is to have holes and slots punched or drilled in the base panel before the stamped wiring is inserted. In this method, the stamped wiring can be attached by spot-welding or resistance-soldering methods, eliminating eyelets. For single connections on one side of the board, eyelets or pins can be put through at some point which will not connect to any metal conductor on the opposite side. The stamped-wiring technique is limited mainly to low-voltage low-current applications,

but has the distinct advantage of corresponding very closely to electronic equipment schematic diagrams.

Instructions for making stamped wiring devices are given in Chapter 6. The experimenter can duplicate some simple yet practical circuits with only a scissors, some copper foil and a few eyelets or rivets.

Stamped wiring is slowly losing favor to the more modern etching methods.

Encapsulation and potting

Encapsulation and potting techniques are relatives of the ancient art of casting parts in metal boxes and pouring pitch over them—a practice reminiscent of old-time radio days. The potting materials keep out dirt and moisture while offering mechanical support.

The worker has a large variety of materials from which to choose in these techniques, which are auxiliaries to printed-circuit and subminiature package production. A practical setup is given in Chapter 6.

Soldering methods

Although conventional soldering-iron techniques would appear suitable enough for printed-circuit work, refinements have been developed. For one thing, cold solder and rosin joints would be more likely to occur in hand-soldering methods and, second, the hand-soldering operation would slow the speed at which printed-circuit boards could be produced. The major soldering techniques are the single-and multiple-dip and jig-soldering systems. However, as important as the actual soldering methods used is the choice of a solder and a flux.

Dip-soldering technique

There are two main kinds of dip soldering—single and double dipping.

In the single-dip method, the circuit board is first fluxed with a 50-50 mixture of alcohol rosin flux. The flux can be “painted” on or else the board can be “dunked” in a tray containing the flux mixture. When the board is completely fluxed, it is dipped into a solder bath at about 450°F. The board must be moved back and forth during the dip. After about 5 seconds, the board is taken out of the solder by withdrawing one edge first and using that edge as a pivot.

Double-dip soldering uses two solder pots and is about the same as single-dip except that the second pot contains a rosin-wax

mixture which floats on the surface of the soldering bath. The wax provides moisture and fungus protection.

Spot and jig soldering

In spot soldering, soldering pre-forms (bits of solder made up in advance in different shapes) are placed at various points on the printed-circuit board. A fixture which holds one or more soldering irons is then brought down on the work. Jig soldering is a variation in which self-feeding irons are brought down on the board.

Dip, spot and jig-soldering methods are shown in Fig. 203. They are mainly for advanced workers and commercial use. The spot-soldering method, using pre-forms, can often be used in printed-circuit repairs.

Solder masking techniques

It is usually necessary in all forms of dip soldering to mask certain areas of the base conductor pattern to prevent the adherence of solder. This is true, for instance, where mechanical tolerances must be held for component mounting. It is also better to mask as much as possible of the conductor base not needed for actual soldering. This prevents solder bridging due to large bare-copper areas.

One of the easiest masking methods is to apply high-temperature masking tape to the areas which require protection; the tape is stripped after soldering. Masks can be made from good insulators such as asbestos or mica—and attached to the circuit panel before dipping. There are also solder-resistant paints or lacquers that can be applied by brush or stencil methods and which will shed the solder during the dip. These materials usually require baking, however, since they are thermosetting compounds.

Soldering troubles

In addition to the difficulties experienced in the soldering end of the operation, there are several troubles associated with the solder pot itself. Quite frequently, there is metallic contamination of the solder due to the solvent action of the molten solder on the work being dipped. The solvent action is really part of the soldering reaction and is perfectly normal. Where copper and zinc base alloys are used, there is rapid contamination of the solder bath because the copper and zinc dissolve easily in the molten solder. In the case of solder baths and pots, the best thing to do when the solder shows signs of becoming "slushy" and hard to work with is to replace it with fresh solder. Do not attempt to adjust

the bath with random additions of pure tin or small amounts of fresh solder.

The temperature of the solder bath is important. Too high a temperature promotes blistering of the board as well as formation of "dross" on the solder's surface. Too low a temperature increases soldering time and the possibility of getting cold joints. The pot should be large enough so that introduction of the printed-circuit board will not drop the pot temperature.

Surface dross and oxides are an ever-present problem, and the use of a so-called "cover flux" is not recommended since these contain chloride salts. These volatile compounds generate annoying fumes and create corrosive residues. An occasional skimming of the solder pot with a steel or ceramic blade is preferred by most workers.

Solder characteristics

Remember that soldering is an alloying operation and that a solder has varying characteristics. Some of these are the way the solder spreads, the speed at which the alloy is formed between solder and object being soldered, the resistance of the joint to mechanical stresses and shocks, the porosity of the joint and its chemical resistance. Avoid impurities such as zinc and aluminum when choosing a solder since they form rough, porous joints. The most popular solders are the 50-50 and 63% tin-37% lead mixtures. This 63-37 mixture is sometimes called a "eutectic." This simply means it is the lowest-melting-point combination of tin and lead for practical uses. Silver solders used in printed-circuit work are tin-lead alloys with small amounts of silver added. They can be used when repairing silver-plated or silver-fired ceramic circuits.

Flux considerations

One of the popular fluxes for soldering is rosin, which owes its fluxing activity to a chemical compound called abietic acid. Since the amount of this acid varies, depending on whether the rosin is from wood or from gums, the activity of the different rosins will vary. In choosing rosin flux for printed-circuit use, bear the following factors in mind: its ability to speed soldering, the amount of heat necessary to melt or activate it, whether it tends to boil or spatter, the forms in which it can be applied, its leakage resistance as it lays on the printed-circuit pattern, and its corrosiveness.

A novel idea is the use of a flux containing a dye. It can be used to indicate soldered joints that need resoldering, at the

same time providing the necessary flux. It is also helpful at printed-circuit inspection points in a production line.

Special soldering techniques

Occasionally it is necessary to solder a glass or ceramic component to a metallic one. One particular case might be the use of

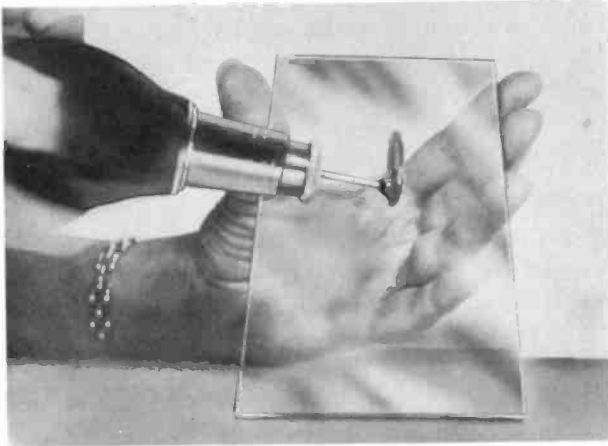

Fig. 204. *Special technique for soldering on glass.*

ceramic or glass tubing as a high-frequency coil form. It might also be necessary to solder to aluminum or stainless steel, using ordinary 50-50 tin-lead solders.

A special technique¹ is shown in Fig. 204. A small hand grinder is fitted with an abrasive wheel, and the wheel is brought to bear against a bar of soft solder. The solder will eventually melt and flow onto the surface of the wheel, actually "loading" the pores of the abrasive with solder. The rotating solder-laden wheel is then brought up against the work surface to be soldered, and slight pressure applied. The friction created melts the solder, and it flows onto the surface of the work, now abraded by the grinding action of the wheel.

After this preliminary "tinning" operation, soldering can be done in the regular way, using 50-50 solder. A little practice is required not to heat the base material too much. An alloy called Wood's metal, available from druggists and chemical supply houses, works very well with glass and ceramic materials. Do not depend on the joint for great mechanical strength, but mainly for electrical connections. High grinder speeds tend to oxidize

¹ Developed by Joseph McGuire of Los Alamos Laboratories.

the solder, but the proper speed will put down a shiny solder coating in a few minutes or less.

Indium-based solders for glass to metals

Solders composed of indium metal and tin have the property of "wetting" glass, mica, quartz and thermosetting plastics. These solders melt in the range of 250°F and are applied by melting in a crucible and swabbing onto the work with a cotton applicator or cheesecloth. The work must be warmed to the solder melting temperature for best results. If the work is too hot, the solder will not adhere. No flux is required in using these solders, but the glass or ceramic must be scrupulously clean.²

Etched circuits

Without a doubt, the best known and most widely produced printed circuits are the so-called etched circuits. A resist is laid down on the laminate material and, by various selective methods, the conductor pattern is caused to appear in the foil. The techniques for laying down the resisting agent and the etching differ widely and can be divided into two broad major classes—mechanical and photographic.

Photographic etch-resist methods

These will be treated first, since they constitute the most popular methods used today. They consist of putting some photosensitive material on foil, after which the sensitized foil is exposed in a conventional manner and then developed.³ The foil is coated with a photosensitive emulsion which changes its solubility after being exposed to strong actinic (ultra-violet) light. After development, the resist is exposed to light, hardens, and the non-exposed resist washes away to leave bare base-metal foil on the laminate. The final step is etching with ferric chloride or chromic acid.

Many precautions must be observed if this material is to yield good results. In the first place, all materials which contact the resist after sensitization must be dry. It is a fundamental property of the resist to harden upon contact with water. In addition, the photo-resist material should be handled in a dim light, preferably a 10-watt amber lamp. Although a darkroom is not necessary, light tends to decrease the activity of the chemicals.

Clean the copper or metal laminate thoroughly with a cleansing powder such as kitchen cleanser, before sensitizing. After the

² A commercial trade name for such a solder is Cerroseal (Cerro de Pasco Co.).

³ One such commercial method is the Kodak photo-resist system.

laminates has been cleaned, handle the plate only by its edges or with a wire handle hooked through a hole in one edge of the laminate. Oil and dirt from the fingers will cause smudging and spotting. The cleanser scouring should be followed with a hot-water rinse, allowing the plate to dry by evaporation.

Pour the photo-resist into a glass tray and dip the laminate



Fig. 205. (above). *Dipping the laminate into photo-resist to sensitize it. (below) Removing the laminate by a wire handle attached for this purpose.* (Courtesy Eastman Kodak Co.)

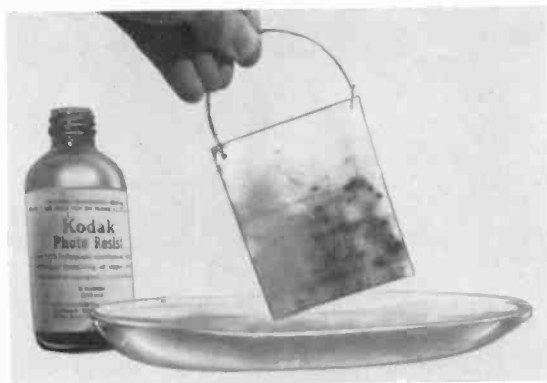

panel face up (Fig. 205) to insure a uniform spread of the photo-resist over the metal foil surface. The panel should then be hung up by a parallel edge—not diagonally as in film-negative drying—to avoid streaking across the plate. The sensitized laminate should be dried in a dust-free room; it will dry in an hour or so without the addition of extra heat. If several laminate panels

are sensitized at one time, be sure to store the extra panels after drying in dark, moistureproof paper, away from light.

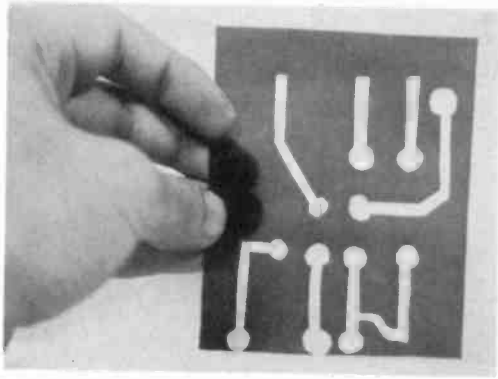

Fig. 206. This negative is used to impress the pattern on the sensitized laminate.

A negative (Fig. 206) is made by one of the methods described in later sections and the sensitized laminate foil and negative are

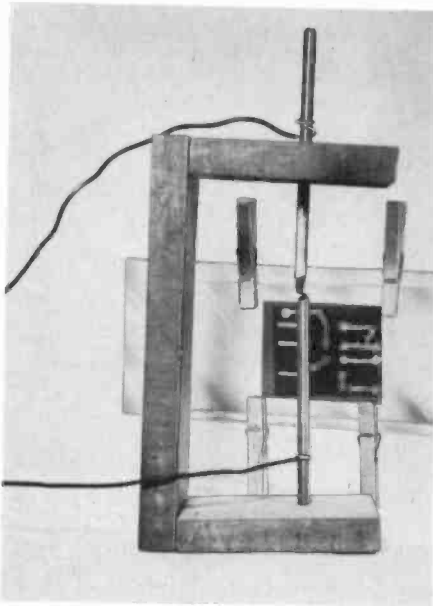

Fig. 207. An arc lamp is used to expose the laminate.

exposed as shown in Fig. 207. A photoflood lamp can be used, but a mercury-vapor ultra-violet light or an arc lamp is better. For

best results, use the special ultra-violet lights made for photographic purposes. The negative or stencil should be in good contact with the sensitized material at all points. Exposure time is a matter of experiment: a rough rule of thumb is about 5 minutes with a Sperti No. 105 lamp at about 2 feet. A wise procedure is to use small pieces of sensitized foil as "test strips," as in contact photoprinting methods.

The exposed image must be developed immediately in photo-resist developer, which can also be set out in a glass tray. De-



Fig. 208. Developing the exposed laminate plate.

velopment takes about 2 to 3 minutes. Agitate the plate constantly during development. It is another peculiarity of this process that the developed image does not show up very visibly, even though the developing agent washes away the resist which was not hardened by the action of the ultra-violet light. Although it is not absolutely necessary to see the pattern, one good way to bring it out is to use photo-resist dye. After removing the developed plate from the developer, transfer it directly to the dye (Fig. 208) and submerge for about 1 minute without wetting the image with water. After dyeing, wash the image under a gentle stream of lukewarm water. The dye will leave the light-struck areas showing as dark black lines, and the light-protected areas will show through as the base laminate foil. The wiring shows as the black pattern and can readily be checked against the schematic or master drawing. The foil is then etched as described in the section on etching.

Glue-type photosensitive resists

For those who do not have time or facilities for compounding their own sensitizers, a photosensitive liquid is available for the job.⁴ This material is an organic colloid, light brown to straw in

⁴ Manufactured by the Permacel-LePage Co.



Fig. 209. A phono-turntable setup for whirling the plate when using the Permacel-Lepage glue-resist technique.

color, depending on whether it is wet or dry. It is syrupy, but can be thinned with water. Although the technique described here

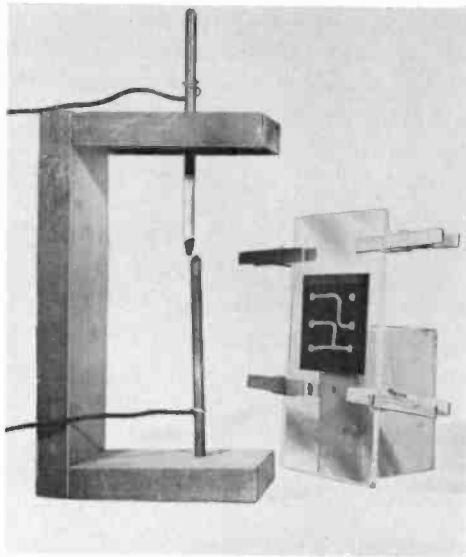

Fig. 210. Exposing the sensitized plate to an arc lamp.

is for a copper laminate, the same method can be used to set up resist patterns on monel, aluminum and steel.

The first step in making printed circuits with this material is to clean the laminate board with pumice or rottenstone. The board is then rinsed with tepid running water. A uniform film of water will indicate a good, clean foil. Drain the excess water off and apply the resist. It can be brushed on or whirled on as shown in Fig. 209, using a deep circular pan attached to a phonograph turntable. The resist can be diluted with water prior to use. Some experimenting is necessary to determine the best consistency for either painting or whirling. An infra-red lamp is used to dry the resist during the whirling process, or the material can be

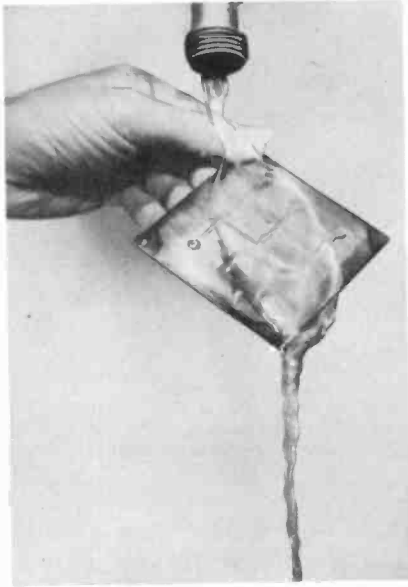

Fig. 211. *Developing the exposed plate.*

dried naturally if desired. One or two coats are used, depending on the thickness required to give satisfactory results.

After coating the laminate foil plate, the negative of the circuit pattern and the sensitized plate are put together in a printing frame and exposed to an arc light (Fig. 210). A rough rule of thumb is to measure the diagonal distance across the frame, and hold the frame at half this distance from the arc if it is a single carbon arc. Printing time varies from 8 to 10 minutes. If the frame becomes too warm, cool it with a small fan.

Develop the exposed laminate foil plate under running water at about 110°F, as shown in Fig. 211. The water should not hit

the exposed plate too hard. Swab the emulsion on the plate lightly with a cotton swab during development.

After developing the image, the colloid material is burned in under the heat lamp or in an oven. This drives off excess moisture and toughens the image for handling. The last step is immersion in an etchant such as ferric chloride or ammonium persulfate.

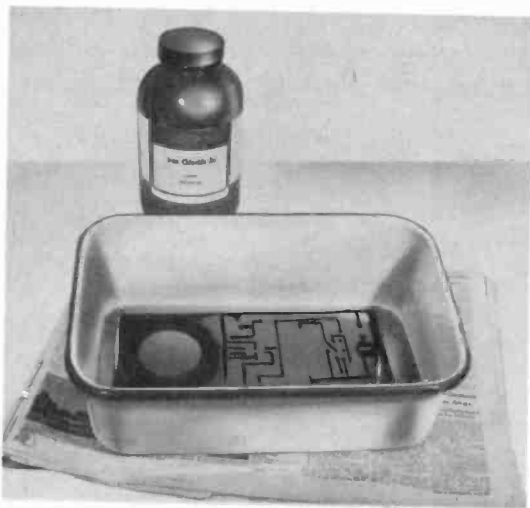

Fig. 212. Etching the laminate. Note that an enameled pan is used because of the corrosive nature of ferric chloride.

The basic principle of the process is that dark areas in the negative protect the sensitized photocolloid surface from exposure, and the lighter areas permit exposure. Exposed areas become insoluble and remain after development as the resist. After etching, the remaining colloid is removed by careful application of dilute (5%) caustic-soda solution or by gently scraping the colloid layer with a knife or very fine sandpaper.

Etching the home-made plate

While etching methods will be detailed more fully later, a simple procedure is outlined here for the home-made circuit pattern. A ferric chloride solution (Fig. 212) is used to etch the unwanted sections of the foil pattern. Use rubber gloves when handling this material, since it is very corrosive. Ferric chloride usually comes in lump form and can be obtained at a drugstore or chemical supply house. An average working solution can be

made by dissolving 4 to 6 ounces of lump chloride in a pint of water. Increasing the concentration of chemical and heating the solution during etching will increase the etching rate. The etchant should be handled in a glass or enamel dish. *Follow carefully the precautions given in the section on etchants.*

After etching, remove the hardened sensitized "emulsion" with household cleanser or by brushing very gently with steel wool. The board is now ready for fabricating operations such as drilling, plating, soldering and mechanical component mounting.

The experimenter may prefer to try other mediums in a home-made "emulsion." Some of the others that have been used are animal glues, egg albumen, casein glues and special grades of gelatin. A photoengraving concern can suggest specialized glues and formulas for making photosensitive "emulsions" which are more refined. Several commercial photosensitizing glues in tubes are on the market, ready to apply.

Etchants

Among the etchants in wide use are nitric and chromic acids and ferric chloride. Nitric acid is a very rapid etchant; however, it gives off poisonous fumes and it is hard to achieve uniformity in small-lots. The tendency for nitric acid to be a violent etcher—that is, to throw off large amounts of gas bubbles—makes it useful with a limited number of etch-resisting materials. Nitric acid offers the advantage of being capable of regeneration, and the copper can be recovered as copper nitrate. Both of these operations can be performed on a continuous basis, making the acid suitable for some forms of commercial work.

Ferric chloride is a more popular etchant and offers good uniformity in etching for small as well as large amounts of work. It is also readily available from chemical supply houses. The commercial or technical grade is best for printed circuits. Ferric chloride does not produce fumes, a decided advantage. About 43% by weight of ferric chloride will dissolve a little over 1¼ ounces of copper for every pound of the solution. However, as the ferric chloride is "spent"—as more copper dissolves—the etching action will become slower.

The temperature of the etching solution is an important factor in etching speed. Higher temperatures will increase the rate of etching. For best results, keep the temperature of the etching solution constant. The etching rate increases about 50% for every 20°F rise between 50° and 90°F. Temperatures in the range of 90° to 120°F are considered best for experimental work.

Concentration also has an effect on etching speed. The more concentrated the etching solution, the slower the etch rate. As the solution is diluted, the etching rate increases until a concentration of about 35% by weight of ferric chloride is reached. As the solution is diluted further, the etch rate slows once again. Add water if the solution has evaporated and become too concentrated.

Etching speed also decreases as more copper is dissolved. A good idea is to time a sample of fresh etching bath on clean samples of copper foil. When the etching time doubles discard the spent etchant and use fresh material.

Etchant handling techniques

There are several handling techniques for materials undergoing the etching process:

Still etching

The material is immersed in a jar or tray. The etchant is then

Fig. 213. A variety of etching techniques are used to prepare printed-circuit boards.

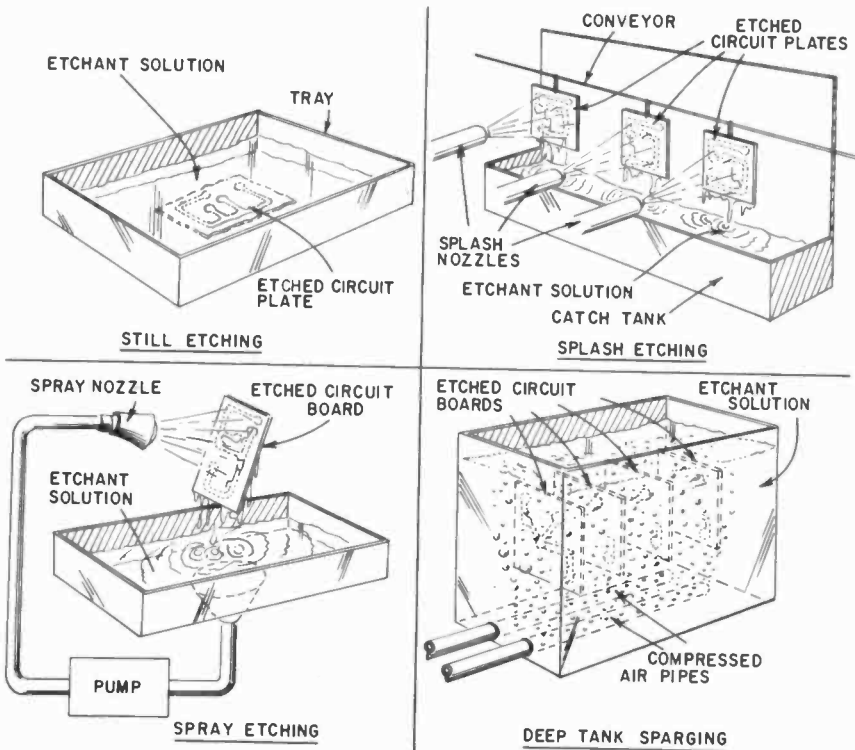

poured over the work and allowed to remain in contact with the work until etching is completed.

Splash etching

The work is mounted to a fixture which moves the work in place against violent streams of etching solution. The operation is limited to machine capacity in handling large numbers of plates.

Spray etching

The etchant is gently sprayed on the work.

Deep tank sparging

Large numbers of plates are immersed in deep tanks of etchant which is agitated by air streams blowing through nozzles.

These four techniques are shown in Fig. 213.

The most suitable approach for the amateur and experimenter is still etching. This method can be speeded by using brushes to simulate the splash technique, and experiments in sparging can be done with a small ear syringe or compressed air pump from a paint sprayer.

Take reasonable precautions with all etchants. Use rubber gloves and wear old clothing. A pair of safety glasses is a good investment if you plan any experiments in which the etchant is likely to splash. If you decide to use nitric acid, provide adequate ventilation for the gas fumes.

Fig. 214. The fundamental steps of silk screening.

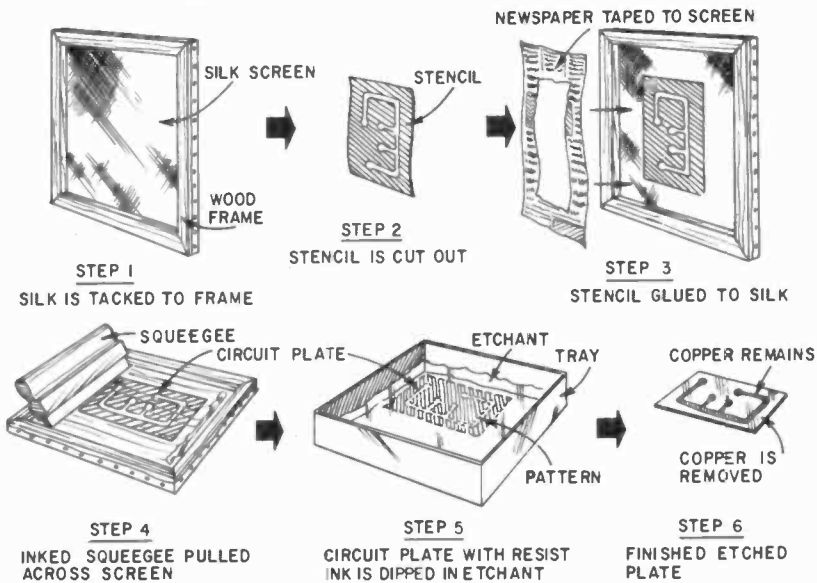

Negative making

All resist-formation methods are variations of negative formation, whether they be stencils, silk screens, or tape and paint type of resists. The purpose of any negative is to prevent desired areas of the copper conductor pattern from being attacked by the copper etchant used to produce the final etched-circuit pattern.

Mechanical methods of etch resists

One of the popular mechanical etching methods uses silkscreen printing techniques. A resist material is applied through a silk screen stencil, and the resulting pattern is then etched. After

Fig. 215. The first step in the preparation of a silk-screen pattern is to cut a piece of presensitized gelatin film, slightly larger than the pattern to be reproduced.



etching, the resist is removed, leaving the finished etched-circuit pattern.

Silk-screen methods

There are many methods for laying out silk-screen patterns, but the basic one is to set up a stencil, part of which is opaque to paint and part of which will allow paint to come through. The paint is spread on the screen, on top of the work to be painted, and a squeegee is run over the paint, forcing it through those parts of the screen that have not been treated to prevent the passage of the paint. When the silk screen is removed from the work, the painted pattern appears. Basic silk screening is shown in Fig. 214.

Making your own silk screens

A presensitized gelatin film is available for making silk screens.⁵ The material can be stripped from its vinyl plastic base, and toughened and transferred to a silk screen with very little difficulty.

⁵ Manufactured by the Craftint Co.

The first step in using this film is to cut a piece to a size slightly larger than the printed-circuit pattern "negative" (Fig. 215). The "negative" in this process is really a positive in the sense that, wherever a dark line on the negative appears, there will be a conductor in the final printed-circuit pattern. In this process, a "negative" can be made simply by using India ink on a sheet of celluloid or vellum. The "negative" and film sandwich are put into a printing frame and exposed to an arc light for 5 to 15

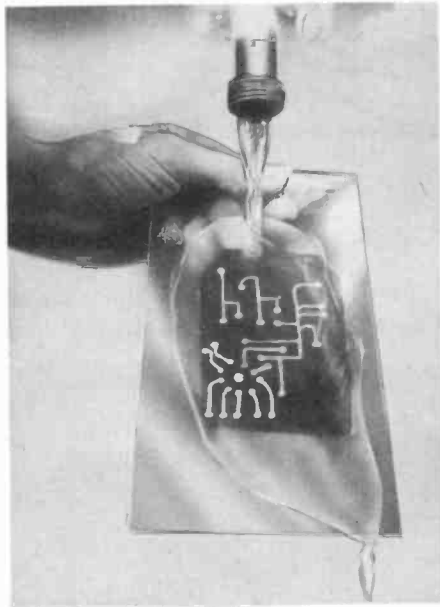

Fig. 216. *Developing the exposed stencil material.*

minutes, depending on the strength of the light and the distance from the light source to the printing frame. The rough side of the presensitized film should be closest to the printed-circuit "negative." The exposure is made with the "negative" reversed in the frame.

The developer comes in powder or liquid form, and is used as a liquid at 65° to 75°F. The powder is mixed with water to make up a pint, quart or gallon, according to directions furnished on the manufacturer's package. Do the developing immediately after exposure to avoid fadeout and diffusion of the latent image into

the gelatin by transferring the exposed film to the developer and rocking the film back and forth in the tray for 1 minute.

After development, place the film gelatin side up on an inclined

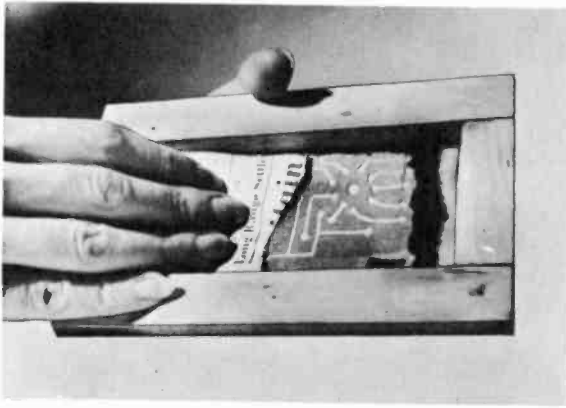

Fig. 217. *Transferring the developed stencil to the silk.*

glass surface and gently wash out the film with running water at 105° to 110°F. Use a thin stream, as shown in Fig. 216. Wash

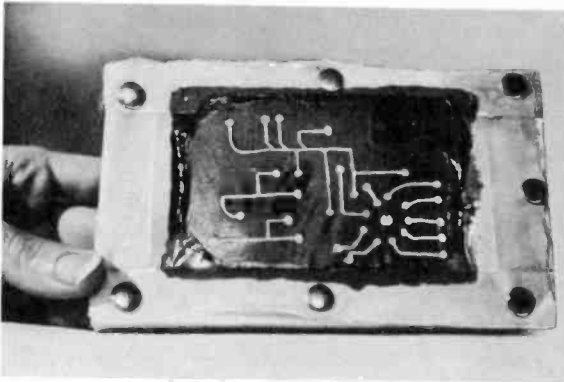

Fig. 218. *Finished stencil and silk mounted on a frame.*

until all details of pattern are clear and free from residues. Proper exposure will prevent loss of image due to overwashing.

Prepare the silk by scrubbing it with hot water and mild detergent to remove any sizing or special treatment. Stretch the silk slightly and tack it to the frame.

Transfer the film to the silk by taking the film from the wash and placing it face up on a flat smooth surface. Bring the silk

screen down on the film squarely and firmly, avoiding side-skidding motions. Then remove excess water with a blotter or newspaper, using flat, uniform pressure to give total adhesion of silk and gelatin (Fig. 217). A blue offset image of the "negative" on the blotter indicates good adhesion and proper exposure time.

Allow the film to dry naturally. When it is dry, the backing sheet normally peels by itself. Do not peel it unless the gelatin is

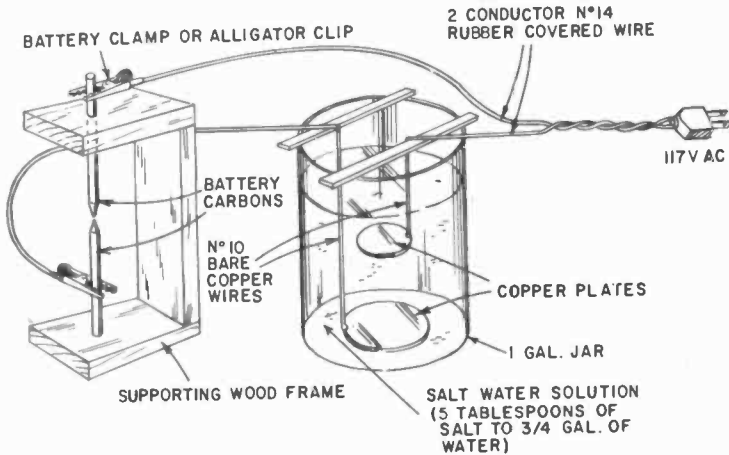

Fig. 219. Home-made arc lamp using old battery carbons and salt-water resistance element.

completely dry. The screen and gelatin combination (Fig. 218) can now be used as a printing device for multiple runs of the printed-circuit pattern. A suitable resist is thinned asphaltum, which can be squeegeed through the screen on to the laminate boards.

Toughening and waterproofing the screen stencil

Where many runs are made, it is a good idea to toughen the stencil. The stencil is placed for about 5 minutes in a tray containing toughening-neutralizing solutions⁹ and is then applied to the screen. Then it is baked for a minute or two at about 200°F with a heat lamp. About 4 to 6 inches between lamp and film is sufficient.

Exposure problems with presensitized material

Some amount of trial and error is necessary in exposing this material. The manufacturer recommends using a test strip. Cut a

⁹ Manufactured by the Craftint Co.

film strip about 1 inch by 6 inches and place it in the printing frame with the rough side against the glass, facing the light source. Close the printing frame. Then put a piece of masking

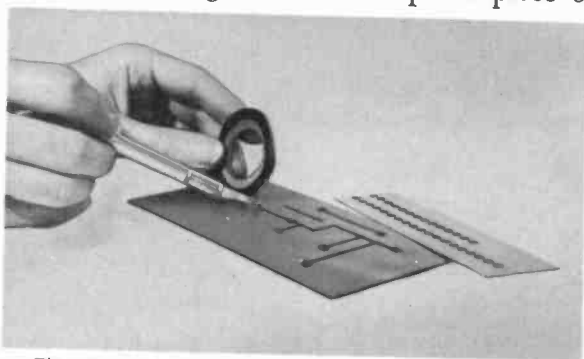

Fig. 220. Using roll-tape resist to lay out a pattern.

tape on the outside surface of the glass so that the tape covers all but 1 inch of the film. Expose the uncovered section of film about 1 minute, and peel another inch of tape and expose 2 minutes. At the end of each succeeding minute, peel an additional inch so that, at the end of 6 minutes, the first 1-inch portion will have been exposed for 6 minutes, the next inch for 5 minutes, and so on down to the last inch, which was exposed only 1 minute.

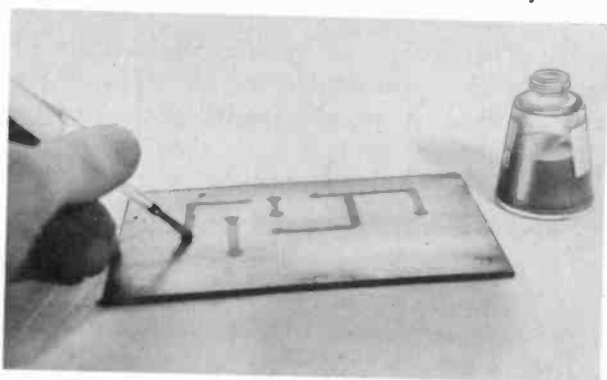

Fig. 221. Fingernail polish can be used as a resist.

When developed and washed, the color of the 1-inch sections will vary from the original blue of the unexposed film to light blue on the 1-minute exposure. Proper exposure time will depend on the final film thickness required, and the lighting conditions. Home-made carbon arcs are very effective, and one can be made

from old battery carbons, as shown in Fig. 219. A salt-water resistance jar is used in series with the lamp and 117-volts ac.

Tape resists

Tape resists are mechanical resists made from various adhesive materials such as Scotch tape. They can be made or purchased in rolls and precut shapes such as circles and squares. The tape resists are put on the surface of the laminate (Fig. 220) and pressed firmly to secure positive adhesion. Tape resists must be joined tightly at conductor intersections and joints to prevent spoiling the circuit pattern by etchant leaking under the tape at exposed joints.

In an emergency, ordinary medical adhesive tape or cellulose Scotch tape can be used, although the heavier masking grades usually give better results.

Paint resists

Lacquers such as finger-nail polishes (Fig. 221) can be used to lay down a conductor pattern by brushing or by stencil methods. One of the more popular etched-circuit resists is asphaltum. Asphaltum is an asphalt-base paint obtainable at most paint stores and is easily thinned with petroleum solvents. Another source of asphalt is ordinary roofing tar or asphalt tile

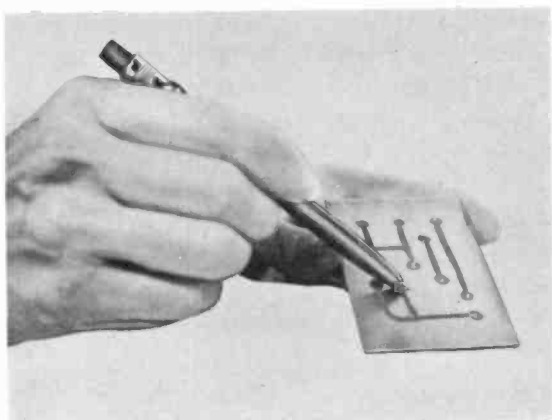

Fig. 222. Using a china marking crayon to lay out a printed-circuit pattern.

cement. Rubber cements are fair resists, and Duco cement can also be used.

Writing-implement resists

A common wax crayon can be used to outline the etched-circuit

pattern on the laminate. This method has the advantage that, since crayons come in colors, more than one color can be used for initial layout purposes.

Two commercial "writing" type resists are also available. One of these is a ball-point pen containing a permanent ink which

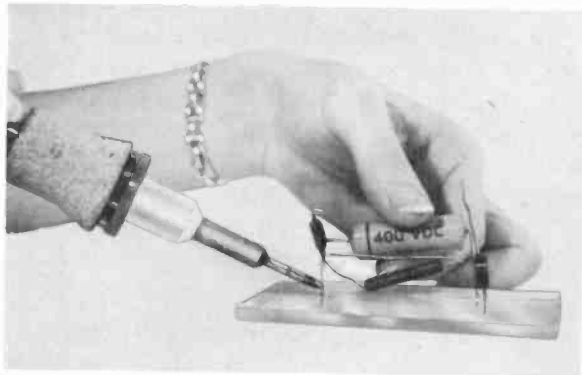

Fig. 223. A block of plastic can be used as a breadboard.

normally resists alcohols, acids and alkalis at temperatures up to 850°F. A special version of this ink resists temperatures over 1,800°F. These pens come in various colors and can be used to lay out an etched-circuit pattern in color code. After etching the circuit, the paint is removed with organic solvents.

The other type of "written" resist is a liquid, also available in colors, dispensed from a ball-point tube. Each tube is good for over a mile of 1/16-inch-wide resist pattern. This ball-point tube material will resist nitric acid in etching processes.

Fig. 222 shows a China marking crayon being used to lay out a pattern resist. Many other items found around the house, such as wax-base eyebrow pencils and children's crayons can also be used.

Circuit layouts and design

The radio experimenter's breadboard technique can be used to advantage in setting up components for a printed-circuit layout. After obtaining all the hardware and electronic components necessary for an experimental unit, the components are placed on a piece of medium-weight cardboard in the positions that will give the minimum layout area with a workable circuit. Be sure to figure in correct lead lengths and mounting-hardware clear-

ances. After roughing in the circuit layout, be sure to locate the input and output terminations, and also any power-source terminations necessary. Lay out tube sockets and interstage components (such as coupling transformers and R-C networks) in approximately the same order in which they appear schematically. If possible, avoid two-sided conductor patterns because they are more complicated. Crossovers can be used if two-sided patterns are needed for size reduction. Crossovers and hole connections are discussed in a following section.

After all the components are in their final position, sketch in the common buses such as ground, B-plus and filament leads, and lay out all grid and plate leads so that they are isolated as much as possible from other leads. It is usually necessary to rearrange the components several times to determine the best combination for the layout. The components are then wired permanently and tested for final circuit operation.

One useful aid in breadboarding is a piece of Lucite or Plexiglas about 1/4-inch thick. Cut this to the approximate base size of the pattern desired. Heating component leads carefully with a soldering iron and pressing them into the plastic base will melt the plastic and allow the insertion of the component lead or mounting lug. When the soldering iron is removed the plastic cools and solidifies, leaving a rigid support for the component assembly. The technique is shown in Fig. 223.

Preparing the master drawing

If the conductor pattern is to be reproduced by photographic methods, a black-and-white master schematic is necessary for best results in final circuit production. For photographic reasons, the materials used in master drawings must have high contrast and be capable of giving sharp definition to the negative that is produced in the process. For average experimental purposes, use a good grade of Bristol board, but for finer work a plastic base material should be utilized. The two most popular materials are Stabilene (a plastic-impregnated glass cloth) and Mylar. These materials are not subject to distortion due to changes in temperature and humidity. The manufacturer can furnish these with what is known as a "nonreproducible grid," that is, when the negative is printed, the grid lines will not show up on the sensitized laminate. The grid lines, however, are used as guides in laying out the conductor pattern.

Use a good grade of black ink, and scale the circuit to 2 to 4 times actual size. Small circuit layouts require more enlargement,

and 8 or 10 times actual size is not uncommon where the detail must be brought out in the final negative. For reference purposes, a scale should be indicated on one corner of the original circuit, or one known dimension should be noted for a guide in photocopying the master.

Conductor line widths and spacings are described in Table 2-3 in regard to current ratings in amperes. However, line widths between $1/16$ and $3/16$ inch are normal. Widths narrower than $1/32$ inch are difficult to maintain in the final etching

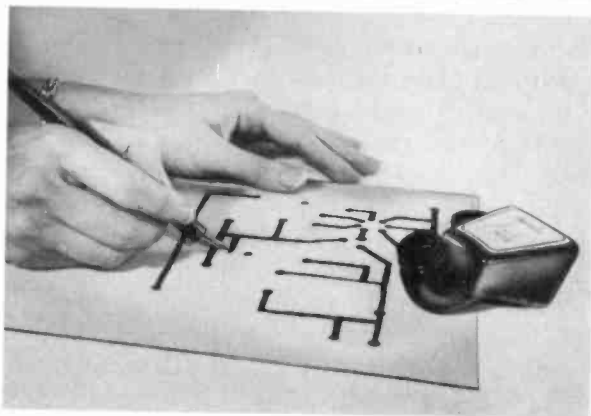

Fig. 224. Drawing a printed-circuit pattern with India ink.

process. The large solid-copper areas should be broken up as much as possible to prevent bridging and blistering of the foil on the laminate base if the pattern is dip-soldered later. Circuitry should not be drawn any closer than $1/8$ inch to the edge of a part unless absolutely necessary. Conductor lines can be rounded when making a 90° turn.

Heavy black circles at least $3/32$ inch in diameter should be used where the circuit lines terminate. To obtain the best soldering results, the circles should be $1/16$ inch larger than the hole which will be pierced in their centers during the final conductor fabrication. Draw letters so as to be at least $3/32$ inch high in the final conductor pattern, and no less than $1/64$ inch wide when reduced to size on the final negative.

The making of a master drawing is shown in Fig. 224. The master drawing is photographed by conventional processes to produce a sharp high-contrast negative, which is then used to print the final circuit-conductor pattern, using one of the sensitization methods described earlier.

Crossovers and holes

Occasionally it becomes necessary to cross over (go from one side of the circuit board to the opposite side) with the conductor pattern. Several methods are used:

1. Eyelets,
2. Machine-screw connections,
3. Through solder on the circuit board proper,
4. "Plated-through" holes.

Table 2-3. Current Ratings of Copper Foil Conductors

conductor width	rating for .001-inch thickness	rating for .003-inch thickness
1/32"	5 amperes	7 amperes
1/16"	10 amperes	15 amperes
1/8"	15 amperes	20 amperes
3/16"	17 amperes	27 amperes
1/4"	20 amperes	35 amperes

The first three techniques, shown in Fig. 225, are suited to amateur and experimental use. Eyelets are usually used where components have to be changed frequently. After drilling the hole in the circuit board, the eyelet is placed in the hole and is "upset" or fastened into the board by flaring the smaller end of the eyelet with a center punch. The flared end can also be flat-

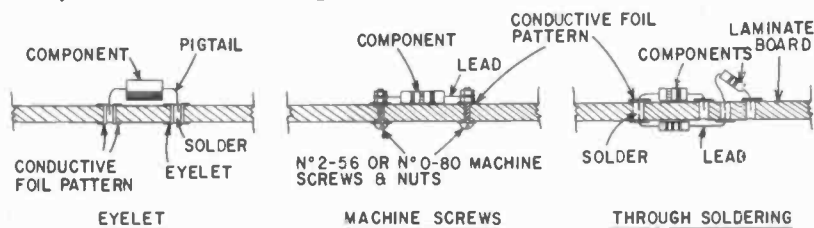

Fig. 225. Various techniques used for crossing leads from one side of the board to the other.

tened into contact with the circuit conductor by "peening" or by pressure in an arbor press.

Some precautions must be mentioned in the use of eyelets for serious commercial work. Poorly plated eyelets will create noise and poor connections in critical circuits. Corroded eyelets will also produce unstable results in circuits subject to shock and vibration. Advanced workers prefer to use gold-plated eyelets for these critical applications.

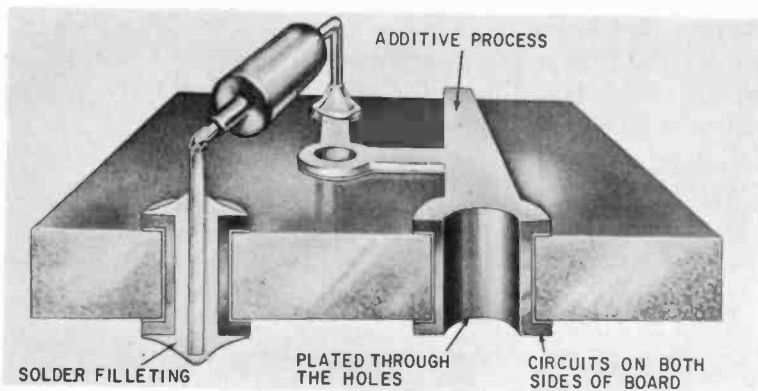

Fig. 226. *The Thru-Con crossover system.* (Courtesy General Electric Co.)

Plated-through holes

This is a commercial process in which the laminate is sensitized and, by a reverse printing process, the hole is prepared for plating directly through the thickness of the laminate board. After electroplating, the resist is removed and the excess foil is etched

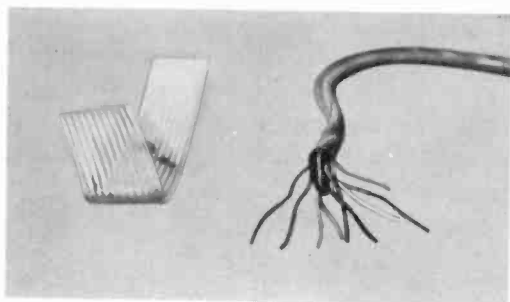

Fig. 227. *Conventional multiconductor cable and cable made with printed-circuit techniques.*

away, leaving a buildup electroplated through hole. One patented version of this process is the Thru-Con[®] method. A sample of a Thru-Con[®] hole is shown in Fig. 226. The major advantage for this type of hole is that there is superior solder "filleting," which results in a more positive solder joint, the solder tending to "lock up" on the component lead.

Machine-screw connections

This type of connection is for smaller quantities of boards where the circuitry is mainly dc or low-frequency ac with no critical points. Small hardware such as 2-56, 1-72 and 0-80 screws, nuts and lockwashers are used to build this type of construction,

[®] Reg. Trademark—General Electric Co.

which is very effective as an intermediate fabrication for pilot runs or prototypes. The possibility of high-resistance connections rules out permanent or large-scale use of this method.

Through soldering of the circuit board proper

This technique should be employed only for small runs; the solder joints made in this way are not very uniform in size and quality. The solder should be permitted to flow down into the junction of lead and board conductor. The soldering iron should be removed promptly after soldering, to avoid blistering.

Laminates

The majority of printed circuits are produced by variations of what are generally known as etched circuit techniques. A laminated base material consisting of a metal foil bonded to an

Table 2-4. Etched-circuit Laminate Properties

Base Material Grade	Dielectric Constant	Moisture Absorption (% 24 hrs.)	Maximum Operating Temperature (Degrees F)	Copper Bond Strength		Punching Quality
				.00135"	.0027"	
XX	5.3	1.3	250	4½-8	6-12	Fair
XXP	4.6	1.0	250	4½-8	6-12	Excellent
XXX	4.7	0.8	250	4½-8	6-12	Poor
XXXP-455	4.0	0.55	250	4½-8	6-12	Fair
XXXP-460-B	4.2	0.69	250	4½-8	6-12	Fair
XXXP-219-C	4.5	0.70	250	4½-8	6-12	Good
N-1	3.3	0.2	165	3-5	4-7	Excellent
G-5	6.8	0.6	250	4-6	5-8	Fair
G-7	3.9	0.2	325	1½-4	1½-4	Fair
GP-9100	4.3	0.2	250	2-4	3-5	Fair
G-10-860	4.6	.19	325	8½-9	10-11	Good

(This chart is based upon material prepared by the Continental-Diamond-Fibre Co.)

insulating base is the starting point for etched methods. The techniques themselves will be described later. However, the experimenter should be familiar with the basic types of laminates and their main properties.

Making the laminate

Laminates are made of a sheet of metallic foil bound in a hydraulic press to an insulating base. Sandwiches made of base

material, adhesive, metal foil and stainless-steel press plates are put into a hydraulic press and cured under heat and pressure.

The base materials themselves are most often made of resin-impregnated paper or cloth. The resins are usually thermosetting and cannot be melted again once the initial fusing and cure cycle has been performed.

Table 2-4 shows some typical laminates and their properties.

Flexible circuits

One unusual class of printed circuits is the flexible circuit. Several commercial variations of these are made, including curved laminate boards formed to the mechanical requirements of the equipment. The flexible materials range in thickness from .001-inch copper foil on .010-.030-inch plastic films to .005-inch-thick copper on 1/16- and 3/32-inch thick resin-composition laminate base materials.

Flexible multiconductor flat cable

Fig. 227 shows an interesting bulk comparison between conventional multiconductor cable and flexible, flat, printed-circuit multiconductor cable. The latter, a recent development in printed circuitry, shows promise of great space and labor savings. Several manufactured types are available with variations in the number of conductors and their spacing, thickness and width.

component selection and application

VITAL to any circuit are the components or "hardware" that go into it. Printed-circuit components manufacture has taken many different paths. Some are merely those already developed for other purposes and are used without changes. Others have needed alteration for use with printed-circuit and subminiature assemblies. Still others have required entirely new development "from scratch." Many, such as wirewound pots and carbon resistors, are three-dimensional or "live" hardware. Printed and etched capacitors and resistors are essentially two-dimensional units, their thickness being negligible in most cases when compared to their other dimensions.

Many developments in subminiaturization and printed circuitry are awaiting the manufacture of certain components in particular forms. For instance, a two-dimensional variable resistor would open up new fields in printed-circuit packaging. Even though a printed-circuit resistor (fixed) is flat, the addition of a slider adds bulk and a third dimension. The most work to be done in printed circuits and subminiaturization lies in power sources. It is common to have a printed-circuit assembly which is one-third to one-fourth the size of the battery powering it.

Resistance components

The tape resistor, an example of which is shown in Fig. 301, was originated at the National Bureau of Standards, mainly through the efforts of Dr. Benjamin L. Davis. The basic ingredients are resin and carbon. They are blended into a mixture which is sprayed or rolled onto a tape base. Depending on the type of

mixture, number of coats and dimensions of the resistor, a wide variety of resistance values can be obtained. The tape is manufactured commercially in either the "cured" or "uncured" form, the latter being used for assemblies such as ceramic-based plates. The "uncured" material is tacky and will stick to the base-plate material. When the base is heated, the resins set permanently, bonding the resistor to the base plate. The "cured" resistor does not require the use of any baking equipment, but will usually have a lower temperature rating since it has no base. Metal terminations are furnished for soldering connections.

Because the resistive element of tape resistors is carbon, such a component has a noise characteristic, just like a carbon-composition unit. For the same reason, the tape resistor is sensitive to excess heat and the resistor body should be kept cool when soldering by using a heat sink, low-melting-point solder and rapid soldering techniques.

Tape resistors are furnished in $\pm 5\%$ and $\pm 10\%$ tolerances. Tolerances of better than 5% are difficult to achieve in large production runs. One unusual feature of tape resistors is that certain varieties can be hermetically sealed and dip-soldered without damage.

A novel variation of the tape resistor is the coaxial unit shown in Fig. 302. This resistor is designed for operation from 90 to 400 mc and is used to terminate 52-ohm coaxial cable. The vswr (voltage standing wave ratio) of the unit at 90 mc is 1.00, compared to 1.40 for a standard 51-ohm $\frac{1}{2}$ -watt resistor. The three outer leads help dissipate heat and provide good grounding.

The painted resistance is still popular and is widely used. Resistance paints contain four major ingredients: a conducting pigment such as powdered graphite or carbon black, a filler, a binder (usually a resin), and a solvent. Typical formulas and resistance ranges are given in Table 2-2 of Chapter 2.

Carbon black is one of the commonly used resistance pigments. It is first treated by heating in a nitrogen atmosphere for several hours to remove the oxygen. The resulting low-oxygen pigment is mixed with a binder in a ball mill in which small flint or steel balls insure uniform dispersion of the ingredients. The operation is checked by measuring the resistance of the mixture. When it reaches its lowest value, the milling process is stopped.

Making your own painted resistors

An important step in laying down painted carbon resistors is surface preparation. The usual base materials are plastics such as

Plexiglas and Bakelite, or glass and ceramic materials. In commercial practice, these surfaces are roughened by sandblasting

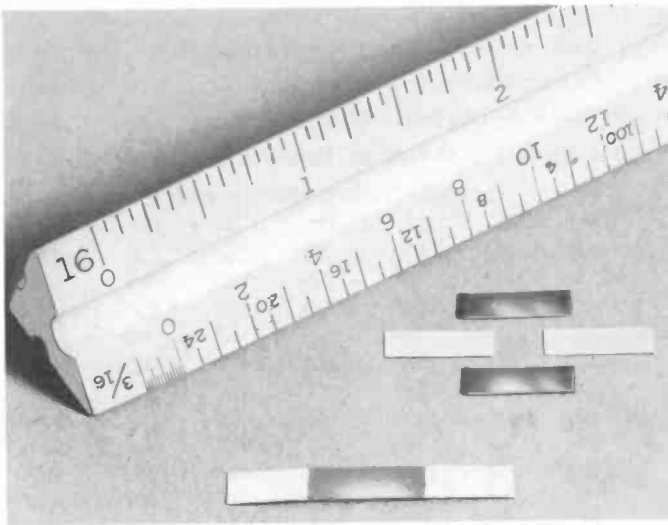
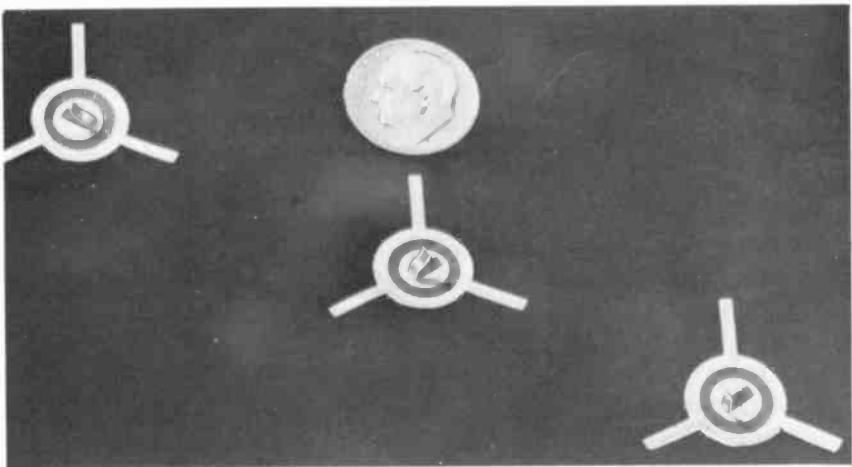

Fig. 301. *Tape resistors are small and easily used. Their flat character is a space-saving feature. (Courtesy Hansen Electronics)*

or etching. The experimenter can use Etchall, a commercial glass-etching compound, on glass and ceramic surfaces. For work on soft plastics, a small sandpaper stick or sanding wheel (hand-

Fig. 302. *The coaxial resistor, a variation of the tape resistor, is particularly suited to high-frequency uses. (Courtesy Hansen Electronics)*



powered type) can be used. A stencil is made out of manila or shim brass to protect the portions of base material that will not receive the resistance paint.

Clean the surface of the base material thoroughly. Glass can be cleaned with ordinary household detergents. TSP (tri-sodium phosphate) is excellent for soft plastics. Bakelite can be cleaned with carbon tetrachloride or chloroethylene.

Table 3-1. Properties of Low-Resistance Paint R11

Width (inches)	Length (inches)—Resistance in Ohms							
	1/8"	1/4"	3/8"	1/2"	5/8"	3/4"	7/8"	1"
1/8"	500 0.15	1,000 0.3	1,500 0.5	2,000 0.6	2,500 0.75	3,000 0.9	3,500 1.1	4,000 1.2
1/4"	250 0.3	500 0.6	750 1.0	1,000 1.2	1,250 1.5	1,500 1.8	1,750 2.2	2,000 2.5
3/8"	167 0.5	335 0.9	500 1.5	665 1.8	830 2.2	1,000 2.8	1,165 3.3	1,330 3.7
1/2"	125 0.6	250 1.2	375 2.0	500 2.5	625 3.0	750 3.7	875 4.4	1,000 5.0
3/4"	84 0.9	168 1.9	252 2.9	333 3.7	417 4.5	500 5.5	584 6.6	665 7.5
7/8"	72 1.1	144 2.2	216 3.4	285 4.2	357 5.2	429 6.4	500 7.7	570 8.7
1"	63 1.2	125 2.5	187 3.7	250 5.0	315 6.2	375 7.5	438 8.7	500 10.0

(Roman figures indicate resistance; italic figures represent wattage rating)
Courtesy Micro-Circuits Co.

Resistance paints are available commercially. The advantage of using such mixtures is that they will give good results without the experimentation required when paints are home-made. These paints are shipped a bit thin by the manufacturer to allow for solvent evaporation in storage and shipment. The drying time ranges from 1/2 to several hours at room temperatures (60-80°F.). Drying under heat lamps or in an oven will speed drying time. The paints must be stirred thoroughly before and during use. If they are allowed to settle, resistance values will be higher than normal.

In general, the resistance of any conductor can be calculated with the following properties in mind: The resistance is directly proportional to the length of the resistor; it is inversely proportional to the width and thickness of the resistor; it is a function of the carbon content in the mixture; the wattage rating is directly proportional to the surface area.

The manufacturer controls the carbon content of commercial mixes closely, leaving the dimensional factors to the user.

The figures in Table 3-1, 3-2 and 3-3 are a guide to dimen-

Table 3-2. Medium-Resistance Paint R21 (1,600 to 100,000 ohms)

Width (inches)	Length (inches)—Resistance in Thousands of Ohms							
	1/8"	1/4"	3/8"	1/2"	5/8"	3/4"	7/8"	1"
1/8"	12.5	25	37.5	50	62.5	75	87.5	100
	<i>0.15</i>	<i>.03</i>	<i>0.5</i>	<i>0.6</i>	<i>0.75</i>	<i>0.9</i>	<i>1.1</i>	<i>1.2</i>
1/4"	6.3	12.5	18.7	25	31.3	37.5	43.8	50
	<i>0.3</i>	<i>0.6</i>	<i>1.0</i>	<i>1.2</i>	<i>1.5</i>	<i>1.8</i>	<i>2.2</i>	<i>2.5</i>
3/8"	4.2	8.4	12.5	16.8	21	25	29.2	33.5
	<i>0.5</i>	<i>0.9</i>	<i>1.5</i>	<i>1.8</i>	<i>2.2</i>	<i>2.8</i>	<i>3.3</i>	<i>3.7</i>
1/2"	3.1	6.2	9.4	12.5	15.6	18.8	22	25
	<i>0.6</i>	<i>1.2</i>	<i>2.0</i>	<i>2.5</i>	<i>3.0</i>	<i>3.7</i>	<i>4.4</i>	<i>5.0</i>
3/4"	2.1	4.2	6.3	8.4	10.2	12.5	14.6	16.7
	<i>0.9</i>	<i>1.9</i>	<i>2.9</i>	<i>3.7</i>	<i>4.5</i>	<i>5.5</i>	<i>6.6</i>	<i>7.5</i>
7/8"	1.8	3.6	5.4	7.2	8.9	10.7	12.5	14.3
	<i>1.1</i>	<i>2.2</i>	<i>3.4</i>	<i>4.2</i>	<i>5.2</i>	<i>6.4</i>	<i>7.7</i>	<i>8.7</i>
1"	1.6	3.1	4.7	6.2	7.8	9.4	11	12.5
	<i>1.2</i>	<i>2.5</i>	<i>3.7</i>	<i>5.0</i>	<i>6.2</i>	<i>7.5</i>	<i>8.7</i>	<i>10.0</i>

(Roman figures indicate resistance; italic figures represent wattage rating)

Courtesy Micro-Circuits Co.

sions and ohmage of the finished resistor. In all cases, the calculation of ohmage is based on a resistor 1-inch square and 1-inch thick, having a unit thickness. The values given list resistor widths in increments of 1/8-inch against progressive lengths of 1/8-inch. At each intersection of a given width and length is the approximate resistance and under the resistance is the approximate wattage. For example, in Table 3-1, let us take a resistor 1/2-inch by 3/4-inch long. The approximate final (dry) resistance of a resistor made up in R11 paint¹ is 750 ohms. The corresponding wattage is about 3.7. Note that the same paint size resistor in R21 paint, Table 3-2, is 18,800 ohms and the wattage is the same. The resistance change has been accomplished in this case by the composition of the carbon mixture. A study of the tables shows three ranges of carbon content listed. Two others are available—a very low range R01, and a very high range R41. Specific directions for the use of these two mixtures are available from the manufacturer.

A good idea in setting up the resistance values is to draw outlines of the resistor first, using a soft lead pencil on the base material. The two "ends" can be painted in with silver-conducting paint. The resistance paint should slightly overlap the silver conductors. To obtain close values of resistance, one of the dimensions can be deliberately undersized and the resistance paint

¹ Manufactured by Micro-Circuits Co.

Table 3-3. High-Resistance Paint R31 (40,000 to 2,500,000 ohms)

Width (inches)	Length (inches)—Resistance in Megohms							
	1/8"	1/4"	3/8"	1/2"	5/8"	3/4"	7/8"	1"
1/8"	0.313	0.625	0.938	1.25	1.56	1.87	2.18	2.50
	<i>0.15</i>	<i>0.3</i>	<i>0.5</i>	<i>0.6</i>	<i>0.75</i>	<i>0.9</i>	<i>1.1</i>	<i>1.2</i>
1/4"	0.156	0.313	0.468	0.625	0.780	0.935	1.08	1.25
	<i>.3</i>	<i>0.6</i>	<i>1.0</i>	<i>1.2</i>	<i>1.5</i>	<i>1.8</i>	<i>2.2</i>	<i>2.5</i>
3/8"	0.104	0.208	0.313	0.416	0.522	0.625	0.730	0.835
	<i>0.5</i>	<i>0.9</i>	<i>1.5</i>	<i>1.8</i>	<i>2.2</i>	<i>2.8</i>	<i>3.3</i>	<i>3.7</i>
1/2"	.078	0.156	0.235	0.313	0.390	0.468	0.548	0.625
	<i>0.6</i>	<i>1.2</i>	<i>2.0</i>	<i>2.5</i>	<i>3.0</i>	<i>3.7</i>	<i>4.4</i>	<i>5.0</i>
3/4"	.052	0.104	0.156	0.208	0.260	0.313	0.364	0.416
	<i>0.9</i>	<i>1.9</i>	<i>2.9</i>	<i>3.7</i>	<i>4.5</i>	<i>5.5</i>	<i>6.6</i>	<i>7.5</i>
7/8"	.045	.089	0.134	0.178	0.223	0.268	0.313	0.357
	<i>1.1</i>	<i>2.2</i>	<i>3.4</i>	<i>4.2</i>	<i>5.2</i>	<i>6.4</i>	<i>7.7</i>	<i>8.7</i>
1"	.039	.078	0.117	0.156	0.195	0.235	0.275	0.313
	<i>1.2</i>	<i>2.5</i>	<i>3.7</i>	<i>5.0</i>	<i>6.2</i>	<i>7.5</i>	<i>8.7</i>	<i>10.0</i>

(Roman figures indicate resistance; italic figures represent wattage rating)

* Courtesy Micro-Circuits Co.

carefully added to bring the dimension to the exact size. Sanding or scraping with a razor blade can remove or add resistance, depending on which dimension is altered.

Lower resistance can be obtained by adding several layers of paint, allowing each layer to dry thoroughly before adding the next.

Here are some tips on resistance-paint technique:

1. Be sure the paint is thoroughly mixed before and during use. Shake or stir occasionally during application.
2. If cracks appear in finished resistors, adhesion to the base material is probably poor. Remove the cracked resistor and clean the base thoroughly. Be careful not to smudge the base with fingerprints.
3. Make allowance for "wet" vs. "dry" resistance. The effects of drying on resistance are shown in Fig. 303.
4. Do not bake resistors until after they are partially dry. If any solvent is left and external heat is applied, the resistor may "bubble." Wait at least 15 minutes before baking.
5. Resistor thickness must be uniform if the resistor is operated near maximum wattage. If it is uneven, the thick section will overheat and possibly crack the resistor.

You may find that resistors do not follow the values given in the manufacturer's literature as closely as might be expected.

Many factors are responsible for this. For instance, the surface treatment must be standardized by the user for reproducible results. If a ceramic base is used and etched a certain way prior to the application of resistance paint, the same preparations must

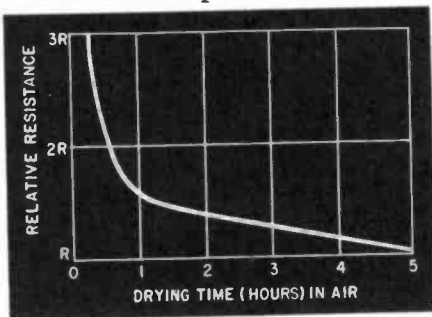

Fig. 303. Variations in resistance occur with drying time when resistance paints are used. The final (stable) value is reached only when the paint is thoroughly dry. (Courtesy Micro-Circuits Co.)

be made the next time the resistor is made. Likewise, if cardboard is used as a base material, an even coating of the same

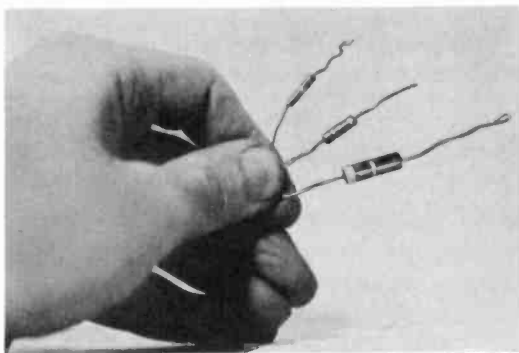

Fig. 304. Many varieties of carbon-composition resistors are commercially available.

type of shellac or varnish must be applied to the cardboard base before applying resistance paint.

One test for consistency is to measure the resistance several times after drying. When the value remains constant, it can be assumed that this value is the final one. Carbon has a temperature coefficient (i.e., its resistance changes with temperature) so the resistance will vary slightly with ambient temperature. This should not cause any trouble for most work at room temperatures.

Subminiature carbon resistors

The conventional carbon-composition fixed resistor is also useful in printed-circuit work. Fig. 304 shows a representative sampling of fixed carbon resistors. Several physical forms are available commercially, including the uninsulated and insulated axial-lead types, and the radial-lug and radial-lead types. The most popular is the insulated axial-lead unit.

Common wattage ratings for printed-circuit uses are in the range of 1/5 to 1/2 watt, and one manufacturer has recently brought out a 1/10-watt unit. Wattage is roughly a function of size,

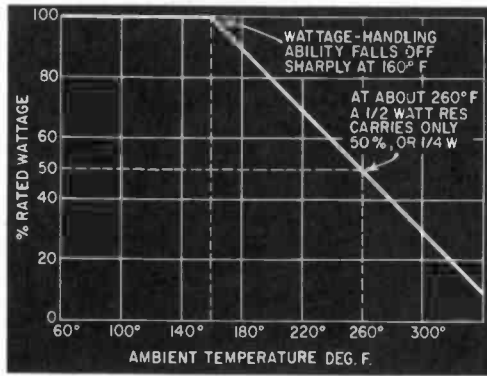

Fig. 305. Resistor derating curve. The wattage rating of resistances decreases with rising temperature. (Courtesy IRC)

but both will vary depending on the individual design. Lead length varies from $\frac{1}{4}$ to $2\frac{1}{2}$ -inches, depending on the end use of the resistor. Longer lead lengths are furnished for components used in automatic assembly machines or that have to be wrapped around terminals.

Insulated resistors are made in several ways. Some units have the resistance element laid down around a glass tube. Each lead has a small upset or flange on it. The two leads are inserted into the ends of the glass tube and pushed in. The flange prevents short-circuiting of the leads. The carbon-composition mixture is then put on the tube surface and the coating is extended on each end to make contact with the flange on the lead. Then the assembly is molded inside of a phenolic plastic.

In others the resistance element is formed, the leads inserted and the entire assembly is encased in plastic as one integrated manufacturing operation. Another method is to make the resistor and leads as a subassembly, insert that assembly in ceramic tubes and then cement the ends of the tubes, leaving the leads to come

through the end caps which are cemented to the body assembly.

Any carbon resistor generates noise. Some of it is due to the agitation of molecules by heat (so-called Johnson thermal noise).

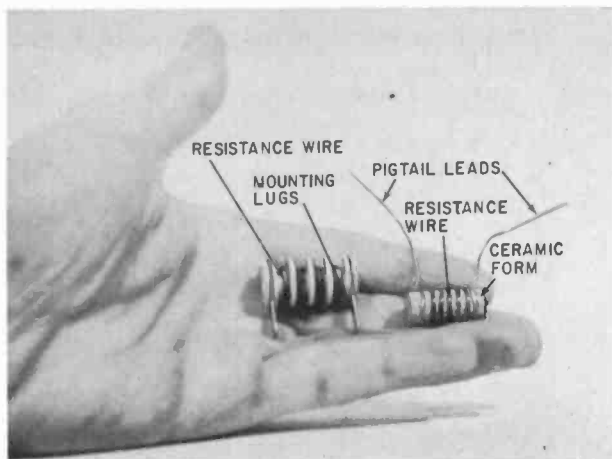

Fig. 306. Special wirewound resistors are manufactured specifically for printed-circuit purposes. Note the size of the units.

Other forms are produced when a direct current is sent through the resistor. Noise created by carbon resistors is usually measured as so many microvolts per volt of dc applied to the resistor. An average figure for resistors in the $\frac{1}{2}$ -watt range and below is 2 to 5 microvolts per dc volt.

When running resistors above their normal temperatures, it is necessary to derate them (Fig. 305) since most carbon-composition resistors have organic binders which decompose at elevated temperatures. It is sometimes possible to add a mass of metal to hold the resistor in place and this metal (called a heat sink) will help cool it.

Voltage ratings of composition resistors are determined by the strength of the dielectric material and the general design of the resistor body. Common carbon-composition resistors in the $\frac{1}{2}$ -watt range have voltage ratings around 300, but special units have been made which go up to 750 and 1,000 volts in the same wattages.

At high frequencies, a resistor will have properties that make it look like an inductor or a capacitor or combinations of both. The value of resistance usually changes with frequency and in general tends to drop off at higher frequencies. Rf bridges are used in one method of measuring resistance at high frequencies.

Selection of subminiature wirewound resistors

Typical examples of commercial wirewound resistors for miniaturized use are shown in Fig. 306. The usual construction is alloy resistance wire wound on ceramic tubes. The winding is then coated with organic cements or vitreous enamels. Resistance-wire

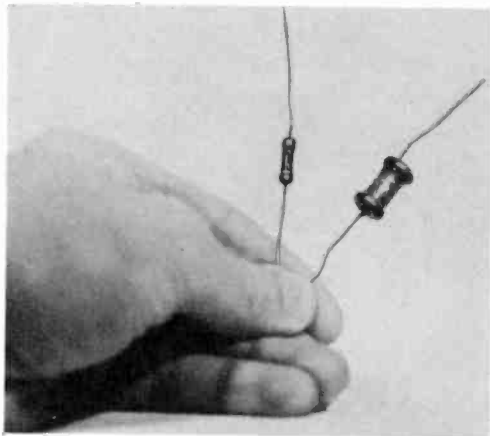

Fig. 307. *Deposited-film resistors are manufactured for low-noise applications.*

materials used are the Nichromes (nickel-chromium), Manganins (copper, manganese, nickel) and Advance (nickel-copper) alloys. The resistivity (resistance per unit length and unit cross-section) varies with the purity of the alloys and differences in the manufacture of the alloy wire.

One special class of wirewound resistors, the "accurate" group, have tolerances of better than 0.5%. These are usually hand-wound and checked for resistance with a Wheatstone bridge.

Deposited film resistors

Another manufacturing technique in fixed resistors is the use of conductive films laid down on a nonconductor base material. These "deposited-film" resistors are shown in Fig. 307. The films are made of either metallic or carbon-bearing materials. The commonest are carbon and boron. Film type resistors find use in circuits where their low noise factor is important and where precision wirebound units in the 0.1% to 0.5% class are too expensive to use. Other uses include meter and voltage-divider circuits requiring high stability and high-frequency circuits in which wirewound units are unsuitable due to inductive or stray capacitance effects.

Flexible resistors

Fig. 308 shows a flexible resistor in use on a printed-circuit board. Developed to fill the need for a high-wattage resistor that

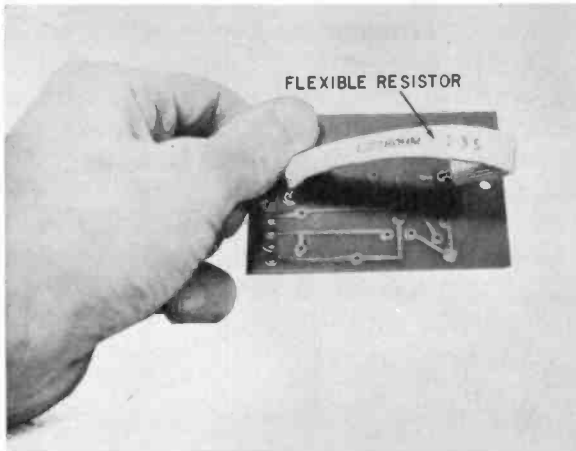

Fig. 308. *Special high-wattage flexible resistors find wide application on printed-circuit boards.*

is mechanically flexible, these units are available in sizes from 1 to 10 watts—the rating being roughly 2 watts per inch of length. They are normally wound on Fiberglas cores and have running surface temperatures of about 300°F at the hottest point.

Miniature variable resistors

Fig. 309 shows representative versions of miniature variable resistances. One form, the linear slider type, is adjusted by a

Fig. 309. *Representative miniature variable resistances.*

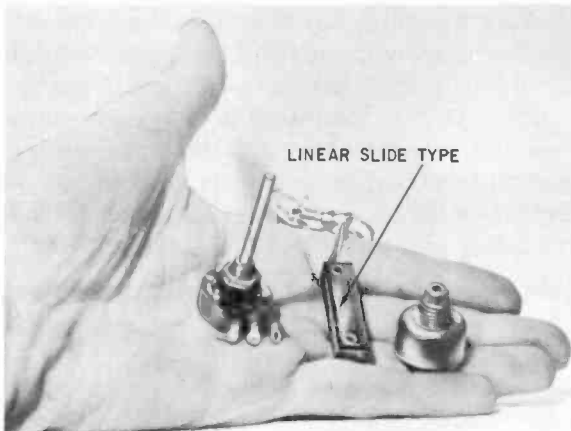

screwdriver slot on one end. This type of unit usually has a clutching arrangement to prevent overtravel of the wiper and subsequent damage to the wire wound element itself. The power rating is between $\frac{1}{2}$ and 2 watts and the terminals are often gold-plated to cut down corrosion. Resistance values available range from 10 to 200,000 ohms with 5% tolerance as the standard or 1% tolerance available on special order. This type of variable trimmer comes with soldering lugs, pigtail leads and pins for direct mounting in printed-circuit base boards.

The miniature potentiometer shown in Fig. 310 is $\frac{1}{4}$ -inch diameter by $11/32$ -inch long. Rated at $\frac{1}{4}$ watt, it takes about 500 such potentiometers to weigh a pound. Standard resistance values are 500, 1,000, 2,000, 5,000 and 10,000 ohms, and the winding is approximately linear with rotation.²

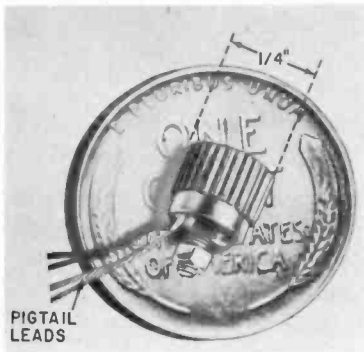

Fig. 310. A miniature potentiometer rated at $\frac{1}{4}$ watt. (Courtesy Minelco)

A very common miniature variable resistance unit is the type shown in Fig. 311. First pioneered for hearing aids, these units have found their way into many printed-circuit and subminiature applications. Several varieties are made, the average of which is rated at $1/10$ watt, measures $23/32$ -inch in diameter with its knob and $3/8$ -inch in diameter without it.³ Another subminiature model measures about $1/2$ -inch in diameter. Units are available with and without integral switches. Mounting is either by stud or bracket. Resistances range from 500 ohms to 5 megohms with a choice of two resistance characteristics or tapers (resistance vs. rotation curves). These tiny units have a breakdown of 900 volts ac rms. A $1/4$ -watt unit is also made for solid- or slotted-shaft tuning.

Capacitors for printed-circuit and subminiature use

The variety of capacitors suitable for printed-circuit and sub-

² Manufactured by Miniature Electronic Components Corp.

³ Manufactured by Centralab.

miniaturization work has been limited only by the ingenuity of designers and our present technology. Of the three common circuit components—resistors, capacitors and inductors—capacitors

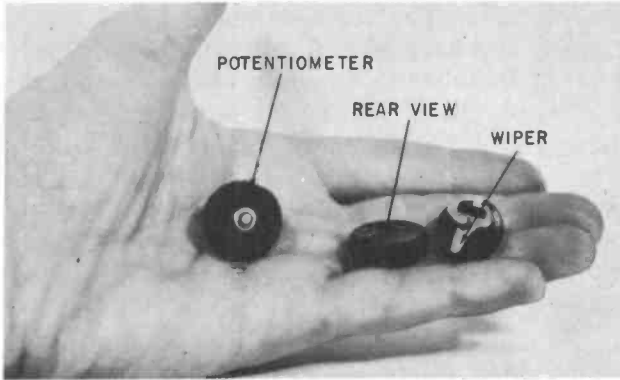

Fig. 311. Ceramic type miniature potentiometer.

are probably the group that has received the greatest attention in printed-circuit work. Materials with unusual dielectric strengths have been substituted for conventional wax and oil, with startling

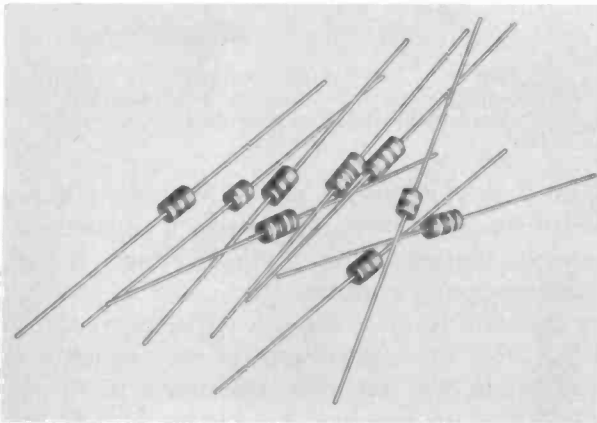

Fig. 312. Miniature ceramic capacitors have been available for a number of years. (Stackpole Carbon Co.)

size reductions. Glass has been used both in fixed and variable capacitors. Newer plastics such as polystyrene in thin films have made possible variable capacitors one-half to one-third the size of conventional units used in ordinary five-tube ac-dc superheterodynes. The introduction of Mylar promises even greater gains in size reduction while increasing capacitances and working voltages.

Ceramic capacitors

One major group of fixed capacitors suitable for printed-circuit work are the ceramics. Some of these (Fig. 312) have been available for a few years. The units are molded with organic thermosetting binders and have normal values of 0.1 to 10 μf . The body material is high-dielectric titanium dioxide, and the working voltages average about 500 dc. Typical applications include rf coil coupling and if transformer coupling. The leads of the units in Fig. 313 are designed to withstand a 10-pound pull.⁴

Other ceramic miniatures have been developed with subminiaturization and printed circuitry in mind. The units, shown in Fig. 313, have vacuum wax-impregnated phenolic insulation.

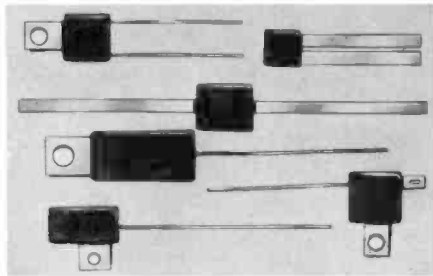

Fig. 313. The flat type miniature ceramic capacitor is very useful in printed-circuit work. Note the mounting tabs. (Courtesy Mucon.)

Standard working voltages are 200 to 500 vdc. Although fixed in the sense that there are no moving parts, a capacitor is also made that changes capacitance with applied voltage. It finds wide use in tuning and frequency controls.

Another common form of ceramic capacitor is the tubular type shown in Fig. 314. The central part of the capacitor is a ceramic tube coated inside and out with conductive material. After lead wires are attached to the two conductive layers, the entire assembly is coated with an insulating dip. Tubular types are also made in the form of feed-through units for high-frequency circuits where lead length and lead dress is important. By various methods of manufacturing, the ceramic capacitor can be given different temperature coefficients. The major types are the negative or N-type, positive or P-type and the NPO or near-zero-type. The N-type gives a decrease in capacitance with increase in tem-

⁴ Manufactured by Stackpole Carbon Co.

perature, the P-type is just the opposite, and the NPO-type does not change capacitance appreciably over wide changes in temper-

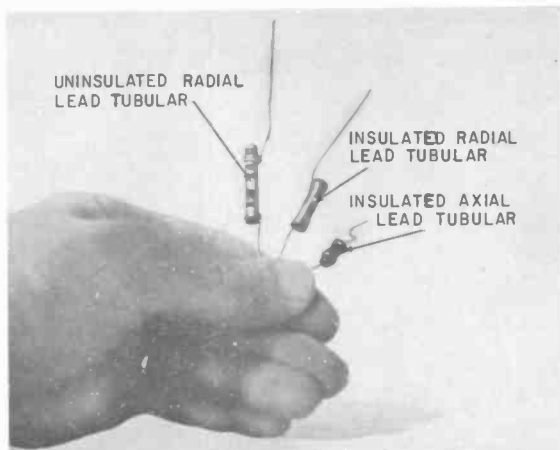

Fig. 314. *The tubular ceramic capacitor is widely used in all branches of electronics.*

ature. Thus, it is an easy trick to make a tank circuit or an oscillator very stable by the proper choice of ceramic capacitor.

Various forms of disc ceramics, such as those in Fig. 315, offer capacitances in the order of $500\ \mu\text{f}$ up to about $0.1\ \mu\text{f}$ in a very compact package. A variation in manufacture of this type con-

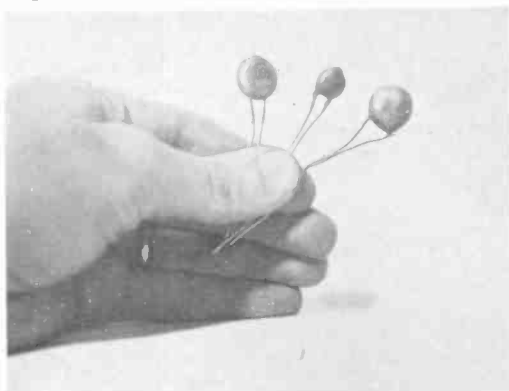

Fig. 315. *Disc ceramics, such as those shown, are easily adapted for use in miniature circuits.*

sists of putting two or more units in one case by stacking single units before encapsulation in the insulating medium used for the body covering.

Metalized paper capacitors

The units shown in Fig. 316 are another development in paper capacitors. They use a metal-coated paper as a substitute for the

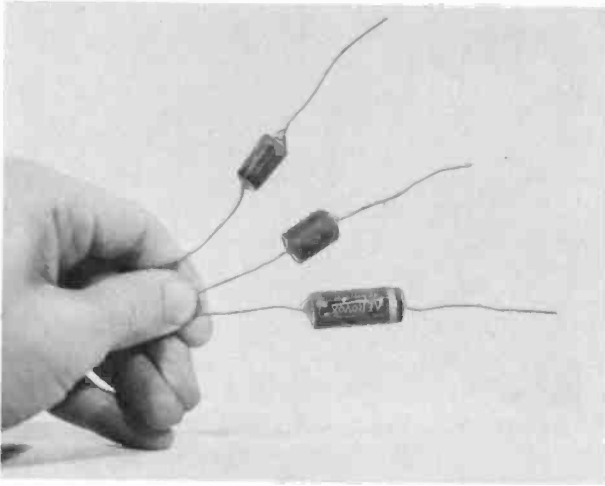
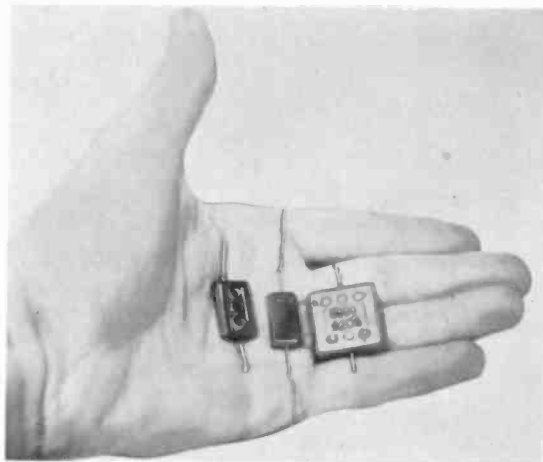

Fig. 316. Modern manufacturing methods permit the manufacture of paper capacitors in sizes suitable for printed-circuit work. (Boughton-Callihan Enterprises)

common paper-foil sandwich. This metal-coated paper is usually a Kraft paper only $1/1,000$ inch thick, and the metal coating is about $1/1,000,000$ inch thick. Capacitors rated $.05$ to $5 \mu\text{f}$ at 200

Fig. 317. The mica capacitor, an old standby, has been miniaturized for use in modern circuitry.



volts are about a third as long as a cigarette. Mineral-oil waxes are widely used sealers for this capacitor.

Mica capacitors

One of the "old-timers" in radio and electronics, the mica capacitor utilizes the dielectric properties of a natural mineral.

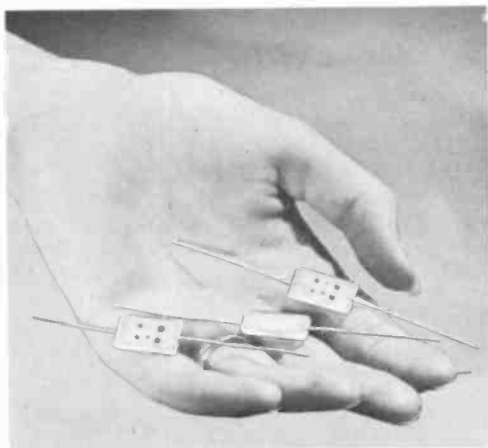

Fig. 318. Glass capacitors, smaller than micas of equal rating, provide humidity-proof components.

Typical construction consists of mica sheets and metal foils arranged in sandwiches with the mica sheets alternating with the foils in the sandwich. Tin, silver and aluminum are common foil materials. The foils are paired to alternate common leads with the mica as spacing material. The whole assembly is then molded in Bakelite and the capacitance value color-coded on the body. Common capacitance tolerances are 20%, 10% and 5%, with the silver mica units rated as the most stable with changes in temperature.

Typical mica units suitable for printed-circuit and allied work are shown in Fig. 317. Improved design and materials permit capacitances as high as 4,000 μf at 500 working volts dc in a unit only 7/16-inch wide by $\frac{3}{8}$ -inch long by $\frac{1}{4}$ -inch thick.

Color codes on mica capacitors have been changed several times, and it is best to consult the particular manufacturer for information on coding. Some manufacturers stamp the capacitance value into the body during the molding process.

During World War II, a serious question came up concerning the continuing supply of mica from India, which has been the largest source. As a result of military-sponsored research, a series of high-quality dielectric glasses for making capacitors was de-

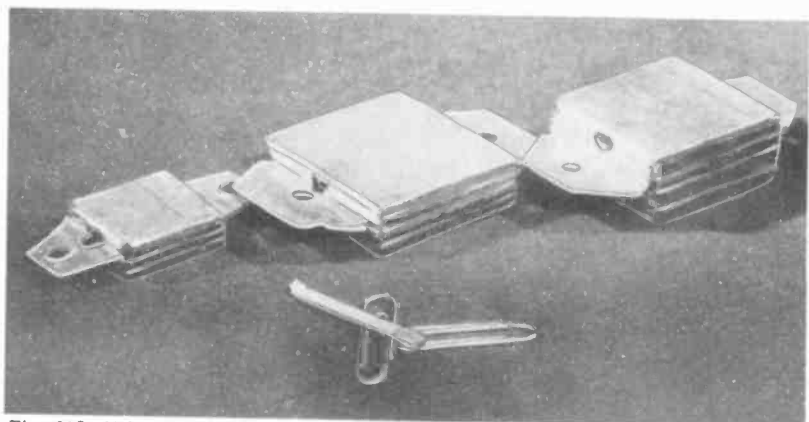

Fig. 319. When glass is used in the manufacture of capacitors, extremely high voltage ratings are possible, even with miniature units. (Courtesy Corning Glass Works.)

veloped. Some of these are shown in Fig. 318. Glass capacitors require many unusual glass-manipulating techniques. The glass is formed into a thin ribbon and, during capacitor assembly, the glass ribbon and a metal foil are sandwiched together to give the required final capacitances. Terminals are added and the entire capacitor units are pressed out like soda crackers. The glass body holds the dielectric sandwich rigidly and capacitance values are more stable than for mica units under similar temperature and vibration conditions. A glass capacitor is usually smaller in volume than a mica unit of the same capacitance at the same working voltage. Q 's of high-capacitance glass units do not drop off as rapidly as those of mica units at higher frequencies and the glass construction eliminates the wax impregnation used on micas for humidity-proofing. Glass capacitors designed for high-voltage use are shown in Fig. 319.

Electrolytics

Electrolytic capacitors are made of two electrodes, most commonly aluminum, separated by a liquid or semi-liquid conductor. The dielectric element is a thin film formed on the anode. The commonest "dry" electrolytics used in radio and television work consist of aluminum foil separated by the electrolyte which is made up as a paper or blotter separator. The separator is saturated with electrolyte and the foil-and-blotter combination is rolled up like a jellyroll and encased in a waxed cardboard or metal case. Various forms of electrolyte are used, ranging in viscosity from liquids to heavy pastes. The insulating film is

formed on the anode by the application of external voltage.

One very interesting feature of electrolytics is polar and non-polar construction. A nonpolar unit is used in circuits where

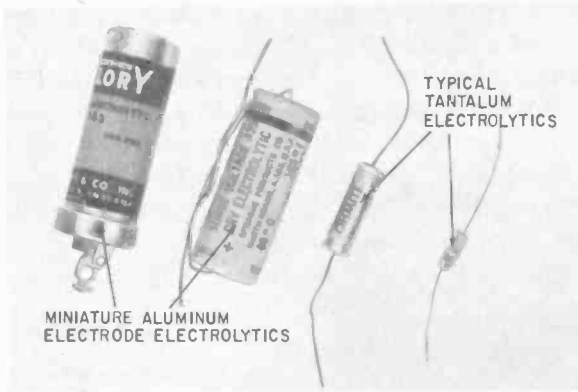
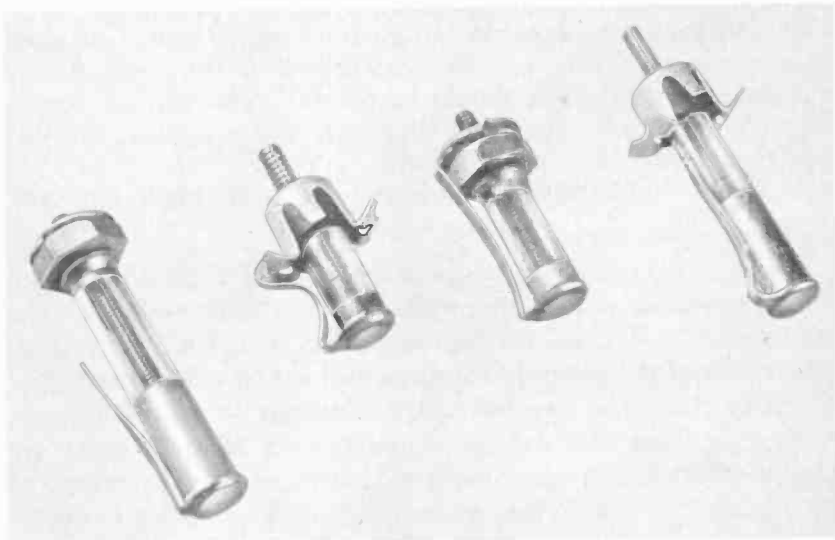

Fig. 320. Quite a departure from the familiar electrolytic, the miniature capacitors shown are about the size of ordinary tubular capacitors.

there is a reversal of polarity. The more common polar, or polarized, units are used in dc circuits where no reversals occur. Capacitance for a given volume is less for a reversible (nonpolar) electrolytic than for a polar unit with the same voltage rating.

Fig. 321. The glass and quartz piston capacitor finds wide use because of accuracy and ease of mounting. (Courtesy Corning Glass Works.)



Tantalum capacitors

Another development in electrolytics, the tantalum unit has several advantages over ordinary aluminum types. The corrosion resistance of tantalum is higher than aluminum, permitting the use of more active electrolytes. Tantalum oxide films, the dielectric in these units, are more stable than their aluminum counterparts. Tantalum units can also be used at higher temperatures and will go down to lower temperatures with less loss in capacitance. Tantalum units generally have a lower dc leakage than does aluminum. Leakage tests are usually made by charging the capacitor for several minutes and then measuring the current



Fig. 322. *A commercial printed-circuit oscillator using a piston type capacitor.*
(Courtesy JFD.)

flowing through the unit after 5 minutes or so. A series resistor is used to limit charging current to a safe value.

In all fairness to aluminum units, however, tantalum still has a few disadvantages. One of these is high cost per unit of capacitance. Another is that present units with capacitances over 1.0 μf are limited to approximate working voltages of 150 vdc.

Electrolytics are subject to failure from excess heat, long shelf storage, and occasional pinholes and defects in the electrode foil material. Polarized units should be carefully checked for proper circuit connections; otherwise they may be ruined or, if overloaded too long, they may explode.

An assortment of miniature electrolytics is shown in Fig. 320.

Variable capacitors

For capacitances in the range of fractions of 1 μf up to about 50 μf , the glass and quartz piston capacitor finds wide use. The units shown in Fig. 321 are representative. A piston of ferromagnetic material is arranged to slide in and out of a metalized glass or quartz tube. The two concentric elements act as a capacitor. Various features claimed by manufacturers of such units are vernier adjustment to increments of as little as .05 μf per turn of the adjusting screw, no tuning, backlash, wide operating temperature range (-90° to $+450^\circ\text{F}$.), silver plating for higher Q 's, and

high dielectric strength for use on circuits up to several thousand volts dc. The most advanced designs employ quartz tubes and invar rotors. Fig. 322 shows one of these units in a printed-circuit oscillator.

Concentric shield units

A unique design permitting variable capacitance up to $50 \mu\text{f}$

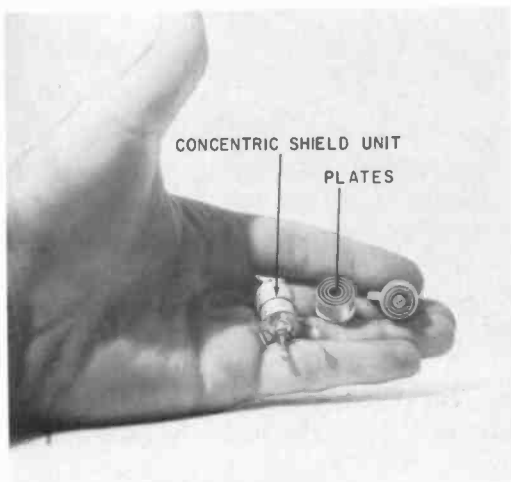
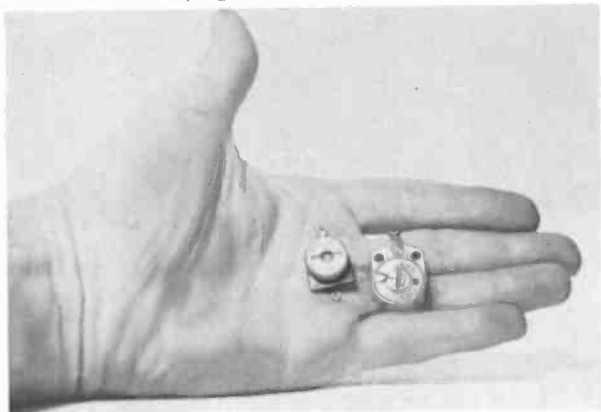

Fig. 323. The concentric-shield variable capacitor is an extremely compact unit.

in small spaces is shown in Fig. 323. The concentric shield capacitor has a Q of about 75 at 27 mc and can be tuned with a knob or extension shaft made of plastic.

Fig. 324. Ceramic trimmer capacitors are well suited to printed circuits. They are extremely stable and are minimally affected by mechanical shock.



Ceramic variables

Manufactured for years for conventional trimmer uses, the



Fig. 325. Mica compression trimmers are easily adapted for miniature work; a) knob-tuned unit; b) shaft-tuned type. (Courtesy Arco.)

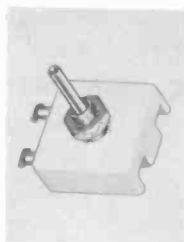

variable ceramics shown in Fig. 324 are ideal for printed-circuit work. Mounted on ceramic or steatite bases, they provide capacitances up to about $60 \mu\text{f}$ in various mounting styles. These ceramic trimmers offer high stability under vibration due to the lightweight rotor which is kept under heavy spring pressure. The rotor and stator surfaces are ground optically flat to eliminate troublesome air films between them.

Mica trimmers

Mica compression trimmers can be adapted to printed-circuit and subminiature uses. Variations include dual and multiple units,

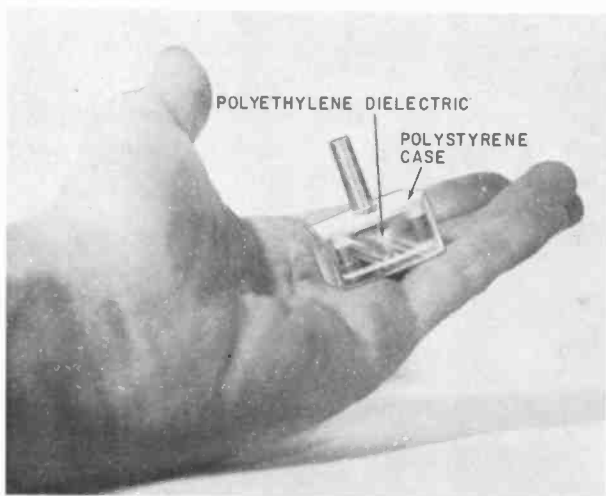

Fig. 326. Meshed-plate variable tuning capacitor. Completely enclosed, the unit uses polyethylene sheets between the plates. (Courtesy Argonne Electronics Mfg. Co.).

half-size units in which the width of the body is about one-half normal size, and knob and shaft tuning units. The latter two types are shown in Fig. 325. Capacitances range from 3 to $30 \mu\text{f}$

in two-plate units to 1,200–2,600 μf in units with 15 plates. Ratings vary from 250 to 500 volts working dc with a 1,000-volt test for flashover.

Mesh-plate units

The meshed-plate variable capacitor shown in Fig. 326 is one of the major advances in subminiature variable capacitor designs

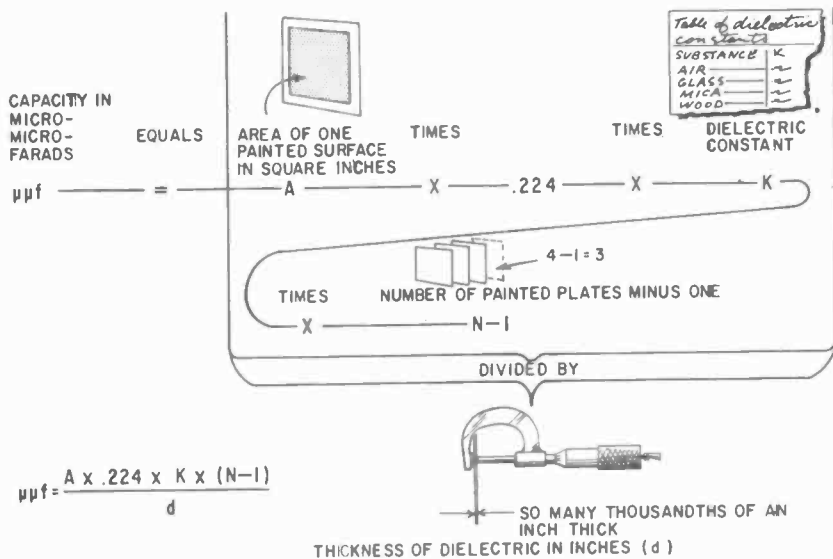

Fig. 327. Step-by-step process involved when calculating capacity. The formula is especially useful when fabricating capacitors.

made as a result of printed-circuit and space demands from manufacturers and amateurs. A polyethylene dielectric is used between plates, and the entire plate assembly is enclosed in polystyrene. The polystyrene case prevents entry of dust and also houses two rotary type trimmers which are adjustable through holes in the rear cover. In addition, body-capacitance effects are cut down by insertion of shielding plates in the rear of the unit when the unit is mounted on a metal chassis. Another novel feature is 175° rotation instead of the conventional 180°. The 5° limit on rotation prevents damage to the polyethylene film in case the rotor plates fall out of mesh with the stator plates. Maximum capacitance of the two-gang unit is 211 μf in the antenna section and 101 μf in the oscillator section. Minimum capacitances of the same sections are 13 and 11 μf , respectively. Breakdown voltage is 50 volts dc after 1 minute. The Q is over 2,000 at 1 mc. The

trimmers range between 12 μf minimum and 50 μf maximum. Single- and three-section 365- μf units are also available. The latter are only 1-1/16-inches square by 13/16-inch deep. The manufacturer claims all units in the line have a life of over 10,000 operations without appreciable capacitance shift.

Making your own printed and etched capacitors

Printed or etched capacitors are limited with present techniques to capacities in the 1–200- μf range. In general, the formula for the area of a conductor–dielectric plate sandwich type capacitor is

$$A = \frac{c \times d}{0.224K(n-1)}$$

where A is the area of one painted or etched surface in square

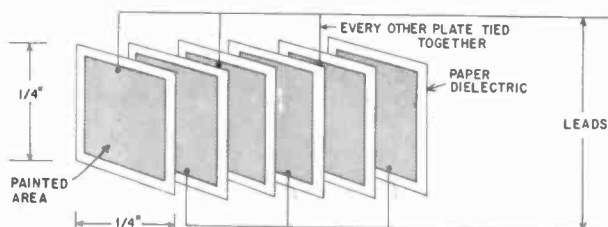

Fig. 328. Practical application of the formula illustrated in Fig. 327.

Practical Example of Formula

Capacitor has 6 plates. Each plate is 1/4 inch square. The dielectric is .006-inch thick paper. Find the approximate capacitance.

$$\mu\text{f} = \frac{A \times 0.224 \times K \times (N - 1)}{d} \quad \text{See Fig. 328}$$

$$A = \frac{1}{4} \times \frac{1}{4} = \frac{1}{16} \text{ square inch}$$

$$K \text{ for paper} = 2.5$$

$$N = 6, \text{ so } (N - 1) = 5$$

$$d = .006$$

$$\mu\text{f} = \frac{\frac{1}{16} \times .224 \times 2.5 \times 5}{.006} = \text{about } 30 \mu\text{f} \text{ capacitance}$$

inches; K, the dielectric constant of the separating material; d, the thickness of the dielectric (separator) in inches; n, the total number of painted or etched plates; c, the capacity in μf of the entire capacitor. The use of the formula is shown in Fig. 327. A practical example is shown in Fig. 328.

Dielectric constants vary from 1.0 for air to about 7 for celluloid among the more common materials. Typical dielectric con-

stants for materials found around the shop or home are given in Table 3-4.

Table 3-4. Dielectric Constants of Common Materials

material	constant
paper	2.5
mica	4-6
shellacked paper	2.9-3
celluloid	5-6
waxpaper	2.4-2.6
glass	5-9

Voltage breakdown for a capacitor depends on dielectric *strength* (not to be confused with dielectric constant). For cardboard, this would be about 100 volts per mil (1/1,000 inch). If there were four plates, each 15/1,000 inch thick, then the total thickness would be 60/1,000 inch. The *theoretical* voltage breakdown would be 60×100 , or 6,000 volts. However, a safety factor of at least 10 should be applied to home-made units. This would give a working voltage of 600.

Subminiaturization and inductors

Inductors have been very difficult to miniaturize, requiring new techniques in wire drawing, insulating and winding. The printed and painted inductor has many limitations and must share a great deal of application with inductors that still use wire. Nevertheless, the conventional receiver intermediate-frequency transformer can, normally a good 1½-inches square by 3-inches high, has been shrunk to a pygmy unit as a result of several years of effort. The search for higher inductance in smaller volumes has also led to the development of new core materials having permeabilities in the hundreds as compared to air. Metallic films and foils deposited on dielectrics have also been used as coils with limited values of inductance in the microhenry and low millihenry ranges. The recent discovery of materials with permeabilities in the thousands and finer wire-drawing techniques offer promise of inductors the size of matchheads with millihenry values. As just one sideline, the art of electronic computers is depending heavily on such components for large quantities of stored information in tiny spaces.

Inductive components

Probably the most familiar of all subminiature inductors are the transformers shown in Fig. 329. These have plastic-insulated

wire on nylon bobbins and use high-grade electrical steels in the ferromagnetic part of the assembly. Transformer designs this small demand special metallurgical techniques such as grain orientation in the steel and heat treatment in gas atmospheres. All of these processes are necessary to achieve acceptable frequency response characteristics for uses such as hearing aids and miniature radios. Many miniature transformer manufacturers employ alloys of iron and nickel for the lower wattage units and specially treated silicon steels for the higher-wattage transformers. Note that we are talking about transformers designed to handle *milliwatts*—and in extreme cases, in power transistor circuits, a few

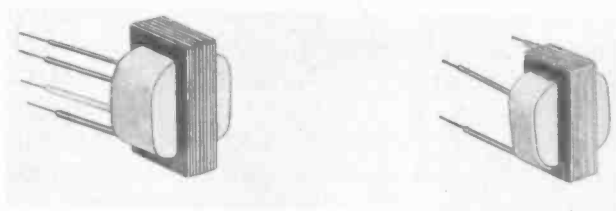

Fig. 329. Construction of miniature transformers seems to be conventional. It isn't. Special techniques are required. (Courtesy United Transformer Corp.)

watts. The problems of distributed capacitance and leakage reactance effects in these tiny units are minimized by special windings such as interleaved windings—a cousin to the old-fashioned “honeycomb” winding.

Pickup of outside signals by induction is a common problem in transformers of this size and power level. One approach to this problem employs two balanced coils which tend to neutralize stray pickup. Multiple shields of high-nickel alloys are also used to attenuate hum.

An extreme example of subminiaturization in transformers is shown in Fig. 330. Measuring only 5/16-inch in diameter by 13/32-inch long, it would take over 150 of these units to weigh a pound. The leads of the unit are insulated with a plastic that melts in the course of soldering the unit into a printed circuit. It is also hermetically sealed and the leads are designed to withstand a 10-pound pull. Depending on the source and load impedances, the transformers have a reasonably flat response in the 300–5,000-cycle range; a typical response curve is shown in Fig. 331. They are available in input, interstage and output designs and have been made with center-tapped windings. Designed mainly for transistor circuits, the input impedances range from 150 to 200,000 ohms, and output impedances vary from 3.2

ohms for speaker matching to 2,500 for interstage coupling. Power levels range from 25 to 500 milliwatts.

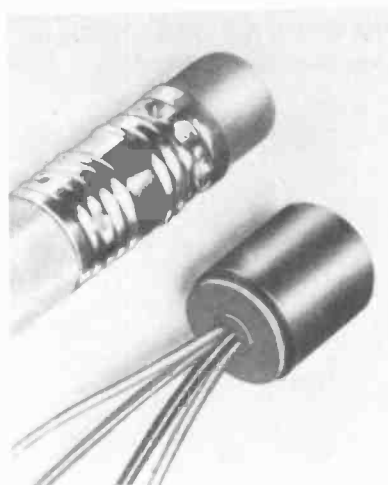

Fig. 330. Among the smallest of the small, this transformer is the size of a pencil eraser. (Courtesy United Transformer Corp.)

Rf inductors

The maximum inductance of printed-circuit coils is usually limited to 100 microhenries or less in the simple single-layer construction; higher-inductance multilayer printed coils are usually plagued by low Q effects. However, three-dimensional rf chokes

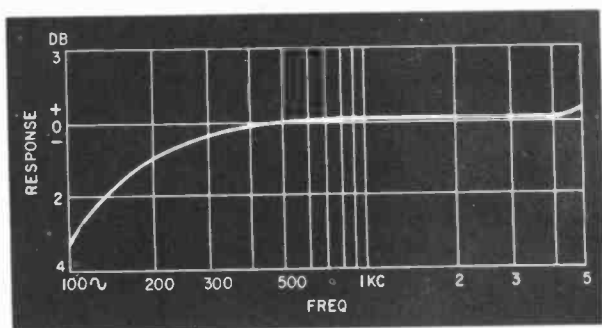

Fig. 331. Typical response curve for a transformer such as shown in Fig. 330. (Courtesy United Transformer Corp.)

have been designed that fit printed circuit and miniature applications nicely.

Typical fixed-inductance-value rf chokes are those shown in Fig. 332. These units have pi-wound coils on ferrite cores. The pi-wound construction reduces distributed capacitance and the cores produce higher inductance in a fixed space.

A variable inductance design is shown in Fig. 333. The core

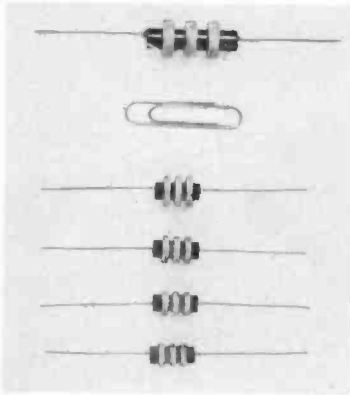

Fig. 332. Typical fixed-inductance rf chokes which can be used in miniature equipment. (Courtesy Superex.)

has been mounted on a threaded stud, permitting adjustment of the core position within the coil. The range of inductance for coils in such designs varies from 40–250 microhenries in the smaller sizes to 0.25–0.5 henry in larger sizes.

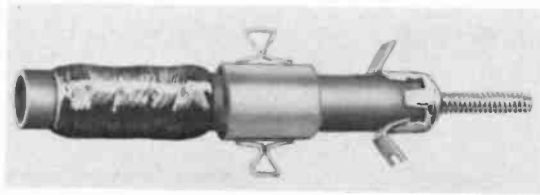

Fig. 333. A variable inductance. The core is movable by means of the threaded shaft. (Courtesy Superex.)

A pair of key components in subminiaturization, especially in superheterodyne circuits, are the if transformer and the oscillator coil. Examples of these are shown in Figs. 334 and 335. Several coil manufacturers have produced if's $\frac{1}{2}$ -inch square by $\frac{3}{4}$ -inch high, and the most recent units are approximately $\frac{3}{8}$ -inch square by $\frac{1}{2}$ -inch high. Q values run up to 150, and many of these tiny if's have built-in shunt capacitors. One typical if unit for transistor circuitry has a primary impedance of 25,000 ohms and a secondary impedance of 600 ohms. The oscillator coil shown will tune with oscillator sections of variable capacitors having only 75–100 μf maximum capacitance in contrast to conventional values of 170 to 210 μf .

The if coils shown in Fig. 336 are examples of plug-in types suitable for TV if strips. They are encapsulated in resin to exclude moisture and dirt, and have adjustable cores.

Loop antennas

The loop antenna that was commonly found in the five-tube ac-dc superhet and usually taking a space about 6 by 8 inches has been improved for miniature circuitry by using ferrite cores.

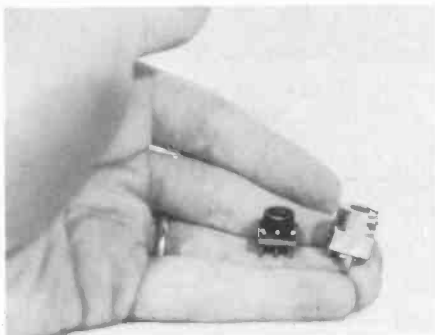

Fig. 334. *Miniature if coils designed to be mounted on a printed-circuit board.*

Fig. 337 shows one loop antenna design using a core 5 inches long by $\frac{3}{8}$ inches in diameter. The Q for such a unit is about 500, and the inductance is 425 microhenries. The coils are impreg-

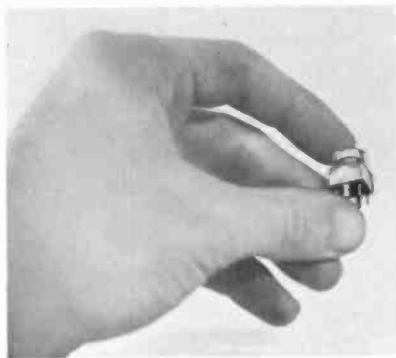

Fig. 335. *A miniature oscillator coil.*

nated with beeswax to seal out moisture. The unit mounts by means of a bracket.

Another antenna design utilizes a flat ferrite slab. This unit, shown in Fig. 338, is available in several inductance values, the two most common being 230 and 397 microhenries, designed to tune the broadcast band with 365- and 210- μ f capacitors, re-

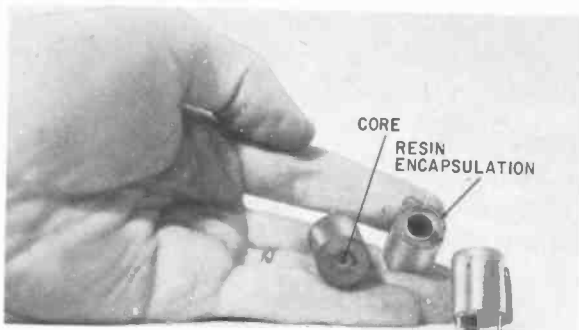

Fig. 336. The plug-in type of coils are extensively used in TV. These units are potted. (Courtesy Essex Electronics Co.)

spectively. This flat type antenna is usually mounted on brackets by cementing or by wrapping a few rubber bands around the flat surface near each end of the coil. Q's of flat units vary from 200 to 350.

Matched-coil kits

A matched-coil kit is available which consists of three 455-kc if's, an oscillator coil, a ferrite loop antenna and a subminiature

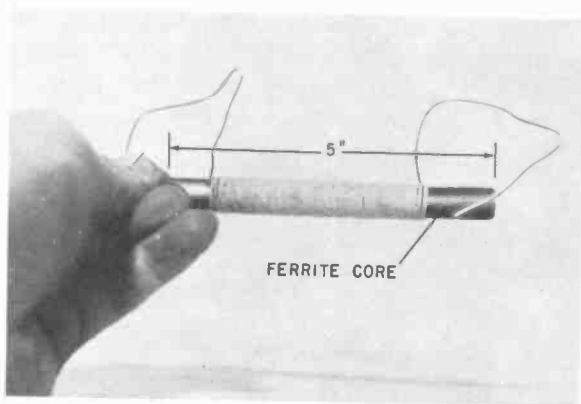

Fig. 337. One type of ferrite-loop antenna used in miniature circuitry.

two-gang capacitor. The entire kit is designed for use in superhet circuits using transistors. The shielded oscillator and if's are only $7/16$ -inch high above the chassis and about $3/8$ -inch in diameter. The oscillator coil has an inductance of 261 microhenries which can be varied by $\pm 20\%$ with a tuning slug. The unloaded Q of the oscillator coil is approximately 140, and distributed capacitance is $7 \mu\text{f}$. The first if or converter output coil has a primary

impedance of 15,000 ohms and a secondary impedance of 250. The second and third if's have similar primary impedances but slightly different secondary impedances. The subminiature two-

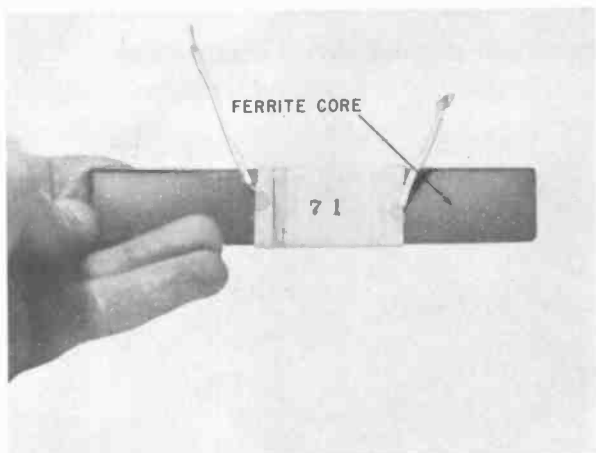

Fig. 338. Flat ferrite rods are also used in loop antenna designs.

gang capacitor is a polyethylene-coated plate unit, as described previously, and is matched to the antenna inductance in one section and the oscillator inductance in the other. The entire kit is shown in Fig. 339.

Glass inductors (metalized)

Designed for use at 25 mc and above, the metalized glass inductor shown in Fig. 340 offers the advantages of high temperature stability due to the low expansion coefficient of the glass form

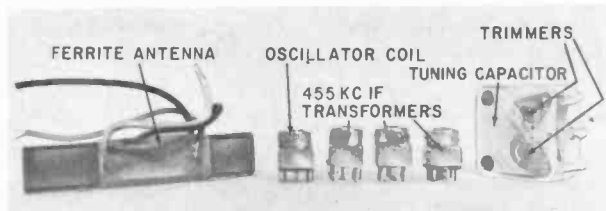

Fig. 339. A matched-coil kit consisting of if's, oscillator coil, antenna and tuning capacitor. Note the size of the units.

and the low temperature coefficient of the glass dielectric. Q's average 150. Typical specifications for such units would be: frequency, 38 to 49 mc, Q at 50 mc (without core) of 150, apparent inductance of about 1/3 microhenry at 50 mc, and average distrib-

uted capacitance of coil approximately $1.6 \mu\text{f}$. The ends of the metalized windings are tinned for soldering. Double-pitch windings are available for rf transformers and inductive coupling. Turn spacing varies from just under $1/32$ to as high as $\frac{1}{8}$ inch.

Making your own printed-circuit inductances

In general, single-plate printed-circuit inductors are limited

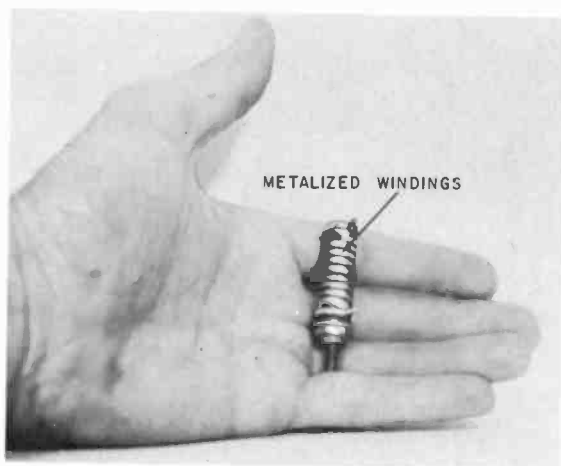

Fig. 340. Metalized glass inductor offers high temperature stability.

to inductance values below 100 microhenries. However, multi-layer inductors can be built up to higher inductances by insulating between layers and coupling coils together. One limitation of the multi-layer construction, unfortunately, is the Q obtainable. Another bothersome effect is distributed capacitance.

For single-layer inductances, three geometric forms are popular. The first of these is the circular coil printed on a section of tubing of which the outside diameter is relatively uniform. A practical application of this type of coil is given in Chapter 7 in the "lipstick" transmitter circuit. There a coil has been painted on the glass envelope of a vacuum tube with silver paint. One formula for such a coil is:

$$\mu\text{h} = .025 \times k \times d \times N^2 \times L$$

These symbols simply mean that the inductance in microhenries is equal to the five quantities, .025, k , d , N^2 and L multiplied together. The formula is explained in Fig. 341.

Another popular design is the flat spiral shown in Fig. 342. The spiral starts out at some central point and moves outward in rings of increasing size to a point on the outside. A riveted

connection or eyelet drilled in the inductor acts as a termination. One formula for the spiral inductor is:

$$\mu h = .02 \times N^2 \times d \times p$$

where μh is the inductance in microhenries; N , the number of turns p , the permeability of material in and around the core (p is 1 for air), and d , the mean diameter of the coil.

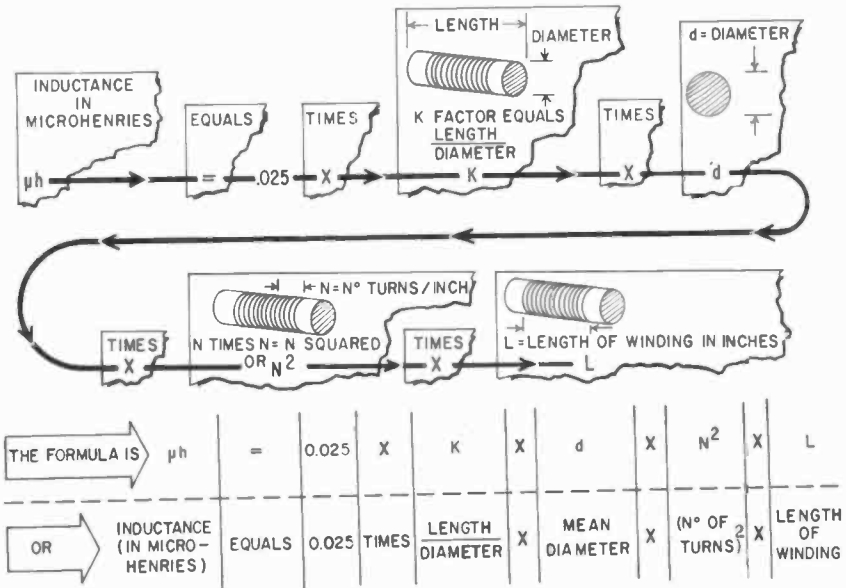

Fig. 341. Method of finding the inductance of a single-layer coil.

Mathematical formulas may be a bit baffling, but Fig. 343 takes most of the mystery out of this one.

Fig. 342. Example of a flat-spiral inductor.



A third form of inductor, the flat square shown in Fig. 344 is easier to draw and offers experimenters another variety in layout.

Fig. 345 shows how to figure the inductance of circular and square type spiral inductors. This method is based on work done by Harold E. Bryan of the Naval Electronics Laboratory, San Diego, Calif.

1. Decide on the approximate size of the coil and select an inside and outside diameter as shown in Fig. 345-a. For example, let's choose an outside diameter of 1-inch and an inside diameter of $\frac{1}{4}$ -inch.

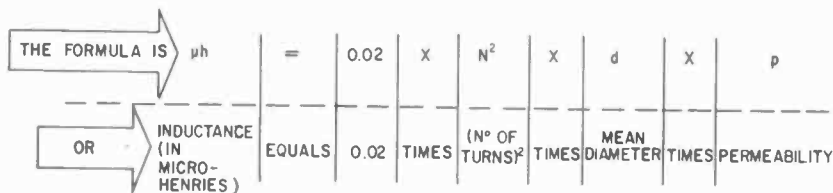

How to Figure the Inductance of a Spiral Inductor:

Coil has inside diameter equal to $\frac{1}{4}$ inch, and outside diameter equal to 1 inch. No. of turns is 6. Find the inductance.

Step 1. Mean diameter, d, is

$$\frac{\text{I.D.} + \text{O.D.}}{2} = \frac{\frac{1}{4} + 1}{2} = \frac{5}{8}$$

Step 2. Calculate N^2 . This is 6×6 , or 36.

Step 3. Multiply all parts of formula together.

$$(\mu h) = .02 \times (N^2) \times (d) \times (p)$$

(Remember p is 1 for air.)

$$\text{Inductance} = .02 \times 36 \times \frac{5}{8} \times 1 = .45 \text{ microhenries}$$

2. Compute the quantities a and c;

$$a = \frac{\text{outside diameter} + \text{inside diameter}}{4} = \frac{1 + \frac{1}{4}}{4} = \frac{5}{16}$$

$$c = \frac{\text{outside diameter} - \text{inside diameter}}{2} = \frac{1 - \frac{1}{4}}{2} = \frac{3}{8}$$

3. Divide a by c or $\frac{5}{16} \div \frac{3}{8} = \frac{5}{6}$ or about 0.83

4. Find 0.83 on the a/c scale (Fig. 345-b)

5. Pick out the inductance (in microhenries) desired. Find this value on the L scale. Assume we are using a value of $1.2 \mu h$

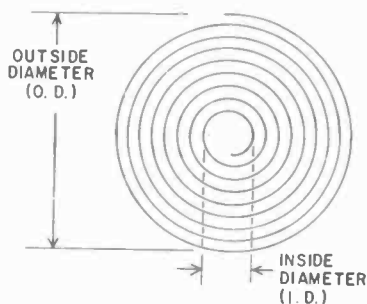

Fig. 343. How to figure the inductance of a spiral inductor.

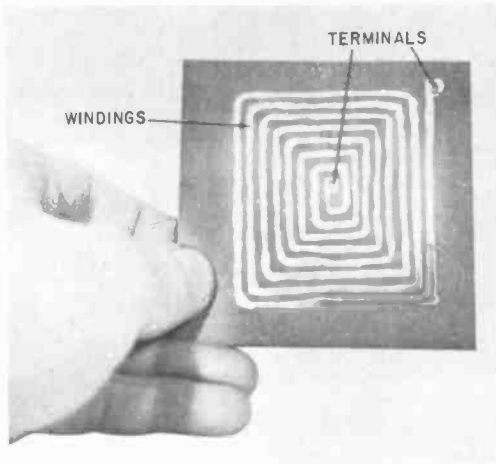

Fig. 344. The flat square is another form of inductor.

and are working with a circular coil. We use 1.2 on the right-hand side of the scale.

6. Draw a line joining 0.83 on the a/c scale with 1.2 on the L scale. This line intersects the index line at a point, X.

7. The original a value was $5/16$ which is about 0.3. Locate this value on the a scale (Fig. 345-b).

8. Draw a line between 0.3 (a scale) and X. The point at which this line crosses the n scale is the number of turns required. In this case about 9.

9. Lay out the coil by painting or etching as shown in Fig. 345-c. If we wanted a square coil we would use the left-hand side of the L scale in step 5. This would result in slightly fewer turns.

Q values of inductances

The Q of a printed-circuit coil is generally lower than that of a conventional wire coil of similar dimensions. This is due mainly to edge effects, a rough edge tending to produce more rf losses than a smooth one. Higher Q's are possible with materials having Teflon or silicone-glass bases. One method of improving Q is to silver-plate the inductor. This can be done by electroplating or else by rubbing a paste of silver chloride or silver nitrate on the copper coil pattern. Because of the many factors affecting Q, actual tests on individual assemblies with Q meters are recommended. In the absence of a Q meter, use a grid-dip oscillator and a vtm, as shown in Fig. 346.

Distributed capacitance

All inductors have some distributed capacitance which makes them look like a tank circuit (L-C) at certain frequencies. At low

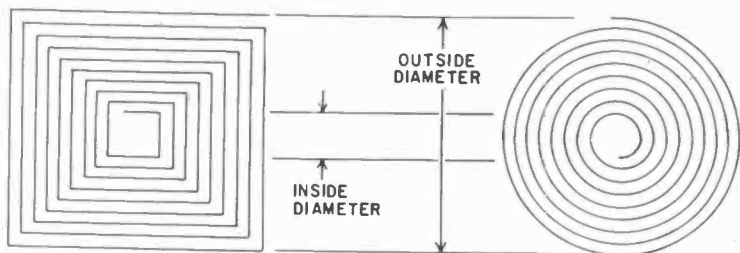

a

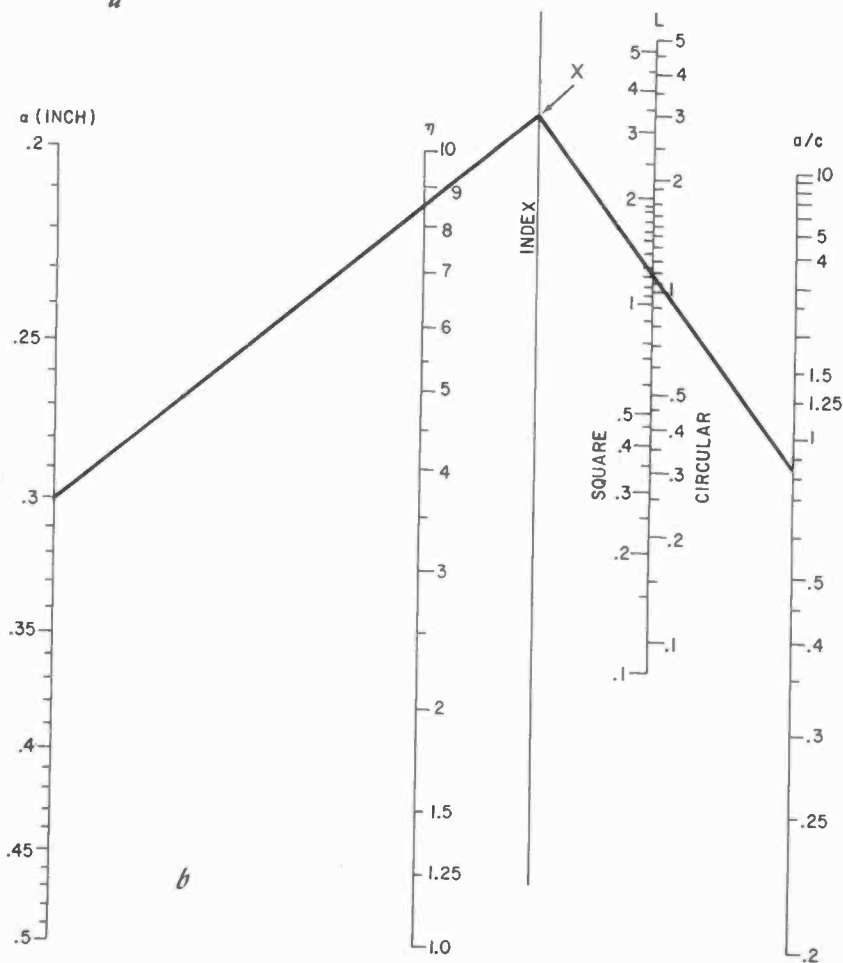

b

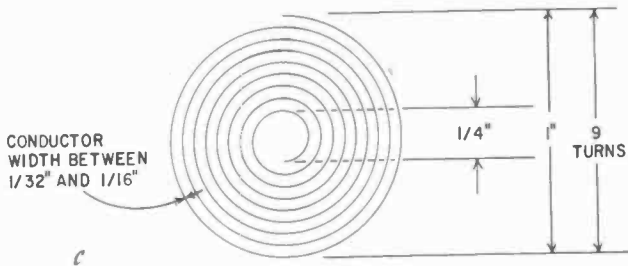
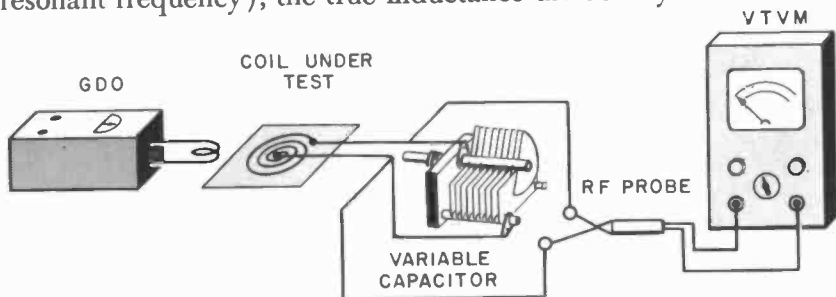

Fig. 345. How to calculate the inductance of square and circular type inductors. Use the chart on the facing page. (Courtesy Chilton Publishing Co.)

frequencies, the inductance tends toward its true or dc value due to distributed capacitance effects. At some frequency, the inductance will resonate as a tuned circuit with its own distributed capacitance. The graph in Fig. 347 shows that, for a given inductance and distributed capacitance (and therefore a fixed self-resonant frequency), the true inductance divided by the effective



To Find the "Q" of a Coil

1. Tune the capacitor for highest voltage, C2, on a vtvm
2. Detune to get 70.7% of C2 on low side (C1)
3. Detune in the opposite direction to get 70.7% of C2 on high side (C3)
4. "Q" is then figured as equal to:

$$\frac{2 \times C2}{(C3 - C1)}$$

The values of C1, C2 and C3 can be in μmf or μf . All values must be in same units, however. If C1 & C2 are in μmf , C3 must be in μmf .

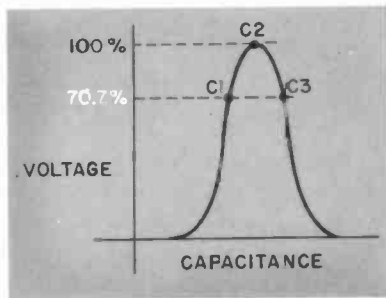

Fig. 346. Method of testing the Q of a coil, using a vtvm and a grid-dip oscillator.

inductance increases as operating frequency decreases. Another way of looking at it is that, as the operating frequency is raised

toward the self-resonant frequency, the effective inductance increases.

Use of magnetic materials

The inductance of printed-circuit inductors on a dielectric surface is usually low because of small size and surrounding permeability. One side of the inductor is very often exposed to the air and the other side is on the insulating dielectric—both mediums having low permeability. Several techniques have been employed to raise the permeability in such cases.

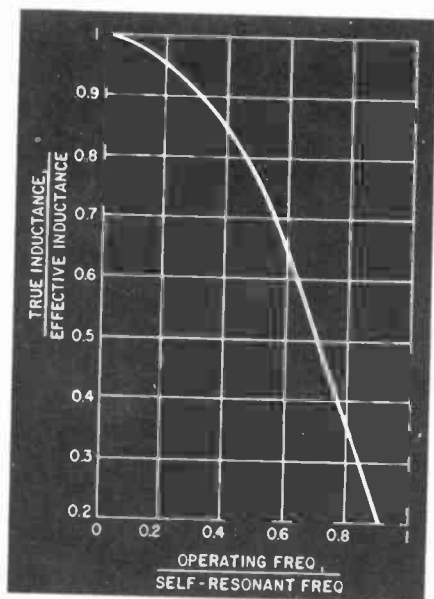

Fig. 347. Chart shows the relationship between inductance and frequency. (Chilton Publishing Co.)

One method is to take out some of the center turns of the inductor and apply magnetic paint to the central portion of the coil. Such a paint consists of a colloidal suspension of magnetic particles with appropriate binders and solvents. Another version of magnetic paint is a paste.

A second method for applying the magnetic material is to spray it on the inductor after insulating it from the magnetic paint by resin or very thin paper. In another technique, the base plate of the inductor is molded with a slot or cylindrical indentation, and a small slug of magnetic material is arranged to fit in the hole. A fourth technique consists of painting a magnetic disc on the in-

ulating base plate of the inductor and then applying another magnetic disc to the opposite side of the inductor, sandwiching the inductor between the two. A further variation of the dual-disc method is to make two magnetic-disc inductor combinations and arrange them to slide over or past each other to vary the inductance. Inductors can be painted on conventional slug coil forms, and a wound inductor and painted inductor of approximately the same value are shown in Fig. 348.

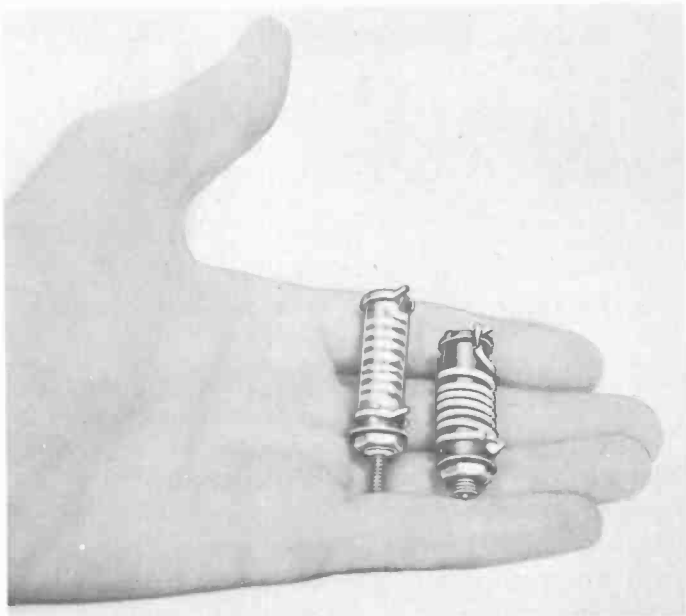

Fig. 348. A wound inductor and a painted inductor of the same value. Note the difference in size.

The total self-inductance of two coils in series is the sum of each of the inductances plus two times the square root of the product of the inductances. Thus, if two similar inductances are used, say 2 microhenries each, the total self-inductance will be $2 \mu\text{h} + 2 \mu\text{h} + 2 \sqrt{2 \times 2 \mu\text{h}}$, or 4 times that of each coil, or 8 μh . This could be done if two similar coils were painted on each side of the dielectric and connected in series. However, the Q of the circuit would be lower than single-coil construction, due to flux paths in the dielectric.

Rf coil forms—winding your own coils

Shown in Fig. 349 are some empty coil forms which can be used

by the experimenter who wishes to wind his own. Two main factors affect coil design. The first is the coil winding itself, and the second is the effect that the core will have on the inductance.

The four major types of magnet wire available to the experi-

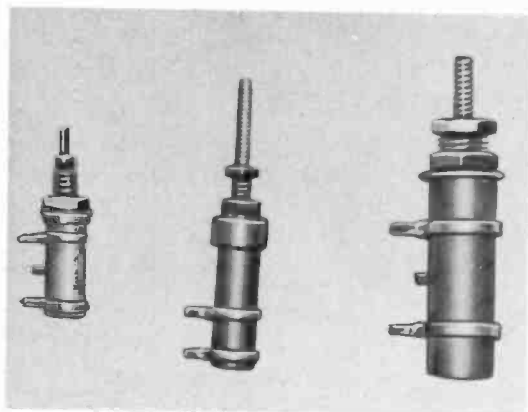
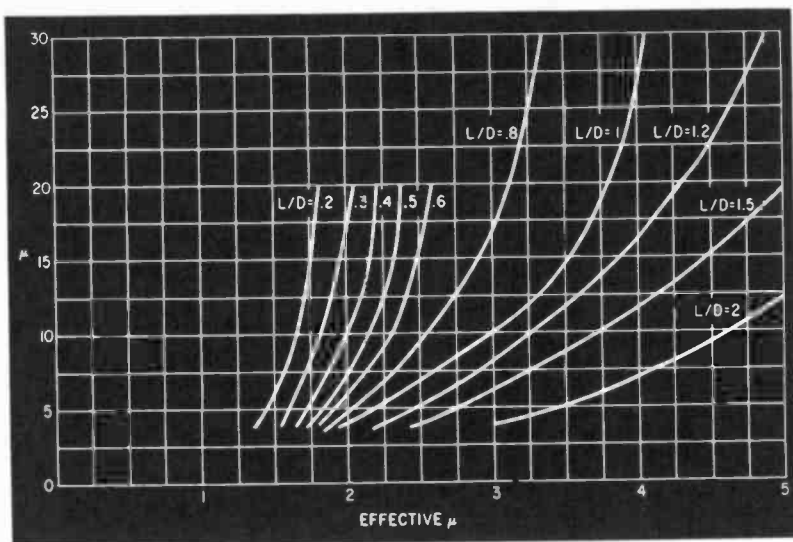

Fig. 349. A variety of coil forms are available for those who want to wind their own.

menter are enameled, single cotton enameled, double-cotton-covered and silk-covered wire. Ordinary enameled wire is made with a baked-on resin which is like household paint. The single cotton enameled is similar to the plain enameled wire, but has a single layer of cotton wrapping over the enamel. The double-cotton-covered material is *bare* copper wire with two layers of cotton cord wrapped over it. The silk-covered wire is becoming less common: the extra cost of silk is seldom practical.

In using the cotton- or silk-covered wire, remember that textiles are porous. Coil dopes are used to keep out moisture and dirt. Another important point to remember is to stick closely to any information which affects the number of turns or type of insulation, if exact results are expected the first time. This is especially true where construction articles specify a certain *length* of winding. Using enameled wire of the same gauge will give more total turns per inch than double-cotton-covered wire. This will affect the inductance and also any frequency characteristics such as being used with a fixed capacitor to tune to a certain frequency.

Most magnet wire coverings can be stripped easily with fine sandpaper or chemical solvents. Some of the plastic-covered wires can be stripped with a hot soldering iron.



Inductance of coil due to Presence of Iron

$$L_1 = L_0 - \frac{d^2}{D_2} (\mu - 1) + 1$$

L_0 = Inductance of Coil Without Iron
 d = Diameter of Core

$$D = \frac{D_1 + D_2}{2}$$

D_1 = Outer Diameter of Winding
 D_2 = Inner Diameter of Winding
 μ = Effective Permeability of Iron

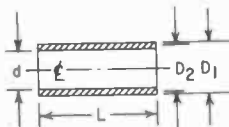

Fig. 350. Effect of cores upon the inductance of coils. The chart and formula are used to calculate effective inductance and permeability. (Courtesy Stackpole Carbon Co.)

Cores

The presence of a permeable material will change the inductance of a wound component. Another factor that enters into coil calculations where there are cores is the length-to-diameter ratio. A set of formulas and a typical family of curves which help predict the effective permeability and also the effective inductance are shown in Fig. 350. Once the effective permeability and L/D ratio are known, the inductance is calculated from the formulas. The actual permeability is determined by the physical nature of the core material.

Iron cores are made by mixing iron particles, 1 to 40 microns

(.001 millimeter) in diameter with a binder and then molding the mixture into shapes such as shown in Fig. 351. Various iron-powder types are used. Some of these are produced by decomposition of iron carbonyl, by grinding iron mill scale and by reduction of iron oxides. Advantages of using iron cores, especially in high-

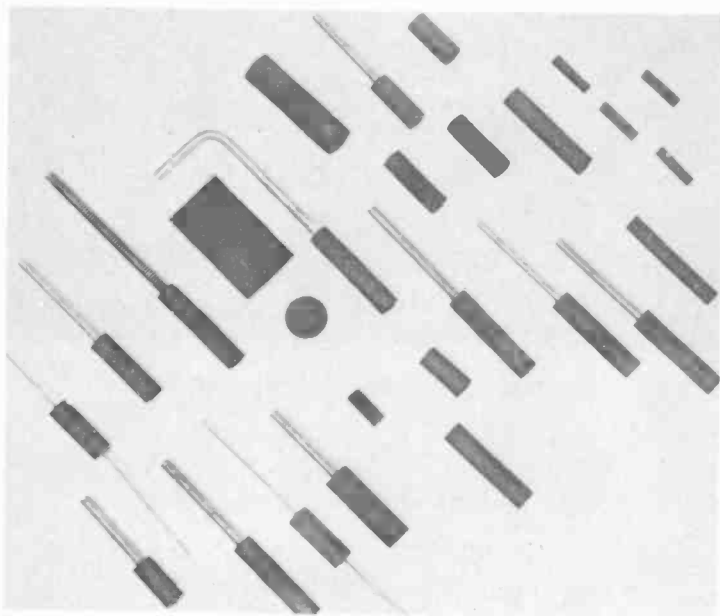

Fig. 351. Various types of molded iron cores. (Courtesy Superex).

frequency circuits, are (1) they reduce the number of turns of coil required for a given inductance, (2) they reduce stray flux and help boost Q 's and (3) they produce coils with smaller distributed capacitances. Design factors influencing core selection center around the properties of the iron, and cores are usually classified into frequency ranges of use. The iron core will add some losses to the finished coil, and these must be balanced out with decreased copper losses due to eliminated copper coil turns and eddy currents in the core itself. For serious work, the core manufacturer should be called upon. Recent advances in core manufacture have produced a series of metallic oxide-ceramic combinations that have up to 10 times the permeabilities of iron cores.

Hardware and special wiring

Vital to the construction of any printed-circuit or subminiature

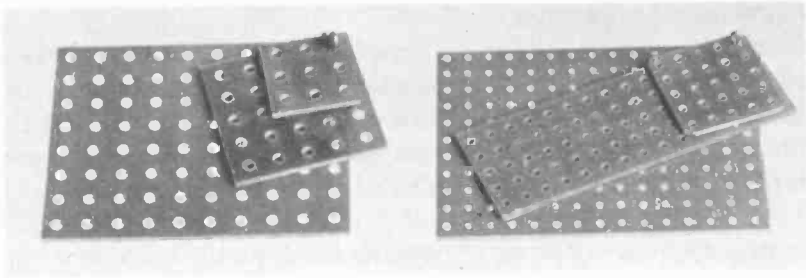

Fig. 352. Punched terminal boards, available in a variety of sizes and shapes, are useful for permanent construction and experimental setups. (Vector Electronic Co.)

assembly is the hardware that holds components in place. Like components, some hardware is conventional and has been scaled down for a particular use. Other units have been modified slightly in form or shape for printed circuitry. Finally, a unique class of hardware has come into existence designed for printed circuits and subminiaturization.

Punchboards

Terminal punch boards (Fig. 352) are used for quick mounting and test setups. These boards are available in several sizes, patterns and materials. One pattern has a hole diameter of about $3/32$ inch spaced on $33/64$ -inch centers and comes in either $1/16$ or $3/32$ -inch thick material. Another has $1/16$ -inch diameter holes on $3/16$ -inch centers.

Fig. 353. Punched boards featuring stitched and tape wiring. (Vector Electronic Co.)

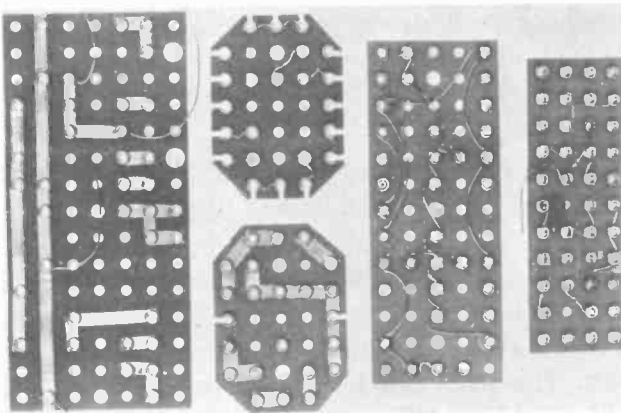

Stitched wiring boards

Stitched wiring is a form of breadboarding in which the connecting wires are fed in under eyelet and terminal boards in any direction and stitched in place like sewing. Wire stitching has the advantage of flexibility in the run direction. The technique permits runs on both sides of a breadboard. Several stitched boards can be wired up with vertical riser conductors, producing a modular structure. In cases of small experimental-quality runs, stitching

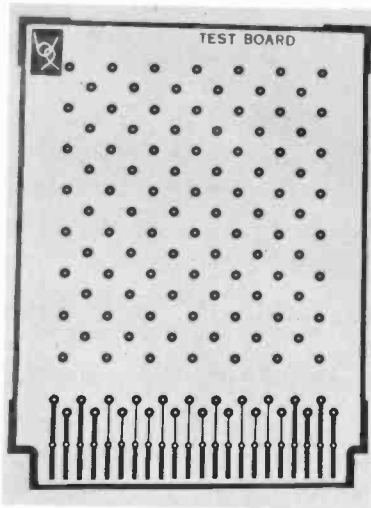

Fig. 354. An example of a pre-etched circuit board for use with special printed-circuit connectors. (Techniques, Inc.)

is usually less costly and time-consuming than etching, especially where the number of wires (wire-density) is low.

Tape stitching is another variation of wire connecting and is confined to straight conductor runs with bends at an angle. This type of stitching finds use as a ground bus, and is a cousin to earlier die stamping techniques.

Both wire and tape stitching are shown in Fig. 353.

Pre-etched test boards

Fig. 354 shows a facsimile of a pre-etched unit designed for use with printed-circuit connectors having $5/32$ -inch contact spacing, $1/16$ inch wide. The material used in the actual board is $1/16$ -inch XXXP laminate with $.00135$ -inch-thick copper on one side. The pads or circles are $1/8$ inch in diameter, and several models of the board are available with different rows of pads on different grid layouts. The pads can be drilled by the user or furnished drilled with No. 55 ($.052$ -inch) diameter holes. Manufacturers also make test boards for diode and resistor networks. The experi-

menter can duplicate any similar patterns in small quantities by etching methods.

Sockets

A versatile socket for breadboards is the surface type shown in

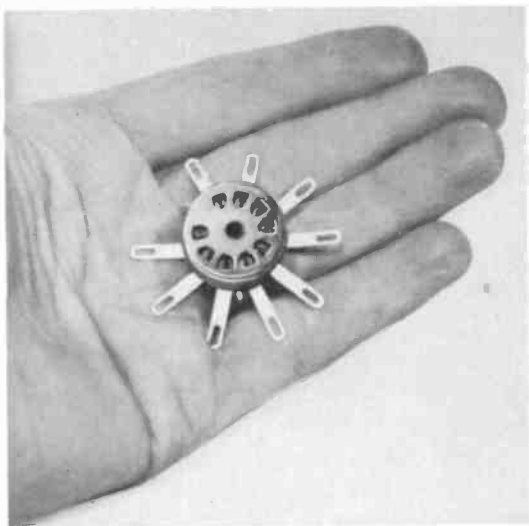
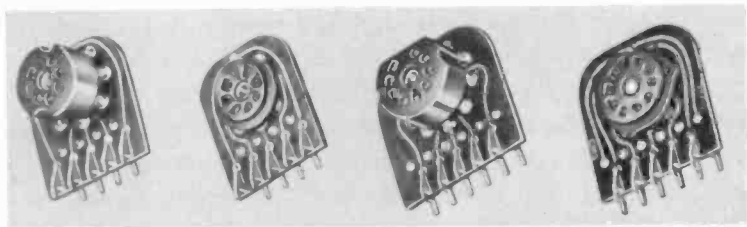

Fig. 355. *The surface type socket is especially suited for breadboard construction.*

Fig. 355. In addition to the regular female socket contacts, this unit has male lugs in parallel with the regular pins. The base connections are numbered and the contacts are usually silver-plated phosphor bronze.

The right-angle socket was developed to save room in certain printed-circuit board layouts and also permit a more flexible arrangement of components. Several versions of this socket are shown in Fig. 356. One commercial design has buttress-ribbed construction to give the associated panel more rigidity.

Fig. 356. *Right-angle sockets save space and permit flexible arrangements of other components. (Cleveland Metal Specialties Co.)*



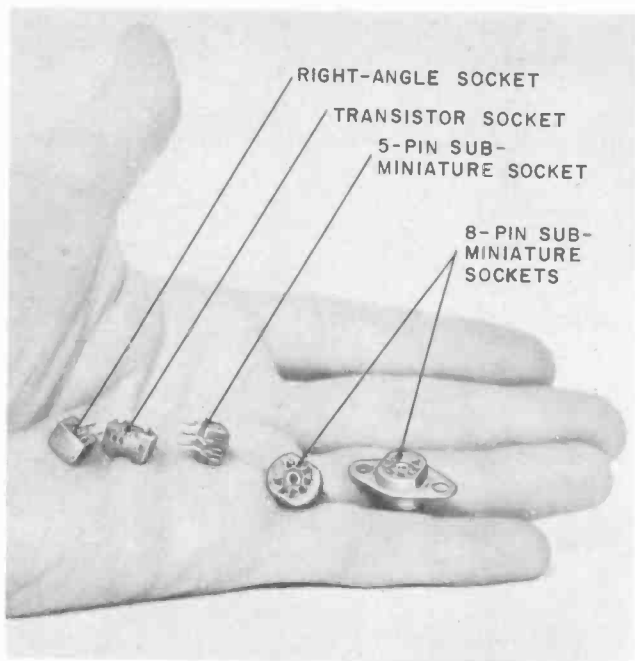

Fig. 357. *In-line and round-type subminiature sockets are used with tubes and transistors.*

A variety of subminiature sockets are shown in Fig. 357. The ones on the left are known as in-line types and those on the right are round designs. Major problems in the application of these sockets are spring-contact design, corrosion and lead identification. Contact materials are usually phosphor bronze, brass or beryllium copper, with cadmium and gold most often used for plating. Body compositions are mica or micaphenolics. Lead identification is made by either an orientation bump or colored dot on the in-line types; the round types are keyed on the socket base.

Connectors

Multiple-circuit male and female connectors for printed-circuit work are shown in Fig. 358. The variations possible include contact spacing, contact spring design and mechanical mounting features. One miniature-series female connector has $5/64$ -inch contact spacing with 12 contacts in a block about $1-3/8 \times 7/16 \times 1/4$ -inch. Another is based on $5/64$ -inch centers to produce a female connector just under 1 inch long, $5/16$ -inch wide by $1/4$ -inch thick. Contact arrangements come in 8, 12, 16, 32, 48 and 60 con-

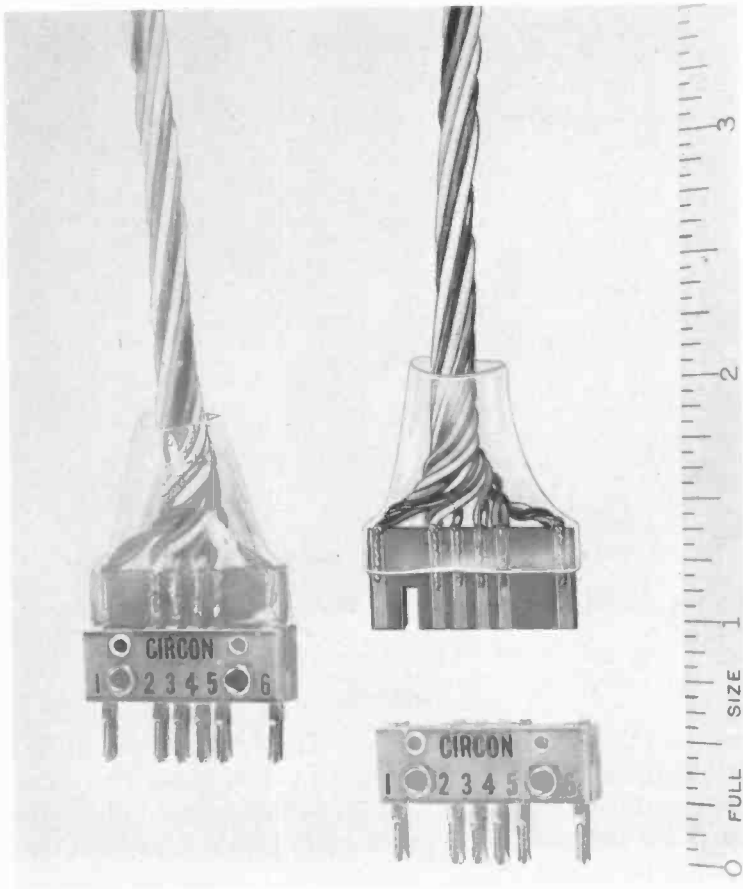

Fig. 358. Some of the special multiple circuit connectors used in miniature work. (Courtesy Circon Component Co.)

tacts with plating and materials to suit the user. Contact materials are spring brass and beryllium copper. Hoods are also available to protect the wires entering the connector.

Miniature coax connectors are shown in Fig. 359. These are made in various impedances, the most common being about 50, 52, 70 and 90 ohms. Cables as small as 1/16-inch outside diameter can be terminated with these connectors. Teflon is used quite often as the dielectric.

Terminals

One form of clip-in terminal, shown in Fig. 360, depends on serrated slots to grip the lead wires. These terminals do not re-

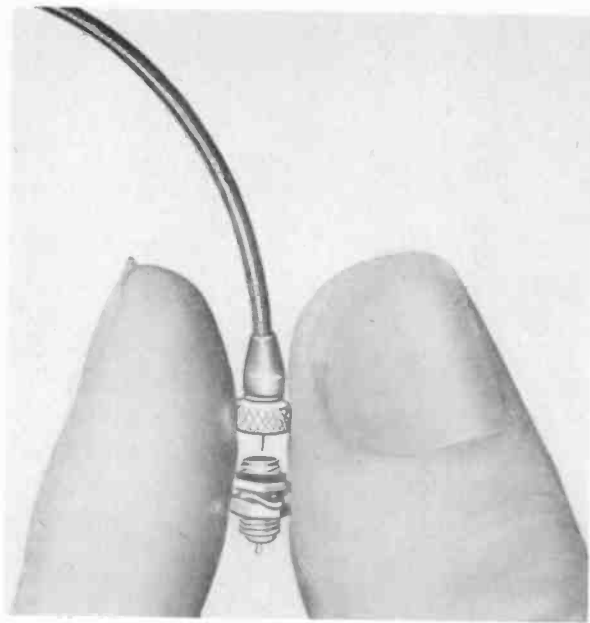
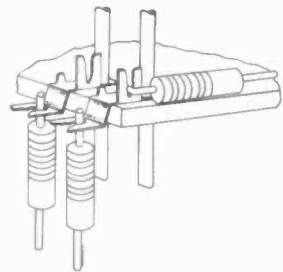

Fig. 359. *Miniature coaxial connectors are available in a variety of styles and impedances. (Amphenol-Borg Electronics Corp.)*

quire soldering in temporary setups. They are made in three forms known as the side-zip, edge-zip and push-in type. The edge- and side-zip units are fastened to $3/32$ -inch-diameter holes with eyelets, and the push-in type slips directly into a $3/32$ -inch-diameter hole without eyelet.

Fig. 360. *Clip-in terminals require no soldering when used in temporary circuits. (Vector Electronic Co.)*



The side-zip terminal has the serrated slots mounted to take components both parallel and at right angles to the base board. The eyelets which hold the terminal can also be used as soldering points for vertical jumper wires or risers between decks of boards.

The edge-zip unit has serrated slots made to take components only parallel to the base board. The side-zip terminal has to be

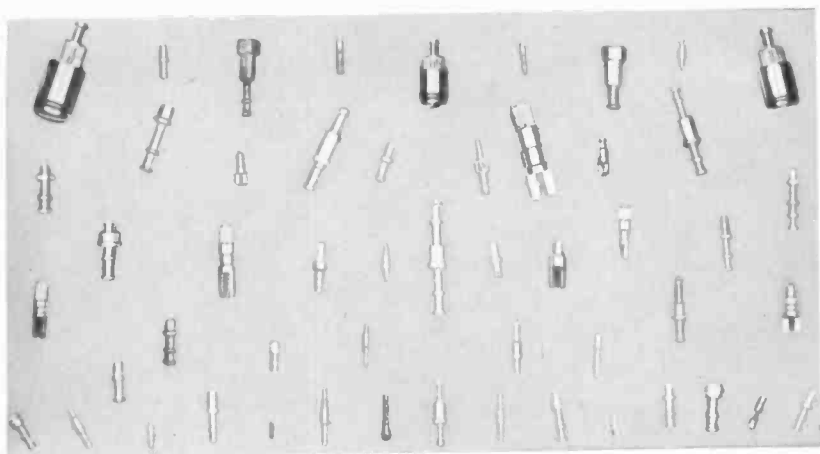
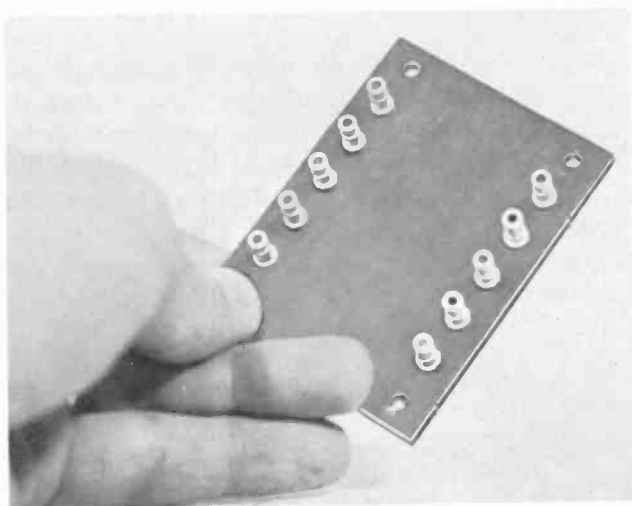

Fig. 361. Staked terminals (above) are mounted to circuit boards (below) by a process similar to riveting. (Courtesy USECO)



offset in some setups to avoid riser and component interference, whereas the edge unit has its eyelet hole offset to eliminate this problem.

Another feature of the edge- and side-zip units is a small strapping fork. This serves a double purpose. First, it permits mating of adjacent terminals when the tongue of one terminal is locked into the fork of an adjacent one with needle-nose pliers. Secondly, it provides a tie or loop point for small-gauge wiring, No. 24 or thinner.

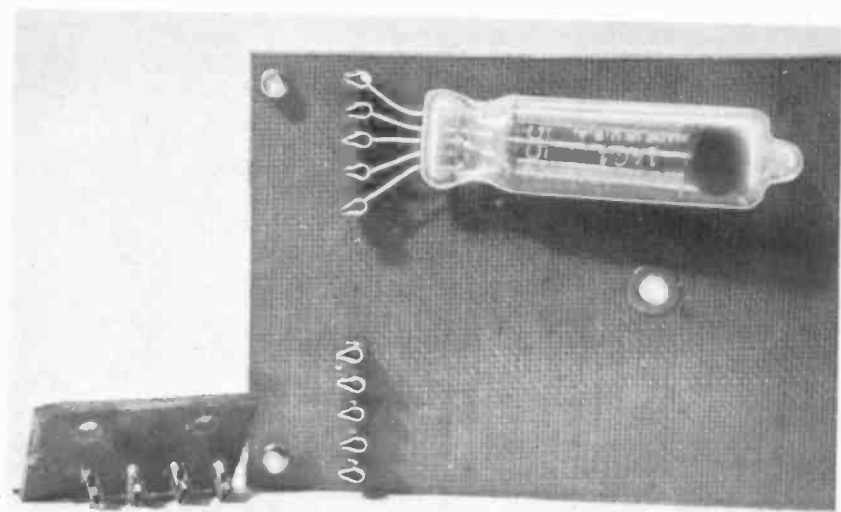

Fig. 362. *The flea clip is a widely used connector in miniature circuitry.*

The push-in terminal is inserted into 3/32-inch-diameter holes with needle-nose pliers. The terminal is formed from sheet brass and the half-tubular end holds the terminal in the base board tightly. A feature of this type terminal is the slot in the inserted end. This slot can be used to hold additional component leads or can be staked into the base board permanently to hold the terminal. Flaring or staking can be done with needle-nose pliers. The slotted tubular section can also be snapped off with side

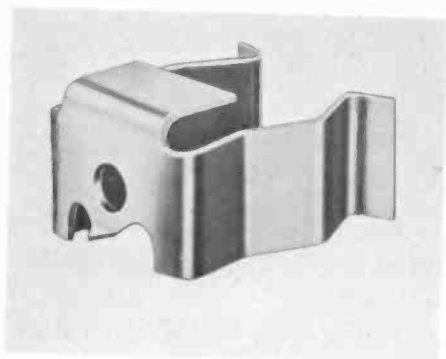

Fig. 363. *Spring clip component holder.*
(General Cement Mfg. Corp.)

cutters close to the underside of the board. The snipping action tends to flare out the tubular section and bind the terminal in place.

Various forms of terminals, designed expressly for staking into a base board, just like riveting, are shown in Fig. 361. These are

usually made from brass, which can be electroplated with tin, tin and lead alloys, cadmium and gold. These terminals can be hand-swaged for small runs or mass-produced swagging can be made

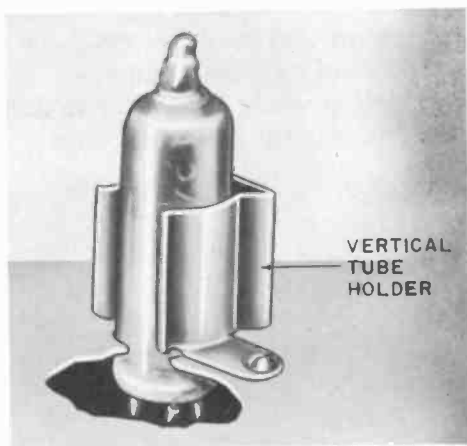

Fig. 364. Component holder for vertical support. (Atlas E-E Corp.)

with motorized equipment. A terminal board using swaged terminals is also shown in Fig. 361. These boards come in nylon, paper and cloth laminates, and other materials bonded with resins such as silicones, phenolics and melamines.

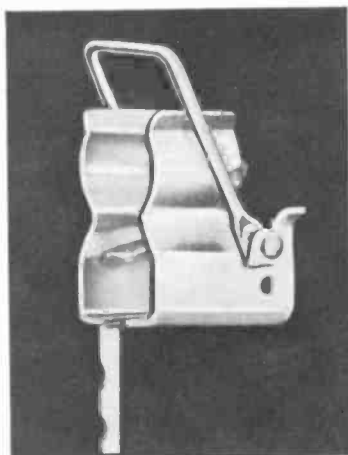

Fig. 365. The locking type component holder gives a positive grip. The large surface area of the holder helps heat dissipation. (Atlas E-E Corp.)

Flea clips

A rather odd terminal is the "flea clip," so named because of its size. Designed especially for mounting subminiature tubes having

co-planar leads, the flea contact is shown in Fig. 362. It is made from beryllium copper and then silver-plated. Mounting is accomplished by pressing the clip into a 1/16-inch-diameter hole. The lower end of the clip has a tapered hole which will take up to 1/32-inch-diameter wires, and the entire assembly can be soldered, if required, for permanent tube lead mounting. Where tighter fits are needed in production work, the clip is mounted in .050-inch square holes punched out of the base stock with a die.

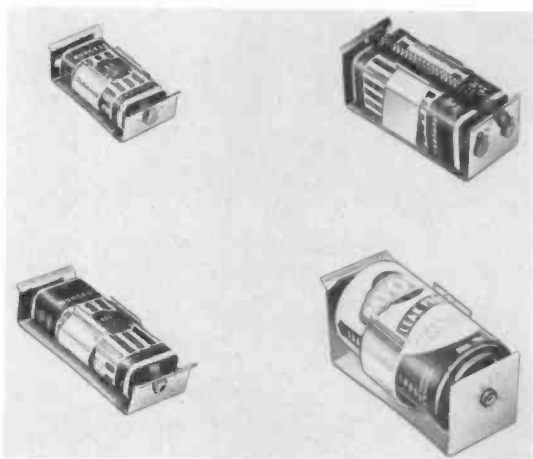

Fig. 366. Various types of battery holders.
(Austin Co.)

Component holders

Another important class of subminiature and printed-circuit hardware is the component holder. These have been manufactured to hold everything from an electrolytic capacitor to a subminiature diode. A common type, the spring clip, is shown in Fig. 363. Vertical holders (Fig. 364) permit component mounting in limited spaces, especially where part of the tube envelope can be kept below the plane of the base board or chassis. Another component holder is the locking type shown in Fig. 365. This gives a more positive grip and increased contact pressure which helps to reduce heating of the component being held. Clips are also available with integral soldering lugs where grounds or common tie points are required.

Battery holders

Fig. 366 shows a few battery holders designed to make battery replacement easier. Numerous constructions are available, including dimpled ends, spring retainers, insulated and noninsulated

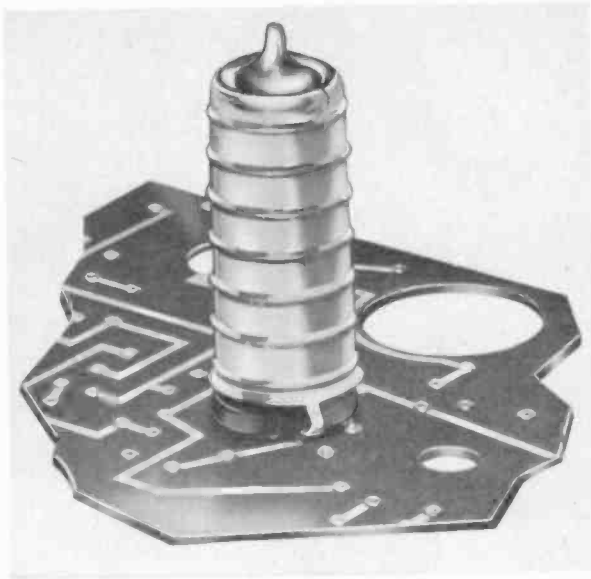

Fig. 367. Metal shield designed specifically for printed-circuit use. (Staver Co.)

bodies, and series-parallel combinations. The usual construction material is aluminum. Sizes available range from single penlite cells to holders for as many as four size-D flashlight cells. Models are made for mercury cells as well as ordinary carbon types.

Shields and heat sinks

Heat, vibration and electrical interference have always been enemies of electronic circuitry, and several ingenious designs have been produced to minimize the effects of these elements on vacuum tubes used in subminiaturization and printed-circuit work. One form of shield for printed-circuit boards is shown in Fig. 367. A modification of a standard miniature shield, it has a flared bottom to allow the shield to fit over the ground lug of the printed-circuit socket and provide contact from shield to circuit ground. A vertical seam makes up for minor variations in tube diameters. The materials used for construction are tinned steel and aluminum. A subminiature shield clamp is shown in Fig. 368.

Shown in Fig. 369 is a corrugated shield insert designed to reduce miniature-tube temperature and prolong tube life. The device is made of .003-inch-thick spring brass with a dull black finish. The corrugated strip is cut to the proper length and formed

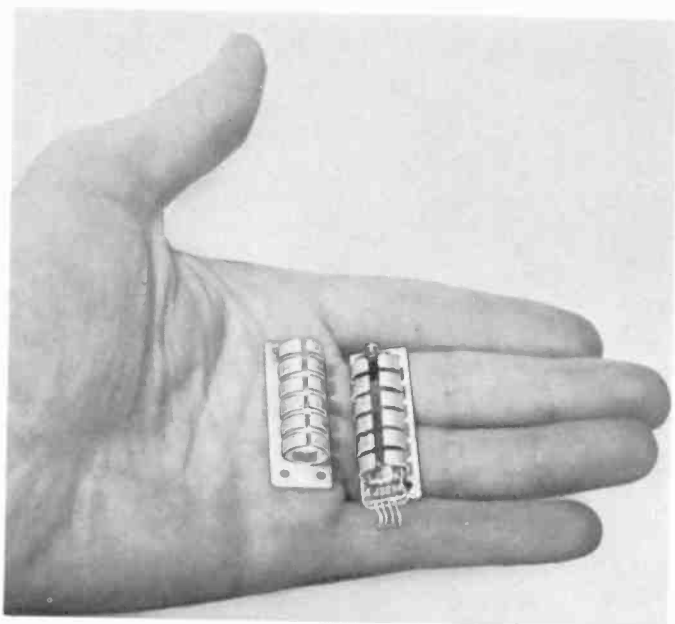

Fig. 368. Shield clamp used with subminiature tubes.

into a cylinder which is then fitted between the tube and a conventional shield. The corrugations touch both tube envelope and shield, providing heat transfer to the shield and shield base. The

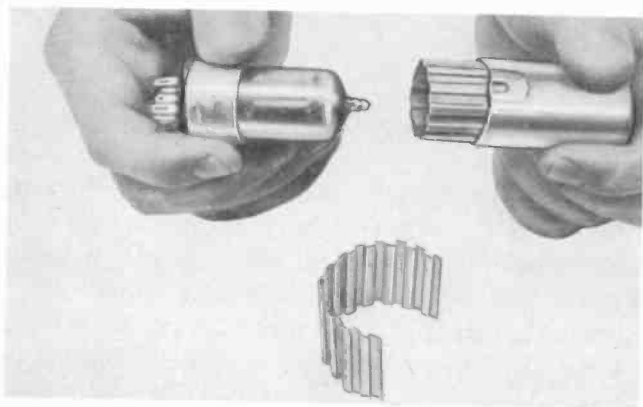

Fig. 369. A corrugated shield insert is often used to help reduce tube temperature. (Bircher Co.)

corrugated shield inserts come in several sizes to fit T-5 1/2 and T-6 1/2 tube envelopes. Other forms are available for the sub-miniature T-3 series.

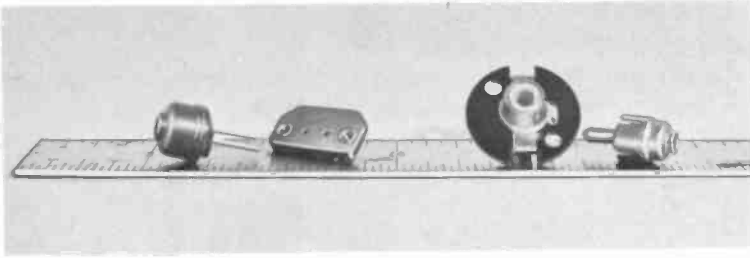

Fig. 370. Extremely small jacks and plugs are needed for compact circuitry.

Individual plugs and jacks

A few of the smaller plugs and jacks adaptable to printed circuits and subminiature use are shown in Fig. 370. The principal points to keep in mind when choosing this type of component is the ease of connecting and disconnecting, and the contact resistance of the combination. Insulating materials vary from nylon to phenolics, depending on voltage breakdown ratings. Contact springs are ordinarily beryllium copper, brass or phosphor bronze. Both open, closed and combination jack circuitry is available.

Electro-acoustic devices

An important class of components used as input-output transducers are microphones, earphones and speakers. Converting sound pressure into modulated electrical voltages and currents, these components have also shrunk to accommodate printed-circuit and subminiature requirements. Typical miniature microphones and speakers are shown in Figs. 371 and 372.

Subminiature tubes

Despite the advent of transistors, certain factors such as standardization in manufacture, power ability at higher frequencies, lower first cost on many types of tubes, and availability of multi-

Fig. 371. Typical miniature microphones and speakers.

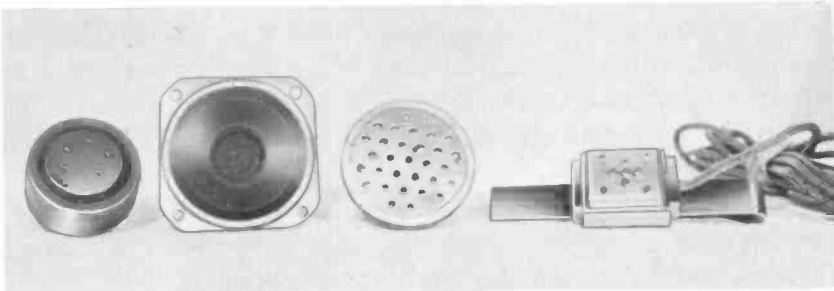

purpose types in one envelope still weigh heavily in favor of continued use of subminiature tubes.

Subminiature tubes are generally of two types—the round envelope and the flat press. Both are shown in Fig. 373, compared to a conventional seven-pin miniature tube.

Considering the size of these tubes, it is almost a miracle that

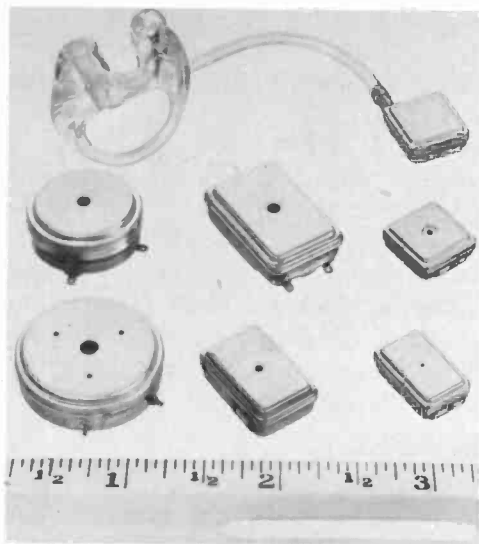

Fig. 372. A variety of "flat" earphones made primarily for hearing aids. (Courtesy Knowles Electronics.)

they can be made, not only to work, but also to be fairly consistent in overall performance. Among the manufacturing problems involved are holding dimensions in the spacing between elements, life expectancies and envelope sealing. Sealing techniques employ special gas atmospheres and tooling. The part carrying the electrode pins, called the mount, is sometimes assembled separately and then set up in special supports. Then the glass envelope is pressed around the mount. The electrodes are also premounted in certain methods of manufacture in a "button" made of glass. This button, in turn, is joined to the tube envelope in later steps of the tube-making operation.

Common filament materials are tungsten wire and nickel alloys. Cathodes are generally coated with metallic oxides. Carbonized nickel is used by several manufacturers for anodes.

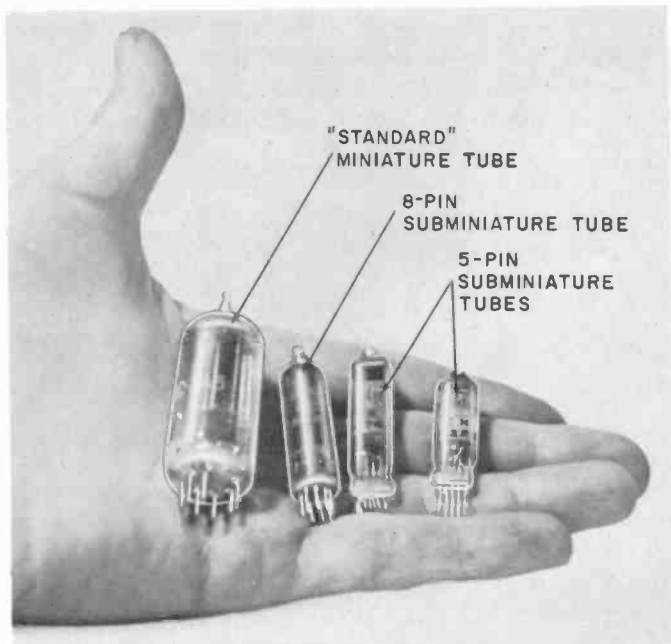

Fig. 373. Round envelope and flat-type subminiature tubes. Note their relative sizes as compared to a standard 7-pin miniature tube.

Cautions in use

With small size, the technician must expect to accept a few problems. Among the bugs present in subminiature tubes are microphonics, poor heat-life ratings, mounting considerations, shielding methods, and the concept of "reliability." Microphonics are the spurious electrical outputs caused by conditions such as vibration, shock or other mechanical forces. The manufacturer tries to overcome this problem with more rigid electrode assemblies, and by relocating electrodes to give the least spurious outputs with external disturbances.

Heat dissipation is a very common problem in subminiature assemblies where component density is high and there are many tubes in the circuit. One method of reducing heat on the tube is shown in Fig. 374; a shield-base-plate combination conducts the heat away from the tubes and radiates it to the air. Excess heat and elevated temperatures also electrolyze the tube leads and they react with the glass in the envelope. Heat will also cause gas to be driven from the tube walls and internal elements of the tube, reducing the life expectancy of the tube.

“Reliability” is a measure of confidence in the use of the tube. Will a certain tube always give a certain number of hours of life under a certain set of conditions? Of, say, 100 tubes, how many will fail after so many hours of use? These are only two of the

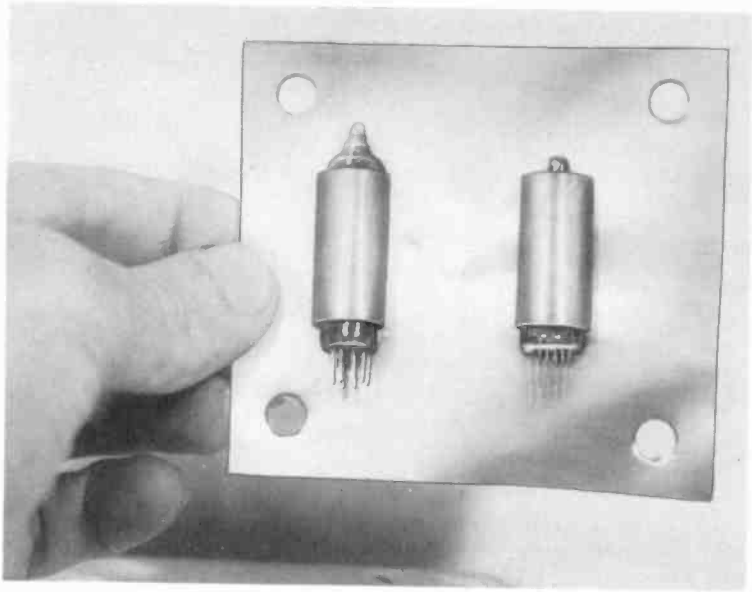

Fig. 374. The combination shield-base-plate helps keep the tube cool.

questions that “reliability” studies attempt to answer. The tube manufacturer is constantly caught in a maze of compromises to achieve dependable performances. In general, two things can happen to affect tube life adversely. The first is that manufacturing know-how can be at fault and the second is that the user can misapply the tube, putting it into a circuit for which it was never designed. The average tube manufacturer employs 10 to 20 tests on a single tube to insure a minimum standard of performance. In the case of the so-called “reliable” or “premium” tubes, the tests often number up to 50. The state of the subminiature tube art has reached the point where a 1,000-hour guarantee is common and 5,000-hour guarantee on the “reliable” types are becoming standard.

Testing subminiature tubes

The most frequent complaint with these tubes is an open filament. This is not surprising since many subminiature tubes operate at A-voltages of 1.5 or less, and sudden surges or accidental

shorts in the filament circuits can be fatal. Filament continuity can be checked with an ohmmeter using one of the higher ranges such as 100,000 ohms or 1 megohm full scale. This is a precaution to prevent the ohmmeter battery from burning out the low-voltage filaments. In making such a check, remember that high-loss dielectric surfaces can indicate false shorts due to leakage resistance, so the ohmmeter probes should not be allowed to come in contact with plastic tabletops or plastic chassis.

Subminiature semiconductor devices

Transistor theory and operation have been covered much more thoroughly in many other books, and only the highlights of transistor techniques as affected by printed circuitry and subminiaturization will be dealt with here. The transistor consists of a wafer of semiconductor material—either germanium or silicon—to which three external leads are attached. Depending on the manufacturer and the particular design, the assembly is encased in metal or glass. In contrast to its minuteness, it is a very rugged component mechanically, especially under shock and vibration. However,

Fig. 375. A number of small component mounting clips are designed for holding transistors to a chassis.

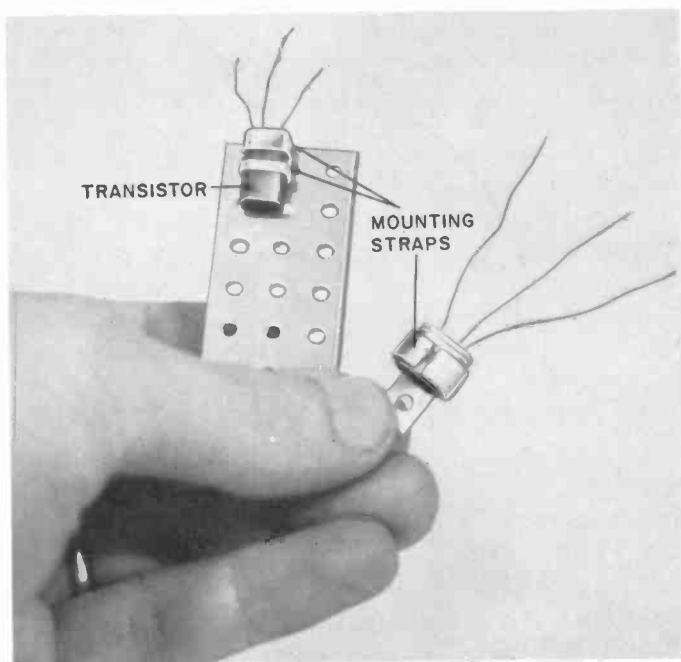

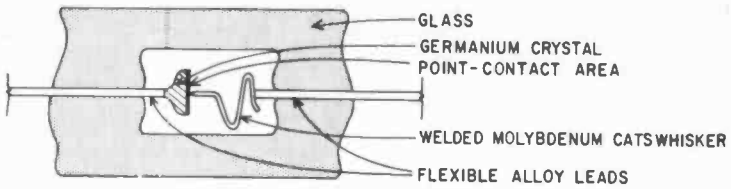

Fig. 376. Internal construction of a germanium diode.
(Hughes Electronics)

transistors are very susceptible to electrical and heat damage. When handling transistors check and double-check manufacturer's data on the unit. Polarities with respect to batteries must be watched closely; the so-called n-p-n types are not directly inter-

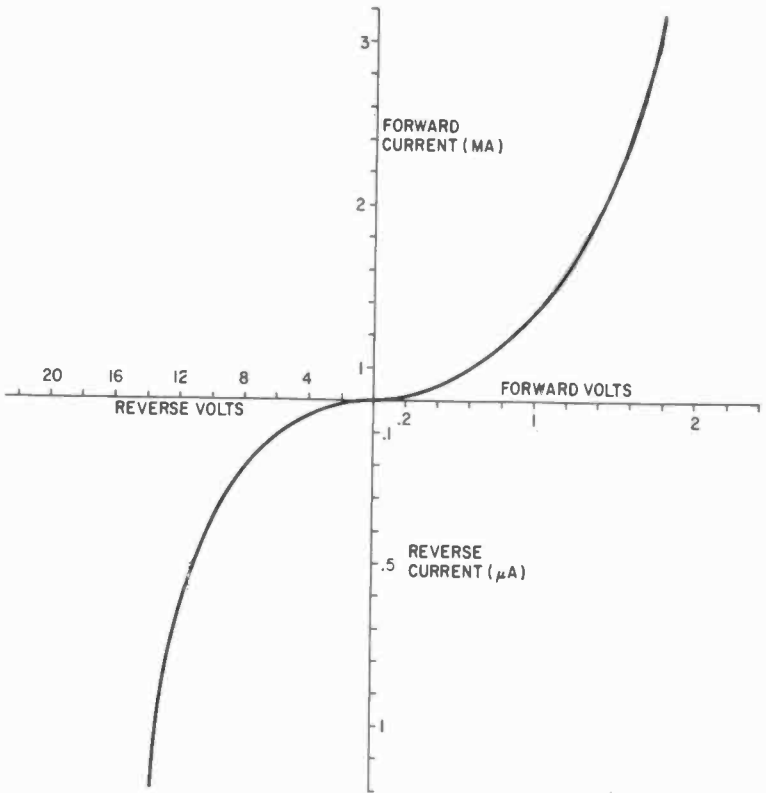

Fig. 377. Characteristic curve of a semiconductor diode shows that it will pass more current in the forward than in the reverse direction.

changeable with the p-n-p on this account. Whenever possible, meters should be used to monitor circuit currents. One potential

danger to transistors, overlooked many times, is using a high-level output from a signal generator to troubleshoot. Do not use a low-range setting on an ohmmeter because of the applied voltage which might damage the transistor.

Mounting transistors

Transistors can either be soldered in or put in sockets. If the transistor is soldered into the circuit, a heat sink must be used

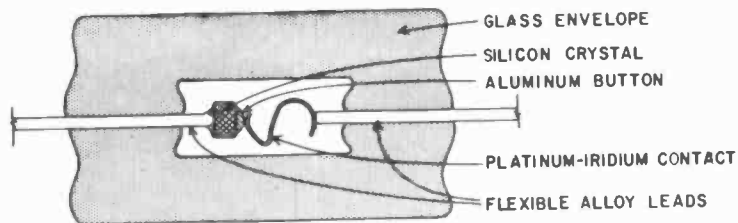

Fig. 378. Internal construction of a silicon diode. (Hughes Electronics)

during soldering. Also use as much of the pigtail as possible and try to keep the heated point as far from the body as you can. Clipping a small alligator clip on the lead during soldering helps dissipate some of the heat that would normally be conducted to the transistor body. Do not twist the leads or bend them too much in installation. They will withstand a few gradual 90° bends, but will not take repeated sharp bends without breaking off. Several

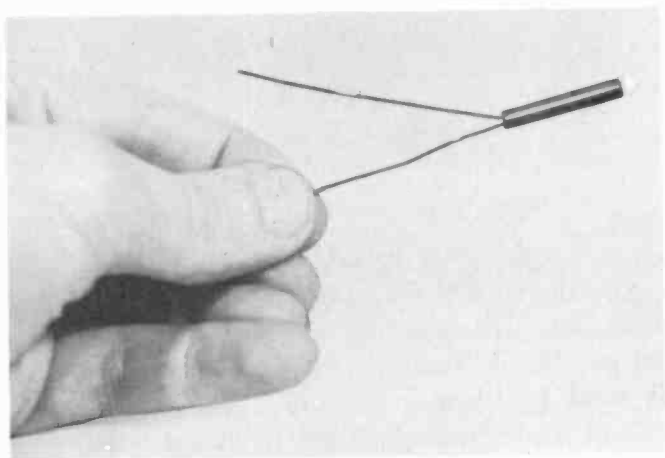

Fig. 379. A typical midget selenium photodiode.

small component mounting clips are made to hold transistors on a chassis. These are shown in Fig. 375.

Testing transistors

Transistors can be tested by substitution or by instruments. The substitution method is more reliable. When checking transistors in place on a chassis, be careful with any sort of test prods. Printed-circuit connections and associated subminiature components are packed in tightly and it is very easy to short-circuit a few terminals with the prod. Accidental shorts can produce enough current to ruin the transistor and, quite often, a few other components.

Diodes

It is difficult for the average user to determine if transistors or diodes are more important and also which of the two components are in wider use. Often mistaken for 1/4-watt carbon-composition

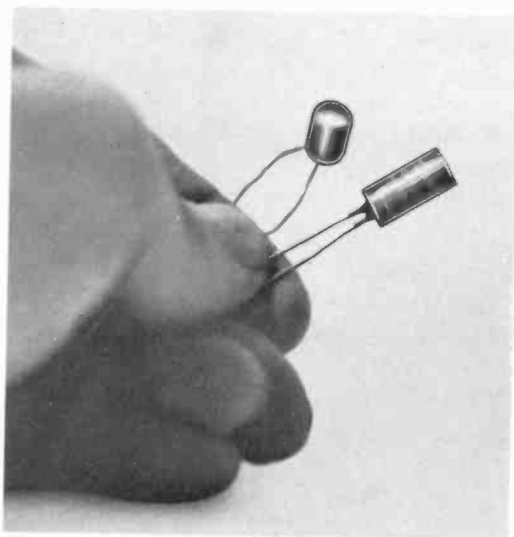

Fig. 380. Cadmium selenide photodiodes.

resistors at first glance, the diode performs all sorts of tasks from simple rectification to FM detection. A major field of use is computers where, in conjunction with small magnetic "memory cores," the diodes provide decision-making and information storage in incredibly small packages.

The bulk of diodes manufactured today are encased in glass envelopes which seal the semiconductor materials from the atmosphere and act as a rigid support at the same time. The wire leads and the glass envelope are made so that they have as near equal temperature coefficients of expansion as possible to insure

against cracking. The semiconductor material is mounted at the end of one of the leads, and a cat's whisker electrode is mounted at the end of the other lead. Various color codes and symbols are used to indicate polarity of the diode. Typical construction is

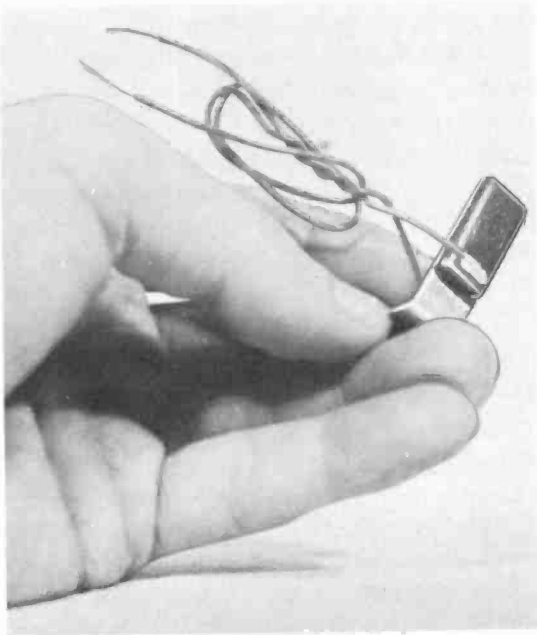

Fig. 381. Germanium photocell. This type of unit can provide power for small radios when a number of the cells are used. (International Rectifier Corp.)

shown in Fig. 376. The average size of such diodes is about $1/8$ to $3/32$ inch in diameter by $1/4$ to $3/8$ inch long, the leads being anywhere from $1-1/2$ to 2 inches. The glass is often coated with an opaque material to cut down effects of light, since many semiconductors are photosensitive.

Basic rectifier characteristics are shown in Fig. 377. The curve simply says that in one direction the diode will conduct more than in the opposite direction. Another way of looking at it is that the unit has a high backward resistance and a low forward resistance. For applications where plain rectification is needed, the user is not concerned too much with a property called recovery time. However, in certain cases, such as computers, the so-called recovery characteristics are very important. This ability of the diode to reach a certain current value or voltage drop in a certain time

is tested by applying a current or voltage pulse. Recovery time is measured in both forward and reverse directions.

Diodes, like other semiconductor devices, are very sensitive to temperature extremes. When soldering, some heat sink such as pliers or an alligator clip should be inserted between the diode body and the soldered point. Spot-welding techniques can be used to apply concentrated heat for very small periods of time.

Silicon diodes, a newer development, permit operation at higher temperatures than germanium and, as a result, also give more power-handling ability than germanium units at lower corresponding temperatures. Normal ranges of germanium diodes run from 60° to 180°F, whereas silicon units operate as high as 270°F. Silicon is a very brittle material, and some silicon diode designs make provision for this property. In the unit shown in Fig. 378, a spring and soft metal mounting button are used to overcome breakage due to sudden shocks and thermal expansion.

Subminiature photoelectric devices

The major materials used at present for small photosensitive elements are the semiconductors, germanium and selenium, and compounds of cadmium with sulfur and selenium. A representative midget selenium photodiode is shown in Fig. 379. About 1/10 inch in diameter and under 1 inch long, it has found use in punched tape reading, scanning and photographic exposure-metering devices. This photodiode has a small, polished germanium slab mounted in a molded plastic body. A tungsten whisker comes up to the slab, and the whisker is bent to bear down on one point of the germanium surface. Leads about 1/32 inch in diameter are brought out from the slab and whisker, through the body, and are color-coded. Illuminating the germanium slab causes its resistance to change. Current will increase with an increase in light. The diode can also be used in modulation applications such as "sound on a light beam" since the frequency response is in the range of 10 to 50 kc.

The units shown in Fig. 380 have a cadmium selenide compound as the photosensitive material. This type of photodiode is sensitive to gamma and X-rays as well as infra-red. Current for a given amount of light is dependent on the applied voltage. Typical operating data are 400 microamps at 100 volts dc and 2 foot-candles, with a decrease to about 40 microamps under the same illumination and 10 volts dc. The diode produces a slight amount of current (dark current) when in total darkness, and

this is in the order of less than 1 microamp. Some versions of this diode have been built with light-to-dark current ratios of 10,000 to 1.

Fig. 382. A module is a vertically-stacked array of components. The parallel wafers are supported by wires known as risers. (Courtesy Aerovox Corp.)

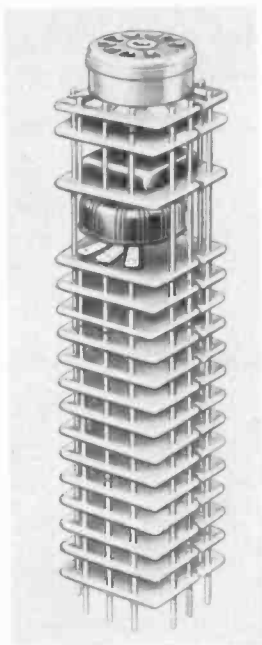

The germanium unit shown in Fig. 381 requires no external emf for excitation, and will produce up to 2 ma across a 10-ohm load. A common experimental use is with a 0-1-ma meter as an exposure meter. The unit mounts on a bracket and is just under

Fig. 383. Method of building a module using laminates and copper wires.

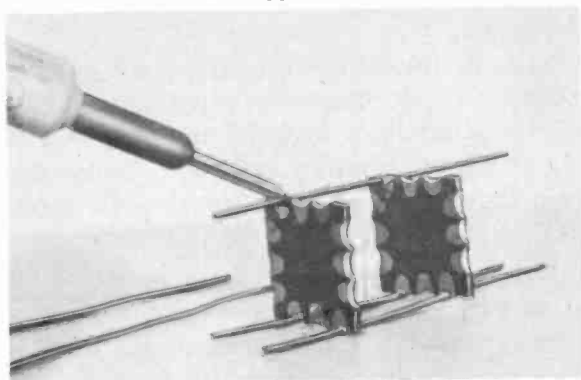

1/2 inch wide by 3/4 inch high and 1/32 inch thick. Banks of these units may be series- and parallel-wired to drive small transistor receivers.

Modules and packaged circuits

Many components are sometimes wrapped up in one package

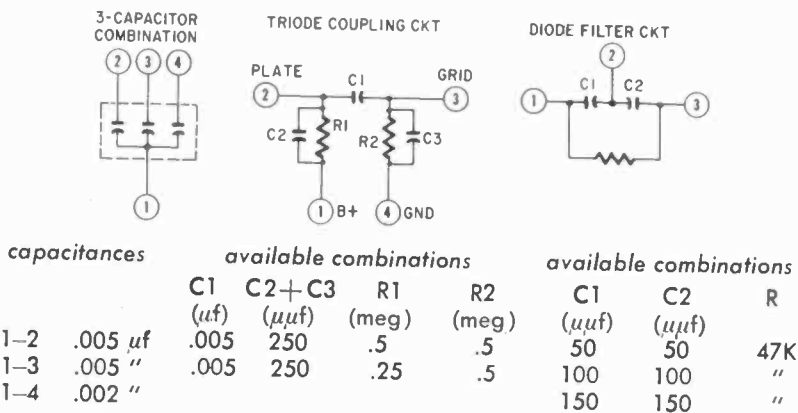

Fig. 384. "Packaged circuit" schematics are available in various combinations. (Courtesy Sprague Electric Co.)

for ease in replacement. Some ceramic-based wax-coated units contain as many as two or three capacitors and a like number of resistors. Others include a three-capacitor combination, a diode filter circuit and a triode coupling circuit. Advanced forms of these ceramic-based units include audio output circuits and detector-pentode coupling circuits. Nine or 10 resistors and capacitors are common in the latter two circuits.

Repair of such packaged circuits is not practical, and ease of replacement and relatively low cost account for the growing use of such components.

A three-dimensional module (sometimes referred to as a Tinkertoy) is shown in Fig. 382. The experimenter can duplicate some of these with laminate material and copper wire as shown in Fig. 383. Tinkertoy modules are made commercially in the form of video limiters, cathode followers, multivibrators and dc regulators.

A third form of commercial module or packaged circuit is the unit shown in Fig. 384. The resistors are molded-composition types and the capacitors are tubular ceramics. Each resistor and capacitor is about 1/8 inch in diameter by 5/8 inch long, and

th
ar

INVOICE



Gernsback Library, Inc.

154 WEST 14th ST., NEW YORK 11, N. Y.

BILLS
PAYABLE
WITHIN
10 DAYS

FOR SERVICING PRINTED CIRCUITS

\$3.35

KEEP THIS PART OF STUB FOR YOUR RECORDS

(Cut Along Line)

LIBRARY
IND ARTS DEPT
EASTERN KY STATE COLLEGE
RICHMOND KY

SERVICING PRINTED CIRCUITS \$3.35

IMPORTANT: PLEASE RETURN EXACT AMOUNT WITH THIS STUB

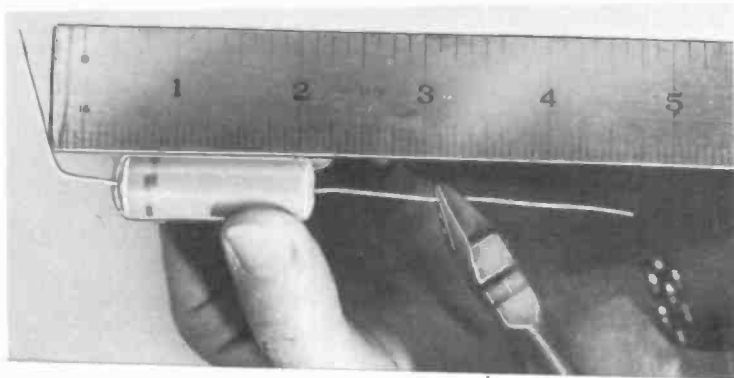

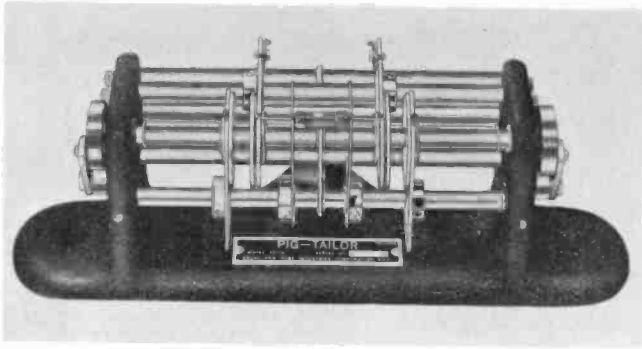

Fig. 387. A "pig-tailor" for measuring, bending and cutting component leads. (Bruno-New York Industries)

Among the more advanced modules are the multistage subminiature tube amplifiers.

Preparation of component leads

One of the methods used to prepare component leads for use

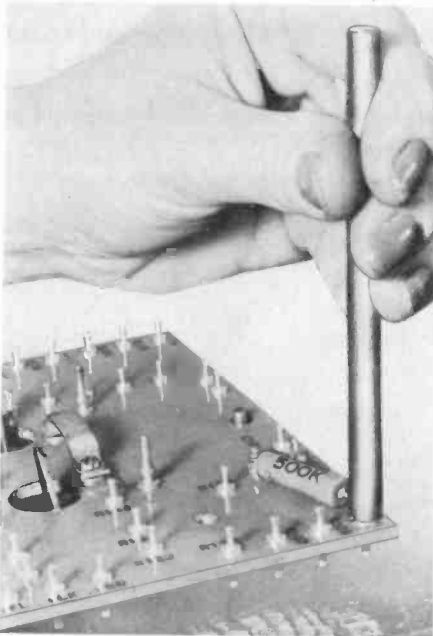

Fig. 388. A spinning is used for wrapping component leads around turret-type terminals. (Bruno-New York Industries)

in printed circuitry and subminiature work is "pig-tailoring." The amateur experimenter can duplicate this technique on a small scale

by building a jig consisting of nails on a board. The component is then laid on the board and the leads bent to the desired configuration and cut to length. These procedures are shown in Figs. 385 and 386.

A commercial machine has been developed to perform these operations in a very efficient manner. The machine, shown in Fig. 387, can be hand-operated, foot-operated or motorized, and is capable of simultaneously measuring, bending and cutting both axial leads of a component to accurate sizes and shapes. Only 2 to 3 minutes is required to make a specific lead-forming setup. Any component 1-inch in diameter or less and 6 inches in overall length (including leads) or less can be "pig-tailed." Bends can be made as close as 1/16 inch to the body of the component. The unit occupies less than 1/3 square foot on the bench.

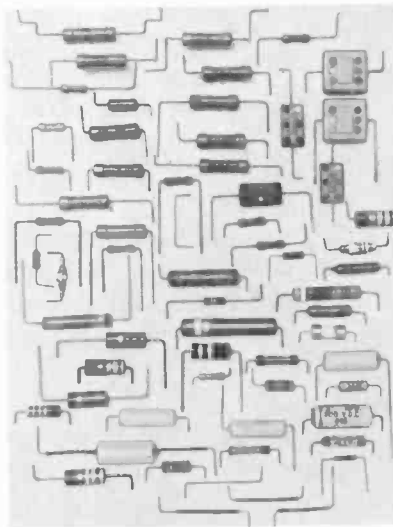

Fig. 389. Types of component lead shapes produced by pig-tailoring. (Bruno-New York Industries)

The body of the axial lead component is placed between two guide supports which are free to move along a guide-support shaft. The component leads fall into notches of shearing and bending elements; one set of shearing and bending elements is used for each component lead. Depressing the main drive lever will move the shafts, which in turn actuate the shearing and bending elements. The direction that each shaft rotates is adjustable with drive links and, by changing drive link positions, S- or

U-shaped leads can be produced. Adjustments are made with Allen type setscrews.

An added feature is the ejector mechanism which is part of the bending elements. The ejector fingers travel vertically between stationary and rotary members of the bending elements when the main drive shaft is actuated. When the rotating blades of the bending elements are clear of the notches in the stationary blade of the bending element, the ejector fingers move up and carry the component leads out of the notches. The components fall forward into a receiving tray and the rejected ends are cast outside the immediate work area.

A slotted tool known as a spinpin is used to wrap the ends of the tailored component leads around turret-type terminals. This tool is a substitute for the needle-nose pliers normally used for such operations and requires less skill to produce acceptable wraps. The spinpin helps cut down broken leads and broken component bodies by allowing the operator to "feel" tautness in the lead as it is wrapped. Handling of the chassis or terminal board is cut down since the spinpin can be used in any place where it reaches. Another advantage is that the lead can be wrapped until no end is left, thus eliminating a clipping operation. The spinpin is shown in action in Fig. 388.

The variety of work produced by pig-tailoring is shown in Fig. 389. The components pictured are used for printed circuits, turret terminal assemblies, socket terminations and tie-point terminations. S- and U-shaped bends in two and three planes are possible.

batteries and power sources

ENERGY sources for printed circuits and subminiature equipment have only recently begun to match the equipment itself in size and power requirements. Recent advances are refinements of long-known electrochemical systems. Few battery systems, however, even approach the transformer or electric motor in *overall* efficiency. The original Leclanché “carbon-mix” cell has progressed from a service life of 3 to 4 hours in 1912 to 12 and 15 hours today in flashlight applications. Industrial types of the D-cell have been made which yield 15 to 20 hours’ use on low-resistance long-duration loads. Following the A-battery improvements have come the flat-cell techniques which make possible very compact B-batteries. Early hearing-aid B-batteries which yielded a useful life of only 10 to 20 hours now have lives measured in hundreds of hours on a comparable load basis. From hearing-aid battery design to printed-circuit and subminiature use has been a very short step.

Classification of batteries

Tradition classifies batteries into two main types—dry or wet, primary or secondary. Primary units are not made to be reusable; however, they can be recharged experimentally. The most common example is the ordinary carbon-mix flashlight cell in which the central electrode is a carbon rod, the outside zinc case is the remaining electrode, and the electrolyte is ammonium chloride. Manganese dioxide is added to the central mix as a depolarizer. This depolarizing action removes hydrogen which harms the cell.

A few improvements have been made recently, one of the most noteworthy being the "reversed" type of construction in which a carbon-coated jacket is put outside the cell and zinc sheets or vanes are distributed inside. The carbon jacket, inert to chemical

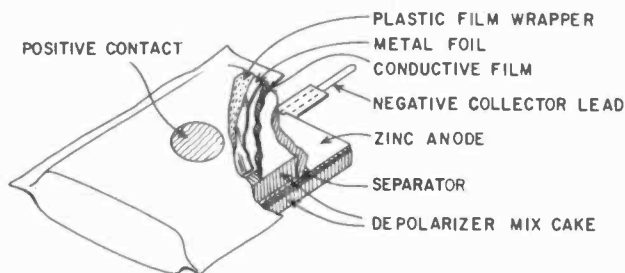

Fig. 401. A reversed-construction dry cell. (Courtesy National Carbon Co.)

attack, keeps the unit from leaking electrolyte even after the zinc is used up and the battery is dead. The cell depolarizes somewhat

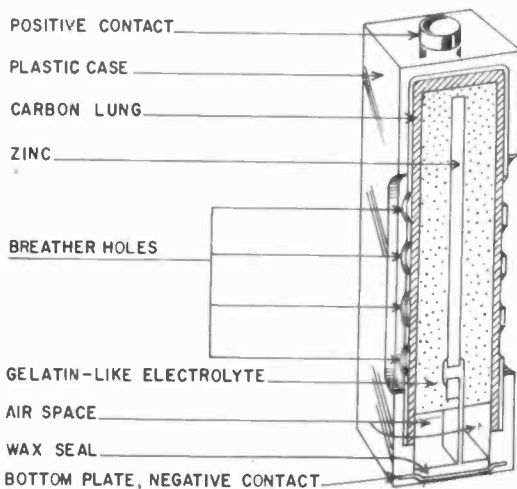

Fig. 402. An air-depolarized cell. (Courtesy National Carbon Co.)

better than the older type. A typical commercial unit is shown in Fig. 401.

The drawbacks of poor shelf life, a drooping voltage-vs-time discharge curve, and sensitivity to temperature have kept this type of electrochemical system from widespread use in printed-circuit and subminiature devices. This type of battery, however,

is still low in first cost, and many users find it suitable for low-quantity applications.

Air cell

Shown in Fig. 402 is an air-depolarized cell which has a zinc center electrode and a porous carbon outside electrode. The mix is a jellylike composition, and the air diffuses through the porous

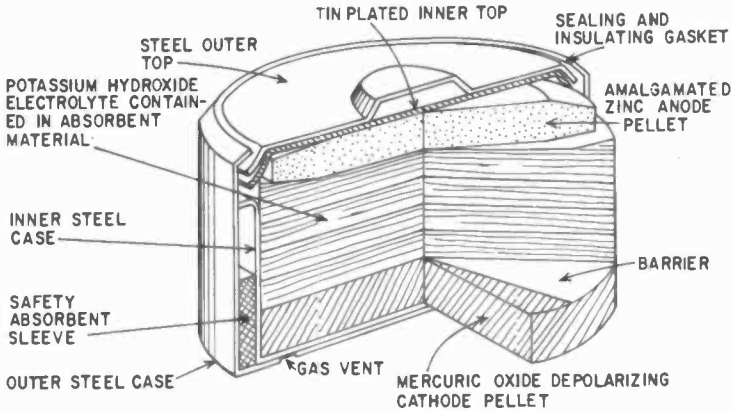

Fig. 403. Typical mercury cell. (Courtesy P. R. Mallory & Co.)

carbon to depolarize the unit. It is activated by removing a tape seal which the manufacturer puts over the outside case of the battery. It has a flatter discharge curve than the Leclanché cell, but still possesses the inherent disadvantage of poor shelf life, even before the activating seal is removed.

Mercury cells

Developed out of wartime research, the mercury cell is pictured in Fig. 403. The main construction features of such cells are: 1) Cell cases and outer tops made of nickel-plated steel to resist external and internal corrosion; 2) Inner tops plated to provide internal surface for a zinc-amalgam bond; 3) Molded sealing gaskets of neoprene or polyethylene plastic; 4) Pressed-powder anodes made of high-purity pelleted zinc powder; 5) Pelleted mercuric-oxide-graphite depolarizing cathodes; 6) Permeable barrier between electrolyte and depolarizer; 7) Nickel-plated outer steel jacket and inner steel case, with an absorbent sleeve that vents gas built up in the cell and 8) Potassium hydroxide (alkali) electrolyte held in absorbing material.

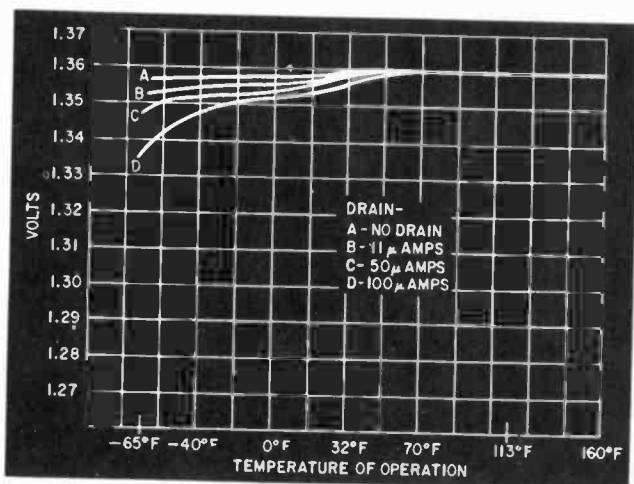

Fig. 404. Typical voltage-vs-temperature curve for a mercury cell.

Using the mercury cell

Fig. 404 shows a typical mercury cell voltage-vs-temperature curve under light current loads. Heavier loads tend to drag the voltage down more at the lower end of the temperature scale. Most amateur and experimental uses are near room temperature so that drains of 10 to 500 ma can be obtained without severe low-temperature voltage losses.

Another interesting curve is shown in Fig. 405. At low drain

Fig. 405. Typical voltage-vs-time curve of a mercury cell.

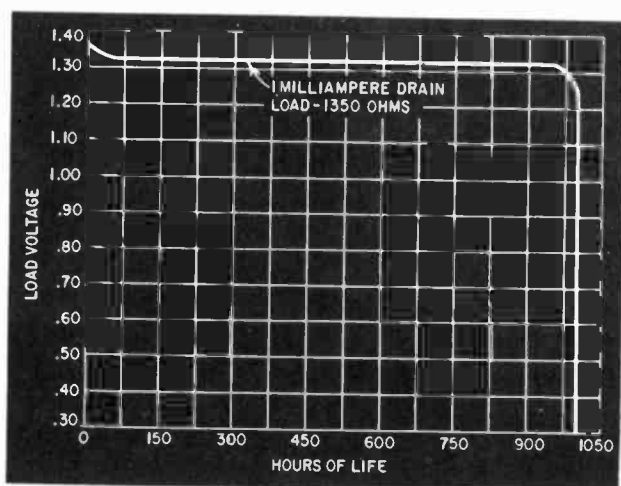

and a 1-milliampere load, the voltage-time curve at room temperatures is extremely flat, suggesting the use of the cell as a voltage standard. Some commercial use has been recently made of this characteristic in potentiometer and measuring circuits.



Fig. 406. Several typical mercury cells and batteries. (Courtesy P. R. Mallory & Co.)

Several typical cells and batteries are shown in Fig. 406. Button and tab connections are standard, but pigtail and plug-in units are available on order. Cells can be stacked in various series and parallel combinations to give higher voltage or current combinations.

One note of caution when using mercury cells: They should never be exposed to open flames or thrown into garbage dumps where there is a possibility of incineration. Like any other type of cell, extreme heat causes them to “pop,” as would a closed can of beans under the same circumstances.

Primary-cell sizes and terminations

Common sizes of cylindrical and flat primary units are given in Table 4-1.

Table 4-1. Size and Voltages of Dry Batteries

<i>approximate size</i>	<i>voltage</i>	<i>american standards association designation</i>	<i>typical commercial types</i>
63/64" dia x 1-15/16" high	1.5	C	Burgess type 1; Eveready 935
35/64" dia x 1-31/32" high	1.5	AA	Burgess type 2
5/16" dia x 2-3/8" high	1.5	D	RCA VSO36; Eveready 950
1-1/16" long x 5/8" wide x 1-1/2" high	15	10F20	Burgess U-10; RCA VSO83; Eveready 411
1-1/16" long x 5/8" wide x 2" high	22.5	15F20	Burgess U-15; RCA VSO84; Eveready 412
1-1/16" long x 5/8" wide x 2-9/16" high	30	20F20	Burgess U-20; RCA VSO85; Eveready 413

D-, C-, and A-cells are more familiar as flashlight cells. The so-called penlite cells vary in size, some manufacturers referring to them as AA- and others calling them Z-size. Mercury units have



Fig. 407. Batteries for radios are available in a large number of sizes and shapes.

been partially standardized around nominal diameters of $\frac{3}{8}$ and $1\frac{1}{4}$ inches. The normal mercury cell voltage is 1.34. Common voltages for the carbon Leclanché types are also shown in Table 4-1. Terminations in wide use are plug-in socket type, snap fastener and flat contacts. The B-subminiatures also have a dimpled end construction. Representative A- and B-units are shown in Fig. 407.

Secondary cells

Silver-zinc cells are one of the most promising developments in the field of secondary-cell power sources, and several commercial models have found application in subminiature devices.



Fig. 408. A typical rechargeable silver-zinc battery.
(Courtesy Yardney Laboratories.)

In contrast to lead-acid secondary systems, the silver-zinc cell (Fig. 408) is capable of about four times the amp- and watt-hour ratings per pound of battery. A vital consideration in the design of silver-zinc cells is the method used to keep the zinc electrode in one piece and still maintain a barrier between silver and zinc ions. The original design did this by using a semipermeable membrane in a "jelly-roll" construction. Present techniques permit the zinc to be held at the surface of the zinc electrode and extend the total number of cycles of useful life. The separator also prevents zinc from going over to the silver anode and silver from going back to the zinc cathode.

Water is consumed during the charging process, as shown by a decreased liquid level in the cell. In the dry-charged condition, the cell has a storage period which depends on temperature, humidity and atmospheric contaminants. Silver-zinc cells are noted for their high current rates on short-time discharges, but the cells can be modified to give low-current, longer-time characteristics. The cell evolves heat on high rate discharges. The temperature must be limited to values recommended by the manufacturer.

Among the commercial types made is a low-rate cell capable of 100 to 150 charging cycles, and rated in the order of 1 amp-hour with a drain of 10 ma and a nominal cell voltage of 1.2. Other

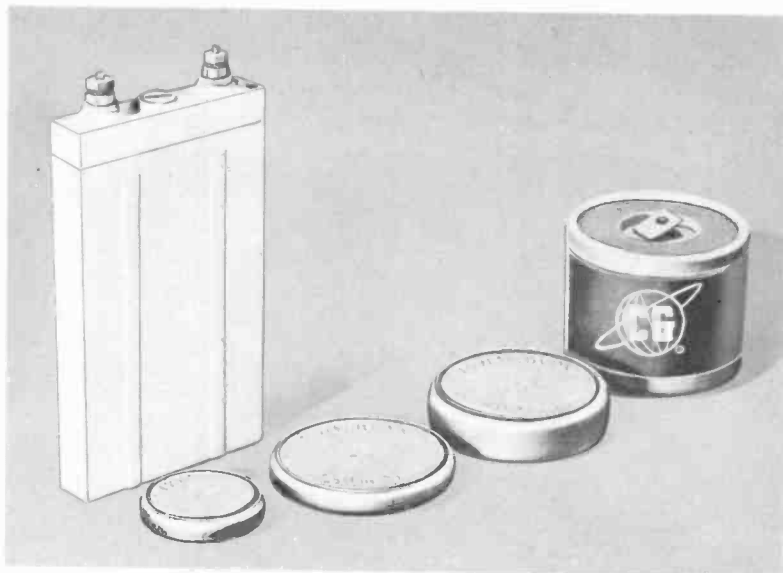

Fig. 409. *An assortment of nickel-cadmium cells.* (Courtesy CG Electronics & Gulton Industries.)

cells are capable of discharges in the order of tens of amperes for short periods of $\frac{1}{2}$ to 4 or 5 hours.

In maintaining this cell, the liquid level above the plates should not be kept constant and, unlike lead-acid cells, there is no need for specific-gravity readings of the electrolyte.

Nickel-cadmium cells

The nickel-cadmium secondary cell is an outgrowth of German developments in the early 1900's. Recent versions have sintered nickel-nickel-hydroxide anodes, sintered nickel-cadmium-hydroxide cathodes, and utilize a potassium hydroxide electrolyte. Cells are usually cased in polystyrene, nylon or steel containers. The nominal cell voltage is 1.2.

The sintered-nickel electrodes are made by running carbonyl nickel, a compound of nickel and carbon, through a hydrogen atmosphere after pressing the powder into grids. The sintering process produces a highly porous plate with about 80% void volume. The electrode chemicals are then introduced into the pores by impregnation. Differences in commercial versions of the cells come from various techniques in the impregnation process.

An important feature of the nickel-cadmium reaction is

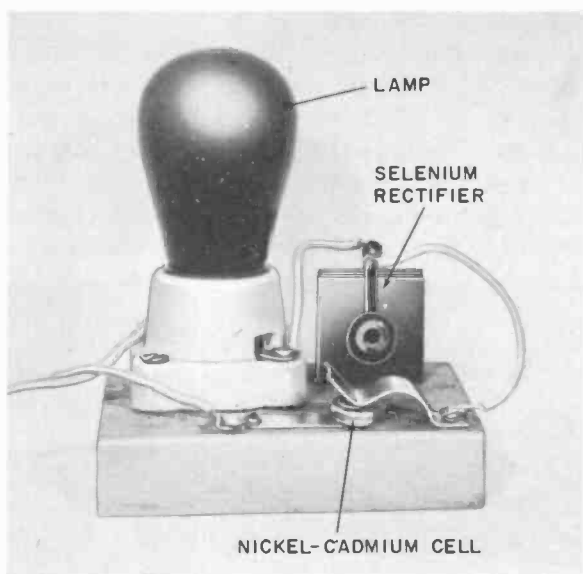

Fig. 410. Simple charger for nickel-cadmium cells. The lamp takes the place of a dropping resistor.

that the specific gravity of the potassium-hydroxide electrolyte does not change appreciably during charge and discharge cycles. Nickel-cadmium units appear to have the longest lives of all commercially available secondary cells, and are not as adversely affected by low temperatures as other types.

Terminations of this type cell are either nut and screw or

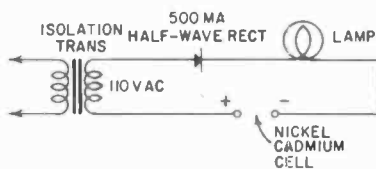
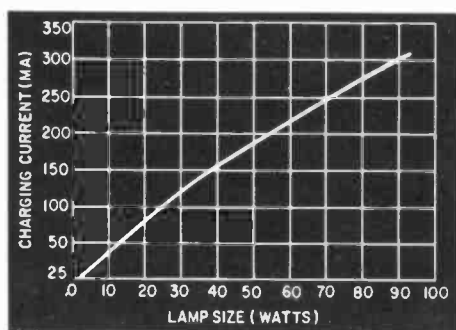

Fig. 411. Lamp-load curve for the charger shown in Fig. 410. (Courtesy Ace Radio Controls)

button. Smaller sizes (Fig. 409) are finding large-scale application in subminiature electronic devices, and they can be recharged very easily with simple equipment.

Recharging nickel-cadmium cells

Fig. 410 shows a home-made charger for use with button type nickel-cadmium cells. These are available in three popular sizes ranging from 80 to 1,750 milliamper-hours (mah). (Chargers of the type shown in Fig. 410 present a very real shock hazard. Always use an isolation transformer between the charger and the power line.) These cells can also be charged from conventional car batteries by putting a 100-ohm 10-watt rheostat in series with

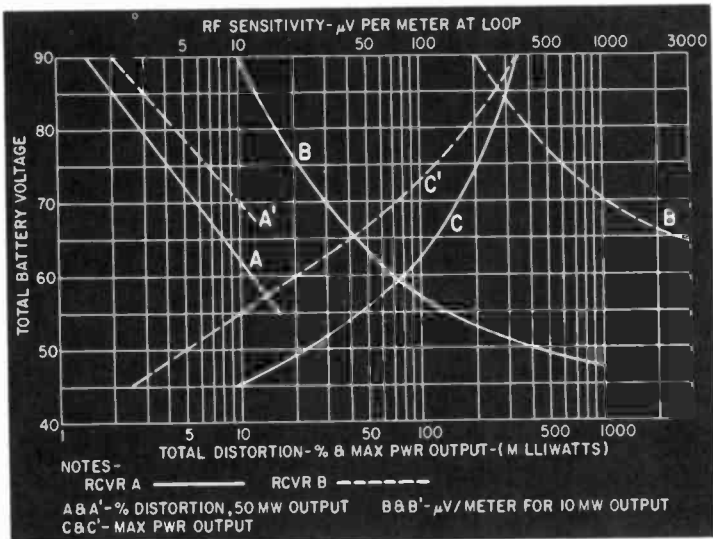

Fig. 412. Curves for B-battery rf performance. (Courtesy National Carbon Co.)

the nickel-cadmium cell and one 2-volt section of the car battery. A series milliammeter is a great help in adjusting the rheostat for a charging current of the desired value.

The curve in Fig. 411 shows the size lamp to be used to give the proper charging rate. In the case of the 250-mah cell, the cell can be fully recharged at a rate of 5 to 25 ma, which would call for a 10-watt lamp used to charge two cells in parallel, each cell taking about 25 of the 50 ma that the lamp passes. Charging current of the 500-mah unit is about 50 ma so that a single cell in series with the 10-watt lamp would be suitable.

Silver-cadmium cells

This cell is composed of a cadmium cathode in combination with a silver-oxide anode. Discharge voltages are in the range of 1.4 to 1.2. Two types of cadmium electrode are commercially pro-

duced. In the first, the active cadmium is put in a spongy material; in the second, the cadmium is impregnated. Silver-cadmium cells are generally slightly heavier than silver-zinc cells having the same volume of materials. Early research and experiments to date seem to indicate that the silver-cadmium cell is better adapted to shallow cycles and low discharge rates than the silver-zinc.

Using B-batteries

Unlike A-batteries in which current drain can be compared to discharge curves and life expectancies predicted, the life of the B-battery can be affected by several other factors. To say that a 22.5-volt B-battery is no good when its voltage under load drops to 18 is not sufficient. The B-battery end-point voltage is determined by rf considerations, output distortion in the circuit, maximum power requirements of the circuit, and oscillator stability in the case of oscillatory circuits.

Rf sensitivity is arbitrarily determined by choosing a transmit-

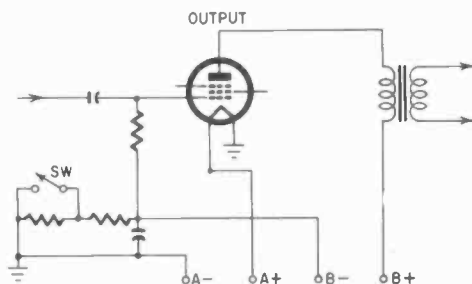

Fig. 413. Economizer circuit used to prolong B-battery life.

ter, setting up a radiation pattern with known field strength and modulation, and making tests on the output of the receiving device. In the case of broadcast receivers, a typical set of conditions might be a field strength of 1,250 microvolts per meter at 1,000 kc, modulated 30% at 400 cycles to give an audio output at the receiver of 10 milliwatts. Fig. 412 compares two receivers. Note that receiver A is a better design since, for a given B-battery end-point voltage, the maximum power output is greater and the required input signal for a given output is less. Receiver A can be used down to a 45-volt end point (from a 90-volt original emf) before the 10-mw output point is reached, but receiver B falls short at about a 68-volt end point due to the sensitivity figure going up above 1,250 microvolts per meter for the 10 mw output.

Battery performance

Antenna design affects B-battery performance, since it is tied up with rf sensitivity through the Q of the antenna circuit. A high

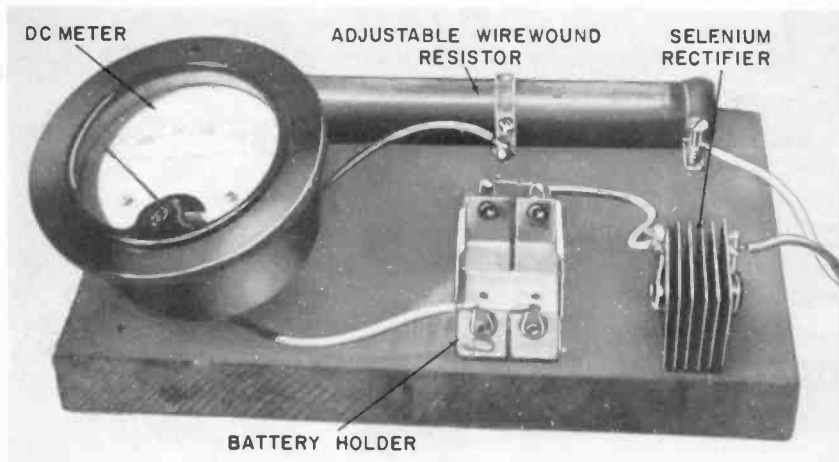

Table 4-2. Charging Rates and Times for Dry Cells

type of cell	charge rate (ma)	charge time	end voltage
penlite	50	¼ hour	1.6
flashlight	100	¼ hour	1.8
22.5-volt hearing aid	5	½ hour	24-26
30-volt hearing aid	10	½ hour	32-35
large flashlight (size D)	100	1 hour	1.8-2.0

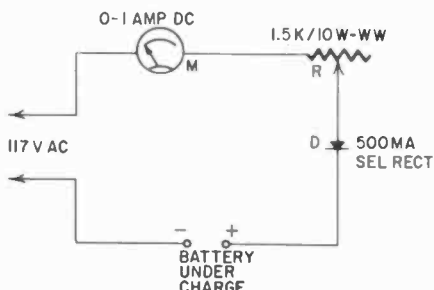

Fig. 414. Setup for rejuvenating dry cells. The table supplies the charging rate and time for various types of cells.

Q antenna, such as a ferrite or ceramic-ferrite-core loop, can improve B-battery life expectancy considerably.

Many circuit combinations are possible in which A- and B-battery characteristics are not matched for best life. The answer to such a problem is to ask for the battery manufacturer's recommendations.

A circuit for B-battery conservation is shown in Fig. 413. It consists of a self-bias resistor which has two sections. There is a shorting switch across one of these sections and, when the B-battery is new, the switch is left open. This overbiases the output tube and also reduces plate and screen currents of the other tubes in the receiver. When the B-voltage falls off in use, the switch is closed. This shorts the bias resistor and gives more power output. The disadvantages of such a circuit are that initial power is reduced a little and distortion is increased. However, the amount of power reduction and distortion is not enough to bother the average listener.

Testing batteries

No single standard exists today for battery testing. Each manufacturer makes special tests on his own batteries and those of his competitors. However, the American Standards Association has compiled a specification for dry cells and batteries under the sponsorship of the National Bureau of Standards. The specification (ASA C18.1-1959) has been issued by the National Bureau of Standards as their circular No. 559. Tests are usually based on a load condition that varies with severity of service and time. The purpose of each test is to simulate as closely as possible the actual conditions under which the battery will be used. Tests are normally made at 70°F.

Recharging dry cells

Although not recharging in the sense that reversal of chemical reaction occurs, a technique can be used to rejuvenate the Leclanché type of A- and B-battery. The process is really a depolarization effect in which the oxygen that collects on the carbon anode in discharge is driven off in recharging.

Fig. 414 shows a setup for rejuvenation experiments. A half-wave rectifier and resistor are used with a series ammeter (0-1,000 ma) and parallel voltmeter to furnish a dc supply adjustable for 1.5- to 30-volt batteries. Fig. 414 also shows the schematic and gives an approximate guide to what you can expect in the way of charging rates and times.

Several factors influence the success of recharging dry batteries.

These include the formula of the battery mix, the age of the battery, the amount of moisture left in the battery and, probably the most important, the duty to which the battery was subjected prior to recharging. A battery that was used on short, light loads would be more likely to recharge successfully for more cycles than a heavily loaded one. After recharging, the battery should be left sitting for a few hours to allow the voltage to stabilize. Otherwise, it will be somewhat erratic when it is first used after being recharged.

repair of printed-circuit and subminiature assemblies

SOONER or later, all electronic components fail to function properly; printed circuits and subminiature devices are no exception. The experimenter and technician should be familiar with the many techniques for restoring these units to working order. Many printed-circuit units (such as ceramic-based types where components are “fired” on) are usually cheaper and easier to replace than to repair.

The most important difference between ordinary wired circuits and printed circuits is the uniformity of the latter. Thus, once a service technician learns how to trace a particular printed circuit, he will not have to learn a new arrangement of components and wires the next time he troubleshoots the same circuit. Many manufacturers of printed circuits also identify components by stamping or coding on the printed-circuit board, which aids the technician considerably. One other helpful feature of printed-circuit boards is that they often resemble the schematic as far as physical layout is concerned. Some manufacturers also bring out a set of test points, which helps immeasurably in rapid testing.

Armed with a knowledge of the possible troubles to be encountered, the precautions to be observed and the testing techniques and tools used, the technician can master any printed-circuit repair.

Possible troubles and diagnosis

The major servicing troubles in printed circuits usually fall into five categories, some of which are interdependent, according to

the circuitry. The five repair classes are (1) circuit opens, (2) circuit shorts, (3) circuit intermittents, (4) defective soldering and (5) mechanical defects.

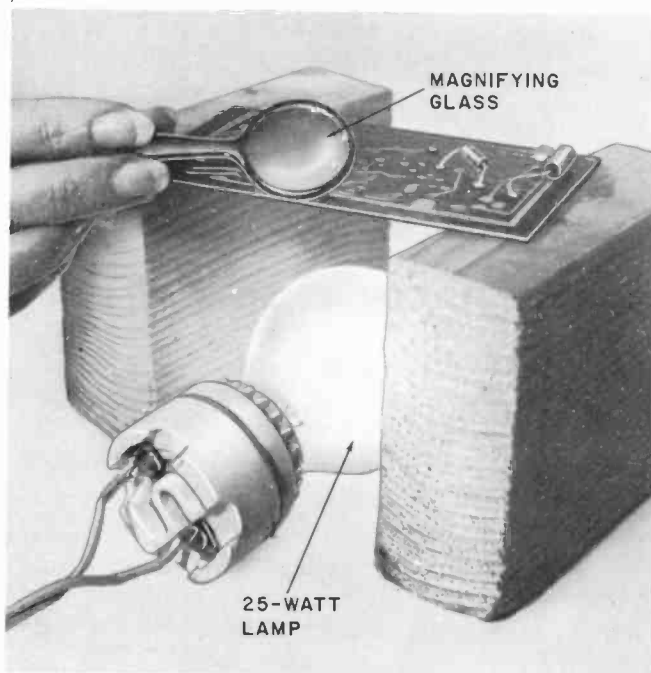

Fig. 501. Magnifying lens and 25-watt lamp used to detect printed-circuit "opens"

Open circuits crop up frequently and most are probably due to the size of the conductor used in some parts of the circuit. Many conductors carrying a low-voltage low-current signal, such as a 1.4-volt 50-ma filament circuit bus bar, could be less than $1/32$ inch wide as shown in Table 2-3, Chapter 2. Although minimum practical widths are closer to $1/32$ inch, this figure is still small compared to solid No. 18 or No. 20 hookup wire.

Bending of the board in shipment, vibration during use or slight inclusions in the foil during manufacture can all lead to opens.

Another cause of open circuits is failure of components themselves. A transformer winding can open due to an overload, or a resistor can open due to repeated overloads or excessive heat. Sometimes the process is reversed and, instead of the copper-foil conductor opening due to component failure, the foil opens and a string of components go.

Opens are detected with point-to-point measurements or by visual inspection. Two handy items for visual inspection are shown in Fig. 501—a 25-watt lamp on an extension cord and a magnifying glass that can often locate opens by visual observation. The 25-watt lamp will not throw too much heat and can be



Fig. 502. Using a vtvm for point-to-point circuit checks. (Courtesy Allied Radio)

used for long periods of time without eye fatigue. Where board thickness and component density are high, a 60-watt lamp should be used. However, the 60-watt unit throws off considerable heat and cannot be held too close to the circuit board or key components for long periods of time. Point-to-point measurement with a vtvm is shown in Fig. 502. A signal generator can be used for opens detection, remembering to keep the output as low as possible since high-level signals are usually fatal to components such as transistors or ultra-low-level milliwatt-range transformers.

Circuit shorts are often caused by dirt, faulty components or loose wire ends and solder particles. When repairing printed-circuit and subminiature assemblies, shake off excess solder and component lead cutoffs, as described under detailed servicing instructions. For the same reasons, steel wool or emery paper is not recommended as a cleaner for printed-circuit assemblies since these materials can leave conductive particles in small crevasses and cause shorts.

A short can also often be detected visually by a “sunburst” pattern of copper caused by sudden overloading and vaporization of the foil.

A very annoying type of short is caused by gradual dirt and

moisture building up between two conductors that are normally insulated from each other. This partial, or high-resistance, short often resembles a resistor in its effects and is sometimes hard to find visually. The dirt in high-resistance shorts can be removed with a toothbrush and solvent. The cleaned base board is then coated with resin to prevent the re-entry of dirt and moisture.

Defects in the printed-circuit base-board material itself and "silver migration" often lead to partial short circuits. The only remedy is to drill out the offending portion of the board.

Intermittents, whether printed-circuit or not, have always been a bane to service people. Intermittents in printed circuits usually pop up in locations where there is mechanical stress such as near tube-socket tabs, component lead-ins (eyelets, crossover and through-board connection points) or sometimes in the leads themselves. A bent pigtail that has been re-formed a few times in repair or in manufacture tends to be brittle, and might even crack when the board is in certain positions. The application of heat, humidity or vibration will help "smoke out" an intermittent. Gently tap the printed-circuit board while the area is checked visually or with instruments. If vibration fails to show up the intermittent, a 60-watt lamp can be held near the suspect area for short periods of time and the board allowed to cool between checks. Sometimes the expansion due to heat will open up the intermittent and thus pinpoint the trouble.

Mechanical defects come from such things as improperly eye-letted holes, poor riveting in original manufacture, and component mounting hardware which puts strains on printed-circuit boards. Check every point at which a component is mounted to the board by mechanical means such as springs, clips, nuts, screws, clamps and brackets. This class of defect is very often obvious from mechanical inspection under the magnifying glass. The remedy is usually a mechanical adjustment with a screwdriver or pliers, and occasionally a small soldering job in the case of some broken parts. Broken dials, springs and items affected by heat must be replaced.

Pitfalls in printed-circuit servicing

Because of the overall compactness and close component locations in printed circuits, certain pitfalls await the technician who attempts a hasty job.

The first hazard is the possibility of damaging the etched circuit foil. Some components are attached to the base in such a way that their removal may cause tearing or peeling of the copper foil.

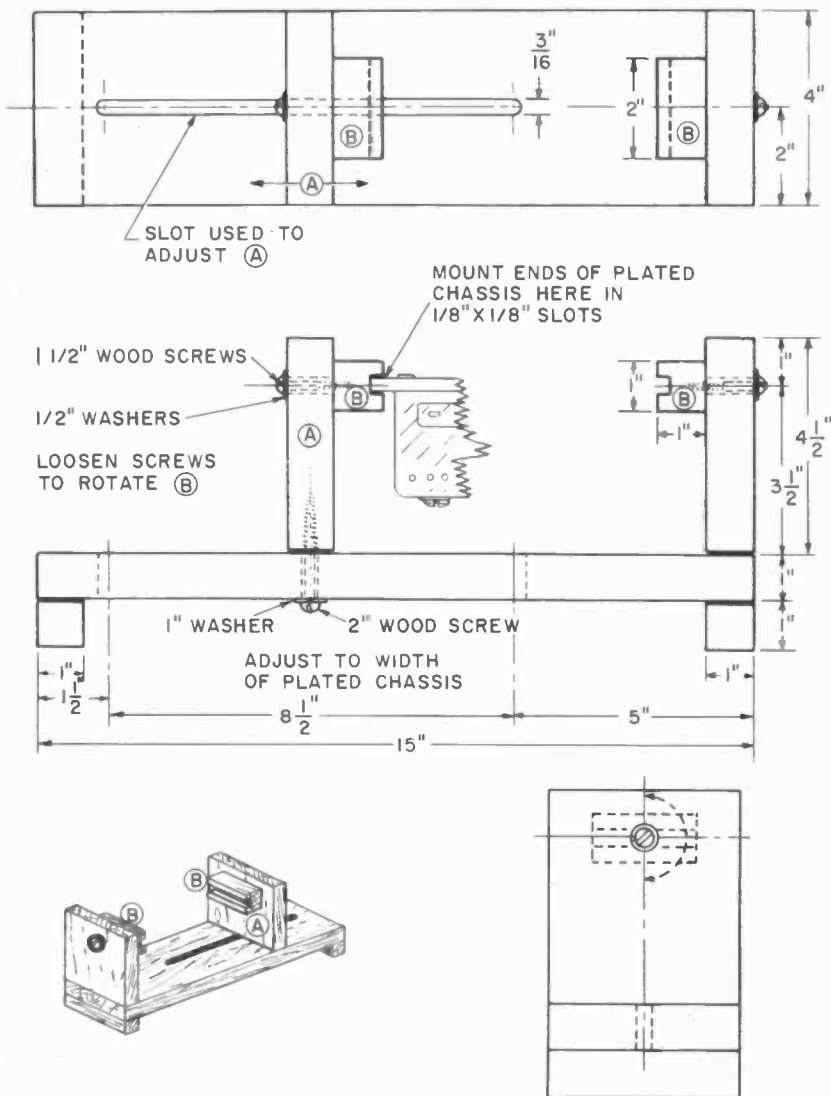

Fig. 503. Some pieces of scrap wood can be used to make a very convenient holding jig for printed circuits.

Replacement of the foil is described later in this chapter.

Damage to the base board proper is another source of headaches. Most printed-circuit boards are thin and cannot be bent too much without cracking. Printed-circuit boards should not be gripped on their corners with pliers or put in vises in a way that

the weight of the board will make it sag and crack. Simple holding jigs can be made up from scrap wood (Fig. 503). If a vise must be used, pad the jaws with felt or sponge rubber and tighten the vise just enough to hold the board securely without bending it.

Excess heat can be ruinous to a printed-circuit board by either blistering the copper foil or actually degrading the base material.

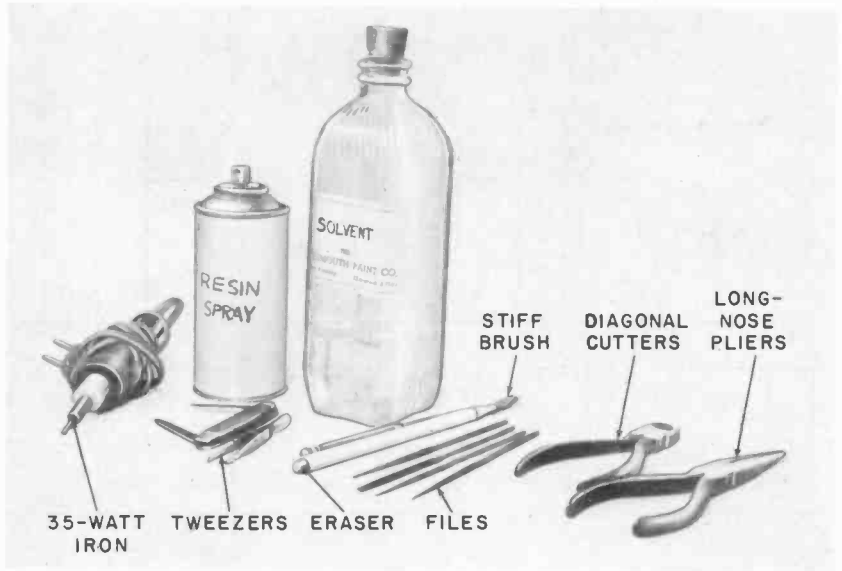

Fig. 504, *Some typical tools used in printed-circuit repair.*

Soldering irons over 60 watts in size should be kept far away from printed-circuit boards. Likewise, blowtorches and soldering guns should never be used for printed-circuit and subminiature repairs. Heat is the result of both temperature and time, and a 25-watt or 35-watt soldering iron can cause as much damage as a 60-watt iron if left on a joint too long. Be careful around soldered joints that cannot conduct heat away fast enough. The old trick of using pliers or an alligator clip for a heat conductor can come in handy here.

Another common printed-circuit repair hazard is the overabundant use of solder. It is extremely easy to get too much solder on a printed-circuit joint, especially if the technician is new to the work and has been soldering conventional wiring for many years. A brush and pick can be very helpful in cutting down excess solder problems.

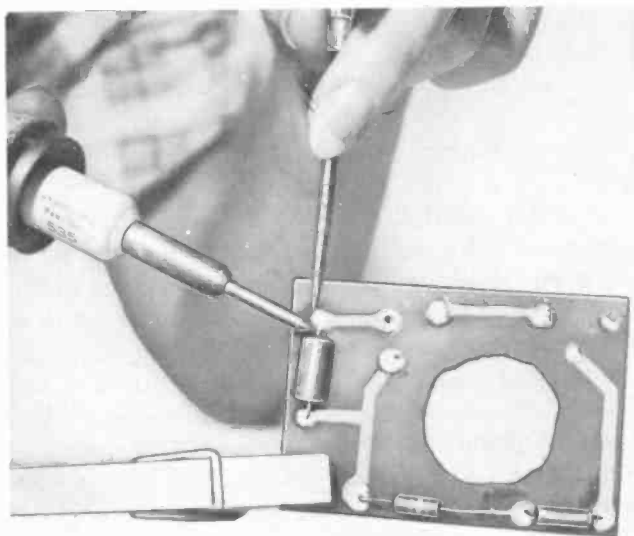

Fig. 505. *The ordinary clothespin can make a convenient third hand when working with printed circuits.*

Tools

Shown in Fig. 504 are the tools recommended for printed-circuit

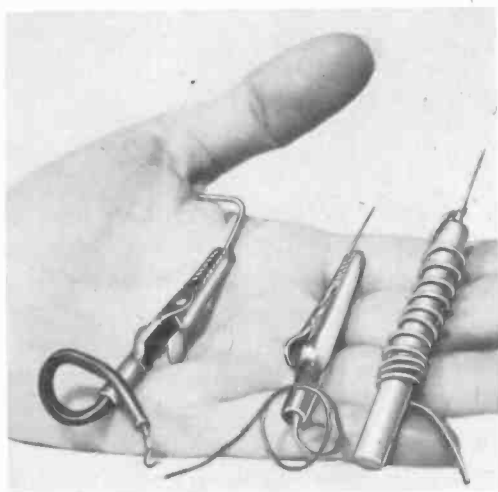

Fig. 506. *An assortment of home-made test prods.*

repairs. A 60-watt iron is used on those extra heavy jobs such as brackets, supports and corners where large amounts of heat must

be applied for very short intervals. Ground lugs can be soldered faster with a 60-watt iron. However, the 60-watt should be reserved only for those jobs where the 25- and 35-watt units have failed to give results. The 35-watt iron is the workhorse of printed-circuit repair, and hints on its use are given elsewhere in this chapter.

When repairing printed circuits, it is always wise to coat the repaired portions of foil with an insulating medium. Several chemicals have been developed for this purpose, most of them resin-base lacquers. They can be applied either by brush or spray can. In an emergency, fingernail polish and polystyrene Q dope can be used. A solvent and soft cloth are handy to have around also. Common solvents are carbon tetrachloride, chloroethylene and wood alcohol. Carbon tet should be avoided unless the work area is well-ventilated.

An assortment of picks is a necessary item in printed-circuit repairs. In addition to removing solder deposits, the pick is often

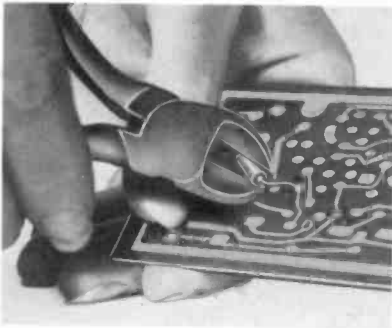

Fig. 507. Replacing a capacitor on a printed-circuit board.

the only way to move or bend a hidden lead to where it is accessible for work. A Fiberglas brush or toothbrush is a must for flicking off excess solder and general cleaning of printed-circuit boards. The Fiberglas, being abrasive, can be used to shine up copper foil prior to soldering; a Fiberglas eraser is particularly convenient for this type of work. An ink eraser with an abrasive rubber core is a good substitute.

A small pocket knife with a few blades is handy for scraping joints or component terminals prior to soldering. A set of tweezers is also useful for handling parts too delicate for a needle-nose pliers.

Side cutters and needle-nose pliers are indispensable for printed-circuit repairs. Several jeweler's models, smaller in size than regular pliers, are ideal. A good set of assorted-shape Swiss needle

files can be worth their weight in gold when fitting in new components or adapting standard hardware to unusual mechanical situations.

Clothespins (Fig. 505) can be used effectively as third hands. Felt inserts should be used to protect the printed-circuit board surfaces.

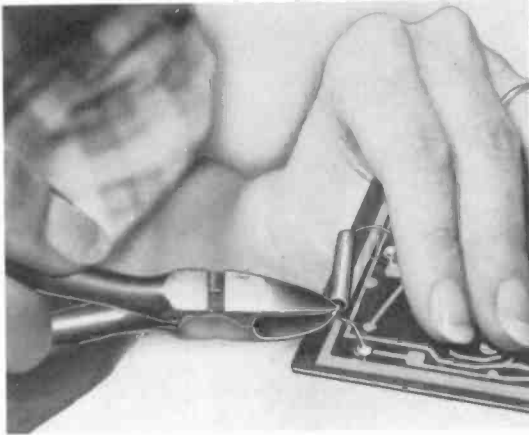
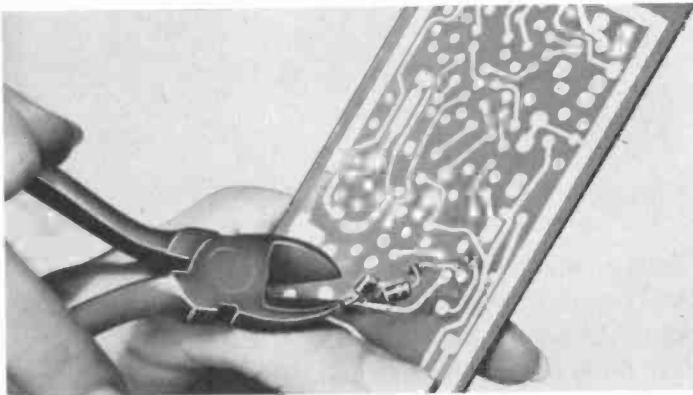

Fig. 508. If the leads are long enough, they can be cut close to the body of the resistor. Additional lead length can be obtained by cutting the resistor in half and crushing the resistor body.

Home-made test prods (Fig. 506) can be assembled from miniature alligator clips and sewing needles. The variety of prods is limited only by the user's ingenuity. A piece of plastic tubing or spaghetti is slipped over the prod to eliminate short circuits when using the prod in close quarters.

Fig. 509. After being cut apart, the two halves of the resistor are separated.



Replacing components

Components can be replaced in several ways. One method is to cut the old component in half, strip the component body off the lead wires, and use the extra lead from the inside of the component as a tie point for the new unit. A second method, where

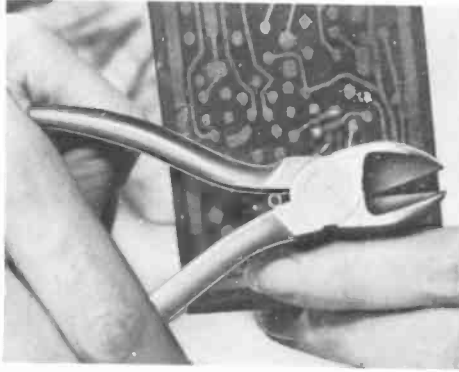

Fig. 510. *Crushing the body of the component in the crotch of the pliers.*

leads of the defective component permit, is to cut close to the component ends and use the old leads as new starting points.

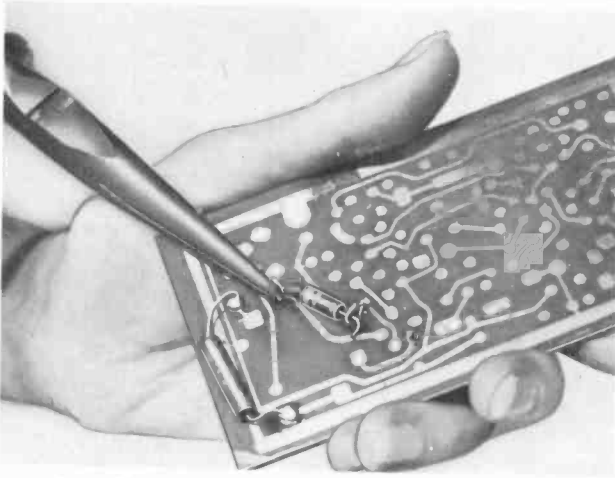

Fig. 511. *Soldering the new component into place.*

Still another technique is to remove the old component completely and repair or replace as tests indicate. Before removing a component, be sure to check it even if the circuit makes it appear that it is defective. Be sure that no other component or wiring is

in parallel with the suspected component, by opening one lead of the component.

Fig. 507 shows a capacitor which has short leads. A diagonal cutter is used to clip the component in half, and then the remaining parts of the component are removed by pinching carefully with the pliers. Sometimes space permits mashing the component body remains in the crotch of the pliers. Be careful to hold the printed-

Fig. 512. Using a wire jumper to repair a broken printed-circuit conductor.

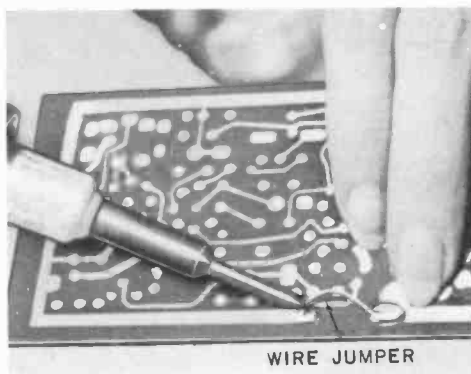

circuit board in such a way as to allow the “mashings” to drop away from the remaining circuitry. The exposed wires are scraped clean with a knife. Avoid nicking wires by scraping at an angle to the wire. The leads of the new component are looped around the old leads with a needle-nose pliers, and the new component is then soldered in place.

Fig. 508 and 509 show the removal of a resistor which has long pigtail leads. The remains are mashed in the crotch of the pliers (Fig. 510). The leads can then be re-formed into loops, and the new component dropped in and soldered (Fig. 511). Excess lead wire should be clipped short, making sure the clippings fall away from the board where they might cause short circuits.

Complete replacement of component

One system for removing components has been named the “10-step” method.¹

1. Determine which component is at fault.
2. Remove defective component by cutting it away from board.
3. Remove any resin coating from the connection to be reworked, using solvent or abrasive brush.
4. Remove solder from connections to be replaced, making sure

¹ Developed by Walter A. Schott Co.

solder flows away from board and adjacent circuitry. Use a brush and pick if necessary.

5. Take off remaining leads with pliers (in case of delicate components, use tweezers) while an iron is still held on the work momentarily to melt solder.

6. Open webbed mounting holes by inserting a pick or knife in the hole while the solder is still soft. After the solder cools, clean the area around the repair with solvent or an abrasive brush.

7. Fit the replacement component into existing mounting holes, taking care not to damage the original foil.

8. With an abrasive brush clean connections on the component being soldered in and solder in. A soldering preform such as a washer or ring of solder wire can save time when soldering in spots that are crowded.

9. Check the soldered joint with pick or knife. Pry the joint gently and look for evidence of cold solder and joints held by flux only. Rework if necessary.

10. Clean off excess flux and any solder particles. Recoat reworked areas with a protective resin.

Replacing foil

Two methods are in use for replacing foil that might be broken in the repair process. One of these is to use a small piece of hookup wire as shown in Fig. 512.

The second method (Fig. 513) employs a repair foil which is

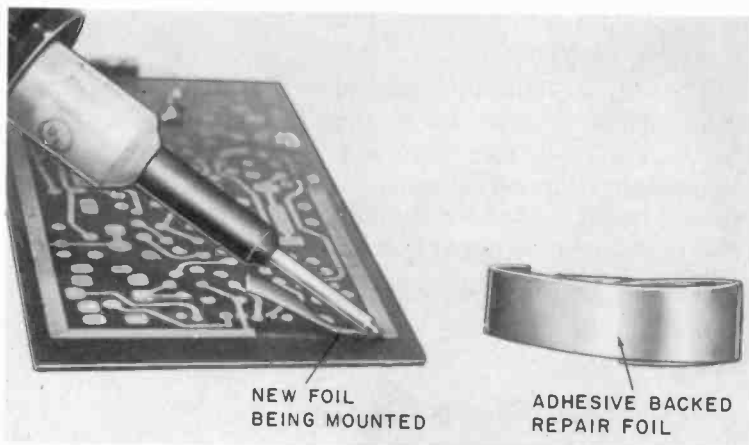

Fig. 513. Using adhesive-backed foil to repair a broken conductor.

adhesive backed. First, outline the path of the old foil on the printed-circuit board with a pencil or scribe made from a fine needle point. Next, put a piece of tracing paper over the defective

section just marked out, and trace the outline of the section on the paper. Allow extra foil for overlapping the new foil on the old copper foil. Remove the tracing paper and paste it on the adhesive-backed copper-foil repair material. Using the outline on the tracing paper, cut the foil to pattern and remove the tracing paper. Clean with solvent the area to be reworked and use an abrasive brush to clean and roughen the surface of the printed-circuit base board. Then put the adhesive side of the cut-out foil nearest the

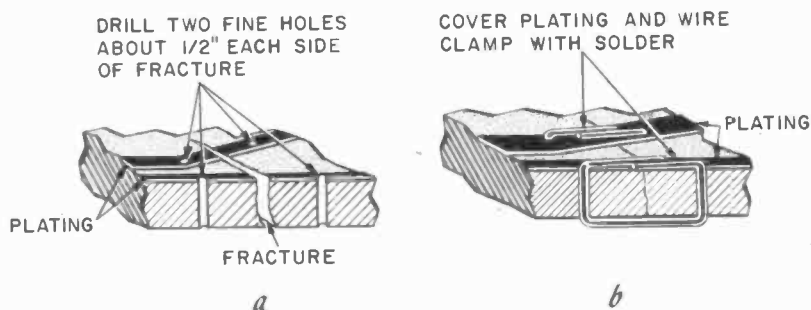

Fig. 514. Steps in the repair of a fractured board. Two fine holes are drilled and wire clamps are inserted. The clamps are then soldered. (Courtesy Motorola, Inc.)

copper foil already on the board, and press down. Use a chisel-tip soldering iron to heat the foil and cure the adhesive. It takes about 1 to 1½ minutes to get a fully cured adhesive bond between the new foil and the base board. Finally, solder the new foil to the old foil along the edge at each end.

Repairing cracked boards

Simple cracks in areas not subject to stress by heavy components or mounting hardware are easily repaired (providing no conductors cross the cracks at any point) by using fast drying plastic cement. Although cracks like these are seemingly harmless they must be repaired to prevent their spreading into areas where they can affect circuit function and to maintain the overall strength in the board.

When a crack occurs in a circuit area, crossing conductors must always be repaired. Sometimes the conductor may not seem to have been harmed, especially if the crack is a hairline. Nevertheless it must be repaired, for it has been weakened.

Drill fine holes in the board as shown in Fig. 514 and insert wire clamps. By proper positioning, the clamps are used to support conductors crossing the line of the break. When the supports have

been inserted and the edges of the crack drawn together, coat the clamps and the associated conductors with solder.

Tube-socket repairs

Printed-circuit and subminiature tube and transistor sockets are a frequent source of trouble. The causes are usually dirt, flux, oxidation and mechanical difficulties such as loss of spring tension or distortion in the contact spacing.

In the case of poor spring tension, a pointed pick or probe can be used to bend the contacts of the weakened spring back into a useful position. This requires patience and slow, gentle manipulation of the bending tool. Distortion of the contact spacing, such as incorrectly positioned contacts, can be detected by comparing

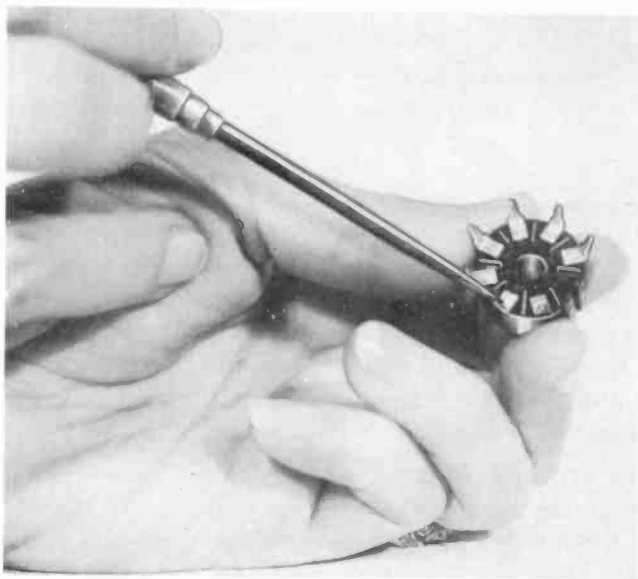

Fig. 515. Using a pick to clean the contacts of a tube socket.

the socket to a tube base-pin pattern overlay. Sometimes incorrectly positioned contacts can be aligned by resoldering the tabbed end. In other cases, where the molding process is such that no amount of tab bending or resoldering will realign the contact, complete replacement is the best answer.

Dirt and light surface corrosion and oxidation can be removed by scratching the contact with a pick or needle inserted in a piece of $\frac{1}{4}$ -inch dowel. Very sparing application of chemicals such as General Cement's De-Oxid sometimes helps dissolve oxi-

dized residues. If flux remains from a previous assembly, dissolve this by using a flux solvent from an eye dropper. Abrasives, such as steel wool, should not be used for cleaning tube-socket contacts because of the danger of short circuits or partial high-resistance shorts due to particle accumulations. The socket scraping operation is shown in Fig. 515.

Replacement of sockets

Wherever possible, the socket should be removed by unsoldering one contact at a time, brushing the excess solder away, and prying up the socket tab with a knife or other thin-bladed tool.

Fig. 516. Inserting a new socket in a printed-circuit board without removing the old. (Courtesy Sylvania Electric Products, Inc.)

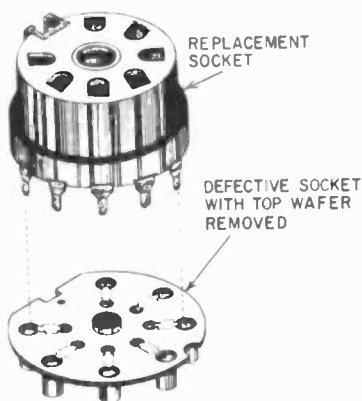

The socket can also be removed by cutting the tabs with a diagonal pliers, but this is not always possible due to cramped space or other components near the socket which might be damaged by the pliers. The ground terminal is usually unsoldered last, and the socket then gently pried loose and free from the base board. The grounding section of the copper foil sometimes breaks and should be replaced with new foil or wire.

Depending on the mechanical mounting details, it may be necessary to enlarge the old mounting hole when installing a new socket. The new socket should be as close to an exact replacement as possible. The socket hole (and, where required, the tap holes) can be enlarged conveniently with a small needle file. If the new socket is slightly oversize, it can be filed down to fit the hole in the base board. If the new socket is undersize, a coat or two of cement will aid in building up the outside diameter of the socket base to a snug fit.

By using specially prepared sockets it is possible to replace a defective wafer type socket without having to subject the foil

to both unsoldering and soldering. Remove the top half of the wafer socket with diagonal cutters. Work carefully, a small section at a time, to avoid damaging the printed-circuit board. Remove

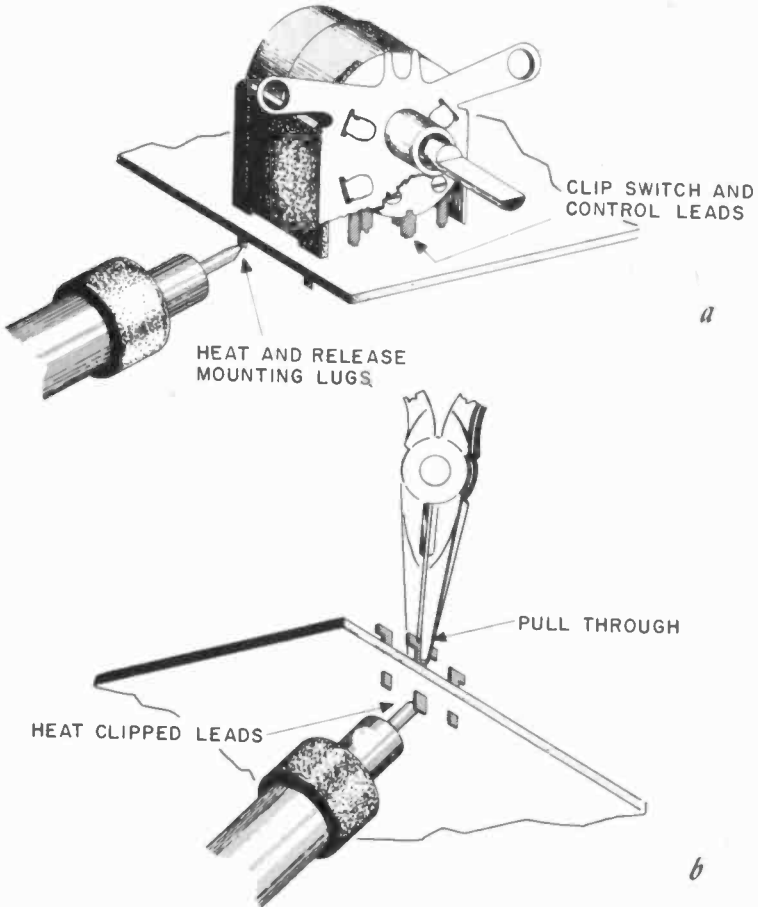

Fig. 517. Method for removal of controls and switches from printed-circuit boards. (Courtesy Sylvania Electric Products Inc.)

all broken socket clips from the old socket and then insert a new one (Sylvania type) as shown in Fig. 516. Next, solder the lugs and the job is done.

Replacing transformers, inductors and if's

Miniature if's and rectangular potted inductors generally have four to six soldering lugs, and are originally mounted by inserting these lugs through punched holes in the printed-circuit board.

The lugs should be unsoldered and bent up one at a time, brushing off excess solder. After the lugs are bent up, it is possible to remove the component by bending the lugs perpendicular to their respective slots in the printed-circuit board and sliding the component off the board. The new component should be an exact replacement to minimize mechanical rework on the base board.

Tabs on the new component can either be bent in place or soldered into the new position. Because of the size and materials used in making the cans or if's and other inductors, component layout must be studied carefully before attempting an exchange. It is also helpful to mark the position of any keyed part (such as a



Fig. 518. Desoldering kit designed for use with printed circuits. (Courtesy Ungar Electric Co.)

slot or special ear on the old component) on the board so that there will be no error in relocating the new unit.

Replacing controls

Controls and switches can generally be treated the same way as other multiple lug components. To replace units mounted directly on the printed circuit board, cut the leads to the assembly about $\frac{1}{4}$ inch above the chassis (Fig. 517-a). The mounting lugs are unsoldered and bent perpendicular to the chassis one at a time. The entire component is then gently removed from the board. The component lead stubs are left attached to the board at this point. They are removed easily, one at a time, by unsoldering, straightening if bent, and pulling through the chassis (Fig. 517-b). The mounting lug slots and component lug holes are then

cleaned with a pick, brush and iron. The new control or switch is mounted and all connections are soldered, completing the job.

Special desoldering methods

Shown in Fig. 518 is a special kit containing cup, bar and slotted

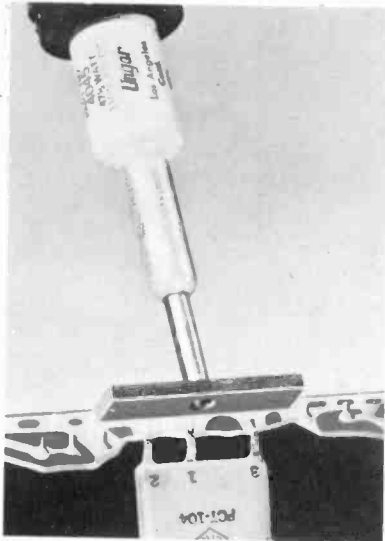

Fig. 519. This soldering-iron tip, in the shape of a bar, can be used to remove packaged components. (Courtesy Ungar Electric Co.)

soldering-iron tips for printed-circuit repair work. The tips are made of chromium-copper alloy. In addition, they have been designed to radiate very little heat along their sides and edges. This promotes heating of the parts to be removed without disturbing nearby components. The tips are interchangeable within the heating element.

The bar type tip (Fig. 519) is designed to remove straight-line components such as packaged circuits and resistor-capacitor combinations. The bar is held against the terminals until the solder melts, and then the component is lifted or allowed to fall off.

Cup-shaped tips (Fig. 520) have been designed in $\frac{5}{8}$ -, $\frac{3}{4}$ - and 1-inch diameters to fit the common miniature tubes as well as larger-diameter components. They are suited for removing sockets as shown in Fig. 521. The cup is positioned over the component tabs or lugs and the component is removed by gentle prying when the solder melts.

The slotted tip is perhaps the handiest of the series, acting both as soldering-iron tip and miniature crow-bar. It is used to straighten bent tube tabs or other component leads. The slotted tip is held against the solder until the latter melts, and then the

slot of the tip is positioned around the tab or lead to be removed. Gentle prying completes removal. Fig. 522 shows the slotted tip being used to bend up a component lead prior to removal.

In many cases, it will not be necessary to remove a printed-circuit board from a chassis for servicing. The versatility of the tips allows the user to apply plenty of heat in tight spots.

Another special soldering technique especially useful when removing multiple-lead components is illustrated in Fig. 523. The soldering pot, a thermostatically controlled unit, is an invaluable bench aid. You just dip the board into the molten solder and remove the component. When replacing single-lug components return to the soldering iron.

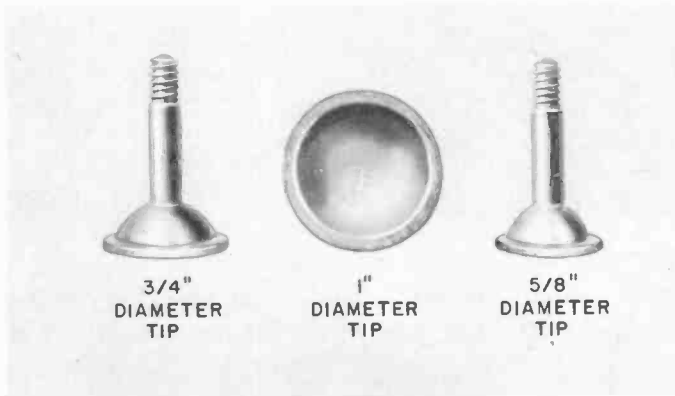

Fig. 520. Cup-shaped solder tips for removing tube sockets from printed-circuit boards.

Test instruments

Although specialized test instruments are not necessary for servicing printed-circuitry, the service technician would do well to add a few items to his bench line-up. In order to do this economically and at the same time gain useful working knowledge of printed-circuit techniques a few useful circuits which are easily constructed are included in this section.

In-circuit component tester

After isolating a malfunctioning stage many technicians rely upon clip-and-check methods to test suspect components. One lead of the component is removed from the circuit to isolate it so that it can be tested for changed value, shorts, and in the case of capacitors, leakage. This procedure is one that is efficient up to a certain point. When working with printed-circuitry, where

manipulation must be kept to a minimum, the clip-and-check method becomes a search for more than a malfunctioning com-



Fig. 521. Removing a tube socket with a cup-shaped soldering-iron tip. (Courtesy Ungar Electric Co.)

ponent—it's looking for even more trouble. The chance of damaging a good component when resoldering and the possibility of cracking the board more than offset the convenience of trouble-

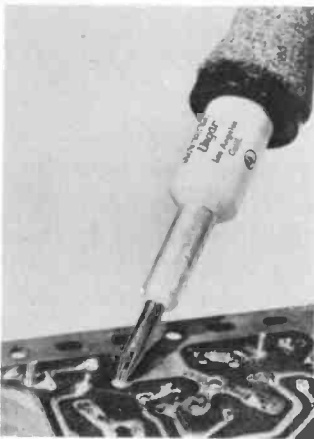

Fig. 522. Slotted soldering-iron tip being used to bend up the lugs of a multiple-lug component. (Courtesy Ungar Electric Co.)

shooting in this manner. In-circuit checkers are a must when servicing printed circuitry. The instrument shown (Fig. 524) is a combined R-C bridge and quick-check unit, which is particularly suited for servicing.

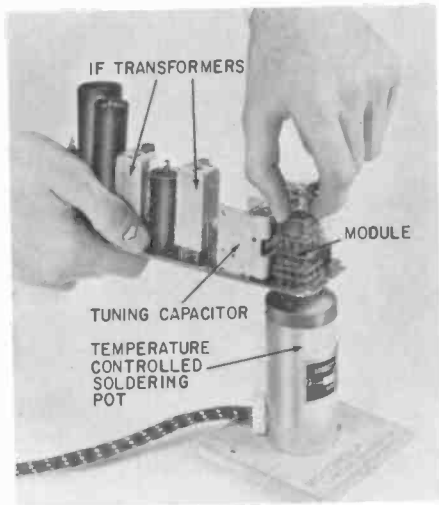

Fig. 523. A number of connections can be soldered (or unsoldered) in one operation, when using a soldering pot. (Courtesy Motorola, Inc.)

The only disadvantage in using instruments of this type arises when the circuits being probed use transistors. The 20 mc and 60-cycle waves put out by these instruments for test purposes can damage transistors. Remove all transistors before using any instruments of this type.

Fig. 524. Combined R-C bridge and in-circuit checker for servicing printed circuits. (Courtesy Allied Radio.)



Subminiature tube tester

The printed-circuit board for a subminiature tube tester is shown in Fig. 525. The flea clips for the tube leads and the switches are also shown in the photograph. Construction details for the unit are given in Fig. 526. Designed for both 0.625- and 1.25-volt filaments, the tester contains a resistor R2 for extra protection when checking lower-voltage tubes.

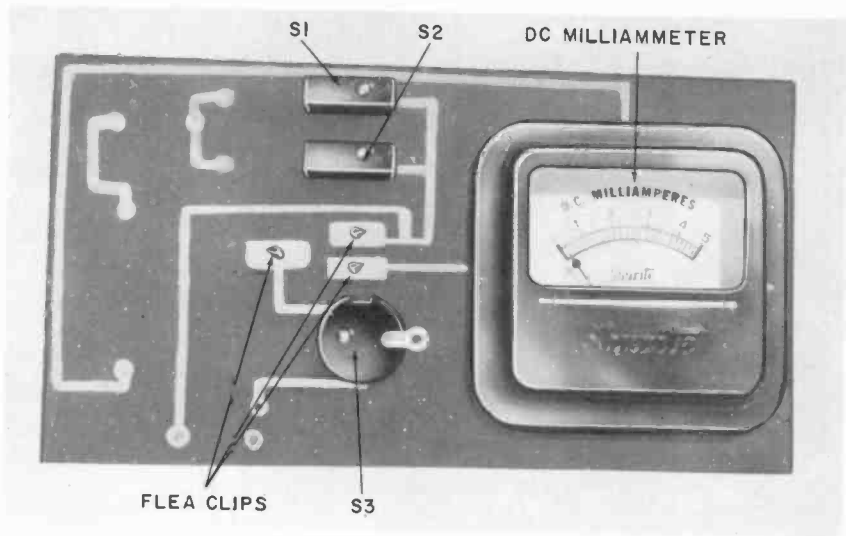
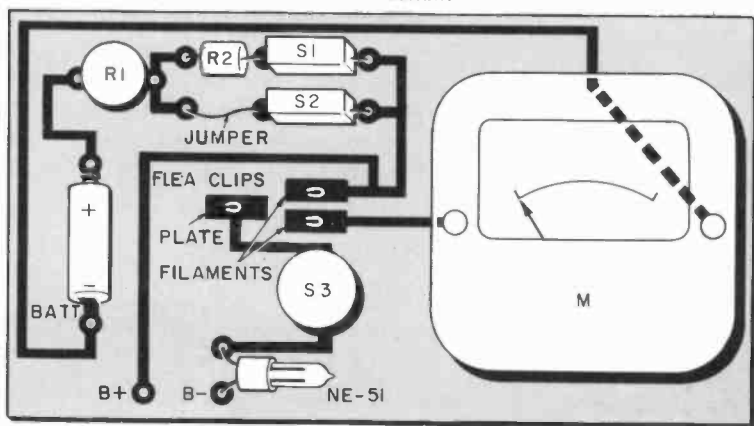

Fig. 525. Photo of the subminiature tube tester taken while the unit was under construction.



Resistors: R1—50-ohm pot; R2—15 ohms, 1/2 watt

Switches: S1, S2—Microswitch 1SM1 or equivalent; S3—MU-switch type Q or equivalent

Miscellaneous: Neon lamp—NE 51; M—0-100-ma meter; 1.5-volt battery; 90-volt battery; printed-circuit board; V1, tube under test.

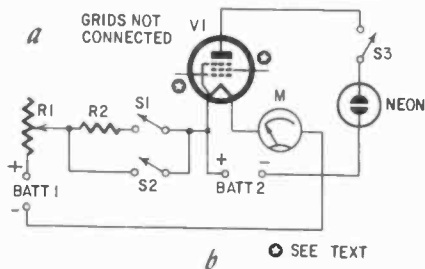
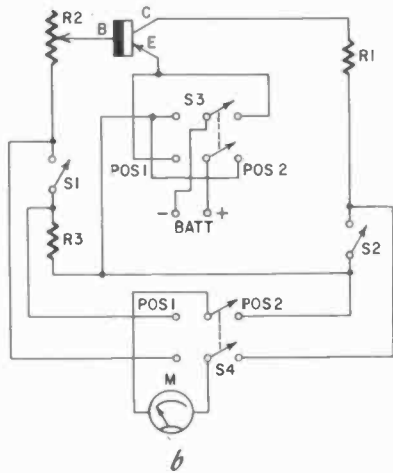
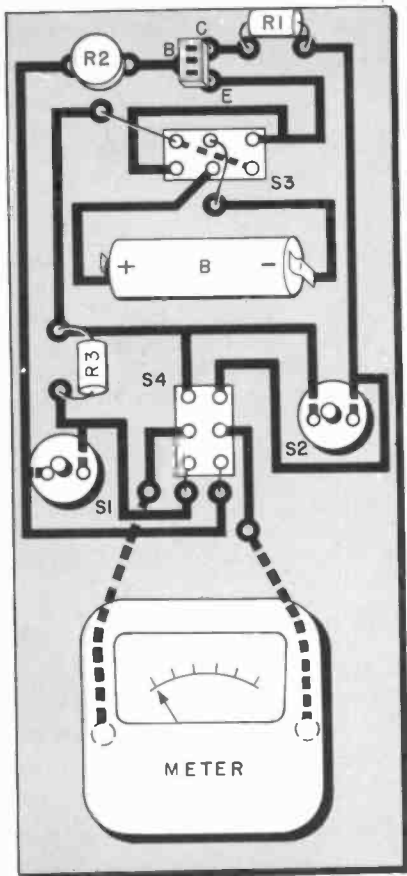

Fig. 526. Layout of the printed-circuit board and circuit diagram for a subminiature tube tester.



Resistors: R1—2,000 ohms, 1/2 watt; R2—1-megohm pot (Lafayette Radio VC-47 or equivalent) R3—51,000 ohms, 1/2 watt.
 Switches: S1, S2—miniature spst rotary; S3, S4—dpdt slide type
 Meter: 0—5-ma dc (Shurite 4302 or equivalent)

Fig. 527: The layout of the printed-circuit board of the transistor checker is shown at the left. The circuit diagram appears above.

Only the two filament leads and the plate lead are used in this checker, which tests for filament continuity and leakage. It's a good idea to use a vtvm or high-resistance vom as a check when setting R1 to obtain the right voltage across the filament of the tube under test. The neon lamp will flash when S3 is depressed if there is leakage from the plate to other tube elements.

Simple transistor checker

A simple transistor checker is shown in Figs. 527 and 528. The emitter is used as the common ground with resistor R2 varying the base voltage. This test circuit is meant to be used as a static checker—no signals pass through the transistor.

Three tests can be made—shorts, opens, and gain. To test for shorts switches S1 and S2 are opened, S4 is flipped to position 2 and current in the collector circuit read on the 5-ma meter. The reading will depend somewhat on the collector resistance

setting but will usually be in the order of 10's or 100's of microamps. A reading in milliamps indicates a short or leakage. For

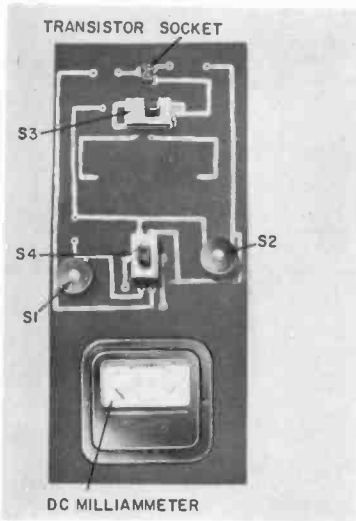

Switch Position Table

	bias effect on		beta step 1	beta step 2
test	collector current	collector current		
S1	open	closed	open	closed
S2	open	open	closed	open
S3	pos. 1 for p-n-p; pos. 2 for n-p-n			
S4	pos. 2	pos. 2	pos. 1	pos. 2

Fig. 528. Photo of the transistor checker. The arrangement shown here follows the circuit diagram fairly closely.

precise results, the manufacturer's data should be checked to determine the collector current for specific collector bias voltages with the base open. An open check is made by closing the base circuit switch S1, opening S2 and then increasing the series resistance in the base circuit. With less base bias voltage, the collector current should rise. If no change occurs, there is usually an open in the transistor.

Gain is checked by flipping S4 to position 1, opening S1 and closing S2. Then set the base resistance to produce a fixed current, say 50 microamps, on the meter. Move S4 to position 2, close S1, open S2, and read the collector current while the base is still biased for the 50 microamps. Collector current divided by base current is used as a rough check of gain, sometimes called the beta of the transistor. Checks for n-p-n units can be made by using S3, which reverses the battery.

A summary of switch positions is given in Fig. 528.

practical assemblies and techniques

HAVING mastered the basic techniques of printed circuitry and learned how to select circuit components, you are ready to try a few simple circuits. The assemblies and techniques in this

Fig. 601. A one-transistor "crystal" radio receiver which employs printed circuitry. (Courtesy Allied Radio.)

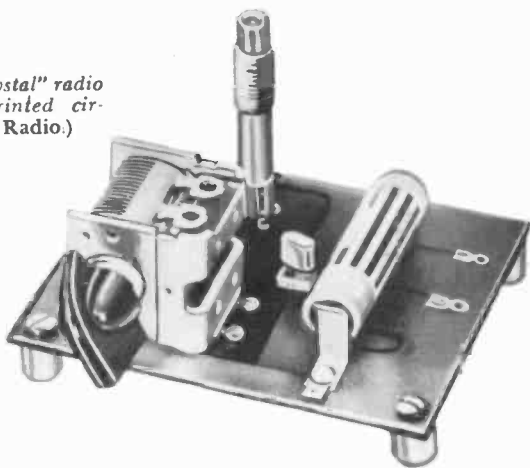

chapter have been chosen for their simplicity so that the builder can gradually acquire the feel of working with printed circuits.

Some of the projects use commercial subassemblies only; it would be impractical and too time-consuming for the average person to build them up himself.

One-transistor radio

Fig. 601 illustrates one of the basic applications of printed-

circuitry: a one-transistor "crystal" set put up in kit form. The circuit pattern and schematic (Fig. 602) for the set can be easily duplicated by silver or copper painting or by simple etching with asphaltum - ferric chloride techniques. The construction procedure given is that used in assembling the commercial kit, but a home-made unit could be put together in a very similar manner once the printed-circuit board is made.

MTG HOLES IN EACH CORNER OF BOARD

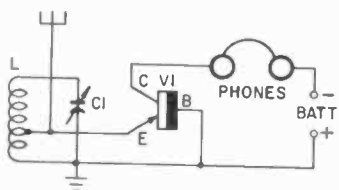
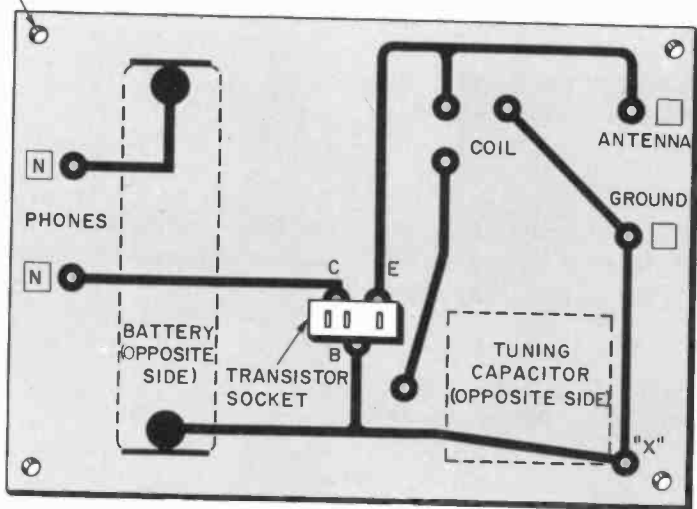

Capacitor: C1—365- μ f variable (Allied Radio 281003)

Transistor: V1—CK722

Miscellaneous: 3,000-ohm earphones; hardware; 1.5-volt penlite cell; printed-circuit board

Fig. 602. The printed-circuit pattern and schematic of the radio shown in Fig. 601. Capacitor C1 grounds at hole "X" by means of a mounting screw. Phones plug into terminals marked N.

The first step is to assemble the necessary tools. For simple circuits, the following are recommended: diagonal cutting pliers, needle-nose pliers, large and small screwdrivers, 25- or 35-watt pencil type soldering iron and rosin-core solder. The next step in any printed-circuit kit assembly is to study the plans carefully and set up the necessary components in the order and place in

which they are used. For a home-made "crystal" set, a plan or sketch should be drawn up as a guide before starting construction.

The procedure below is that suggested by Allied Radio for assembling their transistor kit:

1. Examine the printed-circuit board. Notice that one side of the board is printed with the name of the parts and components which will be mounted on the board. The other side has the printed-circuit pattern on it. In the case of a home-made board,

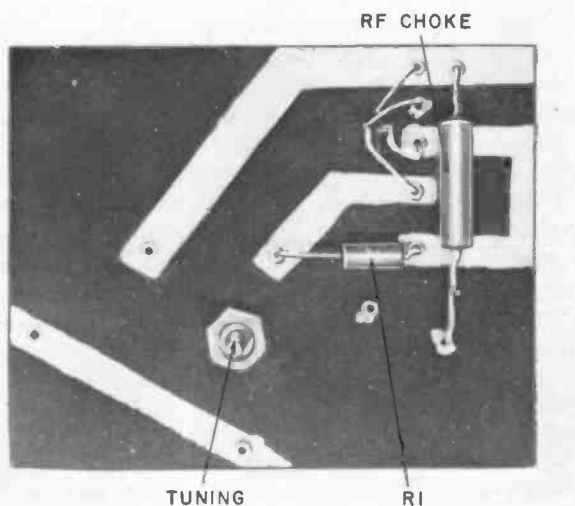

Fig. 603. Underchassis view of a one-tube thyatron receiver.

the builder can either paint or rubber-stamp identifying marks on the board to help him in the assembly.

2. Examine the transistor socket. Notice that there are two holes together at one end of the socket, and the third hole is by itself at the other end of the socket. Push the socket into the board so that the end of the socket with the two holes is toward the words "ground" and "antenna."

3. Solder each of the three small prongs in the socket to the printed-circuit pattern. The two prongs closest together go to the B (Base) and E (Emitter) connections on the printed-circuit board, and the third prong goes to the C (Collector) connection on the printed-circuit pattern. Do not overheat the printed-circuit pattern and blister the copper foil.

4. Mount the spade bolt on the front of the tuning capacitor. This is done with a short machine screw. The hole in the capacitor is threaded, so no nut is required. The tuning capacitor is then mounted on the printed-circuit board in the space marked "tuning capacitor." Insert the spade bolt through the hole and tighten

a nut over it. Insert two of the small screws through the two terminals on the side of the capacitor. Tighten a small nut over each screw. Turn the shaft of the tuning capacitor so that the plates are meshed and fully closed. Loosen the setscrew in the tuning capacitor knob. Slide the knob on the shaft as far as it will go; tighten the set-screw.

5. Put a "foot" on each corner of the printed-circuit board. These feet are internally threaded collars that raise the board off the printed-circuit side and prevent short-circuiting of the board if it is accidentally placed on a conductor.

6. Cut the transistor leads very carefully so that they are each $\frac{1}{2}$ inch long. When cutting the leads, do not twist or bend them too much—they will break if treated roughly. Place the transistor in the socket. If the transistor is the type with two of the leads very close together, just put it into the matching holes in the socket. If the transistor is marked with a colored dot, the lead at the same side as the colored dot is the same as the lead which is widely spaced on the other type of transistor. If there is any doubt about the transistor markings, check the connections very carefully in the manufacturer's data sheet and match up the emitter, base and collector connections accordingly.

7. Insert the battery in the clips. Make sure it is polarized properly for the circuit.

8. Insert the three prongs of the tuning coil in the three holes in the board, and solder all of the coil prongs to the printed-wiring pattern.

9. Hook up the antenna and ground, using a good antenna (50 feet long and about 50 feet high) and a good ground (a cold-water pipe or a rod driven 4 feet into the earth). Use a lightning arrester in the antenna lead for safety.

Testing the one-transistor set

Plug the headphones into the holes provided. This will automatically complete the circuit and turn the set on. A 5,000-ohm headset is recommended. Rotate the tuning capacitor slowly—you should hear several stations. The nearby stations will be strong and clear. If they do not come in check all the wiring on the board. Be sure the transistor is in properly and that the connections are firm. Reversed connections can damage the transistor and will certainly prevent reception. Unplugging the headset will shut off the set. Useful battery life in sets of this type is almost equal to the battery's shelf life.

One-tube radio-control receiver

Fig. 603 shows the underside of a one-tube gas-filled thyratron receiver using printed-circuit techniques. The procedure was to

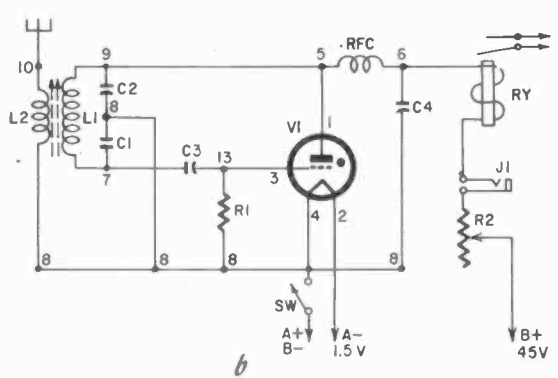
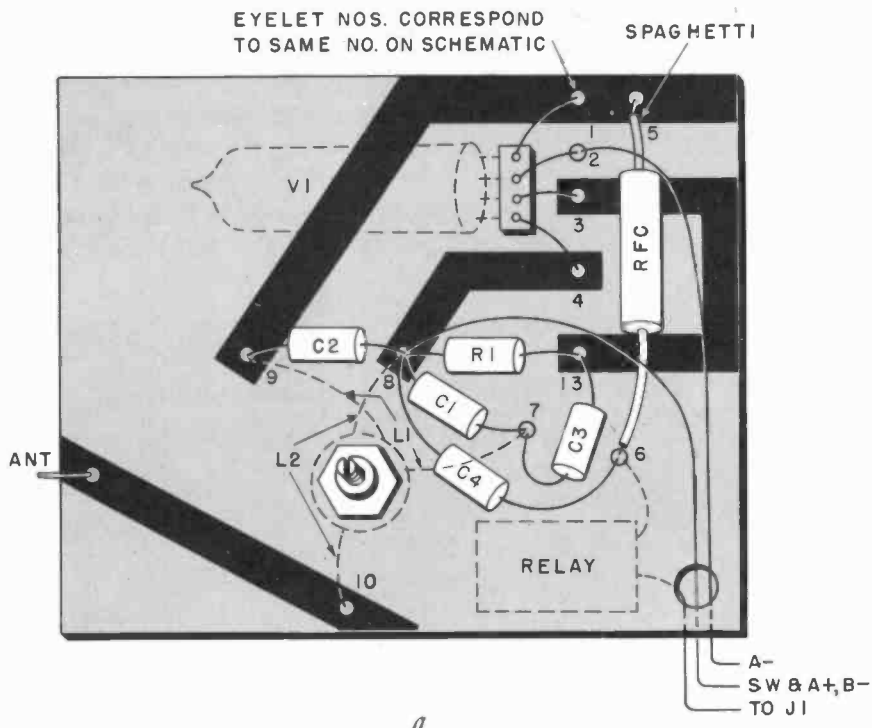

Resistors: R1—2 megohms, ½ watt; R2
25,000-ohm pot
Capacitors: C1—47 μf ; C2—15 μf ; C3—
100 μf ; C4—.02- μf 200-volt paper
Coils: L1—15 turns No. 26 enameled wire
on ⅜-inch-diameter slug-tuned form; L2—

3 turns No. 26 hookup wire wound over
L1; RFC—10 μh
Tube: V1—RK-61 or CK1054
Miscellaneous: RY—8,000-10,000-ohm relay
(Sigma 4F, 26F or equivalent); S—spst tog-
gle switch; closed-circuit jack; 1.5-volt bat-
tery; 45-volt battery; printed-circuit board

Fig. 604. The printed-circuit pattern (rear view) and schematic of the receiver shown in Fig. 603. The tube, relay and coils (L1 and L2) are mounted on opposite sides of the board. The batteries, switch, jack and R2 are mounted separately. Wires from eyelets #2 and #8 should be plastic-insulated type.

paint the conductors on the underside of the board and mount the bulkier components such as the tube, coil and relay on top.

The circuit was developed by E. Lorenz and is sometimes known as the Lorenz 61. The assembly is made using Fig. 604 as a guide. Paint the conductors on the underside of the board with silver paint and allow the board to dry. A 1/16-inch-thick Bakelite board was used in this case. Next, drill out No. 53 holes and rivet eyelets in place.

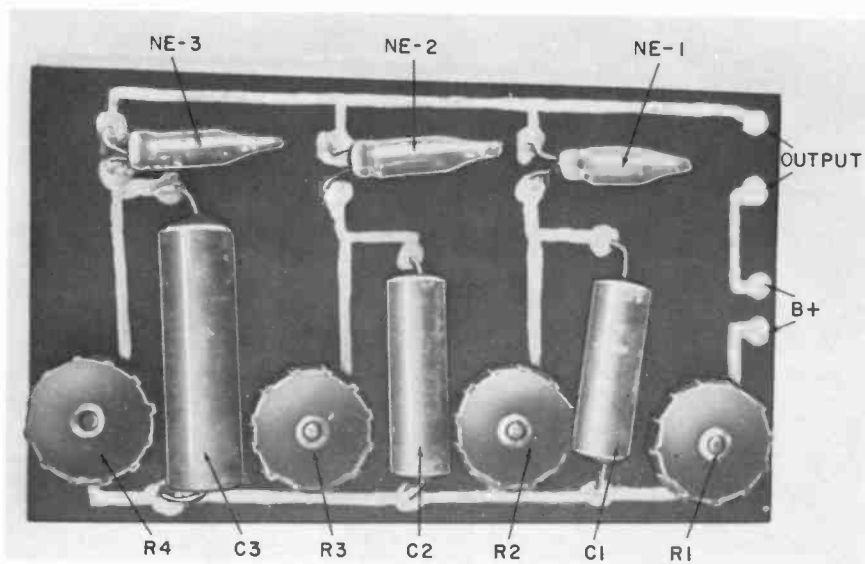
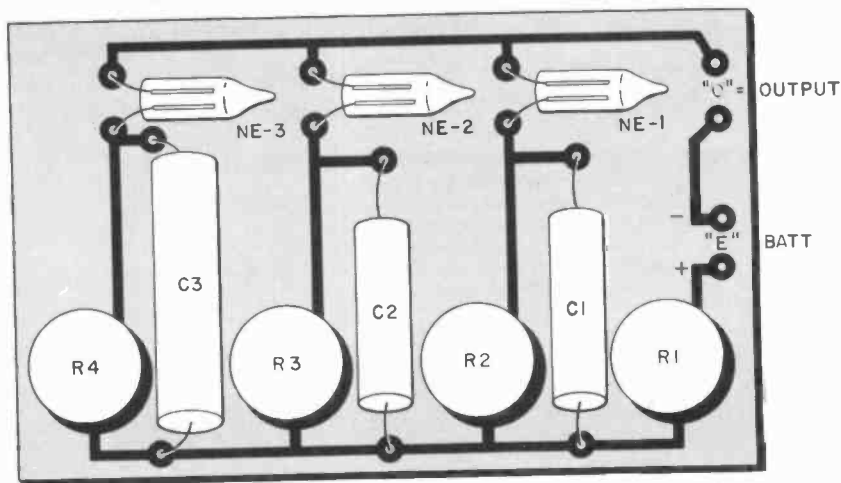

Fig. 605. This unit uses neon bulbs as timing devices.

After the riveted assembly is completed, add the components as follows: Cut out a rectangular hole for a subminiature four-pin tube socket, as shown. The opening for this socket should be cut slightly undersize so the socket fits snugly. Add a few drops of Duco cement around the edges of the socket if necessary. Using a 25-watt pencil soldering iron, solder the lugs to the identically numbered eyelets, making sure all leads are in place. Starting with tube pin 1, one end of the 10- μ h rf choke is connected to eyelet 5. The other end of this choke goes into eyelet 6. Insert the A-minus lead in socket eyelet 2. Next, make sure tube-socket pin 3 is in eyelet 3. The switch lead for A-plus and B-minus should be in socket eyelet 8.

The next components added are the resistors and capacitors. The 2-megohm resistor R1 is placed between eyelets 8 and 13.



a

Resistors: R1, R2, R3, R4—2 meg-ohms; 1/10 watt
 Capacitors: C1—.05- μ f 200-volt paper;
 C2—.25- μ f 200-volt paper;
 C3—.5- μ f 200-volt paper
 Miscellaneous: NE-1, NE-2, NE-3—
 NE-51 neon lamps; (2) 67.5-volt
 batteries (series to obtain 135-
 volt supply); printed-circuit board.

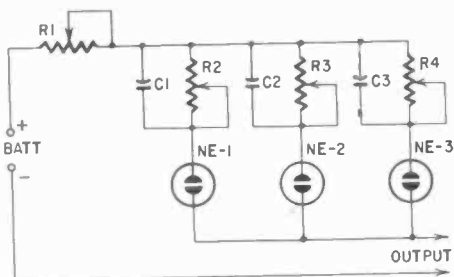

b

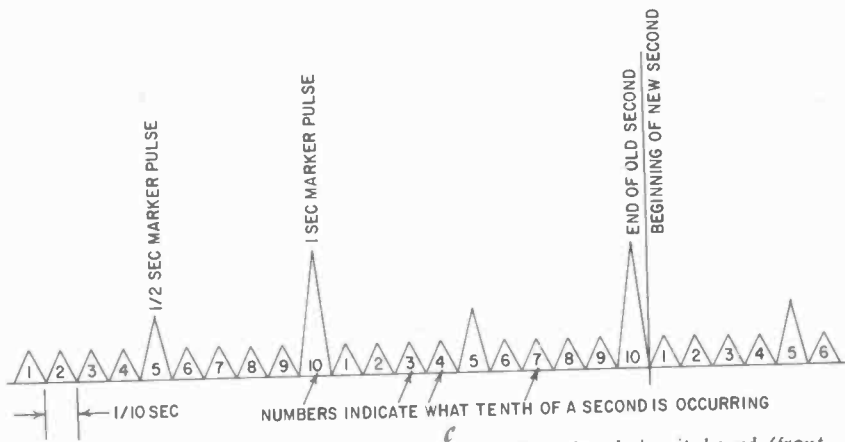

Fig. 606. Circuit diagram and arrangement of the printed-circuit board (front view) of the chronograph neon timer. The illustration at the bottom is the time-scale pattern of the neon timer.

The 100- μf capacitor C3 is laid between eyelets 7 and 13. Capacitor C1, a 47- μf unit, is put between eyelets 7 and 8, and C2 (15- μf) between 8 and 9. Note that eyelets 4 and 8 act as a

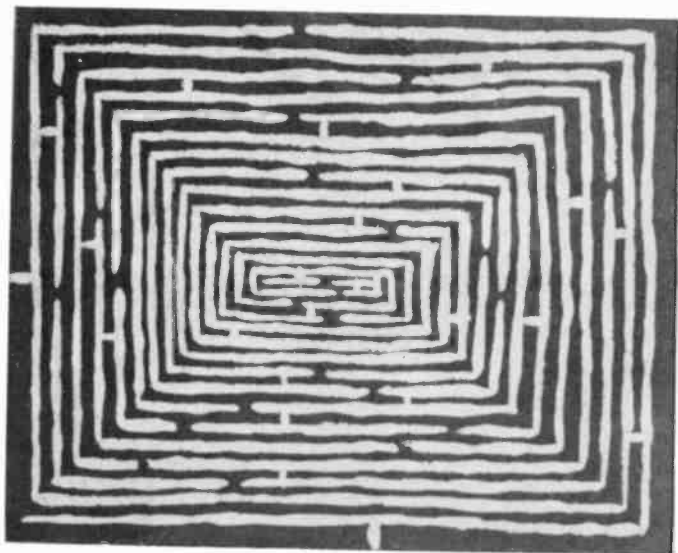

Fig. 607. A printed-circuit maze makes an interesting game.

common A-plus, B-minus return. Capacitor C4 is connected between eyelets 6 and 8.

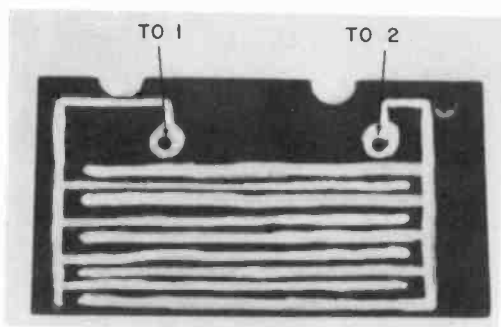
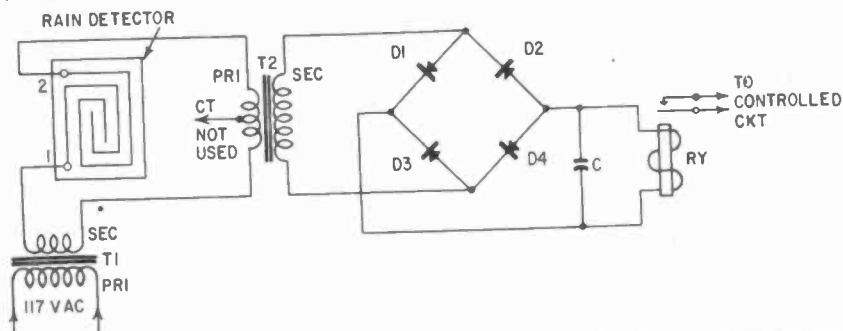

Fig. 608. This printed-circuit maze is used as the sensing element of a rain detector.

Coil assembly L1-L2 is mounted in a $\frac{1}{4}$ -inch hole at right angles to the base, and the leads are brought down to eyelet 7 and 9 for L1, and 8 and 10 for L2. The B-plus side of the relay

goes through a jack and a 25,000- or 50,000-ohm subminiature pot (not shown in the pictorial) and then to the battery supply.



Capacitor: C—.002- μ f 200-volt paper
 Transformers: T1—117-volt primary, 6-10-volt secondary (doorbell type); T2—500-ohm primary, 50,000-ohm secondary (Stancor TA24 or equivalent)

Diodes: D1, D2, D3, D4—Conant meter rectifier type M, series 500 or 4 1N34's in a bridge.
 Miscellaneous: RY—Sigma 4F8000S or equivalent; printed-circuit board

Fig. 609. The rain detector employs a bridge rectifier to trigger the relay.

The battery supply consists of a size D 1.5-volt cell for long life of the filaments and two 22.5-volt Burgess K-15 B units for the high voltage to the plate of the RK-61.

To tune the unit, insert a 0-5-ma meter in the jack in series with the B-plus lead. Be sure that the 25,000- or 50,000-ohm potentiometer is turned to maximum resistance before turning on the A-plus-B-minus switch. The meter should read between 0.5

Fig. 610. A field-strength meter can be easily made using etched-circuit techniques.

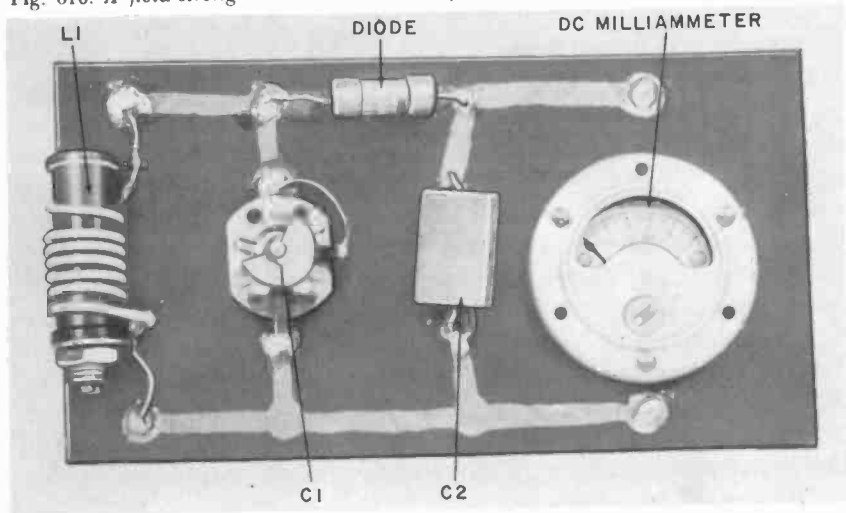

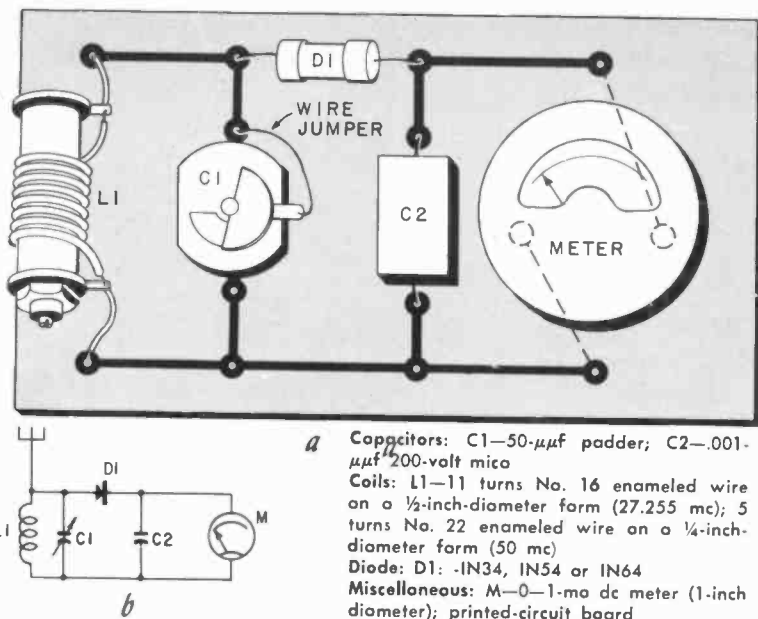

Fig. 611. The printed-circuit pattern and the schematic for the field-strength meter shown in Fig. 610.

and 0.8 ma. A Sigma 4F relay was used and set to pull in at about 0.9 ma. Turn on the 27.255-mc carrier from the transmitter, and key it. With the transmitter keyed, tune the core of the coil L1-L2 until you see a sharp dip to 0.2 ma or less. Field-check the receiver at 500 yards or so with a friend.

Chronograph neon timer

In this timer (Fig. 605) a neon lamp is charged and discharged through an R-C timing circuit. Basically the unit is a set of relaxation oscillators with component values chosen to give neon flashes at 1/10-, 1/2- and 1-second intervals. If the bulbs were placed side by side and mounted so that their flashes fell on a moving photographic film or paper, the unit would put a time scale on the film similar to that in the lower portion of Fig. 606. The bulb circuits must be adjusted individually, and the battery circuit has a 2-megohm series potentiometer to take care of changes in battery voltage and to synchronize the 1/2- and 1-second pulses. Note the symmetry in the printed circuit layout of Fig. 606 which closely resembles the schematic. Again, silver paint was used in the construction, although an etched circuit would have been about as easy to set up.

Printed-circuit maze

One interesting device which can be made using printed-circuit paints is the game shown in Fig. 607. This is a maze, which is used in series with a low-voltage battery and relay. The secondary contacts of the relay are hooked up to a bell or buzzer, and one side of the circuit goes to the maze, which is a common ground; i.e., all its parts connect to each other. The other side of the circuit

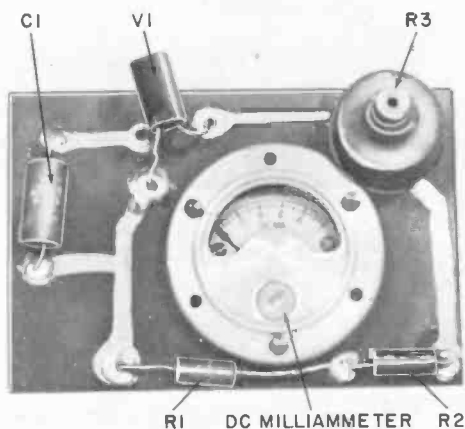

Fig. 612. A printed-circuit amplifier which uses a single transistor.

goes to a test prod with a phono needle in the chuck of the prod. The object of the game is to see who can run the test prod from the outside to the inside of the maze in the shortest length of time without ringing the bell or buzzer.

The maze can be silk-screened and made up in larger quantities by the etch method if desired. For finer results in the "hand-painted" model, use a 000 or 0000 sable paintbrush, and thin the silver or copper paint accordingly. The resistance in series with the relay and battery is adjusted to close the circuit when the prod contacts the maze and yet limit the current to a safe value in the relay coil.

Rain detector

Fig. 608 shows a variation of the maze game in which a painted silver grid with two parallel lines has been used as a moisture detector. Terminals 1 and 2 are hooked up to the input of a low-current sensitive relay circuit (Fig. 609). The output of the relay can be connected to an alarm to signal rain or humid conditions. The plate should be mounted in a spot where it will receive only light rainfall, such as a window ledge on an inside

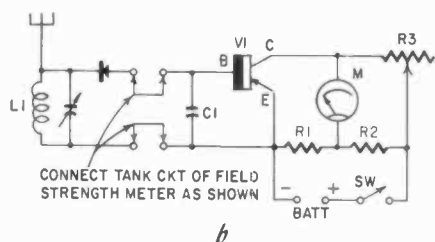
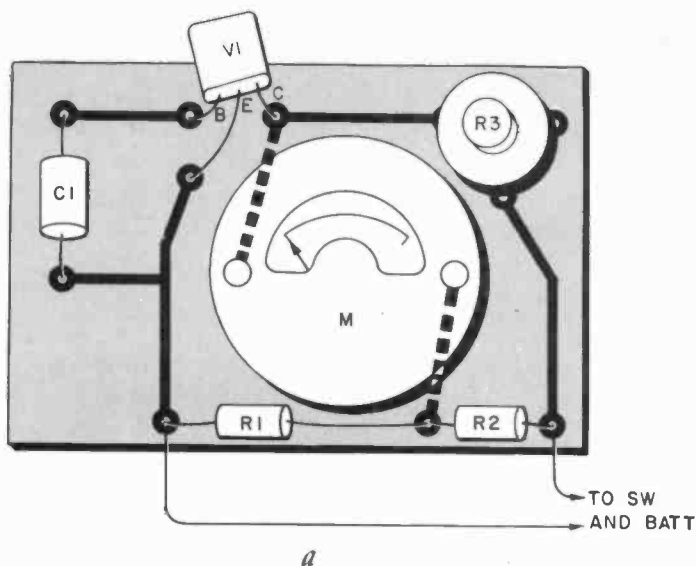

- Resistors: R1, R2—510 ohms, ½ watt; R3—25,000-ohm pot
 Capacitor: C1—.001- μ f 150-volt paper
 Transistor: V1—CK722
 Miscellaneous: M—0–1-ma 1-inch diameter meter; S—spst slide switch; 1.5–3-volt battery; printed-circuit board

Fig. 613. The printed-circuit pattern and schematic of the simple amplifier. Note that this unit can be used with the field-strength meter.

wall. Another method is to mount the detector plate inside a perforated plastic box, drained by sloping the box sideways.

Field-strength meter

A handy unit to make up in printed-circuit form is the etched-circuit version of the field-strength meter shown in Fig. 610. As with all simple printed circuits, the schematic in Fig. 611 bears a striking resemblance to the finished product. To take advantage of the subminiature layout, an 0–1-ma 1-inch-diameter meter was used as the indicator. An antenna can be made from a 2- or 3-foot piece of piano or brass wire, fastened to the unit with a banana plug and jack combination. The entire unit can be used in the form shown or mounted in a small meter box since no batteries are required.

To use the field-strength meter, set it at a fixed distance from

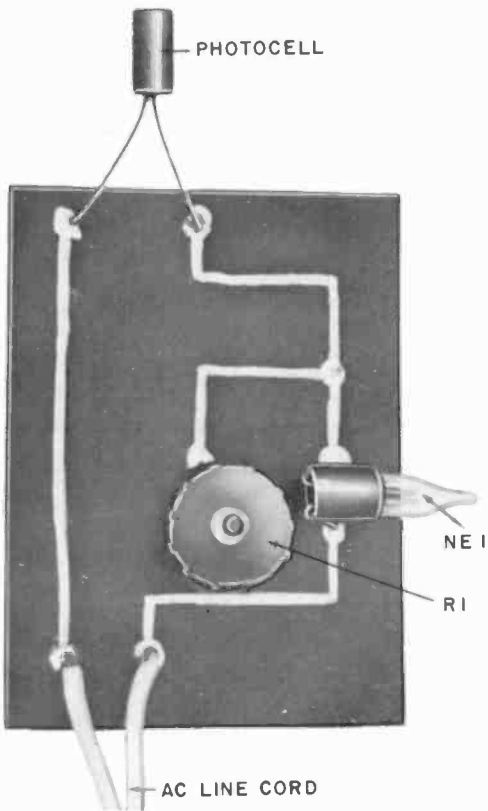

Fig. 614. This photoelectric light meter is built up using etched-laminate techniques.

the transmitter or rf source being checked. Key the transmitter and tune it for the greatest needle swing on the dc milliammeter. Leave the tuning capacitor setting alone and then go back to the transmitter, making whatever changes are necessary in the antenna, crystal coupling, etc. of the transmitter to get optimum performance. The printed-circuit transistor amplifier can be added to the field-strength meter to secure more sensitivity.

Printed-circuit amplifier

Figs. 612 and 613 show a printed-circuit amplifier built up with etching techniques. Carbon-composition resistors were used. The 25,000-ohm control is a subminiature pot, and the voltage supply is two Mallory RM-625 mercury cells in series, Scotch-taped together to form a battery. The circuit has an approximate current-amplification factor of 10, so that an 0-1-ma meter will now be

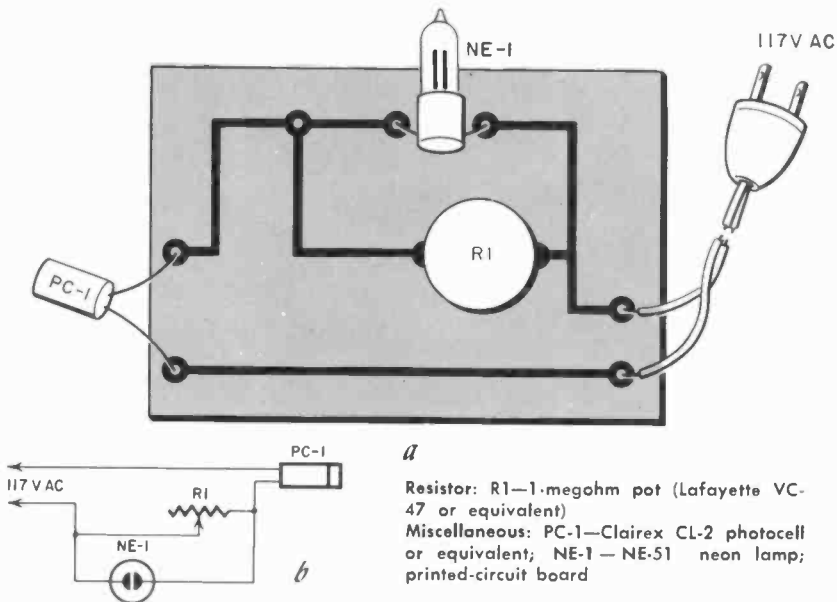

Fig. 615. The printed-circuit pattern and schematic of the light meter shown in Fig. 614.

effectively an 0-100-microampere meter. When using this circuit with the field-strength meter above, hook it up as shown in Fig. 613. Switch on the battery and zero the meter with the 25,000-ohm pot. Then tune the field-strength meter.

Photoelectric light meter

Fig. 614 shows a photo light meter fabricated by etched laminate techniques. The photocell is in series with a neon lamp and 117 volts ac is fed to it. A 1-megohm pot shunts the neon lamp and serves as a sensitivity control. The light source to be measured is set to shine on the photocell, and then the potentiometer adjusted to a point where the neon lamp just lights. Another way to use the meter is to put a set of polaroid filters between the light source and the meter. By using crossed polaroid filters or an old camera iris, the light intensity can be varied and the photocell calibrated in terms of potentiometer rotation.

The schematic is shown in Fig. 615. A socket can be used instead of direct soldering for the photocell leads.

Light-beam relay

Fig. 616 shows the etched board for a light-beam relay. A complete construction schematic is given in Fig. 617.

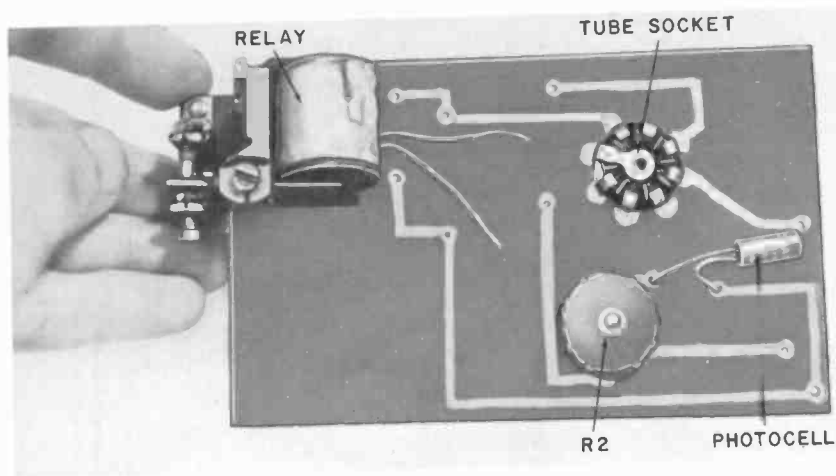

Fig. 616. A light-beam relay which uses a 15-watt lamp for filament dropping and as a light source.

R1 is a protecting resistor and R2 a 500,000-ohm or 1-meg potentiometer for sensitivity control. V1 is a 6C4 triode, and its filament voltage is obtained by a series circuit with a 15-watt lamp. The latter also serves as a light source. C1 is a 4-8- μ f 150-volt electrolytic capacitor which prevents relay chatter. The 15-watt lamp can be set up with suitable optics to give a narrow light beam. When the beam is focused on PC-1, and R2 is adjusted properly, interruption of the light will cause relay action. The spdt relay is wired to give the desired switching action in the outside circuit being controlled.

Circuits using Ampecs*

The following group of circuits are built up around a typical commercially available printed-circuit of the ceramic-based type. They are examples of what can be done with a basic printed circuit such as a three-stage amplifier. In each of the circuits shown, the amplifier was the building block around which the additional components were mounted. Several approaches have been used, mainly to give the builder a feeling for the methods used rather than for the circuitry itself.

The Ampec unit shown in Fig. 618 is a three-stage audio amplifier capable of running 1 millivolt or so input up to two milliwatts output. Output plate loads are in the range of 50,000 to 100,000 ohms and, at 1,000 cycles, the gain of the unit is about 5,000. The

* Centralab Division of Globe-Union, Inc.

WIRE JUMPER—
USE SPAGHETTI TO PREVENT
SHORT TO PRINTED CIRCUIT

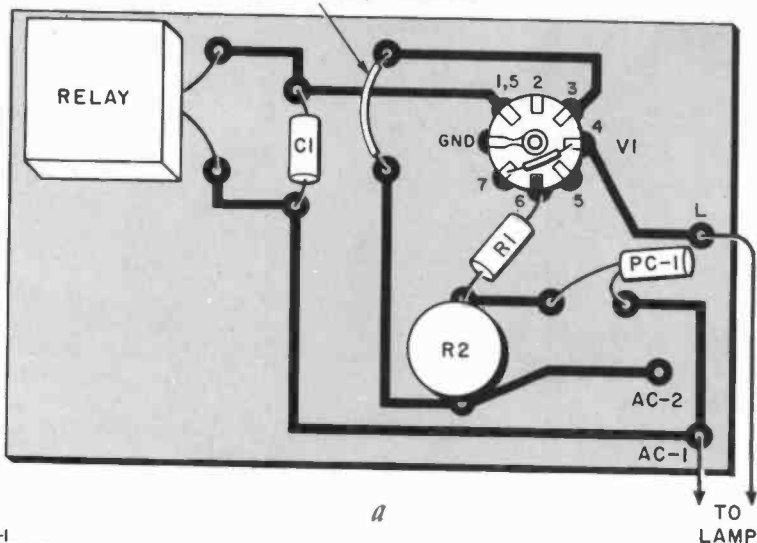

a

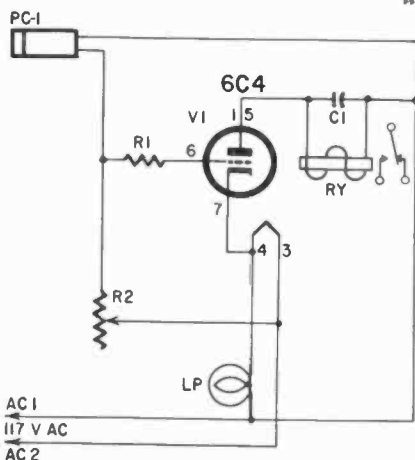

b

Resistors: R1—100,000 ohms, $\frac{1}{2}$ watt; R2—1-megohm pot (Lafayette Radio VC-47 or equivalent)

Capacitor: C1—4- μ f 150-volt miniature electrolytic

Tube: V1—6C4

Miscellaneous: RY—Sigma 4F-8000S or equivalent; PC-1—Clairex CL-3 photocell or equivalent; LP—15-watt 117-volt lamp (GE 15S11/14 candelabra base or equivalent); printed-circuit board

Fig. 617. The printed-circuit layout and schematic for the light-beam relay shown in Fig. 616.

capacitors are rated at 150 working volts dc and tested at 300 volts. The resistors are nominally rated at $\frac{1}{5}$ watt. The entire Ampec is coated with phenolic resin and high-temperature wax. The conductive paths are pure silver fired to a steatite base. The manufacturer furnishes 26-gauge tinned leads approximately $1\frac{1}{2}$ inches long. The model used in these circuits was a No. PC-201 with a tube complement of one CK525AX and two CK512AX subminiatures. The schematic is shown in Fig. 619.

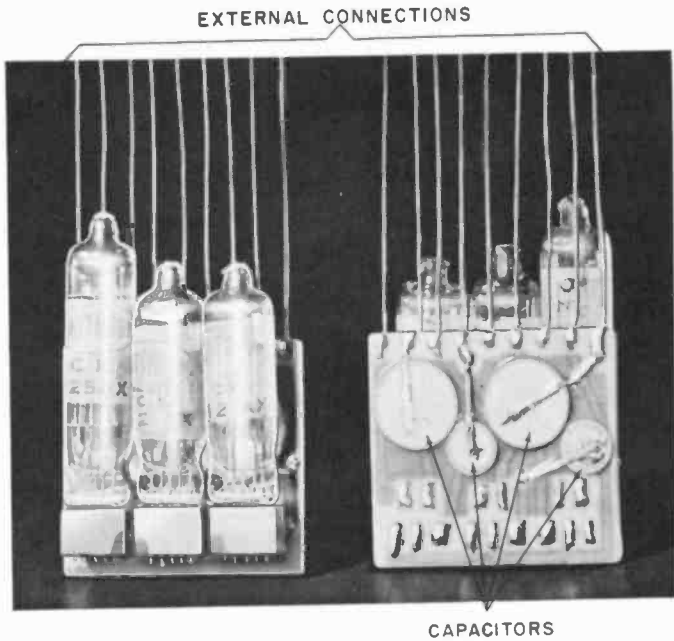

Fig. 618. Several views of the Ampec, a packaged 3-stage amplifier. (Courtesy Centralab Division of Globe-Union, Inc.)

Auxiliary components

Suitable external components for the Ampec would be subminiature volume controls such as the Centralab B16-series, $\frac{1}{4}$ -watt carbon resistors, ceramic capacitors for low capacitances, and tantalytic or metalized paper capacitors for highest capacitances in the 22.5-45-volt range. Subminiature transformers such as the UTC subouncers can be used for impedance matching. The

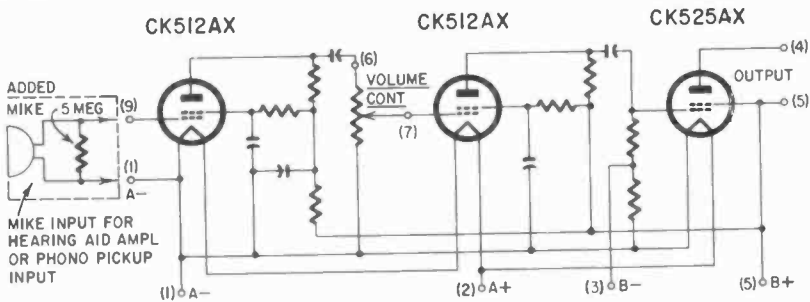

Fig. 619. Schematic of the Ampec. Notice the addition of an external microphone.

B-voltage on the Ampec is usually limited to 45, unless otherwise shown.

Input circuits

The Ampec can be made the basis of a hearing-aid amplifier by tying a 2-5-megohm resistor across the input grid circuit, as shown in Figs. 619 and 620. Another variation is to use a contact

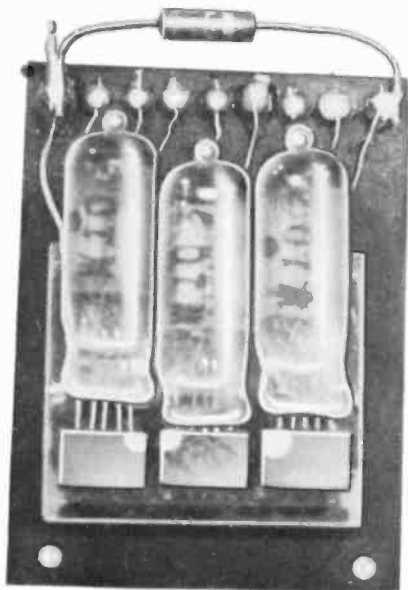
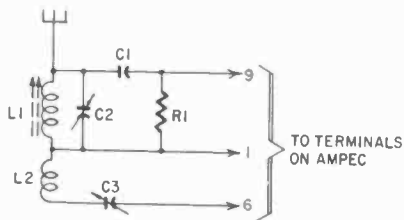

Fig. 620. By connecting a suitable resistor across the input circuit, the Ampec can be used as the heart of a hearing aid.

microphone or phonograph pickup cartridge as an input device. In these two hookups, the Ampec can be used as either an audio preamp or an industrial or medical stethoscope.

Subminiature radio sets

In the unit shown in Fig. 621, the Ampec has been built into



Resistor: R1—5-10 megohms, ½ watt
 Capacitors: C1—5- μ f—.01- μ f ceramic; C2—to match L1 for frequency desired; C3—8-50- μ f trimmer (Centralab 822AN or equivalent)
 Coils: L1—to match C2 for desired frequency (use a slug-tuned form); L2—10 turns No. 22 dcc wire wound over L1
 Miscellaneous: hookup wire; mounting hardware

Fig. 621. This simple circuit converts the packaged amplifier into a grid-detection receiver.

a grid-detection receiver. C1 is a small ceramic and C3 a tubular glass trimmer. R1 is a 6-megohm, ¼-watt resistor. The tank com-

ponents, L1 and C2, are chosen to tune the desired frequency. With modern components, the L1-C2 package for the broadcast

Fig. 622. Another radio receiver built around the Ampec.

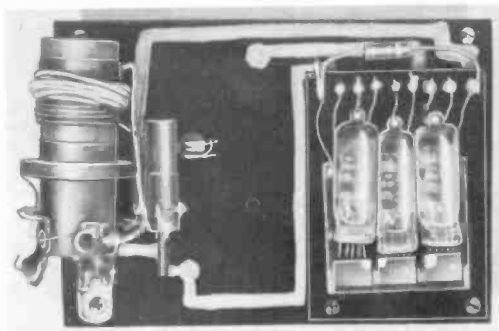

band is smaller than the size of conventional 365- μf tuning capacitors.

Resistor: R1—5–10 megohms, $\frac{1}{2}$ watt
 Capacitors: C1—5- μf -.01- μf ceramic; C2—to match L1 for frequency desired; C3—8–50- μf trimmer (Centralab 822AN or equivalent)
 Coils: L1, L2—standard broadcast antenna; L3—10 turns No. 22 dcc wire wound over L1, L2

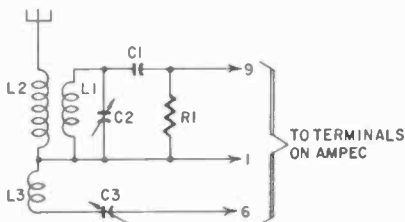
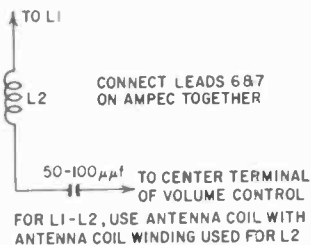

Fig. 623. This circuit is used to convert the Ampec into the unit shown in Fig. 622.

Fig. 622 shows an Ampec with a broadcast antenna coil front end; a tickler winding has been added to the coil. The schematic is shown in Fig. 623.

Fig. 624. A simple circuit which converts the receiver of Fig. 623 into a regenerative type.



The receiver circuits above can be made regenerative by the conversion shown in Fig. 624. Here, L2 is connected to the center tap of the control potentiometer by a 50- μf capacitor, and the plate and No. 2 grid leads are tied together.

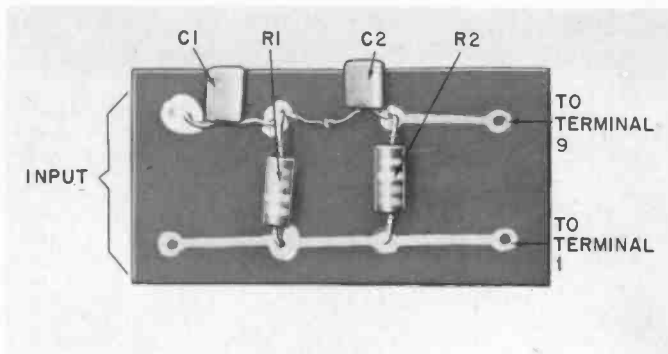
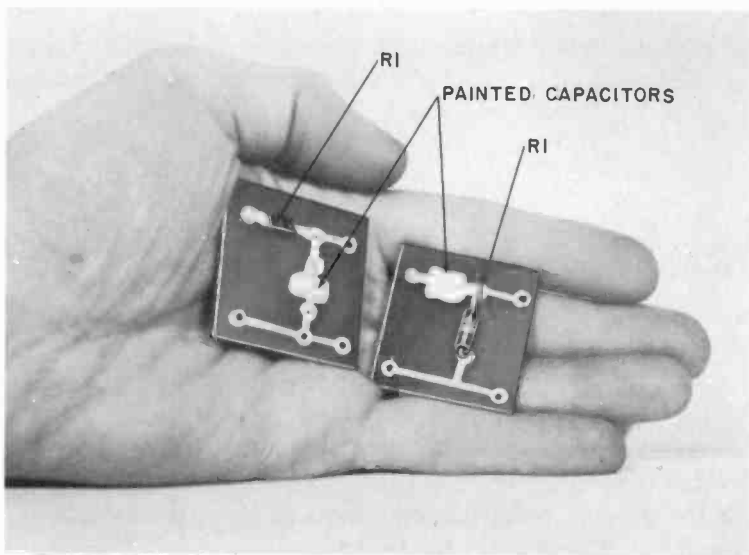

Fig. 625. This simple network is used for the input to a signal tracer.

Signal tracers, integrators, differentiators

Fig. 625 shows an example of a front end for a signal tracer made up for use with the Ampec. Both three-dimensional components and etched circuit techniques are used in the band-pass network that precedes the Ampec itself. Variations of the R-C networks are shown in Fig. 626, where they are used as integrators and differentiators. Their principal advantage is the ease with which they can be plugged into a circuit to change operating

Fig. 626. Variations of the R-C network shown in Fig. 625 are used as integrators and differentiators.



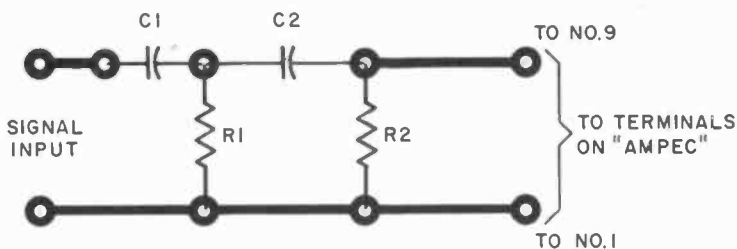

R1, R2—100K TO 10 MEGS, 1/4 WATT
 C1, C2—.002 TO .01 μ f, 200V. CERAMICS

a

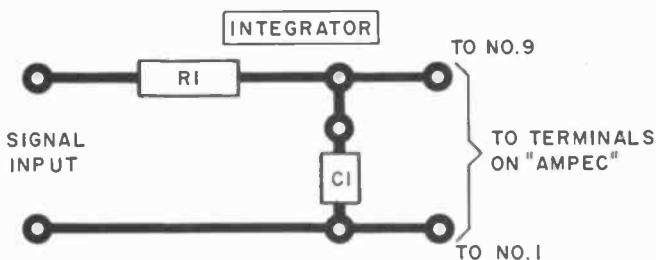

R1—"PAINTED"—5 K TO 1 MEG
 C1—"PAINTED" UP TO 100 μ f; DISC CERAMIC UP TO .01 μ f

b

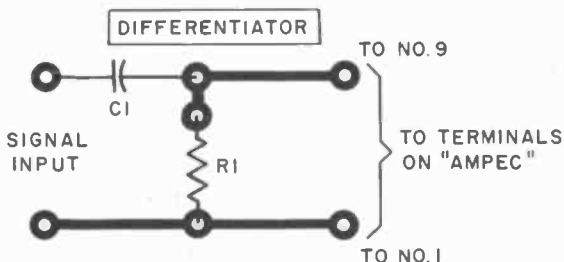

C1—"PAINTED"—SEE INTEGRATOR CIRCUIT ABOVE
 R1—"PAINTED"—5 K TO 1 MEG

c

Fig. 627. R-C combinations in printed-circuit form. The unit at the top is a two-section differentiating circuit.

values. These R-C networks can be used as the basis of many circuits—frequency bridges, af and rf oscillators, and relay timers, to name only a few. Commercial versions of these R-C combinations have been taken up in detail in Chapter 3; but occasions come up where a commercial unit is not available (for original or replacement purposes) and the technician should know how to build his own. Fig. 627 shows the details of the units in Figs. 625 and 626.

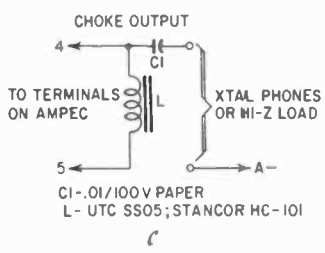
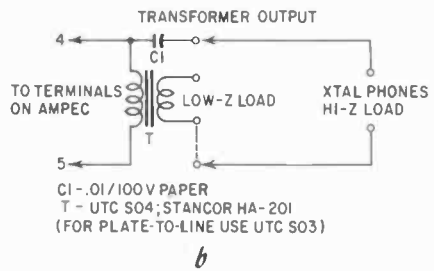
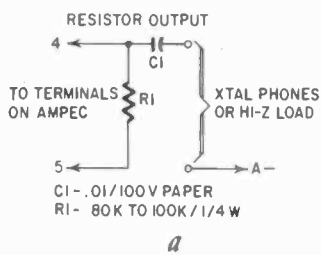
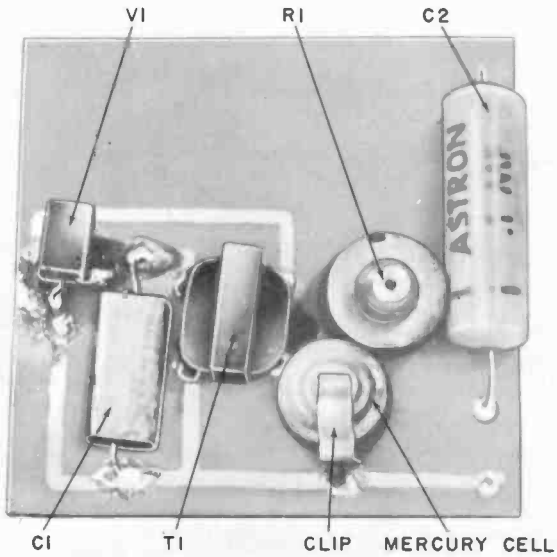

Fig. 628. Types of output coupling circuits commonly used with the Ampec.

Output circuits for Ampecs

Depending on the output device, the plate of the final tube must be matched to the impedance of the load. Shown in Fig. 628 are the three main types of output coupling used with the Ampec.

Fig. 629. A transistor audio oscillator which was built using the copper-laminate technique.



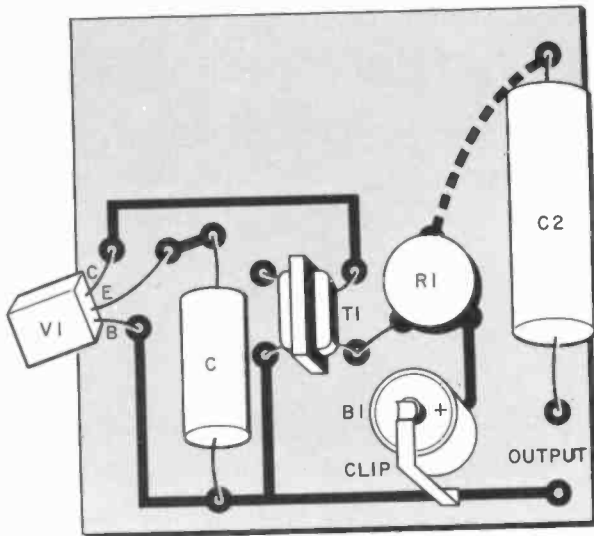

a

Resistor: R1—1,000-ohm pot
 Capacitors: C1—.05- μ f 200-volt paper; C2
 —1- μ f 200-volt paper
 Transformer: T1 Argonne AR-109 or equiv-
 alent
 Transistor: V1—CK722
 Miscellaneous: B1—1.3-volt battery (Mallory
 RM-625 or equivalent); printed-circuit board

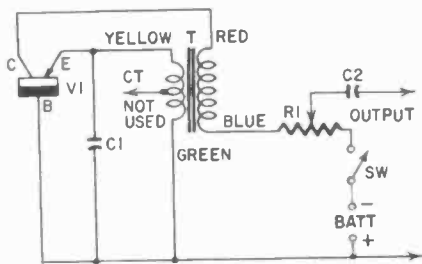

b

Fig. 630. Schematic and printed-circuit pattern for the audio oscillator shown in Fig. 629. The center of the potentiometer, R1, is connected to C2 by a conductor on the underside of the board. The battery is plugged in and out for switch action.

On the left is the resistor type, which generally gives better results at the lower frequencies, according to the manufacturer; on the right, the transformer output. The remaining output circuit is a choke type.

Bias considerations

There are several models of the Ampec, and the manufacturer's instructions should be followed closely to prevent damage to the unit and also to obtain the best results. In the model 201, the 1,500-ohm resistor (R7, Fig. 619) was designed for use with a 30-volt B supply. If the battery voltage and output coupling arrangements are varied, R7 may have to be shunted for best performance. With models 202 and 203, other minor changes are necessary. Model 202 has a zero-bias output stage, and model 203 uses grid-bias. In addition, model 203 is designed to operate

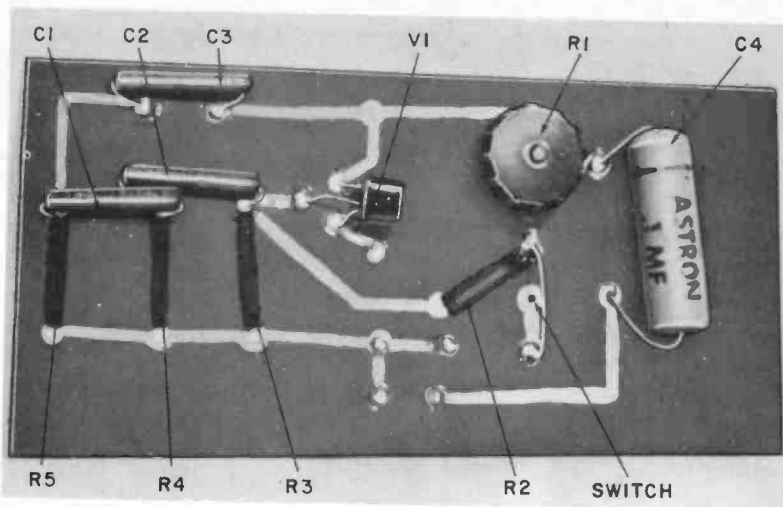
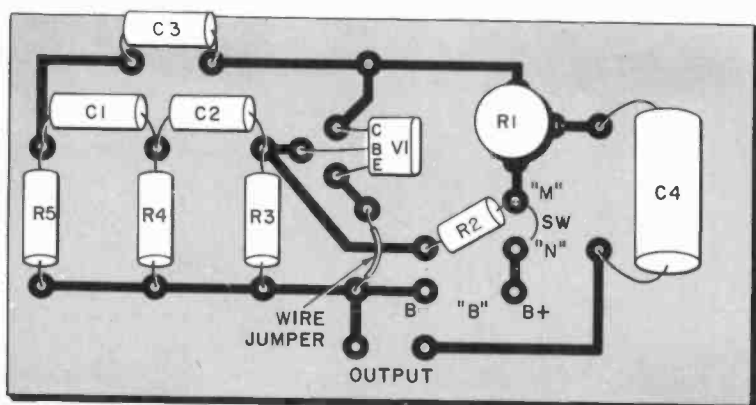
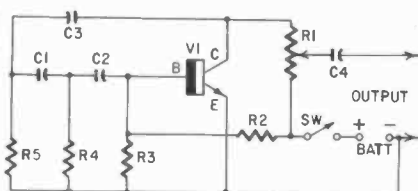

Fig. 631. A phase-shift audio oscillator which uses printed-circuit techniques.



a

Resistors: R1—10,000-ohm pot; R2—750,000 ohms, $\frac{1}{2}$ watt; R3, R4, R5—10,000 ohms, $\frac{1}{2}$ watt
Capacitors: C1, C2, C3—.001- μ f 100-volt paper; C4—0.1- μ f 200-volt paper
Transistor: V1—2N35
Miscellaneous: 22.5-volt battery; printed-circuit board



b

Fig. 632. Printed-circuit board arrangement and circuit diagram of a transistor audio oscillator. The battery is external to the board and is hooked up to the terminals at "B". A wire jumper is soldered from the emitter circuit to the B-minus bus as shown. SW is a piece of tinned hook-up wire soldered at point "M". Pressing SW into hole "N" completes the circuit.

with two CK538DX tubes instead of CK512's, and a CK548DX instead of the CK525.

Printed-circuit audio oscillators

Fig. 629 shows a printed circuit transistor audio oscillator built

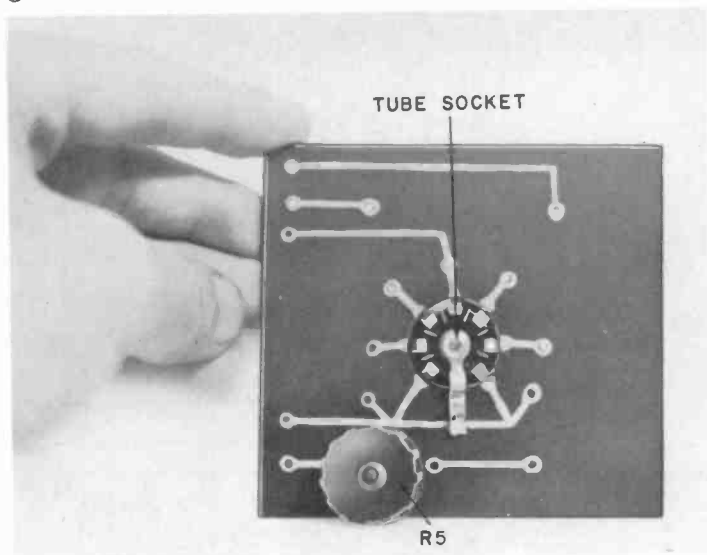
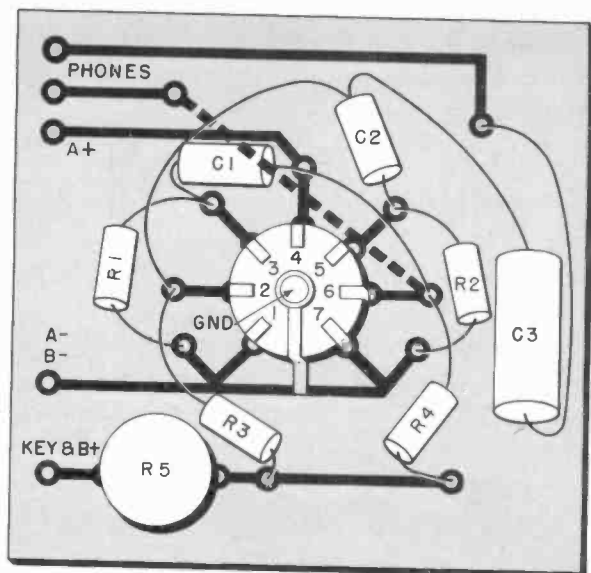

Fig. 633. Printed-circuit board for an oscillator that can be used in radio-control service.

up using the copper-laminate etch technique. The pattern is first laid down with an asphaltum resist or other materials mentioned in Chapter 2. The plate is then etched with ferric chloride or ammonium persulfate, and the resist removed. Then eyelet holes are drilled and eyelets mounted. The schematic (Fig. 630) resembles the circuit pattern closely and should be used as a guide to the layout and mounting of components.

Another version of a printed-circuit audio oscillator is shown in Fig. 631; resistors and capacitors have been used to make up a phase-shift unit. Fig. 632 shows the pictorial and schematic. An etched laminate-base technique was used, but the three 10,000-ohm and 750,000-ohm resistors were painted on, using carbon-base paints (Chapter 2). The resistors should be allowed to age for several days and then checked with an ohmmeter. By scraping or altering the physical dimensions of the painted resistors the builder can come very close to the values given. The values in the schematic should produce a tone between 1,000 and 4,000 cycles. High-impedance phones or high-impedance output transformer



a

Resistors: R1, R2—47,000 ohms, ½ watt; R3, R4—5,000 ohms, ½ watt; R5—500,000-ohm pot (Lafayette Radio VC-46 or equivalent)

Capacitors: C1, C2—.001- μ f 150-volt paper; C3—.02- μ f 150-volt paper

Tube: V1—3A5

Miscellaneous: 1.5-volt battery; 45–67.5-volt battery; printed-circuit board

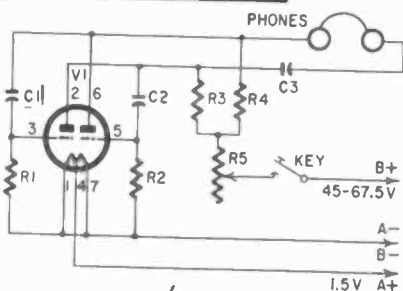

b

Fig. 634. Printed-circuit board and circuit diagram of a twin-triode oscillator. Pin 6 has a crossover on the opposite side of the board which goes to the phones. All component leads should be insulated with spaghetti. The ground lug on the tube socket is soldered to the A-bus for support. The key and batteries are external to the board.

coupling will give the best results. The 750,000-ohm resistor and R3 form a voltage-divider network which stabilizes the bias on the base connection of the 2N35 transistor. Oscillator frequency can be varied by changing C1, C2 and C3 equally. Decreasing the capacitance will raise the frequency.

Tube circuits

A 3A5 high-frequency twin-triode has been used as the heart of the printed-circuit oscillator shown in Fig. 633. Etched-circuit construction has been used, and the schematic of Fig. 634 is a guide to the physical layout. The same circuit can be built up with the coil painted on the envelope of the tube (cf...“lipstick”

transmitter, Chapter 7). the circuit shown here is basically a push-pull oscillator and *can be adapted* for 6-meter radio control work by licensed hams.

Slightly more compact is the printed-circuit board for the Pierce crystal oscillator (Fig. 635). This is built around a CK507AX subminiature hearing-aid tube. Etched technique was used. The circuit, known as the CGQ in Navy circles during World War II, packs a good wallop in spite of its tiny size. A pictorial assembly is shown in Fig. 636.

High-frequency crystal-controlled transmitter

A printed-circuit version of a crystal-controlled transmitter is shown in Fig. 637. The circuit values are for operation in the

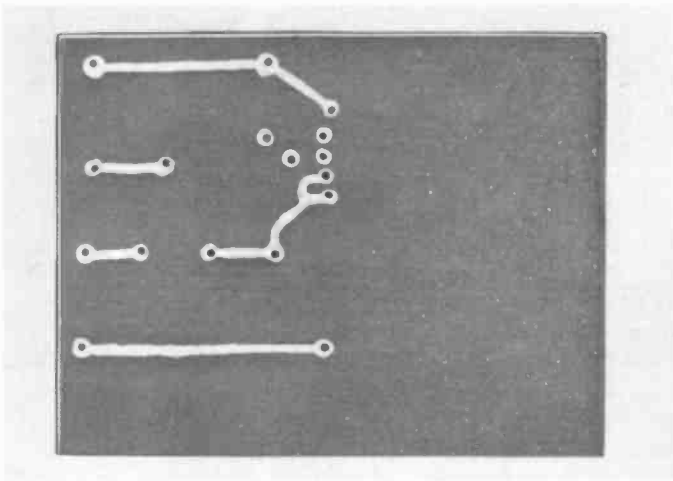

Fig. 635. Printed-circuit board for a Pierce crystal oscillator.

27.255-mc or Citizens radio control band. The advantages of printed-circuit construction can be seen in the “flat” look of the unit; the entire assembly can be incorporated into a hand-held type of transmitter with battery supply. Silver paint was used to lay down most of the conductors, and wire was used at the tube socket to allow for right-angle tube mounting. Fig. 638 shows the construction details.

Phonograph pickup

The phono pickup shown in Fig. 639 is constructed from a piece of 1/16-inch plexiglas. Two “ears” are cut out, and a carbon paint line is run from ear to ear along the Plexiglas. A piece of Plexiglas rod is drilled and tapped for a phono needle at the end

opposite the ears. The entire assembly is put in series with a 1.5-volt battery and potentiometer, and fed into the front end of an amplifier (Fig. 640). The builder will have to experiment with the paint thickness, width and resistance, depending on the amplifier circuit used.

The beam flexes as it rides in the record grooves and causes resistance variations of the printed paths on the beam. These

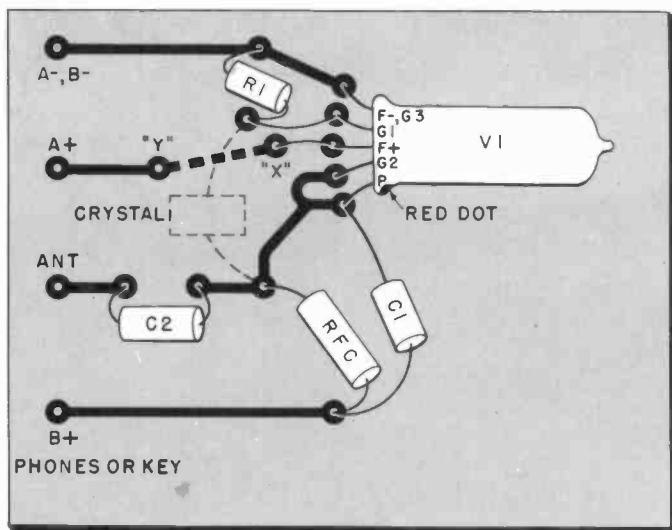

Resistor: R1—220,000-ohms, ¼ watt
Capacitors: C1—10- μ mf tubular ceramic; C2—15- μ mf mica
Tube: V1—CK507AX
Miscellaneous: 2½ millihenry rf choke; printed-circuit board; crystal

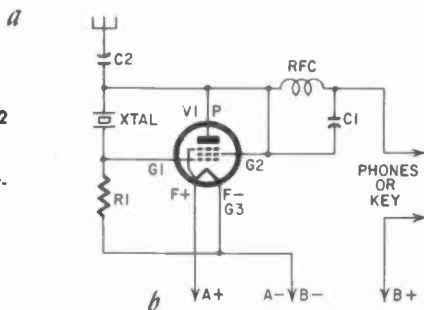

Fig. 636. Printed-circuit pattern (front side) and schematic for the crystal oscillator shown in Fig. 635. The crystal is mounted on the opposite side of the board. The filament plus lead goes under the board at "X" and comes back up at "Y". "X" to "Y" is etched or painted on rear side. The crystal holder should be insulated from this "X" to "Y" length of conductor.

changes modulate the series voltage to the input of the amplifier and are reproduced as sound.

While the unit will not satisfy the critical ear of the high-

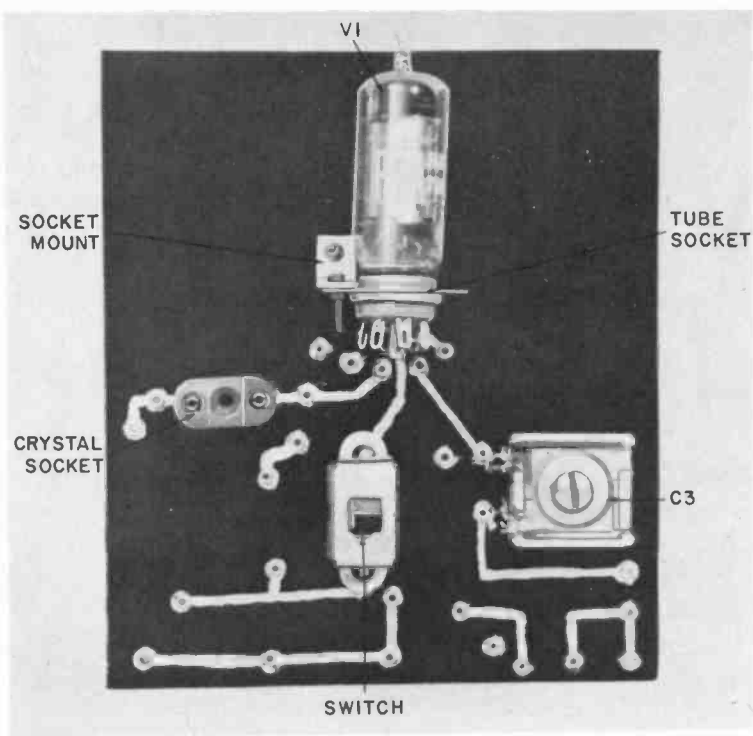

Fig. 637. A printed-circuit board was used in the construction of this 27.255-mc transmitter.

fidelity hound, it is another interesting example of what can be done with printed-circuit techniques.

Printed-circuit switches

Printed circuitry can be used to simplify switch construction. One interesting aspect of switches using printed-circuit designs is that the cost of the switch is fairly independent of its complexity in commercial production quantities. Thus, a 30-pole selector switch could be produced about as cheaply as a 4-pole unit, since the major costs are the master drawing and photographic work. Machining costs of conventional electromechanical switches are several times those of etched-laminate switches.

Copper laminates are too soft to be used commercially without further alterations—copper has a relatively short wearing life. In many cases, the copper pattern is silver- or nickel-plated. The hardest and longest wearing surfaces are produced by combinations of nickel and rhodium plating techniques.

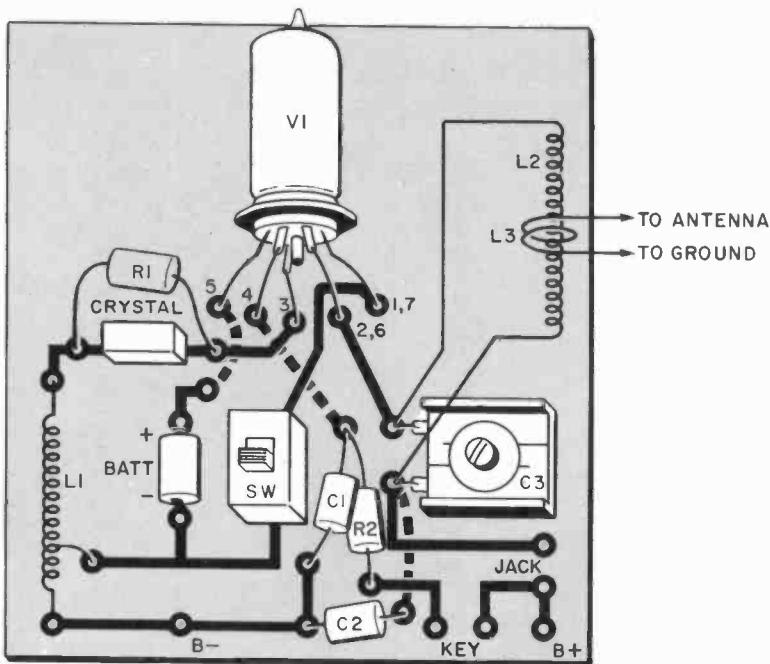

a

Fig. 638. The printed-circuit pattern and schematic of the transmitter shown in Fig. 637.

Resistors: R1—50,000 ohms, ½ watt; R2—15,000 ohms, ½ watt
Capacitors: C1, C2—.005- μ f 200-volt paper; C3—30- μ f trimmer
Coils: L1—30 turns No. 22 dcc wire on ¼-inch-diameter polystyrene rod (tap 3 turns from end near tank circuit); L2—11 turns No. 14 enameled wire on ¾-inch form; L3—5 turns No. 14 enameled wire on ¾-inch form
Tube: V1—1S4
Miscellaneous: XTAL—27.255-mc crystal; SW—spst switch; closed-circuit jack; key; 1.5-volt battery; 67.5-volt battery; printed-circuit board.

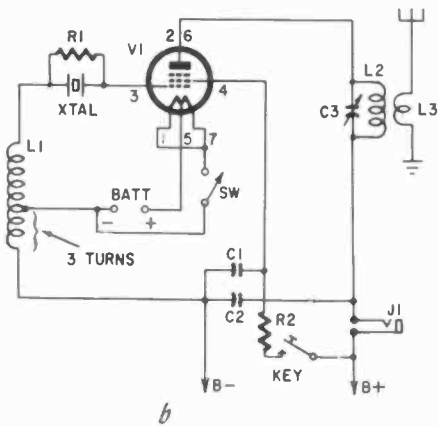

b

One problem inherent in silver plating or the use of silver-laminate combinations is that of silver "migration." The silver particles tend to travel into the nonconducting part of the laminate base and cause short-circuiting under certain conditions such as high humidity or fast operation at high voltage. The amount of "migration" seems to increase with higher applied dc voltages and also with relative humidity increases.

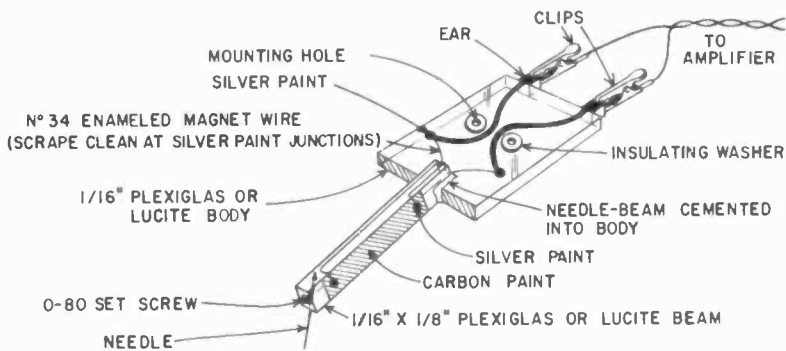
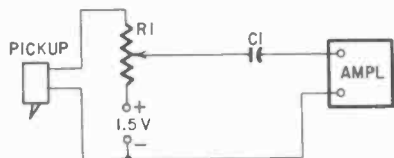

Fig. 639. Scrap plastic and printed-circuit paints are used to construct this simple phono pickup.

Raised and flush switch patterns

The factors to keep in mind when designing printed-circuit switches are speed of operation, life in terms of number of opera-



Resistor: R1—1-megohm pot
 Capacitor: C1—.002- μ f 200-volt paper
 Miscellaneous: scrap Lucite or Plexiglas;
 wire; silver paint; 1.5-volt battery

Fig. 640. Circuit of the printed-circuit phono pickup.

tions before failure, surrounding conditions such as temperature and humidity, and the torque (turning force) required to actuate the switch.

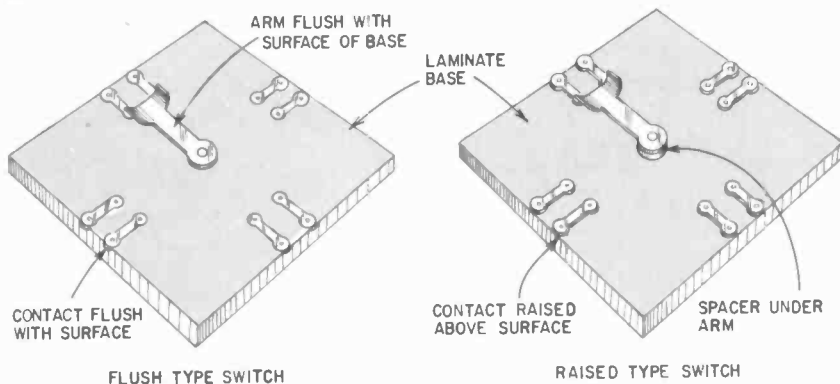

Fig. 641. Printed-circuit switches can be of the raised or flush type.

Either raised or flush contacts can be used in printed-circuit switch construction (Fig. 641). The raised type is suited for low-speed or hand-switching. Raised designs in copper with silver

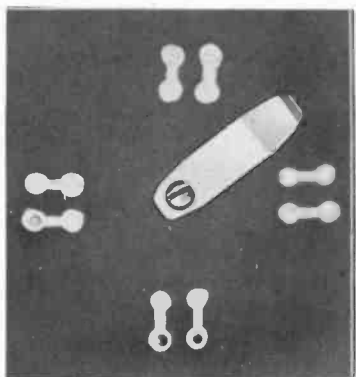

Fig. 642. In this switch the rotary member is independent of the controlled circuits.

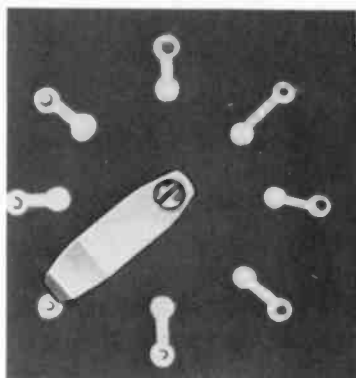

Fig. 643. The rotating component of this printed-circuit switch forms the common return.

plate have a life of up to 500,000 or so operations. On the other hand, flush designs with rhodium plating can give life expectancies of 10,000,000 operations or more. Raised patterns also have the additional disadvantage of bumpy operation and require more turning force to operate.

Because of the low arc resistance of phenolic laminates, epoxy glass is used for switches where arcing is a factor. Brush materials in commercial use include phosphor bronze, beryllium copper, gold alloys and special combinations of silver with graphite. Some manufacturers claim that certain lubricating compounds increase switch life.

Making printed-circuit switches

The raised-contact switches described are made with the etched copper-laminate technique. The experimenter can have these

Fig. 644. This hinged relay switch activates four separate circuits simultaneously.

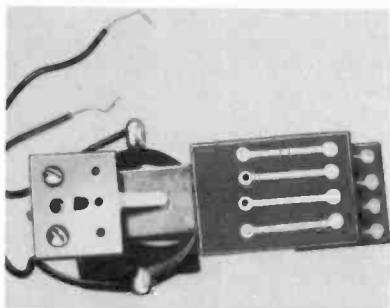
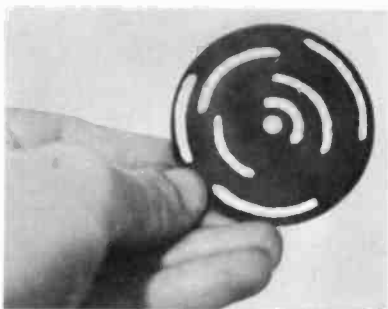

Fig. 645. A rotating switch wheel of this type can be used as the heart of various timing devices.



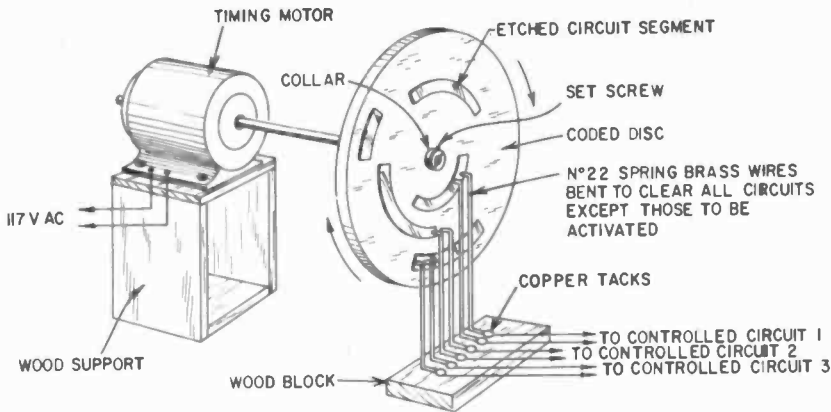

Fig. 646. Rotary printed-circuit switch can be used for timing operations.

plated or else plate them himself. However, since the average amateur usually needs only switches with low life expectancy, plating is generally not required.

The raised-contact switch is the easiest to produce as far as the

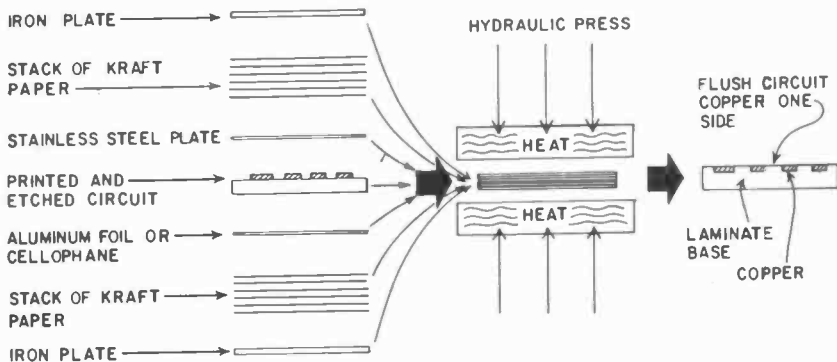

Fig. 647. The steps involved in the fabrication of the flush type of printed circuit. (Courtesy Continental Diamond Fibre Co.)

experimenter is concerned; designs are limited only by his ingenuity.

Fig. 642 is a rotary switch in which the circuits are completed independently of the rotating member; Fig. 643 has a common return through the rotating member. Fig. 644 is a hinged relay switch in which four separate circuits are closed simultaneously by a set of printed-circuit plates.

Fig. 645 is a rotary switch wheel for timing purposes. The wheel can be driven by a motor (Fig. 646), different contacts being used

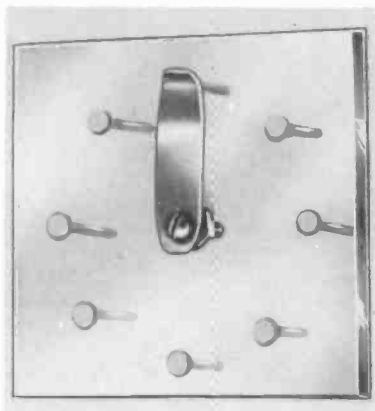

Fig. 648. This switch was made from a plastic plate and copper tacks.

to turn appliances and other devices on and off at various intervals.

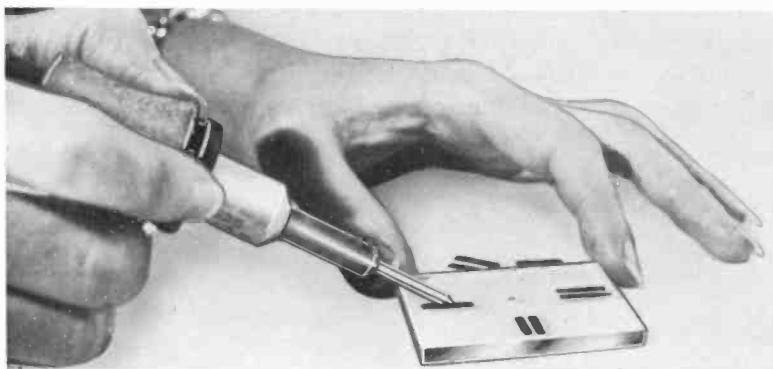
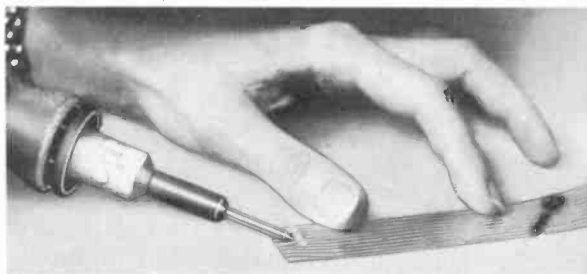

Fig. 649. Copper strips are imbedded in a plastic base to make this switch.

Flush circuit design

One of the industrial techniques for making flush-contact

Fig. 650. Technique used for stripping the insulation from multiconductor cable.



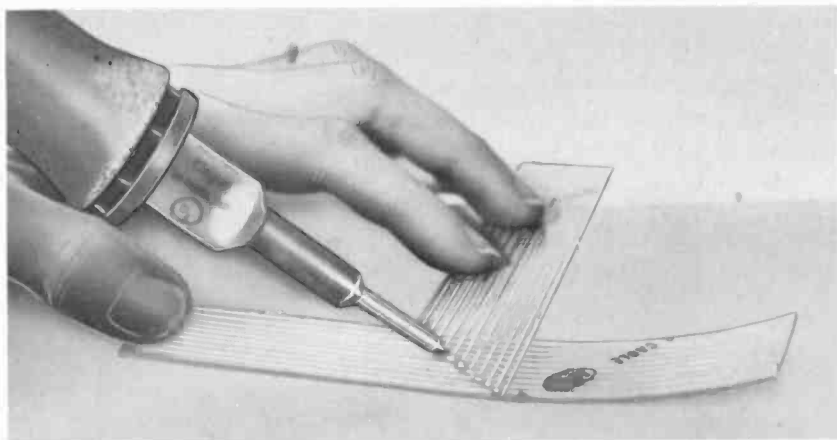
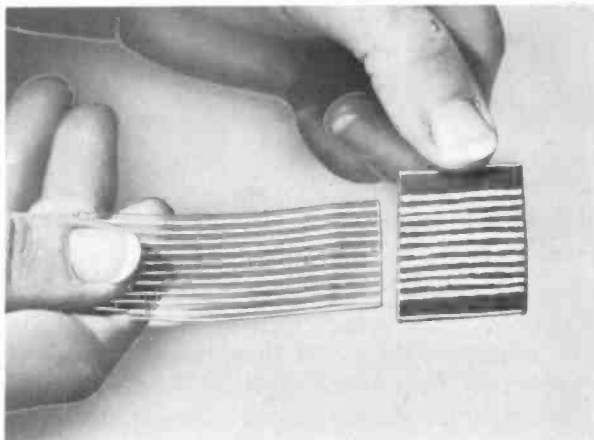

Fig. 651. Splices can be made in flat cable. However, always be sure to insulate the wires from each other.

printed-circuit switches is shown in Fig. 647. A sandwich of paper and metal is built up and placed in a hydraulic press under heat and pressure to produce either a one-sided or two-sided flush printed circuit.

The experimenter can make his own flush switches in several ways by using polystyrene or one of the methacrylate plastics as a base material. Fig. 648 shows a switch made by drilling holes in a polystyrene plate, inserting copper flat-head tacks, and then pressing the tack heads down flush with the top of the plastic plate. The pressing operation can be done with a chisel-tip 60-watt soldering iron or a domestic clothes iron. If the clothes iron

Fig. 652. A home-made male connector etched from laminate stock.



is used, a sheet of shim brass should be laid over the entire top of the plastic plate. The iron is removed as soon as the heads "feel" flush with the plate surface. After the tacks are heated to the flush position, the top of the plastic sheet is polished with fine sandpaper and pumice. A higher polish can be obtained with

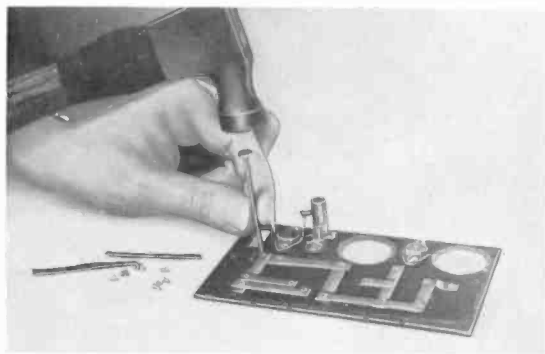

Fig. 653. Stamped-wiring techniques can be duplicated with copper foil riveted to insulating stock.

rottenstone or jeweler's rouge. All abrasives should be washed off the plastic with a detergent and a warm-water rinse.



Fig. 654. Preliminary steps in potting a simple R-C circuit.

A second design is shown in Fig. 649. This is made by pressing rectangular strips of brass into the plate at 90° positions, one pair of strips at each quarter-turn. The imbedded strips are then drilled and polished. The wiper is designed to short each pair of strips, but its width must be less than the distance between adjacent pairs of strips, to prevent shorting between positions.

Each of the switches shown can be silver-plated without elec-

tricity by rubbing with a silver-chloride paste. One commercial plating powder is Cool-Amp¹.

Printed-circuit cables

Fig. 650 shows how to strip the plastic from a multiconductor flat-tape type cable: use a pencil type iron, and apply heat sparingly to melt the plastic around each conductor.

Splices in flat cable can be made as shown in Fig. 651. The splice should be taped with plastic electrical tape such as Scotch tape No. 33.

Fig. 652 shows a home-made male connector for use with flat printed-circuit cable. The connector was etched from laminate stock.

Stamped wiring

Stamped wiring (described in Chapter 2) can be duplicated on a small scale by cutting 28–30-gauge copper foil into strips



Fig. 655. The potting compound is poured around the component until it is covered.

$\frac{1}{8}$ to $\frac{1}{4}$ -inch wide and as long as required for the circuit being laid out. The foil is then drilled with a No. 50 or 53 drill, and brass eyelets riveted in as shown in Fig. 653.

The foil can be obtained from hobby or craft stores where it is normally sold for tapping out or embossing copper pictures.

Potting

“Potting” is a technique for casting components or component assemblies in building blocks so that they can be handled as

¹ Made by the Cool-Amp Co., Portland, Ore.

separate units. The varieties of potting compounds available commercially are too numerous to mention.

A typical working method for the experimenter is as follows:

1. Set up the part or parts to be potted in a box made from household aluminum foil or cardboard. Apply silicone grease (Amphenol No. 307) or vaseline to the box to help strip the box away from the components after the potting compound hardens. Fig. 654 shows the setup for an R-C network.
2. Obtain a pint of No. 17 Castiplast resin and 4 oz of No. 1 hardener catalyst (National Engineering Products, Washington Bldg., Washington, D. C.). Mix 12 teaspoons of the Castiplast with 1 teaspoon of the hardener. Stir thoroughly, but slowly, to avoid formation of too many air bubbles.
3. Pour the mixture around the component setup, as shown in Fig. 655, and allow to harden according to the manufacturer's instructions. In this case, the time is 24 hours at room temperature. The useful "pouring life" of the mixture is about 30 minutes. After this, it becomes too thick to pour, so work accordingly.

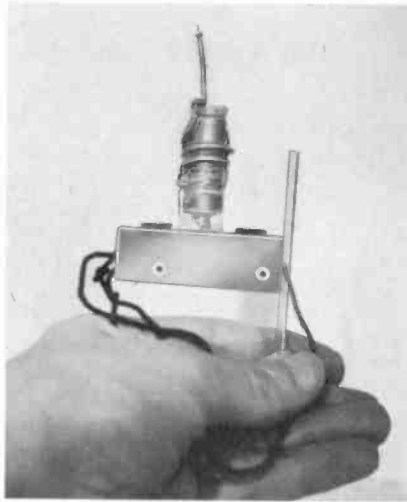

Fig. 656. After the potting job is completed, the component is protected from external heat and moisture.

A finished job is shown in Fig. 656. Coils and inductive components should not be potted unless special grades of potting compounds are used, since potting usually affects the Q in rf circuits. Consult the potting-compound manufacturers before attempting such units.

advanced applications

So far, we have discussed only the basic printed circuit and subminiaturization techniques themselves. The simpler circuits have also been described in detail. However, many of the

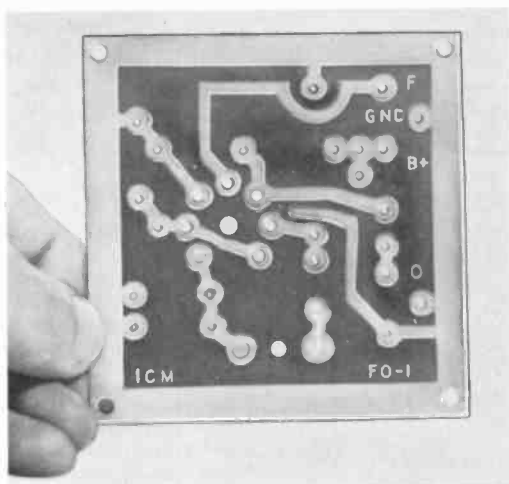
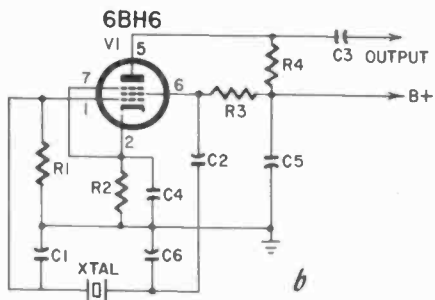
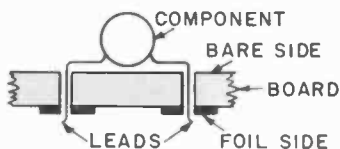
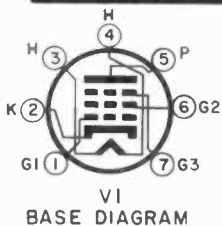
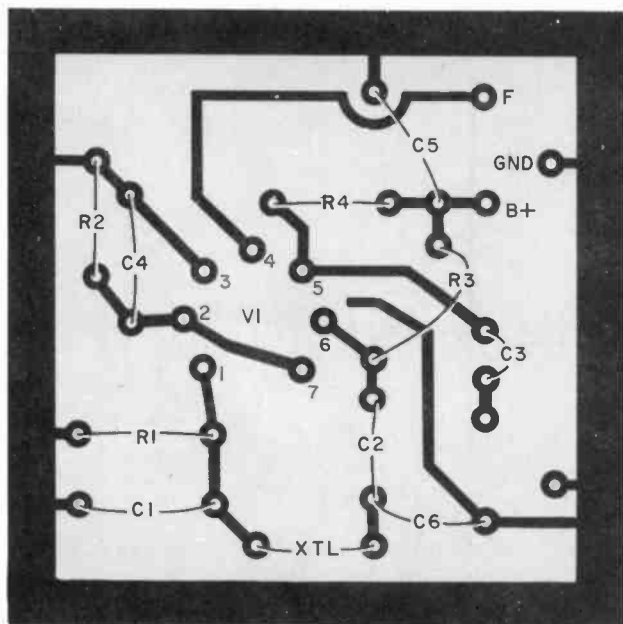

Fig. 701. Printed-circuit board for a crystal-controlled oscillator.

more interesting applications are those relating to ham, commercial and industrial uses. These applications are presented here in sufficient detail to enable the advanced reader to duplicate them successfully.



Resistors: R1—18,000 ohms, ½ watt; R2—470 ohms, ½ watt; R3—47,000 ohms, ½ watt; R4—5,600 ohms, ½ watt
 Capacitors: C1, C6—56- μf tubular ceramic; C2—.005- μf disc ceramic; C3—100- μf disc ceramic; C4, C5—.01- μf disc ceramic
 Tube: V1—6BH6
 Miscellaneous: XTAL—15-mc crystal (International Crystal Mfg. Co. FX-1 or equivalent);
 Power supply—6.3 volts at 150 ma, 200 volts at 5 ma; printed-circuit board

Fig. 702. The upper illustration (a) is a drawing of the printed-circuit board for the crystal-controlled oscillator and shows the positioning of the parts. Component leads are inserted from the opposite side (side without the foil pattern). F goes to 6.3 volts. The lower illustration (b) is the circuit diagram of the oscillator.

Rf oscillator

Fig. 701 is a photo of a printed-circuit board for an rf crystal-

controlled oscillator capable of operating from 200 kc to 15 mc¹. The unit is ideally suited for experimental laboratory work, for transmitter applications (by addition of a powerful amplifier) and for general amateur use as a frequency standard. Fig. 702-a is a drawing of the board; Fig. 702-b is the schematic diagram.

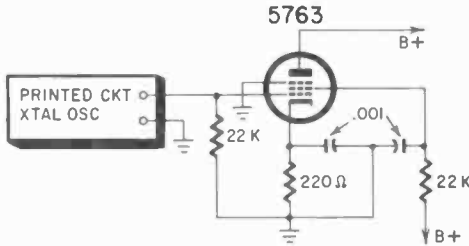

Fig. 703. Buffer amplifier which can be used to drive a power amplifier.

Components are inserted through the board from the bare side, as shown in Fig. 702. Spread the component leads after inserting them through the board. This will hold the component in place

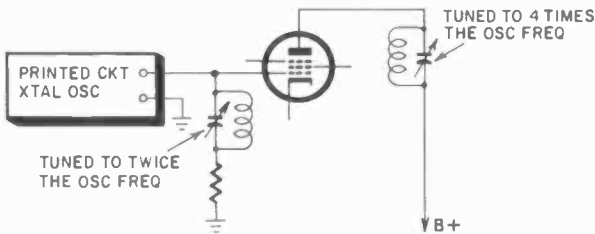

Fig. 704. The circuit following the crystal oscillator can be a frequency multiplier.

and the soldering can be done from the foil side of the board. Use a pencil type soldering iron, and as little solder as possible. Excess lead wire should be cut off to make as much room as possible for the crystal holder and tube socket.

This modified Pierce oscillator will operate over a wide range of plate voltages. Designed for 210 volts of regulated dc, it can be capacitance coupled to other equipment. It can also be operated as a frequency multiplier by using a tuned grid circuit following the plate output of the oscillator.

Fig. 703 shows a buffer amplifier circuit for generating drive

¹Available as a kit or wired unit from International Crystal Manufacturing Co.

for a power amplifier. Another use for this type of circuit is that of a frequency multiplier (Fig. 704). The frequency is doubled once in the grid circuit and again in the plate circuit giving an overall multiplication of four.

Fig. 705 shows a versatile circuit for frequency measurements up to about 500 mc. Crystals in the 5–6-mc range are handy for this purpose. Inductance L is tuned to the second harmonic of the crystal and higher-order harmonics are then compared with

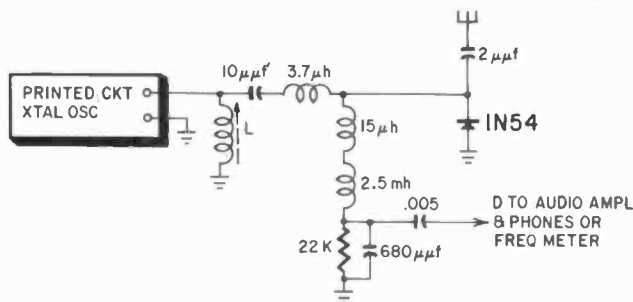

Fig. 705. A diode mixer can be used as an aid in making frequency measurements.

the transmitter frequency in the mixer circuit. The difference frequency, which appears between point D and ground, can be measured on a frequency meter, or the equipment can be set to zero with a known crystal standard while listening to the beat note with a pair of high-impedance phones. An audio amplifier will help in many cases.

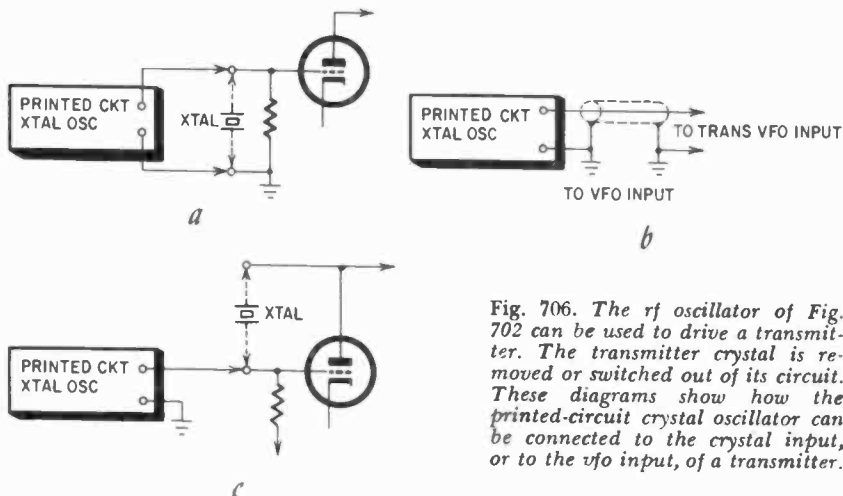

Fig. 706. The rf oscillator of Fig. 702 can be used to drive a transmitter. The transmitter crystal is removed or switched out of its circuit. These diagrams show how the printed-circuit crystal oscillator can be connected to the crystal input, or to the vfo input, of a transmitter.

This oscillator can be used to drive transmitters through their external vfo connections or crystal sockets (Fig. 706). Several variations are possible depending on the nature of the existing

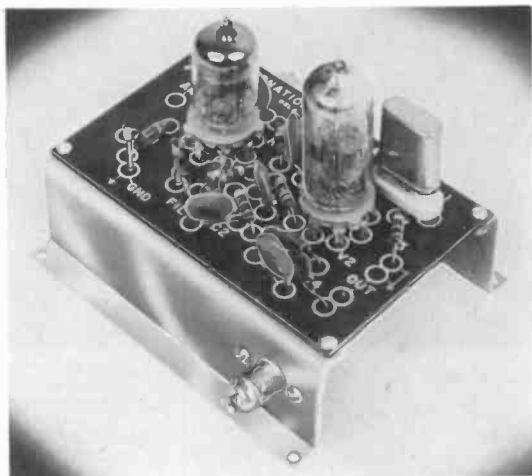

Fig. 707. Two-tube crystal-controlled converter.

crystal connections. The power supply required is 210 volts at 5 ma and 6.3 volts at 150 ma for the filaments. The rf output is between 3 and 10 volts with a load of 1,200 ohms.

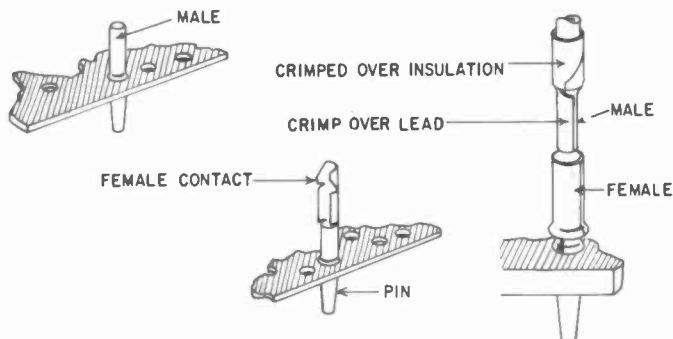
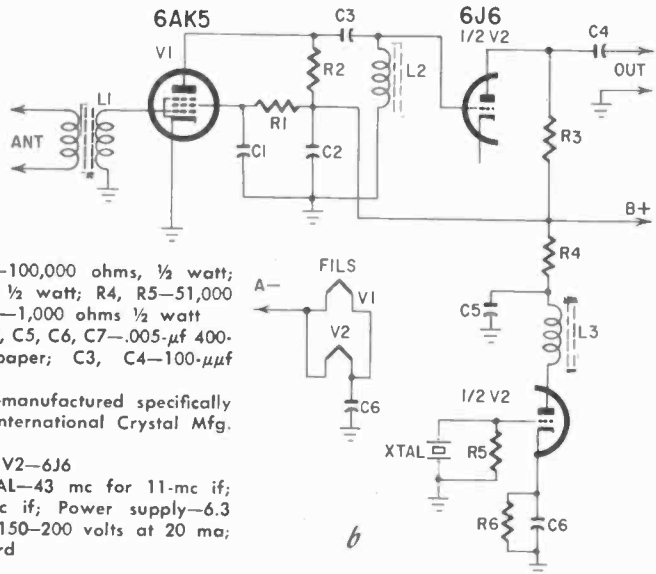
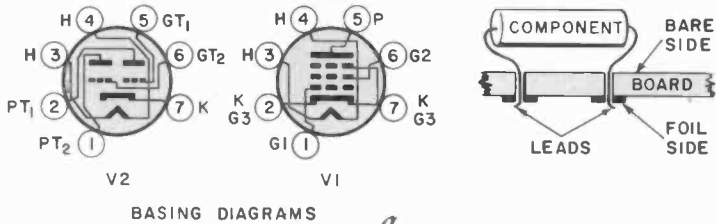
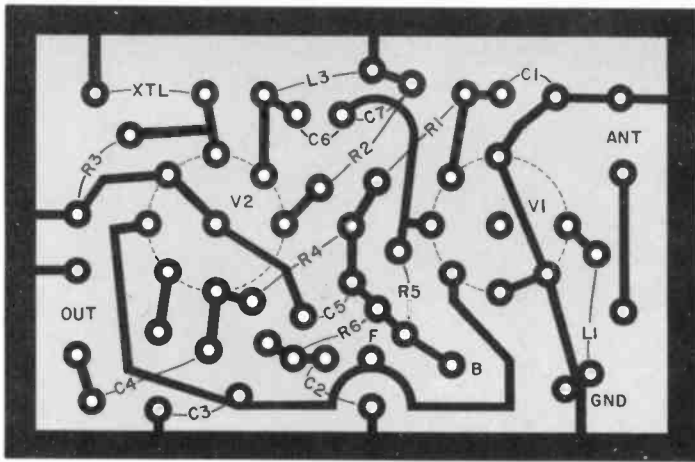

Fig. 708. Tubular pin connectors are used for making snap-on connections.

As with all printed and miniature circuits, make tight connections at tube bases, socket pins and other key points. Mount all hardware firmly to the base and be sure to clip off excess wire after soldering.



Resistors: R1, R3—100,000 ohms, ½ watt; R2—20,000 ohms, ½ watt; R4, R5—51,000 ohms, ½ watt; R6—1,000 ohms ½ watt
 Capacitors: C1, C2, C5, C6, C7—.005- μ f 400-volt metalized paper; C3, C4—100- μ f tubular ceramic
 Coils: L1, L2, L3—manufactured specifically for this unit by International Crystal Mfg. Co.
 Tubes: V1—6AK5; V2—6J6
 Miscellaneous: XTAL—43 mc for 11-mc if; 49.4 mc for 7-mc if; Power supply—6.3 volts at 600 ma, 150–200 volts at 20 ma; printed-circuit board

Fig. 709. The upper illustration (a) shows the printed-circuit board for the crystal-controlled converter. The drawing shows the approximate positioning of the parts. The circuit for the converter (b) is shown below.

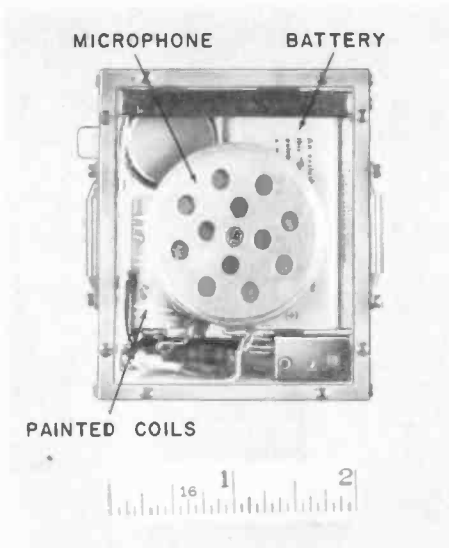
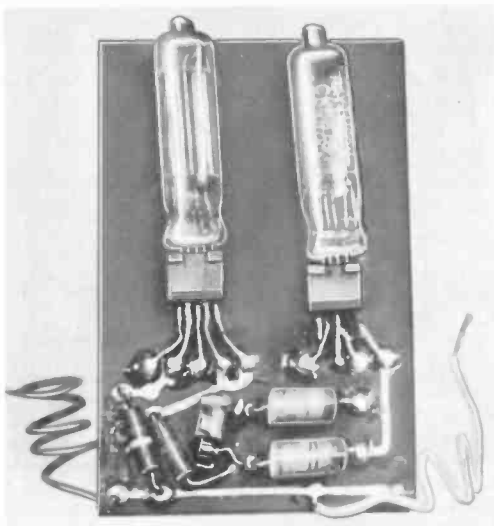

Fig. 710. Two-tube wristwatch AM transmitter. (Courtesy National Bureau of Standards)

6-meter converter

Fig. 707 shows a very compact, broad-band, crystal-controlled converter which has an if output in two ranges—600 to 1,500 kc and 7 to 11 mc. The frequency range is 50 to 54 mc with a 51-mc

Fig. 711. Inside view of the wristwatch transmitter.



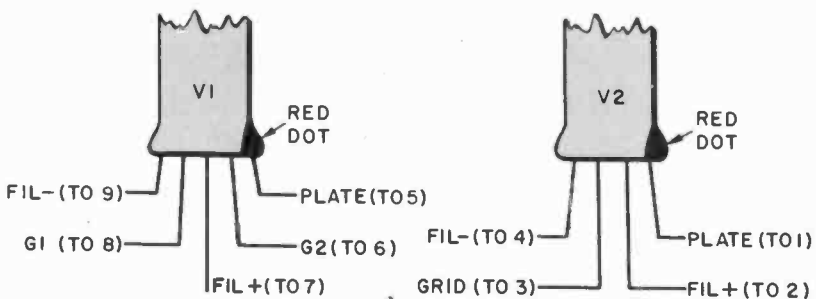
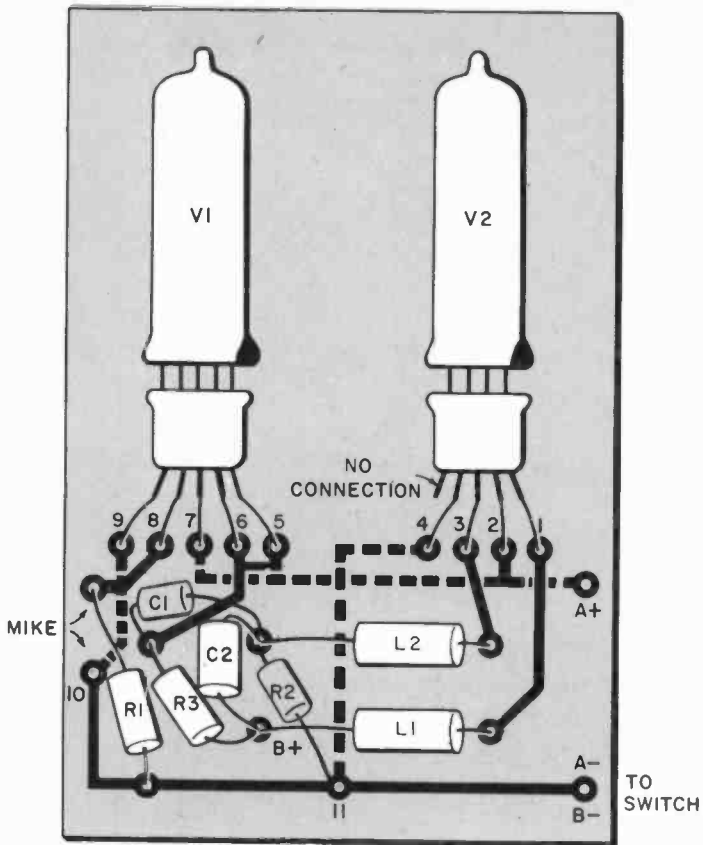
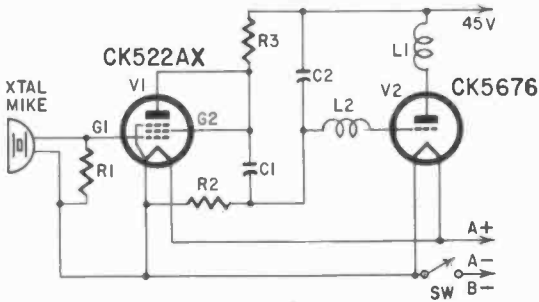

Fig. 712-a. The upper drawing shows how both tubes, their sockets, and the various components are mounted on the printed-circuit board. The filament leads are run on the underside of the board from 7 to 2 and then to A+; underside connections are also run from 4 to the A- bus and from 9 to one side of the mike. Crossovers are made by through-connecting wires 2, 7, 9, 10 and 11. The values of the parts are given in the parts list on the facing page. Since the tubes have symmetrical leads, a red dot is used for lead identification. This is illustrated in the lower drawing.



b

Resistors: R1—5 megohms, ¼ watt; R2—10,000 ohms, ¼ watt; R3—50,000 ohms, ¼ watt
Capacitors: C1—.01 μ f, 100-volt paper; C2—.0001 μ f, 100 volt-paper

Tubes: V1—CK522AX; V2—CK5676
Coils: L1; L2
Miscellaneous: Crystal-type microphone; spst slide switch (SW); 1.5-volt battery; 45-volt battery; printed-circuit board

Fig. 712-b. Circuit diagram of the wristwatch transmitter.

design center. The converter is about 4 by 3½ by 3½ inches overall, and its weight is a mere 3 ounces!

In general, wiring procedures are much like those for the 15-mc oscillator. One feature of this unit is the tubular pin connectors used for making snap-on connections to the printed-circuit board (Fig. 708). Two plugs are provided for connection to a 6-meter antenna. Most commercial receivers have accessory power sockets which can be used to power the converter, which takes approximately 180 volts dc at 20 ma on the plate and 6.3 volts at 600

Fig. 713. Single-tube transmitter in which the tube acts as a form for the oscillator coil.

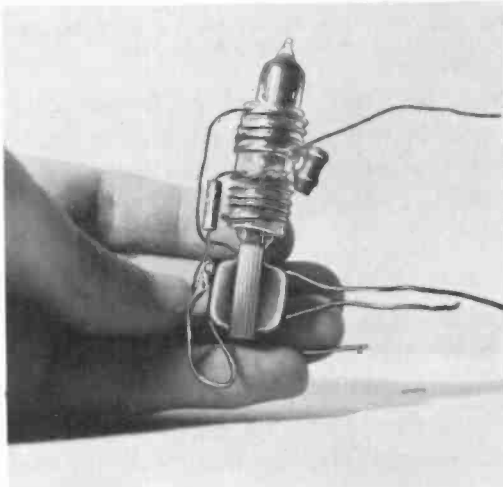

ma for the filaments. Fig. 709 shows the complete details of the converter.

After the converter has been installed, operation is simple. Converters having a 43-mc crystal will cover an if of 7 to 11 mc for the 50-54 mc band. The 50-mc point will appear at 7 mc on

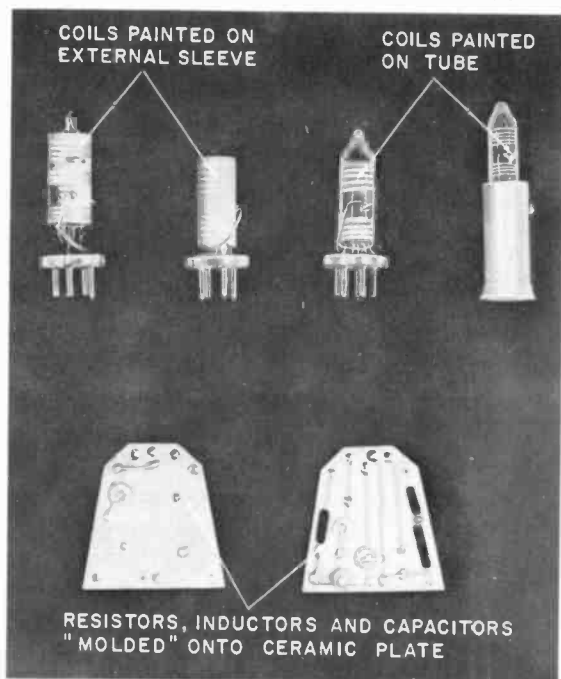
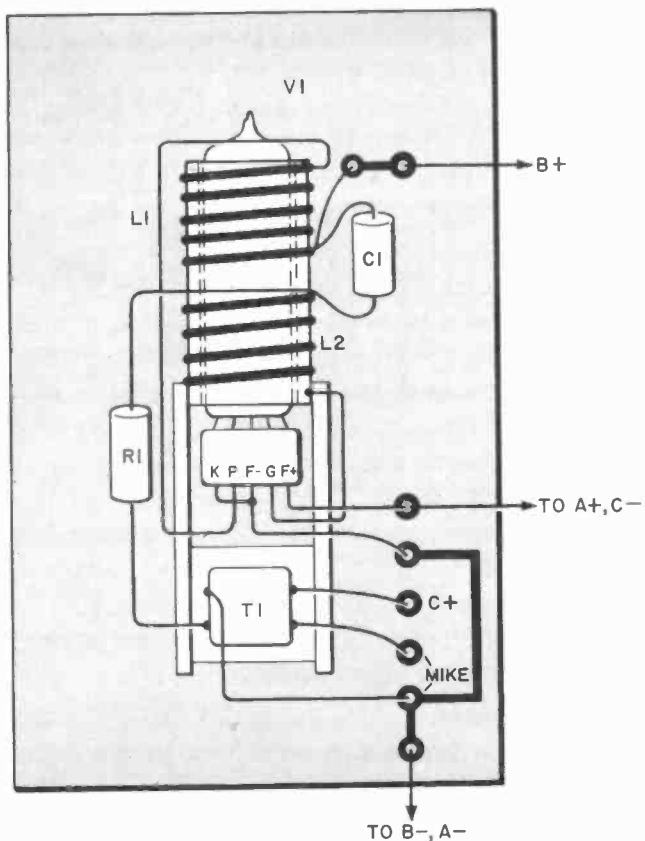

Fig. 714. Coils can be painted on a plastic form which is fitted over the tube.

the tuning dial of the receiver, and the 54-mc point at the 11-mc setting. With a 49.4-mc crystal, 50 mc will appear at 600 kc and 54 mc at 4.6 mc. The extent of the band coverage can be checked using an external high-frequency oscillator with appropriate crystals.

Checking the 6-meter converter

A grid-dip oscillator is one of the best instruments with which to check the converter. Operating the oscillator as a diode detector, check for converter crystal operation by tuning for radiated energy from the oscillator coil, L3. With the converter connected to the receiver, the grid-dip oscillator can be used as a signal generator for test purposes.



a

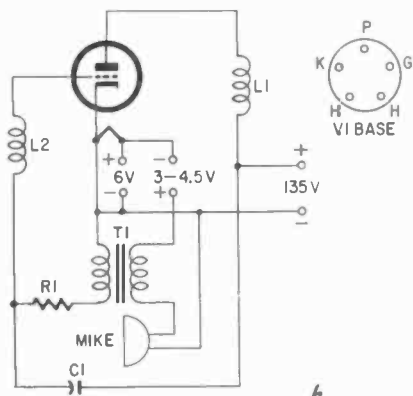

b

Resistor: R1—50,000 ohms, ½ watt
 Capacitor: C1—7.5- μ f tubular ceramic
 Transformer: T1—UTC 50-1 or equivalent
 Coils: L1—5 turns No. 16 enameled wire (see text); L2—3 turns No. 16 enameled wire (see text)
 Tube: V1—6K4 or 5718
 Miscellaneous: 6-volt battery; 135-volt battery; 3-4.5-volt battery; Mike—carbon microphone; printed-circuit board

Fig. 715. Single-tube "lipstick" transmitter. The oscillator coil is wound on a form which is then slipped over the tube.

Be sure to check your receiver before expecting good results from the converter! Proper operation of the converter depends upon the receiver operating correctly. Check the receiver for pickup with antenna terminals open and the converter disconnected. Any signals picked up in the converter if range will show up as undesired signals when the converter is put back into operation.

Two-tube wristwatch AM transmitter

An early version of a two-tube printed-circuit radio transmitter, developed by Dr. Cleo Brunetti when he was with the National Bureau of Standards, is shown in Fig. 710. This transmitter was originally made using a ceramic base and silver-ceramic firing technique; the version in Fig. 711 can be made up by the experimenter, using modern copper-clad laminates.

Fig. 712 shows the layout and the schematic of this novel transmitter which has a range of about 200 feet, depending upon receiver sensitivity and the frequency chosen.

Transmitters such as this have been used for paging and also as remote mikes in industrial systems.

"Lipstick" transmitter

Fig. 713 shows a transmitter in which the inductor pattern was silvered directly on the envelope of the tube. One practical version of this unit can be made by winding or painting the in-

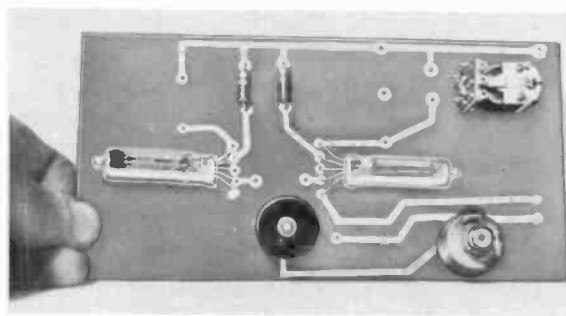
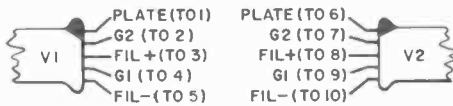
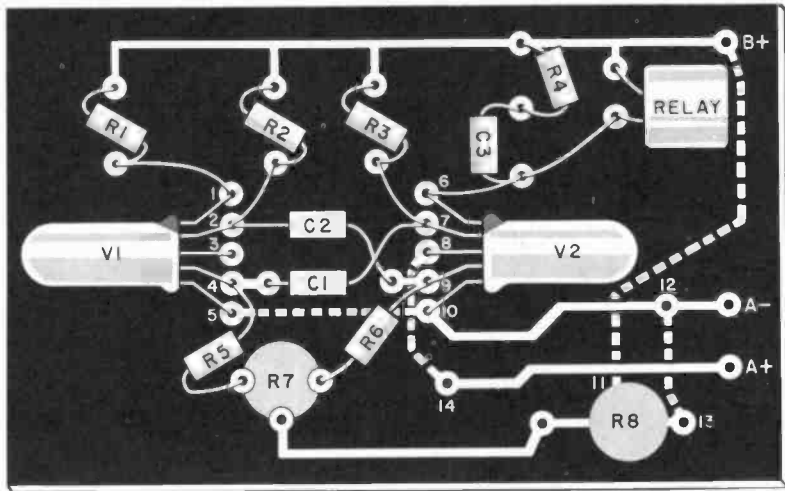

Fig. 716. *Layout of the printed-circuit board for a subminiature multivibrator.*

ductor around the tube. Another technique (Fig. 714) is to wind or paint the inductor around a polystyrene tube which will fit snugly over the tube. All other components, such as capacitors, resistors and miniature matching transformers, can be soldered



a

Resistors: R1, R4—10,000 ohms, ½ watt; R2, R3—15,000 ohms, ½ watt; R5, R6—330,000 ohms, ½ watt; R7—1-megohm pot; R8—100,000-ohm pot
Capacitors: C1, C2—.25- μ f 200-volt metalized paper; C3—0.1- μ f 200-volt metalized

paper
Tubes: V1, V2—1AG4
Miscellaneous: RY—Sigma 4F80005 or equivalent; 1.5-volt battery; 30–60-volt battery; printed-circuit board

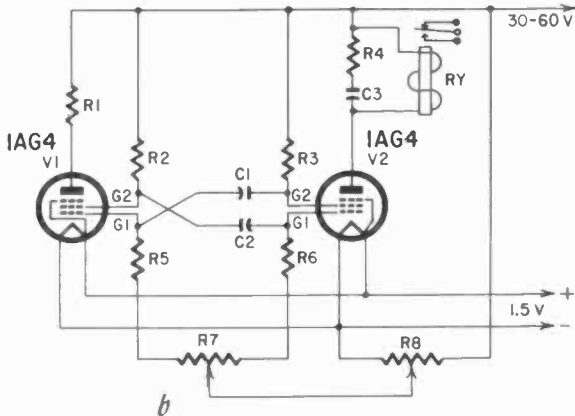

b

Fig. 717. The upper illustration (a) is a drawing of the printed-circuit board for the subminiature multivibrator. The circuit (b) is shown below. Conductors run from 11 to B+ on the underside of the board, and also from 12 to 13. Crossovers are made by through-soldering with a piece of No. 20 tinned hookup wire. A— also has a conductor on the opposite side from 5 to 10. A+ runs on the opposite side from 3 to 14. Also, through-solder at points 5, 8, 10 and 14.

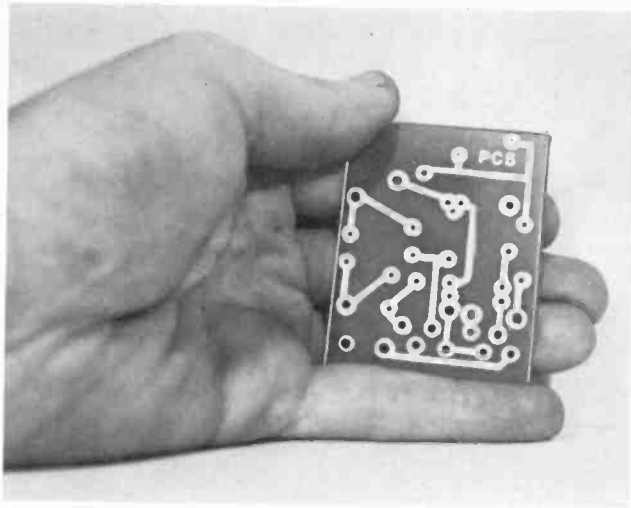
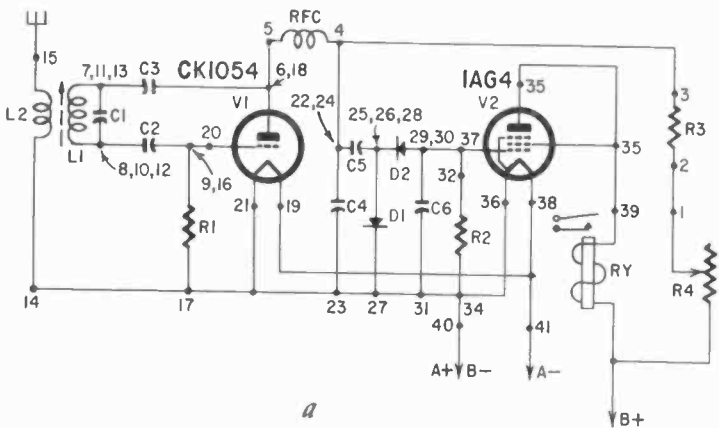

Fig. 718. Printed-circuit board for a two-tube radio-control receiver.

to each other and mounted on the polystyrene tube. The complete schematic of this transmitter, which normally operates above 50 mc, is shown in Fig. 715.



Resistors: R1—5 megohms, ½ watt; R2—10 megohms, ½ watt; R3—3,300 ohms, ½ watt; R4—50,000–100,000-ohm pot
Capacitors: C1—15- μ mf tubular ceramic; C2—150- μ mf mica C3—47- μ mf tubular ceramic; C4, C6—.01- μ f 200-volt metalized paper; C5—.02- μ f 200-volt metalized paper

Coils: L1—17 turns No. 20 enameled wire on ⅜-inch CTC form; L2—3 turns No. 20 dcc wire wound over L1; RFC—10 μ h
Tubes: V1—CK1054 or RK-61; V2—1AG4
Diodes: D1, D2—1N66
Miscellaneous: RY—Sigma 4F8000S or equivalent; Power supply—1.5 volts (filaments), 45 volts (B supply); printed-circuit board

Fig. 719. Circuit diagram of the two-tube radio-control receiver.

Both of the foregoing miniature transmitters point up very dramatically the need for smaller batteries and power sources, since the transmitter units are about the same size or even smaller (in the case of the "lipstick" transmitter) than the batteries needed to power them.

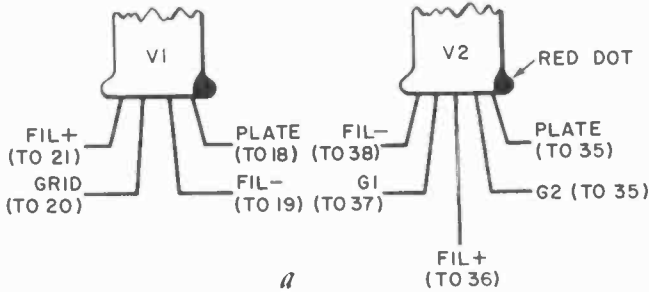
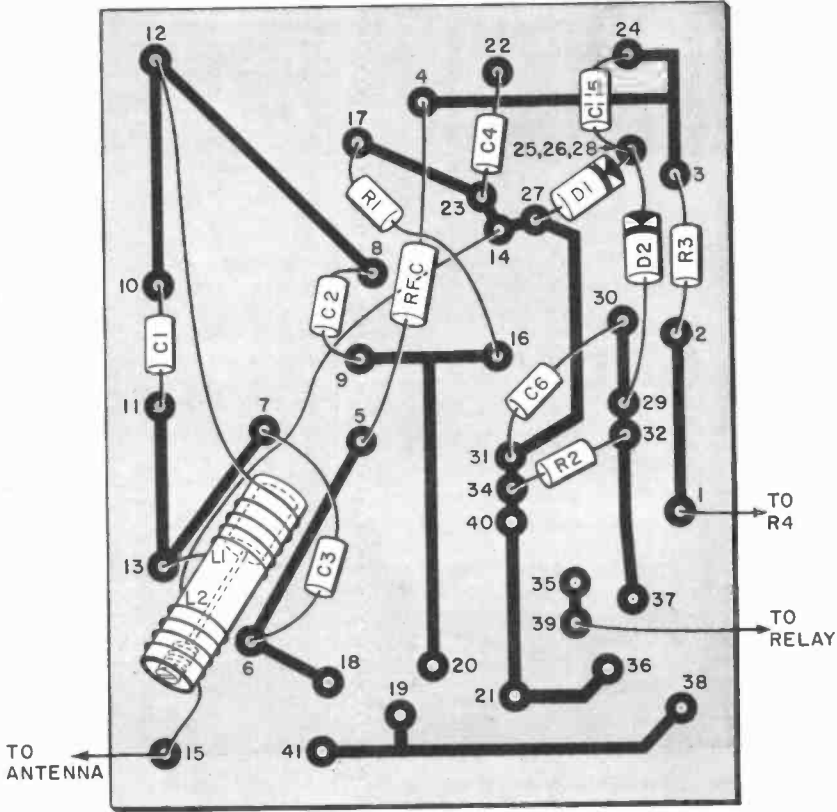

Fig. 719 (continued). Printed-circuit board for the two-tube radio-control receiver. Use spaghetti on tube leads where these might cross.

Adjustable frequency and pulse-width multivibrator

Fig. 716 is a printed-circuit board for a subminiature multivibrator having a pulse frequency range of 2 to 10 pps (pulses

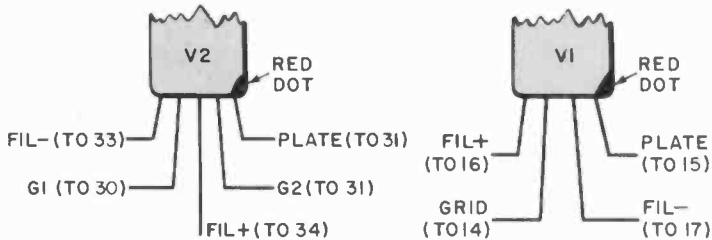
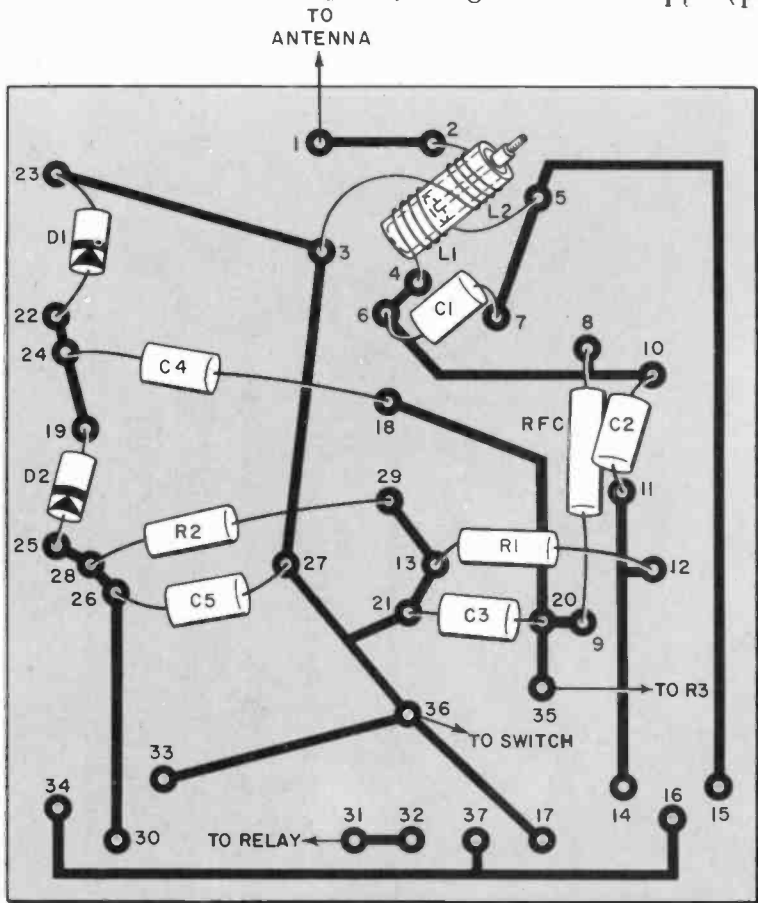

Fig. 720. Printed-circuit board arrangement (a) for the Little Gem duodeode receiver.

Lorenz two-tube receiver

Fig. 718 shows the printed-circuit board for the unit which is especially well-suited to model-plane use. The potentiometer and sensitive relay are mounted in a plastic case or on a separate mount.

Soldering can be done in any order. Using a pencil-type solder-

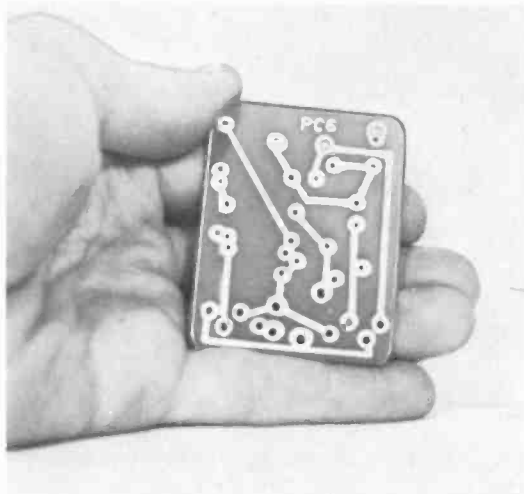

Fig. 721. Photo of a printed-circuit board used for the Little Gem receiver.

ing iron and a good grade of rosin solder, solder components in place by bending leads up, one at a time, and carefully making the solder joints at the copper base strip. Cut off any excess lead after each joint has been made. Where an eyelet is used, make a solder connection between both the eyelet and the copper strip for firm electrical contact.

Be sure to solder coil windings to the soldering lugs on the coil form and also solder the flea clips to the copper to insure good contact.

It is very difficult to solder these small assemblies with a conventional iron, and an investment in a midget pencil-type iron is a wise one.

When all components have been soldered, check the top of the base and use a needle file to smooth gently and carefully any sharp edges left by the cutting pliers. Cover the spot where the tubes will rest with electrical tape or several coats of a good insulating lacquer. If desired, tubes can be cemented in place after insertion by using a good grade of rubber cement on the tube body. The battery and relay leads to the receiver should be

color-coded for easy troubleshooting. The complete hookup is shown in Fig. 719.

Test the assembled unit as follows: Insert V1 only. Plug a 0-5-ma test meter into meter jack 1, and make sure the potentiometer is set at maximum resistance. Turn on the filament switch. The meter should read about 0.1 ma and also be a little unsteady, an indication that the set is superregenerating. If a headset is available, it can be inserted in series with the meter and a loud hiss should be heard. If there is no hiss, check all solder joints very carefully and also recheck wiring, point by point. The set must superregenerate to work right. While the set is superregenerating, turn on the transmitter and key it. Tune the receiver slug until a sharp dip in current is observed. This dip should go down to .02 ma or even less.

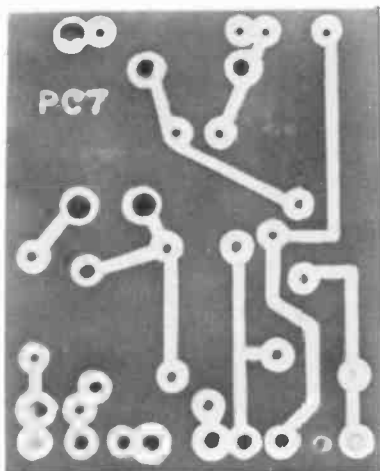

Fig. 722. Photo of the printed-circuit board for the Gazistor receiver.

Now insert V2. Be sure to follow the tube base connections carefully, matching up the proper connections with the little red dot on the base of the tube. The two leads nearest the red dot are the plate and screen grid. Both go into the same flea clip at point 35. Insert the meter in meter jack 2. With the first stage at 0.5 ma, the second stage should draw close to zero current. With both tubes working, the second stage should jump from 0 to 2 or 3 ma when the transmitter is keyed, depending upon relay resistance and tube type in the second stage.

The distance check should be made at 200 yards or so. The meter should be only in jack 1 for this test.

Battery voltages should be watched closely, since a B-voltage below 41 and an A voltage below 1.2 will make operation very unsteady.

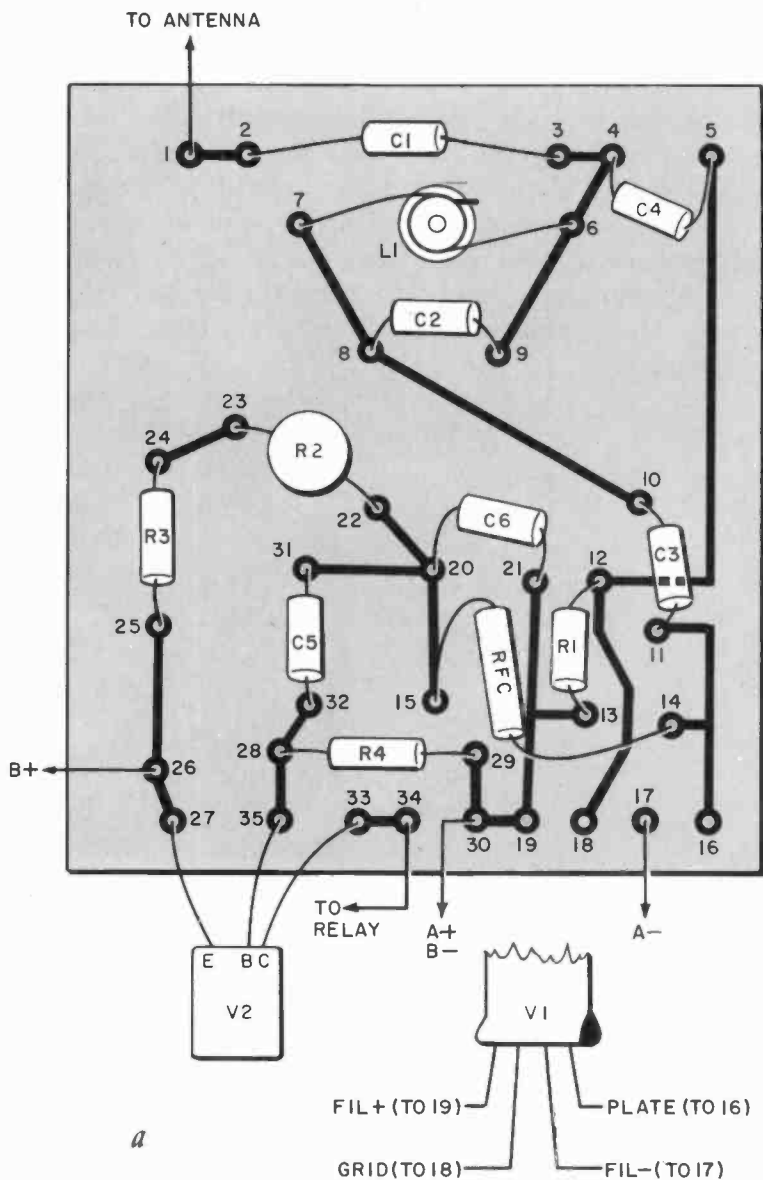
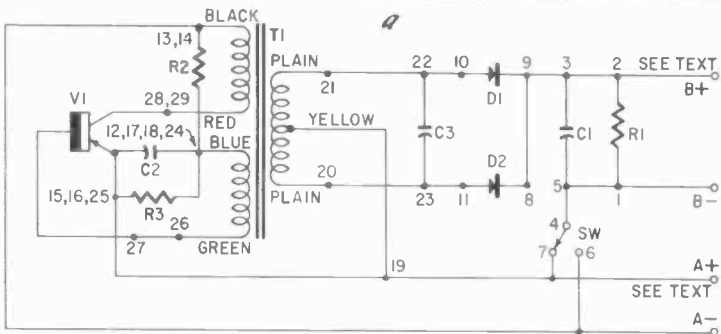
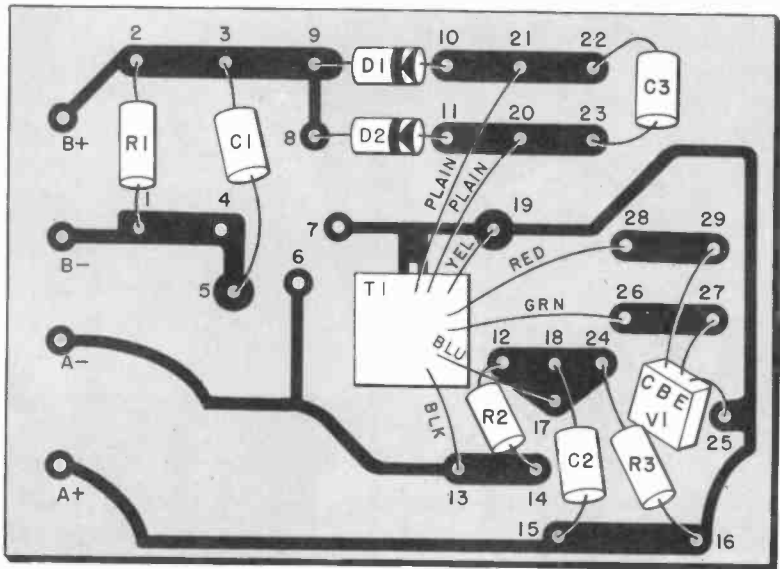

Fig. 723. Printed-circuit board arrangement for the Gazistor receiver. Use spaghetti on leads where these cross the circuit pattern.



Resistors: R1—100,000 ohms, ½ watt; R2, R3—1,500 ohms, ½ watt
 Capacitors: C1—5- μ f 50-volt electrolytic; C2—1- μ f 50-volt paper; C3—.001- μ f 150-volt paper

Transformer: T1—see text (Ace Radio Control)
 Transistor: V1—2N185 or 2N233
 Diodes: D1, D2—1N66
 Miscellaneous: 1.5-3-volt power supply (see text)

Fig. 724. Layout of the printed-circuit board and circuit diagram for a transistor converter.

stages. With the first stage idling at 0.1 ma, the second stage may have a tendency to “jump” once in a while to a high current reading. Advance the pot until this tendency disappears. This is the minimum operating point for your particular receiver. The pot should be advanced slightly beyond this so that lowering battery voltages will not trigger the second stage unexpectedly.

The distance check is about the same as for the previous receiver, care being taken to check the battery voltages under load. This receiver usually does not require tuning constantly, but it is a good idea to make a distance check before putting the model through its paces.

Gazistor receiver

The major feature of this receiver is the transistor second stage

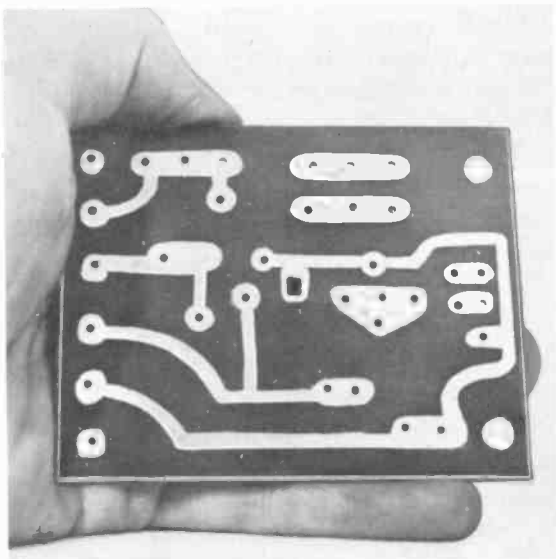

Fig. 725. Photo of the printed-circuit board for the transistor converter.

which helps reduce the space requirements. Fig. 722 is the printed-circuit board layout and Fig. 723 is the schematic. This unit will produce a slightly higher reading in the second stage than the first two receivers described, depending on how "hot" the transistor is.

Test by inserting V1 and plugging the meter into the single jack. Vary the 25,000-ohm potentiometer until the meter indicates 0.6 ma or thereabouts, and then turn on the transmitter. Adjust the receiver slug until the meter drops to 0.1 ma or less when the transmitter is keyed. Turn the switch *off* and *then* plug in the transistor. Be sure the switch is turned off when inserting or removing the transistor. Because transistors vary widely in characteristics, you should get a reading of 1 to 3 ma when the switch is turned on again.

Readjust the potentiometer for a reading of 0.8 to 1 ma. Now, when the transmitter is keyed, the meter should rise to 4 or 5 ma, depending on the quality of the particular CK722.

If the idling current (no transmitter signal) can't be cut down to 1.5 ma or so, increase the 390,000-ohm resistor to 470,000. Sometimes it is necessary to run this resistor up to about 800,000. If the resistor is increased, a check of signal-on current should be made to see the value to which the current jumps. If the idling current is within the range mentioned, and a greater signal-on current increase is desired, the 390,000 ohms can be reduced slightly. Fig. 723 shows the action of the potentiometer, with the solid line representing the current reading on the meter. As you go toward higher resistance on the pot, the meter reading will increase in a jerky manner; toward lower resistance, there will be a smooth current increase. The best setting is slightly beyond the dip, on the steady-current side.

It is a good idea also to install a dpst switch in this unit, since the steady transistor current will run the batteries down unless both B-plus and B-minus are opened.

B-supply (transistor converter)

Fig. 724 shows details of a 45-volt B-supply which uses a single-transistor feedback oscillator.

The transformer is the most critical component, and a ready-made unit is readily available at nominal cost. The ratio of the collector winding to the emitter (feedback) winding is approximately 9 to 5, and the winding procedure is too tricky for the home builder to do himself. Other ratios will produce erratic oscillator starting under various loads or else no starting at all. The ratio shown gives consistent starting under full load. Regulation is achieved with a center-tapped secondary, shunted by a .001- μ f capacitor. Each outside leg of the transformer secondary feeds a diode.

An additional jumper puts the 4.5-volt battery (three penlight cells in series) in as a boost on 3-5-ma loads. The 4.5-volt boost is cut out on lighter loads in the range of 1 to 3 ma.

The oscillator runs at about 6,000 cycles, and a 5- μ f filter capacitor smooths the B-voltage output to the load. The unit can put out 5 ma at 45 volts with a 4.5-volt A-supply, or 30 volts at 3 ma with a 3-volt supply.

Fig. 726 is a photo of the actual printed-circuit board.

index

A

Acoustic Devices, Electro-Adjustable Frequency and Pulse-Width	105
Multivibrator	212
Advanced Applications	197
Aids, Hearing	12
Air Cell	123
AM Transmitter, Two-Tube	
Wristwatch	208
Ampecs, Circuits Using	173
Ampecs, Output Circuits for	180
Amplifier:	
Buffer	199
Printed-Circuit	169, 171
Printed-Circuit Industrial	12
Antennas, Loop	79
Applications, Advanced	197
Arc Lamp, Home-Made	41
Assemblies and Techniques, Practical	159
Audio Oscillators, Printed-Circuit	183

B

Bandswitch, Printed-Circuit	10
Batteries:	
and Power Sources	121
Classification of	121
Testing	133
Battery:	
Holders	102
Performance	132
Silver-Zinc	127
Boards (see also Printed-Circuit Boards)	
Boards, Repairing Cracked	148
Boards, Stitched Wiring	94
Breadboard, Plastic	44
Buffer Amplifier	199

C

Cable, Flexible Multiconductor Flat	50
Cables, Printed-Circuit	195
Cadmium Selenide Photodiodes	112
Capacitance, Calculating	73
Capacitance, Distributed	86
Capacitors:	
Ceramic	64
Ceramic Trimmer	71
Concentric-Shield Variable	71
Disc Ceramic	65
Glass	67
Glass Piston	69
Making Printed and Etched	74
Meshed-Plate Variable Tuning	72
Metalized Paper	66
Mica	67
Mica Compression Trimmer	72
Quartz Piston	69
Replacing on a Printed Circuit	
Board	142
Tantalum	70
Tubular Ceramic	65
Variable	70
Variable Ceramic	72
Carbon Paint Formulas	19
Carbon Resistors, Subminiature	58
Cells:	
Air	123
Mercury	123

Nickel-Cadmium	128
Secondary	127
Silver-Cadmium	130
Sizes and Terminations of Primary	125
Charger for Nickel-Cadmium Cells	129
Charging Rates and Times for Dry Cells	132
Checker, Transistor	157
Chronograph Neon Timer	168
Circuit:	
Economizer	131
Layouts and Design	44
Plate	8
Circuits:	
Etched	28
Flexible	50
Output Coupling	180
Tube	184
Using Ampecs	173
Clip-In Terminals	98
Clips, Flea	100, 101
Coaxial Connectors, Miniature	98
Coaxial Resistor	53
Coil Forms	90
Coil Kit, Matched	81
Coils, Calculating the Inductance of	87
Coils, Winding RF	89
Component:	
Holders	100, 102
Leads, Preparation of	118
Leads, Shaping	117
Mounting Clips	109
Tester, In-Circuit	153
Components:	
Inductive	75
Replacing	143
Resistance	51
Concentric Shield Units	71
Conductive and Resistive Paints	20
Conductors, Current Ratings of Copper	
Foil	47
Conductors, Repairing Broken	145
Connections, Machine-Screw	48
Connectors	96
Connectors, Miniature Coaxial	98
Controls, Removing from Printed-Circuit Board	150
Controls, Replacing	151
Converter, Six-Meter	203
Converter, Two-Tube Crystal-Controlled	201
Copper Foil Conductors, Current	
Ratings of	47
Cores	91
Corrugated Shield Insert	104
Cracked Boards, Repairing	148
Crossing Leads on the Board	47
Crossover System, Thru-Con	48
Crossovers and Holes	47
Crystal-Controlled Transmitter, High-Frequency	185
Current Ratings of Copper Foil Conductors	47

D

Deep Tank Sparging	37
Deposited Film Resistors	60
Design, Circuit Layouts and	44
Desoldering Methods	152

Detector, Rain	167, 169	Hearing Aid Circuitry	11
Development of the Art	7	Hearing Aids	12
Devices, Musical	14	Heat Sinks, Shields and	103
Diagnosis and Troubles	135	High-Frequency Crystal-Controlled	
Dielectric Constants of Common		Transmitter	185
Materials	75	High-Resistance Paint	56
Differentiators	178	High-Wattage Flexible Resistors	61
Diode Mixer	200	Hinged Relay Switch	130
Diodes	112	Holders, Battery	102
Dip-Soldering Technique	24	Holders, Component	102
Disc Ceramic Capacitors	65	Holes and Crossovers	45
Distributed Capacitance	86	Holes, Plated-Through	48
Drawing a Printed-Circuit Pattern	46	Home-Made Test Prods	141
Dry Batteries, Size and Voltages of	126		
Dry Cells, Charging Rates and Times		I	
for	132	IF Coils, Plug-In Type	80
Dry Cells, Recharging	133	IF Transformers, Replacing	150
Drying Time of Resistance Paints	57	Imprinted-Circuit Inlays	22
Duo-Diode Receiver, Little Gem	217	In-Circuit Tester and R-C Bridge	155
		Indium-Based Solders for Glass to	
E		Metals	28
Earphones, Flat	106	Inductance:	
Economizer Circuit	131	and Frequency, Relationship	
Electro-Acoustic Devices	105	Between	88
Electrolytics	68	of a Single-Layer Coil, Finding the	83
Electronic Uses, Industrial	13	of Coil Due to Presence of Iron	91
Encapsulation and Potting	24	Variable	78
Euch-Resist Methods, Photographic	28	Inductances, Making Your Own	
Etch Resist, Mechanical Methods of	38	Printed-Circuit	82
Enchant Handling Techniques	36	Inductances, Q Values of	85
Etchants	35	Inductive Components	75
Etched and Printed Capacitors,		Inductors:	
Making Your Own	74	Calculating the Inductance of	87
Etched Circuits	28	Metalized Glass	82
Etched-Circuit Laminate Properties	49	Replacing	150
Etching:		RF	77
Splash	37	Subminiaturization and	75
Spray	37	Industrial Amplifier, Printed-Circuit	12
Still	36	Inlays, Imprinted-Circuit	22
Techniques	36	In-Line Subminiature Sockets	96
the Home-Made Plate	34	Instruments, Test	153
Exposed Laminate Plate, Developing		Integrators	178
the	31	Iron Cores, Molded	92
Exposure Problems with Presensitized			
Material	41	J	
		Jacks and Plugs	105
F		Jig for Printed Circuits	139
Ferrite-Loop Antenna	80	Jig Soldering, Spot and	25
Ferrite Rods, Flat	81		
Field-Strength Meter	168, 170	K	
Film Resistors, Deposited	60	Kits, Matched-Coil	80
Fixed-Inductance RF Chokes	78		
Flat Cable, Flexible Multiconductor	50	L	
Flat Earphones	106	Laminate, Making the	49
Flat Type Miniature Ceramic		Laminate Properties, Etched-Circuit	49
Capacitors	64	Laminates	44
Flea Clips	100, 101	Layouts and Design, Circuit	47
Flexible:		Leads on the Board, Crossing	172, 173
Circuits	50	Light-Beam Relay	172, 173
Multiconductor Flat Cable	50	Light Meter, Photoelectric	208
Resistors	61	"Lipstick" Transmitter	217
Flush Circuit Design	192	Little Gem Duo-Diode Receiver	101
Flush Switch Patterns	189	Locking Type Component Holder	79
Flux Considerations	26	Loop Antennas	214
Foil, Replacing	147	Lorenz Two-Tube Receiver	54
Forms, Coil	90	Low-Resistance Paint, Properties of	
Formulas, Carbon Paint	19		
Formulas, Silver Paint	18	M	
Fractured Board, Repairing	146	Machine-Screw Connections	48
Frequency Multiplier	199	Magnetic Materials, Use of	88
		Magnetic Paints and Pastes	22
G		Masking Techniques, Solder	25
Gauges, Strain	14	Master Drawing, Preparing the	45
Germanium Diode, Construction of	110	Matched-Coil Kits	80
Germanium Photocell	113	Materials and Techniques	17
Glass:		Maze, Printed-Circuit	169
Capacitors	67	Mechanical Methods of Etch Resist	38
Inductors, Metalized	81	Medium-Resistance Paint	55
Piston Capacitors	69	Mercury Cells	123
Soldering on	27	Mesh-Plate Units	73
to Metals, Indium-Based Solders		Metal Shield for Printed-Circuit Use	103
for	28	Metalized Glass Inductor	82
Glue-Type Photosensitive Resist	31	Metalized Paper Capacitors	66
		Metalizing or Spraying	22
H			
Hardware and Special Wiring	92		

Meter, Field-Strength	168, 170
Mica:	
Capacitors	67
Compression Trimmers	72
Trimmers	72
Micro-Minialization	16
Microphones and Speakers, Miniature	105
Migration, Silver	188
Milling, Spray	22
Miniature:	
Radio	9
Transformers	76
Variable Resistors	61
Mixer, Diode	200
Module	115
Module, Constructing a	115
Modules and Packaged Circuits	116
Molded Iron Cores	92
Motor, Printed-Circuit	15
Mounting Transistors	111
Multiconductor Flat Cable, Flexible	50
Multiple Circuit Connectors	97
Multipplier, Frequency	199
Multivibrator, Adjustable Frequency and Pulse-Width	212
Musical Devices	14
N	
Negative Making	38
Neon Bulb as a Timing Device	164
Neon Timer, Chronograph	168
New Socket, Inserting In a Printed-Circuit Board	149
Nickel-Cadmium Cells	128
Nickel-Cadmium Cells, Recharging	130
O	
One-Transistor Radio	159
One-Transistor Set, Testing the	162
One-Tube Radio-Control Receiver	162
Oscillator:	
Coll, Miniature	79
Printed-Circuit	70
Printed-Circuit Audio	183
RF	198
Output Coupling Circuits	180
P	
Packaged Circuit Schematics	116
Packaged Circuits, Modules and	116
Paint Resists	43
Painted Resistors, Making Your Own	52
Paints:	
and Pastes, Magnetic	22
Conductive and Resistive	20
Putting on the	20
Paper Capacitors, Metalized	66
Pastes, Magnetic Paints and	22
Patterns, Flush Switch	189
Phase-Shift Audio Oscillator	182
Phonograph Pickup	185
Photocell, Germanium	113
Photodiode, Selenium	111
Photodiodes, Cadmium Selenide	112
Photoelectric Devices, Subminiature	114
Photoelectric Light Meter	172
Photographic Etch-Resist Methods	28
Photosensitive Resists, Glue-Type	31
Pickup, Phonograph	185
Pierce Crystal Oscillator	185
Pig-Tailor	118
Pin Connectors, Tubular	201
Plastic Breadboard	44
Plate, Etching the Home-Made	34
Plated-Through Holes	48
Plugs and Jacks	105
Point-to-Point Circuit Checks, Using a VTVM for	137
Potentiometer, Miniature	62
Potting	195
Potting and Encapsulation	24
Pre-Etched Circuit Board	94
Pre-Etched Test Boards	94
Preparation of Component Leads	118
Presensitized Material, Exposure Problems with	41
Primary-Cell Sizes and Terminations	125

Printed and Etched Capacitors, Making Your Own	74
Printed-Circuit:	
Advantages of	15
Amplifier	169, 171
and Subminiature Assemblies,	135
Repair of	183
Audio Oscillators	10
Bandswitch	149
Board, Inserting a New Socket in	146
Board, Repairing Fractured	195
Cables	12
Industrial Amplifier	139
Jig	169
Maze	15, 16
Motor	136
Opens, Finding	70
Oscillator	46
Pattern, Drawing a	43
Pattern, Laying Out a	213
Radio-Control Receiver	140
Repair, Tools Used in	138
Servicing, Pitfalls in	187
Switches	190
Switches, Making	21
Transformer, Construction Details of a	212
Pulse-Width Multivibrator, Adjustable Frequency and	93
Punchboards	93
Punched Terminal Boards	93
Q	
Q Values of Inductances	85
Quartz Plston Capacitors	69
R	
Radio:	
Control Receiver, One-Tube	162
Control Receiver, Printed Circuit	213
Miniature	9
One-Transistor	159
Sets, Subminiature	176
Radios and Printed Circuits	9
Rain Detector	167, 169
Raised Switch Patterns	189
R-C Bridge and In-Circuit Tester	155
Receiver:	
Little Gem Duo-Diode	217
Lorenz Two-Tube	214
Printed-Circuit Radio-Control	161
Thyratron	133
Recharging Dry Cells	130
Recharging Nickel-Cadmium Cells	172, 173
Relay, Light-Beam	135
Repair of Printed-Circuit and Subminiature Assemblies	145
Repairing Broken Conductors	148
Repairs, Tube-Socket	149
Replacement of Sockets	149
Replacing:	
Components	151
Controls	147
Foil	150
Transformers, Inductors and IP's	51
Resistance Components	57
Resistance Paints, Drying Time of	20
Resistive and Conductive Paints	53
Resistors:	
Coaxial	60
Deposited Film	58
Derating Curve of	61
Flexible	61
High-Wattage Flexible	52
Making Your Own Painted	61
Miniature Variable	58
Subminiature Carbon	53
Tape	31
Resists:	
Glue-Type Photosensitive	43
Paint	43
Tape	43
Writing-Implement	78
RF:	
Chokes, Fixed-Inductance	89
Coil Forms-Winding Your Own Coils	77
Inductors	77

Oscillator	198	Subminiaturization and Inductors	75
Right-Angle Sockets	95	Surface Preparation for Painted	
Rotary Printed-Circuit Switch	191	Circuits	19
Rotating Switch Wheel	190	Surface Type Socket	95
S		Switch:	
Screen Stencil, Toughening and		Hinged Relay	190
Waterproofing the	41	Patterns, Raised	189
Secondary Cells	127	Rotary Printed-Circuit	191
Selection of Subminiature Wirewound		Wheel, Rotating	190
Resistors	60	Switches, Printed-Circuit	187
Selenium Photodiode	111	Switches, Removing from Printed-	
Semiconductor Devices, Subminiature	109	Circuit Boards	150
Semiconductor Diode, Characteristic			
Curve of	110	T	
Servicing, Pitfalls in Printed-Circuit	138	Tantalum Capacitors	70
Shield:		Tape Resistors	53
Base Plate	108	Tape Resist	43
Clamp Used With Subminiature		Techniques and Materials	17
Tubes	104	Television Applications	11
Insert, Corrugated	104	Terminal Boards, Punched	93
Units, Concentric	104	Terminals	97
Shields and Heat Sinks	103	Test:	
Signal Tracers	178	Boards, Pre-Etched	94
Silicon Diode, Internal Construction of	111	Instruments	153
Silk-Screen Methods	38	Prods, Home-Made	141
Silver:		Tester, In-Circuit Component	153
Cadmium Cells	130	Tester, Subminiature Tube	155
Migration	188	Testing:	
Paint Formulas	18	Subminiature Tubes	108
Zinc Battery	127	the One-Transistor Set	162
Six-Meter Converter	203	Transistors	112
Size of Dry Batteries	126	Thru-Con Crossover System	48
Sockets:		Thyratron Receiver	161
In-Line Subminiature	96	Timer, Chronograph Neon	168
Replacement of	149	Tips, Soldering Iron	152, 153
Right-Angle	95	Tools	141
Round-Type Subminiature	96	Tools Used in Printed-Circuit Repair	140
Surface Type	95	Tracers, Signal	178
Solder Masking Techniques	25	Transformers:	
Soldering:		Construction Details of Printed-	
Iron Tips	152, 153	Circuit	21
Methods	23, 24	Miniature	76
on Glass	27	Replacing	150
Spot and Jig	25	Transistors:	
Technique, Dip-	24	Checker for	157
Techniques, Special	27	Mounting	111
Troubles	25	Testing	112
Solders for Glass to Metals,		Transmitter:	
Indium-Based	28	for 27.255 Mc	187
Sparging, Deep Tank	37	High-Frequency Crystal-	
Speakers and Microphones, Miniature	105	Controlled	185
Spinpin	118	"Lipstick"	208
Splash Etching	37	Two-Tube Wristwatch AM	208
Spot and Jig Soldering	37	Trimmers, Mica	72
Spray Etching	27	Tube:	
Spray Milling	22	Circuits	184
Spraying or Metalizing	22	Socket, Cleaning Contacts of	147
Spring Clip Component Holder	100	Socket Repairs	148
Staked Terminals	99	Tester, Subminiature	155
Stamped Wiring	23, 195	Tubes, Subminiature	105
Still Etching	36	Tubular Ceramic Capacitor	65
Stitched Wiring Boards	36	Tubular Pin Connectors	201
Strain Gauges	94	Twin-Triode Oscillator	184
Subminiature:		Two-Tube Receiver, Lorenz	124
Assemblies, Repair of Printed-		Two-Tube Wristwatch AM Transmitter	208
Circuit and	135		
Carbon Resistors	58	V	
Photoelectric Devices	114	Voltages of Dry Batteries	126
Radio Sets	176		
Semiconductor Devices	109	W	
Sockets, In-Line	96	Waterproofing the Screen Stencil	41
Sockets, Round-Type	96	Wirewound Resistors	59
Wirewound Resistors, Selection of	60	Wiring:	
Subminiature Tubes:		Boards, Stitched	94
Flat	107	Hardware and Special	92
Round	107	Stamped	23, 195
Shield Clamp Used With	104	Wristwatch AM Transmitter,	
Tested for	155	Two-Tube	203
Testing	109	Writing-Implement Resist	43
Subminiaturization	15		