

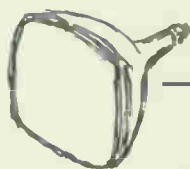

TV and
radio
TUBE
TROUBLES

SOL HELLER



GERNSBACK LIBRARY, INC.
NEW YORK 11, N. Y.

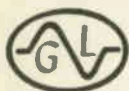

© 1958 Gernsback Library, Inc.
All rights reserved under Universal
International, and Pan-American
Copyright Conventions.

Library of Congress Catalog Card No. 57-14485

contents

chapter

page

1

Safety

Safe servicing. Safety considerations with respect to picture tubes. How great is implosion risk? How implosions occur. Skin tension of glass. How to avoid causing an implosion. How to handle picture tubes. Cautions for minimizing implosion injuries. Using safety goggles. Disposing of unwanted tubes. How to deactivate a picture tube. X-ray radiation. Avoiding TV shock. Aquadag grounding strap. Radio shock hazards. Degree of shock. Avoiding tube-caused burns.

7

2

Tube and component damage

Tube mountings. Positioning of rectifier tubes. Preventing damage to low-voltage rectifier. Plate and screen dissipation ratings. Ventilation. Avoiding damage to horizontal output tube. Cautions on high-voltage rectifiers. High-voltage lead dress. Protecting c-r tubes. Tube damage due to grid emission. Grid-to-ground resistance. Premature tube failure due to leaky coupling capacitor. Miscellaneous sources of arc-caused damage to tube and components. Series-filament circuits. Cautions on use of tube testers.

19

3

Tube troubles in tv

Localizing defective tube when raster and sound are absent. Raster absent, sound normal. Raster absent, hum in sound. Cathode-to-heater short. Intermittent raster. Excessive warmup time. Size, linearity and brightness troubles. Insufficient width due to tube troubles. Reduced line voltage. Vertical deflection absent. Insufficient height. Intermittent vertical collapse. Vertical shrinking. Increasing height by tube substitution. Vertical nonlinearity. Horizontal nonlinearity. Insufficient brightness. Excessive brightness.

37

4

Picture and sound troubles

Pix absent, sound and raster normal. Pix and sound absent, raster normal. Intermittent pix and sound. Pix and sound reception absent on some channels. Receiver inoperative on uhf. Pix missing; sound is strong. Insufficient signal. Snow. Weak uhf reception. Overloading. Negative picture. Poor definition. Resolution troubles. Picture smear. Engraved effect. Ghosts. Buzz. Other sound troubles. Sound absent, pix normal. Weak and/or distorted sound. Noisy sound. Noise drowns out desired sound. Sound and pix do not track.

53

5

Sync troubles

Vertical sync trouble. Rolling due to 6BL7-GT characteristics. Tube substitutions to improve vertical stability in weak-signal areas. Vertical jitter due to lead dress. Vertical blanking bar in pix. Single vertical pix unobtainable. Poor interlace. Horizontal sync trouble. Horizontal sync instability. Horizontal pulling. Horizontal tearing. Horizontal jitter. Symptoms associated with controls. Horizontal sync symptoms. Improving horizontal sync stability. Flashes in picture.

85

6

Interference

TVI. Radiation from horizontal output tube. "Tweets". Barkhausen oscillation. Vertical-line troubles. Vertical lines due to improper lead dress. Vertical white line due to failure of horizontal retrace blanking tube. "Spook" interference. Radiation from audio output tube. "Snivets". Microphonics. Sound in pix. Hum bars in picture and raster. Corona and arcing. Localizing corona. Arcing inside the crt. Arcing at metal C-R tubes. Arcing due to improper crt grounding.

103

7

Picture tubes

Bulb and base differences. Aquadag coating. Glass vs. metal tubes. Picture-tube lengths. Electrostatically and electromagnetically deflected picture tubes. Yoke and focus problems. Centering devices. Ion-trap systems. Damage due to misadjusted ion-trap magnet. Testing and repairing picture tubes. Possible troubles in picture tubes. Loss of emission. Rejuvenation. Cathode defects. Gassy tubes. Filament troubles. Heater-to-cathode shorts. Grid-to-cathode short. Magnetized metal picture tube. Universal picture tubes.

125

8

Radio tube troubles

Intermittent filament troubles. Station drift. Receiver volume below normal. Distortion. Hum. Hum due to heater-to-cathode leakage. Modulation hum. Hum due to cathode-to-heater short. Filament-to-grid coupling. Tube shields and hum. Lead-dress hum. Socket trouble. Obscure causes of hum. Tube-caused buzz. Oscillation. Microphonic tubes. Noisy tubes. Tube troubles in portable radios. Avoiding tube damage. Intermittent operation and fading. Inoperation. Distortion. Low volume. Miscellaneous symptoms.

179

9

Tube replacements

Precautions in making tube substitutions. Salvaging the diode-triode. Replacing tuner tubes. Improving reception through tube substitutions. Replacing rf oscillator tubes. Video if tube replacements. Sweep and sync tube replacements. Tube design. Horizontal output tubes. Substitution rules. High- and low-voltage rectifier tubes. Replacing parallel rectifiers. Avoiding needless picture tube replacements. Renecked picture tubes. Electrostatic-focus picture-tube substitutions. Retaining salvage value of the picture tube. Tube replacement notes.

209

Index

221

introduction

TUBE faults are, by far, the most frequent ones encountered by the TV-radio technician; he runs into them in perhaps 70% (and quite possibly more) of his service jobs. Even the best service technician not infrequently spends an undue number of minutes in localizing some tube defect; less experienced men may waste one or two hours in tracking down some tube-caused faults. The author recalls a case in which a service technician spent several hours in tracing a condition known as "Christmas-tree effect" to a weak video amplifier tube. It had just never occurred to the man to link this particular cause and effect together. Numerous similar instances could be cited. This book is intended to minimize such roundabout troubleshooting.

The reader will find here an organization of TV and radio tube troubles, both familiar and unfamiliar, into a handy form that permits fast reference to needed information. TV-radio service data form a peculiarly elusive body of knowledge in the average technician's mind; information he hasn't used for some time is quite likely to slip away and be missing when it is needed most. This book is intended to act as a memory guide with respect to tube troubles when fast refreshing is needed. The author hopes that even advanced service technicians will find material here with which they are unfamiliar.

A book of this type should prove most valuable for less experienced service technicians and beginners. The outside service technician with a sketchy technical background will find it very helpful; so will the shop owner or manager who wants to train—or increase the efficiency of—a home service technician.

The intent of the book is not only to speed tube troubleshooting directly—it also aims to do so indirectly, by presenting a wealth of

service data about tubes. The author knows of no other book, incidentally, that covers this territory.

The author and publishers acknowledge with thanks the cooperation of the following companies during the preparation of this book: Admiral Corp., DeWald Radio Mfg. Co., Allen B. DuMont Laboratories Inc., Emerson Radio & Phonograph Corp., General Electric Co., Hoffman Electronics Corp., The Magnavox Co., Motorola Inc., Packard Bell Electronics Corp., Philco Corp., RCA, RADIO-ELECTRONICS Magazine, *Radio & Television News*, Sylvania Electric Products Inc., *Technician*, Trav-Ler Radio Corp., Westinghouse Electric Corp., Zenith Radio Corp.

SOL HELLER

Soft cover design by Muneef Alwan
Cover design of the clothbound edition by Thomas Falletta

safety

SAFE servicing is desirable in all troubleshooting operations, not merely in the localization of tube troubles. It is relevant because accidents delay servicing and tend to increase the expenses associated with it. A man who spends a month in the hospital after an explosive session with a picture tube can hardly be said to have repaired a tube trouble quickly.

Delay and inefficiency may be associated with shocks and burns as well as implosions. The author has known technicians to stop working after a severe shock or to work at considerably reduced ability due to the emotional upset they have gone through. Safety is thus definitely linked with faster tube troubleshooting, just as it is with the troubleshooting of any other component.

Safety considerations with respect to picture tubes

There are three dangers associated with cathode-ray tubes that merit consideration. These are implosion, shock and X-rays.

Implosion of a cathode-ray tube can cause severe injury or death.

Shock from the high voltage at the anode cap of a glass tube or the cone section of a metal type is generally more unpleasant than dangerous; secondary effects may, however, be fairly serious for some individuals. Shock suffered during the handling of a C-R tube may result in the dropping of the tube, followed by an implosion. All the more reason, then, for reducing the chances of getting shocked.

How great is implosion risk?

The occurrence of implosions without apparent cause has made some technicians a bit apprehensive while working near picture tubes. However, it's safer to handle a cathode-ray tube—provided proper precautions are observed—than it is to cross a city street.

A rectangular tube is more likely to implode than a round one. The glass thickness in rectangular tubes is greater at the corners of the screen than in the center (the corners represent areas of poor pressure distribution). As a result, heat and cold produce uneven expansions and contractions at different parts of the screen, weakening the tube's resistance to stresses. Greater care in the handling of rectangular C-R tubes is therefore necessary.

Metal tubes offer considerably less implosion hazards than all-glass types.

How implosions occur

Since the picture tube is highly evacuated and its surface is large, the external atmospheric pressure brought to bear on it is very great. The resultant stresses set up are maximum at the tube's front rim. A blow, bump or even a scratch can raise the stress to the breaking point, causing first an inward movement or cave-in of the glass, called an *implosion*, followed by an outward movement or *explosion* of the broken glass sections.

Many service technicians handle picture tubes with a gross lack of respect. The author has seen technicians unimaginatively manipulating screwdrivers and other tools near picture-tube screens in such a way as inevitably to hit them if the tool slipped by accident. Other service technicians place tubes face down, on workbenches littered with little sharp metal particles, and violate elementary rules of safety in numerous other ways. Quite often nothing happens—C-R tubes hold up under substantial amounts of abuse; sometimes a bad accident, however, punishes the technician for his negligence.

It is important to realize that glass has a substantial degree of strength until its *skin tension* is broken. A skin fracture, even one that is microscopically small, may severely weaken the opposition offered by the glass to the heavy pressure of the atmosphere. In one case known to the author, an implosion resulted from the accidental brushing of a technician's ring against the tube's front surface. Even a relatively mild bump of one tube against another or of a tube against a metal surface can lay the groundwork for a subsequent implosion.

How to avoid causing an implosion

Handle a picture tube gently while replacing it. Don't let it strike the chassis or metal units on the chassis. Get someone to help you carry the tube if it is a large one.

Don't set a cathode-ray tube down in any area where people can conceivably stumble over it or where other kinds of undesired collisions can occur. Be particularly careful not to let one tube bump into another; two implosions are worse than one.

Never set a picture tube face down on any surface other than soft cloth. Be particularly careful not to put the tube down on a concrete floor—its surface will inevitably be scratched if you do, weakening the glass.

Never let a picture tube act as a support for the yoke or focus coil. Another crime against safety is to let the tube support the chassis when the latter is turned over for servicing.

Watch out for gritty particles under ion magnets; they can cause scratches on the tube neck. Wipe them off before moving the ion magnet back and forth along the tube neck.

If the yoke and focus coil do not slide smoothly, dust a little talcum powder between the contacting surfaces, to reduce friction.

Make sure that protective rubber or felt strips (see Fig. 101) are reinserted between the metal support band and the tube when the support band is replaced after having been disassembled. These protective strips prevent possible breakage of the tube due to excessive tightening of the band. When they are out of position, put them back into place.

Don't lift or support a tube by its neck. Most of the tube's weight is concentrated at its broad or bulb end. The tube should therefore be supported largely at that end when it is being lifted; very little pressure should be placed on the neck.

Before handling a (disconnected) glass tube that has an Aquadag coating, discharge it by touching a grounded wire to its anode receptacle. More than one discharge or a prolonged short may be required to discharge the picture tube completely. Glass tubes that have been separated from their chassis can retain a charge for 24 hours, possibly longer. The author has, on more than one occasion, seen technicians jump noticeably due to the unexpected shock experienced when an undischarged C-R tube was picked up from its resting place on the floor. Breakage of the tube is more than a remote possibility in cases of this sort.

Avoid using tools in any way that make striking the tube possible. When some tool *must* be used in such a manner, place one

hand between the tool and the tube to prevent the tube from being struck if the tool should slip. (The result of an implosion is shown in Fig. 102.)

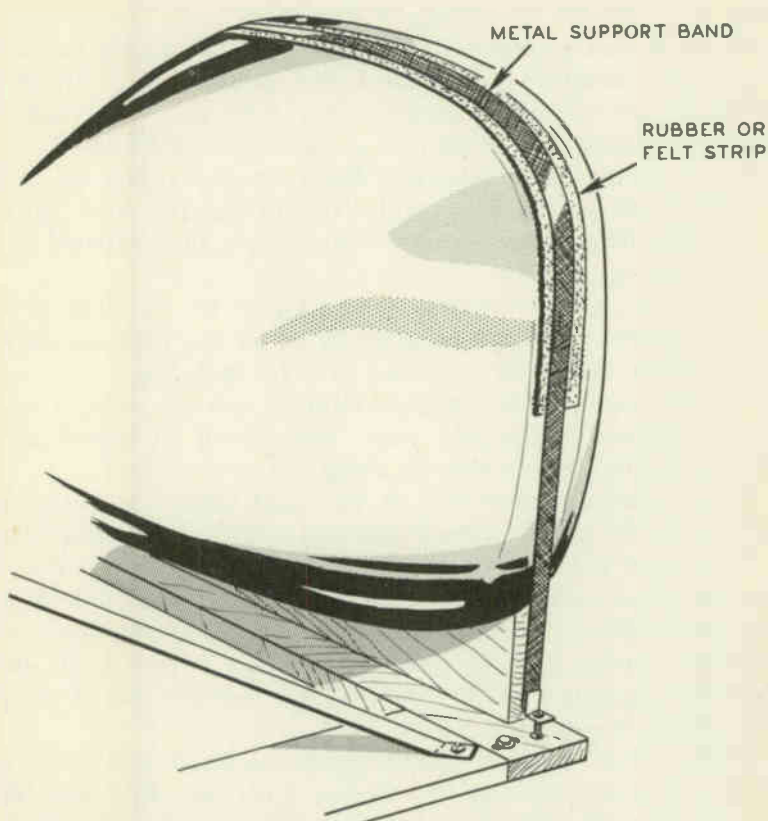

Fig. 101. Position of rubber or felt strip under metal band holding cathode-ray tube in place.

Don't use ordinary C-R tubes for display purposes. Use one that is no longer a vacuum type. Distributors can supply such tubes or the dealer himself can let air into a tube, using the technique described later in this chapter.

Some older types, such as 17CP4's, tend to develop visible cracks. Several inches long, they extend horizontally along the tube and generally appear near its lower surface. The cause is faulty construction, not improper handling. Cracked tubes should be replaced to avoid possible trouble.

When a picture tube is to be removed, follow the procedure recommended in the set manufacturer's service notes (unless you

are so familiar with the mechanics of the job that you can dispense with such guidance).

Cautions for minimizing implosion injuries

While the risk of an implosion is remote under ordinary circumstances, precautions should nevertheless be taken to minimize injuries in case of an accident.



Fig. 102. *Result of a cathode-ray implosion due to inadequate safety precautions.*

If you are working in a customer's home, keep other people at a safe distance from the tube when it has been exposed and is being handled. For maximum safety, send them into another room.

Wear goggles when handling a C-R tube. This is a safety measure widely neglected by technicians. It is, however, uniformly recommended by all TV set manufacturers. The eyes are very fragile, highly important parts of the body—protect them. Some manufacturers recommend the wearing of goggles, not only when tubes are being handled, but when any top chassis work is being

done. The wearing of gloves is also recommended to prevent scratching the tube with rings and also to protect the hands from possible injury. Don't leave old—or new—tubes lying around the shop. Put them into suitable cartons and store in an out-of-the-way place.

Disposing of unwanted tubes

If a defective tube is not wanted, *don't simply throw it into a garbage can*—a subsequent implosion is possible. Neither the garbage collector nor others who may handle the can are likely to



Fig. 103. Deactivating a picture tube. Drilling a hole in the keyway of the tube exposes the exhaust tip, which can then be broken.

treat the tube with the care necessary to prevent an accident. Bear in mind that you or your employer can be held legally responsible for injuries suffered by other people in the event of an implosion resulting from improper disposal of a C-R tube. To make a discarded tube safe:

1. Put the tube you want to dispose of into a carton designed to hold a unit of its size. Enough soft cloth should be placed under the face of the tube to make its base stick out at the top, outside the fold-over flaps of the carton (Fig. 103).
2. Drill a $\frac{1}{4}$ -inch hole in the center of the keyway or locating lug.

3. Now insert a small file or similar tool into the hole and break off the exhaust tip at which the tube is sealed. Shatter only the point if the tube is to be returned for credit; if a larger area is broken, the too-rapid intake of air will blow off the screen coating and reduce the tube's trade-in value. When a metal exhaust tip is present, a small three-cornered file or similar tool can be used to create the small hole needed.

4. To insure that the tube is perfectly safe, break the tip completely later on if you haven't done so right at the outset. The seal may be recessed below the base, hence should be inspected to see if it is broken.

Instead of going through the procedure just outlined, some technicians simply break off the keyway at the tube base with a pair of cutters or pliers. The exhaust tip is automatically shattered during this process. After the tube has had its vacuum filled with air, it can be placed into a sealed carton and thrown out or returned for credit on a trade-in.

X-ray radiation

Picture tubes tend to produce significant X-ray radiation at anode voltages in excess of 16 kv. Since tubes 21 inches or larger in diameter operate at voltages of 16,000 or more, the X-ray radiation produced is worth considering. It does not have sufficient intensity to penetrate the protective faceplate and is therefore not a danger to the set owner. With the protective glass absent, however, some danger of excessive exposure exists for the technician working on the receiver. Most X-rays are given off toward the rear of the tube and come out that way since the glass is thinner there. Keeping the chassis between yourself and the tube is a good rule. How much danger is actually present is not yet certain; it is most likely very small. Nevertheless, when chassis using picture tubes with second anode potentials in excess of 16 kilovolts are worked on, it would seem wise to avoid long or repeated periods of exposure while the tube is in operation, and to keep out of the path of the beam as much as possible. Don't look at or stand in front of the tube face any longer than you can possibly help.

Make sure that the high-voltage cage is in place since a high-voltage rectifier tube operated at potentials above 16 kv will also give off X-rays.

Avoiding TV shock

A certain number of electrical shocks are probably unavoidable

in servicing a TV set; they can, however, be kept to a minimum.

The first precaution to take when a C-R tube is to be substituted in a TV set is to check whether the grounding clip or strap (if the tube is a glass type) is making contact with the Aquadag coating (Fig. 104). If it isn't, the proper adjustment should be made to remedy the condition and insure that no residual charge is left on the tube when the power is turned off and tubes are interchanged. The receptacle or cup of a disconnected glass C-R tube should be discharged to ground before the tube is handled.

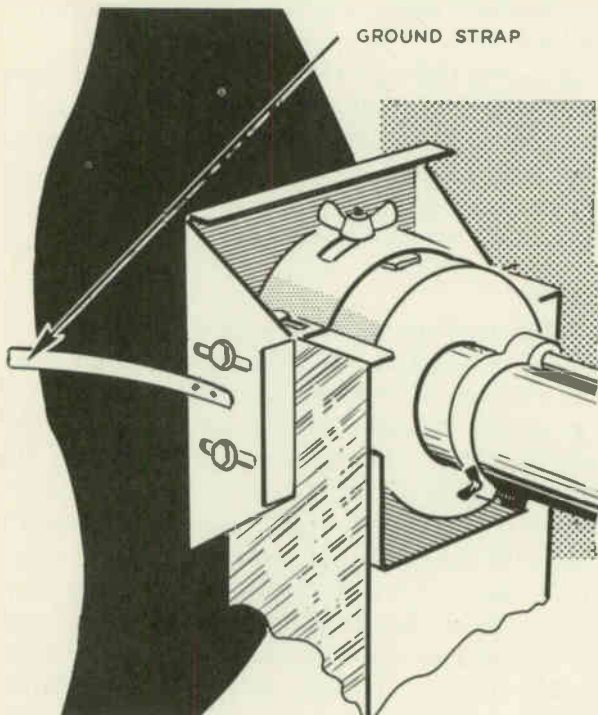

Fig. 104. Sketch showing ground strap on picture tube. Hairpin type clips are also used to place the glass envelope at ground potential.

Avoid changing metal tubes with the power on. Shock is likely if this precaution is not observed. Discharge a metal type tube's anode connector (and receptacle) to ground before putting your fingers near the metal cone section. (Power is, of course, assumed to be off.)

Watch out for shock hazards when handling or adjusting controls near metal tubes (preliminary to changing tubes or after tubes have been changed). A rapid movement of the hand is

likely to result in brushing against the metal surface of the C-R tube, causing a shock.

When the set is on the bench, clear the area around the set. The author still remembers an unexpected shock he got when a stray wire hanging from a shelf over his bench contacted a metal tube at one end and touched his ear with the other. The wire, incidentally, made contact with both tube and ear *through its insulation*.

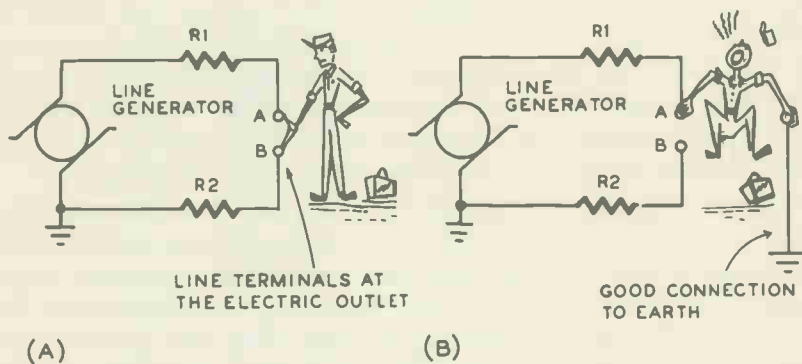

Fig. 105. When a technician (drawing A) puts two fingers of one hand across the line terminals, current flows through the fingers and hand only and does not pass through vital organs. Also, the current is limited by the resistance of the wiring in each branch of the line (R_1 and R_2 represent this resistance). When the technician (drawing B) puts one hand between the "hot" side of the line and a good external ground, current flows from one hand to the other through his body. The current will be greater than in A because R_2 is short-circuited.

Don't attribute undeserved virtues to plastic sleeves covering the metal section of a metal type picture tube. An acquaintance of the author's who inadvertently touched such a plastic covering with one hand while contacting the chassis with the other got blisters that remained on his hand for two days. Interestingly enough, he felt no shock at the time of contact; neither did a skeptical friend who subjected himself to the same experience a short time later.

When working at the underside of a TV chassis (an unfortunate necessity in the case of some tube replacements), discharge the high voltage by shorting the high-voltage capacitor to ground if (power-off) tests or substitutions that involve the handling of components in or near the high-voltage section are to be made. Don't get your fingers too close to high-voltage terminals on any set—they may draw an arc.

Radio shock hazards

The possibility of getting electrocuted while working on a radio must not be ignored. While the risk is not great, it does exist and is something which we must concern ourselves since it is present even during tube substitutions.

You can, while changing tubes in a little innocuous-looking ac-dc set, get a jolt considerably more dangerous than the high voltage present in a television receiver. The author will never forget the "kick" he got when his slightly damp hair came in contact with the metal shade of a lamp while his hand was resting on the chassis of an ac-dc set. The metal shade had shorted internally to the socket and was making contact with one side of the line; the chassis was connected to the other side of the line. The resultant setup was a good one for an electronic murder.

Novices who see old-timers testing for line "juice" by putting their fingers across the ac line terminals should not confuse this with getting their body between one side of the line and a good ground. (See Fig. 105-a,-b. R1 and R2 represent the resistance of the line.) The current-delivering capacity of a line generator is somewhat less in the first case than it is in the second, making an electric shock less dangerous; more important, putting two fingers (of the same hand) across the line limits the path of current to the hand, leaving vital organs unaffected. Actually, the current going through the fingers is greater than that going through the body, but is not as dangerous.

Here are some instances which illustrate the possibilities that lie in wait for the unwary technician:

A service technician working on an ac-dc set asked another technician, also servicing an ac-dc receiver, to pass him a hacksaw. The sets were connected to opposite sides of the line, as they realized very shortly. When the men made contact with the hacksaw, the circuit was completed. Both shook like St. Vitus' dancers until one of the radios fell off the bench and put an end to the shocking business.

Another case involved a man who was cautious enough to wear crepe-rubber-soled shoes (to insulate him from ground). He was holding an ac-dc chassis when his wife came in out of the rain, walked up quietly behind him and kissed him on the back of the neck. The chassis was "hot" and the wife was well grounded because of her wet shoes. The result was a shock that raised the hair on the back of the technician's neck.

Many other cases could be cited, in some of which fire as well

as shock occurred. Fatalities, while infrequent, do take place. A voltage as low as 40 at 60 cycles has caused death. Caution is therefore necessary. The hazards are chiefly associated with the servicing of ac-dc sets. Use of an isolation transformer between line and set will eliminate most of the risks.

Service technicians should keep in mind that shock from the same source may be merely unpleasant in one case, fatal in another. Four factors are important in determining the degree of shock: (1) nature of the voltage (ac or dc); (2) resistance of the skin; (3) pathway of the current through the body; (4) duration of the shock. (We are ignoring the amount of voltage as a factor, since a 110-volt source is assumed.)

Under the conditions present in the typical service shop, 110 volts ac is likely to be far more dangerous than 110 volts dc. Dc voltage does not produce the strong contractions of the heart muscles that ac does.

The internal resistance of the body is relatively small. The skin, however, has a comparatively high resistance—about 100,000 ohms per square centimeter *when dry*. If it is thoroughly wet, the skin's resistance may drop to as low as 1/1,000 of its dry value. Prolonged contact with an applied voltage causes the protection offered by the skin to be largely lost, due to the formation of blisters. With high voltage the protection given by skin resistance is lost because of puncture of the skin by a high-voltage arc.

The pathway of current through the body is vitally important. If no vital organs are in the path of the current, the danger is small. When contact is made between two points on the same arm, no current passes through the body at all; when the path of the current is from head to foot, however, the danger is considerable, since the electron flow passes through the heart. The chances of a fatality vary directly with the duration of contact. The shorter the contact, the less the risk.

Avoiding tube-caused burns

When a receiver has been in operation for some time, most of its tubes will become quite hot. High-current tubes (rectifiers and output tubes) become extremely hot. Caution should be used in withdrawing and replacing tubes to avoid getting a burn. Tentatively feeling a tube before withdrawing it is not always a burn preventive—an adjacent tube that has heated up greatly may bite the technician's hand as he maneuvers the cool tube.

To avoid trouble, remove tubes with the power off. Use a cloth, gloves or a tube puller to protect the hand when a hot

tube, or a tube in the vicinity of a hot one, is to be withdrawn or inserted.

Safety procedures

It is possible and necessary to increase safety during TV and radio servicing by following a few simple precautions:

Make sure that any insulating materials provided by the manufacturer are not removed or damaged during servicing. Replace any worn or damaged insulation.

After the set has been installed in the cabinet, make a visual check, to see if there is anything visibly wrong; then check from chassis to external ground with an ac voltmeter. Reverse the line cord plug in the power outlet, and repeat the test. Make the voltage test with the power switch on and off. In either case, no ac voltage should be measured between chassis and ground.

Make sure that isolating networks; especially in antenna circuits where they are more likely to be disturbed are intact.

Sets should be placed away from grounded objects like radiators, bathtubs or pipes. They should also be situated well away from windows, where rain may drive in the back and temporarily short insulating boards.

Sets should be inspected immediately for damage, when they have been subjected to conditions likely to cause damage—the tipping over of a portable TV stand, for example.

Don't overlook conventional but necessary safety inspections of the line cord; it may be frayed or exposed at some point. Never ignore a possible fire hazard. Check for, and replace, oversize fuses and warn against installations in poorly ventilated places.

The technician may also perform another service of considerable/psychological value. On completing work on a receiver, he can give the owner a statement that the equipment has been tested and found free from shock hazard. This may be typed out on the bill. Such a statement will carry considerable reassurance to the owner and may even be of value if an accident should occur some time after the equipment has been serviced.

tube and component damage

DAMAGE to tubes and other components during or as a result of servicing tube troubles means lost time and increased service costs. A higher bill to the customer may be necessitated, making his emigration to a less expensive competitor a possibility. It is obviously desirable that such damage be avoided. What to do in all cases to avoid such damage is, however, not quite so obvious, particularly to the inexperienced.

This chapter will discuss common, as well as not-so-common, sources of damage to tubes and other components. Enough information will be presented to enable the reader to minimize costly service errors.

Tube mountings

There are a number of considerations with regard to the positioning of tubes that the service technician should know. Technicians sometimes operate receivers—particularly intermittent ones—for long periods of time. In other instances, they may add one or more tubes to the set to improve its performance. In either case, tubes may unwittingly be mounted in the wrong position for long periods of time and damage may result.

The conventional and correct position for a tube is a vertical one with the base of the tube down. In cases where vertical mounting is not used and the tube is directly heated, the filament should be in a vertical plane. A case in point is the mounting of 5U4-G and 5U4-GB rectifier tubes. When such a rectifier is mounted horizontally, its plates should assume the position shown

in Fig. 201. The filaments are correctly positioned in this case, minimizing the possibility of filament sag. Sag of this kind can result in the development of a filament-to-plate short, which may damage the power transformer and filter capacitors as well as the rectifier tube.

Different tube manufacturers do not orient the plates of the 5U4-GB (with respect to the base pins) in an identical manner. It becomes necessary, therefore, when the technician is replacing

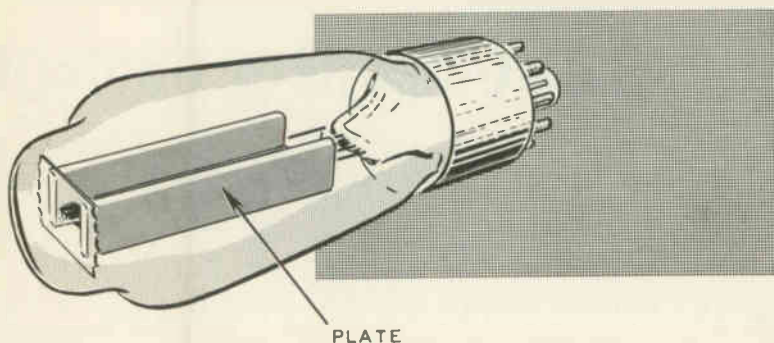

Fig. 201. When a 5U4-G is horizontally positioned, the long sides of the plates should be vertical.

a 5U4-GB that is horizontally mounted, to obtain a tube with a structure identical to the one in the set, one whose plate and base-pin orientation correspond to that of Fig. 201. Otherwise, damage to components may occur. It is desirable to avoid horizontal positioning of the 5U4-GB when servicing a set for any considerable length of time if the positioning of the plates with respect to the pins differs from the one illustrated in Fig. 201.

In the case of indirectly heated tubes with a high transconductance, the major or long axis of the elliptically shaped control grid should be kept vertical to avoid filament-to-cathode shorts as well as microphonics.

High-current tubes, such as rectifiers, video amplifiers, audio power amplifiers and horizontal output tubes, are generally mounted vertically. Other types of mounting tend to reduce the flow of air around the tube envelope and may cause the tube's heat dissipation ratings to be exceeded, possibly damaging it. If ventilation is adequate, horizontal mounting is satisfactory but the filament pins should be in a vertical plane.

Preventing damage to low-voltage rectifier

Small current-limiting resistors (Fig. 202) are used in series

with selenium rectifiers in TV sets as well as in radio receivers. Similar but larger-value resistors are used in series with the plate of a half-wave rectifier tube in an ac-dc radio. Technicians sometimes jump such a resistor with wire when they find one burned out and do not have an identical unit on hand; the fact that the receiver works perfectly well without the resistor convinces them that the unit is not necessary.

A resistor of this kind serves a protective function and should always be replaced. Selenium, as well as tube rectifiers, can safely pass a certain value of peak plate current; if this current is exceeded, the rectifier may be permanently damaged.

At the beginning of the conductive portion of each cycle, when the filter capacitors begin to charge, the impedance in series with the rectifier is extremely small; the current passed by the rectifier

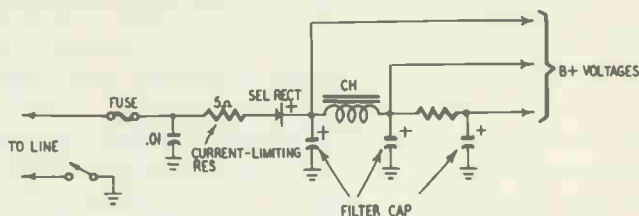

Fig. 202. Representative selenium rectifier power supply, showing one way in which a current-limiting resistor is inserted into the circuit.

at this time can be excessive, particularly when the line voltage is high. With a current-limiting resistor present, the peak current is reduced to a safe value.

In line with promoting longer rectifier life, avoid turning receivers on just after the set has been turned off; customers should be cautioned to the same effect. In such circumstances, a (tube) rectifier cathode is hot and ready to deliver a maximum amount of electrons; the filter capacitor has been permitted to become partly discharged, reducing the impedance in series with the rectifier. The peak current flowing under such circumstances may exceed safe limits and damage the rectifier.

Technicians not infrequently replace the rectifier tube in a TV or radio set with a different type either because the original one is in scarce supply or because they want to boost the supply voltage by using a tube capable of providing a higher dc output voltage. In many instances this is an unsafe practice. The increase in voltage, while it may substantially improve set performance, can cause the design safety margins of the receiver to be ex-

ceeded; the higher voltage produced may damage various components designed for lower-power supply potentials.

When a filament type rectifier is substituted for a cathode type, the dc voltages at the input and output of the filter choke will rise to maximum much more quickly. Since the cathode type output tubes present will require maximum current an appreciable time later, there will be a short interval just after the set has been turned on when the rectifier is operating at full output with very little or no load. The excessive voltage applied to filter, bypass and coupling capacitors in such a case can damage some of them.

When a filter capacitor has just been installed in a set, it is wise to use an old, weak (but still operative) rectifier tube to test set operation. The reason for this precaution lies in the fact that capacitors that have been on the shelf for some time will have a larger-than-normal (momentary) leakage for a short time after they are placed in use; this excessive leakage may damage the rectifier.

Use of an input filter capacitor larger than the one called for in the set's design may injure the rectifier due to the higher surge currents that are permitted to flow. Adding a small amount of resistance in series with the plate circuit of the rectifier will remove this danger. A bad rectifier tube (i.e., one with no emission) should never be replaced before the filter capacitors are tested for a short.

Plate and screen dissipation ratings

When electrons strike the plate or screen of a tube, heat is generated and power is dissipated. Every vacuum tube can tolerate a certain amount of heat; when this limit is exceeded, the tube's performance is impaired and its life shortened.

Heat is produced by the heating of the cathode as well as the plate and screen; most of the heat in a tube, however, is normally due to the flow of plate current. All of the heat must be carried away or dissipated to prevent the tube from being damaged. Radiation, primarily through the tube envelope, as well as convection (transfer of heat by air currents) permit such dissipation to take place.

Excessive heat is generated in a tube, impairing its performance and life, if ventilation is improper. An adequate supply of air must flow past the receiver's tubes, particularly its rectifier and power output tubes. If the set owner keeps the receiver flush against the wall or covers its ventilation openings (Fig. 203) in

other ways, the requisite amount of cooling is not likely to occur. To minimize callbacks the technician should advise the set owner of the need for ventilation. Improper ventilation is particularly likely when high-current tubes are mounted horizontally in a receiver.

Holes are sometimes punched in the bottom of table-model receivers. If the set is placed on some form of soft, decorative cloth, enough of the holes can become blocked to interfere with ventilation.

The presence of a shield around a tube will raise its temperature very markedly. In more than one case, manufacturers have

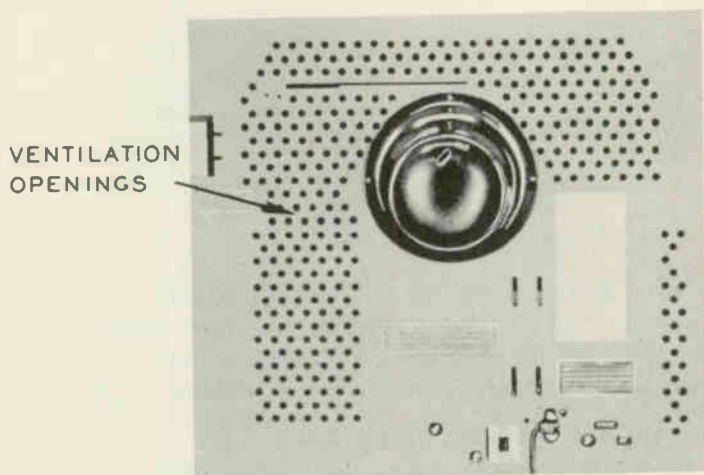

Fig. 203. Ventilation openings in the back of a TV set. Keeping the receiver some distance away from the wall will prevent obstruction of the openings.

recommended that shields called for in the design of a set be discarded to prevent an injurious temperature rise.

Undue heating of a tube enclosed by a shield may cause the tube to break. In such cases, make sure that no decrease in bias or increase in plate or screen potentials is responsible for the undue heating; then try removing the shield. If set performance suffers with the shield off, ventilation holes punched in the shield may reduce the heating sufficiently to permit the shield to be retained. Shields of this kind are commercially available.

In some instances when tubes with shields burn out too frequently and the shields can neither be removed nor adequately ventilated, the plate voltage of the tube involved may be temporarily lowered by adding a capacitor-bypassed resistor (R1

and C1 in Fig. 204) in series with the plate load. This technique has some points in its favor in areas where the line voltage is high; it will probably not work satisfactorily where the line voltage is low and is certainly not recommended in fringe areas. The value of the resistor should be large enough to reduce the plate voltage appreciably, but not so large that the reduction adversely affects set performance. This technique has been successfully used in the case of premature 6AF4-A failures in converters in uhf-vhf television receivers.

Excessive screen dissipation will occur in a power output tube if the load is removed. Thus, an open audio output transformer

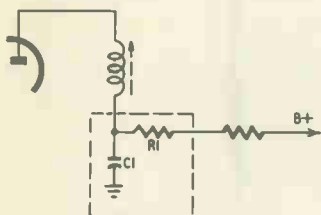

Fig. 204. How a resistor and decoupling capacitor are connected to reduce plate voltage and excessive tube heating.

primary will result in the diverting of the normal plate current flow to the screen, causing the screen to overheat and glow brightly. The tube will be damaged if power is not shut off promptly. Never operate a power output tube without a load.

Avoiding damage to horizontal output tube

A number of conditions may cause premature failure of the horizontal output tube and should be avoided. The most frequent cause of damage to the tube lies, perhaps, in removal of its drive or input signal. Such a condition may result from the failure of the sweep oscillator due to a tube or component fault; from removal of the oscillator tube for test purposes by an inexperienced technician or any defect, in short, that eliminates or greatly reduces the signal input to the horizontal amplifier. The amplifier's (grid-leak) bias is reduced in such circumstances, permitting its plate and screen currents to rise. Furthermore, the dissipation of power is confined primarily to the tube in this case; very little power is dissipated in the load. The tell-tale sign of the trouble will be the excessive heating of the power amplifier plate; this will glow cherry-red in the absence of all drive. In some instances, where the absence of grid drive permits excessive current to flow in the horizontal output tube, the solder on the plate cap will melt, fusing the cap and plate clip together.

When an adequate size cathode resistance (about 100 or 200 ohms) is used in a horizontal output tube, the latter may be operated at three times its rated power for a period of as much as 5 minutes with little risk of its being damaged. Absence of grid drive is not as serious in tubes protected in this way as it is in the case of a tube with no cathode bias.

When a horizontal amplifier with no cathode bias must be operated for a short time to permit voltage readings to be made, insert a resistor of 100 or 200 ohms between its cathode and ground. The resistor's rating should be about 5 watts. Leads and components adjacent to the resistor should be dressed away from it to prevent the heat dissipated in the resistor from affecting them.

When a horizontal amplifier tube requires replacement every few months, instead of once a year, a number of points merit investigation. Is the horizontal drive control setting too low? To check for (as well as remedy) the condition, turn the drive control up far enough to bring overdrive bars (white vertical lines) into the picture, then reduce the drive setting to the point where they just disappear. (Decreasing the capacitance of the horizontal drive capacitor increases the drive.)

Is the horizontal linearity control setting improper? In some sets, such a condition may not noticeably affect linearity and yet can cause tube damage. To check this (when likelier sources of the trouble have been eliminated), vary the linearity setting from one extreme to the other. If two points can be found where satisfactory linearity can be obtained, leave the adjustment at the point where the slug protrudes farthest from the coil. Adjusting the horizontal linearity control for minimum cathode current of the horizontal output tube is often the simplest and best technique. Insert a dc millimeter in series with the cathode of the tube and turn the control for a minimum reading on the meter. (A horizontal linearity control is generally found in older sets.)

Higher-than-normal line voltages may be responsible for premature horizontal output tube failures. Excessive width and/or horizontal nonlinearity are associated symptoms in such a case (Fig. 205). A line-voltage check will verify whether this voltage is above normal.

A defective horizontal output transformer can cause the output tube's rating to be exceeded, damaging the tube. The output transformer should be checked to verify whether this is the case. A flyback tester is recommended for such a check.

If a 6SN7-GTB tube is being used as a horizontal sweep oscillator, the possibility of the tube's being intermittent must be

considered. If the set owner reports that the set failed to produce a raster at certain times, particularly when it was turned on just after being turned off, an erratic 6SN7-GTB may be the source of frequent horizontal amplifier tube failures. Replace the 6SN7-GTB with a 6SN7-GT, which oscillates more reliably. The 6SN7-GT is an older and discontinued type but is readily available.

When excessive failure of the horizontal output tube (or some other tube, for that matter) occurs in a series-filament setup, arcing between heater and cathode of the damper may be applying excessive voltage pulses to the filament strings.

When two horizontal output tubes are in parallel, care must be used in substituting or replacing one tube. If a single tube is replaced and the set is turned on just after being turned off, one



Fig. 205. Effect of horizontal nonlinearity on test pattern. Note greater width of horizontal wedge at left, compared to the corresponding wedge at the right.

of the parallel tubes will be hot while the other is cold, causing an uneven distribution of current between the two. One or both of the tubes may be damaged in such a case.

It is wise to avoid operating a set with the yoke disconnected. In some receivers, removal of the yoke removes too much of the horizontal amplifier's load; the resultant excessive screen current may damage the tube (as well as its screen voltage-dropping resistor).

Cautions on high-voltage rectifiers

Premature failure of the high-voltage rectifier tube may be attributed to three common causes: (1) short life due to arc-over between filament and plate; (2) failures due to arcing caused by improper lead dress; (3) premature burnouts caused by excessive filament voltage.

The miniature 1X2 (used in older sets) is perhaps more prone to internal arc-over than other commonly used high-voltage rectifier tubes. This is so because it has a relatively small peak inverse voltage rating—approximately 15,000. During the portion of the cycle when the plate is negative with respect to the filament, the plate may start thinking it was really meant to be a cathode. If the voltage difference present between plate and filament at this time exceeds the peak inverse voltage rating of the tube, plate and filament reverse roles and a breakdown of the tube results (since current flows during *both* halves of the cycle, instead of only one half, causing the current capabilities of the tube to be exceeded). Replacement of the 1X2 with a 1X2-A or

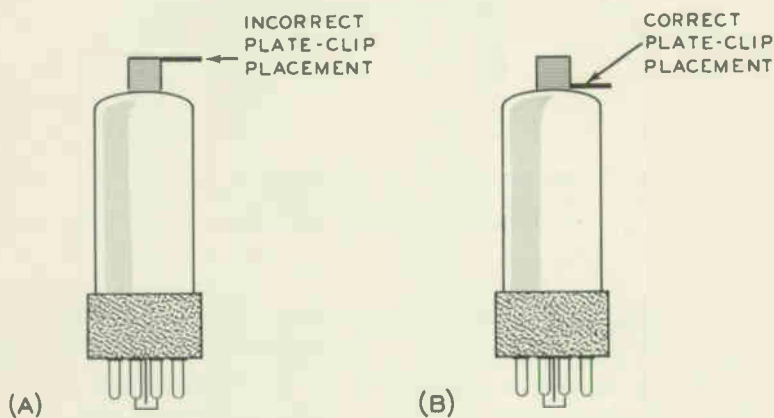

Fig. 206. In receivers where the top of the high-voltage cage is close to the plate clip of the 1B3-GT rectifier, improper placement of the plate clip may be the cause of corona or arcing.

1X2-B which have peak inverse voltage ratings of 18,000 and 22,000 volts, respectively, offers a solution to the problem.

Improper dress of high-voltage rectifier filament leads may cause arcs between filament wiring and chassis or filament and some other wiring, causing excessive current to flow through the tube and thus reducing its life. Avoid disturbing the existing lead dress when making tube checks or replacements, to prevent the introduction of such arcing. Be particularly careful when replacing a subminiature type high-voltage tube which necessitates a soldering and unsoldering operation. In the case of frequent high-voltage rectifier burnouts, consult the manufacturer's service notes for data regarding proper lead dress as well as other infor-

mation that may prove helpful in tracking down the source of trouble.

In general, filament leads of the high-voltage rectifier should be dressed away from the horizontal output transformer proper as well as adjacent wiring and ground points. If necessary, use coil dope to keep the leads in place. Keep all high-voltage rectifier leads away from hot tubes and resistors to prevent deterioration of the leads; such deterioration may lead to arcing and premature failure of the rectifier.

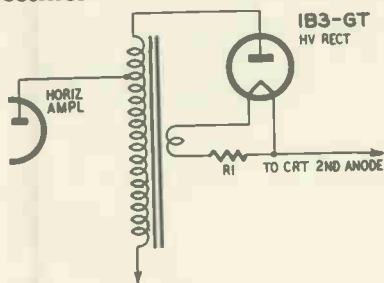

Fig. 207. Portion of high-voltage rectifier circuit, showing location of the filament-dropping resistor (R1).

In cases where the top of the high-voltage cage is very close to the plate cap of the rectifier tube, it is possible to introduce arcing and corona by improper placement of the high-voltage anode clip (Fig. 206). In such "low-bridge" cases, make sure the placement of the clip puts the maximum distance between the grounded cage top and the wire leading to the clip.

When frequent rectifier burnouts occur, check the set for evidence of arcing after the rectifier has been replaced. Replacement of the filament leads, as well as any protective tubing used over them, is recommended when arcing between these leads and other wiring or ground has taken place.

Excessive filament voltage of the high-voltage rectifier is rather difficult to detect since it cannot be measured directly. The voltage across the filament is usually 1.25, but the voltage between either filament pin and chassis is measured in kilovolts. Check the value of the resistor in series with the filament (see R1 in Fig. 207) when frequent rectifier burnout is the complaint. If the resistor has decreased as much as 1 ohm in value (compared to the value specified in the set schematic) replace it with a unit of the correct resistance.

When the line voltage is high in the set owner's location and frequent rectifier burnouts occur, the series-filament resistor can be increased in value to reduce the excessive filament voltage that is probably present. If the filament voltage is reduced too much, of course, the high voltage will be lowered to a level where good set performance is not obtained.

If no filament resistor is present, try inserting a 1.2-ohm $\frac{1}{2}$ -watt resistor in series with the high-voltage rectifier filament. Connect one side of the resistor to the filament socket contact point, the other end to an unused socket contact. Keep the resistor pigtailed

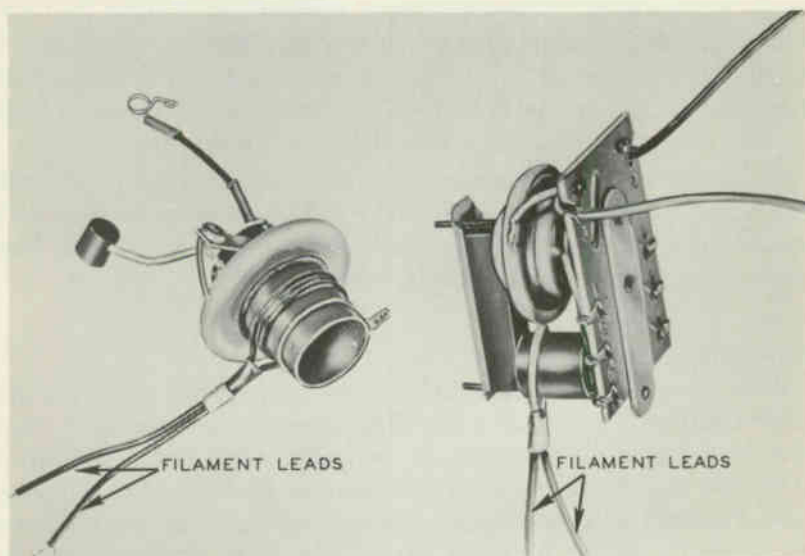

Fig. 208. Photos of flyback units, showing number and position of filament windings. One or two turns may be used, depending on the filament voltage requirements and the construction of the flyback transformer.

short and avoid sharp points on both the wire and the soldered connections to prevent corona. The resistor should be dressed close to the socket.

A shift in the coupling of the high-voltage rectifier filament winding on the flyback transformer may be the source of frequent tube burnouts (Fig. 208). If a similar flyback is present in another receiver, a comparison can be made to verify whether such a shift has occurred. If it has, the filament winding may be moved a short distance—perhaps $\frac{3}{16}$ inch or thereabouts—away from the high-voltage winding on the transformer. If set performance remains satisfactory, the winding may be left in this position.

Insufficient as well as excessive filament voltage may reduce

the life of the high-voltage rectifier. When premature rectifier burnouts are associated with symptoms that indicate the presence of reduced high voltage and no other trouble can be found, the series filament resistor should (if present) be reduced to perhaps half its value. (Shunt the resistor with one of equal value.) This kind of trouble occurs particularly in low-line-voltage locations.

Caution must be observed in the choice of a 1B3-GT as a replacement. All 1B3-GT's, with the exception of some early-make G-E tubes, have a "floating" or unconnected No. 5 pin. In the G-E tubes referred to, pins 5 and 7 are internally connected. Since the filament voltage-dropping resistor often used in high-voltage rectifier circuits may be connected between pins 5 and 7 on the socket, use of one of these early-make G-E tubes may short the filament resistor and increase the filament voltage applied to the rectifier, thus reducing the latter's life.

To avoid such developments, check for continuity between pins 5 and 7 if a possibly early-make G-E tube is to be used as a replacement. If continuity is read, clip pin 5 off at the base before using the tube as a replacement.

Protecting C-R tubes

Before replacing a defective picture tube, make sure that the conditions which damaged the first tube are not present; they may injure the replacement as well. Be particularly careful to check the dc voltage between cathode and filament of the picture tube. Presence of an excessive voltage between these two elements can produce arcing between them. The heat produced by the arcing may either cause the heater to burn out or to short to the cathode. The manufacturer's service data will indicate the correct heater-to-cathode (or heater-to-ground, and cathode-to-ground) voltage. Arcing is most likely to occur where a tube with an abnormally low heater-to-cathode breakdown potential is used. (When a set schematic is unavailable, data regarding a C-R tube's maximum permissible heater-to-cathode voltage may be found in a tube manual.)

When the tube filaments are connected into a series-filament hookup and the heater is found open, the schematic of the set should be studied with care and efforts made to determine whether a short in any tube, or some other component defect, could have resulted in the blowing of the C-R tube's filament.

A mechanical source of danger to the picture tube in some sets is the back panel of the receiver. If care is not used in the removal

of this panel, it may fall on the neck of the tube, damaging or breaking it.

Tube damage due to grid emission

When a vacuum tube is evacuated during manufacture, a small amount of cathode-emitting material is sometimes unintentionally splashed onto the grid. The grid can, in consequence, emit electrons (like a cathode) if it should become hot enough during operation. Since the spacing between grid and cathode in a number of tubes is very small, excessive heater voltage or cathode current can cause enough heat to be generated and transferred from cathode to grid to cause grid emission. A positive voltage is produced between grid and ground as a result of such emission, lowering the bias. The reduced bias tends to cause increased cathode current and greater heating of the grid, promoting a greater degree of grid emission. This cumulative effect may quickly destroy the tube in some cases. In other instances, considerable damage to other tubes and components may occur due to the large current generated. The tube affected could lose all its emission; a rectifier tube through which a large current flows, due to the positive biasing of the grid-emitting tube, may suffer a loss in emission; plate and screen resistors may burn out, etc. The larger the grid-to-ground resistance present in the tube affected, the more severe the grid-emission effect will be.

In a power output tube, the relatively large amount of heat generated during normal operation is particularly likely to promote grid emission. The heavy current produced when grid emission occurs tends to cause liberation of gases from overheated elements. The consequent bombardment of the cathode by the positive ions of gas may destroy the cathode.

Since grid emission is promoted by the presence of an excessive grid-to-ground resistance (such excessive resistance increases the positive voltage produced between grid and ground and thus steps up the rate at which the bias progressively becomes more positive), it is wise to check the grid resistance of any tube which seems to have suffered a premature failure of emission. When the normal value of a grid resistor is in excess of 100,000 ohms, such a check is particularly suitable. Replace any resistors which are substantially above their correct value.

Excessive heating of a tube may also be the cause of grid emission. Make sure that proper ventilation is not impeded by the flush positioning of a receiver against a wall, obstruction of vent holes, etc. To determine whether grid emission is present in a

tube, check its grid-to-ground voltage. If this voltage is positive or insufficiently negative with the tube in its socket and zero or adequately negative with the tube out, grid emission is probably present. Another way to check is to disconnect the coupling to the tube (leaving the tube in the circuit). If an originally positive or insufficiently negative grid-to-ground voltage is still present, grid emission in the tube is probably responsible. Grid emission

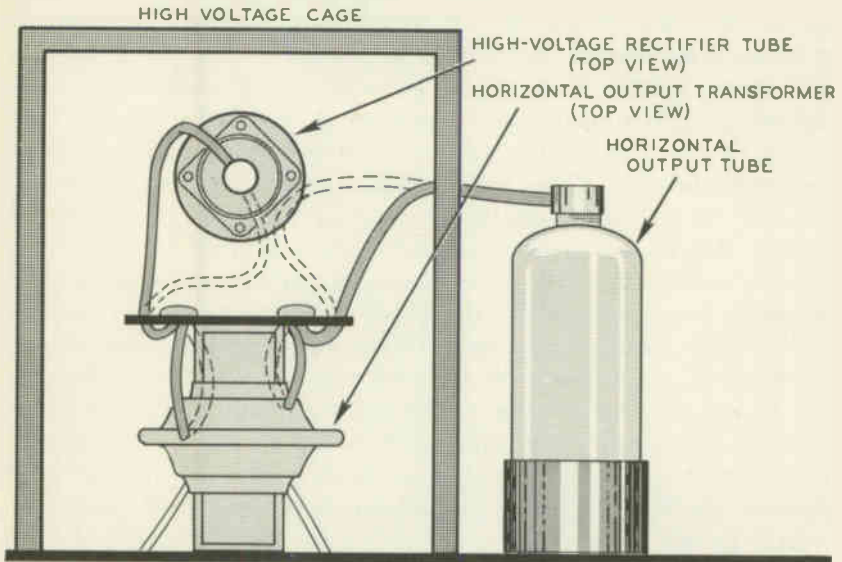

Fig. 209. Proper and improper lead dress in the high-voltage cage. Dotted lines indicate incorrect positioning of leads; high-voltage wires are too close to each other.

generally takes some time to develop. A final voltage test for it should therefore be delayed until the tube has been permitted to heat for an hour or more.

Premature tube failure due to leaky coupling capacitor

A positive grid-to-ground voltage produced by a leaky coupling capacitor not infrequently burns out the tube whose bias has been reduced. A test for this kind of trouble should be made when recurring burnouts (of tube cathodes) are a problem.

Miscellaneous sources of arc-caused damage to tube and components

Some sources of damage to tubes and components due to arcing have already been discussed. Such arcing may be unintentionally introduced by the disturbance or improper placement of lead

dress after a tube replacement in the high-voltage section (Fig. 209).

If the lead to the horizontal amplifier plate cap is incorrectly oriented and lies too close to a wall of the high-voltage cage, a severe undetected corona may cause the output tube to fail within several weeks. The presence of a shiny little circle on the

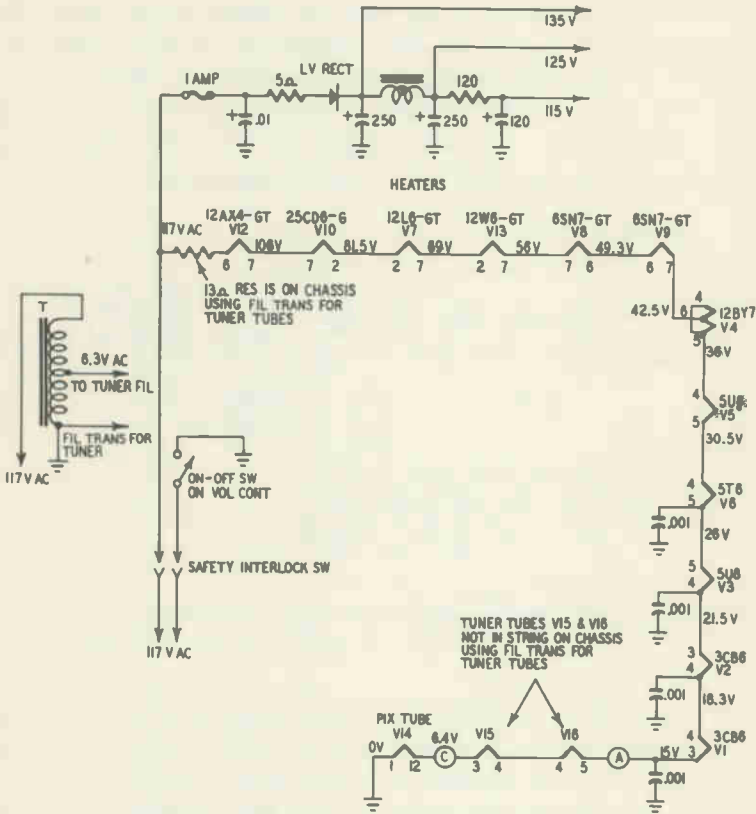

Fig. 210. Series-filament circuit employing only a single string of tubes.

section of the cage opposite the cap will indicate that corona has been (or still is) taking place. Improper dress of the high-voltage rectifier's filament leads may result in arcing that ruins the flyback transformer. Sometimes arcing between the high-voltage rectifier plate cap and the damper tube will occur if the two are in too close proximity, causing destruction of the damper tube. In cases where the damper is a 6W4-GT, substitution of a 6W4-GT with a shorter-sized envelope may minimize the possibility of such arcing.

Series-filament circuits

There are a number of facts about series-filament circuits (Figs. 210, 211) that the technician should know to minimize the possibility of damage in servicing tubes connected in this way.

A primary caution: never remove a tube from a series-filament string while the receiver is in operation. In the first place, the filaments of other tubes in series with the absentee will often be open-circuited with respect to their source of voltage, rendering the receiver inoperative or improperly operative, thus making whatever test was intended valueless. More important, excessive filament voltage may (in some types of filament circuit) be imposed on one or more tubes, possibly damaging them. The

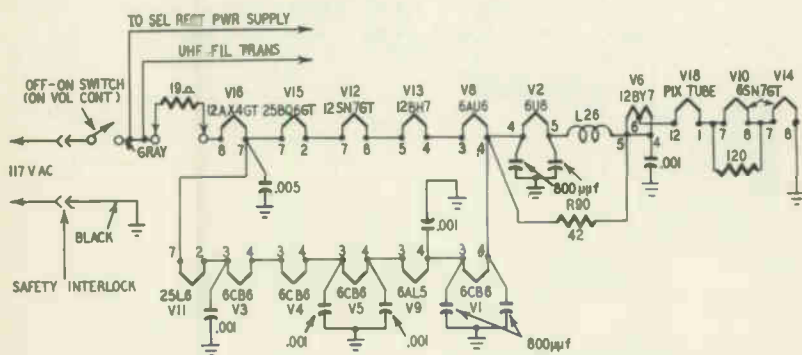

Fig. 211. Series-filament circuit in which two strings of tubes are in parallel. The two parallel strings are in series with a third group of filaments.

possibility of failure of tubes for other reasons is increased as well. If a resistor (R) is in shunt with the tube that has been removed (Fig. 212), the resistor will overheat since an excessive voltage will now be present across it; in a few seconds, it may be permanently damaged.

For similar reasons, switching on a series-filament set from which one or more tubes are absent may prove very detrimental to one or more tubes and should be avoided. Set owners should be cautioned not to leave a set of this type on when it has developed trouble, to avoid increasing the extent of the damage present.

When a tube is replaced in a series-filament receiver, a check of the schematic or the set itself is advisable to determine whether a resistor is present across the tube filament. If there is, the resistor should be checked for an open circuit. If the tube is replaced

without a test being made (and an open resistor is present across the filament) the tube filament will probably burn out.

It is recommended that no defective tube be replaced before the schematic is studied and consideration given to the possibility that a defect in some other tube could have blown the first one out. Here are some of the ways in which a defect in one tube can cause damage to others:

A heater-to-cathode short in one tube can, by bypassing ac voltage from several others, increase the filament voltages on the remaining tubes in the string, injuring one or more of them.

Failure of the filament in a tube which is in a series with the damper will cause the damper to become inoperative. The consequent removal of plate voltage from the horizontal output tube in many receivers will increase the screen current in this tube, tending to damage it, unless its filament voltage has been removed by the first-mentioned defect.

The horizontal output tube may also be damaged if a tube filament open-circuits in the series string in which the horizontal

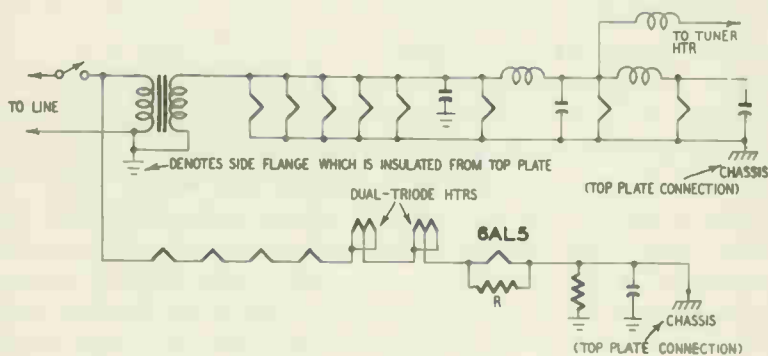

Fig. 212. Series-filament circuit in which a shunt resistor R is used across one of the tube filaments (6AL5).

oscillator filament is positioned. Drive (input signal) to the horizontal output tube is removed in such a case, and its plate dissipation may thus become excessive, damaging the tube. (It is assumed that the horizontal output tube is in a string separate from that of the horizontal oscillator and remains operative.)

The technician should become familiar with the characteristic glow of filaments used in series-filament circuits. That is, he should become familiar with the normal color of correctly lit filaments in various glass-envelope tubes. This knowledge will

enable him to spot more readily excessive or inadequate filament lighting, when such a condition develops.

One cause of excessive or inadequate filament voltage is a change in the value of a filament voltage-dropping resistor. The resistors used in TV sets are generally special temperature-sensitive units with a very low "hot" resistance and a high "cold" one. The function of such a resistor is to eliminate or minimize the filament surge voltages that occur when the receiver is first turned on. Such surges are damaging to the tube filaments.

For maximum accuracy, a temperature-sensitive resistor should be tested indirectly by measuring the voltage drop across it or the filament voltages of the tubes in series with it. When a unit of this type is found defective, obtain an *identical* replacement.

The life of tubes in series-filament circuits is inevitably less than that of tubes whose filaments are connected in straight parallel arrangements, due to the greater stresses imposed on the series-filament tubes. Some tubes are designed with a 450- or 600-milliamperere heater having a controlled warmup time. Such tubes require exact replacements.

Cautions on use of tube testers

When a tube is being tested in an emission type tester, the possibility of its being damaged by improper use of the tester must not be overlooked. In an emission test made in this type of tube checker, no grid control is present and nearly all of the electrons emitted from the cathode of the tube under test flow to the plate. This imposes a very heavy load on the cathode, comparable to the loading on a rectifier tube when a shorted filter is present. To avoid damage to the tube being checked, make the emission test as brief as possible—limit it to the time needed for the meter needle to reach the end of its swing. Leaving the emission button depressed for a longer time exposes the tube cathode (or filament cathode) to swift destruction, particularly when a battery-portable type tube is being tested.

Miniature tubes in which the spacing between elements is extremely close (the 6AK5, for instance) should not be subjected to a short test in a tube tester. During such a test, voltages are applied to the elements being checked; the resultant electrostatic attraction set up between the narrowly spaced elements tends to cause them to short-circuit. Use an ohmmeter to test for a short in such tubes or else try tube substitution.

tube troubles in tv

TUBE trouble can cause the raster to be missing, intermittent or slow in developing. Possible symptoms may be grouped as follows: (1) raster and sound both absent; (2) raster absent, sound normal; (3) raster absent, hum in sound; (4) intermittent raster; (5) excessive warmup time.

Localizing defective tube when raster and sound are absent

When both raster and sound are absent and the receiver's tubes light, the likeliest source of trouble is the low-voltage rectifier. Replace this tube (after first checking for a shorted filter) and note results. The same procedure is used when all glass tubes except the low-voltage rectifier are seen to light.

When a selenium rectifier is present, voltage, resistance and substitution tests will reveal whether a defect in this unit is killing raster and sound.

A shorted rectifier can kill both raster and sound by eliminating or greatly reducing B-supply voltages. This possibility can be checked by measuring the B-supply voltage. A fast check of the B voltage may be made, without removing the chassis from its cabinet, with the aid of a socket test adapter (Fig. 301). This unit makes underchassis socket contacts available *above* the chassis. If an adapter of this type is not at hand, withdraw one of the receiver tubes and measure the voltage between its plate or screen socket contact to ground. Make sure before trying this test that (1) the receiver does not have a series-filament hookup and (2)

removing the tube is not likely to cause overloading of other tubes or components. A good tube to remove for this test is a video if amplifier since its drain is relatively low and its removal is not, in most cases, likely to cause damage. In any case, make the voltage measurement as quickly as possible, then replace the tube. When determining into which socket contact to insert the "hot" voltmeter lead, keep in mind that the reckoning is counterclockwise from the top of the socket.

An alternate way to make a B-voltage check is to remove the video if tube, connect the exposed end of an insulated piece of wire to its plate or screen pin, then reinsert the tube into its



Fig. 301. Test adapter for making above-chassis voltage checks. Adapters for seven- and nine-pin miniature tubes are commercially available.

socket. A top-chassis check of the plate or screen voltage can be made by measuring between the exposed open end of the wire and chassis (or B minus). Be careful not to short the exposed end of the wire to chassis.

If it is found that the B voltage is very low or absent, a top-chassis resistance measurement may be taken from the rectifier filament. (It is assumed that a home service call is being made and that the technician wants to remedy any tube fault right there.) If a short reading is obtained, remove the various tubes in the set one at a time, leaving the ohmmeter connected between the rectifier filament and ground. When removal of one particular tube eliminates the short, that tube is defective.

If the B voltage is low, no short readings are obtained, ac plate voltages on the rectifier are ok (as determined by a top-chassis voltage check) and replacement of the rectifier tube does not cure the trouble, try withdrawing tubes one at a time while monitoring the plate or screen voltage at the socket of a video if tube. (This test is not, of course, to be made on a series-filament receiver.) The tubes should be lifted out of their sockets and kept only a short distance away to facilitate quick reinsertion. Don't leave any tube—particularly the horizontal oscillator—out of its socket for more than an instant to prevent damage to tubes or components. When withdrawal of any tube returns the B voltage to normal, that tube

damper is normally substituted only if the raster alone is absent.

In a series-filament receiver, the open-circuiting of any tube filament that happens to be in series with both a horizontal circuit and sound tube will kill both raster and sound.

Raster absent, sound normal

When sound is normal but the raster is missing, the following procedures may be used to localize any tube trouble present.

Note whether any horizontal sweep circuit tube, the high-voltage rectifier or the cathode-ray tube is unlit. (In the case of the high-voltage rectifier, it may not always be possible to determine by inspection if the filament is lit or not since the filament's voltage is only 1.25 or thereabouts and its lighting is barely visible in the best of circumstances.) Replace any unlit tube and note results.

In the case of a series-parallel filament setup when one or more tubes are seen to be unlit, determine (by inspection of the set schematic) in what string an unlit tube is present, then resistance-check the tube filaments in that string.

If the picture tube is unlit, the trouble may lie in either the tube filament or the filament supply voltage source. To localize the trouble further test the filament supply voltage at the socket of the tube with the tube out. If the proper filament voltage is present, a defect in the picture tube filament is indicated. Sometimes loose filament connections in the base prongs are the source of the trouble; resoldering them is a good way to test for, as well as correct, such a fault.

When filament voltage is absent, a short in some tube other than the cathode-ray tube may be responsible (Fig. 303). In certain TV sets, the filament of the picture tube is in parallel with that of the damper. A short in either tube may eliminate filament voltage in both. Try a new damper, in sets of this kind, when the picture-tube filament does not light. In the case of series-filament receivers, trouble in any tube filament in series with that of the picture tube can eliminate its filament lighting; check for the presence of such a defect when receivers of this kind are being worked on.

When the receiver's tube filaments are seen to light normally, check the high voltage present at the C-R tube anode with a high-voltage probe and voltmeter or—if no fancier and safer test can be made—by holding the anode connector close to the receptacle on the tube and noting whether a spark is obtained. (Sparking the connector to chassis is not recommended even though many

technicians resort to this procedure. It is possible to blow the high-voltage fuse—if one is present—or damage components in the high-voltage circuits when a fuse is absent.) Some experience is necessary to determine whether the strength of the spark indicates an adequate amount of high voltage.

If a normal spark is obtained at the anode and no raster is present, the ion magnet may be improperly set or defective, the tube's bias may be excessive or the tube may be defective.

The first check that seems logical is a test of the ion magnet. When readjustment of this unit (preferably in a darkened room) is ineffective in producing a raster, a dc voltage check between the picture-tube control grid and cathode is the next logical procedure. (Make sure to keep the brightness setting low after the

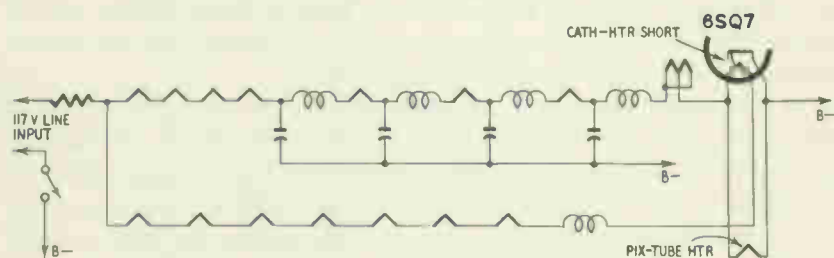

Fig. 303. Filament circuit of a typical TV chassis. A filament-cathode short in the 6SQ7 can shunt the filament current to ground before it passes through the picture tube, causing the cathode-ray tube to remain unlit.

ion-magnet adjustment has been checked since the magnet may not have been returned to its proper setting. Damage to the tube can result if the brightness setting is high and the ion-magnet setting is incorrect.)

If the grid-to-cathode voltage cannot be reduced to zero or to a few volts negative by manipulation of the brightness control, but remains excessively negative at all times, a defective tube may be the cause of the trouble in some cases. In a receiver in which direct coupling between the video amplifier and picture tube is used (Fig. 304), a defective video amplifier may cause an excessive picture-tube bias to be developed, blanking out the raster. Try replacing the video amplifier to check on this source of trouble.

A strong negative bias may indicate overloading due to excessive signal input. Try switching to an unused channel to check on this possibility. If the raster reappears, overloading of this kind is definitely indicated. A defective agc tube (or circuit) may be the cause of the symptoms. Substitution of a new agc tube will determine whether the original one is defective.

If the picture-tube bias is normal, the ion magnet has been absolved of blame and the high voltage applied to the tube seems OK, loss of emission is generally indicated. Use of a C-R tube checker will quickly determine whether the tube is defective in emission. When a C-R-tube tester is not available, the tube will have to be tested by the more laborious process of substitution of a known good tube or the use of a universal picture tube. (See the last page of Chapter 7.)

A corroded or poor contact in the picture-tube anode connection may be responsible for the loss of the raster. To check on this possibility, run a length of high-voltage wire from the anode receptacle to the old anode connector. Attach the end of the wire (or new connector) firmly to the old connector. If a wire is used, it will have to be held in position to keep it from falling out of the receptacle. If the raster is restored by this setup, the old anode connector should be repaired or replaced.

If no satisfactory spark was obtained at the anode connection of the picture tube, the metallic edge of an insulated screwdriver should be brought near the plate clip of the high-voltage rectifier. If an arc is seen to jump across to the screwdriver blade, normal operation of all tubes up to, but not including, the high-voltage rectifier, is indicated and substitution of a new rectifier called for.

If no spark or a very weak spark is noted in this test, remove the plate clip to the rectifier and see whether bringing the screwdriver near the disconnected clip will now cause an arc to be drawn (make sure the clip is not permitted to touch ground). If an arc is drawn, a shorted high-voltage rectifier tube may be present.

If no or little high voltage is present at the picture-tube anode and little or no spark is noted at the plate clip of the high-voltage rectifier, test for a purple (ac) spark at the plate cap of the horizontal amplifier. Presence of such a spark here and its absence at the plate of the high-voltage rectifier indicate a circuit defect between the two points. If little or no spark or only a blue dc spark is noted at the plate cap of the horizontal amplifier, check the horizontal oscillator and amplifier tubes by substitution.

It is preferable to replace the horizontal oscillator and amplifier tubes at the same time rather than in succession. This is so because a bad horizontal oscillator tube may have caused the horizontal output tube to become defective as well. If a new oscillator is substituted and the output tube is dead, the service technician may temporarily arrive at the false conclusion that the oscillator is not defective since its replacement did not restore receiver operation to normal.

Next, the damper tube, as well as any other tubes present in the horizontal circuits, may be successively checked by substitution, and results noted. A defective afc tube may, in some instances, make the horizontal oscillator tube inoperative and kill the high voltage; a substitution test of this tube is therefore suggested, along with the other tube substitutions, when a no-raster condition is being serviced.

If an insulated plate cap is present on the horizontal output tube, the spark test previously described cannot readily be made. In such a case, listen for the characteristic high-pitched sound generated by the horizontal sweep signal. This whistling sound

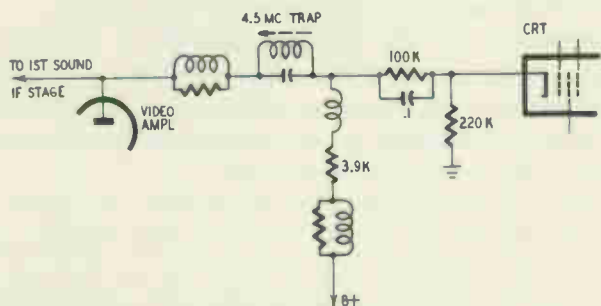

Fig. 304. Direct coupling between video amplifier and cathode-ray tube. Loss of emission in the video amplifier will increase the cathode voltage of the tube, possibly increasing its bias to cutoff in some cases.

may be more readily detected if its pitch is changed by varying the horizontal hold control. Presence of this characteristic sound indicates that all tubes and components as far as the plate winding of the horizontal amplifier are operating; it also eliminates the possibility of a short in the high-voltage rectifier tube.

The presence of visible arcing will eliminate the need for the sequence of tests just described. Such arcing can, by eliminating the high voltage, cause the raster to disappear.

Raster absent, hum in sound

In some receivers using a filament circuit setup such as the one shown in Fig. 303, a cathode-to-heater short in the first audio tube will eliminate filament voltage from the picture tube and kill the raster. The short will also eliminate the sound signal, leaving only a hum audible. If, in sets of this type, raster and desired sound are missing, hum is audible and the picture tube is unlit, try another first audio tube.

Intermittent raster

An intermittently disappearing raster, with sound normal, is often produced by dirt on the picture tube prongs, a loose connection at one of its pins or a defective socket contact.

Oxidized contacts in the picture-tube socket are often the cause of intermittent filament lighting. To test for such trouble, remove the tube, insert ac voltmeter test leads into the filament socket contacts from above the socket, then tap the socket from various angles. Make sure the tapping does not interrupt the contact of the test leads with the socket. If the filament-voltage reading varies or becomes intermittent, a socket replacement is called for. Repair of a socket is often ineffectual and is not recommended.

Loose connections in the filament prongs of a high-voltage rectifier tube may be the cause of an intermittent raster. Resoldering these pins will test for, as well as eliminate, this possible source of trouble. Such a resoldering job is especially recommended when the soldering at the prong end looks poor.

Disappearance of the raster after the receiver has been on an hour or so may be due to an air leak in a high-voltage rectifier tube. The glass in such tubes can deteriorate, partly because the high peak inverse voltage that develops between cathode and plate subjects the glass to bombardment by high-velocity electrons. If a tube envelope has suffered such disintegration, air can leak into the tube, killing the high voltage. The amount of air leakage is very small and may be effective only when the tube has reached full operating temperature. To test for such a defect when the complaint is a raster that disappears after an hour or so of set operation, replace the high-voltage rectifier tube and note results.

Excessive warmup time

TV receiver warmup time, or the time it takes for satisfactory picture and sound to be received, is generally 30 seconds or less. In some cases, it takes considerably longer for raster and picture to develop. Possible sources of such trouble may be:

1. *Reduced emission in the low-voltage rectifier.* This is especially likely if the sound is slow in reaching its maximum volume.
2. *Slow-heating horizontal output tube.* 6BQ6-GT (6BQ6-GTB/6CU6) type tubes in particular are likely to have heaters that take an undue length of time to become fully warmed.
3. *Defective damper tube.* Sometimes slow-heating damper and horizontal output tubes are jointly responsible for the symptoms present. To detect such double trouble, time the warmup interval before and after replacing one tube. If the time has decreased but

is still excessive when one of these tubes has been replaced, try replacing the other. Other pairs of tubes may (among the ones listed) also act as double sources of delayed warmup and should be checked along similar lines.

4. *Poor connection between the internal plate lead and plate cap of the horizontal output tube.* Reheating the cap with a soldering iron will test for, as well as correct, this kind of trouble. A successful repair of this type will save the cost of a tube replacement.

5. *Defect in the C-R tube.* In such instances, not only will the raster take a long time to appear—the picture contrast may not become maximum for some time as well. The picture in a set



Fig. 305. Photo of test pattern indicates insufficient width.

having slow heaters usually has a silvery, three-dimensional appearance.

Size, linearity and brightness troubles

Size, linearity and brightness troubles probably make up the most common group of TV defects. They may be arranged, on the basis of symptoms, into these categories: (1) insufficient width; (2) vertical deflection absent; (3) insufficient height; (4) vertical shrinking or gradual decrease in height; (5) vertical nonlinearity; (6) horizontal nonlinearity; (7) insufficient brightness; (8) excessive brightness.

Insufficient width due to tube troubles

Insufficient width (Fig. 305) may be due to a weak damper, horizontal output tube or low-voltage rectifier. When the rectifier is weak, other symptoms will generally (but not always) be mani-

fest, such as reduced height, lessened contrast, etc. Reduced width may also be produced by lowered emission in a horizontal oscillator tube. A reduction in high voltage will generally be associated with the reduction in width produced by defects in horizontal circuit and low-voltage rectifier tubes; such a loss in high voltage may, however, be too small to produce noticeable symptoms because of the reserves of brightness available.

In series-filament receivers, any defect that tends to reduce the filament voltage of a horizontal circuit tube may reduce the width. Cathode-to-heater leakage in a tube or a defective ballast tube (when one is used in the set) are examples of defects that may reduce width by decreasing filament voltage on one or more tubes.

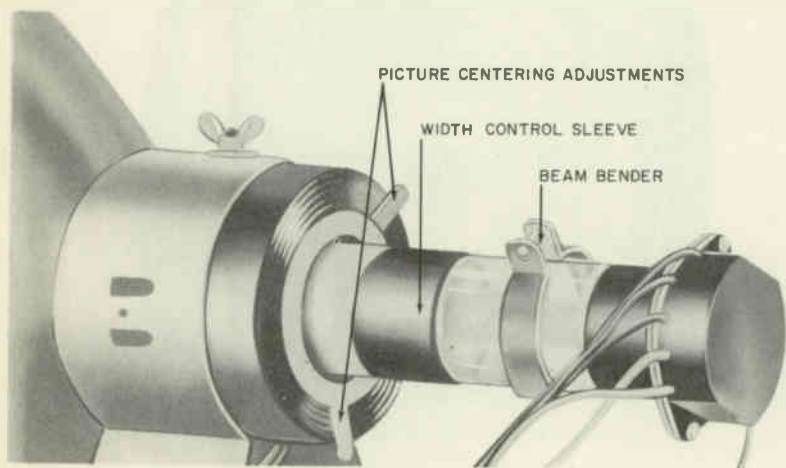

Fig. 306. Sleeve made of brass or aluminum can be used as a width control.

Certain makes of tube, particularly types used as horizontal amplifiers, may not perform as well as others. If the efficiency of the circuit is somewhat below normal and the line voltage available is also below normal, replacement of an old tube with an inferior-make new one may not result in satisfactory width. Try several makes of tube under such circumstances.

Where reduced line voltage is responsible for insufficient width, it may be possible to replace the low-voltage rectifier present with a more efficient one; for instance, a 5V4-G may be used to replace a 5Y3-GT. The service technician must make sure, however, that the increased supply voltages will not damage various components. Before making such a substitution, it is best to check with the set manufacturer or his local distributor's service department.

A rather peculiar and hard-to-find source of insufficient width may develop in receivers where the B boost voltage is used to feed the vertical as well as the horizontal amplifier. The trouble referred to is a defective vertical amplifier tube. The defect (grid emission or excessive gas) produces an excessive flow of plate current in the vertical amplifier and thus imposes a very high drain on the B boost line. The boost voltage is lowered in consequence, reducing width but not necessarily height. Enough reserve height

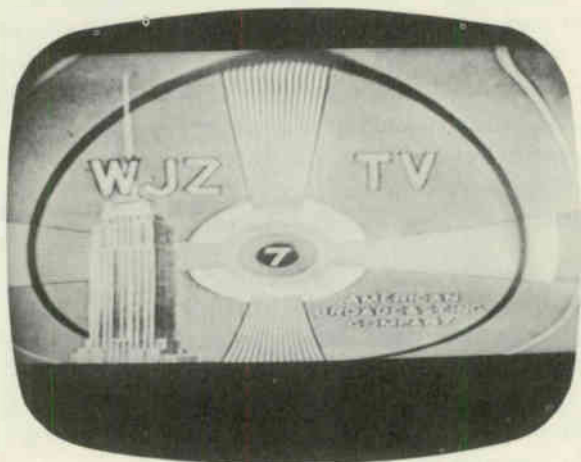

Fig. 307. Photo shows insufficient height.

is present in most sets to make a relatively slight reduction in vertical amplifier output unnoticeable; the same reduction in efficiency may, however, have a marked effect on width.

In some receivers a brass or aluminum sleeve is used on the picture-tube neck for adjusting width (Fig. 306). Improper setting of this sleeve may be responsible for a slight loss in width.

Vertical deflection absent

When a horizontal line alone is seen on the picture tube, the usual cause of the trouble is a faulty vertical oscillator or amplifier tube. (It is assumed vertical height and linearity adjustments are correct.)

Insufficient height

When insufficient height is the complaint (Fig. 307) either the vertical oscillator or vertical amplifier tube may be responsible. If height and vertical linearity adjustments do not restore the height to normal, replace these tubes. If replacement one at a time does not eliminate symptoms, try replacing both tubes simul-

taneously, since both may be defective. The vertical amplifier is more likely to be the source of insufficient height than the vertical oscillator and should be replaced first. An intermittent collapse or reduction of vertical size will sometimes occur in sets using a double-triode tube as a joint vertical oscillator and amplifier.

Vertical shrinking

A creeping or gradual loss of vertical size sometimes occurs in television receivers. The size loss may total approximately $1\frac{1}{2}$ to $1\frac{1}{2}$ inches and the time taken for maximum shrinkage to occur may be 1 to 3 hours. The source of such trouble often lies in a weak vertical oscillator or amplifier, a weak low-voltage rectifier or a weak horizontal output or damper tube (in cases where the vertical amplifier is fed from the B boost line).

When a decrease in line voltage is responsible for the shrinking, use of a more efficient vertical output tube may eliminate the symptoms.

Increasing height by tube substitution

Where an "extra ounce" of height is needed or when adequate height without foldover cannot be obtained, it may be possible to achieve a quick remedy by a judicious tube substitution when a home service call is being made and the customer is not willing to stand the expense of a shop repair.

A 6K6-GT may be replaced by a 6W6-GT, 6V6-GT or 6Y6-G, a 6BL7-GT by a 6SN7-GTB, and a 12BH7-A by a 12AU7. Since the new tube will often draw a larger filament current, such substitutions are not feasible when (1) the tube to be replaced lies in a series-filament circuit or (2) the power transformer will not take the increased filament drain.

To test the power transformer's capabilities, operate the set for 5 minutes or more first with the old tube in the circuit and then with the new one, feeling the transformer in each case. If the transformer runs much warmer with the new tube don't make the substitution. Another way to check on the feasibility of the substitution is to ask the set manufacturer or one of his distributors about the transformer's ability to handle the increased current.

When both height and width are inadequate (Fig. 308) and height and width adjustments do not restore raster size to normal, try a new low-voltage rectifier. Such a substitution is particularly indicated if there is an accompanying reduction in sound volume or insufficient contrast or if the focus control achieves or approaches proper focus only at one end of its range.

A defective damper or horizontal or vertical output tube may reduce both height and width in receivers where the vertical amplifier is fed from the B boost line.

Vertical nonlinearity

Before troubleshooting sources of vertical nonlinearity, the technician must sometimes make sure that it is actually present. When a test pattern is not being transmitted (which is most of the time) and some uncertainty exists whether vertical nonlinearity is present, a fast check may be made as follows: Move the vertical hold control to a setting at which the picture moves slowly downward. Now observe the width or thickness of the vertical blanking bar (Fig. 309). This is the thick, black *horizontal* bar that normally appears at the bottom of the picture, where it is largely out of sight under ordinary conditions. Note whether the thickness of the bar changes as it moves down the face of the tube. If it does, vertical linearity is imperfect.

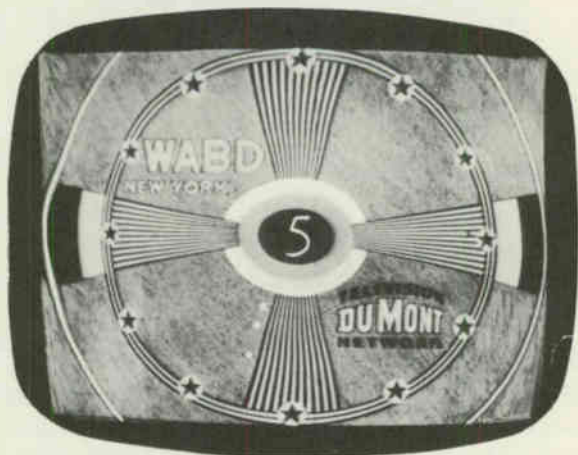

Fig. 308. *The test pattern is pulled in. The photo shows inadequate width and height.*

Vertical linearity is obviously improper when a horizontal bar appears at the top or bottom of the raster and picture. This bar is a horizontal strip that appears brighter than the rest of the raster when the latter is inspected with the contrast setting reduced to zero. The condition is often characterized as vertical foldover. While this label is not really accurate, its use is widespread. The likeliest tube sources of the trouble are the vertical oscillator and amplifier. A weak low-voltage rectifier may also be the cause of vertical nonlinearity.

When the line voltage rises above or drops below its normal level, vertical foldover may appear in some cases. Replacement of the vertical output tube is suggested to clear up such a condition. The efficiency of the vertical output tube is often critical in the presence of line-voltage changes. Since considerable variation is present in the tubes made by different manufacturers, several makes of tube may have to be tried before a satisfactory one—i.e., one that will provide adequate height without foldover in the

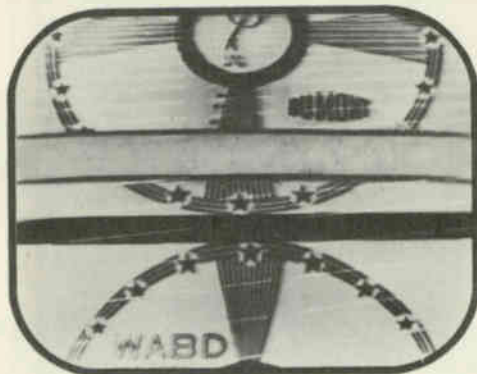

Fig. 309. The vertical blanking bar can be examined by adjustment of the vertical-hold control.

presence of above- or below-normal line voltage—is found. Vertical foldover may sometimes be traced to reduced emission in the horizontal output or damper tube in receivers where the vertical amplifier is fed from the B boost line.

Horizontal nonlinearity

When the picture is not properly proportioned in the horizontal direction, horizontal nonlinearity is indicated. One or more vertical white lines are often associated with such nonlinearity. Width and/or brightness may be below normal.

Possible tube sources of such trouble include the horizontal amplifier, damper, horizontal oscillator and discharge tubes. These should be tested by substitution (after horizontal drive, width and linearity adjustments have been tried).

Other symptoms of horizontal nonlinearity include horizontal stretching of picture elements and/or excessive brightness at the left side of the picture, possibly caused by a defective horizontal output, damper or low-voltage rectifier and wrinkles at the left side of the picture (frequently caused by a defective damper). Poor horizontal nonlinearity may, in some instances, be due to an

improper setting of the ion magnet. Check this by readjustment of the magnet when likelier sources of the trouble have been eliminated.

Insufficient brightness

The most common cause of insufficient brightness (assuming that the horizontal drive setting is correct) is, perhaps, a reduction in emission of the high-voltage rectifier. Replace the tube to test for this source of trouble. Such a replacement is particularly warranted if the picture size increases greatly while its brightness goes down when the brightness setting is advanced. This condition—blooming—may also be noted when the contrast setting is increased. The damper and horizontal output tubes (as well as the high-voltage rectifier) are possible sources of such trouble.

In some cases, a gassy vertical output tube which is fed from the B boost line will cause reduced brightness by causing the B boost voltage to be lowered (due to the heavy drain imposed on the line by the gassy tube).

A loss of emission in any tube in the horizontal sweep circuits may be the cause of insufficient brightness. So can a low-voltage rectifier whose emission has dropped.

Improper setting of the ion magnet may be responsible for reduced brightness. Or the magnet may be defective. Sometimes the magnet's effectiveness is reduced by the presence of metal filings on it; such filings effectively short-circuit the magnetic field. Remove the metal particles with a magnetized screwdriver to correct this kind of trouble.

In some sets using a picture-tube accessory known as a *magnetic shield ring*, brilliance will be reduced if this ring moves too close to the ion magnet (and thus shunts it). A shield of this kind should be approximately $\frac{3}{4}$ inch away from the ion magnet.

A relatively slight loss in brightness may be due to a dirty picture-tube face. Inspection will reveal this source of trouble. Clean the surface with a soft, damp cloth (use a soapy cloth if considerable dirt is present), then dry it. The safety glass may also be cleaned at this time.

Arcing or corona in the high-voltage section may be the cause of poor brightness. Such arcing will almost always be audible even if it isn't visible; listen for it in a silent room.

Unsuspected arcing at the picture-tube anode connection may lead to an incorrect condemnation of the tube as the cause of low brightness. Remove the rubber at the anode connector to determine if arcing exists. If arcing is neither visible nor audible, any

remaining suspicions regarding its presence may be checked by connecting a piece of high-voltage wire between the anode receptacle and the connector and noting whether the symptoms now disappear.

An accumulation of dirt around the anode receptacle may be causing corona here, reducing the high voltage and the brightness. If such corona is noted, wash the area around the receptacle gently but thoroughly with scouring powder, then dry it; this should eliminate the corona.

Corrosion in the plate clip of a horizontal amplifier tube may be the cause of reduced brightness. Check for such a defect by inspecting the clip; remedy it by removing the corrosion layer.

When no other source of insufficient brightness can be found—that is, when the high voltage at the anode connector seems normal, the tube's bias and other element voltages are normal and the ion magnet has been eliminated as a possible source of the trouble, the tube itself is probably faulty. A defective C-R tube is particularly indicated when a blue haze is seen in it.

Don't try a new picture tube without first inspecting the prongs of the old one and resoldering any that look in the least suspicious. Even if they don't look suspicious, it is worth while to resolder those going to tube elements; then recheck the brilliance. The cost of a new picture tube may be saved by such a procedure.

In some G-E sets using half of a double triode for vertical blanking, low picture brilliance accompanied by retrace lines in the picture at normal brightness settings can be due to a defect in this tube section.

Excessive brightness

When the raster brightness is excessive and the brightness control is unable to reduce it to zero, check the picture tube's cathode voltage. If this reading can be made to reach 60 to 100 volts positive with respect to the control grid (with the picture tube disconnected), then the tube is defective.

picture and sound troubles

IN every television receiver, without exception, picture and sound travel through identical paths in the front end, and in most receivers through a larger number of circuits. Since the sound takeoff is generally somewhere between the output of the video detector and the input to the picture tube, it isn't surprising that sound and picture troubles are often found together.

A knowledge of TV circuitry helps pinpoint troubles. Thus, if both sound and picture are defective or missing, the difficulty lies in a circuit handling *both* sound and picture. On the other hand, if sound is defective or missing but the picture is good, then trouble exists in a circuit that handles audio alone. Similarly, if the sound is good but the picture is defective, then the service technician should look at circuits handling video alone. This isn't a strict rule since there can be, and there are, exceptions. (Obviously, a defective low-voltage rectifier tube will kill both picture and sound.)

Many TV troubles can be placed in one of these categories, narrowing the search: 1) picture good, sound missing or defective. 2) sound good, picture missing or defective. 3) picture and sound missing, or defective.

Pix absent, sound and raster normal

When the picture is absent but sound and raster are normal, the source of trouble usually lies in a stage through which the picture—but not the sound signal—passes (Fig. 401). An important

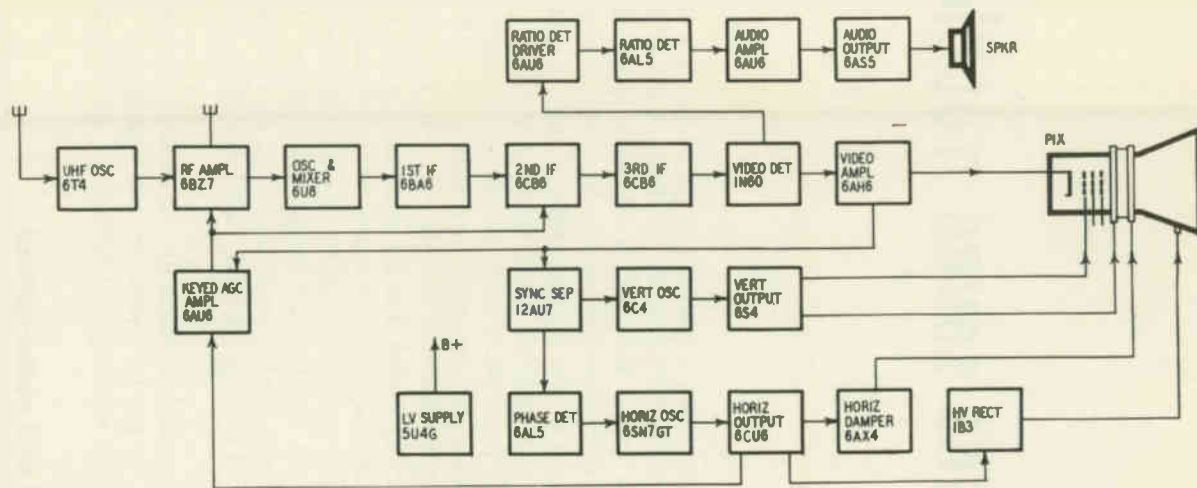

Fig. 401. Block diagram of a typical intercarrier receiver. A brief study of a receiver's block diagram (when the latter is available) is a valuable preliminary step to the localization of tube troubles in the receiver.

exception to this generalization is this: a defective video detector crystal may kill the picture signal but might permit the sound to get through.

When the picture is missing but sound and raster are normal in an intercarrier receiver, a defective video amplifier is likely if the sound is taken off at the video detector or the first of two video amplifiers. A cathode-to-grid short in the picture tube may also be the cause of the trouble. A defective agc tube may affect the picture much more than the sound, eliminating the first but permitting the second to remain.

Pix and sound absent, raster normal

When pix and sound are absent at all channel settings but the raster is normal, inspect the raster carefully with the contrast setting advanced. If a noise pattern (speckles, noise dots, etc.)



Fig. 402. How raster will look when sync pulses are not reaching the vertical oscillator. The vertical retrace lines will drift up and down, indicating that the vertical oscillator is free-running or uncontrolled.

is evident on the screen, trouble in the front end is indicated. Try replacing the front-end tubes one at a time (it is assumed that the possibility of antenna trouble has been eliminated by an indoor antenna substitution or some other test). Replace the rf oscillator first if a rushing sound is heard in the speaker—i.e., if the receiver's sensitivity to background noise is high.

If no noise pattern is seen on the screen, examine the vertical retrace lines on the raster. If these diagonal white lines jump up and down and will not remain stationary (Fig. 402), trouble in some stage preceding the sync takeoff point is indicated. Sync pulses are evidently not reaching the vertical oscillator and the retrace lines are unsynchronized.

If, on the other hand, the retrace lines *are* steady (Fig. 403), vertical sync pulses are generally getting through to the vertical oscillator. (Retrace lines can be steady due to residual hum.) The video signal must, in consequence, be reaching the sync takeoff point and trouble *after* this point is indicated. When a two-stage video amplifier is present in which the sync pulses are picked off

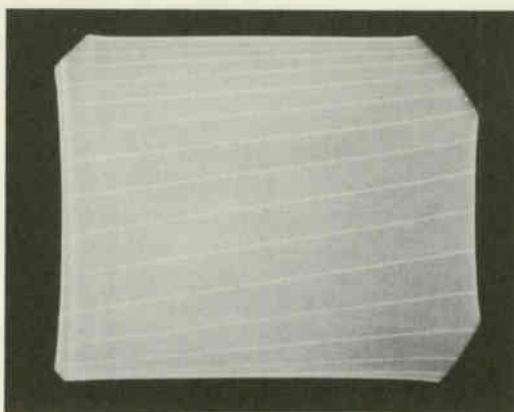

Fig. 403. What the raster will look like when sync pulses reach the vertical oscillator. The vertical retrace lines will be steady, provided the vertical hold control has been properly adjusted.

at the plate of the first video amplifier, trouble in the second video amplifier is indicated.

When both picture and sound are absent, it is advisable to inspect the set schematic to determine which stages are common to both picture and sound. In standard intercarrier receivers, pix and sound signals generally ride together as far as the video amplifier, sometimes only as far as the video detector. In at least one case the author knows of, however, the intercarrier sound signal is taken off in a video if stage. So it pays to take nothing for granted and to inspect the schematic.

In older receivers using split-carrier systems, the sound signal is taken off at the mixer or in one of the video if stages (Fig. 404). Substitute tubes (and crystals, if present) in stages common to pix and sound signals to localize the trouble to the unit at fault.

Sometimes a defective sound tube will kill pix as well as sound. The author has run into more than one split-carrier set where a dead first sound if tube resulted in the detuning of the mixer and caused both pix and sound to disappear.

In sets with stacked tubes a defective audio output tube may be the cause of no pix and sound (Fig. 405) if the video if and

other tubes derive their plate voltage primarily through this tube. In some instances, the raster may be affected by such a defect because the supply voltages to the sweep tubes may be changed.

In some receivers, bias voltage for the agc amplifier is derived from the audio output tube. A defect in this tube may conceivably increase the agc bias and kill pix and sound.

A defective agc tube may cause an excessive bias to be applied to front-end and if stages, killing pix and sound. Replace the tube or tubes present in the agc line to check.

In a circuit such as that shown in Fig. 406, a defective video amplifier may cause an excessive agc bias to be developed, elim-

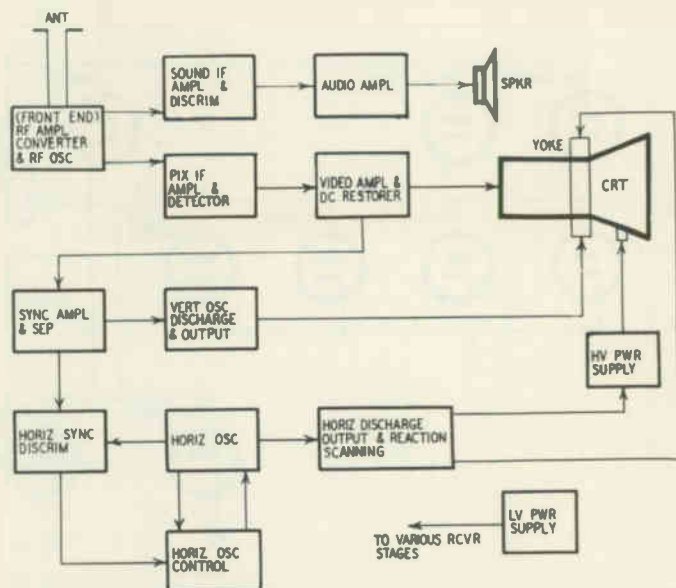

Fig. 404. Block diagram of the older type split-carrier receiver. The sound signal is taken off at the converter.

inating picture and sound. Since the video amplifier is not common to the sound and video signals in this split-carrier set, the technician would not ordinarily look in the video amplifier for a fault affecting both sound and pix.

A loss of emission in the low-voltage rectifier can, in the presence of low line voltage, cause the rf oscillator to stop operating, killing pix and sound without affecting the raster too noticeably.

Intermittent pix and sound

Intermittently disappearing picture and sound are frequently caused by an intermittent tube or loose tube-socket contacts.

Gently tap and wiggle the various tubes carrying pix and sound to locate the possible source of such troubles.

Pix and sound reception absent on some channels

When picture and sound are not received on some channels, try changing the oscillator tube. In some receivers, the oscillator

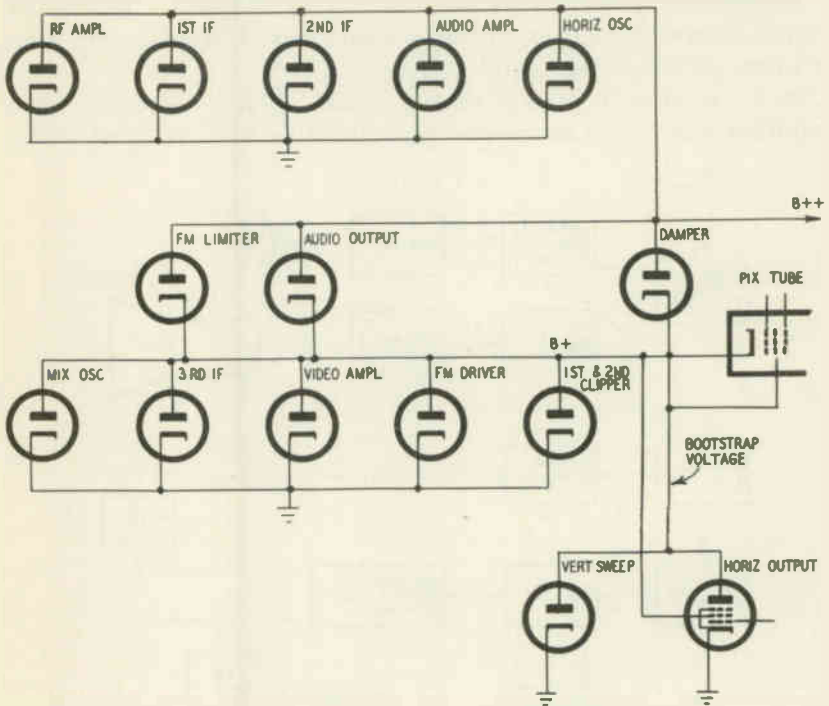

Fig. 405. Block diagram showing a tube-stacking arrangement. Failure of the audio output tube can decrease the B-plus voltages on the video signal carrying tubes with which the audio output tube is in series. Picture as well as sound can be lost.

circuit design does not provide much margin for aging of components or changes in line voltage. A relatively slight loss in emission in the oscillator tube may consequently cause reception on some channels to disappear. It may be necessary to try several oscillator tubes as substitutes before one is found that will restore satisfactory reception on all channels.

Substitution of the rf amplifier is also suggested when reception on some channels—particularly the high-frequency ones—is not obtained. Replace the first video if amplifier tube as well since a defect in this tube can affect the tuning of the mixer.

Receiver inoperative on uhf

When uhf reception is absent, tune in a station if one is operating in the area. Satisfactory reception of one or more vhf channels points to trouble in the uhf tuner. Substitute tubes and/or crystals in this section to localize the faulty unit.

When only one uhf channel is normally received in the area, the possibility of station trouble should not be overlooked. Check

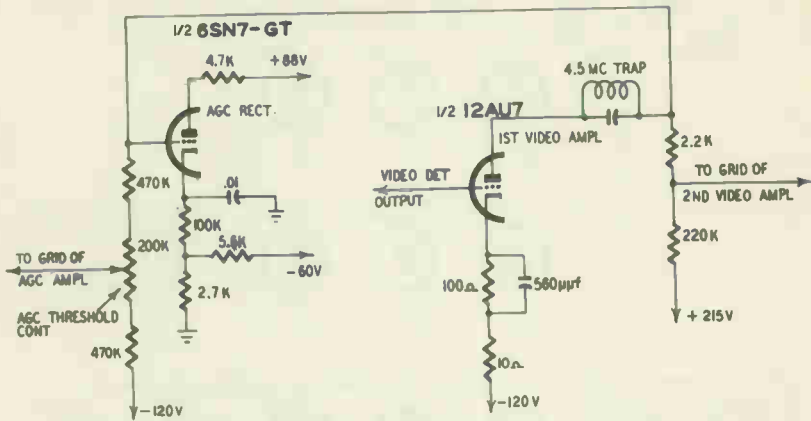

Fig. 406. Video amplifier and associated circuits. Excessive agc bias can result from a video amplifier defect.

uhf reception on another receiver or telephone the station to rule out this possibility.

When no uhf stations are operating in the area and reception on uhf is absent, turn the contrast control to maximum and inspect the raster (it is assumed a normal raster is present). If no snow (noise signal) is evident, look for trouble in the video if detector or amplifier stages of the receiver. When snow is present, but in small amounts, look for trouble in uhf tuner. (Comparison with the snow present in a normal set that is tuned to an unassigned channel will help the service technician decide what amounts of snow should be expected in the receiver under test.) When the amount of snow noted is normal, trouble in either the vhf or uhf tuner is possible.

When a uhf oscillator tube is replaced, check reception on all uhf channels. Some tubes may perform satisfactorily over only a part of the tuning range.

General troubleshooting

Trouble affecting picture and sound generally calls for tube substitutions in stages common to both signals. When some other

stage is the source of the symptoms, the technician may be considerably delayed in his troubleshooting unless he knows what to look for.

In receivers using keyed agc circuits, a defective horizontal circuit tube—particularly the horizontal amplifier or damper—can cause the development of an improper agc bias and affect sound,

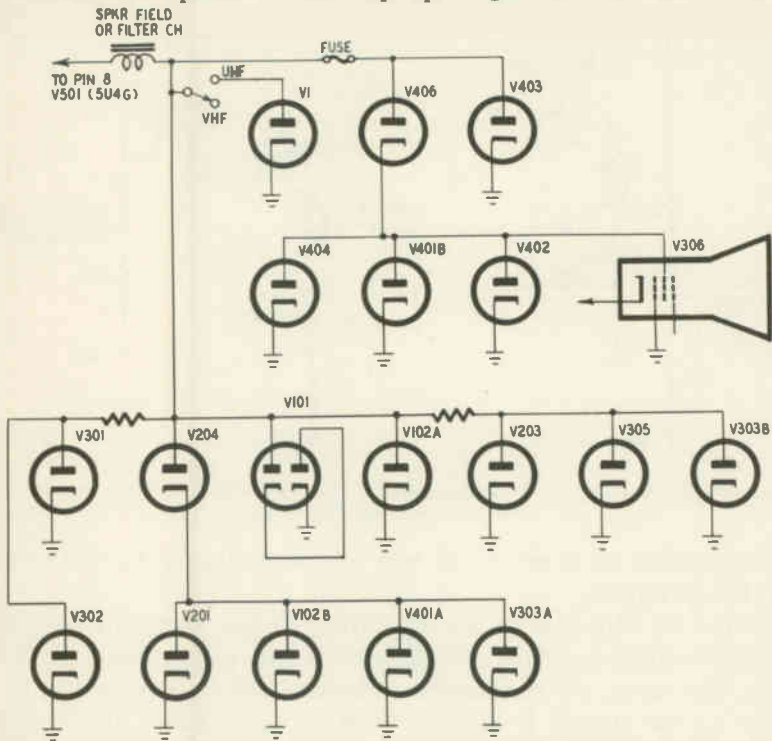

Fig. 407. Block diagram showing tube stacking. V204 is the sound output tube. Its heavy current will be reduced when it loses emission, causing the plate voltages on V101, V102A, V203, V305 and V303B to rise. The tubes are shown as diodes for the sake of simplicity

pix and sync. A gassy damper tube, for example, may cause an improperly shaped ac voltage to be fed from the width coil to the plate of the keyed agc tube, causing a varying or otherwise improper agc voltage to be produced, with possible distortion in both picture and sound. The moral is, don't overlook a substitution of horizontal circuit tubes, when symptoms of this kind are encountered in receivers using keyed agc.

Pix missing; sound is strong

When the picture is missing and sound volume is above normal (some experience will generally be needed to determine that a

receiver's sound volume is above normal), a defect in an agc tube may be present. In a circuit such as the one shown in Fig. 407, a loss in agc bias will cause an excessive signal input to the video amplifier. The video amplifier may be driven into cutoff, thus killing the picture. The sound signal, on the other hand, will be

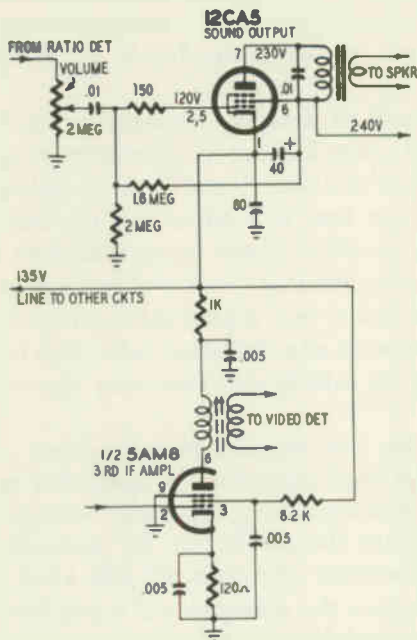

Fig. 408. The audio output and the third if amplifier tubes are in series and act as a voltage divider. A defect in the sound tube can cause loss of picture and sound.

amplified more than usual because of the loss of agc bias at the rf amplifier and first video if stage in this split-carrier set.

Another example of circuitry in which a defective sound tube may affect both picture and sound is shown in Fig. 408. B-plus voltage to the tuner, video amplifier and agc circuits, as well as the sync separator and clipper, are affected when a fault develops in the audio output tube.

Insufficient signal—contrast inadequate

When insufficient contrast is accompanied by snow in the picture (Fig. 409), try substituting new front-end tubes. If no snow is present, substitute tubes—or crystal—in video signal stages.

Sound may or may not be significantly lowered by a reduction in efficiency of a tube in a stage common to both pix and sound.

Agc tube trouble may be the cause of insufficient contrast—try a new agc tube to check. Agc trouble is particularly likely when a gradual reduction in contrast takes place.

A loss of emission in the low-voltage rectifier may be the cause of reduced receiver sensitivity. In some receivers, separate rectifiers may be used for different levels of B voltage—find and check them all.

6CB6 tubes tend to develop high-resistance leakage between grid and filament (the leakage is generally evident on an ohm-meter check, even if the tube is cold). Such leakage in a tube connecting into the agc line will affect the agc bias and reduce the sensitivity of the receiver. Since more than one 6CB6 tube may have developed this trouble, make a resistance check between tube elements before a test replacement of such a tube. In this way, when replacement of a defective tube does not clear up symptoms, it will not be falsely deduced that the original tube was good.

Resetting of the ion magnet may improve contrast when a receiver which has been adjusted for operation in a strong signal area is used in a location where the signal strength is considerably weaker. The magnet should be set for maximum brightness as usual in a readjustment operation of this kind.

In weak-signal areas, the sensitivity of a receiver may be boosted and contrast improved by various tube substitutions.

When 6AG5's are used in front-end or video if stages, replace them with 6BC5's to increase gain. No wiring changes are necessary in such substitutions (or in the ones listed in the paragraphs that follow).

Modifying receiver sensitivity

A 6CB6 may be substituted for a 6BH6 in the front end to improve sensitivity.¹ Some 6CB6's are *hotter* than others—i.e., have a higher transconductance. By testing a substantial number of new 6CB6's from time to time, a stock of peppy tubes can be accumulated and laid aside for use in sets which need the extra push such a tube can supply. Identify these tubes in some way—say, by putting a spot of paint on the base—to avoid mixing them with ordinary 6CB6's in the course of replacement tests.

Some makes of 6CB6—as well as other tubes used in video if

¹ The 6CB6 requires a larger filament current—300 ma—compared to 150 ma for the 6BH6.

and front-end stages—are markedly inferior in performance to competitive brands when used in these stages. To obtain maximum sensitivity from a set, substitute a number of different-make rf and video if tubes and note results. When one brand has been

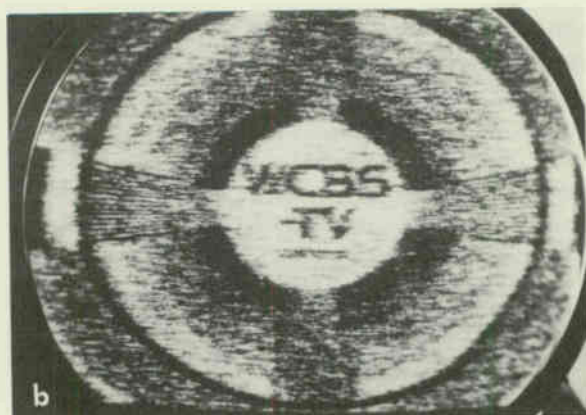
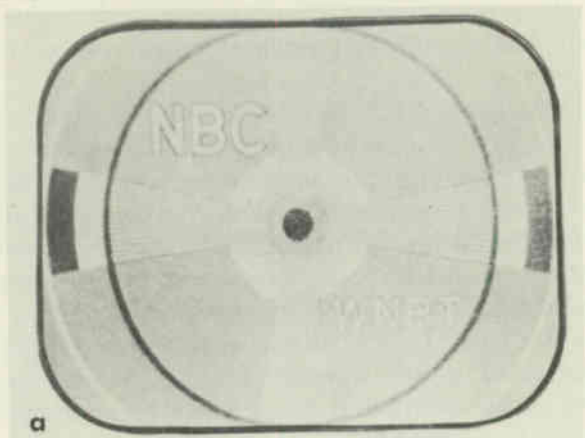

Fig. 409. (a) Weak picture with snow present. (b) Effect of advancing the contrast control setting with a snowy picture.

found best, try a number of tubes of that particular make to find the very best. *Keep in mind that video if gain can be reduced at least one-half (6 db) by the use of inferior new tubes.*

Reduced sensitivity in the presence of weak signals may be due to undesirable characteristics of a 6AL5 used as a video detector. Some 6AL5's have excessive *perveance*—that is, they pass a greater current with the same level of applied input signal than other tubes. As a result, the tuned circuit in the detector input is loaded

down, its response broadened and its output decreased. To get the best tube for the job, it is sometimes necessary to make tube substitutions while watching the response curve on a scope. Use the tube which gives the highest level of correct response curve. Generally, though, a tube with high perveance is desirable. It will load the coil, but it will also produce more voltage across the diode load resistor.

Changing the low-voltage rectifier present to one capable of producing a higher dc output will also increase receiver sensitivity. A 5Y3-GT, for example, may be replaced by a 5V4-G, following which the receiver is realigned. Such a change is not recommended unless the technician is definitely sure that components—particularly the input filter capacitor—will not be damaged by the increased voltages resulting from the substitution.

If the rectifier type is not changed, a new rectifier of the same kind may be tried to see whether the signal level cannot be boosted. Such a substitution is particularly recommended when the B voltage is noticeably below normal.

Eliminating snow

The presence of snow in the received picture indicates a poor signal-to-noise ratio. The commonest cause of snow, as far as tubes are concerned, is a defective rf amplifier. The receiver's signal-to-noise ratio is primarily established in the rf stage; a poor rf amplifier, by causing insufficient amplification of the signal, will bring it closer to the tube noise level, thus preventing the effective masking of noise which occurs under normal conditions.

Snow in the picture is inevitable when the incoming signal is too weak to override the rf amplifier's noise level. Snow is, therefore, a characteristic fringe area problem.

Excessive agc bias may be a cause of snow. If the agc setting has been checked, try new agc and video if tubes. A defect in a video if tube may cause excessive agc bias to be applied to the rf amplifier, introducing snow. Sometimes an improperly seated rf amplifier may be the cause. Make sure that this tube is properly inserted and making good contact with the socket.

Noise introduced by various tubes in the receiver's video signal stages may be helping to push the signal-to-noise ratio down. To check on this, make the following test:

- 1) Place a jumper across the antenna terminals to eliminate the incoming signal. As a further precaution against entrance of a station signal, tune to an unused channel.
- 2) Turn the contrast control to maximum to amplify tube-caused noise as much as pos-

sible. 3) Connect a vtvm across the video detector load resistor.

The voltmeter reading will be solely a noise-caused one. If the voltage measured exceeds 0.6, approximately, the tube noise present is excessive. Tube substitutions should be tried to remedy the condition. Tubes that should be substituted are those in the video detector, front-end and video if amplifier stages.

Corona or arcing in the high-voltage supply may be responsible for an excessive noise reading. It is therefore advisable to disconnect the high-voltage anode connector on the cathode-ray tube and recheck the noise voltage at the video detector (in the test just cited) before making any tube substitutions. Sometimes corona will get worse when the picture tube is disconnected. The high voltage will increase because of the removal of the load.

Weak uhf reception

Low sensitivity on uhf channels is often due to loss of emission in the uhf oscillator tube. If replacement of this tube (as well as other uhf front-end tubes) does not eliminate the symptoms, inspect the contacts of the crystals in this section. Loose or dirty contacts are often causes of poor sensitivity. A thin sealing film at the terminals of a crystal may be impairing its electrical contact, reducing the circuit gain. Clean dirty contacts and tighten loose ones to remedy such troubles.

Crystal replacement should be tried when the possibility of tube and contact trouble has been eliminated. It is generally safest to use an identical replacement for the original crystal. Where a 1N72 is present, however, and snow is seen in the uhf picture, substitution of an 1N82 is likely to improve reception appreciably.

Overloading

Overloading occurs in a stage when the bias of a tube is insufficient or its signal input is excessive. A variety of symptoms may be produced when overloading occurs: dark picture due to excessive contrast, blacking out of the picture, loss of the raster (due to the input signal biasing the picture tube beyond cutoff), sync buzz, as well as loss of horizontal and/or vertical synchronization.

A loss of agc bias is a frequent cause of overloading. A good clue to the trouble is provided by the excessively high detector output that is developed under such conditions. A parallel clue is the low or missing agc voltage that will be read between grid and ground of the agc-controlled tubes. Under normal circumstances, the two sets of voltages are similar in amplitude.

When the set is upended on the bench, the clues cited may be

readily investigated; on home service calls, however, the tube substitutions referred to in the paragraphs following (without the voltage tests) will generally prove simpler and faster.

The presence of excessive picture contrast (Fig. 410) is fre-

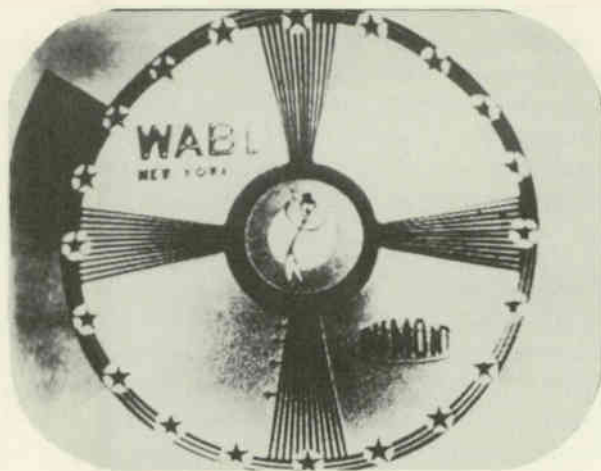

Fig. 410. Photo of test pattern showing excessive picture contrast. Note smearing.

quently due to agc trouble (loss of agc bias). The existence of such trouble is especially likely when a strong signal produces too much contrast or a blackout (a black-and-white raster) whereas insufficient contrast, possibly associated with snow, is evident when weak signals are being received.

If the contrast control requires constant resetting, trouble in the agc clamp circuit may be indicated. Try replacing the diode clamp tube.

A shorted agc tube will sometimes overload the low-voltage rectifier, causing the latter's plates to become visibly red-hot. This symptom, in conjunction with those of overload, will provide a clue to the trouble present.

A gradual increase in contrast, which causes the picture to darken as though the contrast control was slowly being turned to maximum, is often due to a defective agc tube or a gassy video amplifier.

A gassy video if or rf tube or one with cathode-to-heater leakage can cause a reduction or loss of agc voltage. In the case of cathode-to-heater leakage, a hum pattern may or may not be visible in the picture. 6CB6 tubes are particularly able to introduce overload

due to their tendency to develop high-resistance leakage between grid and filament.

Overloading can be produced by a defective video detector crystal. When the defect causes the crystal's signal output to be reduced, a smaller signal is fed to the agc circuit, causing the receiver gain to go up. When the incoming signal is strong, the excessive gain is likely to result in overloading. A video detector tube whose emission has dropped can be the cause of the same condition for similar reasons.

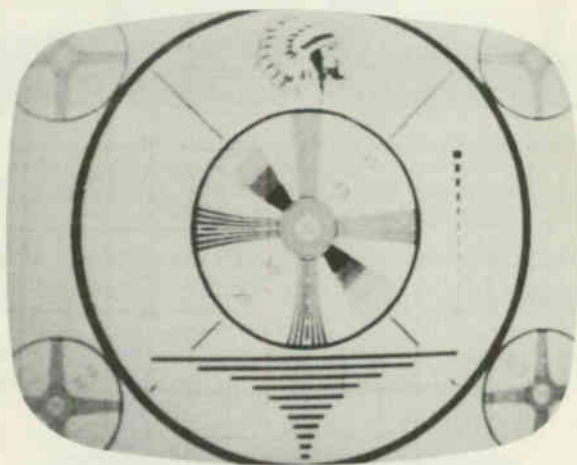

Fig. 411. Test-pattern photo illustrating white compression due to overloading in the if amplifier. Note washed-out appearance of the picture, poor rendition of whites. No snow is present, however. The condition is most likely to be noted on strong signals.

A weak rectifier tube may introduce overloading in receivers using a keyed agc circuit. The plate supply voltage for the horizontal output tube is reduced when the rectifier's emission drops. The amplitude of the flyback pulse applied to the keyed agc tube is correspondingly lowered, reducing the agc voltage put out by the tube. Agc-controlled stages can be overloaded even though the overall receiver gain may go down due to the decreased B supply voltages.

Clues pointing to the stage in which the faulty tube is located may sometimes be obtained by analysis of the symptoms present. If washout is observed (a condition in which blacks become gray when the contrast setting is advanced beyond a certain point), the overload is occurring in a stage *after* the sync takeoff point.

When overload is noted regardless of the setting of contrast and

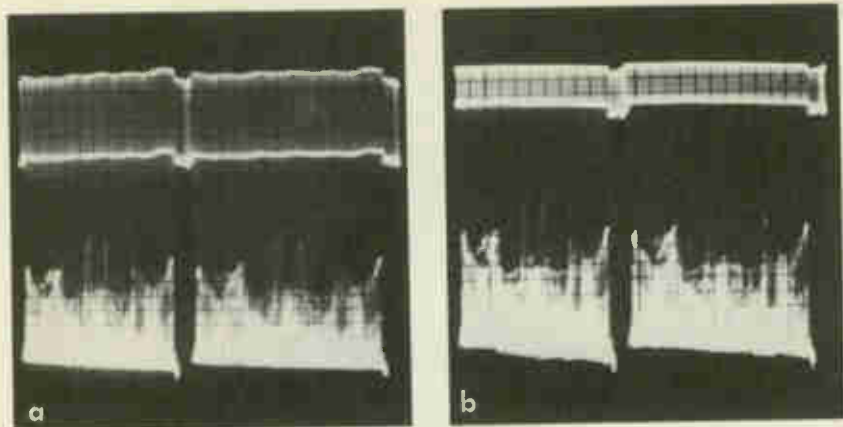

Fig. 412. (a) Normal video detector output waveform. (b) Video detector waveform when black compression is present. Signals in the gray-black region are compressed, causing grays to fall into the black region. Sync pulses are also compressed and reduced in amplitude.

brightness controls in receivers in which a negative voltage supply is used to provide bias voltages, the rectifier in the supply is probably gassy.

Overload symptoms in which sync buzz is included often point to a defective video amplifier although other tubes may also be responsible.

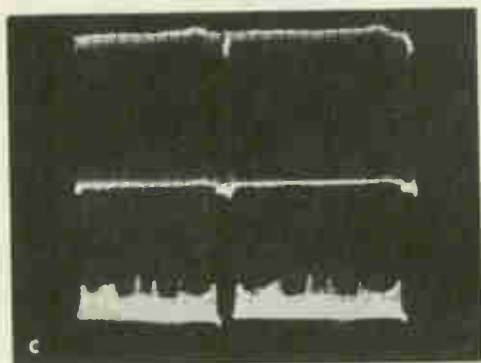

Fig. 412. (c) Video detector output waveform when white compression is present. Note smaller range of variation at bottom of waveform where the white signals are, compared to the normal variation in this region shown in Fig. 412-a.

Overload characterized by white compression (loss of grays in the picture, causing the pix to look flat and washed out) is often due to a faulty rf amplifier (Fig. 411). Defects in either the rf

amplifier, agc or video if tubes can be the cause of the trouble. The presence of white or black compression can be verified by making a scale waveform check at the output of the video detector (Fig. 412).

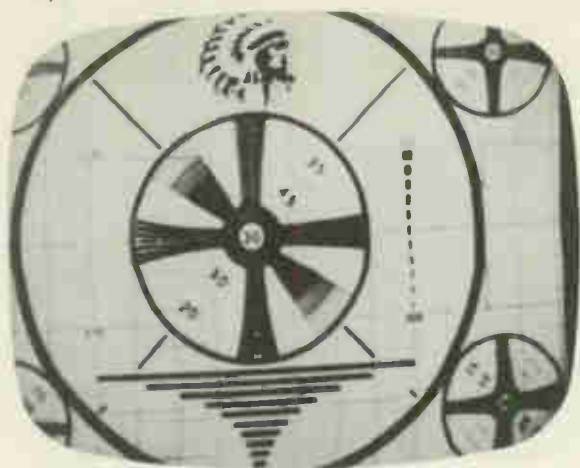

Fig. 413. Test pattern illustrating black compression. Grays are rendered as black, causing the picture to look dark and excessively contrasty.

Sync and black compression (Fig. 413) frequently indicates overload in the video if stages due to insufficient agc bias. Such compression may readily be detected by advancing the brightness control and adjusting the vertical hold control until the picture hovers with the horizontal blanking bar positioned somewhere around the middle of the tube. If the sync pulse hammer is not much darker than the blanking bar proper, sync and black compression is indicated (Fig. 414). The picture will be dark and excessively contrasty when this kind of trouble is present; sync will tend to be lost if the condition is severe.

When the signals being received are excessive (a problem in high-signal areas), overloading is a normal result. One of the ways in which the condition can be remedied is the proper selection and substitution of video if tubes. Tubes with lower than average gain should be found and used. Proper selection of tubes—sometimes merely the interchanging in their sockets of the video if tubes present—may greatly reduce overload symptoms by increasing the signal-handling ability of the receiver.

It is particularly important that the first if tube have a transconductance that is average rather than above average. Use of tubes with transconductances that are well *below* average is not

recommended. A weak if tube in an uncontrolled stage can result in low detector output. This means a lowered agc voltage and can produce an overloaded first if stage.

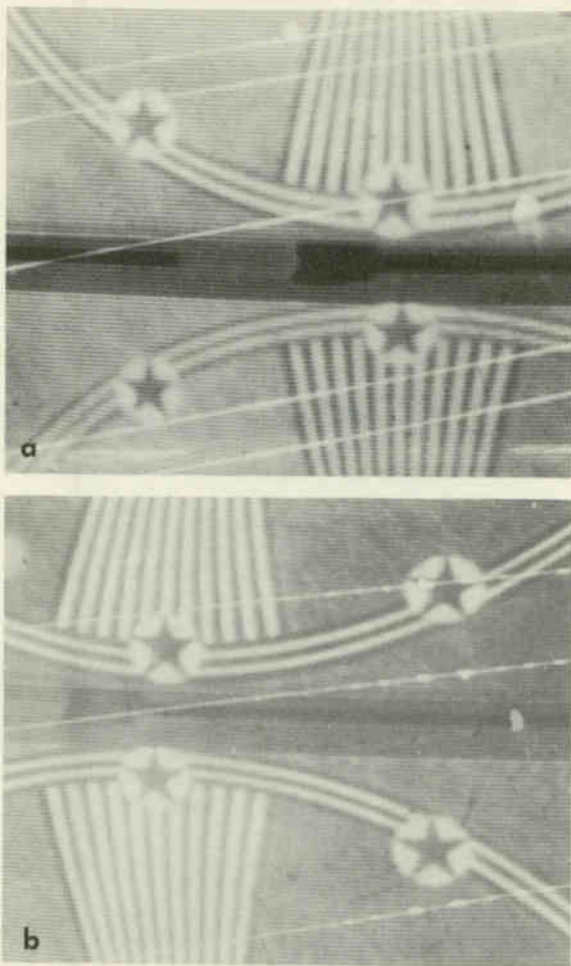

Fig. 414. The photo at the top shows the normal appearance of vertical blanking bar. Note that the sync hammer is black, while the blanking bar proper is gray. The lower photo illustrates the effect of sync compression on the sync pulse and blanking bar. The reduction in sync-pulse amplitude causes the height of the sync pulse to fall closer to the blanking signal level. As a result the shading of both becomes similar.

When overload occurs only at intervals and it has been definitely ascertained that the agc voltage is reduced or lost at such times, check for a dc voltage drop across the grid-return resistors of the

video if and rf amplifier tubes to localize the trouble further. Normally this voltage should be zero; if it isn't, grid current is probably flowing in the tube with which the resistor is associated, possibly because of the development of gas in the tube. Open the

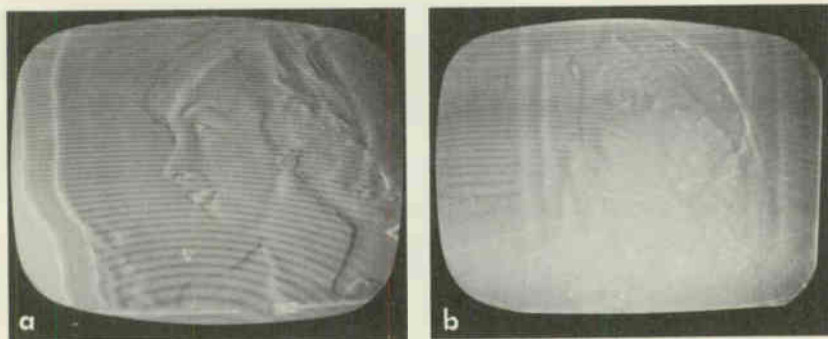

Fig. 415. (a) Negative picture caused by overloading. An inoperative agc tube can cause such overloading by removing the bias from agc-controlled stages. Erratic horizontal and vertical synchronization are often associated with the negative picture. (b) Another example of a negative picture caused by agc trouble. In this case, synchronization has not been impaired. The symptoms illustrated were seen when a medium-strength signal was coming in. With a weak signal and the contrast control setting advanced, the picture may look normal in some cases.

coupling to the grid resistor from the preceding stage; if the voltage drop across it remains, a gassy tube is definitely indicated.

Negative picture

The technician not infrequently encounters a set in which negative pictures are received—one in which normally black areas are white and normally white areas are black (Fig. 415). Overloading is frequently the cause of such phase reversals, particularly when vertical and/or horizontal synchronization is continuously or intermittently affected. An excessive signal in the video if tube grid circuit can produce a negative picture.

Fig. 415. (c) Negative picture caused by low emission in a 5U4-G rectifier. The 5U4-G in question provided high B plus for the horizontal amplifier tube. Reduction of the rectifier tube's output resulted in the feeding of a smaller pulse from the horizontal amplifier to the plate of the keyed agc tube, decreasing the agc voltage and causing overloading of the agc-controlled stages.

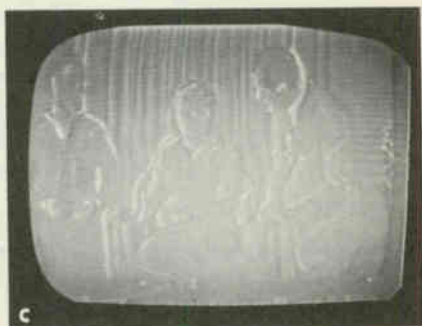

A defective video amplifier can be the cause of a negative picture. Leakage of video signal past the inoperative amplifier takes place in such a case. The phase of the signal at the picture-tube input is opposite to what it should be since one stage of phase inversion has been omitted. A negative picture results.

A defective crystal used as a video detector may be the source of a negative picture. So can a normal crystal that has been improperly connected and as a result is producing an output signal of the wrong polarity.

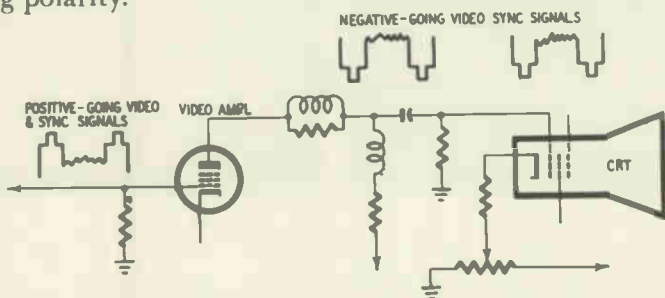

Fig. 416. The sync pulses should be negative-going on a scope waveform test when the video amplifier output signal goes to the grid of the cathode-ray tube. It is assumed that the scope does not invert the signal. When the video amplifier feeds to the cathode of the picture tube, the sync pulses should be positive-going.

Trouble in a picture tube itself can produce a negative picture. Before making a laborious substitution to test for such a source of trouble, simply check the scope waveform at the point where the video signal is fed to the tube. If the signal is applied to the grid, the polarity of the sync pulses should be *negative*; they should be *positive* if the video is fed to the cathode (Fig. 416). If the signal polarity is correct but a negative picture is obtained anyway, trouble in the C-R tube is indicated and another tube should be substituted. (It is assumed that voltage and resistance tests between picture-tube elements and ground have eliminated the possibility of circuit trouble.)

Loss of emission in a low-voltage rectifier, in the type of circuit shown in Fig. 417, may result in negative picture. Knowing what to look for in such instances can save the technician considerable troubleshooting time.

Poor definition—improper focus

A blurring of the entire picture is generally produced by improper focus. The vertical and horizontal wedges in the test pattern will not be sharply defined when this condition is present

(Fig. 418) and neither will the scanning lines of the raster. (Reduce the contrast setting to zero, eliminating the picture, to examine these lines.) When adjustment of the focus control and/or focus magnet proves ineffective in clearing up the condition, one of the following troubles may be present:

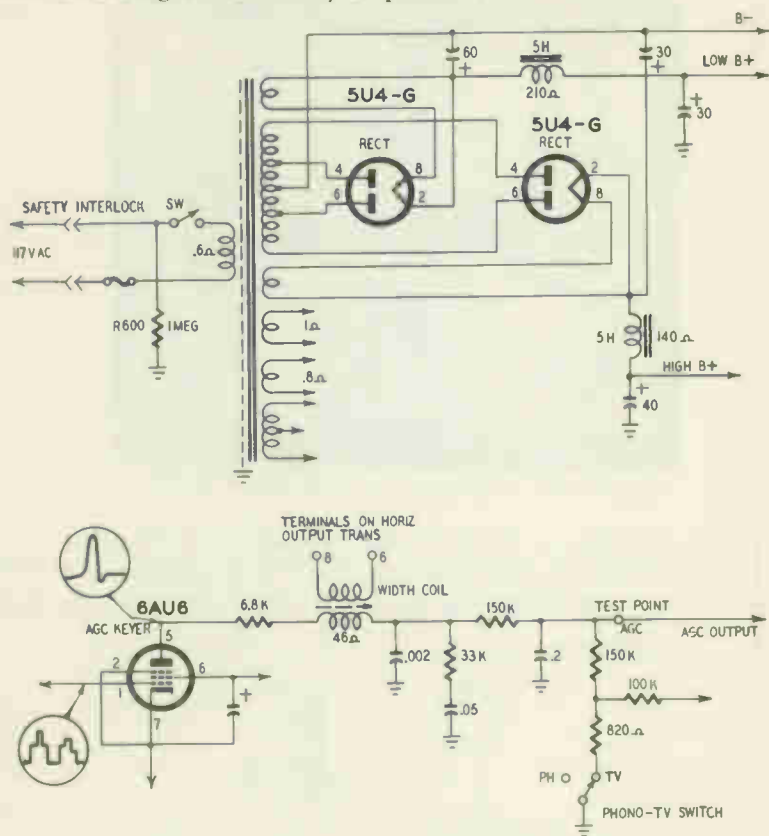

Fig. 417. Typical power supply and agc picture circuits. The 5U4-G at the right (upper drawing) provides high B plus for the horizontal output tube which feeds pulses to the plate of the keyed agc tube (lower drawing). A defect in this rectifier tube can affect agc operation without producing visible symptoms of malfunctioning in other circuits.

Loss of emission in a low-voltage rectifier. The focus control may approach (but not reach) proper focus at one end of its range, when such a trouble exists.

A defective high-current tube—such as a video or power amplifier—may be reducing the current flow through the focus coil (when one is present) to a point where proper compensation by focus-control resetting is not possible.

In some receivers, the power amplifier tube is in series with the focus coil. A weak or gassy tube in this stage will severely affect the focus. Try replacing the tube before going on to circuit tests.

In electrostatically focused sets using a separate tube (usually

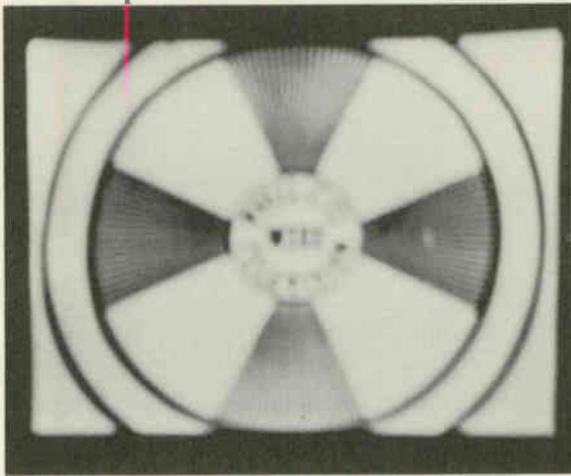

Fig. 418. Effect of improper focus on the test pattern.

a 1V2) to provide the focus voltage needed, reduced emission or some other defect in this tube may make it impossible to achieve proper picture focusing (Fig. 419). The same is true of magneti-

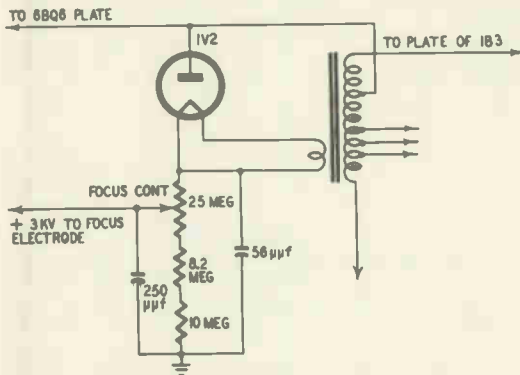

Fig. 419. Focus tube and associated circuit used with picture tubes employing high-voltage electrostatic focus.

cally focused sets that use a separate focus control tube. (Fig. 420).

Improper focus may be due to a gassy cathode-ray tube. A test with a tube tester or substitution of a new picture tube will verify whether the trouble lies here.

Poor focus can be due to magnetization of the picture-tube gun. If substitution of an identical tube restores proper focus, a defect of this type is possibly present. Try demagnetizing the picture tube (as described in the chapter on C-R tubes) before permanently replacing it with a new one.

Reduced emission in the horizontal output tube may have an effect on focusing since the magnetic fields of the yoke and focus coils interact to some extent. The loss in emission may impair focus even when it has no apparent effect on picture width or brightness. The defocusing can also be due to a drop in high voltage. Substitute a new horizontal output tube to test for as well as remedy this kind of defect.

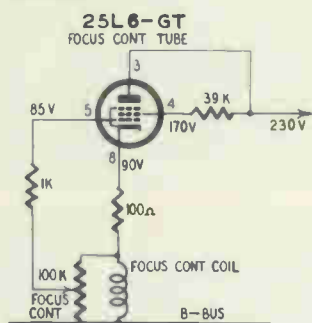

Fig. 420. Focus control tube and associated circuit used in some receivers.

In those electrostatically focused sets in which an adjustable focus voltage is provided, rotating the cathode-ray tube 180° will remedy some cases of poor focus.

Improper setting of ion, centering or other magnets present on the neck of the C-R tube may be responsible for impaired focus and should be investigated when no likelier sources of trouble can be found.

A condition similar to a slight impairment of focus may be noted (Fig. 421) when the size of the scanning spot has increased for some reason. Possible causes for such an increase include: improper positioning of the ion magnet; gassy C-R tube; loss of emission in a tube in the horizontal or high-voltage section (leading to a reduction in the high voltage) and, of course, an improper focus-control setting.

To check the spot size, observe the white scanning lines in the picture or test pattern. In Fig. 421-a illustrating a normal condition, the scanning lines are narrow and the black horizontal spaces between them are clearly visible. In Fig. 421-b illustrating the

effect of an enlarged spot, the increase in the width of the scanning lines has caused the dark in-between spaces to become narrower, poorly defined and almost invisible.

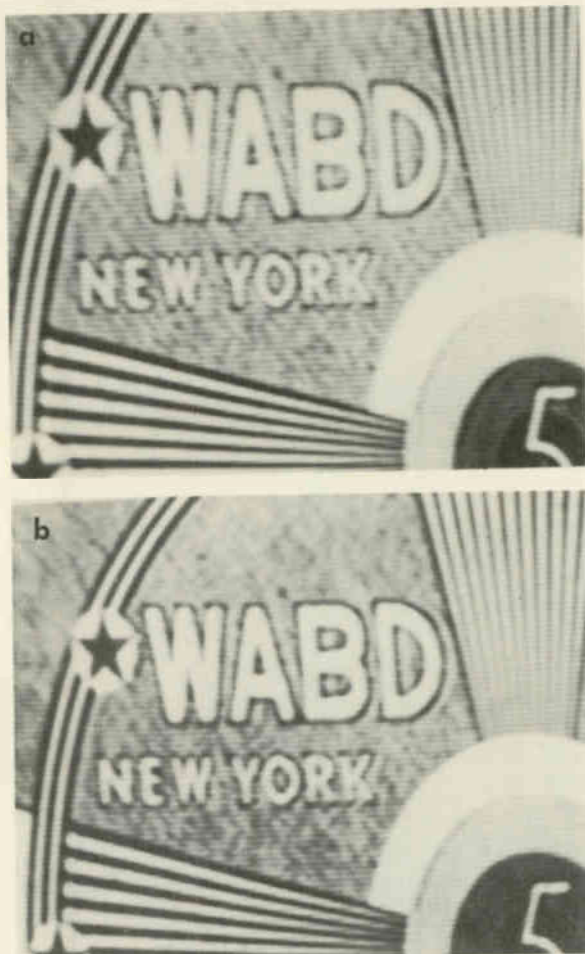

Fig. 421. (a) Appearance of section of test pattern when scanning-spot size is correct. Appearance of same portion of test pattern (b) when scanning-spot size is larger than normal. Note that the dark spaces between scanning lines are no longer clearly visible.

Resolution troubles

Resolution is a measure of picture definition. Good resolution requires the uniform amplification of all the frequencies in the receiver's video bandpass. When high video frequencies are not adequately amplified, picture detail will not be reproduced satis-

factorily. The loss of resolution in such a case can be most readily detected by inspecting a test pattern. The test pattern's vertical wedges will not be clearly defined all the way to the center of the pattern as they should be ideally. If no test pattern is being transmitted, check the reproduction of small light areas in the picture.

When resolution is poor, the fine-tuning control is correctly set and no slight ghost effect (due to a mismatch in the antenna system) is evident, try replacing the video detector or video amplifier tube. (When a crystal is used as the video detector, replace it only when likelier sources of trouble have been eliminated.) A bad video if amplifier, or even a defective picture tube, may also be the cause of poor resolution.

Picture smear

When response is impaired at low frequencies, smearing may be introduced into the picture. Smearing most noticeably affects large

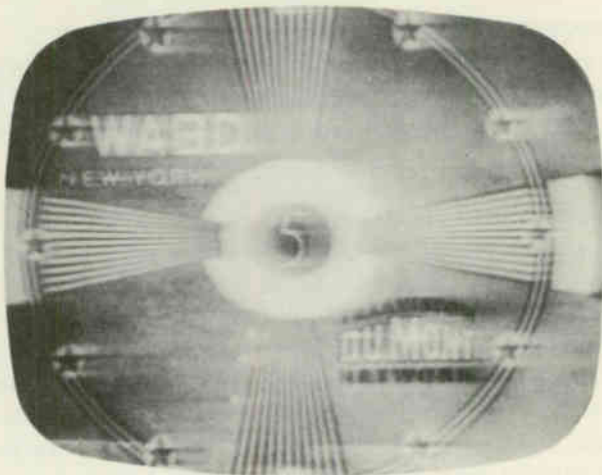

Fig. 422. *Effect of smearing on the test pattern. Symptoms vary somewhat from case to case.*

objects (Fig. 422). White or black edges in the picture, instead of being sharply defined, are smeared generally in the direction of the right side of the screen. Trailing shades ranging from black to white may be seen after large black objects; these shadings go from white to black after large white objects. The picture as a whole will look fuzzy. Smearing is usually due to poor reproduction of low video frequencies.

If the fine-tuning control is found to be correctly set and the presence of smearing on several channels has ruled out the possibility of station trouble, try replacing the video amplifier tube

first, then the video detector. A defective video detector crystal may load down the tuned circuit with which it is in series, causing smear via misalignment.

When a loss in fine detail is associated with the smear, check the setting of the ion magnet. In many sets, a slight missetting of the ion magnet can impair focus and produce a condition resembling smear. Defects in the video if amplifier and C-R tubes may also be the cause of picture smear.

A source of picture smearing likely to be overlooked is the too-close coupling of a horizontal yoke lead to the picture-tube cathode or grid lead. Improper lead dress of this kind can cause horizontal sweep signals to be developed between grid and cathode of the tube, causing grid current to flow in the C-R tube on steep signal peaks. Smearing may result due to the changed picture tube bias. Redress the leads to test for as well as correct the trouble.

Miscellaneous picture troubles—engraved effect

When the picture resembles an engraving and the settings of the fine-tuning and contrast controls are correct, substitute new tubes for the video amplifier and video detector to check whether a defect in these tubes is responsible for the symptoms.

Ghosts due to bad tubes

It is not too well known that a defective tube may cause ghosts or multiple images (Fig. 423) to be seen in the picture. The condition may be explained as follows:

Rf signals get into the receiver via pickup in the antenna system, which is desired, and also by direct pickup in the rf input circuits, which is undesired. Under normal circumstances, the signals picked up at the rf input are much weaker than the desired ones entering by way of the antenna system and the gain of the receiver is not great enough to make them visible.

When a defective rf amplifier tube is present, however, the direct-pickup signal may be as strong, or possibly even stronger, than the one coming in from the antenna. Furthermore, the gain of the receiver goes up considerably because the reduction in signal produced by the rf amplifier defect lowers the agc voltage. Both the direct-pickup and antenna signals may thus become visible.

Since the tuner pickup is not directional, signals from the same station that come in via different paths and have been delayed in varying amounts by reflection from different surfaces may be simultaneously accepted, and as a result, multiple images will be seen.

Clues pointing to the possible existence of such trouble are:

If the ghosts present shift in position or the quality of the picture changes when people move around in the vicinity of the receiver, abnormally strong direct pickup via the tuner is indicated. (This statement applies to receivers that are connected to an outdoor antenna.)

If the picture's ghost content remains unchanged with the antenna disconnected from the receiver input, the same condition is indicated.

Replace the rf amplifier to determine if a fault in this tube is producing the symptoms. The agc tube may next be replaced if



Fig. 423. Ghosts in test pattern.

rf amplifier substitution causes no change in symptoms. (A defective agc tube may increase the sensitivity of the receiver to a point where direct-signal pickup becomes evident on the screen.)

Sound troubles—hum in sound; pix and raster normal

A distinction should be made between 60-cycle hum and buzz, which sound somewhat similar. Such a differentiation will promote a faster localization of the source of trouble. Hum is a smoother, less harsh sound than sync or vertical sweep-signal buzz and may be readily identified because of this characteristic.

Improper setting of the fine-tuning control will cause hum to be heard in many receivers. Check for this condition before going on to other tests.

When hum is heard with the volume control setting at zero, try replacing the tubes in the audio amplifier section and note results. When reduction of the volume control setting to zero eliminates hum, cathode-to-heater leakage in a sound if or sound detector tube may be present. Such leakage in a sound if tube will gener-

ally result in hum being heard only when a station is coming in, a characteristic that should aid in the rapid identification of the source of trouble.

In certain receivers a hum may appear in the sound that varies with the setting of the brightness or contrast controls. Stray coupling between video circuits and the sound if amplifiers is probably the cause. Replacement of the sound if tubes or the use of tube shields over them should clear up the trouble.

A source of hum that may be overlooked is cathode-to-heater leakage in a tuning-indicator tube.

Buzz in sound

Buzz in intercarrier sets falls into one of two basic categories: 1) sync buzz and 2) pickup of the vertical sweep signal by an audio circuit. To determine which kind is present, remove the vertical oscillator. If the buzz stops, condition 2 exists. In many cases, presence of the condition may be verified simply by rotating the vertical hold control. If the buzz changes in pitch, it is due to vertical sweep-signal pickup. Such pickup is generally caused by improper dress of a vertical circuit lead—i.e., too close positioning of the lead to an audio tube.

When the buzz present is *not* eliminated by the removal of the vertical oscillator tube, an overloaded video if or amplifier tube may be present. Overloading in a video if tube can cause buzz for the following reason:

The portion of the video if signal most likely to cause overloading is the part that is modulated by the sync pulse. This is so because the sync-pulse level of the signal is the peak or maximum level. When the if signal is so large or the bias of the video if tube so low that overloading takes place, the tube affected is driven to cutoff at the sync-pulse rate, 60 and 15,750 cycles per second. Interruption of the sound signal at these rates occurs in consequence. The picture is not affected because the interruptions occur during blanking time. The sound is, however, very seriously affected by the 60-cps interruption (the 15,750-cycle interruption is not likely to be audible); the holes that are regularly punched in it are heard as a buzz.

When the video amplifier is overdriven, the 4.5-mc sound signal present in this stage is interrupted at sync-pulse rates, causing the same symptoms. This applies only to sets where the sound is taken off at the video amplifier.

An overloaded video if amplifier is, perhaps, most often due to a video if tube which is either gassy or has cathode-to-heater or

grid-to-filament leakage. Replace the tubes in this section to test for such a source of trouble. A preliminary measurement of a_{gc} and other bias voltages, where this may be readily done, will verify whether insufficient bias is present and warrants the tube-replacement tests just referred to.

A gassy or otherwise defective video amplifier may be responsible for introducing buzz. A defective germanium crystal used as a video detector may also be the source of buzz (poor contrast and sync instability may or may not be associated with it). Substitution is the best way to check a crystal.

An unexpected source of buzz may be linked to a defective picture tube. When the C-R tube is weak, the set owner may advance the contrast control to a higher setting in an effort to get a more satisfactory picture. When the setting of the control is such that the video amplifier bias is close to cutoff on signal peaks, a change in scene that pushes the signal peaks beyond cutoff will produce sync buzz.

Still another cause of buzz is improper lead dress. If the cathode or grid lead of the picture tube is positioned too close to a first audio tube, sync pulses present on this lead may be coupled to the audio tube, producing buzz in the sound. Avoid changing the dress of picture-tube leads during tube substitutions to prevent introduction of such trouble.

In some instances, pickup of the kind just described may take place because of a missing shield on a first audio tube. Add a shield when this condition is suspected and note results. If a shield is already present, make sure it is properly grounded.

Proper shielding of a first audio tube is particularly essential when a picture tube with no outer Aquadag coating is used in the set. A coating of this type acts as a shield; in its absence, radiation of buzz-creating signal becomes much greater. (A more complete description of Aquadag is given in Chapter 7.)

A chalky substance may form on the outer Aquadag of some picture tubes and prevent proper contact of the Aquadag to the spring that grounds it to chassis. Buzz may result since the shielding is no longer adequate. Wash off the chalky material with a damp cloth and dry the area affected very thoroughly. Gently touching up the area at which the spring makes contact with a soft, rather blunt lead pencil will complete the repair.

The procedure just described should not be used on all makes of picture tube unless the service technician is sure that the Aquadag is not water-soluble. In many cases it is and can be washed away when water is applied.

In all sets, buzz may be introduced when the grounding spring that contacts the Aquadag is bent, missing or does not touch the tube.

Buzz that is not affected by the volume control may be due to corona. Reduced picture brightness or other symptoms of corona are likely to be associated with the buzz in this case.

A defective sound if amplifier or detector tube may be responsible for buzz. Replace the tubes in these sections as a test. Buzz is also caused by a misaligned sound detector transformer.

In some receivers operating in strong-signal areas, use of certain 6AG5 type tubes in agc-controlled first video if stages can introduce buzz. Some of these tubes have a grid cutoff characteristic which is exceptionally sharp; a tendency to premature cutoff in the presence of large agc voltages produced by strong signals therefore exists. A tube of this type need not be discarded; it can be used in some video if stage where fixed bias is applied and overloading is therefore less likely.

Other sound troubles—sound absent, pix normal

When a normal picture is received but sound is missing and no background noise is audible, look for a defective tube in the sound section. Click tests can be used to locate the defective section. These tests consist of removing the audio tubes one at a time, starting with the power amplifier and proceeding backward. Listen for a clicking sound as each tube is removed. The clicks should become slightly louder the farther away you go from the last tube since more stages of amplification are being added. When a stage is reached where withdrawal of the tube produces no click or too faint a click, the tube in question should be replaced and results noted. (This test should not be tried in sets with series-string filaments.)

If sound is missing and a background hiss is audible (in a split-carrier set), the rf oscillator may be to blame. Slight retouching of the oscillator tuning adjustment will often restore circuit operation to normal; try a new oscillator tube if it won't.

Weak and/or distorted sound

When the sound is weak and/or distorted but the picture is normal, substitute tubes in the sound section to locate the defective one (it is assumed that the adjustment of the fine-tuning control is correct). In receivers using stacked-tube circuits, a weak video if or sync tube may be responsible for poor sound. The picture will, however, generally be impaired as well in such instances.

In series-filament receivers using power amplifiers with high-voltage filaments, a creeping distortion in the sound that appears after the set has warmed up and grows progressively worse is usually due to a defective audio power amplifier tube.

In some cases of weak sound, the trouble is caused by excessive current drain in the low-voltage power supply produced by a gassy or grid-emitting tube. (The drop in B voltage may not be large enough to affect the picture noticeably.) Remove the tubes one at a time and note whether the B plus (which should be monitored with a dc voltmeter) jumps up very appreciably at any time.

The B voltage will, of course, increase markedly when a high-current tube (such as the video amplifier or audio power amplifier) is withdrawn. The increase in voltage when a low-current tube is removed should, however, be very slight. If an excessive B-voltage increase is noted when any tube is withdrawn, substitute another tube and note results.

In one case known to the author, a gassy picture tube loaded down the power supply heavily enough to weaken the sound greatly but left the picture relatively unaffected.

Noisy sound

When the sound is noisy, a sound if limiter or detector tube may be defective. Replace these in turn and note results. When the sound is weak as well as noisy, a weak sound if tube is the likeliest possibility.

Noise drowns out desired sound

A motorboating sound which occurs when the receiver is first turned on is generally caused by a defective oscillator-mixer tube. Low emission in one or both sections of the tube can cause the trouble. The motorboating sound rises in pitch as the receiver keeps warming up and finally disappears.

Another mixer-oscillator defect may cause a high-pitched whine to become audible when the receiver begins to operate. The picture may break up during this interval. After a short time, the symptoms disappear. Large variations in interelectrode capacitance in the oscillator are generally responsible for the condition.

Sound and picture do not track

When best sound does not appear at the setting where the picture tuning is correct, one of several tube troubles may be present. The rf oscillator or amplifier tube may be defective. Or oscillation in the video if stages, promoted by a tube defect in this sec-

tion, may be producing the symptoms. Trouble in the rf oscillator is particularly likely if drift is creating the symptoms.

Where an afc circuit is used to control the rf oscillator, an ineffective fine-tuning control points to trouble in the afc discriminator. (The output of the discriminator is used to control the frequency of the rf oscillator.)

sync troubles



WHEN trouble is encountered that affects both the horizontal and vertical synchronization of the receiver, make sure to check symptoms on more than one station setting. Not infrequently, station trouble is present—i.e., the blanking and sync signals sent out at the transmitter do not have the correct amplitude relationship to the video portion of the composite signal. A check of reception on several channels will indicate whether it is so.

Unstable sync can be due to signal distortions set up outside the receiver. Undesired additions and cancellations of signal at the antenna site (caused by improper antenna orientation) may be producing such trouble. A test can be made by substituting another antenna for the existing one (an indoor type will usually do). When tests point to the existence of trouble in the receiver proper, tube substitutions are in order.

A good preliminary check to make is an inspection of the sync pulse in the vertical and/or horizontal blanking bar (see Figs. 414 and 501). The brightness control should be turned up somewhat to permit the shading of the sync and blanking pulses to become visible. If there isn't much difference in contrast between the sync pulse and the blanking bar, as shown on the screen of the picture tube, sync compression is indicated.

The test cited will indicate whether the cause of trouble should be looked for in the sync or video signal stages. The presence of sync compression points to overloading in a video signal stage. The various tube substitutions recommended in the section de-

voted to *overloading* (Chapter 4) should then be tried. If sync compression is *not* evident—that is, if the sync pulse is markedly blacker than the blanking signal and the darkest portions of the picture—trouble between the video amplifier and the sweep oscillator in the sync section of the receiver is indicated. Tubes in these stages should be substituted as a test for the trouble.

Poor immunity of the sync system to noise may be due to reduced agc voltage. When noise streaks, tearing of lines and/or

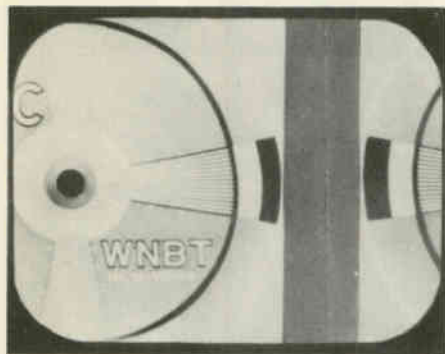

Fig. 501. *Horizontal blanking bar is black when brightness and contrast control settings are normal and no defect is present. The horizontal sync pulses are not visible.*

vertical jitter is observed in the picture, note whether overload symptoms are present as well. If they are, a defective agc tube *may* be the source of the trouble.

Unstable sync due to noise may be due to a defective noise canceller or inverter tube. Substitute another anti-noise tube, if one is used in the receiver, and the symptoms just cited are present.

A defective video detector crystal may be responsible for poor or erratic sync. Before substituting another one, a scope may be used to monitor the output of the crystal. If the sync pulse output is insufficient, erratic, or improperly shaped at this point, and substitution tests of tubes in previous stages have revealed no trouble, replacement of the crystal may be tried. Substitution of a 1N34 for a 1N60 or 1N64 type crystal may be made for maximum improvement in synchronization.

In a receiver using stacked tubes, a bad audio output tube may cause an impairment of vertical and horizontal synchronization because sync tubes (as well as the video if and others) may derive their B supply voltages through it. When sync is poor and sound is distorted or absent in receivers of this type, try a new audio output tube before making other tests.

Trouble in a sync tube (particularly in a relatively high-current unit such as a high-gain sync amplifier in a stacked-tube receiver)

may affect the sound as well as the synchronization. The bias of the audio output tube in a circuit like the one shown in Fig. 302 will be affected by a change of current in the tubes in series with it. If sound and sync symptoms are both present, then substitution of sync as well as sound tubes should be tried. Study the set schematic to determine which tube substitutions are most logical.

Trouble in video if tubes may affect voltages in sync and sound stages; video if tube substitutions are therefore in order in stacked-tube sets when sync trouble exists.

A condition known as *sync lockout* is a possibility in receivers employing keyed agc circuits. It manifests itself as a loss of horizontal and vertical synchronization. Various sources may be responsible so let us consider the general nature of the trouble to understand better which remedies are logical.

Normally, when a receiver is switched from an unoccupied to an assigned channel, the agc voltage goes from zero to some substantial value fairly rapidly. When a weak agc tube (or other circuit trouble) is present, however, the agc voltage may build up too

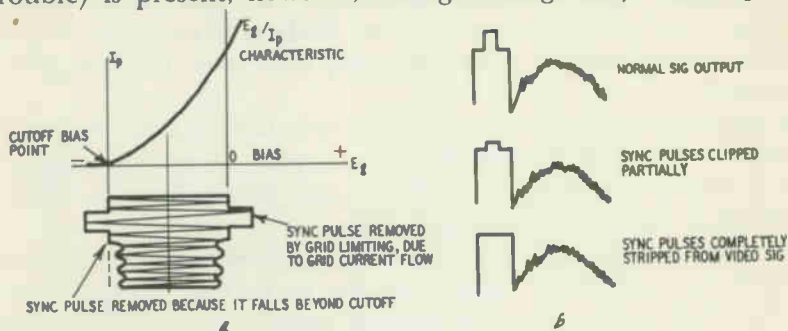

Fig. 502-a, b. Clipping of sync pulses due to overloading of a video if tube. The condition is most likely to occur in the last video if amplifier where the if input signal is highest.

slowly, possibly causing it to be smaller than it should be in the first few seconds after the station switch. As a result, the bias of agc-controlled stages is too low and clipping of the sync pulses tends to occur. See Fig. 502.

Such clipping can remove the sync pulses from the composite video signal. Under these circumstances the agc keyer tube, instead of having flyback pulses applied to its plate and sync pulses to its grid, will be fed only by flyback pulses. Its conduction will therefore drop and the agc voltage output will either be very low or absent. Overloading and sync pulse clipping will result, and the receiver will be "locked out" of synchronization.

The lockout may sometimes lift if, just after a switch from an

unoccupied to an occupied channel, the sync and flyback pulses happen to be in phase. Under such circumstances, the agc voltage at the output of the keyer tube will build up more rapidly and may reach a level large enough to prevent lockout in the short time it has to do the job.

The logical tube substitutions to make in the event of intermittent or continuous sync lockout include the agc tube as well as ones that can affect the agc voltage, such as rf, video if, video detector and video amplifier tubes.

Sync lockout is particularly likely to occur in a receiver using a noise inverter or noise canceller. A tube of this type is normally biased to be nonconducting in the presence of sync pulses. If the bias applied to the inverter is not correct, it may conduct on sync pulses as well as noise, eliminating (in some circuits) or inverting (in others) the sync pulses normally applied to the sync stages. Synchronization is prevented in consequence and lockout occurs.

Since the bias of the anti-noise tube depends in part on the incoming signal level, any condition that greatly changes the signal level may produce lockout of this type. Defects in the rf and video if detector or amplifier or agc tube may thus cause the symptoms described.

A defective anti-noise tube or a bad sync tube can be the cause of lockout. If the anti-noise tube becomes gassy, its resultant reduction in bias may cause it to conduct on sync pulses as well as noise, inverting or eliminating the sync pulses.

In some instances an excessive length of time is required for vertical and horizontal synchronization to become normal. The trouble may lie in a slow-heating sync tube. If sound, picture or raster also take a long time to become normal, a defective low-voltage rectifier is indicated. Substitute another rectifier or try sync tube substitutions to test for such sources of trouble.

Line-voltage changes may be the cause of unstable synchronization—i.e., tendency of the picture to lose horizontal and vertical sync at intervals, coupled with increased difficulty in setting the hold controls properly. A test of set operation at various line-voltage levels (permitted by the use of an autotransformer with a variable output) will determine whether this is the case. When the presence of such trouble at low line voltage has been verified, try replacing the deflection oscillators with several other tubes of the same type but of different make. It is often possible to eliminate symptoms by using as an oscillator a tube with enough reserve emission to operate properly even in the presence of a substantial drop in line voltage.

Vertical sync trouble

When vertical synchronization is absent or unstable (i.e., when continuous or intermittent vertical roll or jitter is present) one of several stages may be the problem. Clues provided by inspection of the picture or test pattern or by various localization tests will often help to narrow down the area in which to substitute tubes.

A helpful preliminary test when continuous roll is present is to remove a sync amplifier tube and note whether the roll can be stopped, even momentarily, by manipulation of the vertical hold control. (A "dummy" tube of the proper filament voltage rating, with prongs other than filaments cut off, may be used in place of the sync tube in series-filament circuits to simulate sync tube removal.) If roll is stopped even for an instant, the vertical oscillator can be eliminated as a possible source of trouble. If it *cannot*, substitution of another vertical oscillator tube is called for.

An exception must be noted at this point: If the vertical hold control in the test just described can be set to produce momentary cessation of roll *only* at the extreme end of its range, the vertical oscillator *cannot* be absolved of blame.

If trouble in the vertical oscillator is not indicated by the foregoing test, quickly inspect the vertical blanking bar for evidence of sync compression. If such compression is apparent, trouble in any of the stages through which the video signal passes or the agc stage may be the source of the symptoms. Try the tube substitutions in the sync stages that pass the vertical, as well as the vertical *and* horizontal, sync signals.

Some readers may wonder at this point why a tube which passes both vertical and horizontal sync signals should affect one but not the other when it becomes defective. Part of the answer lies in the fact that a sync tube may amplify one type of signal more than the other due to the frequency response characteristics of the stage involved. The presence of a very stable afc circuit may also promote adequate horizontal synchronization even when the horizontal sync pulses are reduced in amplitude, whereas nothing comparable may exist to aid vertical synchronization when the vertical sync pulses become smaller than normal.

Cathode-to-heater or filament-to-grid leakage in an rf or video if stage may be responsible for an impairment of vertical sync. Such leakage decreases the agc voltage and thus tends to introduce sync clipping. Tube substitutions in the stages referred to will test for this source of trouble. In some instances the presence of a rather faint horizontal hum bar in the picture (but not in the raster) will point to such leakage as the culprit. Roll produced by

cathode-to-heater leakage may be intermittent or continuous; it is more likely to be noted on network programs than on local ones.

A weak rf or video if tube may also be the source of vertical sync trouble; insufficient agc voltage is developed in such a case, promoting sync clipping due to overloading.

A weak video amplifier may, by reducing the amplitude of the sync pulse fed to the vertical oscillator, be the cause of roll or vertical jitter.

A loss of emission in an audio output tube can promote roll. In a conventional receiver, unstable vertical synchronization may be caused by overloading, resulting indirectly from the increase in B voltage that occurs when the audio output tube loses emission. When a receiver with stacked tubes is producing roll, the fault may be due to the change in the supply voltage of one or more sync tubes. Such a change is produced when the audio tube is in series with the sync tube(s) and acts as a voltage-dropping resistor; a decrease in its plate current is equivalent to an increase in its resistance.

Low output from a crystal used as a video detector may be the cause of roll. A scope test at the output of the crystal will indicate whether grounds exist for trying a crystal substitution. It is assumed that preceding tubes will be eliminated as a possible cause of low output before the more time-consuming crystal substitution is resorted to.

Rolling due to 6BL7-GT characteristics

Early-make 6BL7-GT type tubes used as vertical oscillators tend to introduce rolling because of design imperfections. Symptoms may be described as follows: the picture is steady for some time after the receiver has been turned on, then starts to roll. The roll can generally be eliminated by resetting the vertical hold control. A short time later, rolling will begin again, generally disappearing when another resetting of the vertical hold control has been made. Stable operation will now follow unless the set is turned off and then on again.

In other cases, the symptom may be slow stabilization of vertical synchronization. A warmup time of 25 to 60 seconds may be necessary before roll stops and stable vertical synchronization is obtained.

The reason why 6BL7-GT tubes sometimes give trouble when used as vertical oscillators lies in their tendency to develop grid emission. Such emission changes the frequency at which they operate, due to the change in bias produced by the emission.

Improved versions of the 6BL7-GT are currently being manufactured; substitution of an improved for an early type tube will in most cases solve the problem. Replacement of the 6BL7-GT with a 6BX7-GT may also be resorted to as a means of eliminating the symptoms. A wiring change will not be necessary when such a substitution is made.

Tube substitutions to improve vertical stability in weak-signal areas

In weak-signal areas, vertical stability can often be improved by substituting higher-gain tubes for the ones present in sync (as well as in video signal-carrying) stages. When a 12AU7 is being used as a sync amplifier, for example, a 12AT7 may be substituted.

Vertical jitter due to lead dress

Sometimes the technician during the course of a tube substitution may move a horizontal yoke or flyback lead too close to the vertical oscillator tube. The resultant coupling of horizontal signals into the vertical circuit may cause the oscillator to trigger at the wrong times, causing a rapid vertical jitter to be produced. The remedy, of course, lies in redressing the improperly placed lead.

Vertical blanking bar in pix

When a steady picture is received in which the vertical blanking bar is visible, the condition may be due to cathode-to-heater leakage in a sync tube. (It's assumed, of course, that the condition cannot be permanently eliminated by suitable adjustment of the vertical hold control.) The vertical oscillator may be prematurely triggering on the hum voltage instead of on the vertical sync signal, causing the blanking bar to appear at the wrong place. To check on the source of trouble, try substituting other tubes for the ones present in the sync stages.

Single vertical pix unobtainable

When lock-in can be obtained only for two or more frames (and not for one), a defective vertical oscillator tube may be present. Try substituting another tube as a test.

Poor interlace

Interlace refers to the meshing of the two fields in every picture frame. Slight defects in vertical synchronization may upset interlace and detail will be lost since the lines of one field will overlap, in part or in full, those of the other, masking out picture information.

A loss in interlace can be readily detected when a test pattern is present by inspecting the horizontal wedges. When a moire (see Fig. 503) is noticeable—i.e., circular movement in the horizontal wedges—interlace is being lost.

In the absence of a test pattern, a loss in interlace may be detected by inspecting the scanning lines of the picture or raster. If the dark spaces between scanning lines are nonuniform in width (most obvious when two successive spaces are compared) or the spaces are too wide, interlace is imperfect. See Fig. 504-a,b. The condition will also affect the vertical retrace lines, causing these to pair off. Advancement of the brightness control to the point where the retrace lines become visible will permit their inspection.

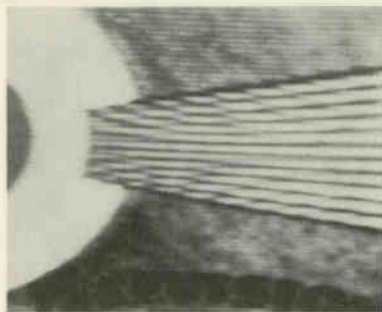

Fig. 503. *Mottling of the horizontal wedges (moire effect) due to poor interlace.*

The first thing to check when interlace is imperfect is whether the setting of the vertical hold control is correct; improper adjustment may be responsible for impaired interlace. If resetting of the control does not clear the trouble, the corrections referred to in the paragraphs following may be made.

Sync compression due to slight overloading in an rf or video if amplifier can be the reason for poor interlace. When the compression present reduces the vertical sync pulse amplitude to the point where proper sync separator action is prevented, video signals will get through the separator from time to time, causing a correspondingly intermittent loss in interlace. Defective tubes in rf or video if or amplifier stages may be the cause of overloading and loss of interlace; a defective agc tube can also create these symptoms. Check these tubes by substitution if inspection of the blanking interval in the picture indicates that overloading exists.

A loss of emission in a sync tube can reduce the vertical sync pulse to a level where it will provide proper oscillator triggering only over a smaller-than-normal vertical hold control range. Loss of interlace due to an improper setting of this control therefore

becomes more likely under such circumstances. Insufficient output from a sync tube, due to reduced emission may also lead to improper sync separation. (Proper sync separator action depends on the feeding of an adequately large sync pulse to the input of the

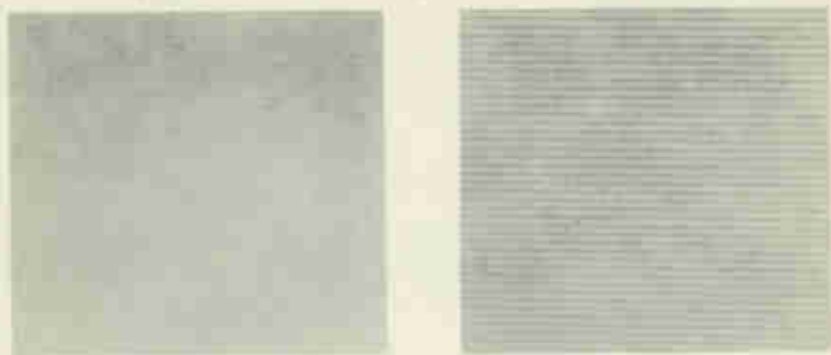

Fig. 504. Good interlace is shown in the photo at the left, but in the photo at the right the scanning lines of one field fall over those of the second field. The dark spaces between lines become wider, more visible.

separator.) Video signals may get into the vertical oscillator as a result, causing intermittent losses in interlace. The presence of undesired video signals in the input to the vertical oscillator is particularly likely if interlace becomes improper only when a large area at the bottom of the picture suddenly becomes dark due to a change in scene. Check sync tubes by substitution to determine if such temporary losses in interlace are due to a weak or otherwise defective sync tube.

An intermittent loss in interlace may cause a slight vertical jitter in the picture. Or it may produce a rather rapid pairing and unpairing of the horizontal scanning lines.

Intermittent losses of interlace may occur when noise is present in excessive amounts. Holes may be punched into the sync signals by the noise. If a hole occurs during vertical sync pulse time, proper triggering of the vertical oscillator will not take place at this time and interlace may thus become improper. Check for noisy tubes or a defective anti-noise tube when interlace is not normal, particularly when waveform tests in sync stages indicate that excessive noise is present. (See Fig. 505).

A continuous impairment of interlace may be due to the entrance of horizontal sweep signals into the vertical oscillator. The condition may be the result of improper lead dress or the absence of a shield on the vertical oscillator tube, among other things. Leads most likely to cause trouble are the plate leads of the horizontal amplifier, the high-voltage rectifier and the "hot" lead of

the horizontal yoke. Be careful not to change the original placement of such leads during a tube substitution. A missing shield is

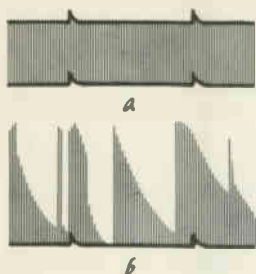

Fig. 505. (a) Normal sync waveform. (b) Sync waveform with holes punched in it.

most likely to produce symptoms when a metal picture tube is used. This type of tube is an effective radiator of horizontal sweep signals.

Horizontal sync trouble

When horizontal synchronization is completely absent and cannot be brought in by manipulation of the horizontal hold control (see Fig. 506), trouble in the afc or horizontal oscillator section is indicated. A defect in one of the sync stages through which both

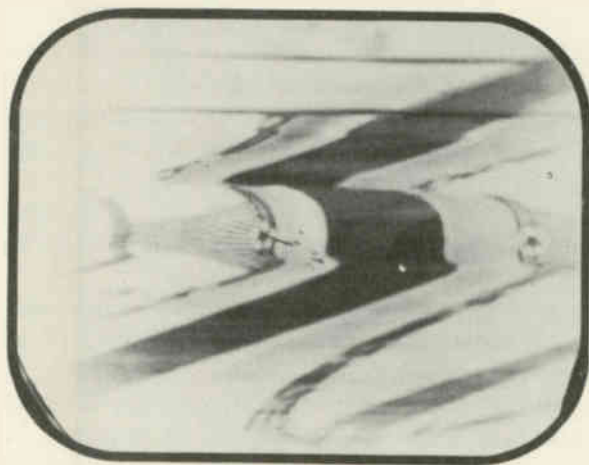

Fig. 506. Complete loss of horizontal synchronization.

vertical and horizontal sync pulses pass may also be the cause. Substitute tubes in these sections to check on this possibility.

If it is possible to remove the afc phase-control tube without disabling the horizontal oscillator or eliminating the picture, a preliminary localization test may be made. To make such a test, withdraw the afc tube referred to and see if a single stationary or almost stationary picture can be brought in. If it can, the horizon-

tal oscillator stage is normal and trouble in the afc or sync is likely.

Horizontal sync instability

A slight horizontal movement of the entire picture, or a section of it, may be due to overloading. Overloading tends to cause sync compression which reduces the height of the sync pulse with respect to the rest of the composite signal. The vertical or horizontal blanking interval may be inspected on the screen for evidence of compression as described previously. If compression is noted,

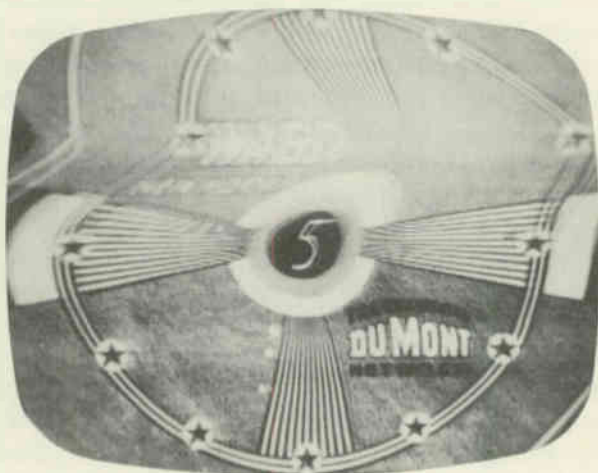

Fig. 507. A case of severe picture "hook" in the test pattern.

overloading due to an agc tube defect or a fault in any of the video signal-carrying stages may be responsible. Substitute tubes in these stages as a check. If compression is *not* noted, substitute tubes in sync stages as a test for trouble here.

Horizontal instability is particularly likely to be caused by a defective reactance tube. Some 12AT7 tubes used in such applications tend to develop grid emission, causing the horizontal oscillator to drift off frequency, thus introducing unstable synchronization. Presence of a positive-going grid voltage with the coupling capacitor disconnected will indicate whether the tube is causing such trouble.

A microphonic tube in the horizontal section may cause horizontal instability. To test, gently tap each of the horizontal-section tubes in turn. If the trouble is intensified when one of these tubes is struck, substitute a new tube and note results.

Horizontal pulling

A certain type of horizontal movement in the picture (see Fig. 507) is referred to as pulling, snaking, bending, hooking or S distortion. Straight vertical sides of objects in the picture are bent when such a defect is present. This should not be confused with tearing, wobble or jitter.

Loss of emission in an afc or other sync tube is a likely cause of pulling and should be checked for by tube substitution.

Cathode-to-heater leakage in an rf amplifier or video if tube may be the source of horizontal pulling. Try replacing such tubes as a test, particularly when hum bars are present on the screen. Cathode-to-heater leakage in sync or horizontal sweep tubes may also be responsible for the trouble. Cathode-to-heater leakage in the damper can very easily pull the raster into the shape of an S.

Pulling of the upper third of the picture is not infrequently due to cathode-to-heater leakage in the horizontal output tube. A similar bending or curling at the top of the picture may also be due to cathode-to-heater leakage in the horizontal oscillator.

Grid emission or the formation of gas in a tuner, video if or sync tube can cause pulling. This problem generally occurs after the receiver has been in operation for some time. If bottom-chassis checks can be made readily, the presence of such a defect may be verified by testing (1) the voltage drop across the agc resistor and (2) the grid voltages of suspect tubes not controlled by the agc system. The voltage drop measured across the agc resistor should not appreciably exceed 0.5 if it has no dc return to ground. A drop exceeding this points to the presence of gas in one of the tubes fed by the agc line. The grid voltages of suspect tubes outside the agc system should be adequately negative with respect to the cathode.

Pulling or picture hook may be due to a defective crystal that introduces sync compression. A dark picture will often be an associated symptom. If a scope waveform check of a crystal detector reveals that the sync portion of the composite video waveform is compressed, try a new crystal in place of the original one.

When the area in which pulling occurs varies with changes in scene, improper sync separation is indicated. Change the sync separator tube to determine if the trouble lies here.

Some 12AU7 tubes used as horizontal oscillators have a marked tendency to introduce a bend in the picture. The bend may be either stationary or move slowly up or down. Leakage between the filament and another element in the tube is responsible for the symptoms. Some 12AU7 tubes are much more prone to de-

velop this condition than others; it is therefore desirable that (1) several makes of tube be tried in making substitutions and (2) several samples of the best make be tested in the set to obtain a tube with the smallest possible leakage.

Elimination of pulling in cases where the strength of incoming signals is excessive may sometimes be obtained by judicious tube substitutions. Use of lower-gain tube types in sync stages is a logical remedy when overloading of such stages is causing the trouble. Tubes with less "hop" may also be tried in video if stages when overloading of these stages is not due to a tube or circuit fault. Such substitutions are, of course, not recommended in locations where weak as well as strong signals are received.

Horizontal tearing

When regular portions of picture information are displaced at the left side of the image, try substituting a new horizontal oscillator tube. If the picture tears horizontally toward the right side of



Fig. 508. Tearing out of lines at the top of the picture. The condition may be intermittent or practically continuous.

the screen, look for a defective horizontal output tube. A defective horizontal amplifier may also be the source of trouble when entire sections of the picture are displaced. Displacement of regularly spaced segments of picture information from the picture proper is likely to be caused by a damper tube defect.

Tearing out of lines at the top of the picture (Fig. 508) is due to insufficient agc voltage. If the contrast and agc control settings are correct, substitute a new agc tube or tubes.

Tearing, particularly intermittent tearing, may be due to a

noisy signal-carrying tube—i.e., an rf or video if, detector or amplifier tube. Tapping and/or replacement tests of tubes in such stages may be employed to locate the source of trouble. Horizontal tearing may also be produced by a defect in a sync or horizontal circuit tube.

Filament-to-cathode or filament-to-grid leakage in an rf or video if tube may cause tearing out of several horizontal lines. Hum shading may not be apparent in the picture when such leakage is present, particularly if the leak is a high-resistance one. Filament-to-grid leakage in 6CB6 tubes used in video if stages can be the cause of line tearing and should be checked for by tube substitution.

When line tearing is present in a receiver using an anti-noise tube, such as a noise canceller or noise inverter, replace the tube and note results. Inoperation of such tubes sensitizes the receiver to noise.

Tearing may sometimes be due to grid-to-cathode leakage in the picture tube. When no other sources of trouble can be uncovered, substitute a good tube and note results.

Tearing out of several lines may be due to a corona discharge taking place at the picture tube or elsewhere. To determine whether corona is responsible for the tearing, inspect waveforms in sync stages with the high voltage first connected and then disconnected. If noise pulses are associated with the sync pulses only when the high voltage is connected, corona is indicated. Localization of corona trouble is described in a separate chapter.

Corona due to improper spacing of the high-voltage rectifier's socket lugs may produce lines in the picture (Fig. 509) similar to those produced by auto ignition interference. Inspect the tube socket terminals of the high-voltage rectifier to check on this source of trouble.

Horizontal jitter

When sideways picture jitter is encountered, a preliminary check should be made of the adjustment of the contrast, horizontal hold and afc controls. If the jitter is associated with displacement of sections of the picture, a new horizontal amplifier should be tried. Horizontal jitter may be due to a defective horizontal oscillator or a noisy or microphonic tube in the rf, video if, video or sweep sections of the receiver. Horizontal jitter (Fig. 510) may be due to cathode-to-heater leakage in a sync tube. Yoke leads may accidentally be dressed too close to the picture-tube grid lead during a tube replacement, introducing jitter. Separate the leads.

Symptoms associated with controls

When horizontal lock-in of the picture is obtained only at the mid-setting of the horizontal hold control and a loss in sync occurs

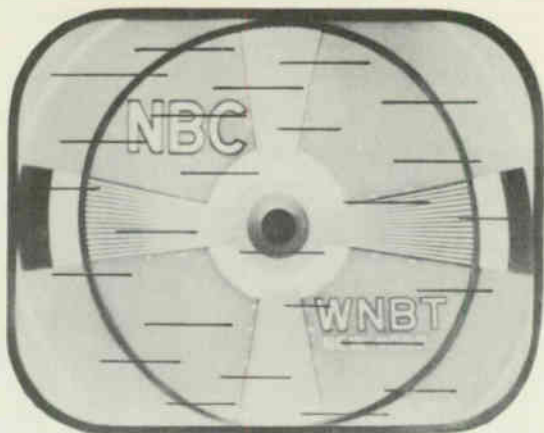

Fig. 509. Lines in picture due to auto-ignition interference. The picture has been retouched to emphasize the effect. Similar lines may be caused by corona trouble at the high-voltage rectifier socket.

at either side of this setting, trouble in the afc section is indicated. Try new tubes in this section, starting with the sync discriminator.

When poor horizontal synchronization is associated with an appreciable decrease in the lock-in range of the horizontal hold control, trouble in the sync separator, amplifier or limiter is likely. A defective afc tube can also be responsible for these symptoms.

If the horizontal hold adjustment is very critical, a defective agc or afc tube may be to blame. Critical hold and unstable sync may also be the result of a drop—even a small drop—in line voltage. Testing the set on a variable source of line voltage will help the service technician determine if this is actually the trouble. Replacement of the horizontal oscillator with a tube having reserve emission—i.e., greater emission capabilities in the presence of reduced line voltage—will often remedy such a condition.

Miscellaneous horizontal sync symptoms

When horizontal synchronization becomes normal only after a long warmup period, low emission in the afc or horizontal oscillator tube may be present. This is especially likely when the two are dual sections of one tube. A faulty selenium rectifier in the set's low-voltage power supply may also be the culprit. A voltage check will reveal whether the selenium rectifier output is below normal during the long warmup interval.

An erratic picture that shifts from left to right calls for substitution of the afc tube (s) present.

The presence of vertically moving notches in the picture and raster may be due to a defective damper, particularly when this tube is a 6AS7-G.

If the picture is stable to begin with but loses phase and finally tears out completely in the horizontal direction, a loose grid cap



Fig. 510. Horizontal jitter or weaving. The trouble in this case was due to a short between cathode and heater of a sync clipper-amplifier tube.

on a 6BG6-G type of horizontal amplifier may be the source of trouble. Reheating the cap will generally cure the defect. Try this only if a tube substitution has definitely localized the fault to this tube.

Poor or missing horizontal synchronization may be due to a gassy picture tube—try another tube as a test if no other source of trouble can be located.

A defective horizontal output tube may cause circles in the test pattern to resemble cogwheels and be responsible for vertical or diagonal lines looking jagged.

A horizontally out-of-phase picture (Fig. 501) that cannot be made normal by suitable manipulation of the horizontal hold or afc control points to a defective afc section. Substitute tubes in this section to check on this possibility.

Improving horizontal sync stability by tube substitutions

In fringe locations, an improvement in horizontal synchronization will be effected if higher-gain tubes are substituted in video signal-carrying stages. A 12AU7 video amplifier tube may, for instance, be replaced by a 12AT7.

Flashes in picture

When flashes in the picture are observed in receivers using a cascode type tuner, the rf amplifier (generally a 6BK7-A, 6BQ7-A, 6BZ7 or similar tube) is often responsible. Less frequently, a defect in the converter tube can introduce the symptoms. A tuner tube fault (intermittent short) is particularly likely if the flashes or white streaks seen in the picture decrease in intensity as the set warms up.

To determine quickly whether the tuner or some other section is the site of the defect, switch the receiver to a blank channel. If flashing is no longer seen, a tube in the front end is most probably the cause of the trouble. When flashing persists at the blank channel setting (as well as on every other channel) there may be a bad horizontal output, damper or front-end tube. Defects in the damper tube may, in certain receivers, cause popping sounds in the speaker as well as flashes in the raster and picture.

"Christmas-Tree" effect

In the presence of certain defects, the picture and raster may break up into several sections of varying width. Their faint resemblance to a Christmas tree has led to the symptoms being labeled "Christmas tree" effect. When the breakup is more severe, the raster may disintegrate into a series of bright horizontal lines that cover the central portion of the raster (Fig. 511) and occupy about 50% of the normal raster area. A loud singing or frying noise coming from the horizontal output transformer often accompanies the symptoms just described. These symptoms, incidentally, are most often seen (in certain cases of trouble) when the station selector is set at an unoccupied channel or when channels are switched.

Since the symptoms effectively represent a loss of synchronization we are grouping Christmas-tree effect with other sync troubles. One possible cause of the condition is regeneration in the video if amplifier section. In such cases, when the station selector is set to an assigned channel, a vertical band *may* be seen at the left edge of the picture. This band or bar contains diagonal stripes of varying width; the stripes are alternately light and dark and cause the bar to resemble a barber pole.

Try replacing the tubes in the video if and agc sections to determine whether a defective tube here is responsible. A defective tube in the afc section may also produce a Christmas-tree effect and should be checked. The author knows of one case where a weak video amplifier was responsible for the condition, apparently

because the sync pulse input to the afc section was inadequate. A bad vertical oscillator or amplifier tube may be the source of the trouble. So can arcing in the high-voltage rectifier socket.

Placement of horizontal yoke leads too close to the picture-tube may cause horizontal sweep signals to be coupled into its input

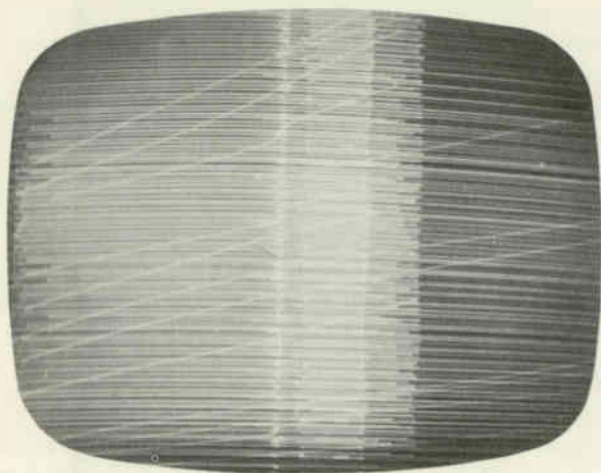

Fig. 511. "Christmas-tree" effect.

(which is effectively part of the output circuit of the video amplifier); from there, these signals may get into the sync stages and produce a Christmas-tree condition. Proper lead dress will remedy such trouble.

Raster sides rough

A raster that looks very rough at both edges may be produced by parasitic oscillation in the horizontal amplifier. We are grouping this symptom with other sync troubles because it may be incorrectly diagnosed as a sign of sync noise.

interference

IN this chapter, interference line and bar effects will be considered. The lines and bars are those created by Barkhausen oscillation, microphonics, radiation from various tubes and other troubles. Picture and raster hum bar symptoms, vertical bars in the picture and microphonics will also be described.¹

TVI due to missing or improperly grounded tube shields

The absence or improper grounding of shields on the following tubes can cause interference: last sound if, last video if, sound and video detectors. Harmonic signals are generated in these tubes that may be radiated back into the TV front end. When the undesired signals fall into the passband of an assigned TV channel, the harmonics may beat with the rf picture or sound carrier, producing herringbone or other interference patterns on the screen. These patterns will vary in step with the sound being received.

To determine whether TVI is due to radiation from a sound tube, remove one of the tubes in the sound if section. If the interference disappears from the screen, a harmonic of the sound if is most probably getting back into the tuner. (Use a dummy tube for series string receivers.)

To check on whether interference is due to radiation from an unshielded last video if or video detector, connect one end of a short length of shielded wire (Fig. 601) to one of the antenna input

¹ Since, in this book we are primarily concerned with tube troubles, outside sources of TVI will not be discussed.

terminals. Hold the other end close to the last video if or detector tube. Approximately 1 inch of wire should protrude from the shield at each end and the shield itself should be firmly attached to the receiver chassis. If the interference is intensified by the increased coupling, radiation from the last video if or video detector is indicated. When the source of interference is a sound or video

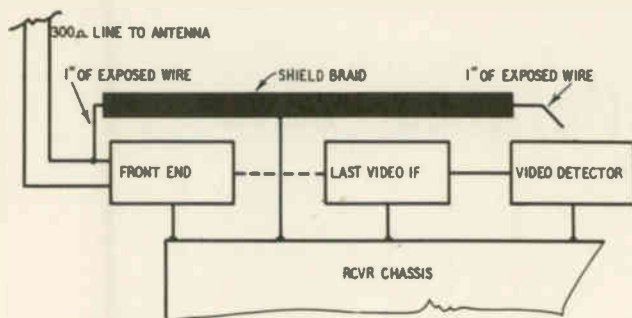

Fig. 601. Technique for checking the source of radiation interference.

tube, add a shield if one is missing or check the ground connection of any shield present.

Radiation from horizontal output tube

In fringe areas the reduction in voltage generally associated with weak incoming signals increases the sensitivity of the receiver. The increased contrast setting also brings up receiver gain. For both reasons, formerly invisible, internally caused TVI may be amplified to a point where it becomes troublesome.

One such condition is due to radiation of harmonics of the 15;750-cycle sweep signal from the horizontal output tube. The interference manifests itself as a floating disturbance whose shape and form vary from set to set. The area of interference is on the right side of the picture-tube screen. The symptom is, in many cases, seen only when the receiver is switched to an unused channel (the agc voltage is then least and receiver sensitivity is maximum). If the interference persists when a station is tuned in and readjustment of the horizontal drive control does not eliminate it, try another horizontal output tube.

"Tweets" due to defective video detector crystal

A herringbone type interference pattern that varies with changes in picture modulation and is caused by the entrance of harmonics from the video detector into the front end, is often referred to as

"tweet" interference. A defective crystal may be its cause. The symptoms may occur on some channels as the fine-tuning control is varied. Replace the crystal to test for as well as eliminate this source of trouble.

Barkhausen oscillation

The most notorious interference produced by the horizontal output tube is Barkhausen oscillation. It causes radiation from the horizontal amplifier to take place; the radiated signal is picked up

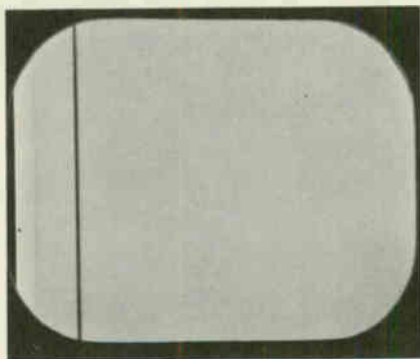

Fig. 602. Appearance of Barkhausen oscillation in the raster.

by the front end or video if section and amplified in succeeding stages. The condition generally manifests itself as one or more vertical black lines on the left-hand side of the screen (see Fig. 602). The lines may appear white if the oscillation is relatively weak.

In some cases, the line will be visible only in the raster; in others, they will be apparent, to a greater or less degree, in the picture as well. They will often be most evident on weak channels since the gain of the rf amplifier is maximum at such settings.

Barkhausen lines will generally change in width and intensity if channels are switched or the brightness setting is altered. They are most noticeable, as a rule, at the higher-frequency channel settings and when the brightness setting is low. When Barkhausen oscillations are severe, synchronization may be upset.

Barkhausen oscillation generally gives trouble when the receiver uses a built-in antenna. A built in antenna often necessitates a higher contrast setting in the receiver since its signal pickup is poor; furthermore, the built-in antenna is positioned close to the horizontal output circuit. For both reasons, pickup of Barkhausen oscillation tends to be maximum in such sets.

One way to determine whether Barkhausen oscillation is present is to loop a section of the lead-in (see Fig. 603) and hold it near the horizontal output tube. If the intensity of the lines increases or if they change from white to black, Barkhausen oscillation is causing them. Another test consists of putting a magnet (ion magnet or a pm speaker core) near the horizontal amplifier tube. If symptoms are diminished or disappear, they are due to Barkhausen oscillation.

In some instances, a slight change in the setting of the horizontal drive control will make the symptoms unnoticeable. When such a resetting provides no solution, an ion magnet or a commercial

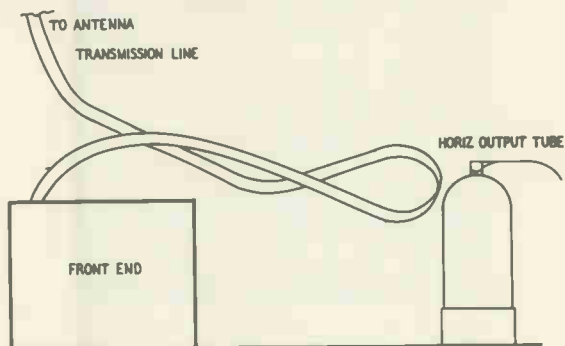

Fig. 603. Bringing the loop near the horizontal-output tube will increase the intensity of Barkhausen lines.

anti-Barkhausen magnet (Fig. 604), may be placed around the horizontal output tube in such a position that the symptoms are eliminated. The output tube can also be replaced to cure the condition. Don't discard the original tube—it will probably function normally in some other set.

In a few instances, a condition closely resembling Barkhausen oscillation has been produced by a defective plate-cap connection on a 1B3-GT high-voltage rectifier tube.

Other vertical-line troubles

Radiations from the horizontal amplifier may produce a vertical black beady line or lines at the left side of the picture or a dotted line at the left or right side of the picture. Vertical lines at the right side can also be due to spurious oscillations or other defects in the horizontal oscillator and damper tubes. Substitute tubes to test for the trouble in each case.

A defective horizontal output tube may produce a condition in which the right edge of the raster begins to pull toward the center

of the screen several minutes after the receiver has been turned on. This right edge takes on the appearance of a steadily broadening milky line, due to a loss in focus toward the end of the horizontal trace. Nonlinear operation of the horizontal amplifier is probably the cause of the trouble.

One or more faint white stripes at the left-hand side of the raster are the normal products of a slight amount of ringing in the

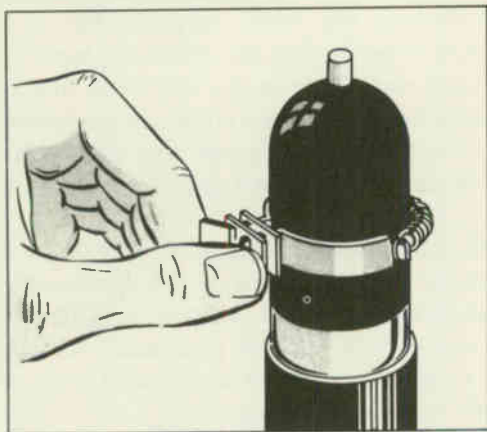

Fig. 604. Barkhausen oscillation eliminator. The magnet is placed over the horizontal-output tube.

yoke; they are unnoticeable in the picture under normal circumstances. When the stripes are intense enough to be noticeable and a resetting of the horizontal drive control does not eliminate them, try changing the damper, horizontal amplifier and other horizontal circuit tubes. When two horizontal amplifier tubes are present, change both at the same time and then readjust the horizontal drive trimmer for best results.

The appearance of one or more vertical lines at the left side of the picture may be due to spurious oscillation in the horizontal oscillator or damper tube; try tube substitutions as a test. Lines or bars produced by damper trouble are most often white. In some cases, trouble in the damper will produce light and dark vertical bars at the left-hand side of the raster. Linearity and width are often impaired when damper trouble is present.

Vertical lines due to improper lead dress

Vertical lines in the picture may be introduced by accidental changes in lead dress during tube tests. The service technician should be particularly careful to avoid bringing picture-tube cathode or grid leads close to the horizontal output tube.

Vertical white line due to failure of horizontal retrace blanking tube

In some TV receivers a horizontal retrace blanking circuit (Fig. 605) is employed. A circuit of this type eliminates the effects of *sync overshoot* at the transmitter. Sync overshoot refers to a narrow spike that is created at the transmitter by the sync pulse and directly follows it. The spike is opposite in polarity to the sync pulse and extends into the white region. Since it effectively un-blanks the picture tube during the blanking interval, it becomes visible as a vertical white line at the left-hand side of the picture. The line generally has a jagged or irregular appearance due to the fact that noise is associated with the sync pulse. It may become readily visible if the horizontal retrace blanking tube becomes defective.

The symptom may be differentiated from similar ones produced by damper trouble by manipulating the horizontal hold control. If the line is caused by sync overshoot, it will shift its position when the horizontal hold control is rotated. Another clue to the source of such trouble lies in the fact that it will generally manifest itself on only one particular channel.

Change the horizontal blanking tube (if one is used in the receiver) when the symptoms just described exist.

"Spook" interference

"Spook" interference is likely to be generated when the enclosure in which the damper tube is often located is not adequately shielded from the rest of the receiver. Radiation of high-frequency harmonic signals from the damper to rf and video if stages is responsible for this condition. The interference shows itself in the picture as a narrow vertical line that is positioned very close to the left-hand margin of the picture or raster. The line resembles the one produced by Barkhausen oscillation. In the presence of a weak signal, the line is black and its edges are ragged. When the signal is relatively strong, the line tends to break up into small, crawling diagonal lines. The line is not usually visible because it falls beyond the mask or in the blanked-out portion of the picture. Spook TVI may cause sync instability as well as the symptoms just described.

To avoid introducing such trouble during tube replacement tests, make sure that the high-voltage section in which the damper is generally found is properly shielded at all times.

Radiation from audio output tube

Symptoms similar to those produced by auto ignition noise may be due to radiation from the audio output tube. Since the symptoms are continuous rather than intermittent as in the case of igni-

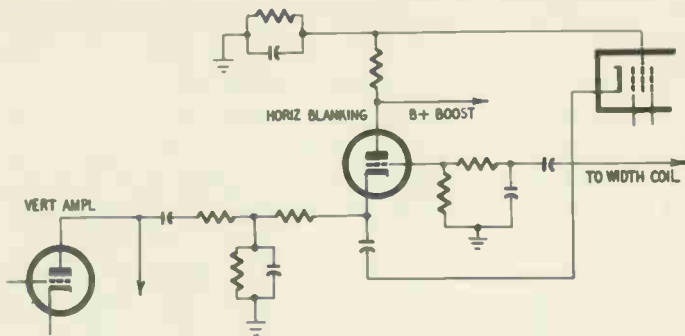

Fig. 605. Horizontal retrace blanking circuit. A sample of the fly-back pulse is fed to the grid of the horizontal-blanking tube. A positive voltage is sent to the picture tube cathode through a capacitor and cuts off the picture tube during horizontal blanking time.

tion TVI, the two conditions may readily be differentiated. Replacement of the audio output tube will, in some cases, eliminate the trouble.

"Snivets"

"Snivets" are black vertical lines that appear in the raster and sometimes in the picture as well on channel settings. The condition is caused by signal radiation from the horizontal output tube. The undesired signals are picked up by the tuner. Snivets in the raster are often masked by the incoming picture signal. When the incoming signal is not strong enough to override the interference, try changing the horizontal output tube. A different tube may either eliminate them or else move them to a portion of the spectrum to which no station is assigned.

Microphonics

Microphonic effects are disturbances in the picture and/or sound produced by undesired mechanical vibrations of tubes or other components. Since this book deals primarily with tubes, we will restrict ourselves to a consideration of tube-caused microphonics.

Microphonics are usually produced by the feedback of sound energy from the speaker to one of the receiver tubes. An undesired mechanical vibration in a tube is reinforced by this sound energy,

causing the vibration to become self-sustaining in many cases. The signal in the tube affected is modulated by the microphonic, due to changes in interelectrode capacitance, gain or other factors.

Sound energy from the speaker may get to the microphonic tube indirectly via mechanical coupling through the chassis and cabinet or directly through the impingement on the tube of the sound waves created by the movement of the speaker cone.

All tubes are microphonic to some extent; it is the job of the set designer to isolate from the speaker those tubes most likely to give trouble. In rare instances, where the tube layout is not satisfactory in this respect, remedial steps will have to be taken by the service technician.

Split-carrier receivers are generally more inclined to produce troublesome microphonics than intercarrier sets. The likeliest source of microphonics in the split-carrier set is the rf oscillator. The symptom generally produced is a howl or whistle when the volume control is at a moderate to advanced setting; noise may also be heard in the speaker when channels are changed. Symptoms stop when the volume control setting is reduced.

To test for as well as remedy the microphonic condition, try substituting tubes in the oscillator stage. Several tubes should be tried since even new tubes may be microphonic to an extent undesirable in any particular application. Test the operation of the new tube on the station at which microphonics have been most troublesome, and with the volume control setting well advanced. The test should be made with the chassis in its cabinet under conditions of normal operation.

In both intercarrier and split-carrier sets, a microphonic front end, video if or video amplifier tube may produce black horizontal bars in the picture. Similar bars can be produced by a microphonic vertical output, horizontal oscillator, afc tube or even the picture tube. To determine whether the symptoms are due to a microphonic, turn down the volume control. If the symptoms disappear, the trouble is probably (though not always) of microphonic origin.

The condition just described is intermittent and should not be confused with the continuously present sound bars introduced into the picture when the fine-tuning control is not properly adjusted (it is assumed an audio signal is being received). Horizontal bars due to microphonics will appear in the picture when the receiver chassis is tapped or when sounds of loud volume are heard. The bars will usually vary in width and their intensity will fluctuate in step with the amplitude of the audio signal.

When a microphonic vertical amplifier is the source of the trouble, alternate light and dark horizontal bars, approximately $\frac{1}{4}$ inch thick, may be seen in the picture. Other symptoms that can be produced by microphonics are quiver in the picture, as if the image were about to be pulled out of horizontal synchronization, and excessive "grain" in the picture. Microphonic tubes in the front end or video if stages are particularly capable of producing such symptoms.

To determine which tube is at fault, try tapping each suspect lightly with the rubber end of a lead pencil or a light screwdriver. When tapping one tube—and *one tube only*—causes the condition to appear or become worse, replace the tube and note results.

If no microphonic tube can be found by these tests, the possibility that inadequate filtering in the audio stages is the cause of the trouble may be quickly checked by opening one voice coil lead. If the bars previously seen in the picture remain, filtering trouble is probably to blame; if the bars disappear, however, microphonics are definitely present and should be checked further. Don't permit the receiver to operate with the voice coil disconnected for more than several seconds to avoid damaging the audio output transformer.

There are a number of remedies that can be tried when a microphonic condition involving a tube is not eliminated by tube substitution (or proper seating of the tubes in their sockets).

When an inspection reveals that the socket pins may be loose, try tightening them with a thin pointed tool. Loose contacts promote microphonics.

In some instances, placing a tight-fitting lead weight over the rf oscillator will clear up a microphonic; in others such a weight may prove more of a liability than an asset. Try removing it (leaving the sheet metal shield around the oscillator in place, however) and note results.

Reversal of the leads going to the speaker voice coil may eliminate a tendency to microphonics in certain receivers.

An effective way of getting rid of low-frequency microphonics is to mount the speaker on rubber or felt. One practical way to do this is to insert rubber washers between the speaker rim and the cabinet. There should be no solid connection between the speaker and the cabinet at any point. For best results, leave a gap no more than $\frac{1}{4}$ inch wide between the edge of the speaker frame and the cabinet section it formerly contacted. (The slight change in the audio response that results will hardly be noticeable.) Before resorting to this expedient, the service technician should first test

set reception with the speaker out of the cabinet and at some distance from the chassis. If such a placement of the speaker eliminates the microphonics, shock-mounting of the speaker in the manner described becomes a logical succeeding step. Relocation of the speaker, when this is practical, will cure many stubborn cases of microphonics.

A socket shock mounting (floating a tube socket on rubber spacers) can be used in those instances when speaker relocation is not feasible and a microphonic-prone tube is positioned too close to the speaker. One set manufacturer, for example, recommends



Fig. 606. *Sound bars in the picture.*

shock-mounting of the 6BL7-GT, a tube used in his receivers as a combination vertical oscillator and amplifier, when a microphonic condition is traced to this tube.

A simple cure for some cases of microphony is to slip a rubber sleeve (the rubber cushion from an old auto-radio vibrator will serve in many instances) around the microphonic tube.

There are cases where a tendency to excessive microphonism is strengthened by the absence of a good connection between the shield envelope of a metal tube used in a video if stage and ground. Make sure that the socket contact going to the tube shield pin is grounded to chassis when a microphonic metal tube of this kind is located. An above-chassis check can be made to verify whether this ground exists by scraping away the paint at the top of the metal tube and connecting a wire between this scraped-off area and chassis. If the signal strength increases, either there is no connection or the tube construction is defective.

Sound in pix

Possible causes of sound bars in the picture (Fig. 606) other than microphonic tubes are few if we exclude circuit troubles. A defective video detector crystal may be one such source—the correct tuning point may no longer coincide with the point where sound ripple is absent. The crystal used as video detector should be checked by substitution if sound appears in the picture when the fine-tuning control is adjusted for optimum resolution and likelier sources of trouble have been eliminated.

It is worth noting that a crystal that is just beginning to deteriorate will, in this early stage, often produce sound bars in the picture. Further deterioration will result in weak or no picture and/or loss of synchronization.

Improper dress of speaker leads that brings them too close to the video detector may in some instances be the cause of sound

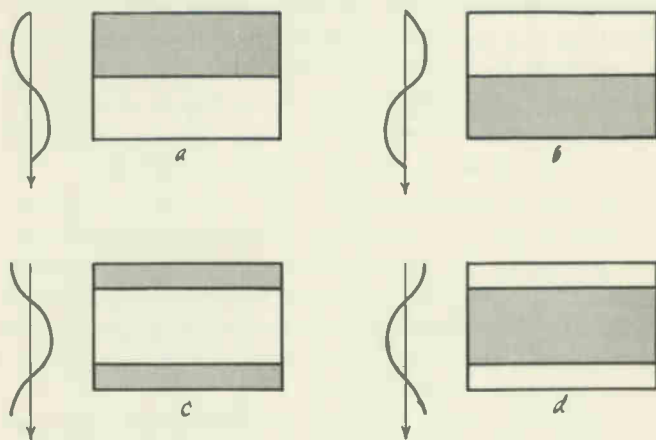

Fig. 607. Bar patterns that may be seen when a 60-cycle hum signal reaches the picture tube. Which pattern will be seen depends on the phase of the hum with respect to the line voltage. Drawings a and c show a 90° phase difference. The drawings in b and d show the effects of reversing the line plug.

bars in the picture. Avoid introducing such a condition during tube replacements. The source of trouble can be readily determined—as well as cured—simply by rerouting the leads and noting results.

Hum bars in picture and raster

Tube-caused hum is often due to heater-to-cathode leakage and less frequently to leakage between filament and grid. In either case, a 60-cycle modulating frequency will affect sweep, sync or video signals. Symptoms produced include: horizontal bars (shad-

ing) in the picture, wavy raster edges, horizontal picture pulling, vertical roll, hum in sound and complete loss of picture.

Horizontal bars due to 60-cycle hum may cause the picture to have a dark bar over approximately half of its vertical area and a light bar over the other half. See Fig. 607. Or else a single prominent hum bar—either light or dark, depending on the polarity with which the line plug is inserted into the outlet—will be visible. Closer inspection will reveal that the shading of the picture sections not covered by the bar is improper (too light when the bar is dark; too dark when the bar is light).

To verify whether cathode-to-heater leakage rather than some other trouble is responsible for the symptoms present, reverse the line plug. If the bar shading reverses—i.e., goes from light to dark or vice versa—the presence of cathode-to-heater leakage in a tube becomes practically certain.

The section containing the defective tube may be located as follows: Remove the last video if tube from its socket, leaving the contrast control at its normal setting. If the symptoms are still seen in the raster, the trouble lies in the video detector, video amplifier or picture tube. (In older receivers, if a dc restorer is present, it must be included among the possible suspects.)

Pull out the video amplifier tube next (unless it is direct-coupled to the picture tube). If the hum symptoms persist, the picture tube is most probably the villain. If the symptoms disappear, try a new video amplifier. If this does not restore conditions to normal, withdraw the video detector from its socket. If the hum effects are no longer visible, the trouble probably originates in the video detector; try a new tube, to verify this.

When the video amplifier is direct-coupled to the picture tube withdrawing it may upset picture-tube bias to an extent where it proves difficult to interpret test results. Simply substitute tubes in the video stages in such a case to check for the source of hum.

If hum symptoms disappeared when the last video if tube was withdrawn, cathode-to-heater leakage in an rf or video if tube is indicated. Try new tubes in these stages as a check. If the receiver is out of its cabinet, the following bottom-chassis tests may be performed to localize the trouble further before tube substitutions are made.

Momentarily short the cathode resistor of each tube in the video if and rf stages. (In the case of a front-end tube whose socket contacts are not readily accessible, either use an adapter that makes them available or else withdraw the tube being tested slightly from its socket and short the cathode prong to chassis with a wire.) When

a stage is reached in which such a short eliminates the hum symptoms, cathode-to-heater leakage probably exists in the tube of that stage.

The procedure just outlined cannot, of course, be used in those cases where shorting a cathode to ground impairs receiver operation to a point where the test results cannot readily be interpreted.

Some service technicians may conclude that the presence of hum symptoms in the raster means that the rf and video if stages cannot be the source of the trouble. Their reasoning is that these stages can pass a low-frequency signal such as hum only when it modulates the high-frequency signals which these stages are designed to accept. This is accurate only if the input signal has been killed by reducing the contrast setting to zero or by shorting the antenna input. If this has not been done, however—if the raster is, let us say, inspected on an unassigned channel, and the contrast setting is up—hum may get through by riding in on top of noise or spurious signals, thus causing raster shading. Incorrect deductions regarding the section causing the hum may result. Reduce the contrast setting to zero and/or short the antenna input to avoid making an error of this sort during a raster inspection.

It is worth noting that a hum bar caused by 60-cycle modulation of the transmitted signal (the condition present when cathode-to-heater leakage exists in an rf or video if amplifier) will be stationary if the station tuned to is being operated from the same line-voltage source as the receiver. In some cases, however—a network telecast, for instance—this condition may not be present. The hum bar will roll up or down the picture under these circumstances.

Intermittent or continuous vertical roll, horizontal pulling and/or hum in the sound may be associated with the hum-caused bars previously described.

In some instances, hum bars of the type just considered may be due to cathode-to-heater leakage in a sync tube. This can occur when the circuit permits a feedback of the hum signal to the video detector or amplifier. Many service technicians may overlook such a possibility because hum-caused raster shading is generally associated with cathode-to-heater leakage in the rf, video if, detector, video amplifier and picture tubes only.

Another possibility that may be overlooked is cathode-heater leakage in an agc tube. The 60-cycle hum signal will be fed to the grids of the agc-controlled tubes and will receive passage through the various stages by modulating any rf or if signals present. Tube substitution (rather than a tube-tester check) should be used in

this case, as well as the others cited, to determine the source of the trouble. In some instances, tube testers may not reveal small leakages that are nevertheless large enough to cause trouble.

When cathode-to-heater leakage in a video or picture tube is severe, a complete or almost complete loss of video information will result, leaving only the hum bars visible. In less severe cases, leakage between cathode and filament of a C-R tube can produce a light, faded picture overlaid by retrace lines. The brightness control may have no noticeable effect on the picture in such cases, since the cathode-to-ground hum overrides the normal bias of the picture tube.

If tube substitutions have eliminated other sources of trouble and the C-R tube seems to be the culprit, a preliminary check may be made before trying a time-consuming replacement. The test is performed with a scope and consists of measuring the hum voltage present between the picture-tube cathode and ground. If a substantial 60-cycle ripple is noted at this circuit point and this ripple disappears when the picture-tube cathode is disconnected from the circuit, a defective C-R tube is indicated.

Similar scope tests may be made at the cathode of any suspected tube. No appreciable amounts of 60-cycle voltage should be measured at the cathode of a tube if cathode-to-heater leakage is absent. More specifically, the 60-cycle ac voltage present between cathode and ground should not exceed the ripple amplitude that exists at the B-plus source feeding the tube in question.

When horizontal pulling is present in the picture and causes it to be bent into the shape of an S; no shading is seen in the picture or raster, and the raster sides are straight, cathode-to-heater leakage in a sync tube is indicated. The setting of the contrast control will, in many cases, have little effect on pulling of this type. Horizontal synchronization will often be extremely critical and horizontal jitter or weaving may be seen most of the time. In other instances, cathode-to-heater leakage in a sync tube will cause the picture to lose horizontal phase; the horizontal blanking bar will become visible in the picture instead of remaining beyond the edge of the mask where it normally is positioned.

A slight amount of leakage in an afc or horizontal oscillator tube may produce no noticeable symptoms when a local station is coming in; in a network program a slow horizontal weaving may develop. Pulling so severe that it makes the picture virtually unrecognizable can occur when considerable cathode-to-heater leakage has developed in an afc circuit tube.

Some cases of corona and arcing are so closely associated with

tubes that they deserve consideration in a book of this kind. Corona and arcing may be unintentionally introduced during tube replacements and merit attention for this reason as well.

These troubles are important not only service-wise but also from a safety standpoint. A bad case of corona, for instance, can start a fire in the television receiver. At the time this was written, newspapers carried a report of the death of two children as the result of a fire that started in a TV set. To remain at peace with his conscience—and sometimes with his pocketbook—the service technician should know all he can about preventing such dangerous conditions and remedying them when they exist.

Causes and effects of corona and arcing

When high-voltage wiring is terminated at a relatively sharp point, the air immediately surrounding this point is exposed to a very high potential. The sharper the terminal, the more concentrated is the charge with respect to the surrounding air. Air exposed to this high potential tends to ionize—i.e., to break up into negative and positive ions. The movement of ions in the air surrounding the high-voltage terminal is called *corona*; it causes a characteristic bluish or purplish luminescent glow. Ozone, formed as a result of the ionization process, has a destructive effect on many kinds of insulation.

Arcing is the name given to a condition where a discharge takes place between two conductors through the air between them. Most cases of external arcing occur between high-voltage points and adjacent ground.

Both corona and arcing reduce high voltage. Arcing will do this to a much greater extent than corona. These troubles also tend to introduce receiver noise whose effects are especially noticeable in the presence of weak incoming signals. Snow in the picture, crackles and buzzing in the sound, noise streaks, bright intermittent flashes on the screen, horizontal tearing and other impairment of horizontal sync can result from corona and arcing. Reduced brilliance due to high-voltage losses, intermittent or continuous in nature, may also be produced.

In areas where humidity is high, the tendency for corona to develop becomes greater because the dielectric constant of the air around high-voltage points is reduced, causing it to break down more readily.

Grit and dust particles are great promoters of corona. When such particles attach themselves to high-voltage conductive sur-

faces, they provide areas small in surface and high in potential—conditions very favorable to the development of corona.

Arcing occurs only when the insulation between two points whose potential difference is high is less than the minimum necessary to prevent arcing. Arcing may be intermittent or sustained in character.

Corona may be identified by the blue or violet discharge visible at its site, the hissing or sizzling sound it produces and the odor of the ozone created by the ionization of air. Arcing generally produces a snapping, crackling or popping sound.

Localizing corona

The detection of corona is not always simple since the fizzing or hissing sound it produces is barely audible under the best of circumstances and the bluish or purplish glow it creates is quite dim. To locate the source of trouble more readily, turn off all external lighting and reduce the brightness control setting. The resultant decrease in picture-tube current will reduce the loading on the high-voltage power supply, increasing the high voltage and intensifying the corona effects. If the area affected still remains invisible, a piece of fiber or bakelite tubing, about 1½ feet long and 1 inch or so in diameter, may be used as a stethoscope of sorts. Put one end of the tubing close to your ear; move the other end around in the area where corona is suspected or is likely. Look for corona at the point where the loudest sound (hiss) is heard.

Localizing arcing

Visual inspection is generally adequate to locate the site of an arc. Look in the high-voltage section of the receiver; when the arc is small, it will help to darken the room. When the arc is too small or infrequent to be readily observed, using a Variac type transformer to apply a larger line voltage to the set will increase the high voltage and promote a larger or more continuous arc.

Another method of locating an arc in the high-voltage is to place a sheet of some good insulating material into different positions in the high-voltage cage. When arcing stops, examination of the area will readily locate the two points between which arcing is occurring.

Arcing and corona associated with tubes

In locations where humidity is high, a breakdown may occur between a high-voltage rectifier and a tube adjacent to it. A polystyrene corona shield for the rectifier tube and socket assembly

may be added to eliminate the condition. Zenith makes such a shield; possibly other manufacturers do too.

Corona may also develop on the outer surface of the glass envelope of the high-voltage rectifier. One method used to eliminate it is to wrap a strip of polyvinyl electric tape about 7 or 8 inches long and $\frac{1}{2}$ inch wide around the tube. Beginning at the point where the prongs emerge from the tube, wind the tape upward diagonally to a distance of about $\frac{3}{4}$ inch above the base. Go three times around the glass. Make sure the surface of the tape is perfectly smooth—wrinkles or sharp edges in the tape may nullify the beneficial effects of this procedure.

In some receivers, arcing between the 1B3-GT high-voltage rectifier plate lead and the glass envelope of the damper may destroy the damper. To avoid such arcing, the lead to the plate cap of the rectifier must be dressed sufficiently far away from the damper (and other tubes) so that arcing does not occur. A damper with a shorter glass envelope may be substituted for the one present in some cases. Similar arcing conditions may occur in other sets. Dress flyback and other high-voltage leads away from tubes to remedy or prevent these troubles.

Arcing between the glass envelope of a 6BG6-G horizontal output tube and some terminals on the horizontal output transformer is possible. Proper insertion of the tube in its socket may prevent it.

Arcing due to improper placement of the plate clip on the high-voltage rectifier may occur. If the clip is placed on the plate cap in an inverted position, the plate lead will be brought closer to the grounded walls of the high-voltage cage, tending to promote arcing. The tendency toward arcing in this case is further increased when the underside of the clip has sharp edges.

When corona or arcing between the high-voltage rectifier and the top of the high-voltage cage occurs and no lead dress changes can remedy it, waxing—or rewaxing—the lead going to the cap of the rectifier at the point where it enters the tube cap may eliminate the trouble.

Arcing between the plate lead of the horizontal output tube and the glass envelope of a nearby damper tube may occur. When adequate separation of the lead and envelope cannot be assured, add several inches of Fiberglass sleeving over the plate lead of the horizontal output tube.

There is an internal connection between pins 7 and 8 in most 1B3-GT rectifiers. If there is none, it is externally made at the sockets contacts. Absence of such an external or internal connection will cause arcing between the two tube prongs through the

air or through the socket. When a 1B3-GT is to be replaced, make a resistance check on prongs 7 and 8 on the new tube. If the reading is infinite, make another ohmmeter check between the socket contacts that go to prongs 7 and 8. If a similarly open reading is obtained, either get a 1B3-GT type in which prongs 7 and 8 are internally connected or add a short wire at the socket, connecting the appropriate socket contacts to each other.

Arcing associated with tube plate-cap leads

The lead going to the plate cap of the horizontal output tube can be troublesome if it is not properly dressed. When it is placed too close to one of the walls of the high voltage cage, arcing will occur right through the insulation of the wire. When such arcing has been noted, replace the lead—its insulation characteristic probably been impaired—and dress the wire away from the cage walls, as well as from any nearby tube or other component.

To prevent breakdown between the horizontal tube plate cap lead and chassis (at the hole where the lead enters the chassis) rubber grommets are often inserted into the hole. A protective sleeving may also be present on the lead as well. Check for these safeguards, when arcing occurs at this point. If such safeguards aren't present, add them.

When snapping sounds are heard at intervals, and the trouble has been localized to intermittent breakdowns between the plate-cap wire and chassis, high-tension auto-ignition type cable may be substituted for the wiring present. (It is assumed that re-orientation of the wiring has not completely eliminated the trouble.) Cables of this type will generally not arc even if they touch the chassis.

When a tube is replaced in the high-voltage section, the service technician should be extremely careful not to change the lead dress present, especially the dress of the horizontal amplifier and high voltage rectifier plate leads. Not only should hv leads be kept away from ground points—leads at or near ground potential should also be kept away from high-voltage wiring. If this precaution is not observed, corona spray (in mild cases) or arcing (in severe ones) can start the insulation on the wires burning, and cause a fire.

Arcing from plate-cap clips that yields to no simpler solutions may be eliminated by substituting ceramic caps for the clips.

Corona and arcing at tube sockets

Corona at the socket of the high-voltage rectifier tube is some-

times due to a poor connection between the hv terminal at the socket and the corona ring. Resolder the connection, to test for as well as remedy the trouble. The corona ring—a round loop made of metal—is generally part of the socket assembly. Its purpose is to prevent corona from developing at the tube socket connection by keeping the air in the vicinity of the socket contacts at a high potential. The surface of this ring should be perfectly smooth; no bumps, scratches, etc. should be visible.

Arcing within a damper tube socket may occur when the boost voltage created by the tube becomes excessive. Such arcing is particularly likely to occur in receivers where the vertical deflection circuits are fed from the B boost supply. When the vertical output tube becomes defective, or when the height control is set at a low point, loading of the B boost supply may be decreased to a point where the boost voltage becomes too high; arcing may develop in consequence.

In severe cases of socket arcing, where no other defect can be found, the socket itself is no doubt the source of the trouble; replace it to eliminate the arcing. For maximum assurance that the trouble will not recur, change a molded bakelite type socket to a mica-filled unit. The insulating properties of the latter make it better suited to withstand high voltages.

Carbonization of a socket is, of course, a sign that it needs replacement. A check of the high-voltage filter capacitor is in order at such a time, to make sure that a leak in this capacitor is not responsible for the trouble.

Covering socket contacts with a high-melting point wax (available from Crosley, to cite one source) will often be helpful in eliminating socket corona or arcing. The wax is melted by heating it, then applied freely with a brush. The wax should not be heated to a temperature above 350° F. If no suitable thermometer is available, heat the wax just enough to melt it, and no further. A good grade of corona dope may be used, instead of the wax, to cover socket contacts.

Arcing inside the crt

Electrostatic-focus C-R tubes have a tendency to arc internally, during the first few days after they have been put into operation. The condition is due to the presence of dust or other particles inside the tube; these particles work themselves into the gun structure and cause intermittent arc-overs. The arcs usually occur between the high-voltage anode and the focus electrode. The effect produced on the screen is a momentary blinking in the picture.

Secondary arcs can possibly be stimulated in other high-voltage areas, especially around the corona ring, by the original arcs. The high-amplitude current that momentarily flows through the B supply may burn out the fuse in the low-voltage section.

Insertion of a resistor of about 47,000 ohms in series with the focus electrode will eliminate the secondary arcs, and protect the fuse. The primary arcing may, however continue for some time—often several days—until the loose particles in the crt gun are all burned away.

Intermittent arcing may occur in any type of c-r tube, particularly when it is first placed in service. The condition does not necessarily indicate a nonremediable defect in the crt. In many instances, the short will burn itself out. In more persistent cases, the trouble can often be eliminated by removing the tube, holding it face down and *lightly* tapping the bell, either with the wooden end of a screwdriver, or the fingers (keeping the fingernails out of action). If the short cannot be cleared in this way, replacement of the crt will generally be necessary.

Eliminating corona and arcing at bell of crt

Corona or arcing may develop at the bell of the crt in different ways, and for different reasons. Arcing from the front of the picture tube to the picture window is possible. The existence of this condition is very likely if the arcing stops when the chassis is removed from its cabinet.

In some receivers, the picture window is electrically grounded by means of a braided shield and spring connection to chassis. Check for an improper connection here, if the type of arcing just described seems to be present. In other sets, arcing between tube and window may be due to the presence of dust. Clean the tube and window, to remedy the trouble in this case.

Defects in the polyethylene sheet which is used in some sets to insulate the picture tube from the window in front of it may be the cause of arcing. Check this unit visually. Clean it with carbon tet if it is dirty; replace it, if it seems imperfect in any way (i.e., has scratches, holes, tears, etc.) When replacing a cabinet-mounted sheet of this type, use short mounting staples. These staples should not be inserted too close to the edges of the sheet.

If any uncertainty exists as to whether the picture tube is the site of the arcing present, disconnect the 2nd anode lead from the tube. If the arcing (or corona) now stops, the trouble is definitely related to the crt.

Corona or arcing at the anode button of an all-glass c-r tube is a common trouble. The trouble is generally due to the effects of dirt, or deterioration of the rubber suction cover on the 2nd anode connector. Certain types of rubber used in anode caps tend to decompose as a result of the high electrostatic stresses present at the anode button. The action increases their conductivity, permitting high voltage to leak onto a normally insulated area. A corona discharge between the button connection on the hv anode lead and the surrounding glass area tends to result, particularly when the air is damp or humid.

One remedy consists in cutting off the suction cap, leaving only the sleeve portion which supports the lead to the button connector. The rubber will no longer touch the glass, eliminating leakage onto the latter. The remedy just described is also helpful in cases where the suction cup has not deteriorated, but is promoting arcing (during humid weather) because of its accumulation of moisture.

To clean off the deposit on the glass made by the defective rubber, use a rag, water, and a mild cleaning material, such as *Bon Ami*. (Water alone may not remove the chemical deposit). Be particularly sure to clean the well or receptacle into which the hv connector fits. Drying, then polishing the area that has been scrubbed clean will insure that no residue is left to cause future trouble.

Carbon tet may be used to clean off the deposit, instead of scouring powder; or both may be used, the scouring powder first, then the carbon tet (after the area has dried). The addition of an anti-corona preparation to the area will serve as additional insurance against a recurrence of trouble here. A similar cleaning and coating process will eliminate corona and arcing at the crt anode receptacle (due to accumulations of dirt). The bell of the tube should, when necessary, be cleaned with a damp rag, then dried.

Elimination of the suction cover (as previously described) is not always desirable, since dust cannot be as readily kept out of the sensitive area around the anode button with this cover missing. In cases where excessive dust accumulation is likely, the best service procedure would be to replace the anode connector and lead (when the suction cup on the hv lead has deteriorated). Use of a connector and lead assembly that provides a Neoprene, corrosion-resistant suction cover is desirable under the circumstances.

In cases where connector and lead are replaced (as well as in instances where sources of corona are being looked for) make sure

that the soldered joint on the anode button terminal to which the anode lead connects is smooth, and has no sharp points.

When the service technician wishes to retain the dust-proofing benefits of a worn or cracked suction cup, several short layers of hv tape should be used to press the cup firmly in place against the bell of the crt.

Arcing may be due to a loose connection at the anode receptacle of an all-glass crt; spreading the prongs on the anode connector slightly will eliminate such trouble in many cases.

Re-waxing the high-voltage cable at the point where it enters the rubber suction cup will help prevent corona spray in humid weather.

In some instances, visible evidence of arcing (streaks in picture, or other symptoms) may be present, but the site of the trouble cannot readily be located. Push back the rubber suction cup, in such cases, turn the set on and look, as well as listen for, arcing at the anode receptacle on the crt. Sometimes arcing occurs between the anode terminal in the c-r tube and the internal graphite coating. Replacement of the crt is the only cure for such trouble.

Arcing at metal C-R tubes

Metal-cone picture tubes tend to develop arcing conditions in the area of their glass bell, due to the presence of dust and moisture here. A method of dealing with this problem used by RCA service people consists of removing the entire coating present on the glass bell, through the application of methanol or acetone. The area is then washed with a good detergent and dried thoroughly; a liberal coating of Johnson's Car-Plate is then applied to it (with a brush). When the coating has dried, the white residue is wiped off.

Arcing due to improper crt grounding

An outer Aquadag coating is used on many glass c-r tubes as a shield. Two hair-pin type springs are often used to connect this Aquadag coating to ground. When the contact between the springs and the coating is poor, arcing in this area (as well as excessive sync buzz, or other symptoms) can be produced. Correct such trouble by pushing the c-r tube into better contact with the springs, or replacing the springs, if the latter are defective.

picture tubes

IN many respects the picture tube is the most important component in the TV receiver. It is, in most cases, the most expensive single unit in the chassis and requires a greater number of adjustments than any other component. Improper adjustment can irreparably damage it. Improper handling of the tube can land the technician in the hospital or burn or shock him. Incorrect diagnosis can lose customers. Insufficient knowledge of the picture tube and its associated circuits can cause the technician to spend an excessive amount of time in locating or eliminating trouble.

There are many reasons, in short, why the service technician should know all there is to know about the adjustment, servicing and replacement of cathode-ray tubes. Some theory must inevitably enter into our treatment since it makes for more enlightened servicing; it will, however, be kept to a minimum.

Numbering system

A certain amount of important information is provided by the code number assigned to a cathode-ray tube. Actually, this is not simply a number. It is, rather, a grouping of numbers and letters.

This grouping may be broken into three or four parts. The first consists of a one- or two-number digit and precedes the first letter. The number is the size designation of the tube and indicates the nominal diameter of the faceplate in inches. (In the case of a rectangular tube, the first code unit indicates the length of the diagonal—i.e., the distance from one corner of the tube to the opposite corner). If the tube is a 30BP4, the coding tells us that the tube's diameter is approximately 30 inches.

The next part of the code is the first letter. In the case of the 30BP4 just referred to, this letter is B. The first letter has a purely historical significance. It indicates when the tube type represented by the picture tube in question was registered with RETMA.¹ The letter *A* is given to the first tube type of a given size registered with RETMA; *B* is the second, *C* the third, etc. In the case of the 30BP4, the *B* indicates that this tube type was the second in the 30-inch series to be developed.

The fact that there is no 30AP4 may seem odd. Why was a *B* assigned when no *A* had apparently been released? The answer lies in the fact that letters are *reserved* with RETMA before a tube type is actually registered. In many cases, the particular tube the manufacturer had in mind never reaches the production lines. The reserved letter is thus never used.

The third coding unit consists of the letter *P* followed by a number. The *P* stands for the word *phosphor*. The number following the *P* indicates the kind of phosphor used for the screen. In the case of black-and-white TV tubes the third coding unit is *P4*. It refers to all-silicate, all-sulfide, and silicate-sulfide type phosphors that have the persistence and color characteristics needed for the proper reproduction of television images. Picture tubes used for purposes other than TV image reproduction have different phosphor designations.

A fourth coding unit sometimes present consists of a letter. It is known as the *modification letter*. Such a letter is added to the code number of a tube when a minor design change is made in the tube by the manufacturer some time after its initial appearance.

The change may be a purely physical one: a different kind of glass, for instance, may have been substituted for that originally used as the faceplate. Or it may be an electrical change—say, the addition of an Aquadag coating to the bell of the tube or an alteration in the basing connections. When the letter *A* is used as the modification letter, it often indicates a switch from a clear to a gray Filterglass faceplate. When the letter *B* has replaced the letter *A*, a further change from the gray Filterglass faceplate to a frosted one is indicated. In any case, the manufacturer's data should be consulted for information regarding the exact nature of the change before a modified tube is substituted for the original.

Bulb and base differences

Cathode-ray tubes may differ from each other physically and/or

¹ Now known as Electronic Industries Association (EIA).

electrically. They are made in many different sizes and shapes and can be constructed of different materials. They may have different deflection and focusing systems, gun structures and external accessories. These differences all have a bearing on servicing.

Round vs. rectangular tubes

The advantage of a rectangular-faced picture tube over a round-faced one is that it permits a larger picture to be shown on roughly the same-size screen. It also requires less cabinet space and weighs less. A round-faced tube, on the other hand, is stronger. Many of the larger-size picture tubes are being manufactured with round faceplates for this reason.

Aquadag coating

To collect the electrons emitted from the screen and return them through the power supply to the picture-tube cathode, a conductive coating commonly known as the Aquadag is placed on the inside surface of the bell in the all-glass tube. This internal coating starts about 2 inches behind the faceplate and extends partly down the neck of the tube in most cases. Internally connected to the high-voltage second-anode contact, it is considered part of the second anode where a second-anode cylinder is used in the electron gun. When such a cylinder is absent, the internal Aquadag in itself comprises the second anode.

Strictly speaking, *Aquadag* is not necessarily the correct name for the cathode-ray tube's internal conductive coating. Aquadag is the trade name of *one* of the several compounds (such as graphite, lead sulphide, etc.) used to form this coating, but the industry uses the term as practically synonymous with the conductive coating.

In most picture tubes, an external as well as internal Aquadag coating is used. The external coating covers the outer surface of the bell of the tube, to a greater or lesser extent, but does not make contact with the anode connection on the tube envelope. It is usually separated from this connection by a circular section of clear, uncoated glass.

The internal and external Aquadag coatings form a capacitor with the glass between serving as the dielectric. This capacitor is used as part of the high-voltage power-supply filter network. The actual capacitance present depends (up to a point) on the size of the tube. In the 3NP4, for instance, the minimum capacitance is 275 μf ; the maximum is 375. In the case of a 24VP4, the mini-

mum capacitance is 750 μf ; the maximum 1,500. Minimum and maximum limits set the extremes allowed by manufacturing tolerances.

On most of the larger-sized picture tubes, the external Aquadag covers a lesser portion of the exterior bell area than it does on somewhat smaller tubes. For instance, the outer Aquadag covers most of the bell area on a GE-type 17BP4-A; the outer Aquadag, however, covers only a 2-inch section (approximately) on GE's 21EP4-B. The reason for this may be explained as follows: A relatively large capacitance, fed from a high second-anode potential, could store a large enough charge to constitute a safety hazard. Any service technician who has been jolted by 2,000-volt .001- μf capacitors in early-make TV sets using transformer-type high-voltage power supplies will readily appreciate this point. Since the larger tube uses higher second-anode potentials, the capacitance formed by its Aquadag coatings must be kept down to minimize the shock potential of this capacitance.

When a glass tube that has no external Aquadag, or a metal tube, is used to replace a glass picture tube with an external Aquadag, a capacitor of about 1,000 μf should be connected between the second-anode point of the high-voltage supply and ground to compensate for the absent capacitance. The compensation will be only partial (but generally adequate) in the case of a tube like the 16HP4, which has a maximum capacitance between its bulb coatings of 3,500 μf .

When an external Aquadag coating is used to form a capacitor with the internal coating, some means of grounding the external coating must be employed to make the capacitance effective in the circuit. Metal clips, bands or spring type wires are used for this purpose (see Fig. 701).

If these connectors do not provide good contact between the external Aquadag and chassis, a variety of symptoms may be introduced. The external Aquadag acts as a shield for the picture tube in addition to forming part of a filter capacitor. If it does not connect properly to ground, however, its shielding (as well as its filtering) action is impaired. Various interference effects (as well as corona and arcing) become possible.

The external Aquadag may, furthermore, be at high-voltage potential with respect to chassis if it isn't grounded. The reason for this is that the charge on the inner coating is transferred to the outer one through the stress set up in the glass dielectric between them. Shock may be experienced when the technician touches the tube.

Glass vs. metal tubes

Cathode-ray tubes are made with all-glass envelopes or envelopes composed partly of metal, partly of glass. Tubes in the latter category are known as *metal tubes* and can have rectangular or round faceplates. Metal is used only for the bell section of the tube.

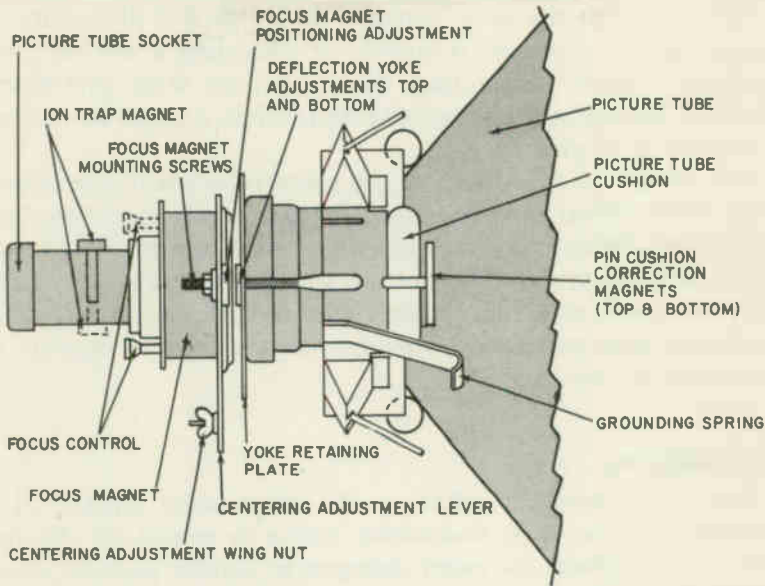

Fig. 701. Components mounted on the neck of the picture tube. The grounding spring connects the outer Aquadag coating to the chassis.

An envelope made partly of metal has greater strength than an all-glass one. The risk of an implosion is thus reduced. An additional advantage of the metal tube lies in the shielding effect it provides. External electromagnetic fields—such as those surrounding power transformers, etc.—are prevented from affecting the electron beam within the tube. A third advantage lies in the fact that it can be made of a lighter glass than an all-glass unit, permitting its weight to be less.

Disadvantages of a metal type tube include the fact that it introduces a considerably greater shock hazard than an all-glass tube. Part of the inner surface of the bell must be at high-voltage potential to collect the electrons emitted by the fluorescent screen. Since no insulation between the inner and outer metal surfaces of a metal tube is practical, both surfaces are at the same high potential. To protect the service technician against shock, plastic insulating covers may be placed over the metal cone area when tests must be made with the power on. These covers, unfortunately,

offer little or no protection against rf burns. An unsuspected source of shock may be created by leakage of high voltage from the metal cone to the deflection yoke, metal cabinet or other components.

In an all-glass tube, the inner and outer Aquadag coatings form a capacitor with the glass between acting as the dielectric. The metal tube is, of course, incapable of providing a similar capacitance. A separate high-voltage filter capacitor must therefore be added to the high-voltage power supply when a metal tube is used to replace an all-glass type.

Still another disadvantage of the metal tube lies in the susceptibility of the metal cone to magnetization. While the cone shields the electron beam from stray magnetic fields, it may itself become magnetized when the fields are too strong and too close. In some cases, the metal shell can be demagnetized by the TV technician. In others, demagnetization attempts can produce incomplete and unsatisfactory results.

The faceplate

The term *faceplate* refers to the large-ended surface of the cathode-ray tube. The fluorescent screen is coated on the inner side of this surface; the outer transparent surface permits viewing of the picture reproduced on the inside of the faceplate.

The faceplate is curved or spherical rather than flat to permit uniformly satisfactory focus over its entire area. A curved faceplate reflects external light more than a flat one would; furthermore, light passing through the faceplate is refracted or distorted. The greater the curvature of the faceplate, the more troublesome do these effects become. Faceplate curvature is described in terms of the radius of the semicircle formed by the faceplate. The shorter the radius, the greater the curvature.

To minimize the undesired faceplate characteristics introduced by curvature, cylindrical shapes are employed in some tubes. Such faceplates can be used only in rectangular tubes. When a cylindrical faceplate is employed, advantage is taken of the fact that the picture height is less than the width; the curvature required for good focusing is consequently smaller from top to bottom of the picture than it is from side to side. The faceplate is constructed accordingly. The reduction in top to bottom curvature decreases undesired reflection and refraction appreciably.

Faceplates may be of clear glass, gray glass, Filterglass, or frosted Filterglass (also referred to as *etched face*). Clear glass permits the

passage of the greatest percentage of light from the inner to the outer surface of the faceplate. A loss in contrast is produced, however, by reflection from the faceplate of external lights. These losses become rather serious in tubes with large-sized faceplates. To minimize these losses, gray or frosted glass is used in most picture tubes manufactured at the present time. The reduction in the picture-tube light-transmission characteristic is more than compensated for by the decrease in reflections. It is worth noting that all cylindrical-faced tubes use Filterglass.

Faceplates range in size from the 3NP4 with a nominal diameter of 3 inches² to the 30BP4 whose nominal diameter is 30 inches. The term nominal merits some explanation.

Nominal means *in name only*. When used in relation to picture-tube sizes, it means *approximate*. The actual diameter or diagonal is different from the nominal one given in the code number. Thus a 27EP4—a rectangular tube—has a nominal diagonal of 27 inches but an actual diagonal of 26-13/16 inches \pm 3/16 inch. Some manufacturers may, in such a case, refer to the number 26-13/16 as being the nominal diagonal of the tube, whereas the actual one falls somewhere between 26-13/16 + 3/16, and 26-13/16 - 3/16. The \pm 3/16 inch is, of course, the tolerance.

In some cases where a picture tube is being replaced, it may be desirable for the service technician to know the exact dimensions of the replacement tube to determine whether it will fit the opening in the cabinet. It will be helpful in such cases to obtain the manufacturer's specifications (from his tube data sheets). The manufacturer is allowed certain tolerances since tubes cannot always be made according to exact design size. This tolerance, as specified by the manufacturer, should be taken into account when the exact dimensions are important.

Another term with which the service technician may be concerned is the *useful screen size* as opposed to the nominal or actual size of the picture tube. The useful screen size is the maximum faceplate area within which a picture may be seen. Masking considerations may make it necessary in some cases to know this size.

Picture-tube lengths

Tubes vary considerably in length. Electrostatically deflected units are longer than magnetically deflected ones with the same size faceplates since deflection plates must be accommodated inside

* Cathode-ray tubes having smaller face diameters do exist. The 1EP1 has a diameter of only 1¼ inches, is designed for lightweight portable equipment. The 1EP1 uses electrostatic focus and deflection.

the electrostatic type. Magnetically deflected tubes with the same size faceplates may have different lengths. In general, the larger the deflection angle, the shorter the tube length for a given-size faceplate.

Tubes that have the same deflection angle, approximately the same size faceplate and are pretty much alike electrically may differ appreciably in length. It is thus important to know the tube length of a replacement picture tube when it is not identical with the original. Relatively slight differences in length may prevent the proposed replacement from fitting readily into the cabinet. Tube length specs are provided in bulletins and data sheets put out by picture-tube manufacturers.

The screen

The inner side of the faceplate is coated with a phosphor material which acts as the screen of the picture tube. The picture is reproduced on it and viewed from the outer side of the faceplate.

The screen contains both fluorescent and phosphorescent materials. It *fluoresces* when electrons strike it—that is, it emits light. The property it has of continuing to emit light when the electron bombardment has ceased is known as *phosphorescence*.

The phosphor coat has two important characteristics, as far as the service technician is concerned: *persistence* and *color*. Persistence refers to the length of time the phosphor continues to emit light after the electron bombardment responsible for the light emission has ended. This time is characterized as *extremely short, very short, short, medium, long* or *very long*.

TV picture tubes use phosphors with a *medium* persistence. A screen with too long a persistence tends to cause blurring of rapid motion.

Screens vary in the color of light they emit. Phosphors used most often emit white light since this is the kind of light that produces maximum contrast and is least tiresome to view for long periods of time. Picture tubes used for TV receivers employ a P4 phosphor for their screen coating; this phosphor has a medium persistence and provides a white light.

Aluminized screens

In some picture tubes, a thin layer of aluminum is added to the phosphor coating on the screen. The aluminum film is also applied to a portion of the inside surface of the bell of the tube. It connects to the second anode terminal on the picture tube.

The aluminum layer is intended to increase picture brightness and reduce the risk of ion damage to the screen. The increase in brightness is the result of decreased light losses in the aluminized tube. In a tube with a nonaluminized screen, a high percentage of the screen light output is lost due to the absorption of light by, as well as its random reflection from, the Aquadag coating on the bell of the tube (or from the inside metal surface of a metal type tube). In the aluminized tube, part of the internal Aquadag coating is replaced by an aluminum film. The aluminum film also overlays the phosphor on the faceplate. Light that would otherwise be absorbed or reflected toward the rear of the tube is now reflected toward the screen face and remains useful. Brightness is thus considerably increased.

The service technician can get an idea of the increase in brightness by making the following visual test: Look through the tube section that lies between the faceplate and the area where the internal Aquadag begins in a conventional glass picture tube of a certain size. Note the brightness of the picture. Next, look into the same section of an aluminized picture tube of the same size (it is assumed that the TV receiver in each case has approximately the same brightness control setting). It will be evident that the picture in the aluminized tube is clearer and considerably brighter.

The aluminum film acts as a barrier for ions (which are relatively large in size) but is readily penetrated by the much smaller electrons. It might be deduced that no ion trap is needed in aluminized tubes. This is true for some makes of 10- and 12-inch tubes used in old receivers. In more-recent aluminized tubes—particularly those 16 inches or larger—an internal ion trap and an external ion-trap magnet are used. Incorporation of an ion-trapping system provides added protection against ion burns. Besides, an aluminum thickness best suited to provide maximum brightness is more readily achieved when the entire burden of ion trapping is not put on the aluminum film on the face of the tube.

The voltage applied to the picture-tube second anode is more efficiently utilized when an aluminized tube is used. In nonaluminized tubes, "sticking" may be encountered at voltages exceeding 10,000. It is caused by the buildup of a negative charge in the vicinity of the screen. This charge forms when the electrons emitted by the screen are not quickly attracted and drained away by the Aquadag coating nearby. As a result of the charge, oncoming electrons are repelled to a certain extent, slowing them down and thus reducing the effective high voltage. When the picture-tube second-anode voltage is very large, this sticking will reduce

its effective value considerably, lowering the maximum brightness obtainable.

Such trouble is not encountered in aluminized tubes. Since the aluminum coating is at second anode potential and directly adjacent to the screen's phosphor coating, it drains off the electrons emitted from the screen more efficiently than the more distant Aquadag coating does in a nonaluminized tube.

High-voltage connector

In most magnetically and some electrostatically deflected picture tubes, the internal Aquadag terminates in a high-voltage connection on the envelope of the tube. Where such a termination is not present, the high-voltage connection is brought out to the base of the tube.

The most common type of anode terminal used on the cathode-ray tube envelope is the *recessed small cavity*. A considerably less common type is the *recessed small ball cap*. Both kinds of connection are recessed below the surface of the envelope. The cavity type anode terminal calls for a male mating connector; the small ball cap requires a female connector. In both cases, the connector generally consists of circularly grouped spring contacts whose tension is relied on to insure a satisfactory connection.

In the case of metal tubes, a metal protuberance known as a *cone lip* is used as the high-voltage connection point. The cone lip is located near the faceplate of the picture tube. A clip type connector is used to mate with it.

Mating connectors for recessed second anodes are sometimes readily damaged since the tension of the spring contacts is easily lost. Care should therefore be used when inserting them into the anode receptacle. Care should also be used to avoid damaging the recessed area or cavity in the picture tube where the anode connection is made.

Some high-voltage lead connectors (generally those used for recessed small cavity caps) are enclosed in shields made of rubber, or some similar insulating material, to reduce the possibility of corona and arcing. Such effects are very likely to develop at the second-anode connection, particularly under humid or damp atmospheric conditions.

If arcing and corona do appear around the area of the high-voltage connector, remove the anode button and thoroughly clean (with scouring powder) the entire surface contacted by the rubber cap on the high-voltage lead. Wipe with a soft, dry cloth. If arcing still persists, it may be caused by decomposition of the rubber cap.

Either replace the cap with a new one or trim it off as shown in Fig. 702.

Picture-tube base

The picture-tube base permits the various elements within the tube to be connected (through base and socket) to the proper circuits. The wires for the tube electrodes enter the base prongs through the seal that terminates the neck of the tube. This fact should be reassuring to those novice technicians who wonder if

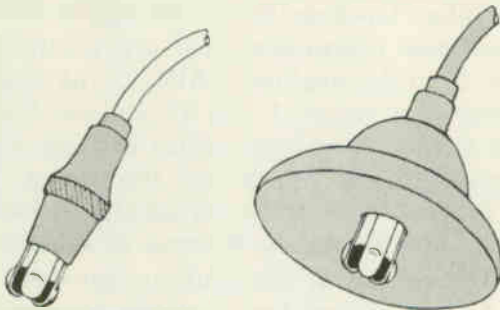

Fig. 702. Picture-tube anode lead and rubber cap. The drawing at the left shows the appearance of the anode lead after the flange portion of the rubber cap has been trimmed.

a loose tube base permits air to get into the tube. The glass or metal seal within the base is, of course, unaffected by the presence of air around it.

It is worth noting that a jar or blow that loosens the base may simultaneously break the glass seal within it, destroying the vacuum in the tube and making the latter unusable. These accidents are not infrequent. No implosion follows the breaking of the seal, since the air pressure at the point of the break is too low to cause one. Picture tubes being transported in automobiles, without cartons, not infrequently suffer such deactivation.

The base is glued to the glass that surrounds it. Loosening of this glue sometimes takes place. Damage to the base of the tube, or even breaking of its neck, is possible if attempts are made to insert a loose-based picture tube into its socket. A loose base should, of course, be glued back to the glass.

A keyway or locating key is present at the base to prevent the base prongs from being incorrectly inserted into the tube socket. To avoid damaging the keyway, the use of undue force should be avoided in inserting a tube into its socket.

On electromagnetic tubes, 5, 6 and 7-pin bases are commonly

used; electrostatic types generally require 12- or 14-prong bases since they contain a greater number of internal elements.

In electrostatically deflected picture tubes, the second-anode connection is often made through the base of the tube. Technicians should be careful in making voltage checks at the socket to avoid shock as well as voltmeter damage due to the wrong connection of a lead.

The fact that two tubes have the same type of base does not, of course, mean that their base connections are identical. Direct-view magnetic tubes, however, have a number of similarities with respect to their base connections that are worth remembering. All such tubes, from the smallest (7AP4) to the largest (30BP4), use 12-pin sockets on which 1 and 12 are the filaments, 11 is cathode and 2 is the control grid. Most of these tubes have an accelerating grid; this is pin 10 on the socket. Magnetically deflected and focused tubes, thus, can usually be interchanged in the same socket, simplifying the business of substitutions.

Picture tubes have basing designations that refer to their base connections. A base designation generally consists of a one- or two-digit number, followed by one or two letters. In many cases (but certainly not in all) the base designation number corresponds to the number of prongs on the tube base. Representative designations are 4-AF and 11-E. A basing designation has a corresponding diagram that indicates the base connections of the cathode-ray tubes to which it applies. If two picture tubes have identical basing designations, no wiring changes will be required at the socket when one is substituted for the other. (It is assumed that the two are electrically similar and otherwise suitable for interchanging).

Picture-tube types

Picture tubes may be divided into two major categories: electrostatically and electromagnetically deflected types. A further breakdown may be made of electromagnetically deflected tubes according to the kinds of focus system they employ.

Electrostatically deflected tubes

Electrostatically focused and deflected picture tubes are found chiefly in early-make TV sets, generally receivers with 5-, 7- and 10-inch screens. They are also used in oscilloscopes and in some modern portable sets. The 7-inch glass and 8-inch metal type tubes are, perhaps, encountered more often than others in these portables.

The electrostatically deflected tube (see Fig. 703) uses two internal sets of plates for deflection purposes. One set is used for

horizontal deflection, the other for vertical. Each set of plates is connected through dc blocking capacitors to the deflection amplifier that feeds it.

Dc voltages roughly equal to the second-anode voltage are fed to the deflection plates to prevent setting up undesired electric fields between the deflection plates and the second anode. Adjustment of these voltages permits centering of the raster. Two potentiometers are used for adjusting horizontal and vertical centering, respectively. When there is no voltage difference between the two sets of plates and the electron gun is perfectly aligned, the

Fig. 703. Internal deflection plates are used in the electrostatically deflected picture tube.

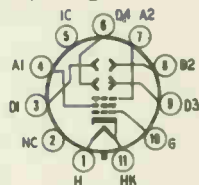

beam will travel midway between the plates. When one plate is made more or less positive than the other, the beam's starting position will move closer toward the more positive plate, causing a corresponding shift in the centering of the raster.

Focusing is achieved with the aid of an electrode called the *focus anode*. This is often referred to as *anode No. 1* in tube manuals and tube data sheets. The focus anode is typically operated at a voltage approximately 25% to 33-1/3% as high as the second anode voltage. Insertion of a potentiometer in the focus-anode circuit permits the voltage to be adjusted for optimum focusing.

The second anode in electrostatic tubes comprises a cylinder as well as an internal Aquadag coating. The second anode's cylinder, in conjunction with the first anode, helps bring the electron beam to focus on the screen. The Aquadag, to which the second anode connects, collects the electrons emitted by the screen. Both the Aquadag and the second-anode cylinder also accelerate the electrons in the beam. Second-anode voltages in electrostatic tubes range from approximately 2,000 to 5,000 dc.

A third anode, known as the *intensifier anode* and referred to as *anode No. 3*, is used in some electrostatically deflected picture tubes. (The 14AP4 is an example of a picture tube incorporating an intensifier anode.) The intensifier anode consists of an Aquadag type coating near the screen. Its function is to increase screen brightness. The dc voltage applied to the intensifier anode is usually twice as high as the voltage fed to the second anode.

The *deflection factor* of an electrostatic tube could be of interest to the service technician on some occasions, particularly when he is substituting one (electrostatic) tube type for another. The deflection factor indicates how much deflection voltage must be applied to the deflecting plates to produce an adequate sweep. It is usually expressed in terms of the average dc voltage needed to deflect the beam 1 inch in a given direction (horizontal or vertical).

Two deflection factor ratings are supplied for an electrostatic tube—one rating is for the vertical deflecting plates, the other for the horizontal. These plates are referred to as D1, D2 and D3, D4, respectively. The deflection factor may be the same for both sets of plates or it may be different.

The set of plates closer to the electron gun is referred to as D3, D4; those further from the gun (and closer to the screen) are called D1, D2. The plates that are further from the screen are capable of providing greater deflection when a given value of deflection voltage is applied to them. These plates, D3 and D4, are said to have a higher *deflection sensitivity* than the D1, D2 plates. Deflection sensitivity is a measure of the distance the beam will deflect when 1 volt dc is applied between a pair of plates. This distance is usually expressed in millimeters.

Since the D3, D4 plates have the higher deflection sensitivity, less deflection voltage will have to be applied to them to move the beam a given distance across the screen. Inasmuch as the horizontal sweep needed is greater than the vertical (due to the 4-to-3 aspect ratio of the transmitted signal), it is logical to expect that the D3, D4 plates will be used to provide horizontal deflection and the D1, D2 plates for vertical deflection. This is usually the case. In some instances, however, when the horizontal deflection voltage is in excess of what is required, but the vertical deflection voltage is not quite adequate and cannot readily be increased by tube replacements, use of the more sensitive set of plates for vertical deflection may offer a quick means of adding the extra height. The picture tube will have to be rotated 90° if this change is made, to keep the picture upright.

The deflection factor is linked to a given value of second anode voltage. At higher anode voltages, the beam becomes "stiffer" or harder to deflect.

The service technician may, if the sweep is insufficient, want to know whether the trouble lies in the sweep system or the picture tube (the deflection sensitivity of a tube may, in some cases, be reduced because of a defect in the tube—excessive gas content,

for instance, or a manufacturing flaw). To eliminate the sweep system as a source of the trouble, it must be determined whether the deflection voltage present is adequate to sweep the tube. To do this, multiply the deflection factor of the appropriate set of plates by the number of inches of screen surface the beam is required to cover.

Suppose the beam should be deflecting 6 inches vertically and the deflection factor of the vertical set of plates is 100. Then 100 volts is needed for each inch of deflection or a total of 600 volts peak-to-peak is required between plates. If this deflection voltage is found (by scope measurement) to be present and the second anode voltage (as well as that of the third anode, if one exists) is normal, trouble in the picture tube is indicated.

Another characteristic that may concern the service technician on occasion is the *cutoff voltage* of the picture tube. This is defined as the bias needed to extinguish the undeflected but focused spot produced on the screen (in the absence of deflection). This voltage varies considerably, depending on the tube type. In a 7JP4, it ranges from 72 to 168 volts; in a 14AP4, from 40 to 120.

There are cases when full counterclockwise rotation of the brightness setting is unable to provide extinction of the electron beam. In such instances, when the technician wishes to learn whether the grid bias voltage present is capable of providing cutoff, he may measure the range through which the bias voltage goes and see if it coincides at any point with the cutoff-voltage range listed in a tube manual for the particular tube involved. The cutoff voltage listing, incidentally, applies only when the typical second-anode voltage at which the tube is supposed to be operated is actually present.

Electromagnetically deflected picture tube

Most TV receivers use electromagnetically deflected cathode-ray tubes. Two pairs of coils, mounted around the neck of the tube in an external assembly referred to as the yoke, provide deflection. Focusing may be either electromagnetic or electrostatic.

The yoke

The yoke basically is made up of two pairs of coils, a magnetic core and an insulated casing. One set of coils comprises the *horizontal deflection coils* or the *horizontal yoke*; the other the *vertical deflection coils* or the *vertical yoke*. Each pair of coils is positioned (around the neck of the tube) at right angles

to the other pair. The vertically positioned ones provide vertical deflection. The core increases the inductance of the yoke. It is generally grounded to minimize radiation from the yoke.

The deflection-angle rating of an electromagnetic tube is a measure of the angle through which the beam must be deflected to scan the picture tube properly in either the horizontal or vertical direction. When a tube is said to have a horizontal deflection angle of 66° , it means that the beam must be deflected 33° to either side of the center axis of the tube, or a total of 66° , to scan the picture tube fully in the horizontal direction. If the deflection provided by the horizontal yoke is appreciably

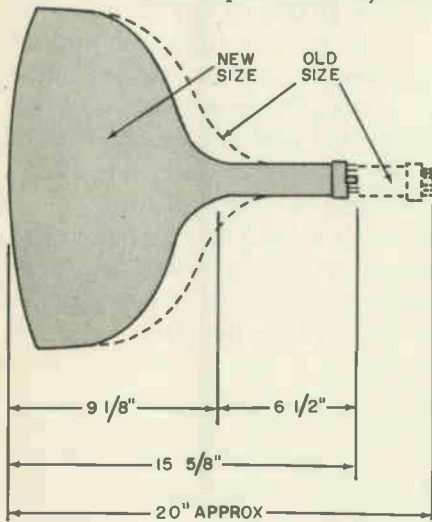

Fig. 704. Picture tubes can be made shorter as the deflection angle is increased. A picture tube with a deflection angle of 110° is less than 16 inches in length. This drawing shows the difference in length between two tubes having different deflection angles.

less than 66° , the sweep width will be inadequate; if it is greater than 66° , the sweep width may be excessive, causing picture information at the boundaries of the screen to be lost.

In the case of round-faced tubes, one deflection-angle rating is generally specified by the tube manufacturer. This rating applies to both horizontal and vertical deflection. In the case of rectangular tubes, where a 4-to-3 aspect ratio is a built-in feature and cannot be changed, smaller deflection angles are needed for vertical than for horizontal deflections. Such differences may be taken advantage of by the tube manufacturer. In these cases, separate deflection angles may be listed; the larger one describes the horizontal deflection characteristic whereas the smaller refers to the vertical deflection. If only one deflection angle rating is given for a rectangular-faced tube, it usually refers to the diagonal angle.

Yokes are also given a deflection-angle rating. This rating is a measure of the deflection angle through which the yoke can swing the beam. The yoke deflection-angle rating should jibe very closely with that of the tube on which it will be used. For tubes with deflection angles of 50° to 60° , differences up to but no greater than 5° between yoke and picture-tube deflection-angle ratings may be tolerable. In the case of deflection angles above 60° , differences of as much as 5° may not always be permissible.

Early-make yokes were manufactured with a deflection-angle rating of about 52° . These angles have progressively increased in size to a maximum (at the time of writing) of 110° . Yokes capable of providing wider angles of deflection were required

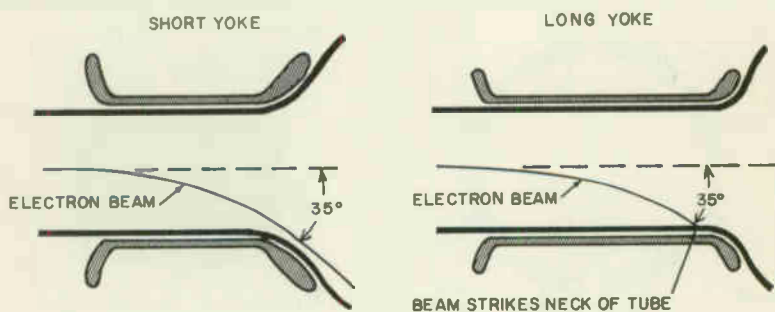

Fig. 705. Wide-angle yokes are shorter, use ferrite cores and have a higher inductance than other types of yokes.

to match the higher deflection angles of large-screen tubes as these were developed. (Higher picture-tube deflection angles mean shorter tubes, as indicated in Fig. 704.)³

To sweep a large-sized screen with a wide-angle yoke, the yoke must be very efficient. Let's see why this is so. The basic difference between the wide-angle yoke and its predecessors lies in the yoke length. The wide-angle yokes are *shorter*. With a long yoke, the possibility of increasing the deflection is limited by the fact that the electron beam tends to strike the neck of the tube if the angle is made too large (see Fig. 705).

The shortening of the yoke necessarily decreased its sensitivity, or its deflection effect, since its inductance was reduced.

³ The 110° picture tube has an overall length of only $14\frac{1}{2}$ inches as compared with an average length of 20 inches for a comparable 90° tube. (Some 90° tubes are between 15 and 16 inches in length.) The 110° represents the diagonal deflection of a tube having a diagonal of $21\frac{3}{8}$ inches and a viewing area of 262 inches. It weighs less than 23 pounds.

To compensate for this, ferrite cores were introduced. (Early yokes used magnetic cores made up of a large number of turns of iron wire.) The greater magnetic flux produced by the ferrite core compensated for the loss in sensitivity that the reduction of yoke length tended to produce.

To provide the increased high voltages needed in larger-sized tubes, the inductance of the horizontal yoke has been made successively larger over the years. The amount of high voltage developed in modern television sets depends on the amplitude of the pulses across the primary of the horizontal output transformer. This voltage, is, in turn, affected by the impedance of the horizontal yoke. Use of a higher-impedance horizontal yoke reduces the yoke's loading effect on the transformer primary, permitting higher voltages to be built up across this winding, thus

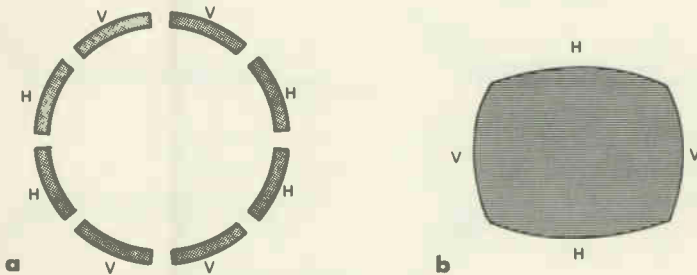

Figs. 706-a,b. Cross-section of the yoke used in older receivers. The field of this yoke is equivalent to four magnets placed as shown in the drawing at the right.

increasing the voltage applied to the high-voltage rectifier. The inductance of the horizontal yoke cannot be increased beyond the point where the size of the yoke becomes excessive, or the point at which the voltage differences built up between windings become too great for the insulation to withstand.

Yoke characteristics and focus problems

Early-make yokes were responsible for nonuniform focusing. So long as the tube present had a relatively small screen, this nonuniformity was not obvious and created no problems. With the coming of larger-screen tubes, however, the impairment of focusing became much more noticeable. Let's consider why and how focusing was affected, then go on to see what yoke improvements were made to remedy the condition.

Focus is related to the size of the scanning spot. When proper focus has been attained, the size of the spot is *minimum*. If

spot size *increases* during the course of deflection, defocusing results in the area affected.

When the magnetic field produced by the yoke is not uniform, the size and shape of the scanning spot change. If the magnetic field *increases* in the direction of deflection, the lines of force will *increase* as the scanning spot moves across the screen. The right-hand section of the spot may, in consequence, be in a stronger field than the left-hand side. The right-hand section

Fig. 707. Two examples of barrel-
ing. The sides of the raster are
pushed out.

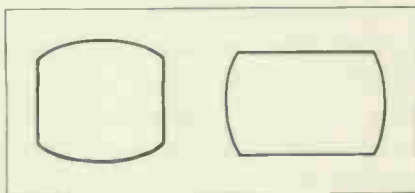

will be deflected more than the left-hand one under these conditions, causing the spot to become elongated toward the right. When the construction of the yoke is such as to cause the lines

Fig. 708. Two examples of pincush-
ioning. The sides of the raster are
pushed in.

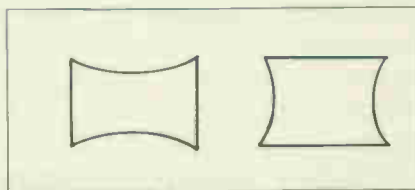

of force to *decrease* in the direction of deflection, the trailing edge of the spot will be in a stronger field than the leading edge, causing it to be deflected more. This will produce an elongation of the spot. The curvature in the flux lines of the field will, in both cases, increase the tendency toward elongation. The increase in spot size, as well as the change in shape, causes defocusing.

Early-make yokes tended to produce a nonuniform field because of their interlocked-winding construction. A cross-section drawing indicating this construction is shown in Fig. 706-a. The effect of such a construction is comparable to that produced by four permanent magnets, arranged as shown in Fig. 706-b. Because the field of the magnets is strongest in their immediate vicinity, deflection in these areas is greatest. The effect on the raster is *barreling*—a condition which causes a bowing outward of the raster sides (Fig. 707).

To eliminate this condition, the *cosine yoke* was developed. This yoke is wound and assembled in such a way as to produce a much more uniform deflection field. The major drawback as-

sociated with the cosine yoke is that it tends to cause an effect called *pincushioning* (Fig. 708). Overlapping of the horizontal and vertical yoke windings in the regions where the corners of the raster appear causes more intense magnetic fields to be produced here than elsewhere. The resultant greater deflection at the corners produces a pincushion effect.

Anti-pincushion magnets

Anti-pincushion magnets are used to correct the tendency of the cosine yoke to produce a nonlinear raster with squeezed-in sides. The magnets are variously known as *anti-pincushion*, *pincushion*, *pincushion correction*, *picture straightener* and *beam corrector* magnets. Small and nonstandard in size, frequently taking the form of a bar, they are mounted on or near the yoke at the side closer to the picture-tube screen (Fig. 709). The magnets come in pairs. One or two pairs of magnets may be used. A set may be found mounted above and below the yoke, as illustrated in Fig. 709, or at each side of the yoke, or both above and below the yoke *and* on each side.

Pincushion magnets are used on larger-sized picture tubes, particularly 24- and 27-inch round-faced units, not only to correct for pincushioning (which may be slight) but also to improve horizontal linearity. They are especially helpful in receivers that employ no horizontal linearity control.

Pincushion magnets are generally preset at the factory and locked tightly into place. They may require resetting, however, because of circuit changes, component replacements, operation of the receiver at low line voltage or other reasons.

Before an attempt is made to readjust the magnets be fairly certain that such readjustment is necessary. The following symptoms point to possible misadjustment of these units:

1. Presence of horizontal nonlinearity accompanied by pincushioning at the sides of the picture and raster. The top and bottom and/or sides of the picture and raster may be affected. The settings of the height and width controls will have to be reduced to make the pincushion effect visible. In some cases, the picture may be noticeably compressed at one side and expanded on the other. When top and bottom pincushioning is being checked for, examine the raster lines in these areas. If the raster lines are bent, misadjustment of the pincushion magnets that affect these areas is indicated.

2. Shaded picture corners.

3. A slight curve in the horizontal sides of the raster. The

symptom could be mistaken for hum in the horizontal circuits.

It is worth noting that the picture may be more severely affected by the misadjustment of pincushion magnets than it would be if they were absent altogether.

Pincushion magnets may be reset with or without test equipment. A better and faster adjustment can be made if a bar or cross-hatch generator is used. The adjustment may also be made

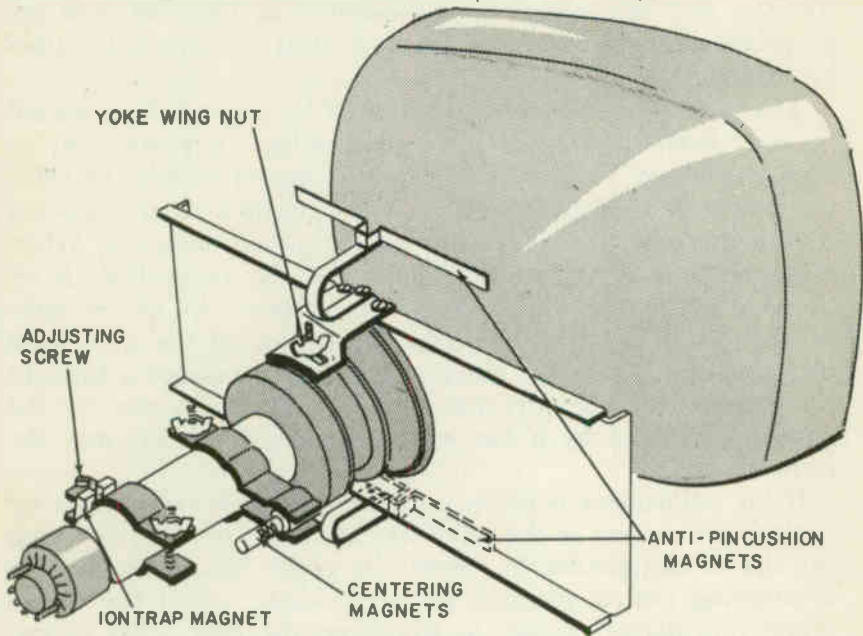

Fig. 709. This drawing shows how the anti-pincushion magnets are mounted.

on a picture or test pattern, particularly one that has horizontal lines near the top and bottom and/or vertical lines at the sides. The adjustment is correct when these lines—and/or the picture sides—are straight. The advantage of using a bar or cross-hatch generator lies in the fact that the size of the picture need not be reduced to observe its edges, eliminating the necessity for subsequent size and linearity readjustments.

When a bar generator is used, it is fed to the receiver either at the input of the video amplifier or at the antenna input terminals, depending on the type of generator employed. The spacing between bars serves as a measure of linearity. Non-uniform spacing indicates nonlinearity. Vertical or horizontal bars may be fed to the screen, depending on whether horizontal

or vertical pincushioning is to be checked for. Vertical bars are used in testing for horizontal pincushioning; horizontal bars for vertical pincushioning. When a cross-hatch generator is available, tests and adjustments may be made without the necessity of feeding two different inputs successively to the receiver (since the cross-hatch generator output is composed of both horizontal and vertical lines). A cross-hatch pattern which shows non-linearity and pincushioning is illustrated in Fig. 710. The appropriate magnets should be adjusted until the cross-hatch lines are straight.

The pincushion magnets are adjusted by moving them toward or away from the bell of the picture tube. They may also be rotated slightly. The closer a magnet is moved toward the tube, the greater is its effect on deflection. When the magnet is moving toward the tube the raster lines will be pulled toward it. When the magnet is moved away its effect on the raster lines is reduced. Each magnet can be moved away from the picture tube to start with; it is then brought slowly toward the tube until the curvature it affects is eliminated. When a magnet is brought too close to the tube, a corner of the picture and raster (or the pattern produced by a bar or cross-hatch generator) may become shaded.

If the adjustment is being made on a picture (and centering controls are present in the receiver) there is no need for reducing the size of the picture to observe its edges. Simply manipulate a centering control to make an edge visible; adjust the appropriate pincushion magnet to straighten the edge, then expose another edge by a suitable centering manipulation, etc.

When the pincushion magnets are mounted by a brass or similar nonmagnetic strap that is readily bent, no tools are needed for adjustment. Simply bend the strap, bringing the magnet toward or away from the tube until the picture, raster or bar-pattern is straight-sided and linear. (A slight rotation of the magnet may also be necessary during the adjustment process.) In some sets a rigid mounting is employed. A screw generally has to be loosened in these cases before the magnet can be adjusted.

If pincushion magnets are to be adjusted in a receiver that has a horizontal linearity control, the control should be correctly set before the magnets are adjusted. For best results, it is desirable either to remove the magnets or place them at a maximum distance from the picture tube before resetting the linearity control. When linearity and width have been made as

satisfactory as possible without the magnets, adjustment of the latter is in order. The magnets should be set to minimize non-linearity as well as pincushioning.

If the pincushion magnets have been mounted backward, it will not be possible to adjust them properly. Such improper polarization is likely to produce a compression along the center of the test pattern or picture. If such a compression is seen and

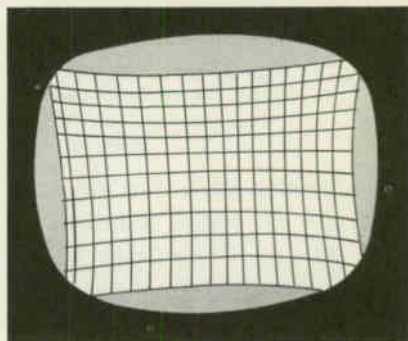

Fig. 710. Cross-hatch pattern showing nonlinearity and pincushioning.

cannot be eliminated by suitable adjustments, try reversing the position of the magnets. When the magnets are color-coded and the code is known, a trial-and-error procedure is not necessary. The set manufacturer's service data will generally call attention to such a code, if one is present.

Components associated with the yoke

A capacitor and two resistors (see Fig. 711) are in most cases connected into the yoke circuits and enclosed in the yoke casing. Yokes are not infrequently condemned and replaced because of defects in one of these components.

During horizontal retrace, the magnetic fields in the horizontal yoke circuits collapse with great rapidity. A counter emf of substantial amplitude tends to be produced in consequence. While the damper tube eliminates most of this ringing or oscillatory effect, some residual ripple may remain in the horizontal yoke coils. If nothing is done to remove it, the ripple may be coupled into the vertical deflection coils, causing wrinkles to form in part of each scanning line. The overall effect is one of dark and light bars at the left-hand side of the picture.

To eliminate this residual ripple, a capacitor of a suitable value is generally connected across one of the horizontal deflection coils. It is not attached across both because an imbalance exists with respect to the capacitance of each winding to ground. One

winding has a larger capacitance to ground than the other (since it is at a greater distance from ground than the other.) To restore the balance and insure linear scanning, as well as to filter out residual ringing signals, the capacitor is connected across

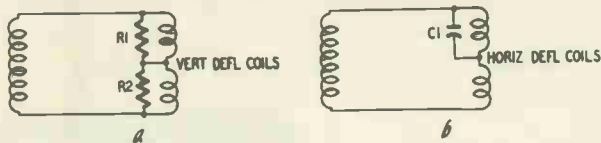

Figs. 711-a,b. Resistors, usually 560 ohms, are shunted across the vertical deflection coils. A single capacitor, with values ranging from 56 to 150 μf , is placed across one of the horizontal deflection coils.

the winding with the smaller capacitance to ground. This is generally the upper winding or the one that is a greater distance from ground. Sometimes (particularly when a late-model cosine yoke is installed in sets using an early-make horizontal output transformer) connection of the capacitor across the lower winding will provide more satisfactory results.

Yokes and yoke components

When too large a value of horizontal yoke damping capacitance is used, severe ripple or waviness will be noticeable in a test pattern. Circles in the test pattern will be distorted, wedge lines in the horizontal wedges will become wavy and other symptoms may result as well.

A short in the horizontal yoke-balancing capacitor will greatly reduce the width of the raster; a characteristic *keystoning* will also be produced (Fig. 712).

Damping resistors are connected across the vertical yoke to keep the circuit from oscillating or ringing during the vertical retrace. When they are too small in value, their shunting effect on the vertical coils will be too large and insufficient height is likely to result. When the resistors increase radically in value or open-circuit, a slight ripple in the horizontal wedges of the test pattern may be produced. Some distortion of the large outer circles of the test pattern may also result. Both symptoms are produced by the undamped or insufficiently damped vertical circuit ringing that is present in this case.

A severe reduction in the value of either resistor will greatly reduce picture and raster height and introduce *keystoning*.

Yoke adjustment

The yoke is invariably positioned as far forward as possible

along the neck of the tube so that it presses against the flared portion of the tube. When the yoke is not sufficiently forward, dark areas are likely to be seen on the screen and a rectangular raster will not be present. Rotation of the yoke (clockwise or counter-clockwise) permits the picture and raster to be brought

Fig. 712. *The photo shows the effect of keystoneing on a test pattern.*

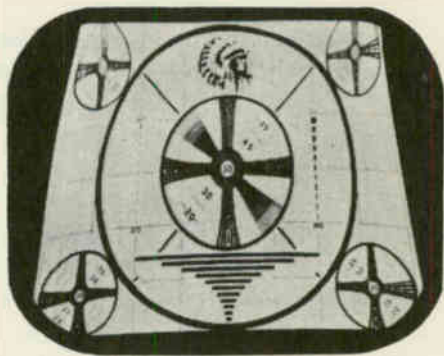

into horizontal alignment with the mask opening. Screws or nuts are provided to keep the yoke fixed in position. These nuts should be loosened before the yoke is adjusted and tightened when its setting is correct.

Vertical-yoke replacement

While the inductance of horizontal yokes has risen over the years, the inductance of vertical yokes has dropped. When a late-model vertical yoke is used to replace an earlier type, mismatching to the vertical output transformer may be introduced. A smaller impedance will be reflected into the transformer primary in such cases, causing the vertical output tube to overload. The remedy is to substitute a vertical output transformer that matches the new vertical yoke.

Loosening "frozen" yokes

Sometimes a yoke becomes stuck to the neck of the picture tube and cannot be moved without the risk of breaking the tube. To loosen the yoke in such a case, apply approximately 50 volts ac to the horizontal coils. The polyethylene sleeve of the yoke will heat and soften under this treatment, freeing the yoke. The 50 volts ac may be obtained from a Variac type transformer. Or an old yoke whose horizontal windings are not defective may be connected in series with the yoke to be freed—that is, the horizontal windings of both yokes are connected in series. Line voltage is then applied to the combination. An ac voltage check may be made across the yoke that is being given the heat treat-

ment, to make sure that the voltage being developed across it is about 50 or 60. Voltage should be applied to the yoke only long enough to loosen it; leaving the voltage on too long endangers the insulation between yoke windings.

Width control sleeve

In some TV sets, a metal sleeve that modifies the magnetic strength of the yoke is placed on the neck of the picture tube. The width of the picture is regulated by adjustment of this sleeve.

Focus systems

The problem of focusing has been attacked in two ways—by the construction of the picture-tube electron gun and by using external magnetic devices placed over the neck of the tube. Early television receivers containing 10- to 16-inch picture tubes such as the popular 10BP4, 12LP4, 14BP4, 14CP4, 16AP4, 16GP4 and 16KP4 used magnetic focusing in which the electron-beam concentration was controlled by the magnetic field of a focus coil or permanent magnetic focus device.

In recent years the low-voltage electrostatic-focus tube has been developed and is growing increasingly popular. This type—the 17HP4, 20HP4-A, 21ALP4-A, 24DP4-A, etc.—requires no external magnet. Its beam is focused by an electrostatic field set up by a potential applied to a focusing electrode (pin 6). Another relatively new development is the automatic-focus type tube, such as the 17KP4, 20JP4, 20VP4 and 21KP4, that needs no magnetic focus field or focus voltage.

Electromagnetic focusing adjustments

Electromagnetically focused tubes use a shielded coil for focusing. The field around the coil penetrates the glass neck and brings the electron beam to focus when the positioning of the coil and the amplitude of the direct current flowing through it are both correct. A potentiometer called the focus control permits the current through the coil to be regulated. Larger-sized tubes use stronger electromagnets than smaller ones do.

The focus coil should be positioned approximately $\frac{1}{2}$ inch behind the yoke. If the focus coil is too close to the yoke, the yoke's deflection sensitivity will be reduced, decreasing the size of the raster. Corner shadows or poor focusing at the corners of the raster may be noticeable in such cases; the raster or semi-raster produced is also likely to rotate when the focus control is varied. If the focus coil is positioned too close to the electron gun (away

from the yoke), interaction of the focus and ion-trap magnet fields will take place, impairing focusing and causing the shape of the raster to be distorted.

To permit proper positioning of the focus coil, the yoke should be placed as far forward along the neck of the tube as possible. The spacing between the two should be a minimum of $\frac{3}{8}$ inch. When proper focus cannot be obtained by manipulation of the focus control, it is very possible that the focus coil is too far from the yoke. The separation of the two should be checked in this case and suitable readjustments tried.

When it is impossible to remove corner shadows by these adjustments, the coil may be removed from the neck of the tube, reversed in position, then put back on the tube neck. (The ion-trap magnet will also have to be removed, then put back and readjusted.) This procedure may prove helpful where other remedies are ineffective.

Another helpful servicing procedure is to reverse the direction of the current flowing through the focus coil. This can be done by unsoldering the leads to the focus coil at the terminals to which they connect, and transposing them. If neck shadow is reduced, centering is easier, and the angle the frame of the focus coil makes with the picture-tube is closer to a right angle than it previously was, the new connections are correct.

Cases occur where the focus control does not have the proper range to produce correct focus. Circuit changes are often made in such instances to suitably reduce or increase the current through the focus coil. On some receivers, however, a different technique is recommended by the manufacturer. This is the addition to—or the removal from—the focus coil of units called *magnetic shunts*. Adding a shunt unit increases the magnetic flux of the focus coil; removing one decreases it. Shunts are added or removed with the focus control at the center of its range, until the picture is sharply focused as well as centered. This technique makes it unnecessary to make circuit modifications where the range of the focus potentiometer is too narrow. Evidence that such a condition exists lies in the inability of the focus potentiometer to go through focus—i.e., provide an approximately center setting at which focus is better than it is at either side.

PM and EM-PM focusing

Focusing is achieved in many cathode-ray tubes by a permanent magnet mounted around the neck of the tube. Units that are a combination of electromagnet and permanent magnet are also

used. The PM section reduces the drain on the receiver power supply and minimizes the number of turns needed in the coil; a potentiometer is used with the EM section, permitting a finer degree of adjustment than is possible with a purely PM focus magnet.

Both PM and EM-PM magnet assemblies may be readily and permanently damaged by careless or improper handling. Jarring or striking a focus magnet assembly can reduce its magnetism, impairing its ability to function properly. Improper storage of such units can damage them too. Leaving a focus assembly on a metal shelf or near metal tools may harm the permanent magnet by weakening its flux. Vibration and shock are likewise damaging and should be avoided during transportation, storage and servicing.

Adjusting PM and EM-PM focus assemblies

PM and EM-PM focus assemblies are moved along the neck of the tube and from side to side into a setting where focus is optimum, as in the case of an electromagnetic focus coil. In general, the correct setting is approximately $\frac{3}{8}$ to $\frac{1}{2}$ inch behind the yoke. A screw type adjustment is often present, permitting the PM field to be increased or reduced. In many cases a shaft that has a knurled metal knob that can be manipulated with the fingers is provided for fine focus adjustments. When a screwdriver adjustment is called for, a brass or nonmetallic screwdriver should be used to avoid damaging the PM unit.

One of the following troubles may be the cause of the adjustment difficulties in EM-PM focus assemblies: (1) Incorrect positioning of the unit on the neck of the tube; (2) PM field too great; (3) PM field too weak; (4) EM winding connected in reverse. Any of these conditions will make it impossible to attain proper focus by manipulation of the focus control.

An EM-PM assembly is generally placed so that the coil's front surface is about $\frac{1}{4}$ inch behind the rear of the yoke. If moving the assembly back improves focusing, the PM field is probably too strong. The assembly should, in such a case, be moved back until focusing can be obtained by focus control manipulation.

When resetting of the assembly does not provide proper focus, either the PM field is too weak or the EM winding is connected in reverse. When the field is too weak, the assembly must be replaced. To decide whether or not this field is weak, the possibility of a reversed winding must first be eliminated. The required test for this is performed as follows:

1. Obtain the best possible focus with the focus assembly moved up against the yoke.
2. Measure the voltage across the EM winding at this focus setting.
3. Move the assembly as far back along the neck of the tube as possible. Readjust the focus control to produce as good or almost as good a picture focus as obtained in step 1.
4. Measure the voltage across the EM winding at this focus setting.

If the EM coil is properly connected, the voltage across it will measure higher in step 4 than in step 2. If the voltage attained is lower or if step 3 does not provide an adjustment comparable to that obtained in step 1, a reversed EM winding is indicated.

If the winding is not reversed, as indicated by this test, and proper focusing cannot be obtained, a new focus assembly should be tried.

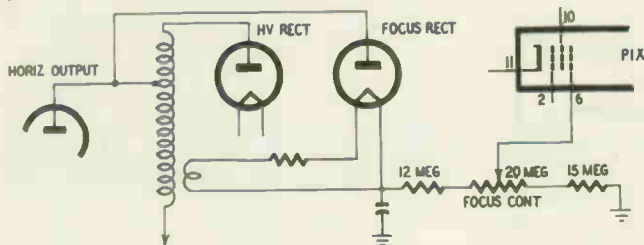

Fig. 713. High-voltage electrostatic focus.

When the PM field is excessive, reversal of the EM winding will decrease it and improve focusing temporarily. Eventually, however, the PM field will be reduced to zero because of the incorrect EM coil hookup, making the assembly useless.

Electrostatic focusing

An electrostatic focus system makes an external focus assembly unnecessary. When an electrostatic-focus system is used, the focus field is obtained by suitable construction of the electron gun. A focusing anode is used in the gun to help supply the required electrostatic field.

High-voltage electrostatic focus

In this system (Fig. 713) the focusing anode is connected to a high dc voltage (between 1,000 and 5,000 volts). Because of its high potential, the focus anode draws some current, causing its voltage to vary when the current through it changes for some

reason. Power-line voltage fluctuations tend to cause the current flowing through the focus anode to vary; the resultant change in the focus anode voltage introduces defocusing, making rather frequent focus control adjustments necessary.

A separate high-voltage supply is used in the high-voltage electrostatic-focus system. When the high-voltage rectifier tube in this supply loses emission or becomes defective, focusing will be impaired. A potentiometer in the high-voltage supply permits the focus anode voltage to be suitably adjusted.

The high-voltage electrostatic system is not widely used in TV sets. Soon after it was developed, superior low- and zero-voltage focus systems appeared.

Low-voltage electrostatic focus

In this focus system (Fig. 714) the voltage required for the focus anode is between -100 v and $+400$ v approximately. The

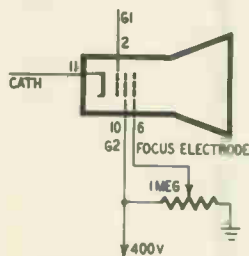

Fig. 714. The low-voltage electrostatic focus system depends for its action on the ratio of the voltages between the first and second anodes.

one advantage of such a system over high-voltage electrostatic focusing lies in the fact that it requires no separate high-voltage rectifier and associated components. A potentiometer in the B supply permits adjustment of the focus voltage.

Proper focusing depends on the ratio of the first and second anode voltages. A change in this ratio will introduce defocusing, necessitating a resetting of the focus potentiometer. Such changes are likely when the brightness control setting is altered or when the power-line voltage rises or falls. Variations in the voltage of the focus anode are more likely because this anode draws appreciable current.

Adjustment of the focus control does not cause the picture to go very noticeably in and out of focus, as with other focus systems. Changes in focus are barely perceptible to the eye when a picture is on the screen and the potentiometer is rotated from one extreme to the other. A better focus adjustment can be obtained by setting the channel selector to an unoccupied channel and adjusting the control to a setting where the raster scanning lines look sharpest.

When the cathode-ray tube is replaced in a low-voltage electrostatic-focus system and focus is not satisfactory, try connecting the focus anode to different B-voltage points in the receiver, leaving it attached to the point that permits best focusing.

Automatic or self-focus

The superiority of the automatic or self-focus picture tube over its electrostatic-focus predecessors lies in the fact that it is much less affected by changes in the voltages of picture-tube electrodes.

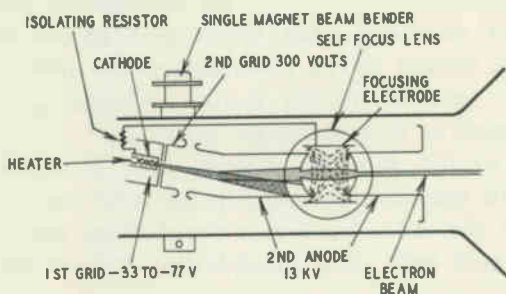

Fig. 715. Gun structure in the automatic or self-focus picture tube.

Variations in line voltage, brightness control resettings, etc. are not likely to cause defocusing because of the structure of the electron gun (Fig. 715). In this type of gun (as in the older electrostatic-focus gun) the second anode is split into two sections and the focus anode is mounted within the gap. A large-diameter focus electrode is used whose field overlaps that of the adjacent electrodes. Since the voltage between the first and second anodes at one side of the gap is always identical with the voltage between the same two anodes at the other side, the focus field remains substantially constant. A resistor, internally connected between the cathode and the focus anode, keeps the two electrodes at the same potential, preventing the defocusing that voltage variations between them might introduce. No external connection to the focus electrode is required for most automatic-focus tubes.

An electromagnetic-deflection magnetic-focus tube may be replaced by a similar electromagnetic-deflection electrostatic self-focus unit. Simply remove the EM or PM focus unit and install the new tube. If an EM focus coil was used with the original tube, substitute a resistor of approximately 5 watts whose value is the same as the resistance of the coil.

Adjusting focus on self-focus tubes

No focus control is generally available for the self-focus cathode-ray tube. Other means must therefore be employed to improve focus. Focusing in tubes of this type is greatly affected by the setting of the ion-trap magnet. It is true that there is only one correct setting for this magnet—the one that provides maximum brightness with no shadowing of the raster or distortion of its shape. When this setting is not perfect, however, brightness may not be noticeably impaired but focusing will.

To obtain optimum focus, set the brightness control at its normal position and turn the receiver off-channel. Carefully observe the raster scanning lines while you adjust the ion-trap magnet. At one setting of the ion magnet, the lines will appear sharpest. *Make sure brightness is not reduced at this setting* Leave the magnet at this optimum position.

If resetting of the ion-trap magnet does not provide sharp focus, reverse the magnet's position on the tube neck (i.e., slide it off the neck of the tube, turn it around, then slip it back on) Readjustment now will often provide the desired results.

Focus adjustments on internal magnetic-focus tubes

When the tube uses an internal magnetic-focus system, an external focus unit will usually be found on the tube's neck. This is a metal sleeve and spring which acts as a shunt on the internal magnetic field and permits the latter to be varied. To adjust focusing, slide the sleeve back and forth until optimum overall focus is obtained.

Centering devices and their adjustment

In many older-make sets, and in some TV receivers of more recent vintage, centering of the picture is attained by potentiometer adjustments. In the case of electrostatically deflected tubes, the potentiometers regulate centering by changing the dc voltages on the deflecting plates. When the voltage on one plate of a set is equal to that of the other, the beam will tend to travel midway between them. When one plate is made more positive, the beam's starting point—i.e., its position when undeflected—will shift toward this plate, causing the raster to move in the same direction. Two potentiometers, one for vertical, the other for horizontal centering, are generally found in these electrostatic deflection sets.

In some electromagnetic receivers, centering is achieved by regulating the dc current through the yoke coils by potentiometers.

Centering accessories on tube neck

In receivers that have no centering controls, centering is often obtained by suitable positioning of the focus coil or magnet (when such a unit is present). The wing nuts or screws holding the coil in position are loosened. By moving the coil slightly in the proper direction and tilting it slightly backward or forward, the picture is centered with respect to the mask. The wing nuts or screws are then tightened. In receivers with centering controls,

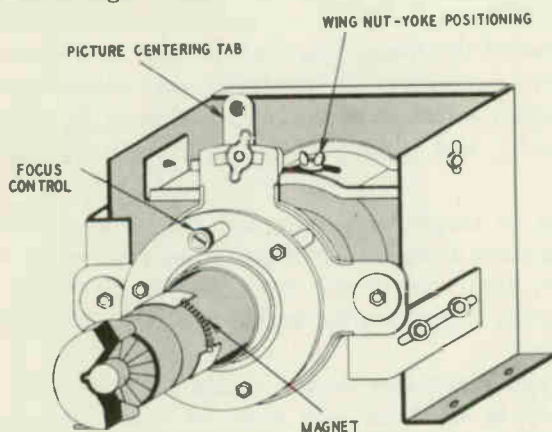

Fig. 716. Adjustment of the centering tab positions the picture.

centering should be achieved, if possible, solely by readjusting the controls. Tilting the focus coil has an undesirable effect on the focus field and should be avoided or minimized.

In some receivers using a focus coil, and in most or all of those using a permanent-focus magnet, a lever on a plate or disk separate from but attached to the focus unit is employed for centering (Fig. 716). Sometimes, movement of the lever up or down provides horizontal centering; moving it right or left produces vertical centering. In other instances, up and down movement of the plate moves the picture up or down; sideways adjustment repositions the picture from side to side. Any nuts holding the lever in position must be loosened before it is free to be adjusted; these nuts are subsequently tightened.

In some receivers using PM or EM-PM focus units, centering is achieved both by a mechanical orientation of the focus unit

and a suitable setting of a centering adjustment screw at the rear of the focus unit. The screw adjustment should be made after the focus unit has been reset to provide optimum centering.

In electrostatically focused tubes (and tubes using internal magnetic focusing), centering is commonly obtained by means of a dual ring magnet. Manufactured in the form of two disks, mounted on a nonmagnetic form or tubing, the assembly is placed around the neck of the tube approximately $\frac{1}{4}$ inch behind the deflection yoke. Rotation of two tabs or levers attached to the magnets (one per magnet) provides centering.

To adjust a centering unit of this type, move the levers toward or away from each other until the picture is centered. When the levers are closest to each other, their effect on centering is maximum. Rotation of the magnet as a whole may also be necessary to obtain proper centering. To minimize the defocusing that the centering magnet tends to introduce, it should be positioned as close to the yoke, and consequently as far from the electron gun as possible.

A defective or improperly designed ring magnet will impair focus. To test such a magnet, bring the test pattern or raster into normal focus, then rotate the two tabs from 0° to 360° . No change or only a slight change in focus should be noted during this procedure.

A clamp type centering device completely separate from the focus assembly is used on the neck of some electrostatically-focused picture tubes (Fig. 717). To adjust such a unit, rotate it to the left or right and turn the knob at its top until centering is proper.

When thumbscrews are found on centering magnets, use thumb and fingers only to adjust them. If pliers or other tools are employed, the magnet is likely to be damaged.

Ion trap and magnet system

One of the most important components in the TV receiver is the ion-trap magnet. Its importance lies in the fact that a mis-adjusted ion magnet can (1) irreparably damage an expensive picture tube and (2) reduce brightness and (in the case of an automatic-focus) impair focus.

Before we go any further, a common error in nomenclature should be noted. Service technicians—even manufacturers—often refer to the external magnet used in ion-trapping systems as the *ion trap*. This is incorrect. The ion trap is inside the picture tube.

The external magnet is the *ion-trap magnet* or *ion magnet* for short.

Need for an ion-trap system

Ions are electrically unbalanced or charged atoms. An atom that has gained or lost one or more electrons becomes an ion. In the first case, the charge of the ion is negative; in the second, it is positive.

Ions are always present in varying amounts inside cathode-ray tubes. The cathode emits ions as well as electrons. Additional ions are formed when the electron beam strikes gas atoms present

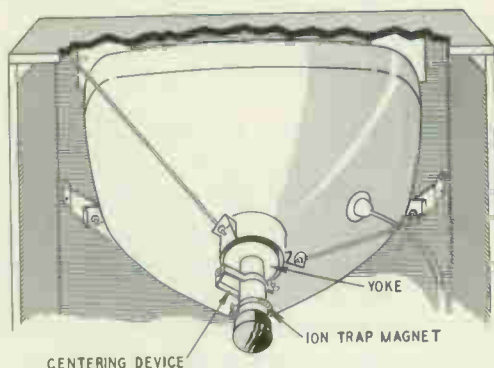

Fig. 717. The centering device is mounted on the neck of the picture tube.

within the tube, knocking off or adding electrons to them.

Positively charged ions, or *cations*, are attracted toward the cathode and cause no trouble. Negatively charged ions, or *anions*, however, tend to be attracted toward the screen. If they were deflected over the entire surface of the screen, they wouldn't do much harm. Ions are, however, about 2,000 times as heavy as an electron and are not appreciably deflected by the magnetic fields that move the electron beam across the face of an electromagnetic picture tube. Ions thus tend to bombard the center of the screen. A round discolored area at the center would result if some means were not used to prevent such concentrated bombardment.

An ion trapping system prevents this undesired condition. The structure of the electron gun is such that both electrons and ions are deflected toward the neck of the tube. The external ion magnet (when properly adjusted) redirects the electrons back

to a path in line with the picture-tube screen. The ions, however, are too heavy to be attracted back and thus never reach the screen.

Types of ion trap

Several types of ion trap are used in cathode-ray tubes. Recognition of the type present has a bearing on the adjustment as well as the replacement of the associated magnet.

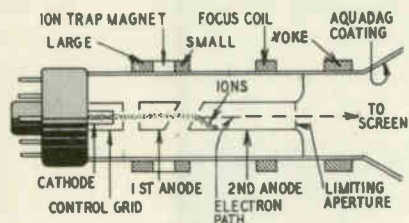

Fig. 718. The straight gun requires a double ion-trap magnet.

In the *straight-gun* (also called the *slashed-field* or *diagonal-cut*) ion trap the axis of the electron gun coincides with that of the tube neck (Fig. 718). A double ion-trap magnet is used around the tube neck. The warped electrostatic field set up in the oblique gap between the first and second anodes causes both ions and electrons to be deflected toward the neck of the tube. The rear or larger of the two ion magnets bends the electrons back to some extent. The smaller front magnet—the weaker of the two—finishes the bending job, causing the electron beam to travel through the second-anode aperture. Two internal pole pieces known as flags are attached to the gun. These units help shape the magnetic

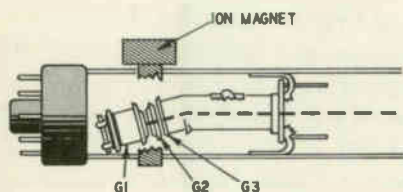

Fig. 719. The entire gun is bent in the tilted-gun system.

field. They are important to the service technician as a guide in the adjustment of the associated ion magnet.

In the *tilted-gun* system; the entire gun is tilted about 3° with respect to the axis of the tube neck (Fig. 719). This causes the gun to look as if it had been inserted into the neck in a slightly crooked fashion. There are no pole pieces or flags in this system. A single ion-trap magnet is employed on the neck of the tube. The electrostatic field present between the first and second anodes

originally directs both ions and electrons toward the tube neck. The external ion magnet bends the electron beam back in the direction of the screen.

The *bent-gun* is similar to the tilted gun (Fig. 720). In the bent-gun system, however, only a *portion* of the gun is bent whereas the *entire* unit is bent in the tilted gun system. The first anode has a bend of approximately 5° . The two preceding grids are in line with the first anode. No pole pieces or flags are present in this system. Because of the bend in the first anode, electrons and ions are originally directed toward its sides or walls. The single ion-trap magnet employed pulls the electrons back so that they take the correct path.

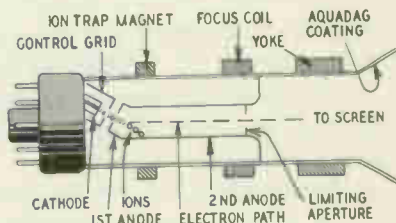

Fig. 720. Only a portion of the gun is tilted in the bent gun.

Ion-trap magnets are commonly PM units. In some of the older-make receivers, however, an electro-magnetic ion magnet is employed. A single ion magnet is used for some picture tubes; a double one in the case of others, depending on the tube's gun structure. Two ring magnets or two pairs of pole pieces will be found in the double-magnet unit.

Symptoms of improper ion-magnet adjustment

Inadequate picture brilliance is most commonly the chief symptom produced by an ion magnet that is slightly out of adjustment. Picture contrast is likely to be unsatisfactory when the reduction in brightness is appreciable. In low-voltage electrostatic-focus tubes, slight misadjustment of the ion magnet may prevent proper focus. Peculiar operation of the brightness control (brightness decreases towards the extreme clockwise setting of the control) may point in some instances to an improperly adjusted ion-trap magnet. In severe cases of misadjustment, corner shadows and a semicircular raster will be noted.

Symptoms of a defective ion-trap magnet

Certain symptoms point to a defect in the ion magnet itself rather than its setting. When a slashed-field gun with internal flags is present and the ion magnet has to be moved more than

$\frac{1}{4}$ inch away from its proper setting with respect to the flags, or has to be pushed up against the focus coil to obtain the brightest raster, the magnet is probably weak. In any case, when an ion magnet has to be set in an abnormal position (too far forward or back), a defect in the unit is generally indicated (assuming that the correct type of magnet is being used).

With an EM type ion magnet, an improper current, or the absence of current through the coil of the unit, may be responsible for its unsatisfactory operation.

When to check the ion-magnet setting

When the symptoms present point to a possible misadjustment of the ion-trap magnet, its setting should be checked. The setting should also be checked even when no recognizable symptoms of misadjustment are visible, under the following circumstances:

1. Whenever a tube or component is replaced in the sweep or high voltage stages, if the substitution has changed the high voltage appreciably.

2. When the set has been moved from one location to another, recheck the ion-magnet setting even if the picture brightness seems adequate.

3. When other accessories (such as the yoke, focus coil, etc.) have been adjusted.

4. When a TV receiver is first installed.

5. When optimum performance is being sought in a weak-signal area.

The setting of the ion-trap magnet depends to an extent on the brightness control setting. Let's assume the ion magnet has been adjusted in a strong signal area at a certain brightness setting. If the set is moved to a weak-signal location, the brightness setting will most probably be different. Repositioning the ion magnet, with the brightness control rotated to the point at which it will be positioned during receiver operation, can produce an effective increase in the contrast of the picture. (There is a tendency to advance the brightness control beyond normal limits in weak-signal areas to make the picture more acceptable. Advancing the brightness setting causes the picture-tube bias to become incorrect and degrades contrast. If greater brightness can be obtained by a resetting of the ion magnet, the brightness control can be left at a more nearly normal level. The picture contrast is effectively improved as a result.

Adjusting the ion-trap magnet

If the ion magnet is being adjusted "from scratch"—i.e., with no

picture or raster visible because the magnet is so far from its correct setting—set the brightness control to a low level. Then move the ion magnet back and forth and rotate it until the screen becomes illuminated. If the technician is uncertain whether the brightness setting is high enough to produce an illuminated screen, but is reluctant to leave it at a more advanced setting for fear of possible damage to the screen, the following procedure may be used: While adjusting the ion magnet, move the brightness control continuously from zero to a high setting, then back to zero. The control will not be at a high setting long enough to damage the tube if the ion magnet is misadjusted; it will, however, be there long enough to permit some illumination to be visible on the screen when the ion magnet approaches the proper setting.

When the screen is illuminated, the magnet may be quickly adjusted (by rotation as well as back and forth movement) to produce maximum brightness. The brightness control should next be turned to a point where the raster's brilliance is low and its scanning lines clear and well-focused, to simulate the conditions present when a picture is on the screen. The ion magnet is then readjusted to provide maximum brightness. The setting should be rechecked if other picture-tube accessories are subsequently adjusted.

The position of the ion magnet should not be changed to remove shadows or rounded corners from the raster if the brilliance of the raster is reduced in the process. Readjust the other accessories (yoke, focus magnet, etc.) to eliminate such symptoms.

In some cases, placing the ion-trap magnet in either of two positions along the neck of the tube will provide a good brightness level. The correct setting in such instances is the one closer to the tube base.

A faster positioning of the ion magnet will be achieved, when the adjustment is started from scratch, by placing the magnet into an initial position close to its correct setting. This may be done as follows:

In the case of the straight-gun (slashed-field system) using a double magnet, the larger of the magnets should be nearer the tube base, directly over the flags. If the flags aren't clearly apparent, set the unit so that the larger magnet is directly over the first anode or grid No. 2.

When a tilted gun is present, place the single magnet over the first anode.

When a bent gun is used, the single ion-trap magnet should be initially placed over the slant cut.

The setting of the ion magnet is affected by the amount of high voltage applied to the picture tube's second anode. The final adjustment of the magnet should therefore be made after any high-voltage faults present have been repaired and the horizontal control reset.

Care should be used in adjusting the ion magnet to avoid breaking the neck of the picture tube.

A blue or green fluorescent glow in the neck of some picture tubes warns of a misadusted ion-trap magnet. The glow is produced by a luminescent coating at the aperture of one of the anodes. The glow is normally scarcely noticeable; it becomes very apparent, however, when the electron beam is off center. In tubes of this type, the ion magnet should be positioned to produce a minimum amount of fluorescence in the neck.

Damage due to misadjusted ion-trap magnet

A misadjusted ion magnet can be responsible for an ion burn on the screen of the tube. This is an area about the size of a half-dollar or less, light brown or yellowish in color. The burning away of the phosphor material on the screen by a concentrated ion bombardment is responsible for the discoloration. Ion burns are most visible—and annoying—when light picture information is superimposed over them.

A far more likely consequence of ion-magnet misadjustment is damage to the top disk of the high-voltage anode cylinder. When the adjustment is correct, beam electrons stream through the aperture in this disk. When the adjustment is incorrect, on the other hand, the direction of the beam is improper and some of the electrons in the beam may now bombard the edges of the aperture. The heat generated by this bombardment can vaporize parts of the aperture, as illustrated in Fig. 721. The damage will impair focus (since the aperture regulates the size and shape of the beam), causing a blurred or poorly defined picture. In some cases, bits of metal that have been torn away from the aperture are deposited on the screen, producing dark areas there.

Gases are given off by the section of the anode being bombarded, due to the excessive heat generated. These gases contaminate the picture tube's cathode and thus tend to shorten tube life.

The higher the second-anode voltage, the greater is the risk of damage to the gun due to ion-trap magnet misadjustment because the beam electrons travel faster when the second-anode voltage is

higher. When misdirected electrons hit the edges of the aperture at a higher speed, more heat will be generated and more damage done. If the heat produced at the accelerating anode exceeds 6 watts, approximately, the metal will vaporize. The technician must be all the more careful in avoiding damage when handling costly, larger-sized tubes, since these are fed higher second-anode voltages.

If the ion-trap magnet is out of adjustment and the brightness control setting is too high, *some tubes may be irreparably damaged in 15 seconds*. This makes it imperative for the technician to make sure that a set with a dark screen (that is undergoing tests) is not permitted to operate for any length of time with the brightness

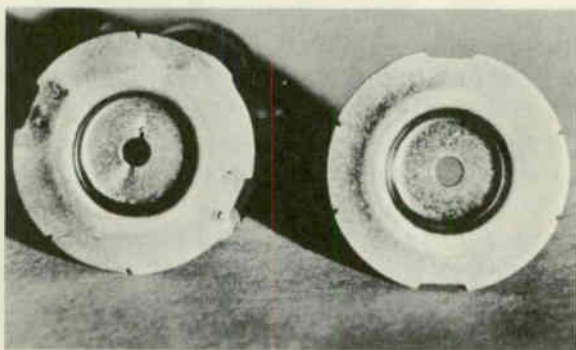

Fig. 721. *Improper setting of the ion-trap magnet can cause damage to the gun structure in the picture tube.*

control setting advanced, unless the technician is sure the ion-trap magnet is not out of adjustment. It also becomes mandatory to keep the brightness control setting low when the ion-trap magnet is being adjusted "from scratch."

Dark spots may develop at the center of the screen in some receivers for reasons other than ion-magnet misadjustment. Irregularly-shaped screen markings are generally the result of defects in the screen material. In some receivers, a dark spot approximately 4 inches in diameter may be seen on the picture-tube screen when the tube is too close to the safety glass. An electrostatic discharge may take place from the center of the screen to the glass, reducing the high voltage at the screen center and thus producing the dark spot. The spot will disappear when the chassis is removed from the cabinet. The remedy is to reposition the chassis (if the picture tube is mounted on it) as far back in the cabinet as it will go.

Replacing the ion-trap magnet

Ion-trap magnets deteriorate with age. In some cases, jarring may have damaged them. In others, they may have become partially demagnetized by placement near a strong magnetic field. Reduction in picture brightness results from such deterioration. When the picture and raster are below normal in brightness, brilliance cannot be increased by ion-magnet readjustment and tube-element voltages are correct, substitution of a new ion magnet (as a test) is warranted. This substitution is particularly logical when the setting at which the original magnet produces maximum brightness is considerably removed from normal.

Certain factors must be taken into consideration when an ion-trap magnet is replaced. In the first place, the correct *type* of magnet must be used: single or double. A straight gun calls for a double magnet whereas other guns require a single unit.

The strength of an ion magnet should be the same as the nominal rating of the unit it is replacing. The rating required depends on the type of gun used and the second-anode potential. Tubes with electrostatic focusing generally employ ion-trap magnets whose field strength is approximately 5 or 10 gauss less than comparable magnetically focused tubes. This is so because the external focus magnet on the magnetic-focus tubes shunts (and thus reduces) the field of the ion-trap magnet, making a higher strength necessary.

When the service technician is uncertain what the strength the substitute magnet should have, an adjustable test magnet will prove helpful. Magnets are available whose strength may be varied from approximately 32 to 55 gauss or higher. To check for required strength with such a magnet, proceed as follows:

Set the magnet strength close to minimum and rotate and slide the unit along the picture-tube neck until the maximum brightness setting is reached. Now increase the strength, going in steps toward the maximum. Each time the unit's strength is readjusted, its setting should likewise be altered to provide the greatest brightness. When a strength setting is reached beyond which an increase produces no corresponding rise in brightness, the strength of the ion magnet is correct. A nonvariable magnet which produces the same level of brightness at the same brightness control setting is now substituted for the variable test unit.

Service technicians who use ion magnets with strengths in excess of what is required, and note no adverse effects, may wonder why a fuss should be made over getting a unit of the proper rating.

The answer is that while a too-strong magnet *may* do no harm in the case of an electromagnetically focused tube, it is very likely to distort the focused scanning spot if the tube is electrostatically focused. Excessive field strength in the magnet is equivalent to a change in the focus voltage of the tube and causes the focus action of the first electron lens system (in which the focus anode plays a part) to be altered. With either an electrostatically or magnetically focused tube, an ion magnet that is too strong may result in an adjustment that is too close to the base of the tube. A brightness peak may be unobtainable anywhere along the tube's neck when the strength of the ion-trap magnet is excessive.

When the magnet is too weak, insufficient brightness, neck shadows and improper centering may result.

In general, when the ion-trap magnet being substituted has to be placed too close to the base of the tube, one of lower strength should be tried. If the ion-magnet setting is too near the bell of the tube, a unit with a higher field strength should be substituted.

A small bar magnet may be used to verify whether the ion magnet substituted is too weak. To make this check, bring the *north* pole of the bar magnet *slowly* toward the ion-trap magnet. Then bring the *south* pole of the bar magnet toward the ion-trap magnet. If an increase in screen brightness occurs at any time during this process (and the setting of the ion trap magnet is correct), the ion trap magnet is too weak.

An arrow or colored dot is often present on the magnet. Make sure that this arrow or dot faces the *bell* of the picture tube (not the base).

When a double ion magnet is being substituted, the larger of the two magnets should be closer to the base of the picture tube.

Testing and repairing picture tubes

Determining whether trouble exists in a picture tube is not always simple. The best test—substitution—is generally too time-consuming to be used except as a last resort. Besides, a substitute may not always be available. Tube checkers have a limited value, particularly where intermittent troubles are concerned. Careful analysis of symptoms and elimination tests offer the best trouble shooting approach in most cases.

Picture-tube "repairs" also merit discussion. The picture tube is generally the most expensive component in the receiver and customers are not always anxious to pay the price of a replacement. A consideration of when repairs are feasible, how to make the repair called for and how reliably the tube (or its socket) can

be expected to function after such servicing is therefore warranted.

To test tubes successfully for the various defects that may develop in them, the service technician must know: (1) what troubles are possible; (2) symptoms and other clues that point to the presence of one particular trouble; (3) test procedures suitable to its detection.

Possible troubles in picture tubes

The following defects may develop in picture tubes: open filament; open circuits in other elements; poor solder connections at the base prongs; partial filament short; short or leakage between cathode and filament; short or leakage between cathode and grid; loss in cathode emission; development of excessive gas; defects in the gun; screen troubles; arcing at the second-anode connection. Poor socket contacts may also prevent proper operation.

Loss of emission

Brightness is reduced when the emission of the picture-tube cathode drops. Since other component defects may also lower brightness, the problem arises of determining whether the fault lies in the tube or elsewhere. If the following symptoms are associated with the loss in brightness but sound is normal, the tube is almost certainly the source of trouble. (1) The picture takes several minutes to develop on the screen (when the set is turned on after being off for a while). (2) The ion-trap magnet (assuming it is normal) must be moved toward the base of the tube, away from its normal position with respect to the electron gun, to obtain maximum brightness. (3) The darkest tones in the picture aren't really black; the lightest areas don't have clear whites.

A picture tube whose emission has decreased considerably is generally incapable of reproducing blacks properly. When the contrast setting is advanced in an attempt to improve the rendition of black tones, picture highlights often assume a silvery appearance. The picture may even become negative when the contrast control is turned up far enough. In some instances, the raster brilliance decreases when the brightness control is advanced beyond a certain point.

If any uncertainty is felt as to whether the picture tube or an associated component is at fault, tests of the tube-element voltages and resetting and/or replacement of the ion-trap magnet should indicate whether substitution is a logical next step. The same tests will be helpful when the symptom is a dark screen and a complete loss of cathode emission in the picture tube is suspected.

Rejuvenation as a remedy for reduced emission

The merits of rejuvenating low-emission cathode-ray tubes have been hotly argued. It is not our intention to endorse one viewpoint or the other but simply to point out the pros and cons and to discuss techniques.

Rejuvenation, or cathode reactivation, works only in some cases. Proponents claim that as many as 80% of low-emission tubes can be restored with proper techniques. Those opposed estimate that a figure closer to 30% would be more accurate. Opponents also point out that the continued successful operation of a rejuvenated tube is very uncertain. Repeated service calls to rejuvenate the same tube are not likely to endear technician to the customer. If the tube fails in a short time, the prestige of the technician is bound to decrease.

Rejuvenation techniques

Commercial rejuvenators generally use one of two methods: *flashing*, or continued application of increased filament voltage. In the flashing method, an increased heater voltage—approximately 1.5 to 2 times normal—is applied to the picture-tube filaments for 1 or 2 minutes. The overvoltage is then reduced to between 1.1 and 1.3 times normal and applied for 1 to 2 hours. This procedure, according to its advocates, changes the contaminated barium compounds in the cathode to the pure barium originally present.

In reactivation via a sustained filament-voltage boost, an overvoltage of 25%—in some cases, even greater—is permanently applied to the picture-tube filament by a booster unit consisting of a transformer or autotransformer. Manufacturers of such units claim that picture-tube heaters are designed to stand up under a 100% overload for a considerable length of time to allow “curing” of the cathode surface during the manufacture. Because of this, the tubes can presumably stand up under the overvoltage produced by the booster. Opponents of this view state that the tube subjected to such an overload will not last long enough to warrant the bother and expense of a booster.

Cathode defects

Not infrequently, a technician is uncertain whether emission trouble is responsible for the symptoms present.

Perhaps a checker has given the tube a clean bill of health but the technician is still suspicious of it. A substitute tube of the correct type may not be available in the shop at the moment or

the technician may be working in a customer's home. Under such circumstances, the test described next (when used in conjunction with an analysis of symptoms) should be helpful in determining whether picture-tube cathode emission trouble is actually present.

Basically, the procedure consists of viewing the undeflected scanning spot on the screen. The scanning spot, we may remind the reader, is actually the image of the picture-tube cathode. Inspection of this image can tell us a great deal about the cathode's condition.

To perform the test, remove the yoke and focus coil (if one is present) from the neck of the tube, without disconnecting these units from their circuits. Removal of the deflection fields will permit the undeflected scanning spot to appear on the screen. If a somewhat larger image of the spot is desired, a PM focus magnet may be inserted on the neck of the tube and moved as close to the bell as possible. The ion-trap magnet (if one is used) should be left on the neck.

Care must be taken during the test to avoid damage to the screen. The possibility of damage is present because the electron beam remains concentrated on a small area of the screen. Turn the brightness control to minimum before the receiver is turned on. After set is on, turn up the brightness control a small amount and adjust the ion magnet for maximum brightness. When this adjustment has been made, leave the brightness setting advanced only far enough to produce a clear image of the scanning spot. If this caution is not observed, the picture-tube screen is likely to be damaged.

Figs. 722-a through j illustrate the kinds of spot that may be seen on the screen. Figs. 722-a,-b show what the spot will look like when a new good tube is present. Note the round, uniformly illuminated appearance of the spot in this case. Fig. 722-c shows what the scanning spot will look like when the tube has been in use for some time. The scattered light shadows are normal. In Figs. 722-d,-e,-f the shadows become progressively darker and more numerous. There is little or no cathode emission from the dark areas. Tubes that produce spots of this kind may or may not perform properly. If a picture-tube checker indicates that the emission is normal, the tube can be considered as still usable. Figs. 722-g,-h-i and j show scanning spots in which extensive areas are dark. The shape of the spot in these cases is effectively distorted as well. Tubes that produce such scanning spots will have impaired focus as well as inadequate contrast.

Fig. 722-a. The photo shows the appearance of the scanning spot on the picture-tube screen

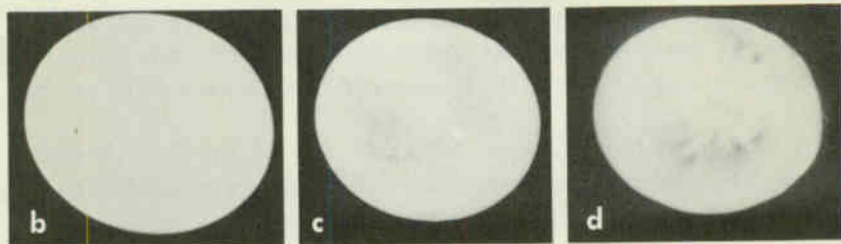
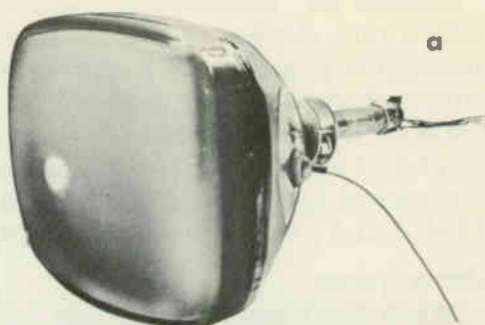

Figs. 722-b,-c,-d. The photo at the left shows the appearance of the scanning spot in a new tube. The other two photos illustrate the effect on the scanning spot after the picture tube has been in operation for some time.



Figs. 722-e,-f,-g. These photos show how the scanning spot becomes progressively worse. Note the distortion of the spot and the appearance of shadows.

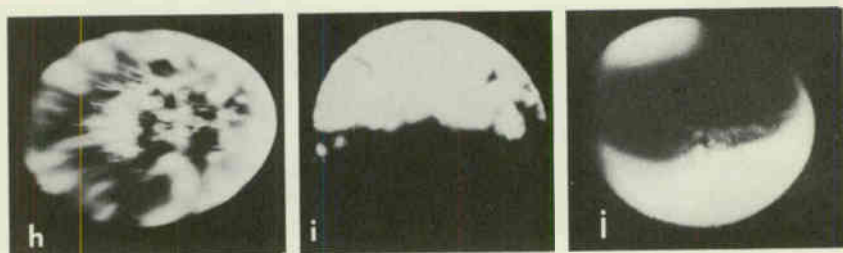

Figs. 722-h,-i,-j. These photos of the scanning spot indicate that a large area of the picture-tube cathode is dead. The dark shadows mean loss of cathode emission. The scanning spots are also severely distorted.

The test just described is a useful supplementary one to a test with a tube checker. When the tube checker indicates that the emission is passable, but a scanning-spot inspection reveals that large cathode areas are dead, the verdict of the spot-inspection test is the more reliable one. (It is assumed the symptoms pointing to a loss of emission in the tube are present.) If emission reads below normal and the spot resembles one of those shown in Figs. 722-h, i, and j, replacement of the tube is also called for.

Gassy tubes

When electrodes in the picture tube become overheated, they give off gas. The getter absorbs released gas to a certain extent. When the gas is excessive in quantity, however, or the getter has become inactive, excessive amounts of gas accumulate in the tube.

A tube that has an appreciable amount of gas in it is called *gassy*. The positive ions formed by collisions of electrons with gas atoms tend to lower the grid bias, impairing the operation of the tube.

Various symptoms may be introduced when a picture tube becomes gassy. When the sync take-off point is in the grid circuit of the picture tube, synchronization may be upset (due possibly to reduction in sync pulse amplitude as a result of grid current flow). If the receiver uses a keyed agc circuit, the out-of-sync condition will affect the agc voltage output, causing picture contrast and sound to be impaired. When excessive grid current flows because of the reduction in bias produced by the gas, a dark picture, even no picture at all (dark screen), is possible. In other cases, it will not be possible to reduce illumination to zero by manipulation of the brightness control. Retrace lines may be visible at normal brightness control settings. Poor focus, insufficient sweep or a negative picture may result from a gassy condition in the picture tube.

If a picture-tube grid-to-cathode voltage check produces appreciably different readings with the tube in and out of its socket, the picture tube *may* be gassy. (A leaky coupling capacitor or a grid-to-cathode short in the tube may also be the source of such discrepancies.) A good test for verifying whether gas is actually present may be made as follows:

1. Let the receiver warm up by operating it for several minutes.
2. Prepare to make a dc voltage check between the picture-tube grid and cathode.
3. Remove the picture-tube socket and *very quickly* connect

the voltmeter test prods between grid and cathode. If the grid is *positive* with respect to the cathode, positive ions have accumulated at the grid and the tube is gassy. (If the grid reads *negative* with respect to the cathode, an electron accumulation on the grid is indicated. This is normal.)

"Sparkers" are commercially available that detect the presence of gas in a picture tube. These units are also used to clear shorts between picture-tube electrodes.

Gas may, in some cases, reveal its presence by producing a pinkish glow in the area near the electron gun. A milky-looking getter is another indication of gas. It may readily be viewed when the glass opposite it is clear. (A little "window" is sometimes provided in the internal Aquadag near the getter to permit inspection.) There is no practical remedy for removing gas from a picture tube. Another tube must be substituted for the defective one.

Leakage of minute amounts of air into a cathode-ray tube will produce symptoms similar to those caused by gas. Usually silvery in appearance, the getter will look black or milky in color.

Filament troubles

An unlit picture-tube filament may, in most cases, be detected by visual inspection. When a visual check is not practical for some reason, feel the neck of the tube (after the set has been on for a minute or more) to see if it is heating up.

If the source of the trouble is an internal open in the filament, replacement is called for. Not infrequently, however, a poorly soldered filament connection is responsible for the apparent open circuit. Resoldering the base filament connections, whether or not they look as if they need it, is a wise preliminary check when an open heater seems to be present.

An ohmmeter check will often indicate when such resoldering is definitely called for. To make such a test, connect the ohmmeter leads between the filament prongs of the picture tube, with the tube out of its socket. If the filament is cold, it should read about 2 ohms (assuming the heater current rating is .6 ampere and the heater voltage 6.3, as is common). Leaving the ohmmeter leads connected to the pins, tap the base of the tube lightly with a small screwdriver or similar light tool. If the meter reading varies appreciably, resoldering of the filament pins is called for. (Make sure the contact of the meter leads to the tube filament pins is not interrupted during the above test.) A retest when the resoldering job has been completed and the pins have

cooled, will indicate whether trouble was really present here in the first place.

Defective socket contacts (as well as poor base prong connections) may be responsible for intermittent or continuous filament opens. Measuring the filament voltage from the top of the socket (with the picture tube out of the socket), while tapping the socket and wiggling the socket contacts, will often determine whether the trouble lies here. An appreciable variation in the voltage during the tapping and wiggling tests calls for a socket replacement. (It is assumed that the variation cannot be attributed to interruptions of the contact between the voltmeter leads and the socket contacts.)

A partial short circuit in the picture-tube heater winding may occur in some cases, reducing the filament voltage of the tube and lowering the maximum screen illumination. When the picture-tube cathode is in good condition and the line voltage is normal, a partial filament short that reduces the filament voltage by 10% or 15% will not necessarily impair receiver performance. When the filament voltage is reduced more than 15% by the short, replacement of the tube is generally necessary.

A word on detecting the short. If the filament supply voltage of the cathode-ray tube is normal or slightly above normal with the tube out of its socket, but drops appreciably below normal when it is in its socket, a partial filament short in the tube is indicated. In the case of series-filament circuits fed from a selenium rectifier, the voltage on the filaments of tubes in series with the picture tube will be normal, while the c-r tube's heater voltage will be below normal if a partial filament short is present. When the reduction in filament voltage is less than 15% but set performance is noticeably affected, use of a separate filament transformer for the picture-tube may be helpful. Removal of the loading effect of other tube heaters will boost the c-r tube's filament voltage, permitting continued use of the tube.

When the filament of a picture tube is internally open, no permanent repair can be achieved. A temporary weld can, however, be made in certain instances that permits operation of the tube for as long as several hours. Since the technician may conceivably run into cases where such an emergency repair is desired, the procedures used to effect the weld will be briefly described.

One technique consists of sparking a high ac voltage across the filament terminals. In another method, a capacitor with a capacitance of 100 to 200 μf is charged to several hundred volts

dc, then discharged across the tube's filaments. The methods described will be temporarily successful only in (some) cases where the filament has broken because of physical shock. No success can be expected when excessive filament voltage, or a loss of the tube vacuum, has caused the filament to open in one or more places.

Heater-to-cathode shorts

Heater-to-cathode shorts are likely because of the close spacing between heater and cathode. The heater actually touches the cathode sleeve in one or more places, with only an insulating coating on the heater separating the two electrodes. When this insulation breaks off at a point where the heater is in contact with the cathode sleeve, a cathode-to-heater short will frequently result.

Cathode-to-heater shorts may be continually present, or they may occur only after the tube has been in operation for some time. Possible symptoms (depending on the circuit present) include: washed-out picture, no picture, raster normal, black-and-white (hum) shading in the picture.

The presence of a cathode-to-heater short may be verified in most instances by an ohmmeter check made between these electrodes while the picture tube is still hot but disconnected from its socket. The ohmmeter section of a VTVM should preferably be used for such a test, with the meter set to the highest resistance scale to permit detection of small amounts of leakage.

Cathode-to-heater shorts are sometimes cleared by application of the line voltage between the two electrodes (tube disconnected from its socket). The method is not recommended, however, because use of such a high-current source may result in damage to the cathode. A better technique lies in using a high-voltage low-current source—the high-voltage power supply of a TV receiver, for instance.

To clear the short via this method, disconnect the picture tube from its socket and connect the cathode prong to the receiver chassis by means of a wire terminated in alligator clips. Connect another wire to the plate cap of the horizontal output tube. Now touch the free end of this high-voltage lead to either of the filament prongs, letting the wire contact the prong only momentarily. Do this several times in succession. If the short does not clear immediately, repeat the process, *gently* tapping the neck of the tube with a pencil or other light tool (Fig. 723) during the time high voltage is applied. The tube need not be removed from the cabinet for this repair operation.

When a cathode-to-heater short cannot be eliminated, the picture tube may be restored to satisfactory service, in some cases, by using a separate filament transformer to feed its filament. This procedure is most likely to be helpful when (1) the cathode-to-heater short is causing the cathode to be grounded through the heater winding; (2) the video signal is being fed from the video amplifier to the grid of the picture tube.

Grid-to-cathode short

Short circuits between the picture-tube cathode and grid are promoted by the very narrow separation between these electrodes. The spacing present is between $4/1,000$ or $5/1,000$ inch. When the cathode has heated, this separation is narrowed still further $3/1,000$ or $2/1,000$ inch. A slight flaking at the cathode can, in consequence, produce a short between cathode and grid. Such a short may disappear when the tube is cold due to the increased spacing present between electrodes when they have undergone contraction.

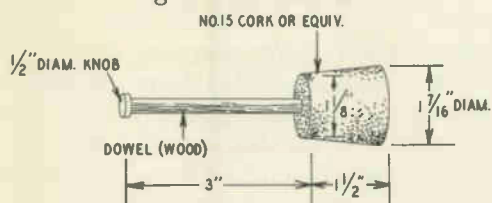

Fig. 723. A cork and a wooden dowel make a very suitable tube tapper.

The existence of a cathode-to-grid short is generally indicated by the inability of the brightness control to regulate brightness. It will not be possible to reduce the excessive brightness present to normal levels when such a defect is present. Retrace lines will probably be seen and synchronization is likely to be impaired. In many instances, the picture will be very weak or absent. Arcing may sometimes be seen in the neck of the tube.

An appreciable difference in the grid-to-cathode voltage readings, when measurements are made with the picture tube in and out of its socket, indicate that a grid-to-cathode short *may* be present. To verify if this is the case, make a resistance check between the two electrodes with the tube disconnected from its socket. To check for a "hot" short, let the picture tube warm up by leaving the receiver on for five minutes or so; then turn the set off, disconnect the tube from its socket and quickly measure the resistance between grid and cathode. The ohmmeter section of a VTVM should be used for this test, with the meter set at its highest ohms range to permit detection of small amounts of leakage.

In many cases, a grid-to-cathode short can be eliminated. The possibility is particularly good if symptoms disappear momentarily when the base or neck of the picture tube is gently tapped.

One method of clearing up the short may be described as follows: Charge a 0.25 μf 600-volt capacitor to approximately 400 volts by connecting it between a suitable B-plus point and ground. Now connect the capacitor between the picture tube grid and cathode, leaving the receiver on. Repeat this discharge process several times.

Fig. 724. This photo shows the effect on a test pattern when the metal cone of a picture tube becomes magnetized.

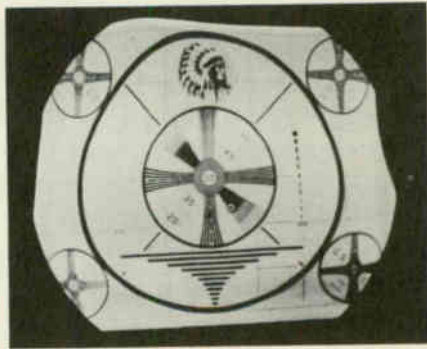

When this method is ineffective, the receiver's high-voltage power supply may be used to "flash" out the short. To apply this technique, proceed as follows: Connect the grid pin of the picture tube to ground through a well-insulated clip. Attach a piece of high-voltage wire to the plate cap of the horizontal output tube. Terminate this wire in a well-insulated clip. Now turn the set on and touch the naked end of the clip to the cathode pin of the picture tube several times in succession, taking care to avoid shock. Gently tap the neck and base of the tube at the same time. The high-voltage arcing that takes place between the electrodes will often clear the short.

The lead going to the tube's 2nd anode is sometimes used as a source of high voltage for the flashing technique just described. The possibility of damaging components in the high-voltage circuit becomes greater, however, when this method is employed.

Magnetized metal picture tube

The metal cone of a metal-glass picture tube will become magnetized if a strong magnetic field is brought near it. Contact of the cone with the magnet of a PM speaker is the commonest cause of cone magnetization. The characteristic symptom produced is a distortion of the picture and raster. The raster's edges are generally twisted out of shape. (Fig. 724). Magnetization of

the middle and small end of the cone tends to cause the severest distortion. The defect is readily identified with the aid of a pocket compass. The needle of the compass will deflect toward the magnetic area on the cone, when the compass is brought near the latter.

To demagnetize the cone, the following procedure may be used. Make up a coil of 1,250 turns of No. 24 copper wire, wound on a flat form with a diameter of 7 inches. Connect a line cord and plug to the ends of the coil and apply power (line voltage). Now move the flat side of the coil over the cone area to be demagnetized.

Power should not be applied continuously to the coil since the unit takes 1 ampere at 117 volts and will overheat if left on for a considerable length of time. Power should not be removed from the coil until it has been moved away from the cone. The back emf that develops when the line voltage is removed may otherwise remagnetize the cone to a certain extent.

Universal picture tubes

A quick way to check on picture-tube performance is to use a picture tube that permits quick substitution. A universal picture tube, the 5AHP4, does not require a focus device or ion-trap magnet. To observe set performance it is necessary only to insert the universal tube in place of the regular picture tube and to connect the high-voltage lead and the regular picture-tube socket to the 5AHP4.

Another type that can be used for testing virtually any picture tube from 10 to 27 inches is the 8XP4. This tube is an 8½-inch rectangular unit featuring self-focusing and a parallel-mounted electron gun, eliminating the need for an ion-trap magnet. No external conductive coating is used.

The 8XP4 may be used in receivers designed for either magnetic or electrostatic focus to check almost any electromagnetically deflected picture tube, regardless of deflection angle.

radio tube troubles

EFFICIENT procedures in the servicing of radio tube troubles will shave valuable minutes off repair time. Our approach is based on the premise that the preliminary testing of all tubes in a set is (a) needlessly time-consuming and (b) inconclusive in many instances, due to the inadequacies of a tube checker.

Need for stage localization tests

Rapid servicing is made possible by localizing trouble to the section and stage involved; then only a single tube will often have to be checked. Procedures to use for different symptoms are summarized in the pages that follow.

One or more tubes don't light

If the set is a straight ac receiver and a (glass) tube is observed to be unlit, resistance-check the filament of this tube. To determine if a metal tube's filament is not lighting, touch the tube momentarily. (Do this only when the set is turned on after having been off for an appreciable time. If a tube is touched when it has been permitted to become very hot, a burn is likely.)

When the set is an ac-dc type and no tubes light, resistance-check the filaments of the tubes, withdrawing the tubes from their sockets, one at a time. Start with the high-voltage filament types (such as the 50L6, 35Z5, etc.) since these are the likeliest to open.

If only some tube filaments in an ac-dc set are seen to light, a shorted tube is probably present. Test the tubes in a tube-tester, starting with those which were seen to light or which were warm

to the touch. These are the tubes among which the shorted one is likely to be found. Check for leakage between elements. A heater-to-cathode short is generally responsible for the symptoms cited.

In some cases, a short of this type occurs only when the tube has heated sufficiently; give the suspect tubes a chance to "cook" in the checker for some time.

Tubes in an ac-dc set may not light because one of them isn't fully in its socket, causing the filament circuit to be interrupted. Enlargement of the socket keyway may have permitted such an inadequate insertion or the key on the tube may be broken.

Sometimes series-connected tubes won't light because two or more of them are in the wrong sockets. Infrequently, a wrong tube type is in some socket (due to an improper substitution by the set owner). The familiarity with tube line-ups and positioning that comes with experience will enable the service technician to spot such troubles quickly.

Intermittent filament troubles

When an ac-dc set plays intermittently, see if the filaments remain lit when the set stops playing. The pilot light (if one is used) will go out if the filament circuit is interrupted, calling attention to this condition. This statement does not apply if the pilot light is not in series with the tube filaments.

A defective tube filament is frequently responsible for intermittent troubles. A thermal fault is often present in these cases. Although the filament is broken, the two sections make mechanical contact when the tube is cold. When the filament heats, it expands and the broken sections part, causing an interruption of the filament circuit. The current flow stops allowing the filament to cool. Contact is now re-established and the tube begins to function once more, until expansion again opens the circuit. The radio stops playing, of course, during the time the filaments are open.

One of the best and fastest ways to locate the source of such trouble (in series filaments) is to check the ac voltage across each filament when the set has gone off. Zero voltage will be measured across normal filaments, since no current is passing through the circuit. When the voltmeter is placed across the open filament, however, the meter completes the circuit (Fig. 801). Current now flows and the voltmeter will register. (The small amount of current, however, will not be enough to light the tubes.) Since the meter's resistance is large, in comparison with that of the tube filaments, almost all of the line voltage will appear across it. If line voltage, then, is read when an ac voltmeter (i.e., the ac section

of a voltmeter) is connected across a tube filament, that tube is the intermittent one. When a make-and-break process takes place in the filament during the time the voltmeter is connected across it, the voltage measured will fluctuate between zero and line voltage.

The novice technician may wonder why such a method is used. Why not check the tubes in a tube tester? The answer is that the tester will not generally reveal such trouble when a conventional test is made.

In some instances, the duration of the set's dead interval—i.e., the time of filament open-circuit—is so short that a voltage test of all the filaments cannot be made before the set starts to operate again. One possible way of locating the trouble lies in applying excessive filament voltages to the suspect tubes. The method is a controversial one but no damage will be done to a good tube if

Fig. 801. An ac voltmeter can be used to locate an open filament.

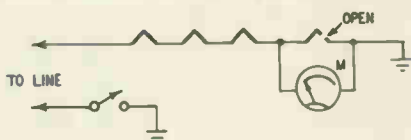

the precautions cited below are observed. Only indirectly heated tubes should be subjected to such treatment; direct-filament types will blow quickly if a filament voltage in excess of their rated one is applied.

The method is this: Put the suspect tube into the tube checker. (Start with the tube that has the highest filament voltage rating and work down to the lowest voltage types.) Apply the correct filament voltage and let the tube heat for awhile. After a minute or so, raise the filament voltage by adjusting the filament control on the tube tester. (Don't apply excessive filament voltage to a cold tube.) If the tube is a 50L6-GT, for instances, the filament voltage applied to it may be increased from 50 to 60, then to 70, all the way up to a maximum of 100. Watch the inside of the tube all the while, noting whether the tube "blinks"—i.e., varies in its filament lighting. If it does, the tube is defective. A second caution: *Don't apply excessive voltage to the tube filament for more than a moment.* The whole procedure should be performed very rapidly. It may be repeated once if no blinking is noted the first time. If the tube seems normal, go on to the next one. It is advisable to apply no more than double the normal filament voltage to any tube.

When the tube tester provides a pilot light in series with the filament of the tube under test, blinking of the pilot lamp will indicate that the tube is defective.

Excessive filament voltage should not be applied to miniature tubes since the close spacing of elements present in this type of tube makes the procedure dangerous. *Never press the emission button on the tester when the filament voltage is above normal.*

Another method of localizing an intermittently opening tube filament lies in resistance-checking the filament of each tube while it is still warm. This involves continuity-testing every tube as quickly as possible after the set has been turned off. When the tube is warm, a thermal break is more likely to manifest itself than when it is cold.

In a few cases, particularly in old sets, when a tube like the 25Z5 is the source of trouble, filament expansion and contraction may be noted by visual inspection. This method is faster than a voltage or tube-tester check and is worth trying in the case of a short-duration intermittent.

Sometimes intermittent lighting of a tube filament is due to a poorly soldered connection at the tube prong. Inspection will frequently indicate whether this is a possibility. If a prong looks as though the soldering may be inadequate, hold a soldering iron against it to renew the connection. A small amount of solder may be applied to the prong when necessary.

Poor contact of socket and tube filament prongs may be responsible for intermittent filament lighting. The defect may be readily checked for in certain socket types by placing a screwdriver blade between the suspected contact and the tube prong associated with it. If a spark is seen and the filaments now light, the contact is imperfect and should be improved. In the case of other socket types, test the contacts by wiggling the tubes. If intermittent filament lighting is produced by such action, a poor connection may be present. To remedy the condition, try pressing the filament socket contacts closer together with a thin sharp-pointed tool, such as a scribe. (This is done at the top of the socket.)

In an ac set, socket-contact trouble may be checked for by measuring the voltage between the "hot" filament socket contact and ground, and the "hot" tube filament prong and ground (if this tube prong is accessible at the socket). If voltage appears at the socket contact but not at the tube prong, contact is not being made between the two.

Set doesn't play but tubes light

When the set doesn't operate but the parallel filaments light, click tests can be made to locate the faulty stage. The procedure is

as follows: Remove the power amplifier tube from its socket and listen for a clicking sound, holding your ear close to the speaker. If no click is heard, test the rectifier in a tube checker. If the rectifier is defective, test the B supply for a short before replacing the tube. (This test may be made from the top of the rectifier socket, avoiding the necessity of removing the chassis from its cabinet.)

If a click is heard, remove the tube that feeds into the power amplifier. A louder click should now be heard. Work backward toward the antenna input, removing tubes one at a time. When a tube is found whose withdrawal does not produce a distinct click, a defect in that tube may be present. The clicks are produced by the interruption of current that takes place in the plate circuit of the withdrawn tube. This interruption constitutes a pulse of current that is amplified in succeeding stages.

In cases where click tests seem inconclusive and the set is out of its cabinet, disturbance tests may prove helpful. To make such tests, use a long wire, or preferably, the lead-in from an external antenna. Rub this wire against the grid of the last tube (the power amplifier). A scratchy sound will be audible in the speaker if the power amplifier, rectifier and speaker are functioning. Now disturb the grid of the preceding tube. The scratchy sound should be louder. Work backward in this way toward the first tube. When a tube is reached which produces no sound when its grid is scratched, a defect in that tube (or its circuit) is indicated. When no scratch is produced at the power amplifier grid, a defective rectifier or power amplifier tube may be present.

The procedures just outlined may be dispensed with if the set sounds "alive"—i.e., has a high noise level and sounds as if it were tuned between stations. In this case a defective converter (or oscillator, if a separate oscillator and mixer are employed) should be looked for. If the set is out of its cabinet, this diagnosis may be quickly verified by touching the lead from an external antenna to the stator terminals of the rf and oscillator tuning capacitor sections. Hum or noise will be heard, or one or more stations will come through when the rf stator is touched; touching the oscillator stator, however, will generally produce no aural effects if the oscillator is inoperative.

When a converter with an external grid cap is used a poor solder connection inside the grid cap may make the converter wholly or intermittently inoperative. If the cap looks at all suspicious, try renewing the connection by holding a soldering iron to the cap briefly, adding a little solder to the top of the cap.

Set plays on some stations

When the set plays on only a portion of the dial, oscillator trouble is often responsible. In some cases where the oscillator is completely inoperative, one station will nevertheless come through. This takes place when a strong station is present near the 550-kc end of the dial and the if stages are not too accurately aligned. The set acts like a tuned-rf receiver in this case and passes the single station.

Converter tubes with defective oscillator sections will often check OK in a tube tester. Substitution is the only safe test for such tubes.

Station drift

When the radio needs to be retuned after it has been on for a while, either because the station originally tuned in is no longer coming through or is coming through distorted, the converter or oscillator tube may be defective. A quick preliminary inspection of the dial cord may be made before the tube is changed. Too-tight stringing of the cord may be responsible for an undesired movement of the tuning capacitor that produces effects similar to those caused by oscillator drift.

Receiver volume below normal

When the set plays low but all stations are received and no hum or distortion is audible, try a new rectifier, power amplifier and audio voltage amplifier, in that order. (Don't waste time testing the rectifier and power amplifier in the tube checker—defects in these tubes that reduce volume are often undetected by such a test since the tester does not put these tubes under their normal heavy load.) After this, test the remaining tubes in a tube checker or by substitution.

When the set's volume drops below normal after a while or does not reach normal volume until the set has been in operation for some time, a defect in the rectifier or power amplifier is quite possibly the source of the trouble.

If a relatively slight reduction in volume is present, see whether the pilot lamp is burned out. If it is, replace it. When the pilot light is connected across a section of a 35Z5-GT (or similar tube) filament, an open in the pilot lamp will cause an increased voltage drop in the rectifier filament section across which the pilot light is connected (Fig. 802). The voltage across the remaining rectifier filament section, as well as that present across the filaments of the

other tubes, will be reduced proportionately. The set volume will drop slightly (but noticeably) in consequence.

When set volume is normal at the high end of the band but inadequate at the low, a defect in the oscillator or converter tube may be responsible.

Distortion

Distortion may be defined as a reduction in receiver fidelity. To determine whether fidelity is normal, the service technician must know what to expect from a particular set. This is not always simple for the novice because some sets are rather poorly designed and have abnormal levels of distortion even when in "perfect" working order. It is generally best for the service technician to leave such redesign work alone, unless his thirst for knowledge exceeds his concern for profit.

The distortion just referred to is relatively slight; when severe or marked distortion is present, there can be no question that it is abnormal and not due to a design fault.

Distortion falls into a number of categories: harmonic, intermodulation (IM), frequency, transient, etc. Harmonic distortion generally results from nonlinear operation of a tube due to a change in its biasing or its e_c-i_b characteristic. Distortion of this

Fig. 802. An open pilot light (filament burned out or bulb removed) changes the voltage across the rectifier filament.

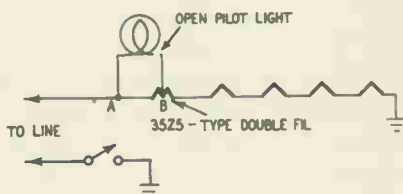

kind affects the amplitude of audio signals very noticeably. It also causes undesired frequencies to be generated, producing intermodulation distortion. IM causes reproduced audio signals to sound harsh and rough.

A tube defect may cause a noticeable change in the frequency range of audio signals. Generally, this change will be masked by the more severe amplitude distortion present; in a few instances, however, it will not, and "thin" tone (narrow frequency range) may be the most conspicuous symptom present.

When distortion is audible and all stations are received, trouble in the audio section is generally indicated. (It is assumed that no hum is associated with the distortion.)

A "creeping" distortion that starts after the set has been operating for several minutes and gradually becomes so bad that speech

is unintelligible is generally due to a defective power amplifier (especially a high-filament-voltage type like the 50L6-GT, 35L6-GT, etc.). Grid emission is present in these instances. The diagnosis may be confirmed, if the chassis is out of its cabinet, by checking the grid-to-ground voltage of the power amplifier. A reading at least several volts positive will generally be present when grid emission exists. This voltage will be present even when the grid coupling capacitor is disconnected.

An emergency "repair" may be made of the grid-emitting tube by lowering the value of the grid resistance to one-half its value or less. Volume will be decreased but the distortion will often be reduced or eliminated. A permanent repair of this type is, of course not recommended since neither the volume nor the fidelity will be normal.

Cathode-to-heater leakage in the power amplifier may be responsible for "hot" distortion—i.e., distortion that takes place after the set has been in operation for a while. Positive ion current may also be the cause of such a symptom. This current is produced when electrons collide with atoms of residual gas, knocking other electrons out of the gas atoms and causing them to become positively charged ions. The ions are attracted to the negatively charged grid of the power amplifier. Their presence at the grid reduces the bias and causes the plate current to rise. The resultant increase in the heating of the plate tends to release more gas, which causes more ions to be formed, etc. The process thus tends to be a cumulative one. The positive ions may bombard the negative cathode of the tube; if enough of these massive ions strike the cathode, its coating will be destroyed.

Distortion produced by positive ion current does not generally cause speech to deteriorate quickly into unintelligibility, as grid emission does. Both types of distortion differ from that caused by heater-to-cathode leakage in that the hum heard at the minimum volume setting will be excessive if heater-to-cathode leakage exists but not if gas or grid emission is the source of trouble.

When a new power amplifier tube has been on the shelf for a long time, its gas content may be greater than normal. The excess gas may be quickly eliminated by operating the tube in the receiver for a short time with a small value of resistance connected between grid and cathode.

A slight amount of gas in a tube will show itself (if the tube has a glass envelope) as a blue glow between cathode and plate. When this glow extends outside the ends of the electrodes, the tube is likely to be seriously gassy.

The glow referred to should be distinguished from two other phenomena that are somewhat similar. One is the fluorescence that may sometimes be seen inside the bulb of a tube. This bluish haze may vary in intensity and area. In some instances, fluorescence may be noted in the surfaces of the mica supports inside the tube. Fluorescence is a harmless condition. A pink-violet glow in a tube is generally a sign that air has entered through a slight crack in the bulb. The tube is "finished" when such a glow is visible.

Gas is most likely to appear in the power amplifier since this a high-current tube; high currents cause considerable heating of the plate, which tends to result in the release of gas.

Sometimes a leaky coupling capacitor *and* a defective power amplifier may both be simultaneously contributing to an audio distortion. Replacement of the tube alone will not clear up the distortion in such cases and may result in a slowing up of the service technician's diagnosis. A grid-to-ground voltage check at the power amplifier will confirm whether this is the stage to be investigated. Presence of a positive voltage here—even a very small positive voltage—points to the possible existence of trouble in this stage. (Note: sometimes a leaky coupling capacitor may produce no significant voltage symptoms.) To check if the coupler is bad, disconnect it at the grid side and test the voltage between the loose capacitor pigtail and ground. If the reading after the capacitor has charged is not zero, try another capacitor. A new power amplifier tube may next be substituted (if distortion is still present) and effects noted.

Faults in a duo-diode-triode detector (such as a 12SQ7) that cause distortion may sometimes prove a bit tricky to localize especially if the distortion is intermittent and possibly more noticeable at certain volume settings than others. The fact that the volume-control setting has an effect on the distortion should point the finger of suspicion at the duo-diode-triode detector—amplifier tube (if the volume control is in series with the diode section of the tube, as it most often is). If the distortion is produced by the power amplifier, the volume-control setting will generally have little or no effect on the amount of distortion heard.

Distorting duo-diode-triode detectors will often produce a faintly noisy response when tapped with a light screwdriver, further implicating themselves as the culprit. The sound heard will resemble "sh-h-h."

When distortion, particularly at high volume-control settings, is noted in a receiver using a "magic-eye" tube, and the magic-eye

tube lights but doesn't work, replace any avc tube (s) present. This distortion will often become much less noticeable when the receiver is tuned slightly off the station, aiding in its identification.

The tuning-eye tube itself may be the source of distortion and possibly a totally unsuspected one. If such a tube is gassy, the avc system is likely to function improperly. A test replacement of the magic-eye tube should not be overlooked among other tube sources of distortion,

Distortion may be due to the presence of a wrong tube in a circuit. Switched tubes are not uncommon when the customer has tried to make a tube replacement. Open pilot light lamps are also, in some instances, responsible for slight amounts of distortion.

Distorted reception may be due to poor socket contacts on a tube, particularly a power amplifier. Volume will generally be low in such cases. Wiggling the tubes in their sockets and noting whether symptoms clear up during such manipulation will serve as a test for this trouble.

Power amplifier tubes connected in push-pull are common sources of distortion. When one tube ages more rapidly than the other—which is generally the case—a point is reached where the resultant mismatch causes noticeable distortion. A fast test for the presence of such trouble may be made by either withdrawing each tube in turn or interchanging them in their sockets. If the distortion becomes less, tube mismatch is indicated. When the receiver is not out of its cabinet, a fast corroboration of this diagnosis may be made by testing the grid-to-ground and cathode-to-ground voltages of each power amplifier tube. If the grid-to-ground voltages are equal (and are zero or slightly negative in each case) but the cathode voltages are not, mismatch between the tubes is almost certainly the cause of the symptoms. This can be confirmed by substituting new tubes that are fairly well matched.

When one tube in a push-pull circuit goes bad or loses considerable emission, replacement of both is generally desirable since it will be difficult if not impossible to find a new tube whose emission matches that of the remaining good one. Even when two new tubes are used, care must be exercised to obtain a matched pair. Checking the new tubes in a mutual-conductance tube checker and getting a pair which read at about the same point on the scale is one way of solving the problem. A better way is to measure the cathode voltages produced by the new tubes. Choose a pair with equal cathode-to-ground voltages. Matched pairs are commercially available, but they cost more than unmatched pairs.

Hum

Hum is a low-pitched sound which technicians will have no trouble in recognizing. It is composed of a power-line-frequency component and harmonics of this component. Modulation of signals by hum often causes distortion. It is important to recognize when distortion is due to hum, to speed up localization of the trouble.

Hum may be so loud as to mask the audio signal entirely; it may appear in the background of the desired sound, without distorting the latter, or it may cause the signal to be distorted while the hum is not recognizable in the background at all at normal volume-control settings.

To determine whether distortion is being caused by hum originating in the audio or power supply stages, turn the volume-control setting of the receiver to minimum. If an excessive level of hum is audible at this setting, one of the stages just referred to is probably the source of the distortion. Even a hum level which seems small when separated from the signal and listened to at minimum volume setting can introduce a very noticeable distortion. Distortion in such cases is a secondary symptom. Hum is the primary trouble; when its presence is recognized, troubleshooting becomes simpler.

A listening test for hum should be made when the room or work-shop in which servicing is being performed is quiet enough to permit a small level of hum to be adequately heard. In some cases, hum which is almost unnoticeable with the chassis out of its cabinet, will be considerably more evident when the chassis is in its cabinet. The baffle effect of the speaker, as well as its low-frequency resonance characteristic, may emphasize the hum frequency. When the hum level is low, listen to it with the chassis in its cabinet to get a truer picture of what reception will sound like to the set owner.

When hum disappears if the volume-control setting is reduced to zero, it is most likely originating in the rf, oscillator or if stages of the receiver. (In rare cases, a duo-diode-triode detector which has filament-to-diode leakage at the socket, or filament-to-grid leakage, can be the source of hum.) When hum originates in an rf or if stage, it will generally be heard only when a station is being received. Hum is composed of low frequencies—60 cycles and its harmonics. These low-frequency signals are not ordinarily able to pass alone through stages tuned to rf and if frequencies without being attenuated to the point of inaudibility. When high-frequency signals are present, however, the hum signals modulate

the latter and form sideband signals. These signals are subsequently detected and reconverted into hum.

Hum may be localized in an ac set by removing the tubes one by one from their sockets, starting with the power amplifier and working backward to the front of the set. When removal of a tube eliminates hum, whereas removal of the tube directly preceding it does not, the trouble lies in that tube or its circuit. (In the case of tube trouble, cathode-to-heater leakage is generally responsible.) When the section in which the hum originates has been determined (by means of the test previously described), tube withdrawals may begin with the last tube in that section.

When removal of the power amplifier eliminates hum, but withdrawal of the preceding tube does not, the defect may lie in either the power amplifier or the rectifier tube (disregarding circuit trouble possibilities). Both tubes may be replaced as a test in this case. A cathode-to-filament short in a rectifier tube can yield symptoms resembling those produced by an open input filter capacitor—i.e., hum, distortion and reduced signal volume.

In an ac-dc or ac set, hum may be localized by shorting the grid of each stage to B minus either directly or through a large bypass capacitor. Start at the last stage and work backward. (If the section in which trouble is present has been deduced by previous tests, start with the last tube in this section.) If the hum is reduced or eliminated with the short in effect, its source lies in some *preceding* stage. The first stage reached where such a hum reduction or elimination is *not* obtained is the one where you should look for tube trouble.

Here's an example of how the procedure works: A loud hum that was most annoyingly audible when the volume-control setting was advanced and that was accompanied by squeals at this setting was the complaint in an ac-dc radio-phono combination. The service technician tested the tubes in a tube checker before pulling the chassis out of the cabinet; no evidence of interelement leakage was found. He now removed the set from the cabinet. When he shorted the grid of the 50L6-GT power amplifier to ground, both the hum and the audio signal disappeared. When the grid of the 12SQ7—the tube directly preceding the 50L6-GT—was shorted, the signal disappeared but the hum remained. This indicated that the trouble lay in the 12SQ7 or its circuit. Substitution of a new 12SQ7 cleared up the symptoms.

Hum due to heater-to-cathode leakage

Cathodes of tubes used in radios and TV sets are either directly

or indirectly heated. Directly heated cathodes are filament wires which have been given an emissive coating. They are found chiefly in portable radios. Indirectly heated cathodes are made up of a cathode sleeve into which a heater is inserted. The sole function of the heater is to increase the cathode temperature to the point where the cathode emits electrons in satisfactory amounts.

To prevent emission from heater to cathode—an undesirable condition—insulation is used between the two elements. This insulation is generally a coating on the heater. The substance used for this coating is usually Alundum whose insulating properties are good even at high temperatures. The Alundum is added to the tungsten or tungsten-alloy wire of which the filaments are commonly made.

Emission from heater to cathode tends to take place because the insulating material contains impurities. Such emission is also promoted by the accidental deposit of cathode material on the heater. The heater of a tube is sometimes connected to a positive dc voltage to reduce its tendency to emit to the cathode.

Emission from cathode to heater is also possible. Where an expensive or hard-to-get tube has developed this trouble, a cure may

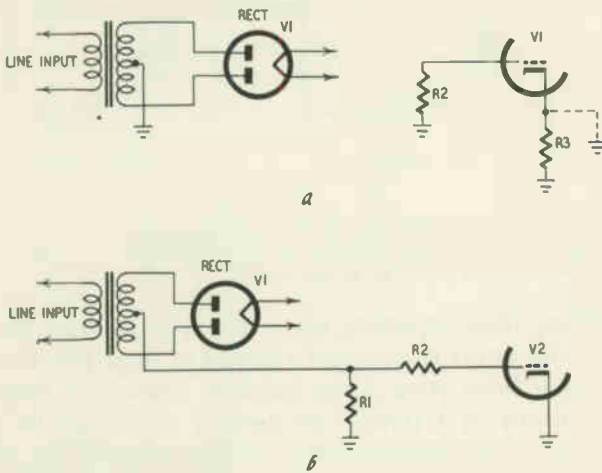

Figs. 803-a, -b. One method for eliminating hum caused by heater-to-cathode leakage is to short the cathode resistor (upper drawing) and replace it with a bias network connected to the power supply (lower drawing).

be effected by connecting the filament to a dc voltage that is negative with respect to the cathode. Cathode-to-heater emission is not common—certainly not as frequent as heater-to-cathode emission. In either case, hum may be produced.

In the case of heater-to-cathode leakage, current flows from filament to cathode and through the impedance between cathode and ground; if this impedance is large and not adequately bypassed by a capacitor, a hum voltage will be developed in the cathode circuit. Since the hum signal affects the grid-to-cathode voltage, it will be passed through the tube unless the latter's load impedance is so small at low frequencies that the hum is severely attenuated. Heater-to-cathode leakage in an audio amplifier—particularly the first audio amplifier—is likely to produce the greatest amount of hum.

Sometimes the effect of heater-to-cathode emission becomes audible because of a loss in capacitance of a cathode bypass capacitor. If a large cathode bypass capacitor in an audio amplifier stage open circuits, for example, a substantial hum voltage may be built up across the cathode resistor of this stage. Replacement of the capacitor, necessary in any case to restore volume to normal, may bypass and eliminate the hum, making a tube replacement unnecessary. Another way to eliminate hum due to heater-to-cathode

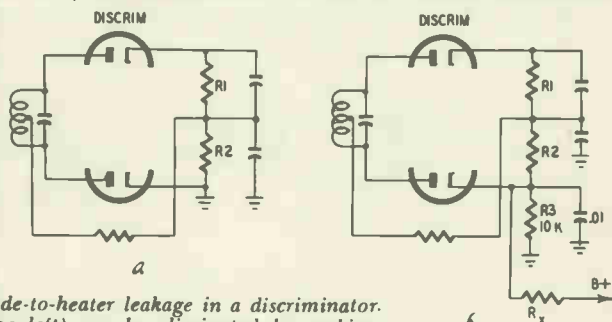

Figs. 804-a, b. Cathode-to-heater leakage in a discriminator tube (drawing at the left) can be eliminated by making circuit changes (drawing at the right).

leakage (other than replacing the tube) is to ground the cathode of the tube and apply the correct amount of negative dc voltage to the grid (as a bias) from some suitable source in the set. The center-tap circuit of a power-transformer secondary in an ac receiver may provide such a source, as illustrated in Fig. 803.

The effects of heater-to-cathode leakage in rf and if stages may sometimes be eliminated by using a larger value of cathode bypass capacitance in these stages (saving the cost of a tube replacement).

Hum generated by heater-to-cathode leakage may prove troublesome in some discriminator stages used in FM radios, particularly if a miniature tube (in which the spacing between cathode and heater is very small) is used in this stage. The trouble may be eliminated either by a suitable tube substitution or by making

the normally grounded cathode positive with respect to the filament (the other cathode is already positive). This may be readily achieved by inserting a resistor of about 10,000 ohms, bypassed by a .01- μ f capacitor, in series with R2 (Figs. 804-a,b). Now add series resistor R_x as indicated in Fig. 804-b. The value of the resistor should be such that 10 to 15 volts is developed across R3, the 10,000-ohm resistor. When the B voltage is 250, use of a resistor of about 160,000 ohms for R_x will provide the correct voltage drop across R3.

The presence of an excessive filament voltage may be the cause of an undue amount of heater-to-cathode leakage. Don't neglect to check filament voltages when likelier sources of hum have been checked and found blameless.

A rather hard-to-detect source of hum may be introduced when a technician improperly wires a filament line in an ac-dc set. In one receiver the filament of a 12AV6 detector-amplifier was posi-

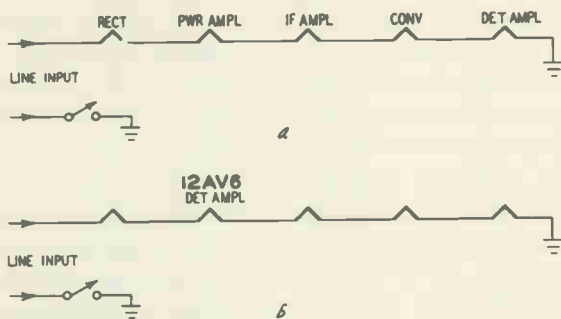

Figs. 805-a, -b. Improper wiring of the series filaments in an ac-dc receiver can be a source of hum.

tioned at too high a point in the filament string (Figs. 805-a,b). The above-normal ac voltage present between heater and cathode of the 12AV6 produced a greater-than-usual amount of leakage between the two elements; since hum in the first audio amplifier receives more amplification than hum developed in any other stage, audio trouble resulted.

The service technician should know the correct lineup of tube filaments in ac-dc sets to recognize similar trouble. The first audio amplifier (and detector) should be at the bottom of the string or nearest ground (Fig. 805-a); next to this filament should be that of the converter (since this tube is very prone to modulation hum); then the if amplifier, power amplifier and rectifier filaments, in that order.

Modulation hum

Hum that manifests itself only when a station is tuned in is known as *modulation hum*. It may be caused by heater-to-cathode leakage in an oscillator, rf or if tube. When the trouble exists in the oscillator, amplitude or frequency modulation of the oscillator by the hum signal is the means by which the hum secures passage through the rf and if sections of the receiver. Heater-to-cathode leakage in an rf or if amplifier tube will become audible if the tube is working along a nonlinear portion of its e_c-i_b characteristic (a mixing or heterodyning action takes place in a tube that presents a nonlinear impedance to incoming signals).

Hum due to cathode-to-heater short

A direct short between cathode and heater may be the cause of hum. The short (as well as the symptom) may be continuous or intermittent. The cathode resistor of the stage affected will probably overheat when trouble is present; this should provide a clue to the source of the trouble. The reason for the overheating lies in the fact that the grid is made substantially positive with respect to the cathode during the negative phase of the hum cycle (negative voltage at the cathode is the same as a positive voltage at the grid). Plate current flow in this interval is therefore high, causing the cathode resistor's wattage rating to be exceeded. In many instances, the resistor will smoke under such circumstances.

A cathode-to-heater short in any tube can produce audible hum. If the short is in an rf or if tube, the large-amplitude hum may force its way through the low-impedance tuned stages (low at 60 cycles, that is) by sheer brute force—i.e., it will not have to modulate the signal to be audible. In other instances it will manifest itself as modulation hum.

Filament-to-grid coupling

A certain amount of capacitive coupling is present between the filament and grid of a tube, causing some hum voltage to be transferred from the heater to the grid. The filament-to-grid capacitance and the grid resistance form a voltage divider in this case (Fig. 806); the larger the grid resistance, the greater the hum voltage that will be developed across it. Normally, so little hum actually appears across the grid resistor (due to the small capacitance and large reactance present between filament and grid) that filament-to-grid coupling is unimportant. When the grid resistance of a first audio amplifier in a high-gain audio amplifier section has increased very considerably, however, hum developed across the grid resistance as a result of the tube action just described may become

excessive and therefore audible. Reduction of the grid resistance to a normal value, rather than a tube substitution, is the proper solution in such cases.

Tube shields and hum

When a tube is near a strong magnetic field (such as that present around a power transformer), hum may be induced into the tube unless it (or the transformer) is properly shielded. When hum is present, a quick preliminary inspection will determine whether any tube shield is missing or improperly mounted. Look for a lonesome shield contact spring—i.e., one which has no shield to make contact with—at the tops of the tube sockets; or look for a shield which is not properly grounded. Sometimes substitution of a glass for a metal type tube is responsible for hum. Putting a grounded shield around the tube will eliminate the trouble; or else the metal type originally present may be used to replace the glass tube.

Lead-dress hum

Improper placement of a grid lead (in cases where a tube grid terminates in an external cap) can produce hum. Such leads should be dressed away from other grid leads as well as the power transformer (if one is present). Improper dress of pilot-light leads may also be responsible for hum.

Socket trouble

Infrequently, leakage from filament to grid or filament to plate

Fig. 806. Filament-to-grid capacitance can result in hum modulation of the control grid.

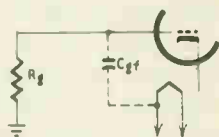

may occur through the socket and produce hum. When other possible sources of hum have been eliminated, the socket of the suspect stage may be replaced as a test as well as a remedy for this kind of trouble. Leakage between a pilot-light socket and chassis when a "floating" ground is present (i.e., chassis is not ground) may also be the cause of hum.

Obscure causes of hum

Leakage may occur from plate or filament pins of a rectifier to unused pins on the tube. If these unused pins go to socket contacts that are employed as tie points, hum (as well as other troubles) may be introduced. A scope test will reveal the presence of hum voltage at such a socket contact. The remedy lies in clipping off

the troublesome unused tube pin, or else using another socket contact as a terminal point. The tube may also be changed, of course.

In a pentode tube which has a low input signal applied to it, the magnetic field surrounding the filament affects the division of current between plate and screen. This effect is normally negligible. When a change in grid or screen voltage has taken place, however, the hum produced by this effect may become audible. Check the tube element voltages when such trouble is suspected.

Tube-caused buzz

A defect in a 50L6-GT type tube may cause a loud buzz to be audible. A clue to the source of the trouble may be obtained by placing a finger on top of the tube. The buzz will either increase or decrease in volume (depending on the polarity of the line plug in the outlet) if the 50L6-GT is causing it. When a permanent magnet is placed at the top of the tube, the buzz will disappear, suggesting that Barkhausen oscillation is responsible for it. Replacement of the tube will eliminate the trouble. A temporary—or permanent—repair may also be affected by taping a magnet from a small PM speaker on top of the tube.

Oscillation

When energy is fed back from plate to grid within a tube or from grid to some preceding stage, oscillation may occur. (Oscillation involving components other than tubes may also be generated in other ways, of course.) Whistles, howls, motorboating or other noises may be heard when oscillation is present. Tubes are not usually the cause of such trouble, but they can be. Shield and lead-dress trouble may also be the causes of oscillation.

Converter tubes may be the source of motorboating, particularly at low-frequency dial settings. The 12SA7, for instance, has produced symptoms of this kind in some ac-dc sets. It is worth noting that a tube which causes motor-boating in one set may work fine in others and will also check normal in a tube tester.

Some brands of if tubes may, when inserted into certain receivers, cause whistles to be heard in conjunction with the desired sound. Defects in such a tube can also cause an oscillation that manifests itself as a loud, continuous noise. The desired sound will be completely drowned out. The defective tube will probably test satisfactorily in a tube checker.

Even a new if tube may be the source of such oscillation. When an oscillating if tube is replaced and symptoms persist, the service technician is likely to look elsewhere for the trouble and keep

looking elsewhere, unless he realizes that new tubes should not be exempt from suspicion.

A loose if tube shield or one that makes imperfect contact with the chassis is not infrequently a source of oscillation that results in whistles, howl or hum. The trouble may be continuous or intermittent. Check the ground contacts of any shields present when such symptoms are heard. Short a suspect shield to ground and note whether symptoms clear up to make absolutely sure that its contact is not imperfect.

In some cases where a metal if tube is used, trouble at the socket may nullify the shielding effect of the metal envelope of the tube. There may be an open at the socket contact connecting the tube shield to the chassis. To check for such a defect when the chassis is in its cabinet, scrape off some of the paint on the tube envelope and connect a wire between the metal envelope and chassis. If the oscillation stops, such an open is probably causing it.

In some cases, many of the howls and squeals that affect broadcast ac-dc sets may be eliminated by substituting a 1N34 crystal in place of the diode of the duo-diode-triode detector generally employed. The squeals are due to the presence of if and audio signals in the same tube; separation of the signals eliminates the undesired coupling effects responsible for the squeal.

Microphonic tubes

A microphonic tube is one that generates undesired electrical signals when it is subjected to mechanical vibration. The vibration causes movement of the electrodes in the tube with respect to each other. The characteristics of the tube vary in consequence, producing spurious signals or noise.

All amplifier tubes are microphonic to a certain extent; in some, however, the defect is great enough to produce very noticeable symptoms. The troublesome tube must be located and replaced.

Tube tapping is perhaps the best way to locate a microphonic. Tap each tube *gently* with the wooden base of a screwdriver. When a microphonic noise is heard only when a certain tube is tapped, that tube should be replaced and results noted. If the tubes are tapped too hard, not only may damage be done to them, but the entire purpose of the tests will be defeated. Noise will be heard even when good tubes are tapped because the good tubes will transfer vibration through the chassis to the bad one. Sometimes, though, tapping tests will be of no help in locating a microphonic tube.

The converter (more specifically, the oscillator) is, incidentally, the stage most likely to be the source of audible microphonic symptoms. This is true because the oscillator tuned circuit is resonant to only a single frequency at any tuning capacitor setting. It is so sharply tuned that the slight shift in interelectrode capacitances produced by a tube microphonic produces a large percentage of frequency change. Rf and if tuned circuits, on the other hand, are quite broad by comparison. A shift in interelectrode capacitance of an rf amplifier or if tube will, therefore, produce a much smaller percentage of frequency change.

Frequency changes in plate currents caused by microphonics are detected in the if amplifiers by the process of *slope detection* and amplitude-modulate the if signal. They become audible after demodulation in the second detector as howls, rattles or other noise.

If the service technician is uncertain whether a microphonic condition is present, the following procedure will help him make up his mind. Detune the receiver slightly from its station setting. If the noise increases in volume, a microphonic is probably the cause of it. Detuning shifts the oscillator frequency and changes the frequency of the carrier slightly. As a result, the if carrier now falls lower down on the slope of the if selectivity curve. A greater amount of slope length now becomes available and the microphonic signal produced by slope detection is therefore increased in amplitude.

Variations in heater-to-cathode capacitances would tend to cause microphonics in the oscillator of FM sets if counter measures were not taken. Consider an FM pentagrid converter, such as a 6BE6, for instance. The cathode connects to a tap on the oscillator coil in the Hartley circuit commonly used in such converter circuits. The heater-to-cathode capacitance is therefore part of the oscillator tank circuit.

If vibration causes the heater to move in the cathode sleeve at an audio-frequency rate, the heater-to-cathode capacitance will vary at the same rate. The oscillator frequency of operation will therefore vary at this rate. This undesired frequency modulation of the oscillator is detected along with desired FM signal and becomes audible as a howl. Connection of the cathode to the heater, either directly or through a capacitor, and the insertion of rf chokes in one or both legs or the heater (Figs. 807-a,b) are often used to minimize such microphonics.

These data are presented so that circuit trouble that makes tube

microphonics excessively noticeable will not be blamed on the oscillator tube. The circuit trouble referred to is a defect in, or omission of, a heater coil, or an open-circuiting of the cathode connection to heater.

Noisy tubes

Tube defects are common sources of noise other than microphonics. Other component defects may, of course, also produce noise. The erratic and intermittent nature of the noise symptoms often produced by tubes can make the localization of the trouble rather difficult.

Some noisy tubes are fairly simple to locate. If tapping a certain tube produces noise, whereas tapping the other tubes does not, chances are the first tube is the source of the trouble. To verify this, substitute a new tube, then try the tapping tests once more.

When a grid cap is present on a tube, the connection to the cap sometimes becomes loose, introducing noise. Tapping the suspect cap from various angles and noting whether noise is produced or increased will help localize this source of trouble. If a loose grid cap seems to be present, reheat the connection by holding a soldering iron for a short while to the cap.

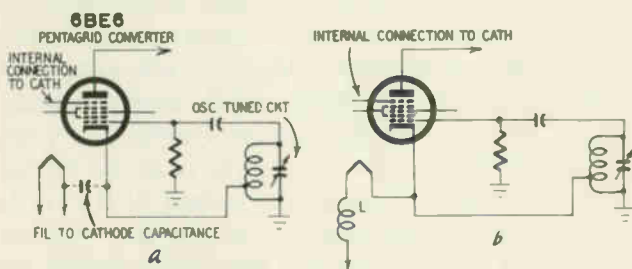

Figs. 807-a, -b. Filament-to-cathode capacitance (drawing at the left) can result in howling. One technique for minimizing this trouble is the use of an rf choke (modified circuit shown at the right).

Sometimes the glass envelope of a tube becomes loose. Normally, this envelope is cemented to the base. A loose envelope will readily vibrate, causing noise. Try moving the envelopes of the various tubes (avoiding a burn, if the set is on, by using a tube puller or equivalent protection). If a loose envelope is found, pour a little radio cement between the glass envelope and the tube base.

One of the leads from the tube elements to the base prongs sometimes loosens inside a prong. Noise, as well as other symptoms

may result. Inspect the base prongs of the suspected tube to determine if trouble lies here. If a connection looks in the least suspicious, apply a hot soldering iron to the prong to re-form the connection between prong and lead. In some cases, a bit of solder may be added to speed the operation. Excess solder may be removed by holding the soldering iron to the prong and scraping off the undesired solder.

In many instances, a tube will not become noisy until it has heated sufficiently. To find the culprit in such cases, let the receiver operate for an hour or more. Then try the tapping tests previously described.

Sometimes an intermittently noisy tube will stay on its best behavior indefinitely when the chassis is out of the cabinet. The additional ventilation present may keep the intermittent from becoming active. Try to duplicate the conditions under which the set usually functions—i.e., either put it back into its cabinet, cover it with a box or expose it to the rays of a hot lamp for a while.

If several tubes produce noise when they are tapped, strike the tubes with increasing gentleness to prevent the nonguilty ones from acting up. If isolation of the bad tube cannot be achieved in this way, disconnect the external antenna (if one is used) and/or short out the built-in antenna (when present). Now turn up the volume control, and repeat the localization test just described.

If this method also proves unsuccessful, set the volume control at *minimum*. If noise—even faint noise—can still be produced by tube tapping, the faulty tube is most likely in the audio section. This deduction is logical because the output of the rf/lf stages is zero at minimum volume-control setting, therefore nothing—neither signal nor noise—can come from these stages under such circumstances.

If noise that is obtained with the volume control setting high disappears and cannot be reintroduced even faintly with the volume-control setting at zero, the trouble probably lies in the rf/lf section.

To localize a noisy tube in an audio section of a straight ac set, proceed as follows: Remove the tube preceding the power amplifier, then tap the power amplifier (or amplifiers). If noise is still faintly audible (you'll have to put your ear close to the speaker to determine this), the tube that produces the noise when tapped is probably to blame. Substitution of a new tube and retest will verify this.

If the noise is no longer heard when the tube preceding the power amplifier (s) is withdrawn, replace the tube and withdraw the one just before it. Now repeat the test procedure. Proceed backward in this way until a tube is found which produces noise when tapped. More specifically: the first tube whose removal causes disappearance of the noise symptoms is the defective one (assuming no circuit component is responsible for the trouble). The procedure is the same for localizing a faulty tube in the rf/if stages except that you begin with the last tube in this section.

If the set being serviced is an ac-dc type, a noisy tube in the audio section may be located as follows: Remove the detector tube from its socket while the set is in operation. There will be a brief period of time immediately following during which the filaments of the tubes remain hot and their cathodes continue to emit. Tap the power amplifier and rectifier tubes during this short interval (we are considering the rectifier as part of the audio amplifier section). If noise is faintly heard, the detector is *not* guilty whereas one of the tubes that has been tapped *is* responsible. If noise is *not* heard, the detector—or a tube preceding it—may be causing it. You'll have to be real quick to make such a test.

Let's assume noise is heard when the test just described is made. How can you localize it to one of the two tubes that may be producing it? Substitution of one tube, then rechecking, offers the simplest isolation test.

In the case of noisy tubes in the rf/if section, the same procedure may be used with the exception that you start with the last tube in this section.

Rectifiers in ac-dc sets may radiate noise in some cases. When a tube element in the rectifier becomes loose, rf interference can be generated. Radiation of this interference to the loop antenna causes the noise to get into the receiver. The remedy lies in either replacing the tube or putting a shield over it and then grounding the shield to chassis.

Another unsuspected source of noise can be the tuning-eye tube. Loose elements can produce noise that is applied to other tubes via the avc line.

In some older-make radio sets, intermittent and hard-to-locate noise that is intensified when the converter is tapped is often due to a defective wafer socket in this stage. The socket, held together by rivets, becomes conductive with age, introducing a varying low-impedance path to ground from the oscillator grid—or some other element—through the rivets.

Intermittent noise may be due to loose or imperfect contact between a tube and its socket. Wiggling the tubes in their sockets is one way of localizing such trouble. Try to find a tube which, when wiggled, will produce this noise when other tubes will not. The associated socket is probably at fault in this case (a component connected to the socket can also be the source of trouble). If some doubt is present whether the socket or the tube itself is causing the noise, hold the tube firmly in place with one hand while tapping it with a screwdriver held in the other. If the tube is defective, the noise will still be produced; if the source of trouble lies in the socket, noise will no longer be audible.

Noisy pilot lamps and sockets are sources of noise that are sometimes overlooked. In certain cases, a defective pilot lamp will flicker abnormally when tapped; in most cases, it probably won't. The pilot lamp may be loose in its socket, or the socket contacts may be dirty or the lamp itself may have a defect in it. Noise produced by a defective pilot light may sometimes take the form of buzz.

Loose tube shields may be the cause of noise. Tapping tests and visual inspection will readily locate such a source of trouble.

Tube troubles in portable radios

Tubes used in portable sets (except for the tube rectifier that is sometimes present) have low-voltage filament cathodes. Battery operation demands such a design. The filaments are generally connected in one of the ways indicated in Figs. 808-a, b, c.

Plate and screen currents pass through the filaments. Proper bias is obtained by returning the grid resistor of a tube to one side of the filament. We mention these things because they have a bearing on the servicing of tube troubles.

Avoiding tube damage

The filament voltage of portable type tubes is either 1.4 or 2.8. Any of a number of defects can cause such small voltage ratings to be exceeded; one or more tubes are likely to "blow" in consequence. To avoid such damage, the technician must know how and why it can take place. The need for such knowledge is enhanced by the fact that portable type tubes used in older-make portable sets are more expensive than those used in standard AC-DC sets.

Tubes should never be removed from or restored to their sockets when a battery-electric portable is being operated from the power line. Burnout of one or more tubes is likely in certain

types of filament circuit if this precaution is ignored (or if a tube is loose in its socket).

Assume that the filament circuit illustrated in Fig. 809 is present. If V1 is withdrawn while the set is in operation, the large charge present across filter capacitor C1 (between cathode of the

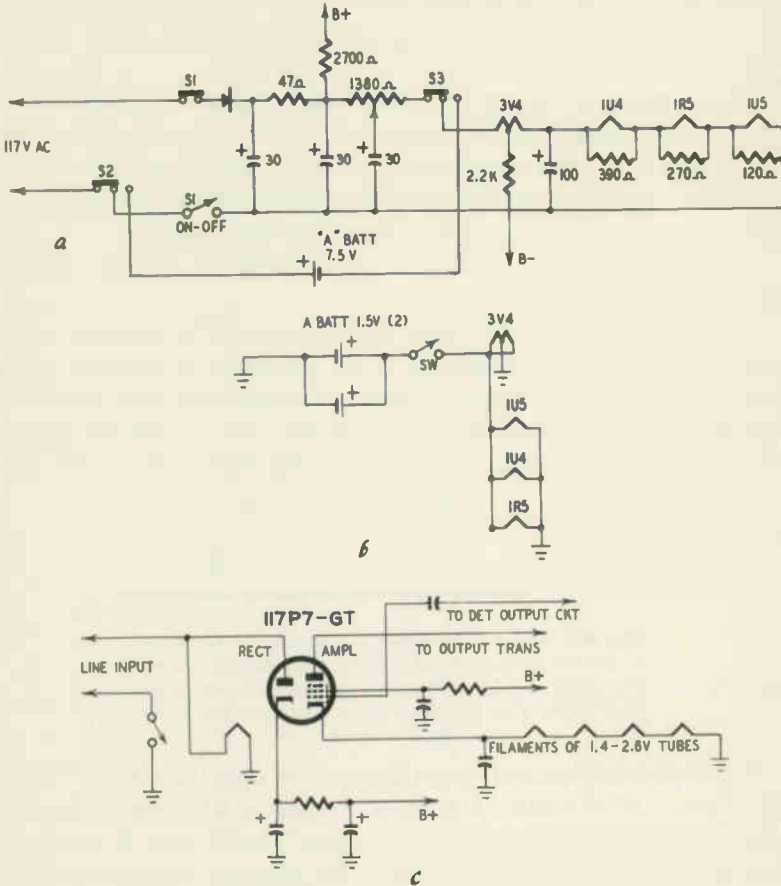

Figs. 808-a, -b, -c. Filament connections in portable radio receivers are shown in these three drawings.

rectifier and ground) cannot leak off through the tube filaments to ground because the filament path has been interrupted. Suppose this charge produces a voltage between cathode and ground of 130. This same voltage will appear across C2 and C3 since no current flows through R1 and R2 and no voltage is therefore lost. When V1 is replaced by a new tube, 130 volts will be imposed on the four tubes in series, instead of the 7 volts normally

present. The burnout of one or more tubes is inevitable under such circumstances. A burnout due to such a chain of events is also possible when a tube is replaced. To make sure a replacement tube is not damaged, short the filter capacitors to ground (with the power off, of course) before the new tube is inserted into the socket. In many instances, the presence of resistors in the filament circuits "bleeds" the filter capacitors, preventing such damage when a tube is withdrawn.

Any component defect that causes the filament voltages of the tubes to rise considerably can result in the burnout of one or more tubes. When a replacement tube "blows" as soon as it is inserted, a check for such component trouble is definitely in order. Possible sources of filament blowouts include the following:

1. Decrease in the value of the dropping resistor between rectifier cathode and filaments.

2. Change in the value of a filament shunting resistor. These resistors shunt enough current from the filament circuits to prevent plate and screen currents from causing normal filament voltages to be exceeded; their normal value is such that the filament voltages are correct. If a filament-shunting resistor increases in val-

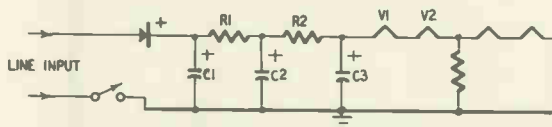

Fig. 809. If $V1$ is removed while the set is turned on and is then replaced the voltage across $C3$ (about 130 volts) will be shunted across the filaments of the four tubes. The filaments of one or more tubes will be destroyed.

ue, it will pass less current, permitting more current to flow through one or more of the tube filaments. Excessive filament voltage results. Such trouble is particularly likely in the case of a double-filament type output tube. Check the voltages developed across each section of the double filament, making sure they are normal and equal, if premature blowouts of the tube are being investigated.

3. Short between filament and some other tube electrode. Such a short is likely to blow tube replacements if the shorted tube is permitted to remain in the circuit. To avoid this possibility, check *all* tubes for short circuits, before replacing one of them.

4. Open in the common negative of a filter capacitor at the point indicated in Fig. 810. While such trouble is not common, it can and does occur. The filtering action is partially impaired

whenever such a defect develops. The ripple voltage that is now applied to the filaments (in addition to the normal voltage) may damage one or more of them if the set is left on for a considerable length of time. Checking the ripple voltage across the filaments will indicate whether such trouble should be investigated. Normally, the ripple voltage measured will be zero or close to zero. A scope should preferably be used for such a measurement since it is insensitive to the dc voltage present.

5. Accidental brushing of the "hot" pigtail of a test capacitor, that has been used to bridge a power-supply filter capacitor, against a filament circuit point. Many novices—as well as some experienced technicians—have gone through this rather depressing experience.

Intermittent operation and fading

One of the most characteristic troubles in portable receivers is intermittent operation. The set fades out after playing a while in some cases; in others reception occurs over approximately half the dial only.

Fig. 810. Increased ripple voltage applied to the filaments (when the filter is open) can result in damage to the tubes.

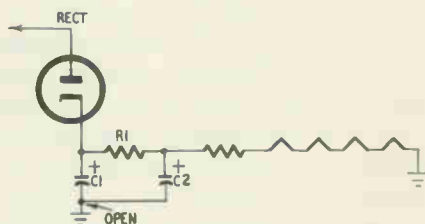

The trouble in such cases is generally an inoperative or partially operative converter tube (such as the 1R5, 1A7-GT and 1LA6). *It must be stressed, however, that this does not necessarily mean that the tube itself is defective*—in many cases, the trouble lies, rather, in the insufficient filament voltage that is fed to the tube. A decrease of as little as 0.2 volt may cause the converter to become partly or wholly inoperative if its transconductance isn't high.

A check to determine whether this stage is the source of trouble can be made by connecting an external antenna or a long piece of wire to the grid of the tube. If reception is restored or the background noise level increases considerably, the converter stage is very probably at fault.

Before replacing a fading converter, check its filament voltage. This is a *must*, not only to save the cost of an unnecessary tube

replacement, but to insure against a callback or a premature service call for the same complaint.

When the filament voltages of all the 1.4- or 2.8-volt tubes are below normal with the line voltage at 117, the following possible causes of trouble should be investigated:

1. Weak rectifier (selenium or tube).
2. Loss of capacitance in the filter capacitors.
3. Increase in the value of the dropping resistor between rectifier cathode and the filament circuit.

4. In the case of a circuit like the one shown in Fig. 808-c, where a combination rectifier-power amplifier tube is present and the amplifier section feeds the filaments of the 1.4- or 2.8-volt tubes, a loss of emission in this amplifier section may be responsible.

5. When the filament voltage of the converter alone is too low, a reduction in the tube's filament resistance may be present. Resistance-check the tube filament to verify this possibility. The normal resistance of a 1.4-volt tube filament is 28 ohms. It is advisable to use a resistance of 30 ohms or more in series with the ohmmeter lead (and subtract this value from the total reading) when making such a resistance check, to avoid the possibility of excessive current from the ohmmeter damaging the tube filament.

When the filament voltage is normal, and fading occurs, a new converter tube should be substituted and results noted.

It is worth noting that in some receivers, 1.4-volt tubes are placed in a circuit where they will be fed only 1.2 volts. This voltage is "normal" in such a case.

There are many cases where fading occurs only at reduced line voltages. To determine whether low line voltage at the customer's home is responsible for the symptoms or whether the trouble lies in the receiver, an autotransformer that permits the line voltage applied to the set under test to be suitably varied is necessary. If the set works for 5 minutes or longer at a line voltage of 105 or higher, a tube or component trouble in the set (rather than the line voltage) is probably to blame and should be checked. The B voltage may, for instance, drop disproportionately in the presence of reduced line voltage due to impaired efficiency of the rectifier or the power supply filter capacitance may be insufficient. The value of the dropping resistor between rectifier cathode and filaments may be too high, etc.

Fading in sets using miniature tubes is sometimes the result of poor contact of tube prongs and socket, due to a bent prong or loose socket. Socket contacts may be tightened with a scribe; bent prongs may be straightened with a pair of long-nose pliers.

Restoring converters to normal operation

Suggestions have already been made for restoring the converter tube to normal operation when its filament voltage is below normal, when the 1.4–2.8-volt tube filaments are fed from the rectifier cathode through a dropping resistor. When the filaments derive their current from the amplifier section of an amplifier-rectifier dual-purpose tube and the amplifier section of the tube has lost some of its emission, the following remedy may be applied to boost the filament voltages of the 1.4–2.8 volt tubes. A 10-watt wirewound resistor of about 5,000 to 7,000 ohms may be connected between screen and cathode of the amplifier section (of the amplifier-rectifier tube). Use a value that will raise the filament voltages to the correct level and no higher. A sticker should be pasted near the amplifier-rectifier tube, advising any service technician who may subsequently work on the set to remove the resistor if the dual purpose tube is replaced.

Fading converters, regardless of the kind of filament-feed circuit employed, can often be restored to normal operation by reducing the screen voltage of the converter tube. When the screen dropping resistor is some value between 10,000 and 50,000 ohms, for instance, substitution of a resistance of 100,000 ohms will often do the trick.

Sometimes a nonminiature converter tube that would otherwise have to be replaced may be given a new lease on life if its base is heated for a few minutes with a soldering iron or a small alcohol torch.

Inoperation

When the rectifier is a tube and it doesn't light (on electric operation), a resistance check of its filaments will quickly reveal whether the latter has open-circuited. When the filaments of the 1.4–2.8-volt tubes don't glow normally (on either battery or electric operation), one of the tube filaments is probably open. (Close visual inspection is needed to check the filament lighting.) In some sets, the pilot light is in series with the 1.4–2.8-volt tube filaments; a burned-out pilot lamp will open-circuit the heaters of these tubes and keep the set from operating.

Distortion

Power amplifier tubes—such as the 3V4, 3Q5-GT, etc.—are frequent sources of distortion. A distorting tube will often be given a clean bill of health in a tube tester; substitution is, therefore, the best test for such trouble.

In some instances an improper tube substitution may be the source of distortion.

A defective power amplifier in a rectifier-amplifier tube (such as a 117L7/M7-GT, etc.) is generally responsible for a "creeping" (slowly-developing) distortion.

Low volume

Loss of emission in any tube will reduce volume. An unusual and unexpected source of lowered volume may be the closeness of a miniature output tube (such as a 1S4) to the speaker magnet. The magnetic lines of force emanating from the speaker magnet affect the space charge in the tube and reduce its amplification. The trouble may arise when the tube is slightly bent in the direction of the speaker. To eliminate the condition, straighten any bent tube prongs. A piece of felt placed between tube and speaker will be helpful in keeping the tube upright and at maximum separation from the speaker.

Miscellaneous symptoms

When symptoms of trouble are present at a high setting of the volume control but not a low one, and vice versa, a faulty detector tube is often to blame. "Quavery" reception that sounds like a grossly exaggerated tremolo effect may be produced by a defective if amplifier or converter tube. Noisy reception is not infrequently due to dirty or corroded prongs on miniature tubes. The prongs may be cleaned by rotating the jaws of a pair of long-nose pliers around each prong, at the same time moving the pliers down along its length. The pliers should have serrated jaws. Squeals and no reception may be due to the absence or improper grounding of a shield on an if tube (such as a 1N5-GT). Difficulties in tuning may stem, in some cases, from a gassy power amplifier.

tube replacements

In a number of instances the replacement of a tube in a television receiver can disturb normal operation. Inserting a new oscillator tube in the front end, for example, can compel realignment of the oscillator slugs. This disturbance of normal operation is particularly likely when one tube type is substituted for another. Such substitutions merit the same serious thought that any other design change does.

Precautions in making tube substitutions

Sometimes one tube type can be substituted for another if a technician has satisfied himself that the pin connections are identical and that the voltage and current requirements are similar.

There are also some cases where tubes having widely different characteristics may be substituted in a given circuit. In the substitution of the 6BA6 for the 6AU6 you have tubes whose major differences are in their cutoff characteristics. The 6AU6 is a sharp-cutoff pentode, the 6BA6 a remote-cutoff type. Other than this, in typical operation, their plate resistance, transconductance and plate current are reasonably close. This does not mean that substitution will necessarily work both ways. A remote-cutoff tube, on occasion, may give slightly inferior but acceptable performance in a circuit requiring a sharp-cutoff tube. However, a sharp-cutoff unit will not usually perform well in a circuit requiring a wide grid-control range.

For optimum performance, try always to use exact tube replace-

ments. Just because a substitution works well in one case, don't assume it will work equally well in others.

Salvaging the diode-triode

Sometimes the diode section of a dual-purpose tube will be defective but a tube-tester check will show that the triode portion of the tube is still in good condition. Do not discard the tube—keep it on hand with a label pasted on the tube to indicate its condition. There are many FM and TV receivers that use only the triode section of the tube. In such applications the tube will be perfectly satisfactory.

Replacing tuner tubes

If a 6BQ7 tube is to be replaced, inspect carefully the tube that you intend to use. Some makes of 6BQ7 are of inferior design and tend to be very short-lived. The makes referred to have plates whose size is too small. The width of the plates in such tubes is between 1/4 and 5/16 inch, compared to 3/8-inch plate width in a tube of satisfactory construction. As a further aid in identifying the inferior-make 6BQ7's, check the number of rivet holes in each plate. The better tubes have two such holes per plate; the inferior ones have only one. By the time these words appear in print, the likelihood of purchasing such inferior-make 6BQ7's ought to be fairly slim; the service technician should, nevertheless, keep his eyes open in purchasing as well as in replacing 6BQ7's, since the possibility of getting—and unwittingly using—one of these substandard tubes will still exist. For purposes of comparison, keep an old satisfactory-make 6BQ7 tube handy.

The comments about plate size do not apply to 6BK7-A tubes. These tubes have small plates, but this construction feature is normal for them.

6BQ7 tubes, when used in cascode tuners, have a tendency to develop heater-to-cathode shorts. The condition is due in large part to the operation of one of the two cathodes at a high positive potential with respect to the filament. When the cathode is, say, 135 volts positive with respect to the filament, a strong electrostatic pull is set up between these elements. Expansion of the filament due to the heat increases the effect of this pull. Because of the two forces just mentioned, the filament may finally butt its way through the cathode sheath; the resultant heater-to-cathode short makes the tube unusable. Substitution of a 6BQ7-A, which is an improved version of the 6BQ7, is recommended, to avoid recurrence of such a defect.

In some receivers you can improve reception by interchanging

the 6CB6's used in the rf and converter stages even though a check in a tube tester will show the tubes to be about equal in quality. Sometimes new tubes that check slightly better in the tube tester will not give this improvement. The tube that performs better is a so-called "hot" tube—one that has a very good noise figure. Often a tube with a good noise figure is used in the converter stage, where its benefits are not utilized to the extent that they would be in the rf amplifier circuit. In some cases, when a great improvement is noted in a receiver after switching front end tubes, it may be a sign that the front end is badly in need of alignment.

Some technicians keep a small stock of these hot tubes expressly for use in replacing 6CB6 rf amplifier tubes. It is a good idea to mark them for quick identification.

Every now and then a particular tube may not be readily available—generally when you need it most urgently. Sometimes a little ingenuity will solve the problem. In the case of 6BQ7-A and 6BZ7 tubes, a type 12AT7 can be used if you wish to take the time to make the conversion.

To make the substitution, tie pins 4 and 5 of the 12AT7 together and clip off pin 4 or 5, whichever one is grounded in the socket. This will place both halves of the 12AT7 heater in parallel. Be certain the pin is clipped short enough to prevent it from going into the socket, as this would cause a short in the heater circuit. Take care in tying the pins together as the glass of the tube is very easily broken. Also take care to plug the tube into the socket the right way, as it will fit two ways when pin 4 or 5 is clipped. This conversion will work with any set in which pin 9 of the 6BQ7-A tube socket and one side of the heater circuit are grounded.

Replacing rf oscillator tubes

If an rf oscillator tube is to be replaced in a TV receiver, try several tubes and select one which will produce the smallest shift in oscillator frequency, and thus avert the need for realignment of the oscillator slug. A reception check should be made on the high channels in such cases, since these are the settings at which the frequency shift is likely to be greatest.

In some cases, several oscillator tubes will have to be tried to obtain one which is capable of providing the proper injection voltage to the mixer. Insufficient injection voltage will produce a weaker picture (and possibly sound). Choose a tube which provides best picture and sound (as well as the least frequency shift).

When a uhf oscillator is to be replaced, the service technician should be careful not to wiggle the tube back and forth during its

removal or insertion. It should be pulled out or pushed in straight from the socket. Wiggling the tube may distort the socket contacts slightly; such a slight physical distortion can have a very marked adverse effect on the reception of uhf signals. The technician should keep in mind that the placement of parts and leads in uhf tuners is much more critical than it is in vhf front ends due to the extremely high frequencies at which the circuits operate. When a crystal is replaced in the uhf tuner, exceptional care should be used to avoid changing lead dress and parts placement.

Some makes of oscillator tube may function better than others in TV tuners. Try different brands of tubes, in cases where the reception obtained after an oscillator tube replacement is not too satisfactory.

Video if tube replacements

Variations in tubes used in video if amplifiers may cause trouble when replacements are made. Where a tendency to overloading is present—due to the presence of receiver tubes with higher-than-average gain, and strong incoming signals—a tube with average gain characteristics should be selected in preference to one with an above-average gain. Several tubes may have to be tried to eliminate any overload. The agc control may have to be reset after each substitution.

The e_c-i_b characteristic curve of some 6CB6 tubes used as video if amplifiers is not entirely linear in the section along which the tube is operated. Limiting may be produced when strong signals come in. The sync portion of the video if signal is likely to be compressed in such circumstances, leading to poor vertical and/or horizontal sync. The trouble just described can occur when a 6CB6 with a somewhat abnormal characteristic is used in the last video if stage; this is so because the signal input at this stage is larger than in any of the preceding if stages. Try several tubes when replacing 6CB6's in video if stages, leaving the one that provides the best reception in the circuit.

Alignment can be affected when a video if tube is replaced. An alignment check, plus a retouching of the adjustments when necessary, is recommended to put the receiver into optimum condition after a video if tube replacement.

Sweep and sync tube replacements

Early-make 6BL7-GT's have a tendency to develop grid emission and cause rolling when used as vertical oscillators. Later-make versions of this tube are less likely to introduce such trouble. The

technician may sometimes unwittingly use a new, but inferior, early-make 6BL7-GT. To avoid the possibility of a callback, keep the set operating (preferably in its cabinet) for several hours after such a tube has been replaced, watching for symptoms of vertical rolling.

When a 6BQ6-GT (horizontal output tube) that has failed prematurely is being replaced, it may be wise in some cases to substitute a 6BQ6-G. The two tubes are identical in all respects except for bulb size. Tubes with the suffix G have a larger surface than GT types and can radiate heat more efficiently; they therefore tend to operate at a lower bulb temperature. Temperature-promoted defects are less likely to occur in G-type tubes. When physical space is not adequate, the substitution of a G for GT type is impractical.

In cases where certain flyback defects are present, substitution of a new horizontal output tube may restore normal receiver operation for a while. Technicians may replace several output tubes in succession over a period of time before they realize where the real fault lies. It would seem wise in these cases to test a suspect horizontal output tube in a normal receiver, before replacing it permanently. If the tube works in the normal set but not in the receiver under test, and if a new output tube restores the operation of the set being tested to normal, a defect in the flyback may be present and should be checked for with a flyback checker. It is assumed no other trouble can be found.

Many technicians tend to condemn new horizontal oscillator tubes on insufficient grounds. When a receiver fails to hold sync after a replacement of the oscillator tube or can't be made to hold sync by suitable adjustment of the horizontal hold control, the technician may deduce that the new tube is defective.

This deduction is often incorrect. The reason for the error lies in the rather critical nature of the horizontal oscillator circuit. Differences in tube characteristics tend to affect the frequency of the horizontal oscillator. Any oscillator frequency adjustment present in the receiver should therefore be reset if replacement of the horizontal oscillator tube is followed by improper synchronization. These adjustments should be made so that the picture is in sync with the horizontal hold control set to its mid-position. If the hold is at an extreme clockwise or counterclockwise setting when the picture is brought into sync, a slight amount of aging in the replacement tube may necessitate another service call. With the hold control properly set enough range is present to provide for reasonable changes in tube characteristics.

When a sweep circuit tube is replaced in a receiver which is to be used in a low-line-voltage location, it is wise to test set operation with a Variac or similar line-adjust unit. This permits a check of the tube's performance to be made at a line voltage comparable to the one under which it will operate in the set owner's home. A selection of new tubes may have to be tried to obtain adequate deflection at reduced line voltage.

Oscillator tubes

Some makes of 6U8 used as vertical oscillators provide appreciably less height than others. Try several brands when replacing a tube of this kind in a receiver where that last $\frac{1}{4}$ inch of height is essential.

Some brands of 12AU7's used as combined horizontal oscillator and afc tubes tend to produce either a permanent bend in the picture or a bend that moves slowly up or down. This symptom is often due to leakage between the filament and some other element in the tube. Some tubes are worse than others with respect to the amount of leakage present. An entire run of tubes in a certain production may have this trouble to a marked extent. Try several makes of 12AU7 if such bending appears when the original tube is replaced.

Tube design

Significant for longer life was the changeover from the old press-stem construction to the newer button-stem construction. In press-stem construction the base leads enter the tube through the glass stem in a straight line (Fig. 901). Lead wires are necessarily thin and there is a considerable distance between the base pins and the tube mount. In button-stem construction the leads go directly from the base pin through the glass into the tube mount, being arranged in a circle similar to that used in miniature tubes. This type of construction uses heavier and shorter leads, resulting in better heat transfer from inside the tube through the base pins. It also leaves more room between the top of the tube mount and the glass, which results in improved heat radiation.

Other improvements to be found in today's tubes are larger and better grid heat radiators on the top of the tube mount. Keeping the grid cool reduces the possibility of grid emission and run-away conditions. Large plate fins are also included to increase heat radiation from the plate area. Other refinements such as

ribbed plates and one-piece beam-plate construction are sometimes added. The result is a more efficient deflection tube that operates at low plate supply voltages and gives satisfactory service in sweeping 90°-deflection-angle picture tubes of large screen size.

A few comparisons

By examining the voltage, current and wattage ratings of several popular deflection tubes, the capabilities of the various tubes may

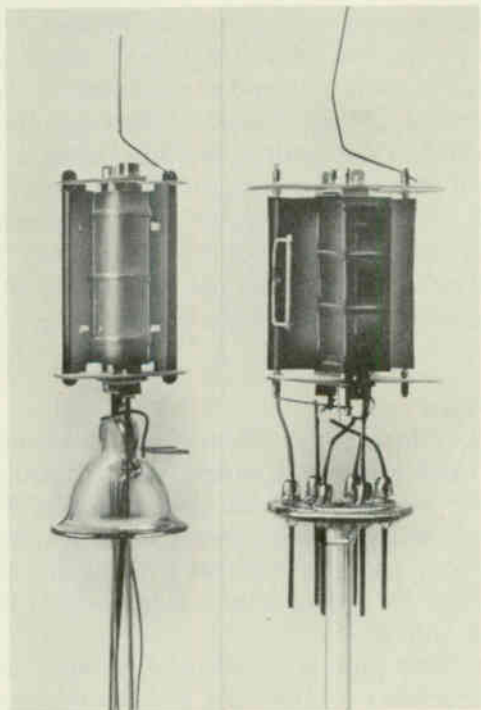

Fig. 901. *Types of stem construction.*

be compared. Types of the same family are pretty much identical but some withstand heat better than others and offer greater resistance to such abuse as misadjustment of the drive control.

Horizontal output tubes

There appears to be some confusion over the interchangeability of horizontal output tubes such as the 6BQ6-GT, 6CU6 and 6DQ6-A. These tubes appear to be almost exactly the same; many of them are even double-branded.

The difficulty here is that these tubes are interchangeable only unilaterally. That is, a 6CU6 can be used in place of a 6BQ6-GT and a 6DQ6-A can be used in place of a 6CU6, and not vice versa.

In a great many instances, trying to use a 6DQ6-A as a replacement for the other two types results in excessive width which can not be sufficiently reduced. As a practical matter, replace with the tube the set has been designed for. If you want improvement, try using the sequence indicated above. In time the 6DQ6-A, which has closer tolerances than the 6CU6, will supersede the other two, but it should not be used indiscriminately as a replacement.

The first horizontal deflection tube, the 6BG6-G, could operate with a high plate supply voltage up to 700 and a relatively low zero-bias dc plate current of 180 ma. Next came the 6BQ6-GT rated at 550 volts plate supply and a maximum dc current beyond the zero-bias knee of 225 ma. Finally, following other intervening types, there is the 6DQ6-A with a zero-bias rating of 300 ma and a supply voltage of 600. Of course there are many other types which either upgrade electrical ratings or have mechanical improvements for better heat transfer. Notable in this respect is the 6CU6 which, though rated the same as the 6BQ6-GT, is improved for conservative operation, thus providing longer life.

Substitution rules

In general, a different type should not be substituted for the original tube used in the set unless the original did not give satisfactory performance or service. For example, if the tube life is short or sweep is insufficient, substituting a tube with higher ratings or improved construction may prolong life. Substituting a more efficient tube for one of lesser efficiency may increase sweep width and high voltage.

If a more efficient tube is substituted, be sure to readjust the drive control to protect components and the damper tube and to insure that the picture-tube anode voltage does not go too high. If substitution of a more efficient tube is not called for, the resulting sweep could be too great and be beyond range of adjustment, especially in receivers without a width control.

If the failure rate of the horizontal output tube is high but sweep is wide enough, substitute a more rugged tube with the same electrical characteristics, such as a 6CU6 for the 6BQ6-GT.

If the sweep width is not sufficient—probably caused by component aging in the flyback circuit or lower B-plus supply voltage and other conditions in the set—then substitute a more efficient tube with higher zero-bias plate current and transconductance, such as 6DQ6-A for the 6CU6. If substitution fails to bring back the sweep to normal, it is time to suspect other components; the

damper tube, horizontal oscillator, high-voltage rectifier, low-voltage rectifier or flyback transformer.

Substituting one type of horizontal output tube for another is fairly simple when the differences between types are fully understood. As new tubes come out in the future, note the differences between these tubes and their predecessors; for instance, does the new tube have a larger glass envelope, does it have higher zero-bias plate current or will it handle higher peak plate voltages?

These pieces of information in addition to plate and screen dissipation, will tell you when to use the tube. Intelligent substitution should help the service dealer to reduce the number of call-backs due to horizontal output tube failure. Remember, although a given receiver may have employed certain tubes that were available at the time it was designed, there is no reason why these same tubes should always be replaced in that receiver for the rest of its life. Tube manufacturers have improved the design of sweep tubes considerably over the years, through greater experience in manufacturing these types, and because of the demand of set manufacturers for higher performance tubes.

High- and low-voltage rectifier tubes

Before replacing a high-voltage rectifier tube, make sure that the power is off, particularly when such a tube is located under the chassis. In the latter case, also short the corona ring to ground to be certain that no residual charge is left at high-voltage terminals with which you may come into contact.

When a 1B3-GT is to be replaced, check for continuity between pins 5 and 7 in the new tube. The presence of such a continuity reading indicates that an internal jumper exists between these pins. If a component is present between contacts 5 and 7 on the socket (a top-of-socket resistance check will determine this), the jumper will short the component. Clip pin 5 off the tube base or use a brand of tube without a jumper, to avoid trouble in such cases.

In some makes of 1B3-GT, pins 3, 5 and 8 or all the unused pins are internally connected to filament pins 2 and 7 to provide an internal anti-corona shield. Clip off all pins except 2 and 7 to avoid shorting any component when such a tube is used, unless the original tube has the same kind of anti-corona shield (as determined by resistance checks at the prongs).

If one of two low-voltage rectifiers connected in parallel requires replacement, change the other one as well to avoid imposing too great a load on the new tube and shortening its life. The same procedure is recommended in cases where one of two high-voltage

rectifier tubes in a voltage-doubler circuit has become defective.

6AX5-GT's used as low-voltage rectifiers have exhibited tendencies to lose emission prematurely. Replace this type of tube with a 6X5-GT, with which it is interchangeable.

Avoiding needless picture-tube replacements

Before condemning a picture tube as too weak for further use, check its filament voltage. When an aging tube's filament voltage has dropped even as little as $3/4$ volt, the emission loss will be considerable. Check for poorly soldered filament prongs on the tube since this is one possible source of the trouble. If the fault is due to reduced efficiency in the power transformer, an inexpensive filament transformer may be used to provide the full 6.3 volts to the tube and prolong its useful life.

Renecked picture tubes

The presence of a slight bulge or indentation in the neck of a new picture tube is no cause for concern. Service technicians sometimes feel that such eccentricities in shape indicate that the tube has been renecked and is therefore not of first quality. The suspicion about the tubes having been given a new neck may be quite correct; the quality of the tube, however, is not impaired.

Renecking may be necessary when a bulb neck is broken by rough handling or bumps suffered while the tube is on a production line. It is also performed when some inner part of the tube is substandard (although its bulb is not). The bulb or bell of the tube can be and is used again; renecking is, however, necessary, since the neck was cut off to remove the gun and wipe away the screen coating.

Many other reasons besides the ones cited may necessitate renecking of a tube. Inasmuch as the process does not affect picture tube quality, performance or life, the service technician need not fret over visible signs of it in a tube that he intends using as a replacement.

Electrostatic-focus picture-tube substitutions

High-voltage electrostatic-focus picture tubes never became popular or widely used because low-voltage types that require less expensive circuitry were soon developed. Where substitution of a low-voltage for a high-voltage type is necessary, due, say, to the scarce supply of the latter, the following procedures can be used:

1. Choose a suitable replacement tube.
2. Disable the focus voltage supply since it will no longer be

needed. (Use caution in working on this supply; terminals on it are at a potential of several thousand volts with respect to the chassis when the set is on.) Remove the focus voltage rectifier tube, and disconnect the wire leading from the focus electrode (socket contact 6) to the high-voltage focus supply. Connect a wire from socket contact 6 (at the chassis terminal post to which it leads) to a variable source of B-voltage. Insertion of a potentiometer between socket contact 10 and ground permits the proper amount of focus voltage to be tapped off.

Before adjusting the potentiometer, the setting of the ion magnet, brightness and contrast controls should be checked to make sure they are correct. Since the focus changes produced by potentiometer manipulation are very gradual, it may be necessary to move the pot quickly through large angles of rotation, to note changes in focus and determine the optimum focus setting. Once the proper focus voltage has been set up, no further adjustment should be required during the tube's life.

Retaining salvage value of the picture tube

Picture-tube manufacturers will not make any allowances on old picture tubes turned in under exchange plans if the tube face has been scratched. Technicians sometimes make a notation in crayon or with a china pencil on the face of an old tube, indicating its condition. These markings are, in some cases, hard enough to scratch the tube face. In other instances, the pencils used react chemically with the tube face, producing an etching on this surface and injuring it. Defacement of the surface in such ways may destroy the tube's salvage value.

Don't use an abrasive type cleaner on the face of the picture tube or any other of its surfaces—use a mild detergent or soap, if needed.

Any scratch on the glass which is deep enough to catch a fingernail drawn at a right angle across the scratch will generally make the tube unacceptable to the manufacturer. In the case of frosted-face tubes, the requirements are even stricter—any scratch, mark or blemish that remains after a soap and water cleaning will make the tube ineligible for an exchange allowance.

To check the condition of the tube, illuminate it with a light bulb of 60 watts or larger about a foot away from the tube. Cracked and chipped sections, most likely to be found on the outer edges of the faceplate, will, in some cases, be visible as mirror-like slivers or lines; in others, they will have star shapes. Rainbow colors, due to the refraction of incident light by the broken sur-

face, will also call attention to the cracked or chipped areas.

Miscellaneous tube replacement notes

TV service technicians will find considerable differences in the quality of tubes made by different manufacturers. It will prove profitable to check the performance of various makes of tubes in different receiver circuits and thus become familiar with good, bad and indifferent brands.

Economy can often be promoted by switching identical types of tube from one section of the receiver to another. A tube that performs poorly in one stage, where circuit tolerances are critical, may do much better in another stage in which the requirements are not quite so strict. A 12AU7, for instance, that has lost a slight amount of emission—too much to perform satisfactorily as a horizontal oscillator—may work well in the vertical deflection circuit.

index

A

Ac-Dc Receiver, Intermittent	180
Adapter, Test	38
Agc Bias, Excessive	59
Agc Tube, Defective	57, 86
Aluminized Screens	132
Anode Terminal	134
Anti-Noise Tube	88
Anti-Pincushion Magnets	144
Aquadag Coating	127
Arc-Caused Damage to Tube and Components	32
Arcing	43, 51, 102, 116, 117, 124, 134
Arcing: and Corona Associated with Tubes	118
and Corona at Bell of CRT	122
Associated with Tube Plate-Cap Leads	120
at Metal C-R Tubes	124
due to Improper CRT Grounding	124
Inside the CRT	121
Intermittent	122
Audio Output Tube, Defective	56
Audio Output Tube, Radiation from	109
Automatic Focus	155

B

Barkhausen Oscillation	105
Barreling	143
Bars due to Hum, Horizontal	114
Bars in Picture, Sound	110
Bent Gun	161
Bias, Excessive	41
Bias Excessive AGC	59
Black Compression	69
Black Vertical Lines	109
Blanking: Bar	70
Bar, Horizontal	86
Bar in Pix, Vertical	91
Bar, Vertical	50
Blue Haze in Picture Tube	52
Brightness: Excessive	52
Insufficient	51
Troubles	45
Burns, Avoiding Tube-Caused	17
Buzz: due to Improper Lead Dress	81
in Sound	80
Sync	68, 80
Tube-Caused	196
Vertical Sync	80
B-Voltage Checks	38

C

Cathode: Defects	169
Flaking in Picture Tube	176
-to-Grid Short	55
-to-Heater Leakage	46, 96, 115, 116, 186
-to-Heater Short	39, 43
-to-Heater Short, Hum due to	194
Cautions on Use of Tube Testers	36
Centering Accessories	157
Centering Devices	156
"Christmas-Tree" Effect	101
Click Tests	183
Clipping of Sync Pulses	87
Component Damage	19
Components Associated with the Yoke	147
Compression, Black	69
Compression, White	67, 68
Cone Lip	134
Connections, Loose	44
Contrast, Excessive	69

Contrast Inadequate: Insufficient Signal ..	61
Controls, Symptoms Associated with	99
Converters, Restoring to Normal Operation	207
Corona	51, 116, 117, 124, 134
Corona: and Arcing Associated with Tubes	118
and Arcing at Bell of CRT	122
and Arcing at Tube Sockets	120
Corroded Anode Connection	42
Cosine Yoke	143
Coupling Capacitor, Premature Tube Failure due to Leaky	32
C-R Tubes, Protecting	30
Creeping Distortion	185
CRT, Arcing Inside the	121
Crystal, "Tweets" due to Defective	104
Current Limiting Resistor	21
Curve in Raster Sides	144

D

Damage, Tube and Component	19
Damper Tube, Gassy	60
Dark Picture	65
Defective Socket Contacts, Picture Tube	174
Definition, Picture	76
Deflection: Angle Rating	140
Factor	138
Sensitivity	138
Vertical, Missing	47
Demagnetizing Metal Cone of Picture Tube	178
Diagonal Angle	140
Diode-Triode, Salvaging the	210
Dirty Picture Tube Face	51
Dissipation Ratings, Plate and Screen	22
Distorted Sound	82
Distortion	185, 207
Distortion, Creeping	185
Distortion, Picture	177

E

Electromagnetic Focusing Adjustments	150
Electromagnetically Deflected Picture Tube	139
Electrostatic: Focus, High-Voltage	153
Focus, Low-Voltage	154
Focus, Picture-Tube Substitutions ..	218
Focusing	153
Electrostatically Deflected Tubes	136
Electrostatically Focused Tubes	136
EM Focusing	151
Emission, Loss of in Low-Voltage Rectifier	57
Emission, Loss of, in Picture Tubes	168
Engraved Effect	78
Etched Face	130
Excessive Bias	41
Excessive Brightness	52
Excessive Heating of Tube	31

F

Faceplate	130
Fading	205
Filament: Circuit, Series	33, 34
Leads, Flyback	29
Locating Open	181
Sparking in Picture Tube	174
-to-Grid Coupling	194
Troubles	173

Troubles, Intermittent	180, 182
Voltage, Excessive, on High-Voltage Rectifier	28
Voltage, Missing	140
Flashes in Picture	101
Flashing	101
Flyback Filament Leads	29
Focus:	
Adjusting on Self-Focus Tubes	156
Adjustments on Internal Magnetic-Focus Tubes	156
Anode	137
Assemblies, Adjusting	152
Control Tube	75
High-Voltage Electrostatic	153
Improper-Poor Definition	72
Low-Voltage Electrostatic	154
Problems	142
Tube	74
Focusing	137
Focusing:	
Adjustments, Electromagnetic	150
Electrostatic	153
PM and EM	151
Foldover, Vertical	50
Frozen Yokes	149

G

Gassy:	
Cathode-Ray Tube	74
Dampner Tube	60
Tubes	172
Vertical Output Tube	51
Video or IF Tubes	66
Ghosts due to Bad Tubes	78
Glass Faceplates	130
Glass vs. Metal Tubes	129
Grid:	
Emission	96
Emission, Tube Damage due to	31
Filament Leakage	62
-to-Cathode Short	176

H

Harmonic Radiation	104
Heater-to-Cathode Short	35, 175
Heating of Tube, Excessive	31
Height, Increasing	48
Height, Insufficient	47
Herringbone Interference Pattern	104
High-Voltage:	
Connection, Corroded	42
Connector	134
Electrostatic Focus	153
Lead Dress	32
Rectifier, Excessive Filament Voltage of	28
Rectifier, Premature Failure of	26
Rectifier Tubes	217
Rectifiers, Cautions on	26
Higher-than-Normal Line Voltage	25
Hissing Sound	118
Hook, Picture	96
Horizontal:	
Amplifier, Parasitic Oscillation in	102
Bars due to Hum	114
Blanking Bar	86
Jitter	98
Line	47
Linearity Control	25
Nonlinearity	26, 50, 144
Output Tube, Avoiding Damage to	24
Output Tube, Radiation from	104
Output Tubes	215
Pulling	96, 115
Retrace Blanking Tube, Failure of	108
Sync Instability	95
Sync, Loss of	94
Sync Stability, Improving	100
Sync Symptoms	99
Sync Trouble	94

Tearing	97
Hum	189, 195
Hum:	
Bars, Horizontal	114
Bars in Picture and Raster due to Cathode-to-Heater Short	194
due to Heater-to-Cathode Leakage	190
Eliminating	191
in Sound; Pix and Raster Normal	79
in Sound; Raster Absent	43
Lead-Dress	195
Modulation	194
Obscure Causes of	195
Residual	56

I

Implosion:	
How to Avoid Causing an	9
Injuries, Cautions for Minimizing Risk	11
Risk	8
Improper Lead Dress	81
Increasing Height	48
Insufficient:	
Brightness	51
Height	47
Signal; Contrast Inadequate	61
Width	45
Intensifier Anode	137
Interference	103
Interlace, Poor	91
Intermittent:	
Arcing	122
Filament Troubles	180, 182
Operation and Fading	205
Pix and Sound	57
Raster	44
Rolling	115
Internal Open in Filament of Picture Tube	173
Ion Trap:	
Adjustment, Symptoms of	
Improper	161
and Magnet System	158
Magnet, Adjusting the	162
Magnet, Damage due to	
Misadjusted	164
Magnet, Replacing the	166
Magnet, Symptoms of a Defective	161
Setting, When to Check the	162
System, Need for an	159
Types of	160

J

Jitter:	
due to Lead Dress, Vertical	91
Horizontal	98
Vertical	86

L

Lead-Dress:	
High Voltage	32
Hum	195
Vertical Jitter due to	91
Vertical Lines due to	107
Leaky Coupling Capacitor, Premature Tube Failure due to	32
Line:	
Tearing	98
Voltage, Higher-than-Normal	25
Voltage, Low	46
Linearity Control, Horizontal	25
Linearity Troubles	45
Lines, Barkhausen	105
Localization Tests, Need for Stage	179
Localizing Arcing	118
Localizing Corona	118
Loose Connections	44
Loss in Interlace, Intermittent	93
Low B Voltage	38

Low Voltage:	
Electrostatic Focus	154
Rectifier, Low Emission in	44
Rectifier, Preventing Damage to	20
Rectifier Tube, Shorted	37
Rectifier Tubes	217
Low Volume	208

M

Magnetic Shield Ring	51
Magnetization of Picture-Tube Gun	75
Magnetized Metal Picture Tube	177
Metal C-R Tubes, Arcing at	124
Metal vs. Glass Tubes	129
Microphonic Tubes	95, 197
Microphonic Vertical Amplifier	111
Microphonics	109
Missing Tube Shields, TVI due to	103
Modifying Receiver Sensitivity	62
Modulation Hum	194
Motorboating	83
Mountings, Tube	19

N

Negative Picture	71
Noise:	
Dots	55
Excessive	83
Streaks	86
Noisy Sound	83
Noisy Tubes	199
Nonlinearity, Horizontal	26, 50
Nonlinearity, Vertical	49
Notches in Picture, Vertically Moving	100
Numbering Systems of Picture Tubes	125

O

Open Filaments, Locating	181
Oscillation	196
Oscillation, Barkhausen	105
Oscillator Trouble in AM Receiver	184
Oscillator Tubes, Replacing RF	211
Output Tube, Avoiding Damage to	
Horizontal	24
Output Tube, Radiation from Audio	109
Overloading	65, 67

P

Parasitic Oscillation in the Horizontal	
Amplifier	102
Phase, Picture Out of	101
Picture:	
and Raster, Hum Bars in	113
and Sound Do Not Track	83
and Sound Troubles	53
Contrast, Excessive	66
Definition	76
Distortion	177
Hook	96
Smear	77
Picture Tube:	
Base	185
Blue Haze in	52
Cathode Flaking in	176
Filament, Unlit	173
Length	131, 141
Replacements, Avoiding Needless	218
Retaining Salvage Value of the	219
Substitutions, Electrostatic-Focus	218
Types	186
Universal	178
Picture Tubes:	
Bulb and Base Differences in	126
Filament Troubles in	173
Possible Troubles in	168
Renecked	218
Safety Considerations in	7

Testing and Repairing	167
Pinkish Glow in Picture Tube	173
Pix (see also listings under Picture and Picture Tubes):	
Absent, Sound and Raster Normal	53
and Raster Normal; Hum in Sound	79
and Sound Absent, Raster Normal	55
and Sound, Intermittent	57
and Sound Reception Absent on	
Some Channels	58
Missing; Sound is Strong	60
Normal, Sound Absent	82
Plate and Screen Dissipation Ratings	22
PM Focusing	151
Poor Definition—Improper Focus	72
Poor Interlace	91
Portable Radios, Tube Troubles in	202
Premature Failure of High-Voltage	
Rectifier	26
Premature Tube Failure due to Leaky	
Coupling Capacitor	32
Protecting C-R Tubes	30
Pulling	96
Pulling, Horizontal	96, 115

R

Radiation:	
from Audio Output Tube	109
from Horizontal Output Tube	104
Interference due to	103
X-Ray	13
Radio Shock Hazards	16
Radio Tube Troubles	179
Radios, Tube Troubles in Portable	202
Raster:	
Absent, Hum in Sound	43
Absent, Sound Normal	40
and Picture, Hum Bars in	113
and Pix Normal; Hum in Sound	79
and Sound Missing	37
and Sound Normal, Pix Absent	53
Intermittent	44
Normal Pix and Sound Absent	55
Sides Rough	102
Ratings, Plate and Screen Dissipation	22
Receiver Inoperative on UHF	59
Rectangular vs. Round Picture Tubes	127
Rectifier, Preventing Damage to Low-Voltage	20
Rejuvenation of Picture Tubes	169
Renecked Picture Tubes	218
Repairing Picture Tubes	167
Replacements:	
Avoiding Needless Picture-Tube	218
Sweep Tube	212
Sync Tube	212
Video IF Tube	212
Resistor, Current Limiting	21
Resolution Troubles	76
Retaining Salvage Value of the Picture	219
Tube	219
Retrace Lines	56
RF Oscillator Tubes, Replacing	211
Rolling	90
Rough Raster Sides	102
Round vs. Rectangular Picture Tubes	127
Rushing Sound	55

S

Safety	7
Salvage Value of Picture Tubes	219
Scanning Spot	75
Screen and Plate Dissipation Ratings	22
Screen of Picture Tube	132
Screen Size	181
Self-Focus	155
Sensitivity, Deflection	138
Sensitivity, Modifying Receiver	62
Series-Filament Circuits	33, 34
Series-String Filaments	34
Set Doesn't Play but Tubes Light	182

Set Plays on Some Stations	184	Replacement Notes	220
Shaded Picture Corners	144	Replacements	209
Shading in the Picture	175	Shields and Hum	195
Shield Ring, Magnetic	51	Sockets, Corona and Arcing at	120
Shock, Avoiding TV	13	Stacking Arrangement	58
Shock Hazards, Radio	16	Substitutions, Precautions in Making	209
Short, Heater-to-Cathode	35	Substitutions to Improve Vertical	91
Shorted Rectifier Tube, Low-Voltage	37	Stability	91
Shrinking, Vertical	48	Testers, Cautions on Use of	36
Signal-to-Noise Ratio, Poor	64	Troubles in TV	37
Sixty-Cycle Hum Modulation	115	Tubes do not Light	179
Size, Linearity and Brightness Troubles	45	Tubes, High- and Low-Voltage Rectifier	217
Sizzling Sound	118	Tubes, Picture	125
Sleeve, Width Control	150	Tuner Tubes, Replacing the	210
Smear, Picture	77	TV Shock, Avoiding	13
Snivets	109	TVI	103
Snow	59, 63	"Tweets" due to Defective Crystal	104
Snow, Eliminating	64		
Socket Trouble	195		
Sound:		U	
Absent, Pix Normal	82	UHF, Receiver Inoperative on	59
and Picture Absent on Some		UHF Reception, Weak	65
Channels	58	Universal Picture Tubes	178
and Picture Absent, Raster Normal	55	Unstable Sync	85
and Picture do not Track	83	Unwanted Tubes, Disposing of	12
and Picture, Intermittent	57		
and Raster Missing	87		
and Raster Normal, Picture Absent	53		
Bars in Picture	110	V	
Buzz in	80	Ventilation Openings	23
Distorted	82	Vertical:	
in Pix	113	Blanking Bar	50
is Strong, Picture Missing	60	Blanking Bar in Picture	91
Noisy	83	Deflection Absent	47
Normal, Raster Absent	40	Foldover	50
Rushing	55	Jitter	86
Troubles	53	Jitter due to Lead Dress	91
Troubles—Hum in Sound; Picture		Line Tubes	106
and Raster Normal	79	Lines, Black	109
Weak	82	Lines due to Improper Lead Dress	107
Sparkers	173	Nonlinearity	49
Speckles	55	Shrinking	48
Spooks	108	Stability, Tube Substitutions to Im-	
Spot Size, Checking	75	prove	91
Stacked-Tube Circuitry	39	Sync Buzz	80
Station Drift	184	Sync Trouble	89
Sticking	133	White Line due to Failure of Hor-	
Streaks, Noise	86	zontal Retrace Blanking Tube	108
Substitution Rules	216	Yoke Replacement	149
Sweep Tube Replacements	212	Vertically Moving Notches in Picture	100
Symptoms Associated with Controls	99	Video IF Tube Replacements	212
Sync:		Volume Below Normal	184
Buzz	65, 68, 80	Volume, Low	208
Hammer	70		
Instability, Horizontal	95	W	
Pulses	72	Warmup Time, Excessive	44
Stability, Improving Horizontal	100	Washed-Out Picture	175
Trouble, Horizontal	94	Weak Picture with Snow	63
Trouble, Vertical	89	Weak Sound	82
Troubles	85	Weak UHF Reception	65
Tube, Loss of Emission in	92	White	83
Tube Replacements	212	White Compression	67, 68
		White Line, Vertical	108
		Width:	
T		Control	46
Tearing:		Control Sleeve	150
Horizontal	97	Insufficient	45
Line	98		
of Lines	86	X	
Test Adapter	38	X-Ray Radiation	13
Test Pattern Pulled in	49		
Testing Picture Tubes	167	Y	
Tests, Click	183	Yoke:	
Tube:		Adjustment	148
and Component Damage	19	Characteristics	142
and Components, Arc-Caused Dam-		Components Associated with the	147
age to	32	Yokes and Yoke Components	148
Caused Burns, Avoiding	17	Yokes, Frozen	149
Caused Buzz	196		
Damage, Avoiding	202		
Damage due to Grid Emission	31		
Design	214		
Mountings	19		

