



EXPERIMENTAL ELECTRICITY COURSE

BY S. GERNSBACK &
H. W. SECOR

Experimental Electricity Course

IN TWENTY LESSONS.

BY

S. GERNSBACK and H. W. SECOR, E. E.

Authors of "THE WIRELESS COURSE," etc.



WITH ILLUSTRATIONS.

THE
EXPERIMENTER PUBLISHING CO., Inc.
233 FULTON STREET, NEW YORK

1916

Copyright by
THE EXPERIMENTER PUBLISHING CO., Inc.
1916

All Rights Reserved

Experimental Electricity Course.

LESSON No. 1.

"ELECTRIC BELLS, BUZZERS AND ANNUNCIATORS."

ELECTRICITY, when utilized for signalling purposes, generally involves the use of electrical bells, buzzers, or annunciators, and so these apparatus will be described in order; also the best methods to pursue in properly wiring for same.

It is advisable, perhaps, to start with a description of the *ordinary vibrating bell*. The action of it is very simple, and may be the more readily understood by looking at the schematic drawing, Fig. 1.

In this drawing are shown the various parts of the simplest bell circuit. Included in the circuit are: the bell itself, of the vibrating type; the battery, of one or more cells, and a push button for the control of the bell. The bell acts upon the principle that whenever an electric current, as from the battery here shown, passes through a coil of several turns of insulated wire, there will be produced within the coil and about it, an electromagnetic field of force, as it is termed. This electro-magnetic effect, produced whenever a current traverses a coil of wire, is introduced in the bell, in the man-

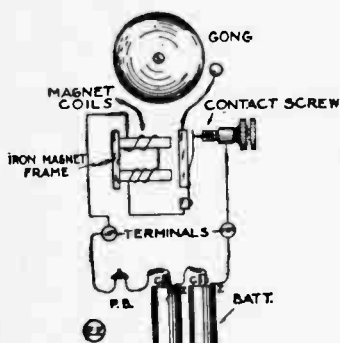

FIG. 1

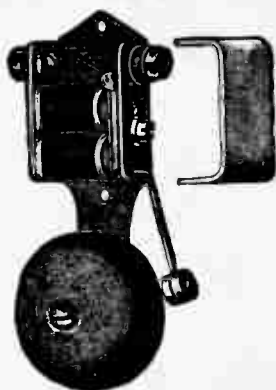

Fig. 2

ner illustrated. There are two coils in most bells, but some types contain but one. Now, if the push button is pressed, the two contact springs in it are brought together, making an electric circuit, through which the battery current passes, and so on around through the electro-magnet coils on the iron frame of the bell. The iron cores of the magnets become suddenly strongly magnetized, attracting the soft iron pivoted armature, which carries the gong hammer. When the armature is thus attracted, and drawn forward, two things happen:—first, the hammer hits the gong, giving out a signal; and second, the contact spring carried by the armature, breaks contact or leaves the contact screw shown in the figure.

The consequence of this is, that the armature is no longer attracted because its forward movement has broken the battery circuit, and no current traverses the magnet coils. Hence the armature, which is normally held away from the magnet cores, but against the contact screw by a spring, at once flies back to this position, or away from the magnets; as soon as this happens, however, the electric circuit is once more completed, the magnets are energized, and the armature is again attracted, striking the gong. As long as the push button is depressed, this action continues, the armature vibrating at a high rate of speed, giving rise to a continuous ringing of the gong. The number of strokes per minute, and the action of the armature are easily regulated by adjusting the contact screw, the tension of the armature spring, and the distance separating the magnet cores from the armature.

A typical vibrating bell of the so-called iron box type, is depicted in Fig. 2, while at Fig. 3 is shown a complete electric bell outfit, including bell, push-button, battery, wire and staples for securing it in place. This outfit forms a very efficient front door bell set, or in any other application for distances not exceeding fifty feet. In Fig. 4, are illustrated, a few ornamental brass push buttons.

It is not always desirable that the electric signal be that of the somewhat noisy bell, and for this class of service, resort is had to an instrument known as a *buzzer*. This is

nothing else but a neatly made bell mechanism, without any gong or striking arm, so that the armature in it can vibrate quite rapidly, sending out a loud buzzing sound, similar to that of a bee. It is much employed in offices, or other quiet places, where the bell is too noisy, or sometimes it is used in conjunction with a bell, so that either the buzzer or the bell ringing, will indicate one or the other of two different signals. For instance, in many private houses, the bell and buzzer are mounted side by side in the kitchen, and so connected to two push buttons that the bell indicates someone at the front door, and the buzzer a call from the dining-room table, etc. Sometimes a number of bells with different toned gongs are arranged in a set, the meaning of each being quite distinct. Common forms of the odd gongs are: the cow bell, the cocoa wood; the sleigh bell; the split gong; the chime gong, etc. A neat and well made buzzer is seen at Fig. 5.

A recent innovation in the realm of electric signalling devices is the *electro whistle*. This instrument gives out a more or less shrill whistling note, quite distinct from any other device. It is built on the same principle as the vibrating bell, excepting that the armature of the bell is substituted



Fig. 3.



Fig. 4

by an iron rod and a thin diaphragm, as shown at Fig. 6. Whenever current is supplied to the terminal binding posts, Ter. 1, and Ter. 2, its path is around through the magnetizing coil, and closed contacts, A. At this juncture, however, the magnetizing coil has drawn forward the iron disc and rod shown, and this also moves the diaphragm, to which the rod is attached. The movement of the rod and disc, simultane-

ously breaks the contact between the springs, A, and the rod and its parts return to their original position. In practice, this attraction and release of the iron rod and also the diaphragm occurs at a very high rate, resulting in a whistling sound being emitted by the diaphragm. This sound may be greatly amplified and directed by attaching a brass or other metal horn to the front of the instrument. This arrangement gives very satisfactory service as a telephone call in power houses or other noisy locations.

The apparatus so far mentioned, form the usual complement of audible electric signalling devices, but before taking up the study of circuits and other details,

reference will be made to a very important instrument, variously called an *indicator* or *annunciator*. A cut of a 6 position annunciator, or one capable of indicating 6 distinct calls, individually, is portrayed at Fig. 7. The annunciator is a very extensively used instrument, particularly in hotels, and other places, where a great

number of different calls are to be registered at one central point, such as a hotel office.

Its principle of action is based upon the electro-magnet, as described in connection with the bell previously. In most cases a bell or buzzer is arranged to operate whenever a call is registered upon the annunciator, but the annunciator itself emits no appreciable sound at all.

Each shutter or drop, bearing any desired number, name or letter, is normally held out of sight, in the type shown in the cut. When an electric current is sent from a certain corresponding push button, however, the shutter is instantly released by an electro-magnet, and drops down into sight. In the cut, Nos. 1, 3 and 5, have been released by the electro-magnets operating them. The shutters are reset, to await another call, by pushing up on a button at the bottom of the cabinet, after each indication. In some annunciators this resetting of the shutters or indicating needles, is accomplished automatically by each succeeding call. This is both a good and a bad feature, inasmuch as the second call may occur, resetting all previous calls, before they have been seen or answered. Hence the manually reset type is generally the most desirable. A sketch of the working action of an annunciator drop, is shown schematically at Fig. 8.

An electro-magnet is arranged with a pivoted soft iron armature, to which is attached a trip bar, so that when the magnet is energized by passing a current through it, the armature will be attracted, raising the trip bar or finger, and releasing the shutter or drop, which rests on a pivot also. The shutter is reset out of range of the window in the cabinet frame, by pushing upward on a button at the base of the



Fig. 5

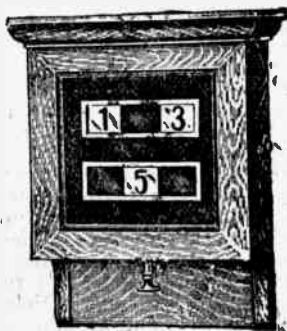
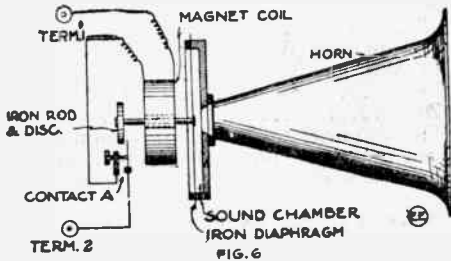
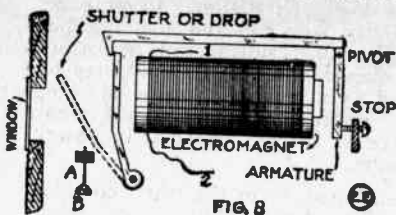

Fig. 7

cabinet. This reset button, B, is secured to a metal rod, A,



which, when pushed upward, presses the shutter upward also, and the slanting edge of the trip finger allows it to rise and then fall over the edge of the shutter, thus retaining it in place, until another call occurs. There are many different styles and makes of annunciators upon the market, but they all operate by means of an electro-magnet and armature of some form.

THE WIRING.

For ordinary electric bell installations it is usual to employ copper wire, about No. 18 gauge, B. & S. (Browne & Sharpe), with two coatings or wraps of waxed cotton over it for insulation. The number of feet per pound of office and annunciator wire, used for bell work, etc., is as follows:

Office wire:	
No. B. & S. gauge.	Feet per lb.
No. 12	35
No. 14	55
No. 16	95
No. 18	135
Annunciator Wire:	
No. B. & S. gauge.	Feet per lb.
No. 18	180
No. 20	225

The annunciator wire, or common bell wire, has two layers of cotton merely wrapped around the conductor, which is then soaked with paraffine wax. It is easily unravelled.

Office wire has two cotton layers braided, which is not so easily unravelled and consequently more preferable. The inner braiding is filled with a moisture repellant compound.

The cheapest wire to buy, of course, would be No. 20, gauge, as it contains the greatest number of feet to the pound, but it is only suitable for comparatively short lines, as it has too much resistance for the low voltages utilized in bell work. No. 18 is permissible for bell or annunciator circuits up to a distance of 100 feet one way or 200 feet of wire in the circuit. For circuits of 100 feet to 150 feet one way, use No. 16 gauge wire. Circuits from 150 feet to 200 feet, No. 14 wire, and circuits of 200 to 250 feet one way, use No. 12 wire. For circuits of greater length than these it is not practical to ring the bells direct, as they require too much current in amperes, which necessitate a very large battery to compensate for the volts drop in the line or circuit, and also large copper wire. For long bell circuits, the most practical arrangement is that involving the use of a high resistance relay, which is actuated directly by the push button and battery, over the long line; and the relay then closes a local circuit containing several feet of wire, a battery of a few cells, and the bell. The relay is wound to a higher resistance than the bell, and does not require nearly as much current in amperes, so that smaller line wire may be used. Relays are quite sensitive, and are the same as used on telegraph lines, the resistance varying from 20 to 100 ohms or more, depending upon the length of the line. A long distance bell circuit with relay is shown at Fig. 9.

In this arrangement, whenever the push button is depressed, current from the battery is sent over the line which actuates the relay electro-magnets at the other end. The magnets then pull forward the iron armature shown, closing the contacts of the local circuit, and allowing the bell to ring from its local battery. A spiral spring holds the relay armature normally away from the magnet poles and contact screw, leaving the local bell circuit open.

In general to ring an ordinary bell of medium size, the battery required either of dry cells or wet cells (sal-ammoniac-carbon-zinc), is about 2 cells for circuits up to 50 feet, one way; circuits up to 75 feet 3 cells; 100 feet 4 cells, etc. The number of cells required will depend

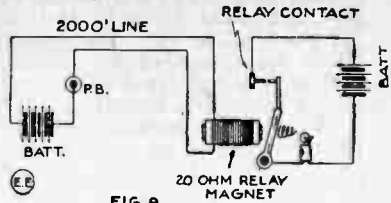

FIG. 9

upon the size of the bell to be operated and the length of the circuit. The standard sizes of bell gongs vary from 2 inches up to 12 inches, the latter requiring about 8 dry cells to operate on a circuit not exceeding 75 feet in length one way.

In the past few years there has been a new source of power for bell circuits introduced, that employing a small step-down transformer, excited from the A. C. electric lighting mains, in the house or building. The transformer does not take a current worth mentioning, and supplies a reliable source of power for bell circuits and the like. A circuit diagram for it is shown at Fig. 10. The secondary coil has several taps brought out from different turns thereon, so that various voltages may be applied to the bell circuit, generally from 6 to 24 volts, A. C. (Alternating Current).

A few words will now be devoted to the subject of *bell wiring* in general. Some of the basic principles underlying good bell work, are: that all wires must be carefully run and

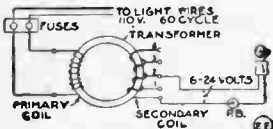

FIG. 10



FIG. 11

well insulated from contact with gas, steam, or water pipes, and all joints in the wire circuit should be soldered and taped up with black friction tape. The best practice in running two or more cotton covered bell wires, is to either have all the wires bunched into a cable, and the cable secured in place by fibre or leather straps, or to run each wire separate from its neighbor and securing each in place by means of iron staples. Insulated staples, such as the Blake, are best, and sometimes the two wires of a circuit are held under one insulated staple, there not being much chance of short-circuiting the two wires together. Unless continual trouble is

desired, therefore, the individual wires will be well insulated by forming into a cable, or by keeping each one separate. A good cable form for several pairs of wires, results by wrapping the whole cable with insulating friction tape. This is often employed for interior telephone work and has proven very satisfactory.

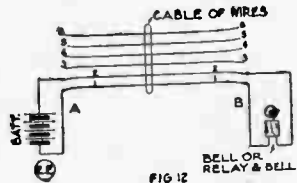

FIG. 12

On new bell work where the building is unfinished, the wires are readily placed in the walls and floors, making a fully concealed job. Where the bells have to be installed in old buildings, the wires may be run inside of the walls to a great extent, by fishing them from hole to hole, making small holes at the baseboard and at the ceiling. Also by taking up a short piece of floor on opposite sides of a room, a steel fish wire or snake, as it is often called in the electrical trade, is easily pushed along between the floor beams. When the fish wire appears at the opposite hole, the bell wires are attached to it and pulled through to the other hole. Wooden moulding makes a good appearance, particularly if hard wood moulding is used to match the trim of the room in which it is installed.

First class bell installations have the wires placed in iron pipe, the same as regular electric light wires.

Before going into the various systems and connections which may be used for electric bells and annunciators, it will be well to give a few simple instructions on the testing out of bell wires, batteries, etc.

The simplest method by which to test out any wires for their continuity, but not always applicable, is that known as

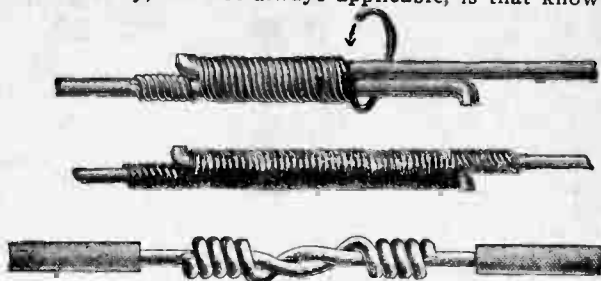

Fig. 13.

the ground test. The manner of accomplishing this test is depicted in Fig. 11, where G is an artificial ground or earth connection, through water, gas, or steam pipes in a building; B the testing battery of a few dry cells; T the testing bell buzzer, or sometimes a telephone receiver for long lines having high resistance, and L the wire to be tested.

The diagram given explains itself, the only thing necessary to do, being to connect the ground wire C to any wire desired, and then testing the ends of the wires at A, until the bell rings, when the wire under test is consequently known to be continuous, and also a certain wire in the system, which it is well to call No. 1. The wires, if more than two in number, should always be tagged and numbered, after which it becomes a simple matter to quickly hook up the wires to any form of system desired.



Fig. 13A.

The ground test, as previously mentioned, is not sometimes applicable, due to the absence of a handy ground connection. In this event, a somewhat different procedure is pursued with the same results, that is, the testing out of individual wires of the system for continuity and number.

The common circuit arrangement for this full metallic test, is shown at Fig. 12. First the testing battery is connected across any two wires as seen, and the tester at B tries different wires or cable terminals, until his bell or relay and bell for long lines, rings. He then knows that he has the first two wires continuous, and usually they are tagged at both ends Nos, 1 and 2. By joining both line terminals, 1 and 2, to one pole of the battery at A, and the other battery pole to a third wire; the tester at B, by connecting his one bell

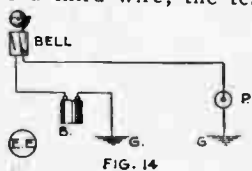

FIG. 14

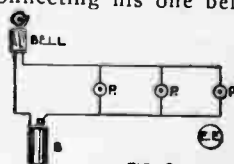

FIG. 15

terminal to lines 1 and 2 and testing the various cable ends, readily finds one that rings his bell, and that one is No. 3 line wire. This is followed out until all the wires above 1 and 2 in number are ascertained. At this stage of the test, however, the wires 1 and 2 are not known one from another, but by separating their respective ends, and connecting one battery pole to No. 3 cable wire, and the other pole to either No. 1 or 2 at the terminus A, then with one bell

terminal hooked on to No. 3 wire, at B, and exploring the other wires, with the other bell terminal, No. 1 or 2 as the case may be, is soon found and tagged. A couple of small battery telephones for tests over long lines are very useful, in this connection, allowing the tester at A to quickly inform his co-worker at B what line number he is connected to. It is assumed of course, that A tags the cable ends arbitrarily first, before any tests are made.

In regard to proper wire joints, a glance at Fig. 13, will show the manner of making same. The wires, where they are to be joined, must be thoroughly cleaned bright by scraping with a knife, or better, by a bit of sandpaper or emery cloth. The joint is made by twisting the wire ends around one another tightly and soldered by heating with an alcohol torch or soldering copper. When hot enough, a good non-corrosive flux, such as rosin; Allan soldering stock, No-Korode paste, etc., is applied, and then the solder, allowing it to flow through the joint thoroughly. The joint can then be well taped to avoid possible short-circuits or grounds.

It is frequently convenient to have stranded wires transformed into solid terminals. Here is a special Electro No. 6225 tip which does the trick in a simple manner. Hold the tip in a gas or candle flame, using a pair of tweezers or pliers until the solder already inside it melts. When the solder melts, push the end of the wire into the tip. When the solder cools, the wire will be soldered securely to the inside of the tip. The wire should be carefully cleaned beforehand.



Fig. 13a represents an E. I. Co. wire joint No. 6485. These joints are of a special construction, a radical departure from the old style joints in use. They have a special beveled edge which allows the joint to fit tight and make a perfect contact with the wire. The joint is as perfect as a welded one. By using these in your telegraph line, telephone line, electrical wiring, and last of all, in constructing your aerial for wireless work you will greatly improve the efficiency of the connections.

This covers the principles and important features in the installation of the wires, and the next topic to engross us will be the different arrangements in use to allow of various dispositions of the bell, push buttons, batteries, indicators, etc. The simplest call bell circuit was shown in the beginning of this chapter.

At Fig. 14 is illustrated the circuit for a call bell system with ground return, the ground being made to water, steam or gas pipes. Fig. 15, shows the connections for ringing one bell from more than one push button.

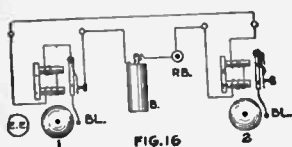

FIG. 16

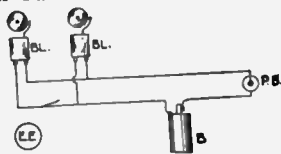

FIG. 17

At Fig. 16, is shown the proper arrangement for ringing two vibrating bells in series at the same time. Bell No. 2 is made single stroke, and its magnet current is interrupted by the armature of the other bell, which can operate several

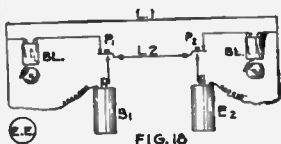

FIG. 18

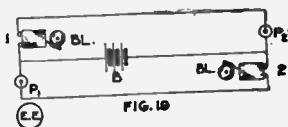

FIG. 19

single stroke bells if required, instead of one.

Fig. 17, depicts how two or more bells may be rung on

multiple simultaneously, from one push button. Fig. 18, is a system allowing either push button to operate the opposite bell, over two wires, but two batteries are required. In diagram 19, the standard return call bell circuit is seen, requiring but one battery and three wires.

A common form of four drop annunciator or indicator is diagrammed at Fig. 20.

Whenever the push, P 1, is pushed, for instance, it closes the circuit around through the annunciator trip magnet coil, also the call bell in series with the circuit.

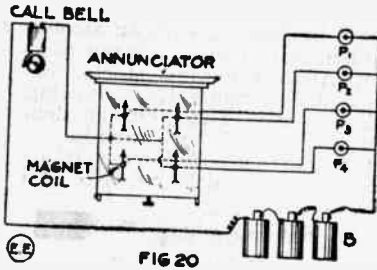

FIG 20

A more elaborate indicator system is outlined at Fig. 21. This has return call bells at each party's push button station, so that the central operator at the indicator A. N. may push the corresponding button for any call rung up, thus signalling the calling party that his call has been heard.

A few diagrams are appended here for elec-

tronic gas ignition systems. The common pull chain igniter burner is given in diagram by Fig. 22; where only one wire leads from the gas lighting coil to the burner. Common ground connection is effected in the basement to the gas pipe, and returns through the gas fixture.

The automatic gas burner and connections are illustrated at Fig. 23. At A, are the connections for a single push button control of the burner, while at B, is a double control of the burner, such as having the pushes at opposite sides of the room. Fig. 24, is another cut of an automatic gas burner hook-up.

The high tension gas ignition system

much used in theatres, as auxiliary, in case the electric lights fail, is seen in diagram Fig. 25. This system employs either a jump spark coil or a special frictional generator which develops about 50,000 volts, at a turn of the handle. The burners are made with fixed spark gaps, and a number of the burners are connected in series. The air gap, which the spark has to jump on each burner is about one-thirty-second of an inch, and therefore there are approximately thirty-two burners to every inch of spark available from the charging apparatus. In practice slightly less than this num-

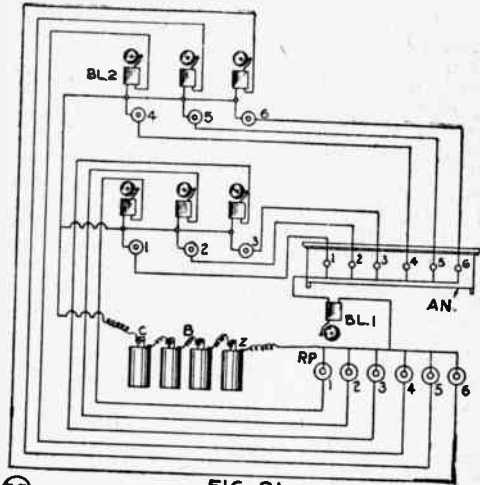

FIG.21

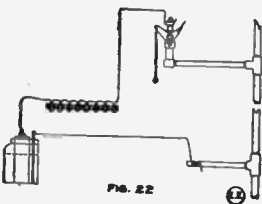

FIG. 22

ber of burners per inch of spark is allowed, on account of the leakage occurring with such high voltage current.

Burglar alarms form another branch of electric signalling and these are installed with both open and closed circuit apparatus. The closed circuit system has many good features to commend it. Sometimes a combination of the closed and open circuit systems are installed, and this is the best burglar proof scheme evolved.

The diagram for an *open circuit burglar alarm system* does not differ from an ordinary call bell circuit, only the push buttons are substituted by special door and window springs, placed so that whenever a window or door is opened the alarm bell will ring.

A switch is placed in the battery circuit, so that it can be cut off during the day, if desired.

The *closed circuit system* is diagrammed in Fig. 26. The

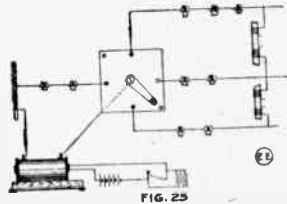
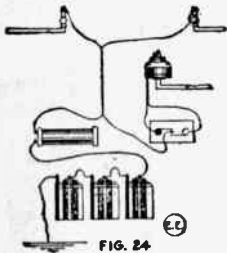
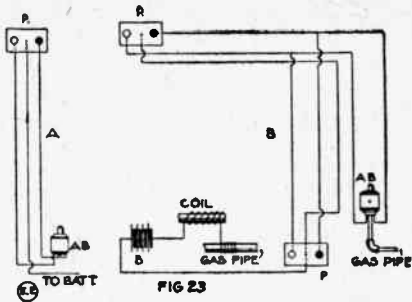

gravity battery is always closed through the window springs and relay magnet coils. If the springs should be opened by raising the window, the relay magnets would have no power, and releasing the armature, would cause the alarm bell to ring. See complete details of Burglar Alarms in Lesson No. 9.

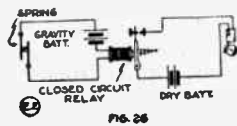

LESSON No. 2.

PRIMARY BATTERIES AND DRY CELLS.

THERE are various kinds of battery cells used in practical electrical work, the two principal classes being: the primary cell, and the storage cell. The former or primary cell will be treated upon in the following paragraphs, the storage cell receiving exhaustive treatment in a later chapter, devoted especially to it.

The discoverer of the primary cell was Alessandro Volta, one of the greatest scientists of the early electrical experimenters, and the greatest opponent of Galvani, born on February 18, 1745, at Como, Italy.

As a boy he was very much interested in natural history, and in the years 1769-1771 he published some interesting scientific and electrical papers through which he made himself a good name.

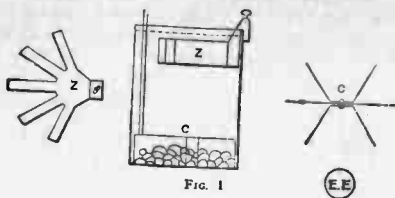

FIG. 1

Volta was an extraordinarily clever experimenter, and due to him is not only the first electric battery, but he also invented the well-known

electrophorus, also the electric condenser is his invention.

In the year 1800 he sent a description of the "Volta Pile" to the Royal Institute of London, and in the year 1801 he was called to Paris by Bonaparte. Here he demonstrated his experiments to the Academy of Scientists, in the presence of Napoleon.

In the year 1804 he ceased teaching, but in the year 1815 accepted the nomination as director of the philosophical faculty of the University of Padua, which was tendered to him by Emperor Francis.

His last years were spent in his home town, Como, and he died there at the age of 81, on March 6, 1826.

Primary cells include all those forms which produce an electric current by voltaic or galvanic action. Each cell is made up of two dissimilar elements, termed the *voltaic couple*, which are in turn immersed in a saline or acidulated solution, known technically as the *electrolyte*.

The elements are selected for a cell, so that one, termed the *anode*, or positive element, will be acted upon by the solution or electrolyte, more readily than the *cathode*, or negative element. The anode comprises that element at which the current enters the electrolyte, and the cathode or negative element, that at which the current leaves the electrolyte.

The chemical action occurring in the production of electrical energy is as follows: The anode is slowly consumed by oxygen from the electrolyte, and hydrogen gas liberated from the electrolyte or solution tends to gather on the face of the cathode. Hydrogen gas is a non conductor, practically, and hence a thin layer of it on the cathode element hinders the passage of a current, resulting in what is called polarization. Some means to reduce or abolish this polarization process which occurs, is always resorted to in primary cells. A *depolarizer* is a substance that will readily combine with the free hydrogen gas, and is placed close to the cathode or negative element to remove the gas formations at this point. Solid and liquid depolarizing agents are commonly employed. The solid depolarizer materials are arranged sometimes about the cathode in a porous cup, through which the electrolyte can seep. When in liquid form, the depolarizer is sometimes placed in a porous cup around the cathode, or it can be of a different specific gravity than the electrolyte, allowing one liquid to remain above the other due to their varying densities. The depolarizing liquid is also mixed with the electrolyte in some cells.



Fig. 2



Fig. 3

It is not necessary to describe here all of the various types

of primary cells that are and have been used, but only those that are principally employed to-day for bell and signal work, running small lamps, motors, etc.

The chief differences in the use of primary cells depends upon whether they are to be used on *closed circuit* or continuous duty, or for *open circuit* or intermittent duty. Open circuit batteries are utilized where electric current in small quantities is required intermittently, as in the ringing of bells, gas-lighting, telephones, etc. The closed circuit battery is employed when a small current is required steadily for long periods of time, as in commercial telegraphy, fire alarms, etc. The gravity or Daniell cell is much used for closed circuit work, as are also the Gordon cells. For open circuit requirements, Leclanché cells and dry cells are used very extensively.

The standard closed circuit cell for telegraph work in the

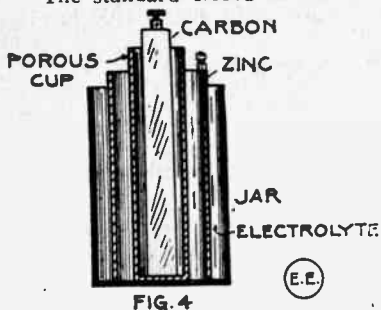

FIG. 4

United States is the Gravity, Crow-foot or Daniell cell, as it is variously called. The gravity cell, Fig. 1, contains a zinc block Z, suspended from the side of the jar, while a number of copper leaves C stand on edge at the bottom. A quantity of blue vitriol (blue-stone or sulphate of copper) is poured over the copper

leaves and the jar filled with water.

In the chemical action of this cell, copper is deposited on the copper plate, and sulphate of zinc is formed at the zinc element. To increase or quicken the action, a small quantity of zinc sulphate is sometimes added to the solution when the cell is first set up. If the cell is not worked enough, all the solution will become blue and the zinc will blacken. If the zinc becomes very dirty from this cause, it should be removed, scraped and washed thoroughly. All the electrolyte or solution should also be thrown out, and replaced by new sulphate. A new zinc is inserted, and then the copper and zinc elements are connected together for a few hours when the cell is ready for constant duty. Its voltage is 1.1 volt, and the current approximately one-half ampere. Warmth causes it to produce a greater current, and it should never be allowed to freeze. The gravity cell must be used only where it can be kept continuously in circuit, and not left standing idle for any length of time. The temperature of the cell should be kept above 70 degrees Fahrenheit for best results, as the resistance of it increases very fast with a decrease in temperature. The internal resistance of the cell is from 2 to 3 ohms. A blue color in the bottom of the cell denotes a good condition, but a brown color shows that the zinc is deteriorating. The blue line which marks the boundary between the copper sulphate and the zinc sulphate, should stand about half-way between the electrodes. If it comes too close to the zinc, some of the copper sulphate can be drawn out by siphoning, or the cell can be short-circuited, thus producing more zinc sulphate. If the blue line sinks too low, a quantity of water and copper-crystals can be added. It requires about 3 pounds of crystals to make a new charge.



FIG. 5

One of the best types of closed circuit cell designed especially for continuous duty and fairly heavy currents, with the capacity is ampere hours ranging from 100 to 600, is the *Gordon primary cell*. A view of this type of cell is shown at Fig. 2. This type of cell is a triumph of the laboratory, and is at once suitable either for open or closed circuit requirements, with very little deterioration on open circuit. The mechanical construction of the cell is especially good. The copper oxide (or negative element) is used in flake form compressed in perforated metal cylinders (see Fig. No. 3), the perforations of which are closed in such a way as to prevent leakage. Attached to the cylinders are three porcelain insulating supports (Lugs); upon these lugs the zinc (or positive element) rests, thus preventing it from coming in contact with the copper and forming a short circuit within the cell.

The zinc is made in circular form and is held in place by the lugs—it does not hang from the cover of the cell. A heavy insulated connection wire is firmly attached to the zinc.

The electrolyte is a strong solution of caustic soda. The top of the solution is covered with a heavy mineral oil such as paraffine to prevent the soda solution or electrolyte from evaporating.

The cells are usually supplied with porcelain or glass jars, and the proper amount of chemicals for a charge are put up in sealed packages.

This form of primary cell has an initial E. M. F. or voltage of .95 volt, which drops to .70 volt when the external circuit is closed and the load put on. The internal resistance is exceedingly low, varying from .02 to .089 ohm, according to the type and size of cell. The following data shows the performance of these batteries:

Continuous capacity in amperes....	1.5	2.5	4.0	6.0	7.0
Maximum capacity in amperes.....	7.49	9.53	15.51	26.68	33.35
Capacity in ampere hours.....	100	150	300	400	600
Internal resistance ohms.....	.089	.070	.043	.025	.020

This cell is well adapted to small lighting plants, gas ignition, operation of spark coils, etc.

For the operation of spark coils, small lights, etc., use is often made of *Bunsen or Grenet* batteries. These cells supply a continuous current until they are exhausted, when they are recharged.

The *Bunsen cell* consists of amalgamated zinc and carbon elements, the latter immersed in dilute sulphuric acid, mixed with fuming nitric acid as a depolarizer. The Bunsen battery is an improvement over the Grove cell, in which platinum was used instead of carbon. Its voltage or electro-motive-force (E.M.F.) is 1.89 volts. The carbon electrode and the nitric acid depolarizer are placed in a porous cup, the construction details being seen at Fig. 4.

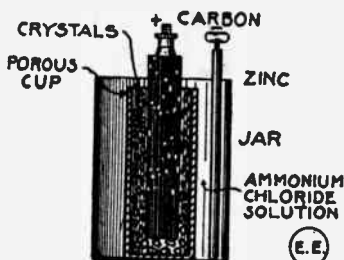

FIG. 6



FIG. 7

(E.E.)



FIG. 8

Meylan, in 1886, made some elaborate tests on the Bunsen cell, with the following results:

The exciting liquid or electrolyte was sulphuric acid, consisting of equal volumes of 60° Baumé, sulphuric acid and water. The depolarizer was nitric acid of 36° Baumé, specific gravity. Zinc electrode having an active surface of 116.25 square inches. External resistance 1.27 ohms. Internal resistance 0.04 ohm, falling to 0.035 ohm, and rising to 0.12 ohm.

Starting	1.93 volts	0	0
After 15 minutes closed circuit	1.87 "	1.42 amperes	0
After 24 hours closed circuit	1.77 "	1.33 "	56 watt hrs.
After 30 hours closed circuit	1.73 "	1.24 "	70 " " "

The Bunsen and Grove cells have the advantage that no salts are used in their solution, so there is consequently no trouble from crystallization in the carbon or platinum compartment. The evolution, however, of nitrous fumes which corrode the battery connections and demand special ventilation arrangements is a bad feature.

A battery which has been extensively employed abroad for experimental and laboratory purposes is the *potassium bichromate* or *Grenet cell*. Its usual form is shown in cut, Fig. 5. A four-cell bichromate battery is shown at Fig. 13. It is comprised of carbon and zinc electrodes immersed in an electrolyte of 100 parts potassium bichromate, 100 parts of water, and 50 parts of sulphuric acid. When not in use the zinc element is withdrawn from the solution to prevent local action and exhaustion of the cell.

For open circuit requirements such as the ringing of bells, signalling devices, ignition spark coils, and the like, or where small quantities of electric current are used intermittently, the *ammonium chloride cell* is generally utilized, as it has many commendable features. Ammonium chloride forms what is called commonly sal-ammoniac or chemically NH_4Cl . Sulphuric acid is expressed chemically as H_2SO_4 . In ammonium chloride cells depolarizing is necessary, unless the carbon surface exposed to chemical action is extremely large compared to that of the zinc.

One of the earliest and best cells of this type was that evolved by *Leclanché*, in 1868, and it is named after him the *Leclanché cell*. There are two general forms of it in use; the porous cup cell, and the agglomerate block cell.

In the porous cup type, seen at fig. 6, the zinc element, in the form of a rod, is placed in the outer vessel, containing a solution of ammonium chloride (sal-ammoniac). The carbon is in a porous jar, which is filled with a mixture of pulverized carbon and black oxide of manganese, preferably in needle-form or crystalline. The porous cup must be of good quality and quite porous. The E. M. F. of this cell is 1.48 volts. The porous cup does not usually last longer than two years. One part of zinc dissolved should reduce two parts of manganese dioxide, and should in turn exhaust one part of ammonium chloride. Strong ammonium chloride is preferable as it is a better solvent for the zinc oxychlorides formed. In figs. 7 and 8 are shown, respectively, the porous cup and agglomerate block *Leclanché* cells.

The *agglomerate block* type of construction, takes its name from the fact that no porous cup is employed, but the depolarizer is made in two cakes, which are held against the carbon plate or electrode by rubber bands. The cakes consist of 40 parts bioxide of manganese, 52 parts of carbon, 5 parts of gum-lac, and 3 parts of potassium bisulphate. These are compressed or briquetted at a pressure of 300 atmospheres at the temperature of boiling water. Ammonium chloride of the best quality must be used for best results, as

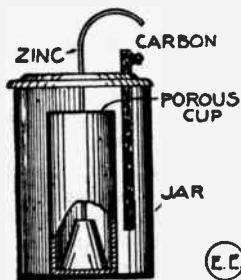
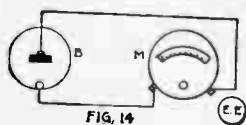

FIG. 9

the commercial sal-ammoniac is liable to contain impurities which tend to increase the resistance of the cell.

The common form of Leclanché cell used in this country for bell work, employs a saturated solution of sal-ammoniac, with a zinc rod about $\frac{3}{8}$ inch in diameter for the positive electrode or negative terminal pole, and a large carbon cylinder about 4 inches in diameter for the negative electrode or positive terminal pole. The electrolyte is made by thoroughly dissolving about $\frac{1}{4}$ pound of sal-ammoniac in the jar a little more than half filled with water. No depolarizer is used, the considerably greater area of the carbon electrode, as compared to that of the zinc, being considered able to care for the production of hydrogen gas. This cell is very poor, however, if much load is placed across its terminals, the carbon element becoming covered with hydrogen gas bubbles. Baking the carbon in an oven often gives increased results in the action of the battery. The internal resistance of the Leclanché cell of the porous cup type is approximately 1.5 ohms.

The Fuller battery cell is one that has been much used for telegraphic purposes in England, and for experimental work in this country. It is often called the *Mercury-Bichromate battery*, owing to these elements being the chief constituents in its make-up. Fig. 9 is a cut of the Fuller cell. It comprises a glass or porcelain containing jar, inside of which is fitted a porous



cup, containing a pyramid shaped zinc electrode, immersed in mercury at the bottom. The mercury thus keeps the zinc continuously amalgamated. A carbon electrode is placed in the outer vessel, which receives the depolarizing solution. The acid electrolyte for the cell is placed in the porous cup. The electrolyte is mixed by adding 6 ounces of potassium bichromate and 17 ounces of sulphuric acid to 56 ounces of soft water. This is poured into the glass jar. In the porous cup is placed two teaspoonfuls of salt; one teaspoonful of mercury, and the cup filled to within two inches of the top with soft water, with the zinc electrode in place.

The color of the solution is orange when the cell is in working order, and the internal resistance varies from 0.5 to 4 ohms. The Fuller cell can be left on open circuit for several months at a time, without any appreciable deterioration. Its E. M. F. is 2.14 volts.

Through the whole category of batteries, there is one which has probably reached a greater adoption than any other, the commonly called *dry battery*. The dry cell has been a boon to the user of pocket flash lights and other portable requirements. The voltage is about 1.5 volts and the current from 1 to 30 amperes for short intervals, depending upon the size of the cell. They last several months for flash light work, and about a year for bells, etc. The cell is generally discarded for a new one, when exhausted, although they may be recharged as follows:

Procure a machine drill of about $\frac{1}{8}$ " to $\frac{3}{16}$ " in diameter and drill holes carefully till the drill touches the carbon. Do not be afraid to drill through the entire portion of the depolarizer, as it is necessary that it gets air and electrolyte. It is obvious that drilled holes do not throw up a rim, but leave a flat, clean hole, making short circuit entirely out of the question. We would recommend to drill about 8 or 10 such holes, being careful to see that all manganese (black filler) is carried out of the hole. Blowing hard in the hole will usually clear

it perfectly. We also recommend to drill each hole as rapidly as possible, because the drill itself, being in contact with both zinc and depolarizer during the act of drilling, for the time short-circuits the cell.

Next prepare a solution of 10 parts (by weight) water and 5 parts of chloride of zinc, which can be bought for about 50 to 60 cents per pound. Ten cents' worth will do for about a dozen dry cells. If the solution is kept in a well-stoppered bottle it can be used over and over, as each cell does not absorb much liquid.

The solution must be well heated before used, but should not boil. Insert the cell in this liquid and leave in same for about 20 to 30 minutes. The cells should then be taken out and rolled on the floor. Each hole should now be inspected to verify if it is clean and if no filler touches the zinc.

Now dry the cell carefully, and if possible insert in each drill hole a dry wooden plug, which can be cut off flush with the zinc.

The battery is now ready for use and in most cases will register from 8 to 12 amperes and about 1.3 volts.

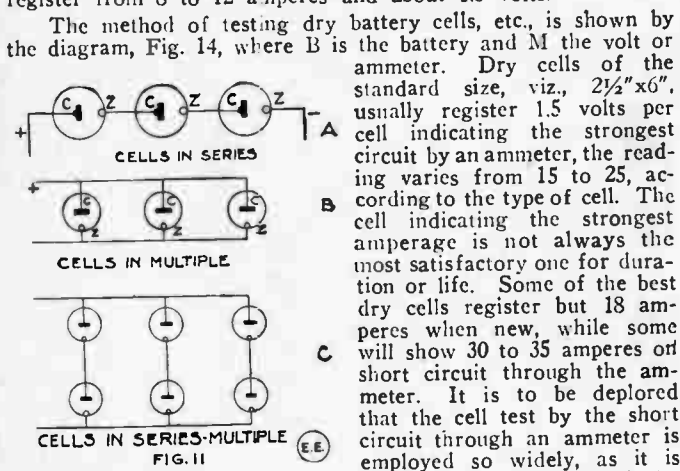

the worst possible thing to do. The correct method is by means of a good voltmeter.

The outer containing jar of a dry cell is of zinc in most types. The carbon or negative electrode is suspended in the centre of the zinc container, and forms the positive terminal pole of the battery. The carbon element must not touch the zinc. The zinc chamber is protected inside by several layers of blotting paper, and filled with a mixture consisting of powdered carbon, manganese dioxide and sawdust (or some other absorbent substance). The mixture is saturated with a solution of sal-ammoniac. After the cell has been thus built up, it is sealed with sealing wax, and the whole slipped into a carton or pasteboard box.

The Gassner dry cell has a negative electrode (positive terminal pole) composed of a



Fig. 10.

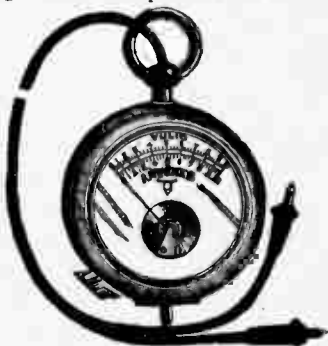

Fig. 12.

cylinder of carbon powder and manganese dioxide. The filling mixture composition is zinc oxide, ammonium chloride, and zinc chloride, 1 part each; plaster of Paris, 3 parts; water, 2 parts. The internal resistance is about 0.3 ohm. A cut of a modern dry cell is seen at Fig. 10.

The arrangement of the various cells of a battery, when more than one cell is used is important, and depends upon the class of work it is to be used upon. In connecting up a number of cells in series to attain increased voltage, the carbon electrode or positive pole of one cell is connected to the zinc electrode or negative pole of the next cell, etc., as shown in Fig. 11A. With this arrangement, the voltage across the line wires coming from the battery is equal to the number of cells times the voltage of one cell. Hence, if one cell delivered 1.5 volts, then 3 cells would deliver 3 times 1.5 volts, or 4.5 volts. The measurement of the voltage or current of batteries is readily made by the use of a pocket volt or ammeter, a cut of one appearing in Fig. 12.

When more current is desired than that obtainable from a single cell, they are arranged in multiple or on parallel, as in Fig. 11 B. If one cell can supply $\frac{1}{2}$ ampere normally, then three on multiple could supply three times $\frac{1}{2}$ ampere, or $1\frac{1}{2}$ amperes, but at the voltage of 1 cell or 1.5 volts. Here all the carbon poles are connected to the same line, and all the zinc poles to the other line.

A combination of the above two conditions, is illustrated by the diagram Fig. 11 C. This allows the battery to care for any desired voltage and current in amperes. The voltage developed by the battery is determined by the number of cells connected

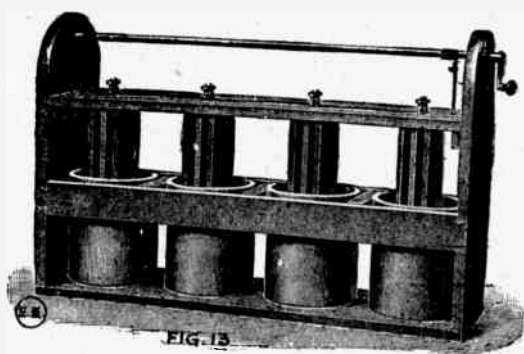

across the line wires C D. The current in amperes by the number of files on multiple across the lines C D. In the illustration, the battery shown would deliver a voltage of two times 1.5 volts, or 3

volts. The current (taking that for each cell at $\frac{1}{2}$ ampere), would be three times that per cell, or $1\frac{1}{2}$ amperes, not three times 1 ampere, because the cells are in series and have twice the resistance of one cell. To get 3 amperes across the line, on the basis taken above, it would be necessary to connect 6 files of two cells each, across the lines, instead of 3 files.

PRIMARY BATTERY CELLS.

NAME.	Electrolyte	Cathode	Depolarizer	E.M.F. Volts	Remarks
Law.	Solution of NH_4Cl	Carbon	None	1.3 to 1.4	For open circuit
Hercules.	" " "	"	"	"	closed circuit
Bunsen.	dilute Solution of H_2SO_4	"	Dilute nitric acid	1.9	"
Grenet	Bichromate-acid solution	"	The bichromate dissolved in the electrolyte.	1.9-2.1	Open or closed circuit
Poggendorf.	" "	"	Bichromate	2.14	"
Fuller	Zinc sulphate	Copper	Copper sulphate	1.07	Closed circuit
(crowfoot)	Solution of NH_4Cl	Carbon	Manganese dioxide	1.4-1.7	Open circuit
Leclanche	Caustic Potash,	Copper oxide	Cupric oxide.	.7	Closed circuit
Edison-Lalande.		Plate			

A few words regarding *flashlights* and their batteries may be of interest, as they are often misunderstood. At Fig. 15 are seen three varieties of modern flashlights; A being a medium size with a 3 cell dry battery, giving $4\frac{1}{2}$ volts; B a very small vest pocket flashlight, having a 3 volt, 2 cell dry battery; and C a tubular type, having a $4\frac{1}{2}$ volt, 3 cell dry battery. A neck-tie electric stick pin may be seen at 15A. The arrangement of these batteries, as regards their construction, will be gleaned readily from the sketch

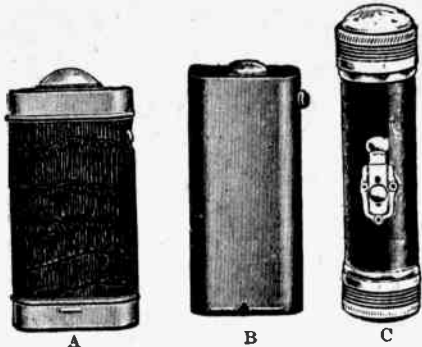

Fig. 15

Fig. 16, A, B, C, the battery circuit having a push button to open and close the circuit at P, the lamp (usually tungsten filament, as it is $2\frac{1}{2}$ to 3 times as efficient as the old carbon filament type), being placed at L. Flash-light batteries give from 2 to 3 months' service, if used only a few times each day. If burned continuously, they will light the lamp for from 2 to 3 hours.

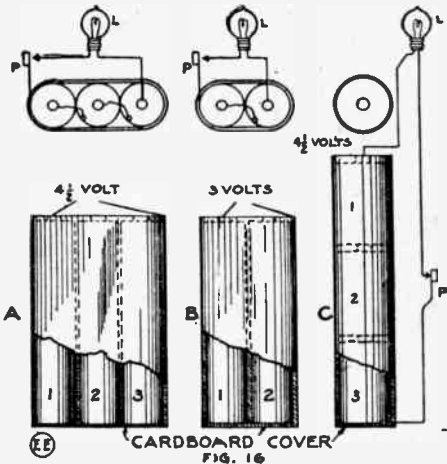

FIG. 16

A new form of *spring binding post*, which has received wide recognition, wherever batteries are used is illustrated by cut Fig. 17. It is reasonable in first cost, and easily applied by a machine

screw and nut. Wires are connected to it, by simply pressing down on the lip, and releasing the pressure again. It is a boon to battery users, having vibration to contend with, such as in automobile ignition, etc., as a wire cannot jar or vibrate



Fig. 15A.

loose. The connection is very solid as evidenced by the adaption of this binding post on all dry batteries employed in modern telephone exchange work, where the slightest imperfect contact is quickly made apparent and will not be tolerated. Double types are very useful for making different connections between wires of various circuits,



Fig. 17

Lesson No. 3.

STORAGE BATTERIES.

STORAGE batteries differ from primary batteries, in that they can be charged and recharged by passing an electric current through them. *Storage battery, secondary battery and accumulator* are the various terms in common use to signify an electrical device in which chemical action is first set up by the passage of an electric current, after which the device is capable of giving off electric current by means of secondary reversed chemical action. Thus any form of voltaic couple that is directly reversible in its action constitutes

a storage battery. The action of storing electrical energy in the battery by the passage of a current from an external source, is known as *charging the battery*. When the battery is giving off current, it is said to be *discharging*.

A storage battery cell has two elements, or plates, the Electrodes, one positive and one negative, immersed in an *electrolyte* of acidulated water or some other solution. The positive and negative plates are generally composed of the same material, but sometimes they are made of two different materials. At Fig. 1A, is

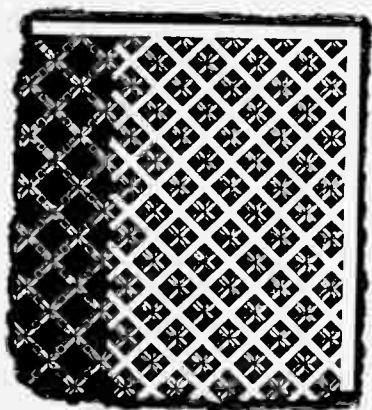

Fig. 1a

shown a plate grid before the active material has been inserted in it. The various methods of forming the grids and inserting the active mixture is shown by Fig. 1B.

The action of a storage battery is as follows:—The production of current by the battery after charging, oxidizes and may dissolve the material of one plate, and the electrolyte is exhausted in the process. The hydrogen gas liberated seeks the inactive plate, and finds there a depolarizer. This is gradually decomposed and reduced as it supplies oxygen to the hydrogen, and after a time the battery is exhausted, no longer being capable of producing a current.

To *recharge* or regenerate it, a current of electricity of opposite polarity or direction to that which the battery formerly produced, is passed through it. By this means, an electrochemical action is created, which reproduces by electrolytic reduction the previously attacked electrode on one plate; it simultaneously forms upon the other plate the depolarizer, also

by electrolysis. During the course of these two actions, the electrolyte solution is restored to its original strength. When the charging has progressed sufficiently long, the battery is restored to its original condition. The charging current is then cut off, and the battery is ready to produce current again.

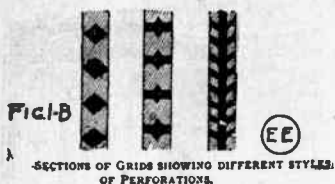

An efficient storage battery must electrochemically absorb the greatest quantity of electrical energy, with the smallest volume, and lastly with the smallest possible weight. It should be capable of retaining its charge for long periods without severe loss. The battery should give a good return of energy, or, in other words, its efficiency must be high, also it should supply a constant current, without intermittence, and should be readily subject to regulation of current strength and voltage.

The function of the storage battery is sometimes misunderstood. Such a battery does not store electrical energy, correctly speaking, but potential chemical energy, as the chemical change in the elements composing the battery, is responsible for the production of current on discharge.

The principal storage battery in use today is the lead type. It usually contains two electrodes, made up of lead peroxide (PbO_2), and sponge lead (Pb) for the active materials, respectively. The lead peroxide is used for the positive electrode, and the sponge lead for the negative electrode. The appearance of a complete cell is seen at Fig. 1C, and of a set of cells for portable use at 1D. The two electrodes are immersed in a dilute solution of sulphuric acid (H_2SO_4).

When the battery is fully charged and in first class condition, the positive plates have a dark reddish-brown or chocolate color, and the negative plates a light gray or slate color. The plates can thus be distinguished one from the other, by their colors, and also by the character of the active material composing them. The lead peroxide is very hard, like soapstone, while the negative material is soft and easily marked by the finger-nail. The negative substance is pure lead, reduced to a spongy form by the electrolysis. It has been suggested that this sponge lead is a mixture of lead and hydrogen, although usually it is considered an allotropic form of lead, which has undergone a physical but not a chemical change.

On the discharge of the cell, the electrolyte combines with the active substances of the electrodes, and on charge the active materials are reduced to their original condition, the chemicals extracted from the electrolyte being released and returned to the electrolyte. It is evident, then, that the electrolyte density or specific gravity, is greater at the end of a charge, than at the end of a discharge; and also that the active substances on the electrodes expand as discharge proceeds.

The unit of capacity of storage cells is taken as the *ampere-hour*, which is usually based on the eight hour rate of discharge. On this basis, a 100 ampere-hour battery would give a continuous discharge of $12\frac{1}{2}$ amperes for eight hours; or a 400 ampere-hour size, 50 amperes for 8 hours. Theoretically considered the 400 ampere-hour cell, should also supply 100



Fig. 1c

amperes for 4 hours; or 200 amperes for 2 hours; but this does not hold true in practice. The ampere-hour capacity decreases with an increase of discharge rate. The inherent capacity of a storage cell will depend upon, and be proportional to, the exposed area of the electrodes, subject to contact with the electrolyte, and also depends on the amount of active substance on the positive and negative plates.

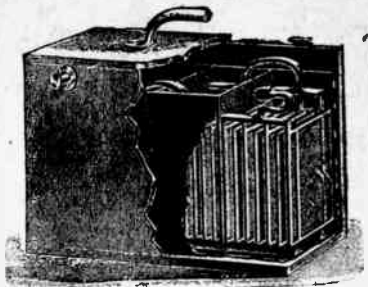

FIG. 1-D
-PORTABLE ACCUMULATOR.

Considered from a theoretical standpoint, the weight of metallic lead on either element or electrode, which is reduced to sponge lead, or to lead peroxide, required to produce one ampere-hour of discharge current is .135 ounces, avoirdupois; and if changed into peroxide this will weigh .156 ounces. In practical operation, the weight of active material necessary per element is from four to six times the theoretical value, due to the fact, that it is impossible to reduce all the active material. It has been ascertained that to produce one ampere-hour discharge at ordinary rates requires .50 to .80 ounces of sponge lead and .53 to .86 ounces metallic lead, converted into peroxide, on each element respectively.

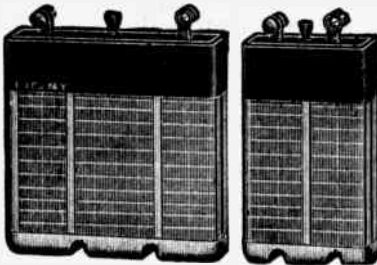

Fig. 2

The actual capacity of storage batteries is dependent upon the area of the electrode and the number of them on parallel; their character and make-up; the discharge rate and the temperature. All these important points have a bearing on the resultant capacity. The 8 hour rate of discharge is considered standard for all sizes of batteries and a temperature of 60 degrees Fahrenheit. The usual capacities obtaining in American practice, gives from 40 to 60 ampere-hours per square foot

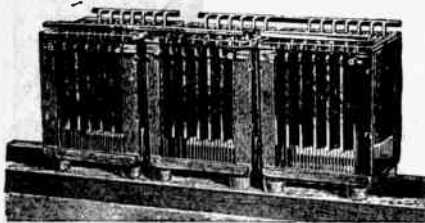

Fig. 8

of positive plate surface, which is found by multiplying the number of positive plates in parallel, times the length, times the breadth, times two, as each plate has two faces exposed to the electrolyte. The change in capacity of a lead type cell under different rates of discharge is given below.

Discharge Rate: Per cent of capacity at 8 hour rate.

	Pasted Plate.	Planté Plate.
8 hour	100%*	100%
6 hour	96%	96%
4 hour	88%	80%
2 hour	70%	61%
1 hour	48%	56%

The voltage of any storage battery cell is independent of the size of the plates. It depends on the chemical make-up of the electrodes, density of the electrolyte and the condition of the

cell as compared to its charged or discharged state.

The E.M.F. or voltage of the lead-sulphuric-acid cell, while in process of charging, varies from 2 to 2.5 volts, and on discharge it varies from 2 volts per cell down to 1.7 volts. Any degree or strength of voltage is attained by joining two or more cells in series, allowing about 2 volts to a cell. Thus, to supply a line, requiring 36 volts, would necessitate using 18 cells in series. To compensate for the drop below 36 volts, or any other line voltage, a few extra end cells may be arranged, so they can be switched into circuit and thus keep the E.M.F. up to the proper value.

Storage cells can be bought nowadays at such low prices, that it does not pay to make them for individual use. A very good little cell, supplying 2 volts and 10 ampere hours of energy is sold by the Electro Importing Company. They also sell a 20 ampere hour cell. Both of these cells are mounted in glass jars, with gas vents in top. The plates are specially made on the best design, for high electrical efficiency and long life. The appearance of the cells is seen at Fig. 2, the former being the 20 ampere hour cell and the latter the 10 ampere hour cell. At the standard or 8 hour rate of discharge the 10 A. H. cell would deliver $1\frac{1}{4}$ amperes for 8 hours. The 20 A. H. type would supply 2.5 amperes for 8 hours. Of course these cells will deliver higher values of current than those cited for shorter periods of time, but somewhat in the ratio aforementioned; the energy delivered being smaller than normal if the discharge rate is increased.

A smaller current than normal may be taken from the cell for a correspondingly longer period, as $\frac{1}{2}$ ampere for 20 hours is the same as 1 ampere for 10 hours. etc. A table of various size storage cells and their capacity in lighting lamps is given below.

A set of several cells connected in series is seen at Fig. 8, mounted on a wooden frame.

The *Electro* ignition storage battery is illustrated by the cut Fig. 3. This is composed of 3 cells in series and delivers a steady and powerful current at 6 volts and 60 ampere-hours of energy. It is also made in the 6 volt, 40 ampere-hour size. Any size of plant can be built up out of several of these units on parallel or in series. Two sets in series would give 12 volts and 60 ampere-hours of energy. Two sets on multiple would supply 6 volts, but 120 ampere-hours of electricity, et cetera.

Storage cells are at once the most economical and satisfactory solution of the small home or laboratory lighting problem, all things considered. They can be easily charged from primary cells of the Edison or Gordon type or from any other direct current source, as from a dynamo. Alternating current cannot be used to charge storage cells directly, but by the interposition of a *rectifier* of the iron-aluminum (see lesson No. 4) type, or by means of a Cooper-Hewitt mercury vapor converter, the A. C. mains form a ready source of charging current. A motor-generator is often employed to charge the battery with also, the motor running on A. C. and the generator unit delivering the necessary D. C. for charging. (See lesson No. 8.)

One of the most important elements to be considered in storage battery operation is the electrolyte and its *specific gravity or density*. This varies with the condition of the cell, as compared to the amount of charge or discharge energy. The density is measured by an instrument called a *hydrometer*, one form of which is shown in Fig. 4, a glass vessel being furnished with it to float the instrument, when filled with a sample of the electrolyte. In large work the hydrometer is



Fig. 3

Amperes per Lamp	Number of Lamps Burned	Candle Power of Tungsten Lamp	Volts of Battery (Storage)	Ampere Hours Capacity	Number of Hours Lamps May be Burned Continuously
1.0	1	6 C.P.	6 Volts	40 A.H.	40 Hours
1.0	2	6 "	6 "	40 "	20 "
1.0	4	6 "	6 "	40 "	10 "
1.0	6	6 "	6 "	40 "	6.6 "
1.0	8	6 "	6 "	40 "	5.0 "
1.0	1	6 C.P.	6 Volts	60 A.H.	60 Hours
1.0	2	6 "	6 "	60 "	30 "
1.0	4	6 "	6 "	60 "	15 "
1.0	6	6 "	6 "	60 "	10 "
1.0	8	6 "	6 "	60 "	7.5 "
1.0	10	6 "	6 "	60 "	6.0 "
1.0	12	6 "	6 "	60 "	5.0 "
1.0	1	2 C.P.	2 Volts	10 A.H.	10 Hours
1.0	2	2 "	2 "	10 "	5.0 "
1.0	4	2 "	2 "	10 "	2.5 "
1.0	1	2 C.P.	2 Volts	20 A.H.	20 Hours
1.0	2	2 "	2 "	20 "	10 "
1.0	4	2 "	2 "	20 "	5.0 "
1.0	6	2 "	2 "	20 "	3.3 "

invariably floated in the cell itself, and this is the best method for accuracy in reading generally.

The hydrometer floats at a different depth in the electrolyte at various densities, the reading being noted on the scale of the instrument at the point where the surface of the electrolyte solution strikes the hydrometer stem.

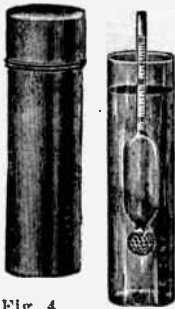

Fig. 4.

There are two scales in common use for hydrometers; the specific gravity scale, and the Baume scale. The specific gravity scale is most used, and is divided up in two ways. Some hydrometers, for instance, may read 1.2 Sp. Gr. meaning that, at that scale division, the density of the solution floating the hydrometer, is such, that it is 1.2 times the density of water. Other scales would read, perhaps, 1,200 degrees Sp. Gr. which is the equivalent of 1.2 Sp. Gr. but is used on certain work to permit of closer readings, being taken.

Floating a hydrometer in the electrolyte and noting the surface reading, does not mean that the density indicated is what it should be. The density varies directly with the temperature of the electrolyte, and so it is always corrected to some standard temperature, usually 70 degrees Fahrenheit for all commercial practice.

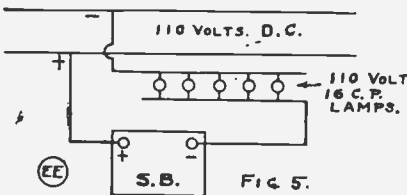

FIG 5.

The density or specific gravity is lower than normal if the temperature is above standard and higher than normal, if the temperature is below standard, (say 70 degrees Fah.); i.e., the density decreases with increase of temperature, and vice

versa. The coefficient of change in Sp. Gr. for one degree change in temperature Fahrenheit is .32 degree. Hence if the hydrometer indicated a density of 1,200 degrees, at 54 degrees Fahrenheit as taken by a floating thermometer in the electrolyte, then the density corrected to 70 degrees Fahrenheit or standard must be lower than 1,200 degrees.

* See Standard Electrical Engineer's Handbook.

The difference between standard or 70 degrees Fahrenheit and the observed temperature or 54 degrees Fahrenheit, is 16 degrees. Hence 16 times the change in Sp. Gr. per degree, (.32) gives a subtractive correction in density of 5.12 degrees. Thus the density corrected to 70 degrees Fahrenheit is 1,200 degrees minus 5.12 degrees or practically 1,195 degrees. If this observed density had been 1,200 degrees at 16 degrees Fahrenheit above standard, or 86 degrees Fahrenheit then the correction coefficient for the corrected density at 70 degrees Fahrenheit would have been additive, or the Sp. Gr. would have been 1,200 degrees plus 5.12 degrees or practically 1,205 degrees. In these readings, if the fraction is .5 or more it is called one degree. In the above it is only .12 and is discarded.

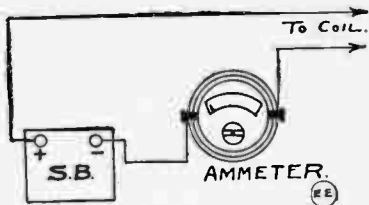

Fig. 5-A.

The electrolyte can be prepared by mixing 5 parts of pure distilled water and 1 part of pure sulphuric acid (acid made from sulphur, not pyrites as this contains iron most always) by volume. The acid must always be poured slowly into the water, stirring the mixture meanwhile with a glass spatula or rod. The mixing can be done in a glass, earthenware, lead, or enameled vessel, thoroughly cleaned out. When first mixed considerable heat is produced owing to the difference in the densities and make-ups of the two fluids. The electrolyte must be cold before filling the cells, or else the plates will be

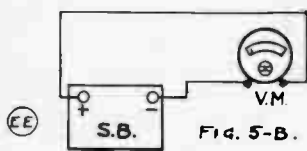

FIG. 5-B.

coated with a white precipitation, and is termed sulphating. This practically puts the battery out of commission, unless the plates are removed and the sulphate scraped off, or still better the sulphate can be removed by a quick overcharge carefully administered sometimes. Charging has to begin soon after the electrolyte is put into the cell.

The battery gases quite violently, while working, and to compensate for the evaporation of electrolyte in this manner, a little water is added from time to time as required, to keep the plates always covered by at least $\frac{1}{2}$ inch of electrolyte. About every six months or so, a little fresh electrolyte or acid is added to the cell to keep the density at the proper figure. The density falls on discharging the cell, but regains its former value when recharged, the range of rise and fall varying from 100 degrees to 200 degrees Sp. Gr. A usual discharge density value is 1,120 degrees in lead cell practice and then the recharge is carried on, until the density reaches 1,200 degrees or 1,210 degrees Sp. Gr. The voltage is also watched closely, and charging is generally complete when the voltmeter in the charging circuit registers 2.5 to 2.6 volts per cell, with circuit closed, and about 2.2 volts per cell with circuit open. Readings of voltage have

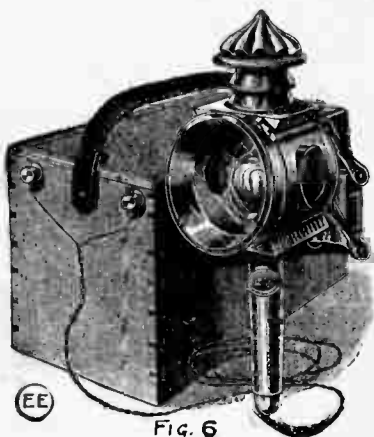

Fig. 6

no practical significance when taken on open circuit, as the cell's E. M. F. drops as soon as the load is put on it. About 10 per cent. more voltage than that given by the cell is required of the charging machine, but this is varied so as to keep the current in amperes at a certain value. As an illustration, on a 400 ampere-hour battery, which delivers 50 amperes, normally for 8 hours (8 hour rate), the charging rate is about the same, i.e., 50 amperes are put into it for a little more than 8 hours, on regular charge. The initial charge on this battery was of 2,500 ampere-hours value, to form the plates. The initial charge was started on an electrolyte density of 1,250 degrees which, on closing the charging switch, immediately dropped to about 1,130 degrees density. From this value of the Sp. Gr. it slowly increased, with charging current at 50 amperes constantly, until ten consecutive and similar hydrometer readings were obtained, when the charge was stopped. The duration of the initial charge was between 40 and 50 hours; current at 50 amperes. Regular charges thereafter were made at 50 amperes for about 8 hours, noting the density also. The manner of connecting up an ammeter in the battery circuit is shown at diagram Fig. 5A, while Fig. 5B, depicts the connections for a voltmeter VM, with storage cell SB.

Great care must be exercised that no impurities or foreign bodies get into the cell, or they may cause rapid deterioration in the life, or a short-circuit, which would cause serious harm, and probably ruin the cell completely, disintegrating the active material composing the plates.

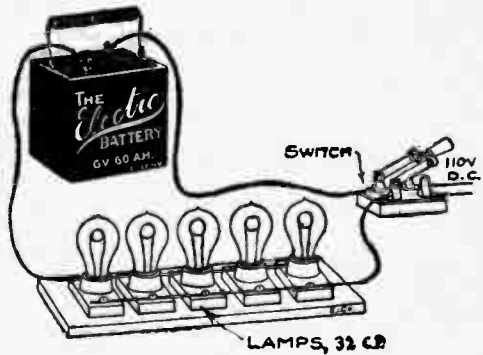

Fig. 7.

The state of charge in a cell can be fairly judged by an experienced battery man, by the color of the positive and negative plates. The positive plates assume a dark chocolate color and the negative a light gray when nearing full charge.



Charging Battery with Charging Plug.

On discharge the density value is a very good gauge of its magnitude, as the density or Sp. Gr. falls in direct proportion to the ampere-hours taken from the cell.

In large battery installations, a charging rheostat or variable resistance is used in series with the battery and the source of current. For charging small cells, it is often convenient to connect them up to a D. C. light circuit, with a few incandescent lamps in series or series multiple with

it. Fig. 5 depicts a wiring diagram for the charging of a

few cells on multiple and a cut of a charging board at Fig. 7. As an example, to charge a 20 ampere-hour cell from a 110 volt D. C. circuit, about four 16 candle-power carbon lamps, passing $\frac{1}{2}$ ampere each, may be used on multiple as shown in the diagram, allowing the battery to receive 2 amperes for 10-11 hours. This may be increased in cases of urgent necessity, giving the battery its charge at a higher rate or current value for a shorter period.

The arrangement of the circuit in charging must be such, that the positive pole of the circuit connects to the positive pole of the battery, which is usually marked with a plus cross (+) or a red seal on it. A simple way to ascertain the polarity of the circuit, is to dip two oppositely charged wires in a glass of acidulated or salt water. The wire from which the most gas bubbles are evolved, is the negative pole. Pole test paper is very handy for this purpose, as also is the liquid polarity indicator sold on the market. A voltmeter, when at hand, forms the best way to find the polarity, providing it is of the permanent magnet type, such as the *Weston*.

A storage cell should never be discharged below 1.7 volts, and better yet, not below 1.75 to 1.78 volts.

Oftentimes it is desirable to put a *storage battery out of commission for a while*. This is accomplished by drawing off the electrolyte as follows: After giving the battery a complete charge, siphon or pump out the electrolyte into carboys or lead lined vessels, which have never been utilized for any other acid. When each cell is emptied, fill them up immediately with clean water, and when all the cells are filled, start discharging the battery, until the voltage drops to about 1 volt under normal load. The water can now be withdrawn.

To start up an idle battery, fill the cells with electrolyte, and begin to charge at normal rate; 25 to 30 hours constant charging will be required to give a complete charge.

Storage cells are a very useful electrical utility, but they have to be treated intelligently, if the best results are to be expected of them. In the cut Fig. 6, is shown a portable storage cell for a carriage light. A storage cell adapted to a small portable shop light, and suitable for watchmen, photograph dark rooms, etc., is depicted by Fig. 9, while cut 10, shows a storage battery lighting outfit for bicycle use.

SUMMARY OF STORAGE BATTERY DATA.

Storage batteries are made for either stationary or portable service. Both positive and negative plates are of pure lead so that local action is reduced to a minimum. This feature results in high efficiency, long life and ability to hold charge through a long period of open circuit.

The mechanical design of the plate is such that the active material is in a thin layer supported by a conductor, and accessible to the current and electrolyte. Provision is made within the positive plate itself to accommodate any distortion of the active portions.

The approximate discharge voltage of a cell is two volts.

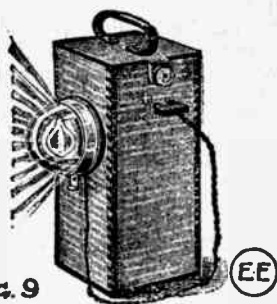

Fig. 9

MINER'S ELECTRIC HAND LAMP.

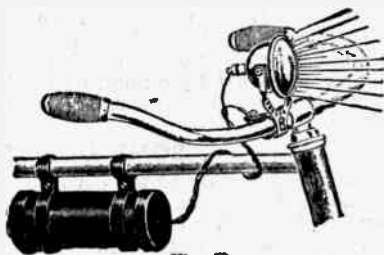

Fig. 10

Therefore, the battery discharge voltage is the number of cells in series multiplied by two. The ampere hour capacity, the rate of discharge and the rate of charge of a battery are determined by the size and number of plates in a cell.

The voltage required to charge a cell varies from 2.1 volts at the beginning to as high as 2.8 volts at the end, the cell charging at a constant current, usually the 8-hour discharge rate. The charging current is usually controlled by a rheostat in series with the battery, booster generator, or generator field control.

The maximum line voltage to be provided for charging a given number of cells in series is the number of cells multiplied by 2.8. The charging current will depend upon the size of the cell.

When a cell discharges, the electrolyte (sulphuric acid solution) forms the active material into lead sulphate and becomes weaker in acid with an increasing per cent of water, and conversely, on charge the sulphate is changed back to acid. A definite amount of sulphate is formed for each ampere-hour discharge, therefore, the density or specific gravity of the electrolyte changes a given amount.

This change in specific gravity of the electrolyte is proportional to the ampere-hours output and is practically independent of the rate of discharge. A very convenient and accurate method of charging is available by using a hydrometer to measure the change in specific gravity between the conditions of full charge and full discharge, and then charging until the original specific gravity of the electrolyte is reached.

The energy remaining in a cell at any time during a discharge can be found by noting the change in specific gravity of the electrolyte from the value at the beginning of the discharge and comparing it with the total range for the given discharge rate.

The range in density of specific gravity of the electrolyte between full charge and discharge, at the 8-hour rate, is approximately from 1,200 to 1,160 for a standard cell in a glass jar, the temperature being 70° F. The range will be approximately from 1,200 to 1,180 for a discharge at the one-hour rate.

The exact change in gravity should be determined for each particular size of cell as it varies with the size and the number of plates.

The normal ampere-hour capacity of a cell is based upon the 8-hour rate of discharge and is arbitrarily taken at 100%. When taken at other rates the ampere-hour capacity varies.

The available ampere-hour capacity varies with the temperature and rate of discharge. For a limited range of temperature at the 8-hour rate of discharge, the capacity varies approximately one-half of one per cent. for each degree Fahrenheit change in temperature above or below 70° F. An increase in temperature will raise the capacity and a reduction will lower it. The lower the rate of discharge, the less will be the variation due to temperature.

Storage batteries may be used to great advantage in maintaining a constant load on a generating system when the load factor is poor. A sample of such regulation is shown in reproduction from recording ammeter records of a battery and regulator maintaining a constant load upon the generating system with an exceedingly variable external load.

When it is desired to maintain a constant alternating-current load, the same degree of regulation may be obtained as in direct-current work, by connecting the battery across the direct-current side of a boosted rotary converter controlled by the regulator.

SOME DON'TS.

- Don't run each cell below 1.8 volts.
- Don't wait long to have it recharged.
- Don't test it with an ammeter alone.
- Don't lay a screwdriver or file across the connections to make it spark.
- Don't recharge with alternating current.

- Don't use the wrench to tighten binding posts.
 Don't bring a lighted cigar near a battery during the charge.

USEFUL RECEIPTS AND MEMORANDA.

- Pole Testing Paper.*—Make a thin solution of white starch and soak strips of thin white blotting-paper in it, and set aside in a clean place to dry. Dissolve $\frac{1}{2}$ oz. of potassium iodide in 1 pint of water. Immerse the strips in the solution for a few seconds and again dry. This paper, when moistened and used in the usual way, turns violet at the positive pole.
- Varnish.*—A good varnish is made of 1 lb. of shellac dissolved in 1 pint of polisher's finish. It forms a tough, coherent surface and adheres strongly if the article to be coated is warmed before the varnish is used. It is best to apply it in two or three thin coats, allowing each coat to dry, rather than in one thick coat.
- Beeswax Compound.*—Equal parts of beeswax and resin well boiled and used hot.
- Insulating Cement.*—A good cement is made for Leyden jars and insulating stands: Sulphur, 100 parts; tallow, 2; resin, 2 parts, melted together until of the consistency of syrup, and sufficient powdered glass added to make a paste. This cement must be heated when applied, and will be found to resist most acids.
- Marine Glue.*—Pure India-rubber (cut small), 1 part; coal-tar naphtha, 12 parts; digest in a covered vessel with gentle heat and agitation, and when thoroughly dissolved add powdered shellac 20 parts. Continue the heat and stirring until perfect liquefaction has taken place and pour the fused mass, while still hot, on slabs of polished metal or stone, so as to form thin sheets. When required for use heat in an iron vessel to its melting-point, 248° to 250° F. and apply in a liquid state with a brush. It can be made as hard as required by increasing the proportion of shellac.

STORAGE BATTERY TERMS.

- Ampere.*—The unit (for practical work) of electric current.
- Ampere-hour.*—A practical unit of quantity; being the quantity which a current of one ampere would carry past a given point in one hour.
- Buckling.*—A term, whose meaning is evident, technically applied to the distortion of accumulator plates by badly distributed current.
- Ebonite.*—A black, hard preparation of India-rubber (Vulcanite.)
- Electrodes.*—The conductors by which current enters and leaves an apparatus: Anode = entering; Cathode = leaving electrode.
- Electrolysis.*—Chemical decomposition caused electrically.
- Electrolyte.*—The conducting medium between electrodes which undergoes electrolysis.
- Element.*—The active electrode of a cell.
- E.M.F.*—Abbreviation for electromotive-force (see above).
- Grid.*—The skeleton framework of an accumulator plate.
- Lead Peroxide.*—An oxide of lead whose chemical symbol is PbO_2 .
- Litharge.*—Lead protoxide; PbO .
- Minium.*—Red lead; Pb_3O_4 .
- Negative.*—Pole, terminal, plate, etc., the pole, terminal or plate by which the current returns to a generator or leaves an instrument.
- Ohm.*—The unit (for practical work) of electrical resistance.
- Pole.*—Equivalent to terminal.
- Pole-testing Paper.*—Used for determining the positive and negative poles of accumulators.
- Positive.*—The converse of "negative," i.e. "outgoing" as applied to a generator, "ingoing" of an instrument.
- Spatula.*—An instrument like a spoon with a flat bowl.
- Terminal.*—The connecting screw by which a conductor is connected electrically.

Thermopile.—An electric generator excited by heat.
Volt.—The unit (for practical work) of electrical pressure.
Vulcanite.—Another name for ebonite, which see.

Temperature Correction Table for Specific Gravity of Electrolyte.

Explanation.—In the vertical column headed with the nearest temperature to the temperature of the cell, find the specific gravity given by the hydrometer. The heavy figures above on same horizontal row is the specific gravity corrected to 70°.

Example.—Temperature of electrolyte, 62° Fahrenheit; observed specific gravity, 1.208. In column headed 61° find 1.205, follow across in same horizontal row to column with heavy faced figure and find 1.202, which is the observed specific gravity corrected to 70°.

62°	63°	64°	65°	66°	67°	68°	69°	70°	71°	72°	73°	74°	75°	76°	77°	78°	79°	80°	81°	82°	83°	84°	85°	86°	87°	88°	89°	90°	91°	92°	93°	94°	95°	96°	97°	98°	99°	100°																																																																																																																																																																																																																																																																																																																																																																																																																																																																																																																																																																																																																																																																																																																																																																																																																																																																																																																																																																																																																																																											
1.210	1.209	1.208	1.207	1.206	1.205	1.204	1.203	1.202	1.201	1.200	1.199	1.198	1.197	1.196	1.195	1.194	1.193	1.192	1.191	1.190	1.189	1.188	1.187	1.186	1.185	1.184	1.183	1.182	1.181	1.180	1.179	1.178	1.177	1.176	1.175	1.174	1.173	1.172	1.171	1.170	1.169	1.168	1.167	1.166	1.165	1.164	1.163	1.162	1.161	1.160	1.159	1.158	1.157	1.156	1.155	1.154	1.153	1.152	1.151	1.150	1.149	1.148	1.147	1.146	1.145	1.144	1.143	1.142	1.141	1.140	1.139	1.138	1.137	1.136	1.135	1.134	1.133	1.132	1.131	1.130	1.129	1.128	1.127	1.126	1.125	1.124	1.123	1.122	1.121	1.120	1.119	1.118	1.117	1.116	1.115	1.114	1.113	1.112	1.111	1.110	1.109	1.108	1.107	1.106	1.105	1.104	1.103	1.102	1.101	1.100	1.099	1.098	1.097	1.096	1.095	1.094	1.093	1.092	1.091	1.090	1.089	1.088	1.087	1.086	1.085	1.084	1.083	1.082	1.081	1.080	1.079	1.078	1.077	1.076	1.075	1.074	1.073	1.072	1.071	1.070	1.069	1.068	1.067	1.066	1.065	1.064	1.063	1.062	1.061	1.060	1.059	1.058	1.057	1.056	1.055	1.054	1.053	1.052	1.051	1.050	1.049	1.048	1.047	1.046	1.045	1.044	1.043	1.042	1.041	1.040	1.039	1.038	1.037	1.036	1.035	1.034	1.033	1.032	1.031	1.030	1.029	1.028	1.027	1.026	1.025	1.024	1.023	1.022	1.021	1.020	1.019	1.018	1.017	1.016	1.015	1.014	1.013	1.012	1.011	1.010	1.009	1.008	1.007	1.006	1.005	1.004	1.003	1.002	1.001	1.000	0.999	0.998	0.997	0.996	0.995	0.994	0.993	0.992	0.991	0.990	0.989	0.988	0.987	0.986	0.985	0.984	0.983	0.982	0.981	0.980	0.979	0.978	0.977	0.976	0.975	0.974	0.973	0.972	0.971	0.970	0.969	0.968	0.967	0.966	0.965	0.964	0.963	0.962	0.961	0.960	0.959	0.958	0.957	0.956	0.955	0.954	0.953	0.952	0.951	0.950	0.949	0.948	0.947	0.946	0.945	0.944	0.943	0.942	0.941	0.940	0.939	0.938	0.937	0.936	0.935	0.934	0.933	0.932	0.931	0.930	0.929	0.928	0.927	0.926	0.925	0.924	0.923	0.922	0.921	0.920	0.919	0.918	0.917	0.916	0.915	0.914	0.913	0.912	0.911	0.910	0.909	0.908	0.907	0.906	0.905	0.904	0.903	0.902	0.901	0.900	0.899	0.898	0.897	0.896	0.895	0.894	0.893	0.892	0.891	0.890	0.889	0.888	0.887	0.886	0.885	0.884	0.883	0.882	0.881	0.880	0.879	0.878	0.877	0.876	0.875	0.874	0.873	0.872	0.871	0.870	0.869	0.868	0.867	0.866	0.865	0.864	0.863	0.862	0.861	0.860	0.859	0.858	0.857	0.856	0.855	0.854	0.853	0.852	0.851	0.850	0.849	0.848	0.847	0.846	0.845	0.844	0.843	0.842	0.841	0.840	0.839	0.838	0.837	0.836	0.835	0.834	0.833	0.832	0.831	0.830	0.829	0.828	0.827	0.826	0.825	0.824	0.823	0.822	0.821	0.820	0.819	0.818	0.817	0.816	0.815	0.814	0.813	0.812	0.811	0.810	0.809	0.808	0.807	0.806	0.805	0.804	0.803	0.802	0.801	0.800	0.799	0.798	0.797	0.796	0.795	0.794	0.793	0.792	0.791	0.790	0.789	0.788	0.787	0.786	0.785	0.784	0.783	0.782	0.781	0.780	0.779	0.778	0.777	0.776	0.775	0.774	0.773	0.772	0.771	0.770	0.769	0.768	0.767	0.766	0.765	0.764	0.763	0.762	0.761	0.760	0.759	0.758	0.757	0.756	0.755	0.754	0.753	0.752	0.751	0.750	0.749	0.748	0.747	0.746	0.745	0.744	0.743	0.742	0.741	0.740	0.739	0.738	0.737	0.736	0.735	0.734	0.733	0.732	0.731	0.730	0.729	0.728	0.727	0.726	0.725	0.724	0.723	0.722	0.721	0.720	0.719	0.718	0.717	0.716	0.715	0.714	0.713	0.712	0.711	0.710	0.709	0.708	0.707	0.706	0.705	0.704	0.703	0.702	0.701	0.700	0.699	0.698	0.697	0.696	0.695	0.694	0.693	0.692	0.691	0.690	0.689	0.688	0.687	0.686	0.685	0.684	0.683	0.682	0.681	0.680	0.679	0.678	0.677	0.676	0.675	0.674	0.673	0.672	0.671	0.670	0.669	0.668	0.667	0.666	0.665	0.664	0.663	0.662	0.661	0.660	0.659	0.658	0.657	0.656	0.655	0.654	0.653	0.652	0.651	0.650	0.649	0.648	0.647	0.646	0.645	0.644	0.643	0.642	0.641	0.640	0.639	0.638	0.637	0.636	0.635	0.634	0.633	0.632	0.631	0.630	0.629	0.628	0.627	0.626	0.625	0.624	0.623	0.622	0.621	0.620	0.619	0.618	0.617	0.616	0.615	0.614	0.613	0.612	0.611	0.610	0.609	0.608	0.607	0.606	0.605	0.604	0.603	0.602	0.601	0.600	0.599	0.598	0.597	0.596	0.595	0.594	0.593	0.592	0.591	0.590	0.589	0.588	0.587	0.586	0.585	0.584	0.583	0.582	0.581	0.580	0.579	0.578	0.577	0.576	0.575	0.574	0.573	0.572	0.571	0.570	0.569	0.568	0.567	0.566	0.565	0.564	0.563	0.562	0.561	0.560	0.559	0.558	0.557	0.556	0.555	0.554	0.553	0.552	0.551	0.550	0.549	0.548	0.547	0.546	0.545	0.544	0.543	0.542	0.541	0.540	0.539	0.538	0.537	0.536	0.535	0.534	0.533	0.532	0.531	0.530	0.529	0.528	0.527	0.526	0.525	0.524	0.523	0.522	0.521	0.520	0.519	0.518	0.517	0.516	0.515	0.514	0.513	0.512	0.511	0.510	0.509	0.508	0.507	0.506	0.505	0.504	0.503	0.502	0.501	0.500	0.499	0.498	0.497	0.496	0.495	0.494	0.493	0.492	0.491	0.490	0.489	0.488	0.487	0.486	0.485	0.484	0.483	0.482	0.481	0.480	0.479	0.478	0.477	0.476	0.475	0.474	0.473	0.472	0.471	0.470	0.469	0.468	0.467	0.466	0.465	0.464	0.463	0.462	0.461	0.460	0.459	0.458	0.457	0.456	0.455	0.454	0.453	0.452	0.451	0.450	0.449	0.448	0.447	0.446	0.445	0.444	0.443	0.442	0.441	0.440	0.439	0.438	0.437	0.436	0.435	0.434	0.433	0.432	0.431	0.430	0.429	0.428	0.427	0.426	0.425	0.424	0.423	0.422	0.421	0.420	0.419	0.418	0.417	0.416	0.415	0.414	0.413	0.412	0.411	0.410	0.409	0.408	0.407	0.406	0.405	0.404	0.403	0.402	0.401	0.400	0.399	0.398	0.397	0.396	0.395	0.394	0.393	0.392	0.391	0.390	0.389	0.388	0.387	0.386	0.385	0.384	0.383	0.382	0.381	0.380	0.379	0.378	0.377	0.376	0.375	0.374	0.373	0.372	0.371	0.370	0.369	0.368	0.367	0.366	0.365	0.364	0.363	0.362	0.361	0.360	0.359	0.358	0.357	0.356	0.355	0.354	0.353	0.352	0.351	0.350	0.349	0.348	0.347	0.346	0.345	0.344	0.343	0.342	0.341	0.340	0.339	0.338	0.337	0.336	0.335	0.334	0.333	0.332	0.331	0.330	0.329	0.328	0.327	0.326	0.325	0.324	0.323	0.322	0.321	0.320	0.319	0.318	0.317	0.316	0.315	0.314	0.313	0.312	0.311	0.310	0.309	0.308	0.307	0.306	0.305	0.304	0.303	0.302	0.301	0.300	0.299	0.298	0.297	0.296	0.295	0.294	0.293	0.292	0.291	0.290	0.289	0.288	0.287	0.286	0.285	0.284	0.283	0.282	0.281	0.280	0.279	0.278	0.277	0.276	0.275	0.274	0.273	0.272	0.271	0.270	0.269	0.268	0.267	0.266	0.265	0.264	0.263	0.262	0.261	0.260	0.259	0.258	0.257	0.256	0.255	0.254	0.253	0.252	0.251	0.250	0.249	0.248	0.247	0.246	0.245	0.244	0.243	0.242	0.241	0.240	0.239	0.238	0.237	0.236	0.235	0.234	0.233	0.232	0.231	0.230	0.229	0.228	0.227	0.226	0.225	0.224	0.223	0.222	0.221	0.220	0.219	0.218	0.217	0.216	0.215	0.214	0.213	0.212	0.211	0.210	0.209	0.208	0.207	0.206	0.205	0.204	0.203	0.202	0.201	0.200	0.199	0.198	0.197	0.196	0.195	0.194	0.193	0.192	0.191	0.190	0.189	0.188	0.187	0.186	0.185	0.184	0.183	0.182	0.181	0.180	0.179	0.178	0.177	0.176	0.175	0.174	0.173	0.172	0.171	0.170	0.169	0.168	0.167	0.166	0.165	0.164	0.163	0.162	0.161	0.160	0.159	0.158	0.157	0.156	0.155	0.154	0.153

tion will be readily perceived by looking at the current diagrams depicted at Figs. 2 and 3. In Fig. 2 is seen the regular curve at the top for an alternating current, i. e., one changing its direction from positive to negative periodically, at a certain number of reversals per second. The direct current wave form, resultant from inserting a single rectifier cell in the alternating current circuit is shown at the bottom of Fig. 2. It is seen that the direct current is very pulsatory and intermittent, having dead intervals corresponding to one-half of the cycle, when the rectifier does not operate. This means poor efficiency.

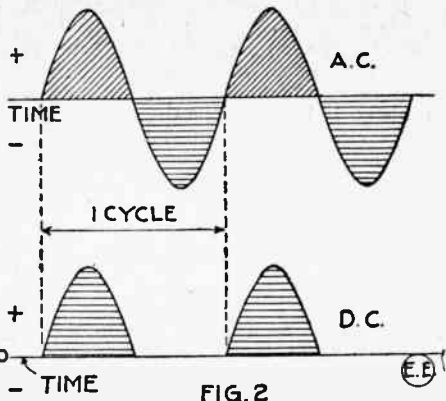

FIG. 2

To overcome this disadvantage, the four cell type of rectifier was developed, as aforementioned. The resultant direct current wave form, occurring from its connection in the A. C. circuit, is seen at the bottom of Fig. 3. Here it is evident the efficiency of rectification is much higher, in fact 100 per cent. higher, than

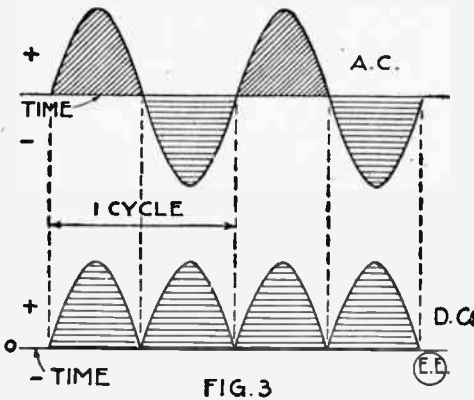

FIG. 3

with the single cell type, as there are two direct current pulsations now, for every cycle of A. C. or there is one pulsation for each alternation.

The electrolytic rectifier is based upon the well known principle that if an aluminum and iron plate

or electrode are immersed in an electrolyte, the cell so formed will pass currents coming in one direction, but practically none of the current coming in the opposite direction. Hence the

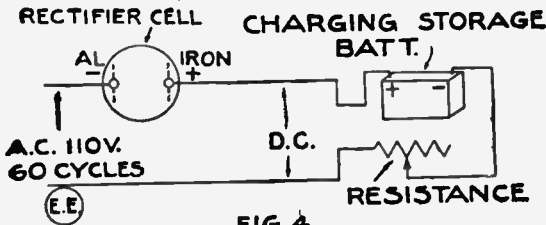

FIG. 4

action of the rectifier on an A. C. circuit is to clip off the reverse half wave of each cycle, and allowing only impulses of a unidirectional character to pass through the cell. The aluminum (when it forms the cathode or negative electrode) will not pass a current can pass from the iron to the aluminum. From this it is seen that if a rectifier does not work right it is only necessary to reverse its connections. The con-

nections of the single cell and the four cell types of electrolytic rectifier are shown diagrammatically in Figs. 4 and 5. The negative—D.C. terminals represent the binding posts on the aluminum electrodes while the positive + D.C. terminals represent the binding posts on the polished steel, or lead electrodes. The efficiency of the four cell type is given by the manufacturers (The Electro Importing Co.) at 85 per cent. This type will pass as much as 5 amperes, and continuously as in charging storage cells at 2.5 amperes. The one and two cell types pass about 1/3 of the above current. The electrolyte bath in which the electrodes are immersed can be of several different compositions, but a very good one is a neutral solution of ammonium phosphate in water.* C. F. Burgess and Carl Hambuechen (Transactions of the American Electrochemical Society) employ

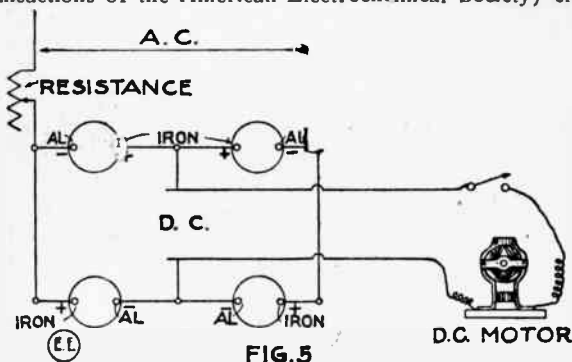

FIG. 5

a fused electrolyte of molten sodium nitrate, with an aluminum and an iron electrode. A saturated solution of bicarbonate of soda is also a very good electrolyte mixture, and is much used for large X-Ray transformer sets.

Transformers. Taking up the subject of *transformers*, it may be said that in general there are two principal commercial types in use, viz., the open core and closed core, respectively. A transformer, in its simplest definition, is an electrical device that can convert or transform the E. M. F. or voltage and current values

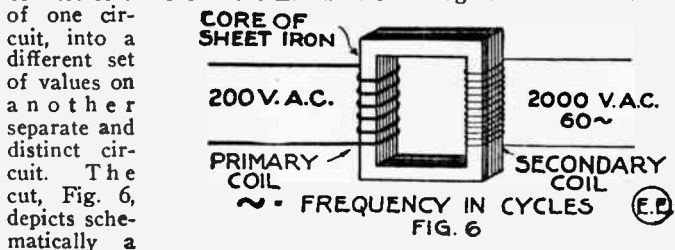

FIG. 6

of one circuit, into a different set of values on a n o t h e r separate and distinct circuit. The cut, Fig. 6, depicts schematically a transformer and its parts, and will serve to explain its mode of operation.

A transformer, of the form shown in Fig. 6, is of the closed core type, i. e., the iron magnetic core is continued on around, forming a closed magnetic circuit, and giving much greater efficiency than the open core type as in Fig. 7.

The action of the transformer is as follows:—An alternating (or sometimes a pulsating, as in the induction coil) current is supplied to one coil or winding on the iron core, marked primary coil, and the current traversing this winding, sets up or creates a powerful magnetic field of varying strength and polarity, corresponding to the changes and variations of the primary current. This fluctuating magnetic field continues around the iron circuit. In doing so, it also simultaneously creates a magnetic field in the air about the core as well. On the other limb of the core is a

* A. Nodon. "Transactions of the International Electrical Congress, St. Louis, 1904, Vol. I, page 510.

second independent winding or coil, which of course lies within the field of magnetic force. As the magnetic flux or field rises and falls or reverses itself, it sets up in this second or secondary

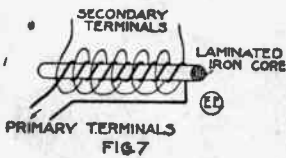

winding an electric current, whose voltage is dependent upon the number of turns of wire in it, as compared to the number in the primary winding.

If the transformer was designed to have the voltage relations existing in the diagram Fig. 6, then to have the sec-

ondary coil deliver 2,000 volts, from 200 volts in the primary coil, would necessitate the ratio of the turns in the two coils being as 10 to 1; i. e., the secondary coil would have to have

10 times as many turns in it as contained in the primary winding. Taking it as an example that the primary coil had 150 turns, then the secondary coil would need to contain 10×150 or 1,500 turns to deliver 2,000 volts. Thus it is, that the ratio of the primary and secondary voltages depend upon the ratio existing between the turns of wires in the two separate coils.

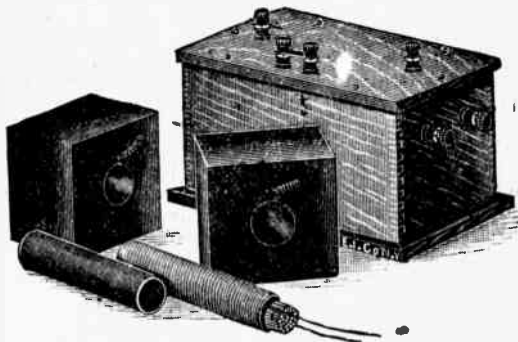

Fig. 8.

In this example, if the secondary was supplying 10 times the primary voltage, it would supply only 1/10 the primary current in amperes, theoretically, as the total watts,* in the secondary circuit could not be greater than those in the primary circuit. In practice, however, the efficiency of transformation of large closed core transformers is extremely high, reaching 98 to 99 per cent. oftentimes. In the smaller ones it does not exceed 75 to 80 per cent. A slight loss in transformation of energy is occasioned in the iron core, and also in the copper wire windings. These are known technically as the *iron loss* and *copper loss*. The iron loss is due principally to *hysteresis* or apparent magnetic friction, occasioned by the molecules of iron refusing to quickly follow the changes in direction of the magnetizing current. It is paramount that the primary current must change in strength periodically or in strength and direction both, to create a varying magnetic flux in the iron. A direct current would only create a changing magnetic field, whenever it was connected to and disconnected from the primary winding. This is the principle of the familiar

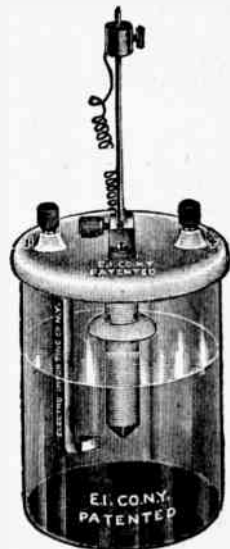

Fig. 9.

* Watts = product of volts times amperes.

induction or spark coil. A vibrator or other interrupter, periodically makes and breaks the primary circuit, resulting in a pulsating direct current passing through it. This causes the iron core to be magnetized and demagnetized rapidly, and in consequence the secondary coil has induced in itself, a current of similar frequency to that in the primary circuit. Induction coils invariably have an open core or magnetic circuit as shown at Fig. 7. They are considerably less efficient than the closed core type of design, in that the magnetic flux leaves the core at each end and completes the magnetic circuit through the air, which offers a very high reluctance to the flux. The efficiency of energy transformation in the open core types does not exceed 60 to 70 per cent. The voltage relations are the same as in closed core transformers.

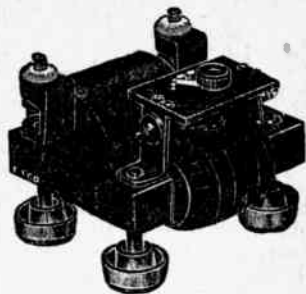

Fig. 10.

A cut of an open core transformer is seen at Fig. 8, this particular one being called a transformer coil, and used for stepping up the voltage of a 110 volt A. C. or D. C. circuit to several thousand at the secondary terminals. It is used for wireless telegraph purposes, in connection with a *Gernsback electrolytic interrupter*. An induction or spark coil is a transformer of the open core type. A 1 inch coil delivers a 1 inch spark from the secondary winding at a voltage of about 20,000, from 6 volts in the primary circuit.

Referring to the *Gernsback electrolytic interrupter*, mentioned above, as used in connection with the transformer coil, its appearance is seen from Fig. 9. It consists of a glass jar containing

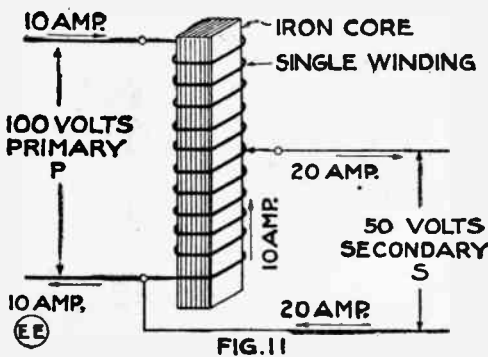

FIG. 11

an electrolyte of acidulated water, into which is placed an adjustable composition rod electrode and a fixed lead electrode. The transformer coil works very well with this interrupter electrolytic rectifier of the four cell type

is also connected in circuit as the interrupter operates best on direct current.

The interrupter itself is well built, having all the electrode connections sealed in a porcelain cover, so that they cannot be attacked by acid. The special rod at the centre sets in a porcelain tube with a constricted lower opening, and the gas bubbles formed electrolytically at the point of the rod, serve to make and break the circuit. The frequency of interruption developed by this instrument is enormous, reaching 5,000 to 7,000 per second. The interrupter causes the secondary winding to deliver a very heavy current, resembling a flame, and also works to good advantage on spark coils.

The action of any transformer is quite unique under different conditions, and some of them will be considered here.

If a transformer, of either the open or closed core type, is connected to an alternating current circuit, with the secondary

winding open, it will take a very small current from the circuit. This is due to the fact that the primary coil magnetizing current so reacts upon itself, that the reactance effect gives a greater resistance to the coil. The reactance is in the form of a counter or bucking E. M. F. and hence tends to lower the effective E. M. F. passing through the primary coil. So, while the secondary coil is open circuited and not connected to any load, the transformer primary winding consumes very little current, due to its reactance or self-induced counter E. M. F.

When the secondary coil or winding is connected to a load of some kind, it will immediately begin to deliver current to that load. Consequently the primary winding must be taking more current from the supply wires, and it does, in direct proportion to the secondary load. The passage of current through the secondary winding is in opposite direction at any instant to that in the primary, hence the magnetic reactance of the primary coil is to some extent counterbalanced by the magnetic field of the secondary winding, and the primary current is therefore greater in proportion to the load on the transformer. If the secondary winding is short-circuited, the transformer would pass so great a current that it would be burned out.

Transformers are known either as step-up or step-down, according to whether the secondary winding raises or lowers the primary voltage. This, as already explained, is dependent upon the ratio of the turns of wire upon the respective coils. Expressed in a formula, it becomes:—

$$K = \frac{\text{Secondary turns}}{\text{Primary turns}}$$

Where K is the ratio factor. If a transformer contained a secondary coil with 100 turns and a primary coil with 2,000 turns then the ratio of transformation would be 100 divided by 2,000 or 1/20; or the secondary voltage would be 1/20 of the impressed primary E. M. F. This transformer would belong in the class of step-down types.

If the transformer just cited was, say, of 1 kilowatt* capacity, had a closed core, and an efficiency of 80 per cent., then to get 1 kilowatt output at the secondary terminals, would require an input at the primary terminals of 1.2 times 1 kilowatt or 1,200 watts. The secondary voltage as remembered is to be 1/20 of the primary E. M. F. which is taken at 100 volts. Hence the secondary voltage is 1/20 of 100 or 5 volts. The secondary output is 1,000 watts or 1 kilowatt, and so the secondary current in amperes will be 1,000 divided by 5 or 200 amperes.

The primary voltage is 100; total input at full load 1,200 watts;

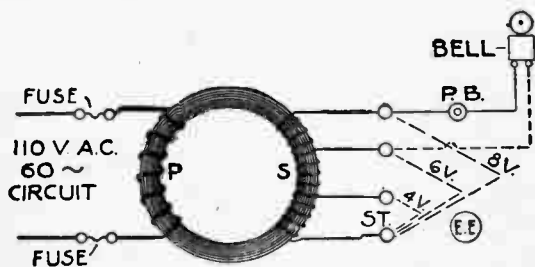

FIG. 12

and current input consequently 1,200 divided by 100 or 12 amperes; this allowing for the loss in efficiency of transformation due to iron core and copper losses.

The primary and secondary wires are designed of such size that they contain 1,000 circular mils of cross-sectional area for each ampere of current they are to carry. From this, the primary wire would require to be of 12,000 circular mils and the second-

* 1 kilowatt is 1,000 watts, or 1 1/3 horsepower.

ary wire of 200,000 circular mils. The size of wire corresponding to these areas can be taken from any standard wire table, such as the "Brown and Sharpe," or "American gauge." The size of wire corresponding to an area of 12,000 cir. mils is No. 9 B. & S. copper wire, whose area is 12,996 cir. mils. The nearest corresponding size of secondary wire having an area of 200,000 cir. mils is No. 0000 B. & S. Gauge copper wire. The wire for transformers is usually double cotton covered. The proper size of iron core for this 1 K.W. transformer operating on 100 volts, at 60 cycle frequency, is 15 inches by $8\frac{1}{4}$ inches by 2 inches thick. The width of the legs on any one of the four sides of the rectangle is also 2 inches. For a change in voltage on the primary mains the number of turns on the primary coil would be changed. For a change in the frequency of the primary supply current the iron laminated mass would also change, becoming less in quantity as the frequency increased, and vice versa.

These considerations all hold good for the open core type of transformer, except of course the efficiency is much less, and more primary current for a given secondary output must be put into the transformer.

A step-up high tension wireless transformer of $\frac{1}{4}$ kilowatt capacity is illustrated by Fig. 10. It is substantially built and mounted in a wooden cabinet, with terminals of primary and secondary windings on the exterior of the case. It operates on 110 volts, 60 cycle A. C. and delivers 15,000 volts and a fraction of an ampere at the secondary terminals. Wireless transformers of the closed core type, such as the one just described, or the open core type, have largely superseded the spark coil for charging the condensers and aerial wire as they are more constant and reliable in operation and give a very heavy amperage in the secondary circuit. The efficiency of the transformer in contrast to the induction coil is quite different too; the latter being approximately 20 per cent. or more, less efficient than the former. The transformer can be built in any desired size and operates very successfully in the larger form, while large induction coils are very expensive and also hard to operate properly in the big sizes.

While discussing transformers, the auto-transformer or single-coil transformer must not be overlooked. The schematic arrangement of its various sections are portrayed in Fig. 11. As observed, there is an iron core of built-up sheets of thin annealed stock, as in regular practice, but only one coil is shown. This coil may contain, say 200 turns of wire, for example.

The single coil has a part of its turns in use for the primary winding and a part of them for the secondary winding of the transformer, as indicated by P and S respectively. We can take the section P, or primary coil, and have it embrace, say, all of the 200 turns of wire on the transformer. The secondary, or S turns, may be taken at 50 turns, or one-half the primary number.

The number of turns on the single coil of an auto-transformer is the same as would be required if it were employed exclusively for the high-tension winding, and a separate additional coil were provided for the low-tension winding. When the ratio of transformation is 2 to 1 or 1 to 2, the amount of copper in the one coil is exactly the same whether it is used as an auto-transformer or as a high tension coil of a regular two coil transformer of the same output. Less copper is required for an auto-transformer than for a two coil type, also less iron is required to surround the copper.

Referring to the diagram, Fig. 11, it is seen that the single coil is designed to carry 10 amperes throughout (considering a 1 kilowatt unit) and for a total voltage of 100. The voltage per turn of wire throughout is identical, so if it is desired to obtain 50 volts on the secondary side, it is only necessary to connect the secondary lead wires to any two points on the continuous coil, so that but one-half of the total number of turns is embraced between them. Also if a secondary E. M. F. of 25 volts was required, the secondary lead wires should embrace

25/100 or $1/4$ of the total turns on the winding. The load or secondary current is 20 amperes for a rating of 1,000 watts (1 kilowatt) at 50 volts, and is opposed in time phase position by the superposed 10 amperes of primary current, so that even in this part of the winding, the resultant current is only 10 amperes.

The auto-transformer is very efficient for certain voltage ratios and exceeds that of the two coil type, besides requiring less material in its construction. Auto-transformers are used for a variety of purposes chief among them being, to control the amount of current supplied to alternating current motors while starting, and also for speed regulation; balance coils, in 2 wire to 3 wire supply systems; tuning coils and helices in wireless telegraphy; reactance coils; etc.

Auto-transformers are used successfully and to advantage in operating single-phase electric railway motors. They are used here to supply low voltage for the motors from the high voltage supply wires. The auto-transformers are arranged in this case with nine intermediate low-potential taps, and are used on locomotives and motor cars, with the line wire potential at 11,000 volts. The employment of auto-transformers in this capacity was dictated more by convenience than by economy, although an auto-transformer with a ratio of 22 to 1 as used here, would be a trifle less expensive and more efficient in operation than a two coil transformer for the same purpose.

In general, the following features are the principal ones, in the construction of modern transformers: The cores, for certain sizes and designs, are often made up of a quantity of charcoal annealed iron wire, such as Norwegian core wire. It must be as soft as possible, otherwise it will lower the efficiency of the transformer. For low voltage types, not exceeding 500 volts, Empire cloth may be placed around the iron core to insulate it from the wire coils to be placed over it.

For low tension 110 or 220 volt primary windings, the wire can be double cotton covered or enamel; if the former it should



Fig. 13.

be well shellacked or impregnated with wax, or, better still, soaked with some good insulating varnish or compound and baked until the compound has permeated all the pores in the insulation.

The secondary windings can be similarly made up, as above described for ordinary low voltages. Common practice is to immerse the whole transformer in oil, such as transit oil, paraffine oil, or double-boiled linseed oil. The oil used should have a high flash value. For voltages over 1,000, it is recommended that the transformer windings and core be oil insulated, but the practice in wireless transformer building seems to be to make them thoroughly portable, and so oil is not used in them generally. In place of the oil a wax-rosin mixture is poured over the transformer when it is placed in its cabinet and they seem to stand up very well, notwithstanding that the secondary potentials often reach 50,000 volts or more. In these classes of transformers, the insulation is kept up to a very high standard by subdividing the high tension winding into a number of smaller sections or pies as they are nicknamed. Each pie is well impregnated with hot paraffine or beeswax, before or after winding.

In the designing of open-core transformers, used mostly for wireless purposes, with high potential secondary coils, it is best to place a mica, fibre or hard-rubber tube of considerable thickness over the primary winding and core, otherwise the

discharge of the secondary will take place into the primary and core, instead of between the secondary terminals.

A small transformer is often employed for ringing bells, running electric toys small motors, etc., and the appearance of one of these is shown at Fig. 13, while Fig. 12 illustrates the connections of the two windings, primary and secondary. The primary coil is connected to a 110 or 220 volt, alternating current circuit, with fuses as indicated. Several voltages may be obtained from the secondary coil, by connecting on to different numbers of turns, suitable leads being brought out to binding posts. These transformers consume practically no current from the A. C. mains, and take the place of troublesome batteries.

One of the largest, and probably the largest, use of commercial transformers is in the stepping up of generator voltages for long distance power transmission, and stepping down the high tension current of feed wires or primaries to a suitable one for operating incandescent lamps, motors, and a hundred other pieces of apparatus in the home and workshop. The transformer and alternating current have made electricity the great master it is to-day.

LESSON No. 5.

SMALL ELECTRIC LIGHTING PLANTS.

THE small electric lighting plant which is usually isolated or away from any ordinary sources of current supply, has grown to be legion nowadays, thanks to the wonderfully developed gasoline engine, and the simplification of the electric generating apparatus. Every farmer can now have his own electric plant, and it will cost him practically nothing in most instances, especially where *water-power* or *wind-mills* are at hand, with which to drive a dynamo. Failing these facilities in the line of prime-movers or driving power, a *gasoline* or *kerosene internal explosive engine* is quite cheaply procured, and often to do duty for driving odd machinery around the place, and the dynamo simply absorbs power during the idle moments, to charge a storage battery floating across the line wires leading from the dynamo. In this arrangement an automatic cut-out must be inserted in the line so that whenever the dynamo voltage falls below that of the storage battery on charge, it will automatically disconnect the battery, otherwise the battery would discharge back through the dynamo. This cut-out is sold by the Electro Importing Co.

A typical farmhouse, or isolated electric lighting plant is illustrated by cut Fig. 1. Such a plant as this, of course, is a little above the average but does not cost over a few hundred dollars for the initial installation. The up-keep, maintenance and safety cannot be estimated in dollars and cents. A farm or dwelling equipped with such a plant or a similar one, can produce electric current at a fraction of the cost charged by the central station companies.

The principal merits of the electric system for lighting the premises, driving small motors and machines, etc., is its comparative safety, cleanliness, and efficiency, as compared to any other scheme for accomplishing like results. For instance, the following features will serve to prove the vast superiority of the electrical system over acetylene, gas, oil, etc.

To begin with an electric incandescent lamp, such as the carbon or tungsten filament type, consumes no oxygen whatever from the atmosphere, and hence it does not devitalize the air, as is the case with any form of oil, wax or gas illuminant. An ordinary gas light consumes as much oxygen in an hour as six full grown people, and a petroleum or kerosene oil lamp consumes a much greater quantity in the same space of time.

More fires are caused by the upsetting or explosion of oil lamps annually, than by all other agencies put together, as proved by insurance statistics. So one of the great features of an electric plant, is its ability to lower the insurance rates. A common cause of fire, when the origin is unknown, is of course the now familiar "crossed electric wires." The wires in the first place, are rubber covered, and rarely ever short circuit or come in contact with each other's metal sections, as the rubber is thick enough to hold the electric charge on them easily. If the wires are properly installed, and rigidly supported in place on porcelain insulating cleats or knobs, or installed in iron conduit, no trouble whatever will be experienced with the system.

DATA ON ELECTRIC LIGHTING PLANTS.

Type of plant.	Volts with Load.	Amp. hours capacity.	No. of Tungsten Lamps normal load.	Hours Lamps can be burned.	C.P. of each Lamp.	Source of Energy.	Charging Rate in Amperes. Cells in Series.	Length of charge in hours.	Price of Lighting Complete
1-P.	1.4	100	4 or 2	25-50	1.25	2-100 A. H. Gordon Cells Chem. Renew.	2	5	\$5.03
2-P.	2.8	150	6 or 3	25-50	2.5	4-150 A. H. Gordon Cells Chem. Renew.	2	5	12.83
3-P.	3.5	300	12 or 6	25-50	3.5	5-300 A. H. Gordon Cells Chem. Renew.	2	5	20.23
1-S.	2.0	10	1	20	1	1-type H. O. Stg. Cells	2	5	2.13
2-S.	4.0	10	2	10	3 1/2	2-type R. E. Stg. Cells	2.5	8	3.33
3-S.	4.0	20	2	10	3 1/2	2-type R. E. Stg. Cells	2.5	8	5.23
4-S.	6.0	40	5	8	6	6-type R. E. Stg. Cells	2.5	8	12.73
5-S.	10	40	6	6.6	10	10-type R. E. Stg. Cells	2.5	8	21.33
6-S.	6	40	4	10	6	1-6 V. 40 A. H. Stg. Bat.	5	8	8.28
7-S.	6	60	6	10	6	1-6 V. 60 A. H. Stg. Bat.	7.5	8	10.83
8-S.	6	120	12	10	6	2-6 V. 60 A. H. Stg. Bats.	7.5	8	21.23
9-S.	12	120	12	10	12	4-6 V. 60 A. H. Stg. Bats.	7.5	8	40.23
10-S.	6	60	2†	17	16	1-6 V. 60 A. H. Stg. Bat.	7.5	8	9.85

	Amps.	Cost of Dynamo	Mechanical H. P. required to drive dynamo
1-D.	6 Volts	\$3.70	1/8 H. P.
2-D.	14 Volts	9.80	1/4 H. P.
3-D.	25 Volts	48.50	1/2 H. P.
4-D.	10 Volts	10.00	1/4 H. P.

† 4 filament 16 C.P. 1.75 amp. 6 volt multiplex lamps.

‡ With reflector C.P. equals 32 instead of 16 C.P.

All of the above listed outfits at the prices quoted include the maximum number of tungsten lamps cited in table; sockets; switch; source of energy, and 1 lb. No. 16 B. & S. cotton covered bell wire, suitable for connecting the lamps. For circuits over 30 feet long, No. 14 B. & S. rubber covered copper wire, Cat. No. 8006, costing \$1.60 per 100 feet, should be employed, also in damp places, etc.

in most cases of private houses and the like, it is not desirable to have an engine operating during the night on account of noise, attention necessary; etc. However, a well regulated system can be run perfectly satisfactory all or a part of the night without any undue trouble or annoyance. A compact engine and dynamo mounted on a single bed-plate is shown at Fig. 2. The engine is fitted with an extra heavy fly-wheel to give a steady turning effort or torque to drive the dynamo, so that the lights will not flicker. Not every engine is suited to drive a dynamo for lighting purposes. If the speed is not sufficiently steady, then neither will the voltage of the dynamo be, and consequently the lights will flicker more or less. Heavy fly-wheels and special governing devices on the engines obviate the flickering to a great extent. If a storage battery is used in conjunction with the engine, the lights will not be subject to any flickering whatever, as the current supplied by the battery is perfectly steady at all times. Slight irregularities in the speed of the engine does not matter so much in this case, as the dynamo simply forces current into the battery, much as a pump forces water into a reservoir; the battery steadying the line voltage.

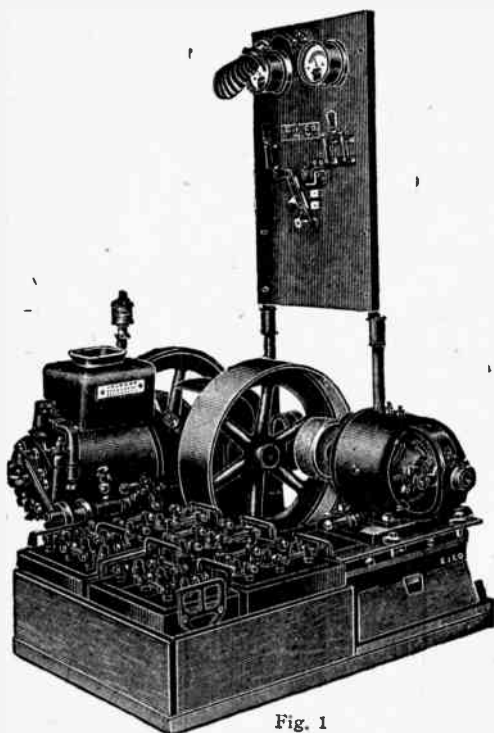

Fig. 1

The two simplest systems for lighting incandescent lamps, are those employing a dynamo and storage battery separately. The common circuit for the dynamo system appears at Fig. 3, the shunt field winding having a variable resistance in series with it, to regulate the voltage applied at the lamps; but this is not necessary in small dynamos under $1/6$ H. P. In Fig. 4 is shown a storage battery circuit, the 6 cells being connected in series to give 12 volts (about 2 volts each).

In the dynamo scheme, the engine or waterwheel must be kept constantly going to drive the dynamo, as long as the lights are wanted. With the storage battery arrangement, some means of recharging the battery is necessary. Gen-

erally a dynamo is employed to fulfill this function, but in some cases the batteries are recharged at a nearby power station, owned possibly by a neighbor.

A few rules regarding the size of *charging dynamos* for certain size storage batteries may be of service to the isolated plant owner. The standard practice in the United States for charging and discharging lead cell storage batteries, with dilute sulphuric acid for electrolyte, is the 8 hour rate, as it is called. This rule works out as follows: If a cell has a rated normal capacity of 400 ampere hours (being the product of the amperes by the hours), then to discharge it at the standard 8 hour rate would mean that 400 divided by 8, or 50 amperes for 8 hours would be the normal rate. The recharging could be at the same rate or the equivalent for a slightly longer time.* The voltage of a freshly charged cell is about 2.4 to 2.5 volts. The usual charging voltage per cell varies from around 2 volts up to 2.6 volts, at end of charge. The dynamo voltage must be always slightly higher (about 10 per cent.) than the storage cell voltage otherwise the battery will discharge back through the dynamo, which is likely to ruin the battery. To prevent such an occurrence as this, a reverse current magnetic relay is often interposed between the battery and dynamo, so that any surge of current in the opposite direction to that delivered by the dynamo will immediately open the circuit, and protect both sets of apparatus.

Some useful data is given here relative to the size of dynamo, battery, number of lamps, load allowable, etc.:

	Tungsten 1-100 watts. 1.18 W.P.C.	Carbon 1-100 watts. 2.97 W.P.C.	Carbon 2-48-100 watts. 2.97 W.P.C.
Candle power	84.7	33.6	83.3
Average cost lamp	\$1.04	.24	.595
Average life lamp, hours.....	1,000	600	600
Renewal cost per 1,000 hours.....	\$1.04	.40	.9917
Power consumed per 1,000 hours in K.W.H.	100	100	248
Cost power at 5c. K.W.H.....	\$5.00	5.00	12.40
Cost power at 10c. K.W.H.....	\$10.00	10.00	24.80
Cost of renewals and power at 5c.....	\$6.04	5.40	13.39
Cost of renewals and power at 10c.....	\$11.04	10.40	25.79
Comparison of light for same cost.....	100%	42.8%	42.8%
Per cent. saving for equal light, 5c. K.W.H.	55%
Per cent. saving for equal light, 10c. K.W.H.	57%

Combined capacity of dynamo and storage battery at 4 hour rate of dis- charge in 16 C.P. lamp.	Number of storage cells.	Engine horse- power.	Engine speed.	Voltage of system.	*Dynamo speed	Capacity Dynamo in 16 C.P. lamps.	Dynamo K.W.	Dynamo Voltage.	Storage battery capacity in 16 C.P. lamps for 8 hours.	Storage battery capacity in 16 C.P. lamps for 4 hours.	Ampere hours es- timated for 16 lamps
20	4	1½	300	8	1,800	10	.22	11	7	10	120
20	4	2	425	8	1,800	10	.22	11	7	10	120
20	4	1½	450	8	1,800	10	.22	11	7	10	120
40	9	1½	300	16	1,800	20	.50	25	15	20	120
40	9	2	500	16	1,800	20	.50	25	15	20	120
50	13	2	600	25	1,800	20	.72	36	20	25	120
85	13	3	600	25	1,800	50	1.44	36	25	35	160
105	32	3	600	57	1,800	50	1.40	80	42	55	120
160	13	5	575	25	1,500	125	3.60	36	25	35	160
180	32	5	575	57	1,500	125	3.50	80	42	55	120
325	32	10	500	57	1,500	270	6.15	65	42	55	120
600	33	20	280	57	1,100	520	11.85	65	57	80	160

* Dynamo belt driven.

* See Lesson No. 3 on Storage Batteries for details.

The methods of wiring up a complete plant, including storage battery, dynamo and lamps is shown diagrammatically in Figs. 5 and 6. In Fig. 5 is represented only the simplest plant, without voltmeter or ammeter to indicate the strength or quantity, of current passing into or out of the battery while charging or discharging. In Fig. 6 the diagram shows two "Electro" magnetic vane measuring instruments in the battery circuit, which (as they indicate with current in either direction) will show the voltage and amperage while the battery is being charged or discharged. The battery generally receives charging current during the day, and discharges on the lamp load at night.

The size of wire to be used for any given length of circuit and load is best found from the regular formula below:

$$C. M. = \frac{\text{Length of run in feet} \times \text{amperes} \times 21.6}{\text{Volts lost in circuit.}}$$

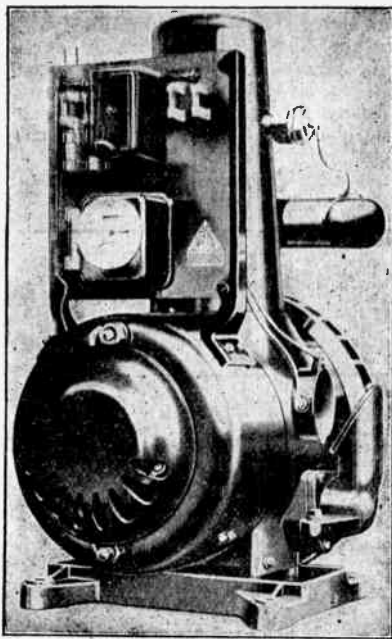

Fig. 2.

same intensity of illumination as the carbon filament lamp.

A few of the "Electro" storage cells which are suitable for electric lighting plants are illustrated in Fig. 7.

Some electric lighting fittings and supplies are seen in Fig. 8, including sockets, snap switches, wall brackets with reflectors, shades, etc., etc.

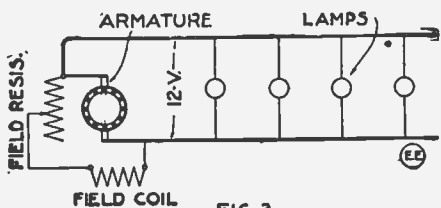

FIG. 3

C. M. is area of wire in circular mils, and the corresponding size of wire is readily found from any wire table.

The volts lost in the circuit is usually taken at 2 to 3 volts for good service, on ordinary voltages of from 50 to 110 volts.

The wire should be rubber covered, single braided, if it is to be supported on cleats or knobs. If the wire is to be installed in conduit or pipe, it must be double braid, rubber covered. For anything above 10 volts, the Fire Underwriters' Rules for electric wiring must be complied with. A copy of their book can be had by addressing the Fire Underwriters' Association, in the principal cities.

Some tungsten lamp data is appended herewith, the tungsten lamp being the greatest boon to small lighting plants ever, as it consumes about 1/3 the

same intensity of illumination as the carbon filament lamp. A standard tungsten lamp is depicted at Fig. 9, the only difference between it and a carbon lamp being that the filament is composed of the metal tungsten, instead of carbon.

A few more

pretentious chandeliers for electric lighting, are shown at Fig. 10. These are made of brass, and make a fine appearance in any house. Any style shade can be fitted to the chandeliers or drop lights, according to the tastes of the purchaser.

Isolated farms usually employ a gasoline engine, steam engine, water wheel or windmill. A

few rules for arranging the plants, of whatever size may be of use to the builder and operator.

The dynamo, to start with, is generally purchased ready to run, as it does not pay to build them nowadays. The dynamo should be located in a spot free from dampness, or else thoroughly housed over by a wooden cover. If of greater capacity than $\frac{1}{2}$ H. P. it should be particularly well set up and secured to a concrete foundation, or it may be fastened to a wood base built out of filled yellow pine.

The dynamo plate of most dynamos supply the necessary

data as to their capacity, speed to be driven at, etc. The capacity is frequently given in kilowatts or horsepower. To find the number of watts this rating is equivalent to, multiply the K. W. by 1,000 or the H. P. by 746. To find the K. W. divide the product of the volts multiplied by the amperes, by 1,000; and for H. P. by 746. With a given number of watts, the volts are found by dividing the watts by the amperes; or

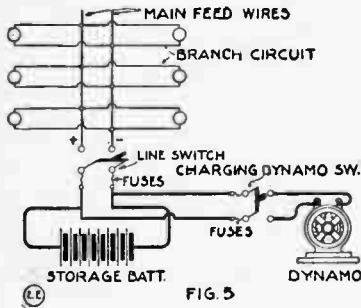

FIG. 5

to find the amperes, divide the total watts by the volts. The watts taken by a lamp of certain candlepower (C.P.) is ascertained from tables in catalogues or textbooks. Hence, from the above it is seen that the number of given size lamps that can be lighted by a certain size of dynamo is equivalent to the total watts capacity of the machine, divided by the total watts per lamp. A 110 volt, standard tungsten lamp consumes, 25, 40 or 60 watts, etc., at about 1.2 watts per candlepower as compared to the carbon lamp's consumption of 3.1 to 3.5 watts per candlepower.

Endless belts are the best for dynamo drives, as a common laced or patent hook splice gives rise to irregularity in speed. The most important

part of arranging the belt is to have the dynamo and prime-mover pulley so related, that the speed of the former is correct. The rule for finding the size of one pulley for a certain drive when the other is known, is as follows: The

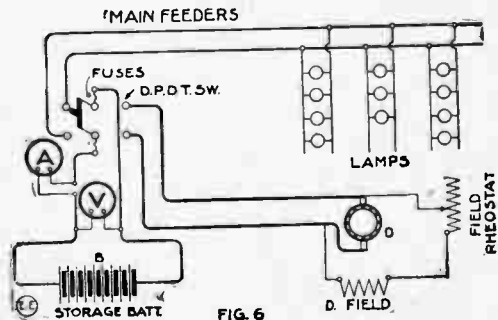

FIG. 6

diameter in inches of the unknown pulley is equal to the diameter in inches of the known pulley, times its speed in

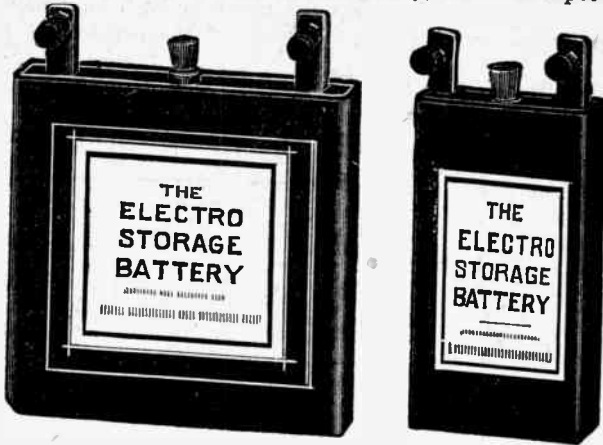

Fig. 7.

revolutions per minute (R.P.M.), and this product divided by

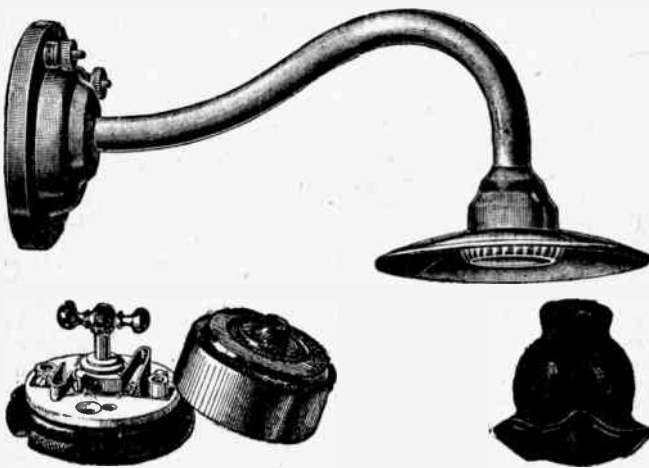

Fig. 8.

the desired speed in R.P.M. of the new or unknown pulley.

As an example, suppose that a 20-inch pulley rotates on an engine shaft at 1,500 R.P.M. and the dynamo is to be driven at 2,000 R. P. M., then what must be the diameter in inches of the dynamo pulley to insure the proper speed? Solution: Diameter of the driving pulley (here 20 inches) times its speed (1,500 R.P.M.) equals 30,000. 30,000 divided by the dynamo speed, viz. 2,000, gives 15 inches as the diameter of the dynamo pulley. This considers that the belt transmission is perfect, but in practice it is not, and it is usual to allow an increase in the calculated dynamo speed of 2 per cent. for slippage. Every friction belt slips some, and frequently on high speeds it creates such a quantity of static or frictional electricity, that special means have to be provided to dissipate it in the ground. A grounded wire, connected to a wire comb or set of metal teeth in



Fig. 9.

close proximity to the moving belt, will dissipate or carry off any static discharges to earth.

The required width of leather belt for any horsepower is given by the following formula:

$$W = \frac{1925 \times H}{D \times N};$$

Also, $W_s = \frac{2,750 \times H}{D \times N};$

Where: W is the width in inches of a suitable double leather belt.

1,925 is a constant.

H is the horsepower to be transmitted.

D is diameter in inches of larger pulley.

N is the revolutions per minute of larger pulley.

W_s is the width in inches of a single leather belt.

The distance between the centres of two pulleys connected mechanically by a belt, should not be less than 3 to 4 times the diameter of the larger pulley. Horizontal drives are always preferable to vertical drives, as the tension on vertical systems has to be raised to a high degree to keep the slippage down. The ideal drive is a well spaced horizontal one, with the loose running side of the belt on top. For short belt drives, where it is not possible to space the individual pulleys at least twice the diameter of the larger pulley apart, then recourse may be had to the idler pulley, as it is called. An idler pulley drive is illustrated in Fig. 11, the position of the idler pulley being plainly indicated. Its function is to increase the area of pulley face covered by the belt, or the arc of belt contact.

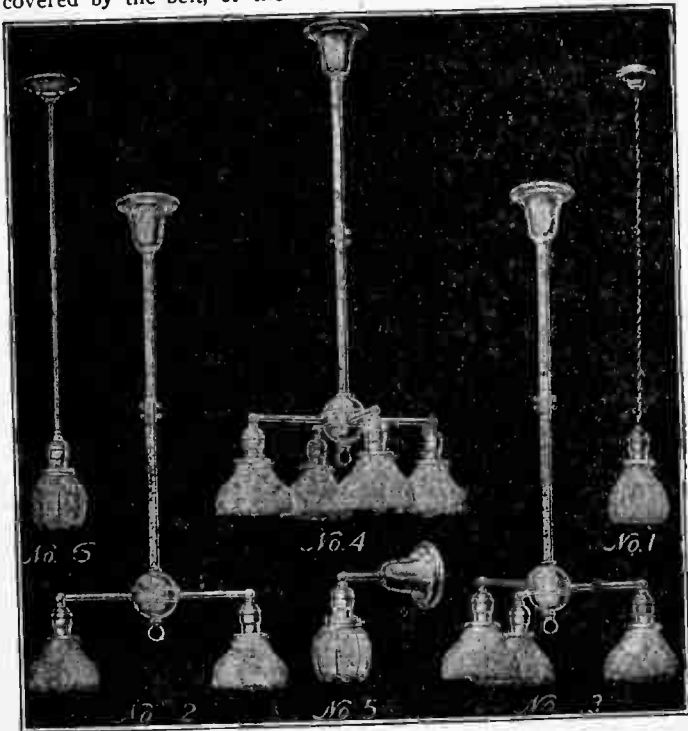

Fig. 10.

Where the speed of the prime-mover permits, the modern method is to direct connect the dynamo, by a metal coupling, to the engine or water-wheel shaft. This is the most efficient method, as some power, even though but 10 per cent., is lost in the belt transmission.

Where water power is available, it behooves the intending plant builder to look it over, and if possible harness it up to a water wheel or turbine. Water power costs nothing in most instances, and the efficiency of the water turbine is very high, being somewhere at about 80 per cent. for medium size and head of water. The pressure in pounds per square inch of any head of water is found by multiplying the heads in feet by .433; (.433 lb. per sq. in. per 1 foot of head).

Windmills are applicable to dynamo drives, but must be specially equipped with automatic cut-outs in the storage battery circuit, so that if the mill slows down to a certain degree, which also lowers the charging dynamo voltage, the dynamo will be cut off from the battery. When the mill has again picked up sufficient speed, and the charging dynamo voltage is greater than the battery E. M. F. then the automatic switch closes its circuit with the battery again, etc. Another automatic cut-out is arranged to cut out the dynamo, when the battery has received full charge.

The dynamo itself, if not given proper attention, gives trouble once in a while, and the following are some of the points to be watched in operating it:

The commutator is the most difficult part of the dynamo to keep in good condition. The cleaner and freer from oil and grease it is kept, the more satisfactory its service.

If the brushes tend to cut or grind, they may be improved by soaking in hot paraffine wax. A carbon and graphite mixture makes the best brush, or those having a woven wire center or core are excellent.

If a dynamo fails to generate current upon first being started, it may be possible

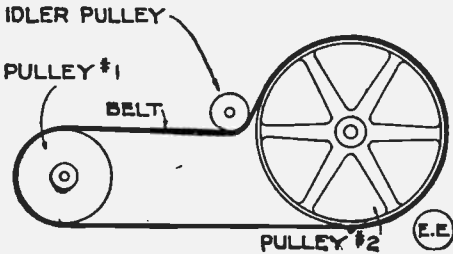

FIG. 11

the direction of rotation is backward. If upon reversing the direction of rotation it still refuses to generate current, shift the brushes or rocker arm back and

forth. If no voltmeter is at hand, a lamp may be connected across the terminal posts connecting to the armature brushes.

When the above trials have been made without success, the next best thing to do, is to charge the field by passing a direct current through its windings from a few battery cells, or a regular D. C. circuit. In doing this the armature should be disconnected from the circuit.

To test the field of armature for open circuits or

grounded windings, use may be made of a battery and bell or a regular testing magneto bell, such as used by electricians can be utilized.

Care must always be observed, in small plants particularly, that the dynamo is not overloaded at any time, as such an occurrence is almost certain to burn out the windings, necessitating a rewinding of the machine. To this end, a reliable voltmeter and ammeter should always be in circuit to show the total load on the dynamo at any instant. The proper current in amperes for

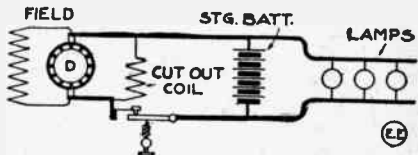

FIG. 12

any given horsepower and voltage is readily figured out as explained previously.

Practically all of the best automobiles and motor boats to-day are equipped with electric lights. An outfit composed of Electro-Importing Co.'s goods is shown diagrammatically at Fig. 12. The dynamo should deliver 8 volts or more, for recharging a 6 volt storage battery, and their No. 165 generator is a fine machine for auto and motor boat lighting plants. It is waterproof and very rugged. Such an outfit should comprise the dynamo, an automatic cut-out at \$9.00; a No. 555 6 volt, 60 A. H. storage battery, and the desired 6 volt tungsten lamps. This outfit will ignite the engine by the jump spark coils, and also furnish several lights simultaneously. An 80 A. H. battery at \$12.00 is often desirable for auto lighting.

LESSON NO. 6.

ELECTRICAL WIRES AND THEIR CALCULATIONS.

THE metallic conductors or wires which are employed to convey the electric current for various purposes are usually of copper. In some cases, as in telegraph and telephone line work, iron wires are used, iron wire having about seven times the resistance of copper wire of similar diameter and length.

In all practical calculations for electrical wiring, etc., the cross-sectional area of the wire is spoken of in circular mils, and sometimes in square mils; one mil being equivalent to one one-thousandth of an inch. A circular mil is the area of a circle of 1 mil or 1-1000th of an inch in diameter, or also it equals the diameter in mils squared. This follows from the well known rule, that the area of a circle in circular inches is found by squaring the diameter in inches, or d^2 . The area in square mils, is evolved by the usual circle formula; $d^2 \times .7854 = \text{area}$; or area in square mils, of wire, equals diameter in mils, multiplied by itself, and then by the constant .7854. The area of a wire in square inches is of course found by the rule—diameter in inches squared, times .7854.

All wires usually conform to some standard gauge or series of arbitrary numbers. The gauge standardized and used entirely in electrical work in the United States, is that developed by the Brown & Sharpe Mfg. Co., and known as the American Wire Gauge, (A. W. G.) or simply the Brown & Sharpe Gauge (B. & S. G.). The various gauges in use and their classification is given below:

Brown & Sharpe's Gauge.

The B. & S. Gauge is standard for copper wire and is understood to apply to all cases where size of copper wire is mentioned in any wire gauge number.

By referring to the table it will be seen that in the B. & S. Gauge, to all practical purposes, the area in circular mils, is doubled for every third size heavier, by gauge number, and halved for every third size lighter, by gauge number.

Every tenth size heavier by gauge number has ten times the area in circular mils.

Every No. 10 B. & S. Gauge wire has an area of approximately 10,000 circular mils, and from this base the other sizes can be figured, if a table should not be at hand.

Classification of Gauges.

In addition to the confusion caused by a multiplicity of wire gauges, several of them are known by various names.

For example:

Brown & Sharpe (B. & S.) = American Wire Gauge (A. W. G.).

New British Standard (N. B. S.) = British Imperial, English Legal Standard and Standard Wire Gauge and is variously abbreviated by S. W. G. and I. W. G.

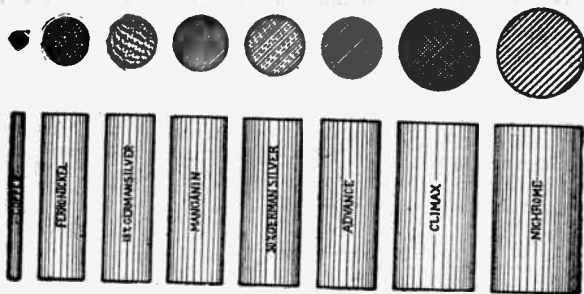

Fig. 1.

Birmingham Gauge (B. W. G.) = Stubs, Old English Standard and Iron Wire Gauge.

Roebing = Washburn Moen, American Steel & Wire Co.'s Iron Wire Gauge.

London = Old English (Not Old English Standard).

As a further complication:

Birmingham or Stubs' Iron Wire Gauge is not the same as Stubs' Steel Wire Gauge.

Table No. 1.

Gauge No.	Diam. Inches	AREA		WEIGHT Lbs. per 1000 Ft.	LENGTH Feet per lb.	RESISTANCE AT 75° F.			Carrying Capacities		
		Circular mils (4 th .) Inch. — .001	Sq. Mils. (4 th 7854)			Length, Feet per Ohm.	R Ohms per 1,000 Ft.	Ohms per lb.	Rubber Ins. Amps	Other Ins. Amps	Gauge No.
1	1.132	1000000.	785100.	3070.	.3275	93100.	.01031	.000003442	650	1000
2	1.015	840000.	628000.	2410.	.4100	76100.	.01313	.000003380	550	840
3	.903	700000.	548500.	2135.	.4680	66900.	.01501	.000003300	500	760
4	.801	600000.	471000.	1830.	.5460	57100.	.01751	.000003250	450	680
5	.719	500000.	392000.	1525.	.6550	47500.	.02101	.000003176	390	590
6	.648	400000.	313000.	1220.0	.8000	38300.	.02537	.000003073	330	500
7	.580	320000.	190000.	762.0	1.32	26383.	.04906	.000003000	275	412
8	.520	211000.	166190.	639.3	1.56	16165.	.06186	.000120309	210	312	0000
9	.466	167500.	131700.	507.0	1.97	12820.	.07801	.000104223	177	262	0000
10	.416	135070.	104520.	402.0	2.49	10166.	.09838	.000385500	127	185	00
11	.374	105335.	82857.	318.8	3.14	8082.3	.12404	.00048904	107	156	1
12	.338	83094.	65733.	252.8	3.90	6393.7	.15640	.00078045	90	131	2
13	.306	66373.	52130.	200.5	4.99	5070.2	.19723	.0012406	76	110	3
14	.276	52634.	41330.	159.0	6.29	4021.0	.24869	.0019721	65	92	4
15	.249	41742.	32754.	126.1	7.93	3188.7	.31361	.0031361	54	77	5
16	.224	33102.	25998.	100.0	10.00	2528.7	.39546	.0049908	46	65	6
17	.200	26250.	20617.	79.32	12.61	2005.2	.49871	.0079204	38	48	7
18	.178	20816.	16349.	61.90	15.90	1590.3	.62881	.012608	33	38	8
19	.158	16300.	12960.	49.88	20.05	1261.3	.79281	.020042	28	30	9
20	.140	13024.	10281.	39.56	25.28	1000.0	1.	.031380	24	23	10
21	.124	10181.	8153.	31.37	31.38	794.18	1.2607	.050082	20	17	11
22	.110	8234.	6467.	24.88	40.20	629.02	1.5896	.080585	17	15	12
23	.098	6629.	5123.	19.73	50.69	498.83	2.0047	.12841	14	13	13
24	.087	5178.	4067.	15.63	63.91	395.00	2.5278	.20322	12	10	14
25	.078	4106.	3225.	12.44	80.38	321.02	3.1150	.31658	10	9	15
26	.070	3256.	2537.	9.84	101.63	248.81	4.0191	.51501	8	8	16
27	.063	2582.	2033.	7.81	128.14	197.30	5.0683	.81900	6	7	17
28	.057	2048.	1609.	6.19	161.69	156.47	6.3911	1.3023	5	5	18
29	.052	1624.	1275.	4.91	203.78	123.99	8.0654	2.0739	4	4	19
30	.048	1287.	1011.	3.88	257.47	88.40	10.163	3.2026	3	3	20
31	.044	1021.	802.2	3.09	324.00	78.06	12.815	5.2357	2	2	21
32	.040	810.1	636.2	2.45	408.50	61.91	16.152	8.2208	In light-	22	22
33	.037	642.7	504.7	1.94	515.15	49.08	20.377	13.238	ing work,	23	23
34	.034	509.4	400.1	1.51	640.66	40.08	25.985	21.070	no small-	24	24
35	.031	401.0	317.3	1.22	819.21	35.91	32.400	25.496	er than	25	25
36	.029	320.4	251.6	.97	1032.9	30.80	40.868	35.476	No. 14 is	26	26
37	.027	254.0	199.5	.77	1302.9	24.46	50.681	45.235	used, ex-	27	27
38	.025	199.5	156.8	.61	1628.9	2.408	103.30	340.28	cept for	28	28
39	.023	156.8	122.8	.48	2128.9	2.408	415.24	5497.4	30	30	29
40	.021	9.9	7.7	.03	33175.	.932	1049.7	34823.	36	36	30

For sizes above No. 0000 the table refers to stranded copper cable. Due to the conditions imposed by proper "laying" of the strands, the figures for circular milage, diameter, resistance, etc., can be given with only approximate accuracy.

One foot of pure copper wire of one circular mil cross-sectional area (diameter, .001 inch), has a resistance of 10.74 ohms at 15°C or 59°F.

General Uses of Various Gauges.

B. & S. G.—All forms of round wires used for electrical conductors, Sheet Copper, Brass and German Silver.

U. S. S. M. G.—Sheet iron and steel. Legalized by act of Congress, March 3, 1893.

Table No. 2.

TABLE OF CARRYING CAPACITY OF WIRES.

Below is a table showing the allowable carrying capacity of wires containing ninety-eight per cent pure copper, which must be followed in placing interior conductors:

RUBBER COVERED WIRES.

B. & S. Gauge.	Amperes.	Circular Mils.	Amperes
18	3	200,000	200
16	6	300,000	270
14	12	400,000	330
12	17	500,000	390
10	24	600,000	450
8	33	700,000	500
6	46	800,000	550
5	54	900,000	600
4	66	1,000,000	650
3	76	1,100,000	690
2	90	1,200,000	730
1	107	1,300,000	770
0	127	1,400,000	810
00	150	1,500,000	850
000	177	1,600,000	890
0000	210	1,700,000	930
		1,800,000	970
		1,900,000	1,010
		2,000,000	1,050

The low limit is specified for rubber covered wires to prevent gradual deterioration of the high insulations by the heat of the wires, but not from fear of igniting the insulation. The question of drop is not taken into consideration in the above tables.

- B. W. G.—Galvanized iron wire. Norway iron wire.
- American Screw Co.'s Wire Gauge.—Numbered size of machine and wood screws, particularly up to No. 14 (.2421 inch).
- Stub's Steel Wire Gauge.—Drill rod.
- Roebbling & Trenton.—Iron and steel wire. Telephone and telegraph wire.
- N. B. S.—Hard drawn copper. Telephone and telegraph wire.
- London Gauge.—Brass wire.

The Brown & Sharpe wire gauge, is given below, see table No. 1. The areas in circular and square mils are both given, also the resistance in ohms per 1,000 feet of length, etc. This resistance is in International ohms, not in B A units.

Table No. 3.

CURRENT REQUIRED TO FUSE WIRES OF COPPER, GERMAN SILVER AND IRON.

B. & S. Gauge.	Copper, Amperes.	German Silver, Amperes.	Iron, Amperes.	B. & S. Gauge.	Copper, Amperes.	German Silver, Amperes.	Iron, Amperes.
10	333.	169.	101.	26	20.6	10.6	6.23
11	284.	146.	86.	27	17.7	9.1	5.36
12	235.	120.7	71.2	28	14.7	7.5	4.45
13	200.	102.6	63.	29	12.5	6.41	3.79
14	166.	85.2	50.2	30	10.25	5.26	3.11
15	139.	71.2	42.1	31	8.75	4.49	2.65
16	117.	60.	35.5	32	7.26	3.73	2.3
17	99.	50.4	32.6	33	6.19	3.18	1.89
18	82.8	42.5	25.1	34	5.12	2.64	1.55
19	66.7	34.2	20.2	35	4.37	2.24	1.33
20	58.3	28.9	17.7	36	3.62	1.86	1.09
21	49.3	25.3	14.9	37	3.08	1.58	.98
22	41.2	21.1	12.5	38	2.55	1.31	.77
23	34.5	17.7	10.9	39	2.20	1.13	.67
24	28.9	14.8	8.76	40	1.86	.95	.56
25	24.6	12.6	7.46				

The table of carrying capacity of various wires, table No. 2, is that recommended by the Fire Underwriters, whose rules must be strictly followed for all electrical wiring and installations.

Some other useful wire data is also appended here, table No. 3, including a table of the current required to fuse wires of various sizes and kinds. A table of equivalent wires, table No. 4, which shows how many smaller wires are equivalent in area to one large one. The other data is for annunciator wire;

Table No. 4.

EQUIVALENTS OF WIRES.—B. & S. GAUGE.

0000	=	2-0	=	4-3	=	8-6	=	16-9	=	32-12	=	64-15
0000	=	2-1	=	4-4	=	8-7	=	16-10	=	32-13	=	64-16
00	=	2-2	=	4-5	=	8-8	=	16-11	=	32-14	=	64-17
0	=	2-3	=	4-6	=	8-9	=	16-12	=	32-15	=
1	=	2-4	=	4-7	=	8-10	=	16-13	=	32-16	=
2	=	2-5	=	4-8	=	8-11	=	16-14	=	32-17	=
3	=	2-6	=	4-9	=	8-12	=	16-15	=	32-18	=
4	=	2-7	=	4-10	=	8-13	=	16-16	=	=
5	=	2-8	=	4-11	=	8-14	=	16-17	=	=
6	=	2-9	=	4-12	=	8-15	=	16-18	=	=
7	=	2-10	=	4-13	=	8-16	=	=	=
8	=	2-11	=	4-14	=	8-17	=	=	=
9	=	2-12	=	4-15	=	8-18	=	=	=
10	=	2-13	=	4-16	=	=	=	=
11	=	2-14	=	4-17	=	=	=	=
12	=	2-15	=	4-18	=	=	=	=
13	=	2-16	=	4-19	=	=	=	=
14	=	2-17	=	=	=	=	=
15	=	2-18	=	=	=	=	=
16	=	2-19	=	=	=	=	=

damp-proof office wire; fixture wire; copper trolley wire, etc., see table No. 5.

Where rheostats or resistances of various kinds are necessary in electrical work, resort is had to some metal whose resistance is many times greater than that of copper. Resistance wires are employed for motor starting boxes, field rheostats, battery charging rheostats, and numerous other appliances, such as heating utensils, etc.

Resistance Wires.

The many new applications of electricity, especially that branch devoted to wireless, has necessitated the production of wires made of alloys having a high specific resistance.

A resistance wire, to meet the requirements of present practice must possess, in addition to a high specific resistance, some or all of the following properties, namely: ductility, high melting point, homogeneous structure, low temperature coefficient, be non-corrosive, have a low thermo-electric effect, compared with copper; its resistance must be uniform and unchangeable, and finally it must not become brittle with repeated heating and cooling.

Table No. 5.

ANNUNCIATOR WIRE.			DAMP-PROOF OFFICE WIRE.	
Size B. & S.	Pounds per 1,000 Ft.	Diameter Over All.	Size B. & S.	Pounds per 1,000 Ft.
14	15.	12	34.
16	9.5	14	24.
18	6.5	16	13.5
20	4.5	18	10.
			20	8.

FIXTURE WIRE—HEAVY WALL.			TROLLEY WIRE.	
Size B. & S.	Pounds per 1,000 Ft.	Diameter Over All.	Size B. & S.	Pounds per Mile.
14	27	3/16	0000	3376
16	17	5/32	000	2677
18	12	1/32	00	2123
19	11	1/8	0	1684
20	10	1/8		

LIGHT WALL.			WEATHERPROOF TWISTED PAIR.	
Size B. & S.	Pounds per 1,000 Ft.	Diameter Over All.	Size B. & S.	Pounds per 1,000 Ft.
16	12	1/8	14	53
18	9	7/64	16	32
19	8	7/64	18	23
20	7	3/32	19	20

WEATHERPROOF IRON WIRE.	
Size B. & S.	Pounds per Mile.
8	470
9	400
10	350
12	230
14	150

Obviously it would be quite impossible for any one alloy to possess all the properties cited, but a number of alloys are manufactured each of which possesses certain characteristic properties rendering each especially adaptable for certain lines of work.

German silver wire is drawn from an alloy of copper, nickel and zinc and the grade most used in electrical work is the one known as 18 per cent. German silver and which contains approximately 18 per cent. of nickel, while its resistance is approximately 18 times that of copper. A 30 per cent. German silver wire contains 30 per cent. of nickel and its resistance is about 28 times that of copper. This wire is not recommended where it is subjected to repeated heating and cooling, as it becomes extremely brittle.

Advance is the trade name of a wire of a copper and nickel alloy and contains no zinc. Its specific resistance is 28 times that of copper and its temperature coefficient is practically nil. This wire does not become brittle with repeated heating and cooling and is absolutely non-corrosive; wire made of this alloy is largely used in the construction of measuring instruments, resistance units, motor starters, etc. It can be procured in sheet, ribbon or wire, and the latter may be had either with hair, cotton or silk insulation.

Another resistance wire that has a resistance of 50 times that of copper goes by the trade name of *Climax*, and a general idea of what this means may be understood when it is stated that ordinary iron wire has but 7 to 8 times the resistance of a copper wire of the same diameter. Unlike German silver wire, Climax wire will not become brittle with repeated heating and cooling and its high specific resistance renders it an economical substitute. It is largely used for rheostats, resistance units, are lamps, resistance potentiometers for wireless receptors, etc.

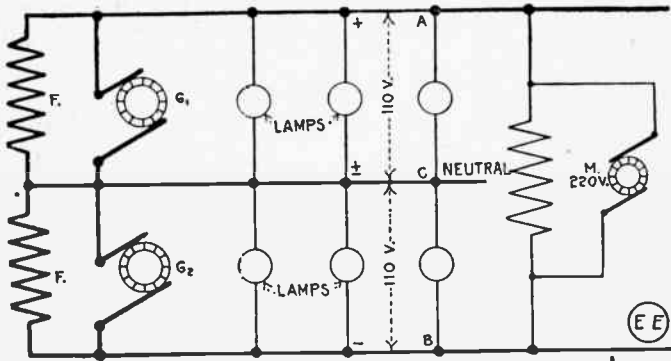

FIG. 2

A new wire known as *Nichrome*, has several important features which makes it distinctive and highly efficient for electrically heated apparatus and resistance elements where severe conditions are to be considered. Its specific resistance is about 20 per cent. higher than any other alloy. *Nichrome* withstands extremely high temperature without oxidization, is practically non-corrosive and will not become brittle with repeated heating and cooling. It may be obtained in either ribbon or wire form.

A wire manufactured especially for use in measuring instruments and standard resistance and therefore extremely suitable for wireless apparatus is known as *Manganin*. An important feature is its exceptionally small temperature coefficient, where only a difference of from 10 to 30 degrees centigrade need be considered, the change in resistance is so small it can be neglected. Cut Fig. 1 shows the relative sizes of wires to carry a given current.

The value of the necessary resistance for a specific case is readily found from Ohm's law, viz:—

$$R = \frac{E}{C}$$

Where R is the required resistance in ohms.
E is the drop in volts required.

And C is the current to be passed.

For electrical circuits the wires are always designed to carry the required load in amperes or watts, with a certain loss, known as the drop in volts. The usual drop for low voltage systems, is 3 to 5 per cent. of the line voltage or about 3 volts on 110 volt systems, etc.

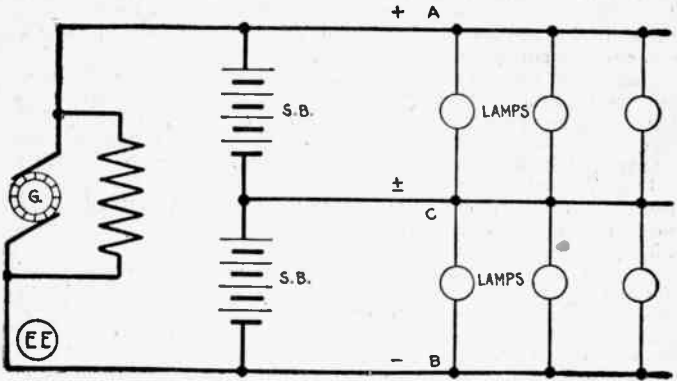

FIG. 3

The simplest method of finding the size of wire required for a certain length of circuit, to carry a given load in amperes, with a known drop in volts, is from Ohm's law:—

$$R = \frac{E}{C};$$

Where R represents the resistance in ohms of the total wire in the circuit.

E is the drop in volts allowable on the circuit, usually 3 to 5 volts on 110 volt systems.

C is the current in amperes to be passed over the circuit.

Finding the resistance of the total wire (both sides) in the circuit, the size of wire B. & S. Gauge, having this resistance per required length in feet, is easily found.

$$C M = \frac{21.6 \times d \times C}{V};$$

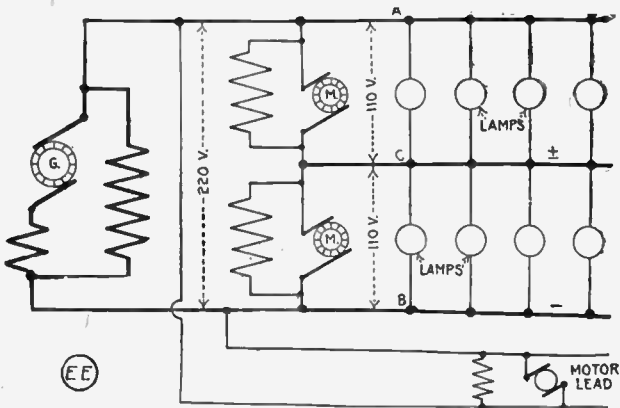

FIG. 4

The standard formula employed for all commercial wiring is given below, with the nomenclature or notation involve:

Where C M, is the circular mils area of wire required, (to be compared with the B. & S. wire gauge.)

21.6 = a constant.

$$V = \frac{21.6 \times d \times c}{C \cdot M.};$$

$$R = \frac{V}{C \times 2d};$$

$$2d = \frac{V}{C \times R};$$

d = distance of load, or length of circuit one way to centre of distribution in feet.

C = current required in amperes.

V = volts drop allowed.

Other useful forms of the above expression are as follows:

Where R = resistance in ohms per foot of wire to be used.

2 = a constant.

The amount of current required for various classes of load, is dependent upon the watts consumed by the apparatus. A 550 watt motor on 110 volts will consume 550 divided by 110 or 5 amperes. Carbon filament lamps, take about .5 ampere for the 16 candlepower unit, and one ampere for a 32 candlepower lamp. Tungsten or Gem metallized filament lamps take the wattage designated on their label, as 40 watts, etc., and this divided by the voltage of the circuit gives the amperes of current consumed by them.

Where a bank of lamps are connected onto the circuit in multiple the total current taken will be the number of lamps, times the current per lamp. As an example:—If 8-16 candlepower carbon filament lamps were connected on multiple, the total current taken by them would be 8 times .5 amperes or 4 amperes. 8-32 candlepower lamps on multiple would require 8

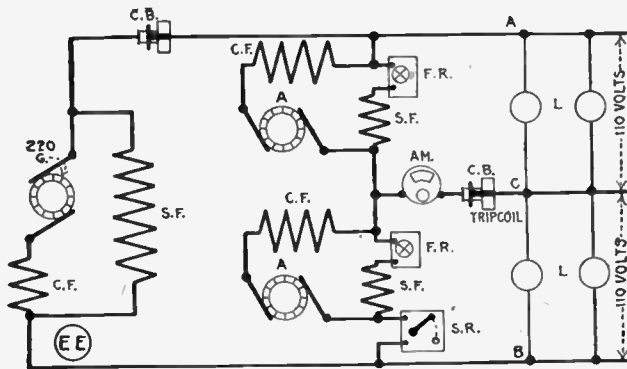

FIG. 5

times 1 ampere or 8 amperes. The load current for a bank of tungsten lamps may be ascertained by finding the total watts consumed by the bank, and then dividing this value by the voltage of the system.

When installing wires for D. C. motors, an extra allowance must be made for the starting current, which is somewhat greater than the normal running current. It is usual to calculate on 25 per cent. greater current than that normally taken by the motor, but 50 per cent. over allowance is better. The regular running current consumed by a motor is not only that given by the number of horsepower mechanical output, but also plus that amount lost in the motor, due to its transforming of electrical into mechanical energy. This efficiency of conversion varies from 70 per cent. up to 98 per cent. in the larger sizes.

Efficiencies of various size D. C. motors is given below:—

Mechanical	H. P. output.....	Efficiency	73%	77	82	84	86	86	87	89	91	92
	.5	1	2	5	7.5	10	20	25	50	100		

A formula may be deduced for the purpose of finding the requisite size of conductors for any size D. C. motor, which takes into consideration the 25 per cent. excess current required by the Fire Underwriters' Rules:—

$$A = \frac{(P \times 746 \times L \times 22 \times 1.25)}{(E \times e \times \text{Efficiency})}, \text{ in C. M.}$$

In which:—P is the rating of the motor in mechanical H. P.

L is the distance in feet to the motor.

E is the impressed voltage of the circuit.

And e the allowable drop in volts in the circuit; (varying from 4 to 8 volts.)

When the proper size of wire has been found from the above or other rule, the table of carrying capacities of rubber covered wires must be consulted, and if the wire calculated has to carry more current than that indicated in the Underwriters' table, then the size of wire recommended by them must be employed even though it is larger, and more expensive than the one calculated. (See tables No. 1 and 2.)

In alternating current systems, as single phase two wire, where the load is only incandescent lamps, the rules and formula employed above for D. C. circuits can be applied; the inductive skin, and other effects being negligible for ordinary lamp circuits not exceeding 500 to 1,000 feet in length. One important item, in the installation of A. C. wires must not be overlooked, and that is; that the two wires composing a circuit must both be placed in the same iron pipe or conduit, otherwise serious inductive effects, and consequent heating will be set up. For this reason it is advisable to always install the two wires of a circuit in the same iron conduit, even if it is to be utilized for D. C. as later it may be desired to change the system to A. C. and it can then be readily done, without any changes in the wiring.

Except in fixture wiring, (where No. 16 or 18 rubber covered fixture wire may be used), no smaller wire is to be installed than No. 14 B. & S. This may be asbestos covered, or weatherproof rubber covered, where the wires are exposed to view and rigidly supported on porcelain knobs or cleats, spaced every $4\frac{1}{2}$ feet. Where the wires are to be placed in iron pipe, flexible circular loom, or in other concealed locations it must be *rubber covered, double braid*. *Single braid rubber covered* wire is permissible for *exposed work*, where the wires are in view at all parts of the circuit.

The so-called *B X cable*, is a very good combination of flexible steel conduit and impregnated wires, which is extensively applied. It comes in any desired size, and has only to be fastened in place, to make the finished job.

For most wiring, it is difficult to install solid copper conductors having greater area than No. 4 B. & S. rubber covered, and so stranded cables, built up of numerous small copper wires, so as to be more flexible, are employed. The equivalent area, of a stranded cable of any size, is found by multiplying the total number of wires in it, by the area in circular mils of one of the individual wires, which gives the equivalent area in C. M. Cables or conductors of greater area than No. 0000 B. & S. gauge are always rated in C. M., thus:—2,000,000 C. M. cable; 4,500,000 C. M. cable, etc.

In three wire D. C. systems it is common to divide up the lamp load between the centre or neutral wire, and the two outside wires. Motors are invariably, except those smaller than one-quarter horsepower, connected across the outside wires. The voltages of the three wire D. C. system are generally 110 volts between either outside wire and the neutral, and 220 volts, (for motors), between the two outside wires. This saves considerable copper, as the current required by motors on 220 volts is only one-half that required on 110 volts, and twice the drop in volts is permissible on 220 volts, as compared to that on 110 volt circuits.

For incandescent lamp loads on the three wire system, it may be considered that the lamps are evenly balanced on the two sides of the system, in which case no current would traverse the neutral or centre wire at all. In figuring out the leads, etc., it is seen that with the lamps, two in series, on 220 volts, the current will be but one-half that, if the lamps were all on multiple, on 110 volts. In other words, the current to be figured on, is but one-half the regular 110 volt rating, and the circuit voltage is doubled, with twice the drop permissible on 110 volts. The outside wires are calculated for the motor load current in the usual manner, at 220 volts rating. The neutral wire is always made equal to the outside wires, in size, in good commercial installations. Acting on the possibility, however, that the system will never become totally unbalanced, the neutral wire is often made smaller than the outside wires. If a fuse should blow in one of the outer feed wires, however, the resulting load on one side of the system, would have to be carried by the outside wire and the neutral; and hence it is always advisable to make it at least as large as the outer wires.

The three wire Edison system is utilized with various combinations of power generators and balancers. The original arrangement was that making use of two dynamos of 110 volts, connected in series. The neutral wire was connected between them as illustrated by the diagram, Fig. 2, M, being a motor across the outside leads; L, the lamp load, balanced on the two sides of the system as near as possible; G, and G2, the two 110 volt generators.

Another development of the three wire scheme is that at Fig. 3, where a storage battery of voltage equivalent to that across the two outer wires, is floated across the generator, and balances the load requirements of the two halves of the divided system supplying lamps.

The latest way of arranging the three wire system, where it is desirable to have 110 volts for a few lamps, and the main plant supplies 220 volts, D. C. is the motor balancer set, illustrated by Fig. 4. The regular 220 volt motor load is taken from the leads of the generator, G. The two small motors M M, connected rigidly to the same shaft, operate alternately as a motor and a generator as the lamp load increases and decreases on either side of the three wire circuit. When the load on one side becomes too heavy the motor on that side acts as a generator, helping to carry the load, and the other motor on the opposite underloaded side of the system, acts as a motor to drive the generator on the other end of its shaft, and vice versa, as the load fluctuates.

Fig. 5, gives a working diagram of a commercial balancer set, including the circuit breaker, C. B.; field regulating rheostat, F. R.; ammeter, A. M.; generator (220 volt D. C.), G.; shunt field winding, S. F.; compound field winding, C. F.; armatures, A.; and starting rheostat, S. R.

When the system is perfectly balanced, no current passes through the neutral wire, the balancer set running idle at a speed sufficient for each armature to generate a counter E.M.F. (voltage) very nearly equal to one-half the voltage across the outside wires. As an example, if the outside wire voltage is say 220, then if the E. M. F. on one side of the three wire system should drop below 109 volts for instance, the armature of the machine on that side of the system, would act as a generator to maintain the voltage, while the rise of pressure on the other side of the system, would cause the armature connected to it, to operate as a motor, and drive its (now generator) element at nearly constant speed.

It is well to have each field of the machines of the balancer set, equipped with a few series field convolutions, and so connected that, when either machine operates as a generator its field is cumulatively compounded, and when running as a motor, it is differentially compounded. By this means the voltage of the generator will be slightly raised, owing to the increased field strength and also to the greater speed of the motor, due

to its weakened field. When the shunt field and series field act in unison, they are termed cumulative and when they oppose one another, they are referred to as differential. (See Lesson No 8, Motors and Dynamos.)

Electrical Units.

The electrical units are as follows:

Volt—Unit of motive force. Force required to send one ampere of current through one ohm of resistance.

Ohm—Unit of resistance. The resistance offered to the passage of one ampere, when impelled by one volt.

Ampere—Unit of current. The current which one volt can send through a resistance of one ohm.

Coulomb—Unit of quantity. Quantity of current which impelled by one volt would pass through one ohm in one second.

Farad—Unit of capacity. A conductor or condenser which will hold one coulomb under the pressure of one volt.

Joule—Unit of work. The work done by one watt in one second.

Watt—Unit of energy, and is the product of the ampere and volt. That is, one ampere of current flowing under a pressure of one volt gives one watt of energy.

One Electrical Horse Power is equal to 746 watts.

One Kilowatt is equal to 1000 watts.

Ohm's Law connects the three units, volt, ohm and ampere. The current in any circuit is directly proportional to the electromotive force, and inversely proportional to the resistance. The units are so chosen so that when there is one ohm resistance in circuit an electromotive force of one volt produces a current of one ampere.

Ohm's law is:

$$\text{Current in amperes} = \frac{\text{Electromotive force in volts}}{\text{Resistance in ohms}}$$

Abbreviated into: C, current; E, volts; R, resistance.

$$1. \quad C = \frac{E}{R} \qquad 2. \quad E = CR \qquad 3. \quad R = \frac{E}{C}$$

(1.) A dynamo with an electromotive force of 60 volts will send through a resistance of 5 ohms a current of 12 amperes.

$$C = \frac{60}{5} = 12 \text{ amperes.}$$

(2.) A dynamo to send a current of 2 amperes through a resistance of 25 ohms must have an electromotive force of 50 volts.

$$E = 2 \times 25 = 50 \text{ volts.}$$

(3.) The resistance of a circuit when an electromotive of 80 volts sends a current of 10 amperes through it will be 8 ohms.

$$R = \frac{80}{10} = 8 \text{ ohms.}$$

To find the watts consumed in a given electrical circuit, such as a lamp, multiply the volts by the amperes.

To find the volts, divide the watts by the amperes.

To find the amperes, divide the watts by the volts.

To find the electrical horsepower required by a lamp, divide the watts of the lamp by 746.

To find the number of lamps that can be supplied by one electrical horsepower of energy, divide 746 by the watts of the lamp.

To find the electrical horsepower necessary, multiply the watts per lamp by the number of lamps and divide by 746.

To find the mechanical horsepower necessary to generate the required electrical horsepower, divide the latter by the efficiency of the generator.

To find the amperes of a given circuit, of which the volts and ohms resistance are known, divide the volts by the ohms.

To find the volts when the ampères and watts are known, multiply the amperes by the ohms.

To find the resistance in ohms, when the volts and amperes are known, divide the volts by the amperes.

Current Required to Fuse Wires of Copper, German Silver and Iron.

Calculated from the formula $a d^2 = C$, where "a" is a constant depending on the nature of the wire. For copper, a = 10244, German silver = 5230, and iron = 3148. (This formula is due to W. H. Preece, F. R. S.)

B. & S. Gauge	Copper Amp.	German Silver Amp.	Iron Amp.
10	333.	169.	101.
11	284.	146.	86.
12	235.	120.7	71.2
13	200.	102.6	63.
14	166.	85.2	50.2
15	139.	71.2	42.1
16	117.	60	35.5
17	99.	50.4	32.6
18	82.5	42	25.1
19	69.	34.2	20.2
20	56.5	29.9	17.7
21	49.3	25.3	14.9
22	41.2	21.1	12.5
23	34.5	17.7	10.9
24	28.9	14.8	8.76
25	24.6	12.6	7.46
26	20.6	10.6	6.22
27	17.7	9.1	5.36
28	14.7	7.5	4.45
29	12.5	6.41	3.79
30	10.25	5.26	3.11
31	8.75	4.49	2.65
32	7.26	3.73	2.2
33	6.19	3.18	1.88
34	5.12	2.64	1.55
35	4.37	2.24	1.33
36	3.62	1.86	1.09
37	3.08	1.58	.93
38	2.55	1.31	.77
39	2.20	1.13	.67
40	1.86	.95	.56

Metric Conversion Table.

Millimeters	×	.03937	=	Inches
Millimeters	=	25.400	×	Inches
Meters	×	3.2809	=	Feet
Meters	=	.3048	×	Feet
Kilometers	×	.621377	=	Miles
Kilometers	=	1.6093	×	Miles
Square centimeters.....	×	.15500	=	Square inches
Square centimeters.....	=	6.4515	×	Square inches
Square meters.....	×	10.76410	=	Square feet
Square meters.....	=	.09290	×	Square feet
Square kilo-meters.....	×	247.1098	=	Acres
Square kilo-meters.....	=	.00405	×	Acres
Hectares	×	2.471	=	Acres
Hectares	=	.4047	×	Acres
Cubic centimeters.....	×	.061025	=	Cubic inches
Cubic centimeters.....	=	16.3856	×	Cubic inches
Cubic meters.....	×	35.3156	=	Cubic feet
Cubic meters.....	=	.02832	×	Cubic feet
Cubic meters.....	×	1.308	=	Cubic yards
Cubic meters.....	=	.765	×	Cubic yards
Liters	×	61.023	=	Cubic inches
Liters	=	0.1739	×	Cubic inches
Liters	×	.26418	=	U. S. gallons
Liters	=	3.785	=	Imperial S. gallons
Grams	×	15.43	=	Grains
Grams	=	.064	×	Grains
Grams	×	.03527	=	Ounces, av'dupois
Grams	=	28.3495	×	Ounces, av'dupois
Kilograms	×	2.2046	=	Pounds
Kilograms	=	.4536	×	Pounds
Kilog's per sq. centimeter....	×	14.2231	=	Lbs. per sq. inch
Kilog's per sq. centimeter....	×	.0703	×	Lbs. per sq. inch
Kilogram per cubic meter....	×	.06243	=	Lbs. per cubic ft.
Kilogram per cubic meter....	=	16.01890	×	Lbs. per cubic ft.
Metric tons (1,000 kilog's)...	×	1,1023	=	Tons (2,000 lbs.)
Metric tons	=	.9072	×	Tons (2,000 lbs.)
Kilowatts	×	1.3405	=	Horse-powers
Kilowatts	=	.746	×	Horse-powers
Calories	×	3.9683	=	B. T. units
Calories	=	.2520	×	B. T. units
Francs	×	.193	=	Dollars
Francs	=	5.18	×	Dollars

LESSON No. 7.

TELEGRAPHS AND TELEPHONES.

THE electric telegraph was the forerunner of the telephone, and so we may naturally take up the study of its operation first. S. F. B. Morse of the United States, was the first one to perfect an electro-magnetic telegraph signalling instrument, which also included a recorder employing a moving paper tape, upon which the

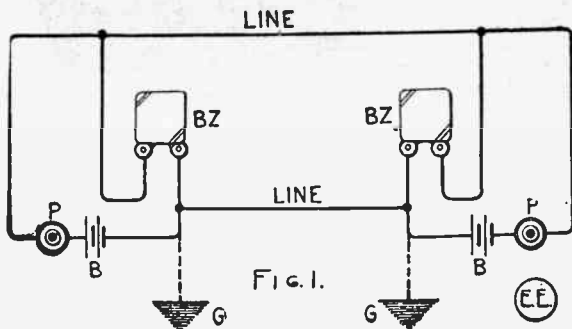

Code dots and dashes were recorded. The tape register is still used in many cases, but generally the familiar "sounder," ticks off the dots and dashes, signified by the short and long durations of the current through the sounder.

The simplest telegraph set for experimental use is easily made of two ordinary "buzzers," two push buttons, and a battery as illustrated by Fig. 1.

In the diagram shown two lines of copper or other wire are represented, but one of these may be substituted by the ground, the latter being denoted as optional by the dotted lines going to G. G. The operator at either end of the line presses the push button P, a short interval for a dot, and an interval twice as long for a dash. The various letters of the alphabet are made up of different combinations of dots and dashes as exhibited below, and make up "Morse" code. In what is known as the

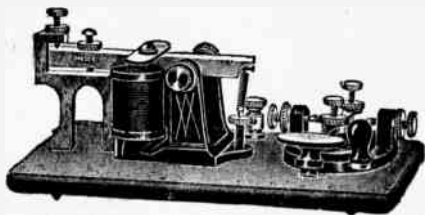
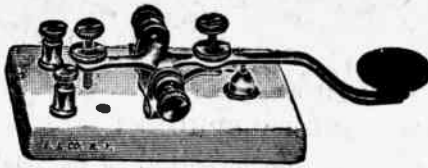

Fig. 2.

wireless telegraphy, there are three codes in common use, viz:—the Morse, U. S. Navy, and Continental. The advantage of the Continental Code lies in the fact that it contains no spaces in the letters or figures, as in the Morse Code.

The average speed of sending and receiving telegraph messages varies from 15 to 50 words per minute; according to the condition of the line, and the adroitness of the operator. In wireless work the speed is usually 40 words per minute, between expert operators. No bad weather conditions hamper the speed of transmission here, as with the ordinary wire lines, which experience considerable leakage, in wet weather, causing the line action to be very sluggish.



Standard Key

The simple learner's telegraph set is depicted at Fig. 2, and comprises a four ohm sounder and key. Two cells of dry battery will work this set over lines not exceeding 50 feet in length. It can be used on

longer lines by employing a relay in connection with it, or its magnet coils may be rewound to higher resistance, allowing it to work with less current. A common resistance for sounders on larger lines is 20 ohms.

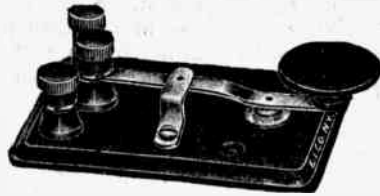

Fig. 3.

A cut of a standard key is shown by Fig. 3, the smaller one being a strap key adapted for light work, such as a buzzer circuit. Several forms of relays are seen at Figs. 4, 5 and 6. At Fig. 4 is the Gernsback relay. Figs. 5 and 6 show the make-up of a polarized relay. These relays work with the current coming in one certain direction only. Reverse current does not effect them. Hence they are utilized on duplex and other telegraph work, where more than two signals are to be sent over a line simultaneously.

For ordinary lines not over 20 miles long, a 150 ohm relay is usually employed. Higher resistance relays are used for long distance circuits.

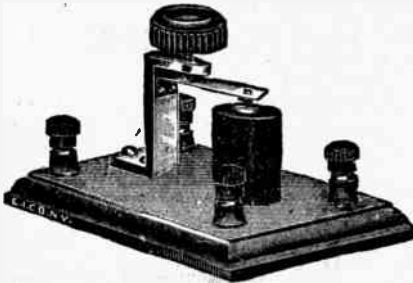

Fig. 4.

For the beginner, the best practice is had by teaching by an expert operator. Where this is not possible, an automatic sending instrument, capable of being regulated for any sending speed, is the "Omnigraph," a cut of which is

shown at Fig. 7.

The battery generally used for all commercial telegraph service is the so-called "gravity" cell, or "Blue Vitriol" battery. Copper Sulphate crystals are placed in water to make the electrolyte, while a zinc and copper elec-

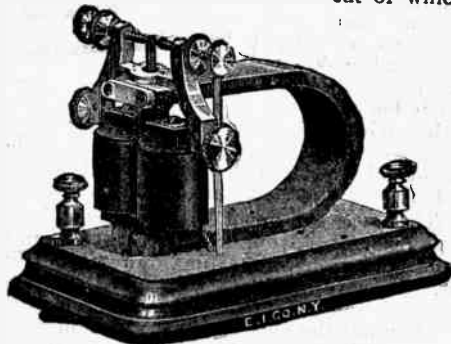

Fig. 5.

trode are immersed in the solution to form the couple. When first setting up a gravity cell, it should be short-circuited by a piece of copper wire for several hours. The gravity cell is essentially a closed-circuit battery, and must be constantly worked,

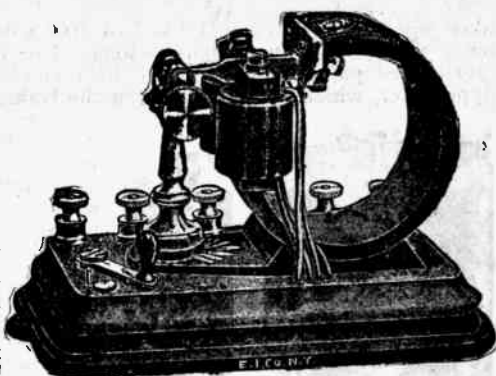

Fig. 6.

or it deteriorates very rapidly. For intermittent service, any batteries may be used. The Edison or Gordon primary cell may be used for heavy duty on closed circuit, and give good results, whether standing idle or not. The various characteristics of the gravity and other cells is thoroughly discussed in the chapter on Batteries. A cut of a dry cell and a Gordon 300 ampere-hour primary cell are shown at Fig. 8.

A few words will now be devoted to the connecting up of the instruments on several lines. In Fig. 9, is shown the connections for a learner's set, consisting of Sounder, S.D., Key, K, and Battery, B. In Fig. 10, is seen the hook-up for a metallic line (two wires) with two sets of instruments, having a local battery at each end of the line. A grounded circuit with lightning arresters complete is depicted at Fig. 11, where X is the lightning arresters, R the high resistance relays, S, the sounders, K, the key, L.B., the local battery for actuating the sounders; M.B., the main battery for working the relay over the line, and G, the ground connection. As will be seen, the depressing of the Key K, at either end of the circuit, sends battery current through the opposite station's relay magnet coils. This causes the relay armature to draw toward the magnet poles, and in so doing it closes the contact for the local battery circuit, through the sounder, S.

In commercial operation now, not only one message is sent over the single wire at one time; but four in each direction, or eight simultaneously; which forms what is known as the "Quadruplex," or simply the "Quad" System. The quadruplex system is quite complicated, and involves the use of loading or balancing resistances and capacities. Maver's Book on American Telegraph Practice.



Fig. 7.

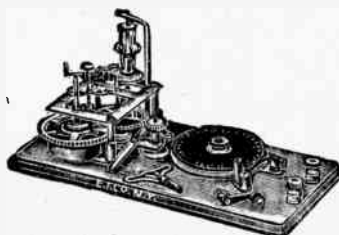

Omnigraph with Spring Motor.

gives all the details of this and other systems. The latest achievement in the realm of telegraphy is the "Delany Telepost," which

makes possible the wonderful speed of 1000 words per minute, over a wire several hundred miles long. The *Telepost* utilizes a perforated paper tape, prepared in a machine resembling a typewriter, which is then placed in the transmitting instrument, and passed through it so fast, that 1000 words, and more, have been transmitted in a minute. This remarkable achievement won for Patrick B. Delaney, the inventor, the Franklin Institute Medal.

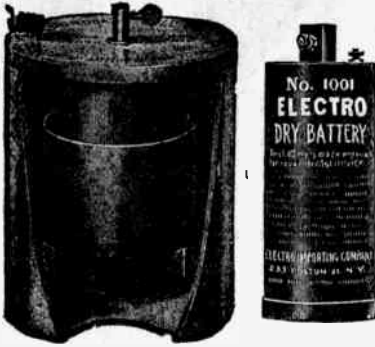

Fig. 8.

Submarine telegraphy is a large branch of the business and makes use of numerous cables sunk in the ocean, and projecting around the world now. Their use will probably be short-lived, now that the wireless system can so readily

bridge distances of several thousand miles. A reflecting galvanometer or Kelvin Syphon recorder is employed for Submarine signalling. The current received is of course very weak, and also greatly retarded owing to the high capacity of the submerged cable. Cable messages are usually transmitted at speeds not exceeding 12 words per minute.

The Telephone is one of the most useful inventions of mankind, many times more so than the telegraph, perhaps, but both fill their particular functions well.

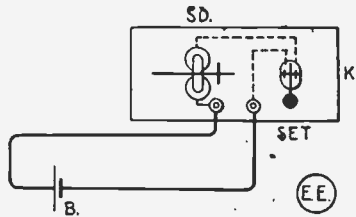

FIG. 9

The first successful speaking telephone was perfected by Alexander Graham Bell, and was exhibited at the Centennial Exposition held at Philadelphia in 1876. It was a weak and puny affair, that first telephone, but it talked, and now we would not know what to do without it. Its loss would paralyze the world's business, at least in such centres of activity as New York or London, where buildings 50 stories high are built.

The various parts going to make up the simplest telephone, are shown at Fig. 12, and consist of the transmitter, receiver, battery, and hook-switch.

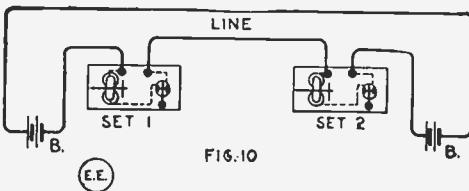

FIG. 10

A cut of a "Telimphone" is seen at Fig. 13. This instrument will talk satisfactorily on circuits not over 4000 feet long, and sells at a very reasonable price.

Referring to Fig. 12 again, we will now discuss the various parts of a telephone and their individual functions.

The battery is usually of dry cells, two being generally sufficient, and supplies current for the set. The transmitter is usually made up of two carbon discs, between which is

placed a small quantity of carbon granules. When the voice is spoken into the mouth-piece of the transmitter, the air currents set up, impinge against a thin iron diaphragm about 2½ inches in diameter. To the center of this diaphragm is secured one of the carbon discs or buttons, and as the voice

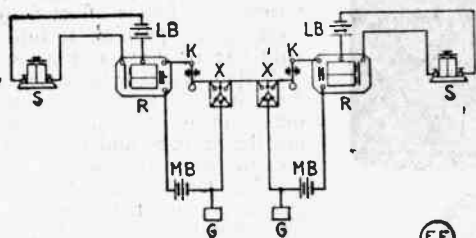

FIG. 11

air waves cause the iron diaphragm to vibrate, the attached carbon disc also vibrates, which causes the contact between the carbon granules and both discs to vary, and the resistance likewise varies according to the strength of the air waves originally produced.

The receiver has a similar soft iron diaphragm, placed before a permanent magnet, upon the end of which is wound a coil of fine insulated copper wire. The variations of the current strength in the circuit, created by the transmitter, react upon the receiver, and causes corresponding varying electromagnetic forces to act upon the soft iron diaphragm, which is a short distance away from the pole face of the magnet.

The action of the various parts in reproducing articulate speech, is more readily perceived by looking at Fig. 14. Here it is seen that two similar electromagnets and sets of iron diaphragms are connected together by copper wires. If the voice is projected into one of the receivers, the slight movement of the diaphragm at that particular instrument will cause currents to be generated in the coil on the end of the strong permanent magnet, and these currents will surge out over the line wires, and into the coil on the receiver, at the other end of the line. When these varying currents pass around the coil of the second receiver, they create variations in the strength of this magnetic flux affecting the diaphragm, and hence the diaphragm is attracted and released simultaneously, giving rise to air currents, corresponding to, and thus reproducing the voice at the transmitting end of the line.

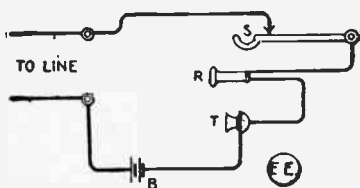

FIG. 12

For short distances two good telephone receivers connected in series may be used for a telephone line, the receiver acting as a transmitter as well. This was the method followed in the early instrument, there having been no transmitter, until Emil Berliner perfected his type. The trouble with the receiver acting as a transmitter, is that its variation is not sufficiently distinct or pronounced for the voice air currents actuating it, and hence the decided change in resistance of the carbon transmitter for changing voice waves, has proved a boon.

In the set shown at Fig. 12, no induction coil is shown, this arrangement being adapted to short line service, but with well made apparatus the talking distances have reached

50 miles. The Anders Push Button Telephone is a series instrument, employing no induction coil. The hook-switch seen at S, is for the purpose of cutting out the battery when through talking, and the receiver simply hangs on it. Its normal position is affected by means of a spring pushing it into contact with one or more contact springs.

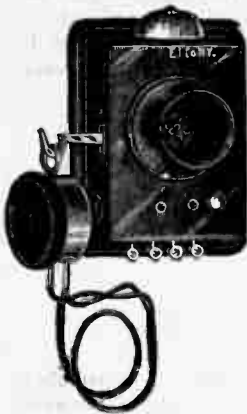

Fig. 13.

A standard telephone set, with induction coil, for battery service is diagrammed at Fig. 15. P and S are the primary and secondary windings of the induction coil, respectively. The primary winding has a low resistance and the secondary coil a high resistance. Its purpose is to step up the voltage of the talking circuit, so that the variations will be more suited to transmission over the line wires. A core of fine iron wires is inserted in the centre of the coil. R, is the receiver, generally of 75 ohms resistance, which is standard for all telephone work.

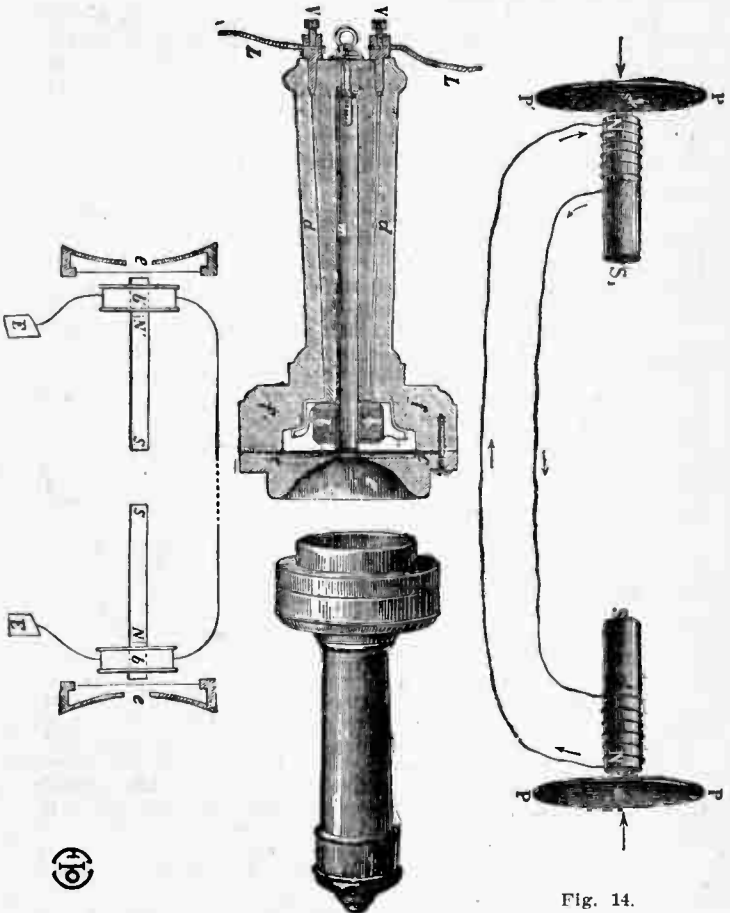

Fig. 14.

The ringing of the bell at the opposite station is accomplished by pushing the button of the double contact push but-

ton, P.H. When this button is in the normal position, it closes the bell circuit, as shown; providing the receiver is on the hook-switch, which depresses it against the ringing contact spring. While talking the ringing circuit is open, the hook-switch making contact against the two upper springs 3 and 4, seen in the diagram.

For a two party line, it is only necessary to string a couple of insulated wires, such as bell wires, and connect their terminals to the line posts of the instruments 1 L, and 2 L, respectively.

A hook-up for a central battery set of two telephones, which has many good points to commend it, is depicted at Fig. 16. In the set, which is not intended for lines over a mile long, no induction coil is used. The central battery, placed at either station, C. B., supplies energy for talking as well as ringing from either station. To ring the opposite station, the ringing key, R. K., is depressed while the receiver is on the hook. This telephone is a series instrument, and is of standard manufacture. C. K. represent resistance coils.

For line wires, No. 18 to 20 B. & S. gauge copper wire is generally employed. Bell wire is very good, if kept separated along the run; or if more than two wires are run, a good plan consists in making up a cable of them, and taping the whole bunch together, by wrapping around with black friction tape, letting it overlap about half of its width. This cable is easily and neatly run, and makes a very fair job.

Intercommunicating telephones are those installed in factories, and numerous other places, which are provided with a multipoint switch to allow of talking to any individual station on the system. Fig. 17 illustrates a four station intercommunicating set, either one of the three instruments being able to ring up any other instrument. The cable of line wires for this system must contain one more wire than the total number of instruments connected, the odd wire being called the common return wire, as all the telephones have one of their leads connected to it. This set is not non-interfering, and one party can interrupt any other, or listen in. Some systems of this type are so arranged, that interference between the various parties is impossible.

In running telephone circuits, it should be arranged that each line is of equal length, or else the capacity of the two lines will be unequal and give rise to unsatisfactory service. Electro-magnet windings, such as bell magnets, or the like should be kept out of the talking circuits.

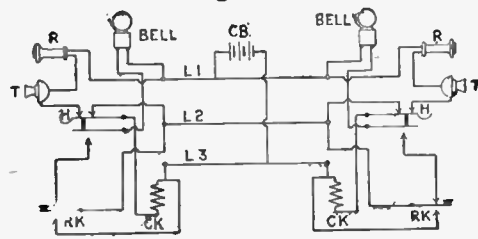

FIG. 16

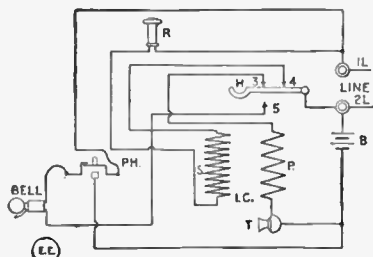

FIG. 15

Long circuits returning by the earth or ground, should be avoided in telephone service, as this creates noise in the instruments. For lines not

exceeding one-half mile, ground returns are generally satisfactory.

In large telephone exchanges, serving such cities as New York or Chicago, the battery power for all talking at the

exchange or subscriber's instrument is centralized at the exchange. A storage battery of 24 volts potential supplies the talking current. Ringing current is usually alternating or pulsating at about 70 volts potential. Calling the operator is done by simply removing the receiver from the hook, which act releases the hook, and this springing upward closes the circuit to the exchange. In this circuit is a sensitive relay, which closes a local circuit through a 24 volt lamp on the switch-board before the operator. When the lamp lights up, the operator plugs into the corresponding circuit jack, and ascertains what number is wanted. Having found out the desired number, the desired party is rung up by pressing a ringing key, and when they respond, the operator connects the two parties together by means of flexible cords and jack plugs.

The automatic switch-board is coming ahead rapidly, and has a host of commendable features. No manual operators are employed, except for effecting long distance calls. Where there are no central girls, there can be no interference, and hence many people will welcome the automatic switch-board. Chicago, Ill., and Los Angeles, Cal., have two of the largest automatic switch-board exchanges extant. Numerous other smaller cities are now equipped with automatic exchanges, having no operators.

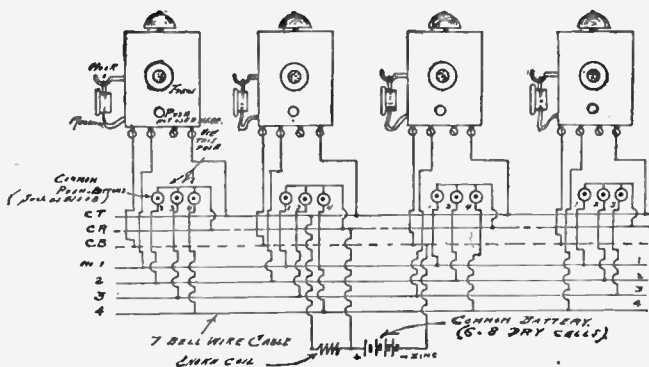

Fig. 17.

The average time consumed in making a connection between two parties in modern telephone practice varies from 4 to 12 seconds.

The telephone has grown to be one of the most highly developed if not the most highly developed branch of electrical engineering to-day. It employs over 200,000 people in the United States alone.

Telephone engineering is a paying and highly interesting profession. There are thousands of problems to be solved yet by the coming generation.

LESSON NO. 8.

DYNAMOS AND MOTORS.

DYNAMOS and Motors are electrical machines employed for the conversion of electrical energy into mechanical energy or vice versa. They depend for their operation upon the repulsion of like magnetic polarities, and the attraction of unlike magnetic polarities.

Primarily, the relation between magnetic polarity and

direction of current is as shown in fig. 1, where A shows the current traveling around a coil of wire clock-wise, or right-handed, with the magnetic pole resultant, *South*. At B, the current travels around the coil left-handed or counter-clockwise, with the magnetic pole resultant, *North*.

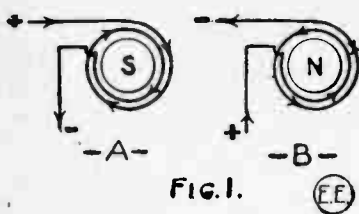

FIG. 1.

unlike poles attract one another. On this law rests the operation of dynamos and motors. Its exact arrangement in the electric motor is depicted schematically by Fig. 2.

In the diagram shown, F. P. is the stationary field magnet pole, (there are always two, or more in actual motors and dynamos), with a coil of insulated magnet wire wound around it. This coil receives current from a battery B, and gives a resultant *North* pole at the face toward the armature.

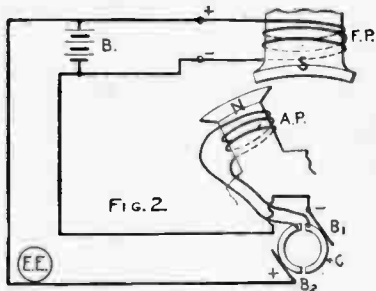

Fig. 2.

The moving armature pole A. P., has a coil of wire around it, (there being two or more in practice), and this coil also receives current from the battery B, through the contact brushes of spring brass B1 and B2.

A commutator or current reverser is represented by C, in figure, and consists of two semi-circles of brass or copper. These rotate with the armature. Now at the instant shown here, the armature coil is creating a magnetic *north* pole, and as *unlike poles* attract each other, the armature pole is drawn toward the *south* field pole. At this instant, however, the commutator has also moved, and the current through the armature coil has been reversed, the negative brush bearing on the opposite strip of the commutator, and the armature pole created is *south*, instead of *north*, with the consequence that the armature pole is repulsed or pushed away from the field pole, etc.

It is readily seen, from this discussion, that if there are arranged two field poles having north and south poles, respectively, and the armature provided with two or more poles, that a continuous rotation will be attained, due to the constantly changing or reversing polarities of the armature poles.

A small motor for use with batteries, is shown by fig. 3. This machine has a three pole armature to prevent it becoming set on dead centre.

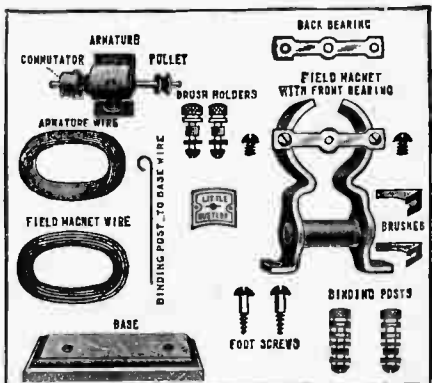

Fig. 3.

The field is a single coil bi-polar (two pole) type. The field and armature coils are

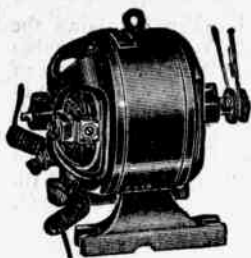

Fig. 4.

or wires, and the field magnets is responsible for the action of the machine. The early experimental machines had no iron in the armature at all, and the present day integrating watt-hour-meter motors have an armature without iron, also a field without iron.

The motor in Fig. 4, runs on a single cell or dry battery, and is very useful for operating models, etc. The motor illustrated by Fig. 5, is provided with a 6 segment commutator and 6 slot armature. It develops considerable strength on 6 volts battery current.

Before going further it will be perhaps advisable to define the exact difference between a dynamo and a motor.

A Dynamo, the principle of which was discovered by Michael Faraday, in 1831, is an electrical machine for the conversion of mechanical energy into electrical energy.

A Motor, the principle of which was accidentally discovered at an Exposition in Germany, half a century ago, is

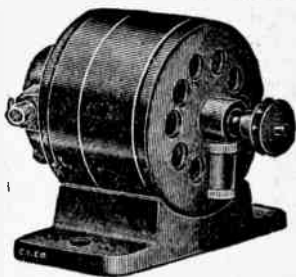

Fig. 5.

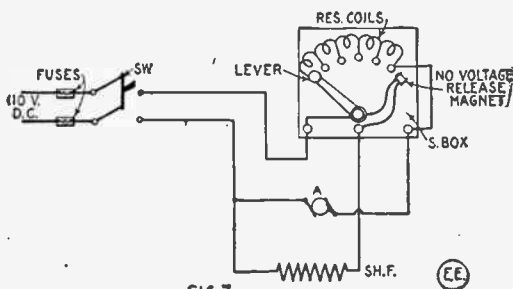

FIG. 7

an electrical machine for the conversion of electrical energy into mechanical energy.

Dynamos are variously called generators, alternators, etc., an alternator being a dynamo deliver-

ing an alternating or constantly reversing current, in contradistinction to the direct current machine, whose delivered current is always traveling in a constant direction; one terminal being known as the positive, and the other as the negative terminal.

Referring to the diagram fig. 2, if the moving armature poles and windings are driven past the excited field pole, then the change in magnetic induction between them will induce or set up in the armature windings, a current of electricity; whose strength or voltage, depends upon the number of turns of wire in the moving coil, its speed in revolutions per given interval of time; and thirdly upon the strength of the field pole, in lines of force per square unit of cross-section. The current in amperes is dependent upon the cross-sectional

area of the armature wire; about 600 circular mils per ampere being a common allowance.

Hence, from the above, it is seen that, with a constant field strength, raising the speed of rotation of the armature or the number of conductors in its coils, raises the voltage delivered and vice versa; in direct proportion to the magnitude of the above quantities, also the greater the area of the wire in circular mils, the greater the current permissible.

In general, there are three principal types of motor or dynamo, as regards the arrangement of the armature and field magnet windings. These types are known as the series, shunt and compound, and are shown diagrammatically in fig. 6.

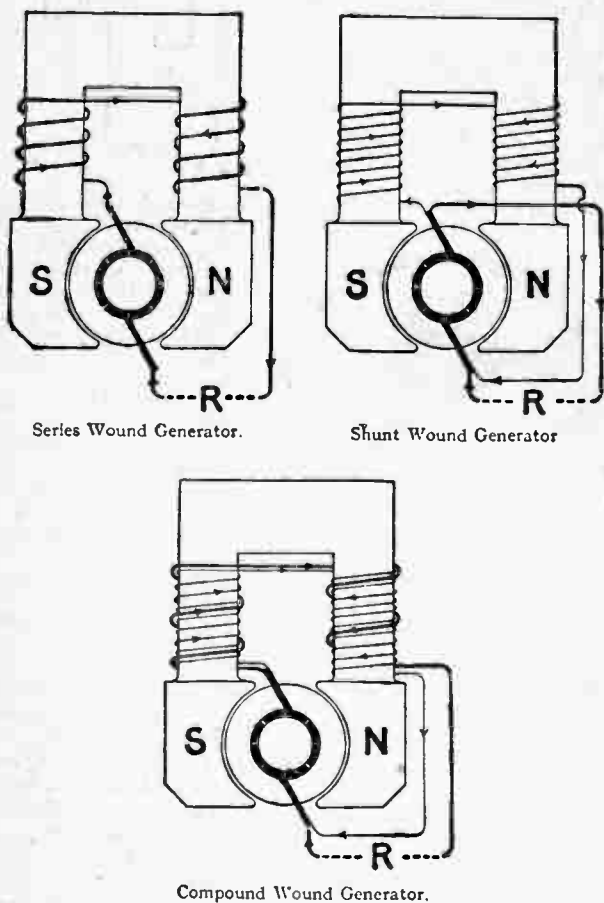

Series Wound Generator.

Shunt Wound Generator

Compound Wound Generator.



Fig. 6.

The series machine has several good and bad features. As a motor, it tends to run away if the load is suddenly removed; but for fans, or other rigidly connected load, as on street cars, etc., this motor has many ideal functions, the chief one being its powerful starting torque, or power. In general, its speed varies with the load, until with too great a load it will stop, and probably burn out.

The shunt machine has its field winding connected in parallel with its armature, and is the most widely employed type extant.

Its popularity is due to its nearly constant speed under all loads, the drop in speed from no load to full load, not exceeding 3 to 5 per cent. of the initial speed, in most cases.

Series motors in small sizes may be easily started by connecting direct to the supply circuit, but shunt motors, with their low armature resistance thrown directly across the circuit, would swamp the line for current, until it has reached sufficient speed to generate enough counter-electromotive-force to check the rush of current at starting.

A starting resistance, known commercially as a starting box, is connected in the circuit, to permit of feeding the current to the armature slowly, gradually increasing its value, as the motor speeds up. A diagram of a no-voltage magnetic release starting box, is seen at Fig. 7, for a shunt motor, and for a compound motor at Fig. 8.

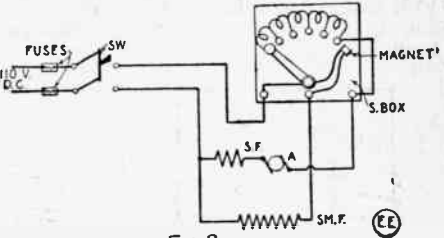

Fig. 8

at Fig. 7, for a shunt motor, and for a compound motor at Fig. 8.

In the diagrams, SW, is the main knife switch. A, the armature of the motor, SF the series or compound field winding, and SH, the regular shunt field winding.

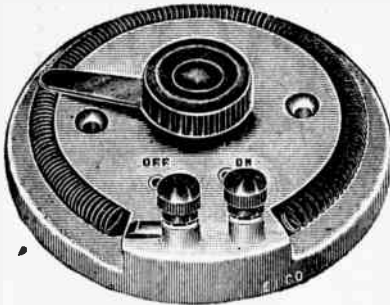

Fig. 9.

Compound wound machines are those having both series and shunt windings. The compound motor is the most constant speed type, while the compound dynamo is the most constant voltage generator, under varying

loads. There are two methods in use, for the connection of compound wound motors, or dynamos. When the series field coils are so connected that current travels around them in the same direction as that in the shunt coils, the two fields are said to be hooked-up "*cumulative.*" If the current passes around each of them in a different direction, then they are said to "*buck*" each other, or they are hooked-up "*differentially.*" In operating as a motor, if the fields are hooked-up cumulative, then the combined coils tend to strengthen the field flux, as the load increases. The armature current passes through the series field coils, and the field flux in lines of force is directly proportional to the number of turns in the coils and the amperes of current traveling through them. This is referred to as the resultant *ampere-turns*, or *amperes times turns* of wire. If the motor is connected up differentially, then as the load current (armature current) increased, it would pass through the series field coils and bucking the resultant field strength would be weaker. This causes the motor to speed up slightly, and so keep the mean speed value nearly constant. The draw-back to this method, however, lies in the possibility of the load becoming so severe, that the greatly weakened field would cause the motor to fail in its duty, and it would gradually come to a stop and burn out. The differentially wound machine is utilized quite ex-

tensively where its peculiar characteristics are of great value.

The speed of any motor is increased by weakening its field. This can be accomplished in a number of ways. The most common is to insert extra resistance in the field circuit. A handy adjustable rheostat for this purpose on small machines is the "Electro" Rheostat Regulator seen at cut 9. This rheostat has a carrying capacity of two amperes, constant load. Its resistance is 10 ohms. The adjustment of the resistance is extremely fine, there being over 200 steps in the instrument.

This rheostat is also very useful for connecting up in dynamo shunt field circuits to adjust the voltage. The voltage of a dynamo is varied by changing the resistance of the shunt field coils, by means of a rheostat; also the speed of rotation of the armature may be varied directly.



Fig. 10.

A well built water motor, having an operating efficiency of 86 per cent. is shown in Fig. 10. This wonderful little motor, when connected to the "Type S" dynamo shown in fig. 11, will light 4 to 5, 6 volt, 6 to 8 candle-power Tungsten lamps, which makes it an admirable adjunct for launch lighting, automobile head and tail lights, etc. The maximum power developed by the water motor illustrated is one-half horsepower on a two-inch main pipe feed, at 60 pounds pressure.

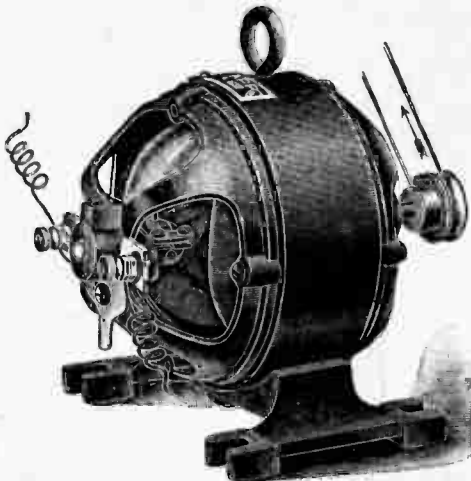
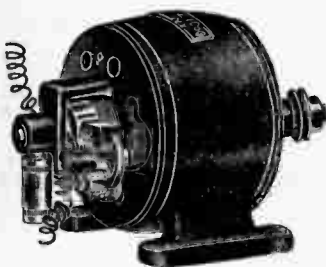

Fig. 11.

A generator especially designed for sturdy service, and adapted to be driven from the flywheel of an engine by contact with the friction pulley supplied with the machine is seen at fig. 12. The output of this dynamo, when rotating at a speed of 1800 revolutions per minute (R. P. M.) is 18 volts and 5 amperes.



Electro 8 Volt, 10 Ampere Dynamo.

The equivalent of this rating in watts, is equal to 18 times 5 or 90 watts, or nearly 1/10 of a Kilowatt; also 90/746 of a horsepower, there being 746 watts to one horsepower. The total watts output of any machine divided by 746 gives the equivalent horsepower output, and total watts divided by 1,000 gives the output in Kilowatts. (One Kilowatt = 1.34 horsepower or 1,000 watts.) This generator just

described will light up seven 18 volt Tungsten lamps at one time. The machine is supplied in two voltages, either 16 volts, 5 amperes, (80 watts) or 6 volts 14 amperes, (84 watts).

A very useful little dynamo known as the "Electrodyn" is depicted at fig. 13. Its output at 3,500 R. P. M., is 7 volts on open circuit. Safe maximum load 4 volts, $1\frac{1}{2}$ amperes. It will light up five 4 volt Tungsten lamps. As a power motor it runs at high speed on 6 volts.

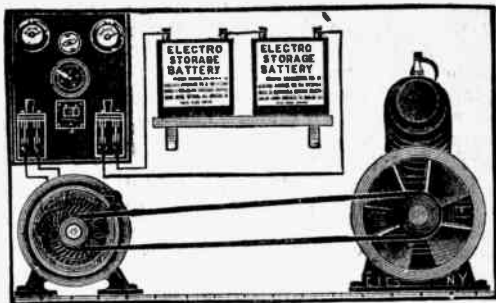

Complete Lighting Plant

For laboratory purposes, demonstrating, etc., a hand power drive for small dynamos has been developed and placed on the market. Its appearance is seen at fig. 15, and as will be at once perceived, it is doubly compounded, so as to drive the dynamo at greatest speed with the minimum exertion upon the part of the manipulator. Special spring belts are supplied with it, which prevent any ordinary trouble, such as slippage, etc.

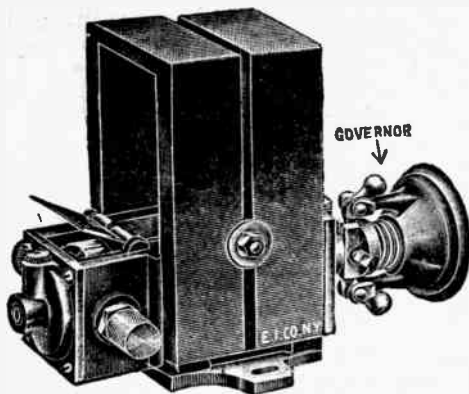

Fig. 12

Dynamos and motors, except in the smaller sizes below one-sixth horsepower, are interchangeable either as generators or motors. They are the same in all essential details, and when operating a motor as a dynamo by gearing it up to a mechanical drive, it may be necessary to change the position of the brushes slightly. Sometimes the dynamo refuses to generate current, and this may be due to a variety of causes, viz:—broken wire, dirt on the commutator or brushes; poor contact of the brushes; too low a speed; demagnetized or weak field. The last trouble is soon remedied by connecting up a few dry cells, storage battery or other direct current source to the field coils, and passing a current through them, for a few minutes. This will magnetize the iron again.

If the dynamo still refuses to build up, it may be necessary to reverse the field connections. All battery motors are direct current motors, i. e., they utilize a current that travels continuously in the same direction.

Some motors operate on alternating current, a diagram for the connection of a three phase A. C. motor, with starting switch, and speed regulator is illustrated by the cut and diagram, fig. 14.

Ordinary direct current motors can sometimes be operated on alternating current (single phase), by simply short-circuiting the brushes by a piece of heavy copper wire, and passing A. C. through the field winding. This arrangement constitutes what is commercially termed, a *repulsion motor*, owing to the fact that the rotation of the armature, or more properly, (*the rotor*), is due to the repulsion of the induced magnetic poles in the armature, by the constantly reversing magnetic poles of the stationary field or *stator*. Small D. C. motors are sometimes connected as series machines to A.C. circuits.

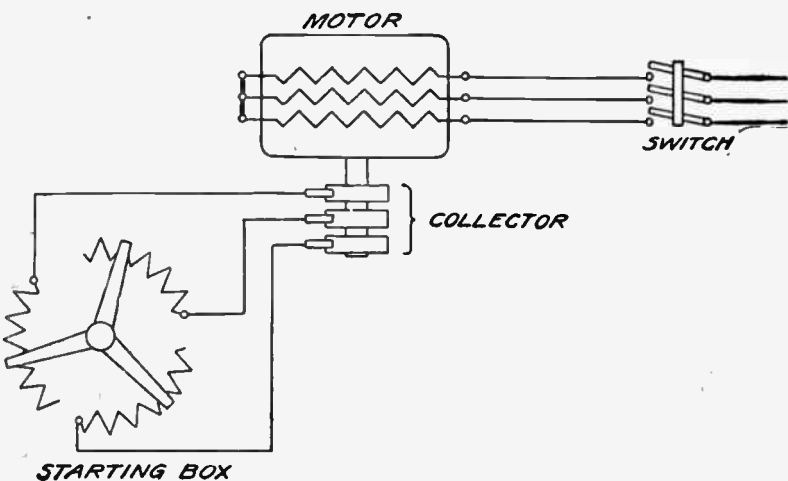
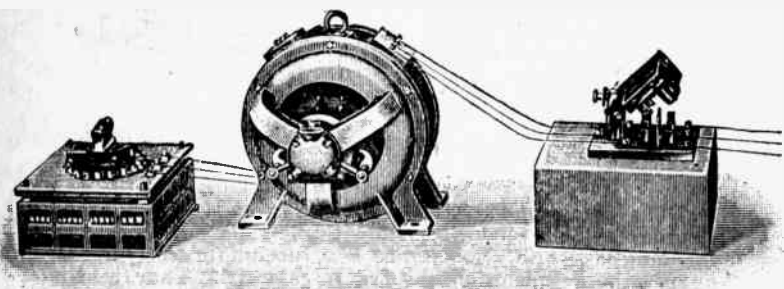

Fig. 14.

There are various types of A. C. motors in use now, principally, induction motors, repulsion motors, and the synchronous motor. The squirrel cage induction motor has a rotating member, having no electrical connection with the main circuit. The rotating member is much the same as an ordinary armature, composed of punched steel sheets, with a number of slots around its periphery. In the slots are placed solid copper inductors, all soldered or riveted to each other at the ends

of the steel drum. The constantly changing magnetic field acting from the *stator, or field portion*, sets up or induces magnetic poles and currents in the rotor or armature. The reaction between the induced rotor poles, and the constantly changing stator field drags the rotor around with it. Induction motors are subject to a slight *slip*, or lagging behind the theoretical speed.

The repulsion motor has already been mentioned. It has its brushes short-circuited, and A. C. is passed through the regular field windings. Usually there has to be a change made in the field windings for use on A. C. as the D. C. resistance is too great, owing to the high self-impedance incurred when A. C. is applied. The Jandus A. C. fan motors are of this type.

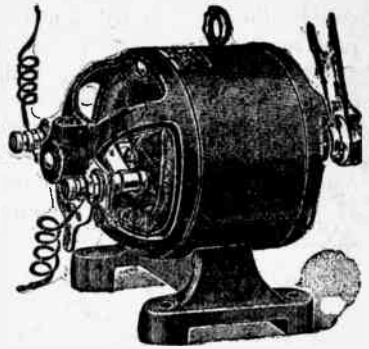

Fig. 13

The synchronous A. C. motor is a constant speed motor, running in step or synchronism with the supply A. C. feeding the motor. These motors are very useful for certain purposes, where synchronous speed is essential. They remain practically in perfect step with the supply current until they are considerably overloaded, when they instantly fall out of step or phase, and come to a sudden stop. Proper protective apparatus should be placed in the motor circuits, so that in event of their becoming stalled for any reason,

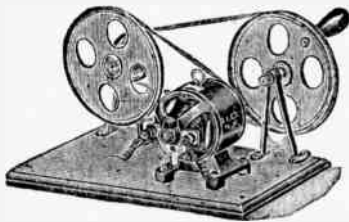

Fig. 15.

they will not be thrown across the line wires, with consequent heavy current surges, which are likely to burn out the main alternator. This has occurred several times, with disastrous results, in the author's experience.

LESSON NO. 9.

SWITCHES, BURGLAR ALARMS AND MISCELLANEOUS CONNECTIONS.

THE control of all electrical circuits is made possible by the use of some sort of mechanical current breaking device, known as a switch, circuit-breaker, etc., according to the style and function of the apparatus.

Some standard switches are shown at figs. 1 and 2. These are of the type known as knife switches, the contact being

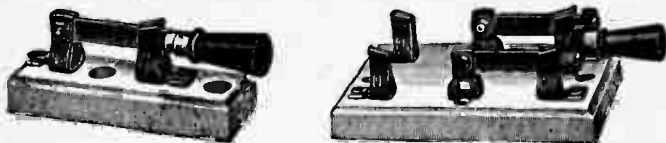

Figs. 1 and 2

made and broken by a knife blade of copper, fitting into a spring jaw also of copper. The movement of the live blade of the switch is accomplished without any shock, by means of the insulated handle shown.

The switch at fig. 1 is called a single-pole type, as it can only open or close one pole, or line of a circuit. The switch at fig. 2, is termed a double-pole type for the reason that it can control the two poles or lines of a circuit. For some purposes the single-pole type will serve, but in other instances the double-pole form is necessary.

For low voltage work and small currents, the "Electro" Baby knife switches, mounted on a black composition base, as in cuts 3 and 4, are

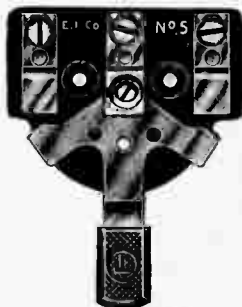

FIG. 3.



Fig. 4.

very useful. The larger of the two switches has a double bladed knife, arranged to swing into a contact at either side, giving quick control of either one of two circuits. The smaller single-pole switch of this type is neatly made and is equally serviceable. The double contact switch is readily used to good advantage for the control of a light from two different locations, as depicted by the diagram fig. 5. In operating this circuit, the switches are thrown either to the left or right-hand contact, and

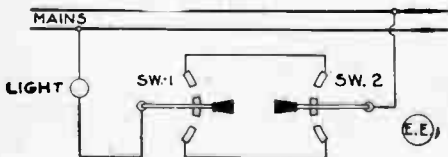

FIG. 5

either switch can then be made to light or extinguish the lamp. In commercial lighting this is a standard arrangement, and three way push-button or snap-switches, are employed in place of these switches, which are permissible only for low voltage circuits.

A miniature snap switch for low voltage work is seen at fig. 6. This is very useful for low voltage lighting circuits, and is a replica of the heavier built commercial snap switches. Its current carrying capacity is 5 amperes. The cap cover is of metal, nickel plated, while the base is of porcelain.

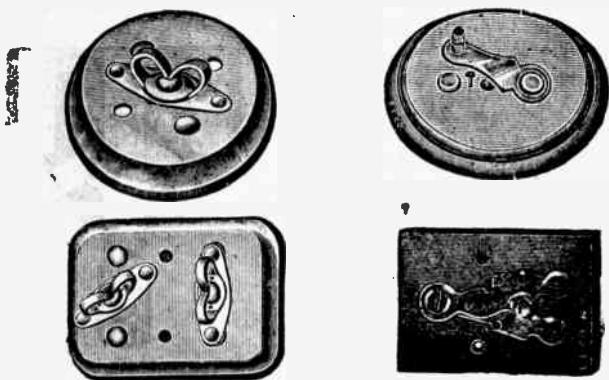

Fig. 6.

A variety of wood base and metal base switches suitable for bell, and burglar alarm work are illustrated by the cuts figs. 7 to 9. For making quick junctures between two portions of a circuit, the separable connector seen at fig. 10 is serviceable. This connector is adaptable to any portable apparatus, which is connected to independent sources of power, when in use, etc.

Having shown the different styles of standard switches, a few words on the use of them may not be out of place.

The proper connection of a single pole knife switch into a lighting circuit is indicated at fig. 11 A. The connection for a double pole single throw knife switch is shown at B. At C is one method of employing the multi-point lever switch for the control of battery power, supplied to a circuit. Another use of the multi-point lever switch is that



Figs. 7, 8 and 9

shown at D with resistance wire connected between the contact points, to form a rheostat for motor speed control, etc. The use of a double pole, double throw knife switch for reversing the polarity of a circuit feeding a motor or other apparatus, is gleaned from fig. 11 E. Throwing the knife-blades to the one side or the other, gives either of two polarities on the apparatus circuits. This is the standard method of reversing the direction of motors. The diagram

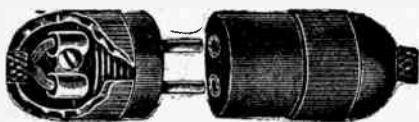

Fig. 10

for this particular purpose being outlined at fig. 12.

In diagram 12, MS, is the main switch in the supply circuit; A is the armature of a series motor; F, the field winding, and S,

the double pole, double throw knife switch, for reversing the field current, and also the rotation of the motor armature.

Diagram fig. 13 is for the reversing switch connected up to a shunt wound motor with armature starting resistance SR. If a compound motor is to be reversed, the compound,

or series field winding is connected in series with armature at X.

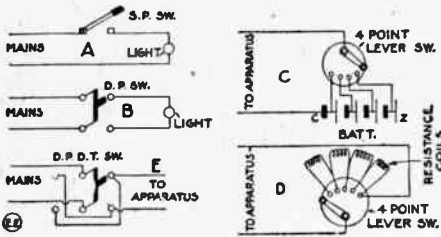

FIG. 11

A decidedly useful field for electrical alarms, is that involved in the detection of midnight prowlers, or burglars. The safes and

strong boxes of the best banks and private residences as well as all windows and doors are well provided with complete electrical alarm systems. In the following paragraphs a few of the best alarm systems will be discussed.

Probably the very simplest burglar alarm circuit, is that operating on the open circuit principle, i.e., normally the circuit is open, and the battery can be of dry or ordinary wet cells. Such an open circuit system is seen diagrammatically at fig. 14. B is the dry or wet cell battery and S is the single pole switch throwing in the battery, say at night before retiring. At W, W, W, W, are the window springs, which close the bell circuit whenever a sash is raised. D may be a door spring, which closes the alarm circuit whenever the door is slightly opened.

The method of mounting the window spring is plainly shown by fig. 15. When the sash is raised the insulated spring S, is allowed to curve outward, and in so doing, it makes contact with the frame of the alarm. At K is the cam shaped portion actuated by the sash as it raises and lowers.

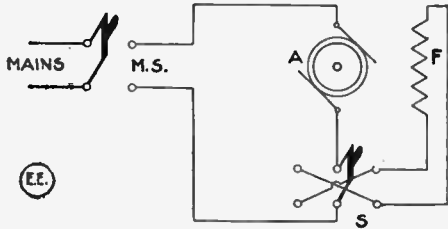

FIG. 12

Burglar alarm systems are usually arranged so that once the alarm bell has been started ringing, it will continue to ring until shut off, irrespective of the position of the window or door spring. There are two ways of accomplishing this function: one is that employing a self-switching bell, and the other by the interposition of a relay drop, in the circuit.

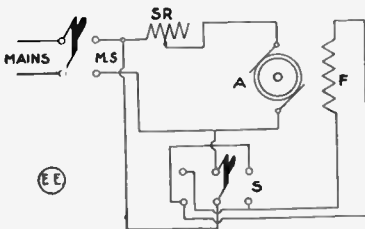

FIG. 13

The circuits of the continuous or self-switching bell, will be understood from fig. 16, which shows the working details; S is a pivoted arm held normally in the open circuit position shown, by means of the projection on the armature of the bell. If the regular circuit of the bell is now closed, by pushing the button P, the

armature moves toward the magnet cores, and in so doing it releases the pivoted arm S, which is pushed upward

against the auxiliary contact screw V, and the bell has a complete working circuit established separately from the push button circuit. It will continue to ring until shut off by a switch, or the trip arm is reset.

The manner of hooking it up in a burglar alarm circuit is seen at fig. 17, where S is a switch; B the battery and W, W, window or other alarm springs. The circuit is of the open type, i.e., normally there is no current passing through the circuit.

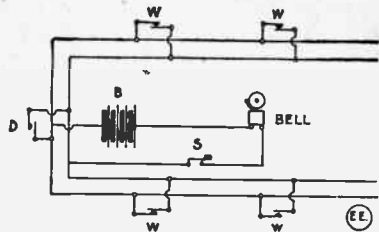

FIG. 14

The closed circuit system of alarm is one of the best and most widely used. It has one great merit: that is, if a wire is cut, the bell will start ringing, and as most of the would-be second story electrical experts cut the wires at the start, it is seen that this system is indeed quite meritorious. The main difference in the closed circuit form of alarm, is that the battery

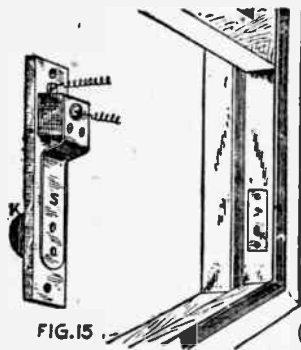

FIG. 15

is of the gravity or other closed circuit type, such as the Gordon Primary Cell. The spring contacts at the windows and doors, are normally closed instead of open, and the relay keeps the armature pulled toward the magnets at all times. When a window spring is open-circuited by raising the window, the circuit is broken, and the relay releases its armature, which falls back against the contact screw shown, closing the bell circuit. The bell used here, may be a common or continuous ringing pattern, already described.

Some elaborate burglar alarm systems have a combination of the closed and open circuit, enabling the alarm bell to ring, if the circuit is opened or closed at a door or window, or if the wires are broken or crossed at any point.

Electrical alarms are often applied to clocks, for signalling the starting and stopping time in factories, arousing purposes, etc. A simple method of ringing a bell, or a number of them, from a large clock is illustrated by fig. 19. As many insulated brass screws are fastened around the dial, as times it is required to ring the bell, in the fashion indicated. They are adjusted, so that the hour hand makes contact with them at the desired time. The bell circuit is closed through the hands of the clock and the contact screw. A simple and effective method of making an electrical alarm clock out of an ordinary alarm clock, (which ordinarily refuses to alarm), is shown by the sketch, fig. 20. An insulated spring S, is mounted on the clock movement, so that when the regular alarm goes off,

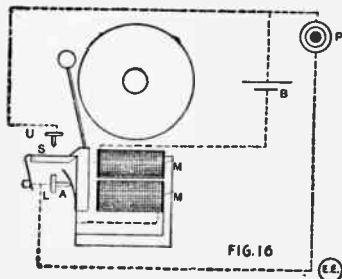

FIG. 16

its spring gradually expands and makes contact with the insulated spring. This closes the bell circuit and it continues to ring until shut off by the switch which may be near the bed. The method of making contact in this case is very positive, and in no way hurts the clock movement.

Instruments capable of giving an electrical alarm when the temperature in a certain location has reached a given degree, are classed under the head of "thermostats." A common form of thermo-

stat, is made of a compound strip of two dissimilar substances, usually metal, such as iron and copper, arranged in the manner shown by fig. 21. In the sketch S, is the compound strip, about $\frac{1}{2}$ inch wide and 6 inches long, with the two dissimilar metal portions riveted together. As the temperature rises, the strip having

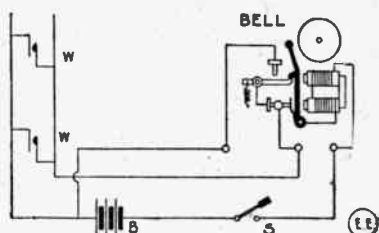

FIG. 17

the greatest coefficient of expansion per unit length, tends to curve the compound strip toward one of the contact screws, C 1 or C 2. By means of these adjustable screws, the thermostat may be set for any rise or fall in temperature, and when a certain degree has been reached in either extreme, the corresponding bell, A or C, will be made to ring. B is the battery common to both bells. In the place of the bells may be inserted a relay, for the control of valves, etc. A common use of thermostats with bell alarm is in greenhouses, where it is desirable to keep the temperature between certain limits at all times.

Another form of thermostat is the mercurial type, built on the same order as the everyday thermometer. Fig. 22 shows the make-up of this pattern, consisting of a glass tube and bulb filled with mercury. As the mercury rises it eventually touches the sealed-in platinum wire A, and closes the bell circuit through battery B; the other pole of the circuit being led into the mercury through the sealed in platinum wire C. This makes a very good fire alarm thermostat, having the top platinum wire even with the temperature mark, of about 110 or 115 degrees.

In commercial fire alarm work, a special form of thermostat is used. There are several types now in favor, but a common one is

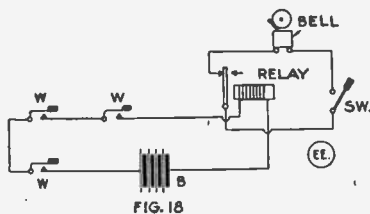

FIG. 18

that comprising a thin air tight metal chamber. When the surrounding temperature increases to a certain point, the expansion of the air in the metal chamber causes its wall to expand, and in so doing, it closes an electrical circuit. The thermostats are well distributed throughout the building which

they are designed to protect; spacing them from 10 to 15 feet

apart on the ceilings. A diagram of a commercial fire alarm installation is depicted at fig. 23. The various groups of thermostats in different sections of a building, are connected with an annunciator, which indicates just what section an alarm comes from. The circuit also includes a relay and clockwork sending machine.

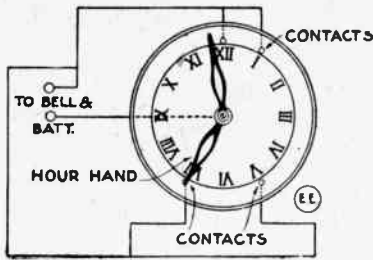

FIG. 19

Now if a fire occurs in any of these sections, the heat causes the air tight chamber to close the circuit, through the battery B2, switch SW, (here shown open), alarm bell drop magnet D, clockwork relay R, and the annunciator drop magnet corresponding to the section from which the alarm came.

In practice fire alarm systems are tested regularly, at 30 day intervals, to see that they are in perfect working order. The clockwork transmitter C1, is released by a relay magnet, controlled by the line relay R. Its spring

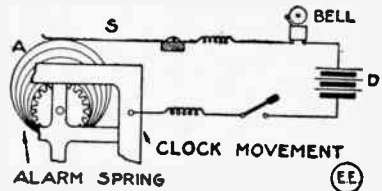

FIG. 20

motor drives the toothed disc F, around slowly, and in rotating, it passes by the fixed contact brush P, a certain pre-arranged set of signals or rings, being transmitted to fire headquarters.

Another class of automatic alarm or signal is that employed for indicating the high and low water stages in a water tank. The common scheme for arranging this alarm, is by means of a ball float, as in fig. 24.

When the ball H, (and water), rise to the highest stage permissible, the arm L, pivoted at P, makes contact at A, and rings the high water bell B. When it sinks to the low water limit, it makes contact at D, and rings the bell E. By substituting relays for the bells, it may be arranged so that the water and ball float open and close the water feed valve.

The connections of the various wires in electrical circuits is of great importance. The joints should always be soldered to ensure permanent working connections. Unsoldered joints, especially on low voltage circuits, such as bell systems, present a high resistance to the passage of a current, and sometimes become so corroded that no cur-

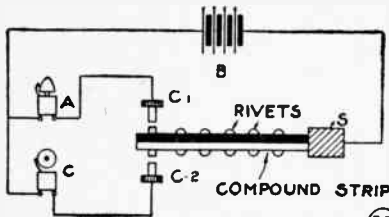

FIG. 21

E.E.

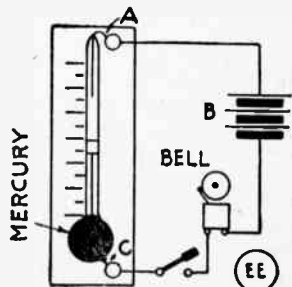

FIG. 22

rent passes at all. All joints between wires should be mechanically and electrically perfect, before soldering. An idea of the method of forming joints of wires will be gleaned from an examination of fig. 25.

For soldering the joints a regular soldering copper may be used, a whole outfit including copper, solder and flux being illustrated in fig. 27, this being the "Electro" set.

All joints between wires should be me-

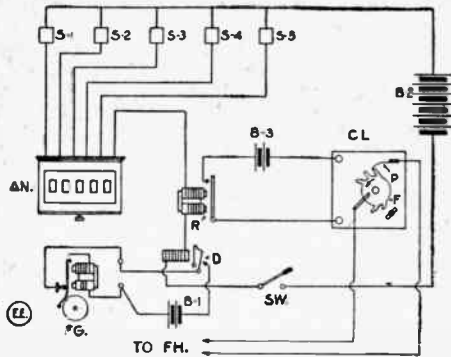

FIG 23

For soldering by means of a blow torch, the "Electro"

automatic self-blowing torch seen in fig. 26, will be found very useful. It burns 2 hours with one filling, and uses alcohol fuel.

For joints on copper wire, any standard flux may be used to make the solder take hold, such as the *Allen* or *No-Korode* compound used by the electrical trade very extensively.

Before attempting to make a soldered joint, the surfaces of the metallic wire must be thoroughly scraped clean, either with a knife or a piece of emery cloth. Having heated the juncture by the application of a hot soldering iron, or a blow torch flame, the flux may be applied, and then the solder.

The solder should run through the joint thoroughly, and permeate all the convolutions of wire. When cold, it is usually taped with black friction tape. For electric lighting work all joints are first covered with gum rubber tape, and then with black friction tape. Painting the tape with black asphaltum or shellac tends to preserve it. Acids of any kind should

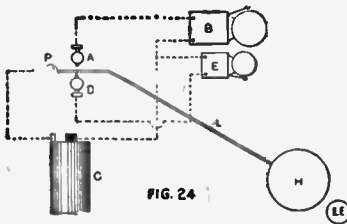

FIG. 24

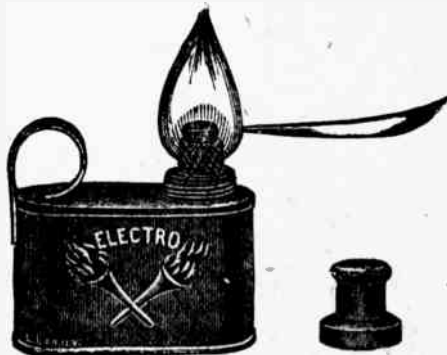

Fig. 26.

never be used for any electrical joints as they soon corrode the metal. Any trouble experienced in tinning the soldering



Fig. 27.

copper, may be overcome by filing it bright, and while hot, rubbing in sal-ammoniac and applying solder.

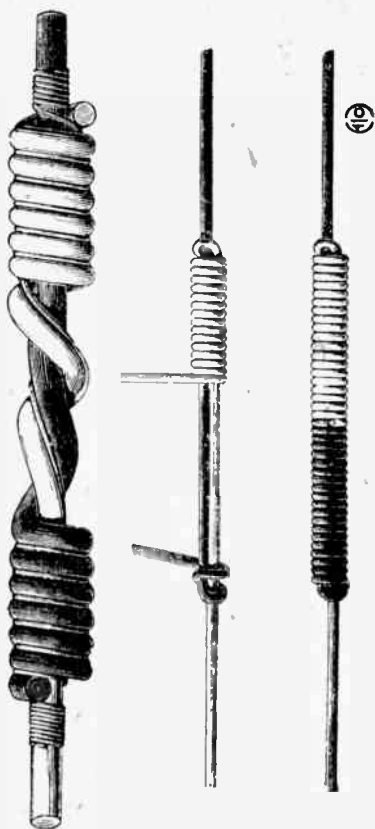

Fig. 25.

Some electrical conductors are furnished with a thin coating of "tinning." This makes the wires much easier to solder, as, they do not have to be tinned with the soldering iron.

LESSON NO. 10.

EXPERIMENTAL ELECTRO-PHYSICS.

THE physics of electricity would not be complete, without a brief summary of the early history of the art, and so the opening paragraphs have been devoted to the more interesting epochs in this connection.

Many centuries ago, before scientists had begun to even faintly understand the phenomena or meaning of electrical manifestations as they occur in nature, it had been observed that when *amber* was rubbed with certain other substances, so that friction was created, the amber exhibited a new property, viz: that of attracting and holding small bits of thread, hair, straw, etc. At that time, it was thought to be some mysterious force, and was referred to as "harpaga," signifying the harpies, or "a thing that

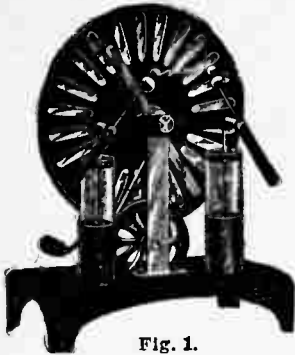

Fig. 1.

clutches." The origin of this odd cognomen, was due to the discovery by the women of Syria, that the amber distaffs or spindles, forming part of their spinning wheels, tended to attract small particles of thread, straw, etc., when the spinning thread had brushed against the amber for a short while.

The word *amber*, and its derivation has not been established positively, but it has been ascribed to either one

of two sources; viz:—The Arabic word "*amber*," signifying "*ambergris*," and the German verb, "*anbrennen*," meaning, "the thing that will burn."



FIG. 2

(E.E.)

Lodestones or natural magnetic ore, as found in the

earth, were not unknown to the ancients either, having been mentioned in the writings of Aristotle, who ascribed to Thales of Miletus, chief of the Seven Wise Men of Greece, and who was the contemporary of Aesop, the view that the action of amber and the lodestone suggests the existence of an "alter ego," or soul, in these substances, meaning undoubtedly when philosophically interpreted



FIG. 3

(E.E.)

ed and construed, an inherent force independent of any external agency.

According to the legends and traditions of the Chinese, who were at one time the wisest people on the earth, the properties of the lodestone or natural magnet, were known fully two thousand years before the dawn of the Christian era. Humboldt relates, in his "*Cosmos*," that the Chinese employed the lodestone magnet to direct their caravans in voyages, the magnet having been used to actuate a small revolving device, which was caused to

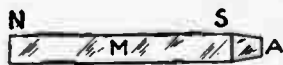

FIG. 4

(E.E.)

point continually in the same direction. All the ancient writings on the subject, however, were of little practical significance, and it was not until the 14th century, that the scientific application of electrical phenomena took any definite shape.

As nearly as known, it was about 1320, that Flavia Gioia, a native of Naples, Italy, invented the compass that we actually have record of. This instrument varied from the true north, but Christopher Columbus and Sebastian Cabot added to this knowledge, that which can certainly be claimed as important scientific facts. From time to time, other scat-

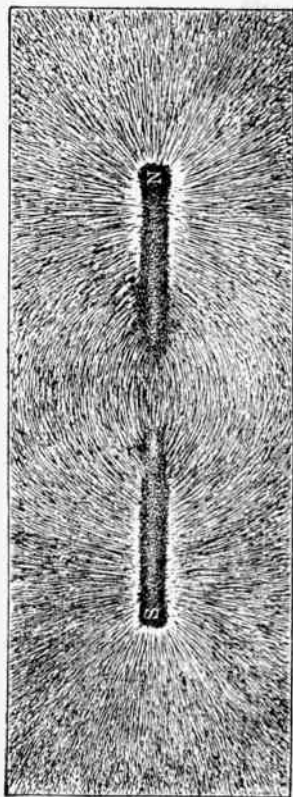

Fig. 5.

tered facts and phenomena were observed and discussed, but to Dr. William Gilbert, born in 1543 at Colchester, about 50 miles northeast of London, England, is due the credit of first publishing a book, giving a connected account of electromagnetic phenomena.

Among the foremost of Dr. Gilbert's discoveries, was that our globe, the earth, was in itself a great spherical magnet. For this important discovery, Gilbert received great praise from the eminent astronomers, Galileo and Kepler, and many others.

Static electricity is the usual form met with in nature, and is distinguished from voltaic or galvanic electricity, by its exceedingly high voltage or potential, and small current value. In its nature, static electricity is the same as any

other form. Electricity in other form usually flows in currents continuously, but static electricity is accumulated in condensers and its discharge is instantaneous, as when lightning passes from one thundercloud to another. The static generator and experiments with it are treated exhaustively in another chapter.

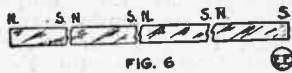

FIG. 6

The first scientist to build a frictional machine for the generation of electricity, was Otto von Guericke, a German. About the year 1750, he constructed a rather crude machine, comprising a rotating ball of sulphur, which when held between the hands, produced electricity by the friction incurred.

From this experiment, the static generator was slowly improved, until it finally reached the form of a glass plate rotating between leather cushions. The friction thus set up created electricity, and later a condenser was connected to the machine to collect the electricity. A cut of a modern static electric generator is shown in Fig. 1.

Other sources of electricity besides the static machine, are as follows:—

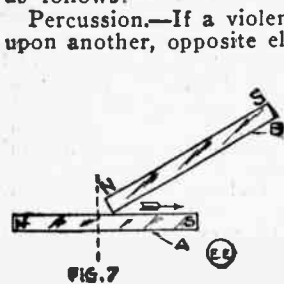

FIG. 7

Percussion.—If a violent blow is struck by one substance upon another, opposite electrical states are produced on the two surfaces. Vibration can produce electricity, as demonstrated by Bolpicelli, who showed that vibrations set up within a rod of metal, coated with sulphur or other insulating substance, produced a separation of electricities at the surface, separating the metal from the non-conductor. **Disruption and Cleavage:**—Tearing a card apart in the dark produces visible sparks, and the separated portions when tested with an electroscope, will be found to be electrically charged. Lumps of sugar crunched between the teeth in the dark exhibit pale flashes of light. The sudden cleavage of a sheet of mica also produces sparks, and both laminae are found to be electrified.

Crystallization and Solidification:—A number of different substances, after passing from the liquid to the solid state, exhibit electrical conditions. For instance, sulphur fused in a glass bowl, and then allowed to cool, becomes strongly electrified, as made evident by lifting out the crystalline mass, with a glass rod. Another substance becoming electrified during solidification is common chocolate. When arsenic acid crystallizes out from its solution, in hydrochloric acid, the formation of each crystal is accompanied by a flash of light, due most likely to an electrical discharge.

***Combustion:**—The generation of electricity by combustion was demonstrated by Volta. A piece of burning charcoal placed in connection with the knob of a gold-leaf electroscope, will cause the leaves to diverge. **Evaporation:**—When liquids are evaporated, electrification often occurs, the liquid and the vapor assuming opposite states.

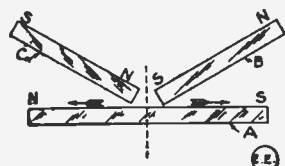
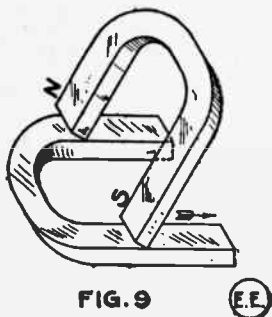

FIG. 8

Atmospheric Electricity:—This is closely allied with electricity of evaporation, and is the atmospheric charge always present in the air, and due, in part at least, to evaporation going on over the oceans. **Animal Elec-**

*See Lowe's Compendium of Applied Electricity.

tricity:—A number of species of creatures inhabiting the water, have the power of producing electric discharges by certain portion of their organism. The most well known of these are the "Torpedo," the "Gymnotus," and the "Siluris," frequenting the Nile and the Niger Rivers. The "Raia Torpedo," or electric ray, of which there are three species inhabiting the Mediterranean and Atlantic, is provided with an electric organ on the back of its head. This organ consists of laminae composed of polygonal cells to the number of 800 to 1000 or more; and supplied with four large bundles of nerve-fibres. The under surface of the fish is negatively electrified and the upper side positively. In the "Gymnotus Electricus," or Surinam eel, the electric organ extends the whole length of the body, along both sides, as seen in cut 2. It is able to give a most severe shock, and proves itself a very formidable antagonist when it has attained its full length of 5 or 6 feet.



It has been shown that the nerve excitations and muscular contractions of human beings, also produce feeble discharges of electricity. There is also the electricity of vegetables, thermo-electricity, contact of dissimilar metals, and other sources.

Magnetism, the basis of most all commercial electrical apparatus to-day, is a very interesting subject. As aforementioned, the properties of natural magnets or lodestones was found in Magnesia, Asia Minor, and was called the magnet stone, owing to the name of the country in which it was found. The properties of the lodestone may be conveyed to other substances such as iron or steel, by friction or rubbing. Nickel and cobalt are also slightly influenced by magnetism.

Steel was found to have the greatest retentivity or holding power for magnetism, and hence it was always employed for magnets and needles in mariners' compasses, in the early days as well as now. Magnetism, like electricity, requires matter as its medium through which to manifest itself, and the present theory is that it is a mode of molecular motion generated by vibration of the molecules, and undulations of the all pervading luminiferous ether, which permeates all matter and fills all spaces not already filled by other sub-

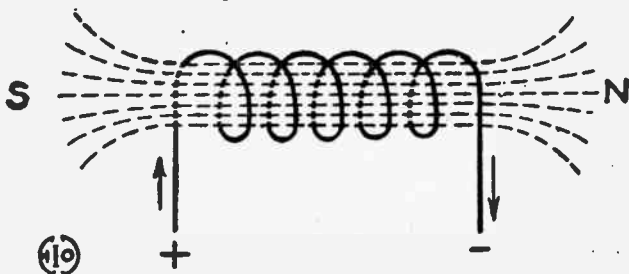

Fig. 10.

stances or matter. The speed or velocity of propagation of electricity through the ether is 186,000 miles per second, or in the metric scale, it is equivalent to 300,000 kilometers or 300,000,000 meters.

There are two common forms of permanent steel magnets in use, one being the horseshoe shape and the other the straight bar. The former is seen at Fig. 3, and the bar mag-

net at Fig. 4. Magnets, no matter what their shape, are always surrounded by a "field of force," as it is termed, caused by the magnetic flux or lines of force tending to return from the north pole to the south pole. To realize the maximum efficiency and life, the magnet should have a complete path through iron, and so an armature or keeper A, is supplied with horseshoe magnets, and when not in use the keeper supplies a low resistance path for the flux, thus preserving the magnet's power.

The appearance of the field of force about a magnet is seen at Fig. 5. Such a flux diagram is easily made for any magnet by sprinkling fine iron filings on a piece of glass, and placing the magnet under the glass. Tapping the glass gently will serve to make the filings evenly distribute themselves, when they may be photographed, or a print may be made direct by placing the printing paper under the glass, and exposing it to the light.

Every magnet has two poles, each of opposite polarity or nature. They are designated respectively, as the north and south poles. Like poles repel each other, and unlike poles, attract each other. The end of the compass needle magnet seeking the earth's north magnetic pole, is really the south pole of the needle magnet, but is often referred to as the north pole of the needle. *North-seeking pole* is more correct. The principle of every magnet having two dissimilar poles is made more manifest, by breaking a bar or other permanent magnet, with the result shown at Fig. 6. As seen every individual magnet has assumed two unlike poles at the ends. The best way in which to observe the changing action of the magnet poles, is by means of a small compass or magnetized needle, pivoted, so as to swing freely about a fixed point. The north pole of the magnet is usually marked in some way, either by an arrow head, or by bluing it. If such a needle is presented to the poles of the horseshoe magnet seen in Fig. 3, the north and south poles of the needle will be attracted alternately. The poles of an electromagnet can thus be tested also.

There are two methods of making permanent magnets from hardened steel bars, by direct touch with another permanent magnet. The first is known as the single touch method, and consists in stroking the steel bar A, from the centre to the end, in the direction of the arrow, removing the magnet B, returning it through the air to the centre, and (with the same pole) again stroking it to the end. The polarity induced in the bar A, is of course opposite to that existing in the magnet pole B, as indicated by the polarity signs in the sketch. Usually 15 to 20 strokes are sufficient, when the other half of the steel bar is stroked with the opposite end of the magnet B, from the centre to the end, as previously, and a similar number of times. Magnetizing by double touch is accomplished by using two magnets, as in Fig. 8, and both poles (of opposite sign) are moved from the centre outward, simultaneously. About 15 to 20 strokes are sufficient. The steel used for making permanent magnets should be very hard, such as Tungsten steel. The harder the steel, the greater the retentivity, also the strength.

Steel magnets are best magnetized, by placing in contact with the poles of a powerful electromagnet. This is the method pursued in most commercial uses of them, especially for magnetos. Sometimes they are magnetized, by winding a coil of insulated copper wire around them, and then passing current through the coils. U-shaped mag-

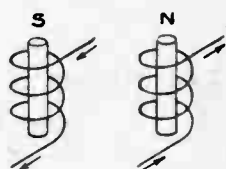

POLARITY OF ELECTRO MAGNETS

Fig. 11.

net bars may be magnetized by direct touch with another U-shaped magnet as shown in Fig. 9, stroking the new magnet from the poles to the U-bend, or vice versa.

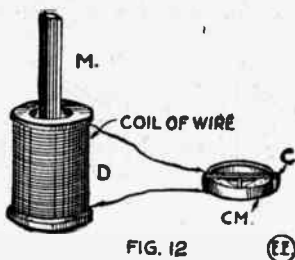

All electrical conductors when carrying current, are surrounded by a magnetic field of force, as depicted in Fig. 10. Here the current (direct current) is shown passing away from the observer, that is, the end nearest him is positive, and then the whirl of magnetic force or flux is right-handed or clock-wise; facing the near end of the conductor. If the current were coming toward the observer, the whirl of magnetic flux would be left-handed, or opposite to that shown.

The effect of winding the conductor into coils about magnet poles of soft iron, gives the result seen at Fig. 11. This shows that if the current passes around the coil clock-wise the resultant magnetic pole is south; but if it passes around the coil counter-clock-wise; then the resultant magnetic pole is north. This is one of the most frequently occurring rules in electrical work of all kinds, and should be well memorized.

Probably one of the most interesting and important laws in electro-physics, is that there is a direct relation between magnetism and electricity. Magnetism and electricity are reciprocal or interchangeable and can produce each other, which may be readily shown by suddenly plunging a permanent steel bar magnet into the interior of a solenoid, or coil of wire, as in Fig. 12. Connected to the coil of wire is a galvanometer CM, which is easily made by winding a coil of a dozen turns of fine wire about a small compass case as seen from the detail, or the "Electro" Galvanometer can be employed. The coil of wire is placed parallel to the needle of the compass. This makes quite a sensitive galvanometer.

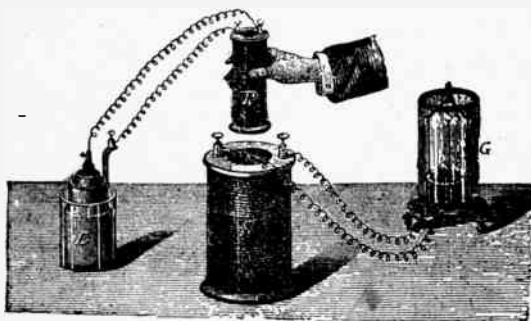

Fig. 12A.

Now if the steel magnet bar M, is suddenly plunged into the coil of wire D, a deflection of the galvanometer needle will be noted. Upon withdrawing the magnet bar from the coil D, another deflection of the galvanometer needle will be noted, but in the opposite direction, to that of the first deflection, occurring from the insertion of the magnet. This is the principle upon which transformers and induction coils operate, the second coil of wire being placed outside the coil D, shown here. Instead of moving a permanent steel magnet, in and out of the coil; the magnetizing current in the coil D, is made to pulsate or alternate giving the same results. The core is stationary and of the softest iron, so

as to lose all the magnetism possible, at each change in the current. Instead of using a steel magnet, a soft iron core wound with a magnetizing coil, may be used as at Fig. 12 A.

This shows the generation of electricity from magnetism. To demonstrate the production of magnetism from electricity, it is only necessary to pass current from a battery or other source through the coil D, when the magnetic force created within the coil, will suck in an iron bar. A permanent iron core fastened within the coil, makes it an electromagnet and this is the basis of the action of the great generators, and motors turning the wheels of commerce to-day. When an electric bell sounds, an electromagnet has actuated the hammer. When a spark several inches long leaps the gap connected across a transformer, electro-magnetism has been responsible for it.

To Michael Faraday, we are indebted for a greater part of our knowledge concerning magnetism and electricity and their close inter-relationship. Faraday was the first to show how magnetism could be changed into, or made to give electric current, when a magnet was acted upon by mechanical motion. He discovered that a coil of wire when moved to or from a permanent steel magnet or active conductor had induced in it another current, and of opposite direction to that of the inducing current. This great discovery by Faraday, was taken up by others, and the real development of electrical apparatus employing these principles, had been started on its way.

LESSON NO. 11.

ELECTRO-THERAPEUTICS.

ELECTRICITY has now become a permanent adjunct to the medical practitioner and surgeon, in their respective duties. Every hospital of any consequence to-day, has a complete equipment for the application of X-Rays, High Frequency currents, Cautery currents, etc., etc., Some methods of applying electrical current for certain purposes are even applicable by the patients themselves,

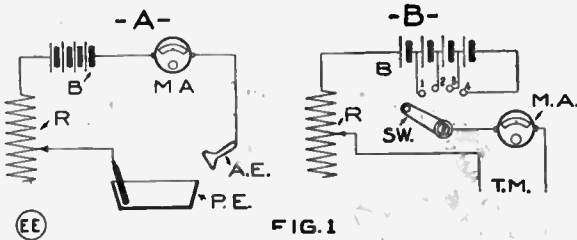

FIG. 1

although in general this is not recommended, as there are plenty of chances for the unexperienced to do more harm, than good, except with the Medical Coils delivering Faradic Current described further on.

Several kinds of current are employed for electro-therapeutical work, the principal ones being as follows:

Galvanic Current, which is ordinary direct current derived from battery cells, or from a direct current lighting circuit.

Faradic Current, which is usually understood to mean the unsymmetrical, alternating, pulsating, current delivered from the secondary winding of an induction or medical coil, as it is more popularly known.

Franklinic Current, or the continuous high potential current

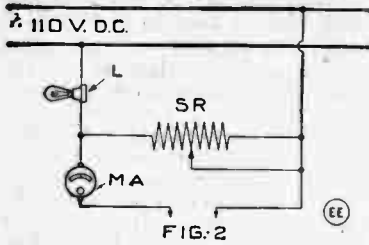

delivered from a static or influence machine, such as the Holtz, or Wimshurst. Oudin and D'Arsonval Currents, supplied from high frequency air core transformers, of the Tesla type; the potential and frequency being very high.

The use and properties of Galvanic or low voltage direct currents will be considered first. *To begin

with, the current strength employed is measured in milli-amperes, one milli-ampere being equivalent to one one-thousandth of an ampere. Hence a current strength of 100 milli-amperes is the same as 100-1000ths or 1-10th ampere.

The resistance of the human body, which is confined principally to the skin, ranges in value between 2,000 to 5,000 ohms and higher, but this is dependent to a great part upon the condition of the skin, nature of the electrodes, and area of skin covered by them. For all galvanic applications it is necessary to keep the body resistance down as low as possible, and this is greatly facilitated by first washing the skin with soap and warm water, after which the skin surface is wetted with salt solution. The electrodes used should have as large a contact surface as possible also.

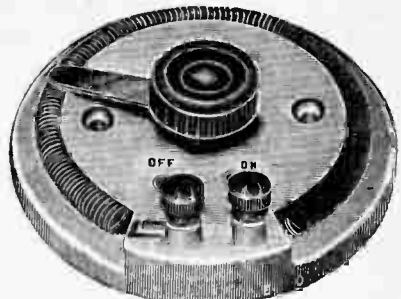

Fig. 3

Galvanism in most cases is applied locally, the terminal applied to the diseased portion being known as the "Active Electrode." It is generally of small size, as compared to the "Passive Electrode," which is the cognomen applied to the one forming the common or general terminal. A good "passive electrode" is made of a piece of sheet lead or block-

tin, afterward wrapping it with several layers of surgical gauze, soaked in salt solution. This electrode is usually applied to the stomach or abdomen of the patient. Another way to form the "passive" electrode, is to have the patient immerse the feet in a tub of salt solution, the solution being rendered electrically active by a small metal plate dipping into it, but not touching the patient.

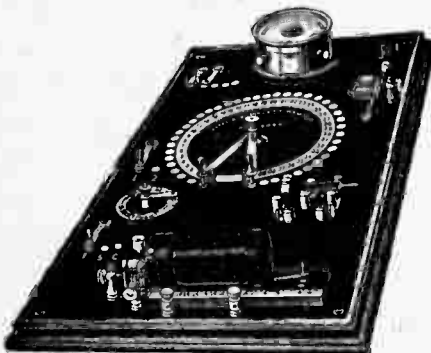

Fig. 4. A Wall Set Medical Coil

The arrangement of the galvanic circuit for batteries (20 to 40 cells usually required) is depicted at fig. 1 A and B, where R is a rheostat or slowly adjustable re-

*For further details see Dr. Strong's treatise on "Modern Electro Therapeutics."

sistance coil; B T the battery of wet or dry cells; M A, a milli-ampmeter or simply mil-ammeter; A E, the active electrode to be applied to the diseased portion; and P E, the passive electrode, shown as a tub at A. In diagram B, a multi-point selector switch is shown for cutting in cells, one by one, as well as the rheostat R. The method of using the direct current lighting circuit as a source of galvanic current, is seen at fig. 2. S R, is the shunt resistance, adjustable in fine steps. L, a 16 Candle power lamp. A very handy rheostat is that illustrated by fig. 3 and it can carry 2 amperes constant current of 2,000 milli-amperes. The resistance is adjustable in numerous steps, enabling very close work to be accomplished.

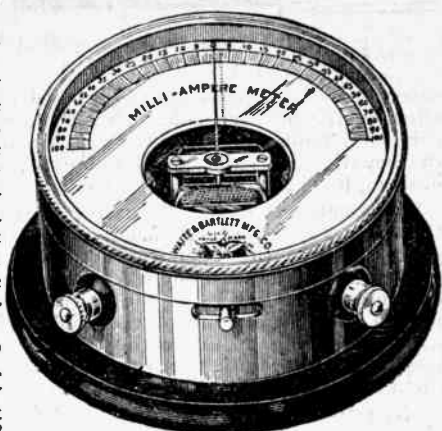
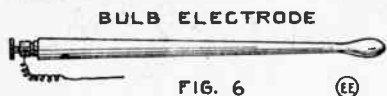

Fig. 5. Magnetic Mil-Ammeter

A typical Galvanic and Faradic Switchboard as supplied for commercial purposes is depicted by fig. 4. This switchboard is for use with batteries and has induction coil, rheostat, necessary switches, interrupters, etc., complete. Other styles and forms of control board are made for 110 volt direct current circuits. All work of this nature should be done methodically and accurately, to avoid harm to the patient; and for



measurements, the mil-ammeter is essential, a cut of a standard type being shown by fig. 5.

One of the commonest treatments is that of "General galvanization." This has an effect on the entire organism. General galvanization is applied chiefly for treating *Organic Spinal Disease, Obesity, and Diabetes.*

The electrodes used can be of block tin, about 6 inches square, and covered with surgical gauze, wetted with salt solution. The



Fig. 7. Needle Holder for Negative Electrolysis

Cathode (Negative pole) is applied over the upper part of the spine, and the Anode (Positive pole), over the abdomen or stomach. The current strength applied varies from 20 to 50 milli-amperes, extending over a period of about 25 minutes. In applying galvanic currents, the following procedure should be adhered to: The electrodes are first placed in contact with the patient's body, then the current is turned on and gradually increased to the desired value. In stopping the treatment, the reverse holds true, that is; the current is slowly reduced to zero, and the electrodes removed.

The application of "Local galvanization," is employed in cases of *Neuralgia, Rheumatism, acute and chronic inflam-*

tion, etc. A small electrode, sponge covered, is applied to the affected area, the passive electrode being the largest one aforementioned. The polarity of the active electrode, is



Fig. 10. Needle Holder for Electrolysis of Birthmarks, Hemorrhoids, etc.

determined largely by the disease to be treated. The local effect of the positive pole, being sedative, hemostatic, germicidal and tending to relieve congestion. The local effect of the negative electrode, on the contrary, is productive of congestion, local stimulation, and counter-irritation.

The treatment called "Negative Electrolysis," is a destructive process, causing diseased tissues to soften and disintegrate, due to the chemical action of caustic soda which gathers about the cathode electrode as a result of the sodium chloride in the tissues of the body. If a galvanic current is passed through the body, the sodium hydroxide or caustic soda, collecting at the cathode electrode, will destroy the tissues in immediate touch with the latter, and will convert them into a soft soap-like substance.

"Negative electrolysis" is applied for many common complaints and ailments, such as the *elimination of superfluous hair, warts, moles, etc.* In fig. 6, is shown the shape of the electrode to be used in removing superfluous hair. Its smaller end is bulb-shaped, the material used for making the instrument being steel. An insulated holder for manipulating the needle is seen at fig. 7.

First the bulb-shaped electrode or needle is carefully entered into the "follicle" or hair duct, as seen at A, using a magnifying glass if necessary to locate the needle's position. At this juncture the current is gradually applied by instructing the patient to slowly immerse his fingers into a bowl of salt solution, containing the anode or positive electrode. The current applied varies from 1 to 3 milli-amperes, and when a white bubble, no bigger than a pin head shows at the mouth of the hair follicle, the patient is told to slowly withdraw his fingers from the solution. The next part of the operation is to remove the needle, and if the action has been complete, the hair has been disintegrated from its root, and a pair of light forceps can be used to slide the hair from the follicle chamber.

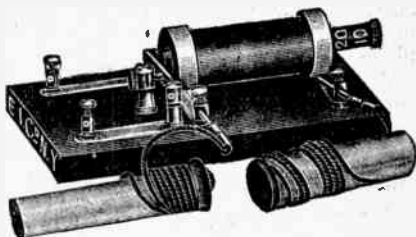

Fig. 11

If the hair does not come out readily, the operation has not been successful, and should be repeated. The time required to remove a hair is from 1 to 2 minutes. Only a few hairs from a given area should be extracted at one sitting.

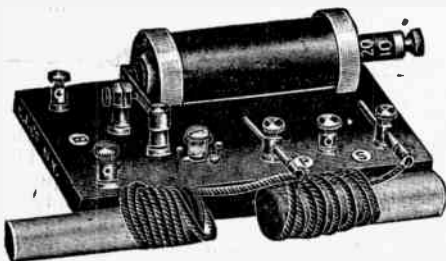

Fig. 12

In removing warts, birthmarks, moles, and the like, use a sharp pointed needle electrode, like the one shown in Fig. 9. The same method of applying the current and stopping it are followed as given above for removing superfluous hair. The point of the needle electrode, connected to the negative pole

of the circuit, is inserted in the growth near its base; and gently entered until it nearly passes through it. The current is then applied by allowing the patient to slowly immerse his fingers into a bowl of salt solution as previously instructed. The current is increased to as high as 15 milli-amperes if necessary, to cause the whole growth to become of a white bleached color. In cases of large growths, larger than $\frac{1}{4}$ in. diameter, the needle can be applied more than once, the second application, being that with the needle inserted at right angles to the first position. Antiseptics should not be applied, as the growth generally dries up into a brown scab, and falls off of its own accord in a week or so.

For removing large growths, such as birthmarks, and the like, a special multiple pointed needle is employed, similar to the one depicted at Fig. 10. The needles are inserted repeatedly at different angles, until the whole area has finally been bleached and destroyed.

The faradic current, supplied by medical coils, which are small size specially wound induction coils,* or transformers, is extensively employed both by physicians, and patients independently.

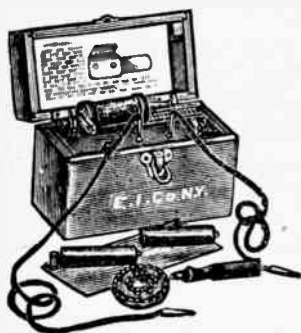

Fig. 13

Several styles of faradic instruments are illustrated by Figs. 11, 12 and 13. The coil shown at Fig. 11 does not deliver a faradic or secondary current, but an interrupted galvanic or pulsating current. This is useful to treating rheumatism, etc. The coils shown at Figs. 12 and 13, both have secondary windings and deliver a regular faradic current, which as stated before is an unsymmetrical, alternating, one of low frequency; and voltages of 1,000 or less up to 5,000, according to the number of turns on the secondary winding. The current

density in milli-amperes of faradic current applied, varies from one one-thousandth up to one mili-ampere, depending upon the size and length of the secondary coil.

Most faradic coils, operate well on 2 to 4 dry cells, but sometimes they are operated directly from direct current lighting circuits.

The physiological effect of faradic currents depend upon their voltage and frequency of interruption and reversal. A low frequency, low potential, current acts on the muscles and motor nerves chiefly, producing "intermittent" or "clonic" muscular contractions, while a current of similar voltage, but of higher frequency, causes a continuous contraction, technically termed "tetanus" or "tonic spasm."

High potential faradic currents for treatment should be of high frequency. Currents of this nature are particularly adapted to treating cases of Neuralgia, Sciatica, also other forms of acute pain, except those connected with in-

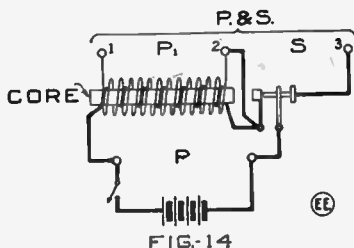

FIG-14

*For details of Induction Coils, see lesson on Spark Coils.

flammation, or Septic Infection. Low Tension, low frequency faradic currents, are used quite extensively to increase muscular growth, relieving stiffness due to rheumatism, etc., and also for producing muscular contractions, as a form of exercise, in cases of partial paralysis, etc. - The low potential faradic current, if employed with high interruption speed, may prove disastrous, and exhaust rather than invigorate the muscles. The medium potential faradic current can be applied at either slow or fast interruption speed, for the purpose of increasing circulation, and relieving congestive headaches.

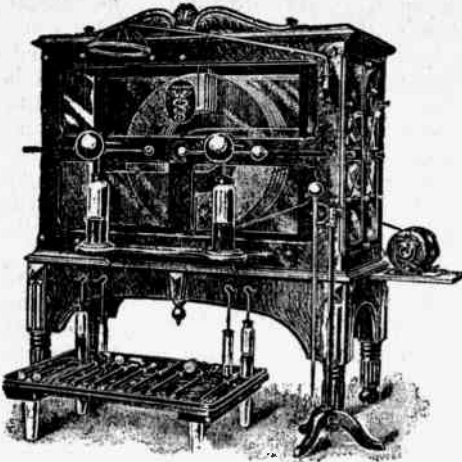

Fig. 15. A Powerful Static or Influence Machine

frequency faradic currents, are used quite extensively to increase muscular growth, relieving stiffness due to rheumatism, etc., and also for producing muscular contractions, as a form of exercise, in cases of partial paralysis, etc. - The low potential faradic current, if employed with high interruption speed, may prove disastrous, and exhaust rather than invigorate the muscles. The medium potential faradic current can be applied at either slow or fast interruption speed, for the purpose of increasing circulation, and relieving congestive headaches.

The polarity (apparent), of the faradic current, delivered by induction coil secondary windings may be tested by means of polarity test paper. The circuits of a faradic coil, including secondary and primary windings are shown in diagram Fig. 14. These coils usually have three binding posts, 1, 2 and 3, connected up as shown; to enable the user to connect up the electrodes, for either galvanic (interrupted primary), current, posts 1 and 2; Faradic (Secondary) current, posts, 2 and 3; or a combination of the two (Galvano-faradic) current, which has been used successfully for treatment of constipation, enlarged prostate, etc.

Static generators are extensively employed for treatment of various ailments. The current from a static machine is continuous, unidirectional, of high potential, but very small amperage. The current for therapeutic purposes averages between 10,000 and 100,000 volts. The current density is from one one-thousandth to two milli-amperes. The more revolving plates there are, the more the amperage; the greater the plate diameter, the higher the voltage.

Static insulation and static breeze are two forms of treatment by this current in wide use. Static insulation or static bath, is accomplished as shown by Fig. 16. Here P represents a platform upon which the patient's body B rests. The

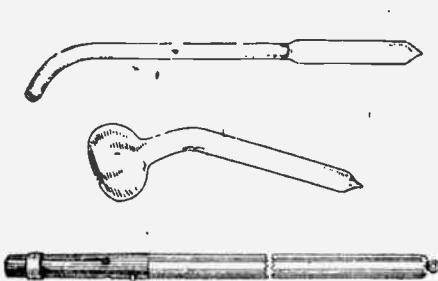

Some Typical High Frequency Electrodes

continuous, unidirectional, of high potential, but very small amperage. The current for therapeutic purposes averages between 10,000 and 100,000 volts. The current density is from one one-thousandth to two milli-amperes. The more revolving plates there are, the more

the amperage; the greater the plate diameter, the higher the voltage.

Static insulation and static breeze are two forms of treatment by this current in wide use. Static insulation or static bath, is accomplished as shown by Fig. 16. Here P represents a platform upon which the patient's body B rests. The

platform should be insulated from the floor by 4 glass legs at least 6 in. long. The patient may stand upon a metal plate on the platform, which is connected to one terminal of the static machine by a chain, or rod. The other terminal of the machine is connected to the ground G, on a water pipe. If the positive pole connects with the patient the effect is soothing, and restful. Hence this treatment is efficacious in cases of *Insomnia*, *Hysteria*, and *Reflex Nervous conditions*.

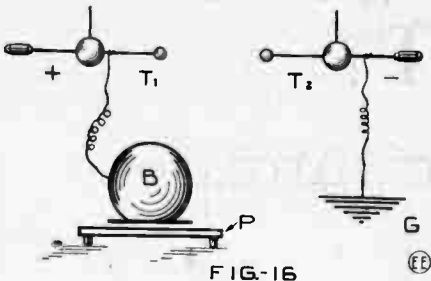

FIG-16

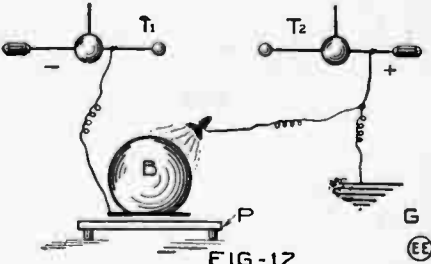

FIG-17

The static breeze is applied as in Fig. 17, the breeze electrode being connected to the positive electrode, which is also grounded. This is of use in treating *Headache*, *local congestion of Nervous origin*, and in *Neurosis*. The pole may be reversed, giving a negative breeze, but the former method is best, as it creates less irritation.

A method of applying electricity in electro-therapeutics in great favor now, is by means of high frequency apparatus after the method of Nikola Tesla, D'Arsonval, Oudin, and others.

A complete high frequency set is diagramed at Fig. 18. Here a step-up transformer raises the primary potential of the alternating current from 100 volts, at 60 cycle frequency, (F), to 10,000 volts at 60 cycles. A is the alternator or circuit supplying the power. In the closed oscillating circuit including the glass plate or Leyden jar condenser C, spark gap G, and primary coil P, of the Tesla air core transformer, T S; the frequency of the current is raised owing to the rapid charging and discharging of the condenser across the spark gap G. Here the frequency may easily reach 100,000 cycles or more per second. The potential is sensibly the same. The next transformation is done by means of the Tesla transformer, which increases the voltage to 200,000 or more, the frequency remaining the same, i. e., 100,000 cycles.

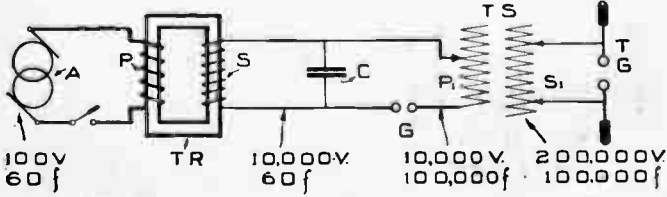

FIG-18

The high frequency current surges across the gap T G. This current possesses many curative properties.

LESSON No. 12.

INDUCTION COILS AND GEISSLER TUBES.

THERE are two general classes of spark coils, one having a single coil winding and utilized mostly for gas lighting, the other composed of two windings, known as the primary and secondary, and used to produce a jump spark, for wireless purposes, gas engine ignition, X-Rays, etc.

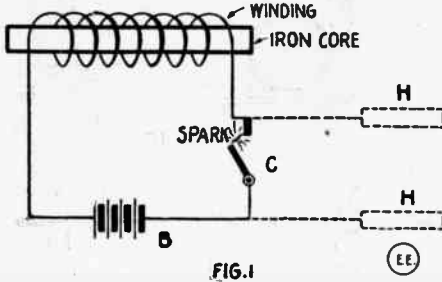
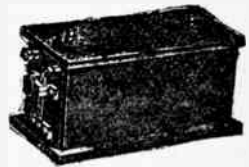

FIG. 1

The single winding type of coil produces a fat spark at the point where its circuit is broken, which is of momentary duration. It is due to the "self induction"

of the coil, and is the result of the following action. Referring to Fig. 1, the circuit of a wipe spark coil, with battery B, and make and break contact C, is plainly shown. When the contact is closed, the battery current flows around the coil, having the soft iron wire core within it, and strongly magnetizes the core. At the instant the contact breaks the circuit, the magnetism in the iron core collapses or dies down very quickly, and this rapid change in the value of the magnetic flux, causes a current of great instantaneous value to be generated in the coil or winding, and this is the current creating the bright spark seen on quickly opening such a circuit. It has great calorific or igniting value, and is much employed for lighting gas jets, exploding gas engine mixtures, etc. If two metal handles or electrodes are attached to either side of the break contact, as indicated by the dotted lines, in Fig. 1, a shock will be felt, whenever the circuit is broken. The self-induced break current, is often termed a "kick current," in electrical parlance and the coil is referred to as a "kick coil" or "inductance coil."

In Fig. 2, is illustrated the component parts going to make up a coil of the "induction or jump spark" class, having both primary and secondary windings, together with a spring vibrator or interrupter, for making and breaking the primary current. The connection of the various sections with the battery is



Box Type Spark Coil

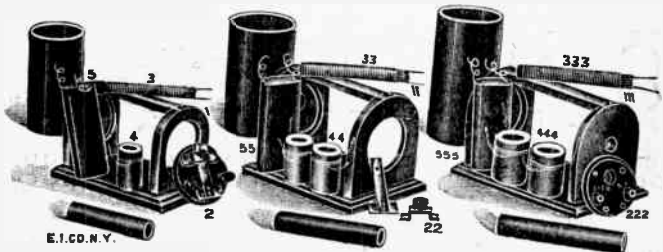

Fig. 2

seen at Fig. 3. Here P P, is the primary coil terminals, and S S, the secondary coil terminals connecting to the spark gap S G. The vibrating interrupter is at V, H being the contact

spring and iron hammer attracted by the core of the coil; C is the contact screw and pillar; K is a paper and tinfoil condenser shunted across the vibrator to absorb the extra or self-induced current at break of the primary circuit, so as to cut down the sparking at the contact points, and also to assist in quickly demagnetizing the core, which greatly enhances the effect on the secondary winding; as the quicker the core is demagnetized, the more pronounced the effect on the secondary coil. The vibrator spring is attracted to the core, but in so doing it breaks the circuit, and hence immediately flies back against the contact screw, completing the circuit again, much the same as in the ordinary electric bell. This keeps up as long as the current is supplied to the primary coil.

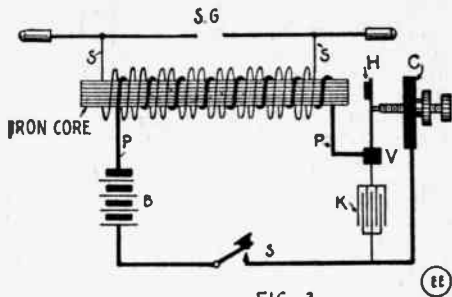

FIG. 3

The physical action of the induction coil is primarily due to the fact that a current passing momentarily in the primary coil, creates about itself, a magnetic field of force, which, when another coil of wire is placed within it, with its axis parallel to that of the primary coil induces in this coil a secondary current, as it is termed. The voltage of this secondary or induced current is proportional to the number of turns of wire it contains, in comparison to the number of turns in the primary winding. Thus, if the primary coil contains 100 turns of wire, and the secondary 50,000 turns, then if 10 volts passes through the primary, the secondary coil will have 50,000 divided by 100 or 500 times 10 volts, or 5000 volts induced in it. This is sufficient voltage to leap a gap in ordinary air, one-quarter of an inch long.

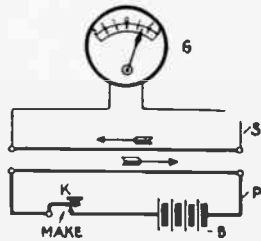

Fig. 4.

The action of the coil at make and break of the primary current is perhaps best explained by the diagrams shown in Figs. 4 and 5. As seen from Fig. 4, the direction of the induced current in the secondary coil, S, is opposite to the direction of the primary current at make. The half wave of the secondary current induced at the make of the primary circuit, is not of a very high value, and is known as the "inverse current." It is very undesirable in operating X-Ray tubes, tending to blacken the tubes. In medical or faradic induction coils, it is always present, but even tho of a weak character, the secondary current of these coils are often referred to as positive or negative currents. In fact, pole test paper will show a predominating polarity. The polarity of the secondary current is readily reversed by simply reversing the primary current. The relation of the inverse or make current of the secondary is graphically shown at Fig. 6B. The strongest half wave, that resulting from breaking the primary circuit is in the same direction

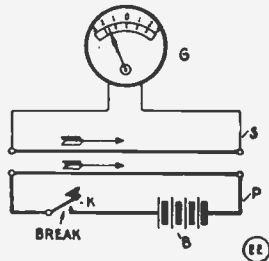

Fig. 5.

as the primary magnetizing current, as shown by the cut Fig. 5. The potential value of the secondary half wave resultant from breaking the primary circuit is seen at Fig.

6, A. The space of time when no current passes in the secondary, C, is during the interval when the contact of the vibrator is open. The curves shown at Fig. 6, are more typical of a medical coil current, the spark coil current wave form being more peaked, like that in Fig. 7, owing to the quickness of breaking the primary circuit, which is here aided by the condenser shunted

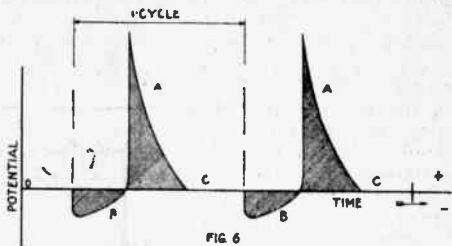

FIG 6

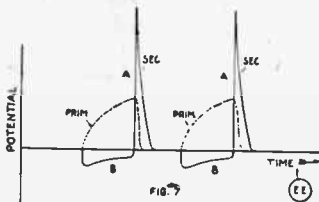

FIG 7

across the vibrator. Here A, A, are the suddenly induced secondary half waves of a spark coil at break of primary circuit; and B, B, are induced half waves produced at make of primary circuit. The dotted lines show the primary current. In most cases, when the spark gap is of any appreciable length, the "break induced" half waves, which may be either positive or negative, according to the polarity of the primary current, are the ones leaping the gap; the weaker "B" half waves of inverse current, not being able to leap the gap. In such an event, the spark takes on a certain polarity, as will be evident; but if the gap is short, and both "A" and "B" half waves succeed in leaping it, then the spark is formed of an unsymmetrical, pulsating, alternating current. A regular sinusoidal alternating current is one whose both half waves, positive and negative, are equal or nearly so, in magnitude and duration.

The polarity of spark coil discharges can be ascertained by attaching two fine iron wires to the secondary terminals. The wire remaining cold is the positive one, while the one becoming hot is the negative pole.

For operating spark coils at maximum efficiency or voltages over fifty, alternating or direct current, the Gernsback Electrolytic Interrupter is a very useful instrument. It consists of a special metal rod resting in a porcelain tube, having a slight orifice or opening at the bottom. The tube and rod are immersed in an electrolyte or acid solution, and when connected into the primary circuit, it interrupts the current at enormous speed, the rate of make and break sometimes reaching several thousand a second. It is very simple in operation, also inexpensive as to first cost and maintenance. Its appearance is seen at Fig. 8. For 110 volts or 220 volt circuits, a choke coil consisting of a bundle of iron wire, wound with several layers of heavy copper magnet wire, is best connected into circuit to prevent an

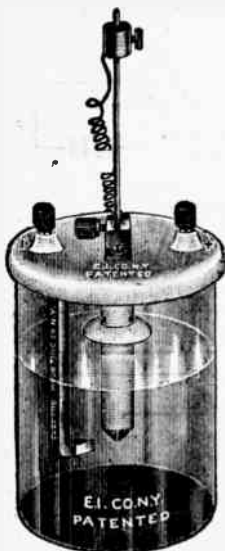

Fig. 8

interrupts the current at enormous speed, the rate of make and break sometimes reaching several thousand a second. It is very simple in operation, also inexpensive as to first cost and maintenance. Its appearance is seen at Fig. 8. For 110 volts or 220 volt circuits, a choke coil consisting of a bundle of iron wire, wound with several layers of heavy copper magnet wire, is best connected into circuit to prevent an

excessive current flowing and blinking the lights. The manner of hooking up the choke coil is shown at Fig. 9. The spark resulting from the use of the electrolytic interrupter, is seen at Fig. 9A.

Spark coils of the induction type are also widely used for gas and gasoline engine ignition. A diagram for connecting up at $\frac{1}{2}$ " spark coil to a single cylinder gasoline engine is shown at Fig. 10.

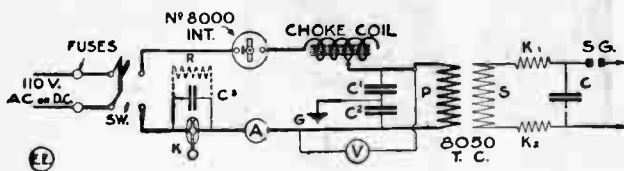

Fig. 9

A standard form of spark coil is depicted at fig. 11. This is the "Bull-Dog" Coil produced by the Electro Importing Co., of N. Y. City, and is built in all sizes from $\frac{1}{4}$ " spark up to 12" spark capacity.

The field of experiment with spark coils is endless, and some of the more interesting and instructive examples are cited below, but it is hoped that these will but serve to lead the way to more elaborate and extensive experiments. It may be said that the bigger the coil, the more elaborate and spectacular the experiments.



Fig. 9A

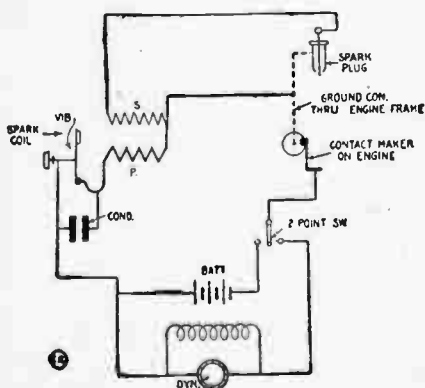

Fig. 10.

A common, yet extremely interesting experiment with any spark coil is the spark ladder. Two thin iron wires are bent as shown at Fig. 12. By a little experiment, the proper shape of the wires will be found, when the spark will run up the ladder, stop, begin at the bottom, etc., repeating the performance indefinitely. The

heated air caused by the passage of the spark, is the reason for the spark tending to rise. Heated air is a better conductor than ordinary air.

A very pretty experiment with spark coils, is that created by strewing carbon or other filings upon a glass plate. The secondary wires are connected to opposite ends of the body

of filings. The spark divides up and takes devious paths thru the filings, forming a very striking experiment.

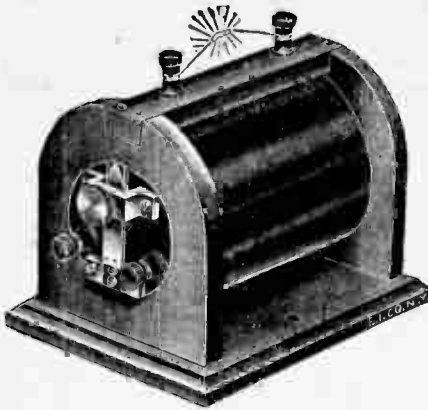
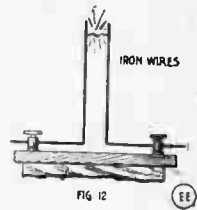

Fig. 11

A spark-board is easily made and amply rewards the builder, as it is extremely pretty in the dark, resembling a million sparkling diamonds. At Fig. 13 A, is shown how to make a regular spark board.

This is nothing but a piece of dry wood well shelled, and coated on the front face with tinfoil. Diagonal cuts with a sharp knife are then made in both directions as shown dividing up the surface into a large number of small spark gaps. Using different kinds of metal foil, such as copper, aluminum, etc., gives different colored sparks. At Fig. 13 B, is shown how to construct a spark word-board. The letters are formed of a narrow strip of tinfoil leading continually forward toward the other end of the board. The foil may be about $\frac{1}{8}$ " wide. After gluing it fast, a sharp knife is used to produce minute spark gaps, about $\frac{1}{8}$ " to $\frac{1}{4}$ " apart. At opposite ends of the word or letters, are attached the terminals of the spark coil secondary.



The length of spark given by a certain coil is always understood to mean when measured between needle points. When metal spheres are used as electrodes, the spark cannot leap such long gaps, as between needle points; for the reason that the spheres present a greater capacity, and part of the energy is utilized in charging them. A striking form

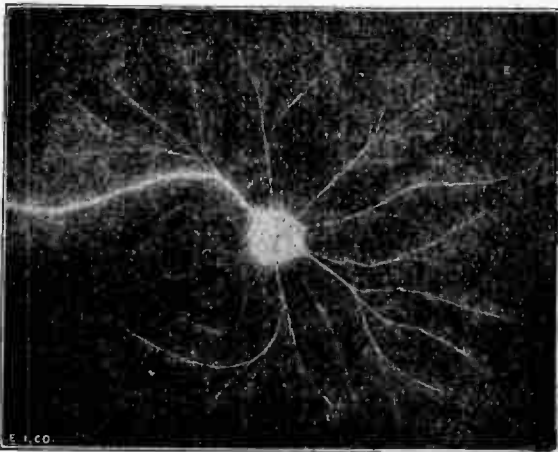
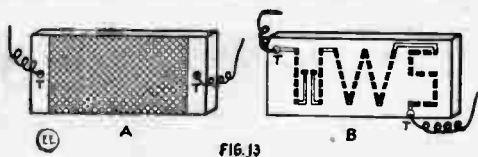

Fig. 14

of discharge is formed between one ball and a pointed electrode; with the ball positive the spark is very different from that when the ball is negative.

When a piece of glass or mica is placed between the electrodes, the spark tends to branch out and strike around the edge of the sheet.

If not too thick, the sheet will be punctured, as the voltage of the spark is very high, being about 20,000 volts for 1 inch spark between needle points.* (Root means square value; the maximum value per 1" induction coil spark is about 50,000 volts.)



The spark coil presents a good means of getting rid of cats, or dogs, which prowl around the yard, or for giving a nice surprise to chicken thieves. One terminal of the secondary in this case, may be grounded or connected to a piece of sheet metal. The other terminal is carefully insulated and led to the object with which the subject is to come in contact.

Photographs of electrical spark discharges are very beautiful and instructive. A cut of a discharge is shown at Fig. 14. Ordinary photographic plates are used, the exposure

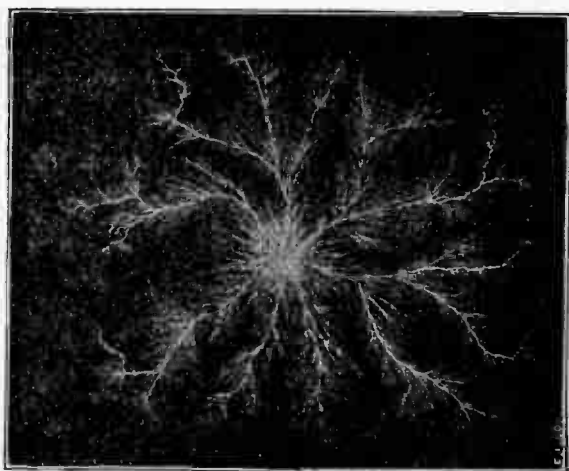

Fig. 15

being made in the dark. Take a small wide mouth bottle, and fill it half full with dry pine starch powder or talcum powder. Over the mouth of the bottle fasten a piece of fine gauze, to serve as a sieve. Tie the gauze around the neck of the bottle with a string.

Then take the photograph plate, and with the emulsion or coated side up, place it upon a piece of sheet iron, tin, etc. Connect the metal plate with one of the secondary terminals of the coil. A thin layer of the powder from the bottle is now sifted over the photographic plate. A fine metal point such as a pin, is set in the middle of the powder pre-

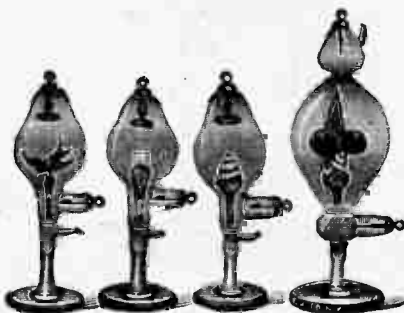

Fig 16

pared surface. The pin point is connected to the other secondary post of the coil. Close and open the coil primary circuit quickly, making one spark. After making the spark, the plate is wiped off to clear it of powder and developed in the regular way. Changing the polarity of the metal point will give different results. Fig. 14, is the result of connecting the negative pole to the point, while Fig. 15, shows the photograph resultant from connecting the positive pole to the point. Patterns, as of a star, your initials, etc., can be cut out of paper, and placed over the plate, before sifting the powder on. When the spark is made and the plate developed, the design will have the shape of the outline used.



Fig. 17

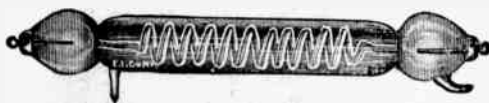

Fig. 18

off by exhausted glass tubes, generally called "geissler" tubes.

Geissler or exhausted tubes are made in a variety of forms and styles, some upright tubes having pedestals

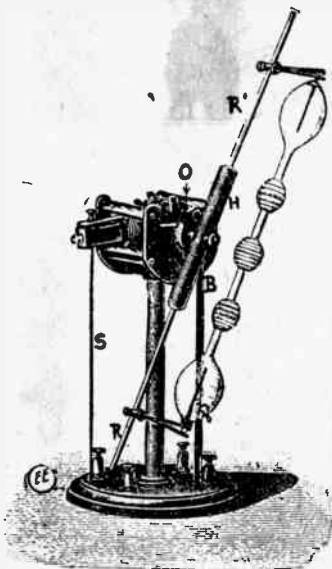

Fig. 19

The most beautiful displays from the high potential discharges of the induction coil are given

when the coil are given off in exhausted vacuum tubes. One of the finest tubes made is that seen at Fig. 18, which is a tube containing certain liquid mixtures, resulting in an indescribable display of color, when excited.

Very little energy is consumed in lighting geissler tubes, and a one inch spark coil will illuminate 12 to 18 tubes at once, depending upon their size. The average size is 8 or 10 inches long. Geissler tubes have been made to form a name, the tube being a continuous

evacuated chamber, with metal terminals sealed in both ends. It may be said here, that the metal lead-wire passing thru the glass, must be platinum, as this has the nearest expansion and contraction coefficient to glass.

The finest and most entrancing displays for lectures or experimental study are obtained from revolving Geissler tubes. A small battery motor such as E. I. Co., type S, serves the purpose admirably well.

A motor attachment for rotating Geissler tubes is seen at Fig. 19. Here H is a fibre or hard rubber sleeve, serving to insulate the rods R R, supporting the Geissler tube. A double contact drum and brushes are fitted to conduct the coil current to the tube as it revolves.

LESSON No. 13.

THE X-RAY.

THE so-called X-Rays or Roentgen Rays, were discovered by Professor Roentgen, of Wurzburg, Germany, in 1895. He was at that time experimenting with electrical discharges in evacuated Crooke's tubes, exhausted to one one-millionth of an atmosphere. X-Rays are the result of an electrical discharge setting up or creating waves in the ether, the same as in wireless telegraphy, with the difference that these waves have a very minute length, and extremely high frequency; as a contrast to wireless waves which are of fairly long length and low frequency.

In consequence of the short wave length of the X-Rays, they are capable of passing through a great number of solid substances, nearly as readily as light waves pass thru glass.

Solid substances including metals, absorb the X-Rays, in proportion to their density generally. Lead and iron are almost opaque. Aluminum offers but slight resistance to the rays. Diamonds are nearly transparent. Glass and quartz absorb a greater portion of the rays. The bones of the human body are fairly opaque, while the vital organs and muscles are not so opaque. The lungs are nearly transparent.

The following data on the relative transparency of various substances to the X-Rays may be of interest to the reader.*

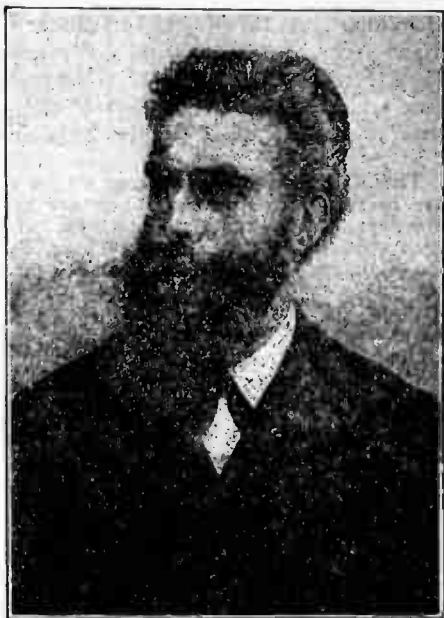

PROF. ROENTGEN

*See "Standard Handbook for Electrical Engineers."

TRANSPARENCY OF VARIOUS SUBSTANCES TO X-RAYS.

(Batelli and Garbasso.)

Material.	Specific Gravity. Water = 1.	Trans- parency. Water = 1.	Material.	Specific Gravity. Water = 1.	Trans- parency. Water = 1.
Pinewood	0.56	2.21	Nickel	8.67	0.095
Walnut	0.66	1.50	Brass	8.70	0.093
Paraffin	0.874	1.12	Cadmium	8.69	0.090
Rubber	0.93	1.10	Copper	8.96	0.084
Wax	0.97	1.10	Bismuth	9.82	0.075
Cardboard	—	0.80	Silver	10.5	0.070
Ebonite	1.14	0.80	Lead	11.38	0.055
Wool-cloth	—	0.76	Mercury	13.59	0.044
Celluloid	—	0.76	Gold	19.36	0.030
Silk	—	0.74	Platinum	22.07	0.020
Cotton	—	0.70	Liquids.		
Bone	1.9	0.56	Ether	0.713	1.37
Coke	—	0.48	Petroleum	0.836	1.28
Glue	—	0.48	Alcohol	0.793	1.22
Sulphur	1.98	0.47	Olive Oil	0.915	1.12
Aluminum	2.67	0.38	Water	1.00	1.00
Glass	2.60	0.34	Glycerine	1.260	0.76
Tin	7.28	0.118	Nitric Acid	1.420	0.70
Zinc	7.20	0.116	Chloroform	1.525	0.60
Iron	7.87	0.101	Sulphuric Acid	1.841	0.50

The X-Rays as emitted from a tube made for the purpose, are invisible to the eye. They are easily rendered visible, however, by observing them thru a cardboard screen, coated with a fluorescent substance such as, Barium-Platinum-Cyanide, Calcium Tungstate, Willemite, etc. These screens be-

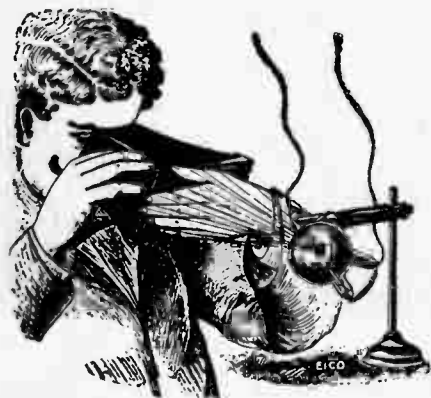

Fig. 1.

come luminous in proportion to the strength of the X-Rays falling upon them. The manner of observing an X-Ray view of the hand is shown at fig. 1, and as seen, the hand is placed a short distance away from the tube, and between it and the fluorescent screen. The screen is usually fitted with plush, fur, etc., at the smaller opening, and cut to fit the face about the eyes. The picture of the hand thrown on the screen, will show the bones and flesh distinctly, owing to the much greater absorbing quality of the bones as compared to the flesh. The bones appear as a dark shadow, the thicker the bones, the denser the shadow. Actually the bones are not seen through a "fluoroscope," but what is seen is a shadow picture produced by the conversion of the X-Rays into light by the fluorescent chemical on the screen.

In fig. 2, is shown the method of taking a "skiagraph" or X-Ray photograph. The tube is excited by a spark coil or static machine. At a is the positive electrode or anode; C is the negative electrode or cathode; h the hand of the patient; P the photographic sensitive plate wrapped in an opaque envelope or enclosed in a plate holder with the slide in; and T, the table. The duration of the exposure to the X-Rays will depend upon the strength of the exciting apparatus and tube, and also upon the thickness of the tissue and bone through which they have to pass.

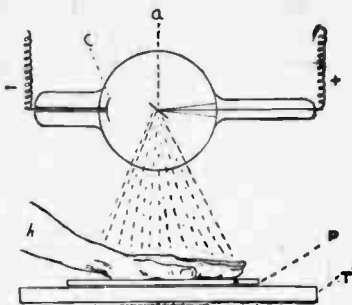

Fig. 2.

With large professional machines, such as used in hospitals, it varies from a few seconds to $\frac{1}{2}$ minute and more, according to whether the "skiagraph" is of the hand, the foot, the head, the pelvis, etc. The pelvis is one of the hardest parts of the human body to skiagraph, as it is so thick.

Many ingenious ideas are utilized to obtain skia-graphs of various parts or organs of the body. As an example, before taking one of the stomach, the patient is fed a bismuth meal, consisting of specially prepared bismuth tablets. The density and transparency of bismuth is many times higher than that of the flesh or muscles, hence a difference in the shadows cast upon the screen, enable the stomach outline to be discerned from that of the bones and flesh.



Fig. 3.

A very good skiagraph of the hand of a lady, with wedding and diamond rings on the finger, is illustrated at fig. 3. This

X - Ray photograph was taken as previously explained, the length of exposure being 10 minutes, distance of tube from hand, 5 inches, photograph plate 8 by 10 inches. The exciter for the tube consisted of a $1\frac{1}{2}$ inch "Electro" spark coil, with French double spring vibrator, and a 6 volt dynamo exciting the primary circuit of the coil with 5 volts and

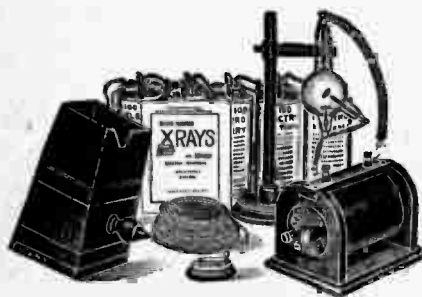

Fig. 4

2 amperes. The tube was a standard tube designed to be operated on from 1 to 3 inch spark coils. In general, the $1\frac{1}{2}$ or 2 inch coil gives the most satisfactory results, and the larger the coil and tube, the quicker the skiagraph can be taken. For surgeons' use a 10 to 12 inch spark coil with

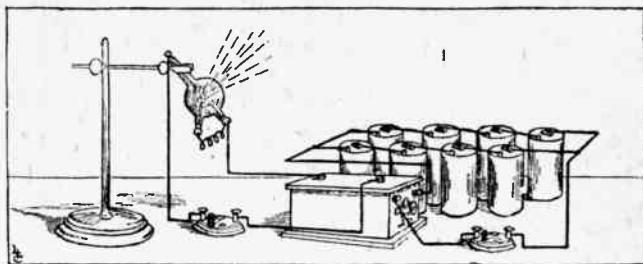

Fig. 5

electrolytic or mercury turbine interrupter is generally employed. Some hospitals and private practitioners make use of as large as 20 inch spark coils, or special transformer sets, utilizing a 120,000 volt high tension transformer, operating from the alternating current circuit.

An X-Ray outfit complete, and comprising a special $1\frac{1}{2}$ inch spark coil, X-Ray tube, fluroscope, wire, switch, batteries, and treatise on X-Rays, is depicted in fig. 4. This enables anyone to experiment with the wonderful X-Rays, and the price is very low, being but \$17.75 for the whole outfit ready to set up. The wiring diagram for this set is shown at fig. 5. The X-Ray tube is connected across the secondary circuit of the spark coil. To prevent puncturing the tube and as an aid to the regulation of it, a safety spark gap is invariably left connected across the secondary terminals of the coil, the length of the gap being a little less than the spark length rating of the coil.



Fig. 6

The tube used in this outfit is shown at fig. 6. It is an imported tube, and is self regulating as regards the vacuum.

In the drawing fig. 7, is outlined the action of the focus X-Ray tube. The cathode or negative electrode is at K, and is of aluminum, concaved so as to direct the torrent of radiant matter to a concentrated focal point on the anode or anti-cathode A. At this point of impact on the molecular target, the X-Rays are abundantly generated, and as the target is of platinum, it is not only enabled to withstand almost any heat developed, but it also allows no penetration of the X-Rays to its reverse face.

The X-Rays which are generated at the point of impact on A proceed radially outwards in straight lines in all directions, and as A is placed at an angle of 45 degrees, with the axis of the tube, the X-Rays pass out thru the glass, opposite to the centre of the plate, without encountering any considerable opposition. In fig. 7, the direction of the cathode stream toward the concentrating point on the anode A, is represented by the dotted lines. The direction of the radiation of X-Rays are represented by dot and dash lines and extend thru the cathode K, but are not drawn in to make the cut clearer.

As the X-Rays pass out thru the glass wall of the tube, they produce fluorescence, usually of a canary yellow or apple-green color, but this varies with the chemical structure of the glass and the degree of exhaustion. It is often bright, and occurs exactly over the area which is exposed to the

Roentgen rays. The results obtained with the focus tube are what one would expect, when the source of the rays is almost a point, i. e. radiographic and screen effects are thereby rendered much sharper and more detailed, without the necessity of working with the tube at some distance from the plate.

A special water-cooled anode tube is seen at fig. 8. The anode electrode tends to heat up and the water cools it to some extent.

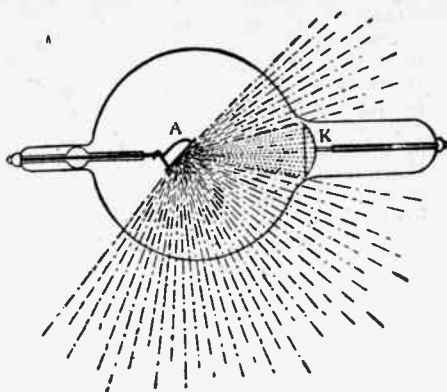

Fig. 7

In the X-Ray tube of standard pattern, the predominant feature governing its behavior under given circumstances is the resistance offered by it to the passage of the discharge.

If the resistance be too high the rays which are produced have great penetrative power, and pass thru bones almost as easily as through flesh, producing *skiagraphs* of flat quality, and wanting in contrast. A tube of too low a resistance produces X-Rays which have little penetrative power, are almost stopped by the flesh, and entirely so by the bones, which appear dead black with no structural detail visible.

There is a wide range for choice between these limits, and in regular practice, a different degree of exhaustion is employed for certain classes of work.

A low resistance tube of small penetrating power is called *low*, or more usually *soft*; and one of high resistance with great penetrating qualities is known as *high* or *hard*. The resistance tho principally governed by the bulb is also affected by the dimensions of the cathode and its distance from the anode.

The cathode, K, in fig. 7, is invariably cup-shaped, and is made of such curvature that the rays emanating from its surface converge with a certain degree of accuracy upon a point in the centre of the anti-cathode or anode electrode surface A.

A high resistance results from the use of a small cathode, and penetrative rays. A large cathode gives a low resistance and soft results. For ordinary work a cathode diameter of one inch is quite suitable.

Aluminum cathodes are much in vogue, because the discharge would disintegrate particles from any other metal, and distribute them all over the inner surface of the bulb, and blackening it thereby. The surface of the electrode should be uniformly curved, and very highly polished.

The greater the accuracy employed in making and mounting the electrodes in the bulb, the more finely the cathode stream (see fig. 7),

can be focused upon a fine point on the anode, and the more sharp and detailed will be the *skiagraphs* obtained.

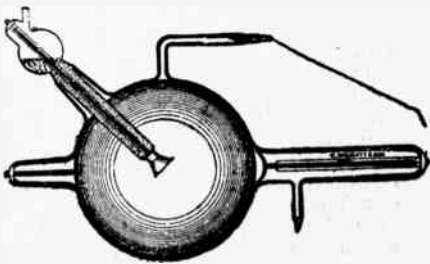

Fig. 8.

This is due to the fact that the source of the Roentgen rays is this point of impact, and from it they proceed in straight radial lines.

Owing to the violent bombardment of the anode surface by the cathode stream, it tends to get extremely hot, especially if the bombardment is centered exactly at one small point, and a hole would soon be burned thru it.

In practice, however, the concentration is never accurate in ordinary tubes, a compromise being made between the sharpness of focus, and the heating effect. From this it is evident, that anything which enables the anode to lose its heat rapidly, or to stand a high temperature without being damaged, also allows of a more accurate concentration of

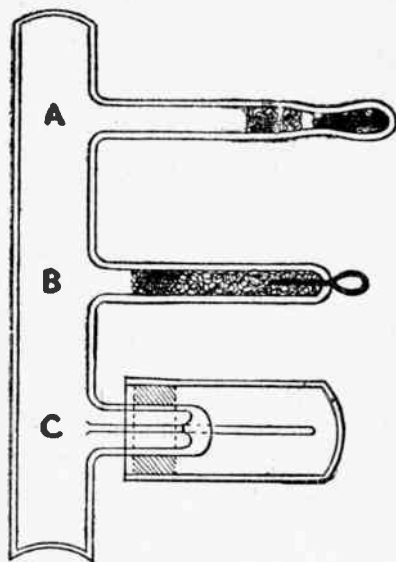

Fig. 9.

the cathode stream, and a greater sharpness in the effects produced. Also, such non-damageable anodes permit of a heavier discharge thru the tube and therefore of greater energy of radiation.

The anode or anti-cathode as it is sometimes called, consists usually of a small plate of metal fixed opposite to the centre of the cathode, and mounted at an angle of about 45 degrees with the axis of the tube.

The X-Rays which are produced radially from it, are thus directed outwards through the side of the bulb, where no electrodes, thickened glass, or other obstructions are met with.

The material employed for the construction of the anode electrode makes a considerable difference in the efficiency of the tube, as found by Roentgen. He states that there is a difference in degree of X-Ray emission, by anodes of different materials, and that at the point of impact of the cathode stream, platinum radiates much more powerfully than aluminum; platinum having a very high melting point (3,000 degrees Fahrenheit), is usually chosen for the material out of which to make the anode electrode.

Excellent results have been obtained with iridium used as a small centre in a disc of platinum.

X-Ray bulbs tend to raise their vacuum after continued use, and change from a soft low vacuum, to a hard high

vacuum. There are various methods in vogue for regulating the vacuum of tubes automatically and otherwise. Three principal schemes employed are depicted by the cut fig. 9, at A, is represented the chemical regulator, which requires the application of external heat to them, to become operative. The sealed glass chamber shown, contains potassium chloride or manganese dioxide, which liberates oxygen gas when heated by the application of a spirit lamp to the outer surface of the glass tube.

The construction shown at B is like the one just described with the exception that a platinum wire is sealed into the portion of the tube containing the chemical. Sparks from the exciting apparatus are allowed to pass into the tube thru the platinum wire, and gas is formed and liberated. The tube can thus be regenerated at will.

The vacuum regulator illustrated at C, is known as the "Osmotic type." It is comprised of a very small tube of metallic Palladium sealed into the side of the X-Ray bulb. The inner end of the metal tube is open and the outer end closed. The tube is covered ordinarily by a glass cap. If this cap is removed, and the flame of a spirit-lamp applied to the closed outer end of the Palladium tube, hydrogen ions from the interior of the flame will be drawn thru the intermolecular spaces of the heated metal, into the exhausted X-Ray bulb. This form of regulator has the advantage over the proceeding two types, in that the vacuum of the X-Ray

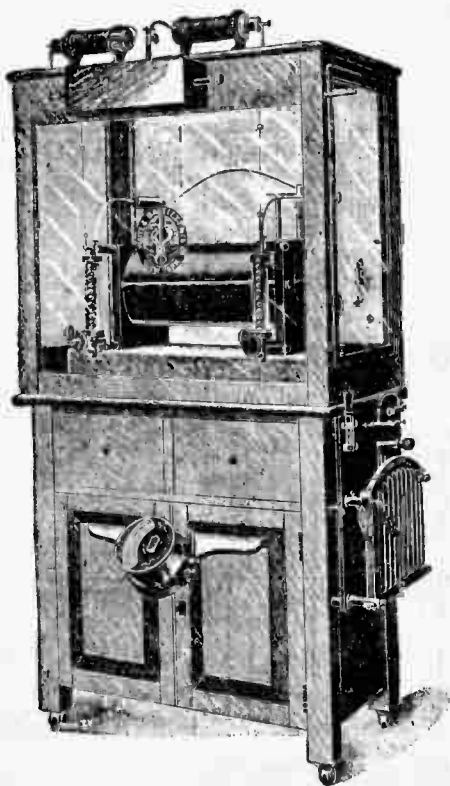

Fig. 10.

bulb, can be adjusted any number of times, but the first two are limited by the amount of chemical in the end of the regulator tube, which is sealed off air tight.

X-Rays present a very entrancing field for unlimited experiment and study, but caution should be observed in subjecting the skin to long exposures of the rays, as they have a property of producing serious sores or growths, which if not checked quickly are incurable. Grave effects are caused on the trophic nerves, and vital resistance of the superficial tissues of the body, followed in a week or more by severe inflammation and necrosis.

A large X-Ray generator with regulating rheostat, ammeter, etc., are shown in fig. 10.

LESSON NO. 14.

HIGH FREQUENCY CURRENTS.

HIGH frequency currents represent the most advanced field of electrical experimentation, and but very few of the wonders of these currents, especially when produced at high potential are known. Hence, a wide scope is given to the investigator and experimenter, in the

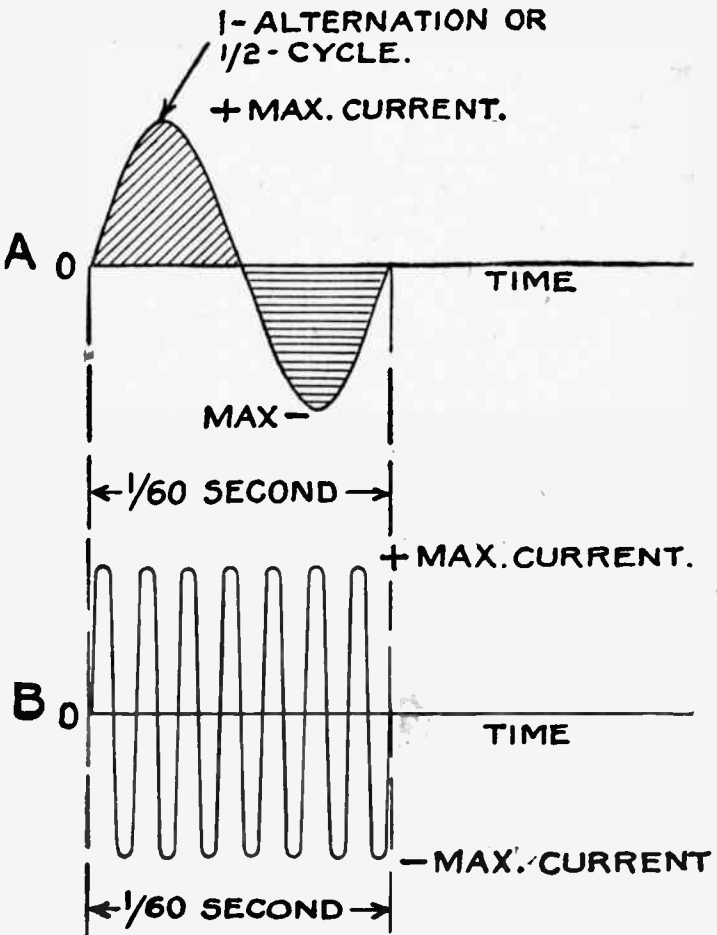

Fig. 1.

evolving of new laws and phenomena, from researches in this most interesting and growing branch of the electrical art.

The production of high frequency currents for experimental research, is usually accomplished by the aid of a Tesla coil, which takes its name from Nikola Tesla, a famous authority and investigator on this subject. Two of the principal scientists who have given us data and explanations of these currents are Tesla and Elihu Thompson, who independently and simultaneously obtained practically similar results.

Before delving into the more intricate details concerning the arrangement and operation of Tesla coils, Oudin coils, etc., a few paragraphs will be devoted to the elucidation of the meaning and scope of high frequency as applied to the currents in question. It may be stated firstly, that high frequency currents are invariably oscillatory in Nature, or alternating from positive to negative, and back again, many hundred times per second. In the diagram, fig. 1A, is given a graphical representation of the "wave form" and time value, of an ordinary alternating current, such as used for commercial lighting, running motors, power transmission, etc. This current is known as a standard 60 cycle current; one cycle meaning the time consumed for the current to rise from zero to maximum positive value, back to zero, then to negative maximum to zero again. The time consumed by the current rising from zero to positive maximum then

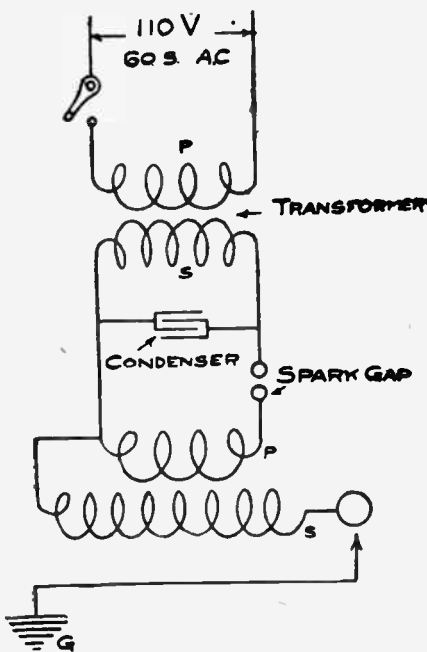

Fig. 3

to zero, is referred to as an alternation; two alternations comprising a cycle. Hence, a 60 cycle current is one having also 120 alternations, and the time for this series of changes to take place is one sixtieth of a second. Also 60 cycles will take place in 1 minute. One alternation or $\frac{1}{2}$ cycle requires for its transmission $\frac{1}{120}$ of a second.

In the curve of fig. 1 B, is depicted a higher frequency current than the 60 cycle just discussed, or as seen in the same time interval, viz., $\frac{1}{60}$ second, seven times as many complete cycles have occurred, or the frequency per second is 7 times 60 or 420

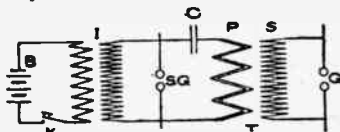

Fig. 2

cycles per second. Likewise, this frequency is equivalent to 840 alternations per second, or also 25,200 cycles per minute. Commercial lighting currents usually have a frequency of 3,600 cycles or 7,200 alternations per minute.

This explanation is for the purpose of making clear the exact meaning of the term high frequency. In actual practice, the term high frequency is invariably understood to mean a current whose frequency is somewhere between 10,000 and 1,000,000 cycles per second.

When such frequencies as these are employed, many wonderful and hitherto unlooked for phenomena appear. Among other features which they possess, are those permitting of passing it thru or rather over the human body, at a potential of half a million volts, or more. Tesla, Thompson and others have often demonstrated the feat of passing a million volts thru the body from hand to hand without experiencing the slightest harm or ill feeling. Ordinarily as in the electrocution of criminals, where low frequency alternating current of 60 to 120 cycles is employed, such potentials as 2,000 volts are sufficient to kill the subject. Generally but $\frac{1}{4}$ to $\frac{1}{2}$ ampere passed thru the heart is sufficient to cause death. With high frequency currents, however, the current strength as indicated by a hot-wire ammeter may easily reach several amperes.

Currents of such frequencies as these, no longer obey the laws governing those of low frequency. For one thing, they travel principally over the surface of conductors, not thru them; penetrating but a few thousandths of an inch, this depending upon the frequency value. The higher the frequency, the less the penetration. From this it is evident that solid conductors for high frequency currents are a waste of material and thin walled or hollow ones of large diameter, are the best. Stranded conductors are always better than solid ones of similar capacity, as the former has much greater surface area for a given cross-section, and this is what counts in this case.

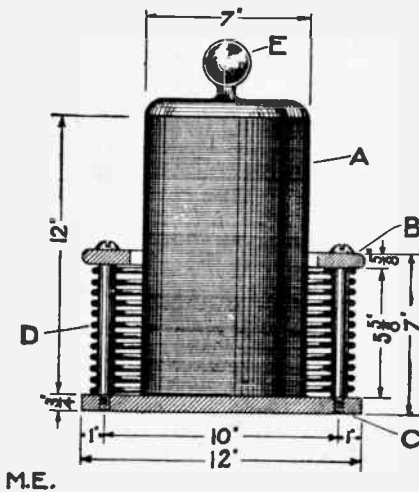

An Oudin Coil.

High frequency currents can be produced in several ways, the principal methods being those involving the use of an Elihu Thompson generator, a Fessenden high frequency dynamo, or by means of the Tesla disruptive discharge set. The latter is the commonest and easiest method of producing such currents, and is widely utilized for lecture work, electrotherapeutics, exciting X-Ray tubes, etc.

The general arrangement of the functional parts composing the complete set is outlined in fig. 2.

Referring to the diagram, I is an induction or spark coil, preferably of not less than 2" spark capacity. T is an air-core transformer, which serves the purpose of stepping up the voltage of the current delivered by the secondary of the induction coil, to many times its original value. At C is a condenser composed of Leyden jars, or glass plates, coated

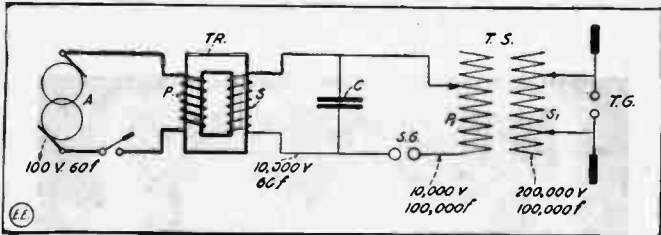

Fig. 4

on both sides with tinfoil. A spark gap is placed at S G between whose electrodes the disruptive discharge of the condenser takes place. G is the discharge air gap of the Tesla coil secondary, across which the high frequency oscillations surge.

The functions of the various parts of the apparatus and their inter-relation is as follows: The induction coil or transformer I is excited from the battery shown at B, or the regular line feed wires; and its secondary current at 10,000 volts or more pressure is caused to charge the condenser C, which

discharges itself thru the primary coil P of the Tesla transformer and the spark gap SG. Now due to the conditions imposed by such circuit, the condenser discharge becomes not a single discharge for each cycle of induction coil secondary coil, but many times greater; so that with certain proportions to the circuits, as regards the capacity and inductance, the frequency of the current passing thru the Tesla

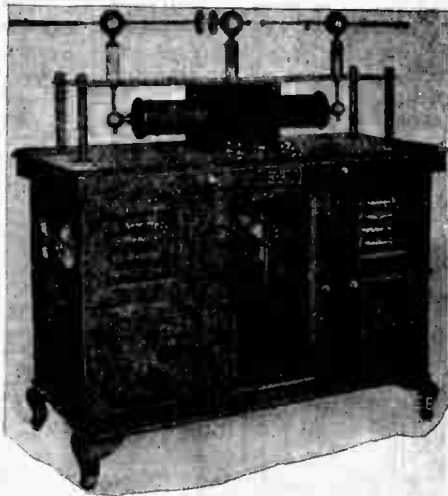

Fig. 5

coil primary may easily reach a million and more cycles per second; rendering the current harmless owing to the "skin effect" already mentioned. The currents thus produced are of course highly damped, i. e., the series of oscillations corresponding to each cycle of exciting current, dies down to zero, before the next series of oscillations start.

The frequency of the Tesla currents produced obey a certain law, which is as follows: They vary as the square root of the product of the capacity and inductance in the closed oscillating circuits. The frequency in cycles per second is found by dividing 10^8 times 5.033 by the square root of the

capacity, multiplied by the inductance; where the capacity is in microfarads, and the inductance in centimeters. For further particulars see "Wireless Course" chapters 17 and 19. Also "Construction of Induction Coils and Transformers," by H. W. Secor.

Another form of high frequency transformer employed extensively for electro-therapeutical applications, is the Oudin coil. Its appearance and connections are given at fig. 3. As

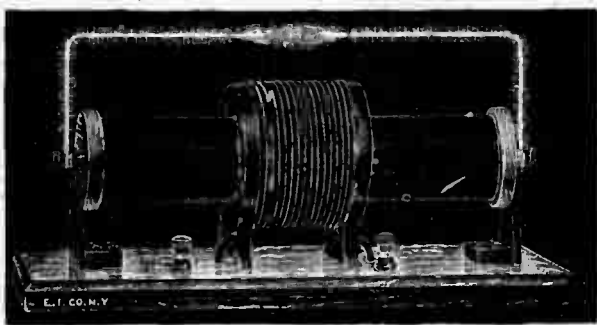

Fig. 6

seen the bottom of the primary and secondary coils are joined together. Any Tesla coil becomes an Oudin type, if the primary or heavy wire winding is simply placed at the end of the secondary, instead of at the center as usual.

The relation of the frequencies and voltages will be more readily understood quite probably by inspecting fig. 4. It is seen that the coils or transformers do not change the frequency in themselves at all but only the voltage, which is dependent upon the relative amount of turns of wire upon the different coils. (See Lesson No. 4). A cut of a powerful high frequency generator designed by Dr. Frederick Strong, for electro-therapeutical purposes, is illustrated by fig. 5.

For experimental research a very neat and efficient form of Tesla transformer is depicted at fig. 6. It is built by the well known electrical firm, The Electro Importing Co., of New York City, and sells for a very reasonable price, in comparison to the wonderful results attainable with it. In full activity, when excited from a 2" spark coil operating on batteries, it takes on the appearance displayed in fig. 6, but the life and beauty of the discharge can only be fully appreciated by actual observation, and not from a mere black and white print. This coil is admirably suited to the requirements of the

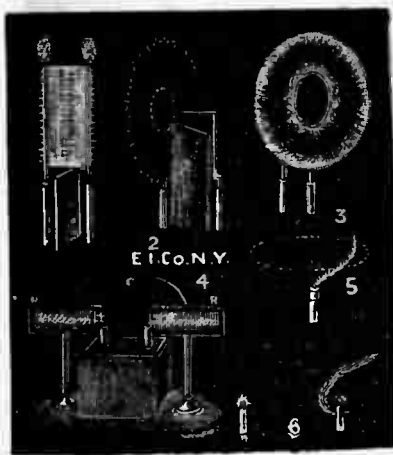

Fig. 7

private laboratory, the School lecture platform, and demon-

strations in general. A larger exciting coil may be employed than that mentioned, and of course the effect is greatly enhanced. (See the Feb., 1914., E. E. for a special article on "Currents of Ultra-High Frequency and Potential.")

The adjustment of the circuits of Tesla or Oudin coils has to be carefully tried out by experiment to attain the maximum results. The length of the spark gap, the amount of condenser capacity and number of Tesla coil primary turns in circuit, all have a direct influence upon the final high frequency discharge, and they should be carefully adjusted simultaneously or successively, until the best high frequency discharges are obtained.

A rotary spark gap is best for the oscillating circuit, as it keeps very cool, and prevents the gap from arcing, which lowers the frequency. The shorter the gap the higher the frequency, and vice versa.

Having described the Tesla transformer, its action and connections, a few experiments of interest will be given: It may be well to state that the most spectacular results are only obtainable in a good dark room or hall. When the high frequency current is to be handled by the body, an unpleasant shock is experienced if the Tesla spark is allowed to jump direct to the skin; and a piece of metal held in the hand, or a Geissler tube, or even an incandescent lamp is best; the brush or spark being absorbed by them, and communicated to the body without shock. Geissler tubes and the like are very useful for demonstration, as whenever the discharge is absorbed thru them they light up brilliantly, making visible the great activity occurring. Several people may be placed in a circle and a Geissler tube placed in the hands of every couple. When the current is applied to the persons at the ends of the circle, the Geissler tubes all way around will simultaneously light up, making an impressive effect.

In Fig. 7 are shown a number of interesting experiments which can be performed with the Tesla coil illustrated in fig. 6. At 1, fig. 7 is an experiment requiring the use of two vertical copper wires as nearly parallel as possible. When the apparatus is working in good shape, with the frequency high, the space (2-4 inches) between the two wires is filled with light, while the ends show a heavy brush discharge.

The experiment seen at 2 is performed by arranging two loops of copper wire, and attaching them to the secondary terminals of the Tesla coil. A similar arrangement is that seen at 3, but here the inner loop is 30 centimeters in diameter (1 inch equals $2\frac{1}{2}$ cms.), while the larger loop is 80 centimeters in diameter. The space between the concentric loops is filled with millions of fine sparks, presenting a very pretty effect.

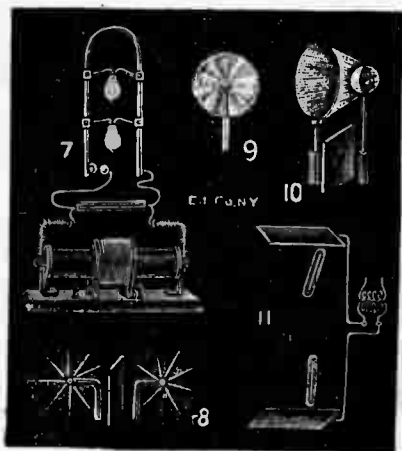

Fig. 8

Illuminated names are produced as shown at 4, fig. 7. The names are made of fine copper wire, placed on one side of glass plates. The backs of the glass plates are coated with tinfoil a little smaller than the glass itself. One ter-

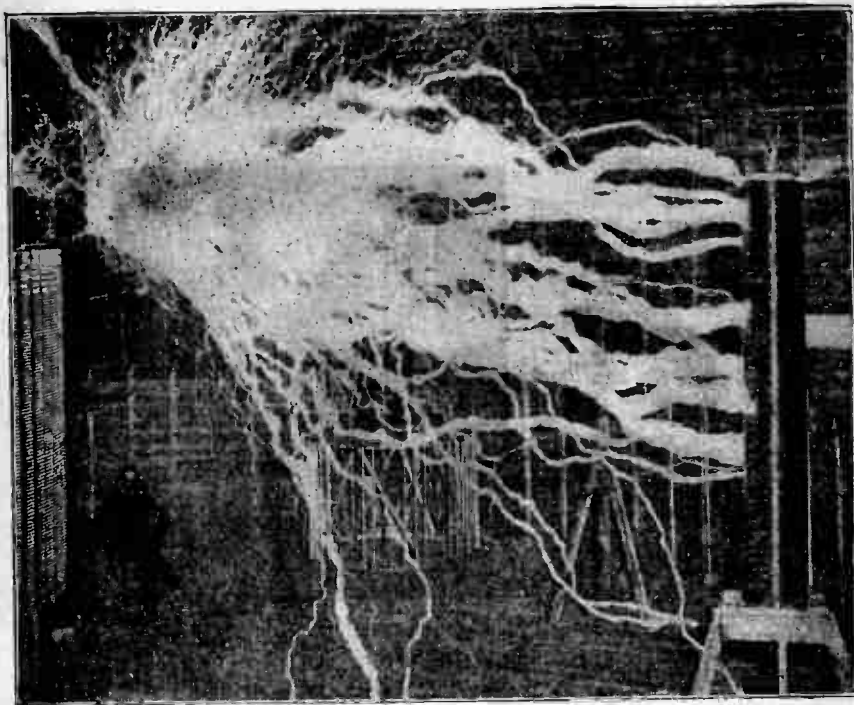

Fig. 9

minal of the Tesla secondary is connected to the wire name, and the other terminal to the opposite wire name. The tinfoil coatings on the back of the glasses are connected together by a piece of copper wire. When the current is turned on the names are illuminated. Hard rubber may be employed in place of the glass.

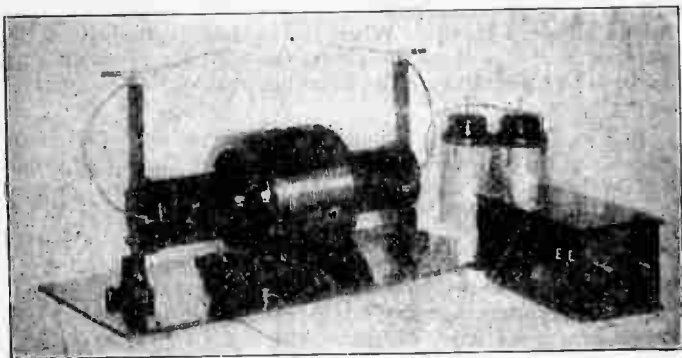

Fig. 11. A Large "Electro" Tesla Coil

The rotating wire, 5, at fig. 7, is very amusing to observe. The wire must be quite fine, and the length determined by experiment. When of the right length, the wire will swing

around a circle continually. It is connected to one terminal. A short piece of thin, cotton covered copper wire when attached to one terminal of the coil, gives out a beautiful flame effect, seen at 6.

One of the most astounding stunts performed with high frequency, high potential currents, is that known as "The impedance bridge or shunt," seen at 7, fig. 8. A heavy piece of copper wire or brass rod may be bent into a U-shape as shown, and when shunted by a low voltage lamp bulb, the lamp will light up brightly; the high frequency current preferring to traverse the comparatively high resistance path of the lamp instead of the low resistance offered by the brass rod. This is probably similar to lightning effects, etc., where it is seen that such high frequency surges, tend to take the shortest path, irrespective of resistance. For this reason lightning rods are always run in as short and straight a path as possible, avoiding sharp bends. In the Tesla coil experi-



Fig. 10. Tesla's "World Wireless" Tower on Long Island, N. Y.

ment here mentioned, a Leyden jar or other condenser is connected across the secondary coil terminals, with a spark gap in one of the leads going to the copper bar. The terminals of the 20 volt lamps are tried in different positions, until the maximum brightness is obtained.

At 8, Fig. 8, is a display of weird appearance, called the "Electrical Phantom." Two thin metal discs, about 1" diam-

eter, are connected to the two secondary terminals of the Tesla Transformer. Their edges are ground thin. With the voltage at a high value, white rays or threads of light strike out from the edges of the discs, which are sometimes of considerable length.

Electrical wind, as performed with static machines, is also reproduceable from the Tesla coil. Its effect is illustrated at 9. A small sharp toothed aluminum disc, about 1/64 inch thick, is mounted on an axle, having very little friction, and when the current is turned on, the little disc will rotate at high speed, becoming enveloped in sparks.

An illuminated cone of light is made by having a wire ring connected to one terminal of the Tesla coil and a metal ball of 1/4 the ring diameter, connected to the other terminal. When current is applied the space between the ring and ball is filled with multitudinous fine sparks, giving a unique and beautiful display.

At 11 is depicted Nikola Tesla's ideal wireless light for illumination. Evacuated glass tubes are placed in proximity to the charged metal plates, connected to a source of high frequency, high potential electric current. The lamps are thus illumined by induction, without any metallic connections whatever being made to them.

Just what can be accomplished when large amounts of electrical energy is transformed into high frequency, high potential form, may be gleaned from the photograph of some electrical discharges of this nature, at fig. 9. This is from some of Tesla's experiments. The sparks shown were 25 feet long, the potential several billion and the amperage 800. Tesla's laboratory and tower erected some years ago on Long Island, for experimenting with world wave telegraphy, is depicted at fig. 10.

LESSON No. 15. ELECTROPLATING.

PART I.

Electroplating is the term applied to that art involving the use of the electric current in the electro-deposition of metals

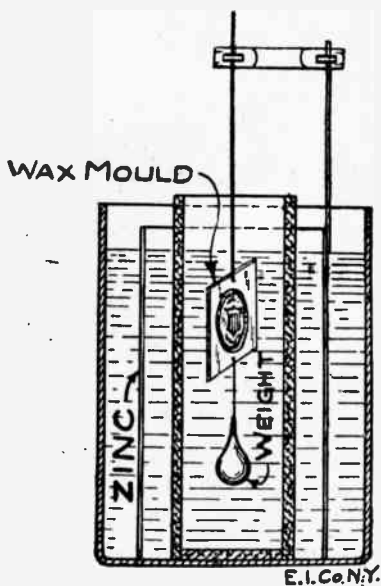

Fig. 1

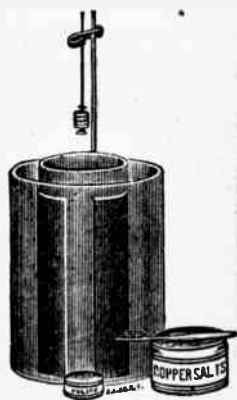

Fig. 2. A Useful Copper Plating Outfit

or their salts on other metals, or metallically coated sub-

stances. Common forms of electroplating, well known to every one now, are the familiar nickel plate on various fittings, utensils, instruments; gold plating and silver plating, as employed in the finer arts, including jewelry, etc., etc.

Besides these more well known phases of electro-deposition of metals is that branch formerly termed galvanoplastic, which has now been abandoned for the term electroplating,

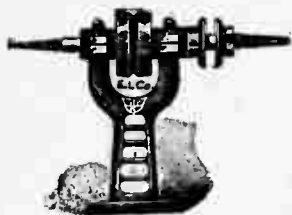

Fig. 3-A. Buffing Head



Fig. 3-B. Foot Power Drive.

or the electrotype process. The several industrial branches of electro-chemistry, including electrical refining and analyzing, electroplating and electrotyping are now embraced under the general name of *electro-metallurgy*.

Electrotyping was originally evolved by De La Rue, in 1836, who observed that in a Daniell's cell, the copper deposited from the solution upon the copper plate electrode serving as a pole, took the exact impress of the plate, including all scratches, indentations, etc., upon it.

During the year 1839, Jacobi in St. Petersburg, Spencer in Liverpool, and Jordan in London, independently developed out of this discovery, a method of obtaining by the electrolysis of copper, impressions in reversed relief, of coins, ornaments and stereotype plates, etc. Murray, another investigator, made the improvement of using molds of plaster or wax, coated with a film of plumbago in order to provide a conducting surface upon which the deposit could be made.

The making of copper electrotypes is readily affected by suspending a suitable mold in a cell containing a saturated solution of sulphate of copper. Thru the cell a battery current is passed, the mold being connected to the cathode or negative terminal. A copper plate immersed in the solution of the cell, acts as an anode, or positive terminal. The copper anode is gradually dissolved into the solution at a rate equal to the rate of deposition at the cathode. Utilizing an external source of current, is more convenient than producing the electrotypes in the actual cell in a Daniell's battery, except, if it is especially designed for the purpose. This process is widely employed at the present time to reproduce repousse and chased ornaments, works of art in fac-simile, and principally for the purpose of multiplying copies of wood block cuts for printing.

The process of forming electrotypes is also sometimes called metallizing. To metallize a non-conductor, such as sealing wax, or rubber, some finely divided metallic powder, such as bronze powder or pulverized plumbago (graphite) is dusted over it. Before applying the powder, the article or mould may, if necessary, receive a very fine coat of wax. Metallizing may also be accomplished by chemically coating such materials as glass, or other objects too fragile to be treated in the manner usually employed in electrotyping, with silver or gold by the ordinary chemical silvering or bronzing processes.

The following simple experiment is of interest:

Having procured a brass button, or other stamped metal article with a design in relief, it is well soaked and cleaned with methylated spirit to remove lacquer or grease. Now take a piece of cardboard and, holding it above a Bunsen gas flame, but not igniting it, it is sufficiently warmed to melt good red sealing wax. The wax may then be rubbed into a pool on the upper side of the card. An impression is now made into the wax, having previously breathed on the surface of the brass button just the same as in regular wax sealing. The depth of the impression at the edge need not be anything much below the centre of the edge of the button.

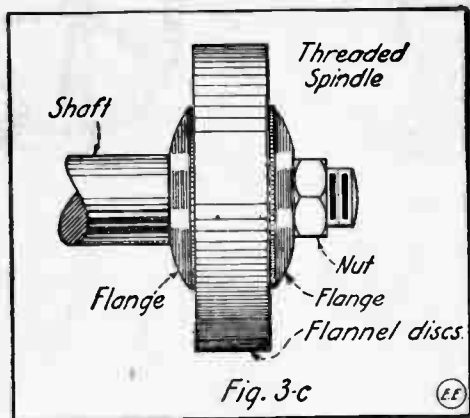

If this has been done successfully, the card is trimmed down, a few drops of alcohol are put on the surface of the wax mould when fine powdered plumbago is brushed over it by means of a soft camel's hair brush. The whole surface exposed should be thoroughly coated with the plumbago, finally brushing off all superfluous material.

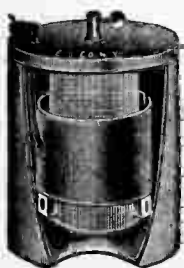

Fig. 4. Primary Cell



Fig. 5. "Electro" Type S.S. 6 Volt, 4 Ampere Generator

The free end of the copper wire connected to the zinc electrode of the plating cell depicted at Fig. 1, is heated slightly and embedded in the sealing wax, with the point projecting just clear of the mold. Over this point a little plumbago is brushed to complete the connection to the face of the mold. The prepared mold, with its plumbago coating, is now to be suspended in the inner porous pot of the plating cell, Fig. 1, as shown, utilizing a weight to hold it down if necessary. The weight should be insulated if used.

The setting up of the plating cell (of the "Electro" make) is done as follows:

The glass jar and porous cup are washed out, and the charge of blue stone (vitriol) is emptied into the porous cup, which is then filled to within $1\frac{1}{2}$ " of the top with hot water, not boiling water. After letting it cool for ten minutes, the mixture may be stirred with a wooden stick. Its color should be deep blue. The zinc cylinder electrode is next placed into the glass jar, and same is filled with a solution consisting of twenty parts water and one part sulphuric acid. The acid must always be poured into the water, and not vice versa, or else the contents of the vessel may be violently ejected into the mixer's face. The porous cup with its solution is placed into the zinc cylinder, noting that the height of the two solutions are both the same.



Fig. 6. Current Controller

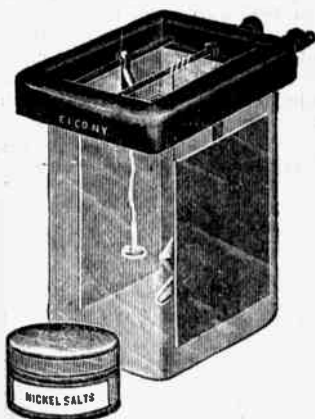

Fig. 7

The object to be plated is attached as seen, to the lower end of the copper wire held by the adjustable clip, allowing of raising and lowering it. Once the object is attached, it is lowered into the porous cup and the plating begins. A very good deposit is obtained in from ten to fifteen minutes, on metal objects. The deposit, of course, is copper. Any metallic object may be coated with it, directions for preparing and cleaning such objects being given fully a little later on.

To resume the subject of metallizing the wax mould with its plumbago coating, it is lowered into the cell solution, within the porous cup. If by chance, the current is too strong, evidenced by burning of the copper deposit which manifests its presence by dark brown smears and marks around the edges, which should normally be of pale salmon pink color, the zinc is suspended a trifle out of the solution. The wax mould is left in the plating cell for approximately twenty-four hours, when it may be removed and stripped. If this does not occur easily, the wax can be melted off with slight heating applied. The electrotype may be cleaned with methylated spirit. If any pin holes appear in the deposit, it is practically certain it is due to imperfect depositing of the copper, or to the presence of loose plumbago on the surface of the mould. When the process has been successful every detail of the original impression is reproduced exactly. If the specimen is to be preserved, a little chloride of zinc may be brushed over the hollow back of the electrotype, having previously cleaned the surface well. A sheet of tinfoil can be burnt on by spreading it over the surface and holding the electrotype face downward over a Bunsen gas flame after

which the body of the shell can be filled with molten tin or lead. The following current density values are good ones, being given in amperes per 100 square inches of surface exposed. For copper electrotyping from an acid bath solution, best quality tough deposit 1.5 to 4; good and tough deposit, 10 to 25; solid deposit sandy at edges, 25 to 40; sandy and granular deposit, 50 to 100. For copper deposit from a cyanide bath, 2 to 3; zinc, for refining, 2 to 3; silver, 1 to 3; gold, 5 to 1; brass, 3 to 3.5; iron (steel facing), .5 to 1.5; nickel, begin at 9 to 10 and gradually diminish to 1 to 2.

For copper plating metal articles, such as brass, iron, etc., the object should first be thoroughly cleaned. Begin by hanging the article in boiling caustic soda solution for five to ten minutes, which serves to remove all dirt and grease from the surface. Rinse the object in cold water and it is then ready for plating. In case the object emerges from the plating bath rough with fine holes on the surface, it is most probably due, to insufficient cleaning; and it should be recleaned. Brass and iron objects should be particularly well scrubbed with the hot caustic soda solution to remove all dirt from crevices, etc. When the plating deposit has been made heavy enough, the article can be rinsed in cold water, and dried by rubbing with a piece of flannel, or by rolling in fine sawdust. The latter is the method usually employed in all commercial plating shops.



{Fig. 8. Water Motor for Driving Dynamos

Small animals, flowers, lace, etc., are metallized by first cleansing in methylated alcohol and while moist, they are thoroughly dusted with plumbago, filling all the crevices and indentations. A wire is then fastened to any part of the object and plumbagoed to the object to make perfect connection. It is then suspended into the porous cup and the copper plating begins. Very beautiful and artistic work can be accomplished in this manner. A cut of the "Electro" copper plating outfit is shown at Fig. 2.

For cleaning up articles preparatory to plating, a power head or buffer head, consisting of an iron standard with a short shaft threaded to fit nuts at each end, and mounted with a driving pulley at the centre, as seen in Fig. 3-A, is very useful. The buffing wheels employed for polishing the plated articles are soft and composed of numerous discs of cotton flannel, sewed in circles and held on the buffing head spindle by a flange plate and nut, as seen in Fig. 3-C. Scratch wheels with wooden or wire bristles can also be fitted onto the buffing head as well as emery wheels, for preparing articles for plating. To drive the buffing head spindle, a foot power treadle will be found handy if motor power is not at hand. A usual form of foot power drive is shown at Fig. 3-B.

For small plating work batteries can be employed for the source of electrical energy. Some form of closed circuit battery is imperative, a good type being the Gordon primary battery cell, depicted at Fig. 4. These cells give about 7/10 volt each, and have enormous ampere hour capacity, ranging up to several hundred ampere hours in the large sizes. They are suited to constant load and sufficient cells can be connected in series to give the desired voltage. For some outfits, a plating dynamo may be more suitable, as when water power, etc., is available to drive it. A suitable dynamo is depicted at Fig. 5. Plating dynamos, as a rule, do not deliver over 6 volts but 15 to 20 amperes in small units, and they are generally shunt wound, viz., the field winding is connected on multiple with the armature brushes; series dynamos are too apt to be reversed by back E. M. F. from the plating tank, which acts as a battery. The "Electro" No. 810 and type "S S" dynamos are suitable.

A useful variable resistance or rheostat for controlling the amount or strength of the plating current, is seen at Fig. 6. This rheostat permits of the finest regulation and can carry 2 amperes for any length of time. It is connected in series with one of the lead wires going to the plating tank.

In preparing smooth finished articles on the flannel buffing wheel they are held against it firmly, applying some polishing rouge from time to time to the wheel. Rough surfaces must be dressed down before attempting to plate them by filing and grinding on an emery wheel, finishing them on the flannel wheel with polish rouge.

Having given these details consideration, attention may be turned to the subject of nickel plating. The first part will

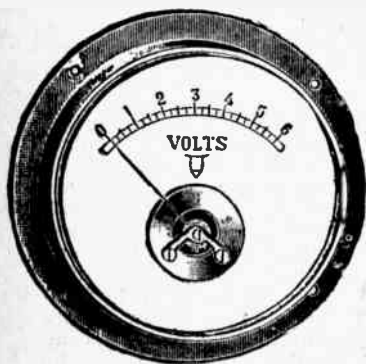
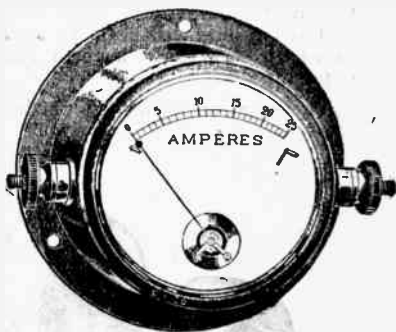

Fig. 9. The Voltmeter or Current "Pressure" Gauge



The Ammeter or Current "Quantity" Gauge

deal with a small nickel plating plant. The illustration, Fig. 7, shows a nickel plating set complete, with glass jar for holding the solution, nickel salts, etc.

For plating articles with nickel not over 6 volts is generally used. To supply the current which must be steady, 2 to 4 Gordon primary cells may be used, also Crowfoot, Bunsen or Daniell cells are adaptable. Storage cells form an excellent source of current supply. The type "S S" 6 volt, 4 ampere dynamo shown at Fig. 5, can also be employed if desired. A water wheel can be utilized to drive it with. The water wheel also would be very useful for driving the polishing head, containing the buffing wheel. A water motor delivering $\frac{1}{8}$ to $\frac{1}{2}$

horse-power, depending upon the size and pressure of the water main feeding it, is shown by the cut Fig. 8.

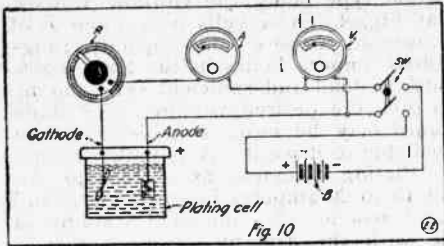

It is advisable to measure the voltage and amperage of the plating, current for any serious work, and the instruments appearing in Fig. 9 are admirably suited to this work. The arrangement of a complete plating

plant, with battery or dynamo B, rheostat R, ammeter A, voltmeter V, and main switch SW, are shown in the diagram Fig. 10.

In the glass plating tank, shown at Fig. 7, two nickel grids or plates are placed in the solution at either side of the tank. These form the "anodes" or positive electrodes, and are connected to the positive pole of the plating circuit, as seen from Fig. 10 diagram. The binding post attached to the centre rod of the frame is connected to the negative side of the feeding circuit, and forms the "cathode" of the tank, when the articles to be plated are connected to it and immersed in the solution. Small copper wires (18-24) may be used to swing the objects from the centre or cathode rod.

Much importance attaches to the manner of suspending the articles to be plated in the tank. If the article is nearer one anode plate than the other, then the side nearest it will receive the heaviest deposit, and vice versa. The object must be spaced as equally distant as possible, from both anode plates, and in this matter, the shape of the object has much to do with determining just how it shall be suspended. A little experience and reasoning will soon teach the experimenter the best way in which to arrange a certain article to receive the most even deposit.

The solution filling the plating tank is made up of the nickel salts dissolved into 35 ounces (the capacity of the tank) of warm water. The mixture is stirred well with a wooden stick until all the salts have been dissolved, when the plating tank is filled with the solution. The following are formulas for nickel plating baths with sulphate as the base:

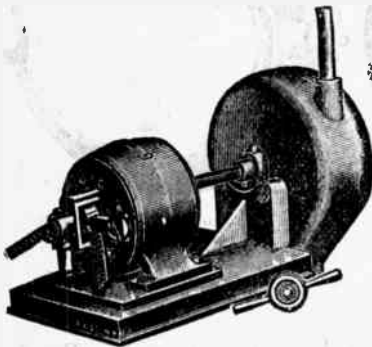

Fig. 11. Water motor direct connected to dynamo.

	—Parts—
Ammonium and nickel sulphate..	4 1
Distilled water....	100 10
Ammonium carbonate (about)..	3

The double sulphate, as given above, is widely used for nickel plating. The chloride may also be employed as a basis for nickel plating, as per the following formula.

Nickel chloride	Parts. 298
Water	2,250
Dissolve and add:	
Ammonium chloride	70
Water enough to make	10,000

The addition of boric acid to nickel plating solutions is recommended by Edward Weston in the following proportion:

Two parts of boric acid to five parts of nickel chloride or one part of boric acid to three parts of nickel sulphate.

Too much alkali in a nickel bath results in a yellow deposit. Too much acid gives a non-adherent coat. The bath must be perfectly neutral. It should have a specific gravity of 1.041 to 1.056, as measured by a hydrometer. If it is weaker, the bath works slowly; if stronger than specific gravity 1.070, the salts crystallize on the anodes. The bath should be constantly watched for changes in its density or specific gravity.

Articles to be nickel plated are very thoroughly scoured and cleaned, using a stiff scouring brush and pumice powder, having first dipped the articles into boiling caustic soda solution for ten to fifteen minutes. When well cleaned, as above described, a fine copper wire is attached, and the object, if of iron or steel, should be dipped in a bath composed of $\frac{1}{2}$ -lb. hydrochloric acid per one gallon water, using a wooden tank to hold the solution. If the article is of brass or copper, they should be dipped in a bath of $\frac{1}{2}$ -lb. cyanide of potassium per one gallon of water. About two hours' immersion in the plating cell here mentioned will give a good deposit. Iron or steel should receive a copper plate deposit first, as a base for nickel or other plate to make a first class job. Further details are given in the next chapter, No. 16. At Fig. 11, is illustrated a complete hydroelectric plant, comprising a water motor and D. C. dynamo on one bed-plate. This set on 50 to 70 lbs. water pressure from a $\frac{3}{4}$ " main will develop 7 to 8 volts and 8 to 10 amperes.

LESSON No. 16.

ELECTROPLATING.

PART II.

In this chapter further details and methods for plating with various metals such as silver, gold, platinum, etc., will be discussed. In the foregoing section, copper-plating with the "Electro" self-exciting cell combining battery and plating tank, was covered, as well as nickel-plating.

A few words are added here, relative to copper plating in the regular manner, that is, with an external battery or dynamo current feeding the plating vat. The best potentials or voltages for different metal depositions are tabulated herein.

For a copper plating bath to be used for objects not attacked by sulphuric acid or copper sulphate, a good make-up is a solution of copper sulphate, with one-tenth of its volume of sulphuric acid. The specific gravity as measured by a hydrometer, (see Fig. 1), should be 1.197, and the bath cold when used. If too much copper sulphate is in the bath, crystals will form on the surface of the anode, or positive electrode. These crystals, altho' quite invisible, will prevent the current from passing. The bath here mentioned is quite limited in use, as it is not permissible for plating iron or zinc, etc. It can be employed for wax moulds, such as those utilized for electrotyping. The exact formula for the above copper-acid solution is: Sulphate of copper, 1 lb.; sulphuric acid, 1 lb.; water, 1 gal. The sulphate of copper is first dissolved in hot water; when the remainder of the water may be added cold. Then the sulphuric acid is placed into the solution, allowing the mixture to cool well before using.

For plating copper on zinc, iron, etc., the solution should be the copper-cyanide mixture, the proportions being as given



Fig. 1.
A Hydrometer

here: Carbonate of potash, $6\frac{1}{2}$ ozs.; cyanide of potassium, 2 lbs.; water, 3 gals. The cyanide of potassium is dissolved in the major portion of the water, and the carbonate of copper in a portion of it, with the carbonate of potash in still another portion; add to the potassium solution, first the copper solution and then the potash solution, thoroly stirring the whole. If the solution, on trying out, does not deposit freely, a little more cyanide or more carbonate, or both, may be added until the right effect is obtained.

In plating copper on zinc, the zinc object is first dipped into a

mixture of 4.5 per cent. sulphuric acid, and after rinsing well in water, it is dipped into a solution of caustic soda or sodium carbonate, after which it is ready for the plating tank. One principal use for copper plate on iron is for a base on which to deposit a silver, gold or nickel layer. This gives the most durable finish, with a smooth even coat.

For copper plating, the plates forming the anodes or positive electrodes are copper grids of as pure a quality as possible. In Fig. 2 is shown the method of arranging the copper anodes and articles to be plated in the bath, the sketch being a view from the top of the plating tank.

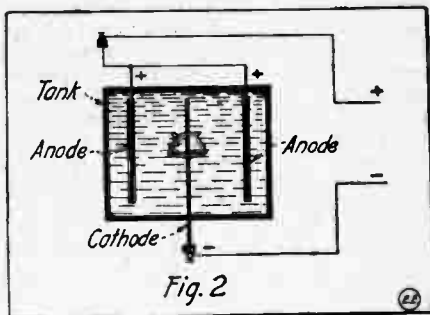

Fig. 2

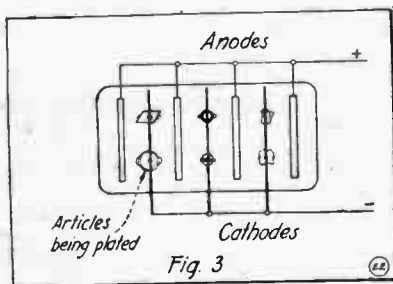

Fig. 3

Below is given a table of the usual potentials employed for various kinds of electro-plating. The voltage should be specially adjusted for each case to give the most suitable current, and depends upon the size of the plating tank, the area of the anodes, the strength of the solution, and several other things, and most platers determine the best po-

tential and current for a certain purpose by experiment.

Metal.*	Approx. Volts Potential
Copper—cyanide bath5 to 1.5
Copper—acid bath	3.0 to 5.0
Silver5 to 1.0
Gold5 to 4.0
Brass	3.0 to 5.0
Iron, steel facing	1.0 to 1.3
Nickel on iron, steel, copper, with nickel anodes; start deposit at 5 volts, diminishing to.....	1.5 to 2.0
Nickel on iron, steel, copper, with carbon anode..	4.0 to 7.0
Nickel on zinc	4.0 to 7.0
Platinum	5.0 to 6.0

For certain purposes, such as wireless telegraph condensers, etc., it is often desirable to deposit a copper coating on glass. For the very best work, the copper or sometimes silver should be burnt into the glass to minimize blistering under heavy charging. However, copper plating in the ordinary way is far superior to the common method of pasting tinfoil on the

*Electrical Engineer's Handbook, International Textbook Co.

glass, as there is bound to be air spaces left between the foil and the glass, and at these points, the weak spots develop, until finally the glass plate or jar fails and is punctured by the high voltage.

The following scheme, of depositing a metal plating on glass plates or jars is described by S. Wein in *Modern Electrics* for August, 1912.

Prepare a mixture of sulphur and oil of spike, (*Lavendula spika*), having it of the consistency of molasses; also a saturated solution of chloride of gold in sulphuric ether. Mix the two and evaporate at a gentle heat to the consistency of paint.

After thoroughly cleaning the glass surface, paint a thin coating of this mixture on the surface to be plated, and bake in an oven or furnace, to drive off the sulphur and other volatile ingredients. The result is a very thin metallic film which strongly adheres to the glass surface, which film may be reinforced by electro-plating with copper in the ordinary manner. This makes a very suitable coating for Leyden jars, and the like.

A somewhat simpler method is to roughen the surface of the glass by means of applying hydro-fluoric acid, sand blasting under air pressure, or grinding with emery or carborundum dust. The surface after being evenly roughened is painted with a saturated solution of silver nitrate. After this has dried, the treated surface should be electroplated with copper.

Still another scheme differs from the foregoing, only that in painting the roughened surface of the glass, the painting medium is a very thin film of prepared Acheson graphite, instead of the silver nitrate solution.

Silver plating is an important branch of electro-plating. Articles which are to be silver plated must be carefully prepared, and should be very smooth on the surface.

The article is first boiled in a 10 per cent. solution of caustic potash to cut all oil, grease and dirt from the surface. After boiling, the object is rinsed in cold water and then dipped in a 10 per cent. solution of sulphuric acid and water, and then washed. (36°), 100 parts; salt, (sodium chloride), 2 parts; calcined lamp-black, 2 parts. After a few seconds they are thoroughly washed and then immersed in the following bath: Nitric acid (36°), 600 parts; sulphuric acid (66°), 30 parts; salt, (sodium chloride), 4 parts.

After emerging from this treatment, they are well washed and cleansed, when they are dipped in the following quickening bath, until the objects appear white on the surface: Water, 100 parts; Mercuric nitrate, 1 part; with sufficient sulphuric acid to dissolve the mercuric nitrate. The pieces are then washed and placed in the plating bath.

The common solution for silver plating is the potassium-silver-cyanide mixture. A solution of silver nitrate in water is precipitated by the addition of lime water, the silver oxide appearing as a brown powder. The precipitate is washed carefully and is kept in vessels filled with water. To prepare a bath for the plating tank a quantity of the brown oxide of silver is dissolved in a solution of potassium cyanide in distilled water.

Iron or lead wire, not copper, must be used to suspend the articles in the bath. At least 4 inches of space must be left between the silver anode grid and the object to be plated. When the pieces have acquired a sufficiently heavy coating of silver, they are removed from the bath, washed in cold water, and then with slightly acidulated water, using a little sulphuric acid in the water, the silver plated articles are finally brushed and polished by the regular process.

Gold plating is accomplished by using a tank bath of gold-potassium cyanide. 154 parts of gold chloride being dissolved in 2000 parts of pure water. A separate solution of 200 parts of potassium cyanide in 8000 parts of water is made. Then the

two solutions are mixed and boiled for half an hour. The bath is used cold. To maintain its strength, gold chloride and potassium cyanide may be added in equal parts as required.

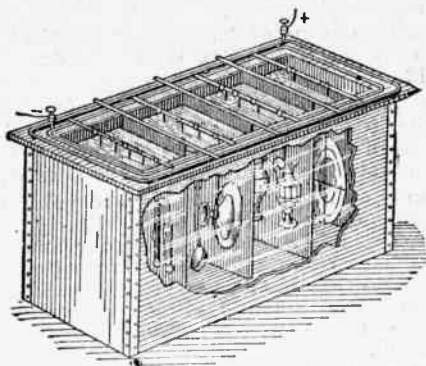

Fig. 5. How various articles are suspended in Plating Tank

For gilding with a warm solution the following baths may be used:

	(1)	(2)
Sodium phosphate (crystallized).....	600 parts	500 parts
Sodium bisulphite	100 parts	125 parts
Potassium cyanide	10 parts	5 parts
Gold chloride	12 parts	12 parts

The first (1) is for gold plating silver, copper and alloys rich in copper. The second (2) is for iron and steel.

The anode for gold plating is a grid or plate of gold. If the bath is too rich in gold, it causes the coating deposited to be black or red in appearance. If the coating is gray, and forms slowly, it indicates too much potassium cyanide. The suspension wires holding the anode, etc., are of platinum.

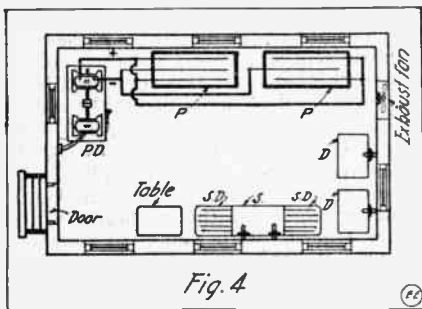

Fig. 4

The plating of platinum on various objects is often required for electrical apparatus, etc. The following bath is suitable for platinum deposits on copper and its alloys: Dissolve 17 parts of platinum chloride in 500 parts distilled water. Then dissolve 100 parts ammonium phosphate in 500

parts of distilled water. The solutions are now mixed, giving a precipitate. Slowly, a solution of 500 parts sodium phosphate in 1,000 parts of water, is added, and the whole brought to boiling; replacing the water lost by evaporation, until the ammonia having been boiled away, the solution becomes acid and loses the yellow color it formerly possessed, and becomes colorless. This bath is employed while hot, and its strength is maintained by adding ammonium-platinum phosphate precipitate as obtained above. The anode plate in platinum plating is always platinum.

Sometimes it is desired to brass plate certain articles, such as small castings, or parts of models or apparatus when the metal is of some other material. A brass solution is easily made out of the copper cyanide bath cited above, by adding zinc carbonate solution. This is prepared by dissolving 2 parts by weight, of cyanide of potassium and 1 part of zinc carbonate in water. The zinc carbonate solution is added to the copper cyanide bath until the desired color of brass deposit is obtained. The anode is of sheet brass.

Zinc plating on iron, has rapidly developed into a large industry. Commercially, it is referred to as galvanized iron, the coating being a protection against rusting. Most of the zinc coating processes in vogue in the United States employ soluble zinc anodes, while Cowper-Coles, in England, uses insoluble, (lead), anodes, in an electrolyte containing 35 ounces of zinc sulphate, ($Zn SO_4 \cdot 7 H_2 O$), and 0.1 ounce sulphuric acid, (specific gravity at 1.84), per gallon of water.

A very good zinc plating solution is obtained, according to Foerster, by dissolving 200 grammes pure zinc sulphate, (free from iron), 40 grammes glauber salt, 10 grammes zinc chloride, and 0.5 gramme boracic acid, so as to get 1 liter of solution. With current densities of 0.005 to 0.02 ampere per square centimeter, good dense deposits up to 0.05 mm. thickness are thereby obtained at temperatures between 18° and 50° centigrade. The method of producing the zinc coating by electrolysis has the following advantages over the old dipping process; electrolytically deposited zinc, when properly applied, is denser, tougher, more uniform and more resistant against corrosion.

Electroplating on aluminum is quite difficult, owing to the thin invisible film on the surface, (oxide or hydroxide film), which persistently refuses to be eliminated from the base metal itself. Unless great care and special cleansing baths are employed, the coating on aluminum will not stick for any length of time. The film of oxide is best eliminated by using a soluble fluoride in the plating bath. Zinc adheres best of all metals to aluminum. Hence, aluminum should always receive a zinc coating first. If gold is to be plated on aluminum, the gold should not be deposited directly upon the zinc, as the gold will soon alloy with the zinc, and apparently disappear. For this reason, the zinc deposit is best given a copper plating and then the gold plate on top of it. The zinc plating solution has about 1% of hydrofluoric acid added to it, or the equivalent amount of potassium fluoride. Before depositing the gold coating on the copper plating, the latter should be well polished, as otherwise a large amount of gold will have to be deposited to give an even coating.

The reverse of electro plating is the electrolytic removal of a metallic coating from the surface of an article. This is generally carried out as an anodic reaction. The most important industry in this field is the detinning of tin scrap, which has assumed considerable proportions in recent years, as a consequence of the enormous growth of the tin can industry. While formerly only the tin scrap of the tin can factory, (a pure material consisting of sheet iron covered with tin), was treated; the treatment of tin cans, boxes, etc., which have been used, has recently been taken up on a commercial scale. Since they contain many impurities, these must first be very thoroly removed, (carbonized, etc.). See "Standard Electrical Engineers Handbook."

The electrolytic process in this field is invoked for the purpose of removing the tin from the iron, so as to get both the tin and iron separate and pure. The iron is sold as scrap to open hearth steel works, etc., and must therefore be absolutely free from tin and in good condition. The process having been the most successful on a large scale, is that of Theo. Goldschmidt, in Essen, Germany. It is a secret process, and employs the scrap as anode in a solution of caustic soda. Recently (1906) detinning with chlorine, has entered

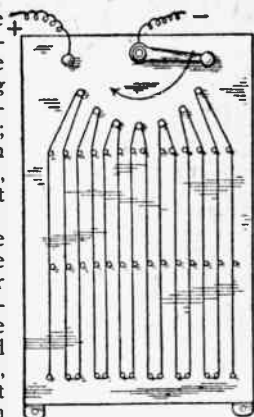

Fig. 6.
A Plater's Rheostat

into competition with electrolytic detinning. Detinning with chlorine may be considered as an electrolytic process only in so far as electrolytic chlorine is employed, while the products of electrolytic detinning are tin and iron; those of chlorine detinning are tin tetrachloride and iron.

In large plating establishments, wooden tanks are used, also porcelain bath tubs, in some places. For the best results the electrolyte should be agitated while plating is going on, and in some cases the articles are moved about, to make the deposit as evenly distributed as possible.

It is imperative that good ventilation be had for the carrying off of fumes from the cyanide or other acid baths and dipping solutions, for these are strongly poisonous and should not be permitted to choke up or stagnate the atmosphere, in which the plater is working. Wool clothes are the best as they are not attacked by acid. The arrangement of a large plating vat, with several anodes, is depicted at Fig. 3, the various articles being suspended between any two anode plates as shown.

In Fig. 4 is shown a fair arrangement of a small plating room. The building or room may have ordinary plastered or wood walls. The floor is best of concrete, or bricks, with wooden slat platforms a couple of inches thick placed in front of the tanks and sink. The plating dynamo and motor to drive it are indicated at P. D. The plating tanks containing the solutions are P. P. Dipping vats are at D. D., while the sink and drain boards are S., S. D., and T. is a table. Hot and cold water should be piped to all sinks and tanks if possible. The floor should drain on a slope from the various tanks, sinks, etc., toward the centre of the room. An exhaust fan in the wall or upper half of a window, as shown, produces a good draught to suck out the poisonous fumes. What the electro-plater pays for in settling his bills for electricity or in renewing his batteries, is the number of kilowatt hours consumed by him. The amount of work performed by him, i. e., the weight of metal plated by him, depends solely upon the ampere hours, tables of the corresponding electro-chemical equivalent being given in handbooks and platers' treatises.

Since the electrical energy measured in watt-hours is the product of the volts and the ampere hours, it is evident that since there is no chance of saving any part of the "ampere hours" necessary for a certain amount of plating, the only possibility of reducing the energy consumption is by reducing the voltage at the plating tanks by a resistance connected in series with the dynamo and tank.

In practice it is usual to lacquer certain plated finishes as they are not capable of holding their lustre for any length of time. Lacquer can be bought ready to apply, both cold and hot lacquer being sold. Hot lacquer is applied by heating the plated object gently and then dipping it in the lacquer, or it may be applied by means of a brush. Chandeliers, ornaments, and numerous other articles dipped or plated are lacquered to preserve their lustre, after polishing. White lacquer is used on nickel, if applied. Nickel plated parts for electrical switch contacts should never be lacquered, as this forms an insulating coating.

STATIC ELECTRICITY AND STATIC GENERATORS.

ALL bodies in the universe are supposed to contain an electric charge, either negative or positive. The earth itself is charged negative and positively at different times, and the strength of the charge varies widely also. The charge residing upon various bodies is supposed to be in a neutral state, unless disturbed. If two dissimilar substances are rubbed, for example, the neutral condition existing on them is upset or disturbed, and when they are separated, an excess of electricity remains on one, while a deficit of electricity exists upon the other. The two independent bodies are then said to be electrically charged. This form of electricity is in a state of rest, as compared to the flow of current from a battery, or dynamo, and hence it has been named "static electricity." It is electricity in potential form, i. e., nearly all voltage, and but slight amperage. The body referred to above, as having the excess of electricity, is known as possessing the "positive" charge, and the one having the deficit of electricity, the "negative" charge.

Hence, there are two forms of static electricity, viz., positive and negative. As an example, if a dry glass rod is rubbed briskly with a piece of silk the glass becomes positively charged with static electricity, and will effect an electroscope, which is described later on, or it will attract bits of paper, etc. If a stick of sealing wax is rubbed with cat's skin or flannel, the sealing wax becomes negatively charged and the cat's skin or flannel positively charged. When the respective positive and negative charges are imparted each to a metal body, and these are brought into contact, the charges combine, and the electricity is restored to the neutral state, or equilibrium.

Bodies charged with positive electricity are indicated by the plus + mark. Negatively charged bodies are represented by the minus sign -. Bodies charged with positive electricity, repel one another, but attract bodies charged with negative electricity. Also bodies possessing a negative charge repel one another, but readily attract positively charged bodies. Hence, like charges repel each other, while unlike charges attract one another.

The commonest form of static electricity is found in nature, when lightning occurs during thunder storms. The voltage or potential of these discharges thru the atmosphere is enormous, probably reaching many million or billion. Thunder is the sound

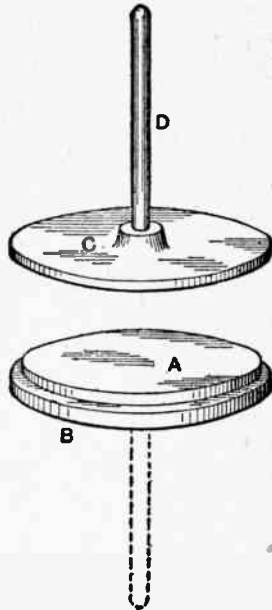

Fig. 1.

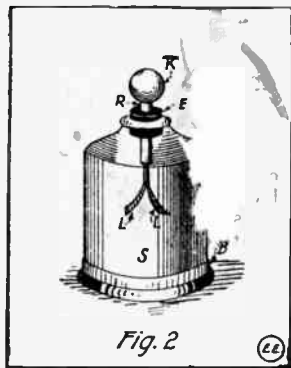

Fig. 2

The Electroscope,

created by the passage of a lightning flash, and is the same as the noise of a spark discharge from a static machine or induction coil. Sound travels at the rate of 1090 feet per second, in ordinary air, and this explains why it is that the lightning flash is seen first, and, after a few seconds, the noise of the discharge or thunder reaches our ears. The velocity of lightning, if it approaches the speed of electricity travelling over conductors, which it probably does, is 186,000 miles per second. From this it is quite simple to compute the distance between yourself and a lightning discharge roughly. The time expiring between the first glimpse of the lightning flash and the thunder, expressed in seconds, and multiplied by 1090 feet, gives the distance over which the thunder has come.

The generation of static electricity in small quantities for laboratory study or experiment, electro-therapeutical purposes, X-Rays, etc., is accomplished by the use of frictional electrical machines, and influence machines, the Wimshurst static generator, belonging to the influence class.

Frictional static machines are not much used any more, except in small sizes, their principal defect being the exact and peculiar conditions surrounding the generation of static charges with them. They must have a very clear, dry air to work properly. The simplest frictional machine consists of a glass plate, rotating on an axle passing through its centre, and silk covered rubbers pressing against its sides as it rotates. Suitable combs or forks are provided around the plate to gather the electrical charge. Apparatus employed in experimenting with static electricity are Leyden jars or condensers, electrophorous, electroscope, etc., and experiments with these will be described presently. A static electric charge resides upon the surface only of bodies, and so a wooden sphere covered with tinfoil, or a hollow ball, is every bit as good as a solid one for the purpose. Hollow tubes are as good as solid rods, likewise.



A simple and inexpensive device for producing an electrostatic charge, is known as the electrophorous. A cut showing its arrangement is shown at Fig. 1. It consists of a thick disc, called the cake by some, composed of an insulating material, (non-conducting), such as ebonite, or a compound of resin. The resin cake A, is placed in a metal tray B. A thin metal disc C, termed the cover, and about the same size as A, and fitted with an insulating handle D, finishes the equipment.

The following manner is employed to generate an electric charge on the electrophorous: The resin or ebonite disc A, is rubbed briskly with a piece of silk or cat's skin, causing the disc to assume a negative electric charge. Now the metal disc C, is placed upon the plate A, which, by electrostatic induction, to cause it to assume a positive electric charge. The positive charge resides on C, as long as it rests upon A only, and as soon as C is removed from the negatively charged plate, it becomes of zero potential, possessing no charge at all. If while the disc C is resting upon A, it is touched by the finger of the operator, (which is the same as connecting it to earth), the charge residing upon A will repel negative electricity from C to earth, and attract a further amount of positive electricity to the disc C. Now if the finger is removed, the positive charge is retained on C, and may be removed if C is lifted off by means of the insulated handle D.

A Leyden jar or condenser may receive a charge by touching the knob of jar with C.

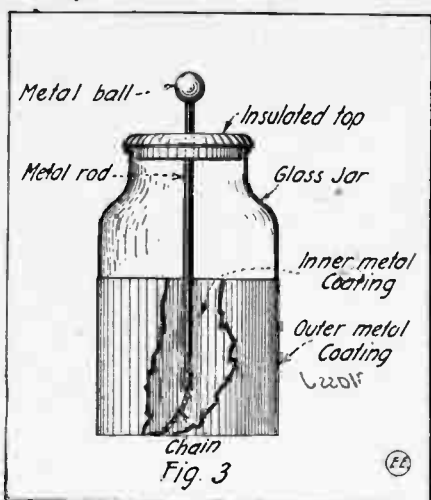

The electrophorous, above all else must be kept very dry, and produces best results in a cool dry atmosphere.

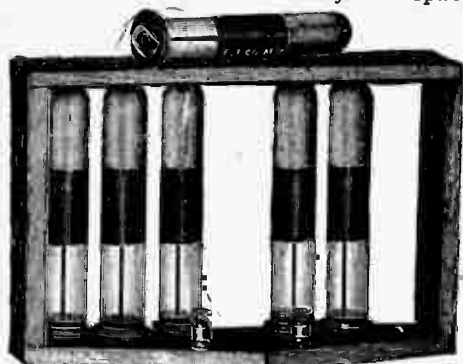

Fig. 5. Battery of Leyden Jars.

If the disc A is of glass instead of ebonite, and rubbed with silk, the glass becomes positively charged.

To ascertain the presence and polarity of static electric charges, use is made of a simple little instrument termed an electroscope. The electroscope is comprised of a glass vessel S, Fig. 2, fitted with an insulated top piece E. Through this top is placed a metal rod k, surmounted with a brass ball K.

At the lower end of the metal rod is secured two pieces of gold leaf, hence this type is often referred to as the gold-leaf electroscope. The glass vessel sits in base B, which is sometimes of metal.

The action of the electroscope is as follows: If a body containing a static charge is presented to the brass ball K, the gold leaves within the glass ball will instantly diverge or fly apart. If no charge exists upon the body, the gold leaves will remain motionless, and close together. The polarity of a certain charge may be found by means of the electroscope also. First, a negative charge may be given the gold leaves LL. This may be accomplished by rubbing a glass rod with silk, and then presenting the glass rod to the ball on the electroscope. A



Fig. 6. Leyden Jar Discharger.

negative charge is left in the electroscope, and the glass rod taken away from the ball.

The gold leaves diverge when first charged in the manner described, due to the charge remaining for quite some time in the electroscope. If now a negatively charged body is

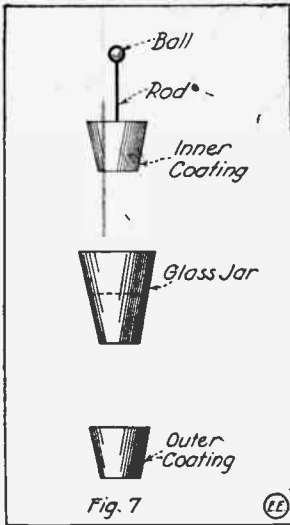

approached to the ball of the instrument, the leaves will be pushed farther apart, but if the body presented to it is positively charged, the leaves will collapse. It makes no difference which kind of a charge is given the electroscope, but if desired a negative charge can be imparted to the leaves by presenting a stick of sealing wax to the ball, having previously rubbed the wax with cat's skin or flannel. The electroscope is a very useful and important piece of apparatus in the realm of high potential or static electricity. A sensitive gold leaf electroscope will respond to the charged field existing about high voltage wires of transmission lines, etc., and such an instrument, for enabling electricians working around such wires, to tell whether they are "alive" or "dead," has been patented.

Leyden jars are bottle-forms of condensers, other forms being the glass plate, tinfoil and paper, etc. The Leyden jar, owing to its peculiar design, has the property of retaining a charge longest, and hence it is most always used for holding static electric charges. In wireless telegraph

sets, the condenser is often composed of glass plates, as they are more compact than Leyden jars, and in this case, they are almost immediately discharged, so any retentive qualities offered by the jar form of condenser is not of such great importance.

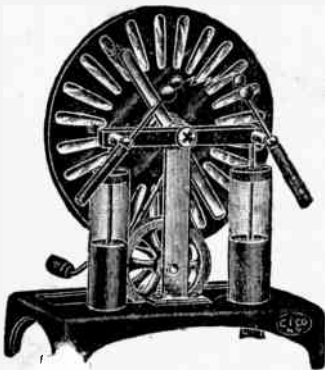

Fig. 8.

In Fig. 3 is illustrated a semi-sectional view of an ordinary Leyden jar condenser, having a glass shell with bottom. The inside and outside, as well as the bottom, are well coated with tinfoil about half way up. Banana oil is a good adhesive for making the tinfoil stick to the glass, altho shellac may be utilized. An insulated top of fibre, hard

rubl or wood holds the metal rod, ball and chain, as shown, for making contact with the inner tinfoil coating. Contact with the outer metal coating is easily affected, of course. Typical manufactured Leyden jars are shown at Figs. 4 and 5. A discharger for these jars is seen at Fig. 6.

The Leyden jar is charged from a static machine, of the frictional or Wimshurst influence type, by holding the jar in the hand, and approaching the ball on top of it, to within sparking distance of the discharging knob of the machine. The jar has its outer coating thus grounded to earth thru the

operator's hand and body. The charge of static electricity passing from the machine to the inner coating of the Leyden

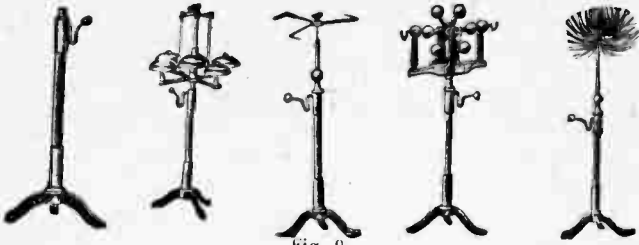

Fig. 9.

jar, thus attracts an electric charge of opposite sign from the earth to the outer tinfoil coating, and retains it there, the two opposite charges mutually attracting each other and trying to combine. The jar is now said to be charged, and in heavy work the stress set up in this manner upon the dielectric or glass, often shatters it. A condenser breaking down in this manner is said to be "punctured." The jar is discharged by connecting the inner and outer metal coatings together, thru a small air gap. If discharged thru the body, a shock will be felt. For batteries of Leyden jars or large ones, the discharger, seen at Fig. 6, should be used.

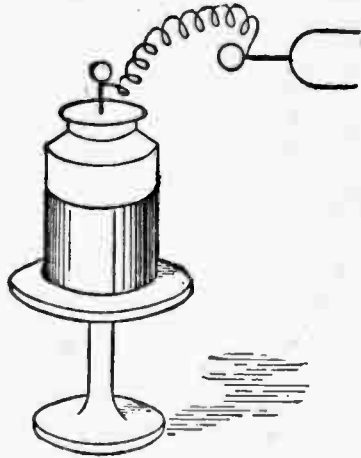

Fig. 10.

An interesting point about the charge in Leyden jars or other condensers, is that the charge does not reside upon the metal surfaces, but upon the glass or other dielectric separating them. The metal portions serve simply to induce the charge or relinquish it upon discharge. This is easily proved by means of a separable Leyden jar as seen in Fig. 7. The jar is first charged, and then its outer and inner metal coatings removed by insulated hooks. If an electroscope is approached to the glass portion of the condenser. Presented to the metal parts, it shows no charge. Reassembled the condenser may be discharged in the regular manner.

As aforementioned, there are two principal classes of static generators: the frictional machine and the influence machine. The Wimshurst influence machine is widely used, both for experimental and professional purposes; and so it will be described here.

The Wimshurst influence machine produces static electricity by electrostatic induction between charged metal plates instead of a rubbing action on the plates, as in the frictional type.

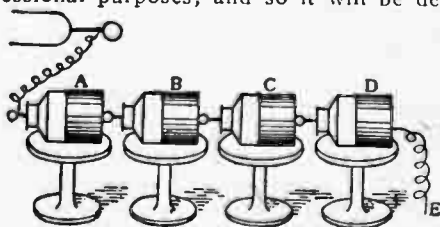

Fig. 11.

James Wimshurst was its inventor, and hence its name. A cut of the "Electro" Wimshurst

Influence Machine is portrayed at Fig. 8. It delivers a 3-inch spark under practically all conditions, which is quite remarkable, as ordinarily static machines are unreliable and refuse to generate a current unless everything is just about perfect. Dry, cool weather is best for their operation.

To resume, the Wimshurst influence machine produces its charge by the rotation of two similar glass discs in opposite directions, the two discs being mounted close together. Each disc on its outer surface carries a number of tinfoil segments spaced equally apart. The same number must be on each disc, and each disc so set that at any given instant the foil sectors on one will be just opposite those on the other.

Two metal rods called neutralizing rods are mounted parallel to the outer surfaces of the two glass discs, the ends of the arms carrying tinsel brushes, making contact with the foil segments on the discs. The neutralizing rod and its brushes on each side of the generator make connection between diametrically opposite foil sectors on the glass or ebonite plates. The two rods on opposite sides of the machine are set at right angles to each other, or less, up to 60 degrees.

Rotating the plates causes changing values of electro-static induction to react between them, and the sectors on one plate act inductively to charge those upon the other. The static current is taken from the plates by collecting combs or points a short distance away from the moving plate. The action of the influence machine, which allows it to charge when starting without being separately excited from an external source of

electricity, is not fully understood as yet, but is probably due to the uneven electro-static condition permanently existing on the plates, causing some of the sectors to be in a different state of charge from others.

In operation, positive electricity is collected at one comb, and negative at the other, these signs remaining constant. If a stationary glass plate is placed between the two rotating glass plates, the polarity reverses regularly and the machine is then termed an alternating Wimshurst machine. When Leyden jars are connected to the machine, as in the "Electro" type, the inner coatings

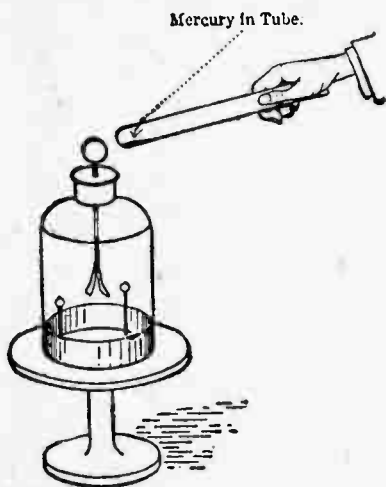

Fig. 12.

to the collecting combs, and the outer coatings to the earth, the jars become charged, resulting in a thicker spark discharge at slower intervals between the discharge balls. The maximum spark length of the machine is attained without the jars. Influence static machines include such types as the Voss, and Holtz, also the Topler-Holtz.

The polarity of the static machine can be ascertained by observing the electrode terminals. The negative electrode, when in a horizontal position, gives a sharp hissing sound, distinguishing it from the positive electrode which does not give any sound. The polarity is easily found by means of the electroscope, previously described.

Many amusing and instructive experiments can be performed with the aid of such a machine as the "Electro" Wimshurst generator. A number of pieces of apparatus that can be worked by it or other static charges are illustrated by Fig. 9, cuts 1 to 5.

At cut 1 is seen a universal stand adaptable to holding geissler tubes, or other apparatus. Cut 2 shows the electric chimes, which are very useful for demonstrating. A spinning wheel is depicted at 3, while a static motor appears at 4. The hair-riser which projects upward when connected to one pole of the machine is seen at 5.

Magnetization can be done by static electricity in the following manner: Form a helix of copper wire separating the turns and then insulating the whole. Within the helix a hard steel bar or needle is placed, and if a few discharges from a Leyden jar are passed thru the helix, the bar will be found to be magnetized.

It should be noted that if a condenser, such as a Leyden jar be placed upon an insulated glass stand as in Fig. 10, no charge will be accumulated by the jar, but if its outer coating is touched with the finger, it immediately assumes a charge, as it is then earthed.

In the cut, Fig. 11, is shown the method of charging Leyden jars in "cascade," as it is termed, or in series. They rest upon insulated stands, such as glass tumblers, and the outer coating of the last one is connected to earth.

A peculiar manner of producing a static charge is depicted at Fig. 12, where a glass tube, containing mercury, is shaken briskly, and then presented to the ball of an electroscope, whose leaves will diverge. A test tube, containing mercury and corked at the open end, will serve well for this experiment.

LESSON No. 18.

ELECTRICAL MEASURING INSTRUMENTS.

To measure the degree of strength and quantity, also several other diversified factors, use is made of electrical measuring instruments. The two types most generally employed are the voltmeter, for ascertaining the potential strength of a certain current, and the ammeter, which indicates what quantity of electricity is passing at a certain point in a circuit.

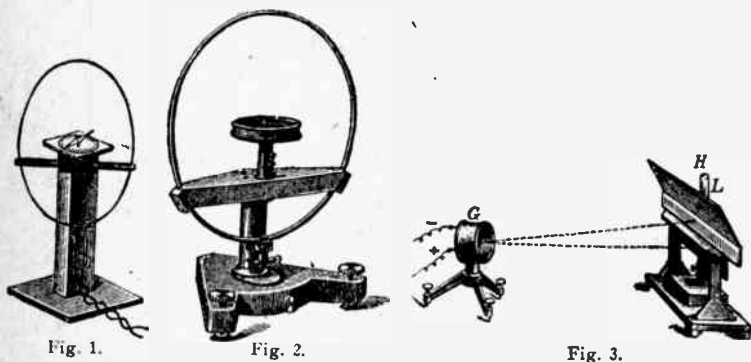

Most measuring instruments work upon the original galvanometer principle, which involves the use of a magnetized needle pivotally mounted within a coil of one or more turns of insulated wire.

The tangent galvanometer was one of the first electrical measuring instruments developed, and a cut of such a type is seen at Fig. 1. It is easily made, comprising a loop of one turn of No. 6 or 8 B. & S. gauge copper wire, made into a loop having a diameter of 62.8 cm. (24.7 in.), and a circumference of 197.2 cm. (77.7 in.). If the instrument is made carefully after the above dimensions, and a galvanometer needle placed upon the pedestal (an ordinary compass needle will serve), a current of 10 amperes passing thru the loop

will cause the needle to deflect over 45 degrees of the circular dial ($\frac{1}{8}$ of the circumference). The compass needle should be placed at the exact center of the coil or loop of wire. A more adjustable type of this galvanometer is illustrated at Fig. 2, which has leveling screws provided in the base feet, so it can be readily set level. Ordinarily, the coil is set parallel with the needle, when the needle has set itself north and south, or with the magnetic meridian of the earth.

Galvanometers as a rule are very delicate and used only for determining very fine differences of current or voltage, as

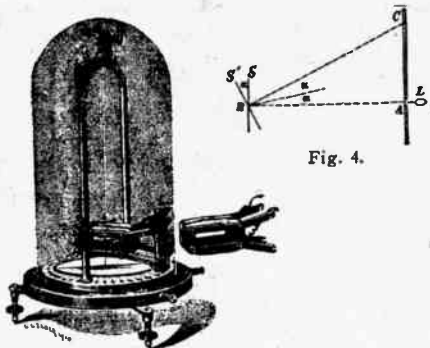

Fig. 4.

Fig. 5

in Wheatstone Bridge measurements, etc. A type much in favor to-day for laboratory research, but unsuited to field work, is the mirror or reflecting galvanometer, shown at Fig. 3. At G is a very sensitive galvanometer provided with a delicately hung mirror of small size. The mirror is suspended on quartz or cocoon silk fibre. Behind a graduated stationary scale H, is placed a source of light, L. This light

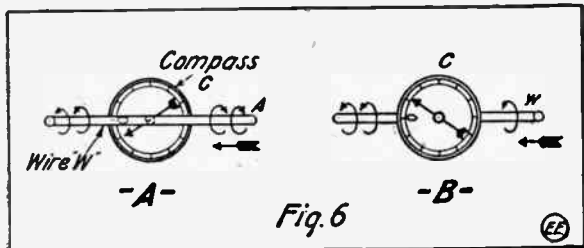

Fig. 6

is allowed to filter thru a small slit in the scale frame, but below the scale, and falls upon the mirror of the galvanometer. When a very minute current is passed through the

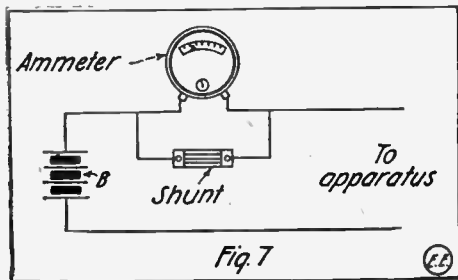
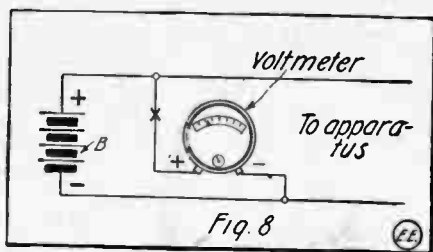

Fig. 7

galvanometer coil, the mirror, with minute permanent steel magnets attached to it, is deflected a trifle, and consequently the beam of light reflected from the mirror is caused to make a relatively large movement over the scale H. In this way, very small currents are made to give easily readable

indications. At Fig. 4 is shown the plan view of the mirror type and its action.



A positive type of direct reading galvanometer is depicted at Fig. 5.

The principle of the action of all types of electrical measuring instruments is that all conductors carrying electric current, set up a magnetic field of force about themselves. This is simply proved with the aid of an ordinary 25 cent pocket compass. In Fig. 6, A and B, is illustrated the manner of using it. The compass needle is set parallel with the wire, by moving the wire, or by the aid of a small steel directing magnet. Now if as at A, where the wire passes over the top of the compass needle, and a current of several amperes passes in the direction of the arrow, i. e., from right to left, then right-handed whirls of magnetic flux are produced about the wire, when looked at from the A end. These cause the compass needle to deflect as shown, if the north-seeking pole of the needle points toward the left. If the current passes from left to right thru the wire, W, then the needle would be deflected just oppositely to the direction indicated at 6A. If the wire W, Fig. 6A, with current passing in same direction, is placed under the compass needle, then the needle will be deflected as shown at B, providing the north-seeking pole of same is pointing toward the left. The north seeking pole of a magnetic compass needle is actually the south pole of the magnet. The north magnetic pole of the earth, which is not the geographical north pole, attracts the south magnetic needle pole as like poles repel, and unlike poles attract.



Fig. 9.

If a galvanometer is to be employed to measure the quantity of electric current in amperes, its coil is wound with heavy copper wire, the size depending upon the number of amperes. Such a measuring instrument is termed an ammeter providing the scale, over which the needle swings is suitably graduated and calibrated in amperes, enabling the deflection to be noted in amperes direct.

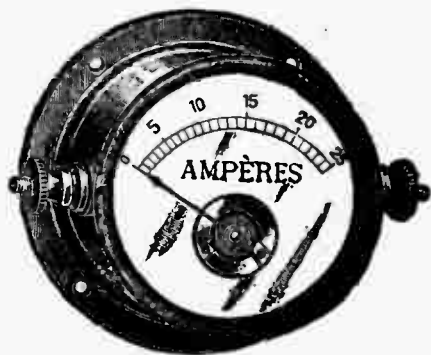

Fig. 10.

This is sometimes referred to as the direct reading instrument. The manner of connecting an ammeter into a circuit is seen from Fig. 7, and this is the usual method. It is placed in series with the circuit whose current is to be measured. For large currents,

it is standard practice to connect the ammeter across a shunt SH, as seen. The shunt is highly conducting, and has a certain resistance ratio to the resistance of the ammeter,

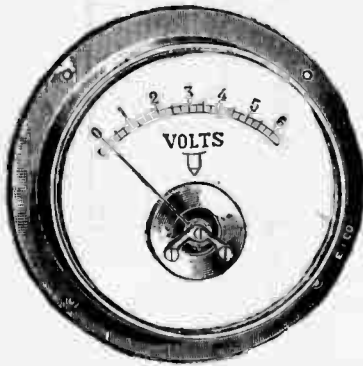

Fig. 11.

so that a large proportion of the current passes thru the shunt, while only a fraction of it passes thru the ammeter coil and movement itself. For instance, the shunt might have $1/10$ and the ammeter winding $9/10$ of the total resistance, and hence the greater portion of the current would pass thru the shunt, while but a small portion would pass thru the ammeter, and when it is calibrated, the shunt should be connected in circuit, otherwise the ammeter needle would indicate only a fraction of

the actual current traversing the circuit.

In measuring the intensity of the current or its voltage, the instrument is connected as in diagram, Fig. 8, and here the coil of the voltmeter or intensity meter, is very small, and so the coil's resistance is many times higher than that of the ammeter. Fine wire is therefore used to wind the coil with. For ordinary voltages not exceeding 500 to 1,000, the voltmeter coil is usually designed to care for the potential along with its resistance coil enclosed within its case. An ordinary voltmeter calibrated to read up to, say, 150 volts, can readily be employed to register voltages much higher than this, by inserting a proper multiplying coil in series with it, as at X, Fig. 8. In these circuits, B represents a battery or dynamo supplying current to apparatus, such as motors, lamps, etc.

The multiplying coil for connecting a series with the voltmeter is made to have a certain definite ratio of resistance,

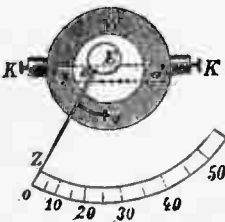

Fig. 12.



thus: Suppose a Weston 150-volt scale instrument is to be used on voltages up to 500 or 600. If the multiplier has a resistance of three times the voltmeter (which is here about 15,000 ohms), then the multiplying value of it is 4. Hence if it had 45,000 ohms resistance, and the voltmeter

but 15,000 ohms, then when the meter registered 50 volts, it would be really reading 4×50 volts, or 200 volts. If the multiplying coil had nine times the resistance of the voltmeter, then the multiplying factor would be 10, or the voltmeter reading times 10, would be the real value of the electro-motive force present.

A small type of pocket measuring instrument calibrated to read amperes direct, is shown at Fig. 9. It is also made to read volts, having in this case a winding of higher resistance than in the ammeter. Such an instrument is extremely suitable for electricians, motorists, and all others having occasion to test batteries and the like. When testing dry cells, the voltage of new ones should be about 1.5 volts, and the current on short-circuit thru the ammeter from 20 to 30 amperes.

A cut of an "Electro" ammeter suitable for use on small switchboards, battery circuits, etc., is illustrated at Fig. 10.

It is calibrated to read from 0 to 25 amperes. A similar type of instrument made to read volts and having a range of 1 to 6 volts, is depicted at Fig. 11. These types operate on magnetic vane principle, which is that form having a soft iron vane mounted on a pivoted staff, and suitably arranged within a coil of wire. Its action is illustrated by Fig. 12, where E is the iron vane, W the coil of wire, and Z the needle deflecting over a scale.

Magnetic plunger or solenoid types of voltmeters and ammeters are extensively used, but are not extremely accurate. In Fig. 13 is seen a German style, comprising a coil of wire, arranged to suck into its center a piece of soft iron, which is fastened by levers to a needle Z. A spiral spring F ordinarily holds the iron plunger up out of the coil.



Fig. 13.

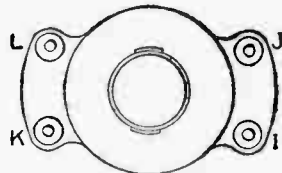

Fig. 14.

Instead of causing a needle to be actuated by the iron plunger, as just described, some makers simply arrange the soft iron core to indicate direct, as in the instrument at Fig. 14. A cut of its make-up is given here, Fig. 15. A hollow tin cylinder, made air-tight, is placed in a glass vial or test tube, half-filled with water or alcohol. Two windings are wound about the lower part of the tube, one a coarse wire for the amperes and the other a fine wire for the volts. These are used separately.

An instrument for use on A. C. or D. C. circuits is seen at Fig. 16, where a side and top view of it are shown. It is known as the Thompson inclined coil meter. The odd feature of it is the soft iron armature E, secured to the moving spindle F. Two coils for volts or amperes are shown on this instrument also, but for commercial work, as built by the General Electric Co., it is invariably provided with one coil, for either volts or amperes, as the case may be.

An instrument originally employed and built by Cardew, of England, is the hot wire meter. Its principle of action will be understood by looking at the diagram, Fig. 17. A length of fine platinum or other wire, E, is suspended between the support F, and adjusting screw A. At the center of the platinum wire is fastened a string or fine wire, G, actuating the



PLAN VIEW

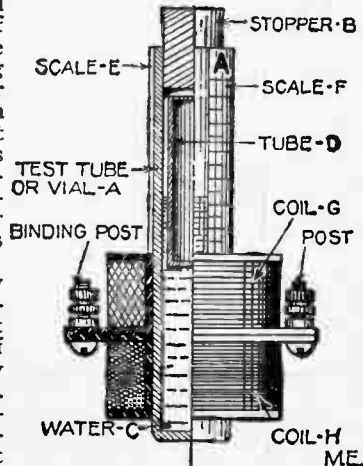

Fig. 15.

pointer B, swinging over a graduated scale C. The needle is pivoted at I, and to help in the adjustment, a fine spiral spring J is adjustable from the screw D. When no current passes

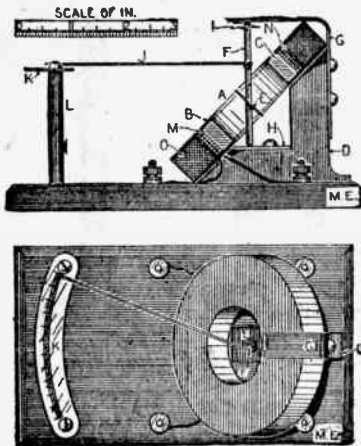

Fig. 16.

thru the instrument, the needle is adjusted to read zero. When a current is passed, the platinum wire E tends to heat up and elongates or lengthens, the degree depending upon the quantity of current. Alternating and direct current both give the same heating effect so that the hot wire meter is applicable to measuring both kinds of current. The hot wire meter in this country is employed principally for the measurement of radiation currents in wireless stations. It is well adapted to this purpose, owing to the extremely high voltage used, which is not very easily passed thru any form of small coil of wire containing a number of turns.

Another form of measuring instrument adapted to reading high potentials, say, above 5,000 volts, is the Electro-static Voltmeter. Its arrangement is shown at Fig. 18. The active part is simply two or more segments of metal, one set of them being mounted on a pivoted staff, to which is secured the index needle, and the other set stationary. When a high potential current is connected to the respective sets of segments, they are charged, and the strength of the charge is dependent upon the value of the current connected to it. The electro-

static reaction between the fixed and moving plates causes the moving ones to swing around a certain amount, and the needle indicates the potential, on the scale, previously calibrated by means of a standard or by the air gap method.

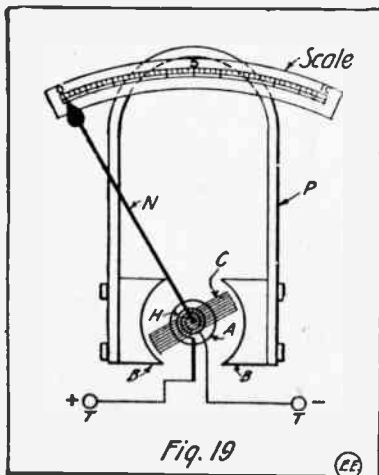

Fig. 19

The standard measuring instrument for electrical work, in this country, is the Weston type, built upon the D'Arsonval galvanometer principle. Its principal parts and their functions are represented at Fig. 19. A powerful and steady magnetic field is provided by the permanent hardened steel

magnet P. This is carefully aged by hitting and boiling in hot water to make its magnetic strength as nearly constant as possible. Two soft iron pole pieces, B B, are screwed to the inner sides of the magnet poles, to form a symmetrical armature space. The moving element, C, is composed of a small copper bobbin, having a number of turns of fine wire

wound about it, and their terminals connected to two hair springs at top and bottom of the coil. The current to be measured is passed from the binding posts T T, thru the two hair springs, and thence around the coil of wire. A magnetic field is set up within the wire coil, and it tends to move one way or the other, according to the direction of the current. Its action is similar to that of a motor, with a permanent field magnet, and if a commutator was substituted for the hair springs, the coil would revolve the same as any motor armature.

Within the moving coil is secured a soft iron core, to make the path of the magnetic lines of force from pole piece to pole piece more conducting or permeable. Weston instruments have marked dead-beat qualities, i. e., they come to rest quickly, and do not swing to and fro to any appreciable extent. This is accomplished by the coil of wire being wound on a copper bobbin. Whenever the coil and bobbin move, Eddy currents, tending to arrest its motion, are set up in the copper. The chief features of the Weston instruments are their reliability, permanence, dead-beat and portability.

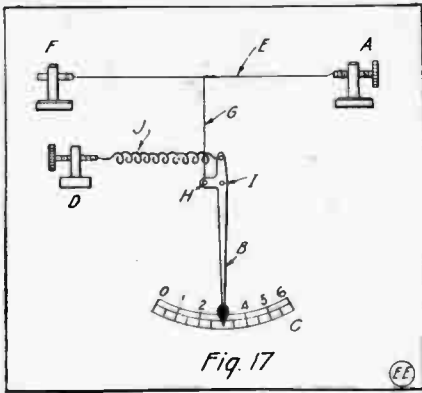

In direct current circuits, the product of the volts by the amperes gives the energy in watts. An instrument reading direct in watts must necessarily combine the action of the voltmeter and the ammeter. Such a combined instrument is illustrated diagrammatically by Fig. 20. The fine wire moving coil is F. The ampere-meter part of the instrument is composed of a heavy wire winding, as H H. The two windings produce independent magnetic fields, and the reaction between them is proportional to the voltage and amperage of the circuit, or since these two quantities represent the components of the watts in the circuit, the instrument's deflection, when correctly calibrated, reads direct in watts.

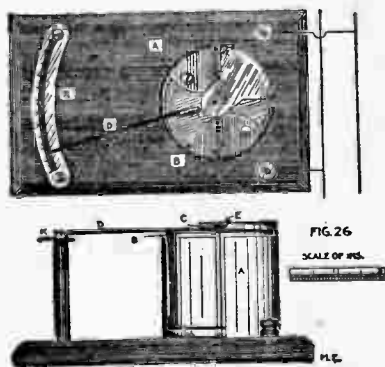
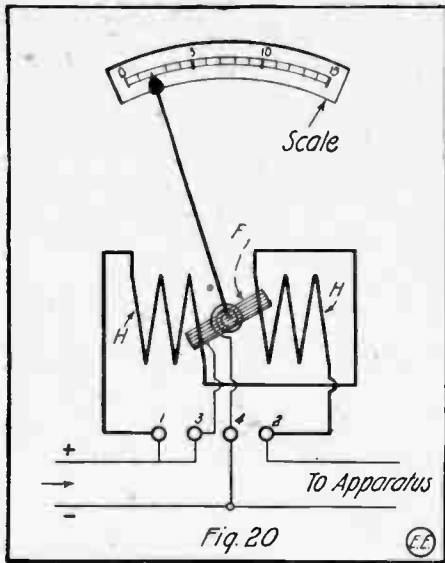

Fig. 18.

The commonest form of the wattmeter is the integrating or recording watt-hour meter used to measure the amount of electrical energy consumed by a customer of Electric Light and Power Companies. It is

really a miniature motor, having no iron in it, and whose speed is proportional to the voltage and amperage of the circuit. It is connected the same as Fig. 20, but the moving coil has a silver bar commutator, and silver brushes for conducting the current to the armature coils. The armature



spindle engages a gear wheel of a train of integrating gears, and the consumption of current in watt-hours or kilowatt-hours is indicated on a row of dials in the front of the instrument. The sum of the dials is read monthly, and the subtraction of successive readings gives the net energy consumed.

LESSON No. 19.

PRACTICAL MATHEMATICS.

THE science of arithmetic or mathematics enters more or less into all branches of human endeavor to-day, and the young experimenter and student will do well to get a firm grasp on least the elementary principles of this subject.

The following paragraphs have been devoted to the explanation of the more practical applications of mathematics, with a few examples showing their value in everyday problems.

The process of evolution and involution of roots and powers of numbers will first be gone over.

Involution is the process of raising any given number to a certain power of that number, thus:— 2^4 means, 2 to the 4th power or 2 multiplied by itself 4 times, or $2 \times 2 \times 2 \times 2$ equals 16.

Evolution is the science of evolving or extracting one of the equal factors constituting the given number. The square root of a number is one of the two equal factors composing the number, i.e., suppose, 4^2 equals 4×4 or 16, then the square root of 16 is 4. Also 4^3 equals 64 and the cube root of 64 is 4, since $4 \times 4 \times 4$ is 64. The cube root represents one of the three equal factors which when multiplied together produce the number.

There are several ways of expressing powers and roots, the usual modes being as follows:—The power of a number such as 6, for example, may be written 6^2 or 6^{-2} . If 6^2 , it means 6×6 or 36, but 6^{-2} means 1 over 6^{-2} or $\frac{1}{6^2} = \frac{1}{36}$.

Powers of ten are much used for various formulae, and a simple method of reading their value at sight is as follows: Thus, 10^6 means one with 6 ciphers after it, 10^9 , one with 9 ciphers after it, or 1,000,000,000.

Roots to be extracted are generally represented or indicated by the radical sign $\sqrt{\quad}$ with the number of the root placed over the V of the radical, thus; $\sqrt[3]{2}$, etc. If no number appears over the radical, then 2 is understood, or the square root is to be taken.

Sometimes the power and root of a number are indicated in the following manner:— $312^{\frac{1}{2}}$ means the second or square root of 312 raised to the first power, or 312. Again it might occur, thus:— $46^{\frac{2}{3}}$ meaning the cube root of 46 to the second power.

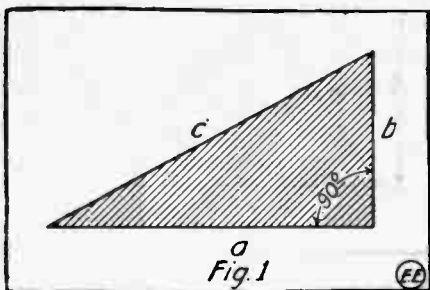

The fourth root of a number is found by extracting the square root twice, or the square root of the square root. The 6th root may be ascertained by finding the square root of the cube root of the given number. Such powers as $42^{1.8}$ and high powers are best found by the use of logarithms. These require the use of a set of logarithm tables, and no explanations will be given here, as nothing will be accomplished without them. Suffice it to say that many otherwise impossible problems are easily solved by their application. Any root, such as 7th, 11th, 17th, etc., is readily found by logarithms. A set of logarithm tables can be bought for 50 cents to one dollar, including instructions. They can also be read from ordinary slide rules, another great boon to those having occasion to use figures much. The ordinary slide rule reads to from 3 to 4 places, and hence is not accurate for large figures, but for figures not extending over 5 to 6 places, it is very handy and gives the result at once. Division and multiplication are quickly performed on them, as well as the extraction of square and cube root, logarithms, trigonometric functions, such as sines, tangents, etc.

The process of extracting the square root of a given number is as follows:—Suppose the square root of 217,668.9025 is to be found; begin by pointing off the number into groups of two figures each, starting at the decimal point, and pointing off left and right, as shown below:—

$$\begin{array}{r}
) 21,76.68.90,25 \mid 466.55 \\
 \underline{16} \\
 (a) 86) 576 \\
 \underline{516} \\
 (b) 926) 6068 \\
 \underline{5556} \\
 (c) 9325) 51290 \\
 \underline{46625} \\
 (d) 93305) 466525 \\
 \underline{466525} \\
 000000
 \end{array}$$

The procedure employed to solve the above is this:—Start, by finding the largest even square in the couplet to the

extreme left, viz., 21. Upon reflection, it is evident that the largest even square in 21 is 16, since 5 times 5 is 25, hence it must be 4×4 or 16. The 16 is put down under the 21, and subtracted as shown, at the same time bringing down 76, or the next couplet, of two figures. The square root of 16 or 4 is placed in the quotient, to form the first figure of the root wanted,—also 4 multiplied by two or 8 is placed at (a) to form the first trial divisor. Then say 8 into 57 goes 6 times, place the 6 in the quotient after the 4, and 6 also after the 8 in the divisor (a). Now multiply 86 by 6, giving 516. Subtracting leaves a balance of 60, plus 68 brought down from the dividend.

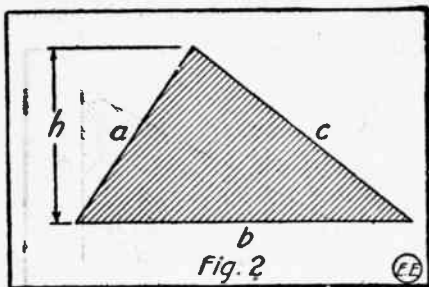

(c) is found by multiplying 466 of the quotient, by 2 or it equals 932, and 932 into 5129 goes 5 times. Place 5 in the quotient and also in the divisor, and multiplying 9325 by 5 gives 46625. Subtracting we have 466525. The trial divisor (d) is arrived at by multiplying 4665 of the quotient by two, or it is 9330. This into 46652 does 5 times. Place 5 in the quotient, also in the divisor, and multiply; the subtraction being zero, finishes this case. The pointing off of places in

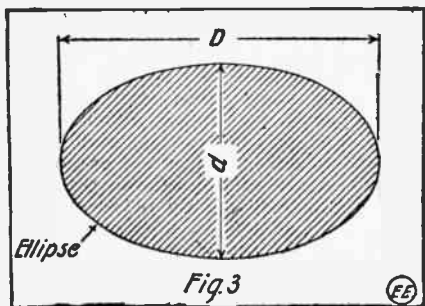

the quotient or square root, is done by observing the number of couplets pointed off in the dividend to the left of the decimal point. Here 3 couplets appear in the dividend to the left of the decimal point, hence 3 places counting from the left are pointed off in the quotient, or the square root of

217,668.9025 is 466.55. This is readily proved by squaring the root, i.e., multiplying 466.55 by itself, which will give the dividend.

The extraction of the cube root is somewhat similar only divisors having larger numbers are employed.

Some of the applications of square root are shown below: Considering the right angled triangle in Fig. 1, if any two of the three sides, a, b and c, are given, then the value of the third side may be calculated. The slanting side c, called the hypotenuse, is equal to the square root of the sum of the base squared plus the altitude squared, or $c = \sqrt{a^2 + b^2}$.

Also
and again

$$a = \sqrt{c^2 - b^2};$$

$$b = \sqrt{c^2 - a^2}.$$

If a perfect square is to have a certain area, then the length of the side of the square is found by extracting the square root of the area. For instance, if a square block of wood was to have 144 square inches area, the length of the side of an equal square having this area, would be:

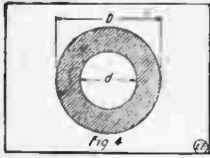

$$\sqrt{144} \text{ or } 12 \text{ inches}$$

The following notation is used for the formulae given here for finding the various functions of plane figures:

D = Large diameter.
d = Small diameter.
R = Radius corresponding to D.

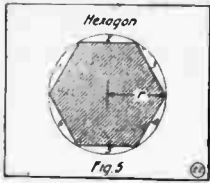

r = Radius corresponding to d.

p = Perimeter, or circumference.

S = Area of entire surface of solid figure.

A = Area of plane figure.

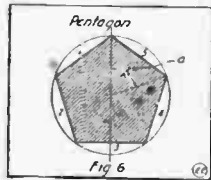
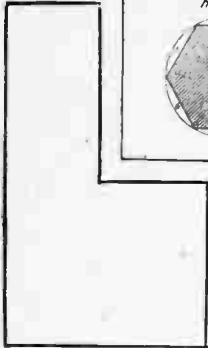

$$\pi = \text{pi} = 3.141592 + \text{etc.}$$

$$V = \text{Volume of solid.}$$

The various functions of the circle are found as follows:

$$\text{Circumference or } p. \left\{ \begin{array}{l} p = \pi d = 3.1416 \times d. \\ p = 2 \pi r = 6.2832 \times r. \\ p = 2 \sqrt{\pi a} = 3.5449 \sqrt{a}. \\ p = \frac{2a}{r} = \frac{4 \angle a}{d}. \end{array} \right.$$

$$\text{Diameter or } d. \left\{ \begin{array}{l} d = \frac{p}{\pi} = \frac{p}{3.1416} = .3183 \times p. \\ d = 2 \sqrt{\frac{a}{\pi}} = 1.1284 \sqrt{a} = \sqrt{\frac{a}{.7854}} \end{array} \right.$$

$$\text{Radius or } r. \left\{ \begin{array}{l} r = \frac{p}{2\pi} = \frac{p}{6.2832} = .1592 \times p. \\ r = \sqrt{\frac{a}{\pi}} = .5642 \sqrt{a}. \end{array} \right.$$

$$\text{Area or } a. \left\{ \begin{array}{l} a = \frac{\pi d^2}{4} = .7854 \times d^2. \\ a = \pi r^2 = 3.1416 r^2. \\ a = \frac{p r}{2} = \frac{p d}{4}. \end{array} \right.$$

The area of a circle varies as the square of the diameter. in other words, a 4" circle has 4 times the area of a 2" circle, etc. The circle has the greatest area for a given circumference or perimeter of any figure.

The area of any triangle, such as shown at Fig. 2, is given by the expression:

$$A = \frac{b h}{2} = \frac{1}{2} b h.$$

also

$$A = \frac{b}{2} \sqrt{a^2 - \left(\frac{a^2 + b^2 - c^2}{2b} \right)^2}$$

3, is ascertained by the formula:

The approximate area of an ellipse, such as shown in Fig.

$$A = \frac{\pi}{4} D d = .7854 D d;$$

The approximate perimeter or $p = \pi \sqrt{\frac{D^2 - d^2}{2} + \frac{(D+d)^2}{8.8}}$

The area of a flat ring, as seen at Fig. 4, is given by the following rule:

$$A = \frac{\pi}{4} \times (D^2 - d^2).$$

The volume of a sphere is given by the expression:

$$V = 1/6 \pi d^3 = .5236 d^3.$$

The surface of a sphere, or S , is found thus:

$$S = \pi d^2 = 4 \pi r^2, \text{ or } 12.5664 r^2.$$

Circles, triangles, etc., are divided up by angles, and these angles again sub-divided by degrees, minutes and seconds.

Sixty seconds make one minute, sixty minutes one degree, 90 degrees one right-angle or quadrangle, and 360 degrees a complete circumference of a circle. Protractors or semi-circles of brass and celluloid are usually employed for drawing, their edge being finely graduated in degrees, etc.

If the dividers are set equal to the radius of a circle, Fig. 5, r , then the dividers can be stepped exactly six times around the perimeter, or forming a six-sided figure called a hexagon. A five-sided figure, or pentagon, is shown at Fig. 6. Any sided polygon or figure can readily be laid out by the aid of the following data:

Table of Polygonal Angles.

Number of sides.	Angle at center. Degrees.	Number of sides.	Angle at center. Degrees.	Number of sides.	Angle at center. Degrees.
3	120	9	40	15	24
4	90	10	36	16	22½
5	72	11	32	8-11	21 3-17
6	60	12	30	18	29
7	21 3-7	13	27 9-13	19	19
8	45	14	25 5-7	20	18

The angle at the center refers to the angle at a , Fig. 6. By means of a protractor graduated in degrees, it is easy to lay out a polygon having any number of sides, by referring to the above table.

For electrical circuits there are a number of different formulas applying for various functions, the basic one for direct current circuits being Ohm's Law. In expressing it the following notation is generally utilized: E = volts or electro-motive force, I or C = current in amperes, R = resistance in ohms.

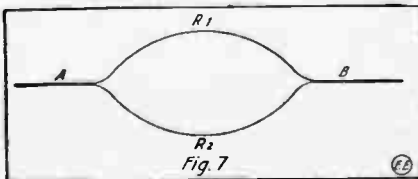

Then: $E = R \times I;$

$$I = \frac{E}{R};$$

$$\text{and } R = \frac{E}{I}.$$

Thus having any two quantities, the third one can be easily

found. The watts in a circuit are given by multiplying the volts by the amperes; also,

$$\text{Watts} = E I = C^2 R = \frac{E^2}{R}$$

The horsepower is found by dividing the total watts by 746, and the kilowatts is ascertained by dividing the total watts by 1,000. The coulombs of electricity in a circuit is found by multiplying the current in amperes by the time of its duration in seconds, the coulomb being a current of 1 ampere passing for one second. The work performed in an electrical circuit in Joules equals the product of the volts by the amperes by the time in seconds. The joule is equivalent to 1 watt or 1 volt-ampere for 1 second.

The heat produced in electrical circuits may be calculated as follows: The heat in calories equals:

$$\text{Heat in calories} = I^2 \times R \times T \times .24.$$

T being the time in seconds. The heat produced in British thermal units (B. T. U.) is:

$$\text{Heat in B. T. U.} = I^2 \times .24 \times R \times T \times .0033.$$

The volts lost in a circuit equals the product of the current by the resistance. The resistance of a copper wire increases 21-100ths. of one per cent. for each degree rise in temperature Fah., or the degree Fah. constant for copper wire is .0021.

The joint resistance of a divided or split circuit, such as that appearing at Fig. 7, is found as described below. If the circuit has two branches, such as R_1 and R_2 , then the joint resistance of the two branches, from A to B, is:

$$\text{Joint } R = \frac{R_1 \times R_2}{R_1 + R_2}$$

For a number of like resistances connected on multiple the joint resistance is:

$$\text{Joint } R = \frac{R_1}{\text{number on multiple}}$$

The joint resistance of several different resistances connected on multiple is found by taking the reciprocal of the sum of the reciprocals of the separate resistances, or conductances. The conductance of a circuit in ohms, being the reciprocal of the resistance.

$$\text{or } \frac{1}{R}$$

The joint resistance of three branched circuits connected on multiple, as in Fig. 7, is completed from the above rule as follows:

$$\text{Joint } R = \frac{1}{\frac{1}{R_1} + \frac{1}{R_2} + \frac{1}{R_3}} = \frac{1}{\frac{1}{R_4}}$$

And the reciprocal of this is $\frac{1}{R_4}$, or the joint resistance. For

example, let the three resistances have assigned values of 4, 5 and 2 ohms, respectively, then:

$$\text{Joint } R = \frac{1}{\frac{1}{4} + \frac{1}{5} + \frac{1}{2}} = \frac{19}{20}$$

and the reciprocal is:

$$\frac{20}{19} \text{ or } 1 \frac{1}{19} \text{ ohms.}$$

The capacity of electrical condensers is approximately computed by the equation:

$$C = \left(\frac{2,248 \times K \times a}{t \times 10^{10}} \right) \div 10^6;$$

Where: C is the capacity in farads. K is the inductivity of the dielectric, taken from table in any text book. a is the active area of dielectric or insulation, coated on both sides with charging foil, expressed in square inches. t is the thickness of the dielectric in inches. To ascertain the capacity in micro-farads (a microfarad is one one-millionth of a farad), solve only that portion of the equation enclosed in parenthesis.

The joint capacity of several condensers connected on multiple is given by the following equation:

$$\text{Total } C = C_1 + C_2 + C_3, \text{ etc.}$$

The total or joint capacity of condensers connected in series is ascertained thus:

$$\text{Total } C = \frac{1}{\frac{1}{C_1} + \frac{1}{C_2} + \frac{1}{C_3}, \text{ etc.}}$$

The area in square centimeters for a condenser dielectric to have a certain capacity in micro-farads is deduced by this formula:

$$\text{Area in sq. cm.} = \frac{36 \pi D C 10^5}{K};$$

Where $\pi = 3.1416$ or pi.

D = the thickness dielectric in cm.

C = capacity in micro-farads.

K = the inductivity factor.

$10^5 = 100,000$.

LESSON No. 20.

"HOW TO MAKE THINGS."

The young experimenter generally finds himself sooner or later called upon to make the parts of various apparatus, models, attachments, etc., and in this chapter it is intended to deal with some of the more potent features that often prove stumbling blocks to the junior mechanic; such as laying out work, finishing it, drilling and tapping of screw holes, etc., etc.



Fig. 1. The Divider.

It may be said that, primarily, the beginner should make it a point to master the

art of laying off specific distances from a rule; using a steel scale if possible.

A good mechanic can lay off work on metal with an accuracy of at least $1/64$ inch, and often $1/100$ inch. The closest working by eye does not usually exceed $1/200$ inch. For finer measurements than this, i. e., in the order of thousandths, or ten thousandths of an inch, recourse is had to an instrument known as a micrometer, which is used for all good machine work.

In Fig. 1 is seen a pair of dividers, or compasses, for striking circles, spacing center marks, etc. The micrometer is shown by the cut, Fig. 2, at A. Its scope is a wide one, and it is regularly used for finding diameter of wire, twist drills, sheet metals, rods, and for innumerable other purposes. It ordinarily reads in thousandths of an inch, but by a simple set of graduations around the stem, termed "Vernier graduations," after their inventor, it is easily possible to measure the size of an object, such as a wire, in ten thousandths of an inch.

A word about reading the micrometer may not be out of place here. The adjustable part of the micrometer is a carefully cut steel screw, hidden inside the barrel, the pitch of the screw being 40 threads to the inch. Hence every time the barrel is turned through one revolution it advances or recedes from the anvil or measuring on the solid stem by single graduations. Every four graduations, or 100/1000 of an inch is indicated by a longer line, as seen by glancing at cut. The reading in the figure is 300/1000, or 12 single divisions, which is 12 times 25/1000, or 300/1000. Note that when reading this value the zero mark on the revolving barrel is coincident with the graduated line along the solid stem. Odd fractions in thousandths are read by noting the number on the barrel index B coinciding with the stem line. For instance, suppose the barrel is unscrewed sufficiently to expose three single divisions and the No. 7 on the barrel index B was opposite the stem index line. Then the value of the caliper reading would be 3×25 thousandths (mils), plus 7, as read on the barrel index, or 75 and 7, which is 82 mils, one mil being equivalent to 1 thousandth of an inch. If the barrel index had been set so that the stem index line was midway between 7 and 8, then it could have been approximated as 75 mils, plus $7\frac{1}{2}$, or the reading would be .0825 inch, the ten thousandths figure being guessed at.

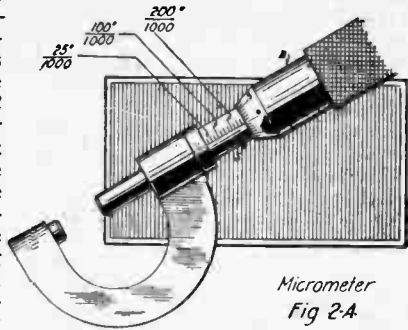

The easiest way to lay off work for machining, drilling, etc., on iron or steel is to cover it with a coating of chalk, which permits the lines scribed on the surface with a steel pointed instrument, so as to be readily seen. A scriber is easily made out of a piece of Stubb's steel, or drill rod, about 6 to 8 inches long and $\frac{1}{8}$ " thick. After grinding a fairly tapering point on the ends it can be hardened by heating in a Bunsen flame or other fire, to a red heat and then plunging into water.

All lines showing the size location of holes, etc., are scribed out on the metal, previously chalked over, as aforementioned, or if on wood, simply by a hard pencil, and all centers of holes to be drilled should then be center punched by a hard steel punch. (See Fig. 3.) For measuring the inside of a hole, or the exterior diameter of a drill or rod, use is made of outside or inside steel calipers, shown at Fig. 4; "a" being the outside caliper. These must be compared with a scale or rule after calipering a rod or hole. A little experience with these calipers, which are employed in all machine shops for measuring the diameter of shafts, journal boxes, etc., will enable the amateur to caliper quite closely. Some machinists can discern a difference of a few thousandths by means of these calipers, but for very accurate work micrometers are invariably used.

For cutting off small portions of soft iron and other odd work the hack saw, Fig. 5, using hardened saw blades from 8" to 12" long, is the usual tool employed. In using it too much pressure should not be exerted downward, as the teeth, being highly tempered, will break off, also the saw should be kept steady, not wobbling it, as it is swung back and forth.



Fig. 3. Centre Punch.

For cutting off small portions of soft iron and other odd work the hack saw, Fig. 5, using hardened saw blades from 8" to 12" long, is the usual tool employed. In using it too much pressure should not be exerted downward, as the teeth, being highly tempered, will break off, also the saw should be kept steady, not wobbling it, as it is swung back and forth.

A small drill press arrangement with a hand drill attached for boring small holes through metals, fiber, wood, etc., is seen at Fig. 6. The substance to be drilled is easily clamped on the bed plate attached. Further drilling accessories are illustrated at Fig. 7, "a" to "c." An automatic reciprocating ratchet drill for drilling thin sheet metal, leather fiber, wood, etc., is seen at "a," the different size drills being carried in the handle. A small hand drill with geared handle and capable of drilling $3/16$ " holes through iron or soft steel is depicted at B, while C shows a magazine tool handle with chuck clamping any of the tools displayed.

Tables giving size of tap drills for various machine screws are given in any tool catalog. The common sizes of machine screws and taps used are: No. 4, 56; 4, 36; 8, 32; 6, 32; 10, 32; 10, 24; 8, 24; 12, 24; 14, 20; $1/4$ "—20; etc.; the first numeral indicating the tap number and the second numeral the number of threads to the inch pitch.

Tap numbers each correspond to certain decimal parts of an inch, and can be found in any tap or drill catalog. A few of



A



Fig. 4 B



Fig. 6



Fig. 5
Hack Saw

Inside and Outside Calipers

Small Drill Press

Hack Saw

the common tap numbers and their inch equivalents are cited below (Kent):

Tap or screw number.	Diameter of body of screw. (Max. diameter.)
No. 2.....	.0842"
" 4.....	.1105"
" 6.....	.1368"
" 8.....	.1631"
" 10.....	.1894"
" 12.....	.2158"
" 14.....	.2421"
" 16.....	.2684"
" 18.....	.2947"
" 20.....	.3210"

As seen from the above, No. 14 size tap is slightly smaller than $1/4$ inch, hence it is nearly the same whether $1/4$ "—20 pitch or No. 14—20 pitch is designated; but a $1/4$ "—20 machine screw fits into a hole tapped with a No. 14—20 tap pretty snugly, and the exact designation should always be watched and adhered to.



Fig. 7 A

For tapping threads in holes a tap, Fig. 8 A, is utilized in a

tap wrench or holder B. The holder has an adjustable chuck taking several sizes of taps. For cutting threads on rods, etc., a steel die and holder, Fig. 9, is employed. In drilling and tapping cast iron no oil is required. For working wrought iron or steel oil is always used. Brass, aluminum, or any other metals require oil for drilling and tapping of any considerable extent.

A vise is essential in all shop work, and a neat one capable of being clamped to a table top is seen at Fig. 10.

A most useful machine is the lathe, upon which any shape of wood, fiber and brass may be turned up, and a good one for the amateur costs but little. A pair of heavy scissors, known as tinner's snips, are very handy for cutting out sections of thin fiber, tin, sheet iron, etc., not exceeding 1/16" thick.

For laboratory or shop use, in heating joints to be soldered, brazing and innumerable other operations, the Bunsen gas flame shown at Fig. 11 is a valuable asset. It uses the regular house gas, and by a set of air holes at the base transforms the flame into a strong blue one of intense heat, instead of the yellowish flame of low heat emitted by the usual tip.

For driving screws use is made of a plain or ratchet screw driver. A pressure exerted on the handle drives the screw or removes it, according to how the mechanism is set by the button on the side of it. This is a great time saver where many screws have to be placed.

Wrenches of various kinds are used to handle rods, nuts and the like, a Stilson wrench for handling pipe, etc., being very useful — also for fitting round rods of any kind.

Muriatic acid cut by dropping bits of zinc in it may be employed as a flux to solder iron with, but for soldering electrical joints on copper wires it should never be used, only the non-acid fluxes such as rosin, being permissible.

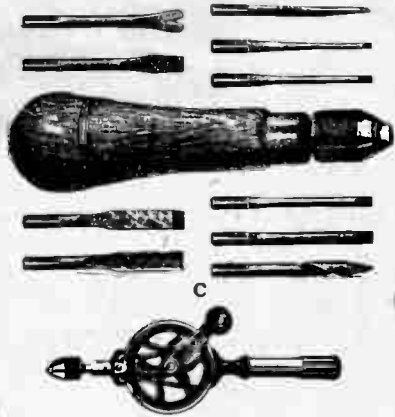

Fig. 7 B

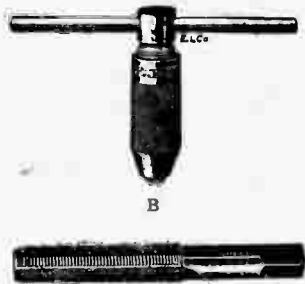

Fig. 8 A



Fig. 9
Thread Cutting
Die and Holder



Fig. 11
The Bunsen Burner

Fig. 12 depicts a speed counter for taking the speed in

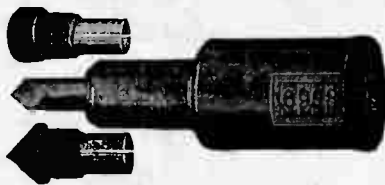

Fig. 12. Speed Counter

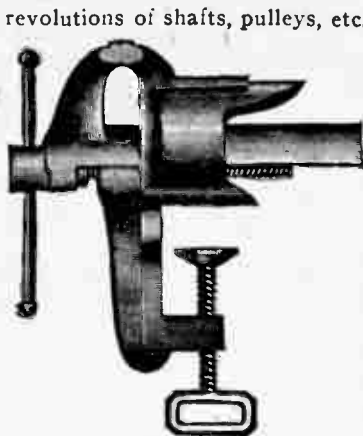

Fig. 10
Bench Vise

revolutions of shafts, pulleys, etc. The speed of a belt driven shaft is dependent upon the proportion existing between the diameters of the driving and driven pulleys. Briefly expressed, it is as follows: The speed of one pulley, A, is equal to the product of the diameter of the other pulley in inches (say we call it B), by the revolutions per minute it makes, divided by the diameter of the pulley A, in inches, the result being in revolutions per minute (R. P. M.).

The speed ratio of gears is found by dividing the number of teeth on the large gear by the number of teeth on the smaller one.

For example, suppose one gear had 100 teeth on it and the smaller one 12 teeth, then the ratio of speed would be 8 to 1, or the smaller gear wheel would make eight revolutions to every one of the larger gear.

THE METRIC SYSTEM OF MEASUREMENT.

Measures of Length

1 Millimeter (mm.) =	0.03937079 inch, or about 1/25 inch
10 Millimeters=1 Centimeter (cm.) =	0.3937079 "
10 Centimeters=1 Decimeter (dm.) =	3.937079 "
10 Decimeters=1 meter (m.) =	39.37079 inches, 3.2808992 feet, or 1.09361 yards
10 Meters=1 Decameter (Dm.) =	32.808992 feet
10 Decameters=1 Hectometer (Hm.) =	19.927817 rods
10 Hectometers=1 Kilometer (Km.) =	1093.61 yards, or 0.6213824 mile
10 Kilometers=1 Myriameter (Mm.) =	6.213824 miles
1 inch=2.54 cm., 1 foot=0.3048 m., 1 yard=0.9144 m., 1 rod=0.5029 Dm., 1 mile=1.6093 Km.	

Measures of Weight

1 Gramme (g.) =	15.4324874 gr. Troy, or 0.03215 oz. Troy, or 0.03527398 oz. avoird.
10 Grammes=1 Decagramme (Dg.) =	0.3527398 " "
10 Decagrammes=1 Hectogramme (Hg.) =	3.527398 " "
10 Hectogrammes=1 Kilogramme (Kg.) =	2.20462125 lbs.
1000 Kilogrammes=1 Tonne (T.) =	2204.62125 lbs., or 1.1023 tons of 2000 lbs., or 0.9842 ton of 2240 lbs., or 19.68 cwts.
1 grain=0.0648 g., 1 oz. avoird.=28.35 g., 1 lb.=0.4536 Kg., 1 ton 2000 lbs.=0.9072 T., 1 ton 2240 lbs.=1.016 T., or 1016 Kg.	

Measures of Capacity

1 Liter (l.) =	1 cubic decimeter = 61.0270515 cubic in., or 0.03531 cu. ft., or 1.0567 liquid qts., or 0.908 dry qt., or 0.26417 Amer. gal.
10 Liters=1 Decaliter (Dl.) =	2.6417 gal., or 1.135 pk.
10 Decaliters=1 Hectoliter (Hl.) =	2.8375 bu.
10 Hectoliters=1 Kiloliter (Kl.) =	61027.0515 cu. in., or 28.375 bu.
1 cu. foot =	28.317 l., 1 gallon, Amer. = 3.785 l., 1 gallon, Brit. = 4.543 l.

(Finis.)

USEFUL INFORMATION.

SYMBOLS FOR ELECTRICAL APPARATUS

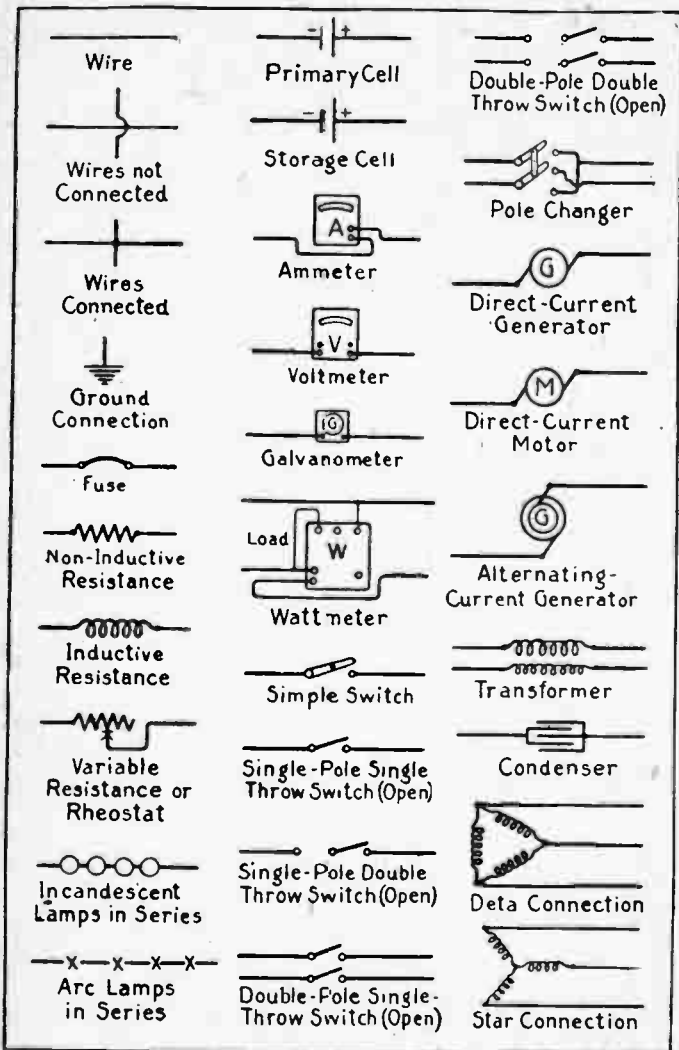

DIAMETER OF WIRE WHICH WILL FUSE WITH GIVEN CURRENT

Amp.	Diameter in Mils								
	Copper	Alum- inium	Plat- inium	German silver	Plat- inoid	Iron	Tin	Tin lead alloy	Lead
1	2.1	2.6	3.3	3.3	3.5	4.7	7.2	8.3	8.1
2	3.4	4.1	5.3	5.3	5.6	7.4	11.3	13.2	12.8
3	4.4	5.4	7.0	6.9	7.4	9.7	14.9	17.3	16.8
4	5.3	6.5	8.4	8.4	8.9	11.7	18.1	21.0	20.3
5	6.2	7.6	9.8	9.7	10.4	13.6	21.0	24.3	23.6
10	9.8	12.0	15.5	15.4	16.4	21.6	33.4	38.6	37.5
15	12.9	15.8	20.3	20.2	21.5	28.3	43.7	50.6	49.1
20	15.6	19.1	24.6	24.5	26.1	34.3	52.9	61.3	59.5
25	18.1	22.2	28.6	28.4	30.3	39.8	61.4	71.1	69.0
30	20.5	25.0	32.3	32.0	34.2	45.0	69.4	80.3	77.9
35	22.7	27.7	35.8	35.6	37.9	49.8	76.9	89.0	86.4
40	24.8	30.3	39.1	38.8	41.4	54.5	84.0	97.3	94.4
45	26.8	32.8	42.3	42.0	44.8	58.9	90.9	105.2	102.1
50	28.8	35.2	45.4	45.0	48.0	63.2	97.5	112.9	109.5
60	32.5	39.7	51.3	50.9	54.2	71.4	110.1	127.5	123.7
70	36.0	44.0	56.8	56.4	60.1	79.1	122.0	141.3	137.1
80	39.4	48.1	62.1	61.6	65.7	86.4	133.4	154.4	149.9
90	42.6	52.0	67.2	66.7	71.1	93.5	144.3	167.1	162.1
100	45.7	55.8	72.0	71.5	76.2	100.3	154.8	179.2	173.9
120	51.6	63.0	81.4	80.8	86.1	113.3	174.8	202.4	196.4
140	57.2	69.8	90.2	89.5	95.4	125.5	193.7	224.3	217.6
160	62.5	76.3	98.6	97.8	104.3	137.2	211.8	245.2	237.9
180	67.6	82.6	105.6	105.8	112.8	148.4	229.1	265.2	257.3
200	72.5	88.6	114.4	113.5	121.0	159.2	245.7	284.5	276.0
225	78.4	95.8	123.7	122.8	130.9	172.2	265.8	307.7	298.6
250	84.1	102.8	132.7	131.7	140.4	184.8	285.1	330.1	320.3
275	89.7	109.5	141.4	140.4	149.7	196.9	303.8	351.8	341.3
300	95.0	116.1	149.8	148.7	158.6	208.6	322.0	372.8	361.7

CHARACTERISTICS OF TIMBER

This table must be used with caution as there is frequently wide variations in any timber.

Description	Weight per cubic foot in lbs.	Tensile Strength per sq. in. in lbs.	Crushing Strength per sq. in. in lbs.	Relative Strength for Cross Breaking White Pine equal 100	Shearing Strength with the Grain lbs. per sq. in
Ash.....	43 to 55.8	11,000 to 17,000	4,400 to 9,400	130 to 180	458 to 700
Beech.....	43 to 53.4	11,500 to 18,000	5,800 to 9,400	100 to 144
Cedar.....	50 to 56.8	10,300 to 11,400	5,600 to 6,000	55 to 63
Cherry.....	130
Chestnut.....	33	10,500	5,350 to 5,600	96 to 123
Elm.....	34 to 36.7	13,400 to 13,500	6,831 to 10,480	96
Hemlock.....	8,700	5,700	88 to 95
Hickory.....	12,800 to 18,000	9,000	150 to 210
Locust.....	44	20,500 to 24,800	9,200 to 11,700	132 to 227
Maple.....	49	10,500 to 10,600	8,150	122 to 220	367 to 647
Oak, White.....	45 to 54.5	10,250 to 19,500	4,700 to 9,500	130 to 177	752 to 966
Oak, Live.....	70	6,850	155 to 189
Pine, White.....	30	10,000 to 12,000	5,000 to 6,650	100	225 to 423
Pine, Yellow.....	28.8 to 33	12,600 to 19,200	5,400 to 9,500	98 to 170	286 to 415
Spruce.....	10,000 to 19,500	5,050 to 7,850	86 to 110	253 to 374
Walnut, Blk.....	42	9,286 to 16,000	7,500

(12)

**TABLE OF COMPARISON OF CENTIGRADE AND FAHRENHEIT
THERMOMETER SCALES**

Cent.	Fahr.	Cent.	Fahr.	Cent.	Fahr.	Cent.	Fahr.
0	32.0	26	78.8	51	123.8	76	168.8
1	33.8	27	80.6	52	125.6	77	170.6
2	35.6	28	82.4	53	127.4	78	172.4
3	37.4	29	84.2	54	129.2	79	174.2
4	39.2	30	86.0	55	131.0	80	176.0
5	41.0	31	87.8	56	132.8	81	177.8
6	42.8	32	89.6	57	134.6	82	179.6
7	44.6	33	91.4	58	136.4	83	181.2
8	46.4	34	93.2	59	138.2	84	183.4
9	48.2	35	95.0	60	140.0	85	185.0
10	50.0	36	96.8	61	141.8	86	186.8
11	51.8	37	98.6	62	143.6	87	188.6
12	53.6	38	100.4	63	145.4	88	190.4
13	55.4	39	102.2	64	147.2	89	192.2
14	57.2	40	104.0	65	149.0	90	194.0
15	59.0	41	105.8	66	150.8	91	195.8
16	60.8	42	107.6	67	152.6	92	197.6
17	62.6	43	109.4	68	154.4	93	199.4
18	64.4	44	111.2	69	156.2	94	201.2
19	66.2	45	113.0	70	158.0	95	203.0
20	68.0	46	114.8	71	159.8	96	204.8
21	69.8	47	116.6	72	161.6	97	206.6
22	71.6	48	118.4	73	163.4	98	208.4
23	73.4	49	120.2	74	165.2	99	210.2
24	75.2	50	122.0	75	167.0	100	212.0
25	77.0						

One deg. Fahr. = .5556 deg. centigrade.

One deg. centigrade = 1.8 deg. Fahr.

To convert Fahr. to centigrade, subtract 32, multiply by 5 and divide by 9.

To convert centigrade to Fahr., multiply by 9, divide by 5 and add 32.

If temperature is below freezing, the above formula should read "subtract from 32" in place of "subtract 32" and "add 32."

**EQUIVALENT CROSS-SECTIONS OF DIFFERENT SIZE WIRES
(Brown and Sharpe Gauge)**

Equiv. section	Number of wires of various sizes						
	2	4	8	16	32	64	128
0000	0	3	6	9	12	15	18
000	1	4	7	10	13	16	One each
00	2	5	8	11	14	17	1 and 3
0	3	6	9	12	15	18	2 and 4
1	4	7	10	13	16	...	3 and 5
2	5	8	11	14	17	...	4 and 6
3	6	9	12	15	18	...	5 and 7
4	7	10	13	16	6 and 8
5	8	11	14	17	7 and 9
6	9	12	15	18	8 and 10
7	10	13	16	9 and 11
8	11	14	17	10 and 12
9	12	15	18	11 and 13
10	13	16	12 and 14
11	14	17	13 and 15
12	15	18	14 and 16
13	16	15 and 17
14	17	16 and 19
15	18

Table of Multiples

- Diameter of a circle $\times 3.1416 =$ Circumference.
 Radius of a circle $\times 6.283185 =$ Circumference.
 Square of the radius of a circle $\times 3.1416 =$ Area.
 Square of the diameter of a circle $\times 0.7854 =$ Area.
 Square of the circumference of a circle $\times 0.07958 =$ Area.
 Half the circumference of a circle \times by half its diameter $=$ Area.
 Circumference of a circle $\times 0.159155 =$ Radius.
 Square root of the area of a circle $\times 0.56419 =$ Radius.
 Circumference of a circle $\times 0.31831 =$ Diameter.
 Square root of the area of a circle $\times 1.12838 =$ Diameter.
 Diameter of a circle $\times 0.86 =$ Side of inscribed equilateral triangle.
 Diameter of a circle $\times 0.7071 =$ Side of an inscribed square.
 Circumference of a circle $\times 0.225 =$ Side of an inscribed square.
 Circumference of a circle $\times 0.282 =$ Side of an equal square.
 Diameter of a circle $\times 0.8862 =$ Side of an equal square.
 Base of a triangle \times by $\frac{1}{2}$ the altitude $=$ Area.
 Multiplying both diameters and .7854 together $=$ Area of an eclipse.
 Surface of a sphere \times by 1-6 of its diameter $=$ Solidity.
 Circumference of a sphere \times by its diameter $=$ Surface.
 Square of the diameter of a sphere $\times 3.1416 =$ Surface.
 Square of the circumference of a sphere $\times 0.3183 =$ Surface.
 Cube of the diameter of a sphere $\times 0.5236 =$ Solidity.
 Cube of the radius of a sphere $\times 4.1888 =$ Solidity.
 Cube of the circumference of a sphere $\times 0.016887 =$ Solidity.
 Square root of the surface of a sphere $\times 0.56419 =$ Diameter.
 Square root of the surface of a sphere $\times 1.772454 =$ Circumference.
 Cube root of the solidity of a sphere $\times 1.2407 =$ Diameter.
 Cube root of the solidity of a sphere $\times 3.8978 =$ Circumference.
 Radius of a sphere $\times 1.1547 =$ Side of inscribed cube.
 Square root of $(\frac{1}{3}$ of the square of) the diameter of a sphere $=$ Side of inscribed cube.
 Area of its base \times by $\frac{1}{3}$ of its altitude $=$ Solidity of a cone or pyramid, whether round, square or triangular.
 Area of one of its sides $\times 6 =$ the surface of a cube.
 Altitude of trapezoid $\times \frac{1}{2}$ the sum of its parallel sides $=$ Area.

Table of Contents

	Page
LESSON No. 1. Electric Bells, Buzzers and Annunciators.....	3
LESSON No. 2. Primary Batteries and Dry Cells.....	11
LESSON No. 3. Storage Batteries	20
LESSON No. 4. Rectifiers and Transformers.....	30
LESSON No. 5. Small Electric Lighting Plants.....	38
LESSON No. 6. Electrical Wires and their Calculations.....	47
LESSON No. 7. Telegraph and Telephones.....	59
LESSON No. 8. Dynamos and Motors.....	66
LESSON No. 9. Switches, Burglar Alarms, and miscellaneous connections	75
LESSON No. 10. Experimental Electro-Physics	83
LESSON No. 11. Electro-Therapeutics	89
LESSON No. 12. Induction Coils and Geissler Tubes.....	96
LESSON No. 13. The X-Ray	103
LESSON No. 14. High Frequency Currents (Tesla Transformer Experiments, etc.)	110
LESSON No. 15. Electroplating, Part I.....	118
LESSON No. 16. Electroplating, Part II.....	125
LESSON No. 17. Static Electricity and Static Generators.....	131
LESSON No. 18. Electrical Measuring Instruments.....	137
LESSON No. 19. Practical Mathematics	144
LESSON No. 20. How to make things. (The Use of Raw Material)	150
USEFUL INFORMATION	155

TWO REMARKABLE BOOKS

How to Make Wireless Sending Apparatus.

This book will surely be welcomed by every wireless enthusiast, and by the one who is fond of making his own apparatus.

Only strictly modern and up-to-date apparatus are described in this book, and if we asked you 50c for it, we are sure that you would think it a bargain.

Among others, this book contains instructions for making the following important apparatus: Experimental Arc Set, Speaking Arc Light, Quenched Spark Gap, 1/4 K.W. Transformer, Oscillation Transformer in System, Photophone, Rotary Spark Gap, Independent Vibrator, Calibrated Spark Gap, and many others.

Size of the book is 7x5 inches, substantially bound in paper; the cover being printed in two colors. There are 100 pages and 88 illustrations.

No. 1.—How to Make Wireless Sending Apparatus. Price prepaid\$0.25

How to Make Wireless Receiving Apparatus.

This book has been written and published entirely for the wireless enthusiast who makes his own receiving apparatus.

Only strictly modern apparatus are described.

Among the many good articles, the following will be of particular interest: How-to-Make a Receiving Set With Aerial or Ground; How-to-Build a Magnetic Detector, Wireless Relay, Wireless Lecture Set, Intending Radio Sign Construction of Improved Loose Coupler, Conical Tuning Coil, Interference Preventer, Unig

Receiving Transformer, Efficient W Meter, Pocket Wireless Set, Etc.,

Size of the book is 7x5 inch, bound in paper; the cover being printed in two colors. There are 100 pages and 90 illustrations.

No. 2.—How to Make Wireless Receiving Apparatus. Price prepaid\$0.



Experimenter Publishing Co., Inc., 233 Fulton Street, New York City

The Electrical Experimenter



"Wrinkles, Recipes, Formulas"; "With the Amateur"; "Prize Contests"; "Latest Patents"; "Phoney Patents." The "Electrical Experimenter" is unquestionably the most up-to-date, and snappiest electrical and wireless magazine published, and one you MUST have.

It is published each month; there are 12 numbers per year. Subscription price in U. S., \$1.00 a year, Canada and Foreign Countries, \$1.50 a year. Single Copy 15c.

Money orders, checks (if out-of-town checks add 10 cents for exchange) must be drawn to the order of Experimenter Publishing Co., Inc.

**SEND POSTAL FOR FREE SAMPLE COPY
FOR SALE ON ALL NEWS STANDS**

AS A SPECIAL OFFER WE WILL GIVE YOU FREE, A COMPLETE COPY OF THE 20 LESSON WIRELESS COURSE WITH A YEAR'S SUBSCRIPTION TO THE ELECTRICAL EXPERIMENTER AT \$1.00. DON'T DELAY. SEND YOUR SUBSCRIPTION TO-DAY.

Experimenter Publishing Co., Inc., 233 Fulton Street, New York City

EXPERIMENTERS ! !

Here is a publication devoted solely to the Electrical Experimenter. It prints practically nothing but experiments on electricity and wireless. It is clean, up-to-date and original all through. It is the magazine YOU have always been looking for. Only the best writers contribute to its pages, and you will be delighted every month with its contents.

What "The Electrical Experimenter" Contains

Every issue contains at least 80 big pages, and over 200 illustrations. Most issues have 96 pages and every one is full of the finest art work money can buy. Some of the regular departments are: "How to Make it Dept"; "The Constructor"; "Radio Department"; wonderful scientific fiction; "Question Box"; "Patent Advice"; "Experimental Chemistry";