

FUN WITH ELECTRONICS

GILBERT DAVEY

EDITED BY JACK COX



This book is a perfect introduction to Electronics. It provides the reader with details both of ready-built designs and of circuits which can be built up from components; it gives advice on components, their manufacturers and suppliers. The home constructor will find here full details of battery and transistor radios operating on short waves or with an all-wave receiver, and amplifiers and loudspeakers, including Hi-Fi; he will also discover much about mono and stereo apparatus, record players, tape recorders, electronic musical instruments and many modern devices and uses of Electronics, the scientific hobby of the 70's.

Gilbert Davey's great talent and enthusiasm for Electronics makes the subject exciting and fascinating to explore. He is a radio and T.V. broadcaster on Electronics, and the author of three other titles in this series: *Fun with Radio*, *Fun with Transistors* and *Fun with Short-Wave Radio*; he was the Amateur Radio correspondent to *Boy's Own Paper* and still writes on radio for *Boy's Own Annual*.

Jack Cox is the editor of *Boy's Own Annual* and was for many years editor of *Boy's Own Paper*. He has edited all of Gilbert Davey's radio books, continuing a partnership that began with Gilbert Davey's contributions to *Boy's Own Paper*.

ISBN 0 7182 0079 9

£3.25 net
(in U.K. only)

KAYE & WARD LTD
Century House
82/84 Tanner St.
London SE1 3PP

Fun with Electronics

by Gilbert Davey

(Radio Correspondent, *Boy's Own Paper* and *Boy's Own Annual* since 1946)

Edited by JACK COX

(Editor of *Boy's Own Paper* 1946-67 and Editor of *Boy's Own Annual* since 1959)

Drawings by B. Gerry from Originals supplied by the Author

KAYE & WARD LTD · LONDON

First published by Edmund Ward (Publishers) Ltd
1962

Revised edition first published by Kaye & Ward Ltd
1972

Copyright © 1962 Edmund Ward (Publishers) Ltd;
revised edition © 1972 Kaye & Ward Ltd

All Rights Reserved. No part of this publication
may be reproduced, stored in a retrieval system,
or transmitted, in any form or by any means,
electronic, mechanical, photocopying, recording
or otherwise, without the prior permission of
the copyright owner.

Note: Every effort has been made by the author to ensure
that proper application of the advice and information
given will produce satisfactory and pleasing results.
But no responsibility can be accepted by the author,
editor or publishers for damage, loss or injury resulting
from the application of the information and guidance
given in this book.

ISBN 0 7182 0079 9

All inquiries and requests relevant to this title
should be sent to the publisher, Kaye & Ward Ltd,
21 New Street, London EC2M 4NT,
and not to the printer.

Printed offset in Great Britain by Bishopsgate Press, London.

Contents

<i>Chapter</i>	<i>Page</i>
Foreword	6
1. Introduction to Electronics	8
2. Radio: the Home Constructor's One-Valve Battery Receiver	15
3. Kit Sets and Car Radios	21
4. Short Waves and the Construction of an All-Wave Receiver	26
5. Amplifiers: A Simple Two-Valve Amplifier	34
6. Amplifiers and Loudspeakers: High-Fidelity and Commercial Designs	38
7. Amplifiers and Loudspeakers: Home Construction and a Stereophonic Design	43
8. Records and Record-Players	48
9. Tape Recorders and Their Uses	51
10. Electronic Applications: Suggested Ideas	54
11. More Electronic Devices and Uses of Electronics	59
Appendix	63

Foreword

This is another Gilbert Davey book on practical radio, this time on *Fun with Electronics*, and all that stems from it in the technical times in which we live. I am sure that all who have enjoyed *Fun with Radio*, *Fun with Short Wave Radio* and *Fun with Transistors* will read it with pleasure and profit, for the author covers a very wide field in this branch of engineering. We live in the age of electronics and maybe we have only just touched the fringe of it here; but all modern boys, and particularly those who have made radio sets, and operated them, from Gilbert Davey's many designs, will want to know something about it.

Gilbert Davey is a gifted amateur who has retained all the enthusiasm and skill of the man who loves a craft for its own sake. His BBC Television series on practical radio have emphasized this point. He has never earned his living in radio and this has kept his approach keen, lively and unbiased. I am sure he will make many new friends with this revised edition of *Fun with Electronics*.

If you have not seen his work before perhaps I should explain that I was Editor of *Boy's Own Paper* from 1946 to 1967; I also revived the *Boy's Own Annual* in 1959 and still edit this annual publication in which the magazine was merged in 1967. Gilbert Davey was my amateur radio correspondent from 1946 onwards in this magazine and annual and still continues to delight new generations of boys who love practical hobbies and interests.

JACK COX

Photographs by courtesy of:
Mullard Ltd (Figs. 7 & 8)
Codar Radio Co. (Fig. 9)
World Radio Ltd (Fig. 10)
Rank Wharfedale Ltd (Figs. 18 & 19)
BBC, Broadcasting House (Fig. 22)
H. J. Leak & Co. Ltd (Figs. 21 & 26)
BSR Ltd. (Fig. 25)
Hammond Organ (UK) Ltd (Fig. 30)
BBC Radio Medway (Fig. 31)
Armstrong Audio Ltd (Fig. 11)

For the technically minded, and those studying electronics, the following are a selection of symbols and abbreviations used in this science:

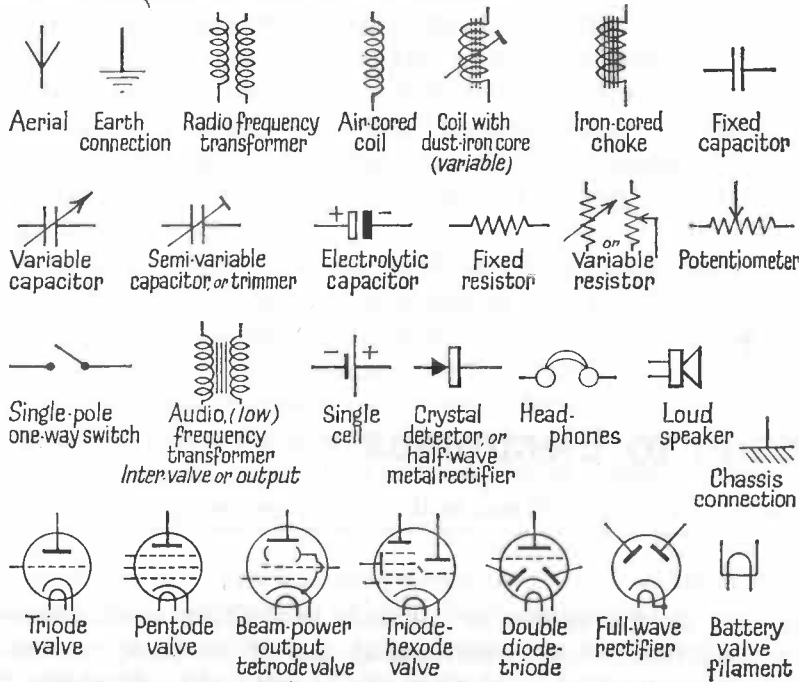

All these are indirectly heated mains types

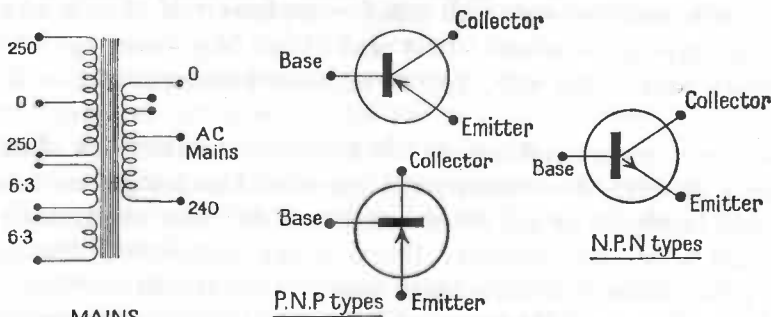

MAINS TRANSFORMER

TRANSISTORS

Wavelength = λ	metre	= m	<i>Prefixes for Abbreviations</i>
Frequency = f	frequency		
Voltage = E	unit (c/s) = Hz	One million millionth = micromicro = $\mu\mu$	
Current = I	volt = V	usually known as pico = p = ($\times 10^{-12}$)	
Power = P	ampere = A	One millionth = micro = μ = ($\times 10^{-6}$)	
Inductance = L	watt = W	One thousandth = milli = m = ($\times 10^{-3}$)	
Resistance = R	henry = H	One thousand times = kilo = k = ($\times 10^3$)	
Impedance = Z	ohm = Ω	One million times = mega = M = ($\times 10^6$)	
Capacitance = C	farad = F		

Examples: megohm = $M\Omega$; microfarad (mfd.) = μF ; milliamp = mA

Chapter 1

Introduction to Electronics

It is ten years since the first edition of this book in 1962 and in the electronics world ten years is a long time. Now established as one of the basic modern industries, development in electronic design and research is rapid and involved and the industry has become far more complicated, with many more branches, than it was in its early beginnings in the days of 'wireless'. That was about fifty years ago! 1972 was the fiftieth anniversary year of the BBC and of organized broadcasting in Britain as we know it today.

So, while much electronic development has been made in the fields of industry since 1962, particularly in relation to computers, considerable change has taken place in the domestic field in which we are more interested. All these changes are associated with what is called 'solid-state' circuitry, that is to say, transistors, diodes, and similar devices. Their great virtue is compactness and a much smaller voltage and current requirement. The most recent development has been 'integrated monolithic circuits' where the transistor itself, and most of its associated components, are created in one piece by a machine in the factory. You can now buy amplifiers which are quite inexpensive and give a large output at first-class fidelity, yet are little larger than the top joint of your finger! For space exploration and scientific projects the devices manufactured can be as small as a pin-head.

Apart from the high-fidelity amplifier itself, development has occurred in other 'Hi-Fi' fields and this has become a popular, though somewhat expensive, commercial proposition. The old idea of large cabinets for amplifiers and loudspeakers has been dispensed with and modern compact amplifiers provide good quality from quite small loudspeakers. The extreme bass is probably missing but the results are more than adequate. Since the tendency today is towards small individual units instead of large

radiograms, the products fit comfortably into the small apartments and flats of modern living. As development of 'stereo' reproduction has also progressed rapidly two amplifiers and two loudspeakers are required and the smaller units aid in this respect.

The use of Very High Frequencies (VHF) and of Frequency Modulation (FM) has increased and on the VHF band many BBC local stations are available to serve the larger cities and urban areas. Some BBC programmes are broadcast in stereo and these can be received in stereo by means of a special 'decoder' attached to the VHF FM tuner. If the decoder is not employed they are equally available in 'mono' in the normal manner.

Valves are now very little used and with new techniques 'home construction' by means of assembling components in accordance with circuit designs and plans has declined considerably. Components are difficult to obtain as so many manufacturers no longer make them for the constructor market and items such as coils are almost unavailable. However, the interest in the hobby of electronics appears to have increased but this is no doubt due to the interest now shown in the assembly and operation of factory ready-built 'modules' and other units. As far as amplifiers are concerned, many modules are available quite cheaply and these can be assembled together to form the required design.

In this revised edition of *Fun with Electronics*, therefore, we shall continue our policy of providing the reader with details of ready-built designs and of circuits which can be built up from components. Also modular designs are mentioned and details of how they can be obtained. May I say, at this stage, what I repeat at the end of the book, that I shall be glad to help readers with any difficulty they may find with diagrams or designs which we include in the book. I cannot supply designs, components or books nor can I correct or criticize circuits made up by amateurs or taken from other books. Components' suppliers are listed at the end of the book together with manufacturers so please write to them as necessary and not to me.

All that I have written up to now has been relevant to the second, revised edition of this book. The Editor and I hope you will enjoy it and will find the information in it interesting and instructive.

In other books in this series, I have devoted the first chapter to a description of the subject with which I dealt in the book. This was a simple matter, as they all deal with one aspect or another of radio. When I approached electronics, however, I found some difficulty, as I did not know what 'electronics' really was! Suppose you were invited to take part in your favourite television quiz game and were posed the question 'What is electronics?' What would you say? Perhaps you would reply: 'Electronics is a new science', or 'Electronics were invented by Marconi', or 'Electronics is something to do with wireless'. *The Encyclopaedia Britannica* gave me, as a definition:

Electronics is the branch of engineering concerned with the theory, design and use of devices utilizing electron emission or absorption, such as electron tubes, cathode-ray tubes, photo-electric cells, transistors and the circuits in which these components are used.

I am grateful to the proprietors of *The Encyclopaedia Britannica* for allowing me to

quote their definition, especially as it gives so clearly and succinctly the exact details we are seeking. 'Electron tubes' is an American term for our thermionic valves, better known to us as radio valves and which have been for so many years the chief source of electron emission. Now we also use cathode-ray tubes in television, transistors in radio and television, and both of these, plus valves and photo-electric cells, in every kind of application in our life today. It is one of the marvels of our age that this technique of electronics has spread rapidly throughout all aspects of modern living until there is virtually nothing in our modern world which does not use electronics in some form or another.

So, at last, I have reached the point of telling you what I am proposing to do in this book. I will describe, somewhat briefly because it has become a vast subject, some of the ways in which electronics are used today. Readers of *Fun with Radio*, *Fun with Short Wave Radio* and *Fun with Transistors*, however, have come to expect some practical ideas which they can work out for themselves. Those books are filled with designs for radio sets which the keen reader can build. I have not disappointed him, therefore, in this book, and there are full details of a number of first-class designs which you can build up from components. In addition I tell you of other designs which are published, of kits which you can purchase to make up and of ready-made apparatus which is available in the shops. The book deals mainly with the sound-reproduction side of electronics, that is to say, radio, amplifiers, tape recorders and the like.

This would be an appropriate point at which to say 'Thank You' to many people who have assisted me by providing information, components for experimenting, apparatus for examination and photographs for reproduction, and have shown the friendly help and interest which seems to be a special feature of the electronics industry. I acknowledge with gratitude the help which has been freely given to me over many years by so many good friends in the radio trade.

In the Appendix at the end of the book I give you a list of firms whose products I have mentioned and they are the ones to whom I am especially grateful for assistance. If I have mentioned these particular products it does not mean, unless I specifically say so, that I consider them to be better than those I have not mentioned. Conversely, those not mentioned are only left out because I know of the others by experience or have had an opportunity to test them. In the extremely competitive conditions which the electronics industry faces today shoddy products just cannot secure a foothold and any article which you buy will, I am sure, be good value, within its price range, for the money you pay.

I would like now to return to the definition of electronics which I quoted at the beginning of this chapter, as I feel some clarification of electrons themselves might be of assistance. I am sure that everybody today knows that an atom is the smallest possible particle of an element. Just how small it is impossible to imagine, but the atom itself is composed of three particles, called 'proton', 'electron', and 'neutron', and the numbers of these existing in each atom determine the type of element of which that atom forms a minute part. Protons are positively-charged electrically, electrons have a negative charge and, as their name implies, neutrons have no charge at all.

All these items are not just thrown together anyhow to form the atom. The protons and neutrons are together in what is called the *nucleus*, which forms the core of the atom, while the electrons revolve all the time around the nucleus, rather like planets going round a sun. There are always an equal number of protons and of electrons, so that they cancel one another out.

The atom has thus no preference for either a positive or a negative charge. There are also an equal number of neutrons but they have no charge at all, so do not affect the issue. The negative electrons, revolving round the nucleus, can sometimes be attracted away and persuaded to attach themselves to other atoms. Those atoms which lose electrons become positively-charged, while those atoms gaining electrons become negatively-charged unless the incoming electrons can displace some of the existing electrons and take their places. In such an event the displaced electrons have to find another home, and so it goes on. Electrons, being negatively-charged, are attracted by positively-charged particles and vice versa.

I did state above that electrons can sometimes be attracted out of their orbit. Three ways of doing this are by friction, by light, or by heat. It was noticed by Edison that the glowing filament of an electric lamp gave off electrons which were attracted to a positively-charged plate. Fleming used this principle in the two-electrode valve, which could be used as a rectifier similar to the diode-valve or germanium-diode rectifiers which we use today. The diode valve could not be controlled in any way until it was discovered that a grid of wire placed between the filament and the positively-charged plate could, by means of a varying negative potential, be used to control the flow of electrons which were emitted from the wire filament when it was heated by an electric current passing through it.

Thus the earliest triode valve was formed, with a filament of tungsten wire, heated by (usually) a 6-volt battery to white heat and surrounded by a coil of wire, forming the grid, and then both of these surrounded by a tube of metal (often nickel) forming the plate (or anode). Experiment and research found that different effects resulted from different distances between these three electrodes. Better electron emission came through improved materials used for filaments, until we now have the indirectly heated valve, which has a tube of electron-emitting material heated by an independent filament not itself responsible for the electron emission. More grids and other complications were added so that today the three-electrode valve is rarely used in electronic work. Instead we have the modern small, highly efficient valves which nevertheless depend entirely, absolutely entirely, on the flow of electrons from the indirectly heated cathode.

Fig. 1 shows an experiment you can try which will illustrate the electron flow in a valve. The valve represented by the theoretical symbol is a DL 91 battery RF pentode, which operates from a 1.4-volt filament battery with up to 90 volts high-tension voltage on the anode. It has three grids, one of which is connected internally to the filament and can be disregarded by us. That one is known as grid 3, and the next one, known as grid 2, we connect externally, by connecting pins 2 and 3 together, to the anode so that, in effect, within the valve it becomes one with the anode. We thus

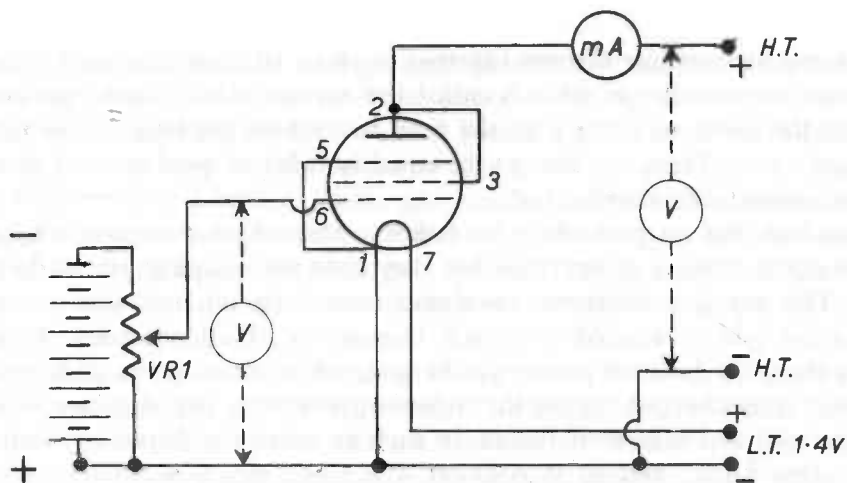

Fig. 1 Measuring a Valve's Characteristics

form a three-electrode (triode) valve consisting of filament (pins 1 and 7 or 5 and 7, 1 and 5 being connected internally), grid (pin 6) and anode (pin 2 to which 3 is connected).

In the lead to the high-tension battery is placed a milliammeter, which is a device to read current and which need not read higher than 20 milliamps. Voltmeters, as shown by the dotted lines, can either be connected permanently across the high tension and/or between grid and LT minus, or simply tried across from time to time whenever a voltage change is made. The arrangement of long and short lines to the left of the diagram represents a battery of $10\frac{1}{2}$ volts, each unit of one long and one short line indicating one $1\frac{1}{2}$ -volt cell. The long line is the positive pole and the short is thus the negative one. Across this is connected VR 1 which is a potentiometer of 5,000 ohms (5 kilo-ohms) resistance and the slider is connected to the grid of the valve.

By the act of moving the slider from one end of the resistance range to the other any voltage from positive to the full negative voltage of the battery can be applied to the grid of the valve. It is quite likely that you will be unable to obtain a $10\frac{1}{2}$ -volt battery for they are little used now, so three $4\frac{1}{2}$ -volt torch batteries may be connected in series (plus to minus, plus to minus, leaving a plus and a minus free at each end) to give $13\frac{1}{2}$ volts, or two 6-volts in series would give 12 volts. If you can obtain a $10\frac{1}{2}$ - or 13-volt grid-bias battery, tapped at each $1\frac{1}{2}$ -volt cell, you can dispense with the potentiometer and, by means of a wander-plug on a piece of flex, vary your voltage on the grid in $1\frac{1}{2}$ -volt steps.

The purpose of the experiment is to indicate the change in current which occurs as the voltage on the grid is varied. The filament is heated by the current passing through it from the 1.4-volt cell and gives off electrons which are attracted instantly to the anode, which is positively-charged. But they must first pass through the grid, which is negatively-charged, and on which you can vary the voltage by means of the potentiometer.

meter or of the taps on the battery. If you obtain a piece of squared paper, you will be able to draw a graph showing the variations in current in relation to grid voltage. Should you have an HT battery which is tapped at various voltages, say 30, 45, 60 and 90, you can draw various graphs for the different voltages.

Fig. 2 shows the anode-current grid-volts curves (see overleaf, page 14) for the Mullard DL 94 valve. I am grateful to Mullard Ltd for allowing me to reproduce this diagram, which I have chosen because the DL 94 valve takes a heavier current than the other valves in this range, and its curves are thus more pronounced. Most details about a valve can be ascertained from its characteristic curves, but here we are entering the realm of radio theory and, as this is not a theoretical textbook, I will refer you to two excellent books: *Foundations of Wireless* by M. G. Scroggie, B.Sc., A.M.I.E.E. (Iliffe) and *Radio Servicing, Theory and Practice* by A. Marcus (Geo. Allen and Unwin).

Transistors are mentioned in this book but I have not given any practical designs for building transistor radios as these, I feel, are fully covered in *Fun with Transistors*. Designs for all types of transistor receivers are frequently published in technical journals such as *Practical Wireless* or *Radio Constructor* and I recommend these monthly periodicals to you.

Transistors are used in all the commercial designs mentioned (except the short-wave receivers) and they have superseded the valve in the domestic fields of radio, television and record reproduction. For this reason I make no excuses for keeping in the book several designs for radio receivers and amplifiers which use valves. There is a certain versatility about a valve receiver which appeals to the young experimenter apart from the fact that a complete knowledge of electronics work requires some experience with valves.

Designs using valves have been gradually disappearing during the sixties and early seventies and I think it will help readers to have all available details given here. Popular types of valves have been used and these should be obtainable without difficulty at radio dealers or the retail shops of component suppliers. Alternatively, valves can often be bought quite cheaply by mail order from specialist advertisers in the periodicals mentioned above. In the next chapter, therefore, we deal with the first application of electronics, namely radio, and it contains a practical design of a one-valve receiver which you can make up quite easily.

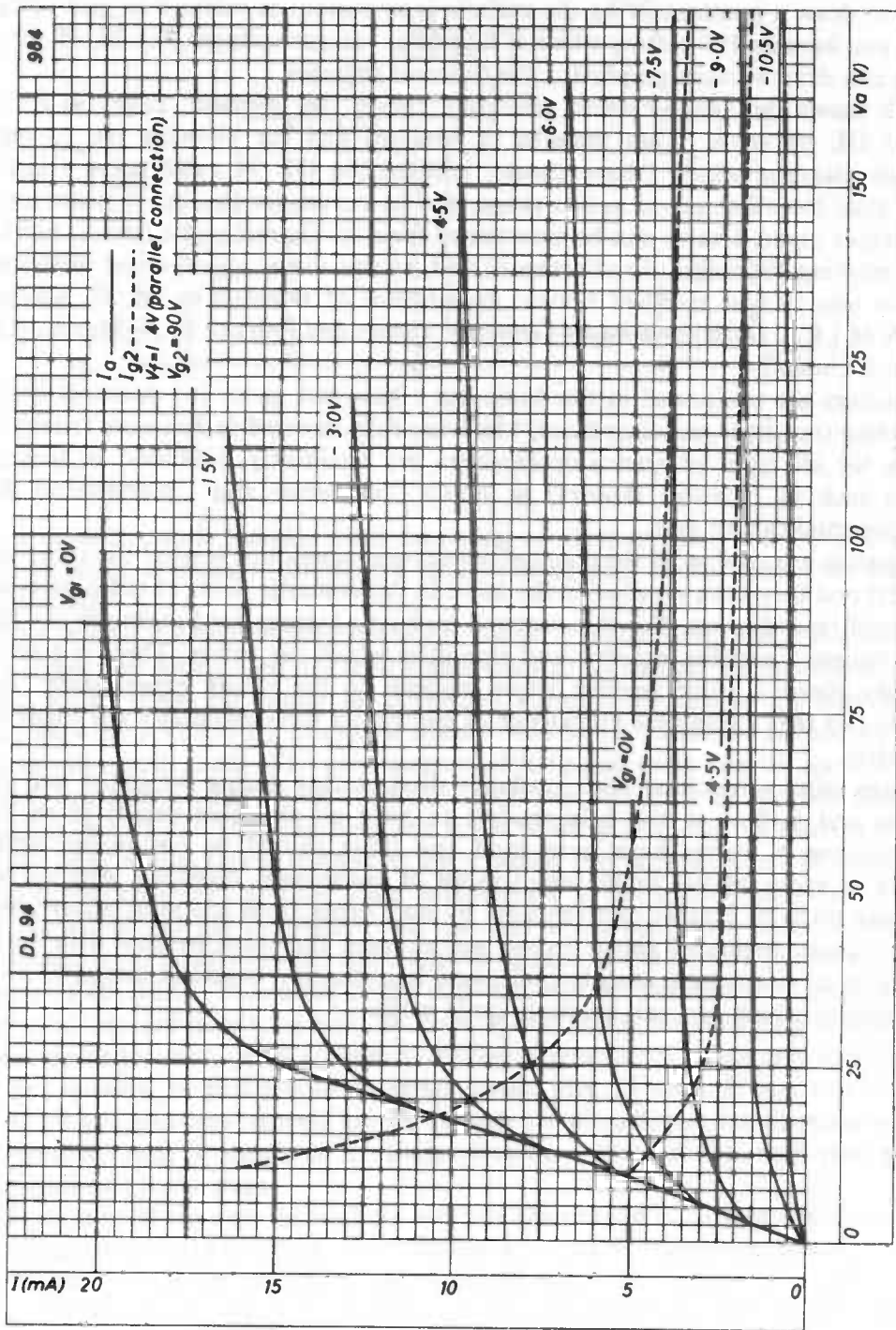

Fig. 2 Characteristic Curves of the DL 94 Valve

Chapter 2

Radio: the Home Constructor's One-Valve Battery Receiver

The one-valve receiver using a pentode valve is a most useful introduction to radio. Excellent reception can be obtained with a small aerial and the cost in batteries is low. You must earth this set to a water tap or pipe, and NEVER to a gas pipe, which can be very dangerous indeed.

In the previous chapter I told you something of the way in which a valve works, and you were shown an experiment to determine the manner in which the control of the flow of electrons from the filament to the anode is dependent on the negative voltage on the grid of the valve. Now the signals which are received by an aerial are of an alternating current which, as you probably know, means that they are neither completely positive nor completely negative, but alternate between the two, changing constantly from positive to negative at a rate of so many times per second. The number of times per second that this occurs is known as the frequency of the current.

The incoming signal is fed into the grid of the valve which, while its grid has a steady negative voltage on it, will be taking a steady current, and which, as soon as it receives these varying additions to and subtractions from that steady negative voltage as a result of the imposition of the incoming AC signal, will produce fluctuations in the current drawn from the HT battery. We are able to use those variations to make the valve work for us and it can be made to rectify the signals received and to amplify them.

The one-valve receiver is a useful introduction to radio because the valve is used for both these purposes in the one design. How exactly it does this always seems to be a point of argument among technicians, but the textbook you study will have its own theory to put forward. The usefulness of the one-valve design is increased by incorporating reaction, which is a form of controllable 'feed-back', as a result of which the sensitivity and volume are increased many times. Many beginners try to gain some elementary knowledge of radio and of building receivers by making a crystal set, as it is called, but I believe that it is much more useful to start with a one-valve set.

The initial cost is somewhat greater but even so is quite small and the ultimate result proves more satisfactory.

A crystal receiver has only a small diode rectifier (we no longer use the crystal and catswhisker, but instead a sliver of germanium with a fixed contact, all sealed in a capsule). That rectifier is only capable of rectifying the signals which it receives from the aerial: that is to say, it converts those signals into currents which will activate the headphones, causing their diaphragms to vibrate, and allow the listener to hear the broadcast sounds. The volume of those sounds is entirely dependent, therefore, on the strength of the signals passed through the diode detector.

Large signals are the product of a large aerial and the crystal-user erects one, possibly of the maximum length allowed by law, i.e. 100 feet; but he quickly discovers that such an aerial has poor selectivity, that is, the power to separate stations, and he often has loud signals from two stations together. So the only possible way to improve matters is to cut down the size of the aerial, or to loosen the coupling of the aerial to the tuning coil by means of a small series capacitor or of a small aerial coupling coil. Unfortunately this often results in the selectivity being improved so much that there is no signal left to hear!

Now the one-valve receiver detects the signal but also amplifies it after detection; as a modern one-valve set uses a pentode valve the amplification is quite considerable. In addition there is the further advantage of reaction, which can build up the signal many more times still. As a result, extremely satisfactory reception can be obtained with only a small aerial and the cost in batteries is very low indeed. I agree that today we are now able to use transistors which give remarkable results for very little battery cost, but a transistor set can still be expensive, so that for a simple experimental receiver I recommend the one-valver.

The schematic diagram of the receiver is shown in Fig. 3. The round device in the centre symbolizes the valve, a DF 91 pentode, the latter word meaning that it has five electrodes. You can see them depicted—with the filament a semi-circular line between pins 7 and 1, three grids each designated by hatched lines, and the line for the anode. The filament is heated by a 1.5-volt dry cell and takes 50 milliamperes (mA) of current. This, you will remember, causes electrons to be emitted. These fly towards the anode to which you will note the positive HT is connected via the phones and a resistor.

Between the filament and the anode there is, firstly, the control grid to which the signal from the aerial is connected after tuning by the coil and the capacitor. Then there are two more grids, both of which are added for stability purposes to assist in obtaining greater amplification from the valve. The one connected to pin 3 has a fairly low positive charge, and that nearest the anode is connected internally to the filament and does not concern us.

The coil used is for medium waves only and is tuned by a small compact-type capacitor of $0.0005 \mu\text{F}$ (i.e. 500 pF) capacity. A similar capacitor but of $0.0003 \mu\text{F}$ (300 pF) capacity is used for the reaction (feed-back) control. To make this small set I suggest that you obtain a piece of hardboard (it is cheaper than three-ply wood, although this is equally suitable), size $4\frac{1}{2}$ inches square, and two pieces of $\frac{1}{2}$ -inch-square timber,

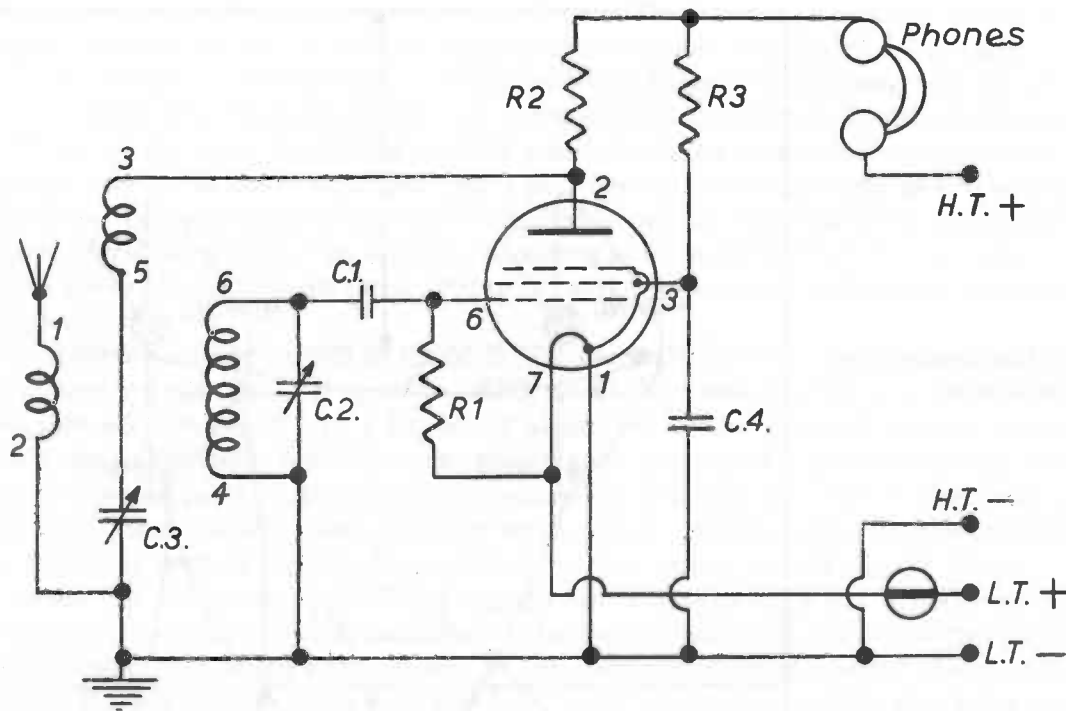

Fig. 3 One-valve Receiver: Schematic Diagram

Components required:

CAPACITORS:

- C.1. 100 pF fixed mica
- C.2. 500 pF variable solid dielectric
- C.3. 300 pF variable solid dielectric
- C.4. 0.1 μ F paper 150 (or more) v. wkg.

RESISTORS: (all $\frac{1}{4}$ watt)

- (K = 1,000; M = meg = million)
- R.1. 1 M Ω
- R.2. 10 K Ω
- R.3. 47 K Ω

1 coil (see text)

1 Mullard valve, RF pentode, type DF91 or DF96

1 valveholder, type B7G

Two 2-socket strips, on-off switch

Knobs, wire, solder, 'phones etc.

4½ inches long. Lay the hardboard on the two runners so that they are level with two parallel sides and fix them in position with small panel pins. Somewhere about the centre of this small platform make a ½-inch-diameter hole for the valveholder.

Fig. 4 shows how the components are arranged, and the valveholder must be inserted so that the connections to the socket are on the underside. After you have made the hole, the valveholder can be fixed into place with two 6 BA nuts and bolts. A small panel of board, also 4½ inches square, is stood on edge at the side of the platform where the two runners terminate, so that two or three panel pins can be driven through the panel into these two runner ends, fixing it in position. Three holes for the two capacitors and the switch have to be drilled in the panel. Unless you have a drill capable of drilling to the size required, it would perhaps be preferable to make

Fig. 4 One-valve Receiver:
Wiring Diagram

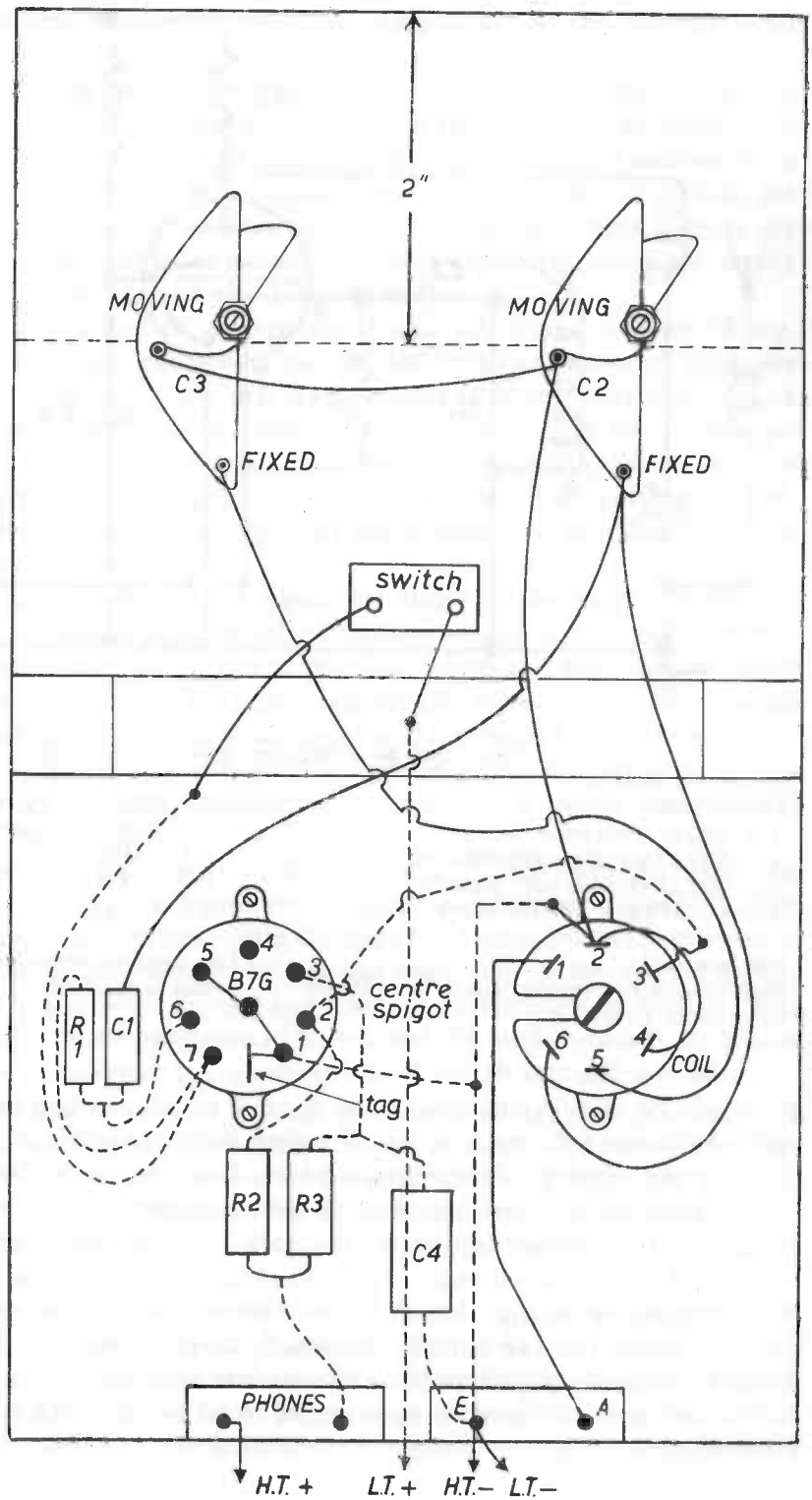

these holes before fixing the panel to the chassis. The advantage of using hardboard for this work is that, if you have no suitable drill available, a screwdriver can be driven through the board and the hole can then be made larger with the tang of a file or a pair of pliers. The edges of the hole are easily cleaned up afterwards with sandpaper.

When all the holes are drilled and the panel fixed, the components can be bolted into position. The small fixed capacitors and resistors are suspended in the wiring. Note the two socket strips at the rear of the chassis, one for aerial and earth connections and the other for phones. Fig. 4 shows the wiring as from the TOP of the set, and those wires which are led through the baseboard to make connections under it are shown in hatched lines.

It is essential to be careful to make correct connections to the valveholder sockets and these are given here. It is a 7-pin B7G valveholder and, looking at its underside, the pins are numbered 1 to 7 beginning at the left of the gap and working round clockwise to the right: pin 1 filament, pin 2 anode, pin 3 grid 2, pin 4 no connection, pin 5 same as pin 1 (being connected internally), pin 6 grid 1, pin 7 other side of filament. These 1.4-volt valves have the most delicate filaments, so that it is essential to avoid any contact with the high tension as the filaments would quickly 'blow'.

When you have completed the wiring, do not insert the valve but connect up the phones, the high-tension and low-tension batteries and switch on. Now stick two pieces of bare wire, each about 2 inches long, in the sockets numbered 1 and 7 of the valveholder. Take a 3.5-volt torch bulb and hold it across these two wires, that is to say, put the 'pip' of the bulb firmly against one of the wires and touch the other wire against the outer screw thread. The bulb should light up, but not very strongly as it is only receiving 1.5 volts, yet enough to indicate that the LT circuit is in order. If it does not light up, or if it 'blows', you must search for a fault; in the latter case be particularly careful to find the fault before inserting the valve. When you do find it, try again with another bulb, for they are cheaper than valves!

By now I assume that you have completed the actual wiring of your receiver and have fixed a knob on each of the spindles protruding from the capacitors on the front panel. Aerial and earth can be plugged in and phones and batteries connected up. Turn both knobs to the left, so that the vanes of the capacitors are fully open, and switch on. Test for oscillation by swinging the right-hand knob carefully to the right, when, at one point, a loud rushing noise will begin to build up in the phones until the set actually bursts into a howl. Immediately turn the capacitor back to stop it, because that oscillation can be heard in other sets, and it is a breach of licence conditions to allow any radio set to cause interference in other receivers.

You must try and keep the reaction capacitor at a point just below oscillation, at the same time turning the other capacitor gently clockwise to tune in the stations. If the volume is too loud, you may find it necessary to turn reaction right back in order to listen comfortably, but you will soon get the knack of tuning with one hand and controlling reaction with the other. In this way you should log quite a few stations.

This design was originally built around the Teletron coil type DR2 which is no longer in production. Some of the larger component suppliers, such as Home Radio

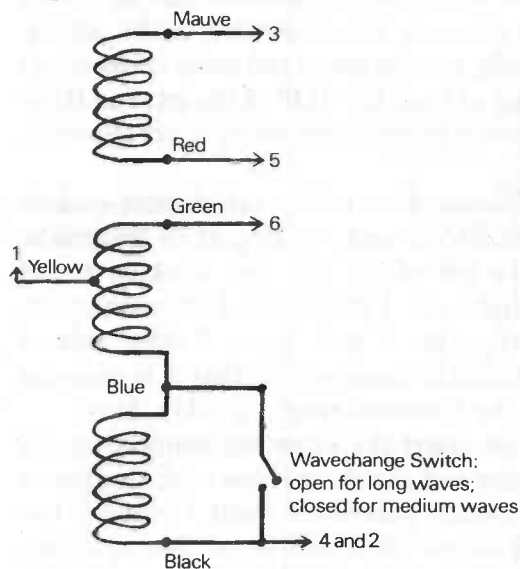

Fig. 5 Connections to DRR2 Coil

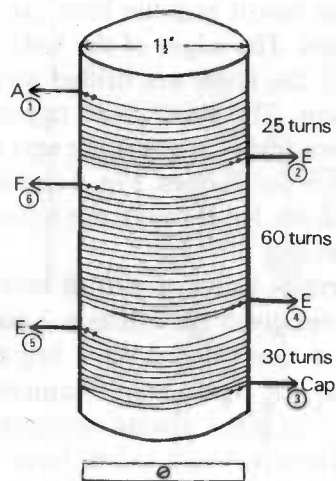

Fig. 6 A Home-made Coil

A piece of cardboard tube (such as a postal tube) $1\frac{1}{2}$ ins. diameter; plastic piping would do (but *not* metal). Wind on numbers of turns as indicated—exact numbers are not critical. Wire is anchored by drilling two small holes at beginning of winding and at end. Coil is mounted by cutting small piece of wood to 'press-fit' and screwing to baseboard. Use 28 d.s.c. wire or try any insulated wire you have handy.

(Components) Ltd., may still have some in stock. If not, use the Repanco coil type DRR2 which is a dual-range coil and connections for which are given in Fig. 5. If you would like to make up your own coil some details for this are given in Fig. 6.

The original edition of this book used the word 'condenser' to describe that which we now call a 'capacitor'. We have now changed *condenser* to *capacitor* in the text, but this has not been possible in all the diagrams. The meaning is the same however.

Try the set out at first with about 20 feet of aerial around the room. It will be better if it is an upstairs room. You will soon get an idea of how much aerial you require and can then, perhaps, put one up in the loft. Do not make it too large, however, as selectivity will suffer. You can try operating without an earth at first. Try a connection to a *water tap* if you have a basin in your room, or can reach one outside somewhere. *Never attempt to earth to gas pipes or apparatus for it is dangerous in the extreme.*

I hope you enjoy building this one-valve set; in the next chapter I am going to describe some useful sets which you can buy ready-made or as kits.

Chapter 3

Kit Sets and Car Radios

We recommend kits which can be bought at a reputable radio dealer's shop and which we know to be reliable. A correctly matched aerial makes all the difference to good reception and this is important. Finally we give details of car-radio kits.

In the early days of amateur radio in the twenties and thirties, the great majority of listeners made their own receivers, or perhaps had a relative or friend who was kind enough to make one for them. By 1939 the electronics industry had progressed enormously, particularly in regard to radio, and it played a great part in all spheres in the Second World War. As often happens in wartime, development proceeded much more quickly than is normal in peace time, and after 1945-6 the radio industry offered so much attractive equipment at reasonable prices that the tendency to make one's own set declined. Some real enthusiasts still do so. There are others interested in radio and in amplifying equipment who also buy such equipment, but are nevertheless keenly interested in experimenting and in the results to be obtained from it, rather than being passive listeners.

There are many who like to make things for themselves and are able to save money by doing so. For them 'kits' are sold. In this chapter I shall tell you something about this aspect of radio and I am going to mention certain kits which I think might be of interest to you. I must make it clear that neither the Editor nor myself has any commercial interest in any of the products that I mention, other than the fact that we know them to be reliable. Some have been on the market and known to us for years. Others are household names and are well known. Some I have tried out for myself through the kindness of manufacturers who have made them available to me. If you are interested in any product I mention, the manufacturer's address is given in the Appendix, but I am sure a local dealer will help you to buy anything you require and maybe can even recommend something more suitable for your particular requirement than what I suggest.

In Chapter 2 the one-valve set described was for medium waves only, but the BBC are now transmitting three programmes on very high frequencies and using frequency

modulation. The advantage of these transmissions is, briefly, that interference is virtually eliminated, whether it be caused by local electrical equipment or by foreign stations, and that much better quality reception is obtainable because a greater range of frequencies can be transmitted, particularly in the higher-frequency range. On one programme, when a special concert is being broadcast, 'stereo' is adopted and those listeners whose sets have the requisite 'decoder' can receive in this manner.

If you are going to obtain high-fidelity equipment, it is essential that you use an FM feeder for the radio side, as the response obtainable is so much better.

Firstly, like television, it is transmitted on very high frequencies (VHF) and, while it has the advantage of the wide frequency range possible on that band, it suffers from the short distances which these waves are able to travel, and also from the unpleasant effects of reflection by such things as hills and gas-holders. Such items can also block the signal, so that it is possible to be in a 'shadow' where reception is often difficult.

If you like listening to foreign stations (and there are excellent programmes available from stations such as Hilversum, the American Forces Network and Radio Luxembourg) the ordinary amplitude-modulated (AM) receiver, operating on medium waves, is also necessary. Most portable transistor radio sets work on medium and long waves. Some designs incorporate both AM and FM, which is an added expense, naturally, and some TV receivers can be obtained with an FM channel added. So many receivers are supposed to work with an internal aerial, or a pull-out 'whip' aerial, but I find a correctly matched aerial makes all the difference to good reception. My home is in the outer North West London area and perhaps I am located a little too far away from the nearest FM transmitter to dispense with a proper aerial. You can obtain a BBC Engineering Information Department leaflet on the design of aerials for VHF. They are simple to make. Finally, from the home constructor's point of view, FM receivers need most careful adjustment and alignment for correct reception. This can only be carried out satisfactorily with expensive equipment, usually by the manufacturer.

This makes home construction of VHF FM receivers rather difficult because the alignment is so important for good results. Martin Electronics Ltd., however, overcome the problem by supplying factory-assembled modules which can be put together by the home constructor to build up a complete receiver or amplifier. I have built one of their designs and this gives VHF FM radio which feeds into a high-fidelity amplifier. The latter can also be used for record reproduction. A further addition of an amplifier allows for stereo record playing. The tuner and 'mono' amplifier as a kit cost about £30 (1972). I have fitted them into simple plywood cabinets which I have covered with Storey's 'Contact' vinyl covering in a simulated wood pattern.

I cannot recall any other FM tuner kits but there are many kits for hi-fi amplifiers and stereo amplifiers on the market and the prices are very reasonable. Lasky's Radio Ltd. will send their catalogue on request and this is full of ready-made and kit designs at varying prices. They supply the Sinclair Electronics 5-watt integrated monolithic amplifier and pre-amp. which gives 5 watts output for £2.50 (1972). Two for a stereo outfit cost less than £5.

Fig. 7 Mullard
Unilex Modules
and Control Unit

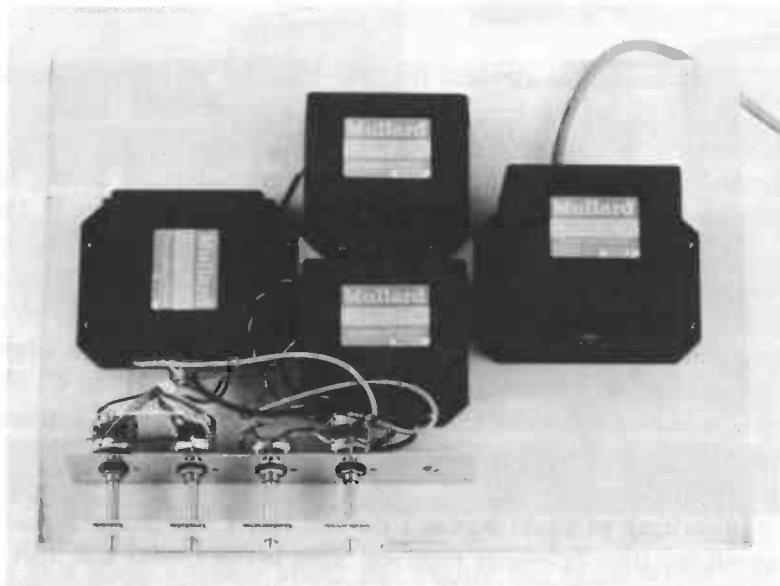

A new departure from Mullard Ltd. is illustrated in Fig. 7. This is 'Do-it-yourself stereo' using the modules shown in the photograph. Mullard publish a booklet at 25p which shows how to assemble the modules and how to make cabinets for them, and also how to construct cabinets to hold the record-playing deck and the loudspeakers. Several projects are shown for different ideas to suit your own individual taste. The complete outfit (shown in Fig. 8) costs about £60 (1972) but the heart of it, the Mullard modules, are only £13.50 (1972) with another £3 for the control unit. So as many readers will already have playing decks and loudspeakers this system could be installed quite cheaply. Lasky's Radio Ltd. supply the booklet and parts required.

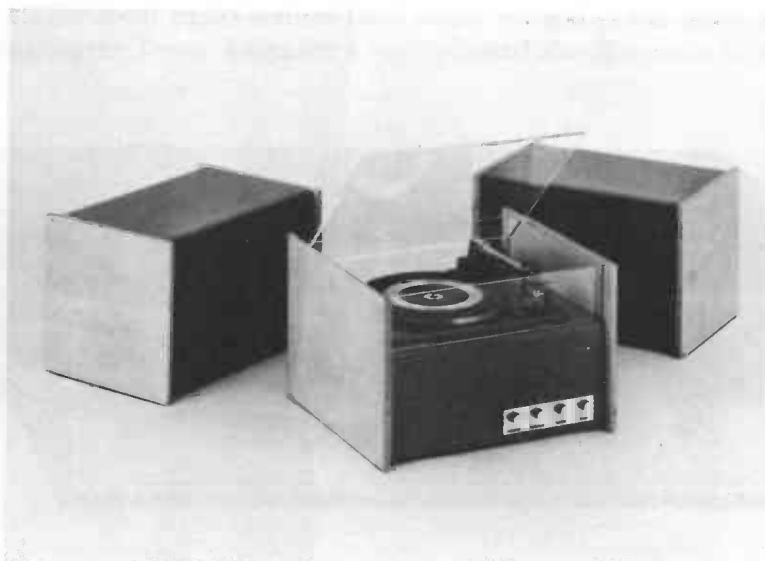

Fig. 8 Mullard Unilex
System complete
with Loudspeakers

Many electronic devices for the amateur and professional and, in particular, for educational establishments are available in the Heathkit designs available from Daystrom Ltd. These are supplied ready-made and in kit form for making up at home, the latter arrangement showing considerable saving in cost. A well illustrated comprehensive catalogue is available from the address in the Appendix.

One very popular aspect of electronics as a hobby is the reception of short waves and the next chapter deals with the construction of a special receiver for this purpose. It is a 'mains' receiver and will probably cost about £7 or so to build so that if you do not want something quite so expensive or if you are a beginner wanting something simpler I would recommend the kits supplied by H. A. C. Short-Wave Products who have a one-valve model at £3.30 (1972). Headphones and other accessories are available from them and so are additional components to increase the range and power of the receivers. Write for details to the address in the Appendix.

In writing of short waves I do not feel I can leave the subject without telling you about my own favourite receiver. This is the Codar CR 70A Communication receiver which costs £22.50 (1972) and is a valve receiver covering the range 560 kHz to 30 MHz in four switched ranges (see Fig. 9). It is an all-mains receiver with five valves but two of them are double valves so it is equivalent to a seven-valve set. All the usual communications receiver features, such as 'B.F.O.', are incorporated and it only needs a loudspeaker added to receive the world! Quite regularly I receive Sydney, Australia and listen to tomorrow's news at today's breakfast! Save up for one, for it's worth it.

Fig. 9 Codar CR 70A Communication Receiver

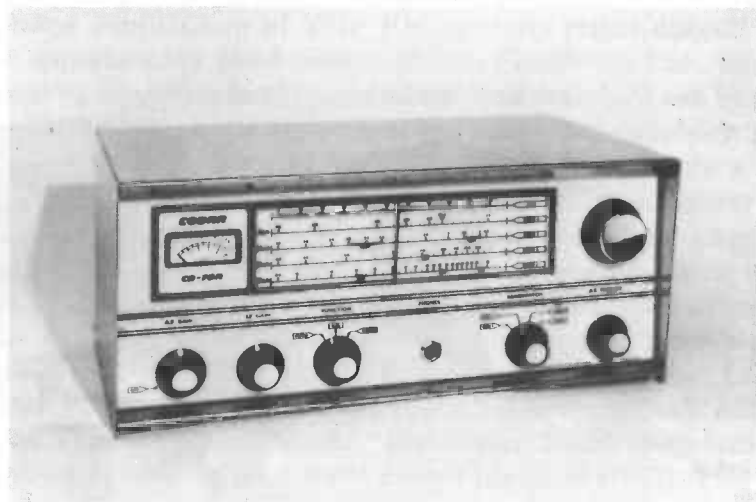
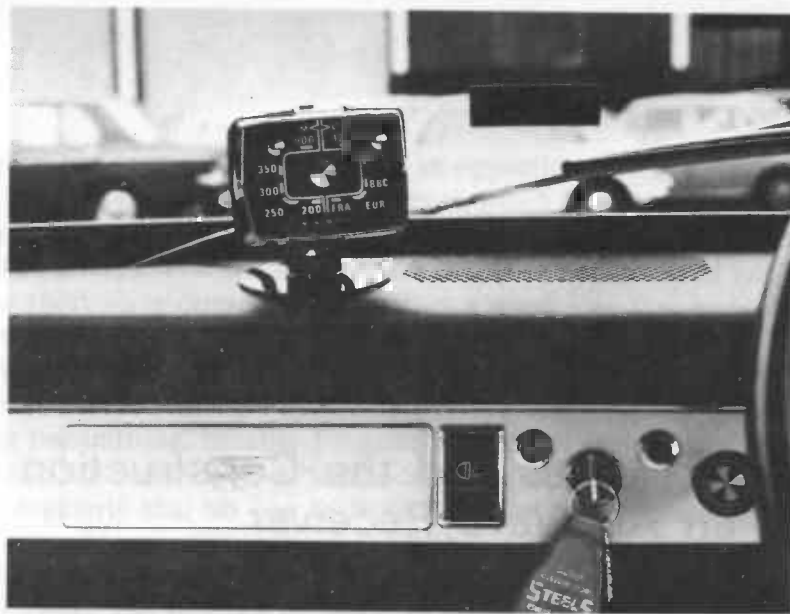

Fig. 10 The Courier Mini-mate Car Radio is no larger than two matchboxes!



In the first edition of this book I wrote about the Philips car radio which was a hybrid type employing both valves and a transistor. Today, however, Philips and other prominent manufacturers make car radios which are all transistor-operated for valves are no longer used. The 12 volts which a car battery gives are very suitable for transistor working and these sets give fine results. Some even incorporate a record-playing arrangement and stereo sound as well. One car radio which is marketed by the well-known car radio manufacturers World Radio Ltd., is the Courier Mini-mate, shown in Fig. 10. Not much larger than a couple of match boxes it is a fine example of modern transistor miniaturization and gives a powerful output on many stations, being extremely sensitive. Instructions are given on how to fit it yourself and, complete with loudspeaker in a black plastic case, I think it is good value at £17.50 (1972).

While on the subject of VHF radio, the photo shown in Fig. 11 is a receiver on which you can hear your local radio station (and many others) at the finest quality. This is the Armstrong Stereo Tuner Amplifier which we shall also discuss in Chapter 6.



Fig. 11 The Armstrong 526 AM-FM Stereo Tuner Amplifier

Chapter 4

Short Waves and the Construction of an All-Wave Receiver

This attractive All-Wave Set can receive, by means of plug-in coils, the complete band of stations from 10 metres to 2,000 metres. Thousands of stations are thus within your reach! Exceptional care is needed when working from the mains. Leads and flexes must be in good order and free from fraying; do try always to use an earth to chassis.

It is over forty years now since it was realized that short waves covered great distances more effectively than long ones did. The world is now covered with a network of broadcasts on the higher frequencies, that is to say from about 100 metres or 3,000 kilocycles down to, say, 1 metre, or up to the equivalent frequency of 300 megacycles. These latter frequencies, that is to say the very-high-frequency bands, are used for such transmissions as those of television, local stations working with frequency modulation, the police and fire services, taxicabs and other mobile telephone services and air-to-ground radio. All these are restricted to short-distance working, although from time to time reflections caused by atmospheric conditions can cause them to bounce quite long distances and, indeed, cause interference on bands where they are not intended to be.

In the present instance our interest lies between the limits of about 150 metres (2,000 kilocycles) and 10 metres (30 megacycles). In this considerable space lie many thousands of stations, pouring items of one kind and another into the ether in every language under the sun. There are the BBC's broadcasts to the Commonwealth for both entertainment and information; similar broadcasts from United States stations; news broadcasts from all over the world; propaganda of all kinds from religious and political stations, and counter-broadcasts to the latter, as well as many rather pleasing forms of propaganda put out by stations in countries which wish to advertise themselves for tourist or trade purposes. Then there are the amateurs who have a number of bands wherein they can call up one another and have what is termed 'a rag-chew' about this and that, chiefly relating to experiments carried out in the gear being used.

If you are interested in short waves, I have devoted a whole book, *Fun with Short*

Wave Radio, to the subject, but I am going to give you an opportunity to experiment with them by building the receiver described in this chapter, which I call an 'all-wave' set because it can receive, by means of plug-in coils, the complete band of stations from 10 metres up to 2,000 metres. You can thus receive the BBC medium- and long-wave stations as well as short-wave ones. It is sometimes a good idea first to build the set as a medium-wave set and then to acquire the other coils from time to time as you wish; they cost about 30p each (1972).

Before describing the receiver, however, I should like to say two things of importance. The first concerns transmitting, because I receive so many letters from young readers asking how to build a transmitter or a 'walkie-talkie' (which is partly a transmitter). I have to reply regularly that no one in Britain may operate a transmitter without a Postmaster-General's transmitting licence, which is only granted when the applicant satisfies the Post Office authorities that he has sufficient knowledge to pass an examination in radio theory and practice in regard to transmitting and reception, and can send and receive Morse code at 12 words per minute at least. A pass in the City and Guilds of London Institute radio examination is acceptable instead of the PMG examination, so you can see from this that the standard set is quite a high one. In fact, as I usually tell enquirers, if you have the necessary knowledge to pass the examination there is no need to write to ask me how to set up a transmitter—you will already know very well!

The second matter I wish to mention relates to using the electricity mains, as we all do for our radios now, although transistors have restored the use of batteries.

Electricity is so very useful, but if it is misused it can be a real danger. It gives no warning but strikes suddenly and, unfortunately, it is all too often fatal. Always bear in mind the need for care when working with the mains and remember it is usually the clever chap who thinks he knows all about it who comes to grief. Never take a chance—it really isn't worth it. Keep mains leads and flexes in good order and free from fraying; do try always to use an earth to chassis (except on receivers, such as TV, which have the chassis connected to mains).

Not only does this help to reduce hum, but it makes for safety if the chassis should become 'live'. Such earthing of the chassis only refers, of course, to AC mains receivers employing a double-wound transformer connection to the mains, such as I describe in all mains apparatus in this book. If you make a Universal or AC/DC design where one side of the mains goes to chassis, you must not make any direct connection between chassis and earth. I always tell readers to ensure that some kind of cabinet is provided for mains sets, as the danger of smaller brothers and sisters, and even domestic animals, prying into sets connected to the mains is too great to be ignored.

I do not like the idea, either, of connecting headphones to receivers which are mains-operated, as there can be great danger if the connecting is not done correctly and I will not risk subjecting my readers to such danger. In my experience, however, the receiver needs a lot of care to make it hum-free, otherwise the noise in the headphones is most uncomfortable, particularly, in a simple set with reaction, just at the point where the set is coming to the threshold of oscillation. The set described in this chapter is mains-operated and is the result of my observing for some time past that the need for such a design exists.

Fig. 12 gives the theoretical, or schematic, diagram of the receiver, from which you will see that it uses three valves, one of which is the rectifier for the AC mains. The set, therefore, qualifies as a two-valver but, due to the steep 'slope' of both the valves, is capable of a large output and is very sensitive. It has only one tuned circuit, which is ideal for short-wave work, but as selectivity on medium-wave bands could be poor in the event of too large an aerial being used, it is made to give good results, due to the sensitivity and the use of reaction, on quite a short aerial.

For short-wave work it is often preferable to use only a few feet of aerial and quite a lot of experiment can be made with the aerial. As mentioned earlier in the chapter, an earth is desirable, but it may be found to make little difference to the results on the shorter wavelengths. I have not shown them in the diagrams, but it is sometimes an improvement to connect a 0.1 mfd. paper capacitor (500- or 1,000-volt working) between each connection of the mains winding of the transformer and earth. In my sets such capacitors by-pass all kinds of noises and hum from the mains to earth.

The coil is plugged into an Octal valveholder and the pin numbers shown on the schematic relate to the numbers on such a valveholder when viewed from below as, in fact, is shown in detail in the wiring diagram which appears in Fig. 13. This is the underside of the chassis which is of metal and of a standard size. It will need to have holes cut in appropriate places for the coil and the valveholders and the drop-through mains transformer. Small holes will also be required around the coilholder for wire to pass through to the capacitors above, as well as clearance holes for the sockets on the A/E and speaker socket strips at the rear.

At the side (or rear, if you wish) a hole is needed to allow the mains flex to pass through. It is desirable, where a metal chassis is used, to fit this hole with a grommet to avoid chafing the flex on the sharp metal edge. A topside view of the chassis is given in Fig. 14 and no doubt the shop where you purchase it would cut out the holes for you. You could also make up your own chassis from wood, hardboard and foil, as described in *Fun with Short Wave Radio*. The panel is a piece of hardboard 8 inches long, to match the chassis, and 7 or 8 inches high. It simply carries the two tuning capacitors and, as the set is to be used on short waves, the main tuning capacitor will require a good slow-motion drive. These are not cheap, but make a lot of difference to the ease of handling of the set.

If you have an enterprising dealer in your district, it is frequently possible to obtain an ex-Service-type drive at a reasonable price. The main tuning capacitor is of 300 pF capacity ($\cdot 0003 \mu\text{F}$) and the other one is the reaction capacitor, capacity 100 pF ($\cdot 0001 \mu\text{F}$). It is possible to make tuning easier by adding 'bandsread' tuning and how this is done is shown in dotted lines on the schematic diagram. It simply means adding a very small tuning capacitor in parallel with the main one. This means that the fixed vanes of the additional capacitor are connected to the fixed vanes of the main one and likewise to the moving vanes.

You should find room on your panel to add the small additional capacitor, it is only 15 pF in size, and short wires must be connected between it and the 300 pF main capacitor. You can try using the small tuning capacitor without any slow-motion

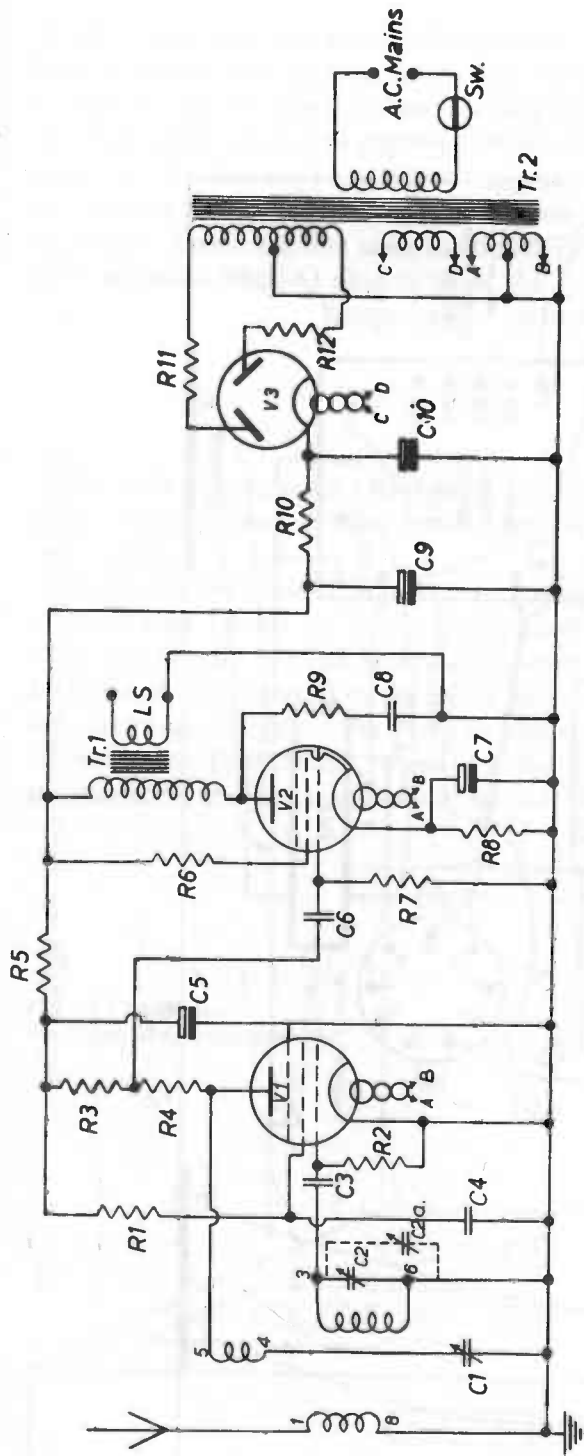

Fig. 12 Mains-operated All-wave Receiver: Schematic Diagram

Components required:

- Coils: Denco Maxi-Q 'Green' ranges as required (see text)
 Valves: EF 91, EL 84, EZ 80 (Mullard)
 Transformers:
 Tr. 1, Output, to match EL 84 to loudspeaker
 Tr. 2, Mains, 0/250 v. input, 250-0-250 v. 60 mA, 6.3 v. 1A, 6.3 v. 2A
 Mains on-off switch
 Slow-motion dial(s), knobs
 Valveholders: one B7G, two B9G, one Octal (for coil), all nylon or ceramic
 Flex, wire, solder, chassis etc.

RESISTORS: (values in ohms)

- R.1. 100 K
 R.2. 2 M
 R.3. 100 K
 R.4. 10 K
 R.5. 47 K
 R.6. 1 K
 R.7. 500 K
 R.8. 270
 R.9. 22 K
 R.10. 270
 R.11. 125
 R.12. 125

CAPACITORS:

- C.1. 300 pF solid dielectric reaction type
 C.2. 300 pF air-spaced ceramic short-wave type
 C.2a. 15 pF air-spaced ceramic short-wave type
 C.3. 100 pF mica fixed
 C.4. .01 μ F paper 350 v. wkg.
 C.5. 16 μ F electrolytic 350 v. wkg.
 C.6. as C.4
 C.7. 50 μ F electrolytic 25 v. wkg.
 C.8. as C.4
 C.9. 50 μ F electrolytic 350 v. wkg.
 C.10. as C.9

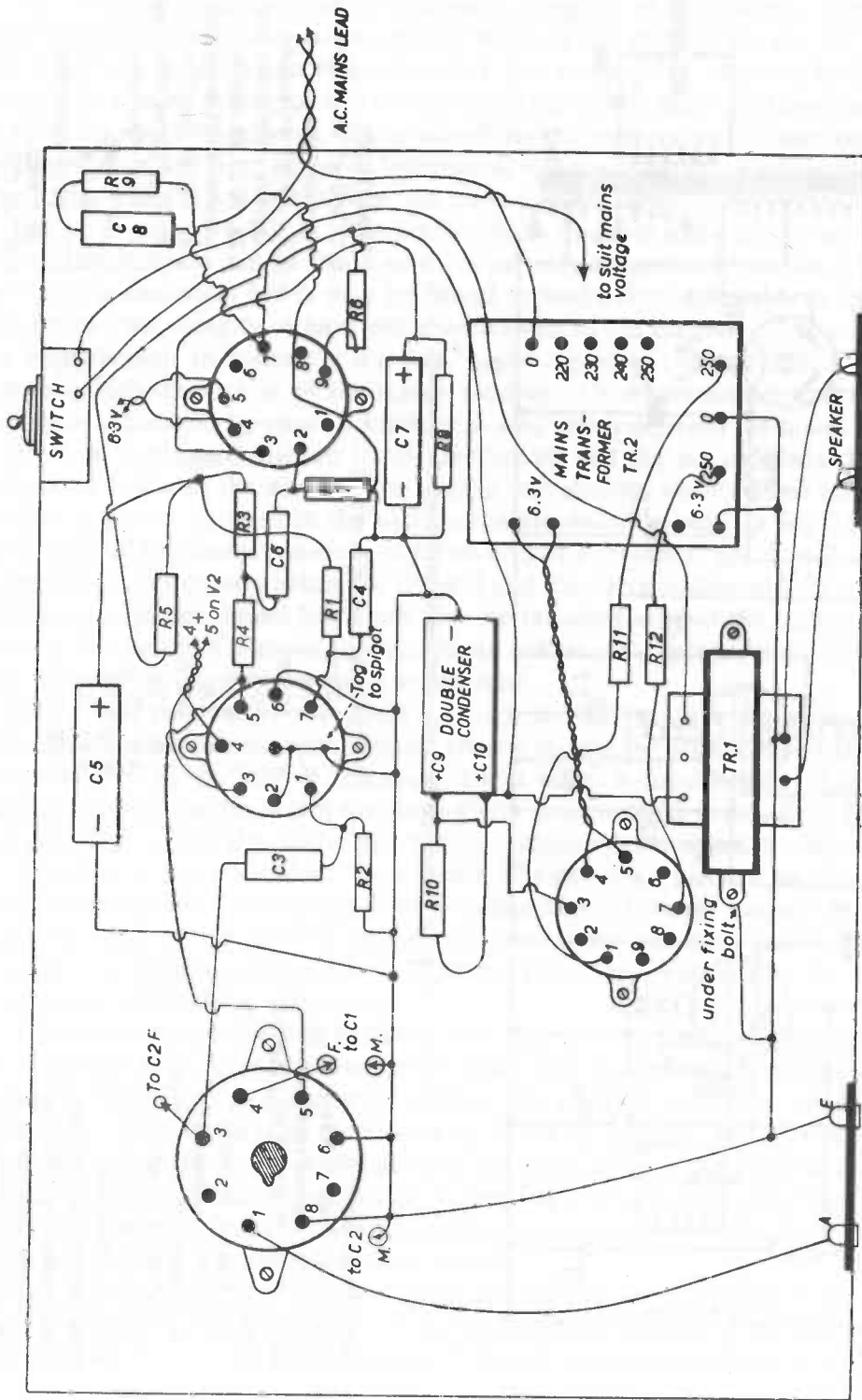

Fig. 13 Mains-operated All-wave Receiver: Wiring Diagram

drive, if you have not already bought this, but even the small tuner will be easier to handle with a slow-motion drive. The method of tuning is to move the large tuning capacitor, say 10 degrees, then, leaving it there, to explore with the small tuner (to the full extent of its 180 degrees). Move the larger capacitor (now called the 'band-spreader', by the way) another 10 degrees and explore again—and so on. If you do not intend to use the short waves, this bandspreading arrangement will not be necessary. There are five coils in the range used, and these are made by Denco Ltd. and are called Maxi-Q plug-in coils, the type description being 'Green'.

Range-band 1 covers 750—2,000 metres

„	2	„	194—	580	„
„	3	„	57—	180	„
„	4	„	20—	60	„
„	5	„	10—	28	„

The coils plug into the Octal holder as required. There is a white spot on the green body of the coil and this is a marker spot which should coincide with the 'pip' on the valveholder.

There may be some difficulty in obtaining the Octal-based coils; as we go to press we hear that Denco no longer make them (1972). If your supplier cannot provide them you should use the Denco miniature dual-purpose coils, plugging them into a B9A valveholder instead of the Octal valveholder. The 'Green' series is the one to use and the range-bands are the same as above; there are 5 coils covering the wavebands as indicated. Incidentally, these are the same coils used for the H.A.C. receiver mentioned in the previous chapter so that if you do have difficulty in obtaining them

Fig. 14 Chassis for All-wave Mains Receiver

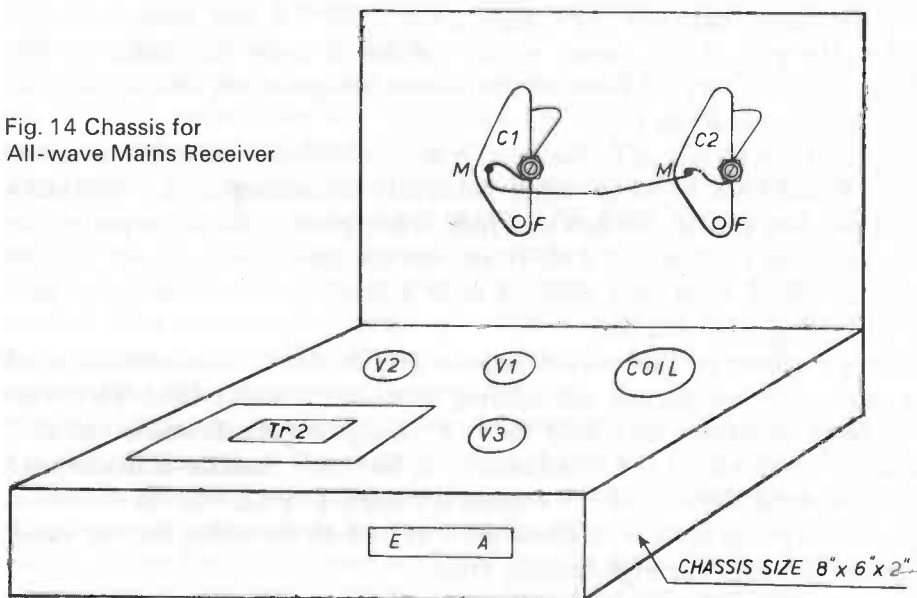

you ought to be able to get them from H.A.C. At the time of writing, however, Home Radio (Components) Ltd. tell us that they have these coils in stock. Connections to them are made in accordance with the instructions given with each coil.

Tuning is similar to the method described in Chapter 2 and it is best not to allow the set to oscillate even on the short-wave band, although there are many enthusiasts who advocate tuning on that band by allowing the set to oscillate gently, when each station which comes into tune will cause a 'chirp' in the loudspeaker. For the reception of CW (i.e. Morse) it is essential to have the receiver oscillating gently in order to be able to read it, but remember that a simple receiver of this type when oscillating can cause interference in other people's receivers (and TV sets). So if you do allow your set to oscillate, do not be surprised if the GPO interference-detector van turns up at your home one day!

A pentode valve, such as the EL 84 used in this receiver, tends to over-accentuate the top notes and a correcting device, consisting of a capacitor in series with a resistance, is placed between the anode of the valve and earth to by-pass the excessive 'top'. With fixed components, as shown, there is no possible variation to give either more or less bass or top. In Fig. 15 I show how it is possible to make R9 variable which, in conjunction with C8, will allow a suitable alteration in tone right down to deep 'mellow'. This is very useful on the short waves, where there is a good deal of interference in the form of whistles and 'bangs' and various atmospheric noises.

As most of these are high-pitched in character, they can often be controlled by cutting the top slightly and this is where the variable device is useful. Sometimes, also, a loud atmospheric crash intrudes just as one is on the point of tuning in an elusive station, and it is useful to have another means besides the reaction control for reducing the volume. Fig. 15 also shows R7 made variable for this purpose. A 1-megohm potentiometer is connected between the coupling capacitor C6 and earth, with the slider connected to the grid of the output valve. Volume is easily adjustable by this means. There is ample room on the front of the chassis alongside the switch for both these potentiometer controls to be fitted.

Smoothing is carried out by means of the resistor R10 in conjunction with two rather large capacitors, C9 and C10, of 50 μF each. Adequate smoothing is very necessary with a short-wave receiver and, if you feel that hum is too great, it might be preferable to use a smoothing choke in place of R10. If you do use this the capacitors may be dropped in value to 16 μF each, but there is little difference in cost, and I should prefer that the 50 μF types be retained.

Good results in a receiver of this nature depend greatly on a smooth build-up of reaction, going gently into oscillation, not spilling over into it with a loud 'plop'. To achieve this it may be necessary to adjust the HT voltage on the detector valve; if reaction is too fierce, reduction of HT is necessary. If, however, reaction is inadequate a higher voltage is required. Control of HT voltage is achieved by altering the resistance of R5, and it should be made smaller to allow more HT on to the valve, but increased in size if it is desired to lower the high-tension volts.

If you have one or two resistors on hand you could try different values for R5.

Fig. 15 Volume and Tone Controls
for Mains All-wave Receiver

Components required:

- R.7.1 megohm potentiometer (preferably log. law);
- R.9. 50 K Ω variable resistor (or potentiometer)
- Other items as Fig. 12

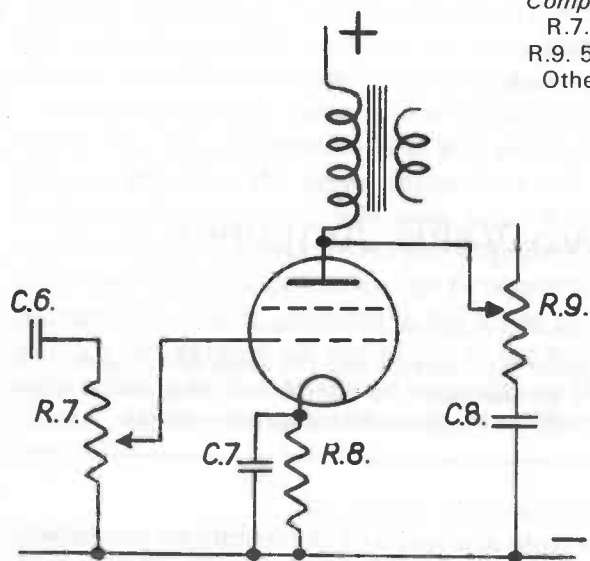

The output resistance into which your loudspeaker must match is 5,000 ohms and so, if your speaker has the usual impedance of 3 ohms, the output transformer ratio will be 40:1. One final word on the wiring diagram relates to the mains transformer, where you will see that the 6.3-volt winding for the receiving valves is only shown as connected to earth on one side. I have shown it thus to avoid confusing matters by drawing the heater connections all over the diagram.

The heater wiring is carried out in twisted twin flex and you will note that 3 and 4 on the B7G valveholder are connected to 4 and 5 on the B9A valveholder which then has a piece of the flex running over to the 6.3-volt terminals on the transformer. The rectifier has its own separate 6.3-volt winding, but should your transformer have only one such winding it does not matter. All three valves may use one winding, but two are better. Again the schematic diagram shows the centre tap of the AB 6.3-volt winding as being connected to earth, whereas the wiring diagram shows one side as earthed. This is just to indicate to you that it does not matter if your transformer has no centre tap on the 6.3-volt winding, for you simply earth one side of it. Do not earth both: one side only *or* the centre-tap.

If there is a separate winding for the rectifier that is not earthed, the rectifier will have to participate in the earth winding if there is only one 6.3-volt output. I hope all this is clear to you. In the next chapter we leave receivers and turn to amplifiers. These can be used to form part of a radio receiver by the addition of a tuner, such as was mentioned earlier in relation to FM, but we mainly relate them to the reproduction of gramophone records in the course of the next few chapters.

Chapter 5

Amplifiers: a Simple Two-Valve Amplifier

This amplifier will enable you to play your favourite 'pop' records and LPs easily and cheaply. You must ensure that the chassis is deep enough to accommodate the components when standing flat on a table or bench. Later on this useful amplifier forms the basis of a stereophonic design.

Originally records were 10-inch discs revolving at a speed of 78 revolutions per minute, but they were rapidly superseded by the 45-r.p.m.-speed discs of 7-inch diameter and the larger records of 12-inch size known as LPs (long-players) which revolve at $33\frac{1}{3}$ r.p.m. All LPs are now in 'stereo' and while they can be played 'mono' a specially 'compatible' cartridge is required in the pick-up.

My next constructional item should be popular for it is a two-valve amplifier for the amplification of gramophone records; the pick-up used is one of the high-output crystal variety. Such pick-ups are normally supplied with the simple type of record-player which one can buy quite cheaply at most reputable radio stores; and the combination of the two, plus a small loudspeaker, will make a most useful record-playing arrangement. A crystal set may be used as a radio feeder to make a complete installation for radio and gramophone. I would emphasize that this is quite a simple arrangement which does not qualify for the label 'high fidelity' but which gives most satisfying results for quite a small outlay. It is made possible by use of the Mullard ECL 82 valve which combines, in one envelope, a triode valve and an output pentode.

The triode valve is fed with the minute impulses created by the gramophone pick-up as it moves in the grooves of the record, and amplifies them before passing them into the pentode section of the valve. This amplifies the signals yet again, and passes them into the loudspeaker by way of the output transformer. The bulkiest part of the outfit is the mains transformer which is required for providing the heater voltages and high tension. The latter is rectified by the second valve of the amplifier, the Mullard EZ 80, which has a 6.3-volt heater exactly the same as the ECL 82 has.

I have given you the complete schematic diagram in Fig. 16 and the mains transformer envisaged there is a full-sized component giving 250-0-250 volts at 60 milliamps, plus two 6.3-volt windings. Even with this size of transformer the whole

amplifier can be built on a chassis which is only 6 inches by 4 inches. It is possible to obtain a yet smaller transformer, which gives the same high-tension output but has only one 6.3-volt winding. This can be used, and both valves run from the one heater winding. It should be earthed as in the AB winding in the diagram. Such a transformer will make it possible to build an even smaller amplifier which, with an elliptical speaker, could be built into a record-player or other small cabinet in a confined space.

In this connection there is one factor to watch, however, which is that both the valves give off considerable heat and some means must be provided to allow this to escape. Otherwise the valves themselves will overheat, the adjacent components will be damaged and trouble will soon arise. Remember that heat rises, and so it is best to allow for an opening above the amplifier. A covering of a piece of expanded metal is the best means of protecting the equipment while still allowing the heat to get away. If some holes can be provided in the lower part of the cabinet, cooler air can be drawn in when the warmed air passes out at the top.

Smoothing in this amplifier is similar to that in the two-valve receiver of the last chapter, namely, using a resistor and two 50 μ F capacitors. The latter can be obtained

Fig. 16 Two-valve Mains Amplifier: Schematic Diagram

Components required:

Valves: one ECL 82 and one EZ 80 (Mullard)

Valveholders: two B9A

Transformers:

Output: to match ECL 82 to speaker

Mains: same as for Fig. 12

Terminal blocks: Input and LS

Chassis, wire, flex, mains on-off switch

RESISTORS: (values in ohms)

R.1. 250 K variable

R.2. 220 K

R.3. 4.7 K

R.4. 390

R.5. 15 K

R.6. 220 K

R.7. 1 K

R.8. 470

R.9. 125

R.10. 125

CAPACITORS: (values in microfarads)

C.1. 16-350 v. wkg.

C.2. 25-25 v. wkg.

C.3. as C.2

C.4. 0.1-350 v. wkg.

C.5. 50-350 v. wkg.

C.6. as C.5

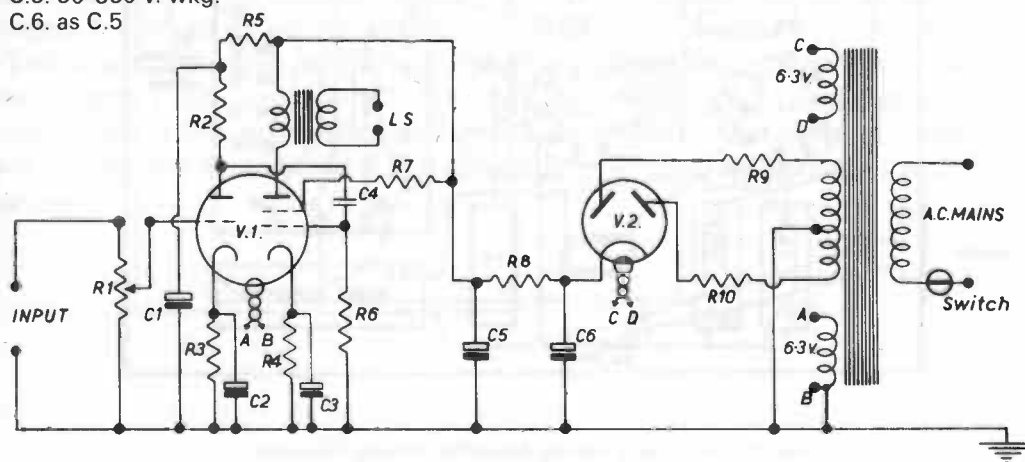

as a double capacitor where both are built into one case with a common negative connection. Such a capacitor saves a good deal of space and, in fact, the resistor method of smoothing requires less room than a bulky choke. The wiring diagram does not show the connections with the 6.3-volt heater winding on the transformer, as it would involve too much confused cross-wiring, but these are carried out with twisted flex. PVC-covered flex does very well but should be twisted a little more tightly than it normally is when one buys it, and this runs between the 6.3 output points and pins 4 and 5 on the ECL 82 valveholder.

It may be that the transformer you obtain will have wires providing the output leads and, in this event, those from the 6.3 winding should be twisted together like flex before being connected to the valveholder. If they are not long enough, you will

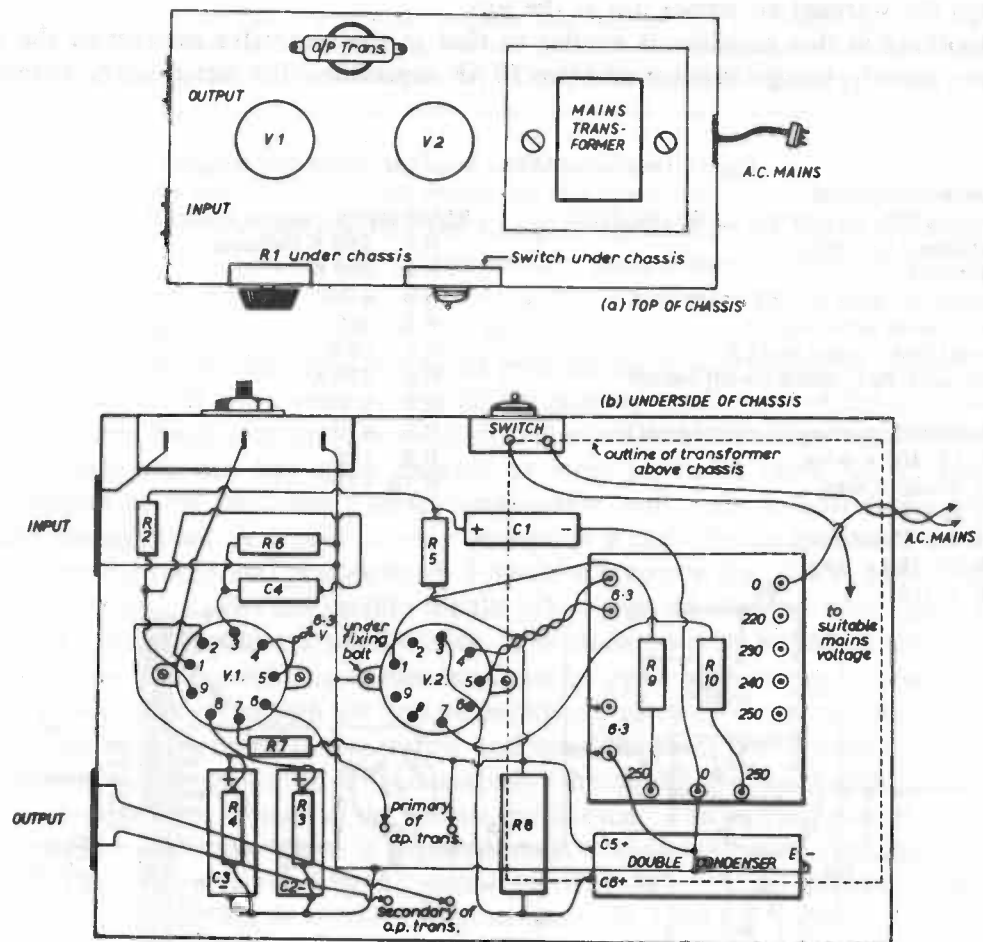

Fig. 17 Two-valve Mains Amplifier: Wiring Diagram

need to connect a short piece of flex to lengthen them and must then tape the joint carefully with black insulating tape to avoid short circuits. You must be sure that the chassis is deep enough to accommodate the components when it is standing flat on a table or bench. It often happens that you wire up such an amplifier when it is upside-down, and then, when all appears finished, turn it the right way up for testing. Unfortunately the components are badly placed, with the result that, when they are on the bench, they are pushed up into the amplifier and cause short circuits, and often damage, as a consequence. So, when wiring the underside of a piece of equipment, it is a good idea to run a straight edge, such as a ruler, across the bottom of the chassis from time to time to ensure that all components are tucked well inside.

You will see that the input from the gramophone pick-up is fed into the amplifier across the volume-control potentiometer, the slider of which is connected to the grid of the triode portion of the valve for volume adjustment. You will also note that one side of this volume control is led to earth and the other, if the slider is placed at that end, goes direct to the grid. It is a good idea to mark with a pencil on the metal chassis which socket of the input strip goes to G (for grid) and which to E (for earth). The reason why this is important is that the leads from the pick-up on many record-players consist of one main wire and a metal mesh surrounding it which acts as the other connection but which also, when earthed, shields the inner lead and prevents instability, hum and so on. You will thus already see that the central wire must go to the G input point whereas the other, the screening covering, must go to the E side.

It has not been possible to include either tone control or negative feed-back in this amplifier, as both of these reduce the available volume considerably, and it is desirable to have all the amplification which it will give. Tone control would entail the provision of a pre-amplifier and in a simple design such as this the cost involved would be disproportionate. It would be preferable to spend more on a larger and more comprehensive outfit.

With regard to negative feed-back, and the favourable improvement which it can make in an amplifier, the reduction in volume is not too great where a sensitive pick-up is in use. This amplifier forms the basis of the stereophonic design shown in Chapter 7; you can try out the addition of NFB as indicated in that design if you wish.

This chapter has been an introduction to amplifiers on a simple scale, and in the next chapter I am going to tell you something about high-fidelity amplifiers and loudspeakers which are available as ready-made units. Also there are one or two books which you should read if you are going to develop an interest in sound reproduction.

Chapter 6

Amplifiers and Loudspeakers: High-Fidelity and Commercial Designs

Each person may hear differently, and what is 'first-class' to one ear may not be so to another. If you are purchasing Hi-Fi gear it is important to hear it in use first, in the room in which it will be used. Do not over-stress this business of fidelity because the main purpose of listening to music is to enjoy it, surely.

'Beauty,' it is said, 'is in the eye of the beholder.' I think we should add, 'Fidelity is in the ear of the listener.' Having experimented for many years with high-quality sound reproduction, I have been astonished at the different sounds one hears reproduced through loudspeakers, all of which the owners or advertisers have described as giving 'top-quality sound reproduction'. I have always taken the view that if one listens to an orchestra playing, and then listens to a reproduction of the same orchestra playing the same piece, the latter should sound *exactly* the same as the original. But it is not so.

Take the one amplifier and then reproduce the music through it *four* times using a different speaker each time, and you get *four* different versions. Use a different amplifier each time, and you get still more versions! Where does the listener who is going to spend a lot of money on Hi-Fi equipment go from here? It is only recently that I have read a medical suggestion that each person hears differently, and that what sounds first-class to you has, in fact, a quite different sound to your brother!

Again, if you are going to purchase Hi-Fi gear for use at home or, indeed, anywhere else for that matter, it is vital to hear it in the place where it is going to be used. The acoustics of individual rooms vary so much that very different effects will be noticed in listening to the same reproducers in different rooms. The room in which I write is quite small and once had linoleum on the floor; there was always a severe echo. This meant that certain notes from the Hi-Fi equipment were accentuated where they resonated with the room acoustics. But then I covered the floor with carpet and the echo disappeared! The tone of the reproduction altered considerably. If I take all the equipment downstairs into a much larger room fitted with carpets, curtains, upholstery and so on, the higher frequencies are absorbed more and the equipment sounds different again.

Equipment for high-quality sound reproduction costs a good deal and one can spend a lifetime buying this and that, altering here and there.

Eventually one is listening to the imperfections in the equipment, wondering whether there was a slight distortion on a certain note and forgetting entirely the fact that *the purpose of the equipment is to listen to music in order to enjoy it*. I have decided that the real answer is to make up one's mind what it is possible to afford to buy, or build, then to obtain it, and from then on to enjoy listening to it. Naturally, improvements come along with the passage of time, and one alters equipment to keep up with progress.

Today it is difficult to predict any great alteration in the immediate future because our equipment has become so good in quality. I do not think anyone would disagree with me when I say that British sound-reproduction equipment is the finest in the world. Certainly our amplifiers and loudspeakers are in the forefront, though the Swiss, with their expert mechanical knowledge, may have progressed just a little more than we have in the sphere of record-playing equipment. There is no doubt that British loudspeakers and amplifiers have had a phenomenal success in the United States and have been acclaimed all over the world. In fact, equipment which you can buy for use in your home is also installed by the BBC and many other broadcasting authorities throughout the world for use in their studios and control rooms.

The best idea I can suggest, if you wish to take an intelligent interest in Hi-Fi sound, is that you read some books on the subject. The ones I like best, because they are full of common sense, and yet are highly instructional and still entertaining to read, are those by Mr G. A. Briggs, a director of Rank Wharfedale Ltd, who make the Rank Wharfedale range of loudspeakers. Mr Briggs has given demonstrations of high-fidelity reproduction in Britain and the United States. In London his demonstrations packed even the Royal Festival Hall. His books are published by Rank Wharfedale.

Mr Briggs is mentioned as an authority in another book well worth reading; this is *High Fidelity*, written by Charles Fowler and published by McGraw-Hill. The author is the publisher of an American magazine of the same name. This book covers in a most practical and sensible manner all aspects of sound reproduction, but it must be borne in mind that it relates to practice in the United States, which is somewhat different from ours. For instance, we do not have half a dozen FM channels with another six TV channels, nor do we have to cope with difficulties caused by tropical electric storms. The theory is of high standard, however, and simple to understand.

The loudspeaker is still the weakest link in the high-fidelity chain and you cannot buy a suitable speaker for Hi-Fi use for under £5 (1972). There is no doubt that a good speaker will effect wonders in improving reproduction of even a cheap amplifier, and with the loudspeaker is associated the cabinet. Reams have been written about the design of loudspeakers and arguments often last for hours! Some experts like a horn design, others a reflex cabinet, but in Britain I think the reflex design is most popular.

Fig. 18 shows the Rank Wharfedale three-speaker system with a 12-inch speaker for bass, a 5-inch for middle, and a 1-inch 'tweeter' for top. It costs £42.50 (1972) and gives superb results. The next figure (19) shows the Rank Wharfedale Super 8/RS/DD chassis which you can purchase for £7.60 (1972). Make your own cabinet and you have a Hi-Fi speaker for under £10.

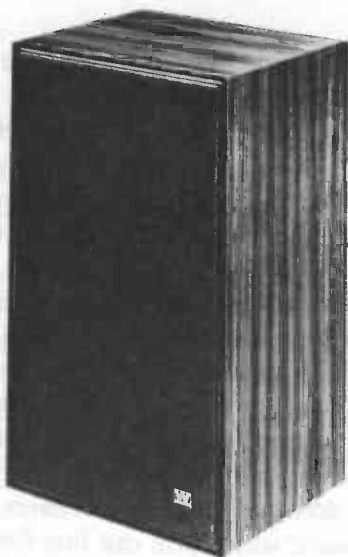

Fig. 18 Rank Wharfedale Three Speaker System: the Dovedale III



Fig. 19 The Rank Wharfedale Super 8 RS/DD Speaker Chassis

Rank Wharfedale publish a cabinet-construction sheet Issue 12A which is freely available if you forward a foolscap stamped and addressed envelope to the address given in the Appendix. With the improved magnets now being manufactured, very successful high-fidelity 8-inch speakers are made by most manufacturers, and there are several in the Rank Wharfedale range. The leaflet mentioned gives details of suitable cabinets which can be made for them and which are fairly small in size. No doubt this has much to do with their present-day popularity, as they do not take up so much room in modern small houses.

I have used an earlier Rank Wharfedale design for the cabinet; it was easy to construct because my timber supplier cut the wood to size. I give details in Fig. 20. I have two of these; in one I used the Super 8/RS/DD (as shown in the figure) and in the other an 8-inch Bronze RS/DD (£4.40, 1972). Both give excellent results.

For absolute fidelity, however, it is impossible to avoid the need for size, whether of the speaker cone or of the speaker cabinet. Fidelity is impossible in an assembly where the speaker is in the same cabinet as the rest of the equipment, so the latter will need a fairly comprehensive cabinet of its own. High fidelity can involve a large assortment of cabinets, with possibly a third one being added for holding records, and for stereo (about which I shall say more later) yet another loudspeaker cabinet.

Cabinets can be purchased to Hi-Fi requirements ready-made by the Rank Wharfedale company and specialist cabinet makers such as Lockwood of Harrow who specialize in speaker cabinets, many of which are used by radio and TV authorities and recording studios, as do Record Housing.

Ready-finished cabinets which are packed flat and require only to be assembled with the aid of a screwdriver are sold by Whiteley Electrical Radio Company Ltd for their Stentorian range of speakers. I use one of these speakers in a reflex cabinet and

Fig. 20 Totally Enclosed Cabinet for 8" Unit

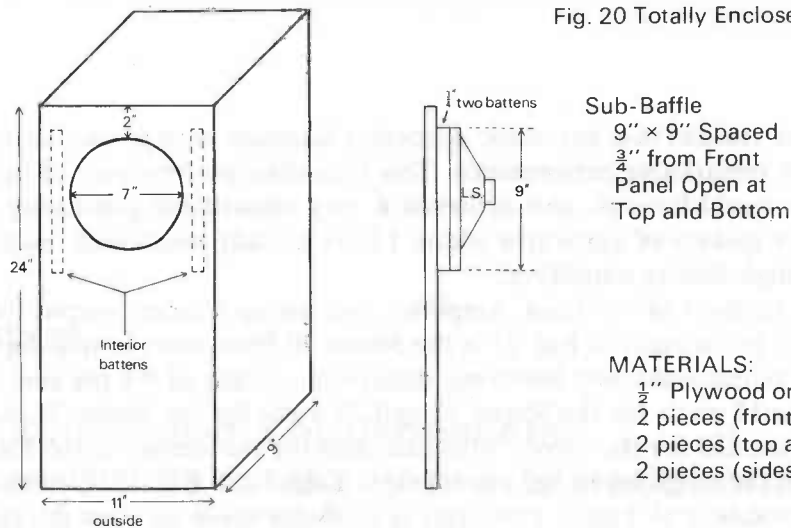

Sub-Baffle
 9" x 9" Spaced
 $\frac{3}{4}$ " from Front
 Panel Open at
 Top and Bottom

- MATERIALS:
- $\frac{1}{2}$ " Plywood or Chipboard
 - 2 pieces (front and back) 24" x 11"
 - 2 pieces (top and bottom) 11" x 8"
 - 2 pieces (sides) 23" x 8"

This cabinet has a volume of 1 cu. ft. and gives optimum results with the Rank Wharfedale Super 8 RS/DD or the 8" Bronze RS/DD. The sub-baffle is spaced $\frac{3}{4}$ " away from the front panel and the rest of the cabinet is totally enclosed. This spacing replaces a turned vent. Line the cabinet with 1" absorbent material such as carpet felt, cellulose wadding, cotton wool or bonded acetate fibre on two sides top and back.

get first-class results. There are a number of models in the Stentorian range. Domestic applications are not the only uses made of high-fidelity equipment—it is also used in cinemas, theatres and dance-halls.

You are no doubt familiar with the large bass speakers used by 'pop-groups' and speakers are also used in the modern electronic organ (see Fig. 30).

Loudspeakers must be driven by some means and for high-fidelity work it was usual to employ a valve audio amplifier. But today transistors can provide high power and high fidelity and are used in the designs we feature here.

I invite you to look at Fig. 21 which depicts on the right the famous Leak amplifier. This is a stereo 'solid state' design which follows the former valve amplifier, the TL/12 Plus, which succeeded the world-renowned TL/12 'Point One' amplifier. The latter name is of interest and is explained in this way. There are two main sources of distortion which trouble us in sound reproduction, called 'inter-modulation' and 'harmonic', and how and what they are you must study closely in your radio handbook. Suffice it to say that 'harmonic' is the most objectionable kind of distortion and, for the ordinary type of commercial radio set with pentode output of, say, $4\frac{1}{2}$ watts, the harmonic-distortion content will be around 8 per cent.

In 1945 Mr H. J. Leak astounded all fidelity enthusiasts by producing an amplifier which at 12 watts output had a total harmonic-distortion content of *point one* per cent

Fig. 21 Leak Stereofetic FM Tuner and Stereo 30 Plus Amplifier



(0.1%)! When one realizes that harmonic distortion increases with power output, one can see this was a remarkable performance. This high-class performance of the Leak amplifier became world-famous, and achieved a very remarkable popularity in the USA. Most of the makers of apparatus whom I have already mentioned, make their own versions of high-fidelity amplifiers.

There are two versions of the Leak Amplifier, one giving a larger output than the other. That shown to the right of Fig. 21 is the Stereo 30 Plus; there is also the Stereo 70. Each has the fantastically low harmonic distortion content of 0.1 per cent for all power levels up to 12 watts for the Stereo 30 and 25 watts for the Stereo 70. And the cost? In 1972 it was £69 for the Stereo 70 chassis and for the chassis of the Stereo 30 £56.50. Alongside the amplifier in the photograph is the Leak FM VHF tuner which they call the Stereofetic FM Tuner. The name is probably made up from the fact that it provides a stereo output and uses 'F.E.T.s'. These are 'field effect transistors' which make the circuit somewhat unconventional, but being a Leak design there is no doubt that it is first-class. (However, it is expensive—the 1972 price was £66.50 for the chassis.) Add the Leak 'Sandwich' loudspeaker and you have the finest equipment you could desire.

Forty years ago Armstrong Wireless and TV Co. Ltd were building a radio chassis which could be purchased at a very reasonable price and incorporated in one's own cabinet to make up a radio set or radiogram.

In the first edition of *Fun with Electronics* we published a photo of one of their sturdy radio chassis which cost some £22 in 1962. Today the company is known as Armstrong Audio Ltd at the same address. Armstrong produce amplifiers for high-fidelity sound. In this edition we illustrate in Fig. 11 the Armstrong 526 AM-FM Stereo Tuner Amplifier. This is a perfect example of the compactness possible with solid state circuitry, 17 inches by 10 $\frac{3}{4}$ inches by 4 $\frac{5}{8}$ inches high covering Medium Long and VHF bands plus two amplifiers for stereo. The price is a long way from that chassis of 1962, but good Hi-Fi cannot be cheap: it was £104.71 in 1972.

Most amplifiers have a pre-amplifier interposed between them and the input, whether radio or records. Those I have been describing have the pre-amp already built in. As you probably know, different makes and types of records have differing frequency characteristics due to technical variations in their cutting and manufacture. One day we shall, no doubt, have all discs recorded to a common standard of frequency 'cut' or 'boost' but, until then, means have to be available in the reproduction to compensate for the fact that the frequency output is not a level one. Apart from the record, the pick-up has its own particular characteristics which must be taken into account. The pre-amplifier accordingly has controls for boosting or cutting bass or top.

Volume control is effected in the pre-amplifier, and often a switch control allows a selection to be made of the proper fixed compensation to balance the record being used. Switch points also provide for the correct type of input to compensate for tape recorders, microphone or radio. A high-fidelity pre-amplifier unit will often cost almost as much as the amplifier itself. However, excellent results can be achieved by building one's own equipment and I tell you more about this in the next chapter.

Chapter 7

Amplifiers and Loudspeakers: Home Construction and a Stereophonic Design

Now we are in one of the most fascinating parts of the world of electronics. There is no compromise about stereophonic sound; you either love it or detest it! The amplifier we recommend has a moderately good quality performance giving, with the stereo effect, a very satisfactory result. It presents few difficulties and will give you lots of fun.

If you have studied the question of high-fidelity reproduction closely in the books recommended earlier, you will by now have acquired a fair knowledge of the subject and, I hope, a keen interest in it. There is another book which will provide a tremendous fund of information on the subject, as well as several designs which you can still make for yourself. This is entitled *Circuits for Audio Amplifiers*, published by Mullard. It is now out of print since it has all-valve designs, but your library may have a copy or be able to get it for you.

There is a 3-watt amplifier in this book which uses three valves and is relatively cheap to construct, and gives what the book describes as 'reasonably high quality'. Comparing its output with that from a cheap design, I know from experience that it gives superb reproduction, although the technical specification is not as good as that of the renowned 10-watt amplifier (also known as the 510 amplifier) which is of Hi-Fi design and as good as most commercial equipment available. If you are interested in good reproduction and want to learn more, do your utmost to obtain this book. In it you will find designs for stereophonic amplifiers as well as for monaural listening.

All the amplifiers so far discussed have been 'monaural' types, although I feel that the word complementary to stereophonic should be 'monophonic'. Mullard suggest this latter and it may, in fact, soon become the accepted term. However, in the lazy way which is prevalent today, the words used are generally 'stereo' and 'mono'. I am sure that many of my readers already know the difference between the technical implications involved but I will, nevertheless, briefly set them out here.

We all possess two ears which are set a certain distance apart according to the width of our heads. Contrary to the old music-hall joke, it is never possible to look into one ear and out of the other, but the arrangement by Nature at a certain distance

apart of these listening devices has a definite purpose. It enables sounds to be located, primarily, since the spacing of the ears allows us to hear whether a sound comes from the right or left side of us. If you go to the opera, for instance, you can see a singer move across the stage because your eyes show you the movement. If you then close your eyes, you will continue to be conscious of the movement, because your ears will tell you that the song being sung by the singer is coming from a varying position. Similarly, if you stand on a railway platform, looking in front of you all the time, you will hear an express train approach you on one side, roar across in front of you and disappear on the other side. Fig. 22 shows one of the BBC orchestras and you can see how it is divided so that all the string instruments (mainly playing the higher notes) are on the right while the percussion instruments are on the left. The piano, woodwind and brass are more or less central at the lower and top ends. You can see all the microphones distributed about the orchestra and the outputs from these are led to a central control. From here the left and right groups of sounds can be fed appropriately into the recording tapes for stereo reproduction; this form of recording was first introduced at the 1959 Radio Exhibition but it did not catch on very quickly at first. It is now beginning to prove very popular.

There is a good selection of stereo gramophone records now available and it is possible to operate stereo players which use them. You need a special pick-up for stereo because, by one of the modern miracles of electronic ingenuity, the two sides of the extremely narrow track of an LP or EP disc carry the two different channels, as they are called, one left, the other right, of the stereo recording. As stereo is only produced on the plastic discs used for LPs or EPs, the stylus must be of the fine gauge normally used on that type of recording. It is, incidentally, of one thousandth of an inch ($.001''$) radius at the tip, whereas that for 78 r.p.m. records is three thousandths.

Fig. 22 Main radio orchestra studio, BBC Broadcasting Centre at Pebble Mill, Birmingham



The stylus has to move freely in two ways, firstly as normally, that is from side to side, for one signal, and also up and down for the other, as each wall of the groove carries one of the signals and affects the movement of the stylus in this way. The stylus has to be connected to two generators—crystals, in the usual form of pick-up in general use in this country—and there will, naturally, be two outputs from the pick-up.

Normally one is 'common' and provides the earthed side, possibly through an earthed braiding to provide shielding. With the older type of stereo equipment, it was normal to have to use a special pick-up, which meant having either an interchangeable pick-up head or a complete change of instrument. The modern type, however, can be used for both stereo- and normal monophonic recordings without change of head. This is called 'compatible' and must be used for playing modern stereo recordings on mono equipment.

Many enthusiasts dote on stereo, but others detest it! Supporters of stereo say they would rather have not-so-Hi-Fi stereo than Hi-Fi mono, whereas enthusiasts for the latter say that stereo is even more noisy than normal monaural Hi-Fi. As I have indicated before, in high-fidelity sound reproduction one man's beat is another man's counterpoint, to coin a phrase!

However, thanks to the ingenious two-in-one valve made by Mullard, the ECL 82, it is possible to make up a unit for stereo quite easily and cheaply and I have designed one for you in accordance with the schematic diagram in Fig. 23. This is very similar to the single-valve design shown in Chapter 5; it is, in fact, the same basic outline with the addition of negative feed-back, and doubled.

The line down the centre of the drawing is the earth line, the common negative, to which the common earth side of the stereo pick-up will be connected. There are two other input terminals, one for the left-hand channel from pick-up and the other for the right. These would have connections to the relative leads from the pick-up. Each ECL 82 valve has its own amplifier, and deals with the input from its own channel, passing it through to the output transformer in each case. The latter is Tr.1 in one case and Tr.11 in the other.

Two loudspeakers are required and are fed by the respective output transformers. The loudspeakers must be correctly placed as to left or right channel and about 6 feet apart. For best results, the listener should sit on a line at right angles to the centre line, between the loudspeakers and about 6 to 10 feet away from them. If you are only going to play monaural records or radio then the two inputs are connected together. Between that connection point and earth we feed in the signals from the pick-up or radio feeder. You then get a spread of sound from the two speakers which is most effective, but it is monaural and *not* stereophonic.

You will observe that each channel in the amplifier has its own volume control. They are arranged in this way to avoid the extra expense that ganged control involves, as well as to simplify the building on to the small chassis employed. This dual control means that two volume controls have to be operated together and as well a sound balance must be maintained between them so that one channel does not come over louder than the other. I did not find this a difficulty, or inconvenience, but the more

expensive stereo amplifiers have ganged volume control, plus a balance control in each channel's amplifier to compensate for differences in amplification which, surprisingly enough, do arise between them.

The amplifier described here, thanks to negative feed-back, has a moderately good quality performance which, with the stereo effect, gives very satisfactory results. Fig. 24 shows the layout for building purposes. There are no special difficulties involved, the only departure from normal being the screen across the chassis which separates the two amplifying sections. A small piece of aluminium bent into a flange, for the purpose of connection to the chassis, is adequate. Do see that R10 is large enough, otherwise it is liable to overheat and break down.

When you wish to build something a little larger and more comprehensive, refer to the Mullard book already mentioned, which has two excellent designs, plus a design for a pre-amplifier. It has not been possible in this design of mine to incorporate any compensating devices, as they tend to reduce the input to the amplifier. A simple pre-amplifier would have to be used to provide compensation, and something incorporating the ECC 83 double-triode valve could, no doubt, be built by anyone with the relevant working knowledge. Now we pass from designs that you can make up yourself to record-players which you can buy, with a special word or two about the record-player units themselves.

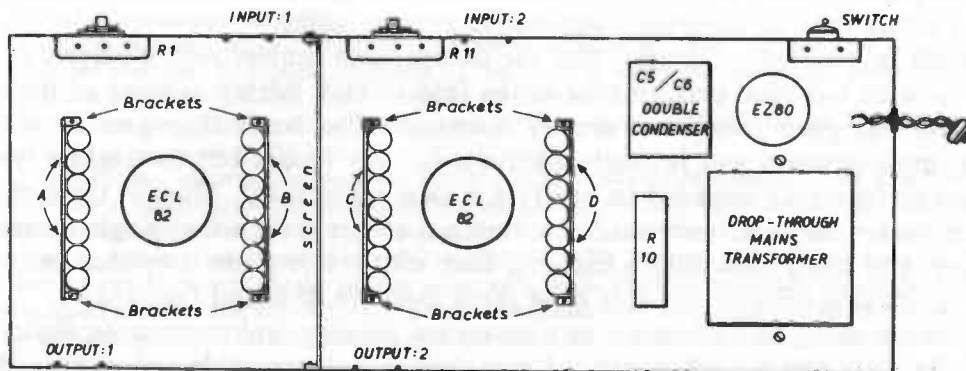

Fig. 24 Suggested Layout for Stereo-amplifier Shown in Fig. 23

Wire as the schematic diagram (or as Fig. 17 each section, plus feed-back). A, B, C, and D are tag-boards, mounted vertically, to carry resistors and condensers and to save space. Wire them up before fixing in position. Output transformers are mounted on top of chassis. Any layout may be used to suit design required, but the above can be very compact.

Chapter 8

Records and Record-Players

Unbiased and expert advice is given about some outstanding record-players available, and Gilbert Davey will always advise readers on technical problems if they write to him c/o The Publishers on condition that the problems are relevant to this book and a stamped, addressed envelope is enclosed. All the prices quoted are those prevailing in 1972 and may need checking before enquiry or purchase.

I now find myself in a dilemma! I wish to tell you something about the various records and record-players you can buy from any good dealer, but I do not want the chapter to sound like a catalogue of manufacturers' products. I have, therefore, picked a selection of items about which I have some personal knowledge, or where there is some especial interest for you. There are many manufacturers turning out excellent products, as you must know if you visit the radio department of a large store or can visit the Audio Show, and I do not necessarily believe a product which I mention to be any better than an equivalent product in another make.

It must be realized, of course, that the cheaper and simpler record-players cannot give the same technical performance in the field of high fidelity as some of the more expensive equipment we have already discussed. The result they give is, without doubt, most pleasant and perfectly adequate for any record but the highest type of musical performance intended to satisfy a critical musical ear. Most of these record-players make use of a ready-made commercial player unit, either single or record-changer, and build them into a carrying case with the requisite amplifier and loud-speaker. Playing units of this sort most often used are BSR and Garrard.

If you are going to build up your own record playing equipment, your dealer will no doubt offer you a wide variety of complete motor, turntable and pick-up decks which you can build into your own cabinet. There are a variety of prices from about £12 upwards, and the more you pay the better equipment you are likely to get. An expensive record-player must have good amplifying equipment to go with it, or else results will be disappointing. Fig. 25 shows an excellent record-changer which I like very much and which is in the average price range, costing £15-£20 (1972). As you can see, it is the BSR/McDonald, a new product only recently made available to the

Fig. 25 BSR/McDonald—MP60 Four Speed Single Play Turntable Unit



home constructor. It is supplied *without* a pick-up cartridge so that you can plug in one of your own choice. Naturally you can choose according to the price you can afford and it is wise to consider carefully the advice which a good dealer will give you in this respect.

I can tell you best about this turntable unit by quoting from the BSR/McDonald leaflet about it:

After making record changers for the popular market so successfully, BSR have now produced a brand new range called BSR McDonald, specially designed to appeal to the serious audio enthusiasts who prefer to build their own installations.

There are four models in the range: the MP60 four speed single play unit and the 610, 510 and 310 four speed automatic/manual units.

Star of the new BSR McDonald range is the MP60 single player, first choice for the select circle of music lovers who insist on manual operation. At the end of a record the arm returns automatically, and the arm lock clips on to the arm as the turntable switches off.

The viscous cueing device (silicone damped for ultra-slow descent) allows the pickup arm to be raised or set down at any point on the record.

An exclusive new low mass high precision pickup arm has been created specially for the BSR McDonald series. Made of lightweight square section aluminium, it is supported on ball race bearings to allow greater stability, freedom of movement, and tracking at very low stylus pressures. This new arm is fully counter-balanced by means of an adjustable weight to produce highly sensitive and accurate tracking. Perfect balance is achieved by rotating the balance adjusting control, which automatically moves the decoupled weight along the arm. The required stylus pressure, depending on the cartridge fitted, is then set on the stylus pressure selector, which in turn operates a finely stepped detent for a precise micro-setting.

However, being perfectionists like yourselves, BSR were not satisfied even with this. So the MP60 has an anti-skate force control (bias compensator). Skating is the tendency of the fully counter balanced pickup arm to move towards the centre of the record faster than the rotating groove would normally bring it. The inner wall of the groove is then tracked with more force than the outer wall of the groove, resulting in distortion and uneven wear of both stylus and record. The anti-skate force control, when adjusted to a figure corresponding to the stylus pressure applied, neutralises this tendency completely.

The MP60 also features a large heavy balanced diecast turntable driven by an induction type dynamically balanced 4 pole motor, a muting switch, a switch 'pop' filter, a slide-in cartridge carrier, and of course conveniently grouped and easy to operate precise linear controls.

I have used this changer for some while to test the amplifiers which have been described in this book, and can recommend it as coming up to the maker's claims in every way. The pick-up I use is an Acos ceramic type, and Acos specialize in high-fidelity units. There are other types of pick-up available, naturally, but for the highest output for use with the simpler type of amplifier, the crystal is best. The price of pick-up heads can be anything from £1 to £45 (1972)!

One unit I also use of transcription-turntable quality, but which has automatic changing capabilities, is the Garrard Laboratory Series Type A. The price was over £20 in 1962, and the cost of the pick-up is extra, according to type used. The one I use is an Acos turnover ceramic pick-up which is a stereo instrument and costs about £2.50 (1972).

This playing deck is still as good as when it was new despite its age. Garrard have modernized their players now and they are still of top quality. Prices are in the £15 to £70 range. They are normally mounted on a plinth which costs a few pounds more.

One of the finest playing decks available is that made by Leak which is illustrated in Fig. 26. Note the massive turntable and that no record changing equipment is included; note also that only speeds of 33 and 45 r.p.m. are catered for. Truly a fine piece of engineering.

Fig. 26 Leak Truspeed Turntable



Chapter 9

Tape Recorders and their Uses

The tape recorder is only now in wide use, yet the invention was made by a Danish experimenter in the late nineteenth century. His discovery required thirty to forty years' work on it before perfection was realized. Now there is a recorder for every type of work and this chapter enables you to realize their potential.

When I was stationed in Berlin in 1945 after the end of World War II, two close friends of mine were the officers in charge of the American Forces Network station which was set up there in order to broadcast to the United States troops in Germany. The programmes were mainly recorded and were sent out on huge discs, 18 inches in diameter, which revolved at $16\frac{2}{3}$ revolutions per minute. Only local news items were 'live' and my friends were very proud of a 'captured' German recorder which they had, and with which they went round Berlin to record items during the day for re-playing in the evening programme.

This rather cumbersome suitcase affair employed a steel wire on which the recording was made magnetically and, as I recall, it gave very good results and little trouble. It was a development of the discovery, made at the end of the nineteenth century by a Dane named Poulsen, that records could be made magnetically on steel wire. It was not until the 1930s that his discovery was perfected sufficiently to be of much use. I recollect a device called a 'Blattnerphone', which the BBC used for recording on steel tape. There were many difficulties, however, in the use of these steel-wire or tape devices and during World War II a method was perfected by which an iron-oxide coating was deposited on a thin paper or plastic tape, which could be used instead of the wire with great advantages. So there came into being the modern tape recorder with which you are familiar.

I first encountered the tape recorder in an office where the records actually took the form of discs which revolved under a moving recording, or play-back, head. The machine was used for the purpose of dictation which was later listened to by a typist who translated it into letters. This is one excellent use of the tape recorder and a number of small models are available for business men who wish to take them on

their travels. They may be used for recording information or instructions on reels of tape which can be posted back to a head office by air-mail.

In musical spheres the tape recorder has many functions and for broadcasting and gramophone recording purposes it is always in use. In recent years it has been discovered how to record television programmes on tape, but now both the BBC and commercial television use tapes constantly. There is no doubt that the next development will be taped programmes which you can buy, or borrow from a library, to play through your own TV set, in the same way as you can obtain 'home movies'. As I write this, Philips have announced such an instrument which will at first be available for educational establishments. It is expected to be sold to the general public within a short time. As far as the technical side of tape-recording is concerned, I do not feel it is necessary to go into this here, as it is a rather technical matter and is dealt with very well in the Mullard book on audio amplifiers which I have already mentioned. This book has a full description of a 3-watt tape amplifier which serves as a pattern for many manufacturers. The book also describes a tape pre-amplifier.

You can either build your own tape-recorder unit or buy one ready-made and, if you decide to build your own, it is necessary to consider whether to make a real hi-fi arrangement or merely a moderately sized portable unit. If you decide on the former, the whole layout will have to be built on quite generous, and expensive, lines. Even so such equipment will not be as comprehensive as that used in studios, where they use what is known as professional equipment.

Two of the most popular tape-decks, as they are called, are the Brenell and the Garrard. A very popular tape-recorder is the Philips and there are many other makes at varying prices on the market. Many Japanese recorders are also available and this equipment can be of very good quality. Three speeds are given, viz. $3\frac{3}{4}$, $7\frac{1}{2}$ and 15 inches per second. These refer to the speed at which the tape passes across the recording head and, conversely, runs through for reproduction after recording. The faster the speed the better the reproduction, particularly in relation to top frequencies.

Some tape recorders have a speed incorporated of as little as half that of the lowest on the Brenell deck, namely $1\frac{7}{8}$ inches per second, and at this speed the highest frequency which can be satisfactorily reproduced is around 4,500 cycles per second. Each time the speed is doubled, about 3,500 cycles are added to the frequency, so that at 15 inches per second the frequency is around 15,000 cycles. This is quite satisfactory for normal use, but not good enough for professional recording purposes where speeds of 30 inches per second are encountered, with a frequency range of up to 20,000 cycles.

You can see the disadvantage of such a high speed; the tape is going to run through about fifteen times as quickly as that of the $1\frac{7}{8}$ -i.p.s.-speed recorder, and large spools will be required to contain a programme of any length. The Brenell deck has only the three speeds which give the better-quality recordings and it costs around £30 (1972). It has one very useful counting device on the right of the deck, which enables you to note where an item is placed on the tape in case you wish to refer back to it.

The Garrard unit is a useful one when it is desired to make a more compact piece

of equipment. It has a magazine loading, which is a compact one-piece plastic magazine containing the two reels of tape, which is fitted easily on the deck simply by placing it in position. These are called 'cassettes' and are becoming increasingly popular. The Garrard deck offers a good compromise between the length of playing time and fidelity of reproduction in that it has but one speed, viz. $3\frac{3}{4}$ i.p.s. These decks require an amplifier embodying the special features needed for recording on tape, and also a microphone if speech is to be recorded. The only design for such an amplifier which I know to be available is the Mullard one already mentioned and play-back can be through the same amplifier or a hi-fi type such as the Mullard 510.

Brenell and Garrard decks are encountered in many ready-made tape recorders produced by other manufacturers, and pre-recorded tapes can also be obtained from many record companies for playing on tape recorders in the home. BSR also manufacture a popular deck at a reasonable price and this is designed to play cassettes.

I hope this chapter has helped you a little with tape recorders. If you are thinking of buying one, go and see the selection at the dealer or store of your choice, not forgetting the stereophonic models. The next chapter brings us back to things you can make and there are one or two model ideas for you to work out.

Chapter 10

Electronic Applications: Suggested Ideas

Here's a simple idea for baby-sitters who want to know exactly when baby wakes up—a piercing yell via electronics will tell you! Another good idea is an electric guitar or ukulele-banjo, or even a zither, if you like! Full details are given with diagrams, and making one is fun!

Have you a younger brother or sister for whom you 'baby-sit' while your parents go out? Or perhaps you baby-sit for a sister's baby, or to help out a friend? Perhaps you have found it very difficult to sit watching TV while you keep one ear tuned in to the baby upstairs! Figs. 27 and 28 give details of a transistor amplifier, which you can easily make up, to sound the alarm whenever baby cries. Using transistors, it is small and light and portable and, if you are caring for someone else's baby, you can take the gadget with you and rig it up to give you a warning when necessary.

The device is very simple and consists of a crystal microphone (such 'insets' are available quite cheaply) which picks up the signal, that is, the baby's 'yell', and passes it into the transistor amplifier. The amplifier has three transistors and is worked off a small $4\frac{1}{2}$ -volt torch battery. There is an output transformer which matches the third transistor into a small loudspeaker. This loudspeaker has a small box or cabinet of its own, so that the microphone and amplifier can be left beside the sleeping baby and a length of twin flex runs to the loudspeaker in the other room where you are sitting.

Nothing elaborate is required as we are not trying to get high-fidelity results, merely a warning sound from the disturbed infant, and I hope your television programme is not the cause! Be careful how you place the microphone near the baby. It wants to be in such a position that it *cannot* fall on the baby's face, nor should there be any wires around in which baby can entangle himself. A small child in a cot is almost entirely helpless and you must take care that you do not place the gadget where he can get mixed up with it. Of course, there is not the slightest danger of any shock whatever, since it is transistor-operated at $4\frac{1}{2}$ volts.

There is much more about transistors in our companion title, *Fun with Transistors*. These astonishingly versatile electronic devices have come more and more into use

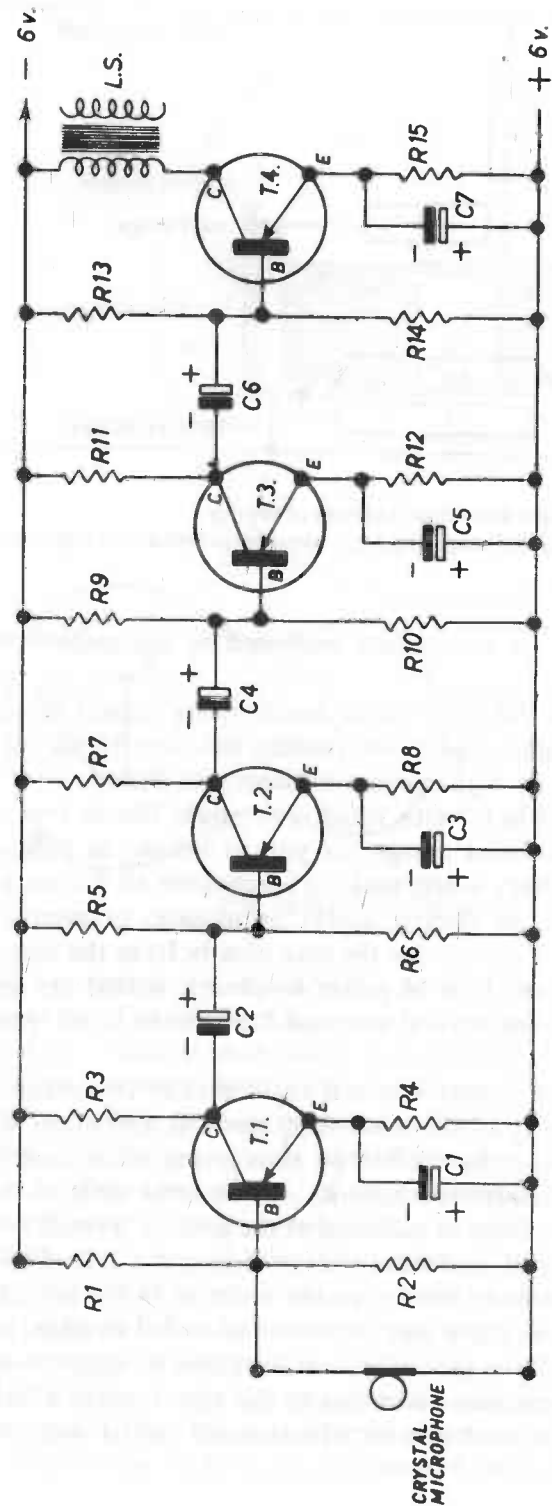

Fig. 27 Transistor Amplifier Suitable for Baby Alarm: Schematic Diagram

Components required:

- Four LF transistors, OC 71, OC 70, red-spot or similar type
- Transistor output transformer to match LS
- Crystal microphone insert

RESISTORS: (values in ohms)

- R.1, R.5, R.9, each 150 K
- R.2, R.6, R.10, each 33 K
- R.3, R.7, R.11, each 4.7 K
- R.4, R.8, R.12, each 3.3 K
- R.13, 18 K
- R.14, 10 K
- R.15, 120

CAPACITORS: (values in microfarads)

- C.1, C.3, C.5, C.7, -50
- C.2, C.4, C.6, -2
- All 12- or 15-volt working

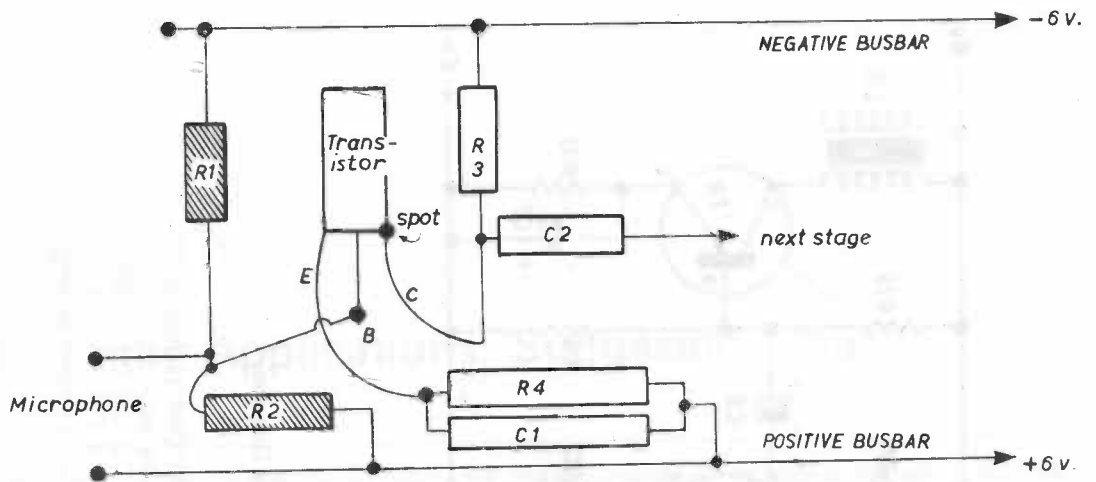

Fig. 28 Transistor Amplifier: Method of Wiring

Suggested layout: four (or three, as required) stages laid out between positive and negative busbars on a baseboard or in a small box.

in all aspects of electronics. They are now being produced by the million in many parts of the world.

'Semiconductors', incidentally, is the term which describes the crystal devices such as transistors and germanium diodes. These are coming into use to an increasing extent in such pieces of equipment as high-speed accounting machines.

In Fig. 29 I show you another little novelty which you might like to try out. It is not feasible to set out any hard-and-fast design for you to follow, as difficulties in obtaining components and other items often make it impossible to follow a design absolutely exactly. This one is for an electric guitar or ukulele, or even a zither, according to the way you make it. You can see the idea clearly from the diagrams in Fig. 29. Four strings (they can be any type of guitar or ukulele string) are anchored at one end, passed over a bridge in the normal way and fixed to the usual type of key for tightening at the other end.

The bridge is where the difference lies, as you will know that in an instrument like a violin this rests on the hollow body of the instrument and the vibrations set up in the strings are transmitted to the body by the bridge, thus giving to the violin its full tone. You probably know that a headphone consists of two large coils of thin wire wound round spools which are placed one at each end of the poles of a small horseshoe magnet. The signal currents are passed into these coils of wire and will tend to add to, or subtract from, the magnetism already present in the magnet. In the model, at the end of the magnets, just not touching them and anchored all round its edge, is placed a thin diaphragm of iron—generally a special material known as stalloy—which is attracted to, or repelled from, the magnets according to the signal currents' influence. It moves in sympathy with the latter and sets up vibrations in the air which we hear as *sound*.

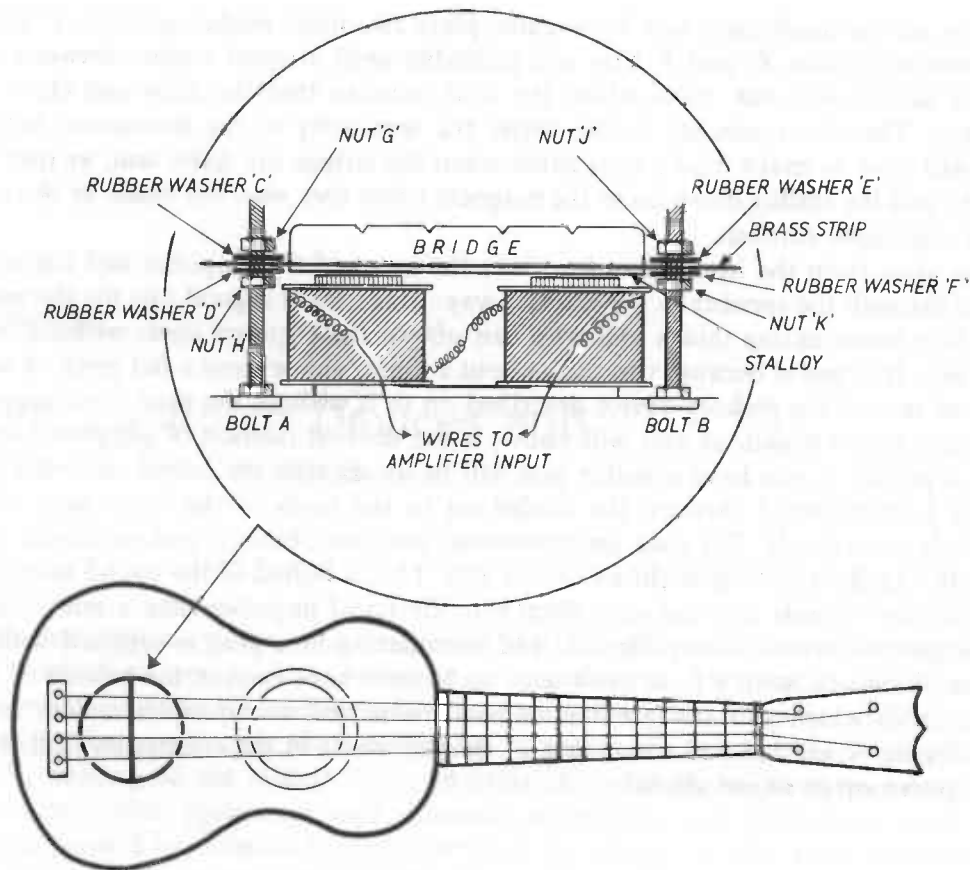

Fig. 29 A Simple Design for an Electronic Guitar

The converse to all this applies, and if you can vibrate a piece of stalloy before the magnets of an earpiece, currents will be induced in the surrounding spools of wire and can be amplified in the same way as current provided by a microphone. You will see that an earpiece (without the diaphragm) is sunk into the wood, which you have cut out according to shape required, at the position where the bridge would normally be. Two long bolts or pieces of studding are screwed into the wood and held firmly by means of nuts at each side of the earpiece. A piece of stalloy (a small strip from an old transformer lamination would do, or even a piece of tin) is then soldered round the edges to a piece of brass. Just a small strip is required, long enough to stretch across the bolts to which it must be fixed by means of two holes drilled near its ends. In the diagram the bolts are shown as A and B. The brass strip is indicated and the stalloy shown fixed beneath it. Above this strip, lightly glue a piece of rounded, thin wood as a bridge, with four notches to hold the wires. Run two nuts, H and K, on to bolts A and B, then run on a couple of washers of rubber, D and F (to prevent vibration; they can be cut from an old piece of india-rubber).

Now, on the diaphragm you have made, place two more rubber washers, C and E, and two more nuts, G and J. You will probably need a metal washer between each rubber washer and nut. Now adjust the four bolts so that the alloy just clears the magnets. The closer you get it, the better the sensitivity of the instrument will be. You will have to make final adjustments when the strings are quite taut, as they will tend to pull the stallo down on to the magnets *which they must not touch, or there will be an unpleasant rattling.*

The wires from the headphone lead into the input of the amplifier and the sound comes through the speaker in the normal way. This idea is a good one for the reader who likes constructing things and who can obtain the required items without much difficulty. It is useful because you can cut out a guitar shape from a flat piece of wood and can mount the pick-up device described on to it without the need for a resonant sounding board which, as you will know, is the normal method of obtaining sound from a guitar. If you have a guitar you will be aware that the sound created by the strings is transmitted through the bridge on to the body of the instrument which resounds accordingly. For such an instrument you can obtain a pick-up device quite cheaply—Lasky's catalogue shows one at 65p. This is bolted to the sound board and picks up the sounds and converts them into electrical impulses (like a microphone) for amplification by an amplifier. A lead terminating in a plug is supplied with the device. The main items I have dealt with up to now have been in the branch of electronics with which you are familiar, namely, radio and sound reproduction. In the next chapter I will tell you something of developments in the electronics field which have grown up in recent years.

Chapter 11

More Electronic Devices and Uses of Electronics

In the first edition of *Fun with Electronics* we told the reader something about the uses to which electronics were being put in everyday life. The past decade, however, has seen much progress in electronics: not only does the reader know that UHF radio is used for communication with astronauts in space, but he has actually seen them, on TV, walking on the moon! Radio in aviation, radar at sea, electronic devices in computers, office equipment and domestic apparatus and radio-taxis are today commonplace. I have decided to end the book by telling you about one or two more items which will be of interest in experiments and in your personal study of electronics.

Firstly, may I draw your attention to the product Veroboard which has been developed in recent years, and which is a most useful piece of equipment for the home constructor. It consists of a bakelite panel to which is bonded a series of copper strips. Holes are located along the centre of the copper strips. Veroboard panels are more versatile than group boards and are ideal for prototype work or to take the place of a printed circuit. Available in three lengths, they can also be supplied plain, i.e. drilled, but without the copper strip. Home Radio list the sizes in their catalogue. One particular panel has the holes so-spaced as to accept the pins of components designed for printed circuits. Vero Electronics Ltd produce a leaflet entitled *Theory into Practice* which has been reprinted from *Practical Electronics*. This describes a very useful transistor amplifier and also shows how to use Veroboard in building it. If you are interested write to the company, enclosing a stamped addressed envelope for reply.

As you will know, with the coming of colour television all three programmes are now being transmitted on UHF; TV sets are now 'single standard' for reception of the 625 line signals on UHF only. These signals are sometimes difficult to pick up for they are often interfered with by hills, tall buildings, brick and stone railway bridges, etc. Indeed, some people find difficulty in obtaining good reception of BBC 2

on 'dual standard' sets for this very reason. I do so myself with one of my receivers. I have overcome the difficulty in my own case quite simply with a transistor pre-amplifier sold by Velco Electronics. The type for the 625 line UHF band, and the one I am using, is known as the L45 and costs £3 (1971). There are others for 405 line VHF, FM VHF and many other radio wavebands. Prices are all about the same and the boosters are complete in a neat bakelite box all ready to plug in and switch on, battery included.

In Chapter 3 I wrote about the Codar CR 70 communications receiver; another excellent product of Codar is the Codar Electronic Control System. These are controllers for 12 volt D.C. motors and Codar say that they completely out-date the conventional variable resistance or transformer method of control. The latest techniques in solid state circuitry are employed to produce precision control from the slowest crawl to the highest speed. Power supply units are available for mains supplies and these controllers can be bought as kits for home construction or ready-made; prices range (1971) from £4.25 to £9.75 according to type. If you are interested in model railways or other models run by small electric motors, this product is worth investigating.

Another product of the modern electronic industry has become available to the public at a fairly reasonable price (reasonable, that is, compared with the price before solid state circuitry was developed), is the electronic organ. There are a number of these on the market but the name which one thinks of usually in this connection is the Hammond organ. Fig. 30 shows their Piper Autochord and you can see that it takes up no more room in the home than an upright piano. When I go shopping on



Fig. 30 The Hammond Piper Autochord Electronic Organ



Fig. 31 The Control Room at BBC Radio Medway with Colin Slade at the Microphone

Saturday mornings, a shop which deals in Hammond organs usually has one on show being demonstrated and the crowd which gathers around is quite impressive. So are all the effects which can be obtained on this organ which Hammond say is easy to learn to play whatever one's age!

Talking of learning reminds me that Mullard Ltd still provide educational facilities for schools, colleges and training establishments. Teachers and lecturers have been using their slides and filmstrips for many years. Many of the services are free, others are reasonably priced or available on free loan. If you are studying physics or electronics, it might be a good idea to mention these items to your teacher or tutor and suggest that he (or she) might like to write for a catalogue of films, filmstrips or slides to the Mullard Educational Service at the address in the Appendix.

Mullard Ltd have been connected with the electronic industry for as long as I can remember, and their superb valves have been used throughout the years in our radio receivers. The Mullard laboratory at Cambridge has carried out valuable research and made remarkable discoveries in Outer Space by means of their own radio-telescope. Today Mullard are in the forefront of solid state circuitry and research in connection with it.

A recent development in broadcasting has been the establishment of BBC local radio stations in London and many of the major towns and cities in the country. These spend a good part of their broadcasting time in giving local news bulletins, road reports and items of interest to local listeners. They are in the VHF band between 88 and 97 MHz and are frequency-modulated (FM). They are of quite low power and intended only to serve the immediate area around the town in which the transmitter is located. However, at my home in N.W. Middlesex, in addition to the three BBC main stations and Radio London, I can pick up the local stations at Brighton, Medway, Oxford and Solent. Fig. 31 shows the control room of Radio Medway. It is a simple arrangement of control panel, microphones, gramophone turntable and cue lights, but it is adequate for the local service the station provides. As we are already on the subject of VHF radio the photo shown in Fig. 11 (page 25, Chapter 3) is of a receiver on which to hear at finest quality your local station (and many others). This is the Armstrong Stereo Tuner Amplifier which I have also discussed in Chapter 6.

We have thus progressed in Revised Edition of this book from a simple one valve receiver you can build yourself to this modern marvel of compactness and fidelity. The Editor and I hope that in doing so we have enabled you to learn something, to want to learn more and want to experiment in order to do so. In the Appendix which follows we give you details of books, suppliers and manufacturers to help you in this way.

Appendix

We are always happy to receive letters especially those offering constructive suggestions, and we will gladly help you if you find difficulty with something which arises from this book. Many radio queries are answered in our three other titles which are uniform with this book: *Fun with Radio*, *Fun with Short Wave Radio* and *Fun with Transistors*, and a forthcoming 1973 title, *Fun with Hi-Fi*.

If they are technical points almost certainly one of the following books, already mentioned in the text, will help you. These books are usually available in public libraries, but it is worth while buying radio books (or hinting for them as birthday or Christmas presents!) since they are so useful for reference at all times. Any bookshop or bookstall can obtain them to order.

Foundations of Wireless, M. G. Scroggie B.Sc., A.M.I.E.E. (Iliffe and Sons Ltd)

Radio Servicing, Theory and Practice, A. Marcus (George Allen and Unwin Ltd)

Practical Wireless—monthly periodical

Radio Constructor—monthly periodical

A to Z in Audio, G. A. Briggs (Rank Wharfedale Ltd, who also publish other books by G. A. Briggs)

High Fidelity—A Practical Guide, Charles Fowler (McGraw-Hill Publishing Company Ltd)

Circuits for Audio Amplifiers, Mullard Technical Service Department (Mullard Ltd)

The following is a list of the names and addresses of the manufacturers whose products I have mentioned in the book. I would again emphasize that the fact that a product is mentioned is in no way meant to imply that it is specially recommended. Nor does the absence of any name imply that it is not recommended. I have written about items which I know and which I think will interest you. There are many others. If you have trouble with a component or other product, please write not to me but to the manufacturers, unless you bought it from a dealer, in which case you should

return it to him. Catalogues and brochures are generally available, but return postage is always welcome. I have given prices where I can, as listed in the manufacturers' leaflets or in the catalogue of Home Radio Ltd, 187 London Road, Mitcham, Surrey. These must always be considered approximate, as they do tend to vary. The addresses below are given in alphabetical order:

Armstrong Audio Ltd, Warlters Road, London, N7.
Birmingham Sound Reproducers Ltd, McDonald Division, Cradley Heath, Warley, Worcestershire.
Brenell Engineering Co. Ltd, 231 Liverpool Road, London N1.
British Broadcasting Corporation (Engineering Information Dept), Broadcasting House, Portland Place, London, W1.
Codar Radio Company and Codar Electronics, Unit 1, Meadow Road Industrial Estate, East Worthing, Sussex.
Cosmochord (Acos) Ltd, Enfield, Middlesex.
Daystrom Ltd, Gloucester.
Denco Ltd, 357-9 Old Road, Clacton-on-Sea, Essex.
Garrard Engineering and Manufacturing Co. Ltd, Swindon, Wiltshire.
Gramophone Co. Ltd, The, Hayes, Middlesex.
H.A.C. Short-Wave Products, 29 Old Bond Street, London, W1.
Hammond Organ (U.K.) Ltd, Deansbrook Road, Edgware, Middlesex.
H. J. Leak and Co. Ltd, Brunel Road, Westway Estate, London, W3.
Lockwood Ltd, Harrow, Middlesex.
Martin Electronics Ltd, 154 High Street, Brentford, Middlesex.
Mullard Ltd, Mullard House, Torrington Place, London, WC1.
Mullard Educational Services (address as above).
Philips Electrical Ltd, Century House, Shaftesbury Avenue, London, WC2.
PMG Licences, Radio Branch, GPO, St Martin's-le-Grand, London, EC1.
Rank Wharfedale Ltd, Bradford Road, Idle, Bradford, Yorkshire.
Record Housing, Brook Road, London, N22.
Sinclair Radionics Ltd, London Road, St Ives, Huntingdonshire.
Teletron Co. Ltd, 112b Station Road, London, EC4.
Velco Electronics, 62 Bridge Street, Ramsbottom, Bury, Lancashire.
Vero Electronics Ltd, Industrial Estate, Chandler's Ford, Eastleigh, Hampshire.
Whiteley Electrical Radio Co. Ltd, Mansfield, Nottinghamshire.
World Radio Ltd, 950 North Circular Road, London, NW2.

The following are retailers of components and of receivers etc:

Henry's Radio Ltd, 303 Edgware Road, London, W2.
Home Radio (Components) Ltd, 187 London Road, Mitcham, Surrey CR4 2Y9.
Lasky's Radio Ltd, 3-15 Cavell Street, London, E1 2BN (and branches).

The 'Learning with Fun' Series

FUN WITH ARCHAEOLOGY

by C. A. Burland

FUN WITH ARCHITECTURE

by William C. Cartner

FUN WITH ASTRONOMY

by Mae & Ira Freeman

FUN WITH CHEMISTRY

by Mae & Ira Freeman

FUN WITH CLAY

by G. C. Payne

FUN WITH COLLAGE

by Jan Beaney

FUN WITH COOKERY

by Fanny & Johnnie Cradock

FUN WITH DRAWING

by Tony Hart

FUN WITH ECOLOGY

by Geoffrey G. Watson

FUN WITH ELECTRONICS

by Gilbert Davey, Edited by Jack Cox

FUN WITH GEOLOGY

by William C. Cartner

FUN WITH GEOMETRY

by Mae & Ira Freeman

FUN WITH HISTORICAL PROJECTS

by Tony Hart

FUN WITH LIGHT

by Mae & Ira Freeman

FUN WITH MAP-MAKING

by Tony Hart

FUN WITH PALAEOLOGY

by William C. Cartner

FUN WITH PAPER MODELLING

by G. C. Payne

FUN WITH PHOTOGRAPHY

by Tony Hart and Jack Harley

FUN WITH PHYSIOLOGY

by Dr Ann B. Gilmour

FUN WITH RADIO

by Gilbert Davey, Edited by Jack Cox

FUN WITH SCIENCE

by Mae & Ira Freeman

FUN WITH SCIENTIFIC EXPERIMENTS

by Mae & Ira Freeman

FUN WITH SCULPTURE

by G. C. Payne

FUN WITH

SHORT WAVE RADIO

by Gilbert Davey, Edited by Jack Cox

FUN WITH TOOLS

by W. Moore & R. Cynar

FUN WITH TRANSISTORS

by Gilbert Davey, Edited by Jack Cox

Printed in England

Also published by

KAYE & WARD

in the Better Sports series

BETTER ATHLETICS

by John Heaton

BETTER BOXING

by David James

BETTER CHESS

by Fred Reinfeld

BETTER COIN COLLECTING

by Tom Mulligan

BETTER CRICKET FOR BOYS

by Mike Smith

BETTER CYCLING

by Peter Roberts

BETTER DANCING

by Courtenay Castle

BETTER FISHING—FRESHWATER

by John Mitchell

BETTER FISHING—SALT WATER

by John Mitchell

BETTER GOLF FOR BOYS

by the editors of Golf Digest

BETTER HOCKEY FOR BOYS

by Geoff Poole

BETTER HOCKEY FOR GIRLS

by Brenda Read

BETTER JUDO

by Geoff Gleeson

BETTER NETBALL

by Joyce Wheeler

BETTER PHOTOGRAPHY

by Gordon Catling

BETTER PHYSICAL FITNESS

by David C. Cooke

BETTER RIDING

by Lt.-Col. 'Bill' Froud

BETTER RUGBY FOR BOYS

by D. Cyril Joynson

BETTER SAILING

by Harvey Weiss

BETTER SOCCER FOR BOYS

by Tommy Docherty

BETTER SURFING

by Joseph J. Cook & W. J. Romeika

**BETTER SWIMMING FOR BOYS
AND GIRLS**

by Helen Elkington and Tony Holmyard

BETTER TABLE TENNIS

by Johnny Leach, MBE

BETTER TENNIS

by Harry Hopman

21 New Street, London, EC2M 4NT