

BERNARDS RADIO BOOKS

37.	MANUAL OF DIRECT DISC RECORDING	2/-
42.	SHORTWAVE RADIO HANDBOOK	2/-
43.	MODERN RADIO TEST GEAR CONSTRUCTION	1/6
44.	RADIO SERVICE MANUAL	2/6
45.	RADIO REFERENCE HANDBOOK	12/6
48.	RADIO COIL AND TRANSFORMER MANUAL	2/-
52.	RADIO TUNER UNIT MANUAL	2/6
53.	RADIO CONSTRUCTORS' MANUAL	3/-
54.	RADIO RESISTOR CHART	1/6 & 1/-
55.	HANDBOOK OF RADIO CIRCUITS No. 2	2/6
56.	RADIO AERIAL HANDBOOK	2/6
57.	ULTRA SHORTWAVE HANDBOOK	2/6
58.	RADIO HINTS MANUAL	2/6
59.	TELEVISION CONSTRUCTION MANUAL	3/6
60.	RADIO REPAIRS MANUAL	2/6
61.	AMATEUR TRANSMITTERS' CONSTRUCTION MANUAL	2/6
62.	CAR AND PORTABLE RADIO CONSTRUCTORS' MANUAL	2/6
63.	RADIO CALCULATIONS MANUAL	3/6
64.	SOUND EQUIPMENT MANUAL	2/6
65.	RADIO DESIGNS MANUAL	2/6
66.	COMMUNICATIONS RECEIVERS' MANUAL	2/6
67.	RADIO VALVE EQUIVALENTS MANUAL	2/6
68.	FREQUENCY MODULATION RECEIVERS' MANUAL	2/6
69.	RADIO INDUCTANCE MANUAL	2/6
70.	LOUDSPEAKER MANUAL	2/6
71.	MODERN BATTERY RECEIVERS' MANUAL	2/6
72.	EXPERIMENTAL CIRCUITS MANUAL	2/6
73.	RADIO TEST EQUIPMENT MANUAL	2/6
74.	RADIO VALVE APPLICATIONS MANUAL	5/-
75.	INTERNATIONAL RADIO TUBE ENCYCLOPEDIA	42/-
76.	RADIO ANTI-INTERFERENCE MANUAL	2/6
77.	WALKIE-TALKIE CONSTRUCTION MANUAL	2/6
78.	RADIO AND TELEVISION LABORATORY MANUAL	2/6
79.	THE RADIO MODERNISATION MANUAL	3/6
80.	TELEVISION SERVICING MANUAL	4/6
81.	USING EX-SERVICE RADIO APPARATUS	2/6
82.	AC/DC RECEIVER CONSTRUCTION MANUAL	2/6
84.	INTERNATIONAL WORLD RADIO STATION LIST	1/6
85.	MINIATURE RADIO EQUIPMENT CONSTRUCTION MANUAL	2/6
86.	MIDGET RADIO CONSTRUCTION MANUAL	2/6
87.	THE OSCILLOSCOPE: DESIGN AND CONSTRUCTION	2/6
88.	WIRE RECORDER CONSTRUCTION MANUAL	2/6
89.	HIGH DEFINITION TELEVISION CONSTRUCTION MANUAL	3/6
	HAM NOTES FOR THE HOME CONSTRUCTOR (Nos. 1 to 4)	1/-

In Preparation

RADIO INSTRUMENTS AND THEIR CONSTRUCTION
 AN INTRODUCTION TO "HAM" RADIO
 CIRCUITS MANUAL No. 3
 HANDBOOK OF AUDIO DESIGNS
 LOW FREQUENCY EQUIPMENT MANUAL
 VALVE DATA MANUAL
 HAM NOTES (continuation of series)

The Midget Radio Construction Manual

3/6

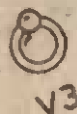
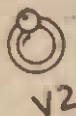
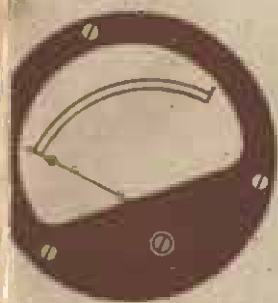

by **EDWIN N. BRADLEY**
 BERNARDS RADIO MANUALS * No. 86

**THE MIDGET RADIO
CONSTRUCTION MANUAL**

By

EDWIN N. BRADLEY, A.I.P.R.E.

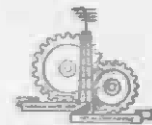

**BERNARDS (Publishers) LTD.
LONDON**

Contents

	<i>Page</i>
<i>Introduction</i>	6
<i>Chapter I</i>	
A "PERSONAL" SUPERHET FOR THE MEDIUM WAVEBAND	7
<i>Chapter II</i>	
A MIDGET BATTERY HOME RECEIVER	21
<i>Chapter III</i>	
THE "FOUR-WAY" AC/DC MIDGET	30
<i>Chapter IV</i>	
A T.R.F. MIDGET	40
<i>Chapter V</i>	
A "FULL-SCALE" MIDGET AC/DC RECEIVER	47
<i>Chapter VI</i>	
A MODERN MIDGET RECEIVER	61
<i>Chapter VII</i>	
A CRYSTAL DIODE RECEIVER	68
<i>Chapter VIII</i>	
CONSTRUCTION HINTS	71
<i>Appendix A</i>	
ADJUSTING LINECORDS	76
<i>Appendix B</i>	
SWITCHING AND SAFETY PRECAUTIONS IN AC/DC RECEIVERS	79

First Published 1949

Printed by

The Reynard Press, Ltd., Flitcroft Street, London, W.C.2 for
Bernards (Publishers) Ltd., The Grampians, Western Gate, London, W6

Introduction

THE present popularity of midget radio receivers is very marked, and for the benefit of home constructors who desire to build small receivers capable of giving good performances this Manual has been prepared. Tested circuits, with the fullest possible building instructions, are given, and even the beginner should find no difficulty in building receivers to these designs.

Because of the small sizes of the chassis, wiring diagrams have not been shown, except in the case of the Personal Portable battery set. Such diagrams would be chiefly a matter of artist's licence, for it would be impossible to show the components in their true places—wiring and small resistances would be hidden by by-pass capacitors, etc., and whilst the final diagram would be of no help to the experienced constructor it might well confuse the beginner.

In place of wiring diagrams a short chapter on the subject of wiring and construction is included.

A great advantage to the constructor of midget receivers is the ease with which cabinets for such sets may be made at home and finished simply in bright enamel or other decorative colourings to harmonise with the room in which the set is placed. A bright, well-toned and efficient receiver in every room can be the aim of the midget set constructor.

THE MIDGET RADIO CONSTRUCTION MANUAL

Chapter I

A "PERSONAL" SUPERHET FOR THE MEDIUM WAVEBAND

PROBABLY no type of receiver has become so rapidly popular as the "Personal" set, a midget superhet which can be carried about in the hand—sometimes in the pocket—for radio reception at any time and practically in any place. The personal midget receiver is a direct result of modern trends in component design, using, as it does, miniature glass-based valves and a layer-built H.T. battery, and although the home constructor is not quite so well served as the commercial manufacturer insofar as miniature components are concerned, it is now possible for him to build his own personal set. Generally, this will not be quite so small as the manufactured article, but it need yield nothing in efficiency to the commercial designs, and the circuit to be described has been developed from a long and exhaustive series of bench trials and experiments which have culminated in the production of a really excellent little receiver.

The personal set has its own drawbacks, as might be expected. Battery life is not great, especially so far as the H.T. battery is concerned, for a current of something like 12 or 13 mAs. is drawn from a battery whose size is of the order of 4" x 3" x 1½". but in the present design the life of the L.T. battery is excellent as the battery drain is only 50 mAs., the valves being connected with filaments in series. The potential drop across the filament circuit is also used for grid-biasing.

A 3" speaker is used in the personal receiver, and this means that tone cannot be perfect. The personal receiver, however, is not intended to give high fidelity results, and it should not be thought that tone is bad or that vibration, note cracking or other such effects are obtained. Tone is actually quite pleasing, particularly on voice.

THE GENERAL CIRCUIT

The general circuit of the personal portable is shown in Fig. 1, although it is necessary immediately to point out that the input circuit, shown as a conventional tuned coil, can also take the form of a frame aerial input. When the personal set is to be used in a semi-fixed position, as in a camp or beach hut, the use of a normal tuning coil input coupled with an aerial (which need be no larger than about 10' or 12' in length) is recommended, and in a good reception area it is quite possible that a metal plate aerial, or an open spiral of wire wound within the receiver case, would bring in stations all round the dial. When the receiver is to be completely portable then the frame aerial input will, of course, be used, and this can be provided with a small secondary winding to allow an external aerial and earth to be coupled in inductively.

Fig. 2 shows the input circuit using a frame aerial and also an alternative method of feeding H.T. to the freq. changer. It will be seen that voltage is fed to the I.F. transformer through the oscillator secondary winding L3. Some constructors prefer this system as it tends to give increased oscillator stability with an ageing H.T. battery.

The first tuned circuit has A.V.C. applied in common with the I.F. stage.

The only real difficulty encountered in the tests on the prototype was to ensure stability in the L.F. stage. Various types of I.F. transformer as well as various methods of valve feed were tried, but it was found impossible entirely to eliminate feed-back over this stage apparently by reason of the close spacing of the components. The most satisfactory method of stabilisation proved to be the addition of a shunt resistance across the secondary of the first I.F. transformer (R2 in Fig. 1), adjusting this resistance to give the greatest gain and efficiency possible whilst maintaining stable operation.

The correct resistance value for the original receiver was 100,000 ohms, and this value may be incorporated when building up the receiver. On the first test the resistance should be checked after the alignment procedure is complete; if gain seems low then the resistance may be increased, but if gain is high and there is L.F. feed-back, made evident either by howling or by the cracking of notes on powerful passages of music, then the resistance can be decreased a little in value.

If feed-back is sufficient to cause howling the resistance value required would be approximately 47,000 ohms: for distortion on a strong signal the decrease need not be so great and a value between about 60,000 and 80,000 ohms should be found correct.

The demodulator-first audio stage is conventional, although it will be noted that there is no I.F. filter between the second L.F. transformer and the volume control. As a result C11 is required, by-passing the anode of the audio stage to earth.

In the output stage the centre of the filament is by-passed to the chassis. This capacitor is not strictly necessary, but it provides a slight improvement in tone and volume and, as the specified capacitor is very small in physical size, it was retained in the original receiver.

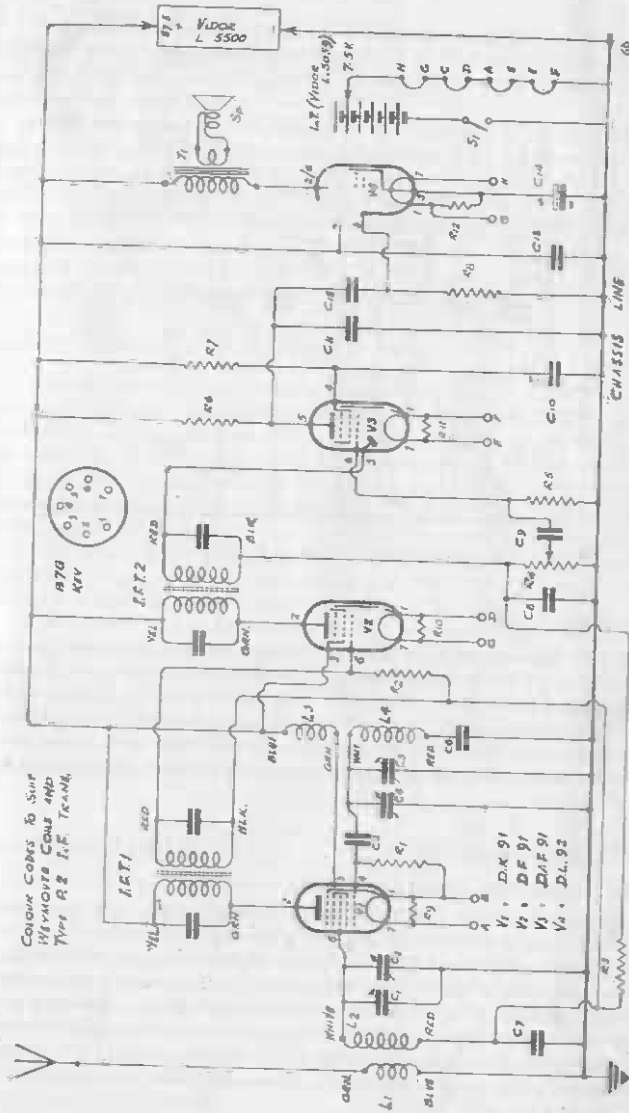

Fig. 1. The "Personal" Superhief. NOTE. Before connecting L.T. supply see text.

COLOUR CODES TO SUIT HIGHWAYS CODE AND TYPE R2 I.F. TRANS.

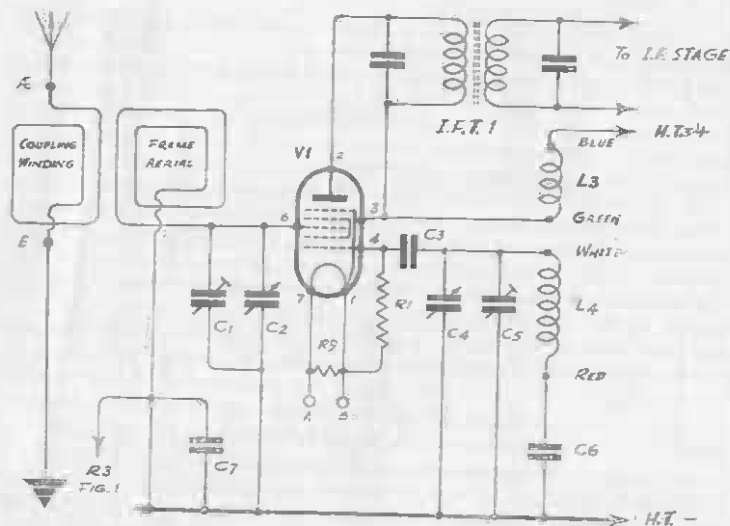

Fig. 2. Input Circuit using a Frame Aerial

FILAMENT CIRCUIT

When the filament circuit is being wired up some care must be taken to observe the wiring key shown in Fig. 1. The filaments are connected in such a way that that of the output valve is 7.5 volts positive to the chassis; as the grid leak of this stage is taken to the chassis the valve is automatically biased. The I.F. valve is next in the chain whilst the demodulator-first audio valve filament is at chassis potential, so that audio gain is full and there is no delay on the A.V.C. line.

TUNING ARRANGEMENTS

The Use of Normal Size Tuning Capacitors

The original receiver was built using a normal size 500 pfs. tuning capacitor. Jackson Bros. Type E 2-gang, and this capacitor is not too difficult to fit into a fairly small space. When this or any other 500 pfs. tuner is used the oscillator coil should be a Weymouth HO3, this coil being no more than $1\frac{1}{2}$ " in length and $\frac{3}{8}$ " overall diameter, yet possessing an iron-dust core, which enables the padding operation to be carried out easily and efficiently.

If the input circuit is to use an ordinary coil the Weymouth HA3 is used, but for portable operation the frame aerial described later matches perfectly with the Weymouth HO3 coil.

If size is not of great importance the Weymouth KO3 and KA3 coils may be used; these are equivalent to the H types, but are fitted into cans and, instead of the delicate connecting wires of the H series coils, have sturdy soldering lugs.

When connecting up the H type coils care must be taken to clean both cotton covering and enamel insulation from the wires; coding is by means of a coloured bead on each coil lead.

The H type coils are mounted by a 6 B.A. bolt tapped into the end of the former. With either H or K coils the trimming capacitors are all 50 pfs. maximum: when the frame aerial is used, however, the oscillator trimming capacitor should be increased to 100 pfs. The colour coding of Fig. 1 is for Weymouth H or K coils and P4 I.F. transformers.

MIDGET TUNING CAPACITORS

Messrs. Jackson Bros. are now producing a miniature tuner, type M.M. 2-gang, which may be ordered through retailers (price 13/6), and this is excellent for personal receiver construction if suitable coils are used. In order that the tuner may be kept small the maximum capacitance is reduced to 362 pfs., whilst a second type of M.M. has a slightly lower maximum capacitance to give a capacitance swing of 300 pfs. If a miniature component is ordered then the 300 pfs. swing should be specified; suitable coils for use with this capacitance swing are to be found in the Denco range. The Weymouth H and K coils are for use with a 500 pfs. tuner and so cannot be used with a 300 pfs. without upsetting the tuning range.

If an external aerial and earth are to be used and a normal coil-capacitor input circuit employed the aerial coil should be a Denco Blue 2C, whilst the oscillator coil for either an aerial coil or a frame aerial input, should be a Denco Red 2C.

The type C coils are chassis mounting, a 4 B.A. clearance hole taking the coil thread, and the core adjusting thread protrudes through this bushing so that both the coil mounting and core adjustment are at the same end of the coil.

THE FRAME AERIAL

The frame aerial used with the original receiver and tuned by a 500 pfs. capacitor is wound on a former sized $7\frac{1}{2}$ " \times $4\frac{3}{4}$ " \times $2\frac{1}{2}$ ", this former being an open rectangle which would just fit into the receiver case.

The winding consists of 20 turns of 30 S.W.G. enamelled wire, the turns being spaced one from the other slightly so that the whole 20-turn winding occupies a depth of 2". Fig. 3 shows the method of construction. The ends of the winding are anchored by threading them through double holes in the frame, and are taken directly to the first section of the tuning capacitor.

The material of the frame was stout cardboard: thin plywood may be used in place of cardboard.

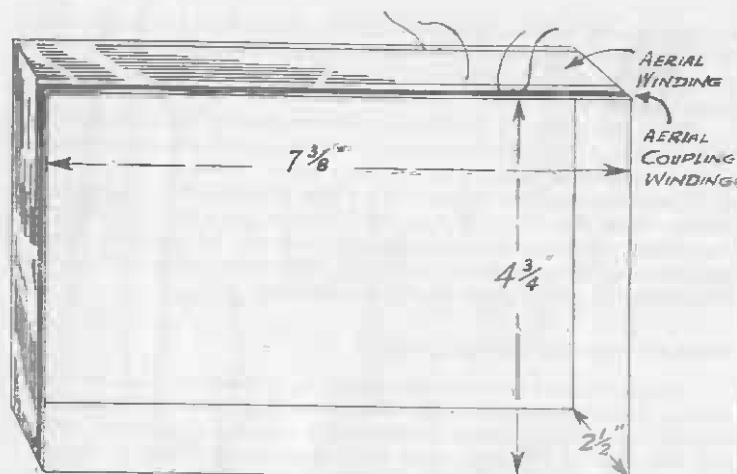

Fig. 3. The Frame Aerial

The receiver was built into a wooden case—a metal case would, of course, shield the frame aerial—with the frame aerial in place as a 'lining' to the case, the receiver and batteries being within the frame aerial.

Beside the main frame winding is placed a smaller winding of five turns of 30 S.W.G. enamelled wire close wound, to act as a coupling coil for an external aerial and earth. The tuned and coupling windings are separated by $\frac{1}{8}$ ", and the small winding should be at the 'earthy' end of the tuned winding.

If the frame aerial is to be used with a 300 pfs. tuner the tuned winding must be increased by ten turns, so that the whole tuned winding is then 30 turns, the spacing being reduced so that the winding depth is still 2". The final exact number of turns should be checked by trial since it may be found desirable to add or subtract a turn: the increase in distributed winding capacitance and the reduction of tuning capacitance swing mean that the final matching between the first tuned circuit and the oscillator must depend on a little experiment.

When the main tuned winding consists of 30 turns the aerial coupling coil should be increased to seven turns.

If the personal receiver is built to fit a different sized case from that specified, and the frame aerial is therefore wound on a different size of rectangular frame, the number of turns in the main winding will most probably have to be altered to maintain the tracking—that is, the matching

between the first tuned circuit and the oscillator tuning. The new winding must be determined by experiment, starting with, say, a 20-turn winding and adding or subtracting turns until the oscillator circuit can be brought into alignment with the input tuned circuit when the receiver is tested and lined up.

COMPONENTS LIST FOR THE "PERSONAL" RECEIVER, FIG. 1

Tuning Components for different Input Circuits

TUNING COMPONENTS FOR 500 PFS. CAPACITORS

L1, L2 ..	Aerial coil, Weymouth HA3. Or frame aerial, as text.
L3, L4 ..	Oscillator coil, Weymouth HO3.
C1 ..	4-50 pfs. Walter Instruments MS50.
C2, C4 ..	500 pfs. 2-gang capacitor. J.B. Type E.
C5 ..	As C1 when Weymouth coil is used. 2 x 4-50 pfs. in parallel, Walter Instruments MS50. ¹⁾ when frame aerial is used.
C6 ..	500 pfs. mica. T.C.C. Type CM20N.

TUNING COMPONENTS FOR 300 PFS. CAPACITORS

L1, L2 ..	Aerial coil, Denco Blue 2C. Or frame aerial, as text.
L3, L4 ..	Oscillator coil, Denco Red 2C.
C1, C5 ..	4-30 pfs. Walter Instruments MS30.
C2, C4 ..	300 pfs. 2-gang capacitor. J.B. Type M.M.
C6 ..	350 pfs. Use 300 pfs. T.C.C. Type CM20N, with 49 pfs. T.C.C. Type CC30y (Disc) in parallel.

COMPONENTS STANDARD TO EITHER TUNING CIRCUIT

C3, C8, C11 ..	500 pfs. mica. T.C.C. Type CM20N.
C7, C12 ..	0.01 mfd. tubular. T.C.C. Type 543.
C9 ..	0.005 mfd. tubular. T.C.C. Type 543.
C10, C13 ..	0.1 mfd. tubular. T.C.C. Type 246.
C14 ..	25 mfd. 12 v.w. Electrolytic. T.C.C. Type CE31B.
R1 ..	100,000 ohms, $\frac{1}{2}$ watt.
R2 ..	47,000-100,000 ohms, $\frac{1}{2}$ watt. See text.
R3, R8 ..	2.2 megohms, $\frac{1}{2}$ watt.
R4 ..	1 megohm volume control. Centralab midget.
R5 ..	4.7 megohms, $\frac{1}{2}$ watt.
R6 ..	1 megohm, $\frac{1}{2}$ watt.
R7 ..	3.3 megohms, $\frac{1}{2}$ watt.
R9 ..	180 ohms, $\frac{1}{2}$ watt
R10 ..	220 ohms, $\frac{1}{2}$ watt
R11 ..	200 ohms, $\frac{1}{2}$ watt
R12 ..	330 ohms, $\frac{1}{2}$ watt

All resistors are standard values. If $\frac{1}{2}$ watt components are not obtainable, $\frac{1}{4}$ watt components of equal value may be used.

- I.F.T. 1, 2 Weymouth I.F. transformers, Type P4. Order I.F.T.1 without flying lead, for single-ended valve.
- Sp. with T1 Celestion 3" speaker with midget output transformer matched to 5,000 ohms anode load.
- S1 S.P. On-Off switch, ganged with R4.
- V1 Mullard DK91.
- V2 Mullard DF91.
- V3 Mullard DAF91.
- V4 Mullard DL92.
- 4 B7G chassis mounting valveholders.
- Chassis, cut and bent from sheet aluminium, $6\frac{3}{4}$ " long, $1\frac{1}{4}$ " wide, with end supports $2\frac{1}{4}$ " high. See diagrams.
- Carrying case (wooden if frame aerial is to be used), $8" \times 5\frac{3}{4}"$ (recessed to take panel $7\frac{1}{4}" \times 5\frac{3}{4}"$, $4\frac{1}{4}"$ deep).
- 2 L.T. battery plugs.
- Springy brass strip for battery clips, etc.
- 2 control knobs, Eddystone 1044.
- 2 Banana plugs and sockets for external aerial-earth connections.
- H.T. Battery: Vidor L5500 or surplus replacements type, 67.5 volts.
- L.T. Battery: Vidor L5059.

CONSTRUCTING THE PERSONAL RECEIVER

All the units which make up the complete receiver are mounted on the front panel, which may be of either sheet aluminium or brass; the metal panel appears to have no shielding or screening effect on the frame aerial when this is used.

The valves, I.F. transformers, oscillator coil (and input tuning coil, when this is used) are mounted on a small strip chassis whose overall and drilling dimensions are shown in Fig. 4. Note especially the angles at which the valveholder retaining-screw holes are drilled which, in turn, determine the manner in which the valveholders are placed in the strip chassis. These angles of rotation ensure that the valves are held in positions which prevent their internal electrodes from sagging together when the valves are horizontally mounted, as they are when the receiver is stood on one end. If the constructor is in any doubt as to the method of mounting the holders he has only to inspect the valves themselves. It will be found that in each valve the electrodes are mounted on a row of supports; when the valves are to be held in the horizontal plane this row of supports must be vertical. Secure a soldering tag under one bolt of each of the valveholders to act as earthing points.

The mounting lugs on the two I.F. transformer cans are rather large in view of the chassis size, and they are accordingly trimmed down—they can be cut by shears or even by one or two strokes of a single-edged razor blade—and then drilled with new 6 B.A. clearance holes. It will be noted from Fig. 4 that I.F.T.1 and I.F.T.2 each have one mounting hole common with the mounting holes of the valveholder for V2.

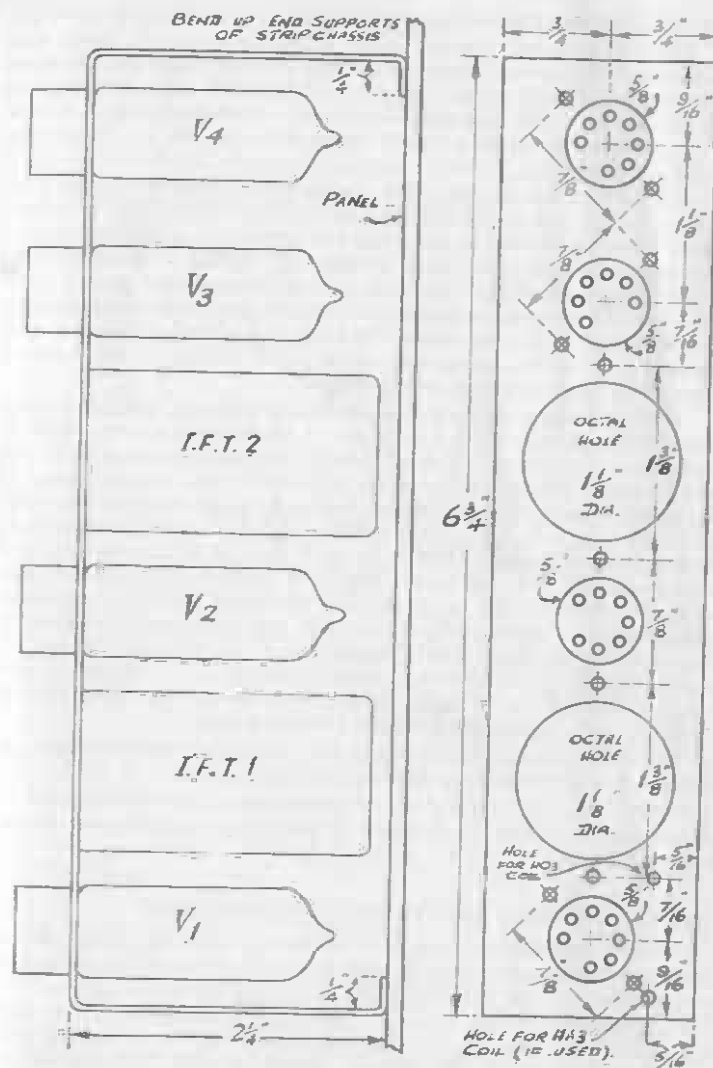

Fig. 4. The Strip Chassis

The strip chassis has end supports bent up at right-angles to the valve-I.F. strip. By means of these end supports the strip is mounted on the main panel in such a way that it becomes a cradle with the valves and I.F. transformers and coils held between the strip and the panel. All connecting tags and lugs are then readily accessible and small components such as resistors and capacitors are mounted directly across the valve and I.F. transformer connecting tags.

A general rear-panel view of the receiver is shown in Fig. 5 where it can be seen that the tuning capacitor illustrated is a full size J.B. Type E 500 pfs. tuner. This type of tuner has its fixing feet removed, and the rivets holding them to the capacitor frame can be drilled away. Pressed holes will be found on the front frame plate of the tuner, and the component is bolted to the panel by 6 B.A. bolts $\frac{1}{8}$ " in length which pass through these frame holes and through holes drilled in the panel. The tuner is spaced from the panel by $\frac{1}{8}$ " washers; this spacing accommodates the raised bearing on the capacitor frame which carries the main tuning spindle.

In the original model no slow motion drive was used, and direct tuning drive was found to be quite convenient. A tuning scale was drawn up by hand and fastened round the tuning spindle, a pointer type knob being used as the combined tuning drive-tuning indicator. In the original model, no effort was made to hide the various boltheads which protruded above the panel surface, but in a 'finished' model these bolts can easily be camouflaged by first covering the panel with thick card, the card having holes cut in it to surround each bolthead so that head and card are level, the card then being covered in its turn by leatherette, thin sheet ivory (on which the tuning scale could be drawn direct), cloth or any other decorative covering. The tuning spindle and volume control-on-off spindle would be the only parts protruding through this final panel covering, and a decorative loudspeaker fret could also be cut to cover the speaker aperture which must, of course, be cut in both metal panel and cardboard cover.

If a final covering of cloth is used the loudspeaker aperture requires no fret design, and may be covered completely by the cloth.

Above the main tuning capacitor is mounted the loudspeaker, with the midget volume control-switch bolted directly to the panel between the two larger components.

THE H.T. BATTERY AND OUTPUT TRANSFORMER

Special note must be made of the methods of mounting the H.T. battery and the output transformer, for both of these units are supported by the main tuning capacitor; the side view of Fig. 6 is fully explanatory.

The battery is held in a strong clamp made of springy brass strip which is bolted firmly to the 'top' of the tuner frame ('top' when looking at the rear view of the receiver with the panel vertical, as in Fig. 5), further support being given to the battery by a second clamp of brass strip bolted to the strip

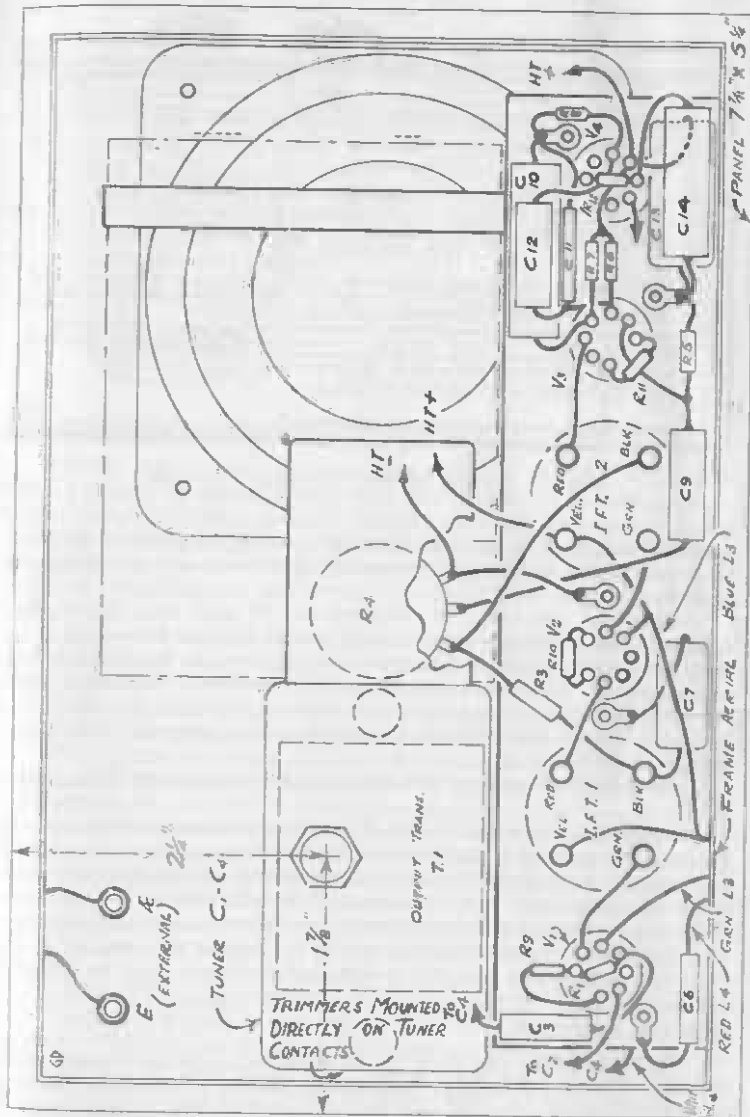

Fig. 5. Layout and Chassis Wiring of the "Personal" Portable. Filament Wiring not shown

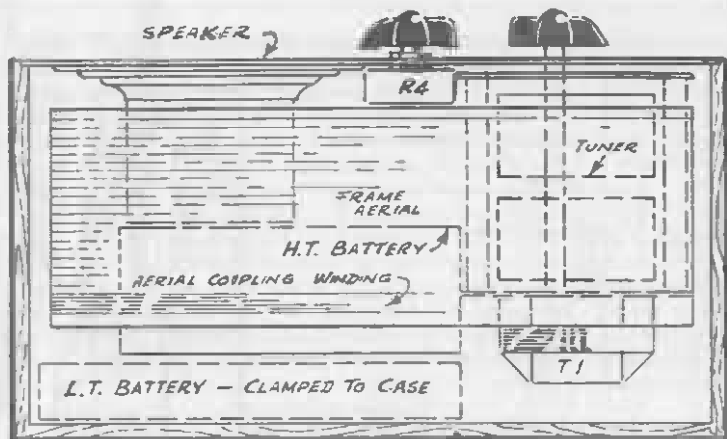

Fig. 6. Section through "Personal" Portable

chassis. The battery is distanced from the panel by the depth of the loud-speaker, of course, but even so the total depth of the receiver at this point is no more than $3\frac{1}{4}$ ".

The output transformer (a 'Radiospares' 30 mAs. multi-ratio midget was used in the original) is fastened to the rear of the tuner frame; not by its fixing feet but by a metal strap so that the transformer can lie on its side thus reducing depth. The metal clamp around the transformer laminations, with the drilled fixing feet at its ends, can be removed if desired, but there is no real need for this and retaining the clamp ensures that there will be no lamination chatter.

The depth of the receiver from the front panel to the output transformer is $3\frac{3}{8}$ ".

Note that the connections to the H.T. battery are made of rubber-covered flex leads whose ends are actually sweated to the battery contacts. This avoids the making of a complicated contacting strip or arm and totally obviates the chance of short-circuits or other damage. The leads must be sweated on to the battery terminals as rapidly as possible; well clean the leads and terminals, then lightly tin and make the joints resting the iron on the terminals for as short a time as possible to avoid heating up the battery.

THE L.T. BATTERY

It remains only to find room for the grid-bias battery used to supply the filaments. The battery is rather large in proportion to the rest of the receiver, but tests with series and parallel connected filament circuits, and with separate

and combined H.T. and L.T. batteries, showed that the extra space needed was worth providing in terms of circuit simplification and efficiency of supply.

In the original receiver the battery is clamped to the rear or bottom of the receiver case so that when the receiver, on the panel, is dropped into the case and fastened down the L.T. battery takes up the position shown by the dotted line in Fig. 6.

The battery leads are made sufficiently long to allow the set to be withdrawn from the case without breaking the L.T. circuit; rubber-covered flex leads are again employed and are fitted with normal banana plugs for insertion into the battery sockets.

IMPORTANT. CONNECT L.T. NEGATIVE TO S1 AND L.T. POSITIVE TO HEATER CHAIN

**REMEMBER TO TAP OFF 7.5 VOLTS FROM THE BATTERY
DO NOT USE THE FULL 9 VOLTS AVAILABLE**

ALIGNING THE PERSONAL RECEIVER

With the receiver built and the wiring checked carefully, it may be switched on and aligned before being fitted into its case. To bring the set into correct operation a signal generator is very desirable; the receiver can be trimmed without a generator, but the work is then made much more difficult. The constructor who has no signal generator is advised to take the receiver to a good service engineer who has the instruments and who will carry out the work.

If the receiver has been built to instructions it may be taken for granted that the frequency changer oscillator section is working correctly, but if it should be desirable to check the action of the oscillator break the connection of R1 with point B and insert a low range milliammeter or a microammeter in the circuit. A reading will be obtained if the stage is oscillating correctly.

First align the I.F. stages and check the demodulator and output stage by feeding into the frequency changer control grid (point 6 on V1) a 465 kcs. modulated signal. Use a fairly high output from the generator at first and trim the I.F. transformers from the demodulator stage back to the frequency changer anode winding, setting each core adjustment to give the best volume possible and reducing the generator output as soon as possible until only as low an output as will give clear indications is used. At this point check carefully on the damping of R2 across the secondary of the first transformer, varying the generator output and ascertaining that the damped winding can be peaked or tuned exactly without signs of feed-back or oscillation.

With the I.F. circuits correctly aligned transfer the signal generator output lead to the aerial and earth terminals, and be sure to use the generator's artificial aerial for this section of the work. With some generators it is advisable to use the artificial aerial output, rather than the plain output, for the L.F. alignment as well; in some cases connecting the generator directly across L2, C1 may lead to some de-tuning of the generator.

If the receiver has a frame aerial the signal generator output will be fed into the small aerial winding of five or seven turns; in sets with a coil tuned input circuit the feed to the aerial and earth terminals will be conventional.

Set the generator to give a reasonably high output at 250 metres, 1,200 kcs., and set the main tuner of the receiver about 1/5 in mesh. Trim C5 until the signal is heard; if the input circuit is much out of trim it may be necessary to make some trial settings of C1 before the signal can be tuned.

Trim C5 to obtain best volume, turning down the generator output if possible. With C5 trimmed, adjust C1 to make any further increase in volume possible.

Note or mark the position of the tuning knob on a temporary tuning scale so that the tuner can be returned exactly to its present position, and then tune the receiver and the signal generator to 500 metres, 600 kcs. On the receiver this will require the vanes of the tuner to be about 4/5 fully meshed. If for any reason the H.T. voltage is low the oscillator may go out of action before this tuning point is reached—a faint 'plop' indicates that the oscillator section has gone out of action. With correct H.T. the set should not, of course, fail to oscillate.

With both receiver and generator tuned, pad L4 by varying the adjustment of its iron core. Using Weymouth H type coils, note that a trimming spanner, not a screwdriver, must be used to tune the coil cores. As the core position is varied 'rock' the main tuner of the receiver first to one side, then the other, of the tuning point, and continue to adjust the coil core until the signal is heard. Set the main tuner and adjust the core for loudest volume, checking with a final rocking of the main tuner.

Return to the first tuning point, 250 metres, after marking the exact tuning point for 500 metres on the receiver temporary dial, and reset the generator for 250 metre output. Correct the trimming of C5 for any possible increase of volume, then return both set and generator to 500 metres and correct the padding by the coil core.

Repeat the trimming and padding operations till each has no effect upon either.

Now tune to 500 metres on both set and generator and vary the core position of L2 (if coil tuned input is used) to obtain any possible increase of volume. Retune both set and generator to 250 metres and correct the trimming of C1. Balance the trimmer, C1, and the core position of L2, to give equally good results over the tuning band.

If a frame aerial is used this last adjustment is not possible. Instead, try pushing the turns of the aerial very slightly apart, or closer together, to see if improved band coverage is possible, and if coverage seems poor try using a turn more or less on the aerial. Such experiments take time, but they are well worth while.

Greatest patience will be needed to find the correct core position for L4; but when the receiver is finally aligned it will be found surprisingly sensitive and powerful.

The receiver has been tested with a frame aerial at Land's End, and with a conventional coil input circuit and a 10' aerial in the Welsh mountains, and in both these difficult locations it gave excellent results.

When the receiver is finally aligned it is mounted in its case; the frame aerial can be fixed either inside the case walls or, by brackets, to the front panel. A shallow lid should be fitted, just sufficiently deep to clear the two control knobs, to give protection to the set when it is not in use.

A carrying handle should be fitted to the top of the cabinet for ease of portability.

Chapter II

A MIDGET BATTERY HOME RECEIVER

MINIATURE valves, such as are used in the personal receiver in the foregoing chapter, have done much to popularise the modern battery driven set. The large and troublesome accumulator has been made obsolete, battery receivers now being driven entirely from dry batteries with excellent life duration, and it is therefore possible to design a most efficient receiver which will fill not only the needs of the country dweller possessing no mains electrical supply but which is also sufficiently inexpensive to be built by the town dweller as a standby or 'garden' receiver; a set which can always be brought into service at odd moments and which is ready to operate in the event of mains failure or 'load-shedding.'

Such a receiver should obviously be small and neat, in order that it may easily be stored when not in use and placed in any odd corner of the room, or on a small table, when pressed into service. At the same time the design to be described was required to have the greatest range possible, and the receiver is made practicable by the remarkably efficient new Type B.5 coil pack marketed by Messrs. Weymouth Radio Manufacturing Co. Ltd. The majority of coil packs are not suitable for use with battery frequency changers of the DK91 class, but tests prove that the B5 pack will give excellent results in this receiver, and work over all three wavebands without dead spots, even when the H.T. potential falls to 50 volts.

The set may, therefore, be made even smaller and operated from a 67.5 volt battery by the experimenter who needs a really tiny receiver; the following instructions describe a receiver suitable for use with a 90 volts H.T. battery.

As the circuit employs a coilpack the receiver does not contain a frame aerial, but is intended to work from an outside aerial. In most reception areas only a short length of wire is needed; an efficient earth connection is of considerable help to good reception, as with any battery set.

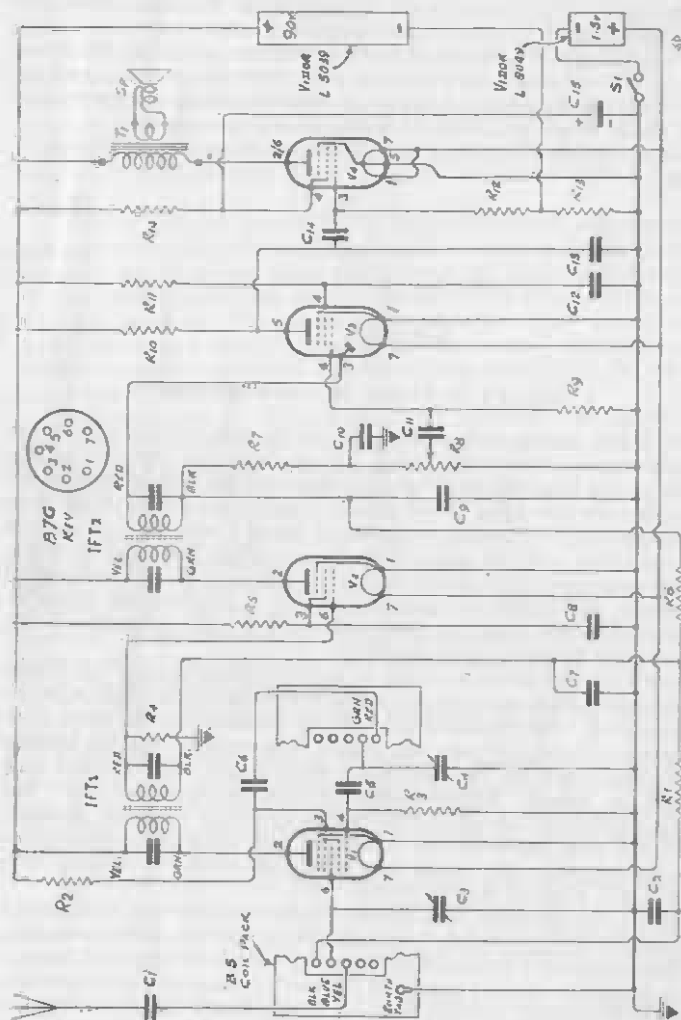

Fig. 7. The Home Midget Battery Receiver

The circuit is shown in Fig. 7 with coils and I.F. transformer connections colour coded to suit the Weymouth B5 coilpack and P4 I.F. transformers.

The receiver, using all standard parts and batteries, fits a cabinet of internal dimensions 10 $\frac{1}{2}$ " \times 6 $\frac{1}{2}$ " \times 6 $\frac{1}{2}$ ".

The waveranges covered by the receiver are:—
16-50 metres.
200-550 metres.
800-2000 metres.

It must be noted particularly that the B5 pack is tuned by a 365 pfs. swing tuning capacitor, *not* by a 500 pfs. tuner. A suitable tuner may be obtained from Messrs. Jackson Bros. list. Type E, and when the variable capacitor is bought or ordered the 365 pfs. swing must be specified.

With the variable capacitor should be obtained the 2 $\frac{1}{2}$ " diameter drum and the cord driving spindle, together with an A.P.D. pointer and cord tensioning spring.

COMPONENTS LIST FOR THE HOME MIDGET BATTERY RECEIVER, FIG. 7.

Coilpack, B5	..	Weymouth Radio Mfg. Co. Ltd.
C1, C9, C10	..	200 pfs. mica. T.C.C. Type CM20N.
C2, C7, C8	..	0.05 mfd. tubular. T.C.C. Type 346.
C3, C4	..	365 pfs. swing tuning capacitor, 2-gang; Jackson Bros., Type E.
C5, C6, C13	..	500 pfs. mica. T.C.C. Type CM20N.
C11, C14	..	0.01 mfd. tubular. T.C.C. Type 346.
C12	..	0.1 mfd. tubular. T.C.C. Type 346.
C15	..	4 mfd. 200 v.w. Electrolytic T.C.C. Type CE32G.
R1	..	220,000 ohms, $\frac{1}{2}$ watt.
R2, R7	..	10,000 ohms, $\frac{1}{2}$ watt.
R3, R4, R5	..	100,000 ohms, $\frac{1}{2}$ watt.
R6, R10	..	1 megohm, $\frac{1}{2}$ watt.
R8	..	1 megohm volume control, Centralab midget.
R9, R12	..	2.2 megohms, $\frac{1}{2}$ watt.
R11	..	3.3 megohms, $\frac{1}{2}$ watt.
R13	..	470 ohms, $\frac{1}{2}$ watt.
R14	..	15,000 ohms, $\frac{1}{2}$ watt.

All resistors are standard values. If $\frac{1}{2}$ watt components are not obtainable $\frac{1}{2}$ watt components of equal value may be used.

- I.F.T. 1, 2 465 kcs. I.F. transformers. Weymouth, Type P4. Order I.F.T.1 without Flying Lead, suitable for single ended valve.
- Sp. with T1 Elac 5" P.M. speaker with transformer to match to 8,000 ohms anode load.
- S1 S.P. On-Off switch ganged with R8.
- V1 Mullard DK91.
- V2 Mullard DF91.
- V3 Mullard DAF91.
- V4 Mullard DL92.
- 4 B7G chassis mounting valveholders.
- Chassis, cut and bend from sheet aluminium. $5\frac{1}{2}" \times 3\frac{1}{2}" \times 3\frac{1}{2}"$ high. See Fig. 8.
- Cabinet, internal dimensions, $10\frac{1}{2}" \times 6\frac{1}{2}" \times 6\frac{1}{2}"$.
- H.T. battery, Vidor, L5039. L.T. cell, Vidor L5049.
- H.T. and L.T. battery plugs.
- Aerial and earth socket strip, with \mathcal{A} . and \mathcal{E} . plugs.
- 2 $\frac{3}{4}"$ drum and Standard Cord Drive, with driving cord for tuning capacitor.
- Pointer, Type A.P.D., cord tension spring. Messrs. Jackson Bros.
- 3 Control knobs.
- Wire, sleeving, nuts, bolts, etc.
- Midget 3-waveband tuning scale.

CONSTRUCTING THE HOME MIDGET BATTERY RECEIVER

Cut the chassis from sheet aluminium and, before bending down the $3\frac{1}{2}"$ walls, drill as shown in Fig. 8. The high walls to the chassis permit the B5 coilpack to be mounted below the tuning capacitor in the vertical position so that little chassis space is taken up by the coilpack. The pack is mounted so that the adjusting screws of the trimmers and coil cores are to the right, and thus readily accessible at the right-hand end of the chassis.

When the chassis is drilled bend down the front and rear walls and mount the valveholders, coil-pack, aerial and earth socket strip, variable capacitor, drive spindle and volume control. Commence the wiring with the filament circuit, then wire through the receiver from the aerial point to the output stage. The yellow tag on the second I.F. transformer makes a convenient tie-point for the H.T. positive line, and earth connections are provided by securing a soldering tag under one bolt of each valveholder.

Chassis depth is such that wiring in the components is a very simple matter. Use rubber-covered flex for the L.T. and H.T. leads and also for the loudspeaker leads; as shown in Fig. 9, the speaker is not mounted on the chassis but is fastened directly to the cabinet on the left-hand side of the chassis.

When wiring the B5 coilpack first remove the two screws which hold the screening cover in place, slipping the five wires to the pack connections through the slot in the cover. Make the joints, then replace the screening

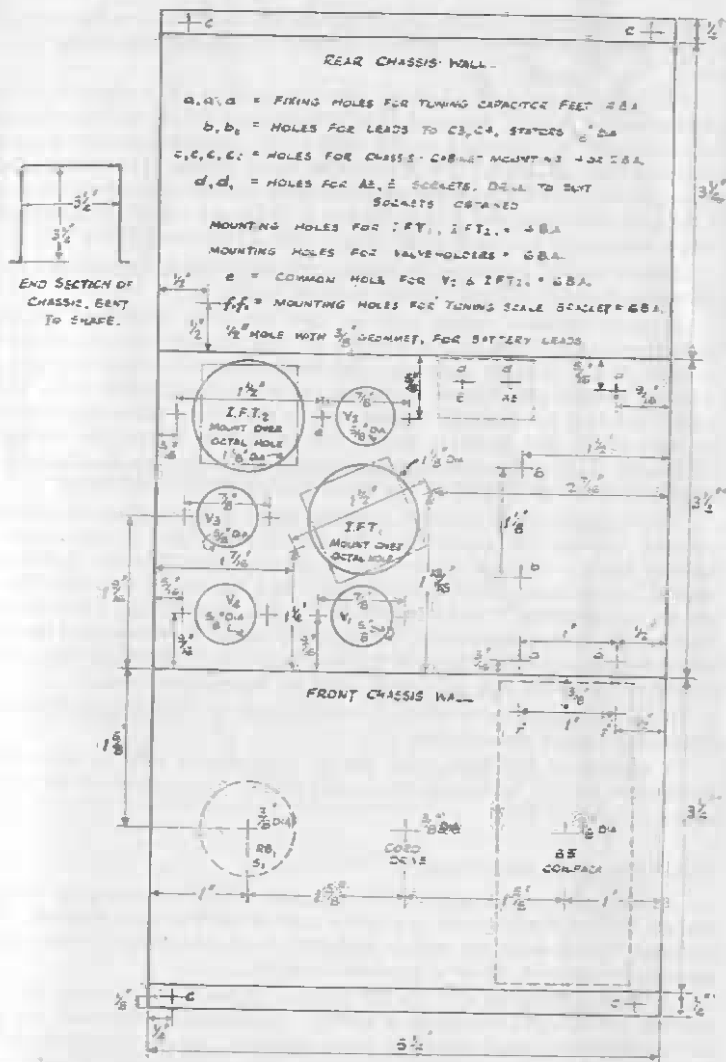

Fig. 8. Chassis Details for the Home Midget Battery Receiver

cover and screw down. Ensure that the leads to the pack are correctly sleeved so that there is no chance of earthing any lead against the edge of the cover slot.

One mechanical point requiring some attention is the method of drive adopted for the tuning. The cord drive is fitted centrally in the front chassis wall, whilst the drum is placed on the shaft of the variable capacitor in such a way that the drum groove is in line with the pulley groove. The driving cord is then passed round the drive and the drum in the usual manner, and tensioned by the cord tensioning spring so that rotation of the drive shaft causes a slow motion rotation of the tuner shaft. The system is illustrated in Fig. 10.

Several ways of mounting the tuning scale and pointer are possible; the method used on the original receiver is shown in Fig. 11.

A small standard tuning scale as used for three waveband midget receivers was drilled dead centrally with a $\frac{1}{8}$ " hole through which would pass the shaft of the variable capacitor, and from sheet aluminium was cut a mounting bracket which could be bolted on to the front chassis wall. The bracket was bent out from the chassis to clear the driving drum mounted on the tuner shaft, then upwards so that the drum falls behind the bracket. The bracket is cut to have two upright arms on which the scale is mounted—final dimensions will depend on the scale obtained by the constructor.

The capacitor shaft is cut to a length which will just allow its end to protrude through the central hole in the tuning scale. A fine-toothed hacksaw blade or a stout fretsaw may be used to make the cut. A 6 B.A. tapping hole is then drilled dead centrally into the end of the shaft (drill No. 44) to a depth of $\frac{1}{8}$ " and tapped with a 6 B.A. thread. The J.B. pointer, Type A.P.D., is then bolted on to the end of the shaft, the tuning scale having been bolted into place on the scale bracket, so that the pointer just clears the surface of the tuning dial and rotates with the variable capacitor.

In the cabinet of the receiver, to coincide with the tuning scale position, is mounted a small glass window.

A portion of the tuning scale bracket must be cut away to allow the driving cord to pass freely from the driving spindle to the drum on the tuner shaft.

ALIGNING THE RECEIVER

The use of a signal generator is very desirable for trimming the Home Midget Battery Receiver and, as in the case of the Personal Portable, the constructor who does not own a generator is advised either to borrow a generator or to have the set aligned by an expert.

A chart is supplied with the B5 coilpack, showing the location of the trimmer screws and core-adjusting screws. Adjustments to the pack, and to the transformers, should always be made delicately, and no attempt made to force screws beyond their extent of travel. (For constructors' convenience the B5 location chart is shown in Fig. 12.)

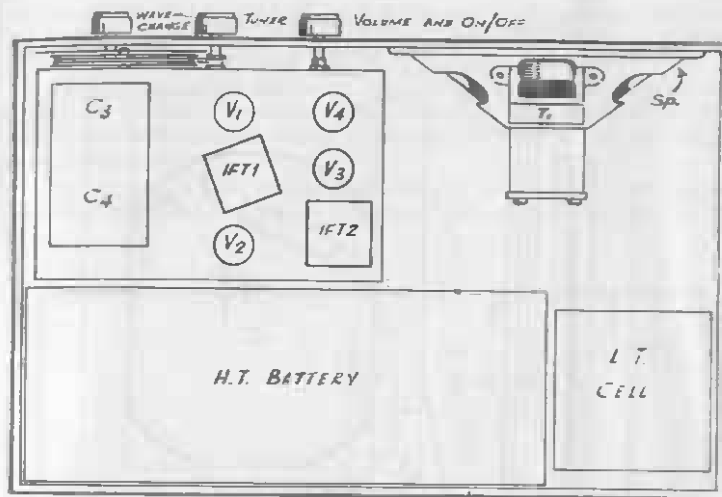

Fig. 9. Plan of the Home Midget Battery Receiver

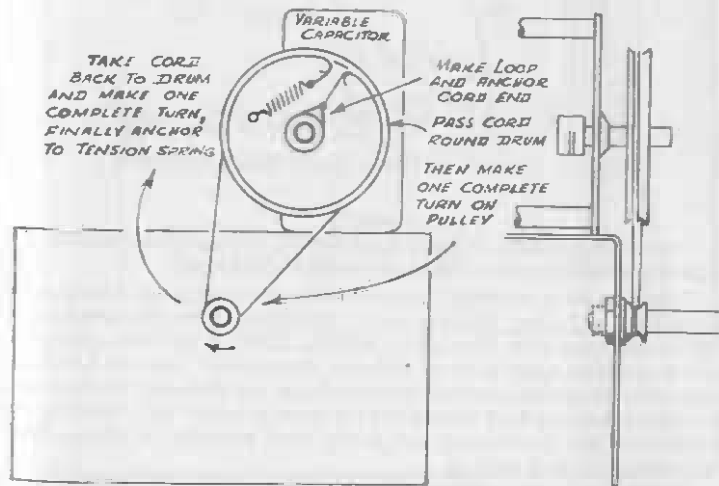

Fig. 10. The Cord Tuning Drive

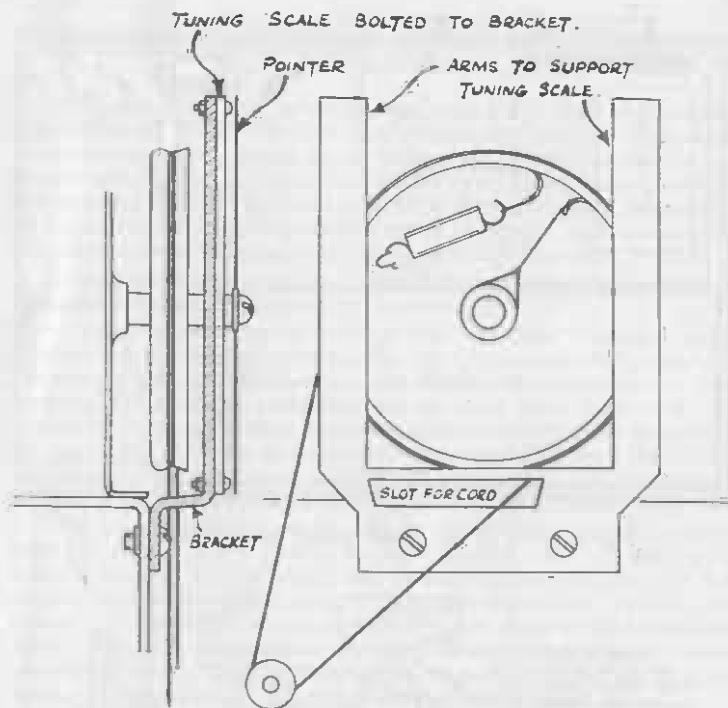

Fig. 11. Details of Tuning Scale Mounting Bracket

The switch positions, 1, 2 and 3, correspond with the short, medium and longwave ranges, position 1 being extreme anti-clockwise.

When the set is completed and assembled, after a thorough wiring check, switch on the receiver and the signal generator. Tune the generator to 465 kcs. and connect it, through its artificial aerial, to the third grid of V1, point 6, and the chassis or earth socket of the receiver. Trim the I.F. transformers for maximum response, commencing at the secondary of the second transformer and working through to the primary of the first, reducing the generator output in the usual way as the work proceeds, so that as small a signal as possible is used.

With the I.F. transformers aligned, transfer the signal generator leads to the aerial and earth input sockets of the receiver, switch the set to the

medium waveband and tune both set and generator to 230 metres, 1304.3 kcs. Adjust the 2o trimmer for maximum volume, then adjust the 2a trimmer for any further increase in volume possible.

Tune receiver and generator to 500 metres, 600 kcs., and adjust the 2o core for maximum response, whilst rocking the main tuning to and fro. Then retune both set and generator to 230 metres and correct the 2o trimmer as may be necessary.

Correct the 2o core setting at 500 metres, and retrim at 230 metres, repeating the procedure until one adjustment fails to have any effect on the other.

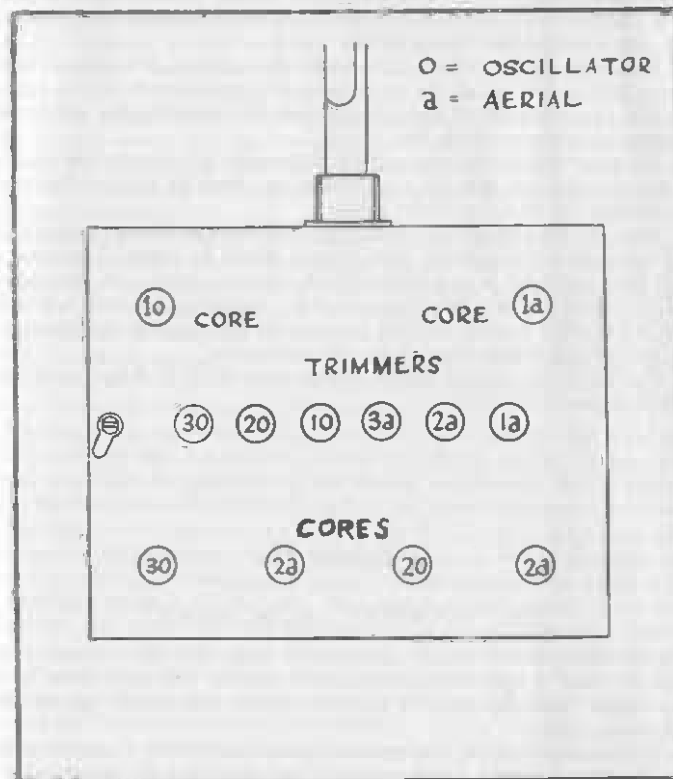

Fig. 12. Rear Adjusters on the B5 Coilpack

Switch the receiver to position 3 for long waves, and trim and pad the longwave range in the same manner, using the 3a trimmer and 3a core, with an adjustment on the 3a trimmer. Trim at 900 metres, 333.3 kcs, and pad, using the core adjustment, at 1740 metres, 172.6 kcs.

Switch the receiver to position 1 for shortwaves, and trim at 17 metres, 17.64 Mcs., using the 1a trimmer with an adjustment for maximum response on the 1a trimmer, and pad at 45 metres, 6.66 Mcs., using the 1a core.

Now disconnect the generator and connect in the aerial and earth to the receiver, switching to the medium waveband. Tune in a fairly weak signal at about 230 metres and adjust trimmer 2a for any possible increase in volume. Then tune the set to a station at about 500 metres and by adjusting the 2a core, see if any increase in volume can be made. Return to the station at about 230 metres and correct the trimmer setting if necessary, then check the core setting on the 500 metres station.

Repeat on the longwaves, using a station at about 1,000 metres—or the Airmet station—to adjust the 3a trimmer and a longwave station such as Moscow 1 on 1724 metres to adjust the core 3a, balancing the adjustments for good reception over the dial.

Switch to the shortwaves and adjust trimmer 1a on a station at about 17 metres, adjusting core 1a on a station at about 45 metres. Shortwave adjustments will be found rather sharp.

Note that the chassis may be secured to the cabinet floor by means of the bent-over edges of the chassis walls; holes should be drilled in the case for small mounting bolts to pass through both case and chassis feet. The cabinet may have small feet or battens to mount it at a height to clear these bolt heads, or, if thick wood is used, the bolt holes in the case may be countersunk so that the bolt heads are recessed into the workwork.

The aerial and earth leads are passed over the H.T. battery and down to their respective sockets.

Chapter III

THE "FOUR-WAY" AC/DC MIDGET

THERE are probably many constructors who, like the present writer, prefer to build a separate, self-contained receiver for each room in the house where radio reception is required, rather than install an extension loudspeaker system.

To be comprehensive, the speaker system should have a remote control at each point, besides a volume control, and even then the whole chain of speakers is limited to the single station to which the main receiver is tuned.

The use of separate receivers allows listeners in different rooms to choose their favourite programmes, and for bedrooms, a guest room, and in cases of illness, individual receivers are invaluable.

One of the greatest drawbacks in the construction of individual receivers is the provision of a number of cabinets, and the question of size must also receive some consideration. The largest components in an AC/DC set are the tuning capacitor and its drive; accommodating the tuning scale in the cabinet and providing a tuning window further complicate the cabinet work to no small degree.

Dispensing with manual tuning altogether is the obvious solution: the cabinet can then be both small and very plain, and the initial cost of the receiver can be reduced. Preset tuning using separate coils and switched trimmers and padders presents difficulties in layout and the prevention of feed-back, however a new switched tuning unit, produced by Messrs. Electro Technical Assemblies, Eta Works, West Hill, St. Leonards-on-Sea, Sussex, considerably simplifies the construction of a 4-station superhet receiver. One longwave and three mediumwave stations may be selected (each station at any point in its band: complete band coverage of the medium and long ranges is given), and since small individual receivers are used almost exclusively for reception of the local or home stations the four tuning points are perfectly adequate.

In the Eta tuner four aerial coils and four oscillator coils are grouped round a small 4-way selector switch. The coils are tuned by long core screws which move iron dust cores along the entire coil lengths, the screws being colour-coded. The two red screws tune over the longwave band with the blue, green and pink screws covering the medium waveband. At no time should any screw be forced beyond its extent of easy travel; it will be found that there is no necessity, in practice, to have the screws very far extended unless a very longwave station in either band is being tuned.

Looking at the rear of the unit, the oscillator coils lie to the right and the aerial coils to the left. Looking at the front or spindle side of the unit, the extreme anti-clockwise position of the spindle switches in the longwave station, the three following position selecting the three mediumwave stations.

The circuit of the receiver is shown in Fig. 13 (where uncoded coils and capacitors are those included in the tuning unit), and it will be seen that the circuit is, in the main, conventional except for the anti-parasitic resistors in the screen-grid leads of V1 and V2. In mains-operated midget sets where components and valves are close together the use of such resistors is highly recommended: in several cases it will probably be found by the experimenter that they may be omitted without any effect on circuit operation, but if they are built in as a matter of course they may save a considerable waste of time in tracing feed-back and parasitic oscillation.

The stopper in the grid circuit of the output valve may be considered as essential, not only in midget but in larger receivers. This resistor, like the anti-parasitic screen resistors, should be mounted right at the appropriate

valveholder pin; when it is to be connected to a top cap grid, as in the receiver, the stopper should be in the grid lead and supported by the top cap clip.

COMPONENTS LIST FOR THE "FOUR-WAY" AC/DC MIDGET, FIG. 13.

C1	300 pfs. mica. T.C.C. Type CM20N.
C2, C3, C6, } C7, C8, C9 }	0.1 mfd. 500 v.w. tubular. T.C.C. 543.
C4, C5, C10, C11	100 pfs. mica. T.C.C. Type CM20N.
C12, C17 (C18, Optional)	0.01 mfd. 500 v.w. tubular. T.C.C. 543.
C13	50 mfd. 25 v.w. Electrolytic. T.C.C. Type CE18C.
C14	10 pfs. Silver-mica. T.C.C. Type SMWN.
C15	16 mfd. 350 v.w. Electrolytic. T.C.C. Type CE19L.
C16	8 mfd. 450 v.w. Electrolytic. T.C.C. Type CE19P.
R1, R12	220,000 ohms, $\frac{1}{2}$ watt.
R2	22,000 ohms, $\frac{1}{2}$ watt.
R3, R7	33,000 ohms, $\frac{1}{2}$ watt.
R4, R9	10 ohms, $\frac{1}{2}$ watt.
R5	220 ohms, $\frac{1}{2}$ watt.
R6	47,000 ohms, $\frac{1}{2}$ watt.
R8	68,000 ohms, $\frac{1}{2}$ watt.
R10	4,700 ohms, $\frac{1}{2}$ watt.
R11	330 ohms, $\frac{1}{2}$ watt.
R13	470,000 ohms, $\frac{1}{2}$ watt.
R14	1 megohm volume control.
R15	10,000 ohms, $\frac{1}{2}$ watt.
R16	180 ohms, $\frac{1}{2}$ watt.
R17, R18	1 megohm, $\frac{1}{2}$ watt.
R19	200 ohms. 1 watt for 250 volts mains. 100 ohms. 1 watt for 230 volts mains. Omit for 200-210 volts mains.
R20	0.2 amp 3-way line cord. Adjust to pass 0.2 amp. through heaters, or cut to resistance, 963 ohms for 250 volts mains, 863 ohms for 230 volts mains, 763 ohms for 210 volts mains. (16 feet of 60 ohms per foot line cord, for 250 v.)
I.F.T.1, 2	465 kcs. I.F. transformers, Weymouth, Type P4 (I.F.T.1 with flying lead.)
Eta Tuning Unit	Type TS41.
Sp. with T1	Elac 5" permanent magnet moving coil speaker, with transformer matched to 4,500 ohms anode load.

L.F.C.	25 henries 60 mAs. 560 ohms L.F. choke. Partridge Type C25/60/VSE.
Rec.	S.T.C. SenTerCel rectifier, Type RD18-9-L.
V1	Mullard CCH35.
V2	Mullard EF 39.
V3	Mullard CBL31.
3 International octal chassis mounting valveholders.	
SI, a-b	2-pole On-Off switch, ganged with R14.
Chassis, cut and bent from sheet aluminium to size, and drilled as shown, in Fig. 14, with bracket for R14.	
Aerial socket, Belling-Lee L315 with plug L1021/3.	
2 Control knobs.	
3 Grid caps.	
Wire, sleeving, solder, nuts, bolts, etc.	

CONSTRUCTING THE "FOUR-WAY" RECEIVER

The first step in the construction of the "Four-Way" receiver is to cut out and drill the chassis to the dimensions shown in Fig. 14. It will be noted that in most of the designs shown in this Manual the chassis is not a 'standard' component which may be bought from a retailer, but this should not deter the prospective constructor. Sheet aluminium of suitable thicknesses may be bought in sheets of 6' x 3', at the present time, quite cheaply, and several chassis can be cut from such a sheet with a fine-bladed hacksaw. This is, undoubtedly, the cheapest method of procuring chassis, whilst at the same time the constructor can build exactly what is required without the need for adapting or altering the design and layout of the set as sometimes is the case when a standard chassis is obtained. All constructors should have a wheel brace, with an assortment of drills, for drilling out screw-holes, etc., and a chassis punch for each size of valve used (generally an octal punch, diameter $1\frac{1}{8}$ ", and a B7G punch, diameter $\frac{3}{8}$ ", will suffice) with, possibly, a tank cutter for taking out holes between $1"$ and $2\frac{1}{2}"$ in diameter (the tank cutter is used in a plain brace) make up a single and quite inexpensive tool-set with which practically any chassis work can be executed. Useful additions to the kit are taps and a tap holder for threading holes 4, 6 and 8 B.A.; dies and a dieholder are hardly ever required.

Note that in the "Four-Way" receiver the chassis slopes backwards, the front edge being $1\frac{1}{2}"$ high and the rear edge $15/16"$ high. This is to bring the controls out of the cabinet face at a slight angle, as it is suggested that the face of the cabinet, as well as the sides, should be sloped gently to improve the appearance of the receiver. The internal dimensions and general shape of the cabinet are shown in Fig. 15; internal dimensions are always given, rather than external dimensions, in order that any thickness of wood which may be to hand can be employed.

Both controls of the set are mounted above the chassis. The tuning unit is bolted down on the right-hand side of the chassis by means of the two

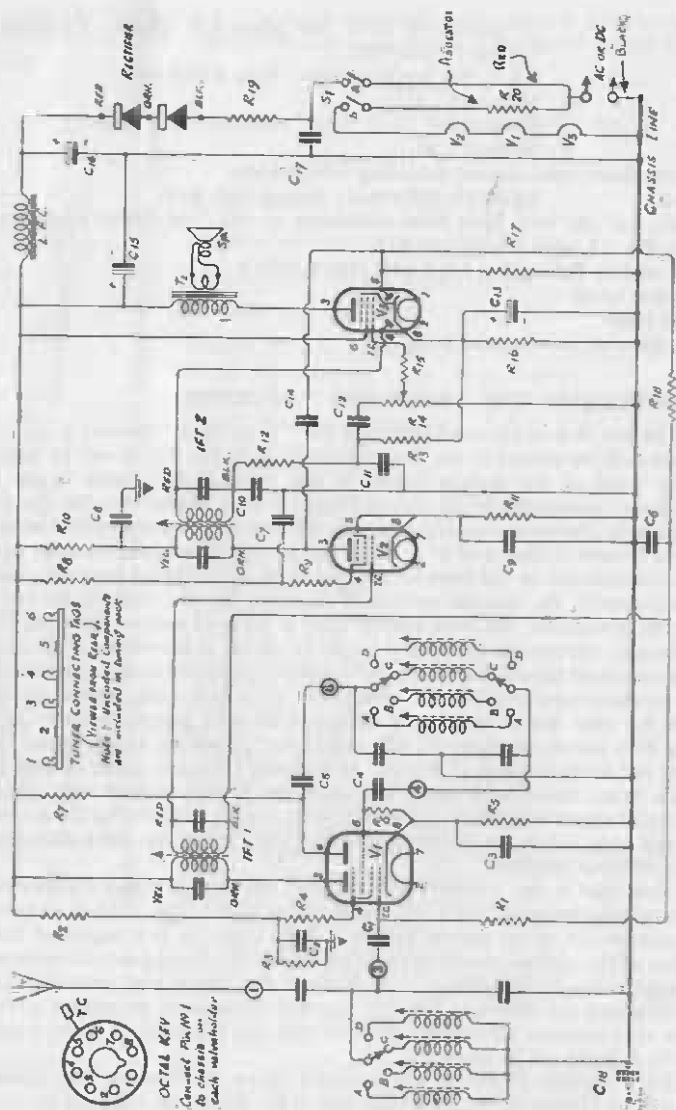

Fig. 13. The "Four-Way" AC/DC Midget

bolt holes provided in the unit, and to bring the On-Off volume control spindle on to the same level this component is mounted on a simple bracket or strip of aluminium sized $2\frac{1}{2}'' \times 1\frac{1}{2}''$, which is in turn bolted on to the front edge of the chassis.

The valveholders, choke, tuning unit and I.F. transformers, with the aerial socket, may be bolted down before wiring is commenced; the height of the choke protects the transformers and tuning unit when the chassis is inverted for wiring. The volume control on its bracket should not be mounted until wiring is almost completed, however, to prevent bending the bracket.

Note that two main components are mounted on the woodwork of the chassis, the loudspeaker bearing the output transformer, T1, and the SenTerCel rectifier. The speaker is mounted on the front face of the cabinet behind a suitable cut-out or fret, whilst the rectifier is mounted on the left-hand wall of the chassis looking in from the rear, at any convenient height which clears the valves. Avoid mounting the rectifier on the right-hand wall where it would be held in a constant stream of hot air from the CBL31. The rear of the cabinet should be either open, or of well-slotted card or wood, to provide adequate ventilation.

The rectifier, RD18-9-1, is provided with a mounting foot through which two woodscrews are driven into the wall of the receiver case. The long axis of the rectifier should be horizontal so that there is an airflow round all the fins. In some localities there may be a little difficulty in obtaining this type of rectifier, although a good store should be able to order it; in the event of difficulty, Messrs. Standard Telephones & Cables Ltd., Rectifier Division, Oakleigh Road, New Southgate, London, N.11, may be contacted direct.

Before wiring the chassis the three electrolytic capacitors, C13, C15 and C16 should be mounted below the top deck in the angle of the chassis and front wall, the position shown by the dotted circle in the chassis section of Fig. 14. The capacitors are held in place by strips of aluminium or brass bent round the cans and bolted to the chassis; drill holes are not shown on the drilling plan as these may be placed in positions to suit the strips of metal or, alternatively, the clips may be fastened under existing bolts—those holding the tuning unit and the choke, for example.

The capacitors have insulating sleeves fitted; these should not be removed and care must be taken to see that in each case the capacitor's negative tag is connected directly to the chassis. This is sometimes overlooked by constructors more used to the 'earthed-can' type of capacitor.

The tuning unit is earthed automatically by the two fixing bolts, and the two earthing tags, Nos. 2 and 5, need not be connected to the chassis.

Under one fixing bolt of each valveholder, I.F. transformer, choke, etc. should be secured a soldering tag to provide a good number of earthing points.

Wire the valve-heater circuits first, keeping the leads pressed up against the chassis so that they have a measure of shielding and are also out of the

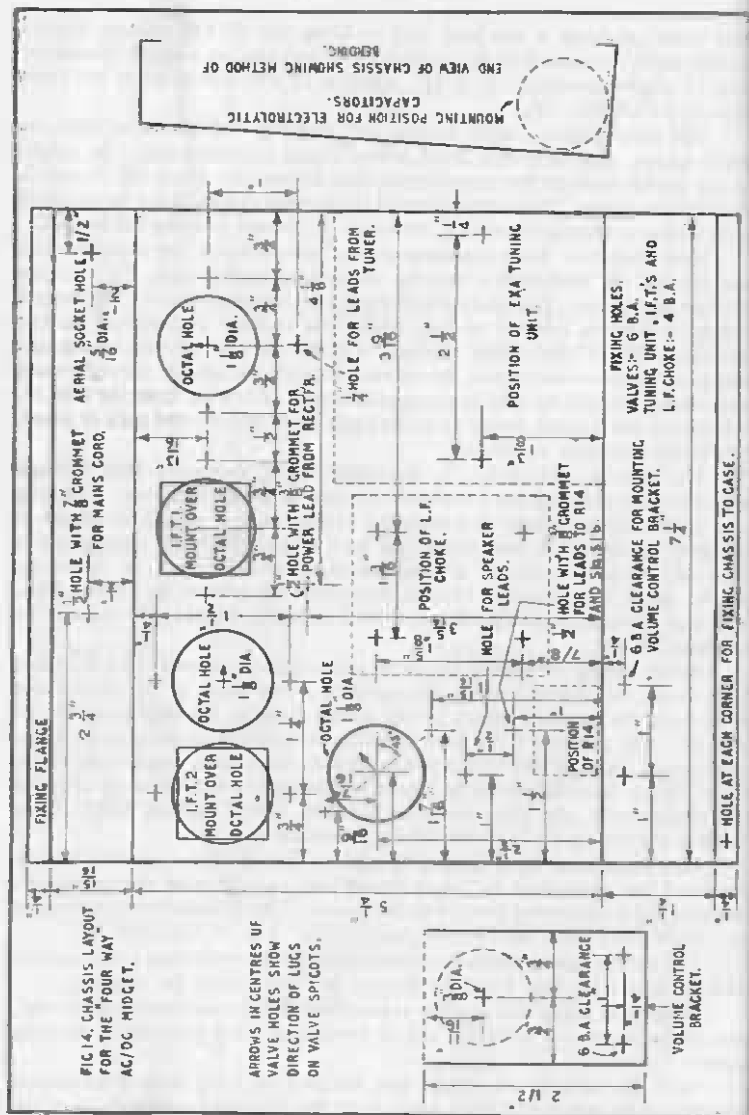
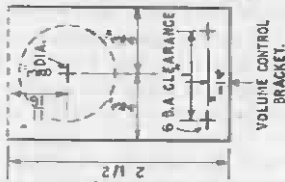

FIG. 14. CHASSIS LAYOUT FOR THE FOUR WAY AC/DC MIDGET.

ARROWS IN CENTRES OF VALVE HOLES SHOW DIRECTION OF LUGS ON VALVE SPICOTS.



way of other components, then wire from the aerial socket on to the output and power stage. On A.C. and properly wired D.C. supplies the receiver is automatically earthed, but if a direct earth connection is required this must be taken through C18, shown dotted in Fig. 13. The earth socket should be placed beside the aerial socket on the rear chassis edge.

Whilst the chassis is not very deep, adequate room for components will be found. Components are mounted in the wiring, using in most cases the component wire leads as the connections between circuit points.

H.T. anchoring points are the yellow tag on I.F.T. 1 and the screen pin, No. 6, on V3.

The line cord should not be fitted until the receiver is practically complete. Inside the receiver, where the cord passes into its grommetted hole in the rear chassis edge, it should be secured under a small clip bolted in by the left-hand fixing bolt of I.F.T. 1. The clip can be cut from a scrap of sheet-metal; ensure that there are no sharp edges which might cut the cord insulation. Of the three leads in the line cord the negative (D.C.) or neutral (A.C.) is taken direct to the chassis, the 'live' lead is taken to the first switch section, S1a, and thence to C17 and R19, whilst the resistance element is taken to S1b and thence to the valve heaters. At the supply or plug end of the line cord the 'live' line and the resistance lead are, of course, connected together to the 'live' plug pin.

The leads from the receiver to the rectifier pass through a hole in the chassis top deck and this hole, like the hole behind the volume control mounting allowing the power line and volume control leads to pass through the chassis, should be fitted with a rubber grommet. The leads to the rectifier must be of rubber-covered flex, as with the loudspeaker leads which pass through another hole, protected by a grommet, beside V3.

The leads to the L.F. choke pass through the same holes as the rectifier leads.

R19 must be well insulated, but is small and light, and so does not need a special mounting. It can be connected and firmly sweated to the black rectifier tag and so supported above the chassis, the lead from S1a and C17 coming up to R19 for anchorage.

When making connections to the rectifier avoid over-heating this component with the soldering iron. The rectifier tags and leads should be well tinned before the joint is made.

TONE CONTROL

Some constructors may find the high note response of this receiver to be a little too accentuated, in which case a fixed tone control may be fitted. One method of control is to take a capacitor direct from the anode of V3 to chassis, adjusting the capacitance to give the effect desired; a value of 0.004 mfd. will be found a suitable starting point.

A second method of control is to use larger value capacitors for C10 and C11; 1000 pfs. mica capacitors in place of the specified 100 pfs. should serve.

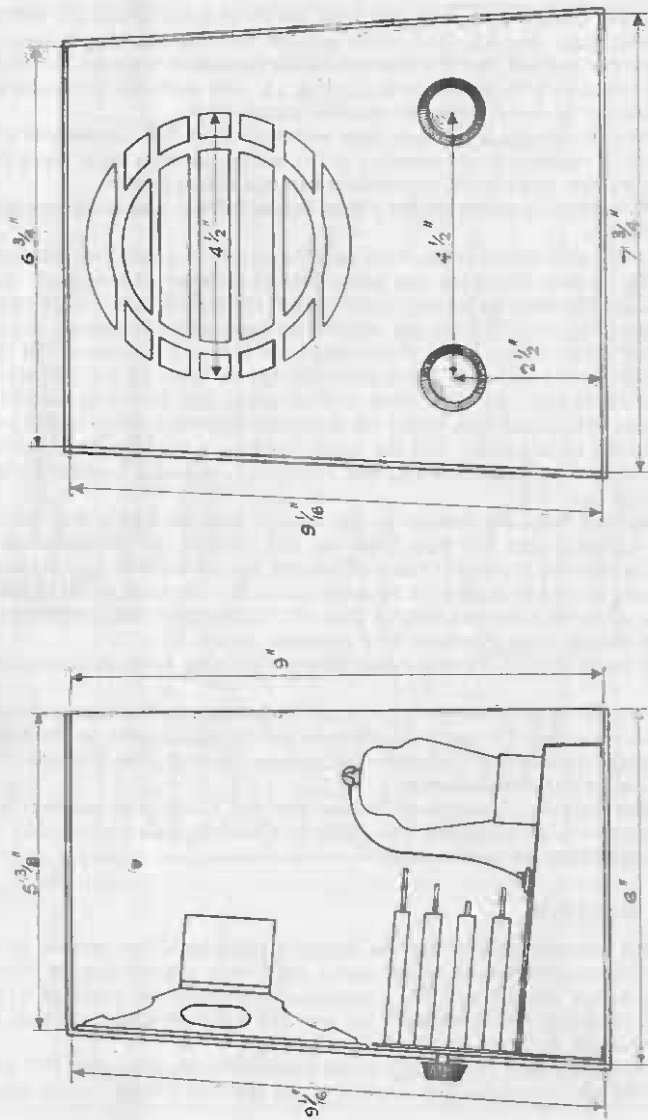

Fig. 15. Side and Front View of the "Four-Way" AC/DC Midget. All Dimensions are Internal

ALIGNING AND TUNING THE RECEIVER

When the receiver is completed and the wiring carefully checked it may be switched on and aligned. A point of interest to many constructors is that the "Four-Way" receiver can be tuned to the selected four stations without employing a signal generator, if this should not be available.

The switch positions, A.B.C.D. commence at the left, the extreme anti-clockwise position. A. is the longwave position, B., C. and D. the medium-wave positions. At position B. should be tuned the longest wavelength station in the medium band, the second and third longest wavelengths in the medium band being selected on points C. and D. respectively.

If a signal generator can be employed for the receiver alignment, switch the unit to A. and feed in a 465 kcs. signal to the aerial and earth sockets. If no earth socket is used connect the generator earth lead to the receiver chassis.

Trim the LF transformers for maximum response, commencing with the secondary of the second I.F. transformer and working back to I.F.T.1. Reduce the generator output, as the transformers come into tune, to a point where the signal can just clearly be heard.

With the transformers aligned, set the signal generator to the frequencies of the four stations required, tuning the generator and adjusting the coil cores of the tuning units at the appropriate switch positions. Adjust the oscillator core first, in each case, until the signal is heard, then bring up the volume with the aerial coil core. The oscillator cores are at the right, the aerial cores at the left.

Disconnect the signal generator and connect in the aerial (and earth if used). Switch the tuner to its four positions to ensure that the required stations are heard, and at each position make a further correcting adjustment to the aerial coil cores—a slight re-adjustment to the oscillator cores may also be tried.

When a signal generator is not available connect the aerial through a 0.1 mfd. capacitor directly to the grid top cap of V1 and leave the I.F. transformers tuned as obtained from the manufacturers. Switch the unit to position A. (unless the longwaves are received poorly in the constructor's reception area, when the unit should be set to position C.) and, adjusting first the red oscillator core and then the red aerial core (the green cores for position C.), endeavour to tune in a signal.

When a signal is obtained, trim up the I.F. transformer cores, one by one, to increase the volume.

If no signal can be obtained set the I.F. transformer cores to their midway positions by carefully unscrewing each core to its limit, then screwing each core fully home, counting the number of turns necessary. Do not use force. Then unscrew each core half the number of turns taken to drive it fully home; this sets the cores to a midway position.

Again endeavour to receive a station on the red or green cores, and when a signal is tuned make a final adjustment to the LF. transformer cores to improve volume as much as possible.

Switch the unit over its four positions and tune in at each the required station, adjusting first the oscillator core, then the aerial core, step by step. With the four stations tuned, transfer the aerial connection to its correct socket, removing the 0.1 mfd. capacitor, and correct each core setting slightly as may be found necessary.

The aerial and oscillator cores are kept in step, when searching for stations, by making the aerial core protrude from its coil to about the same extent that the oscillator core protrudes from the oscillator coil.

On the original model of this receiver it was found that good reception could be obtained on a very small aerial, but the aerial used will, of course, be determined by the reception location where the set is used, and also by the requirements of the chosen stations as regards their distance, power, and ease of reception.

A considerable advantage given by this type of tuner is the ease with which interfering signals may be eliminated, whether these are of the heterodyne type which cause whistles or of the I.F. break-through type, often found in coastal locations where Morse signals are heard as a background to the station programme.

Using the oscillator core tuned to the station where interference is most marked detune the oscillator by turning the core in or out so that the whistle note, on heterodyne interference, becomes higher in pitch. Retrim the I.F. transformers for greatest volume. If the interference is still present make a further re-adjustment by the same process, until the station is heard clearly without interference.

Finally re-adjust the other oscillator cores, turning through the switch positions one by one, until all the required stations are again received.

Chapter IV

A T.R.F. MIDGET

A MIDGET T.R.F. receiver is both simple and economical to build and, although there would appear to be a widespread conviction that a T.R.F. receiver is not capable of tuning sufficiently sharply for good reception under modern conditions the circuit shown in Fig. 16 has given excellent results both as regards selectivity and, equally important, tone.

Unlike many T.R.F. sets this circuit provides for tuning over both the medium and longwave bands, and foreign station reception on an indoor aerial has proved surprisingly good under normal evening conditions.

An outdoor aerial is to be preferred for any type of receiver, for apart from the poor signal strengths provided by the average indoor aerial there

must also be taken into account the fact that an indoor aerial is almost always well within the interference field inevitably set up around house wiring. This results in noisy reception, with crackles and other mains noises swamping the station programme. Nevertheless, many midget receivers are built and used in preference to normal-sized receivers by owners who live in flats and apartments, where outside aerials are impractical, and for this reason the midgets described in this Manual have all been tested on a very small and inefficient indoor aerial.

In the majority of cases, unless reception conditions are very poor, it will be found that a length of wire draped from the receiver behind its table or other support will serve as an aerial.

Apart from the 2-waveband coverage the circuit of the T.R.F. Midget has been based on the popular American midget set design. The first valve acts as an R.F. amplifier, the volume control being incorporated in this stage since R4 is a variable resistor which controls the bias on the R.F. stage.

The signal from the first stage is passed by an inductive coupling to the detector-audio amplifier, V2. V2 is an anode bend detector; R8 biases the valve back so that only a small anode current flows, when negative half-cycles have no effect on the current through the valve. The current is, however, increased by positive half-cycles, and thus the valve detects or demodulates the signal.

V3, the output valve, is connected via a normal capacitive coupling and a grid stopper to the anode of V2. The by-pass capacitor C16 from the anode of the output valve to chassis acts both as a tone corrector and as an R.F. by-pass capacitor, filtering out any trace of R.F. which may be amplified and passed by V3. Omitting C16 sometimes results in instability over the longwave band.

COMPONENTS LIST FOR THE T.R.F. MIDGET RECEIVER

L1, L2	Weymouth CT2W2 coils. (Ignore reaction windings points 4 and 6 on H.F. coil.)
C1	100 pfs. mica. T.C.C. Type CM20N.
C2, C3, C8, C9 ..	3-30 pfs. trimmers. Mullard-Philips concentric.
C4, C10	500 pfs. variable 2-gang capacitor. Jackson Bros., Type E.
C5, C6, C7, C11	0.1 mfd. 350 v.w. tubular. T.C.C. 346.
C12, C15	25 mfd. 25 v.w. Electrolytic. T.C.C. CE32C.
C13	500 pfs. mica. T.C.C. Type CM20N.
C14, C19	0.01 mfd. 500 v.w. tubular. T.C.C. 543.
C16	0.001 mfd. mica. T.C.C. Type CM20N.
C17, C18	16 plus 8 mfd. respectively, 450 v.w. T.C.C. Type CE28P.
R1	68,000 ohms, $\frac{1}{2}$ watt.
R2	10 ohms, $\frac{1}{2}$ watt.
R3	330 ohms, $\frac{1}{2}$ watt.
R4	20,000 ohms, variable. Volume control.
R5, R10	10,000 ohms, $\frac{1}{2}$ watt.

- R6 1 megohm, $\frac{1}{4}$ watt.
 R7, R9 220,000 ohms, $\frac{1}{4}$ watt.
 R8 22,000 ohms, $\frac{1}{4}$ watt.
 R11 180 ohms, $\frac{1}{4}$ watt.
 R12 3-way 0.2 amp. line cord. Adjust to pass 0.2 amp. through valve heaters, or cut to resistance:—
 922 ohms for 250 volts mains.
 822 ohms for 230 volts mains.
 722 ohms for 210 volts mains.
 (Approx. 16' of 60 ohms per foot line cord, for 250 v.)
 Sp. with T1 .. 5" Elac permanent magnet speaker with transformer to match to 4,500 ohms anode load.
 L.F.C. Small L.F. choke, 10 henrys, 60 mAs., 250 ohms approx. See text.
 V1 Mullard EF39.
 V2 Mullard EF37.
 V3 Mullard CL33.
 V4 Mullard CY31.
 4 International octal chassis mounting valveholders:
 S1, a-b 2-pole double pole wavechange switch, rotary. Messrs. Walter Instruments Ltd.
 S2, a-b 2-pole on-off switch, ganged with R4.
 Chassis, cut and bent from sheet aluminium, finished-size 8" x 4 $\frac{1}{2}$ " x $\frac{1}{2}$ ". drilled as in Fig. 17.
 3 Control knobs (2 round, 1 pointer type).
 2 grid clips; 1 crocodile clip.
 Wire, sleeving, nuts, bolts, solder, etc.

CONSTRUCTING THE T.R.F. MIDGET RECEIVER

Commence by cutting, drilling and bending the chassis as shown in Fig. 17. Note the cut-out portion which allows the loudspeaker to be set into the chassis; should a different speaker from that specified be used the shape and size of the cut-away segment may need altering.

The variable capacitor is mounted on the right-hand side of the chassis (looking from the front), and it must be noted that direct drive is used in this receiver. A slow-motion drive, employing a cord drive and a drum on the tuner spindle as used in the Home Battery Midget may be fitted, but direct drive will be found perfectly satisfactory.

The chassis will suit many of the undrilled midget receiver cabinets to be obtained on the market at the present time. These cabinets are generally of wood, sometimes finished and sometimes plain, and the constructor can drill the face, and cut out the tuning window to suit his own receiver. The tuning window of this receiver should contain a 2-waveband dial for the ranges 200-550 metres and 800-2,000 metres, the dial being of perspex or

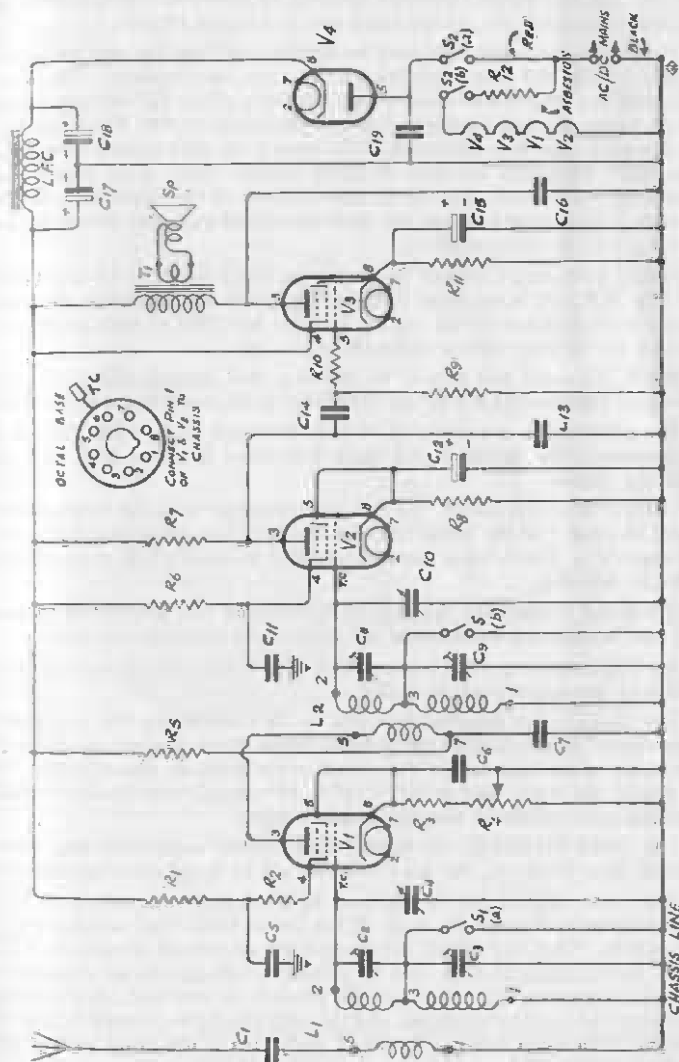

Fig. 16. The T.R.F. Midget

celluloid. The dial should be drilled centrally to allow the tuning spindle to pass through it, when the pointer knob acts as a tuning pointer.

If required the tuning dial may be illuminated from the rear by introducing a 6.3 volt 0.3 amp. bulb behind the translucent material. The bulb can be held in a bulb holder mounted on the frame of the variable capacitor, the bulb being connected between S2b and the heater of V4. The resistance of the line cord should be decreased by 20 ohms if the bulb is used. The bulb holder must have both contacts insulated so that there is no connection between the bulb circuit and the grounded frame of the capacitor; *this is important*. Connection between the bulb circuit and capacitor frame would result in a serious short-circuit.

Behind the tuning capacitor on the chassis top is mounted L1, the aerial coil. The H.F. coil is mounted horizontally below the chassis, so that the coils are both screened by the chassis material and held at right angles, so that there is very little chance of feed-back.

Below the aerial coil should be drilled a hole through the chassis to allow a lead from point 3 of this coil to be taken to the wavechange switch S1a.

The valveholders are mounted in their positions, and wiring may then be commenced, the heater wiring being connected first and kept well up against the chassis.

There is no aerial socket. C1 has its connecting leads cut short and is sweated to point 5 of the aerial coil, the crocodile clip being sweated to the other tag of C1. The aerial is then brought into the back of the receiver and secured by this clip.

If a socket is preferred this may be fitted to the rear wall of the chassis and a lead brought up to the aerial coil through a hole in the top deck.

An H.T. anchoring point is provided by pin 4 of the output valve socket, and also by one tag of the L.F. choke.

The choke is not specified by name in the components list as a small 'replacement' type is used in the original model of the receiver which could be fitted on to the rear wall of the chassis in the position shown in Fig. 17. The size of the choke used is $2\frac{1}{2}'' \times 1\frac{1}{2}'' \times 1\frac{1}{4}''$ overall, and similar chokes sometimes even smaller in size, are in good supply.

The choke inductance, 10 henrys, is a smaller value than that often specified, 20 or 25 henrys, but the smoothing will be found quite satisfactory.

The choke should not be mounted in place until the wiring of V3's socket is completed since the body of the choke masks the valveholder to some extent. When the choke is mounted the smoothing capacitors, C17, C18, in their single can may also be mounted, and the wiring completed. The linecord is passed into the chassis via a hole in the rear wall, which should be protected by a rubber grommet, and the cord should be gripped by a small clamp cut from scrap metal and secured under one of the fixing bolts of the V1 holder.

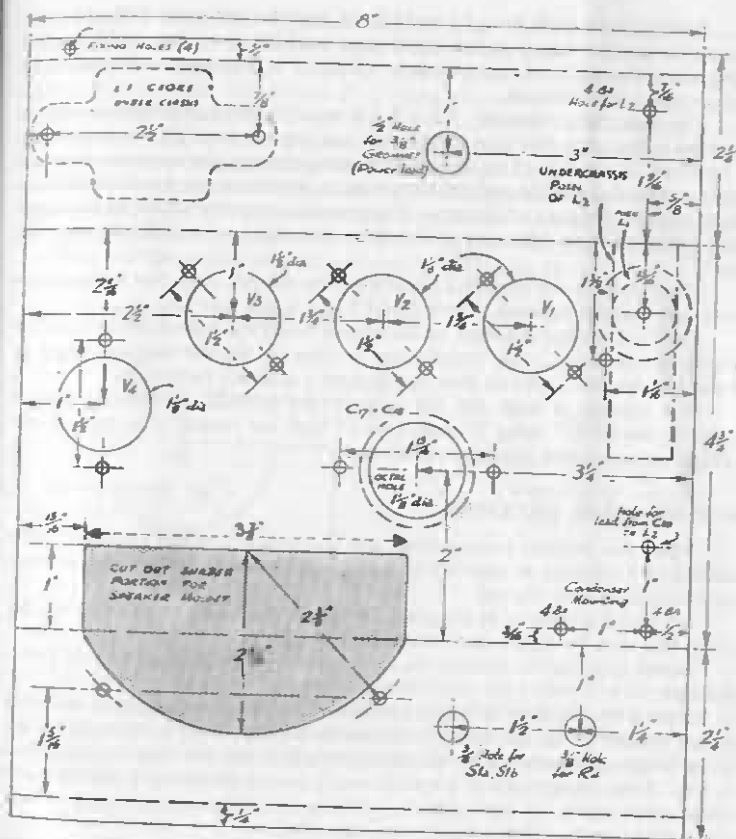
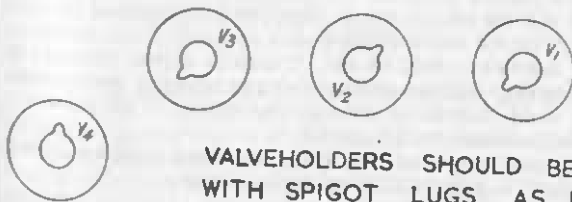

Fig. 17. Chassis Dimensions for the T.R.F. Midget



VALVEHOLDERS SHOULD BE MOUNTED WITH SPIGOT LUGS AS INDICATED.

Although the leads from L1 and L2 run together for some little distance to reach the wavechange switch there is no need for screening, and screened lead was not used for the grid leads to V1 and V2; ordinary rubber-covered flex proved quite suitable.

The concentric trimmers, C2, C3, C8 and C9 may be difficult to obtain in some areas since this type of trimmer has not yet received the popularity it deserves. It consists of two sets of concentric sleeves, the upper set running down a threaded spindle and meshing with the lower set, the capacitance thus being variable between wide limits. If concentric trimmers cannot be obtained then postage stamp trimmers of the same maximum value, 30 pfs., may be used.

The trimmers are mounted directly across the coil tags, two trimmers to each coil sweated between points 2 and 3 and 3 and 1.

The loudspeaker is bolted to the chassis when the rest of the circuit and wiring is completed. The transformer is mounted on the speaker-frame in the model specified, and so does not require a separate mounting.

If a cabinet is built for the receiver the internal dimensions should approximate to 8½" long, 5" deep and 7" high, or larger. The rear of the cabinet should allow adequate ventilation.

ALIGNING THE RECEIVER

When the receiver is assembled and the wiring checked carefully, with the linecord adjusted to pass 0.2 amp through the valve heaters, the set may be switched on and aligned.

No signal generator is required; it is only necessary to connect up the aerial and trim the tuned circuits on station signals.

Before aligning the receiver the four trimmers should be set to a mid-way position.

Switch the receiver to the mediumwave band—it is suggested that the switch rotated to the left brings in the medium and rotated to the right brings in the longwave bands. Some care must be taken over the switch wiring, and in Fig. 18 the connections to a typical rotary switch are shown from the rear; some constructors of the author's previous designs have confused switch connections and so obtain faulty wavechanging.

Tune in the local home programme which should be clearly heard with the trimmers in the midway positions. If the station cannot be tuned vary the position of C8 until the signal is found. Then check the indicated position of the tuning point on the dial with the correct position; if the pointer is set to too high a wavelength, both C8 and C2 must be slightly increased in capacitance, turning the variable capacitor back and adjusting the trimmers till the station is tuned correctly on the right dial setting. If the pointer is too low reduce the capacitance of C8 and C2.

Then tune in a weak station at the low wavelength end of the tuning dial and, without varying C8, adjust C2 for maximum volume.

This sets the mediumwave band.

Switch to the longwave band and tune in the Light programme on 1,500 metres. Again check the setting of the tuning pointer on the dial with the correct wavelength and, if the pointer is set to too high a wavelength, slightly increase the capacitance of C9 and C3, which will allow the main tuning pointer to be brought back to the correct setting. If the reading is too low in wavelength, reduce the capacitance of C9 and C3, so allowing the main tuning control to be slightly advanced to the correct position.

Then either tune to a station at the low wavelength end of the dial, or if such a station cannot be found use the Light programme with the volume control turned well down and, without varying C9, adjust C3 for maximum volume.

The receiver is then aligned and may be fixed into its case.

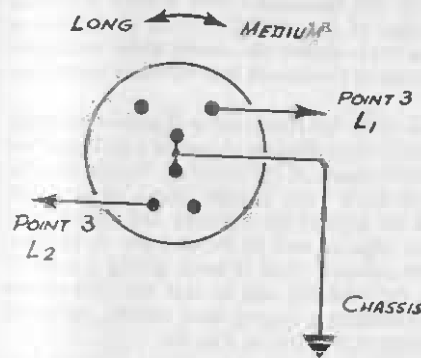

Fig. 18.
Switch Connections for
Wavechanging on the
T.R.F. Midget

The receiver is earthed automatically through the mains and no separate earth connection is provided. Connect the mains plug to the wall socket in the sense which gives least hum, when the chassis will be connected to the earthed or neutral line (on D.C. circuits the set will work only when the red linecord lead is positive).

Chapter V

A "FULL-SCALE" MIDGET AC/DC RECEIVER

WHILST the appearance of the home-built receiver must almost always be a secondary consideration, performance and reliability coming first, there are occasions when the appearance of the cabinet is allied with receiver efficiency, and this is particularly so in the midget receiver tuning arrangements.

One particular cabinet set-out has become practically standard for the smaller receiver; loudspeaker to the left and tuning scale to the right, and the tuning scale, moreover, is generally rather small.

This is of little moment when the set is to tune over the medium and longwave bands only, for then the receiver will be working for a very great part of the time on local and home stations, but when the receiver is made to give shortwave coverage as well, the small tuning scale definitely leaves something to be desired. The "Full-Scale" receiver was designed to give good reception on three wavebands, to use a full-sized tuning scale, and to occupy a cabinet which could be built at home and yet which would give a new appearance to a receiver still small enough to be classed as midget.

There are, accordingly, one or two departures from normal technique in the layout and mechanical design of the set: the circuit is normal, as will be seen from Fig. 19. In Fig. 20 is shown the chassis blank as it must be cut from sheet aluminium, and it is in the chassis that the main innovation occurs.

To use a full-sized tuning scale and a full-sized tuning capacitor generally means that the top edge of the scale is some distance above the top deck of the chassis, giving a considerable overall height to the receiver. To counter this the tuning capacitor, in the "Full-Scale" set, is sunk into a chassis well, bringing the tuning spindle below the level of the top deck and allowing the scale to be mounted on the front edge or wall of the chassis. A straight-through slow-motion drive of the epicyclic type is used, giving a ratio of 6:1, and, so that the scale has full visibility and so that the controls are easily handled, the receiver is mounted in a sloping-back cabinet above the loudspeaker. The cabinet arrangement is shown in Fig. 23.

The circuit uses Weymouth CS3W3 coils which have long, medium, and shortwave coils, all on a single former on both aerial and oscillator coil, these coils therefore saving space to a considerable degree. To avoid undue shielding these coils are mounted above the chassis, the leads from the top connecting tags passing down through the body of the coil and through the chassis via a central hole below the former, the leads from the bottom connecting tags passing through a further hole beside the coil. The leads below chassis from coils to wavechange switch are short and direct. The aerial is coupled in through C_{ae} which may be varied in value to give the best overall results—on a small or inefficient aerial this capacitor may have a value of 0.05 or 0.1 mfd., so that it acts as nothing more than an isolating capacitor to ensure that the aerial cannot be connected through the receiver to the mains, but when a long or very efficient aerial is available it may be found beneficial to reduce C_{ae} to 500 pfs. or so.

Note that the aerial is inductively coupled to the medium and long aerial coils, but that the shortwave coil is coupled in capacitively.

A normal frequency-changer couples into the I.F. stage through a high-Q I.F. transformer, and the wiring of this and the second I.F. transformer must be short and neat. If any I.F. instability should occur and the wiring cannot

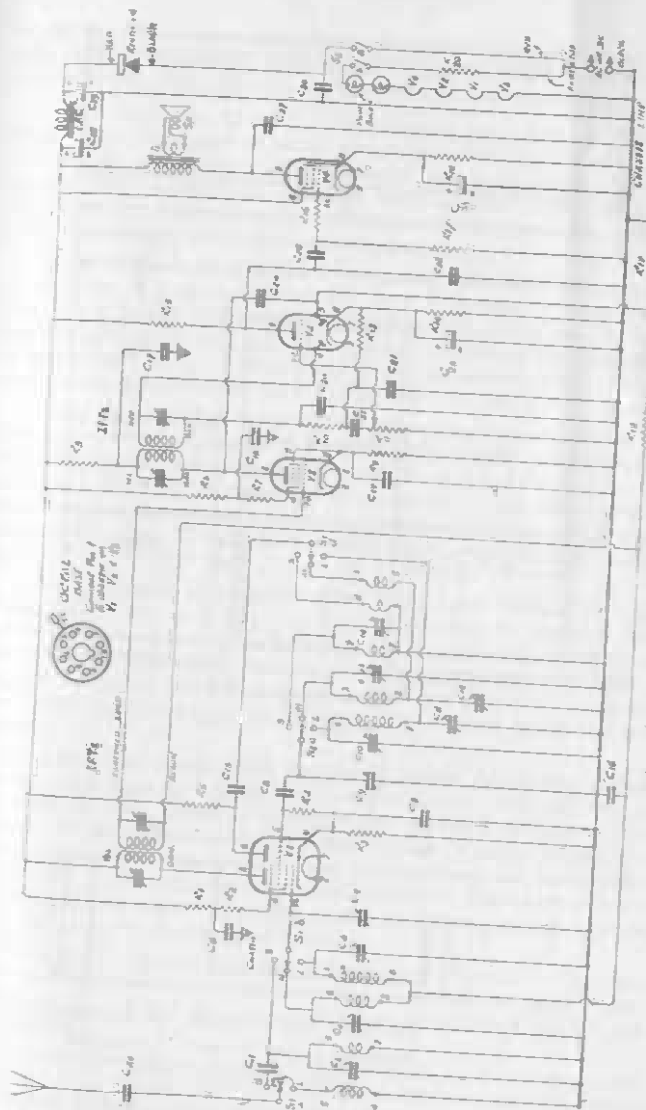
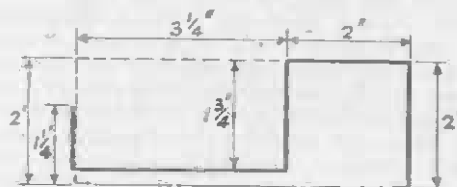
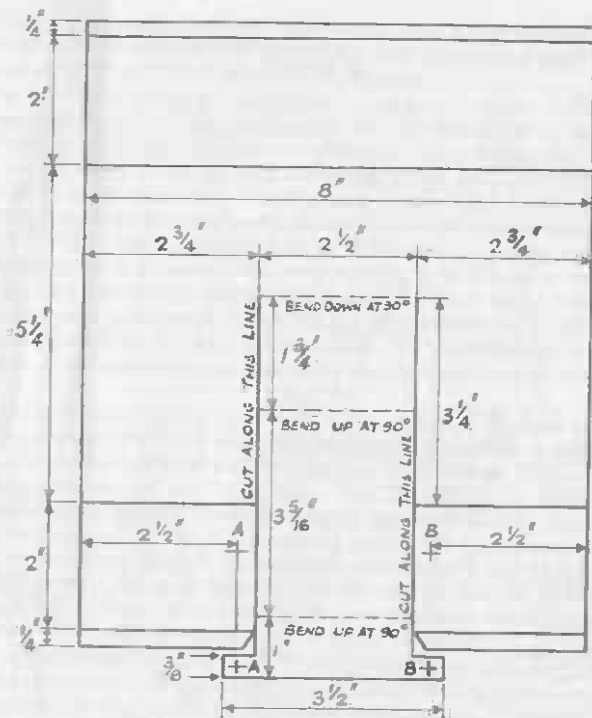

Fig. 19. The "Full-Scale" AC/DC Midget



SECTION THRO' CENTRE OF CHASSIS,
SHOWING HOW TUNING CAPACITOR
WELL IS BENT DOWN.

Fig. 20. The Chassis Blank for the "Full Scale" Midget Receiver

be improved then the screen voltage to the I.F. valve, the EF39, may be reduced by increasing the value of R6 to 100,000 ohms or even more, but despite the high gain of the receiver there should be no trouble on this account.

Weymouth Type IFM2 I.F. transformers were used on the original. These transformers are of some advantage to the constructor of midget receivers, as the trimming adjustments fall below the chassis. These transformers may therefore be mounted between other components without requiring a clear approach to the top can for trimming tools. The transformers are iron-cored with variable capacitor trimming.

A double-diode-triode in the V3 position gives demodulation, A.V.C. and a first stage of audio amplification. As a 5" speaker is used there is no advantage in having too much audio gain, however, as then the volume control would require to be well retarded to avoid overloading the speaker and the set could never be run "all-out," and so an EL32 output valve is used. This valve is less sensitive than the CL33 specified for the T.R.F. receiver.

Good smoothing of the H.T. line is necessary for this receiver and the 25 henrys choke is mounted above the chassis with the reservoir-smoothing capacitor strapped below the chassis under the choke position. The capacitor specified, a Hunts J46, is chosen for its small size; it is double-ended with an earthed can, so that the can and chassis must be in perfect contact. The straps securing the capacitor may be bolted in place under the nuts securing the choke.

Two dial lamps are included in the heater chain so that the large scale is illuminated from each side. The lampholders must be mounted inside the cabinet on either side of the scale window, and positioned so that there is no chance of the bulbholder touching the chassis or any other metal of the receiver—including the tuning pointer. The clearance of $\frac{1}{8}$ " or so between the chassis front edge and the interior of the cabinet makes this a simple matter.

The dial lamp leads, which must be of twisted rubber flex, are brought through a grommetted hole in the chassis front edge, and sufficient play in the leads must be allowed to permit of the set being withdrawn from the cabinet. If bulbholders on sliding supports, such as are often fitted to commercial receivers, can be obtained, then the lamp leads may be shorter as the bulbholders can be dismantled and withdrawn with the receiver, but this is not of great importance as there is plenty of cabinet space for the surplus lamp flex when the receiver is in place.

Note that 0.3 amp, rather than 0.2 amp, bulbs are used. The lamps are then able to take the rather heavy current surge through the heater chain when the receiver is switched on; as the set warms up the bulbs dim but still give adequate light.

The metal rectifier, a SenTerCel Type H35-26-1L, is mounted along the rear edge of the chassis where it is cool and away from the hot air flow from the valves. This position adds no extra depth to the receiver cabinet since

the chassis is mounted on the slant and the rectifier uses space which would otherwise be wasted. As the rectifier is working well below its full rating of 100 mAs., it will be found to run practically cold with very little warming, if any. The rectifier is supported by brackets cut from sheet aluminium to the size and shape shown in Fig. 21 and fastened to the chassis rear edge by 6 B.A. bolts and nuts.

COMPONENTS LIST FOR THE "FULL-SCALE" AC/DC MIDGET, FIG. 19.

Aerial Coil, Oscillator Coil, Weymouth CS3W3, 1 pair.

C _{ae}	0.05 mfd. to 500 pfs. See text.
C1, C24	49 pfs. ceramic. T.C.C. Type SCD.6 (Disc).
C2, C3, C4, C10, C13, C14	3-30 pfs. trimmers. Mullard-Philips concentric.
C5, C9	500 pfs. 2-gang variable capacitor. Jackson Bros. Type E.
C6, C7, C16, C17, C18, C19	0.05 mfd. 350 v.w. tubular. T.C.C. 346.
C8	100 pfs. mica. T.C.C. CM20N.
C11, C12	Double padder. C11 160 pfs. (yellow) C12 650 pfs. (orange), Walter Instruments Type 356.
C15	150 pfs. mica. T.C.C. Type M.W.N.
C20, C21, C26	200 pfs. mica. T.C.C. CM20N.
C22, C25, C30	0.01 mfd. 500 v.w. tubular. T.C.C. 543.
C23	25 mfd. 12 v.w. Electrolytic. T.C.C. Type CE31B.
C27	0.002 mfd. mica. T.C.C. M2N.
C28, C29	12 plus 12 mfd. 450 v.w. Electrolytic. Hunts J46.
C31	25 mfd. 25 v.w. T.C.C. Type CB32C.
R1	33,000 ohms, ½ watt.
R2, R7	10 ohms, ½ watt.
R3	220 ohms, ½ watt.
R4, R5, R15	47,000 ohms, ½ watt.
R6	68,000 ohms ½ watt.
R8	4,700 ohms, ½ watt.
R9	330 ohms, ½ watt.
R10, R16	10,000 ohms, ½ watt.
R11	1 megohm volume control.
R12, R19	1 megohm, ½ watt.
R13	470,000 ohms, ½ watt.
R14	1,200 ohms, ½ watt.
R17	220,000 ohms, ½ watt.
R18	470 ohms, 1 watt.

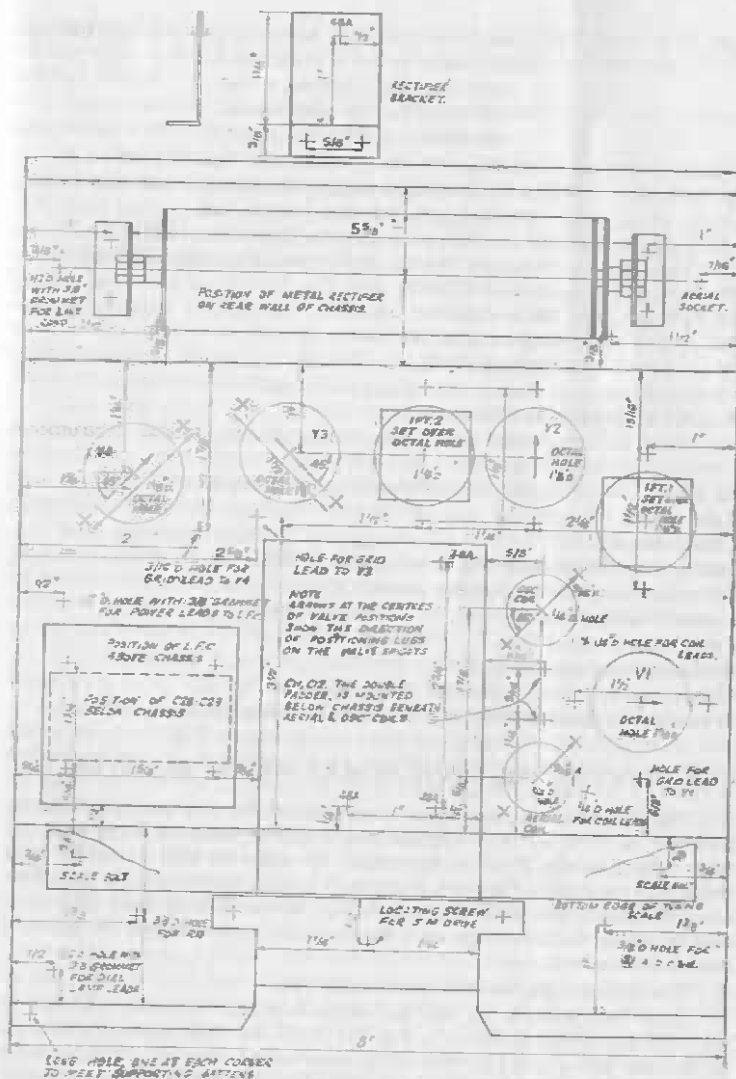

Fig. 21. Chassis Dimensions for the "Full-Scale" Midget

- R20 .. 0.2 amp 3-way linecord. Adjust to pass 0.2 amp. through heater chain, or cut to resistance:—
 1,080 ohms for 250 volts mains.
 980 ohms for 230 volts mains.
 880 ohms for 210 volts mains.
 (18' of 60-70 ohms linecord, for 250 volts.)
- Sp. with TI .. Elac 5" permanent magnet loudspeaker with transformer matched to 8,000 ohms anode load.
- I.F.T. 1, 2 .. 465 kcs. I.F. transformers, Weymouth IFM2.
- L.F.C. .. 25 henrys 60 mA. 560 ohms. Partridge C25/60/VSE.
- V1 .. Mullard CCH35.
- V2 .. Mullard EF39.
- V3 .. Mullard EBC33.
- V4 .. Mullard EL32.
- 4 International octal chassis mounting valveholders.
 Rec. S.T.C. SenTerCel H35-26-1L.
- S1, a-b-c-d .. 4-pole 3-way wavechange switch. Walter Instruments Type B.T.
- S2, a-b .. 2-pole On-Off switch, ganged with R11.
- 2 dial lamps, 6.3 volts, 0.3 amp.
- 2 bulbholders.
- Tuning scale, Weymouth TS1 to suit coils CS3W3.
- Epicyclic tuning drive. Jackson Bros.
- 3 control knobs, round.
- 4 grid caps, shielded type.
- Aerial banana plug and socket.
- Chassis, cut and bent to size and shape shown in Fig. 20.
- Wire, sleeving, screened sleeving, solder, nuts, bolts, etc.

CONSTRUCTING THE "FULL-SCALE" MIDGET RECEIVER

The chassis is cut from sheet aluminium to the size shown in Fig. 20, to make an 8" x 5½" x 2" chassis with a central well extending from the front edge to within 2" of the rear edge. To make the well a strip 2½" wide is cut into the chassis, the front of the strip protruding beyond the rest of the chassis material and shaped to overlap on to the normal front edge at A and B, where the front edge or support of the well is bolted to the main chassis front edge.

The tuning capacitor is situated in the well.

After the chassis is cut out, but before it is bent to shape, it should be punched and drilled as shown in Fig. 21. As in the other receivers described so far, the valves and I.F. transformers are seated over 1½" diameter holes punched with an octal punch; the securing boltholes for valveholders should be sized to clear 6 B.A. bolts and those for the I.F. transformers, choke,

tuning capacitor and coils may be either 4 or 6 B.A. The majority of these components have 4 B.A. clearance fixing holes, but 6 B.A. bolts may also be used if desired.

Holes carrying the linecord, lamp leads and other power lines through the chassis should be fitted with rubber grommets.

A soldering tag should be secured under one bolt of each valveholder and other components to provide plenty of earthing points.

First bolt on the valveholders, wavechange switch and volume control on-off switch and wire the heater circuits, then add the top deck components—coils, choke, tuning capacitor, etc., and fix the double-padder under the chassis below the tuning coil positions. Note that once again the concentric type of trimmer is specified: if these trimmers can be obtained they will mount very neatly on the coil connecting tags, but postage stamp type trimmers such as Walter Instruments Type MS50 may be used if the concentric trimmers are not obtainable.

Tags Nos. 1 to 6 will be found at the top of the coil former in both the aerial and oscillator coils, tags 7, 8 and 9, easily being identified at the base of the former. Note that one side of each trimmer is connected to the chassis; this 'earthed' side should be the adjustable plate of the trimmer, the central connector in the case of concentric trimmers.

With the components in place, wire the receiver through from aerial socket to output stage. The loudspeaker leads are taken from points 3 and 4 of the V4 valveholder and, as the speaker is below the chassis, these leads do not have to pass to the top of the chassis. The speaker leads, similarly to the power leads, should be of rubber-covered flex.

H.T. anchoring points are provided by tag 4 of V4, and the positive lug of C28.

If the bulbholders are fixtures on the inside of the cabinet and cannot be withdrawn from slide fastenings the lamp leads must be left sufficiently long for trimming and connecting to the holders when the receiver is connected up and fitted to the cabinet. If removable holders are used, it must be remembered that when the set is on test outside the cabinet the holders and lamps must on no account come into contact with the chassis or any other part of the set. The linecord can be secured by a clip of scrap metal fitted under a rectifier support bolt. The rectifier should be fitted after the main part of the work is finished, and just before the power circuits are wired.

The tuning scale specified to suit the three waveband coils, a Weymouth TS1, is 7½" long by 4" high. The bottom of the scale should be butted down to the upturned and bolted front edge of the tuning capacitor well—that is, the bottom edge of the tuning scale is ¼" below the chassis top deck. A slot must be cut centrally in the bottom edge of the scale upwards for a distance of about ½" to allow the scale to slip over the spindle of the tuning capacitor. The scale is bolted to the front edge of the chassis by 6 B.A. bolts; between the boltheads and scale should be placed fairly large washers.

A side view of the method of driving the tuning capacitor spindle is shown in Fig. 22. The capacitor spindle is cut down by a hacksaw or fretsaw to a length of approximately $\frac{3}{4}$ " or a very little less, and on the spindle is mounted the pointer. It was found, when building the original chassis, that the simplest and most satisfactory method of making the pointer was to employ a length of ordinary tinned copper wire of 18 S.W.G. A length of wire is unwound from the reel, the end gripped by strong pliers and the wire pulled hard until it stretches slightly. This straightens the wire. A 6" length is then cut off and a $\frac{1}{4}$ " internal diameter loop made at one end of the wire. The loop is passed over the capacitor spindle which should previously be tinned at a point about $\frac{1}{2}$ " from the bearing, and the loop and straight wire soldered in place on the spindle. Remember that the wire must be perpendicular to the direction of the moving vanes—that is, with the vanes exactly at half-mesh, the wire pointer must be exactly vertical. The pointer is then trimmed, the end being cut to a suitable length—about $3\frac{1}{2}$ " from the capacitor spindle—and, for best appearance, painted black. If the wire is cleaned and de-greased, a good brand of indian ink can sometimes be persuaded to coat the pointer, but much more satisfactory is a coat of matt black paint. Black enamel may also be used, but a matt rather than a glossy surface to the pointer is to be preferred.

The epicyclic drive, as shown in Fig. 22, is fixed on to the end of the capacitor spindle by a grub screw, the drive's own spindle protruding through the front panel of the cabinet. The body of the drive must be held stationary, a lug being provided for this purpose, and this lug is fixed by a $\frac{1}{4}$ " 6 B.A. bolt which is anchored in a hole in the front edge of the tuning well.

To hide the epicyclic drive and also the slot in the tuning scale the tuning window of the cabinet should be raised in a semi-circle or decorative curve centrally; the driving spindle will then pass through this portion of the panel and the curved woodwork will make a background for the tuning knob.

The shape of the tuning window is indicated in Fig. 23.

In this receiver, as in others, it is as well to drill the holes for the control spindles by measurement against the receiver itself. To do this, cover the ends of the spindles (after they have all been trimmed to the same length, sufficient to pass through the panel of the cabinet and provide a seating for the control knobs, but not so long that the knobs are held away from the face of the cabinet by any appreciable distance) with a coating of chalk. Then insert the chassis into the undrilled cabinet, centre it exactly, and press the chalked ends of the spindles against the wood of the cabinet. When the chassis is removed the exact location of the spindles will, of course, be chalk-marked, and a small pilot hole may be drilled from the back of the cabinet face through to the front. The cabinet is then inverted and the main holes drilled through from front to back, following the pilot holes. For the usual $\frac{1}{4}$ " spindles, $\frac{3}{8}$ " holes in the cabinet are sufficient.

The tuning window of this receiver should be slightly less in size than the scale itself since the scale is at some little distance behind the window.

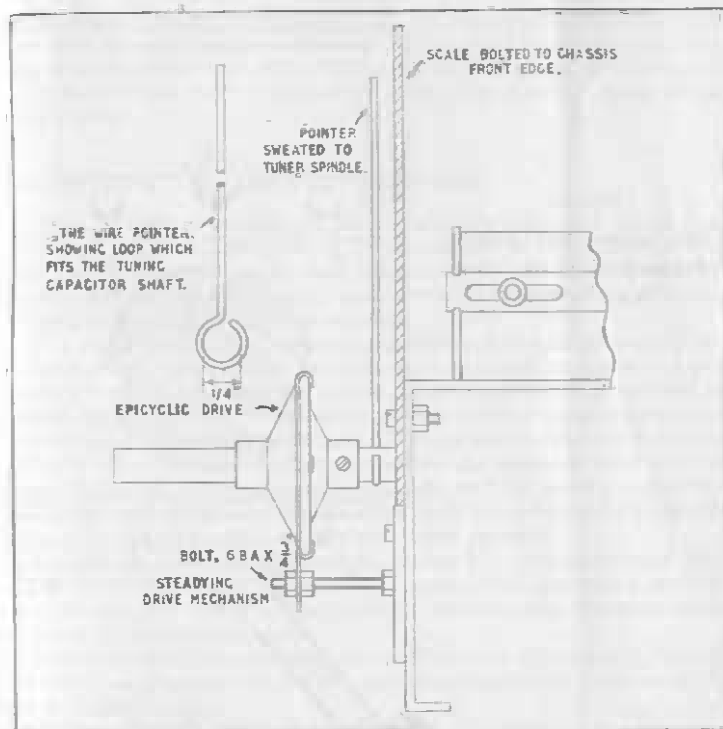
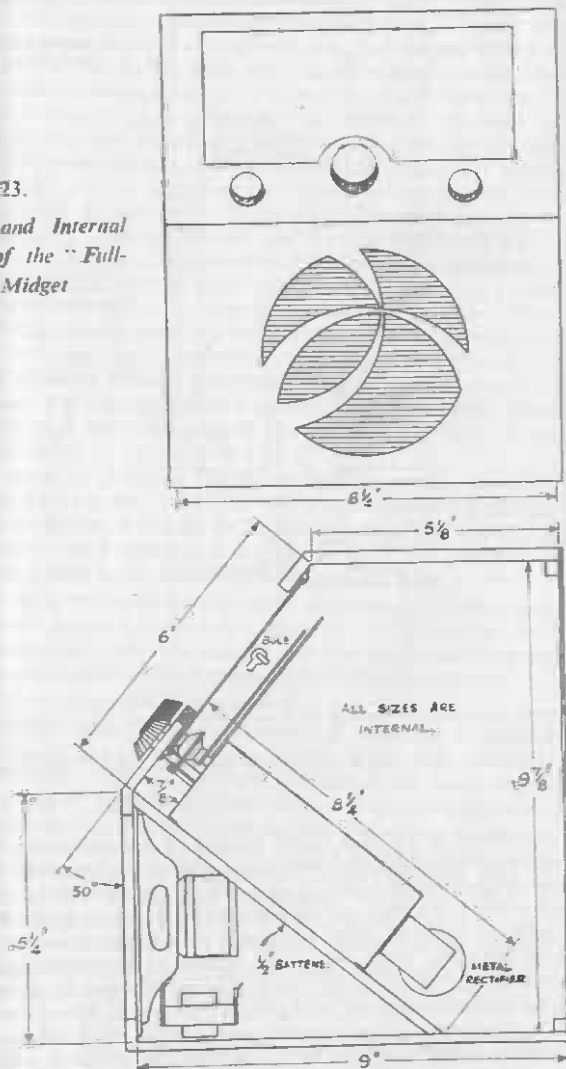

Fig. 22. Side View of Tuning Drive for the "Full-Scale" Midget

A size of $6\frac{1}{2}$ " \times $3\frac{1}{2}$ " was found suitable in the prototype, but this may be varied by the individual constructor. This size of window will just allow a sheet of glass to be used, secured behind the face of the cabinet by small clamps of scrap metal, the glass measuring $\frac{1}{8}$ " larger than the aperture in all dimensions, but if a deeper window is used the glass would then have to be cut or drilled to allow the tuning spindle to pass through it. This can be accomplished, however, by using perspex in place of glass. The perspex can be worked very easily, and given a high polish, before the final mounting, by treating both sides of the sheet with a good metal polish.

Fairly stout wood should be used for the cabinet to take the $\frac{1}{4}$ " battens on which the receiver chassis is supported and also in order that the speaker

Fig. 23.
The Cabinet and Internal
Arrangement of the "Full-
Scale" Midget



may be screwed directly to the front panel. If a separate baffle-board were to be used, the speaker mounted on this and the baffle-board, in turn, then being mounted in the front of the cabinet, the speaker magnet would then be too far back to clear the chassis and the angle of the receiver chassis would require altering.

ALIGNING THE "FULL-SCALE" RECEIVER

When the receiver is made and the wiring carefully checked, the set may be switched on. It will be standing by the cabinet, in order that the dial lamps may be connected up by their length of flex; the chassis should be standing on end, so that both the trimmers above the chassis and the trimmers and padders below the chassis are accessible.

If a signal generator is available the alignment should proceed in the normal manner. Ascertain that the mains plug is connected so that the receiver chassis is earthed—touching the chassis may give a shock unless this is checked—and allow both set and generator to reach operating temperature. Remove the top grid-clip from the grid of V1 and feed in from the generator a 465 kcs. signal, at good strength, connecting the generator earth lead to chassis. Bring the I.F. transformers into trim, starting with the secondary of I.F.2 and working back to the anode circuit of V1, reducing the generator output as the signal becomes audible to get clear response.

Remove the generator lead from the grid of V1, restoring the grid clip, and feed in the signal generator signals, by means of the generator's artificial aerial, to the aerial socket on the receiver. Again connect the generator's earth lead to the receiver chassis.

Switch the receiver to mediumwaves, and tune it to 250 metres, 1,200 kcs. Tune the signal generator to 1,200 kcs. and adjust the oscillator trimmer, C13; until the signal is heard.

Always adjust the oscillator circuits, both when trimming and padding, from minimum towards maximum capacitance.

When the signal is found, adjust C3 to obtain any possible increase in volume.

Tune both the receiver and generator to 500 metres, 600 kcs., and, whilst rocking the set's main tuning capacitor to and fro, adjust the padder C12 to bring in the signal, setting it so that the main tuner can be set at 500 metres on the scale.

Retune both set and generator to 1,200 kcs. and correct the setting of C13, then retune both to 600 kcs. and correct the setting of C12. Continue to trim and pad in this way until variation of one control has no effect on the setting of the other.

Switch to the longwaves and trim at 1,000 metres, 300 kcs., adjusting first C10 to tune the signal correctly then C4 to improve the signal if possible. Then pad at 1,750 metres, 171.4 kcs., using C11, and re-trim and re-pad until the two adjustments are balanced.

Switch the receiver to the shortwave band and tune it and the generator to 25 metres, 12 Mcs. Trim the oscillator, using C14, to bring in the signal, and trim C2 to bring up the volume. There are no padding adjustments to be made on the shortwave band.

With the receiver aligned by the signal generator, remove the generator and connections, and, before setting the chassis in place in the cabinet, connect up the aerial and make a last adjustment to C3, C4 and C2, switching to the appropriate bands and trimming the aerial coils on a weak station at the low wavelength end of each band to obtain the best volume possible.

If no signal generator is available the "Full-Scale" receiver can be aligned using the B.B.C. stations. Even with the receiver mis-aligned it should be possible to pick up the Light programme on 1,500 metres, so switch to the longwave band and endeavour to tune the signal—it will almost certainly not be found at the correct point on the dial.

If the signal cannot be heard set the trimmers on the I.F. transformers to the midway position, and tune over the band again. As soon as the signal is found, trim up the I.F. transformers for maximum volume, working, this time, from the first I.F. transformer through to the second.

With the transformers trimmed, set the tuning capacitor to the correct tuning position on the scale, 1,500 metres, and adjust C11, the longwave padder, from minimum to maximum position until the Light programme is brought in at the right spot on the dial.

Tune down the band until a station on a lower wavelength is found—possibly Leningrad or, failing this, the Airmet service at about 1,200 metres—and adjust C10 for correct tuning and C4 for maximum volume.

Retune to the Light programme and, using C11, correct any shift in the tuning point.

Retune to the lower wavelength station and correct any shift in the tuning point by adjusting C10.

Continue with these adjustments until the varying of the padder has no effect on the oscillator trimmer and vice versa.

Switch the receiver to the mediumwave band and tune the variable capacitor so that the pointer indicates 449 metres, 668 kcs., the tuning point of the North of England transmitter. Adjust the mediumwave padder C12, from minimum towards maximum, until the North of England transmitter is heard. When the signal is brought in tune the set to a lower wavelength station, such as the Light programme on 261.8 metres, 1,384 kcs., and trim the oscillator, using C13, until the station is heard. Bring up the volume by adjusting C3.

Retune to the North of England transmitter, and correct the padding to bring this signal back on tune, then retrim on the Light programme and continue to trim and pad on these two stations until once again the two adjustments cease to have mutual effect.

To align the shortwave trimmers, switch to the shortwave band and find a station, preferably one which can be identified as to wavelength and

frequency, in the 25 or 31 metre bands. Do not use the highest frequency bands as there will be a chance of image reception. Having tuned a station, adjust the oscillator trimmer C14 to bring the station tuning on the dial to the correct setting, if this can be found from a station list, or if announced, then adjust the aerial coil trimmer C2 to give maximum volume.

The receiver may then be mounted in its cabinet; as adjustments in this case have been made on the signals supplied by the receiver's aerial no further trimming is needed.

Chapter VI

A MODERN MIDGET RECEIVER

IT is certain that the new all-glass midget mains valves with B8A bases will become very popular with the home constructor as soon as these types are generally available, and a circuit illustrating their use is accordingly shown in Fig. 24, a 5-valve midget receiver for the mediumwaves, the whole set requiring a chassis no larger than $7\frac{1}{2}'' \times 4\frac{1}{4}'' \times 2''$.

Mediumwave coverage only was chosen as in so many areas all listening can be carried out with perfect results on this one waveband. For a very great percentage of time, listening is limited to the Light and Home programmes, and as all the Home stations and one of the two Light programme transmitters are included in the medium band the single range of this receiver should be adequate for most listeners, giving as it does, a choice of all the British stations and a wide selection of foreign signals.

If longwave reception is required, it is necessary to add longwave aerial and oscillator coils, trimmers, a 150 pfs. padder, and a wavechange switch. The experimenter will find no difficulty in making such additions, but at the same time, it will probably be found desirable to increase the chassis size.

The circuit of the receiver is shown in Fig. 24. A triode-hexode frequency changer, the Mullard UCH41 passes the I.F. signal to a diode-pentode, a Mullard UAF42. The diode of this valve is ignored, and the pentode used as an I.F. amplifier, whilst in the following stage a second UAF42 is connected with the diode as a demodulator-A.V.C. valve, the pentode acting as a first audio amplifier. A Mullard UL41 acts as the output stage and a UY41 gives half-wave power rectification.

The U40 valves have 0.1 amp heaters, so that these types are economical to run in an AC/DC receiver, the power dissipation in the complete heater chain—including the volts dropping device—being small. The valves fit into small holders and are positioned by a boss on the side of the valve base which locates in a recess in the holder. When withdrawing the valves

from their holders the circular spring clip which closes over the locating boss should be eased back to free the valves.

As in the case of B7G valve sockets, the B8A holders have a cylindrical metal stem fastened centrally to the base of the holder. This is not in direct contact with any valve pin or electrode, but may be used as an earthing tie-point for by-pass circuits—the stem itself must, of course, be wired to an earthed soldering tag secured under one of the valveholder fixing bolts.

COMPONENTS LIST FOR THE MODERN MIDGET RECEIVER. FIG. 24.

L1	Wearite PA2, aerial coil.
L2	Wearite PO2, oscillator coil.
C1, C17, C21	0.01 mfd. 500 v.w. tubular. T.C.C. 543.
C24	
C2, C9	4-60 pfs. trimmers. Walter Instruments MS70.
C3, C5, C6, C12,	0.05 mfd. 350 v.w. tubular. T.C.C. 346.
C13, C14, C19	
C4, C8	
C7	2-gang 500 pfs. variable capacitor. Jackson Bros. Type E.
C10	100 pfs. mica. T.C.C. CM20N.
C11	500 pfs. maximum padder. Walter Instruments Type 356, grey spot.
C15, C16, C20	150 pfs. mica. T.C.C. M.W.N.
C18, C26	200 pfs. mica. T.C.C. CM20N.
C22, C23	25 mfd. 25 v.w. T.C.C. CE32C.
C25	16 plus 8 mfd. (respectively) 450 v.w. T.C.C. CE28P.
R1, R5	0.001-0.005 mfd. See text. Tubular, 500 v.w. T.C.C. 543.
R2, R9	22,000 ohms, $\frac{1}{2}$ watt.
R3, R8	10 ohms, $\frac{1}{2}$ watt.
R4	47,000 ohms, $\frac{1}{2}$ watt.
R6	220 ohms, $\frac{1}{2}$ watt.
R7, R12, R18	100,000 ohms, $\frac{1}{2}$ watt.
R10	10,000 ohms, $\frac{1}{2}$ watt.
R11	1 megohm, $\frac{1}{2}$ watt.
R13	330 ohms, $\frac{1}{2}$ watt.
R14	1 megohm volume control.
R15	470,000 ohms, $\frac{1}{2}$ watt.
R16, R19	2,700 ohms, $\frac{1}{2}$ watt.
R17	470,000 ohms, $\frac{1}{2}$ watt.
R20, R21	220,000 ohms, $\frac{1}{2}$ watt.
R22	680,000 ohms, $\frac{1}{2}$ watt.
	150 ohms, 1 watt.
	0.1 amp volts dropper. Adjust to pass 0.1 amp or use resistance of:—
	1,350 ohms for 250 volts mains.
	1,150 ohms for 230 volts mains.
	950 ohms for 210 volts mains.

Resistor rated at
15 watts.

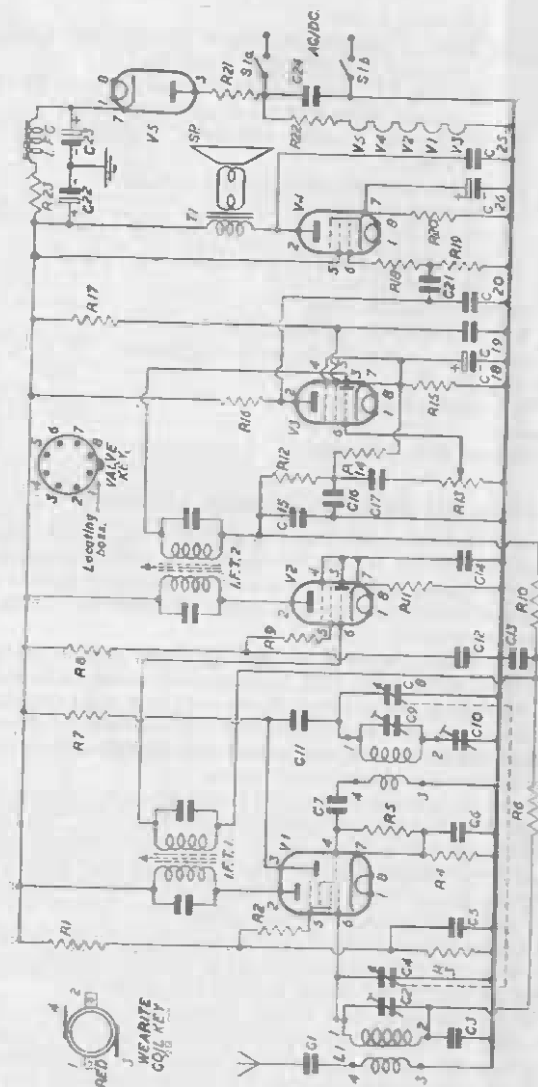

Fig. 24. The Modern Midget

- R23 . . . 470 ohms 3 watt.
 Sp. with T1 . . . Elac 5" permanent magnet speaker with transformer matched to 3,000 ohms anode load.
 I.F.T.1, 2 . . . 465 kcs. I.F. transformers, Weymouth Type P4 (I.F.T.1 without flying lead for single-ended valve).
 L.F.C. . . . 10 Henries. 80 mAs. 300 ohms. Partridge Type EEC/3 /VSE.
 S1, a-b . . . 2-pole On-Off switch, ganged with R13.
 V1 . . . Mullard UCH41.
 V2, V3 . . . Mullard UAF42.
 V4 . . . Mullard UL41.
 V5 . . . Mullard UY41.
 5 B8A valveholders, Belling-Lee L620.
 Aerial socket, Belling-Lee L315, with plug L378/3.
 Chassis, cut and bend to size from sheet aluminium. $7\frac{1}{2}'' \times 4\frac{1}{2}'' \times 2''$.
 Drilled as Fig. 25.
 2 control knobs, 1 pointer type for tuning.
 Small tuning scale.
 Wire, solder, sleeving, nuts, bolts, etc.

CONSTRUCTING THE MODERN MIDGET RECEIVER

The chassis is cut to size and drilled as shown in Fig. 25, and note must be made of the small flange, on the right-hand side, which is bent down at right angles to the chassis top deck to provide a mounting bracket for the aerial and oscillator coils which are thus supported below the chassis, under the tuning capacitor position.

If a suitable chassis is already to hand the flange may be replaced by a bracket, cut from sheet metal, bent to shape, and bolted on to the right-hand side of the chassis. An existing chassis with four sides may have the coils mounted on an end wall, when the bracket will, of course, be unnecessary.

The holes for the B8A valves may be made with a $\frac{1}{4}''$ punch or with a tank cutter, which can be closed down to a $\frac{1}{8}''$ radius.

When the chassis is made all the parts except the choke, voltage dropper and loudspeaker may be mounted and the circuit wired up. The trimmers, of the postage-stamp type in this receiver, are mounted directly across the coils, anchored to the upright tags Nos. 1 and 2 in each case, and the padder is bolted under the chassis in the position indicated in Fig. 25. The padder is held off from the chassis by short-spacing sleeves.

The I.F. transformers are mounted, as usual, over octal holes $1\frac{1}{4}''$ in diameter. Note that I.F.T.2 is set at an angle so that the adjusting screws are accessible from the rear of the chassis and not masked by V2.

The choke, loudspeaker, and voltage dropper may be mounted when the receiver wiring is complete and the power section is to be connected up. As the voltage dropper requires a rather high resistance it is impractical to use linecord, and a vertical-mounting resistor is therefore employed. No make is

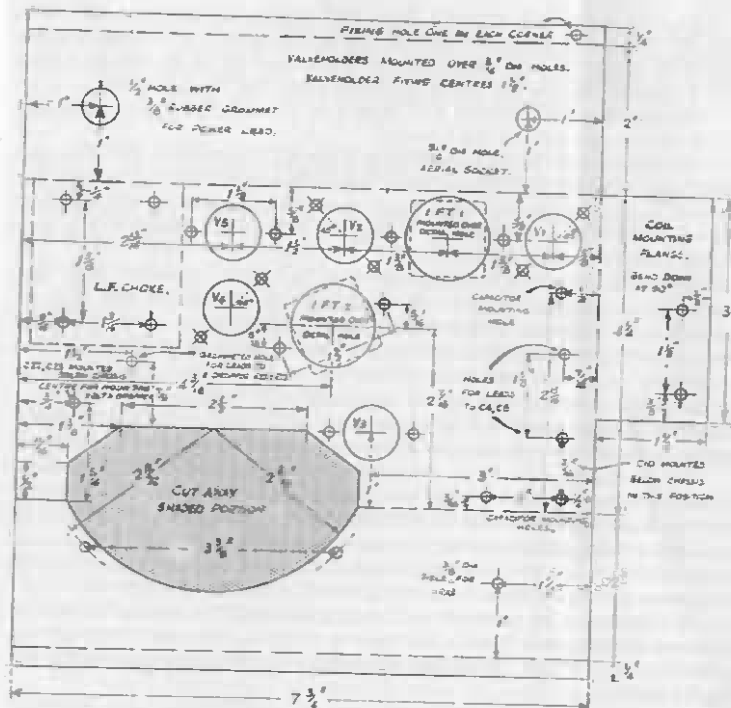

Fig. 25. The Chassis Dimensions for the Modern Midget

specified as a choice will have to be made bearing in mind the exact resistance needed to suit the mains supply voltage to the set, and a resistor must be chosen from those in stock at the constructor's supply store. In the original model a vitreous resistor rated at 1,000 ohms, 15 watts, fitted into the available space on the chassis. The supply voltage was 230 volts, so to bring up the total resistance value to the required 1,150 ohms a further 150 ohms resistor was wired in series with the main resistor, and this method is recommended. Remember that the extra resistance does not need the large wattage rating of the main resistor. If the supply is 230 volts, making a further 150 ohms necessary over and above the 1,000 ohms of the main resistor, the wattage rating of the smaller resistor will be no more than 2 watts. (As 0.1 amp is flowing the voltage drop across 150 ohms is 15 volts, and the power lost is 1.5 watts.) This resistor may be mounted in the wiring under the chassis

or it may be suspended vertically from the top tag of the main 1,000 ohms resistor. The main resistor, which if not provided with a vitreous coating should be wound on a porcelain former, is clamped to the chassis by a long bolt, a large washer on the top of the resistor holding the bolthead.

The double capacitor, C22, C23, is held by a metal clip secured under two of the choke bolts beneath the chassis.

C25 is shown in the components list as having a value between 0.001 and 0.005 mfd., and the final capacitance should be chosen by trial to suit the listener. Increasing the capacitance will naturally cause a cut in the high note response, and if the full response is required only a small capacitance, say, 500 pfs., need be connected in.

On the average mains supply the voltage of the receiver's H.T. line should be approximately 160-170 volts, and, if convenient, this may be checked by a voltmeter with a high internal resistance. A drop in voltage below this figure, caused by a low supply voltage, is of no consequence, but an increase in the H.T. voltage much above this figure may cause distortion or instability. Should this be the case, the H.T. may be dropped by a resistance greater than the 470 ohms of R23. The order of resistance necessary would be approximately 125 ohms for every ten volts to be dropped.

The tuning drive is direct, the spindle of the variable capacitor passing through the tuning scale which must therefore be mounted in a suitable position at the right-hand side of the front panel of the cabinet. A perspex or translucent scale, drilled centrally to take the spindle, or a hand-drawn scale on white ivory or a similar material serves very well, and the scale acts as its own cover, saving the trouble of fitting a drilled window as well.

The scale may be mounted on the chassis, using a mounting bracket as described in chapter 2, but in this case a window must be fitted to the cabinet to exclude dust. Mounting the scale within the cabinet aperture is the simpler method.

ALIGNING THE MODERN MIDGET RECEIVER

The Modern Midget may be aligned either with or without the use of a signal generator. If the tuning scale is mounted in the cabinet it will be necessary to fit a temporary cardboard scale, marked up with the main tuning or wavelength points, so that the receiver adjustments can be trimmed with the set out of its cabinet.

This temporary scale can be bolted or even stuck to the frame of the tuning capacitor. If the set is to be trimmed using a signal generator the scale need be marked only with the points 250 and 500 metres, but if the receiver is to be aligned using B.B.C. stations as standard signals then the points of the North of England transmitter, 449 metres, and the Light programme, 261.8 metres, should be marked. In either case take these tuning points from the tuning scale proper, mounted in the cabinet; the required points may be measured off by dividers or by making a simple tracing from the commercial scale.

To align the set using a signal generator, switch on both receiver and generator for some minutes to allow both to reach operating temperature, and connect the signal generator output lead (using the artificial aerial) into the aerial socket of the receiver, clipping the generator earth lead to the receiver chassis.

Set the tuning capacitor almost fully meshed and tune the generator to 465 kcs., using almost full output until the I.F. transformers are brought more closely into tune.

Commencing with the secondary of I.F.T.2, trim the transformer cores for maximum signal, working back towards the primary of I.F.T.1, reducing the generator output as far as is possible for sharp indications of response.

With the transformers in tune, set the generator and the receiver tuning to 250 metres, 1,200 kcs., and trim C9, the oscillator trimmer, from minimum towards maximum capacitance to bring in the signal. When the signal is heard and C9 is set for best results, trim C2 to improve the volume.

Now tune both generator and receiver to 500 metres, 600 kcs., and, whilst gently 'rocking' the tuning capacitor spindle, adjust the padder, C10, from minimum towards maximum capacitance until the signal is received with the main tuning capacitor set correctly.

Retune both receiver and generator back to 250 metres and correct the setting of C9, then retune both to 500 metres and correct the setting of C10.

Trim and pad alternately until one adjustment fails to have effect on the other, and then disconnect the signal generator. Connect in the aerial to the aerial socket, and tune in a weak station at the low wavelength end of the dial at about 210 or 220 metres, giving C2 a final trim to give the best volume possible on this station. The receiver is then aligned and may be mounted in the cabinet, after removing the temporary scale.

To replace the main tuning pointer knob correctly, once the receiver is in the cabinet, tune the set to the local programme or to the Light programme on 261.8 metres, using the bare tuning spindle, and turning it with the fingers—ascertain, first, that the mains plug is inserted correctly into the mains socket, so that the chassis and metalwork of the receiver cannot give a shock. The plug position in which the set gives least mains hum is correct.

With the set tuned to a known signal, replace the pointer knob on the tuning shaft so that the pointer points to the correct wavelength or station name on the dial and tighten the knob screw.

To align the receiver without a signal generator, connect in the aerial and endeavour to tune in a station anywhere on the dial without disturbing the settings of the I.F. transformer cores. If a station cannot be found set the cores to the midway position and tune over the band again.

When a station is heard vary the core settings on the I.F. transformers, working from I.F.T.1 back to I.F.T.2, to give the best volume possible.

Now tune the receiver to the Light programme point on the scale, 261.8 metres, and adjust C9 from minimum towards maximum capacitance until the signal is heard. Trim C2 to improve volume.

Now tune the receiver to the North of England transmitter, and, whilst rocking the main tuning spindle gently, adjust C10 until the required signal is heard with the main tuning set on the 449 metres point. Retune to the Light programme, and correct C9, then tune back to the 449 metres station and correct C10, continuing to trim and pad until the two settings cease to have mutual effect.

The chassis is then placed in the cabinet and the tuning pointer knob replaced correctly so that with the set tuned to the Light programme the pointer knob indicates the station name or correct wavelength on the proper tuning dial.

This receiver is earthed automatically through the mains, as are the other AC/DC receivers described, but if a short earth-lead is required, this may be connected to the chassis through an 0.01 mfd. 500 v.w. or, preferably, 750 v.w. capacitor, an earth socket being mounted in the rear edge of the chassis beside the aerial socket for this purpose.

The internal dimensions of the cabinet should be of the order of 8" long by 5" deep. The cabinet height must accommodate the voltage dropper; a well-chosen resistor will be little higher, if taller at all, than the L.F. choke, and a cabinet height of 6" should prove adequate and give good ventilation. The rear of the cabinet must be slotted or drilled to allow a good airflow.

Chapter VII

A CRYSTAL DIODE RECEIVER

THE ultimate in midget sets is the crystal receiver, which by the nature of its circuit and the fact that it requires no power supply can be made very small and compact indeed. The ordinary crystal receiver is unsuitable for the needs of most constructors as it requires a delicate adjustment of the crystal—even if this is of the semi-permanent type—and must not be moved once the crystal is operating correctly, but if a modern crystal diode of the radar type is used this difficulty is overcome.

Such crystals are now obtainable on both the regular and the surplus goods markets, and a popular type is the B.T.H. CS7A silicon crystal (also coded as CV253 amongst Service 'valves'). This crystal is no more than 13/16" overall length and 5/16" maximum diameter, and a receiver built up around such a component can be small enough to suspend directly in the headphone leads.

A rather different circuit from the usual crystal set arrangement is needed to suit the characteristics of a crystal diode. The diode must be tapped on to the tuning coil, and it is found that the tuning circuit itself gives best results if a series-tuned acceptor circuit is employed; the circuit of a radar crystal

receiver is therefore of the form shown in Fig. 26. The type of aerial used with this circuit has a very great bearing on the behaviour of the receiver for, in effect, the tuned circuit, with a series resistance equivalent to the reflected crystal load resistance, is in series with the capacitance of the aerial to earth and the aerial's effective series resistance.

At resonance—when the combination is tuned to any particular signal—the inductance resonates with the capacitances of the tuning condenser and the aerial in series, and the final effect is that the reflected load of the crystal, in series with the coil's R.F. resistance, is paralleled across the aerial's series resistance.

For maximum power transfer the crystal load resistance must be made equal to the aerial series resistance and the coil R.F. resistance together, and so the method in which the crystal is tapped into the tuning coil, and the exact capacitance required to tune the receiver to any required signal, must depend to a very great extent on the aerial itself.

At the same time the crystal resistance varies with the signal strength, the resistance being high for weak signals and dropping by as much as 50 per cent. and more for strong signals, so that this effect also has a bearing on the correct coil tap. The output impedance of the crystal also varies in a like manner, affecting the matching of the headphones into the crystal diode, and so for any set of conditions, the receiver requires to be matched up to both the aerial and the signal being received for best results. This would mean a series of coil taps and (theoretically, not practically) a matching transformer between the diode and the headphones, but in practice it will be found that a receiver using standard parts can be built up to give very good results over a wide range of conditions.

For best results both the aerial and the tuning coil must have as great efficiency as possible; in the case of the coil this means a low R.F. resistance and a high value of 'Q.' Best results would, therefore, be obtained from an air-cored coil wound on a rather larger former, with a series of taps brought out at points between about 1/7 to 1/3 of the whole winding as crystal tapping connections.

A small commercial coil with an iron-dust core has been tested and found to give very reasonable results, however, and the circuit of Fig. 26 is coded with the coil connections for this component, an H.C. Atkins Laboratories Red No. 2 coil.

The inductance required is rather larger than that generally found in standard tuning coils, but by connecting the coil with both the main and secondary windings in series the inductance is increased and, at the same time a crystal tapping point is provided.

In place of the Atkins coil a Wearite PHF7 coil might also be tried. Using the coil key shown in Fig. 24 for Wearite coils the connections for the PHF7 would be:—

- Aerial, via the tuning capacitor, to point 1.
- Crystal tap and junction of the two windings, points 2 and 4.
- Earth, point 3.

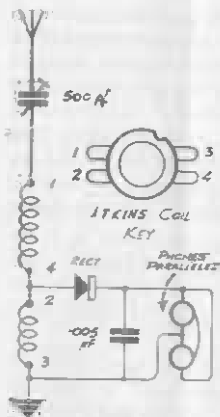

Fig. 26.

A Crystal Diode Receiver

It is recommended that experiments be confined to the medium wave band. The inductance for a coil suitable for the longwaves is rather high, and whilst a standard component, with the two windings in series, can give the required value a suitable crystal tapping is not provided.

It has been shown already that the tuning of the receiver depends to a great extent on the characteristics of the aerial, and whilst a 500 pfs. semi-variable capacitor is shown in Fig. 26 as the tuner the constructor must be prepared to experiment with different capacitance values until the required station is tuned in. The range of reception given by the receiver is quite good, if a really long and high aerial, and a good earth connection, are used, but no more than the local station signal can be expected, and so the tuning must be adjusted to suit the station frequency.

A semi-variable capacitor takes up less space than a variable capacitor, and once the required capacitance has been found by experiment a suitable padder can be installed.

It must be noted that the headphones are shown parallel connected. High resistance headphones of the 4,000 ohm type must be used, and if two of these are connected in parallel rather than in the more usual series method, they will provide a roughly accurate match to the crystal. If more than one pair of headphones are to be connected in, then the pairs of headphones may be left series connected in the usual manner, the sets of headphones being connected in parallel.

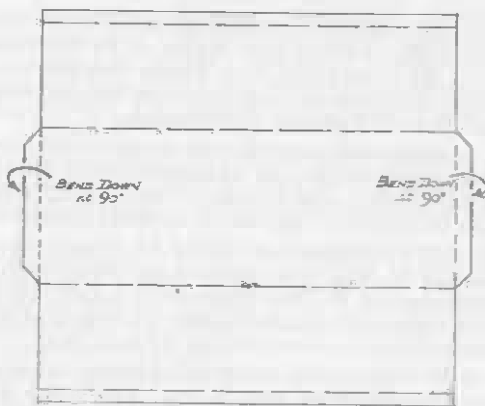

Fig. 27.

Strengthening Tabs to add Rigidity to Chassis Top Deck

The capacitor across the headphone terminals completes the crystal R.F. circuit, and any value between about 0.001 and 0.005 mfd. will serve. The higher capacitance will, of course, by-pass some of the higher audio frequencies, so that if good steady reception is obtained some experiment with this condenser is also worthwhile.

If results with a commercial coil are poor—perhaps because the aerial cannot be made sufficiently high, or because of a long-distance reception path—a specially made coil may give a considerable improvement. Such a coil could consist of 150 turns of 26 S.W.G. enamelled copper wire, close-wound on a 1½" diameter paxolin former, with crystal tapping points brought out at 20, 25, 30, 35, 40 and 45 turns from one end of the coil. At each tapping point the wire should be twisted up into a loop and the winding then continued without breaking the wire; when the coil is completed and the ends anchored the tapping loops can be bared.

Chapter VIII

CONSTRUCTION HINTS

IT has already been pointed out, in the Introduction to this Manual, that wiring diagrams cannot be shown except in the case of the Personal Portable. The wiring diagram of a midget receiver must be chiefly a matter of artist's licence—it is not practical to show the components in their true positions since small resistors and similar components are hidden by the larger capacitors, etc., as is much of the wiring—and therefore wiring diagrams would be of no practical assistance to the experienced worker whilst to the beginner they might very well prove extremely confusing.

A few notes on the wiring of midget receivers will, it is hoped, take the place of wiring diagrams and also be of greater assistance.

Before dealing with the wiring of the receiver, the chassis must be obtained or made. The grades of sheet aluminium and duraluminium now on the market are very suitable and are easily worked, but in one or two cases it may be found that the chassis top deck is inclined to sag slightly when only a front and a rear wall are provided as is the case in the majority of chassis designs shown in this Manual. The constructor should, therefore, assess the rigidity of his material before cutting the chassis, and if it seems likely that the chassis top will sag or bend under the weight of heavy components—the L.F. choke, for instance—this is prevented very simply by providing the two ends of the top deck with a stiffening tab, the tabs being cut as shown in Fig. 27. The two tabs, one at either end of the chassis, are bent down at right angles when the chassis is shaped, and thus give a girder form of construction to the top deck, adding remarkably to the chassis strength.

Chassis with four walls may be made instead of two-wall chassis, but the constructor will then find it more difficult to bend the last wall into place, no matter in what sequence the walls are bent down. When a two-wall—*or front and rear edge*—chassis is being bent the chassis can be clamped between two wooden bars in a bench vice or a pair of clamps and the bend made along the edge of these bars, the wood being as long as, or longer than, the chassis. When end walls have to be bent down, however, the wooden bars must then be cut to exactly the chassis width in order that they may fit between the front and rear walls. The method of bending chassis walls or edges is shown in Fig. 28. No other method is so convenient or as certain to produce a straight and unblemished a bend.

The bending of the chassis should follow the drilling and punching. Always work on the flat metal if possible; in some cases and especially in experimental work, drilling must proceed along with design, but when working to a finished design the bending of the walls should be the last step in the chassis manufacture.

Holes carrying power leads should always be fitted with rubber grommets. These may be obtained from any good radio store—by mail order if necessary, from a large radio house—and are very inexpensive. They add to chassis appearance, as well as ensuring perfect insulation and protection against fraying of lead coverings and sleeving.

RECEIVER WIRING

When wiring the receiver, first fasten on to the chassis the under-chassis components, valveholders, padders, coils, etc., and bolt on to the chassis top deck only those components which are sufficiently strong to take the weight of the chassis when it is inverted for wiring. In some instances it is better to have no top deck components fitted at all, but in the majority of cases they will hold the chassis propped at a convenient angle for wiring whilst, at the same time, they are required to be in place so that their connections can be made in sequence.

The first wiring in any receiver should be the heater leads, the heaters being in series in the case of AC/DC receivers. It is recommended that all wiring be carried out with 22 S.W.G. tinned copper wire bought in $\frac{1}{4}$ or $\frac{1}{2}$ lb. reels, the wire being insulated with 1 mm. sleeving. Thicker sleeving is unnecessary, and whilst twin rubber-covered flex is suitable and popular for the heater wiring of A.C. receivers it offers no advantages and several disadvantages for AC/DC receivers.

As one end of the heater chain is earthed to the chassis only one heater power lead is brought out. This must be left sufficiently long to connect to the voltage dropper—or, if a linecord is used and a double-pole switch provided the lead can be finished off at its switch contact.

The rest of the circuit can be wired in sequence, but at each stage—that is, practically speaking, at each valveholder—the wiring of the stage should also be sequential. In Fig. 29 are shown the main components of an

R.F. stage, the bias resistor and its by-pass capacitor, and the screen resistor with its by-pass capacitor and anti-parasitic resistor, and the component placing should be noted. When wiring the stage the first lead to be connected is that connecting the suppressor screen with the cathode, from tag No. 5 to tag No. 8. Then connect tag No. 1, in the case of R.F. pentodes of the EF37, EF39 and similar classes, to an earthed soldering tag secured under the valveholder fixing bolt, and connect the bias resistor between tag No. 8 and

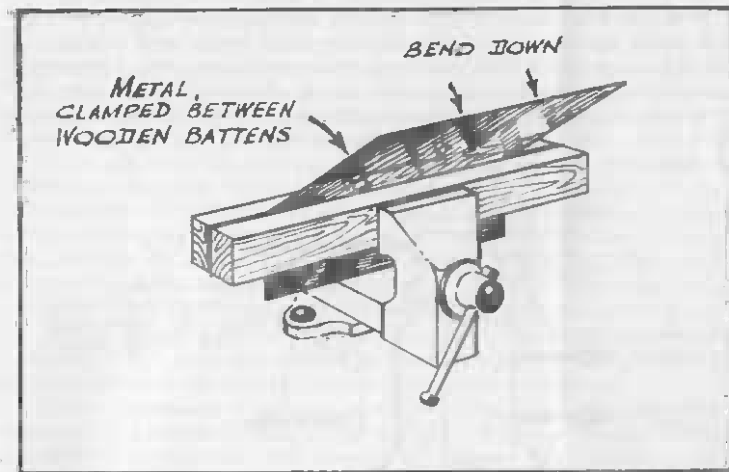

Fig. 28. Bending Chassis Walls

tag No. 1, running the body of the resistor up to the tags and trimming off the spare lengths of the resistor leads after making them mechanically sound to the valveholder tags. Remember that a soldered joint is only to ensure perfect electrical contact, mechanical strength must already be ensured before the soldering operation. The leads must therefore be anchored firmly through the tag holes provided and a turn taken round the tag, clipping the wire down firmly with pliers.

Do not put one lead into place, solder it, and then connect another lead to the same tag by winding it over the soldered joint and re-soldering. For example in Fig. 29, three leads go to tag No. 8, the suppressor lead from tag No. 5, the bias resistor lead and the lead from the bias by-pass capacitor. Before soldering run each of these leads through the tag hole or holes and secure each one separately, then solder all three leads to the tag.

If resin-cored solder is used there is usually no need to tin the tag before making the connections. Apply the cored solder to the tag, set the iron on the solder and the tag so that the solder is melted directly on to the tag and wires and the flux runs over the joint, then remove the solder and iron and allow the joint to cool without disturbing it. Never carry melted solder on the iron to the joint. By the time the solder is applied to the metal the flux is completely lost, and if the solder 'takes' at all the joint will be 'dry'—brittle, with a dull appearance which means a very poor contact. A dry joint is a fruitful source of noise and a certain spot for a later circuit breakdown.

With the bias resistor in place add the bias capacitor, holding it by its leads against tags Nos. 1 and 8, then solder the joints on tag No. 8. A soldering iron with a pencil bit is much more convenient than an iron with a broad bit; the pencil bit is of little use for heavy sheet-metal joints, but the radio constructor is concerned with wire joints and for these the pencil bit is excellent, whilst there is far less chance of burning or charring sleeving and nearby components.

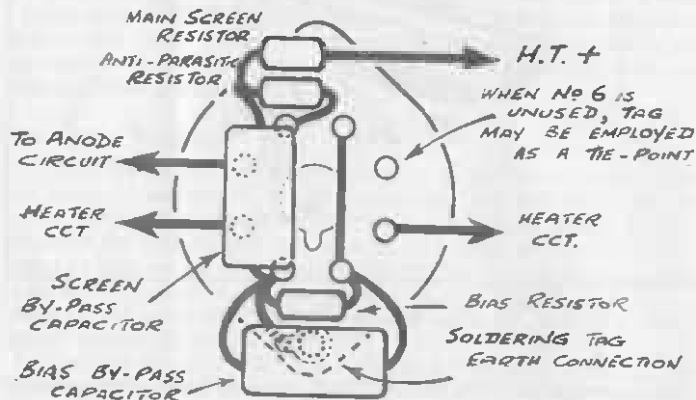

Fig. 29. Typical R.F. Stage Components Arrangement

Every lead, no matter how short, should be protected by sleeving. To measure the correct length secure one end of the wire to its tag, run the wire to the next connecting point by the correct route, measure the sleeving against the wire, cut off the sleeving and trim the wire, allowing a surplus for the joint, then slip the sleeving over the wire and finally make the joint, securing the wire before soldering. Avoid charring the end of the sleeving as the joint is made. When components are wired in by their own leads, as they are in the example of Fig. 29, the sleeving should run right up to the body of the component.

With the suppressor and cathode circuits completed (the joint on tag No. 1 should not yet be soldered), add the screen anti-parasitic resistor to tag No. 4, running the body of the resistor as close as possible to the tag. Solder the joint, leaving the resistor standing upright from the valveholder. To the top wire end of the resistor secure one side of the screen main resistor and one side of the screen by-pass capacitor, once again running all the bodies of these components close together, and solder the joint.

Run the earthed end of the screen by-pass capacitor through tag No. 1 and secure and solder this joint.

Apart from the tuning coils, etc., the bulkiest of the components are now assembled and grouped round the valveholder in a manner which not only conserves space but also provides very short earthing and by-pass leads. As a result there is very little chance of feed-back or instability, plenty of spare chassis space is left for components such as smoothing capacitors, and all components can be identified at a glance.

Many valves have a spare tag on the holder which makes no connection with a valve electrode—in the example shown, an R.F. stage, using a valve such as an EF39, it will be found that pin No. 6 on the valve base is missing, leaving a connecting tag spare at position No. 6 on the valveholder. This tag may, therefore, be used as a tie-point or anchoring point for other circuit components and is often very convenient as an H.T. anchoring tag, where a main H.T. lead can be secured and connected to screen and anode leads.

As each stage is wired the screen and anode circuits should be completed at the nearest H.T. anchoring point in each case, and the H.T. line, connecting all these anchoring points, run when the power circuits are wired.

Wiring the receiver in sequence, from aerial socket to mains plug, with sequential wiring in each stage, as just described, is strongly recommended, especially for the beginner. The receiver then grows in a logical order whilst a clear picture of its working is obtained; all too often the newcomer to radio construction wires up piecemeal, ticking the connections off on the theoretical circuit as they are put in. This makes for long leads and the confusion of one stage with another—quite possibly it is found that the tags across which a bias resistor should go are hidden beneath a set of wires and components which have no connection with that stage. It is that kind of construction which causes instability, feed-back, and, quite often, component damage through short circuits.

Appendix A

ADJUSTING LINECORDS

The majority of AC/DC midget receivers, whether home-built or commercial models, provide the heater chain of the set with its correct voltage by means of a linecord, a length of flex which has two plain leads to carry the mains supply to the chassis and rectifier of the receiver with a further lead made of thin resistance wire wound spirally round an asbestos cord. The heater current flows through the resistance wire so that a voltage drop along the line is produced, and the final voltage, as presented across the ends of the heater chain, is of the correct value to pass the correct current through the heaters.

The linecord is bought by length, average specimens having a resistance of 60 to 70 ohms per foot, and so when a cord is fitted either to a new receiver or as a replacement to an old receiver it must be adjusted to produce the correct voltage drop and so to pass the correct current through the heaters. A discrepancy of 5 per cent, either way in the current flowing must be considered as the limit, and so it is not possible to adjust the linecord simply by cutting to an estimated length. The resistance of each foot of cord will vary, and the current flowing, or the voltage across the heater chain, must be adjusted to the correct value by measurement. Of the two methods the measurement of the current, rather than the measurement of the voltage, is much to be preferred.

On the surplus market there are, at present, to be obtained thermo-couple ammeters with a maximum reading of 350 mAs. (0.35 amp). Properly used, these instruments are ideal for linecord adjustments on either A.C. or D.C. circuits. Their scales are often marked 'For Radio Frequencies Only,' but the scale calibrations are almost always set and checked by 50 cycles A.C., and so give correct readings for both A.C. and D.C. supplies.

Thermo-ammeters are limited in their surge-carrying capacity, and so must be used with care. When an AC/DC midget receiver is first switched on the current through the heaters is more than the rated value and falls to correct

value as the heaters warm up and their temperatures rise to operating levels. In many cases the surge is not sufficient to damage a thermo-ammeter connected in series with the heater circuit but, as a precaution, it is strongly recommended that the instrument be connected with a parallel shorting switch, as shown in Fig. 30. The instrument is connected in series with the linecord and the valve heaters and the shorting-switch thrown; the set is then switched on and the valves allowed to warm up and then the switch is opened to obtain a meter reading.

The linecord must be bought so that the length is slightly in excess of that finally required; the length may be obtained by dividing 60 ohms into the resistance needed to give the number of feet of cord. The cord resistance will generally be a little over the 60 ohms per foot, so that the division will provide a length slightly in excess of that required.

For each current measurement the valves should be allowed to operate for two minutes before taking a current reading; the circuit may then be switched off, the linecord resistance wire shortened slightly, and another current reading taken. The cord is trimmed down until the meter indicates that the correct current is flowing when the valves are heated up and working correctly.

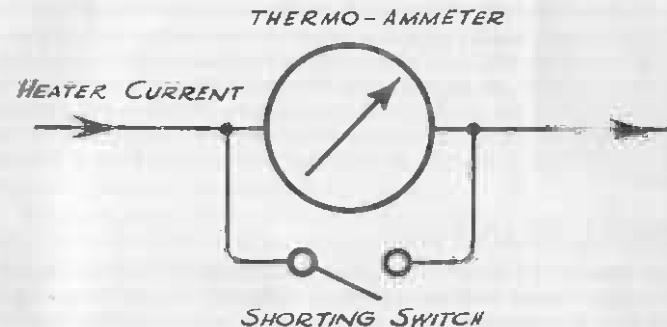

Fig. 30. Connecting the Thermo-Ammeter for Linecord Adjustments

To adjust the linecord by voltage measurements, a high resistance voltmeter must be connected across the valve heater circuit. If the mains supply is A.C. then, of course, an A.C. voltmeter must be used.

The voltage required across the heater chain is found by adding the valve-heater voltages together. For a superhet receiver with a valve sequence such as, for example, a CCH35 frequency changer, EF39 I.F. amplifier, EBC33 double-diode-triode and a CL33 output valve, with a CY31 rectifier the respective heater voltages are 7, 6.3, 6.3, 33 and 20 volts, making a total

of 72.6 volts. The voltmeter is connected to the chassis and to the junction of the linecord with the heater chain (excluding any dial lamps which may be included), and when the linecord is correctly cut to length the voltage registered by the voltmeter will be that required by the heater chain—in the example, 72.6 volts.

A lower voltage will indicate that the cord is too long; a higher voltage will indicate that too much current is flowing and the cord is not long enough. Running the valves under such conditions would lead rapidly to serious damage.

The current surge as the valves are switched on will again be evident, and so the voltmeter may be disconnected at one point until the current settles down, the connection then being made and the voltage read. The reading should be taken after about one to two minutes.

A high resistance voltmeter is essential. If a low resistance voltmeter is used a serious error will be introduced by the voltmeter current which will flow with the valve-heater current through the linecord resistance, and so cause the voltage across the valve heaters to appear low. If the cord is then adjusted and the voltmeter removed, too high a current will flow through the valves which will, in consequence, be damaged.

An A.C. voltmeter will almost certainly have a resistance of 1,000 ohms per volt or more, which makes the instrument very suitable for this purpose of linecord adjustment, but if a D.C. voltmeter is used on a D.C. mains supply care must be taken not to use one of the cheaper types of instrument which may require as much as 50 mAs. for a full-scale deflection and draw, say, 30 or 40 mAs. through the linecord resistance. Such an instrument could lead to an error of 15 per cent. or even more in the current through the valve heaters.

SECURING THE LINECORD

Because of its internal construction linecord should never be strained or bent sharply—spare cord may be loosely coiled and hidden behind the set, but it must be remembered that it is dissipating power and, therefore, heat, and so spare linecord should be in a ventilated position.

At the receiver end the line should be secured under a clamp and the asbestos cord on which the resistance wire is wound should be tied to an anchoring point, the resistance wire being unwound for an inch or so and passed through sleeving to its own connecting point. If no anchoring point for the cord can be found a soldering tag, bolted under a component fastening, can be used as a support for the end of the cord.

Appendix B

SWITCHING AND SAFETY PRECAUTIONS IN AC/DC RECEIVERS

AC/DC receivers must always be connected to the mains supply so that the chassis is connected to the neutral line in A.C. circuits, and negative in D.C. circuits. A large number of D.C. circuits will have the negative side earthed, but in many cases it will be found that the positive line is earthed.

On A.C. supplies the correct plug connection is almost always identifiable by listening for hum in the loudspeaker, the plug position giving least hum being correct. If doubt exists as to the earthed side of a D.C. supply, a neon bulb may be connected between the positive lead and a direct earth connection such as a waterpipe. A household neon lamp of the Beehive type should be used—if a neon lamp is not available then a low wattage incandescent household lamp may be employed in its place.

The bulb should light: if it fails to do so then the positive side of the D.C. supply is earthed and the receiver should have a separate earth lead taken to its chassis through an 0.01 mfd. 750 v.w. capacitor. On no account may the capacitor be dispensed with; a direct earth connection would clearly result in a partial or direct short circuit of the mains supply and serious damage may be caused, or a fire started.

The same ruling applies to A.C. receivers, and a separate earth line, if used, must always be connected to the chassis of the set through a 0.01 mfd. capacitor of 750 working voltage rating.

Inspection of the A.C./D.C. circuits in this Manual will show that a double-pole on-off switch is always specified, one pole breaking the direct D.C. positive or A.C. 'live' line to the rectifier and the other pole breaking the 'live' side of the heater circuit. This method of switching leaves the chassis of the receiver permanently connected to the negative line, in D.C. circuits, or to the neutral line in A.C. circuits, and the set is therefore safe unless, in a D.C. circuit, the positive line is earthed.

If for any reason a single pole rather than a double pole switch is used, then this single pole must obviously be used to break the negative or neutral line connection to the receiver chassis, leaving the 'live' line to the rectifier, and the 'live' line to the heater chain unbroken. The chassis of the set is then 'live' to earth through the valve heaters, and for that reason a double-pole switch is always to be preferred.

When the receiver contains the voltage dropper, as does the Modern Midget, and only two supply lines enter the receiver, a double-pole switch can be used to break both lines and so isolate the set from the mains entirely. This type of switching is to be preferred above all others, and should be used whenever possible.