

**THE SOUND METHOD FOR
MEMORIZING THE CODE**

For success in telegraphing the letters must be learned by the sound.

Each letter has a distinctive cadence or rhythm which is easily memorized by a few hours' practice.

The charts attached give the key to the rhythm of each letter of the telegraph alphabet in form; no picture in the student's mind, but instead, a sound is memorized, like a part of music.

The chart is particularly valuable in learning to receive which is many times more difficult than learning to send. An hour a day devoted to memorizing the distinctive rhythm of each letter will enable the student to send or receive a message in a few weeks.

The beginner is strongly advised not to practice with charts or books which show the actual dots and dashes. Once a picture of each letter is formed in memory it will be found difficult to send or receive in the telegraph alphabet properly—by sound.

WIRELESS PRESS, INC.

326 Broadway, New York

Copyright, 1921, Wireless Press, Inc., N. Y.

STUDY THE CODE ANYWHERE

THIS NEW WAY OF LEARNING THE CODE

is the easiest, quickest and most thorough ever devised for learning without instruments.

If you want to learn the code—

If you want to "cinch" the signals you can't remember easily

If you want to help some one else learn the code—

GET ONE OF THESE CARDS

Don't try to teach the Ears through the Eyes

This system teaches the signals as they come through the Head Phones

Contains both Continental and American Morse—
Printed on Celluloid—Fit Your Pocket

Price 50c

THE WIRELESS PRESS, Inc.

DEPT. C.

326 Broadway

New York

AR 5th SCIENCE N.Y.

**WIRELESS
CONSTRUCTION AND
INSTALLATION FOR
BEGINNERS**



**PRICE
35 CENTS**

Wireless Construction and Installation for Beginners

A PRACTICAL HANDBOOK GIVING DETAILED
INSTRUCTION FOR THE CONSTRUCTION AND OPERATION OF A
BOY'S WIRELESS OUTFIT

BY

A. P. MORGAN

With Illustrations by the Author

Fourth Edition



COPYRIGHT 1916, 1919
BY
COLE & MORGAN, Inc.

INTRODUCTION

The purpose of this little volume is to aid the young wireless experimenter in building and operating an inexpensive wireless outfit.

Those wishing to progress farther and build more elaborate apparatus will find complete details and instructions in our other wireless construction books.

In our book "Lessons in Wireless Telegraphy," we have described the elementary principles of wireless telegraphy, and in the "Amateur's Wireless Handbook," will be found a list of commercial and amateur wireless telegraph stations and a comprehensive series of wiring diagrams for connecting together wireless telegraph instruments of every description.

The purpose of "The Operation of Wireless Telegraph Apparatus" is to aid the wireless experimenter and operator in understanding more fully the methods whereby best efficiency and consequently best results can be obtained with his instruments.

CHAPTER I.

WIRELESS TELEGRAPHY.

A N Intensely Interesting Subject.—No branch of electrical science appeals more to the young experimenter than wireless telegraphy. At first glance, the subject seems to be a mysterious one, capable of little explanation, but contrary to this general opinion the whole theory and practice of the wireless transmission of messages is capable of the simplest explanation.

The instruments used in wireless telegraphy are so comparatively simple that any boy can not only readily understand how they operate, but build and operate them himself.

There are probably from 100,000 to 300,000 amateur wireless stations in the United States. These, together with the numerous government, commercial and ship stations, make it possible for one to rig up a wireless set and receive messages almost anywhere in the country.

Any boy can learn to receive and send messages slowly in two or three hours. If he puts his mind on it he can not only master the code and be able to read all of the messages in a few months, but will by that time have become a proficient telegraph operator.

The time signals sent out by the government Wireless Stations are readable for hundreds of miles and a small wireless set will enable one to set his watch or clocks daily by Washington Observatory Time.

Amateur Wireless Telegraphy is one of the most fascinating, wholesome and educational sports of modern times. It is considered to be of such educational value that schools and colleges throughout the country are equipped with outfits. It should be part of every boy's education, for it will teach some of the most valuable fundamental principles of electricity and it must be realized that electricity is the greatest force in the world to-day.

When an electric spark snaps between two points it creates an invisible ripple or wave in the space surrounding it. This ripple or wave travels at the rate of thousands of miles per second, penetrates thick walls, goes around corners, over hills, into valleys, and, in fact, everywhere.

By means of delicate receiving instruments properly arranged the waves can be detected many miles away. If the waves are arranged or timed so as to come at definite intervals like the telegraph code it is easy to send messages with them.

The Purpose of the Aerial and the Ground.

It has been discovered that if the sparks take place in a wire elevated in the air at one end and connected to the ground at the other, the waves are much more powerful and travel to greater distances. For that reason, a wireless telegraph station is always provided with a huge net work of wires elevated high in the air and termed an aerial.

The Apparatus used to send Wireless Messages.—The instrument used to make the sparks which generate the waves is called an induction coil or a spark coil. The spark coil is connected with two metal rods separated a short distance and called the spark gap. The batteries which supply the current to the coil are connected with a telegraph key.

The batteries supply current to the coil. The key enables one to turn the current on and off at will so that it can be broken up into dots and dashes corresponding to the telegraph code.

One side of the spark gap is connected to the ground or earth. The other side is connected to the aerial wires.

When the key is pressed, the current from the batteries flows through the coil. The coil causes sparks to jump across the gap and they create electric currents which flow back and forth very rapidly in the aerial wires and which are known as oscillatory cur-

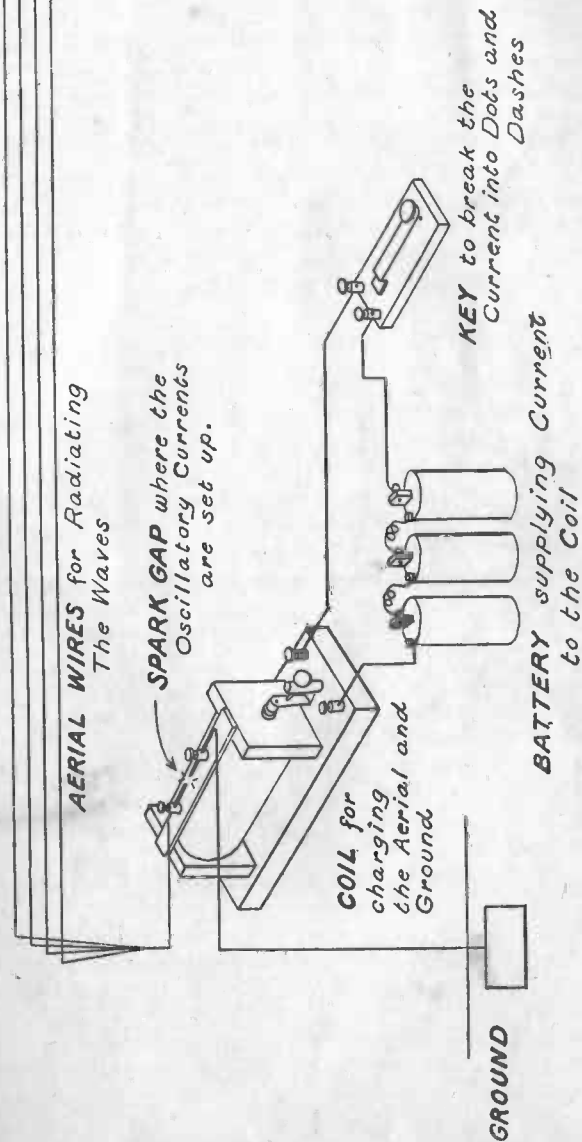

FIG. 1.

A Simple Transmitting Outfit for Sending Wireless Messages.

rents. These oscillatory currents are what create the electric waves. The aerial wires radiate the waves and send them to a greater distance than if the station had no aerial.

If the atmosphere around a wireless station could be sliced in the same manner that an apple is cut with a knife and the electric waves could be held stationary long enough to be seen they would appear much like the dotted lines in Figure 2.

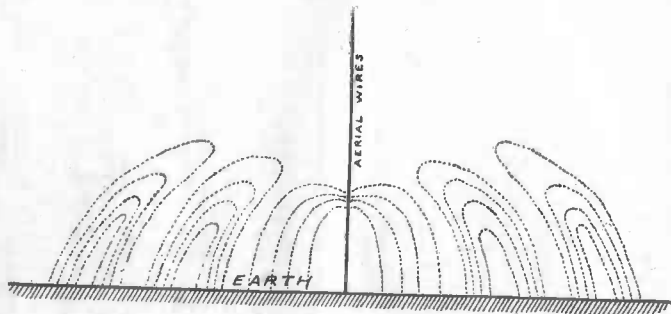

FIG. 2.

If the Atmosphere in the vicinity of a Wireless Station could be sliced in somewhat the same manner as an Apple, and the Waves held stationary long enough to be seen, they would appear like the dotted lines shown in the illustration above.

The black line in the centre represents the aerial wires. The dotted lines are the electric waves passing outwards over the earth away from the aerial.

The Apparatus Used to Receive Wireless Messages.

When the electric waves pass out through the atmosphere and approach the receiving station they are intercepted by an aerial connected to the receiving apparatus.

The waves cause oscillatory currents just like those set up by the spark at the transmitting station to be generated in the receiving aerial.

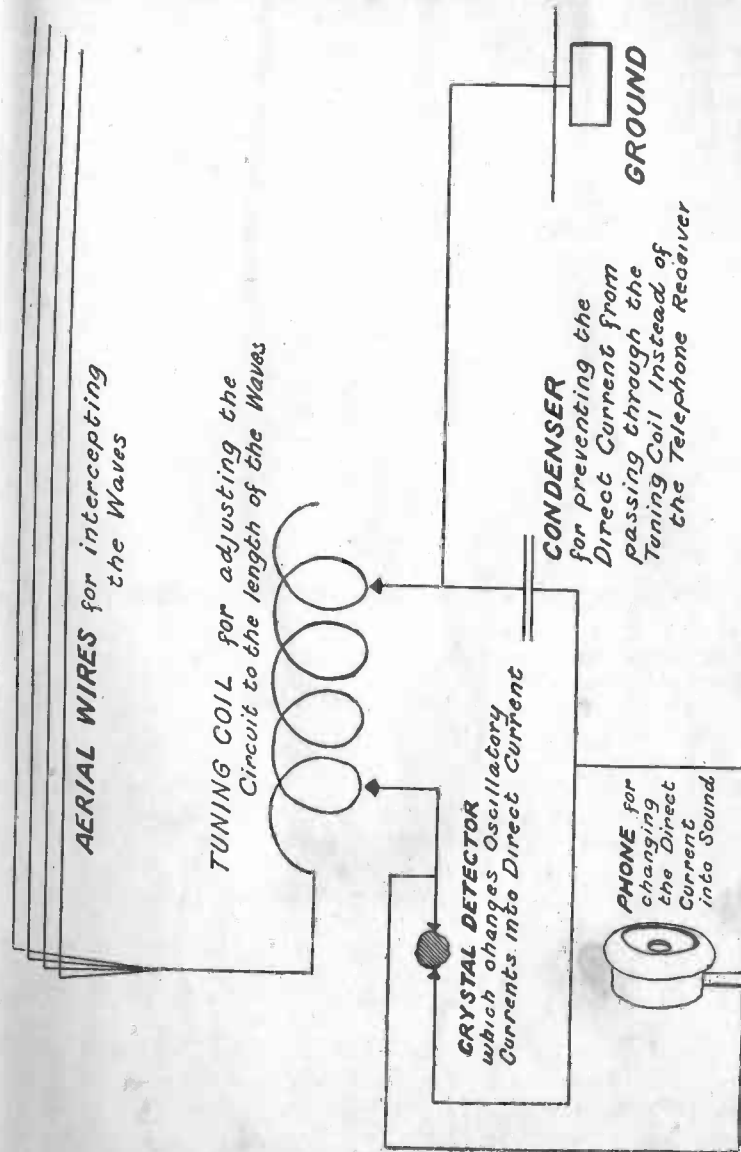

FIG. 3. A Simple Receiving Apparatus showing the Part each Instrument Plays,

The waves have a definite length which can be measured in feet and inches and in order for the waves to produce the best effect upon the receiving station, the aerial must be adjusted to suit the length of the waves.

This is accomplished by means of an instrument called a **tuning coil**. Oscillatory currents will not have any effect upon a telephone receiver and so they must first be passed through a device called a **detector**. The detector consists of a piece of certain minerals, such as silicon or galena, clamped in a small cup underneath a fine wire point. The telephone receiver is connected to the detector and when the oscillatory currents strike the detector they are immediately changed into direct currents. Direct currents will pass through a telephone receiver and so the direct current is changed into sound and if the phone is held to the ear the buzzing of the sparks at the transmitting station can be heard even though it is many miles away.

A device known as a condenser is also necessary in most stations in order to prevent the direct current from passing through the tuning coil instead of the telephone receiver.

The condenser consists simply of two sheets of tin-foil separated by a piece of paper.

A **Tuning Coil** consists of a cylinder around which is wound a single layer of wire. Two contacts called **sliders** move back and forth over the wires and touch them as they go along so that it is possible by moving the sliders to add to or subtract from the amount of wire in the circuit.

A **Loose Coupler** is a device serving the same purpose as a tuning coil and constructed along the same lines. A loose coupler has two windings instead of one and is much more sensitive.

CHAPTER II.

AERIALS AND GROUNDS.

EVERY wireless station must be provided with an aerial to send out and intercept the waves accordingly as the station is transmitting or receiving. The aerial might be called both the eye and the ear of the station.

Where to Put Up the Aerial.—The arrangement and location of the aerial will largely determine the distance over which the station can transmit or receive.

The aerial should be as long and as high as it is possible to make it. In order to secure good results the aerial should be at least 40 feet high and 75 feet long. It should be made 60 to 75 feet high and 150 feet long whenever possible.

It is probable that most experimenters will have to put the aerial up in some one place and make it as high and as long as possible without much choice as to poles or trees from which to support it.

Whenever possible, the place selected to put up the aerial must be such that the aerial will not be in the immediate neighborhood of any tall objects or electric wires, such as trees, smoke-stacks, telephone wires, power wires, trolley poles, etc., because they will tend to shield or shadow the aerial and noticeably decrease the distance over which the station will be able to receive or send.

The aerial may be supported from a short pole placed on the roof of the house or from a tree or pole in the yard.

The facilities which are to be had for supporting the aerial will largely determine which form of aerial to use.

Types of Aerials.—There are several forms and types of aerials which may be used.

When there is a high pole or tree available so that one end of the aerial is quite high and the other end

drops down vertically or on a slant somewhat like that shown in Figure 4, the aerial is of the type known as a "grid" aerial.



FIG. 4.

An Aerial of the Grid Type.

When two supports may be used such as a tree in the yard and a pole on the house or two poles on the house it is best to use an aerial of the "flat top" type. Figures 5 and 6 show two aerials of the "flat top" type. The form shown in Figure 5 is a "T" aerial and that in Figure 6 is an inverted "L."

The difference between these two forms of aerial lies in the place at which the wires leading in to the instruments are attached. In the "T" aerial they are attached to the middle of the flat portion of the aerial and in the "L" aerial they are attached to one end.

The "T" Aerial is the best "all around" form and may be recommended wherever it is possible to erect an aerial of this sort. The inverted "L" type is a very good aerial and is probably the one most employed by experimenters because they usually find that their station has to be located at one end of the aerial and

if they employed the "T" type the leading in wires would take too much of a slant.

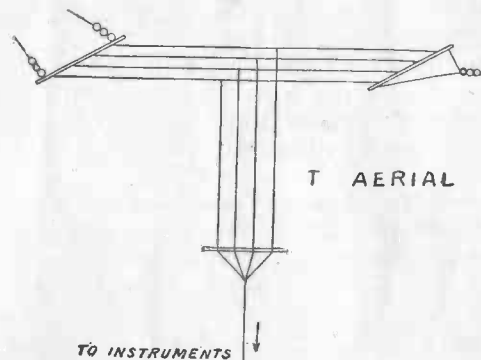

FIG. 5.

A Flat-top "T" Aerial.

The Masts which support the aerial should be of wood and provided with pulleys so that the aerial may be raised or lowered at will. The mast should be thoroughly braced with stays or guys so as to counteract the strain of the aerial and the effects of the wind.

It must also be remembered that in the winter time the aerial is very liable to become thickly coated with sleet and ice and unless it is put up strongly it will probably come down in a heavy storm.



FIG. 6.

A Flat-top Aerial of the inverted "L" Type.

Where a tree is to be used to support the aerial it is sometimes a good idea to fasten a short pole or mast in the top of the tree so that the aerial may be pulled up clear of the trees.

The Wire used for aerials should be either aluminum or copper. Never use iron or galvanized iron wire. Iron wire tends to choke the currents which pass up and down the aerial whenever the station is in operation.

Four wires are generally used on an aerial. The wires should be placed as far apart as possible and held in position by a wooden spreader or arm.

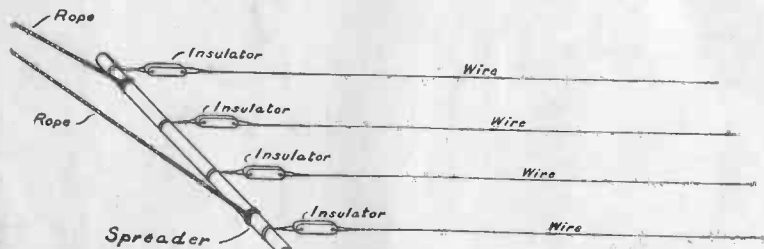

FIG. 7.

A Diagram showing how a four-wire Aerial is arranged and insulated from the Spreader.

Insulators.—The aerial must be very carefully insulated from the mast and from all surrounding objects. The insulators must be strong enough to support the weight of the aerial and to withstand the strains caused by winds and storms.

Ordinary porcelain cleats may be used as insulators on small aerials.

The wire used for the aerial should not usually be smaller than No. 14 B and S gauge.

Figure 7 shows how to arrange the wires. One insulator should be placed at each end of each wire close to the spreader or spar.

A piece of strong rope forming a bridle is attached to each end of the spreader.

Whenever it is possible, use the special moulded aerial insulators known as Electro-se Insulators. They have an iron ring imbedded in each end for attaching a rope or wire. They are very strong and have a high insulating value.

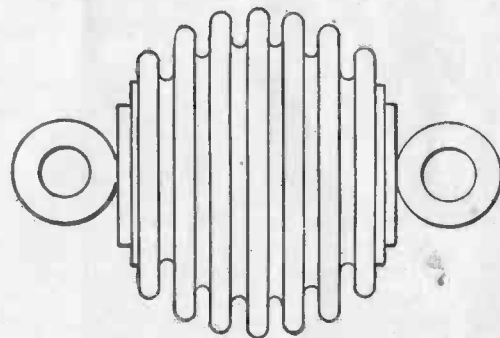

FIG. 8.

An Electro-se Insulator of the Ball Type.

Two porcelain cleats may be connected together with a short piece of wire and will form a very good insulator for a light aerial.

Figure 10 shows the details of an aerial of the inverted "L" type. In addition to an insulator at each end of each wire, an Electro-se insulator is placed in the bridle at each end of the aerial.

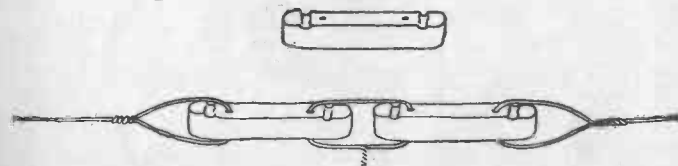

FIG. 9.

Showing how Porcelain Cleats may be used as Insulators for Light Aerials.

The stays attached to the end of the spreader are ropes fastened to the supporting pole at the lower end and prevent the aerial from twisting or turning over.

An aerial should not be hoisted up perfectly tight, but should be allowed to hang somewhat loose, so that it will not put too much strain on the poles and ropes when the winds blow.

Leading In the Wires.—The wires leading from the aerial to the receiving instruments are known as the "rat-tail" or "lead-in." The wires should be brought in gradually, that is, if the aerial has four wires, bring in four wires, but do not connect them all together until they almost reach the apparatus.

The "lead-in" should be just as carefully insulated as the aerial and where it enters the house or building it should be led through a porcelain or glass tube.

The ground connection is almost equally as important as the aerial.

In cities and towns where water systems exist the best way of securing a ground is to connect to a water pipe.

Gas pipes and radiator pipes are sometimes used, but they do not form as good a ground as a water pipe.

When gas pipes are used, in a house where there are electric lights also, the fixtures or chandeliers are often electrically separated from the pipe by an insulating joint, and attaching a wire to a fixture or chandelier will for this reason not always give a ground.

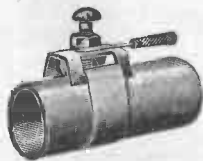

FIG. 11.

Ground Clamp for connecting Wires to a Water Pipe.

A device known as a ground clamp, illustrated in Figure 11, provides the best method of connecting a wire to a pipe.

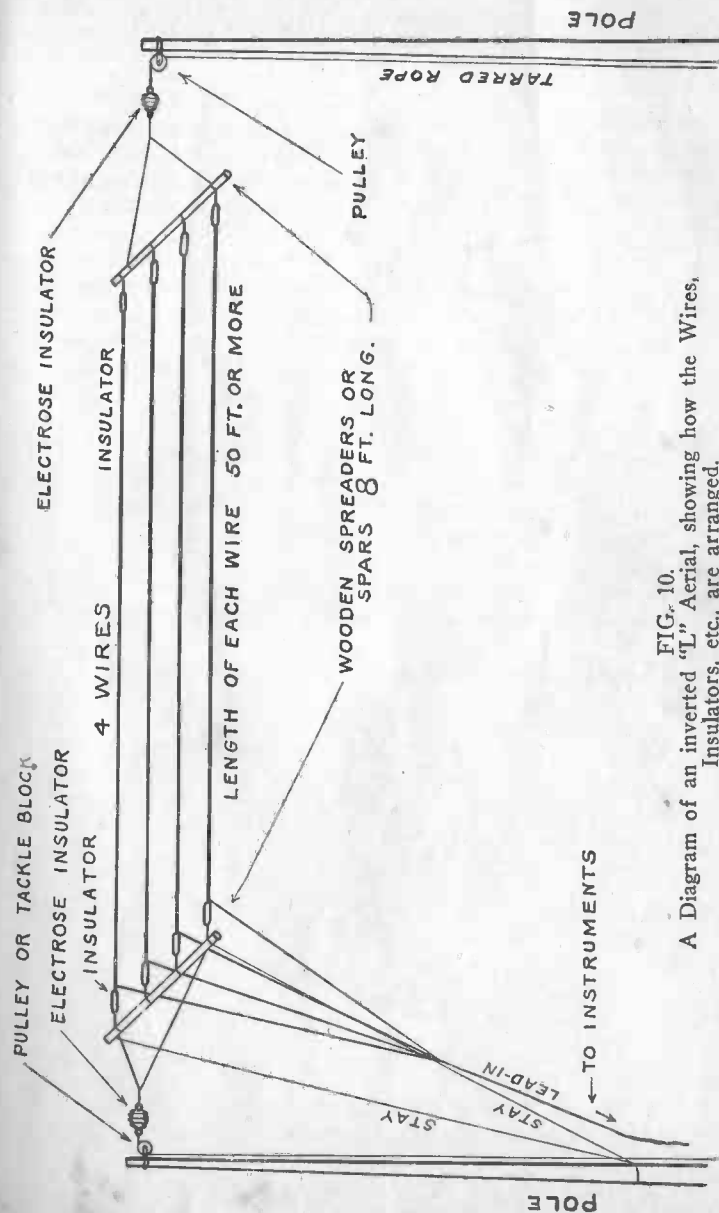

FIG. 10.
A Diagram of an inverted "L" Aerial, showing how the Wires, Insulators, etc., are arranged.

In the country where no water or gas pipes are available, it is sometimes possible to secure a ground by connecting a wire to a well pipe, or to form a ground by burying a sheet of copper or zinc about four feet square in a moist spot in the earth and connecting a wire to it.

When the aerial has been erected, the wires led in and a ground provided, the station is ready for the instruments.



CHAPTER III.

HOW TO BUILD AND OPERATE THE SIMPLEX DOUBLE SLIDE RECEIVING OUTFIT.

THE Simplex Double Slide receiving outfit consists of a double slide tuning coil, a detector and a fixed condenser mounted upon a wooden base. It is a simple arrangement, and is at the same time very efficient and capable of receiving wireless messages from a considerable distance.

Any boy can construct the outfit without using elaborate tools or expensive materials and for this reason it is the ideal set for the beginner in wireless telegraphy.

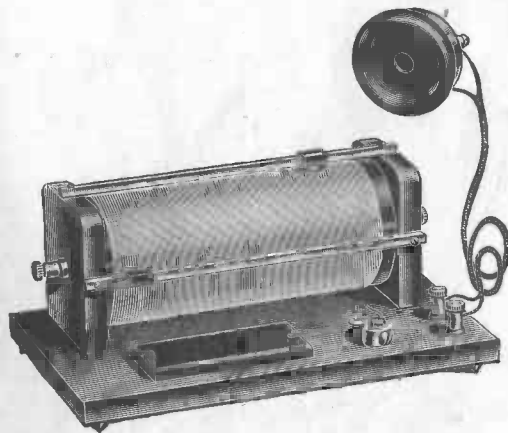

FIG. 12.

Simplex Receiving Outfit complete with Telephone Receiver.

The parts and materials required in order to construct the receiving set are: a wooden base; two

wooden tuner heads; one cardboard tube; two slider rods; two sliders; one-half a pound of No. 26 wire; four binding posts with screws; one detector cup; one piece of phosphor bronze wire; one small sheet of thin paraffined paper; tinfoil; screws; brass nails.

The Tuning Coil is the first part of the outfit to build. The tuner heads are made out of two hardwood blocks, three inches square and one-half of an inch thick. A circular ring is turned in one face of each of the blocks. The ring should be one-quarter of an inch deep and two and one-half inches in diameter so as to receive a cardboard tube.

The two upper corners of each of the heads may be rounded slightly so as to improve their appearance. The heads should be stained, preferably some dark color such as mahogany, and then given a coat of shellac or varnish.

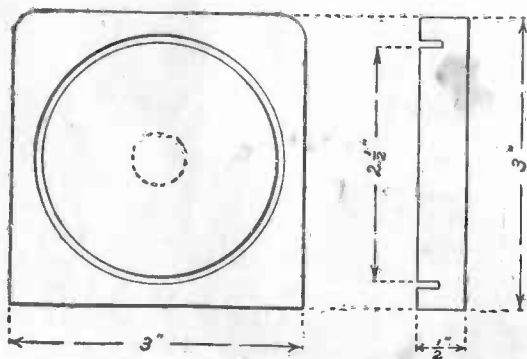

FIG. 13.

Wooden Tuning Coil Head.

About one-half a pound of No. 26 B and S. gauge single cotton covered wire will be required to wind the tuner. The wire is wound smoothly in a single layer over a cardboard tube two and one-half inches in diameter and seven inches long. The winding should be done very carefully. Each turn should just touch

the preceding one without overlapping or without any space between.

The winding should start and finish about one-half an inch from each end of the tube.

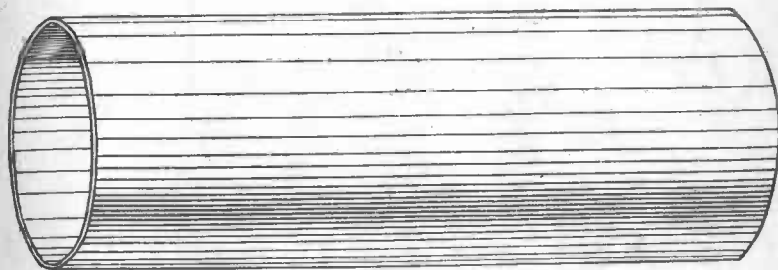

FIG. 14.

Cardboard Tube upon which the Wire for the Tuning Coil is wound.

The Tube should be "impregnated" before winding. The best way to do this is to place the tube in a dry, warm place such as an oven until it is thoroughly dried. Then give it a thick coat of shellac both inside and out. After the shellac has dried, the tube is ready for winding. The precaution of impregnating the tube is taken in order to prevent the tube from warping and shrinking with changes of temperature and weather. If the wire were to be wound on the plain tube it would be very liable to become quite loose during warm or dry weather. After the winding is finished it should be given a single coat of shellac or varnish and laid away to dry.

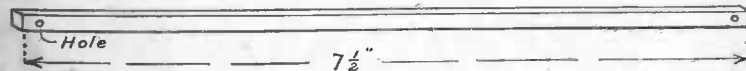

FIG. 15.

Slider Rod.

Two Slider Rods will be required to support the sliders which make contact with the wires. These rods are each seven and one-half inches long and are square. They may be either five thirty-seconds or three-sixteenths of an inch square. A small hole should be bored one-quarter of an inch from each end of each rod.

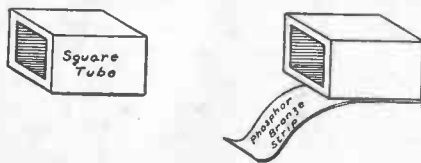

FIG. 16.

Showing how the Sliders are made.

The Sliders are made from square brass tubing which will just fit over each rod. Two pieces of tubing, each one-half of an inch long, will be required. A short piece of No. 30 gauge phosphor bronze sheet about three-quarters of an inch long and three-sixteenths of an inch wide is soldered to the under side of each of the pieces of square tubing. It is then bent into the shape shown in Figure 17.

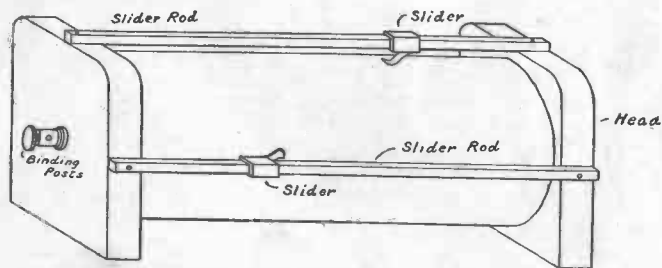

FIG. 17.

The complete Tuning Coil.

Figure 17 shows how the tuning coil is assembled. A binding post of the type known as a No. 4 Post is mounted on the centre of each of the tuner heads.

The right hand end of the coil is connected to the binding post on the right hand head (marked A in Figures 23 and 24). The binding post on the left hand head is connected to the slider rod mounted on front of the coil. The slider running on this rod is marked No. 1 in Figures 23 and 24.

The ends of the tube are slipped into the circular groove in the wooden heads. The sliders are slipped into position on the rods and then one of the rods mounted across the top of the tuning coil by driving a brass nail through the holes in each end of the rod into the wooden head. The other rod should be mounted across the front of the coil. The rods should be exactly in the center of the heads so that they are parallel with the axis of the coil. The phosphor bronze strips on the lower side of the sliders should be bent so that they slide smoothly and firmly over the wire. The insulation should be scraped off the wire in a straight narrow path under each of the sliders so that the phosphor bronze strip makes contact with each and every wire as it is moved along.

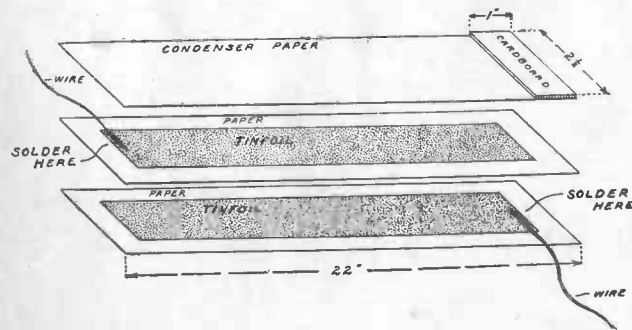

FIG. 18.

Showing how the Fixed Condenser is built up.

The Fixed Condenser must be carefully made in order to insure its proper operation. It consists of two strips of tinfoil, twenty inches long and two inches

wide. A piece of copper wire about six inches long should be soldered to one end of each strip.

Lay one strip of tinfoil in the centre of a strip of paraffined paper, twenty-two inches long and two and one-half inches wide. Place a second strip of tinfoil in the centre of the second sheet of paper. The wire connected to this strip of tinfoil should be at the opposite end from the wire on the other strip. Place a third sheet of paraffined paper over the top strip of tinfoil. Cut out a small rectangular shaped piece of cardboard, two and one-half inches long and one inch wide. Place this at one end of the pile of paper and tinfoil and roll the whole thing up, using care to keep the edges even and to prevent the tinfoil from sliding or slipping.

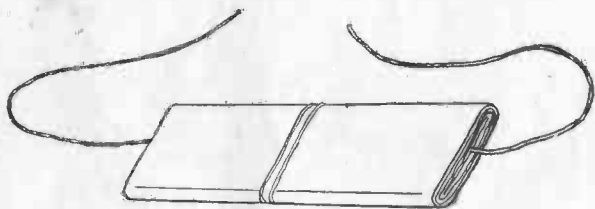

FIG. 19.

The Fixed Condenser rolled up ready to be placed in its case.

The cardboard will serve as a guide in rolling up the condenser and will keep it flat. In rolling the condenser around the cardboard do not bend the cardboard so that the paper and tinfoil roll up round in the same manner as a roll of wall paper, but take a flat form like a bolt of cloth. Tie the condenser with a piece of string to keep it from unrolling. The finished condenser should appear like that shown in Figure 19 and have the wires coming out at opposite ends.

When selecting the paper for making the condenser, be absolutely certain that it has no holes in it. The paper used in winding coils and sold under the name of waxed condenser paper is the best.

Use care not to damage or tear the paper when rolling and completing the condenser. The two strips of tinfoil should be perfectly insulated from each other by the strips of paper and should not touch each other. If they touch or are electrically connected the condenser is "short-circuited" and if you use a short circuited condenser on your wireless set you will not be able to receive any messages.

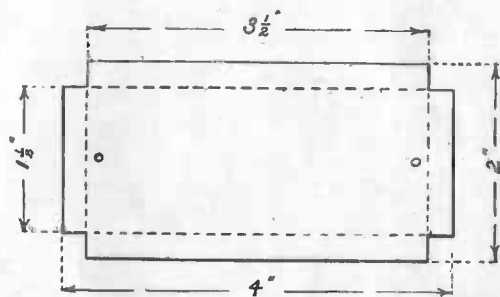

FIG. 20.

The Case for the Fixed Condenser.

When the condenser is mounted on the receiving set it is placed in a metal case made according to the plan and dimensions shown in Figure 20.

The case is made from a rectangular piece of sheet tin four inches long and two inches wide. A notch, one-quarter of an inch square is cut in each corner. The case is then bent along the dotted lines so as to form a shallow tin box. Two small holes are drilled in the case near the ends to pass a brass nail so that the case can be fastened to the base of the receiving set.

The Detector Parts are illustrated in Figure 21. They consist of a round brass cup, five-eighths of an inch in diameter and a piece of No. 30 phosphor bronze wire with the necessary screws to hold the wire and the cup in position. The cup is fitted with a set screw so

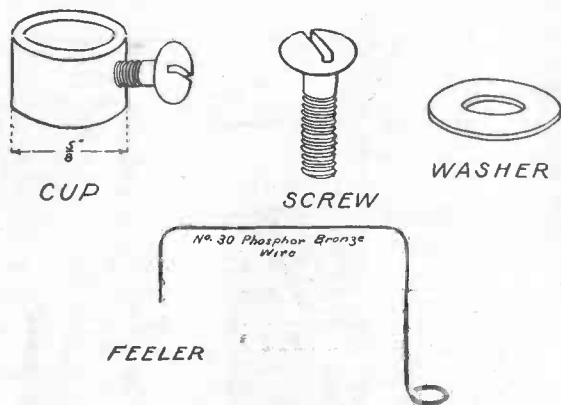

FIG. 21.

The Parts of the "Cat-Whisker" Detector.

that the mineral may be very firmly clamped. The illustration shows just how the phosphor bronze wire should be bent.

Figure 22 shows a side view of the detector when it is mounted upon the base of the receiving set.

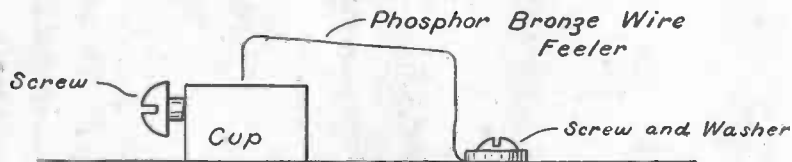

FIG. 22.

A Side view of the "Cat-Whisker" Detector showing how the Parts are arranged.

The base is a piece of hardwood, nine inches long, six inches wide and one-half of an inch thick. The base should be stained to match the tuner heads and then given a coat of shellac or varnish.

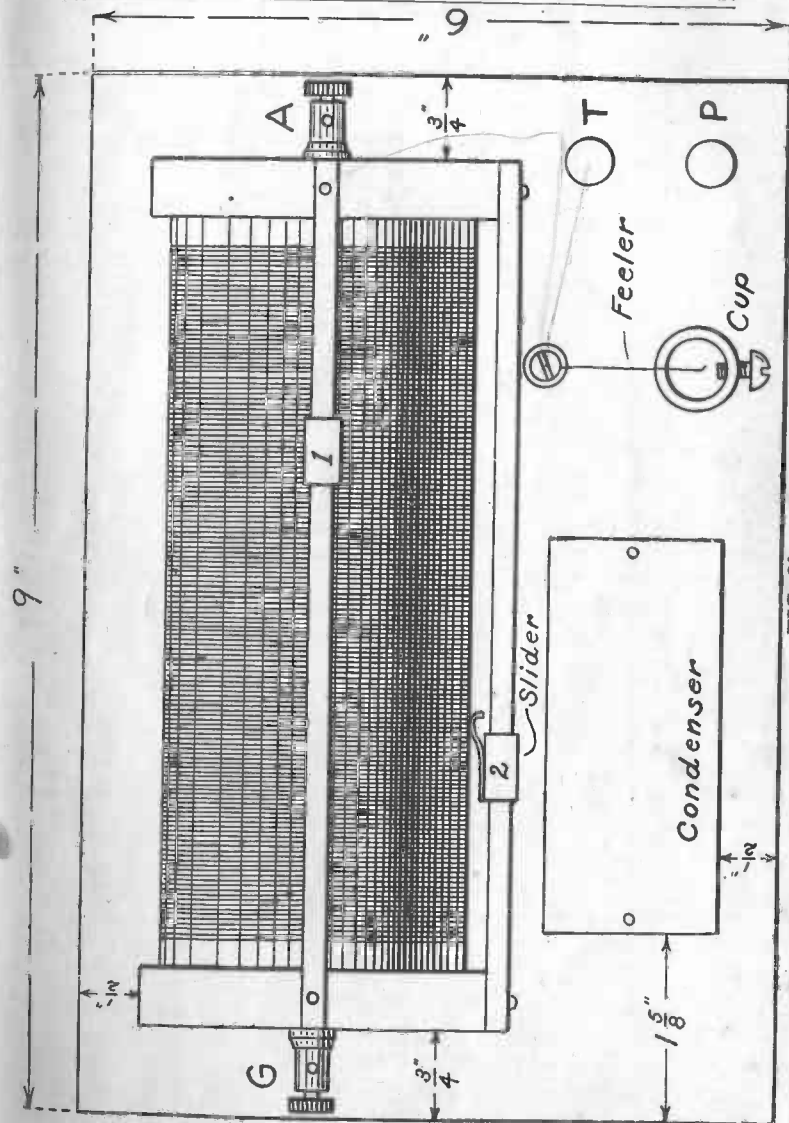

FIG. 23.

A top view of the complete Simplex Receiving Set.

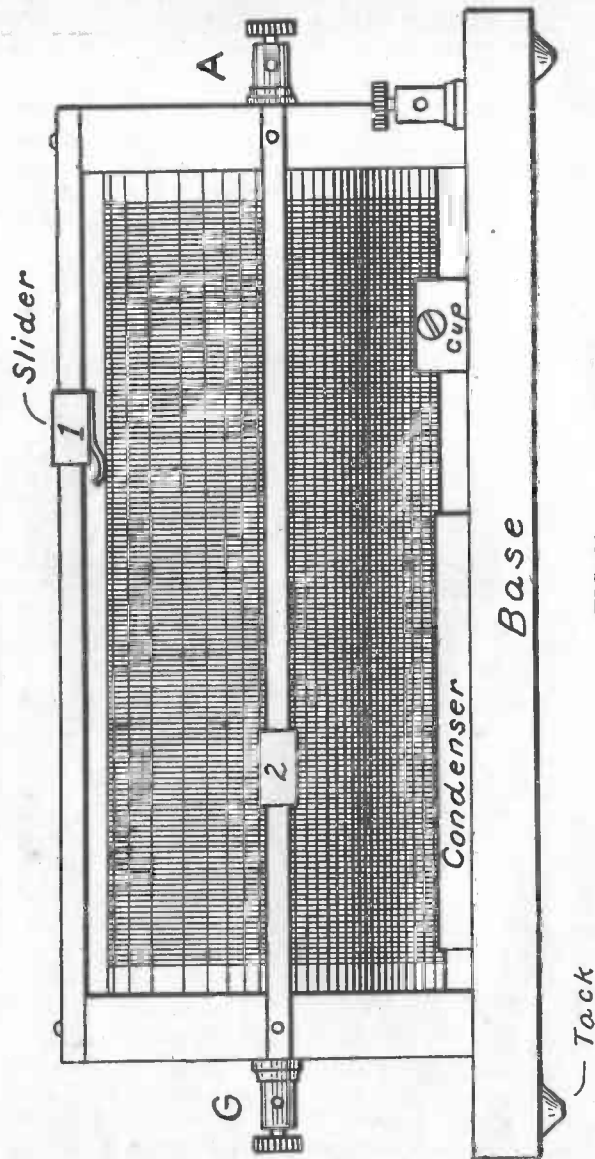

FIG. 24. Complete Simplex Receiving Set.

Assembling the Set.—After the base has dried the parts of the receiving set may be mounted in position. The tuning coil is fastened to the base by two screws or brass nails passing from the under sides of the base into the heads of the coil. The coil heads should be about three-quarters of an inch from the sides of the base and one-half inch from the back.

The condenser is mounted in front of the tuning coil to the left of the centre. It is placed in such a position that when the cover is on it will be one-half of an inch from the front edge and one and five-eighths inches from the left hand edge. The wires from the condenser should be passed through two small holes in the base. The tin cover is fastened over the condenser by two brass nails passing through the small holes drilled there for that purpose.

The detector is mounted in front of the tuning coil to the right of the condenser. The rear end of the phosphor bronze wire is placed between a washer and the head of the screw which fastens it to the base.

Two binding posts of the type known as No. 4 are mounted at the right of the detector.

The illustration in Figure 23 is a top view of the complete receiving outfit. This, together with Figure 24, which is a front view, will show exactly how the parts are arranged and located.

Connecting the Instruments.—The diagram in Figure 26 is the "hook-up" or connection diagram for the set.

The binding post, marked A in the drawing, and mounted on the right hand head of the tuner, connects to one end of the wire wound around the tube. This binding post is the one which should be connected to the aerial.

The binding post, marked B in the drawing and mounted on the left hand head of the tuner, connects to the slider rod mounted on the front of the coil and carrying the slider marked 2. This binding post is the one which should be connected to the ground.

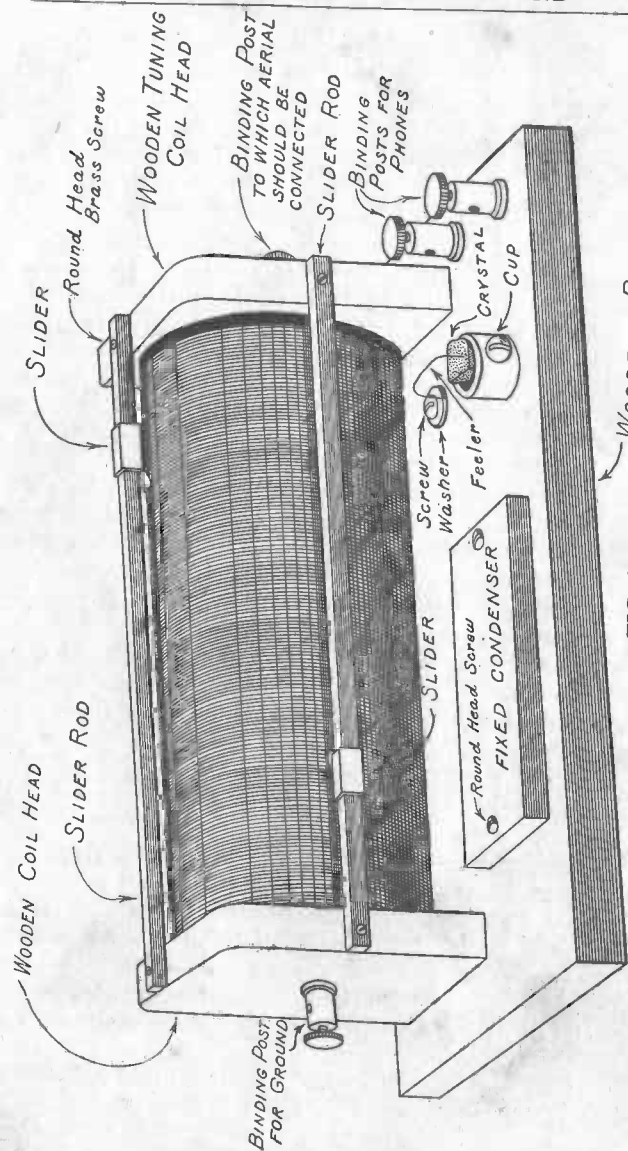

FIG. 25.

The completed Simplex Receiving Set.

A wire also leads from the slider rod on the front of the coil down through the base and along the under side where it is connected to the left hand wire leading out from the fixed condenser.

The right hand condenser wire is connected to the screw which holds the detector cup in position and runs from there to the binding post marked P in Figure (23).

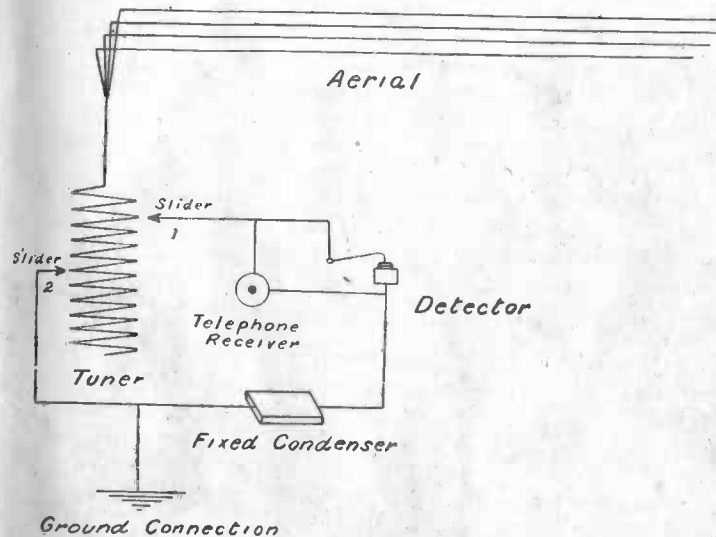

FIG. 26.

A Diagram showing how the Instruments are connected.

A wire leads from the post marked T and connects to the screw which fastens the phosphor bronze wire or "feeler" to the base. From there, it runs along the bottom of the base to a small hole and up through to the slider rod mounted on top of the coil and carrying the slider marked No. 1.

The two binding posts, P and T, are the ones to which the telephone receiver is connected.

Care should be taken when connecting the set to see that none of the wires touch each other, so as to cause a "short circuit."

The wires may be fastened to the base by placing them under the heads of some small tacks or by gluing a strip of paper over them.

After the set is wired, drive a large upholsterer's tack in the under side of the base at each corner so as to raise the set up above the table or any object upon which it may be resting.

Operation.—In order to place the set in operation all that it is necessary to do is to connect the wire leading from the aerial to the binding post A. The binding post B is connected to the ground. The telephone receiver is connected to the binding posts P and T. Place a small crystal of galena about three-eighths of an inch square in the cup and clamp it in position with the set screw. Then using a match-stick or a tooth pick raise the end of the phosphor bronze wire up and allow it to come down on the crystal. It should be bent so that the end of the wire bears firmly on the crystal.

It may be necessary to move the wire about quite considerably before a sensitive spot is found. Never touch the crystal any more than is absolutely necessary with the fingers and always use the end of a wooden tooth pick or a match stick to move the wire.

Hold the telephone receiver to the ear and move the sliders back and forth. By moving the sliders and adjusting the detector you will be able to hear very faintly any message which is within the radius of your receiving station. Adjusting the detector by moving the wire and trying various spots and faces of the crystal together with constant adjustment of the sliders will soon enable you to find the place where the messages may be heard loudly and clearly.

You will probably have to move the sliders to a different position for each station that you listen to, but you will soon learn how to secure the best adjustment, or "tuning" as it is called, in a few seconds, by a little practice.

CHAPTER IV.

HOW TO BUILD THE SIMPLEX LOOSE COUPLER, DETECTOR AND CONDENSER.

THE Simplex Loose Coupler is an exceedingly simple instrument of the highest efficiency which, when used to replace a double slide tuning coil, will greatly increase the distance that messages can be received. It is also far more "selective" than a tuning coil, which means that it is more easily possible to tune out undesired messages or signals.

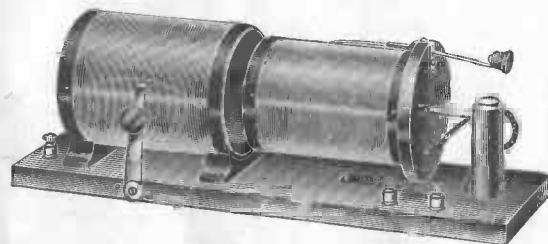

FIG. 27.

The **Base** of the loose coupler is a piece of hardwood, twelve inches long, three and five-eighths inches wide and one-half an inch thick. There are several holes to be bored in the base as shown in Figure 28. The base should be stained and then given a coat of varnish or shellac.

The **Primary** consists of a single layer of No. 24 B and S gauge cotton covered wire wound over a cardboard tube three and one-eighth inches diameter and four and one-eighth inches long.

The winding starts and finishes three eighths of an inch from the ends of the tube. The wire should be wound tightly and evenly. After the winding is finished, give it a coat of shellac or varnish. The ends of the wire may be fastened by passing through a small hole near the edges of the tube.

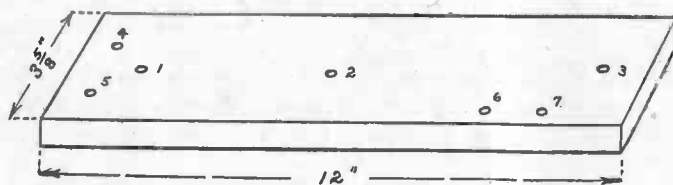

FIG. 28.

Loose Coupler Base.

The tube should be carefully impregnated by soaking it in shellac and allowing it to dry before the wire is wound on. This will prevent the tube from warping or shrinking due to changes in the weather or temperature with consequent loosening of the wire. If this precaution is not taken it will be found that the tube grows smaller during dry weather and expands in damp weather.

The primary is mounted upon two wooden blocks called "pillow" blocks and shown in detail in Figure 29. The blocks are placed under the winding at opposite edges of the tube and fastened in place by means of several small brass nails. The wire at one end of the tube should be led down through the tube so that it extends out at the bottom five or six inches.



PILLOW BLOCK

FIG. 29.

Pillow Block for supporting the Primary Tube.

The primary head is a circular piece of wood one-quarter of an inch thick and about two and seven-eighths inches in diameter or of such size that it will just slip into the end of the primary.

The head is placed in the same end of the primary at which the wire is led down and fastened in position by several small brass nails.

The primary may then be fastened to the base by two small screws passing upwards through the holes marked 1 and 2 in Figure 28 into the pillow blocks.

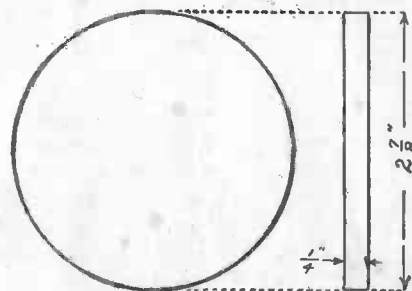

PRIMARY HEAD

FIG. 30.

Primary Head.

The sketches in Figures 36 and 37 are drawn to scale and are just one-half the size of the finished loose coupler. It is therefore easily possible to determine any dimensions or positions by measuring the drawings and multiplying by two.

The left hand end of the primary is the one having the head fitted in it. This end of the winding should be about one inch and one-eighth from the left hand edge of the base.

The Secondary winding consists of a single layer of No. 28 B and S gauge single cotton covered wire wound over a cardboard tube, two and five-eighths inches in diameter by three and three-quarter inches long. This tube must also be impregnated with shellac to prevent shrinkage. The winding should start and finish one-quarter of an inch from the ends of the

tube. It should be given a coat of shellac or varnish when completed and laid away to dry.

When dry the secondary is fitted with two wooden heads which slip into the ends of the tube. The head known as the front head is a circular piece of wood two and one-half inches in diameter and one-quarter of an inch thick having a flange three and one-quarter inches thick. The rear secondary head is two and one-half inches in diameter and one-quarter of an inch thick.

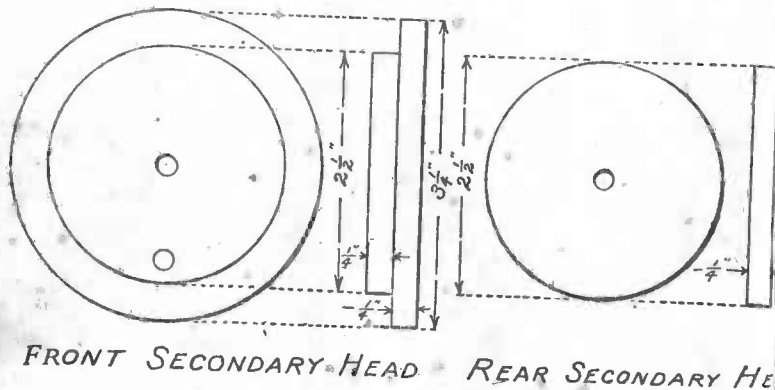

FRONT SECONDARY HEAD REAR SECONDARY HEAD

FIG. 31.

Secondary Heads.

Both of the heads have a round hole, three sixteenths of an inch in diameter bored through the center.

The heads are slipped into the ends of the tube and fastened in place by several small brass nails.

The secondary slides in and out of the primary on a brass rod running through the centre of the wooden heads. One end of the rod is supported in a hole in the centre of the primary head. The other end of the rod rests in a hole in a wooden pillar. The pillar is a cylinder of wood two and one-quarter inches long and three-quarters of an inch in diameter. The hole in the pillar which supports the brass guide rod is about

one inch and seven-eighths from the lower end or exactly the same height as the centre of the primary is above the base. The pillar is stained the same color as the base and then given a coat of shellac or varnish.

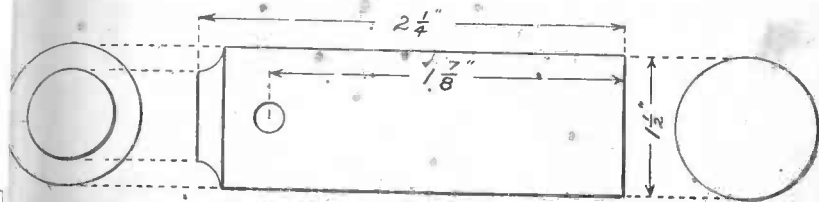

PILLAR

FIG. 32.

Pillar for supporting one end of the Guide Rod.

The Pillar is mounted in an upright position by a screw passing upwards through the hole in the base marked 3. It should be in such a position that the axis of the secondary is in a line with the axis of the primary, and the secondary will slide in and out of the primary with perfect freedom and without touching anywhere.

The primary is "varied" or tuned by means of a switch. The switch is made out of a piece of spring brass two and seven-eighths inches in diameter and one-half an inch wide. It is fitted with a No. 8005 Electrose Knob to serve as a handle. The lower end of the switch lever is rounded and drilled to receive a small round headed brass wood screw. The upper end of the switch is also rounded, but is bent at right angles.

The Switch is mounted on the front of the base at a point below the centre of the primary by means of a small round headed wood screw. It is a good plan to place a washer both under the head of the screw and between the lever and the wooden base. Place a copper wire under the washer and connect it to a binding post mounted upon the base over the hole marked 4.

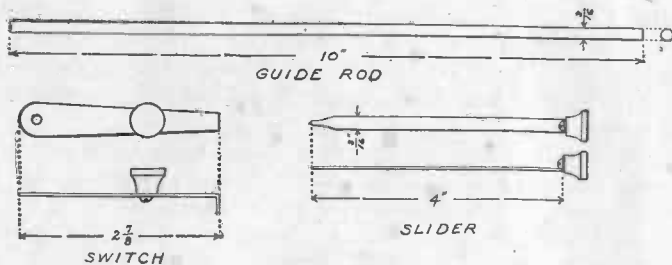

FIG. 33.

Guide Rod, Switch and Slider.

Lead the wire coming from one end of the primary down through a hole in the base and along the under side to the screw connecting to a binding post mounted over the hole 5.

The insulation should be scraped off the wires directly under the path of the switch end so that as the lever is moved back or forth, it makes contact with each and every wire.

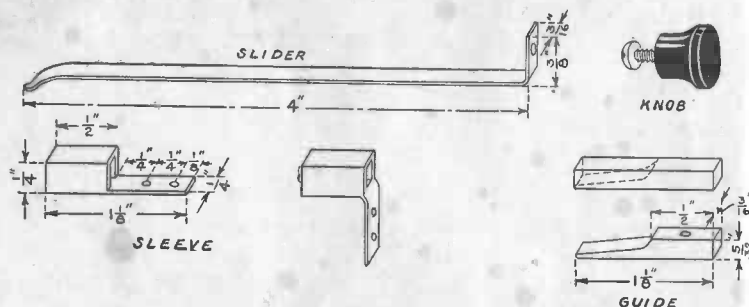

FIG. 34.

Details of the Secondary Slider.

The secondary is varied or tuned by means of a slider running back and forth in a sleeve. The slider itself is a piece of sheet phosphor bronze, four and one-quarter inches long and three-sixteenths of an inch wide. One end is bent up at right angles and fitted

with a small electrose knob which is held in position by a screw passing through a hole. The other end of the slider is cut into the shape shown in the drawing.

The slider runs in a small brass guide. The guide is made from a piece of three-sixteenths square brass tubing an inch and one-quarter long. Part of the tube is cut away so as to only leave a small tongue, three-quarters of an inch long as shown in Figure 34. Two small holes are drilled in the tongue to pass a small round headed brass wood screw. The under side of

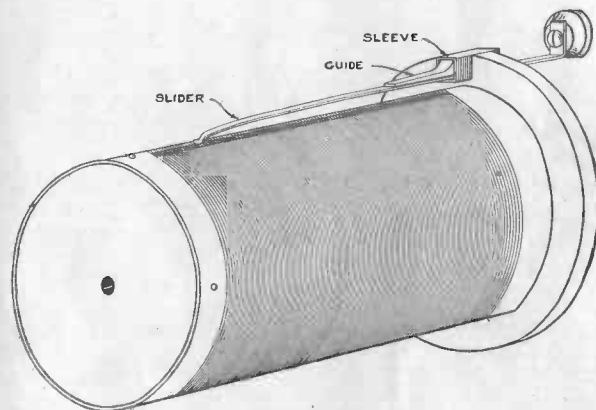

SECONDARY COIL

FIG. 35.

Details of Secondary Slider arrangement.

the guide is filed away so that when the guide is placed in the sleeve and pulled up against the upper part, by means of a small machine screw passing through a hole in the sleeve and threading into the guide, there will be just room enough underneath between the guide and the sleeve to permit the slider to slip through.

A square notch is cut in the flange of the front secondary head, at the top, of such a size that the sleeve can be just slipped in snugly. It is fastened in place by two screws passing through the holes in the tongue.

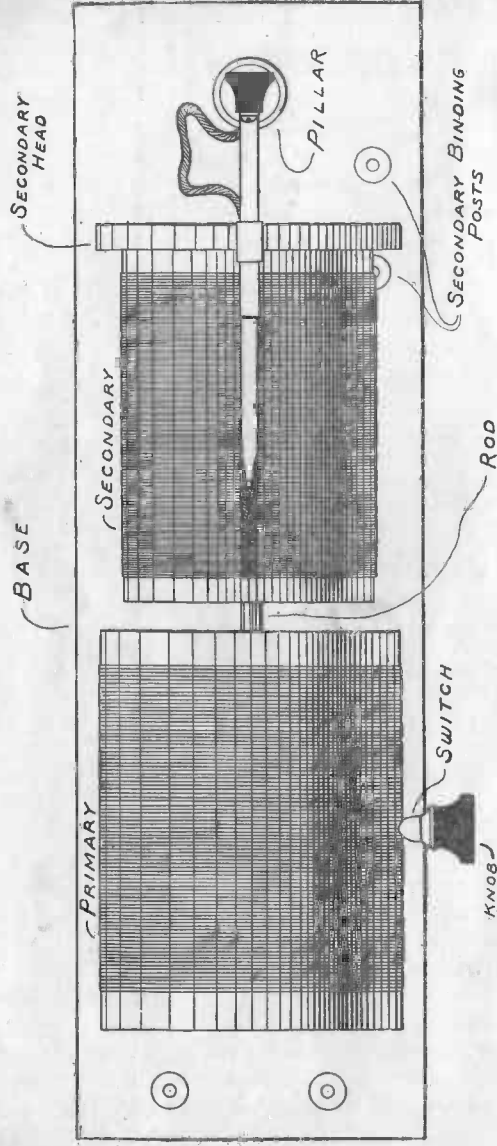

FIG. 36.

Top view of the Simplex Loose Coupler.

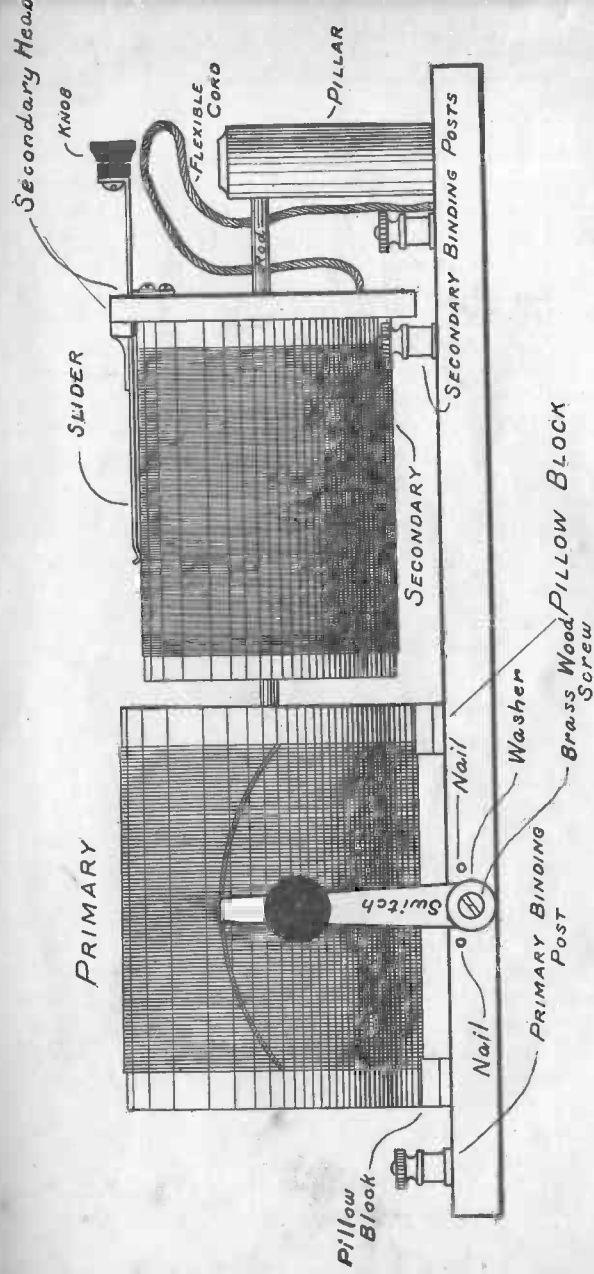

FIG. 37.

Front view of Simplex Loose Coupler.

The slider is bent into a slight curve so that the end will bear down firmly against the wire when it is pulled in and out. The insulation should be scraped off the wire directly under the path of the slider and the end of the latter should be bent so that as it is drawn in or out it will make contact with each and every wire in turn.

A piece of double, flexible wire known as "flexible conductor" or "cord" passes through a hole near the bottom of the front secondary head. One of the cords is connected to the end of the secondary winding nearest to the rear end. The other flexible cord is connected to the slider sleeve. The other ends of the cords connect to two binding posts mounted near the front edge of the base and marked "secondary binding posts" in the illustrations.

The loose coupler is now complete and ready to be connected to the other instruments.

HOW TO MAKE THE SIMPLEX "CAT-WHISKER" DETECTOR.

The detector parts have already been illustrated in Figure 21. They consist of a round brass cup, five-eighths of an inch in diameter and a piece of No. 30 phosphor bronze wire with the necessary screws to hold the cup and the wire in position. The cup is provided with a set screw so that the mineral may be firmly clamped in place.

The cup is mounted near one end of a wooden base three and one-half inches long and one and three-quarters inches wide. A No. 4 binding post, marked B in the illustration, is mounted near and connected to the cup.

The phosphor bronze wire is placed under the binding post B at the other end of the base. The wire or "cat-whisker," as it is sometimes termed, is bent so

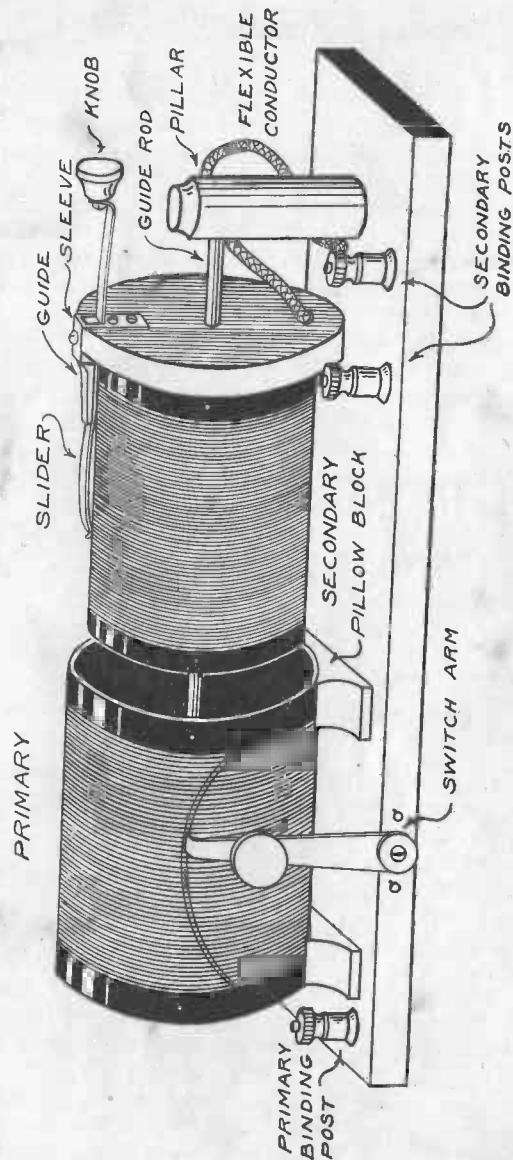

FIG. 38.

Simplex Loose Coupler completely assembled.

that the end will rest firmly on any mineral placed in the cup.

How to Make the Simplex Fixed Condenser.

The fixed condenser must be very carefully made in order to insure its proper operation.

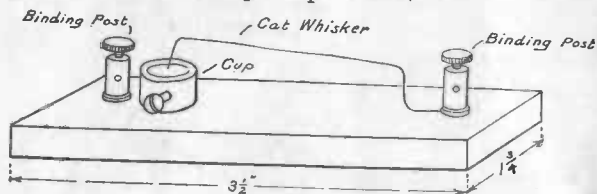

FIG. 39.

Simplex "Cat-Whisker" Detector.

It consists of two strips of tinfoil, twenty inches long and two inches wide. A piece of copper wire about six inches long should be soldered to the end of each strip.

Lay one strip of tinfoil in the centre of a strip of paraffined paper, twenty-two inches long and two and one-half inches wide. Place a second strip of paraffined paper over the tinfoil. Lay the other strip of tinfoil in the centre of the second sheet of paper. The wire connected to this strip of tinfoil should be at the opposite end from the wire on the other strip. Place a third sheet of paraffined paper over the top strip of tinfoil. Cut out a small rectangular shaped piece of cardboard, two and one-half inches long and one inch wide. Place this at one end of the pile of paper and tinfoil and roll the whole thing up, using care to keep the edges even and to prevent the tinfoil from sliding or slipping.

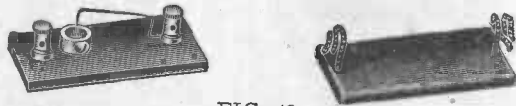

FIG. 40.

Simplex Detector and Condenser.

The cardboard will serve as a guide in rolling up the condenser and will keep it flat. In rolling the condenser around the cardboard, do not bend the cardboard so that the paper and tinfoil roll up round in the manner of a roll of wall paper, but take a flat form like a bolt of cloth. Tie the condenser with a piece of string to keep it from unrolling. The finished condenser should appear like that shown in Figure 41, and have the wires coming out at opposite ends.

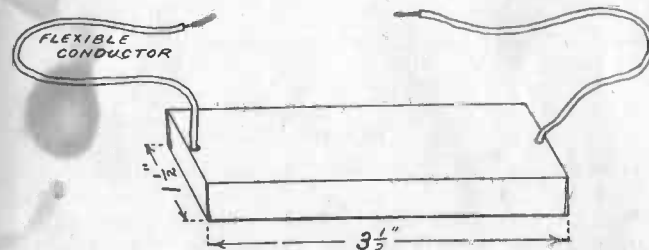

FIG. 41.

Simplex Fixed Condenser.

When selecting the paper for making the condenser, be certain that it has no holes in it. The paper used in winding coils and sold under the name of waxed condenser paper is the best.

Use care not to damage or tear the paper when making the condenser. The two strips of tinfoil must be perfectly insulated from each other. If they touch or are electrically connected, the condenser is "short circuited" and a short circuited condenser is of no value on your wireless set.

The case for the condenser is made from a rectangular piece of sheet tin, four inches long and two inches wide. A notch, one-quarter of an inch square is cut in each corner. The case is then bent along each of the dotted lines so as to form a shallow tin box. Two small holes are drilled in the case near the ends to pass the wires which connect with the tinfoil sheets.

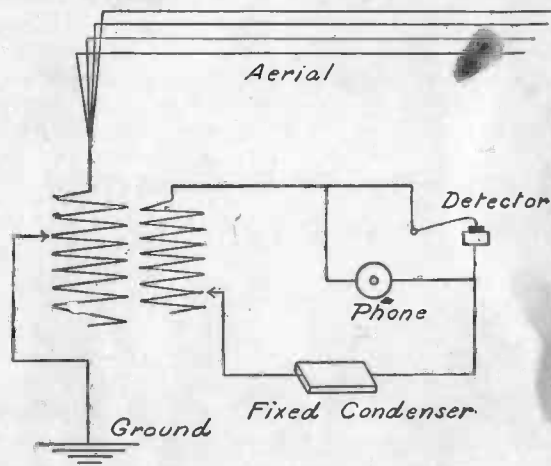

FIG. 42.

Diagram showing how to connect the Simplex Loose Coupler, Detector and Fixed Condenser.

A piece of flexible conductor should be connected with each of the wires and led out through the holes in the case. The bare wires should not touch the case at any place or the condenser will be short circuited. The tin case should be poured full of molten sealing wax so as to hold the condenser in place. The case may then be finished by painting it black.

How to Connect the Apparatus.

Figure 42 shows a diagram for connecting the instruments.

The primary binding post on the loose coupler, connecting with the end of the winding is connected with the aerial. The other post connecting with the switch lever is led to the ground.

One of the secondary binding posts is connected to one of the binding posts on the detector. The other binding post is connected to one of the wires leading

from the fixed condenser. The other terminal of the fixed condenser should be connected to the post on the detector.

The telephone receivers may be connected directly across the terminals of the condenser or across the terminals of the detector as shown in the illustration.

How to Tune with the Loose Coupler.

In order to tune the apparatus to any incoming message, move the secondary inside of the primary as far as it will go. Then move the switch lever until the signals are the loudest. Next pull the secondary slider in and out until the spot where the signals are the loudest is located. After both the primary and the secondary are adjusted it may be found that the signals can be brought in still louder by pulling the secondary out of the primary a short distance.

How to Adjust the Detector.

The adjustment of the detector will of course affect the range of the station quite considerably. Never handle the crystal any more than is necessary. The best mineral or crystal to use in a detector of the cat-whisker type is galena.

The phosphor bronze wire should be bent so that its point will press firmly on the mineral. The mineral should be clamped tightly in the cup by means of the set screw. The surface of the crystal must be searched for the most sensitive spot, that is, the spot which, when the wire is resting on it, brings in the signals the loudest. In moving the wire over the surface of the crystal use a match stick or a wooden tooth pick.

CHAPTER V.

TELEPHONE RECEIVERS AND HEADBANDS.

THE telephone receivers used for wireless telegraphy are usually of the "watch-case" type.

A receiver having a resistance of 75 to 80 ohms will be found to be entirely satisfactory for short distance wireless outfits.

If, however, it is desirable to receive messages from commercial stations over 200 miles away, a receiver having a resistance of 1,000 ohms will be necessary.

A telephone receiver cannot be made by the average experimenter and will have to be purchased.

It is advisable to have a headband of some sort so that the receivers can be clamped to the ears and the hands left free to manipulate the instruments.

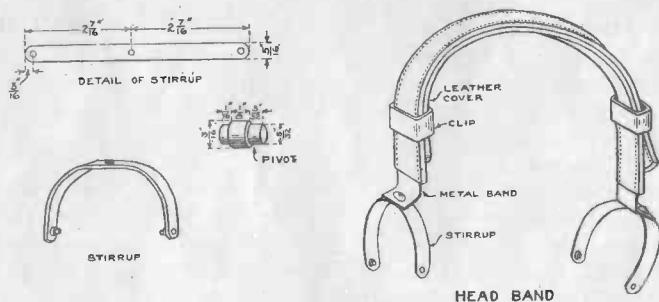

FIG. 43.

The complete Head Band with Details of the Stirrup.

A single headband may be made from a strip of spring steel twelve and one-half inches long and one inch wide. Bore a hole in one end of the band and rivet a small brass stirrup made as illustrated in Figures 43 and 44.

The head band should be encased in a leather cover made by stitching two strips of leather together along the edges and slipping the metal between.

The pivots on the stirrups fit into two small holes on opposite sides of the telephone receiver case.

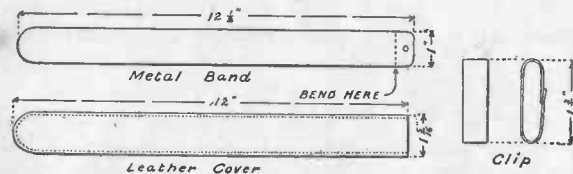

FIG. 44.

Details of the Metal Band, Clip and Leather Cover.

Two receivers can be accommodated by fastening two head bands together by slipping them between two metal clips. The clips may be made by bending a piece of sheet brass around the bands and soldering the ends together.



CHAPTER VI.

HOW TO BUILD THE SIMPLEX SPARK COIL.

A spark coil is one of the most interesting pieces of apparatus that an experimenter can possess. Not only can it be used to transmit wireless messages, but numerous and various experiments may be performed with its aid.

The purpose of a spark coil is to generate enormously high voltages which are able to send sparks across an air space which ordinary battery currents of low voltage could not possibly pierce.

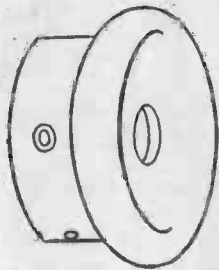

FIG. 45.

Watch Case Telephone Receiver.

It consists of an iron core surrounded by a coil of heavy wire known as the "primary" and by a second outside winding of finer wire known as the "secondary." The primary is connected to a few cells of dry battery in series with an "interrupter."

Every time that the interrupter shuts off the battery current in the primary, currents are induced in the secondary which are of sufficiently high voltage or pressure to leap across a space in the shape of sparks.

All the good features of the most up-to-date coils are incorporated in the "simplex." It only requires three or four dry cells to operate the coil and they will

operate a very long time on account of the small current consumed. The coil will give a hot spark about one-half an inch long.

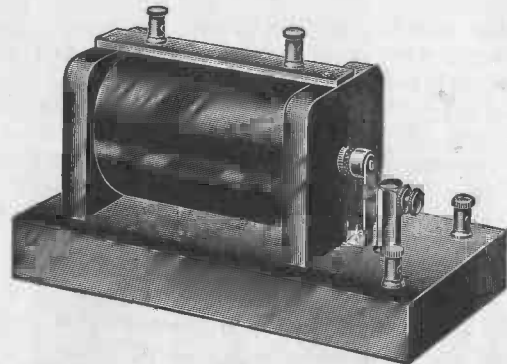

FIG. 46.

Simplex Coil.

A spark coil is not very hard to construct, but it requires careful workmanship and patience. It is not usually a job which can be finished in a day, but will take quite a little time, especially in winding the secondary.

Parts for spark coils are for sale by many electrical houses and it is possible to purchase the complete parts for less than the separate materials would cost. Such parts are made by special machinery and therefore are produced quite cheaply.

The Core is made of soft iron "core wire" about No. 20 or 22 B and S gauge. Each piece should be four and three-quarters inches long. Iron wire may be bought already cut to length from various houses dealing in experimenters' supplies. Considering the amount of labor that is required to cut each piece to length and then straighten it out, it is cheaper to purchase the wire already cut.

•"Core wire" is a special grade of wire which is very soft and has been annealed.

If ordinary iron wire is used in making a core, it must first be annealed. This is accomplished by tying the wire in a compact bundle and placing it in a wood fire until it is red hot. After the wire is hot, cover it with ashes and allow the fire to die away.

When the fire has gone out and the wire has cooled the annealing process is complete. Enough wires each four and three-quarters inches long to form a compact bundle one-half inch in diameter will be required.

Cut a piece of tough wrapping paper about six inches long and four and one-half inches wide. Roll it up in the form of a tube so that it is six inches long and one-half inch in diameter inside.

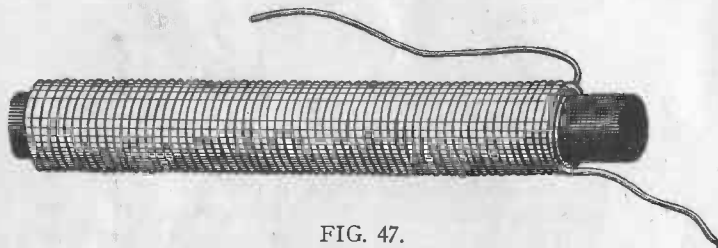

FIG. 47.

Complete Primary and Coil.

Glue the inside and outside edges of the paper so that the tube cannot unroll and then slip the core wires into it until the tube is packed tightly and no more can be slipped in.

The core is now ready for the primary, which consists of two layers of No. 18 B and S gauge cotton covered wire wound over the core for a distance of three and three-quarters inches. The winding should start five-eighths of an inch from one end of the core. The wire must be wound on very smoothly and carefully. The inside end of the wire can be fastened so that it will not become loose by placing a short piece of tape lengthwise of the core and winding two or three turns over it. Then double the end back and complete the winding over it. The end of the wire

can be fastened by imbedding a piece of tape under the winding with a small loop projecting and then passing the wire through the loop.

Figure 47 shows the complete core with primary winding in position.

The secondary is a much more tedious job than the primary and must be very carefully made. Whenever it is possible for the experimenter to purchase a secondary already wound he is advised to do so.

The secondary consists of 5,000-6,000 turns of No. 37 B and S gauge enameled wire wound in smooth, even layers, with two layers of paper between every two layers of wire.

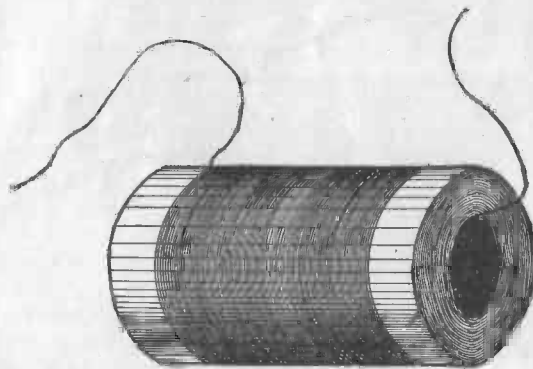

FIG. 48.

Completed Secondary Winding.

The primary winding is wrapped with six layers of "empire cloth or paper." Empire cloths and papers are a yellow insulating material made by treating linen or paper with linseed oil.

Roll up a paper tube of five or six layers of paper so that the finished tube is two and one-half inches long and of proper inside diameter to just slip over the primary winding when the empire cloth or paper is in position.

The secondary is wound over this paper tube. It will be necessary to mount the tube on a round wooden mandrel fitted with a small crank or handle so that the tube may be revolved. A "winder" may be very easily made by mounting a round wooden stick of the same diameter as the inside of the paper tube in a pair of wooden supports. Bore a hole in one end of the stick and bend a piece of stiff wire in it so as to form a crank.

The paper placed between each two layers of the secondary winding should be the special waxed paper which is made for that purpose.

Start and end each layer of wire one-half inch from the edges of the paper. Wind the wire in smooth even layers permitting each turn to touch the other, but none to lap over. Wind on two layers of waxed paper between each layer of wire and the next. The paper must be put on smoothly and evenly so as to afford a firm foundation for the next layer of wire.

The wire should never come nearer to the edges of the paper than one-half inch or the insulation of the secondary will be weak and the coil not liable to give a long spark.

The utmost care should be used not to break the wire. If it should break, the ends must be very carefully connected. The number of turns that each layer averages should be carefully noted so that by keeping a record of the number of layers it is possible to tell how many turns have been wound on. When five to six thousand turns have been wound on the secondary it is sufficiently large, and the outside end of the wire should be fastened and prevented from unwinding by securing it with a drop of sealing wax.

When winding a secondary remember that if at any point in the work, you allow the winding to become irregular or uneven, the irregularity will be much exaggerated on the succeeding layers. For this reason do not allow any irregularities to occur and if the wire tends to go unevenly, wind on two or three extra layers of the waxed paper to smooth it out.

The Condenser consists of alternate layers of tinfoil and paraffined paper piled on top of each other and then rolled up.

Four sheets of tinfoil, thirty-six inches long and two and three-quarters inches wide will be required. Eight strips of waxed condenser paper, three and one-quarter inches wide and thirty-six inches long are necessary.

Lay one sheet of paper out flat on a table or board and place a sheet of tinfoil over it. The tinfoil should be along the centre of the paper strip so that there is a one-quarter inch paper margin along the sides. One end of the tinfoil should project over the end of the paper about two inches. Lay two sheets of waxed paper over the tinfoil making them line up with the first paper sheet all around. Then place another strip of tinfoil on the paper. It should be directly above the first sheet of tinfoil, but the end of the tinfoil must overlap the paper by two inches at the opposite end from the first sheet. Place two more sheets of paper over the tinfoil and on top of that a third strip of foil. The third strip of foil should line up exactly with the first strip. Then lay two more sheets of waxed paper over the third sheet of foil and place the fourth sheet of tinfoil in position making it exactly line up with the second sheet. Place a single sheet of paper on top.

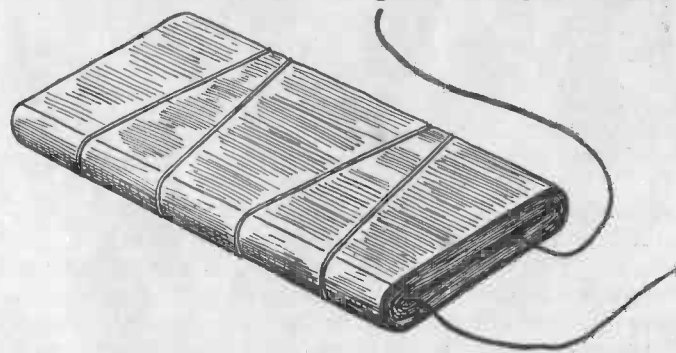

FIG. 49.

Completed Primary Condenser for the Simplex Coil.

The result should consist of four sheets of tinfoil insulated from each other with two strips of paper between each two strips of foil.

Connect the first and third sheets together with a wire and the second and fourth sheets likewise.

Cut out a piece of cardboard, one and one-quarter inches wide and three and one-quarter inches long. Lay the cardboard on one end of the condenser and roll the condenser up around it very tightly. Tie it with a piece of string to keep it from unrolling and dip it in some melted paraffine. Then place it between two boards with a weight on top so as to press it out flat.

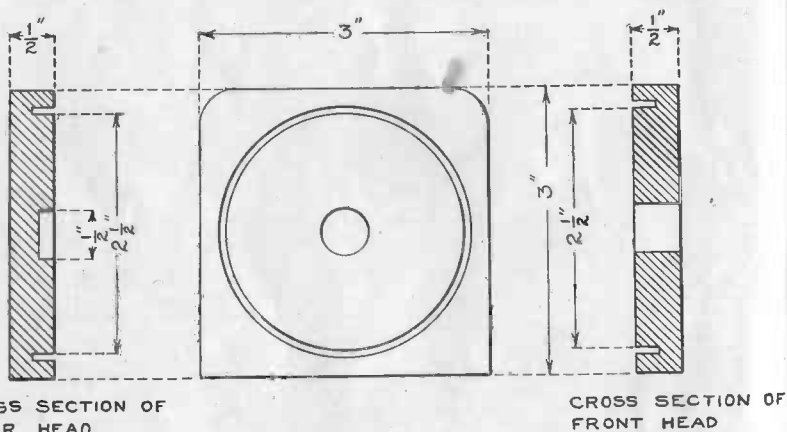

FIG. 50.
Coil Heads.

The Coil Heads are made from two hardwood blocks three inches square and one-half an inch thick. A circular groove, two and one-half inches in diameter and one-quarter of an inch deep is turned in each block to receive a cardboard tube of the same diameter. The two upper corners of each of the blocks are rounded slightly to improve their appearance. One of the heads has a round hole one-half inch in diameter bored

through the centre so that one end of the core may be passed through. The core should project through about one-eighth of an inch. The other head is bored with a hole of the same diameter but the hole should not pass all the way through, and serves merely to receive and support the other end of the core.

The Base of the coil is a box eight inches long, four inches wide and one and one-eighth inches deep. It is made in the form of a hollow box. Give the base a coat of stain, preferably some dark color, such as mahogany, and then a coat of shellac or varnish.

The wooden heads should be stained black.

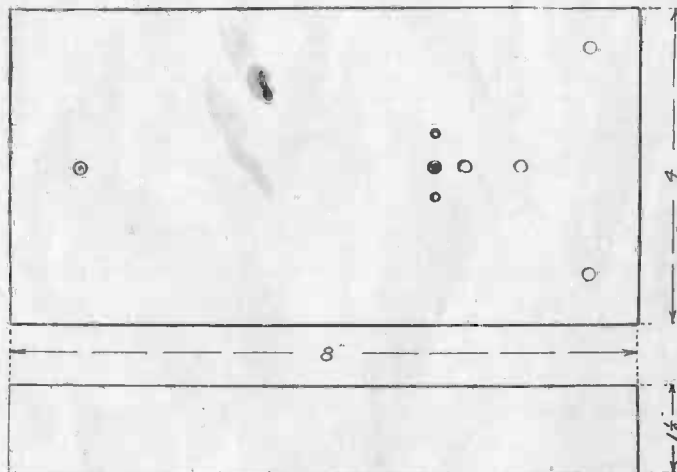

FIG. 51.

The Base of the Simplex Spark Coil. The Base is in the form of a box, open underneath.

The parts of the interrupter are shown in Figure 52. They cannot be made by every experimenter on account of the tools required, but can be purchased very cheaply from concerns dealing in material for experimenters.

The **Standard** is a piece of hexagonal brass rod one and three-sixteenths inches long and three-eighths of an inch in diameter. The lower end of the standard is tapped to receive an 8-32 machine screw. A hole is bored at right angles to the axis of the standard, one inch from the lower end and tapped to receive an 8-32 thumbscrew.

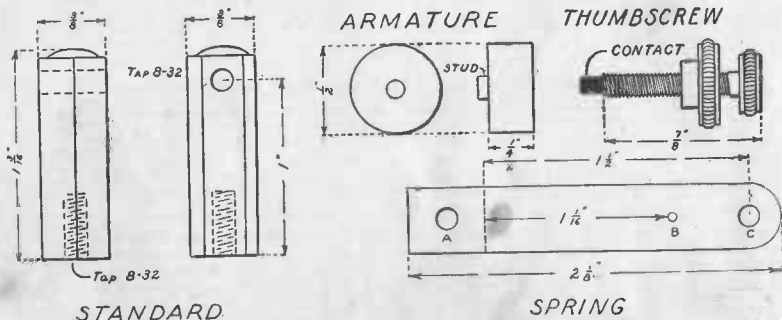

FIG. 52.

Parts for the Interrupter.

The **Thumbscrew** should be about seven-eighths of an inch long and be provided with a lock nut so that it can be fastened in position. The end of the thumbscrew is drilled with a small hole and a contact point driven in tightly. The contact point is usually a piece of platinum wire, but in the case of a small coil may be a piece of the special contact wire which is sold for just this purpose.

The **Spring** is a piece of thin steel, three-eighths of an inch wide and two and one-eighth inches long. Several holes are drilled in it. The illustration shows the exact location of these holes. The holes A and C should be just large enough to allow an 8-32 machine screw to slip through. The hole B is just large enough to receive a piece of contact wire.

The **Contact wire** should be about three-thirty-seconds of an inch long and be slipped in the hole and riveted in place.

The **Armature** is a piece of soft iron cut out of a rod one-half an inch in diameter. It should be about one-quarter of an inch thick, but should have a small stud left on one face so that the stud may be slipped into the hole marked C in the steel spring and the armature then riveted firmly to the spring by flattening out the stud.

The spring is bent at right angles about one-half inch from the end as shown by the dotted line in Figure 52.

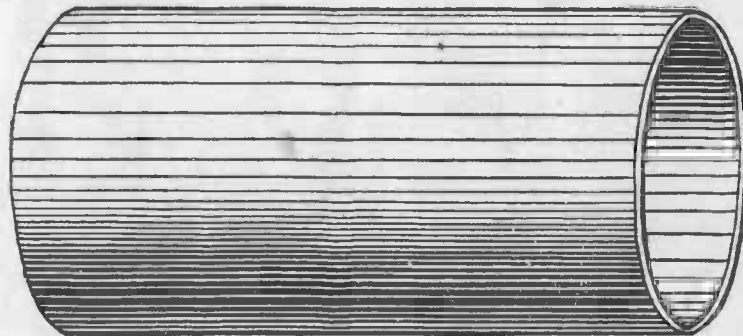

FIG. 53.

Cardboard Tube.

A **Cardboard Tube**, two and one-half inches in diameter and four and one-quarter inches long, is used to inclose the primary and secondary windings when they are in position. The tube may be given a very fine appearance by gluing a single layer of black book-binders' cloth over it.

The **Bridge** shown in Figure 54 is a strip of wood about one-eighth of an inch thick, four and seven-eighths inches long and three-quarters of an inch wide. It is stained to match the base and is then given a coat of shellac or varnish. Two holes are bored in the bridge, one inch from each end.

The coil is now ready for assembling. Figure 55 shows a cross section of the complete coil.

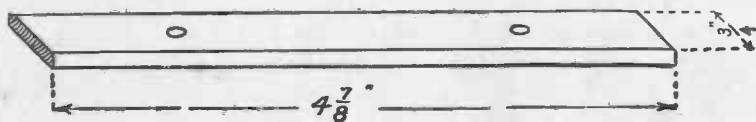

FIG. 54.

Secondary Bridge.

Slip the secondary over the insulating cloth or paper wrapped around the primary. Pass one end of the core through the hole in the coil head, making sure that the groove is on the side towards the secondary. The secondary should be exactly in the centre of the primary.

Slide the cardboard tube over the primary and secondary into the groove. Lead the secondary terminals out through small holes in the cardboard tube at opposite ends so that the wires are separated as far as possible. Slip the other coil head over the end of the core and the tube and then mount the coil on the top of the base. The coil should be in the centre of the base when considered from front to back. It should be to the left of centre, however, when viewed from side to side.

The two primary heads should be four inches apart when the coil is assembled.

Figures 56 and 57 are scale drawings just one-half the size of the finished coil, and the experimenter can find just where the coil should be located by measuring the distances in the illustration and multiplying them by two.

The primary wires are led down close to the wooden head and through the base under the coil. They should be kept as far away from the secondary as is possible.

The coil is fastened to the base by a wood screw passing through the base into each of the wooden heads.

Figure 57 will show best how the interrupter is arranged. The brass spring carrying the armature at

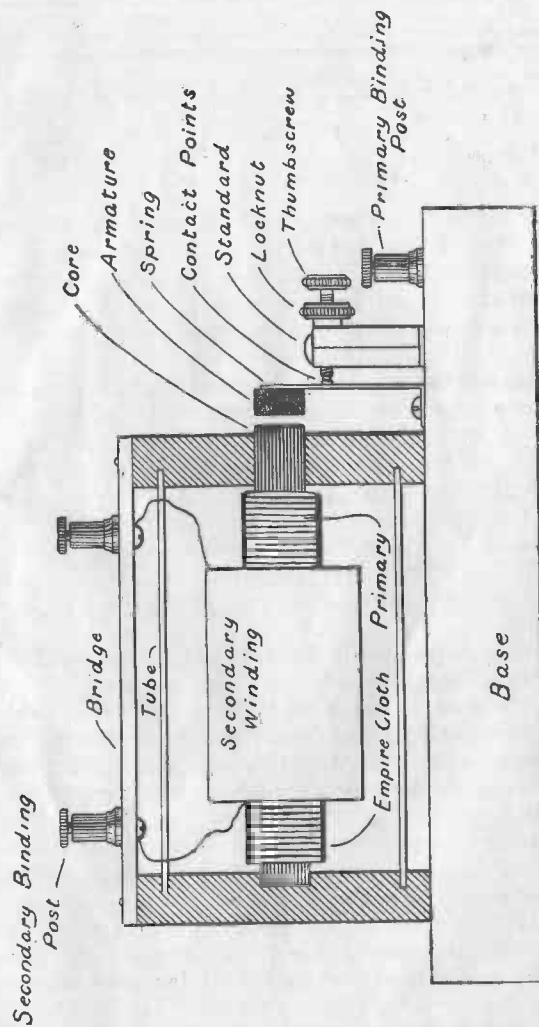

FIG. 55

Cross Section of the Simplex Spark Coil showing the arrangement of the Parts.

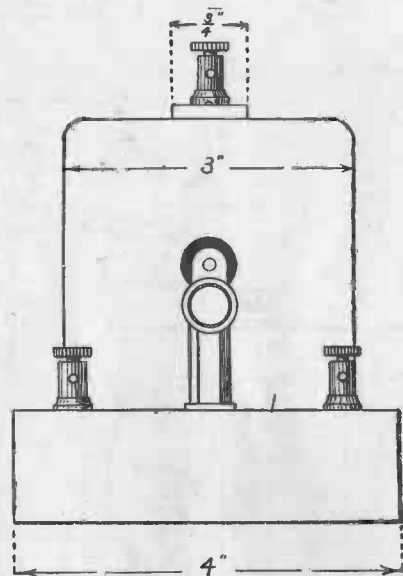

FIG. 56.

The Simplex Coil viewed from the end showing the Interrupter.

its upper end is mounted in front of the core end projecting through the wooden head. The standard carrying the thumbscrew and the locknut are mounted directly behind the spring in such a position that the contacts touch each other and line up perfectly.

A small brass washer is placed between the standard and the base so that it will not "bite" into the wood when the screw is tightened. The standard and the spring are both mounted by 8-32 brass machine screws passing through the base.

Two binding posts are mounted on the corners of the base near the interrupter.

The condenser is fastened to the under side of the base by means of a wooden strip passing across it and secured to the base by means of two small wood screws.

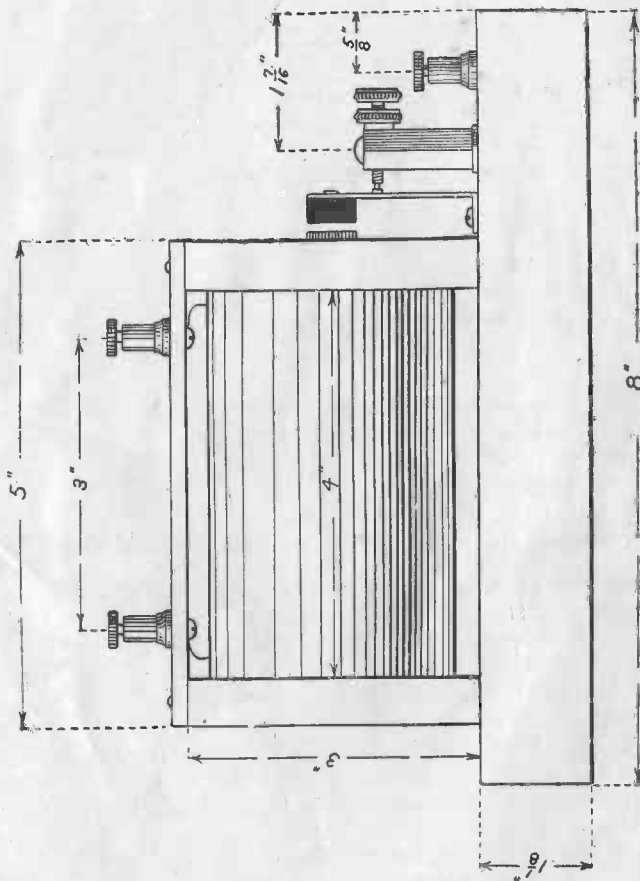

FIG. 57.

Side view of the completed Simplex Coil.

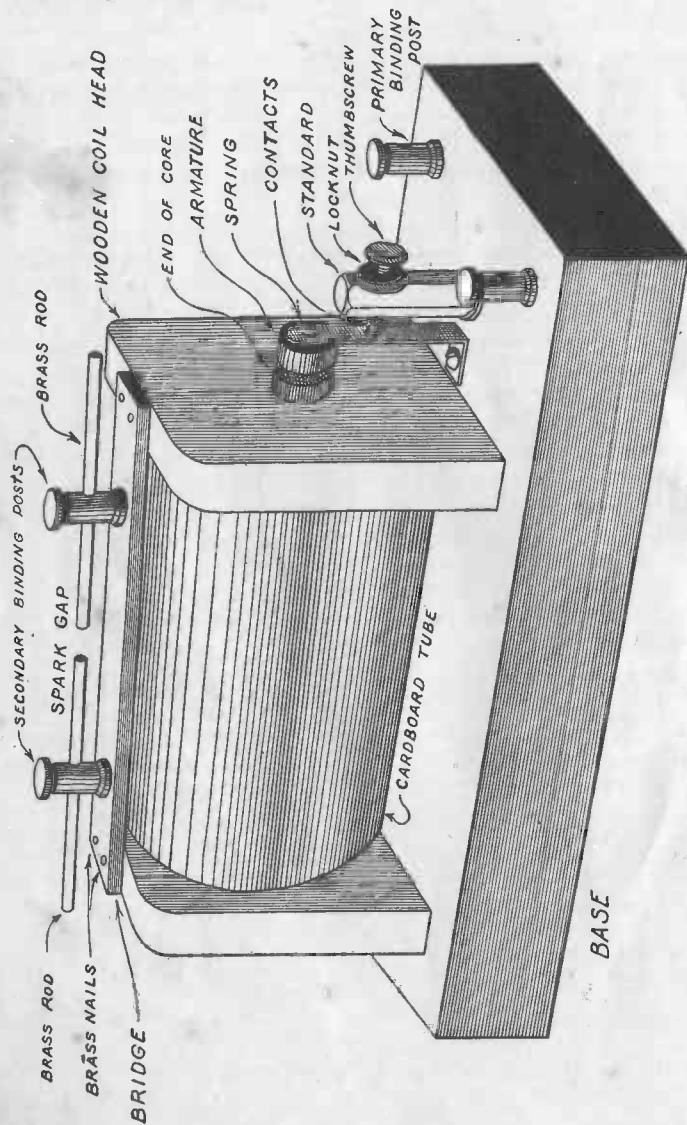

FIG. 58.
Perspective view of Simplex Coil.

One of the binding posts is connected to one of the primary wires. The other primary wire is connected to the spring. The other binding post is connected to the standard.

The condenser is connected directly "across" the interrupter, that is, one wire is connected to the spring and the other wire to the standard.

Two binding posts are mounted on the wooden bridge and then the bridge is fastened across the top of the coil by means of two brass nails. The secondary terminals are connected to these binding posts.

The coil is now ready for operation. Connect two small pieces of wire to the secondary binding posts and bring them toward each other until they almost touch. The space between should be about one-quarter of an inch long.

Connect three or four good dry cells to the primary posts and turn the thumbscrew until the contact point on the end touches the contact on the spring. The interrupter should immediately commence to "buzz" and if the coil has been properly constructed and connected, a stream of sparks will jump between the wires connected to the secondary.

It may be possible that the action of the interrupter and consequently the strength of the sparks at the secondary can be improved by bending the spring either away or towards the core. A little experimenting will soon show just how much tension the spring should have. When the proper position of the thumbscrew is found, tighten the locknut so that it cannot change its adjustment.

CHAPTER VII.

HOW TO MAKE THE SIMPLEX KEY.

A key is really a switch arranged so that the current can be readily turned off and on by a slight movement of the fingers.

The frame of the key is shown in Figure 59 and is made from a small iron casting. The dimensions and the location of the holes can be easily understood from the drawing.

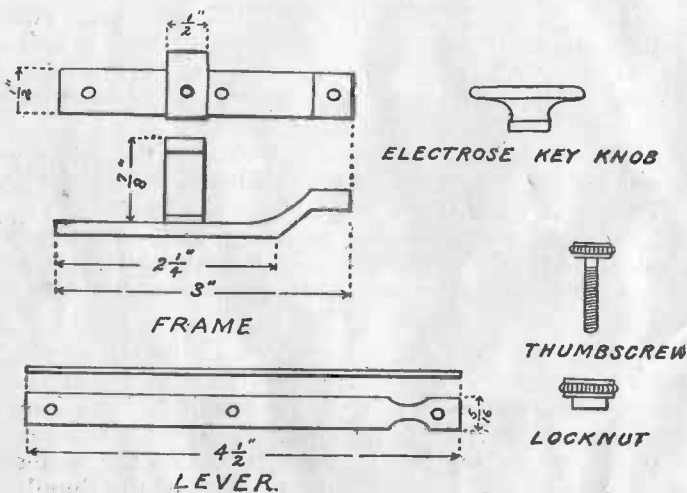

FIG. 59.

Parts of the Simplex Key.

The key frame is made by first making a small wooden pattern similar to the finished article desired. Send the pattern to a foundry and have a casting made from it.

The key lever is a strip of brass, four and one-half inches long, five-sixteenths of an inch wide and about one-sixteenth of an inch thick.

It has three holes bored in it located as shown in the illustration.

The key knob, thumbscrews, springs and locknuts can be purchased from almost any electrical supply house.

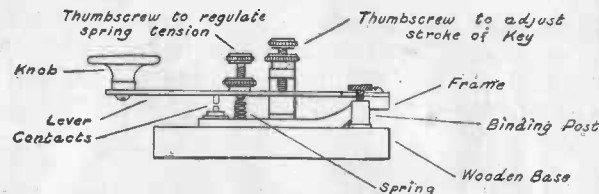

FIG. 60.

Side view of the Simplex Key.

The key is assembled as shown in Figure 60. It is mounted upon a wooden base three and three-quarters inches long and two inches wide.

The contacts are made from silver wire. The lower contact must be insulated from the frame of the key by a fibre washer. Two binding posts are mounted

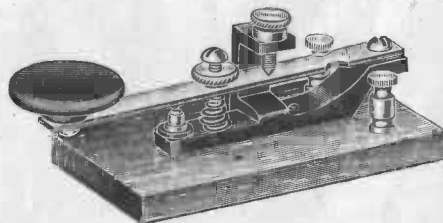

FIG. 61.

The Simplex Key.

at the back of the wooden base. One of the posts is connected to the lower contact and the other post is connected to the iron frame. The frame should be painted black.

CHAPTER VIII.

HOW TO CONNECT AND OPERATE THE APPARATUS.

HOW to Use the Simplex Coil for Sending Messages.
The primary of the coil should be connected in series with the key and three or four fresh dry cells as shown in Figure 63.

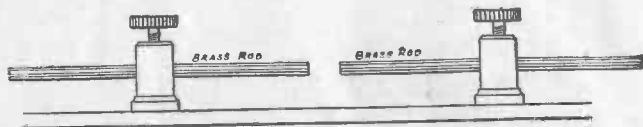

FIG. 62.

Showing how the Secondary Binding Posts of the Simplex Coil may be provided with two Rods to form a Spark Gap.

The secondary of the coil is provided with a spark gap made by fitting two brass rods into the binding posts mounted upon the bridge. The ends of the rods should be about three thirty-seconds of an inch apart.

One of the rods is connected to the aerial and the other rod to the ground.

When the key is pressed sparks will pass between the ends of the two rods and the aerial will send out wireless messages.

If you touch the key so that the sparks only pass for an instant you have made a dot. If you hold the key down three times as long you have made a dash. The telegraph code consists of a series of dots and dashes.

How to Connect and Operate a Complete Wireless Station.

When a station is arranged for both transmitting and receiving, some method of quickly connecting the

aerial and the ground to either the transmitting apparatus or the receiving instruments is necessary.

This is supplied by an aerial switch.

Figure 64 shows a complete form of aerial switch termed a double-pole, double-throw, porcelain base switch.

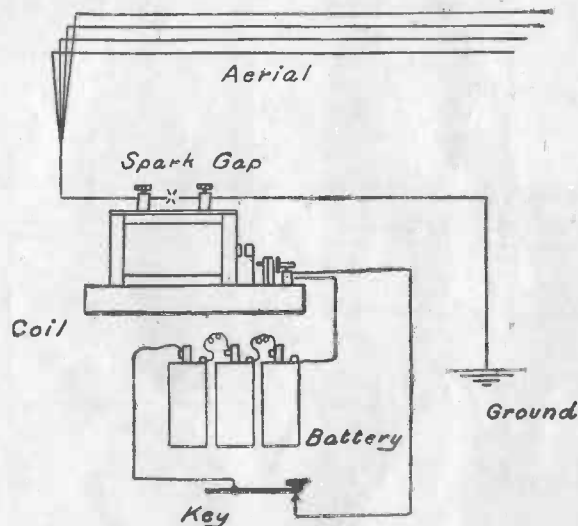

FIG. 63.

Circuit showing how the Simplex Spark Coil is connected in order to send Wireless Messages.

Figure 65 shows how to connect a receiving set consisting of a double slide tuner, a detector, condenser and a receiver, to an aerial switch. It also shows a transmitter consisting of a coil, key, spark gap and battery connected to the switch.

Throwing the switch to the left connects the aerial and the ground to the receiving apparatus. Throwing the switch to the right connects the aerial and the ground to the transmitting apparatus.

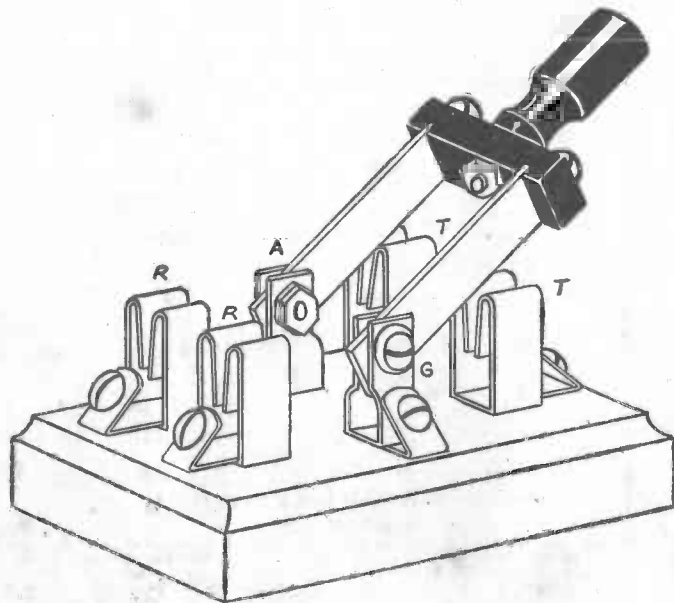
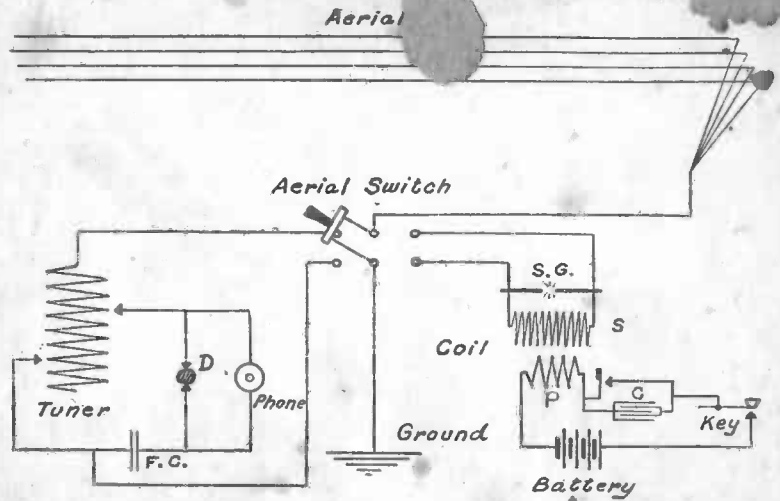

FIG. 64.

Double-pole, double-throw Switch for connecting Aerial and Ground to either Transmitting or Receiving Apparatus at will.

The diagram shown in Figure 66 is practically the same except that the Simplex loose coupler has been substituted for the double slide tuner.

The diagrams are what are known as conventional diagrams. The various instruments and parts are represented in the manner that is usually practiced by electrical engineers. The explanation of the diagrams given immediately underneath each one will quickly enable the young experimenter to trace out the circuit and familiarize himself with this method of drawing. It is commonly used in electrical books and magazines.



RECEIVING APPARATUS TRANSMITTING APPARATUS

FIG. 65.

Diagram showing how to Wire a complete Station using the Simplex Double Aerial Slide Tuner.

Aerial

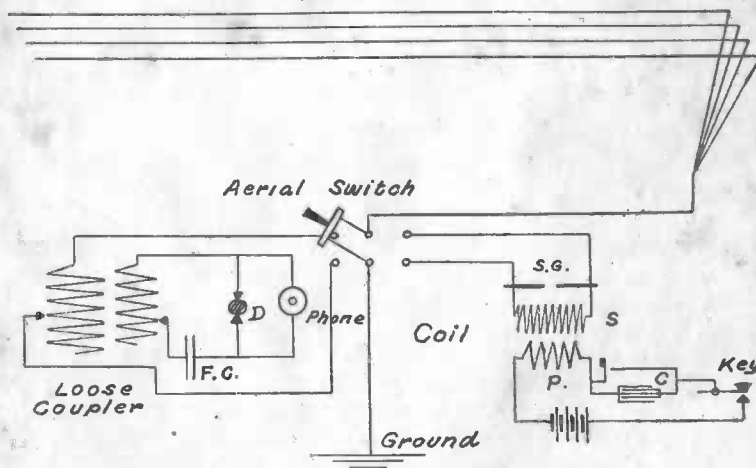

RECEIVING APPARATUS

TRANSMITTING APPARATUS

FIG. 66.

Diagram showing how to Wire a complete Station using the Simplex Loose Coupler.

WIRELESS CONTINENTAL TELEGRAPH ALPHABET

A	B	C	D	E	F
G	H	I	J	K	
L	M	N	O	P	
Q	R	S	T	U	
V	W	X	Y		
Z	Wait	Understand	Don't Understand		
Period	Interrogation	Exclamation			
1	2	3			
4	5	6	7		
8	9	0			
Call	Finish	or			

Fig. 67.

Continental Wireless Alphabet.