

THE THOUGHT IS IN THE QUESTION THE INFORMATION IS IN THE ANSWER

HAWKINS

ELECTRICAL GUIDE

NUMBER
EIGHT

QUESTIONS
ANSWERS
&

ILLUSTRATIONS

A PROGRESSIVE COURSE OF STUDY
FOR ENGINEERS, ELECTRICIANS, STUDENTS
AND THOSE DESIRING TO ACQUIRE A
WORKING KNOWLEDGE OF

ELECTRICITY AND ITS APPLICATIONS

A PRACTICAL TREATISE

HAWKINS  AND STAFF

THEO AUDEL & CO.  72 FIFTH AVE. NEW YORK.

IMPRESSION 1923

COPYRIGHTED, 1917.
BY
THEO. AUDEL & CO.,
NEW YORK

Printed in the United States

TABLE OF CONTENTS

GUIDE NO. 8.

THE TELEGRAPH - - - - - 2,201 to 2,262

Definition—essential parts of a telegraph—**classification**—**Morse single line system**; operation; circuits included in the term Morse single line—description of instruments; elementary diagrams showing principles of operation—key—sounder—relay, etc—Foote-Pierson main line relay—simple short line with relays—**repeaters**—*elementary repeater* showing insulated parts essential for the *contact breaker*—*elementary repeater as connected in a circuit*—essentials of the so-called button repeater—button repeater diagrams showing operation—Kitton's three wire repeater—Postal telegraph repeating system—simple automatic repeater—Ghegan automatic repeater—Bunnell special relay for Milliken repeater system—Bunnell tongue contact repeater for Milliken repeating system—spring contact breaker repeater for Weincy-Phillips repeater system—three spool differentially wound relay for Weincy-Phillips repeating system—**duplex telegraphy**—principle common to the various systems of multiplex telegraphy—**duplex telegraphy**; *classification of systems*—differential duplex system—operation of polarized relay—Stearns differential duplex; diagram—view of **transmitters**—view of transmitters showing construction and circuit of the two way contact breaker—detail of contact breaker end of a transmitter—why transmitter is used—the "split"—object of condensers—W. U. cross bar switchboard—voltage key—**polar duplex system**—essential parts of a walking beam pole changer—difference between pole changer and pole changing transmitter—**battery polar duplex system**; diagram of circuits—**dynamo polar duplex system**—**bridge duplex system**—diagrams of duplex systems—Foote-Pierson walking beam pole changer—erroneous use of the name Wheatstone for Christie—comparison between differential and bridge duplex systems—**the quadruplex system**—

THE TELEGRAPH—Continued

essentials for quadruplex working—division of the battery—resistance in tap wire—diagram showing elements of the quadruplex system—*how to adjust the quadruplex*—quadruplex system with battery current supply; diagram—**telegraph codes**; Morse, Continental, Phillips, Bain—**code specification—automatic telegraphy**—Wheatstone system—**Delaney multiplex telegraph**—**Rowland multiplex printing telegraph**—Bunnell automatic paper winder—**sub-marine telegraphy**—diagram of simple sub-marine cable circuit—Thomson siphon recorder—special device necessary—sub-marine key—**condenser on sub-marine cable circuits—duplexing of sub-marine telegraph cables—tests and troubles**—Christie bridge used for testing—static discharges—adjustment of relays—open ground coil—selection of dynamo—resistances of parallel circuits—telephone test receiver—testing open lines—**proportional test set—printing or typewriting telegraphy**—Morse system—Phelps system—Wright system—Rowland system—Buckingham-Barclay system—**stock printer or tickers**—construction and operation—Bunnell double pen ink writing register—**messenger call service**—messenger call box—**Western Union time signals—simultaneous telephony and telegraphy—fire alarm telegraphy**—diagram of elementary fire alarm circuit—connection of fire boxes—supply current—location of ground.

WIRELESS TELEGRAPHY 2,263 to 2,338

Definition—history of wireless telegraphy—conductivity method; earth the medium; water the medium (Morse's experiment)—Dolbear's induction system—work of Phelps, Edison, Preece and others—inductivity method—Hertz's standard oscillator and resonator or detector—Branley's filing tube coherer or detector—**the codes**—international Morse code and conventional signals—list of abbreviations used in radio communication—rules relating to the codes—*how to learn a code*—secret wireless telegraph code—form of blank used in wireless telegraphy—**elementary theory of wireless telegraphy**—sound waves—electric wave method of wireless telegraphy—detection of waves—velocity of ether waves—mechanical analogy illustrating tuning—apparatus necessary for practical wireless telegraphy—**propagation of electromagnetic energy**—Hertzian detached electrical waves—Fessenden sliding half waves—experiment in resonance—**syntonic** wireless telegraphv—

WIRELESS TELEGRAPHY—Continued.

Lodge's syntonic Leyden jars—**practical system of wireless telegraphy**—oscillation of ring shaped Herz resonator—high frequency oscillations—Marconi wave meter—"chopper"—**formula for wave length**—first Marconi system; *diagram*—*diagram* illustrating reflection of electric waves—**Lodge-Muirhead syntonic system**; *diagram*—Lodge-Muirhead coherer—**Fessenden tuned system**; *diagram*—**Telefunken or Slaby-Arco multiplex system**—wave diagram of multiplex system—Fessenden detector or liquid barreter—*diagram* of Telefunken system—De Forest system; *diagram*—form of detector used—wireless systems of different countries—Fessenden's Marhianish station—Mauern station—*diagram of Marconi system*—**commercial Marconi apparatus**—"Boston" pattern wireless key—Marconi $\frac{1}{2}$ kw. converter with disc discharger—wireless station switchboard—kind and size of condenser in Marconi system—location of spark gap—oscillation transformers—inductance—tuning coil inductance—**anchor gaps**—**emergency set**—emergency transmitter—how to operate the emergency set—aerial or antennæ switch—**auxiliary induction coil**—connection of spark gap, secondary, short wave condenser—**aerial inductance**—**type D Marconi tuner**—ball bearing slider for tuner—**detector circuit**—**tuned receiving circuits**—Mesco receiving tuning coil—three receiving circuits—loose couple receiving transformer with variable] contacts—**telephone receiver and detectors**—winding of secondary—Marconi type D tuner—special Marconi type D tuner circuit—auxiliary induction coil—receiving tuning coil with double contact—crystal detector—double crystal detector—galena, silicon, and ferrom detectors—Marconi magnetic detector—electrolytic detector—characteristics of valve and audion detectors—Marconi valve—inductance coupled tuner or loose coupler—connection of valve detector—peroxide of lead detector—*diagram* of complete Marconi sending and receiving system with valve detector—DeForest budion detector—D and W tuner—inductively coupled receiving tuner and connections—**how to establish a small station**—apparatus necessary—the aerial switch; antenna; ground clamp; receiving apparatus; tuning coil; variable condenser; sending apparatus; battery and key; spark gap—operation—single and double wireless receivers—wireless recorder outfit—modern amateur wireless station—**wireless telephony**—Marconi break in system with parallel receiving tuner—*diagram* showing receiving and transmitting wireless telephone stations—professional type of audion detector; amateur type—**transmission of pictures by wireless**—

WIRELESS TELEGRAPHY—*Continued.*

Marconi wireless directive system—elevation and plan of ship showing receiving aerials of wireless compass—radiogoniometer of the wireless compass—method of locating ships; two coast stations within range; one within range—train dispatching by wireless—Major Squire's "wired wireless."

ELECTRIC BELLS - - - - - 2,339 to 2,410

Classification—trembling or vibrating bells—*elementary diagram*—*cycle*—rate of vibration—object of contact breaker spring—Bunnell vibrating bell—**proportion of parts**—table—**single stroke bells**—operation—*elementary diagram*—action of hammer—Mesco single stroke bell—the outer and inner stops—**combination vibrating and single stroke bells**—*elementary diagram*—how to change vibrating bell to single stroke bell—**shunt or short circuit bells**—operation—essential parts *elementary diagram*—*cycle*—adaptation—kind of circuit suitable for shunt bell—to render shunt bell both single stroke and vibrating—Bunnell iron box bell—Partrick and Wilkins emergency gong—*elementary shunt or short circuit, combination vibrating and single stroke bell*—**continuous ringing bells**—conditions suitable for—*elementary continuous ringing bell with mechanical circuit maintainer*—*elementary continuous ringing bell with electrical circuit maintainer*—operation of both types of circuit maintainer—*elementary continuous ringing bell with electro-mechanical circuit maintainer*—**buzzers**—difference between buzzers and bells—sectional view of buzzer—**differential bells**—the two windings—arrangement of parts—operation—*elementary differentially wound vibrating bell*—*cycle*—how sparking is reduced—Holtzer-Cabot bells—**combined differential and alternate bells**—*elementary differential and alternate bell*—operation—*cycle*—Partrick and Wilkins wood box type bells—**high voltage bells**—*elementary heavy duty high voltage bell*—detail of parts—pneumatic analogy illustrating action of condenser as applied to a bell—suggestions for the prevention of sparking on special bells—**alternating current bells**—*elementary alternating current bell with permanent magnet armature*—effect of high frequency current—diagrams illustrating operation—*elementary alternating current bell polarized by magnetic induction*—diagram illustrating operation—**double acting bells**—*elementary double*

ELECTRIC BELLS—Continued.

acting bell—operation—**motor driven bells**—*elementary motor driven, or revolving strike bells*—detail showing clapper construction—**electro-mechanical bells**—*elementary electro-mechanical bell or gong*—operation—how set: for single stroke; for continuous operation—action of clapper—Edwards electro-mechanical weather proof gong for exposed places; type for indoor use—**relay bells**—*elementary relay bell and connections*—definition of relay; erroneous use of the word—*elementary relay bell with relay having continuous ring device*—difference between relay bell and relay operated bell—**reducing the resistance of bell coil**—diagram of connection alteration—**push button or pusher** construction—various push buttons—**bell wire—wire joints**—method of making a joint in covered wire—**bell wiring—bell circuits**—simple bell metallic circuit; ground return—parallel connected push buttons—circuit connection for ringing two bells from one push button; for ringing two bells from either one or two push buttons—**annunciators**—operation of shutter or gravity drop annunciator—pendulum signals—arrow or needle annunciator drop—automatic annunciator for residence service; for factory service—various annunciators—**annunciator circuits**—method of wiring annunciator—precautions—return or fire alarm annunciator system—**elevator installation**—single elevator circuit; two elevator circuit—dumb waiter buzzer circuit—**faults in bells**: armature sticking—weak spring—screechy sound—too rapid vibration—dirty or loose contacts, etc.—*diagram* of bell and buzzer circuits for apartment houses—method of connecting a bell ringing transformer—test for crossed wire; for break—cause of short circuits—saddled staples—insulating tape—**current supply for bell ringing**—dry cells—sal-ammoniac cells—best method of connecting cells—method of operating bell from electric light circuit—step down transformers—circuit connections for ringing the more distant of two bells from either of two push buttons—spring snap connections—circuit connections for signals for three rooms—how to wire twenty-five buzzers and 25 push buttons *with ten wires*; **with nine wires**—ringing transformer—**burglar alarms**—Yale lock burglar alarm switch—floor tread and connector—window switch—automatic burglar circuit with gravity drop circuit maintainer—house equipped with burglar alarm system—burglar alarm traps—six drop annunciator with one burglar alarm switch—Jupiter fire alarm box—milonite nails and method of tacking two insulated wires.

ELECTRIC LIGHTING - - - - - 2,411 to 2,532

The term *lighting*—first production of electric light—historical—Faraday's dynamo—natural division of the subject—**sources of electric light—the electric arc**—how maintained—production of carbon vapor—various electric arcs—**general characteristics of the electric arc**—watts consumed for arcs of different lengths—intensity of one light—appearance of arc—**the arc stream or flame**—watts consumed—temperature of the arc—**resistance of arcs**—resistance with solid carbons; with cored carbons—governing factors—**the electrodes or carbons**—most luminous portion—conditions for proper operation—“*hissing*”—**classes of carbon**—object of core—moulded and forced carbons—characteristics—**candle power of arc lamps—proper sizes of carbon—voltages and currents for arc lamps**—general appearance of arc—**efficiency of the arc—classes of arc—operating conditions of carbon—carbon feed mechanism**—*elementary series control arc lamps*—kind of current used on *elementary shunt control lamps*—points relating to shunt lamps—*elementary differential control lamps*—effect on dynamo—effect of carbon in contact at starting—**clutches**—Adams-Bagnall clutch as used on series lamp—carbon feed—rod feed—*elementary series lamps with ring clutch rod feed*—definition of dash pot—Adams-Bagnall adjusting weight—**cut out and substitutional resistance**—*elementary series control lamp with air dash pot and adjusting weight*—conditions necessitating cutting out of a lamp—Adams-Bagnall cut out as used on A. C. series circuit differential control arc lamp—Adams-Bagnall starting resistance for series lamp—**enclosed arcs**—operating conditions—life of carbon on enclosed arc lamps—light distribution—arrangement of carbons—enclosed carbon A. C. arc—semi-enclosed or intensified arc lamps—the alternating current arc—characteristics—*humming*—*hissing*—light emitted—**alternating current arc lamps—arc lamp circuits**—Adams-Bagnall alternating current series circuit arc lighting system—wiring diagram of 100 light transformer with two 50 light regulators—Fort Wayne regulation curve MA transformer—**series arc lamps**—Adams-Bagnall A. C. series circuit differential control arc lamp—Westinghouse series circuit A. C. differential control arc lamp—how “constant” current is obtained—proper size of wire for series arc circuits—service and advantages of series system; disadvantages—Fort Wayne series circuit differential control enclosed d. c. arc lamp—Fort Wayne parallel circuit, single magnet series control 110 volt d. c. lamp—**methods of control for series operation**—Westinghouse parallel circuit series control a. c. enclosed arc lamp—

ELECTRIC LIGHTING—Continued.

parallel arc lamps—Fort Wayne (special transformer type) parallel circuit series spring control a. c. enclosed arc lamp—impedance coil Fort Wayne 104 volt a. c. lamp; construction details—Westinghouse parallel circuit series control d. c. enclosed arc lamp—wiring diagram of parallel a. c. system of arc lighting—detail of Fort Wayne gas cap and clutch mechanism—Westinghouse series parallel circuit differential control d. c. enclosed arc lamp—**series parallel arc lamps**—where used—essential features—Westinghouse parallel circuit metallic flame arc lamp—luminous arc lamps—Westinghouse series parallel circuit metallic flame arc lamp—diagram showing air circulation—electrode arrangement of Westinghouse metallic flame arc lamp—**flaming arc lamps**—lower mechanism of Beck flaming arc lamp—Helios flaming arc lamp—**inverted arc lamps**—exterior view of Toening inverted arc lamp—**special forms of arc lamp**—various types—hand feed arc lamp with carbons at right angles—beam of parallel rays; of radial rays—**search lights**—dispersion lenses—marine search light for pilot house—carbon feeding mechanism—current and candle power of search lights—**installation and care of arc lamps**—unpacking—connecting—adjusting—returning—defective carbons—**vacuum tube lamps**—Moore lamp—connections of Cooper-Hewitt lamp—a. c. and d. c. types—advantage of Moore lamp—features of Cooper-Hewitt lamp—Cooper-Hewitt lamps in series—**incandescent electric lamps**—construction—classification—object of exhausting the air—peculiarity about resistance—voltage variation table—size of filament—various filaments—**high voltage incandescent lamps**—efficiency—**varieties of incandescent lamp**—**metallized carbon** or gem lamps—the term *metallized*—**treated carbon lamps**—radiation for helium filament—**osmium lamps**—various forms of lamp base—**tantalum lamps**—life curves—tantalum filament which has been renewed—points on tantalum lamps—behavior of tantalum filament—**tungsten lamps**—the Kuzell process—features of tungsten—difficulty with tungsten—standard American tungsten lamps—lamps for sign lighting—**iridium lamps**—*turn down incandescent lamps*—two filament arrangement—**Nernst lamps**—*elementary diagram of Nernst lamp*—behavior of the glower—**illumination**—definition—division of the subject—nature of light—how light is propagated—**nomenclature**—intensity of light—candle power—various standards—out rigger suspension for arc light—comparison of candle power standards—early standards—lumen—lux—indirect system of lighting—candle foot—

ELECTRIC LIGHTING—*Continued.*

unit cone—mean conical candle power—**photometry**—
 photometric characteristics of the arc—Rumford's photo-
 meter—mean spherical candle power—mean horizontal
 candle power—Leeds and Northrup station photometer—
 integrating photometer—comparative distribution of light
 from various sources—distribution curves of light from
 various sources—**globes for arc lamps—reflectors and
 shades—diffusers**—reflection and diffusion—concentric
 diffuser—holophane globes and reflectors—concentric dif-
 fusers—**construction of holophane globes—require-
 ments of good illumination**—section through center of
 holophane globe—dazzling effect of search lights—table of
 intrinsic brilliancy of light sources—refraction—distribution
 of light by holophane globes—**calculation of illumina-
 tion**—the candle foot—table of required intensity of illu-
 mination—**point by point method of calculating illu-
 mination**—illumination curves for Mazda lamps—**color of
 walls and ceiling**—table of illumination intensity for
 various points—**table of reflection coefficients—rapid
 method of calculating illumination**—frosted incan-
 descent lamps—table showing increase of illumination—
 table of properties of various lamps—vertical section of holo-
 phane globe—**choice of reflector**—conditions governing
 same—various incandescent filaments—table of spacing of
 units for uniform illumination—table showing consumption
 of various lamps.

CHAPTER LXIX

THE TELEGRAPH

The word telegraph means *an apparatus for transmitting messages between distant points.*

Broadly, it includes telegraphs operated by mechanical, pneumatic, and hydraulic means, but now these devices are known as signalling apparatus, and the term telegraph is restricted to mean some form of apparatus employing electricity and transmitting more than mere calls or signals.

Ques. What are the essential parts of a telegraph?

Ans. 1, a *line wire*; 2, a *battery*, or other source of electricity; 3, a *transmitting instrument*, and 4, a *receiver*.

Ques. What is the transmitting instrument usually called?

Ans. A key.

Ques. What is the receiver usually called?

Ans. A sounder.

NOTE.—*A new word:* A friend desires us to give notice that he will ask leave, at some convenient time, to introduce a new word into the vocabulary. The object of this proposed innovation is to avoid the necessity, now existing, of using two words for which there is very frequent occasion, where one will answer. It is "*telegram*," instead of "telegraphic despatch" or "telegraphic communication." . . . Telegraph means to write from a distance—*telegram* the writing itself, executed from a distance. Monogram, logogram, etc., are words based upon the same analogy and in good acceptance.—*Albany Evening Journal*, April 6, 1852.

Classification.—The telegraph, like other inventions, has been considerably developed, resulting in numerous systems. A classification of these various systems, to be comprehensive, must be made from several points of view, as with respect to:

1. The kind of circuit, as

- a. Ground return.
- b. Metallic.

2. The method of operating the circuit, as

- a. Closed;
- b. Open.

3. The transmitting capacity.

- a. Single Morse line;
- b. Diplex.

c. Duplex { single current or differential;
double current;
polar;
bridge;
high pressure "leak";
high efficiency;
city line;
short line.

d. Quadruplex. { gravity battery;
Jones;
Field;
Davis-Eaves or Postal quad;
single dynamo;
metallic circuit;
Gerritt Smith;
Western Union;
British post office.

- e. Multiplex { synchronous.
- f. Phantoplex.

4. The method of receiving, as

- a. Non-recording
- b. Recording { by perforations;
by printing.

The Morse Single Line System.—This ordinarily includes a battery for supplying a low tension current and a line wire connecting two or more stations serving to establish a circuit between them: a return connection to the battery, formed either by another wire or by the earth to a transmitting key, and a sounder or recording apparatus at each station.

Ques. How does this system operate?

Ans. On depressing the transmitting key at the sending station, the electric circuit is completed in a manner corresponding to a predetermined code of signals; these signals are transmitted along the wire by the electric current to the distant receiving station, where they are reproduced by the electromagnetic action of the sounder or receiver.

Ques. On what does the operation of the telegraph depend?

Ans. It is possible, because of the fact that an electromagnet can be magnetized and demagnetized with great rapidity on respectively making and breaking the magnet circuit, the magnetic action thus obtained being used to operate a sound producing mechanism so that the various combinations of "dots" and "dashes" representing the letters of the alphabet are indicated audibly.

Ques. What circuits are included in the term "Morse single line?"

Ans. Those that are so equipped and operated that transmission is carried on in one direction only at a time.

Ques. What instruments are necessary on a Morse single line of short length?

Ans. A key and sounder at each station.

Ques. Describe a key.

Ans. As shown in fig. 3,050, it consists essentially of a pivoted lever provided with a contact and adjusting screw, and carried on a base having an insulated contact and a spring to keep the lever normally in the open position. A switch is provided to close the circuit when the key is not in use.

Ques. Explain its operation.

Ans. The operating disc is grasped by the 1st, 2nd, and 3rd fingers; depressing the disc causes the two contacts to touch,

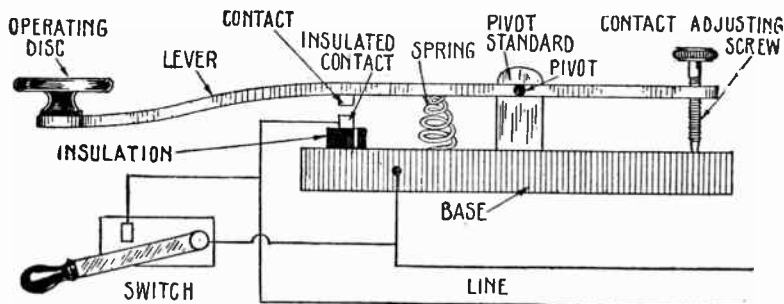

FIG. 3,050.—Elementary key. In actual construction the switch is attached to the base, but is here shown separately, in order that the connections may be more plainly seen.

thus closing the line circuit. When the operator ceases pressing on the disc, the spring forces the contacts apart and breaks the circuit.

Closing the circuit for a short period corresponds to a "dot" and, for a longer period, to a dash. The periods in which the circuit is closed are indicated audibly by the "sounder."

Ques. Describe a sounder.

Ans. As shown in fig. 3,051, it consists essentially of a heavy pivoted lever arranged to vibrate between two stops and held normally against one of these stops by the action of a spring,

there being an electromagnet which when energized acts on an armature attached to the lever causing the latter to move from the upper stop to the lower stop.

Ques. Why is the instrument called a sounder?

Ans. Because, in operation the lever is forced against the stops with considerable rapidity, the blows thus produced, owing to the heavy construction of the lever, being distinctly audible.

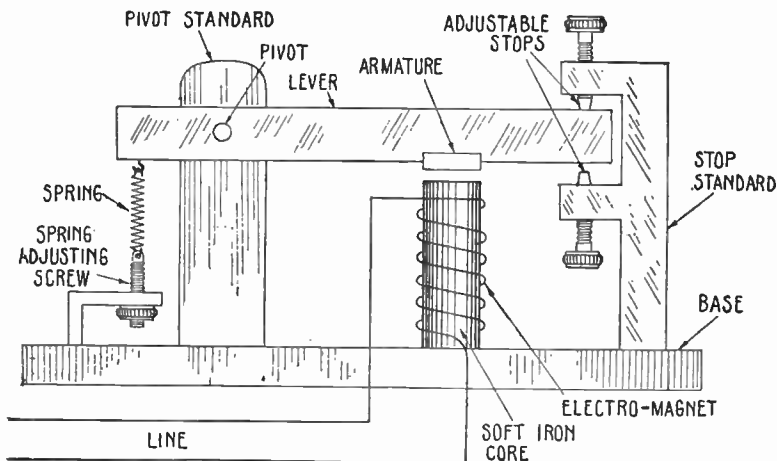

FIG. 3,051.—Elementary sounder showing essential parts.

Ques. Describe a simple short line circuit.

Ans. A simple line having two stations is shown in fig. 3,052. Each station is provided with a key, including a switch, sounder, and one or more cells according to the length of the line, the apparatus being connected in series as shown.

The diagram shows the elementary apparatus for clearness in illustrating the circuit; of course, in actual construction the details are different, for instance the switch forms a part of the key, the standards are double, giving two bearings instead of only one, etc.

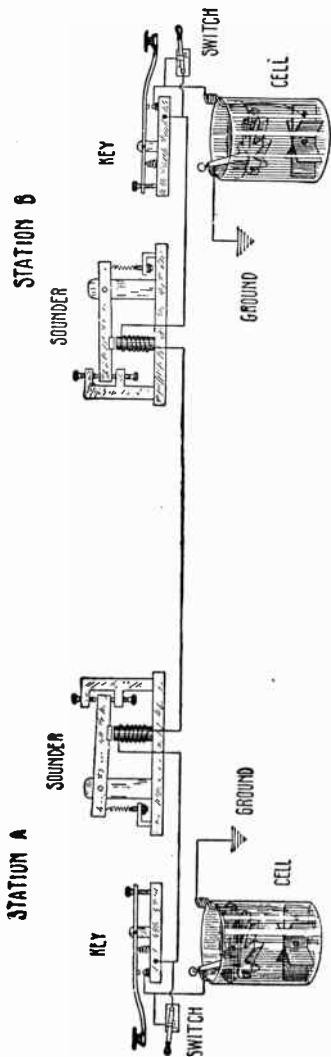

FIG. 3,052.—Elementary diagram showing a simple short line closed circuit system. It is called closed system from the fact that the circuit is normally closed with current on the line, that is to say, when not in operation the switches are closed and current flows which energizes the magnets and holds the instrument armatures in the down position. This necessitates the use of a closed circuit cell as for example the crow foot gravity type which is capable of supplying a very weak current for a long duration of time.

Ques. What is the circuit shown in fig. 3,052 called, and why?

Ans. It is called a closed circuit, because both switches are kept closed except during operation, when the sender's switch remains open.

Ques. Describe a simple open circuit system.

Ans. As shown in the elementary diagram, fig. 3,053, the only instruments necessary are a key with insulated contacts, a sounder, and cell at each station. One insulated contact of each key is connected to the cell, and the other insulated contact is connected in series with the sounder and the latter grounded as shown. The base of each key is connected to the line.

In operation only the battery at the send-

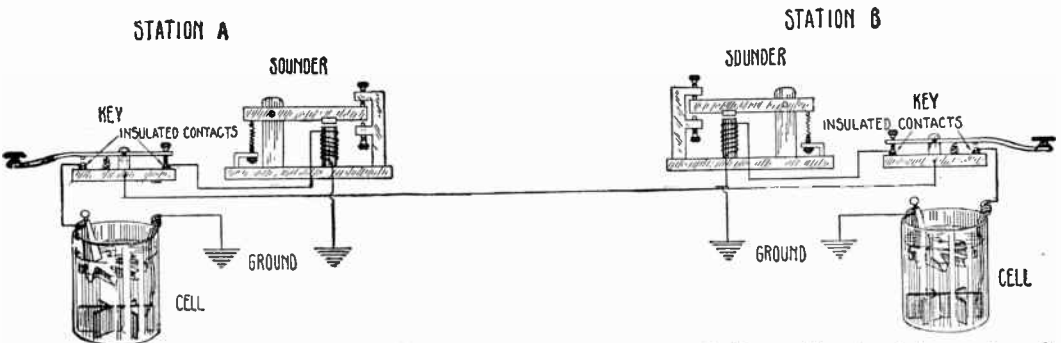

FIG. 3,053.—Elementary diagram showing a simple short line **open circuit** system. In Europe this system is in general use; it consists essentially of so arranging the apparatus that the battery shall only be placed to the line when a message is being transmitted; A main battery is necessary at each station, whereas in the *closed system*, employed in America, main batteries are required only at the terminal stations. An advantage of the open circuit system is that when not in use, the battery is not required to supply current to the line; another advantage is that the resistance of the sounder (or relay) is not always in the circuit, since the closing of a key cuts out the relay. On relay lines local sounders or registers are provided. In some cases a "telltale" galvanometer is placed in the main line at each station to indicate to the operator the condition of his transmitted signals, etc.

ing station is available, hence twice the battery capacity is required as compared with the closed circuit system. Ordinary keys may be used by insulating the back contact of each.

Ques. What is a relay?

Ans. In general, a relay is a device which opens or closes an auxiliary circuit under predetermined electrical conditions in the main circuit.

Ques. What is the object of a relay?

Ans. Its function is to act as a sort of electrical multiplier, that is to say, it enables a comparatively weak current to bring into operation a much stronger current.

Ques. What is accomplished by the use of relays on telegraph lines of moderate or long distance?

Ans. It reduces considerably the battery capacity required.

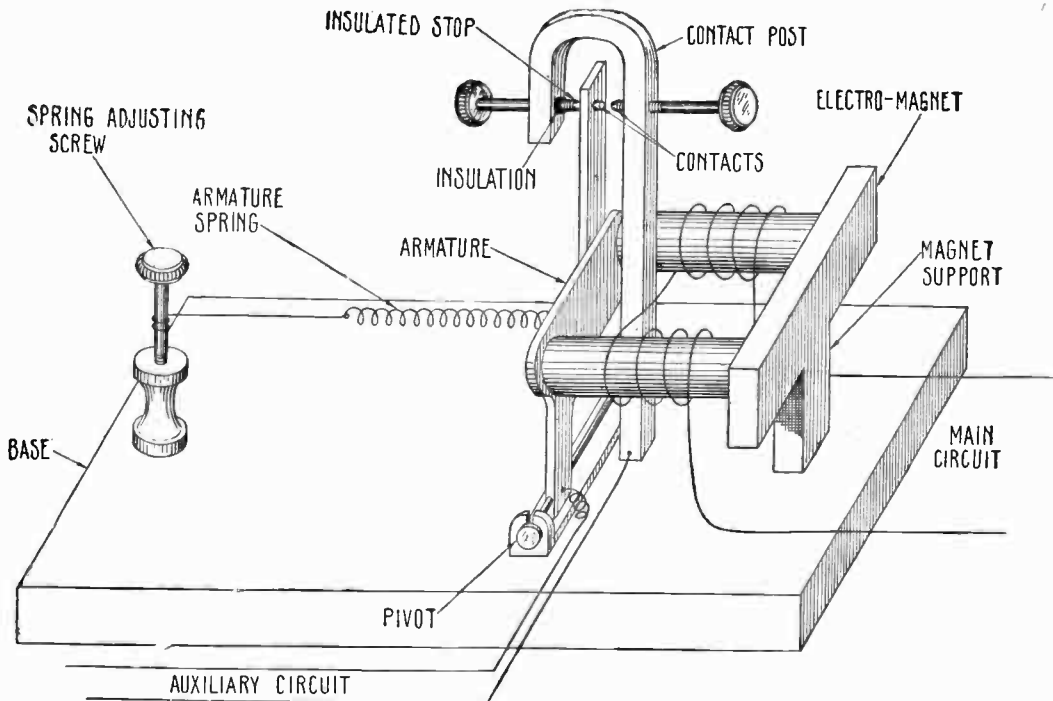

Fig. 3,054—Elementary relay showing magnet, insulated armature contacts, insulated stop, armature spring, main and auxiliary circuit connections. The office of a relay is to open or close an **auxiliary current** under *predetermined electrical conditions in the main circuit*, so that a *comparatively weak current may bring into operation a much stronger current* to effect a saving in battery capacity. Note the delicate armature construction as compared with sounder, thus requiring very little energy to operate. A relay is virtually a very delicate sounder with a contact maker at the end of the armature lever.

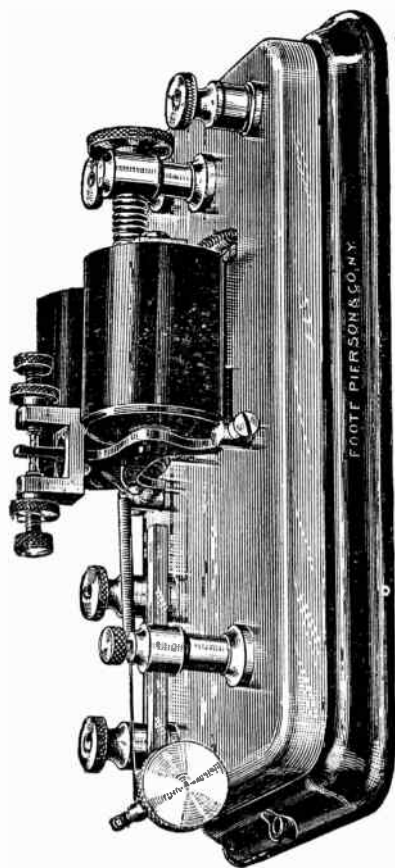

FIG. 3,055.—Foote, Pierson main line relay. In this instrument the magnets are regularly wound from 150 to 300 ohms.

Ques. How is this done?

Ans. When relays are used, a very weak current will suffice for the main line, since the moving parts of these instruments are very light they require very little energy for operation. The relay controls a comparatively strong local current to operate the sounder.

Ques. Of what does a relay consist?

Ans. Its essential parts, as shown in fig. 3,055 are: 1, an electromagnet, energized by the main circuit current; 2, an insulated armature of very light construction and pivoted so as to vibrate between a contact and an insulated stop as shown; 3, an adjustable spring to hold armature against stop when not attracted by the

magnet; 4, leads connecting the magnet winding to the main circuit, and 5, leads connecting the insulated armature and contact post with the auxiliary circuit.

The insulated stop and contact maker at the end of armature lever is very clearly shown on the elementary diagram fig. 3,054.

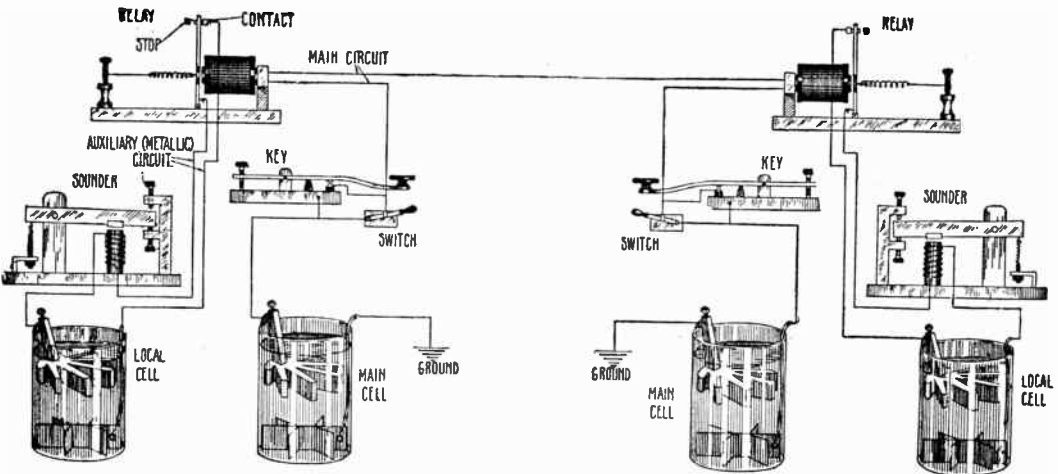

FIG. 3,056.—Elementary short line with relays, showing the main circuit and the auxiliary circuit at each station. The relay, as stated in the text acts as a sort of multiplier, that is to say, it enables the comparatively weak current of the main circuit to bring into operation the much stronger current of the auxiliary circuit to operate the sounder. On lines of moderate or long distance, as can readily be seen, a considerable saving in battery capacity is effected, by localizing the strong current necessary to operate the sounder, it being understood that considerably more energy is required to operate a sounder than a relay.

Ques. Describe a simple short line with relays.

Ans. As shown in fig. 3,056, it consists of one main circuit and an auxiliary circuit at each station. The main circuit includes the relays, keys, and main cells all connected in series with ground return. The auxiliary circuit at each station is made up of a sounder and local cell joined in series and connected with the auxiliary circuit of the relay as shown.

Ques. How does it operate?

Ans. Normally both switches are closed; this energizes the relay magnets and keeps the auxiliary circuits closed by holding the relay contacts together. In operation, the sender opens his switch and with the key sends the message by successively making and breaking the main circuit in proper sequence. This causes the relay armature to move back and forth against the contact and stop, thus making and breaking the auxiliary circuit in synchronism with the movements of the key. In this way, the very weak main current is enabled to bring into action the much stronger current of the auxiliary or local circuit, thus, the movements of the delicate relay armature are reproduced by the heavy armature of the sounder.

Ques. For what length lines is the system shown in fig. 3,056 suitable?

Ans. For lines not exceeding about 500 miles.

Repeaters.—When the length of a telegraphic circuit exceeds a certain limit, dependent upon the ratio of its insulation to its conductivity resistance, the working margin becomes so small that satisfactory signals cannot be transmitted even by the aid of increased battery capacity. This limit under existing conditions is much less in wet weather than in dry weather.

There is no difficulty of directly operating a telegraph of three hundred miles or less, if the line be fairly well insulated and there are not too many offices connected in the circuit. The difficulty arising from the number of office usually settles itself, since the traffic cannot be handled without great delay when the number of office is too great, and accordingly, it becomes necessary to employ more wire and divide the offices among them. When, however, the length of a single line increases, the

difficulties with *leakage* and *retardation* increase, until the speed and certainty of signalling are largely reduced. Under such conditions it was formerly necessary to retransmit all communications at some intermediate station, but this duty is now performed by an instrument called a *repeater*.

Ques. What is a repeater?

Ans. A sounder provided with a circuit maker, for synchronously controlling a second circuit.

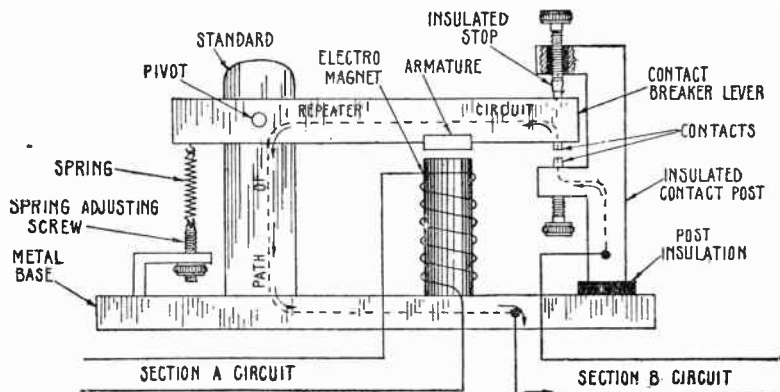

FIG. 3,057.—Elementary repeater showing the insulated parts essential for the contact maker, and path of the current through the repeater portion of the instrument. The insulated stop on the upper arm of the contact post is shown in sectional view to clearly indicate the insulation at this point. Compare this instrument with the elementary sounder fig. 3,051 and note the essential points of difference.

That is to say, it is simply a piece of apparatus in which the sounder (or in some cases the relay), receiving the signals through one circuit, opens and closes the circuit of another line, in the manner that a relay opens and closes the auxiliary circuit of a sounder.

Ques. Describe a simple repeater.

Ans. As shown in fig. 3,057, it consists essentially of a sounder of the same construction as in fig. 3,051, with the exception that the contact post is insulated and is provided with an insulated

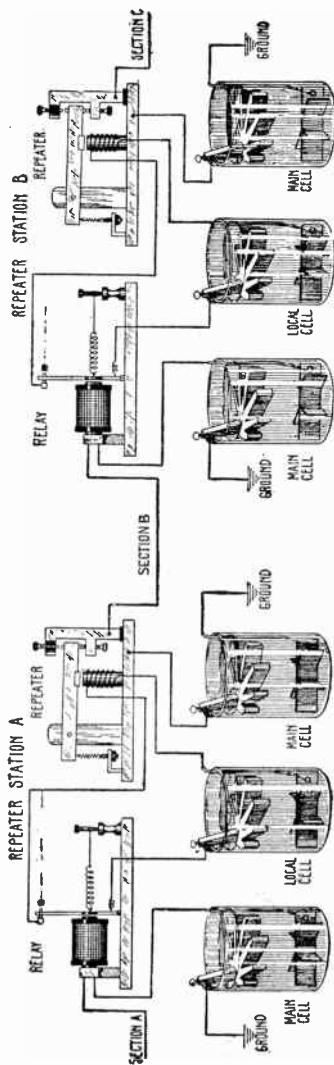

Fig. 3 058.—Elementary repeater as connected in a circuit. In operation, if the home station or beginning of section A line send a message, the movements of the relay at station A will cause similar movements of the repeater, this in turn is repeated at station B, and all other stations on the line.

stop, thus forming a contact maker for the repeating section of the circuit. As indicated by the dotted line and arrows, the path of this circuit is (when closed) through contact post, contacts; contact maker lever, pivot, standard, and out through base.

Fig. 3,058 shows how the elementary repeater shown in fig. 3,057 is connected in the circuit.

As shown, the line is divided into a number of section A, B, C, etc., depending upon its length, there being a repeater station joining each section to the preceding one.

The end of section A is connected to the relay main circuit, and the auxiliary circuit to the electromagnet of the repeater.

There is a ground return on main circuit, and metallic return on auxiliary circuit, one or more cells being included in each of these circuits as shown.

The contact maker circuit of the repeater (which corresponds to the auxiliary circuit of the relay) is connected to section B and ground.

At the end of section B is another repeater station identical with the one just described,

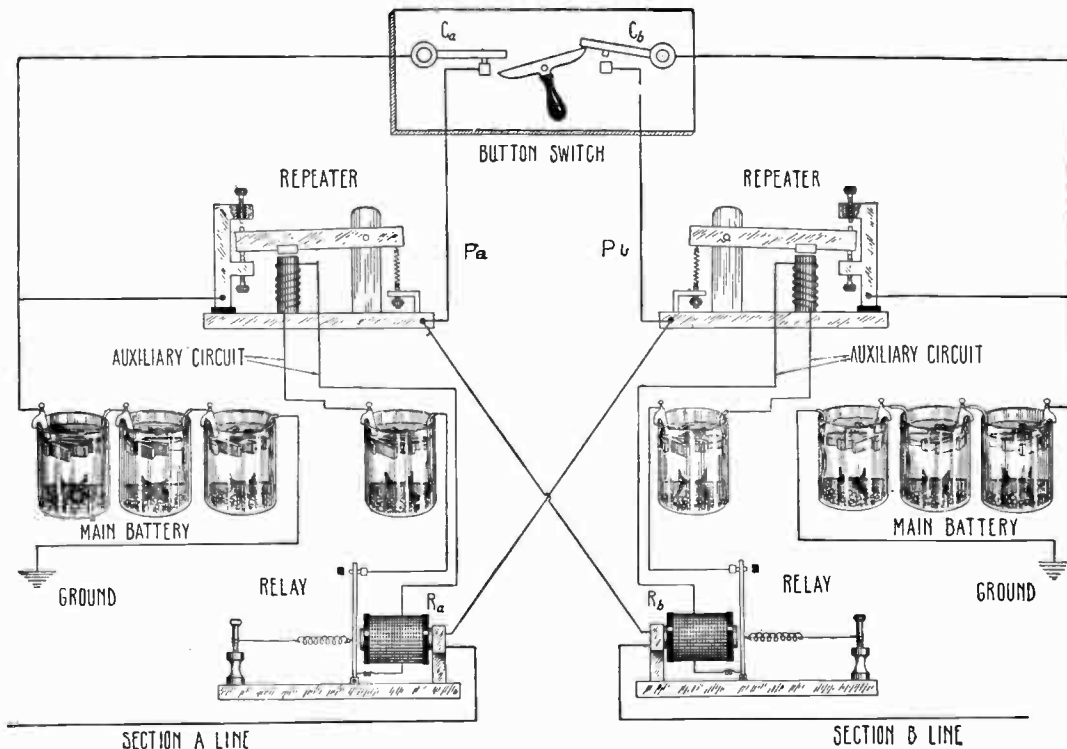

FIG. 3.059.—Diagram showing essentials of the so called button repeater, consisting of two relays, two simple repeaters, a button switch and connections as shown.

and from which section C begins, the number of repeater station depending on the total length of the line.

Ques. What is the objection to the arrangement shown in fig. 3,058?

Ans. It will only work in one direction.

Ques. How is this overcome?

Ans. By use of a button type repeater or equivalent.

Ques. What is the principle of operation of the button repeater?

Ans. The line circuit is extended by making the receiving instrument at the distant terminal of one circuit do the work of the transmitting key of the next circuit, by opening and closing the latter.

Ques. Of what does the so called button repeater consist?

Ans. It comprises two relays and two simple repeaters, a "button" switch, and connections as shown in fig. 3,059. For its operation, two local and two main sources of current supply are required.

Ques. Describe the circuits.

Ans. Section A line (fig. 3,059), after traversing the coil of section A relay R_a , passes through the circuit breaker of section B repeater P_b (the movements of which are controlled by section B relay R_b), and thence to section B battery, the opposite pole of which is grounded. **Similarly**, section B line traverses the coil of section B relay R_b , and the circuit breaker of section A repeater, P_a , thence through section A battery, and to ground. The circuit maker of each repeater is connected to the button switch and to main battery as shown.

NOTE.—The author objects to the use of the word repeater for the collection of instruments necessary to permit repeating in both directions, and prefers the term "repeater system"; the word repeater is properly used to designate the instrument in fig. 3,057.

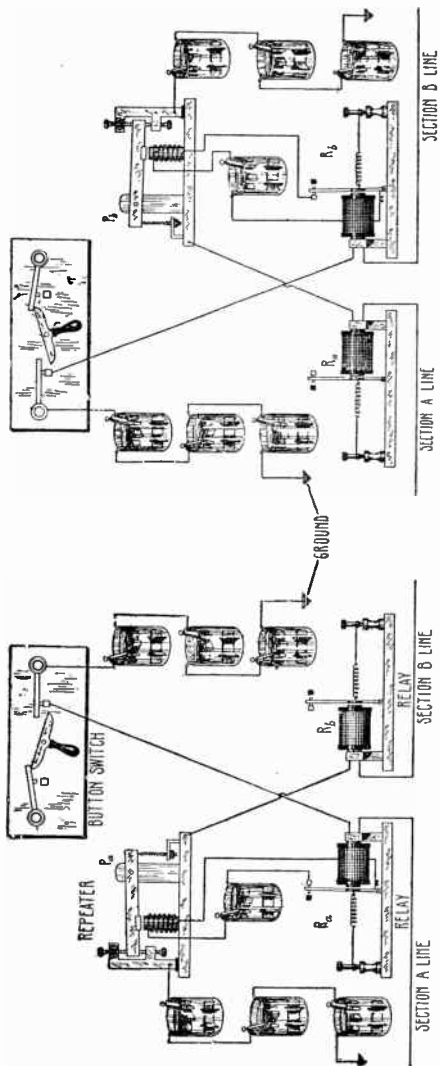

FIGS. 3,060 and 3,061.—Button repeater diagrams showing circuits actually in operation when communicating from section A of the main line to section B, and from section B to section A. The complete apparatus is shown in fig. 3,059, in each of the above diagrams parts are omitted in order to clearly show the circuits in use when operating at either end of the line.

Ques. What is the object of the button switch?

Ans. It provides means for cutting out or closing the circuit around the breaking points of each sounder, otherwise the apparatus would remain unopened.

Ques. Describe the operation of the button repeater.

Ans. If, say, section B line be opened by the key of the operator, the armature of section B relay will open, which in turn opens section B repeater, whose circuit breaker breaks the circuit of section A. This causes the armature of section A relay to open, followed by that of section A repeater,

the circuit breaker of the latter also breaking the circuit of section A. The operator of section B line cannot now close the circuit, because it is still open in another place, viz., at the circuit breaker of section A repeater. The button switch eliminates this difficulty, for when it is swung to the left, it closes a

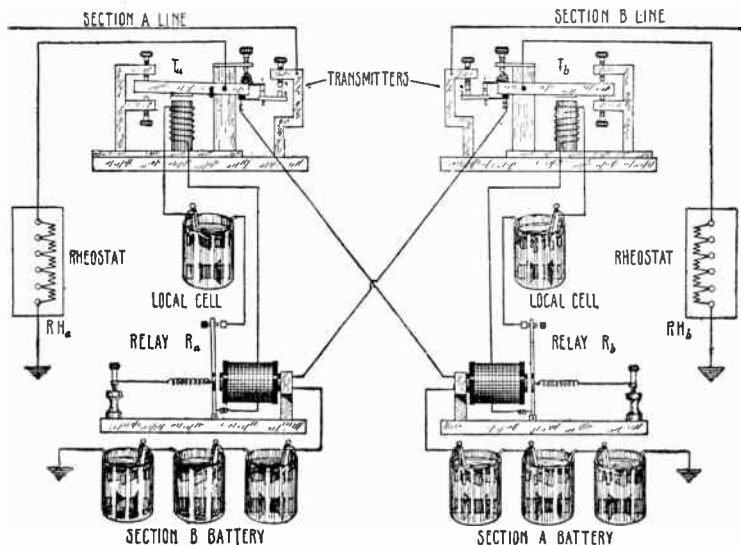

FIG. 3,062.—Diagram of Toye "repeater" or transmitter system, used extensively in the United States and Canada. It comprises two relays, two transmitters with tongue contact breakers, two rheostats and connection as shown. **In operation**, if section B send or open his key, the armature of relay R_a will open as shown, thus opening transmitter T_a lever, which causes contacts 2 and 1 to close and 4 and 3 to open. This change opens section A line, and puts in circuit with relay R_b , section A battery and rheostat R_{H_a} , the resistance of the rheostat being adjusted so that it equals the resistance of section A line. Since this transposition of circuit maintains the current passing through relay R_b at the same strength as before the change of circuit was made, that relay remains closed and likewise also transmitter T_b , thus preserving the continuity of the line while a communication is being sent from section B to section A. Since repeater T_a connects and cuts out section A battery from section A line in response to the operation of relay R_a , relay R_b is prevented opening because section A battery when not in contact with the A line, is given a path to earth through the rheostat R_{H_a} by way of contacts 1 and 2 of transmitter T_a , thus holding relay R_b closed until section A operator desires to "break" or begins sending to section B. In sending from section A to section B a process the reverse of the foregoing holds. A disadvantage of this system is the excessive consumption of current, moreover the adjustment of the artificial resistance must be varied to equal that of the line or lines connected through the transmitters, in order to have equal magnetic pull on the relay armatures whether the relay be in circuit with the artificial line or the main line.

spring contact C_a , forming a connection between the circuit breaker of section A repeater, enabling the operator of section B to open and close its circuit, at pleasure, while his signals are repeated into Section A by the action of the circuit breaker of section A repeater.

Ques. Describe the button switch.

Ans. It consists of two pairs of contact, C_a and C_b (fig.

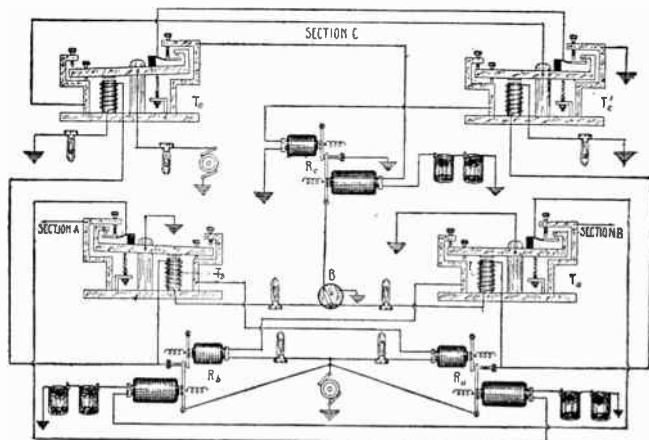

FIG. 3,063.—Kitton's three wire repeater. The current starts from the generator or other source and flows through the contact points (when closed) of relay R_a , to a tap where it divides, one half going through the magnet of T'_c and its lamp to the ground. The other half traverses the coil of magnet T_a through lamp and button B and contact points of R_c to the ground. The back contact points of transmitters T_a and T'_c hold section B and C main circuits closed while similarly the local circuit is maintained intact through relay R_b and transmitters T_b and T_c . The open contact points of relay R_a and transmitters T_a and T'_c indicate that the operator at section A has his key open or is sending to sections B and C. While section A line is open it is necessary that T_b and T_c be held closed in order to preserve continuity through the points of these transmitters.

3,059), normally closed by a spring action, one pair or the other being separated as the handle H is moved to the right or left. If the handle remain in the center, both sets of contact are closed and both sections of the line are independent of each other.

Ques. To what class does the button repeater belong?

Ans. It is called a *manual* repeater as distinguished from the *automatic* type.

The manual repeater is usually employed for temporary purposes and is so called because it requires the constant attendance of an operator to change the position of the button switch, in accordance with the direction in which the message is passing. The automatic repeater requires no attention other than that necessary to insure the apparatus being kept in proper adjustment.

Ques. In operation when should the attendant reverse the button switch?

Ans. When he hears either repeater fail to work in unison with the other.

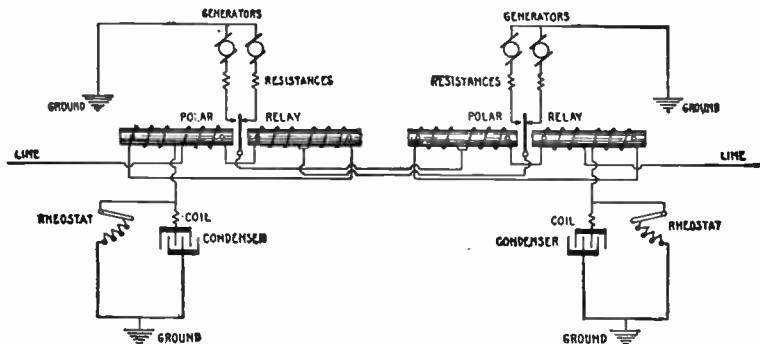

FIG. 3,064.—Diagram of the Postal telegraph repeater system. The Postal direct point duplex repeater is an arrangement by which the respective armature levers of two polar relays at the repeater office connect the positive and negative main battery currents direct to the line wires. Its principle is represented diagrammatically in the figure. The armatures of both polar relays are closed when a distant office closes the key, as shown in the diagram. This results in placing the duplex negative battery in contact with the other line. As the current passes through the coils differentially, the armature of the open line will not be affected by the impulse thereof. When the closed key is opened the positive battery is presented to the line.

Ques. Describe a simple automatic repeater.

Ans. One of the simplest repeater systems for single telegraph working is shown in fig. 3,065. This repeater consists of a transmitter having a second lever placed above the regular armature lever in such a position that one electromagnet is

employed to work both. There are three distinct pairs of circuit, the main line circuits, the local circuits, and the shunt circuits.

Ques. How does it operate?

Ans. When a key on the western circuit is opened the instruments assume the positions shown in the diagram. The

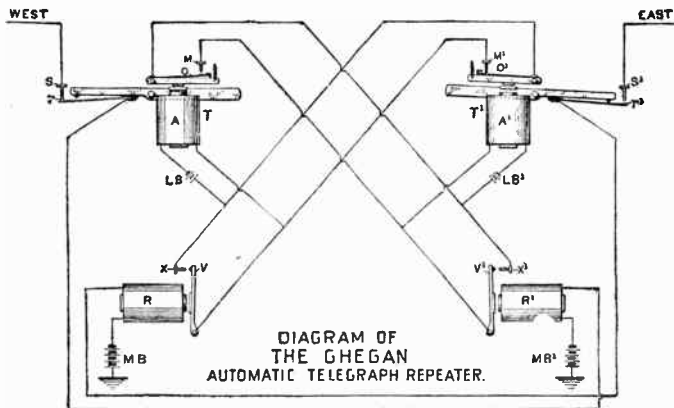

FIG. 3,065.—Diagram of Ghegan automatic repeater. Its principle of operation is based upon the fact that an armature, on being drawn towards a magnet becomes itself magnetic by induction, and that the closer it approaches the magnet cores, the stronger the magnetism becomes. The circuits and operation are further explained in the accompanying text.

armature of relay R^1 , first falls back and opens the local circuit of transmitter T^1 , which in turn opens the eastern circuit $s^1 r^1$, thus causing the armature of relay R to fall back.

This falling back of the armature of relay R , however, does not affect the local circuit of transmitter T , because before the eastern circuit was broken at $s^1 r^1$, the shunt around the local contacts of relay R was closed at $M^1 O^1$.

On closing the western key, the armature of relay R^1 closes the local circuit of transmitter T^1 , which in turn first closes the eastern circuit at $s^1 r^1$, and, as already explained, after sufficient time has elapsed to permit the armature of relay R to reach its front stop, opens the shunt circuit of transmitter T at $M^1 O^1$.

Should east "break" when west is sending, the armature of relay R would remain on its back stop, thus breaking the local circuit of transmitter

first downward stroke of the superposed armature of transmitter to break the western circuit at s r.

being no extra weight or attachment of any kind to either the transmitter armatures, the quickest possible action can be obtained s repeater. As both **relay armatures** work in **unison**, it can be seen at a glance if the signals are being **properly repeated**.

transmitters are provided with switches for working the lines **independently** or putting them together at will.

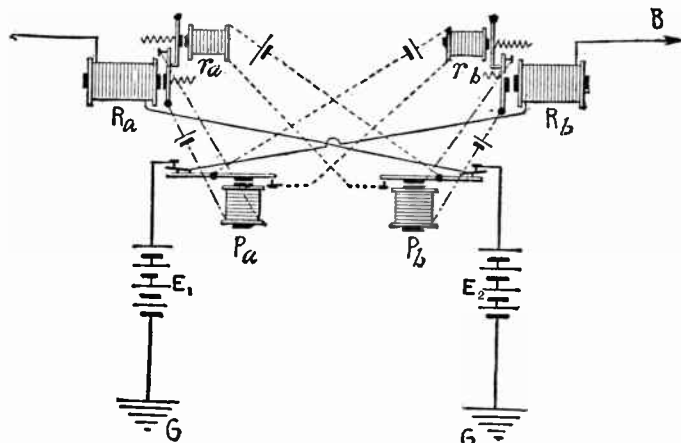
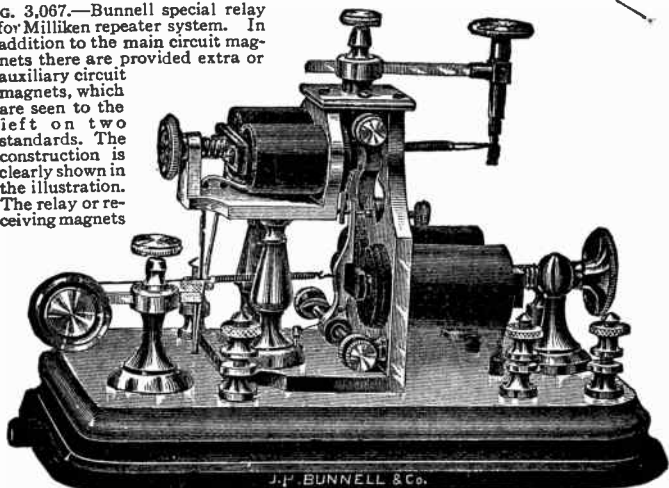

FIG. 3,066.—Milliken repeater system. It consists of two extra magnet relays and two tongue contact repeaters, connected as shown. In the figure, the relays R_a and R_b are provided with additional or extra magnets r_a and r_b , whose levers press against the main levers in such a manner that when the working current is cut off, the working winding, the spring of the extra magnet closes the local contact against the tension of its spring, so that in order that the relay should open its local circuit at the local contact, it is necessary that the current should be cut off its main line circuit and the current should be passing through the local circuit of the extra magnet. The repeaters are provided with two contacts, one for the local circuit of the opposite extra magnet, and the other, for the closing of the opposite main line circuit. When one of these repeaters opens, its local contact is always broken very shortly before the main line contact is broken, while in closing, the opposite takes place. If section A operator be sending to section B, the incoming signals will be repeated by the tongue of relay R_a . This operates repeater P_a , which in its turn repeats the signals into section B. The repetition of these outgoing signals in the relay R_a , would cause the circuit on the incoming side to open at its local contact, if the extra magnet r_b were not coincidentally demagnetized by the action of the repeater P_a opening the circuit. Accordingly the outgoing signals cannot disturb the line on the incoming side.

Duplex Telegraphy.—Within thirty years from the first establishment of the telegraph, the inconveniences arising from the multiplication of wire proved so serious that it became urgently necessary to adopt measures of relief. The effort to

FIG. 3,067.—Bunnell special relay for Milliken repeater system. In addition to the main circuit magnets there are provided extra or auxiliary circuit magnets, which are seen to the left on two standards. The construction is clearly shown in the illustration. The relay or receiving magnets



are in the main circuit which connects the battery and ground through the repeating contact points of the opposite sounder. The local sounder magnets are operated by the relay magnets.

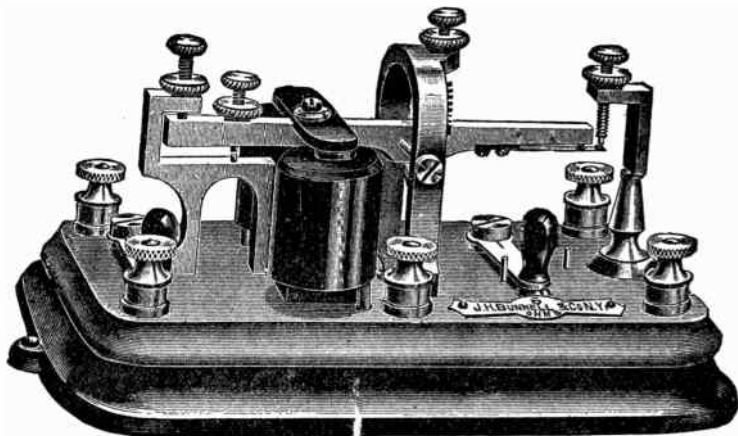
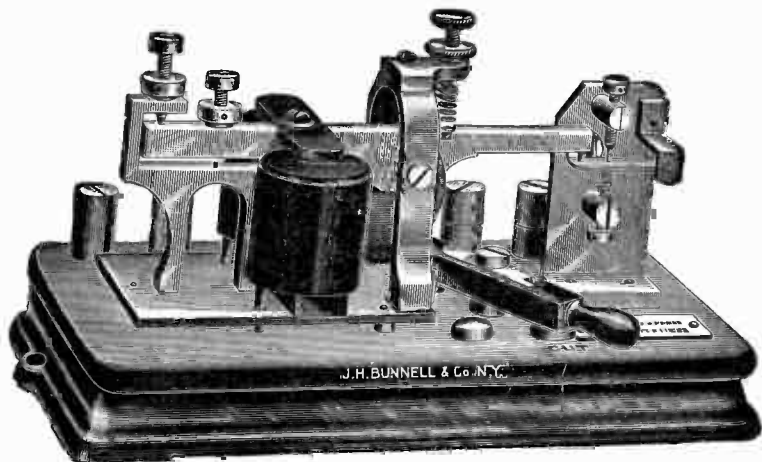

FIG. 3,068.—Bunnell tongue contact repeater as used for Milliken repeater system. Duplicate connections are made at and between the special relay and repeater or sounder here shown and consequently the relay operates the repeater and produces the loud sound from which the signals are read.



FIGS. 3,069.—Bunnell spring contact breaker repeater as used for Weiny-Phillips repeater system.

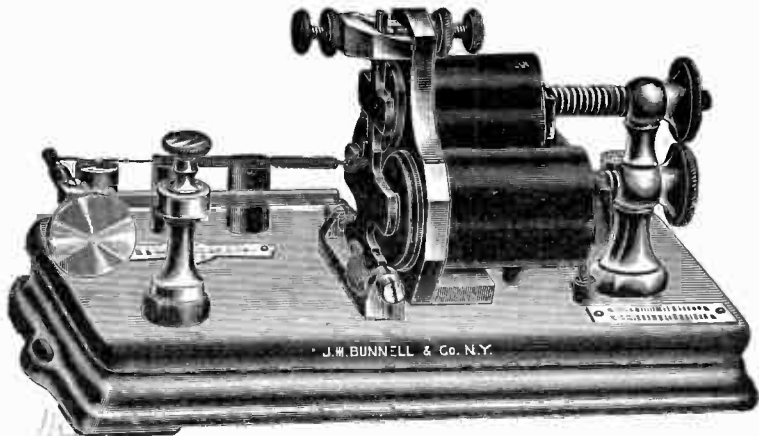

FIG. 3,070.—Bunnell three spool differentially wound relay as used for Weiny-Phillips repeater system. The third spool of relay is differentially wound, so that normally the windings neutralize each other and no magnetism is developed in this spool. One of the coils of the differential spool is in circuit with the front contact of the repeater of opposite side so that the instant the repeater circuit is broken, the corresponding coil of the differentially wound spool is opened, thereby permitting the second coil to act and hold the relay armature closed.

devise an effectual remedy led to the invention of systems of multiplex telegraphy, in which the same conductor might be used for the transmission and reception of more than one communication at the same time.

Of these systems, the diplex is defined as a system which permits two messages to be transmitted in the same direction at the same time over a single wire.

Ques. What is the principle common to the various systems of multiplex telegraphy?

Ans. The receiving instrument at the home station, while free

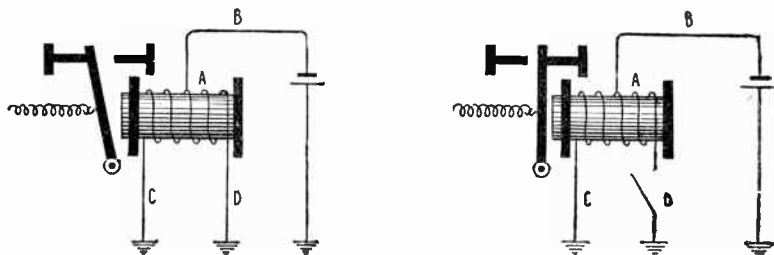

Figs. 3,071 and 3,072.—Detail of the differentially wound third spool of relay of the Weiny-Phillips system. In fig. 3,071, one terminal of the battery is shown grounded while the other terminal is shown connected differentially with two equal windings of the magnet. The current divides at A, half going through each coil. It may be observed that the direction of the winding of one coil is opposite to that of the other. Thus, when current flows through the wire B, the magnetization of the core due to the action of current in the coil A-C is neutralized by the presence of current in the coil A-D, and as a result the core is not magnetized at all; so that the retractile spring attached to the armature holds the latter in the "open" position as shown in fig. 3,071. If, however, while the coil A-C remains closed, the coil A-D be opened, as in fig. 3,072, the core will be magnetized due to the presence of current in the coil A-C while no current exists in coil A-D, the latter no longer neutralizing the magnetic effect of the former. The armature, therefore, is attracted and held in the "closed" position as shown in fig. 3,072.

to respond to the signals of the key at the distant station, shall not respond to the signals of its associate key.

Ques. How does the diplex system operate?

Ans. Referring to fig. 3,073, if the operator depress key K_2 , this brings both sections of the battery in circuit on the line, causing the armature of the neutral relay R_2 to be attracted.

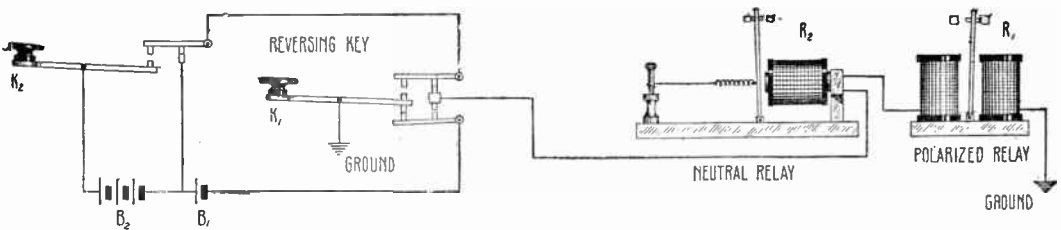

FIG. 3,073.—Diagram illustrating the principle of duplex telegraphy. K_1 is a reversing key and K_2 a non-reversing key. The battery is in two sections, B_1 and B_2 , both sections being included in a loop, the terminals of which are reversed by the depression of key K_1 , but the greater section B_2 of the battery only comes into action when the other key K_2 is depressed. In operation K_1 controls the polarity of the outgoing current regardless of its pressure, while K_2 controls the pressure of the outgoing current regardless of its polarity. At the receiving end of the line is a neutral relay and a polarized relay connected in series, as shown. If the armature spring of the neutral relay R_2 be adjusted to such tension that it cannot respond to the comparatively weak current of the battery B_1 it is obvious that signals may be sent by reversing the smaller battery section by means of K_1 which will actuate the polar relay R_1 , but will produce no effect whatever upon R_2 . Again, signals may be sent by K_2 , each depression of which throws upon the line the additional pressure of the stronger battery B_2 , the additional strength of current thus secured will operate R_2 but not R_1 other than to increase the pressure of its armature against which ever stop it may happen to be in contact. The polarized relay will however respond to each reversal whether of the weak or strong current.

If now another signal be sent by the depression of key K_1 , the full strength of the current traversing the neutral relay R_2 will be reversed. If the armature spring of the neutral relay R_2 be adjusted so that it cannot respond to the weak current of battery B_1 , it is evident that signals may be sent by reversing the smaller battery B_1 , by means of K_1 , which will operate R_1 , but not R_2 .

The principle and operation of polarized relays is explained in the accompanying cuts.

Duplex Telegraph.—

This system is one which permits the sending of two messages simultaneously in opposite directions over a single wire.

There are several systems of duplex telegraphy, namely:

1. Differential;
2. Polar { with battery;
with dynamo;
3. Bridge.

Differential Duplex System.—This method employs a relay wound with two sets of coil, in each of which the current flows in a different direction. Consequently, when two currents of equal intensity are passed through the relay at the same time, they neutralize each other, and the relay does not become magnetized. Each station is provided with a differential relay, and there are two complete circuits, one including the line wire,

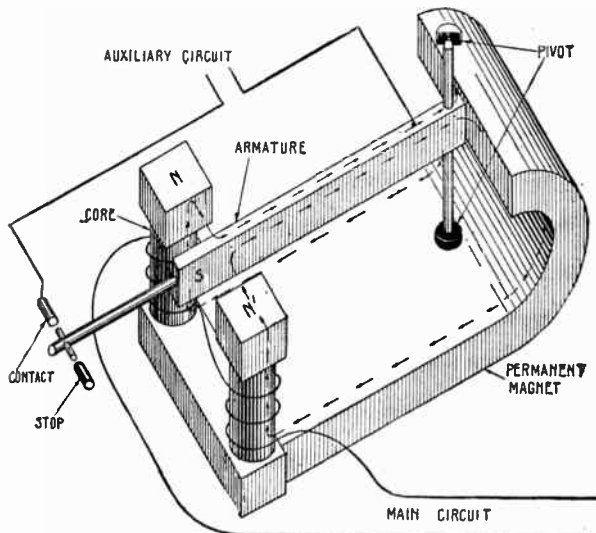

FIG. 3,074.—Diagram explaining the operation of a polarized relay. The relay consists essentially of a permanent magnet, electromagnet, and an armature arranged to vibrate between a contact and a stop. The permanent magnet is of a curved shape as shown; at one extremity is attached the electromagnet, and at the other is pivoted the armature so as to work between the two pole pieces of the electromagnet. The armature being pivoted at one extremity of the permanent magnet is permanently magnetized of the same polarity as the end, which may be assumed to be a south pole. Similarly the ends of the electromagnet cores being under the influence of the other extremity of the permanent magnet are north poles, that is at times when they are not neutralized or reversed by the electromagnet. Accordingly when no current flows through the electromagnet, the armature (having no spring), when placed midway between the poles of the electromagnet will be attracted equally by each and accordingly will approach neither. When, however, the electromagnet is energized, the magnetism thus reduced in its cores either increases or overcomes that due to the permanent magnet, producing unlike poles according to the direction of the current. Thus the armature is attracted by one and repelled by the other. The magnetism of the electromagnet of the polarized relay changes in response to the reversals of the distant battery and the armature vibrates to and fro between its front and back stops in accordance with those changes.

and the other consisting of resistance coils having a resistance equivalent to that of the line and known as the *artificial line*. The key and battery at each station are common to both circuits, the points of divergence being at the relay and at the ground plate.

When the key at one station which may be called the *home station* is depressed, the current flows through both sets of coil of the relay at that

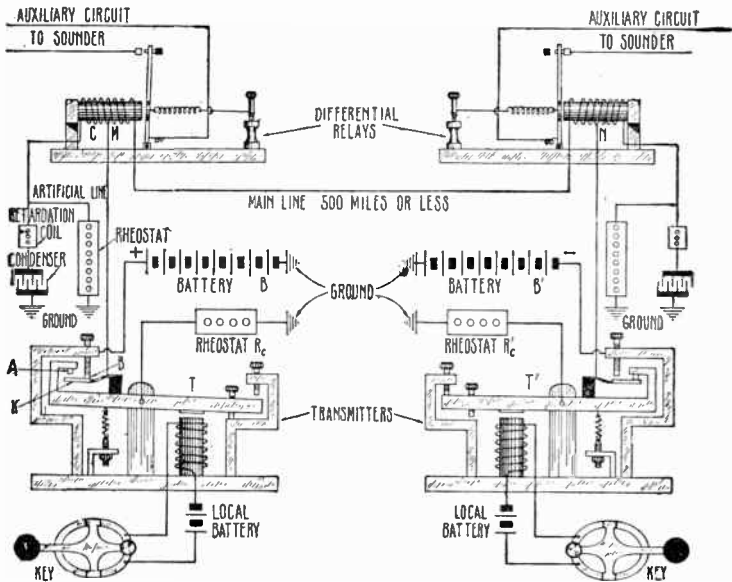

FIG. 3,075.—The Stearns differential duplex telegraph system. The equipment for each station consists of a key, transmitter, differential relay, sounder, rheostats, condenser, retardation coil, batteries and connections as shown. The batteries B and B' contain the same number of cell. The lever of the transmitter T is connected to ground through the resistance R_c which compensates for the internal resistance of the battery, making the resistance of the circuit the same whether the transmitter be open or closed; similarly for T'. The circuit can be traced from the tongue contact K to the point of division M, known as the "split." At this point one branch goes through the right portion of the relay winding to the main line, and the other through the left portion of the relay, the artificial line and to ground. When K is in contact with B, the circuit is through battery B to ground, and when in contact with A, it is through the transmitter lever, and rheostat R_c to ground. The purpose of the rheostat R_c is to divide the current passing through the relay coils equally between the main and artificial lines. When this condition is established, no matter what be the size of battery, the current will pass through the relay with no appreciable effect upon it and the duplex is said to be "balanced."

station without producing any magnetizing effect. Consequently, the relay and sounder at the home station remain unresponsive, but at the distant station, the current will flow through only one set of coil at that station and will cause it to operate the local sounder. The same effect, of course, is produced when the key of the distant station is depressed.

Ques. What happens when the keys at the two stations are depressed simultaneously?

Ans. The current from the combined batteries increases the

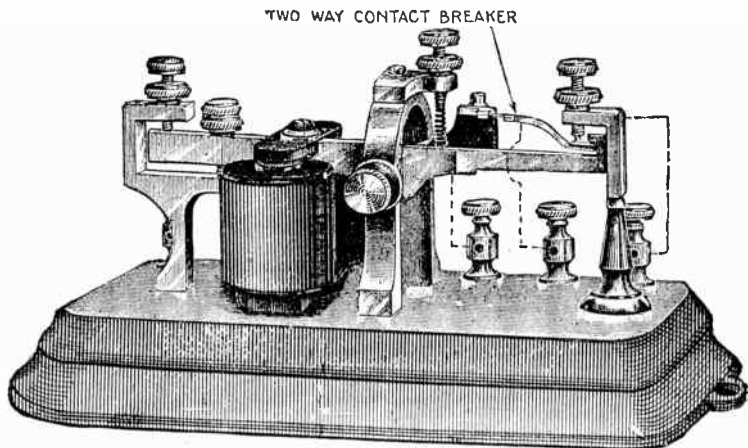

FIG. 3,076.—View of transmitter showing construction and circuits of the two way contact breaker. The distinction between a repeater and a transmitter should be noted, viz: a repeater has a two point contact breaker and a transmitter a three point contact breaker, controlling respectively one and two circuits. The three point contact breaker is shown in detail in fig. 3,078.

strength of the current flowing through one set of the differential coils of each relay, magnetizing them and causing them to work their respective sounders in response to the signals sent from the opposite station.

Ques. In practice are the relays connected direct to the keys as indicated in the preceding questions?

Ans. No.

Ques. How are they operated?

Ans. The relays are operated indirectly by the keys by means of transmitters.

Ques. What is a transmitter?

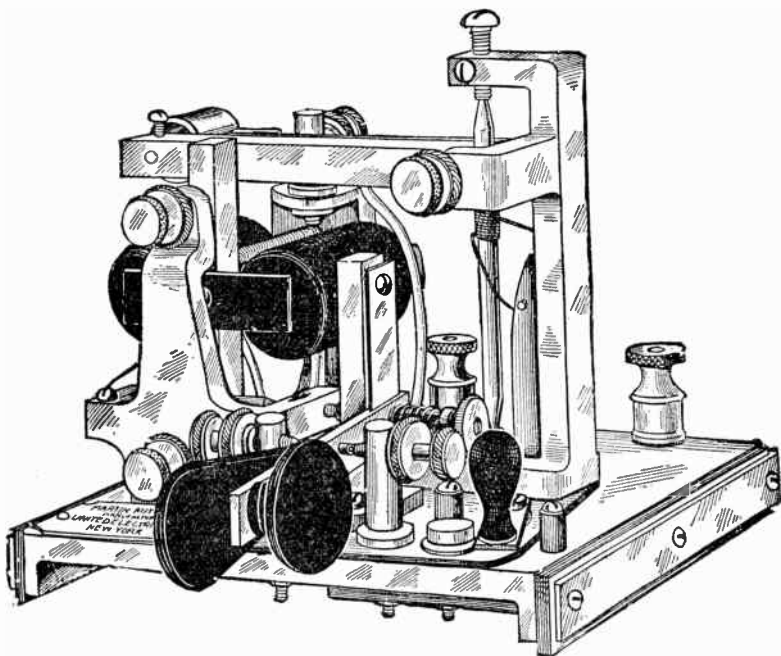

FIG. 3,077.—Bunnell autoplex or semi-automatic transmitter. This apparatus is for automatically making dots, so as to enable operators to transmit Morse characters without the excessive strain necessary for such transmission with ordinary key. It is a simple instrument, and has a highly polished base, upon which is placed the dotting mechanism and the binding posts for main and local batteries. Its speed can be adjusted from 10 to 90 or more words per minute. Explicit directions for use accompany each instrument.

Ans. A sounder provided with a two way circuit breaker.

That is to say, it is equivalent to a single pole two way switch, or a key with an insulated contact at each end.

Ques. What is the difference between a repeater and a transmitter?

Ans. A repeater has a one way contact breaker and a transmitter has a two way contact breaker.

Ques. Why is a transmitter used instead of connecting the key direct to the relay?

Ans. To obtain prolonged contacts.

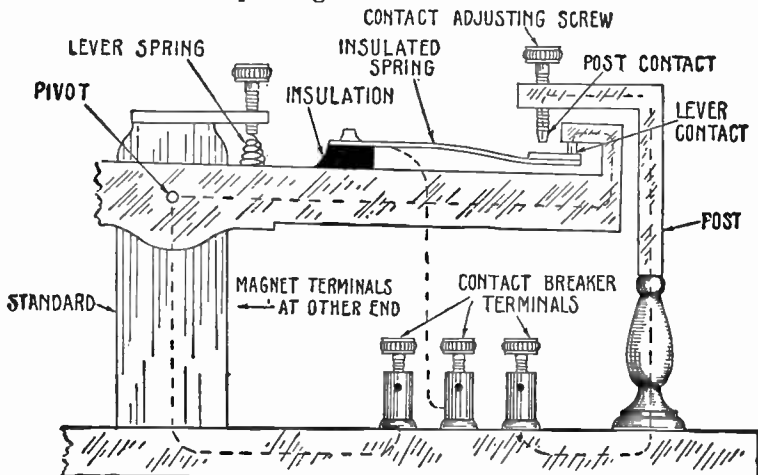

FIG. 3,078.—Detail of contact breaker end of a transmitter showing the three contacts, method of mounting the spring contact, and the circuits from the contacts to terminals. The duration of contact, or portions of the stroke of lever during which the circuit through the post contact and spring contact remains closed is regulated by the contact adjusting screw. This adjustment and other construction details are clearly shown in the illustration.

Ques. Explain this feature.

Ans. One of the three contacts of the contact breaker is mounted on a spring, which by its elasticity allows the contacts to remain together during a considerable portion of the stroke of the lever, whereas the key contacts touch each other only at the end of the stroke.

Fig. 3,078 illustrates the construction of a transmitter.

Ques. At what point of the relay winding is the "split" M located?

Ans. At the middle point.

Ques. What is the object of the condensers?

Ans. To give a capacity equivalent to that of the line. The electrostatic capacity of overhead telegraph wires is much less

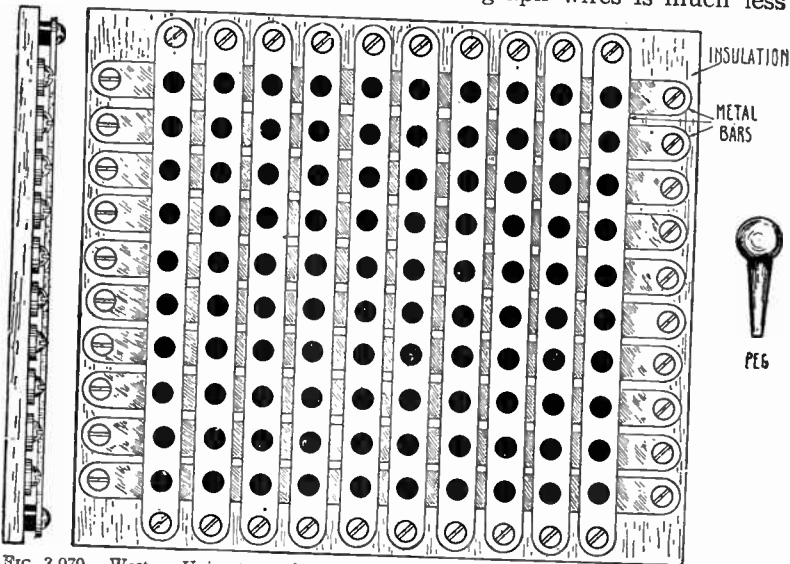

FIG. 3,079.—Western Union type of cross bar switchboard. The bars are made of copper or brass and are connected by plugging metal pegs into the holes, which closes the horizontal and vertical bar circuits.

than underground or marine cables, in the ratio of about 1 to 23. The effect of charging a conductor is that, at the moment of charge a greater rush of current takes place into the wire than would be the case if the capacity were zero. When the battery is removed and a route to earth provided, the accumulated charge rushes out in a direction opposite to that of the charging

current. Accordingly, when, due to electrostatic charge or discharge of the main line, the current in the main line coil of the relay is increased above that traversing the artificial coil of the relay, a false signal will be produced unless, at that instant, the current flowing in the artificial line side of the relay is increased to an equal value. This is what is accomplished by using **condensers** and **retardation** coils in connection with the artificial line.

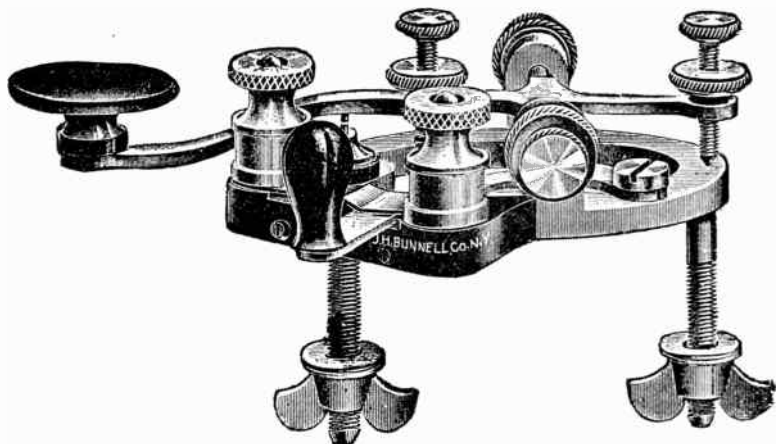

FIG. 3,080.—Voltaplex key as used in the voltaplex system of duplex telegraphy. The voltaplex is a system of duplex telegraphy of the superposed type; that is, a wire provided with ordinary Morse instruments is also equipped with the voltaplex instruments, and as neither system interferes with the other, they may be used as independently as if wired separately. As there is no artificial line, as in other duplex systems, no balancing is required for changing conditions on the line. No expert knowledge is required, for this system and operators of average ability are able to take care of it after it has been installed. The system is, therefore, especially adapted to situations where it is impractical to employ men trained in wire work.

Were it not for the compensation accomplished by the condensers, the effects of the electrostatic charges and discharges upon the home relays when both stations are sending would be of such an injurious nature that duplex and quadruplex telegraphy (especially the latter) would be impracticable.

Ques. Explain the use of the retardation coil.

Ans. It is employed to retard and diminish the condenser charge and discharge to conform more closely to the actual conditions in the main line.

Ques. Describe some features of the type of condenser commonly used.

Ans. There are usually five discs, marked 40, 32, 16, 8, 4, to denote the percentage of tin foil area connected to the disc.

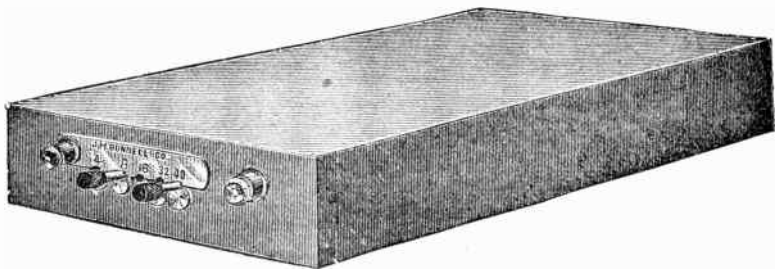

FIG. 3,081.—Bunnell adjustable telegraphic condenser showing 4, 8, 16, 32, and 40 per cent. peg adjustment. The interior construction consists of a number of sheet of tin foil interleaved with insulation, usually mica. As connected in the duplex system alternate leaves are connected with the artificial line and the intervening leaves to ground.

If pegs be inserted uniting the bar with the discs 4, 16, 40 and 60 per cent. of the capacity is in use, and the charge and discharge will be in just that proportion. Fig. 3,081 shows the appearance of a telegraphic condenser.

Ques. What size of condenser is usually employed?

Ans. 2.5 or 3 micro-farads. One micro-farad is equal to the capacity of about three miles of Atlantic cable.

The Polar Duplex System.—This method is an important modification of the differential method. Each station is provided

with two batteries or dynamos, which are arranged in such a manner that the direction of the current in the line depends on whether the key is in its raised or depressed position. As in the case of the differential method, the current divides at the relay, which instead of being of the differential type is known as a *polarized relay*.

In regard to this instrument, which has already been described, it should be remembered, that in the ordinary relay the movement of the armature is effected by the action of a retractile spring in combination

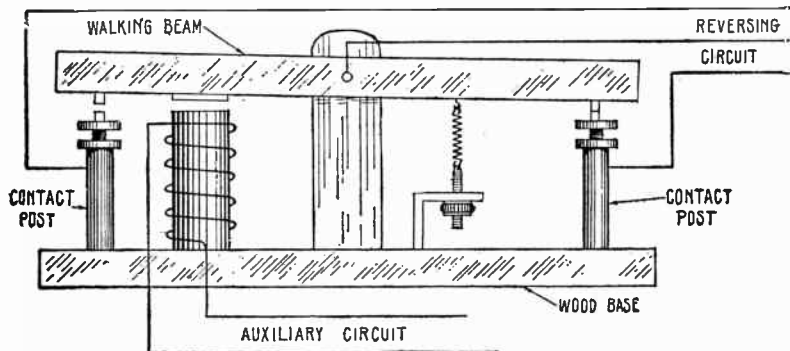

FIG. 3,082.—Essential parts of a walking beam type pole changer. As can be seen it is impossible for all three wires of the reversing circuit to be connected at any instant, that is before each reversal, the circuit is broken, thus interposing an air gap; this is an undesirable condition where dynamos are used for current supply, because, their very small internal resistance would otherwise permit considerable sparking.

with the magnetization and demagnetization of the relay electromagnet, but in the polarized relay the retractile spring is not employed to effect the backward movement of the armature, this being done by means of a reversed current or a current having a direction opposite to that which caused the forward movement.

Ques. How is the reversal of the direction of the current effected?

Ans. By means of a pole changer.

Ques. What is a pole changer?

Ans. A sounder or relay having a circuit reverser.

Ques. What is the difference between a pole changer and a pole changing transmitter?

Ans. The construction of a pole changer is such that the circuit is momentarily broken at each reversal, whereas in the pole changing transmitter, continuity of circuit is preserved.

When dynamo currents were introduced in the operation of telegraph lines it was found that pole changing transmitters or circuit continuity preserving pole changers were not satisfactory owing to the momentary

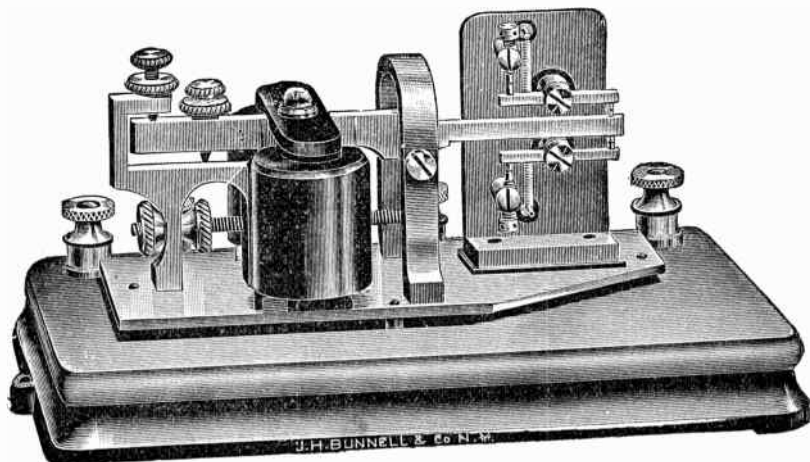

FIG. 3,083.—Bunnell, new type Western Union model pole changing transmitter, or circuit continuity preserving reverser, suitable for use with battery currents.

short circuit existing at each reversal, which, on account of the extremely small internal resistance of the dynamo as compared to the battery, resulted in excessive sparking. Accordingly, a pole changer or air gap preserving reverser became necessary. An instrument of simple construction which has this feature is the walking beam type of pole changer as shown in fig. 3,087.

Ques. Describe the operation of the battery polar duplex system.

Ans. The diagram fig. 3,084 shows the system. The equipment

and connections are exactly the same at both terminals, and the description of the operation at one will serve for both. The diagram shows the keys open and the batteries of equal strength connected in opposition. Accordingly no current flows in the main line but in the artificial line, the current flows round the core in a direction to produce north and south polarities, as indicated. When the key K' is depressed, thereby closing the

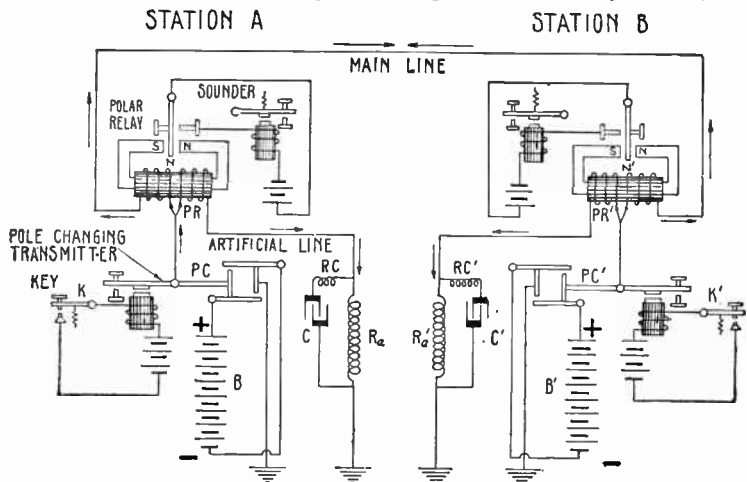

FIG. 3,084.—The battery polar duplex system. When the resistance of the main line is balanced by the resistance of a set of adjustable coil in the rheostat R_a of the artificial line, the current will divide into two equal parts at the polarized relay, and passing around the cores in different directions will neutralize each other and thus fail to magnetize the relay. This is called the *ohmic balance*. The *static balance* is effected by neutralizing the static discharge on the line by shunting the rheostat R_a , by means of an adjustable condenser C and a retarding coil RC.

pole changing transmitter PC' at station B, the connections of battery B' are changed or reversed, and it adds its pressure to that of battery B, and the current flows from the positive terminal of battery B to the negative terminal of battery B' , or from the station A to station B. The current in the main line is, however, twice as strong as in the artificial line, and the

magnetic conditions produced on each side of the armature N and N' of the permanent magnets are such that the relay PR' is held open and the relay PR is caused to close thereby closing the local sounder also. If the key K at station A terminal be closed at the same instant the key K', is closed, the batteries will be placed in opposition with their negative (—) poles

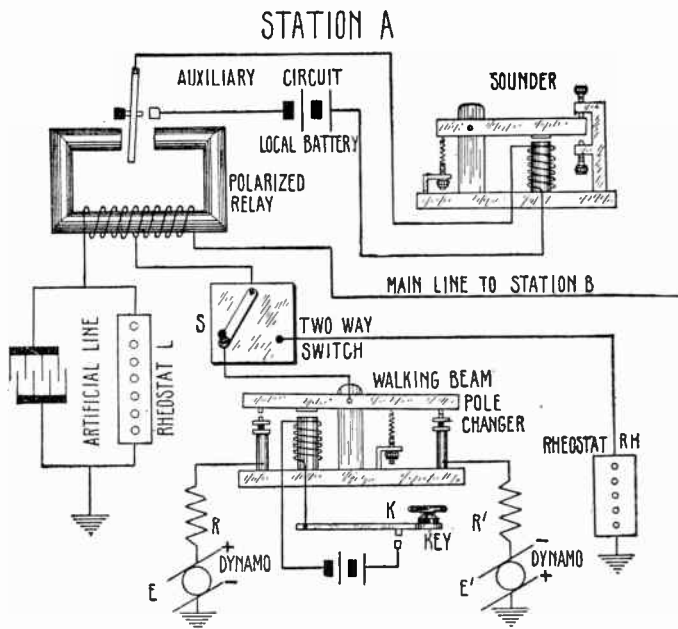

FIG. 3,085.—The dynamic polar duplex system. E and E' are the dynamos, E for the positive and E' for the negative current. These supply their currents through resistance coils R R' either of German silver wire or of incandescent lamps. K is the key which closes the local circuit of the walking beam pole changer. The position of the lever of the pole changer determines which current is being sent to line through the pivot of the lever. The two way switch S is for changing from duplex to ground connection through a rheostat RH for the purpose of enabling the distant station to obtain a balance. From the switch the current goes to the junction of the two coils of the relay where it divides, one-half going to the main line, if the line circuit be closed at the distant station, and the other half through the artificial line to ground. The resistance in the artificial line is made equal to the resistance of the line and relay coils at the distant station. This is adjusted, not by measurement, but by trial. The operator at the distant station turns his switch to the ground position and signals are then sent by the operator at the home station.

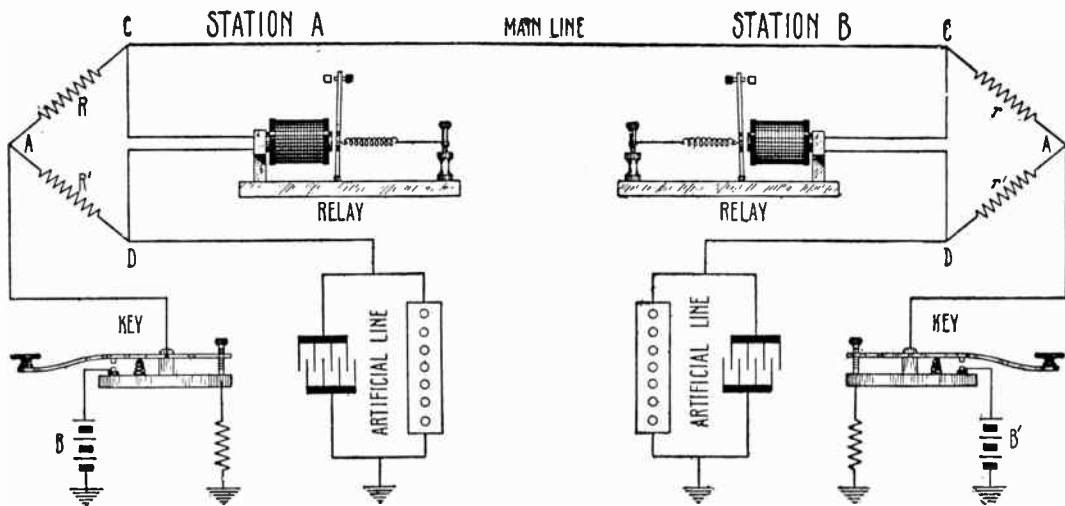

FIG. 3,086.—Diagram illustrating the operation of the bridge duplex system. In the figure, B and B' are the main line batteries, one at each station. R , R' and r , r' are the bridge resistances at each station. The various connections are clearly shown in the diagram. In operation, closing station A key sends out a current which divides at A, half passing over the main line to station B, and reaches earth via the apparatus at that end of the line, while the other half passes through the artificial line at station A, reaching the earth at that end of the circuit. Since the resistance between C and D is the same as R or R' , the pressures at C and D are equal, and no current will flow through station A relay. This holds only when the resistance of station A artificial line is made equal to the resistance of the actual line to ground at the distant end. The relay at A is accordingly not affected when A sends to B. The same condition obtains when B alone sends to A. Signals from A operate the relay at B because the incoming signals have a joint path made up of the branches CD and CA, thus setting up a difference of pressure between the points C and D sufficient to operate the relay. The operations which take place with different key combinations at either end of the bridge duplex may be traced without difficulty. Since the line relay employed in the bridge duplex does not need to be differentially wound, it is evident that any ordinary relay may be used with this method of duplexing. It is apparent, also, that the outgoing currents do not pass through the windings of the home relay, and, as the currents pass directly to line, there is a minimum amount of retardation in the sending circuit.

to the line and there will be no flow of current on the main line, but the current in the artificial line, flowing from the ground to the negative poles of the batteries will produce the magnetic condition required to close relay PR' at station B while the relay PR remains closed by the action of the key K', thus fulfilling the conditions necessary for duplex working, viz, *that the movement of the key at either of the two terminals should have no effect upon its own local relay, but should operate the relay of the other terminal.*

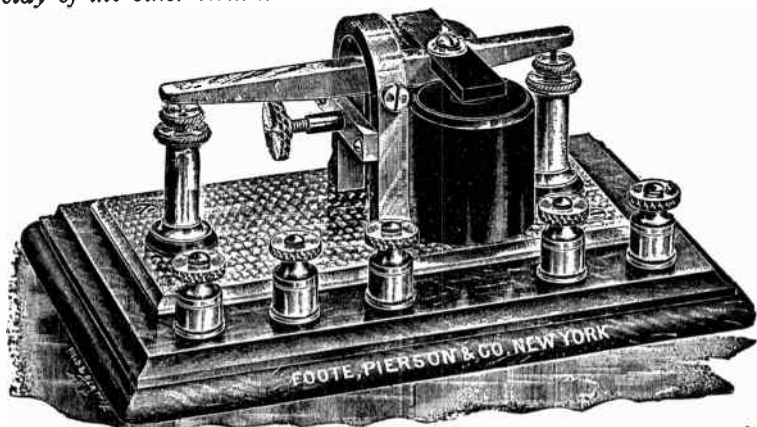

FIG. 3,087.—Foote, Pierson walking beam type pole changer or circuit breaking reverser for use with dynamo currents.

The Bridge Duplex System.—This method is based on the principle of the **Christie** or so called **Wheatstone bridge***. It is used in the operation of submarine telegraph cables. In

*NOTE.—The author desires to again emphatically protest against applying the name **Wheatstone** to this bridge. This ingenious and useful system of electrical measurement was first described by **Samuel Hunter Christie**, in *Phil. Trans. R. S.*, 1833, 95-142. Its importance remained unappreciated until attention was directed to it by Professor **Charles Wheatstone**, in a lecture before the Royal Society in 1843, entitled "An account of several new Instruments and processes for determining the constants of a voltaic circuit." *Phil. Trans. R. S.*, cxxxiii, 303-327. Although full credit was accorded to **Christie** by **Wheatstone** for his admirable device, electricians have ever since persisted in calling it the **Wheatstone Bridge**, and it seems probable that it will always continue to be known by that name, despite the injustice of such error.

this method, the relay is placed in the cross wire of a Christie bridge and the key is so arranged that connection is made with the battery before the line leading to the earth is broken. Adjustable resistance coils are placed in the arms of the bridge and a wire connects the key with one arm of the bridge, which is completed at the opposite end by a suitable arrangement. If the resistances be equal, the relays will not operate when the current is transmitted, but since the earth is employed to complete the circuit, they will respond to the received current, thus enabling each operator to send and receive signals at the same time.

Ques. What comparison is there between the differential and the bridge method of duplex telegraphy with respect to induced line disturbances or to earth currents?

Ans. The line relays of the bridge duplex, because of their position in the bridge are less responsive to induced line disturbances or earth currents.

Ques. Why?

Ans. Because in the bridge system only a portion of the line currents pass through the relay, no matter whether the currents be the result of an induced impressed pressure, or of conduction for neighboring circuits, while in the differential duplex, all currents existing in the main line pass through the windings of the line coil of the relay magnet.

The bridge duplex has been more highly developed in Europe than in America, and several of the refinements applied to its operation there are particularly noteworthy as having a bearing on the general subject of high speed signaling.

The Quadruplex System.—This method of telegraphy permits the simultaneous sending of two messages in either direction over a single wire. Theoretically it consists of an

arrangement of two duplex systems, which differ from each other so greatly in their principles of operation that they are capable of being used in combination. The earliest system was devised by Edison, and was first used by the Western Union Telegraph Company in 1874. Since then new and improved methods have been devised by Prescott, Gerritt Smith, Stearns, Fields, and others, and at the present time quadruplex working is employed on all busy lines, particularly those between large cities.

Ques. What devices are essential for quadruplex working?

Ans. The sending apparatus consists of a reversing key and a variable current key (or equivalent), and the receiving apparatus consists of a neutral relay and a polar relay, batteries and connections as shown (in part) in fig. 3,088.

Ques. What are the two divisions of the main battery called?

Ans. The long end and the short end.

Ques. What is the name of the wire joining the intersection of the long and short end of the battery?

Ans. The tap wire.

Ques. What is the object of the resistance inserted in the tap wire?

Ans. To act as a compensation for the sudden change in resistance when the long end of the battery is short circuited by the variable current key.

Ques. Where should the tap wire connect with the battery?

Ans. At a point dividing the battery in the ratio of about 1 to 4.

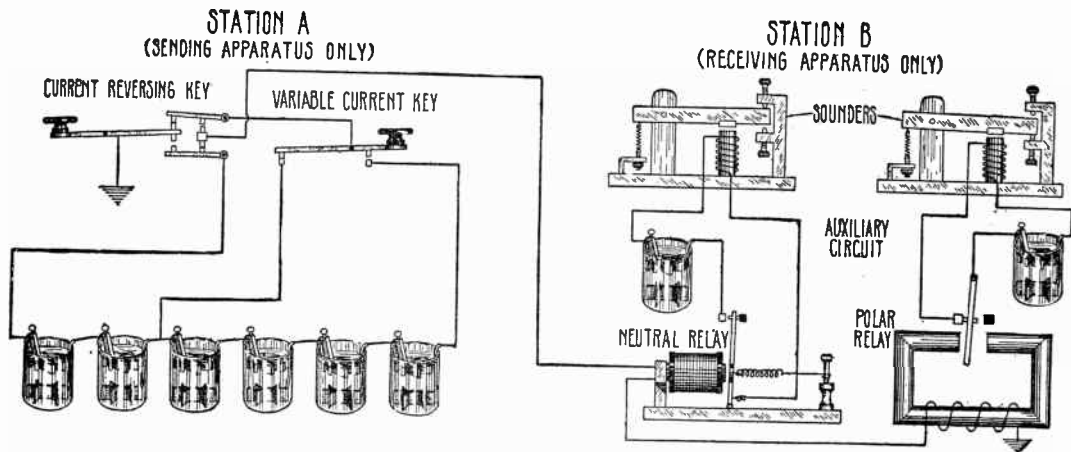

FIG. 3,088.—Elements of the quadruplex system. For simplicity, the receiving apparatus is omitted at station A and the sending apparatus at station B, the complete installation being shown in fig. 3,089). Because of the fact that a polar relay responds solely to changes in direction of the current, and a neutral relay to changes in strength of the current, it must be evident that, if the two relays be connected in series as shown, signals may be produced by the polar relay by operating the current reversing key, and with a sufficiently weak current the neutral relay will not respond; also, if the *direction* of the current be maintained constant by using the variable current key signals will be produced on the neutral relay but not on the polar. Hence, with this arrangement, two messages may be sent from station A to station B simultaneously, and by extension, if the reader imagine each station fitted with both sending and receiving apparatus, four messages may be sent at one time, thus giving quadruplex operation.

Ques. Of what does the "No. 1 side" of the quadruplex consist?

Ans. The polar key, pole changing transmitter, polar relay, and their auxiliaries.

Ques. The No. 2 side?

Ans. The neutral key, transmitter, neutral relay, and their auxiliaries.

Ques. What name is sometimes applied to the battery compensating resistance?

Ans. The ground coil.

How to Adjust the Quadruplex.—The following method of procedure has been recommended by experienced operators, though it is proper to say that some difference of opinion exists in reference to the minor details of adjustment:

1. Instruct distant station to "ground." He will then put the line to ground through his ground coil. Both stations should assure themselves that the resistance of the ground coil is equal to that of the battery.

2. Center the armature of the polar relay. When centered, it should remain indifferently in either an open or closed position of the local circuit as placed by the finger.

3. Switch in the home battery, and vary the rheostat resistance in the artificial line until the polar relay can be again centered.

4. Instruct the distant station to switch in his battery. This may assist in adjusting the polar armature.

5. Instruct distant station to close both keys, thus sending full current to you. Close No. 2 key; send dots with polar key, and alter the capacity of condenser until its effects on the home polar relay are eliminated. This condition is termed the *electrostatic balance*.

6. Instruct distant station to send dots with polar key and words with neutral key. While this is being done, alternately open and close both keys at the home station. If both sets of signal from distant station come distinctly under all circumstances, the balance is obviously correct. The same test should be repeated by the distant station, in order to insure an accurate working adjustment.

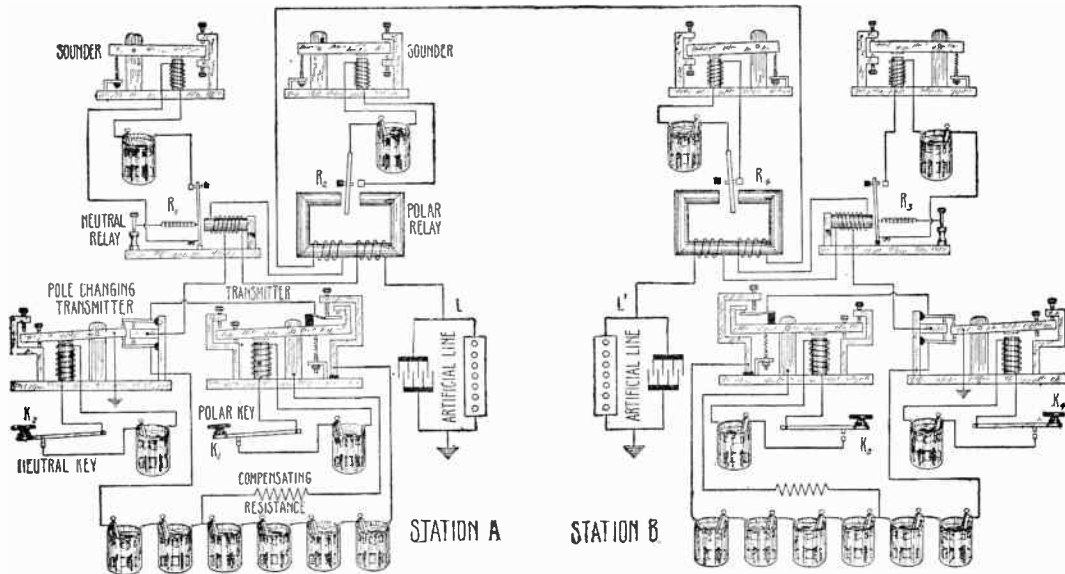

Fig. 3,089.—Quadruplex system with battery current supply. The apparatus employed in operating the polar system of the duplex is generally called the "No. 1 side of the system," or the polar side. It consists of the polar key and the polar relay at either station. The apparatus employed in operating the other system of the duplex is called the "No. 2 side of the system," or the neutral side. It consists of the neutral key and of the neutral relay. In operation, when none of the keys are depressed, no current flows through the line, but a comparatively feeble current flows through the artificial lines L and L', insufficient to operate the neutral relays, and to maintain the polarized relay tongues on the dead stops. Consequently, none of the sounders respond. If now K₁ be depressed, a strong positive current is sent to line at station A. This does not affect the relays at A, since it passes through them in opposite directions but on arriving at B, it tends to keep the polarized relay tongue R₄ on the dead stop, while it has sufficient power to operate the neutral relay R₃. In the same way if K₃ alone be depressed, relay R₁ alone will respond. If K₂ alone be depressed, a feeble negative current will flow to line, in a direction which will actuate R₄, but it will not have sufficient power to actuate R₃. If K₄ alone be depressed R₂ alone will similarly respond alone. The depression of any key will cause its corresponding relay to close its local circuit at the distant end of the line, regardless of the condition of the keys at that end. In practice the reversed position of neutral relay stop requires a repeater with contact on the upstroke between each neutral relay and sounder, or the equivalent secured by transposition of battery, for synchronous operation; these modifications are here omitted for simplicity.

If the sending on No. 2 side should fail to come well, instruct distant station to hold No. 1 key open for a few seconds, and then closed the same length of time. If the signals come imperfectly in both cases, it indicates that the contact points of the distant pole changing transmitter require cleaning. A very fine flat file is the proper tool to use for this purpose.

If the dots on No. 1 fail to come well at the same time with the writing on No. 2, instruct distant station to alternately open and close No. 2 key at intervals of a few seconds; the trouble may usually be traced to defective contacts upon the transmitter, provided the balance has been properly attended to.

It should not be forgotten that a change of weather which is sufficient to affect the insulation of the line, may necessitate a readjustment, to a greater or less extent, of both the rheostat and condenser balance of the quadruplex. Both the line resistance and the electrostatic capacity are diminished by a defective state of insulation.

Telegraph Codes.—There are three *codes* or systems of signals used for general telegraphic purposes, *the Morse code*, which is exclusively used in the United States and Canada; *the Continental code*, used in all European and other countries, and in all submarine telegraphy by international agreement; and *the Phillips code*, which is used for “press” work in the United States.

In the *Morse code* the letters of the alphabet are made up of the simplest combinations of the three elements defined as:

1. The dot;
2. The dash;
3. The space.

The shortest combinations are given to the letters which are most frequently used. For example: E and T are the letters which occur most frequently in the English language, therefore, E is represented by the simplest signal, a dot, and T by the next simplest, a dash.

In the *Continental code* spaces are not used, the letters being made up of the simplest combination of the dot and the dash.

The Codes

LETTERS				PUNCTUATION MARKS		
Morse	Continental	†Navy	*Bain	Morse	Continental	Phillips
A ···	A ···	A ···	A ···	Period..... ·····	····	····
B ····	B ····	B ····	B ····	Colon..... ·····	····	····
C ····	C ····	C ····	C ····	Colon Dash..... ·····	····	····
D ····	D ····	D ····	D ····	Semi-colon..... ·····	····	····
E ···	E ···	E ···	E ···	Comma..... ·····	····	····
F ····	F ····	F ····	F ····	Interrogation..... ·····	····	····
G ····	G ····	G ····	G ····	Exclamation..... ·····	····	····
H ····	H ····	H ····	H ····	Fraction Line..... ·····	····	····
I ···	I ···	I ···	I ···	Dash..... ·····	····	····
J ····	J ····	J ····	J ····	Hyphen..... ·····	····	····
K ····	K ····	K ····	K ····	Apostrophe..... ·····	····	····
L ····	L ····	L ····	L ····	Dollar Mark..... ·····	····	····
M ····	M ····	M ····	M ····	Pound-Sterling..... ·····	····	····
N ····	N ····	N ····	N ····	Shilling Mark..... ·····	····	····
O ····	O ····	O ····	O ····	Pence Mark..... ·····	····	····
P ····	P ····	P ····	P ····	Capital Letter..... ·····	····	····
Q ····	Q ····	Q ····	Q ····	Colon Followed by Quotation..... ·····	····	····
R ····	R ····	R ····	R ····	Cents..... ·····	····	····
S ····	S ····	S ····	S ····	Decimal Point..... ·····	····	····
T ····	T ····	T ····	T ····	Paragraph..... ·····	····	····
U ····	U ····	U ····	U ····	Italics or Under- line..... ·····	····	····
V ····	V ····	V ····	V ····	Parenthesis..... ·····	····	····
W ····	W ····	W ····	W ····	Brackets..... ·····	····	····
X ····	X ····	X ····	X ····	Quotation..... ·····	····	····
Y ····	Y ····	Y ····	Y ····	Quotation in Quotation..... ·····	····	····
Z ····	Z ····	Z ····	Z ····	Per Cent..... ·····	····	····
& ····	& ····	& ····	& ····			

NUMBERS			
1 ·····	1 ·····	1 ·····	1 ·····
2 ·····	2 ·····	2 ·····	2 ·····
3 ·····	3 ·····	3 ·····	3 ·····
4 ·····	4 ·····	4 ·····	4 ·····
5 ·····	5 ·····	5 ·····	5 ·····
6 ·····	6 ·····	6 ·····	6 ·····
7 ·····	7 ·····	7 ·····	7 ·····
8 ·····	8 ·····	8 ·····	8 ·····
9 ·····	9 ·····	9 ·····	9 ·····
0 ·····	0 ·····	0 ·····	0 ·····

Learning a Code.—The student should first thoroughly commit to memory the groups of signs representing the letters of the alphabet, the numerals and the principal punctuation points, viz., the period, comma, and point of interrogation; the remaining characters can be learned afterwards, as they will be little needed by the beginner. By constant drill the habit of making dots with regularity, uniformity, and precision must first be acquired; then dashes, and lastly in order, group of dots and dashes, letters and words. If possible for the student to obtain a register, he should by all means employ it in his practice, for he will then be more easily enabled to observe and correct the faults in his own manipulation. The student should learn to form the conventional characters accurately and perfectly; speed will come in good time, but only as the result of constant and persistent practice.

†NOTE.—The Navy code is now obsolete, being discontinued Nov. 16, 1912; the Navy at present uses the Morse.

*NOTE.—The Bain code was at one time in use in parts of America and Europe in connection with the Bain chemical telegraph system, but is now obsolete, though of historical interest.

These instruments are operated as follows: By means of the three punches constituting the perforator, the operator punches a series of holes in a paper tape to correspond with the code signals required for the message, as shown in fig. 3,090. The center punch produces a row of holes along the center line of the tape, which are of no use electrically, but which merely serve to carry the tape forward. At each stroke, the left hand punching disc produces two holes, *bb*, located directly opposite each other, along the edge of the tape. At each stroke, the right hand punch produces two holes *cc*, located diagonally to each other. The tape thus punctured is passed through the transmitter by the movement of a clock work mechanism.

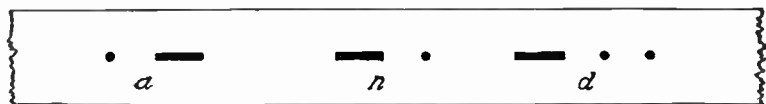

FIG. 3,091.—Receiving tape of Wheatstone automatic telegraph system. The receiving tape is passed to copyists who understand the Morse code and who translate the characters. The receiver complete includes the polarized relay, the inking gear, the tape moving mechanism and the paper tape. The speed at which the tape travels under the inking wheel may be regulated to suit the speed of the received signals.

The holes of the *bb* order allow a momentary passage of current through the transmitter, thus sending a dot to the receiver. The holes of the *cc* order allow a current of longer duration to pass through the transmitter, thus sending a dash.

The dots and dashes thus transmitted are reproduced by the receiver on a paper tape as shown in fig. 3,091, both the transmitting and the receiving being done with a mathematical accuracy which is unattainable with the standard key. The speed of transmission depends upon the length of the line and the atmospheric conditions at the time, but the movements of the clockwork, of both the transmitter and receiver, can be adjusted to any speed up to 150 words per minute.

The Delaney Multiplex Telegraph.—This system provides for the simultaneous transmission of a number of messages either in the same or opposite directions. The apparatus employed consists of a circular disc or table carrying a number of contact pieces, some of which are connected with the separate transmitting instruments, while others are connected with the local relays, the batteries and the earth.

A rapidly revolving arm, called the trailer, connected with the line wire passes over these contact points and successively completes the circuit through the different instruments at one station, while the trailer at the other station, revolving synchronously with the trailer at the first station, makes connections with an equal number of receiving instruments.

The speed at which the trailers revolve is regulated by means of two tuning forks or pitch pipes of the same pitch and an ingeniously designed synchronizer keeps them always revolving together. With this arrangement it is possible to transmit simultaneously twelve different messages over a single wire. The manner in which this is accomplished may be briefly explained as follows: When an operator closes his transmitting key, the contacting of the revolving trailer will connect his instrument to the line wire about 36 times per second, thus transmitting that number of impulses to the synchronizing receiver. Therefore, if the operator desire to send a signal corresponding to a dot, and closes his key for a brief interval of time such as a fraction of a second, the impulse will be transmitted to the receiving instrument at the other station, which is the only one in a position to receive the signals from his transmitter. The same holds true for the other operators and their instruments, each one using the wire for a certain fraction of the same second.

The Rowland Multiplex Printing Telegraph.—This system has been used in several European countries. It employs four transmitters and receivers, which are operated by alternating current and can be used in connection with one wire. The signals are transmitted by means of a mechanical keyboard somewhat similar to that of a typewriter, and are reproduced on tape or ordinary letter pages in type written characters by an automatic printing receiver.

Submarine Telegraphy.—The practice of submarine telegraphy differs in many ways from that of land lines. This is due

to the fact that usually the current has to be transmitted along a conductor of great length and necessarily of small cross section, consequently having considerable resistance. Furthermore, due to electrostatic induction the cable acts as a condenser, the core of the conductor forming one of the plates or conducting surfaces, and the metallic sheathing acting as the other.

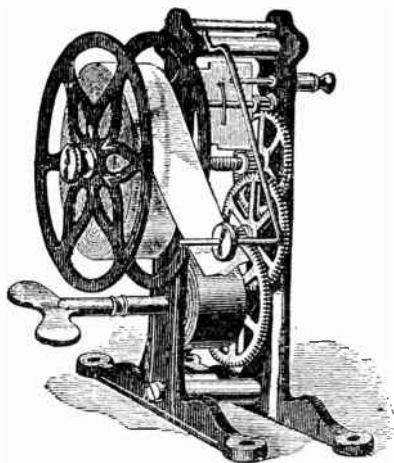

FIG. 3,092.—Bunnell automatic paper winder; view showing clockwise mechanism, winding key and paper reel.

As a result of these conditions, it takes an appreciable length of time for the cable to become charged and discharged when a current is passed through it, so that there is a certain limit to the speed of transmission beyond which the signals lose definition and become confused and unintelligible. As the length of the cable increases, the time required by it to charge and discharge increases, and the rate of transmission varies inversely as the square of the length.

Another serious drawback is the attenuation of the current on long cables. On those over 500 miles in length the current

is so feeble, that the use of ordinary telegraph instruments is impossible, and only on lines not exceeding 150 miles can an ordinary rate of transmission (about 25 words per minute) be maintained by means of hand worked keys.

Ques. What special device is necessary on long lines?

Ans. A sensitive instrument, such as a mirror galvanometer or Thomson siphon recorder.

Ques. Describe the Thomson Siphon recorder.

Ans. It consists of an exceedingly light coil of fine wire suspended between the poles of a powerful magnet. When the

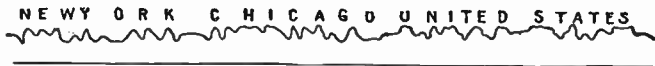

FIG. 3,093.—Siphon record of a message received over a long ocean cable.

current transmitting the signals passes through the coil, the latter is swung around by the attraction of the magnet, either backward or forward, according as the current is positive or negative. The motions of the coil are communicated by means of silk fibres to a little glass siphon about the thickness of a needle and three or four inches in length, so suspended that while one end dips into a vessel containing ink, the other is in very light or vibratory contact with a strip or tape of paper, which is moved through the apparatus either by electrical means or by clockwork.

When the coil moves in response to the signals transmitted, the pen end of the siphon traces a wavy line on the tape, as shown in fig. 3,093, the curves of which represent the message or signals by the code of dots and dashes. These curves are above or below the line of rest or normal position of the pen on open circuit, depending upon the direction of the current passing through the coil, an upward curve representing

a dot produced by a positive current over the wire, and a downward curve representing a dash produced by a negative transmitting current.

In transmitting, the current reversals necessary to produce the results described above, are effected either by means of keys worked by hand or by the use of automatic transmitters.

Ques. Describe a submarine key.

Ans. In construction, it is practically the same as the ordinary Morse key employed for land telegraphy, except that two keys are used side by side, constituting a pole changing device, by which either a positive or a negative current can be sent over the circuit by simply pressing one or the other of the two keys.

With this key, a first class cable operator can send a maximum of about 30 words per minute for a few minutes at a time, but a speed of 20 words per minute is a good average in sustained working.

The method of automatic transmission used on the trans-Atlantic cable and other busy lines is a modification of the Wheatstone automatic telegraph described on page 1,293. By its use an average rate of 50 words per minute is easily attained.

Condensers on Submarine Cable Circuits.—In the practical operation of submarine cables it was soon discovered that the efficiency of the cable, as represented by the speed of transmission, was doubled, and the effect of **earth currents** eliminated by the insertion of a condenser between the transmitter and the cable at both ends of the line. Fig. 3,094, shows the connections of a simple cable circuit of this description.

The Duplexing of Submarine Telegraph Cables.—This was effected in 1875 by Dr. Alexander Muirhead and Herbert Taylor, and their system employing a special form of cable relay was first successfully used on the trans-Atlantic cable in 1878. Since then, over 80,000 miles of submarine cable have been duplexed almost entirely with the Muirhead system, thereby increasing the rate of transmission to about 90 words per minute, and consequently doubling the commercial value of the cables thus operated.

Tests and Troubles.—Conductivity tests of wires are essential with telegraph systems as well as battery and generator troubles and proper adjustments of relays. The **Christie** or so called Wheatstone bridge is therefore much used by telegraph men for testing.*

The wire to be tested is grounded at some distant station after the distant operator has been informed to ground it. At the testing station the ring side of battery is applied by plugging a peg in the proper switch-board disc. The mil-ammeter is then connected in the circuit with

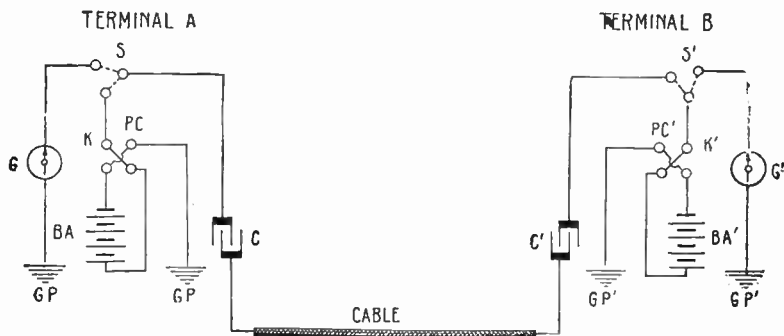

FIG. 3,094.—Diagram of a simple submarine telegraph cable circuit. The equipments of both terminals A and B are exactly the same, consisting of the transmitting keys K, K', the pole changing switches PC, PC', line switches S, S', galvanometers G, G', condensers C, C', batteries BA, BA', and the necessary ground plates GP, GP'. By means of the switches S and S', the current may be allowed to pass either to the earth through the galvanometers or other recorders, or to the transmitting keys K and K', thence through the batteries BA, and BA' to the earth, depending on whether the signals are being sent or received at the respective terminals. By means of the pole changing switches PC and PC', operated by the keys K and K', either pole of the battery can be connected to the condensers C and C', and thereby to the line at the will of the respective operators, and the cables charged inductively, the corresponding signals being reproduced at the distant terminals by connecting the galvanometer with the line by means of the switches S or S' as the case may be.

plug and cord at a spring jack. The meter reading will then show the strength of the current flowing, which is noted, and the mil-ammeter disconnected. As this meter resistance is less than one ohm it does not alter the current flowing. Then the meter is connected in series with the ground side of battery and the line (across the battery) and used as a voltmeter, showing the voltage used in causing the current previously noted, to flow in the line. From these current and voltage readings the resistance of the wire is calculated by Ohm's law; that is,

*NOTE.—See note on page 2,239.

the voltage is divided by the current to give the resistance. This test will show whether or not the wire be clear; that is, well insulated from other conductors and from dampness and other high resistance grounds.

To eliminate static discharges of the line the distant operator is asked to close his key and the condenser is then adjusted. If the static do not appear when the relay point is closed it cannot cause trouble at any other time.

The adjustment of relays must necessarily be experimental and uncertain and is left to the judgement of good operators and branch office attendants.

If a station be informed that difficulty is being found with a distant station relay, even though the balance be apparently O. K., and that the relays are interfered with by the local battery, the station attendant so informed should immediately inspect his ground coil.

An open ground coil would compel the incoming current to find a path to ground through the rheostat or the leak coil, either of which contain greater resistance than the compensating ground coil. A loose connection might add hundreds of ohms resistance to the coil.

In choosing a dynamo for telegraph circuits, it should be noted that very fine wire is used on the relay magnets and the problem is somewhat different from that of other electrical distribution. In every electrical problem the strength of the current must not be beyond the carrying capacity of the conductor, and nowhere is it more necessary to exercise this care than in telegraph engineering.

The resistances of the parallel circuits and of the series circuits must be well known and the liability of their variation.

Generally three or more dynamos are connected in series and taps from each extended to three separate rows of disc at the main switch-board. One side of the battery feed is grounded as is the tip side in telephone exchanges. These taps of the ring side would be designated the first, second, and third pressure, or sixty, one hundred and twenty, and one-hundred and eighty volts.

The telephone test receiver is used to a great extent in testing the quality of electric telegraph currents because of its sensibility to weak currents. Especially in cable testing is the test receiver valuable for locating faults. A trouble hunter will soon become accustomed to the several different tones or "clicks" which he hears in the receiver when connected in a circuit supplied with battery. In cases where the receiver and battery are connected through a high resistance the click will be faint and will be recognized as a "leak" click.

In the testing of open lines and fuses the test receiver is invaluable, for by strapping a receiver across the terminals of any open instrument or fuse the circuit is temporarily completed and the diaphragm will click sharply.

Printing or Typewriting Telegraphy.—In 1837 Alfred Vail, an associate of Morse, made elaborate and detailed working drawings of his proposed printing telegraph. However, this was never developed because both inventors were of the opinion that it could not successfully compete with the practically simple system which Morse had invented two years before.

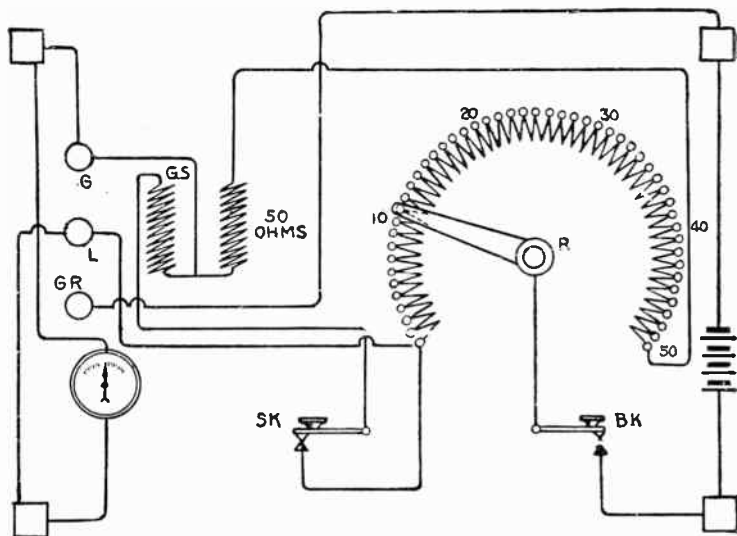

FIG. 3,095.—Circuit diagram of the Western Union proportional test set for the use of line-men and cable testers. This set consists of a simplified rheostat, a galvanometer and a battery contained in a box 7×9×5 inches in size. The component parts of the apparatus, with their connections, are here shown where GS is a galvanometer shunt, R a rheostat with a radial contact arm, BK a battery key, and SK a shunt key.

In 1846, E. House of Vermont invented and patented a system of printing telegraphy and ten years later D. Hughes of Kentucky patented another system.

In 1875, twenty years later, Phelps worked out and patented a practical system of telegraph printing which has since been improved.

Of the later systems developed there are three; the Wright, the Rowland, and the Buckingham-Barclay systems.

The Rowland and the Wright typewriting telegraph systems have each been tried out by the Postal Telegraph Company and while both performed excellent work under favorable conditions they have been abandoned temporarily and returned to the laboratory for further development.

The Buckingham-Barclay typewriting telegraph system is employed by the Western Union Telegraph Company for commercial work and is found favorable, but is still capable of further improvement.

Although the services of typewriter operators can be procured for less than the services of regular telegraph operators, in all cases it has been found that the cost of equipment and maintenance of the typewriting system equals or exceeds the cost of the services of expert telegraph operators, while the latter are more dependable for all traffic conditions.

Stock Printers or "Tickers."—As early as 1866 a type printing system was developed by S. S. Laws of New York, and the next year an improved system was patented by E. A. Calahan. Later Gray and Phelps developed a commercially practical type printing telegraph system which was introduced on the Western Union Telegraph Company's lines between New York and Washington. It was then adopted by the Gold and Stock Telegraph Company of New York for the sending out of stock market reports.

Ques. Upon what principle are stock tickers based?

Ans. The step by step method of operation.

Ques. Describe briefly the apparatus and its operation.

Ans. The operator has a keyboard consisting of two keys for opening and closing the circuit and a switch for starting or stopping the rotation of a small motor. Each key is connected to one of two wires and as many times as the operator breaks and closes the circuit with the keys, just so many steps forward or backward is the dial moved. Pulsating currents from these keys operate the relays and printing magnets of the distant

tickers with distinctly audible sound. When it is necessary to stop because the tickers are not working in unison a break switch is thrown.

Two standard tickers are in use by the Western Union Telegraph Company,—one of which is of the self-winding type. The other is

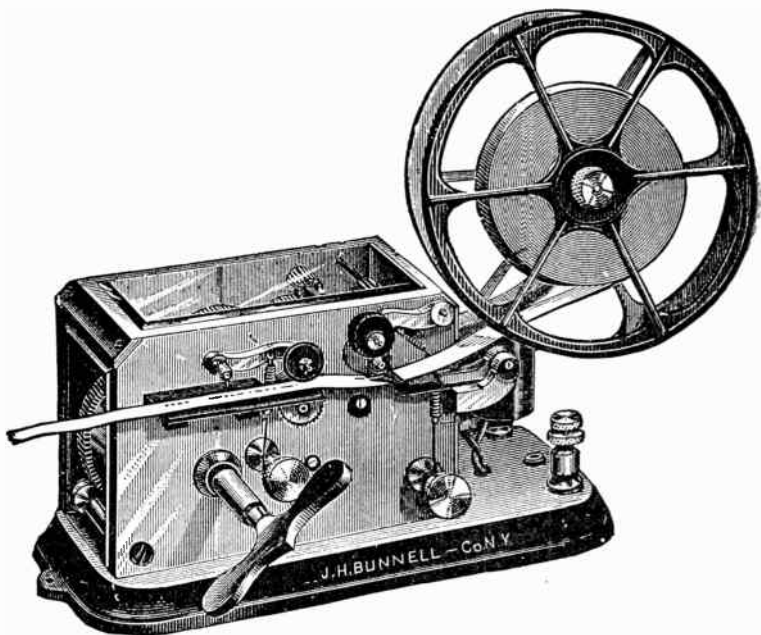

FIG. 3,096.—Bunnell double pen ink writing register for Morse telegraph with lever for starting and stopping at will.

called the "Universal" ticker and is the invention of Edison. Either can work at a speed of at least forty words per minute.

Messenger Call Service.—In former years, when any one wished to send a message by telegraph it had to be taken to the nearest branch office for transmission. But rivalry between

competing companies finally resulted in the installation of mechanical call boxes in houses throughout New York City, whereby a patron could summon a messenger boy by turning a handle. By the turning of this handle, or lever, a revolving wheel with raised teeth is operated which closes the circuit a number of times, corresponding to the number of teeth, and rings an electrically operated bell a correspondingly number of times.

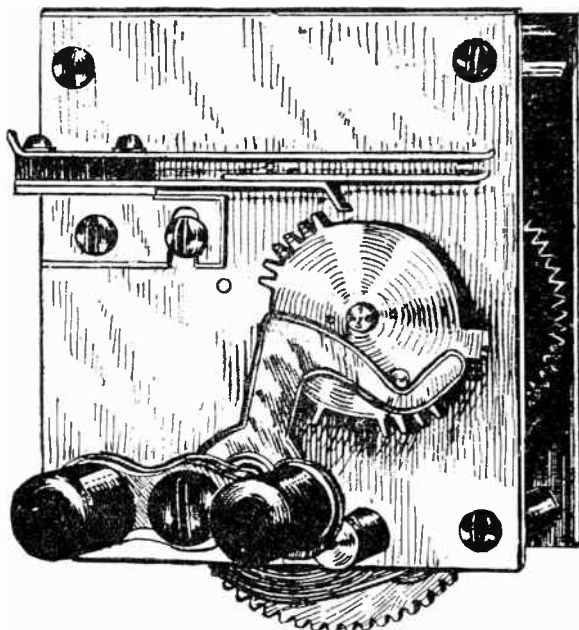

FIG. 3.097.—Messenger call box (cover removed). This box operates the Gili selector and is connected around a Morse key, the combination number of the box being stamped on the handle. In order to transmit the combination over the line the handle is given a quarter turn and then released.

Ques. Of what does the system consist?

Ans. It consists of two relays, a paper tape register, bell and switches for temporarily diverting the local and main line

circuits so that the register will catch incoming signals regardless of line defects.

Ques. How are the circuits arranged?

Ans. The circuits are looped together in pairs, and the office terminals of each loop are connected to a battery of opposite polarity.

Ques. What is done if an open or break occur?

Ans. The distant open station is temporarily grounded so that all stations on both sides of the break can send in their calls through one or the other of the two registers.

Only in the case of a defective call station is the call box circuit grounded.

Western Union Time Signals.—Since 1865, noon time signals have been sent out daily by the United States Naval Observatory at Washington and since 1883 it has been standard time. About noon time, Washington is connected to all lines of the Western Union Telegraph Company east of the Rocky Mountains; the country west of these mountains being supplied by standard time from Mare Island Navy Yard, California.

The signals begin at three or five minutes before twelve o'clock noon and consist of a series of short beats of a transmitting clock at each observatory. The electrical connections of the transmitting clock are arranged to omit certain seconds of each minute.

As one hears the relays and sounders giving out the time, there are heard at first twenty-nine dots, then one is skipped, resembling a space and then twenty-five dots follow and a space of five dots which ends the number of seconds for the first minute. The second, third, and fourth minutes are signalled like the first; namely, twenty-nine seconds, one space, twenty-five seconds,

and five dot spaces for each minute. Then for the minute preceding noon time twenty-nine seconds, one space, then twenty-seconds and ten dot spaces and then one long dash, corresponding to the final twelve o'clock beat at the government station.

Wireless telegraph circuits are worked at the same time through telegraph relays which automatically close the high pressure wireless current circuits.

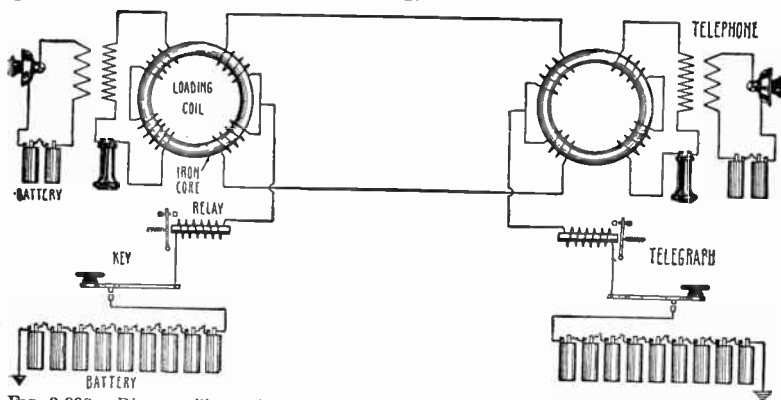

FIG. 3,098.—Diagram illustrating simultaneous telephony and telegraphy. Although in long distance telephony metallic circuits are used exclusively, it is possible to use single line grounded circuits for simultaneous telephony and telegraphy. In the diagram two telephone stations are connected by a metallic circuit through repeating coils. Taps are taken from the middle of one side of each coil to telegraph sets, thence to the telegraph main line battery and ground at each station. The two line wires carry the telephone current in opposite directions, but, acting as a joint circuit to the telegraph current, the two line wires form one side of a ground return telegraph circuit.

Simultaneous Telegraphy and Telephony.—The art of telegraphing and telephoning over the same line was the result of Van Rysselberghe's efforts to prevent the interference of induction from parallel telegraph wires on the telephone circuits.

By inserting coils of wire in the telegraph line the sudden rise and fall of current was choked or retarded and the induction thus reduced was not noticeable in the adjacent telephone line.

The original form of the magneto telephone consisted of battery, transmitter, and primary coil connected in series, and the secondary coil and receiver in series with the line which terminated in the secondary and receiver series circuit at the distant telephone. Consequently, a

telephone similar to the magneto is used in connection with the telegraph for simultaneous operation; also circular retardation coils are used. Fig. 3,098 shows a simple diagram of the circuits. In practice there are two circuits used called the physical and the phantom; the former being the circuit proper and the latter an arrangement by which three circuits may be obtained from two pairs of line wire.

Fire Alarm Telegraphy.—In large cities call bell fire alarm boxes are mounted on street lamp posts or other suitable places along the streets. These boxes are of two kinds, the keyed

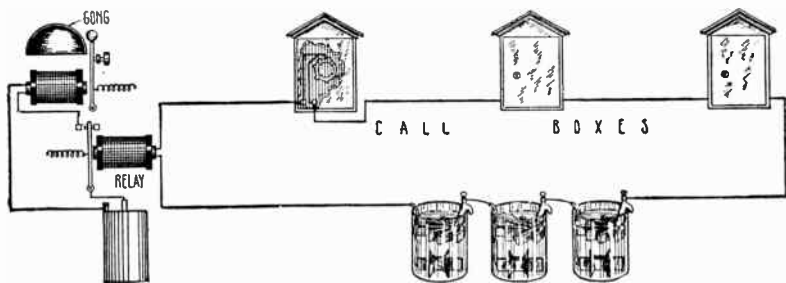

FIG. 3,099.—Diagram of elementary fire alarm circuit. Fire alarm apparatus forms that element of the system depended upon to announce to the fire fighting force the existence of and location of a fire. The equipment consists of gongs and indicators located in the fire department houses, and where volunteers form part of the fire department, public alarms are given by means of devices for automatically striking large bells or blowing whistles.

and the keyless, the former requiring the opening of a door by a key which is generally in the possession of a policeman on the beat.

The keyless boxes may be opened by anyone simply by the turning of a large handle. These are each provided with a gong operated to ring by local battery, so that the opening of one arouses the neighborhood. Then, by turning a small handle inside the door or by pulling a chain or knob, clocklike mechanism is set in motion, which causes a notched dial to revolve, thereby making and breaking the circuit periodically. Thus,

the different signals are registered at the central office and automatically sent through to the various fire houses.

Ques. How are the signals automatically sent?

Ans. They are sent by a set of repeating relays to make sure of successful transmission.

Ques. How are the fire boxes connected?

Ans. In series.

They are generally placed on a closed circuit which is opened by the breaking of the contact.

Fig. 3,099 shows a simple fire alarm circuit, with boxes on a closed circuit connected in series. The breaking of the spring contacts at the boxes sends in the alarm by ringing the bell.

The Gamewell fire alarm telegraph system is used in New York City and has been successfully developed for municipal use. The system includes central office switchboards and other necessary apparatus.

Ques. What form of current supply is used for fire telegraph system?

Ans. The main system is operated by storage batteries.

Duplicate sets of cell are provided for each circuit in order that one set may be charged while the other is connected for use and discharged. Any call or break of the circuit is detected.

Ques. How are grounds located?

Ans. By an automatic ground detector.

CHAPTER LXX

WIRELESS TELEGRAPHY

The term wireless telegraphy may be defined as *any system of telegraphy which successfully substitutes some medium other than wire for the connecting conductors.*

Many have confounded wireless telegraphy with the system invented by Marconi, but the latter is only one form out of many, the term was used to describe other systems years before Marconi's spectacular success added it to the popular vocabulary.

History of Wireless Telegraphy.—A brief history of the method of electric signaling without the aid of conducting wires will serve to facilitate a thorough understanding of the art.

The systems of wireless telegraphy which have so far been proposed may be classified as:

1. Conduction;
2. Induction;
3. Radiation.

The first was an attempt to substitute the earth and bodies of water in place of the connecting lines, then came the induction systems, taking advantage of those peculiar electrical phenomena known as electrostatic and electrodynamic induction.

In this case the substituted medium was the ether, that invisible substance which is supposed to fill all space. Last came the radiation systems, which also make use of the ether, but in a different way, viz.: by distributing it in such a manner as to produce far reaching waves which can be detected at distant points.

The possibility of *wireless telegraphy* appears to have been first recognized in 1795 by the Spanish physicist Salva, who thought that if the

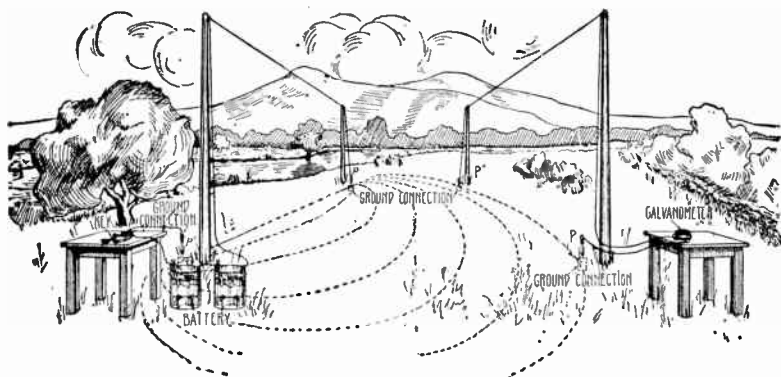

FIG. 3,100.—Conductivity method. *Earth the medium.* Steinheil of Bavaria discovered that the earth could be utilized in place of the usual return conductor of a wire telegraph line as here shown. By placing earth plates p p' and P , P' connected together and having a galvanometer in circuit parallel with the first, which included a battery and a key, Steinheil found that there was enough leakage of current from one to the other to deflect the needles of the galvanometer. The dotted lines represent current in the earth.

earth at the Island of Majorca in the Mediterranean Sea was charged with positive electricity, while that at Alicanti, Spain, was negatively electrified, the attraction of the opposite charges would establish communication, through the water, between the two places, situated about 180 miles apart. The first actual experiment, however, which demonstrated that an electrical connection could be established between two distant points with water as the only connecting medium between the transmitter and the receiver was performed in 1811, by Sommerring, of Munich, who employed the dispersion or leakage method.

The next step in the direction of wireless telegraphy was taken in 1838, by Steinheil, when he accidentally discovered that by grounding the terminals of a single telegraph wire, the earth could be used as a

conductor for the return current. Up to this time the Morse telegraph system had employed a wire for this purpose, thereby operating with a complete metallic circuit, which was essentially a modification of the dispersion method, and to Morse belongs the credit of the first practical achievement in wireless telegraphy, for it is well known that at one time, by the application of the dispersion method, he succeeded in establishing electrical communication between Castle Garden, New York City, and Governors Island situated in the harbor, at a distance of about one mile.

About the year 1866, Dolbear of Tufts College, Massachusetts, produced his electrostatic method of wireless telegraphy, by means of which he succeeded in transmitting and receiving signals between stations located half a mile apart.

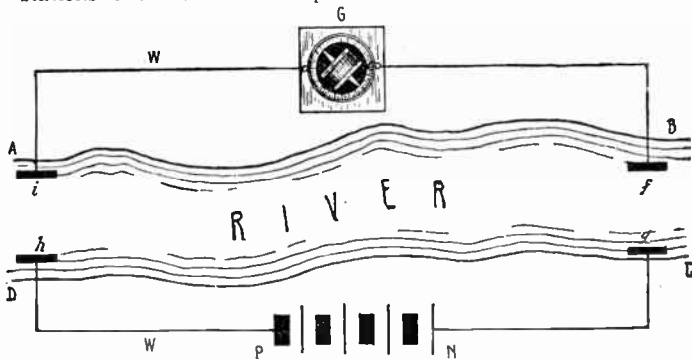

FIG. 3,101.—Morse's Experiment. *Water the medium.* In 1844 Morse addressed a letter to Congress which reads in part as follows: "In the autumn of 1842, at the request of the American Institute, I undertook to give to the public in New York a demonstration of the practicability of my telegraph, by connecting Governor's Island with Castle Garden, a distance of a mile; and for this purpose I laid my wires properly insulated beneath the water. I had scarcely begun to operate, and had received but two or three characters, when my intentions were frustrated by the accidental destruction of a part of my conductors by a vessel which drew them up on her anchor and cut them off. In the moments of mortification I immediately devised a plan for avoiding such accidents in the future, by so arranging my wires along the banks of the river as to cause the water itself to conduct the electricity across. The experiment, however, was deferred until I arrived in Washington; and on Dec. 16, 1842, I tested my arrangement across the canal, and with success. The simple fact was then ascertained that electricity could be made to cross a river without other conductors than the water itself; but it was not until the last autumn that I had the leisure to make a series of experiments to ascertain the law of its passage. The diagram will serve to explain the experiment. A, B, C, D, are the banks of the river; N P is the battery; G is the galvanometer; W W are the wires along the banks, connected with copper plates *f, g, h, i*, which are placed in the water. When this arrangement is complete, the electricity, generated by the battery, passes from the positive pole P to the plate *h*, across the river through the water to plate *i*, and thence around the coil of the galvanometer to plate *f*, across the river again to plate *g*, and thence to the other pole of the battery N." Morse's experiments show that electricity crosses the river and in quantity proportional to the size of the plates in the water. The distance of the plates on the same side of the river from each other affects the result; the distance he states should be three times greater than that from shore to shore across the shear.

About 1891, Phelps and Edison took out patents on what they called *induction telegraph* systems, based on the principle that a rising and falling electric current in one wire tends to induce a similar current in a neighboring parallel wire. This system was employed for a short time on several railroads, but was finally abandoned for lack of patronage. In the meantime some notable experiments were being made by European inventors.

Preece in England, with a wire several miles long stretched on poles planted along the coast of the mainland, and a parallel wire strung on

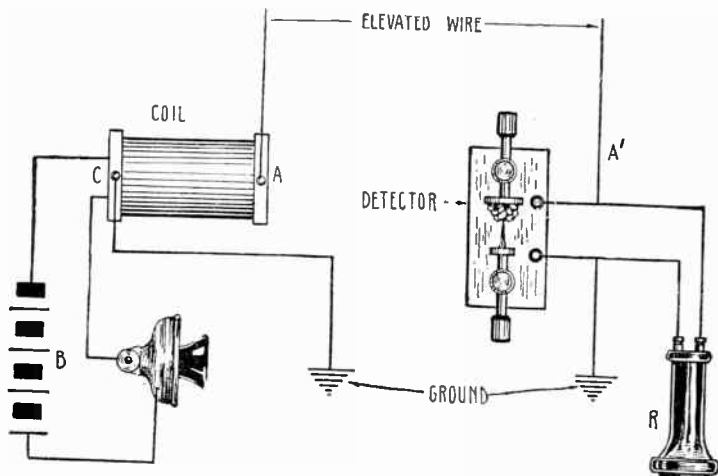

FIG. 3,102.—Diagram of Dolbear's induction system (1882). The left side represents the transmitting circuit and the right, the receiving circuit. B is a battery connected through a carbon transmitter to the primary winding of an induction coil, the secondary terminals, A and C, of which are connected, respectively, with an elevated wire and the ground. The receiving end consists essentially of a similar elevated wire A' connected to one terminal of a telephone receiver, the companion terminal of which is connected directly with the earth. The higher these wires are raised, the farther signals can be transmitted, so that Dolbear was prompted to attach them to kites. This is a curious anticipation of Marconi's antennæ. Dolbear later made many modifications in his apparatus in an endeavor to reach greater distances by employing condensers raised to a considerable height and charged by batteries; but the system remained in all important respects the same as shown. In operation, the diaphragm of the telephone transmitter is caused to vibrate by talking or whistling, thereby producing variations of resistance in the powdered carbon; this constantly varies the amount of current which flows into the induction coil; and consequently the wire A is charged to pressures which are constantly fluctuating in value, the degree of fluctuation depending on the degree of variation of resistance in the transmitter. The wire A' at the receiving station follows by electrostatic induction all the fluctuations of A; and with every change of pressure, currents flow between A' and the ground through the telephone receiver R. The latter consequently repeats all the vibrations set up in the transmitter, and the corresponding sound is reproduced. This particular method of operation is telephonic; but it will be seen that the same, or rather better, results could be obtained by a Morse key and telephone receiver.

poles on the shores of a neighboring island, succeeded in transmitting intelligible signals between points four miles apart. The terminals of the parallel wires were grounded, and electromagnetic pulsations were passed through one wire by means of a battery and an induction coil operated by a Morse telegraph key, and the vibrations induced in the parallel wire were noted by means of a telephone receiver.

Similar induction systems were used by several other experimenters, but in none of them did the electromagnetic pulsations exceed 300 per second, so that in spite of the scientific conclusions deduced by Trowbridge, the possibilities of trans-Atlantic wireless telegraphy appeared to be entirely beyond the capabilities of signaling by true induction.

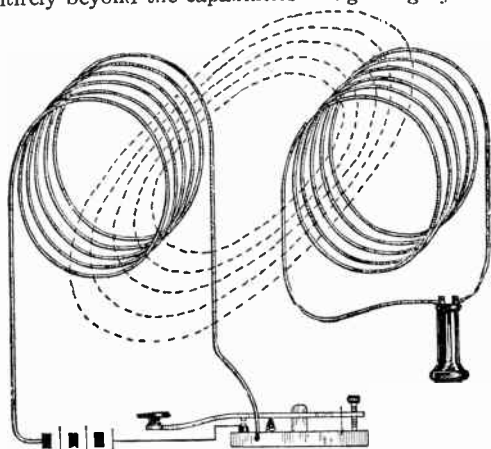

FIG. 3,103.—Inductivity method. By placing two coils of many turns with their axes parallel to each other and connecting in series with one a battery and key, and joining the end of the other to a telephone receiver, the make and break of the key causes the electric energy to be transformed into curved magnetic lines which link the two coils as shown, inducing in the second coil a pressure proportional to the rate of linkage. Trowbridge who experimented along these lines, believed the coils could be made to operate satisfactorily between vessels at least a mile apart.

In the year 1896, however, Marconi brought out a new system in which he made practical application of certain well known principles which were first stated in 1845, by Faraday in his theory of the *Electromagnetic origin of light*. This theory was mathematically proved as correct in 1864, by Maxwell, but its physical demonstration did not occur until 1888, when Hertz, by a series of brilliant experiments not only proved that electric waves conformed exactly to the same laws as light waves, but also showed how they could be produced by purely physical means, and furthermore, how to detect their presence when thus produced.

Sometime between 1883 and 1885, while delivering a lecture at the University of Keil, Germany, which involved an experiment with a Leyden jar and two flat coils of wire, Hertz observed that when the jar was discharged through one of the coils it would induce an electric current in the other, provided there was a spark gap in the first or inducing coil. This accidental discovery led to subsequent experiments, in the performance of which he perfected the *oscillator and detector apparatus* shown in fig. 3,104.

In operation, when the interrupter was vibrated, thus making and breaking the battery circuit, the electric pulsations produced in the primary of the coil magnetically induced alternating pulsations of

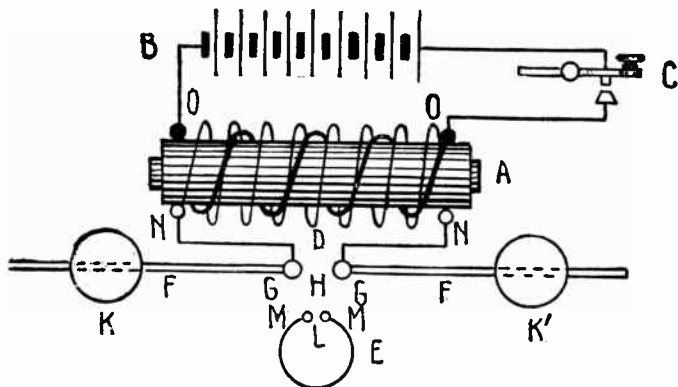

FIG. 3,104.—Hertz' standard oscillator and resonator or detector. It consisted of a powerful induction coil A, a battery B, an interrupter or telegraph key C, an oscillator D, and a resonator or detector E. The oscillator consisted of a pair of brass rod F, F, terminating in two highly polished brass knobs G, G, the brass rods being so arranged that the spark gap or distance H between the brass knobs could be varied at will. The brass rods were also provided with a pair of sliding metal spheres, K, K', by altering the position of which, the oscillator could be put in *tune* with the detector. The detector consisted of a piece of copper wire bent into a small circle, broken at one point L, with the broken ends terminating in a pair of small polished brass ball M, M, so as to make a very small spark gap. The terminals N, N, of the secondary winding of the induction coil were connected to the balls G, G; and the terminals O, O, of the primary winding of the coil were connected to the battery B, and to the interrupter C.

greater pressure in the secondary, until the electric pressure was raised to a point sufficiently great to break down the resistance of the spark gap H, and produce oscillatory electric discharges, back and forth, between the terminal balls G, G, of the oscillator circuit. In a darkened room, with the detector circlet of copper wire placed on an insulated stand, Hertz explored the space around the oscillator, and observed electric sparks oscillating between the terminal balls M, M, of the detector whenever the oscillatory discharges occurred between the

terminals G, G, thus physically demonstrating the existence of electric waves in the ether as predicted by Maxwell.

This was the real beginning of practical wireless telegraphy, and its further development merely required the production of a more sensitive detector for the receiving circuit.

The significance of this necessity will be better understood when it is known that while the rate of vibration of the interrupter of an induction coil may range from 50 to several hundred per second, the oscillations of the electric oscillator may be hundreds of millions per second.

As determined by Hertz, the electric waves experimentally discovered by him, and which are now commonly known as Hertzian waves so as to distinguish them from light and heat waves, vibrate at the rate of about 230,000,000 vibrations per second, and have a velocity equal to those of light or about 186,600 miles per second.

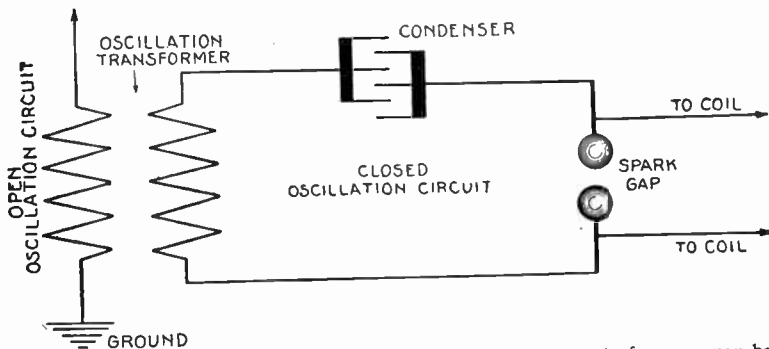

FIG. 3,105.—Tuned oscillation circuits. In order that a larger amount of energy may be delivered to the radiating aerial and to better sustain the oscillations set up in it, commercial installations have an open and a closed oscillation circuit coupled together, as here shown. The spark gap is placed in the closed circuit, as is an *adjustable condenser* formed of a Leyden jar battery and a *variable inductance coil*. Before the disruptive discharge takes place, the secondary of the inductance coil charges the battery of Leyden jars until the pressure is sufficient to produce a disruptive discharge. When the spark passes the oscillating current surges through the closed circuit. The large capacity of the Leyden jar battery permits a much larger quantity of energy to be utilized; the aerial and earth wires being connected to the closed circuit through the inductance coil as shown, the oscillations are impressed upon it when it radiates them into space as electric waves. The open circuit must be in tune with the closed circuit, so that the period of oscillation of each may be identical.

Two other accidental discoveries led to the invention of the required sensitive detector. About 1886, Onesti observed that loosely scattered metal filings showed a tendency to cohere when a previously electrified wire or coil was impulsively discharged. Further experiments showed, that while metal filings loosely thrown together in a little glass tube offered a high resistance to the passage of an electric current *through*

the tube, the passage of the current *around* the tube would cause the filings to cohere, arranging themselves in symmetrical lines transversely to the direction of current flow, with a greatly diminished resistance.

In 1890, Branley discovered that metal filings placed in a glass tube were affected in a similar manner by Hertzian waves, and produced the Branley tube coherer, which in 1891, Lodge demonstrated could be used as a marvelously sensitive detector for wireless telegraphy.

There are several types of coherer, but the general construction and principle of operation of the filings tube device is shown in fig. 3,106.

Codes.—There were formerly two codes used by commercial companies: the Morse code and the Continental code. The

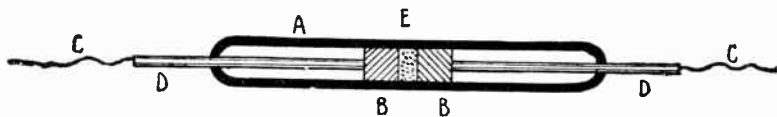

FIG. 3,106.—Branley's filing tube *coherer* or *detector*. A is a sealed glass tube about $1\frac{1}{2}$ inches long, and having a bore about $\frac{1}{16}$ inch diameter. B, B, are metallic plugs, often made of silver, which are connected to the external wires C, C, by sealed-in platinum connections D, D. The plugs B, B, are held separated so as to leave a small gap E, about $\frac{1}{16}$ inch wide, containing metallic powder or dust, which lies loosely in the gap. In operation, the exact character of the action of the device under the influence of an electric impulse is not clearly understood, but it is assumed that its action depends upon the positions taken by the grains of metallic dust under varying degrees of electric pressure. At any rate, the gap with its contents offers a very high resistance to the passage of a feeble voltaic current such as that flowing from a single voltaic cell, but if a higher pressure be applied even for a very small interval of time, it will break down the resistance of the gap and allow the voltaic current to pass continuously through the tube. The current flowing in the closed circuit thus established is naturally very feeble, in fact too feeble for making signals of any kind directly, but if the coherer be connected in circuit with a battery and a sufficiently sensitive relay, this feeble current will operate the relay to close the more powerful electric circuit which can be utilized for producing either an audible signal, as when a telephone receiver or a telegraphic sounder is used, or to a visual signal, as when ink marks are made on a paper tape by means of an ink printing register. It is evident that after bridging the gap, the current in the coherer or local circuit would continue indefinitely, thus preventing the device responding to any more electric impulses at the sending station, unless some suitable means were provided for *decohering*, or restoring the coherer to its original insulating state. This is usually accomplished by means of a vibrator or trembler, such as is used in electric bells, which is operated by the current in the relay circuit and caused to tap lightly against the coherer tube, thus shaking apart the metallic grains in the gap and breaking up the conducting bridge formed by them between the plugs B, B, under the influence of the previously applied or received electric impulse.

former is seldom used today and the latter has been made universal and called by the radio convention the International Morse. It is sometimes called the Continental Morse. This

DEPARTMENT OF COMMERCE
BUREAU OF NAVIGATION
RADIO SERVICE

INTERNATIONAL MORSE CODE AND CONVENTIONAL SIGNALS

TO BE USED FOR ALL GENERAL PUBLIC SERVICE RADIO COMMUNICATION

1. A dash is equal to three dots. 3. The space between two letters is equal to three dots.
2. The space between parts of the same letter is equal to one dot. 4. The space between two words is equal to five dots.

A	• —	Period • • • • •
B	• • • •	Semicolon — — — — —
C	• • • • •	Comma • • • — — — —
D	• • • •	Colon — — — — • • •
E	•	Interrogation • • — — — • •
F	• • • •	Exclamation point — — — • • — — —
G	• • • • •	Apostrophe • — — — — — • •
H	• • • • •	Hyphen — — • • • • • — —
I	• •	Bar indicating fraction — — • • • — —
J	• — — — —	Parenthesis — — • • — — — • •
K	• • • •	Inverted commas • • • • • — — • •
L	• • • • •	Underline • • — — — — — • •
M	— — — —	Double dash — — • • • — —
N	• •	Distress Call • • • • • — — — • • • • •
O	— — — —	Attention call to precede every transmission — — — — — • • • • •
P	• • • • •	General inquiry call — — • • • — — — — — • •
Q	• • • • •	From (de) — — • • •
R	• • • •	Invitation to transmit (go ahead) — — — — —
S	• • • •	Warning—high power — — • • • — — — — — • •
T	— — —	Question (please repeat after)—interrupting long messages • • • — — — — — • • • • •
U	• • • •	Wait • — — • • •
V	• • • • •	Break (Bk.) (double dash) — — • • • — —
W	• — — — —	Understand • • • — — •
X	• • • • •	Error • • • • • — — • • • • •
Y	• • • • •	Received (O. R.) • — — •
Z	— — — • • •	Position report ^a (to precede all position messages) — — • • • — — • • •
Å (German)	• • • • •	End of each message (cross) • • • • •
Å or Å (Spanish-Scandinavia)	• • • • •	Transmission finished (end of work) (conclusion of correspondence) • • • • • — — • • •
CH (German-Spanish)	— — — — —		
É (French)	• • • • •		
Ñ (Spanish)	— — — — —		
Ö (German)	• • • • •		
Û (German)	• • • • •		
1	• • • — — — —		
2	• • • • — — —		
3	• • • • • — —		
4	• • • • • •		
5	• • • • • •		
6	• • • • • •		
7	• • • • • •		
8	• • • • • •		
9	• • • • • •		
0	• • • • • •		

INTERNATIONAL RADIOTELEGRAPHIC CONVENTION

LIST OF ABBREVIATIONS TO BE USED IN RADIO COMMUNICATION

ABBREVIATION	QUESTION	ANSWER OR NOTICE
PRB	Do you wish to communicate by means of the International Signal Code?	I wish to communicate by means of the International Signal Code.
QRA	What ship or coast station is that?	This is.....
QRB	What is your distance?	My distance is.....
QRC	What is your true bearing?	My true bearing is.....degrees.
QRD	Where are you bound for?	I am bound for.....
QRF	Where are you bound from?	I am bound from.....
QRG	What line do you belong to?	I belong to the.....Line.
QRH	What is your wave length in meters?	My wave length is.....meters.
QRJ	How many words have you to send?	I have.....words to send.
QRK	How do you receive me?	I am receiving well.
QRL	Are you receiving badly? Shall I send 20?	I am receiving badly. Please send 20. * * * * * for adjustment?
QRM	Are you being interfered with?	I am being Interfered with.
QRN	Are the atmospheres strong?	Atmospheres are very strong.
QRO	Shall I increase power?	Increase power.
QRP	Shall I decrease power?	Decrease power.
QRQ	Shall I send faster?	Send faster.
QRS	Shall I send slower?	Send slower.
QRT	Shall I stop sending?	Stop sending.
QRU	Have you anything for me?	I have nothing for you.
QRV	Are you ready?	I am ready. All right now.
QRW	Are you busy?	I am busy (or: I am busy with). Please do not interfere.
QRX	Shall I stand by?	Stand by. I will call you when required.
QRY	When will be my turn?	Your turn will be No.
QRZ	Are my signals weak?	Your signals are weak.
QSA	Are my signals strong?	Your signals are strong.
QSB	Is my tone bad?	The tone is bad.
QSC	Is my spark bad?	The spark is bad.
QSD	Is my spacing bad?	Your spacing is bad.
QSF	What is your time?	My time is.....
QSG	Is transmission to be in alternate order or in series?	Transmission will be in alternate order.
QSH	Transmission will be in series of 5 messages.
QSN	Transmission will be in series of 10 messages.
QSQ	What rate shall I collect for.....?	Collect.....
QSK	Is the last radiogram canceled?	The last radiogram is canceled.
QSL	Did you get my receipt?	Please acknowledge.
QSM	What is your true course?	My true course is.....degrees.
QSN	Are you in communication with land?	I am not in communication with land.
QSO	Are you in communication with any ship or station (or: with.....)?	I am in communication with.....(through.....).
QSP	Shall I inform.....that you are calling him?	Inform.....that I am calling him.
QSQ	Is.....calling me?	You are being called by.....
QSR	Will you forward the radiogram?	I will forward the radiogram.
QST	Have you received the general call?	General call to all stations.
QSU	Please call me when you have finished (or: at.....o'clock)?	Will call when I have finished.
*QSV	Is public correspondence being handled?	Public correspondence is being handled. Please do not interfere.
QSW	Shall I increase my spark frequency?	Increase your spark frequency.
QSX	Shall I decrease my spark frequency?	Decrease your spark frequency.
QSY	Shall I send on a wave length of.....meters?	Let us change to the wave length of.....meters.
QSZ	Send each word twice. I have difficulty in receiving you.
QTA	Repeat the last radiogram.

*Public correspondence is any radio work, official or private, handled on commercial wave lengths. When an abbreviation is followed by a mark of interrogation, it refers to the question indicated for that abbreviation.

International Morse code differs from the American Morse; the Naval code was used officially by the U. S. Navy till Nov. 16, 1912.

Ques. What are the rules in regard to these codes?

Ans. Whatever be the speed at which signals are sent, the following rules must be remembered and strictly adhered to: A dash is equal in length to three dots. A space between two elements in a letter is equal in length to one dot. The space between letters in a word is equal in length to a dash. The space between words in a sentence is equal in length to five dots.

The Morse telegraph code has always been used most in the United States and it is undoubtedly more adapted to the relay and sounder than is the Phillips or Continental code. For wireless operation, however, the latter code, which is now known by radio operators as the International Morse, is best suited. This was originally adopted by English Marconi operators because in Europe the Continental code has always been used on land and hence their familiarity with it.

In the early days of commercial wireless operation, the trans-Atlantic boats carried Continental operators and the United States coast steamers carried Morse operators. It was impossible then to get Continental operators in America because, although there is a difference of only eleven letters between the two codes, the United States operators were not familiar with the International code. Accordingly, until the time of the steamer Titanic disaster, wireless operation was generally very slow and very poor, due to the fact that both codes were used, which was always confusing.

Since the adoption of the International Morse as the standard wireless code, however, radio operators have become experts and it is not unusual now for them to send thirty or forty words a minute.

Mastering a telegraph code is like learning a foreign language; it is not to be grasped within a week or even a month. To become a good operator one needs about three hours daily practice for at least a year.

There are various devices on the market to assist one in becoming a telegraph operator, all of which have been designed with the object of giving the student the benefit of constant practice.

The Omnigraph is considered the standard of these and is used to test operators for government licenses. This has a notched dial made to revolve by hand or motor power; the notches spell words in dots and dashes. The dials come in sets and are transferable; a full set will give the student excellent practice in receiving.

SECRET WIRELESS TELEGRAPH CODE

A	B	C	D	E	F	G	H	I	J	K	L	M	N	O	P	Q	R	S	T	U	V	W	X	Y	Z
B	C	D	E	F	G	H	I	J	K	L	M	N	O	P	Q	R	S	T	U	V	W	X	Y	Z	A
C	D	E	F	G	H	I	J	K	L	M	N	O	P	Q	R	S	T	U	V	W	X	Y	Z	A	B
D	E	F	G	H	I	J	K	L	M	N	O	P	Q	R	S	T	U	V	W	X	Y	Z	A	B	C
E	F	G	H	I	J	K	L	M	N	O	P	Q	R	S	T	U	V	W	X	Y	Z	A	B	C	D
F	G	H	I	J	K	L	M	N	O	P	Q	R	S	T	U	V	W	X	Y	Z	A	B	C	D	E
G	H	I	J	K	L	M	N	O	P	Q	R	S	T	U	V	W	X	Y	Z	A	B	C	D	E	F
H	I	J	K	L	M	N	O	P	Q	R	S	T	U	V	W	X	Y	Z	A	B	C	D	E	F	G
I	J	K	L	M	N	O	P	Q	R	S	T	U	V	W	X	Y	Z	A	B	C	D	E	F	G	H
J	K	L	M	N	O	P	Q	R	S	T	U	V	W	X	Y	Z	A	B	C	D	E	F	G	H	I
K	L	M	N	O	P	Q	R	S	T	U	V	W	X	Y	Z	A	B	C	D	E	F	G	H	I	J
L	M	N	O	P	Q	R	S	T	U	V	W	X	Y	Z	A	B	C	D	E	F	G	H	I	J	K
M	N	O	P	Q	R	S	T	U	V	W	X	Y	Z	A	B	C	D	E	F	G	H	I	J	K	L
N	O	P	Q	R	S	T	U	V	W	X	Y	Z	A	B	C	D	E	F	G	H	I	J	K	L	M
O	P	Q	R	S	T	U	V	W	X	Y	Z	A	B	C	D	E	F	G	H	I	J	K	L	M	N
P	Q	R	S	T	U	V	W	X	Y	Z	A	B	C	D	E	F	G	H	I	J	K	L	M	N	O
Q	R	S	T	U	V	W	X	Y	Z	A	B	C	D	E	F	G	H	I	J	K	L	M	N	O	P
R	S	T	U	V	W	X	Y	Z	A	B	C	D	E	F	G	H	I	J	K	L	M	N	O	P	Q
S	T	U	V	W	X	Y	Z	A	B	C	D	E	F	G	H	I	J	K	L	M	N	O	P	Q	R
T	U	V	W	X	Y	Z	A	B	C	D	E	F	G	H	I	J	K	L	M	N	O	P	Q	R	S
U	V	W	X	Y	Z	A	B	C	D	E	F	G	H	I	J	K	L	M	N	O	P	Q	R	S	T
V	W	X	Y	Z	A	B	C	D	E	F	G	H	I	J	K	L	M	N	O	P	Q	R	S	T	U
W	X	Y	Z	A	B	C	D	E	F	G	H	I	J	K	L	M	N	O	P	Q	R	S	T	U	V
X	Y	Z	A	B	C	D	E	F	G	H	I	J	K	L	M	N	O	P	Q	R	S	T	U	V	W
Y	Z	A	B	C	D	E	F	G	H	I	J	K	L	M	N	O	P	Q	R	S	T	U	V	W	X
Z	A	B	C	D	E	F	G	H	I	J	K	L	M	N	O	P	Q	R	S	T	U	V	W	X	Y

Each station has a short word code call which is only known to the operators interested. Assuming that one station call is w-i-r-e and another r-o-p-e, and w-i-r-e station wants to send a secret message to r-o-p-e it is outlined thus:

W i l l s e n d b a t t l e s h i p t o d a y
 R O P E R O P E R O P E R O P E R O P E R O P
 N W A P J S C H S O I X C S H L Z D I S U O N

The letters that are really sent are on the bottom line and are obtained from the place where W and R meet at N, where I and O meet at W, etc. These letters can be sent in any code without interception providing the station code word is known only to the operators. The receiving station writes down the letters received, N W A P J S C H S O I X C S H L Z D I S U O N, and writes above these its own code call R-O-P-E over and over again and then with the chart finds that R through to N gives W, O through to W gives I, P through to A gives L and E through to P gives L also, which is the translation of the first word of the message. The government assigned station calls are first used in calling the desired station and its word code kept secret.

Another automatic outfit runs prepared tape containing perforated messages between revolving wheels where wire brushes make the electrical contact.

The simplest device of this kind consists of a metal sheet coated on one side with insulating enamel except where the code is engraved. In other words, the enamel surrounds the dots and dashes, these being formed of the metal plate itself, which plate connects with the sounder

Form of blank used in Wireless Telegraphy

Called Station	Paid D. H.	Radio	Nr.	Wds.	Sent From	Sta.	Date

or buzzer to be operated. An ordinary steel pen is connected to a flexible wire cord. Where the pen is rubbed over five dots the sounder responds with the letter P and then by running the pen over the enamel wherein is left a space of one dot, the letter I is sounded, then over dash, dot, and the letter N is heard.

Any such device will help the beginner to become a good operator if at the same time transmitting is practiced with a telegraph key. It is generally considered easier to transmit messages, however, than to receive, and therefore it is necessary to get as much practice in receiving as possible.

Elementary Theory of Wireless Telegraphy.—It is well known that a pebble thrown into a pond causes ripples or waves on the surface of the water, which move away from the point of disturbance in concentric circles of ever increasing diameters. These waves represent the combined effect of two

motions of the medium through which they are propagated. a vertical and a horizontal motion, both of which decrease in strength with the increase in the distance from the center of disturbance. Disregarding for the present the exact nature of these oscillations, it is evident that suitable apparatus can be devised to be operated by either of the motions, and thereby indicate the occurrence of the original disturbance. Furthermore, it is evident, that the greater the distance between the center of disturbance and the indicating apparatus, the greater must be the energy of disturbance, or the sensitiveness of the indicating apparatus.

Likewise, the vibrations of a struck bell or a tuning fork are propagated through space by the air and set up corresponding vibrations in other suitable elastic bodies such as strung wires, tuning forks, glass lamps, globes, etc.

Sound waves represent the advance of a disturbance into a medium and are due to the elasticity of the medium.

Heat waves, light waves, and waves due to electric oscillations such as those employed in wireless telegraphy belong to the latter class, and differ from sound waves only in the nature of the medium by which they are propagated.

The experiments of others as Van Sulricke show that if a bell be set ringing in a glass jar from which the air has been exhausted, no sound is heard, thus clearly demonstrating that air or some other *ordinary* form of matter is necessary for the propagation of sound waves. On the other hand, the luminous filament of the incandescent electric lamp which transmits its light waves through the high vacuum of its containing globe, demonstrates that air is not only not necessary for the propagation of those waves but is an actual hindrance to their free movement, and leads us to the accepted conclusion that light waves are propagated by that medium called *the ether*.

Therefore, radiant energy in the form of heat, light and electric waves are designated *ether radiations*, and differ from each other only in the lengths of their waves.

Ques. How do the wave lengths of different forms of radiant energy emitted by ordinary matter vary?

Ans. From less than $\frac{1}{167,640}$ of an inch to $\frac{1}{500}$ but longer

waves varying from an appreciable fraction of an inch such as $\frac{1}{14}$ of an inch to many hundreds of feet may be produced by electrical means.

The latter constitute the form of radiant energy, commonly known as *Hertzian waves*, which are utilized in wireless telegraphy

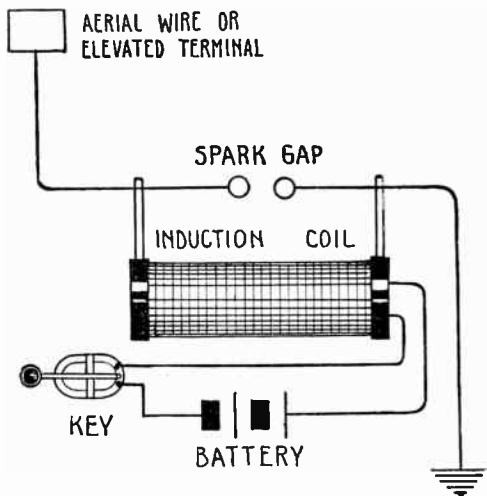

FIG. 3,107.—Electric wave method of wireless telegraphy. The theory upon which this is based assumes, that where one terminal of the oscillator system is grounded and the opposite terminal elevated as shown, the electric waves remain spherical and are propagated in a straight line until they come in contact with the upper stratification of rarefied air, which is a conductor of electricity and therefore an insulator of electro-magnetic waves, when they are reflected back to the surface of the earth.

Ques. What is transmitted by all forms of ether waves?

Ans. Energy.

Ques. How is the presence of these waves detected?

Ans. By means of suitable apparatus. Thus: ether waves shorter than about $\frac{1}{64,714}$ of an inch cannot be detected by the eye, but produce effects on photographic plates. Waves ranging

in length from $\frac{1}{64,714}$ to $\frac{1}{33,866}$ of an inch appear to the eye as light of different colors, the former violet and the latter red; while waves longer than $\frac{1}{33,866}$ of an inch are invisible to the eye, but produce temperature changes indicated by suitable thermometers. Likewise ether waves produced by electrical oscillations, and exceeding $\frac{1}{362}$ of an inch in length, produce no effect on photographic plates, are invisible to the eye, have no effect on thermometers, and can be detected only by means of suitable apparatus such as coherers or other detectors.

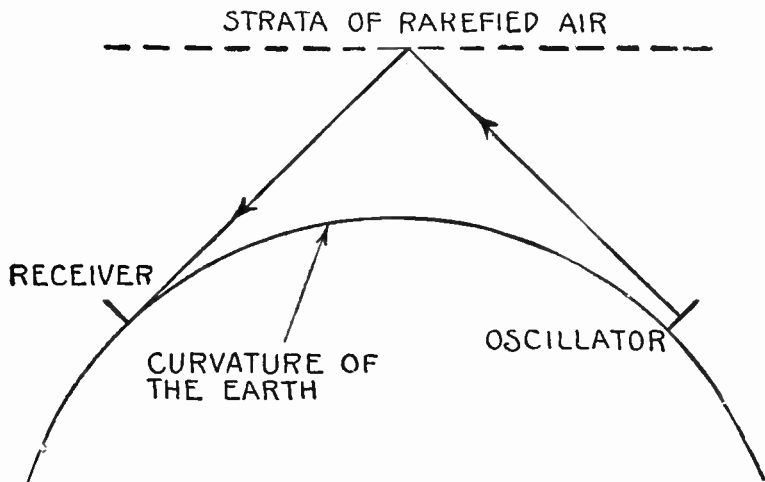

FIG. 3,108.—Electric wave reflected to the surface of the earth by strata of rarefied air.

Ques. What should be noted about the velocity of ether waves?

Ans. The velocity of ether waves of all lengths is the same in a homogeneous medium; the velocity varies with the wave length, so that the velocity is different in different media.

FOR EXAMPLE.—The velocity of light waves in atmospheric air is about 186,600 miles per second, but Foucault's experiments showed that it was much less in water.

Ques. How does the velocity vary with the lengths?

Ans. As a rule the velocity decreases as the wave length decreases, or in other words, the larger waves suffer less attenuation in passing through various forms of ordinary matter, and therefore, are capable of penetrating the medium propagating them to greater distances.

For instance, the violet and blue rays of light are absent in the depths of the ocean, having been entirely filtered out by the *dispersion* property of that medium.

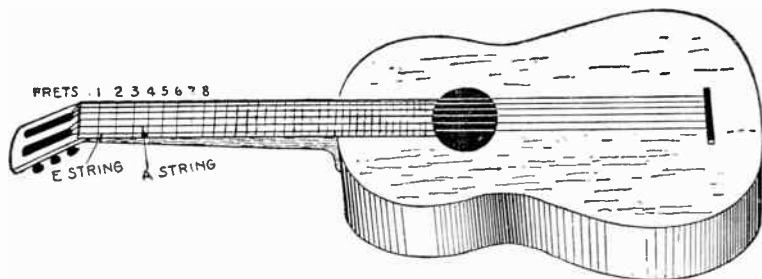

FIG. 3,109.—Experiment with guitar to illustrate the fact that air waves, when set in motion by one string of a certain note will cause to vibrate another string tuned to the same note. In trying this experiment, to avoid troublesome stretching of strings, it will be advisable to keep about a half-tone below "concert pitch." When the A string is brought to such tension as to be in its proper relative tune with the E string, it will sound in unison with the latter, whenever the E is stopped by the finger pressing the E firmly against fret 5.

It has been satisfactorily determined by calculation and experiment that Hertzian waves have a velocity of 186,600 miles per second, or the same as that of light waves, therefore, atmospheric air in its normal condition may be safely assumed to be incapable of propagating light waves or electromagnetic waves, although it may exert an appreciable dispersion effect on both.

Hertzian waves are, however, much longer than light waves and for that reason they are invisible. By holding one's hand near a charged antenna wire these waves are shortened and rendered visible.

Ques. Upon what does the variation of wave length in the different forms of ether radiation depend?

Ans. Upon the frequency.

The shortest waves of the invisible spectrum, which have been detected by means of photographic plates, are $1/167,640$ of an inch in length, and have a frequency of 1,600 billions per second; the frequency of light waves varies from about 800 billions, for ultra violet to about 40 billions for bright red; the longest heat waves, about $1/362$ of an inch in length have a frequency of about 10 billions per second. In other words the lengths of ether waves produced by natural conditions vary inversely with their frequency, that is, the higher the frequency the shorter the length of the wave.

From the data given in the foregoing paragraphs, it is evident that different kinds of ether wave may be distinguished from one another by their wave length or by their frequency, due care being always taken

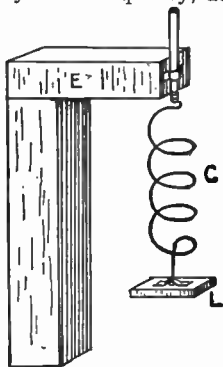

FIG. 3,110.—Mechanical analogy illustrating "tuning." If a stick of timber L be suspended from a rigid support E by a spiral steel spring C, and the timber be given a push upward, or downward, it will vibrate a certain number of times per minute. If it be pushed gently it will move slowly through a small space, if pushed forcibly it will move more quickly through a greater space, but the oscillations in a unit of time will always be the same. This *rate of vibration* is governed by the *resiliency* of the spring C and the weight of the timber L. If the resiliency of the spring be increased, or the weight of the timber be decreased, the rate of vibration will be quickened. If C be made less springy, or L heavier, the rate will be slower. To change the rate, by altering either or both of the conditions has been called by clockmakers "regulating"; scientists of today call it "*tuning*."

however, to remember that the longer waves have the greater penetration or capability of passing through transparent media to great distances; while those having the higher frequencies or more rapid rates of vibration represent more powerful sources of energy.

Ques. What kind of apparatus is necessary for practical wireless telegraphy?

Ans. Apparatus for producing high frequency electro-magnetic ether waves of great length.

Ques. Of what does the apparatus consist?

Ans. It comprises various modifications of the Hertz oscillator shown in fig. 3,104, the devices being suitably proportioned with respect to the inductance and capacity of the oscillating circuit.

By means of such apparatus ether waves ranging from 200 to 1,500 feet in length, with frequencies up to several hundreds of millions cycles per second, are now being used in the practice of wireless telegraphy.

Propagation of Electromagnetic Energy.—There are two theories to explain the mode by which electromagnetic energy

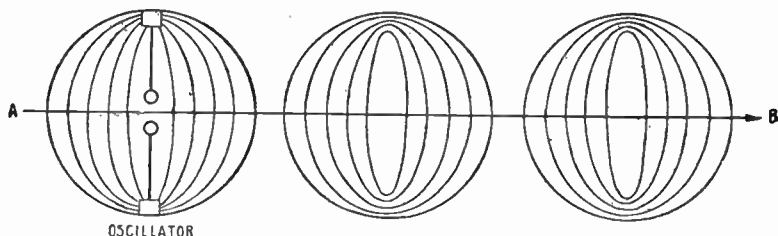

FIGS. 3,111 to 3,113.—Hertzian detached electrical waves said to be emitted from the oscillator and propagated through space along the axis AB at a velocity of 186,600 miles per second.

is propagated through space by means of ether waves:

1. Detached wave theory;
2. Half wave theory.

According to the first, the oscillations of high frequency current cause spherical electric waves in the form of transverse vibrations in the ether which are emitted from the oscillating system as shown in fig. 3,111, each one being detached and propagated through space along the straight line AB, at a velocity of 186,600 miles per second. One terminal of the oscillator system is grounded and the opposite terminal is elevated as shown in fig. 3,107.

Ques. In what direction are electric waves radiated?

Ans. In all directions at right angles to the oscillator.

A resonator or detector placed in the direct visual line to the oscillator, will be disturbed by the waves, and absorbing a portion of the energy carried by them, will respond to any signals that may originate from the oscillator.

Considering the curvature of the earth, as shown in fig. 3,113, the rarefied air will reflect the waves back again to the surface of the earth at the receiving station.

This theory is also known as the *free wave theory*, and accords with Hertz' physical demonstrations of the electromagnetic theory of light,

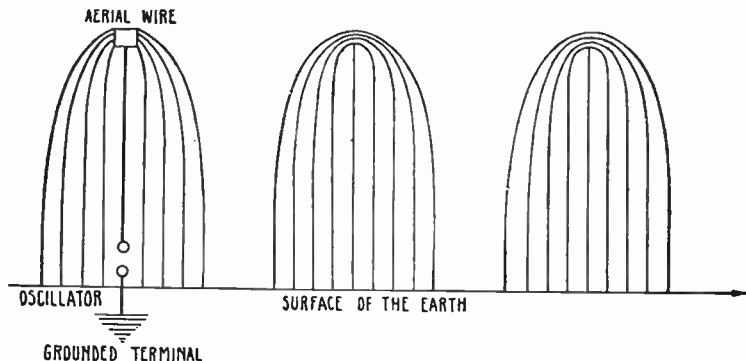

Figs. 3,114 to 3,116.—Fessenden sliding half waves; theory based on the experiment made by Hertz.

in which he shows how long, invisible and free electric waves are propagated in the same manner as exceedingly short, visible free waves of light, the earth being assumed to offer a conducting path for the electric waves.

According to the second, or half wave theory, the earth is assumed to offer a conducting path for the electric waves which are virtually cut in half and skim or slide along the surface of the earth as shown in figs. 3,114 to 3,116.

This theory was evolved by Professor Fessenden and is based on the results of experiments made by Hertz relative to the propagation of electric waves by means of wires, in which he

demonstrated how electric waves may slide over the surface of conducting wires with wave fronts perpendicular to the direction of the wires.

As the spark gap of the oscillator is located very close to the surface of the earth relatively to the height of the radiating wire, it is assumed that the electric waves are emitted only from the upper part of the oscillator system and accounts for their transmission over obstacles, the earth or sea having sufficient conductivity to allow the waves to slide over their surfaces.

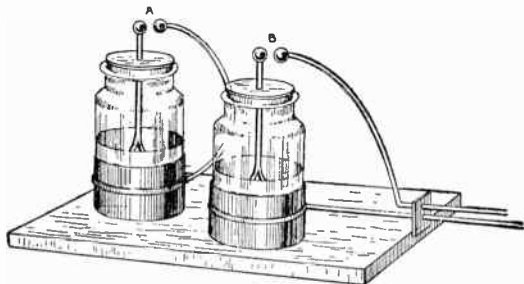
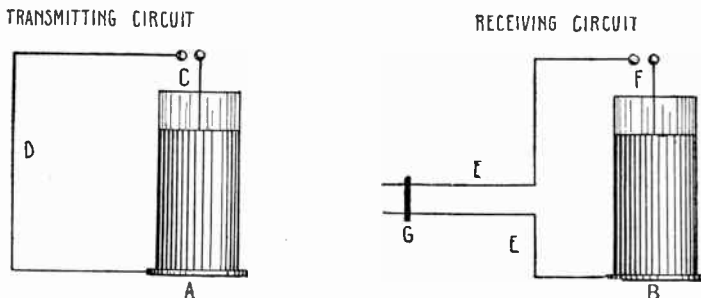

FIG. 3,117.—Experiment in resonance. If two oscillatory circuits consisting in each case of a Leyden jar and an external circuit possessing inductance be taken, it is found that a discharge in one circuit will produce a discharge in the other. Under certain conditions, sparks are found to oscillate across the spark gap B, provided the inductance in B's circuit is properly adjusted. The oscillation constant of the two circuits must be the same. This effect may be produced when the two circuits are some distance apart, and is due to the electro-magnetic waves radiated from the first circuit impinging on the second circuit and setting up corresponding oscillations in it. If the distance between the two circuits be great, the energy in the second one is not sufficient to break down the spark gap and no discernible oscillations are set up in the circuit. The amount of energy in the receiving circuit depends to a great extent on the surface presented to the oncoming waves. An oscillatory circuit consisting of an earthed elevated conductor is a good radiator and presents a great surface on which waves may impinge. Thus an elevated conductor may be used at a wireless station for both transmission and reception purposes. In wireless stations of low power the same conductor or aerial is used for both purposes, but where large power is used, it is found that separate transmitting and receiving aeriels are required. If the frequency of such a conductor be the same as that of a distant similar conductor, oscillations in the latter produce electro-magnetic waves which set up oscillatory currents in the former. These oscillatory currents are so very weak, however, that their detection can only be effected by the insertion in the circuit of very delicate apparatus.

Syntonic Wireless Telegraphy.—As already demonstrated, electric waves are radiated in every direction from the oscillating system, therefore, any receiver in the field of disturbance of force, will respond to the waves emitted by any oscillator or transmitter. In order to enable operation of different sets of transmitting and sending instruments situated in the same

field, to send and receive messages independently, apparatus constructed on the principle of electric resonance have been employed with different wave lengths used between different sets of station.

The phenomena of electric resonance was first illustrated by Sir Oliver Lodge in his well known experiment with his so called syntonic jars as shown in figs. 3,118 and 3,119.



Figs. 3,118 and 3,119.—The phenomena of electric resonance as illustrated by the experiments with Lodge's syntonic Leyden jars. In the figure, A and B represent syntonic Leyden jars in the transmitting and receiving circuits. A is employed for emitting the electric waves and is connected in series to the spark gap C and the loop of wire. It is charged to a high pressure and when discharged through the spark gap C, sets up electric oscillations of high frequency in the transmitting circuit D. This circuit is a closed circuit, hence, the oscillations are very persistent, or in other words, a much longer time is required for their conversion into electric waves than in the case of the Hertz open circuit oscillator, which on the other hand the waves emitted by the closed circuit oscillator are much more feeble than those of the open circuit type, where the oscillations are damped out quickly. The jar B of the receiving circuit is connected with a closed circuit E,E, through the spark gap F. A sliding metal bar G is provided for syntonizing or tuning the receiving and transmitting circuit by varying the induction of the former. When the feeble electric waves emitted by the transmitter impinge upon the receiving circuit, they are gradually absorbed and transformed into electric oscillations and by their effect charge the jar B to its sparking capacity, so that it breaks down the resistance of the gap F, and thus indicates the presence of the waves. If the jar B be not in tune with jar A, that is, if the inductance capacity and resistance of the transmitting and receiving circuit are not identical, the receiving circuit will not respond to the waves emitted by the transmitting circuit.

Practical Systems of Wireless Telegraphy.—For the successful practice of ordinary wireless telegraphy two things are essential:

1. A powerful oscillating system;
2. A sensitive detector.

As originally employed, both the oscillator and the detector were of the open circuit type, the oscillator consisting of a vertical wire, called an *aerial* or an antenna, the upper end of which was supported by a mast, and the lower end connected to the earth through a spark gap.

The capacity and inductance of the oscillator system are distributed along the entire length of the vertical wire in conformity with a law that makes the length of the electric waves approximately equal to four times the height of the antenna.

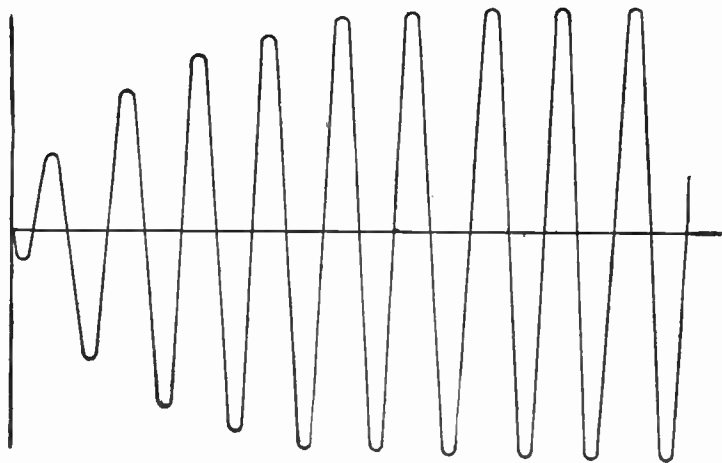

FIG. 3,120.—Oscillation of ring shaped Hertz resonator excited by syntonie oscillation.

EXAMPLE.—With an antenna 150 feet in height the wave length will be 600 feet, and the frequency is equal to the velocity divided by the length as:

$$\frac{186,600 \times 5,280}{600} = 1,642,080 \text{ cycles per second.}$$

High Frequency Oscillations.—High frequency oscillating waves are best adapted for wireless telegraphy and are absolutely essential for wireless telephony. With a generator having

a frequency of 10,000 cycles per second and connected to a quenched spark gap, a high frequency train of waves will be transmitted which will sound like music in a receptive device and can be heard over a greater distance than a low frequency wave because the human ear is more susceptible to high notes.

The Poulsen Wireless Company have developed a non-interference system by transmitting oscillations of so high a frequency that they cannot be heard without a secret "chopper" that reduces them to a frequency perceptible to the human ear. Details of this system have been kept from the public so that there is no interference whatever.

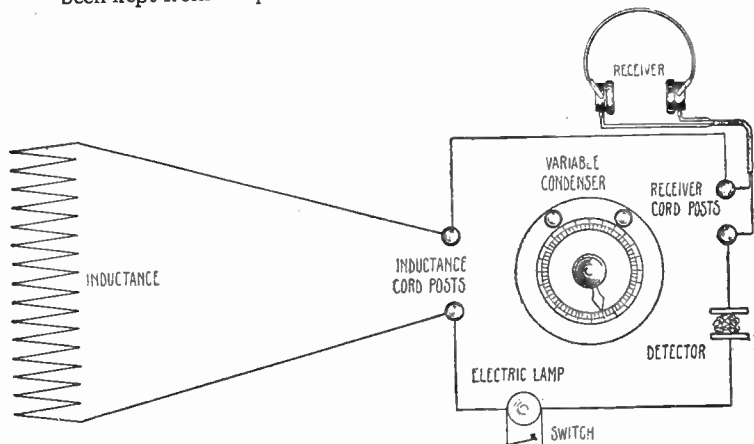

FIG. 3,121.—Marconi wave meter. This includes an electric glow lamp and a detector, but generally the lamp is short circuited by a switch. Beside this glow lamp the wave meter includes a variable condenser, crystal detector, pair of telephone receivers and an inductance. The latter is connected by cord wires so that it can be placed near the transmitting helix. The radio inspector places the receivers on his head and presses the station transmitting key intermittently and then adjusts the condenser to the point where the oscillations sound loudest.

Measuring Wave Lengths with Wave Meters.—A wave meter may consist of either a variable inductance and a fixed condenser, or a fixed inductance and a variable condenser. The latter is generally used, connected in parallel and in connection with a detector and telephones.

Fig. 3,121 shows the circuit of a Marconi wave meter used by radio inspectors for the determination of transmitted wave lengths. By placing this near an oscillatory circuit, energy will be absorbed and maximum current will flow in the wave meter when it is in resonance with the circuit.

A reading is taken at the variable condenser, the fixed inductance being connected by flexible cord wires and hence transferable.

The carborundum crystal is connected in *series* with a pair of telephone receiver.

A small lamp is used which is cut out by a switch.

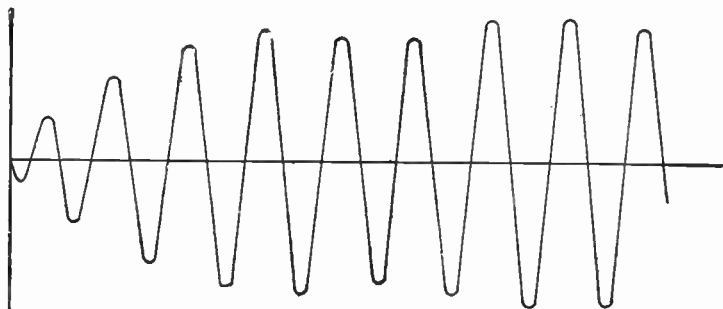

FIG. 3,122.—Oscillation of ring shaped Hertz resonator excited by oscillation not quite syntonie with it.

When the lamp is in circuit and is found to be glowing brightly it indicates the maximum current flow in the wave meter, whereas only the crystal detector indicates the maximum voltage.

Three readings are taken and if the station be not in resonance with a three hundred or a six hundred meter wave length, it is properly tuned.

The three readings to be taken are:

1. Wave length of open circuit;
2. Wave length of closed circuit;
3. Measurement of the radiation.

The third reading is the number of amperes radiated, and is indicated by the reading of a hot wire ammeter or any delicate ammeter connected in series with the aerial.

Formula for Wave Length.—That point where the electric wharp and the magnetic flux meet, or the distance through space traveled during one oscillation cycle is considered the wave length, the formula for same is:

$$W = 3.1416 \times 2 \times 2V \sqrt{L \times C}.$$

in which

W = Wave length in meters;

V = Velocity of light (186,600 miles per second);

L = Inductance in henries;

C = Capacity in farads.

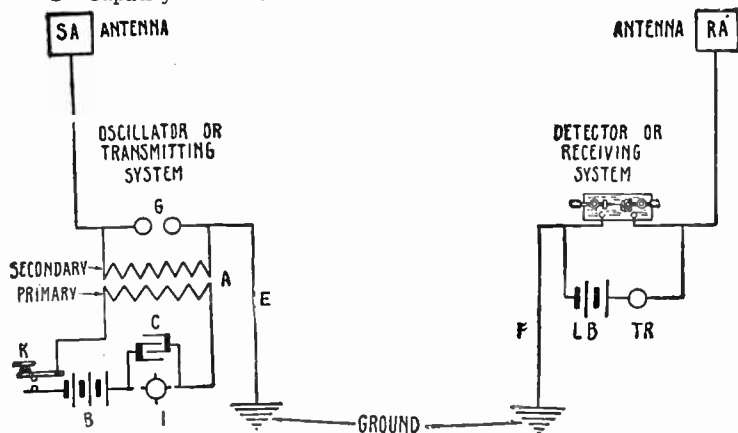

FIG. 3,123.—Diagram showing earliest form of Marconi system. The transmitting apparatus as shown, consists of a powerful induction coil A, the primary winding of which is included in the circuit with the battery B, or other source of electric energy, the interrupter I, the condenser C, shunted around the interrupter, and the Morse transmitting key K. The terminals of the secondary winding are connected with the spark gap G, as shown. One terminal knob of the spark gap leads to the aerial wire or sending antenna SA, and the other side leads to the ground plate. The receiving apparatus consists of the receiving antenna RA, the grounded wire, connected to a detector, usually of the coherer type, the local battery circuit includes the detector, the battery LB, and a telephone receiver TR.

First Marconi System.—Fig. 3,123 shows the apparatus of the first Marconi system; the various devices are described under the figure.

In operation, the low tension direct current supplied by the battery is rendered intermittent by the interrupter I, and every electric impulse

passing through the primary winding of the induction coil sets up an alternating current in its secondary.

Since the secondary consists of many turns of fine wire as compared to the few turns of heavy wire in the primary, the low voltage direct current is transformed into a high pressure current having a frequency equal to the rate at which the primary circuit is made and broken by the interrupter. The high voltage low frequency current thus produced charges the aerial and grounded wires SA, and E, with positive and negative electricity and establishes a difference of pressure of many thousand volts, which at its maximum, breaks down the resistance of the air gap C, causing a spark to pass between the brass terminal knobs of the gap, and almost instantaneously equalizing the difference of

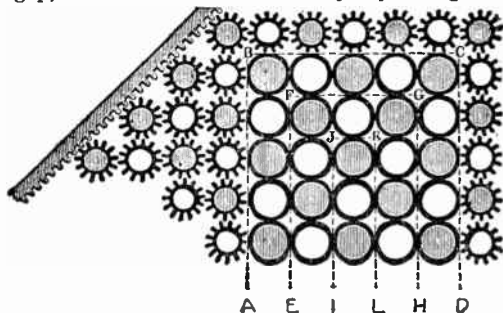

FIG. 3,124.—Diagram illustrating the reflection of electric waves at the surface of a conductor. The rack here shown, representing a charged body, is supposed to be oscillating backwards and forwards and transmitting a disturbance through the wheelwork. If the cogwheels gear perfectly into one another, that is to say, if the medium be a non-conductor, the disturbance will spread without loss until it reaches the outer layer of the conducting region, A, B, C, D, where there will be a certain amount of slip, and a lesser amount of oscillation will penetrate to the next layer, E, F, G, H, and less again to I, J, K, L. If a conductor be sufficiently thick it must therefore be opaque to electric radiation. Now a good conductor dissipates but little energy into heat, and therefore the greater part of the radiation must be reflected and not absorbed. To explain *refraction* consider an advancing wave impinging upon the boundary of a medium of greater density or less elasticity, or both. If the new medium be a non-conductor there will be no slip, and therefore no dissipation of energy at the surface; if not, there will be some slip and consequent dissipation. In either case some will be reflected and some transmitted, and the transmitted portion will begin at the boundary to travel more slowly, and therefore, if the incidence be oblique, will necessarily follow a different path, that is to say, it will be refracted.

pressure by the high frequency currents which oscillate from the top of the aerial wire to the ground plate, through the conducting bridge of heated air across the gap, at the rate of one or two million times per second.

In this process, these electric oscillations transform their energy into electromagnetic waves which are propagated by the ether to the receiving apparatus at a velocity of 186,600 miles per second. When these waves strike the aerial wire RA of the receiving system, they are absorbed by that wire and retransformed into electric oscillations of a frequency exactly the same as those of the transmitting system. These

oscillations are of course, much more feeble than those of the transmitting system, but are sufficiently powerful to break down the resistance of the sensitive detector or coherer D, thus permitting the local current from the battery LB, to pass through the coherer and the telephone receiver or relay TR.

For sending signals the primary circuit of the transmitting system is closed and opened for short or long intervals of time by means of the telegraph key, thus limiting the duration of the oscillations in the oscillator circuit. These variations in the duration of the wave producing oscillations are reproduced by the receiving system in the form of dots and dashes by means of the coherer and a Morse register receptor.

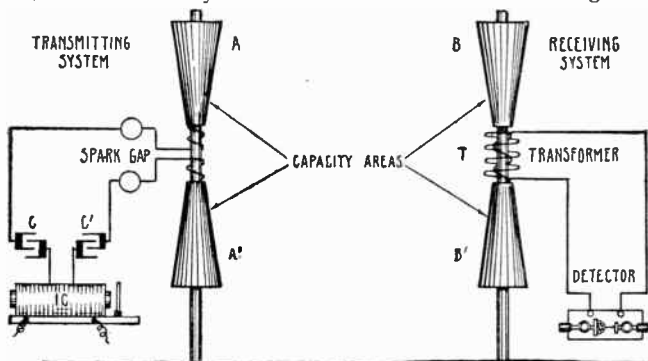

FIG. 3,125.—Lodge-Muirhead syntonic system. A, A' and B, B' are capacity areas made of sheet metal in the form of cones. Those of the transmitting system A and A', are connected to the induction coil IC, through the inductances 1, 2, and the condensers C, C', which are provided for the purpose of increasing the capacity of the length of the electric waves, and for establishing a definite frequency of oscillation. The capacity areas B and B' of the receiving system are exactly similar to those of the transmitting system. They are connected to the primary of the transformer T, the secondary of which is connected to the detector D. The local battery circuit is not shown.

The Lodge-Muirhead Syntonic System.—This system, which is shown in fig. 3,125, embodies the recent improvements which have been added to the original Lodge system of syntonic jars, by both Dr. Lodge and Dr. Muirhead.

The Fessenden Tuned System.—As shown in fig. 3,127 this system embodies many features radically different from the other systems. The illustration shows a Fessenden combined transmitting and receiving apparatus.

The Telefunken or Slaby-Arco Multiplex System.—The operation of this system depends on the principle that when rapid electric oscillations are set up in a vertical wire, having one end free and the other end grounded, the maximum amplitude or pressure of each oscillation will be at the upper or free end of the wire, while the nodal or neutral points will be at the earth, provided the length of the vertical wire be one-fourth of the length of the emitted wave.

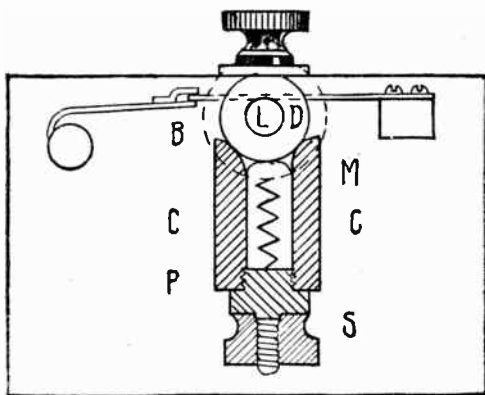

FIG. 3,126.—Lodge Muirhead coherer. It is of the wheel type and consists of a steel disc *D*, rotating on a column of mercury *M*, held in the cup *C*. Electrical connection is made through the binding screw *S* and the platinum wire *P*; the copper brush *B*, bearing on the shaft *L*, connects with the disc *D*, and completes the circuit. The detector is connected directly to a siphon recorder. In this system grounded terminals are not employed, thus avoiding a variable capacity, that of the earth, on the oscillator and the detector, which would otherwise make tuning very difficult.

EXAMPLE.—*ABCDE*, fig. 3,128 represents a complete electric wave. Then its crest or point of maximum amplitude is at *B*, its point of extreme depression at *D*, and its nodal points are at *A*, *C* and *E*. Where the vertical wire is one-fourth the wave length, the ground plate or the point of connection of the vertical wire with the earth must necessarily always be a nodal point such as *A*, *C*, and *E*. Therefore, if a second wire *AG*, equal in length to the vertical wire *AF*, be carried from the nodal point *A*, the wave of which *B* is the crest will be propagated along *AG*, and the crest of the new wave will be formed at *G*. The receiver is placed at such point as *G*, and as it is assumed that the coherer is only affected by the maximum pressures of the emitted waves, it is evident that it will be affected only by waves of predetermined

length, having nodal points at A. All other waves will fail to be propagated along the wire A G, and will be dissipated into the ground. This method protects signals to a certain degree from interception or interference, and furthermore, by employing a number of differently constituted receiving circuit, each capable of responding only to waves of certain lengths, they may be connected to a single receiving antenna, thus giving a system of multiplex wireless telegraphy. Fig. 3,130 shows the general arrangement of the apparatus of the system.

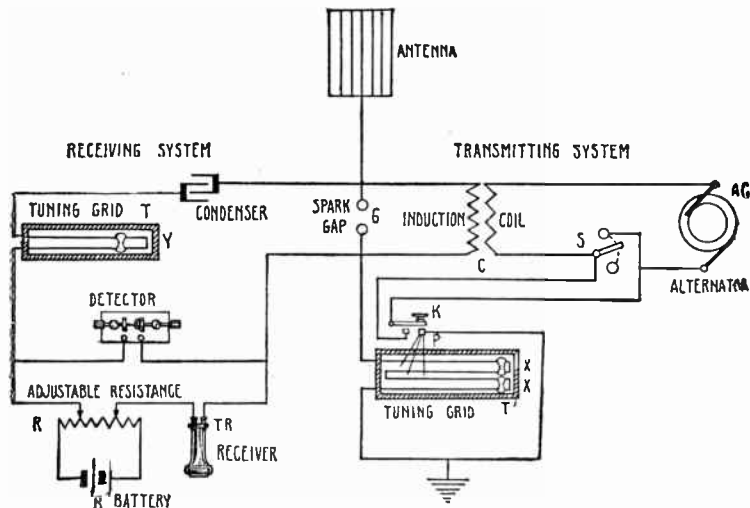

FIG. 3,127.—The Fessenden tuned system. There are many variations of this system. In the case illustrated, the transmitting system comprises the antenna consisting of 15 or 20 vertical wires, the induction coil C, the spark gap G, the key K, for throwing the aerial wire in and out of tune, the tuning grid T', the source of alternating current supply AC, and the switch S in the primary circuit of induction coil C. The tuning grids T and T', consist of a number of parallel wires immersed in oil, the inductance and capacity are controlled by the movable contacts XX, and Y, respectively; T' is used for tuning the oscillator of the transmitting system, and T, for tuning the detector of the receiving system, which is in shunt with the telephone receiver TR, the adjustable resistance R, and the battery B. In transmitting, a succession of pulsations are allowed to pass to the antenna the frequency of the oscillation being varied as may be desired by means of the tuning grid T'. In receiving, the switch S is thrown to open the primary circuit of the induction coil C, and the receiving system tuned to correspond with the normal frequency of the transmitting system. When the receiving circuit is thus set it will not respond to waves of a higher or lower frequency emitted by the transmitting circuit, when its inductance and capacity in the tuning grid T' is varied by the short circuiting prongs P, when the key K is depressed. The receiving circuit readily absorbs the energy of incoming electric waves due to the normal frequency of the transmitting oscillations, and the energy thus absorbed breaks down the resistance of the shunt circuit, which is held at a certain normal value by the heating effect of the battery B, and the variations of current strength due to the energy thus absorbed are indicated as dots and dashes of sound in the telephone receiver. The battery B, being composed of two cells in opposition, with the voltage of one slightly higher than that of the other, gives a low initial current which is regulated by means of the adjustable resistance R.

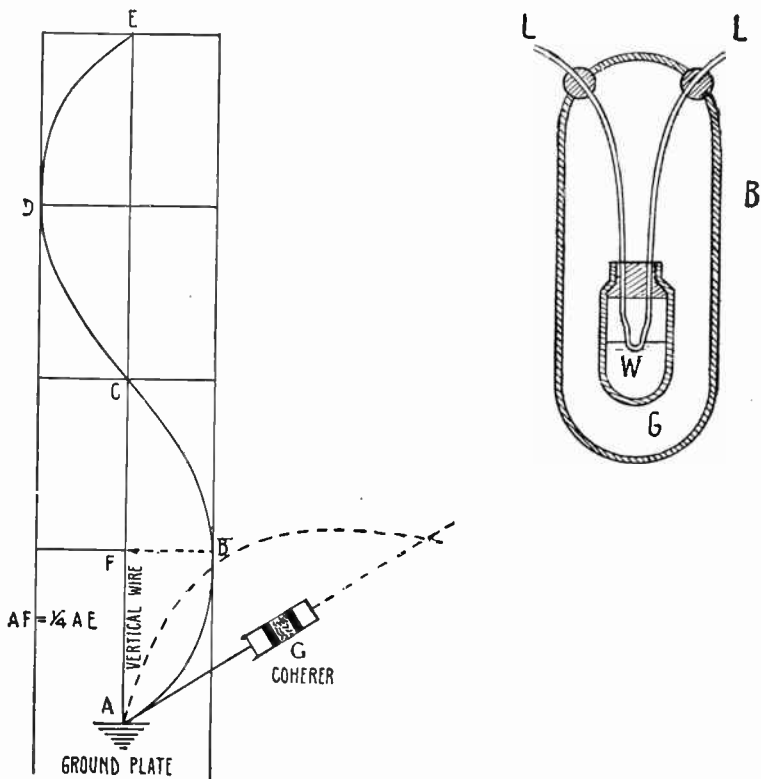

FIG. 3,128.—Wave diagram of the Telefunken or Slaby-arco multiplex system.

FIG. 3,129.—Fessenden detector or liquid barreter. It consists of a short loop of silver wire W having a platinum core of an extremely small cross section. This loop is attached to the terminals of the leading in wires, and the tip of the silver loop is immersed to a depth of about .005 of an inch in a dilute solution of nitric acid held in the glass vessel G, which dissolves away the silver and leaves the fine platinum wire core exposed. The whole arrangement is then sealed in the glass bulb B, which is finally exhausted. This detector operates by the current developed by the oscillations in the receiving circuit instead of the pressure established therein as is the case with those of the coherer type. Furthermore, its action is thermic and not electrolytic. In other words all the resistance in the conducting medium is concentrated within a short distance of the point where the fine platinum wire enters the acid thus rendering all effects local, or confining them to a hemisphere of very small radius.

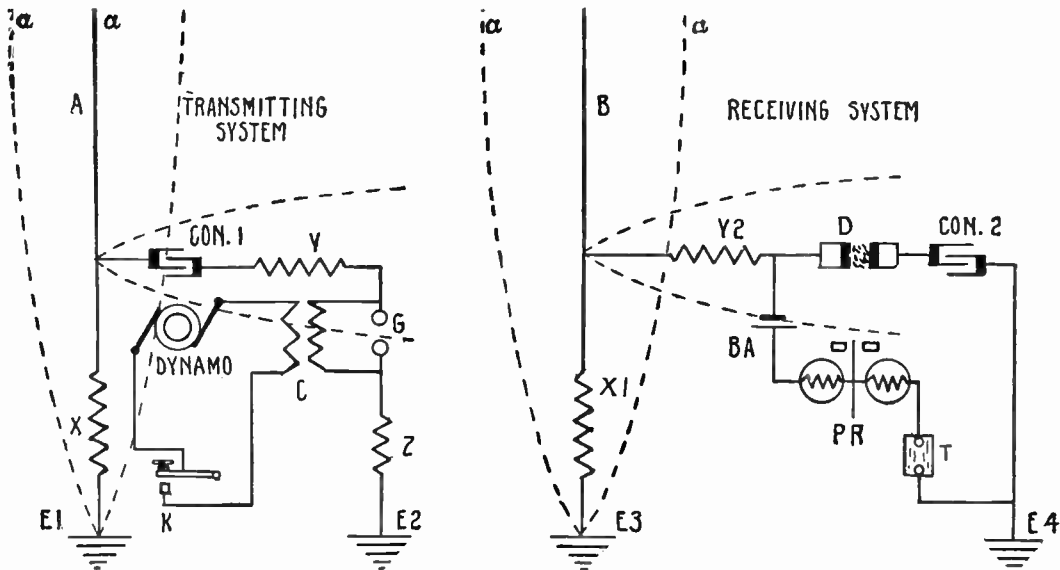

FIG. 3,130.—Diagram showing general arrangement of the transmitting and receiving apparatus of the Telefunken or Siaby-arco multiplex system. A is the transmitting antenna, and B, the receiving antenna. **The transmitting apparatus** consists of the dynamo, the induction coil C, the spark gap G, enclosed in a mica case to deaden the noise due to powerful sparks, the inductance coils X, Y, and Z, by the proper selection of which the wave length may be varied as desired, the condenser CON. 1, and the telegraph key K. The vertical wire A is grounded at E1 and the side of the spark gap G is grounded at E2. **The receiving apparatus** consists of the inductances X1, and Y2, the very sensitive polarized relay PR, the detector D, the battery BA, the condenser CON. 2, and the tap or decoherer T. The receiving vertical wire is grounded at E3 and one side of the receiver circuit is grounded at E4. Electric oscillations set up in the vertical wire, and having their nodal points at E1, and maximum pressure at *a, a*, or the top of the vertical wire A, are propagated along the horizontal wire of the spark gap circuit and oscillate therein with their maximum pressure at the gap G, as shown by the dotted lines. In the receiving system, the detector D, instead of being placed at the top of the receiving antenna B, is placed on a horizontal wire at a point where the amplitude of the emitted wave is a maximum, corresponding to the spark gap G.

The De Forest System.—The features of this system are diagrammatically shown in fig. 3,131. In this system, the imperfections of the induction coil, when operated with the ordinary interrupters, is avoided by the employment of alternators for supplying the current for the electric oscillations.

Ques. What form of detector was originally employed in this system?

Ans. A liquid detector.

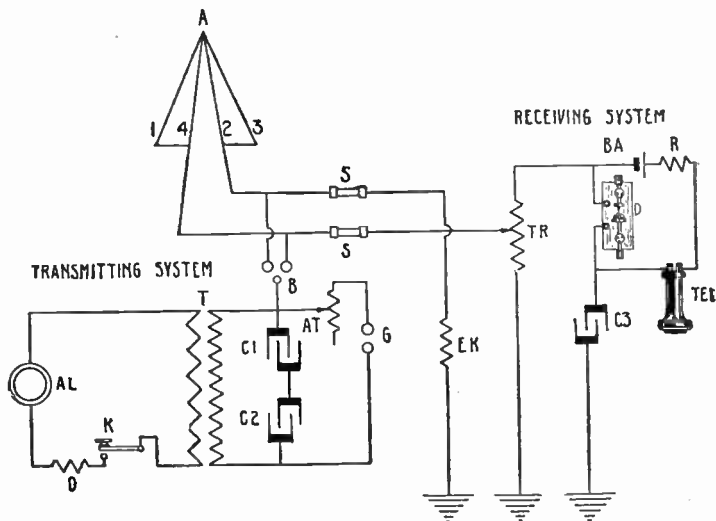

FIG. 3,131.—Diagram of the DeForest system. The transmitting apparatus comprises the alternator AL, the impedance coil O, the telegraph key K, the transformer T, the auto-transformer AT, the condensers C1 and C2, the spark gap G, and the antenna A, which instead of being directly connected to the oscillating circuit, is arranged to communicate therewith through a short air gap B, commonly known as the Shoemaker method. The circuits of the receiving system include the detector D, the small condenser C3, the adjustable resistance TR, used for tuning, a small battery BA, a variable resistance R, and a telephone receiver. The antenna consists of several wires 1, 2, 3, joined together. For receiving, these wires are connected to the earth through the resistance EK and a wire 4 is connected through the tuning resistances with the detector D. For transmitting, the aerial wires are disconnected from the receiving system by means of the knife switches SS. In transmitting, the alternations set up in the primary of the transformer T, at a pressure of from 200 to 500 volts, is stepped up by the secondary to 25,000 volts, which charges the Leyden jars composing the condenser C1, and C2, to their capacity, when they break down the resistance of the spark gap G, and discharging through it set up rapid oscillations in the aerial wire A and the oscillating circuit.

This type of detector is more sensitive than the filings coherer form. Instead of using metal filings loosely placed between the conducting plugs, an oxide of lead mixed with glycerine was used for this purpose.

Ques. What kind of detector was later employed?

Ans. A form known as the *audion* as shown in fig. 3,132.

Wireless Telegraphy Systems of Different Countries.—
The wireless telegraphy systems principally employed in the

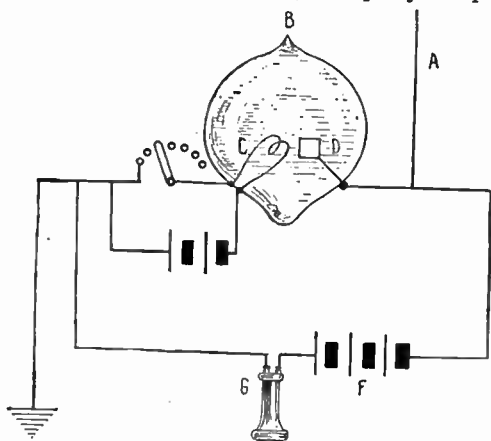

FIG. 3,132.—Audion type detector used in the DeForest system. The receiving aerial A is associated with the audion B, consisting of an evacuated glass bulb containing two electrodes, one of which, C, is an incandescent lamp filament receiving current from a low voltage storage battery, the strength of the current being varied at will by means of a rheostat, the other electrode D is a platinum wing connected to the positive pole of the battery F, in the local circuit external to the bulb, and including the telephone receiver G. The passage of the electric oscillations across the gap between the electrodes C and D causes variations in the current through the telephone receiver, thus producing sounds at its diaphragm.

United States are the Marconi, the Telefunken or Slaby-Arco, the Fessenden (principally used by the U. S. Government), the De Forest, the Clark (principally used on the Great Lakes), the Massie, and the Shoemaker, the latter being extensively used in the U. S. Navy and many government land stations.

The principal systems employed in England are the Marconi and the Lodge-Muirhead. De Forest apparatus, and the Poulsen arc transmitting systems are also installed at some of the stations.

France employs the systems known as the Branley-Poff, the Rochefort and the Tissot.

Russia uses the Popoff; Italy, the Marconi; Spain, the Cervera-Baveria, and Germany, the Telefunken.*

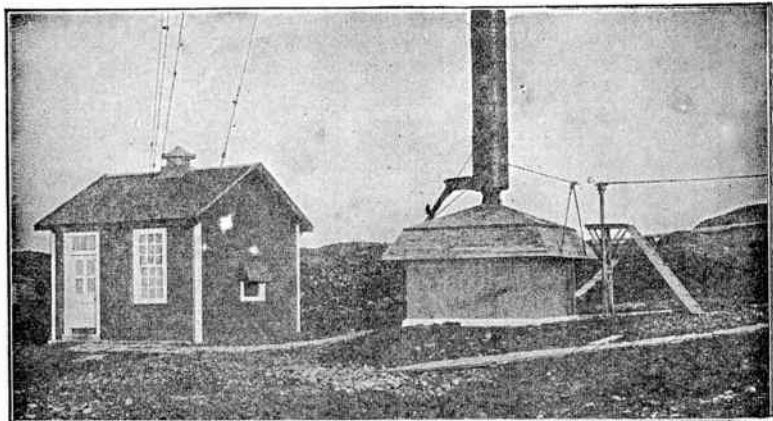

FIG. 3,133—Fessenden's Marhihanish station base of aerial conductor, showing insulating cup and ball joint supporting it, and sending and receiving leads.

*NOTE.—One of the most powerful wireless stations is located at *Mauen*, about 25 miles from Berlin. The equipment of this station consists of an antenna 330 feet high in the form of an iron mast of girder conduction, and triangular cross section, each side of the triangle being about 13 feet. The leads to the station consist of 154 cables in the form of six grids held together by means of wooden batteries. As these leads are not insulated from the tower, the latter forms a part of the oscillator system. The earthing consists of 324 iron wires, which spread from wire into the earth and cover a space of about 1,500,000 square feet. These wires join at a center, whence they are led to the station house. The current is supplied by a 50 cycle, 25 kw. single phase alternator belt driven by a 36 h.p. portable steam engine. This current is fed through two choke coils to a four part step up transformer. The transmitting apparatus consists of a condenser of 360 Leyden jars, a ring shaped spark gap and a self-induction coil composed of a spiral of silver plated copper tubing with suitable connections for the exciting circuit and for coupling to the aerial and earthed wires. An odometer permanently connected to the system enables the determination of the wave lengths generated. The condenser is charged from the secondary winding of the transformer, the circuit of which includes also an inductive reactance coil. By the establishment of exact resonance between the capacity and the inductance at the charging frequency, the condenser is charged by the expenditure of a comparatively small amount of apparent power. The current in the condenser circuit is interrupted, not by opening the primary circuit, as practiced in small stations, but by short circuiting the primary winding of the transformer, and at the same time the winding of the alternator through the reactance coil. On the other hand, the condenser is charged by the breaking of the short circuit. Since the currents used are very powerful, the short circuiting operations are effected by means of a special switch located in the machine operated by a relay worked by a Morse key located on the receiving table in the telegraphing room. This station is capable of sending messages to a distance of 1,500 miles over the sea, 850 miles over the land.

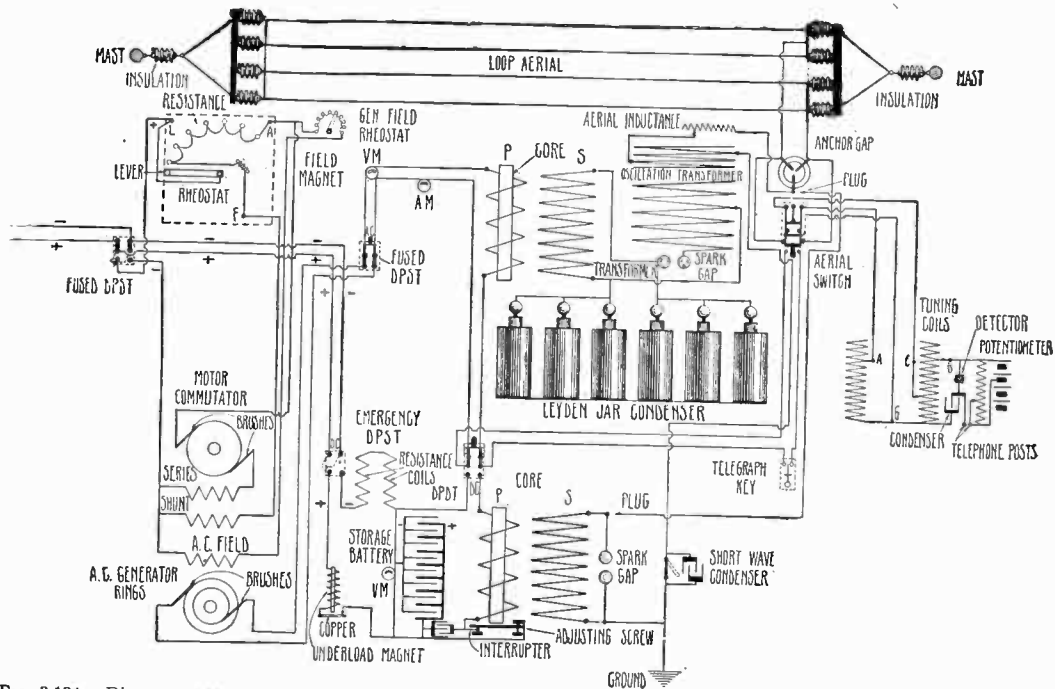

Fig. 3,134.—Diagram of Marconi system. Both transmitting and receiving equipments consist of two circuits each—open and closed. Antenna is the loop aerial type with an anchor gap and special triple blade switch. There is also an aerial inductance coil having a sliding contact by means of which the wave length of the open circuit may be altered. For efficient operation it is necessary that the closed and open circuits of each apparatus have the same time period or resonance. By throwing the antenna switch up the operator receives messages and by throwing it down messages are transmitted.

Commercial Marconi Apparatus.—A diagram of the complete Marconi wireless telegraph system is shown in fig. 3,134. While there are various parts of apparatus which may supplant those shown, such as the audion detector, the loosely coupled inductance, receiving tuner, the magnetic detector, and other aerial systems, this loop aerial system shown is most practical for commercial work.

Ques. What apparatus is included in the system?

Ans. A set comprising an alternating current transformer,

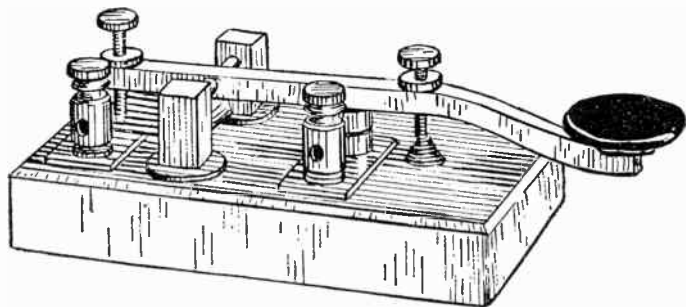

FIG. 3,135.—Central Scientific Co., "Boston" pattern wireless key. In construction, all metal parts except the steel pins of the center bearings are of solid brass. The key is mounted on a polished marble base $3\frac{1}{2}'' \times 6''$. As shown, the current from the lever is not conducted through the bearings but is carried by a heavy conductor direct to the binding post base. Current capacity of key, 10 to 50 amperes.

motor generator, and an auxiliary set consisting of an induction coil operated by storage batteries.

For practical work the transformer is necessary; since this can only be operated by alternating current, at stations where there is no alternating current, a motor generator is used to generate alternating current from direct current, or a rotary converter to convert direct current into alternating current.

A type of motor generator suitable for wireless service is shown in fig. 2,073 (Guide No. 6). It consists of a direct current motor mounted on the same shaft with an alternator. On the motor end of the shaft, on which are mounted the armature coils of the motor which connect

to the contact plates of the commutator, are the brushes which convey direct current into the motor. On the generator end of the shaft whereon are mounted the armature coils of the generator which cuts the lines of force between the field magnets and conveys alternating current to the ring contacts, are the brushes which give out the alternating current.

Where a rotary converter is used, rather than a motor generator, the effect is the same but the construction of the machine is different. The motor and the generator fields are all wound on the same cores

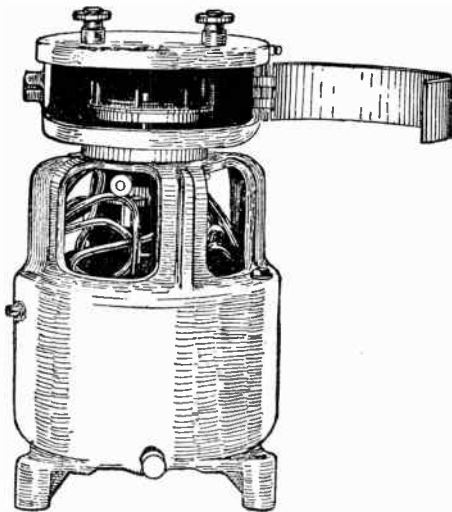

FIG. 3,136.—Marconi $\frac{1}{2}$ kw. converter with disc discharger. This rotary converter is like a dynamotor turned on its side. The shaft runs horizontally, being placed in a vertical position and well protected from wear by bushings on the lower end which carries the weight of the armature. On the upper end are the motor commutator segments and the dynamo ring type collectors, on which the brushes ride. Above this is a rotary spark gap or disc discharger which is well insulated from the converter.

and the armature coils of both machines are wound on the same armature, there being only one case covering and in appearance only one machine, but there are contact brushes at each side, one set making contact on the motor commutator and feeding it direct current on one side and the other set making contact on the generator rings and deriving alternating current from the other side.

Fig. 3,136 shows a special rotary converter installed on some cargo boats for Marconi wireless operation. Both commutator and A. C. rings are at one end of the armature shaft, which is in a vertical position, as though the whole machine was placed on one end. To control the

motor and gradually step up the speed of the motor generator, a rheostat or starting box is used.

If one of the rheostat resistance coils be burned out or otherwise open, the motor armature would not start to rotate until the rheostat lever had reached the contact button beyond the open coil. This, then, would leave the shunt field winding open and the machine would work as a series motor. If wireless transmission be now attempted, the

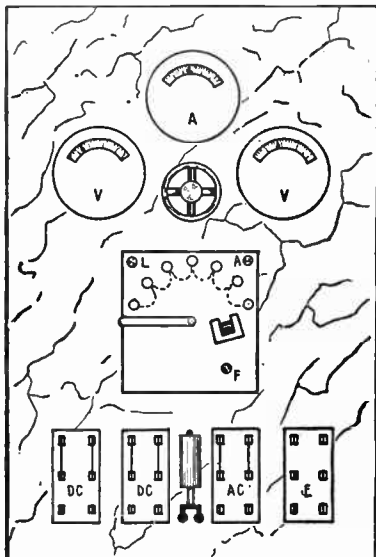

FIG. 3,137.—Wireless station switchboard. Two voltmeters and one ammeter are mounted upon a panelboard in the positions shown. A field rheostat is mounted in the back of the panel and its controlling handle in front. The main rheostat is mounted in about the center of the panelboard and three or four double pole double throw switches below. The solenoid circuit breaker is placed between the switches. All connections are made in the back of the panelboard.

safety fuses would probably blow out. The only way to get wireless messages off under such circumstances is to strap out the open coil with a piece of heavy copper wire. This will give temporary operation until a new rheostat can be obtained.

A field rheostat or regulator is used to regulate the voltage of the generator, and is mounted on a panel as shown in fig. 3,137.

Ques. What kind of condenser is used?

Ans. The Leyden jar.

Ques. How many jars are used for a one kw. set?

Ans. Usually six.

Ques. How are they connected?

Ans. In series parallel; three in parallel between the spark gap and the transformer and three in parallel between the inductance or helix and the transformer, and the two parallel sets connected in series at the base of the jars as in fig. 3,134.

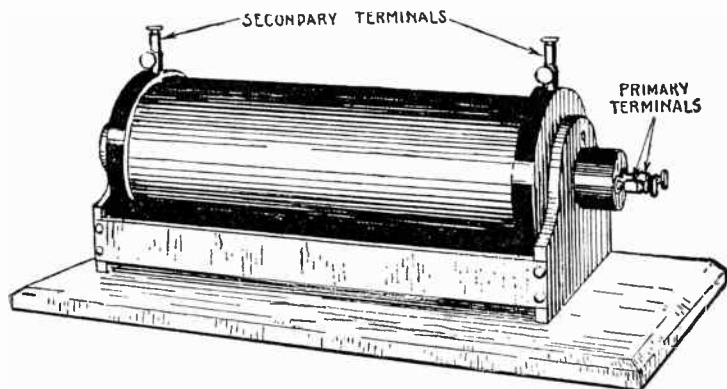

FIG. 3,138.—Open core transformer. This is generally set in a box covering for protection. The transformer primary coil winding is connected to the brushes of the generator by double pole single throw switch and the operation of the telegraph key. When the aerial switch handle is down and the transmitting key depressed, alternating current of about one hundred cycles per second (which is comparatively low frequency) surges back and forth through the primary coil, which is a winding of several layers of heavy wire. These surgings cause a rising and falling of magnetic lines of force, which reverse their direction with the reversals of the alternating current in the coil, cutting through the secondary winding which is composed of many turns of very fine wire. The output of electricity at the secondary terminals is consequently an induced high pressure of between 15,000 and 50,000 volts, with a current strength of one ampere.

Ques. Where is the spark gap usually placed?

Ans. It is generally enclosed in a muffler placed inside the helix.

Ques. What should be done if one of the Leyden jars puncture?

Ans. It should be removed and replaced by another.

If there be no spare jar, this and a corresponding one from the other parallel bank must be taken out and the others reconnected. If the set be connected in parallel straight, only the fractured one will be required to be removed. In either case, to compensate for the loss of capacity one turn or less of inductance should be added at the helix to bring the wave length up to where it was originally. The small condenser must be short circuited by the switch when using the transformer.

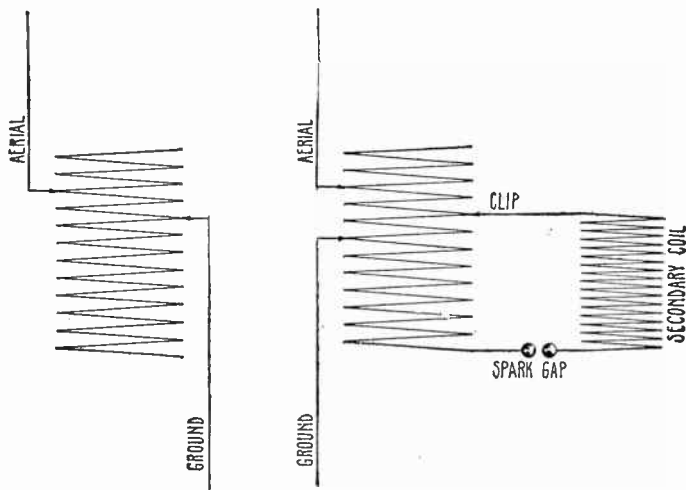

FIGS. 3,139 and 3,140.—Oscillation transformers. This style of transformer consists of a winding of heavy wire on a wooden rack and variable contact is made with these wires by means of metal clips to which are attached conducting wires. When the transformer is operated the secondary coil sets up high pressure oscillations which break across the spark gap and surge through the transformer. The aerial and ground wire clips are then adjusted on the transformer helix and the wave length emitted will vary according to this adjustment.

Ques. Of what does the inductance consist?

Ans. It may be either a single helix as shown in fig. 3,141, or a primary and secondary loose coupling, known as an *oscillating transformer*, 3,139 and 3,140.

The latter form gives a sharp, high frequency wave, and by proportioning the circuits of the two, currents of greatest value may be obtained. This is called *resonance* which means that the product of both the inductances times the capacity in each is equalized.

Ques. Why is an oscillating transformer necessary?

Ans. To comply with the radio law, and to produce a small logarithmic decrement.

Anchor Gaps.—These devices are used to allow a spark of about one sixty-fourth of an inch to jump from the induced open circuit into the loop aerial. It cannot be used with the straight aerial.

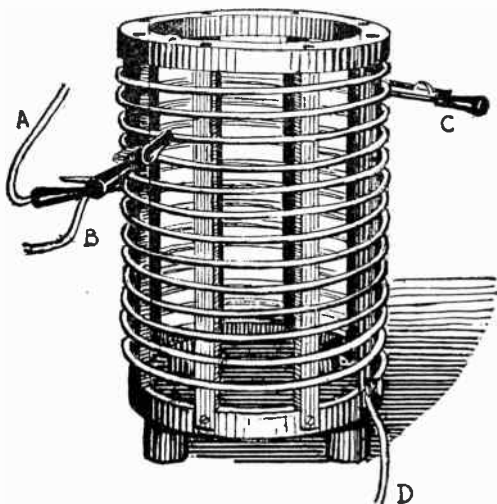
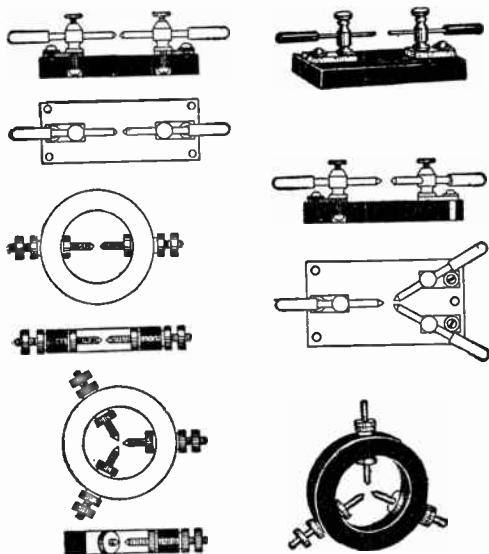

FIG. 3,141.—Tuning coil inductance, generally known as a "helix." This is composed of heavy wire wound on a dry wooden frame in the form of a spiral. By attaching adjustable clips to any part of the winding the inductance is changed. It is equivalent to an auto-transformer. The manner of connecting the leads A, B, C, and D is shown in figs. 3,139 and 3,140.

The gap offers small resistance to high pressure currents, but because of the small pressure of the received oscillations from the antenna the receiving tuner is automatically held open when the aerial switch is thrown down, thereby preventing received signals being grounded through the transformer.



Figs. 3,142 to 3,151.—Various forms of anchor gap. These little devices of which two types and several designs are shown, are employed to automatically connect the high tension circuits with the aerial wire when messages are being received. These anchor gaps are useful in conserving the received energy in the receptor circuits and serve as an additional protection to the apparatus. Figs. 3,142 to 3,144 show a side elevation, plan, and photographic view of a **simple anchor gap**. It consists of two ordinary binding posts set on brass plates with screws in the ends for connecting in the aerial wire, switch or instruments. The binding posts and plates are then mounted on a hard fibre or hard rubber base $4\frac{1}{2}$ inches long by $1\frac{1}{2}$ inches wide by $\frac{1}{2}$ inch thick. Through the binding posts two brass rods two inches long and $\frac{3}{8}$ inch in diameter are fitted. The approaching pointed ends of these rods form the gap which are adjusted by means of hard rubber handles. Figs. 3,145 and 3,146 show a side elevation and top sectional view of a **simple ring anchor gap**. This gap is based on the same principle as the preceding one but it differs in construction for instead of a base to support the electrodes these are mounted in alignment in a fibre or hard rubber ring; the latter may conveniently have an outside diameter of 3 inches and an inside diameter of 2 inches with a wall $\frac{1}{2}$ inch thick. The **compound anchor gap**, shown in figs. 3,147 and 3,148, consists of three binding posts mounted on a block of fibre or hard rubber. Three pointed brass rods with insulated handles, made like those shown in figs. 3,142 to 3,144, are arranged to form a dual gap. The **compound anchor gap**, shown in figs. 3,149 to 3,151 is similar to the compound type indicated in figs. 3,147 and 3,148, but in the one under consideration, which is made like the simple ring anchor gap, it is mounted in an insulating ring as illustrated in figs. 3,145 and 3,146. The electrodes in this case are mounted so that their approaching ends are at angles of 60 degrees. In connecting in either of the simple forms of anchor gap, one of the terminal screws is connected with the transmitter circuit while the opposite terminal screw is secured to aerial switch, as shown in the wiring diagram, fig. 3,134. The compound anchor gaps are used only in connection with looped aeriels when the terminal screws on the block or ring are connected with the double leading-in ends of the aerial as well as to the aerial switch of the receiver while the third and oppositely disposed post is connected direct to the transmitter as in fig. 3,134.

Emergency Set.—This consists of a storage battery to which is connected a voltmeter, a solenoid circuit breaker, a set of resistance coil, and an open core transformer.

An advantage of this type of transmission in cases of emergency is that the receiving circuit of stations not strictly in tune are affected by the highly damped waves.

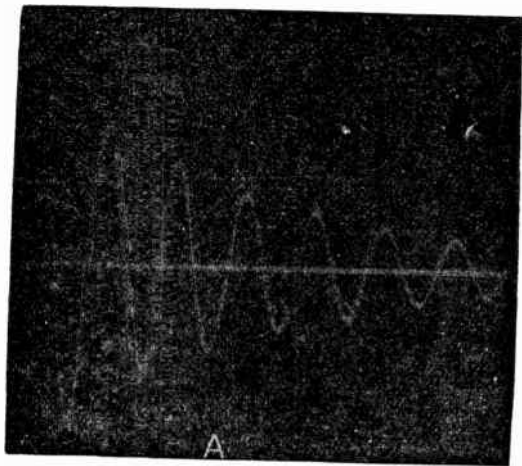

FIG. 3,152.—Form of oscillating waves. These electric waves are often called Hertzian waves because of their discovery and demonstrative proof by Prof. Hertz. They may be several feet in length or several miles long, and are represented as the distance traveled through space during one cycle. The shortest distance the electric strain is at a maximum in the same direction and period of time is considered the wave length. The formula for finding this wave length has previously been given. It may be varied by increasing or decreasing the open circuit with the adjustable helix clips and by changing the closed circuit inductance in the same way. Also by altering the coupling space between the two. If they be too near together, two wave lengths will be emitted. This is desirable in emergency cases where help is needed, as when sending out the S O S distress call, but it violates the radio law at other times. Before boats leave port their wireless stations are inspected by Marconi inspectors and sometimes by government radio inspectors and their wave lengths fixed.

The emergency transmitter may not be included in the outfit on cargo boats and small steamers. It is operated by the key only when the double pole double throw switch is thrown down, and it has a storage battery source of supply, charged by direct current over night.

Ques. What should be done in operating the emergency set?

Ans. The switch connecting the direct current with the storage battery must be thrown off.

The strength of the *storage battery* is ascertained by pressing the button of the voltmeter. Before operation, a flexible cord with plugs at each end is connected between the bottom electrode of the anchor gap and one side of the coil spark gap, the other side of the coil oscillator or spark gap being permanently grounded.

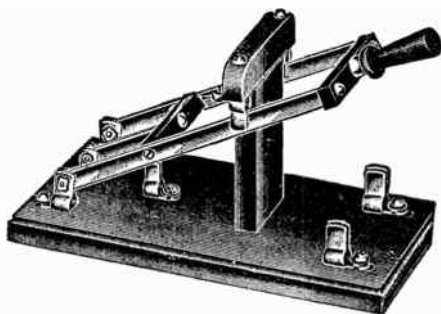

FIG. 3,153.—Aerial or antennæ switch used at Marconi stations. It differs from almost every other kind of switch, and has two heavy copper blades and a small inner half-blade which are raised and lowered by an insulated handle. When thrown *down*, it is used for *sending* as it then breaks the antennæ and earth connections from the receiving tuner and completes the power circuit when the telegraph key is depressed. When thrown *up*, it connects the *receiving* tuner to the loop aerial and the ground to the G post of the type D tuner shown. The switch is also shown diagrammatically in fig. 3,134.

Auxiliary Induction Coil.—When operating the auxiliary coil, shown in fig. 3,164, the storage battery furnishes the primary current.

In operation, the magnet core attracts the spring armature interrupter when the circuit is closed by the key, but in doing so breaks the primary circuit by pulling the armature away from the contact screw. (A paper dielectric condenser is shunted around the interrupter to absorb the spark.) This causes the spring armature to fly back against the contact screw and close the circuit again, when the operation is repeated. The faster this armature makes and breaks the circuit the greater will be the *spark frequency*. This is not to be confused with the "high frequency" of the oscillating circuit.

Ques. How is the spark gap connected?

Ans. Directly across the secondary winding.

Ques. How is the secondary connected?

Ans. It is connected on one side to the anchor gap, and on the other, to ground.

Ques. How are the short wave condenser and the secondary oscillator connected?

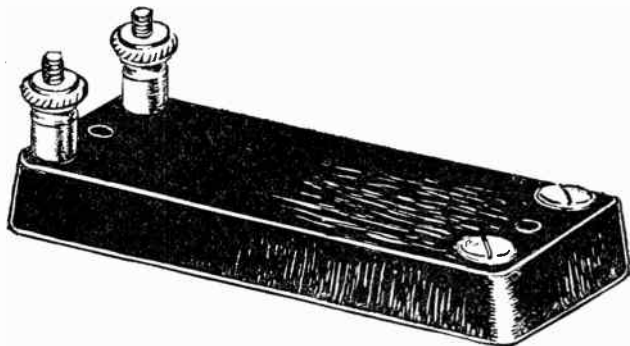

FIG. 3,154.—Short wave condenser. It consists of glass plates which form the dielectric between tin foil sheets, and is used when the auxiliary set is operated on a three hundred meter wave length. The switch which short circuits it must then be turned off.

Ans. In series between the lower anchor gap electrode and the ground which throws them in parallel with the spark gap.

The Aerial Inductance.—This is a separate induction coil of the open core type, known otherwise as the “loading” coil and connected in series between the secondary inductance of the oscillator and the bottom electrode of the spark gap. It is not always included in the circuit but its use permits sharper tuning, particularly with the inductance of the emergency machine.

Type D Marconi Tuner.—This was formerly the property of the United Wireless Telegraph Co., until that company went into the hands of receivers and finally, in 1912, was merged with the American Marconi Co.

It consists of two inductance tuning coils, like the one shown in fig. 3,165, each composed of a layer of fine, insulated wire wound on cores of seasoned wood, over which contact sliders, like that shown in fig. 3,155, rub on a portion of bared wire from which the insulation has been removed. These two coils are connected together at their lower ends but their upper ends are left open. To the wire connecting the two ends fig. 3,162 is attached the binding post marked G. The

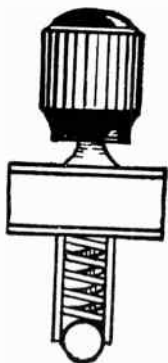

FIG. 3,155.—Ball-bearing slider for use on tuning coils, potentiometer or any device requiring a slider. In construction, the ball is contained in a round tube fastened to the square slide tube.

brass bars on which the sliders move are each connected to the binding posts marked A, B, and C respectively. A and C are connected each to an end of the aerial loop and B is connected to the detector.

Detector Circuit.—Around the *detector* is bridged or shunted a variable resistance. This may be inductive or non-inductive, and is generally composed of resistance units connected in series, each connection soldered to a contact button like a rheostat over which a lever slides. Connected between this lever and the detector are the telephone posts which hold the receiver

cords, thereby connecting the receiver in series with the circuit. Two or more receivers or receiver cords are connected in parallel at the telephone posts so that several pairs may be used. The battery current is also variable and its object with the potentiometer is to increase the sensitiveness of the carborundum crystal.

In other words it acts like a local telephone battery to boost up the minute current produced at the sensitive detector contacts. With a fused silicon crystal or with galena the battery is not necessary.

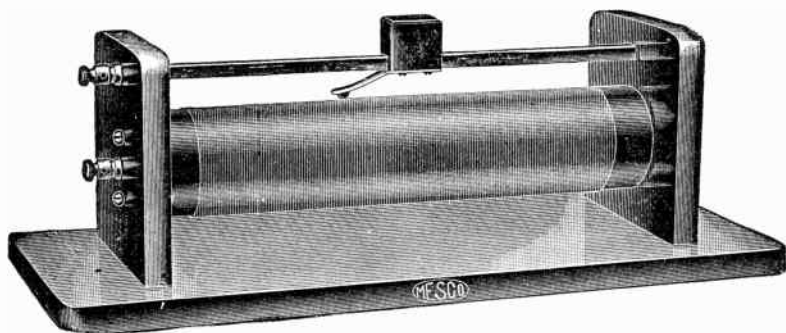

FIG. 3,156.—Mesco receiving tuning coil. **In construction**, the coils are wound with black enameled wire and are properly designed for the use of such wire. The sliding contact maintains connection with the wire of the coil. Adapted for wave lengths from zero to 1,500 meters.

Tuned Receiving Circuits.—There are many ways of connecting the various parts of apparatus used for detecting wireless messages, but, reduced to their simplest forms, they are all derived from three distinct circuits. Figs. 3,157 to 3,159 show a diagram of each of these elementary circuits.

A, represents a crystal detector in series with the tuning inductance and aerial.

B, represents the detector variably shunted around the variable inductance and thereby forming a closed circuit.

C represents the detector inductively coupled to the variable tuning inductance.

In the A circuit no condenser should be used unless it be of high capacity. The detector must be closely adjusted and very sensitive to give the best results. The receiver is shunted around the detector.

In the B circuit, a low capacity condenser must be used in series with the detector, which may either be fixed or variable. The detector should also be very closely adjusted in this case to give the best results.

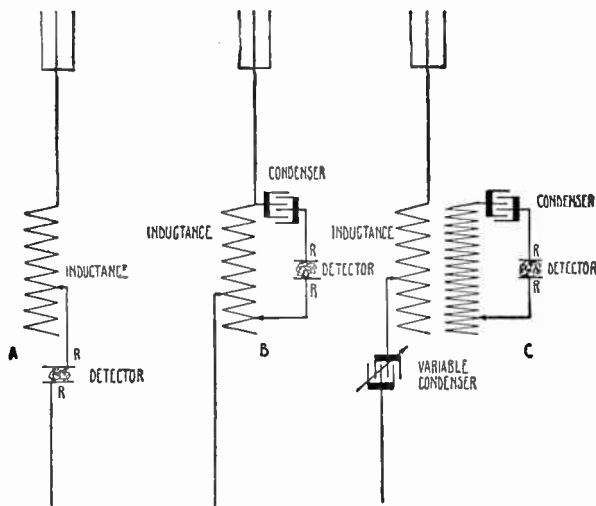

FIG. 3,157 to 3,159.—Three receiving circuits. Upon the principles of these three receiving circuits are based all of the most complicated circuits that can be devised. The open circuit is shown in fig. 3,157, the closed circuit in fig. 3,158 and the inductively coupled circuit in fig. 3,159.

The receiver may be shunted around the detector or the condenser, and in actual practice it seems to make no difference which way it be done. The tuner of this style is often called an auto-transformer. In reality it acts like a step up transformer wherein the primary and secondary are both of the same winding of wire, the primary consisting of that portion of inductance which is connected between the aerial and ground and the secondary, that around which is shunted the detector and condenser circuit.

The best form of an auto-transformer is when the aerial is connected, through a brass rod or otherwise, to a variable contact, the ground wire

the wire from the detector, and the wire from the condenser are also connected to variable contacts. This gives a wide range for selectivity and when all four variable contacts are at their proper points, can hardly be excelled for resonance by any other receiving system.

In the C circuit, an *inductively coupled tuner* or "loose coupler" is shown. This is considered the best tuning inductance known, especially when both primary and secondary are variable.

Figs. 3,160 and 3,161 show two loose couple receiving transformers ("loose couplers"). The condenser should be of low capacity, about five hundredths of a micro-farad and may be of the variable type if

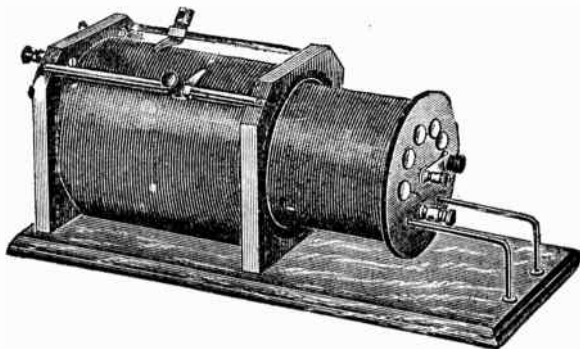

FIG. 3,160.—Loose couple receiving transformer with variable contacts. This has an advantage over the type of receiving tuner with a secondary variable slider in that the inductance is varied from the end of the secondary and can be inserted far into the primary inductance. But it has the disadvantage of the close adjustment made possible with the variable slider.

desired. There is a variable high capacity condenser shown connected in the ground circuit. This is an advantage in receiving short wavelength stations with a long aerial, but with a short aerial may be dispensed with. With the inductively coupled tuner, the detector does not have to be so accurately adjusted because the oscillations from the primary cut into the secondary inductance and are "boosted" up on the principal of an induction coil.

Ques. When is the greatest degree of selectivity obtained?

Ans. When the secondary coil is somewhat separated or withdrawn from the primary.

This gives the best results from distant stations and from stations using long wave length transmission.

Ques. What ill effect results from bringing the two coils close together?

Ans. There will be too much damping effect and the sensitiveness of the messages will be decreased.

Telephone Receivers and Detectors.—These are important parts of receiving apparatus, for without the use of both, radio

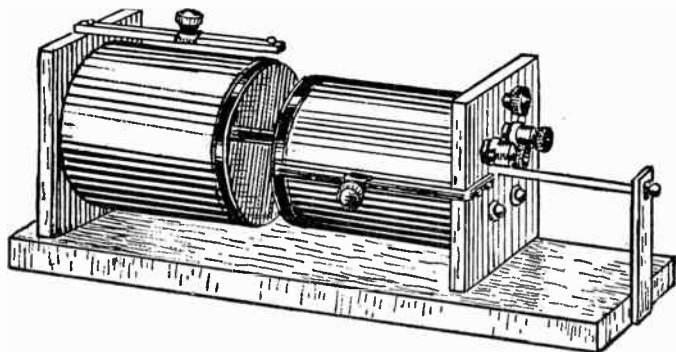

FIG. 3,161.—Loose couple receiving transformer with variable slider. While this type of receiving tuner has the closest inductance variability possible with any transformer, it has the disadvantage that the secondary coil cannot be inserted very far into the primary. From long distance transmitting stations, however, the messages will come in better when the secondary is withdrawn from the primary, which makes this tuner very serviceable.

messages could not be intercepted. The receivers do not differ greatly from an ordinary sensitive watch case receiver, except that their magnets are wound with as great an amount of extremely

NOTE.—Manufacturers and experimenters contend as to whether the secondary winding should be evenly or unevenly wound. Probably the best results are obtained with the secondary wound *unevenly* on a shallow insulated spool like that shown in fig. 3,171 and arranged so that taps are taken from every foot or two of wire and soldered to the pins of brass tacks or contact buttons over which a lever glides like the lever of a rheostat. The even winding of the fine secondary wire on a long spool is usually resorted to because it allows a variable contact to slide easily over that part of its surface from which the insulation has been removed, thereby giving more accurate variable adjustment than where taps are taken. It is evident in the latter case that unless there be a great many contact buttons a close variance is impossible.

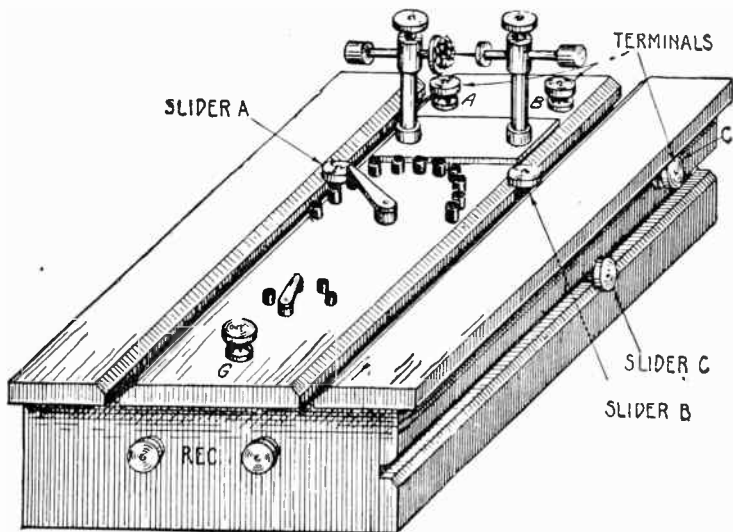

FIG. 3,162.—Marconi type D tuner. In adjusting, the wave length of the open circuit is varied by the sliders A and C. A closed oscillatory circuit is variably bridged around one of these coils, the inductance of which is varied by means of the sliding contact B. This circuit includes a carborundum crystal and a fixed condenser connected in series, a potentiometer and battery and the telephone receivers. When electric waves are brought to this tuner by *throwing up the aerial switch* the oscillations traverse these coils. Those produced in the second coil set up magnetic lines of force which interlink and cut through that part of the inductance included in the closed oscillatory circuit and pass through the detector, and being alternating in nature, surge through the condenser. Very interesting experiments have been made with the type D tuner, some of which will be noted here. If the A sliding contact be pushed up and off the open end of the first inductance one end of the loop aerial will be opened. Now the antenna would appear to have a very long wave length due to the fact that the linear length of the antenna is twice what it was before. But while the action of the loop aerial is not thoroughly understood, tests have shown that it has none of the characteristics of the ordinary plain aerial. Comparative tests were made when the antenna sliders A and C were on the inductance and when the A slider was pushed off, with the following results: With both the sliding contacts close to the open ends of the tuning coils, a wave length reading of 875 meters was taken. By pushing the A slider off the first coil, leaving the loop antenna connected only at one end like an ordinary plain aerial, a wave length reading of 930 meters was taken. Thus, by disconnecting one side of the loop, an increase of only 55 meters could be obtained. The reason for such a slight increase is due only to the fact that the antenna doubles back on itself and the open end of the loop vibrates along with the other wire or wires. To get the best results in receiving from stations operating with long wave lengths, the ground wire should be taken off the binding post G and the loop end of the aerial, connected at the post C, should be disconnected as in fig. 3,163. Then connect the ground wire to the post C and close together the two upper screws of the anchor gap, thereby short circuiting the ends of the loop and changing it to an ordinary plain aerial. The circuits will then be as shown in fig. 3,163 and will be capable of receiving wave lengths of over five thousand meters. In this way there will be no dead ends from the antenna and the first inductance coil by A slider will be converted into a variable loading coil in series with the second inductance which supplies energy to the detector circuits.

thin copper wire as possible. For that reason they are called high resistance, and are the most sensitive telephones made. Sometimes they are connected in series but best results are obtained when, if they be all of the same resistance, they are connected in parallel.

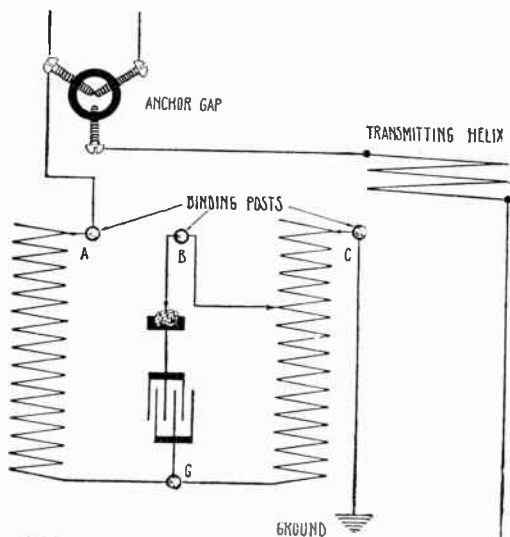

FIG. 3,163.—Special Marconi type D tuner circuit. This illustrates the outcome of an experimental investigation by Marconi engineers for the receiving of long wave lengths with the type D tuner connected to a loop aerial. By closing the anchor gap the antenna becomes a straight way aerial and the A slider and coil acts as a loading coil.

There are various kinds of detector in commercial use and many more are being experimented with by amateurs.

The *coherer* is generally considered impractical and hence obsolete. It was found to be either too sensitive or not sensitive enough. Now, with the use of telephones, operators have become so accustomed to transmitting stations that they can readily recognize fellow operators before they sign.

The Marconi *magnetic detector* is shown in fig. 3,168. This too, is fast being replaced either by crystal detectors or by the audion.

There are many natural or fused crystals in use in various types of detector stand. The oldest form is the *carborundum* type and is best used when clamped between carbon cups.

Lead peroxide has about the same sensitiveness and should be clamped between flat lead and platinum electrodes. Beside the audion the two

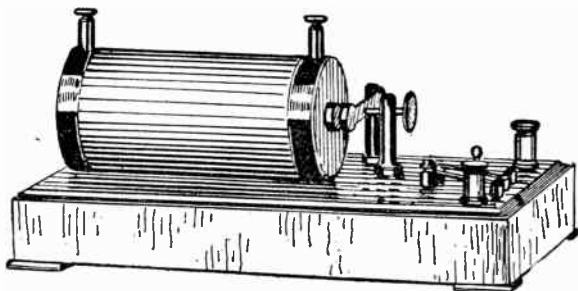

FIG. 3,164.—Auxiliary induction coil. This is an open core transformer built in the shape of a large Ruhmkoff coil with a heavy vibrator and contact screws. It is only used when there is no power available to run the motor generator. Its source of electrical supply is a storage battery which should always be kept fully charged. The auxiliary induction coil is connected by flexible wires terminating in plugs.

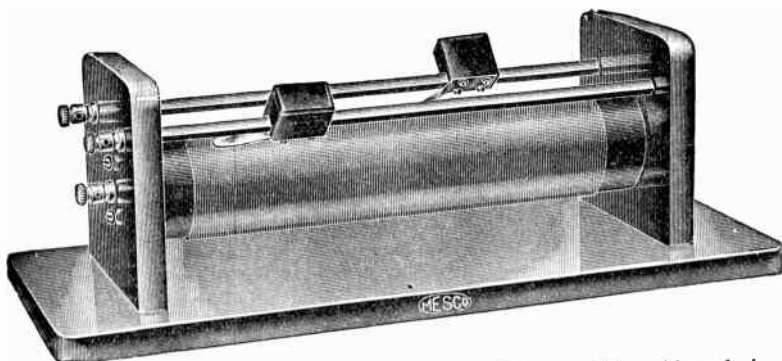

FIG. 3,165.—Receiving tuning coil with double contact. It has two slides and is used where closer tuning is required than can be obtained with a single contact coil. Adapted to wave lengths from zero to 1,500 meters.

just mentioned are the only forms used commercially which require local battery current to operate them.

Galena is very sensitive when a clamped piece is touched by a thin copper wire, and thus completes the circuit.

Silicon is a sensitive detector and does not lose its adjustment easily. "Perikon" is the commercial name for a detector much used by the

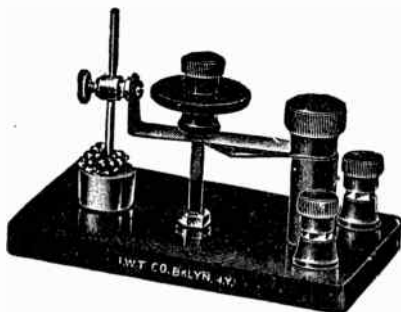

FIG. 3,166.—Crystal detector with double adjustment. This instrument is particularly designed to readily allow the delicate adjustment of any crystal or mineral. The very finest micrometer adjustment can be had by simply turning the hard rubber knob. It has two adjustments, one by means of the sharply pointed rod which can be lifted up or down and the other by the knob.

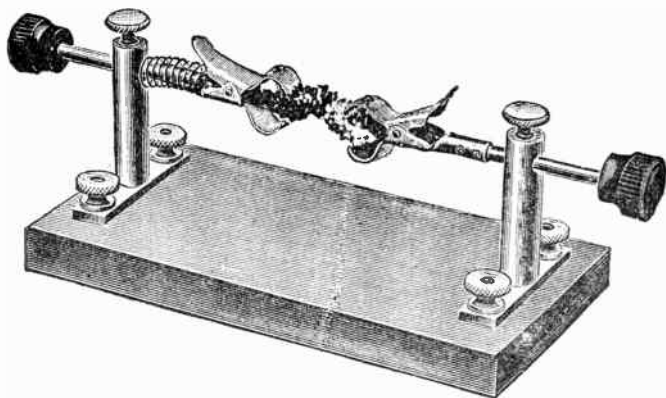

FIG. 3,167.—Double Crystal detector. Two crystals in contact often form a very sensitive detector, especially if one be an inactive substance and the other sensitive. This is the feature of the "perikon" detector. Carbon and carborundum may be used in this detector stand.

U. S. Government. It is very sensitive and consists of a piece of *zincite* in contact with a piece of *bornite* or with *chalcopyrite*.

The *ferron* detector is also used by the U. S. Government and is not only very sensitive but is not easily affected by the transmitter.

Originally, detectors were protected from the transmitted spark by a lead screen, through which the waves cannot penetrate, but the modern detector is not injuriously affected and can easily be re-adjusted. Figs. 3,166 to 3,170 show several different styles of detector.

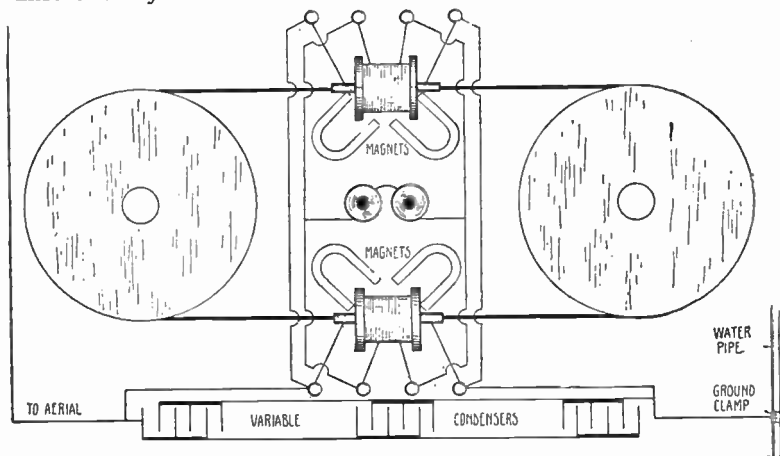

FIG. 3,168.—Marconi magnetic detector. The aerial is connected to one end of the primary coil and the ground to the other and the variable condensers are connected in parallel and used for tuning. The receivers are connected to the secondary coil. Two strong permanent magnets are placed with like poles together and serve to magnetize the revolving steel band but this is destroyed by wireless waves and a clicking of the receiver diaphragm is the result.

Ques. What are the characteristics of the valve and the audion detectors?

Ans. They are very sensitive and retain their sensitiveness even when close to a transmitting spark. But both are of different construction although each is based on the rectifying principle of the Fleming valve described in Guide 6, fig. 2.087.

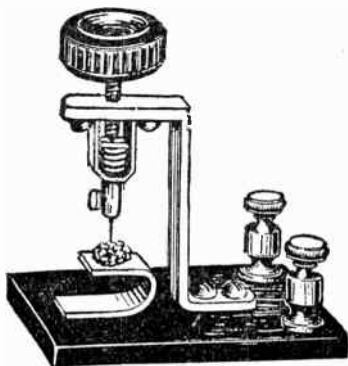

FIG. 3,169.—Crystal detector. When the hard rubber knob at the top of the detector stand is turned, the needle point, which presses into the crystal is moved up or down. This allows of a variable adjustment which may be tight or loose, as desired. The spring shown helps to push the crystal up against the needle point.

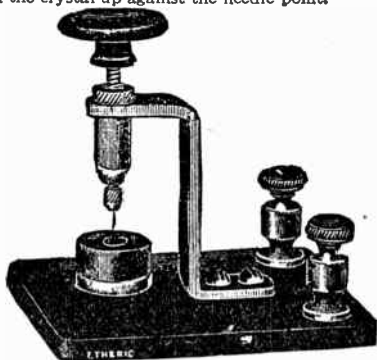

FIG. 3,170.—Electrolytic detector invented by Fessenden. It is probably the most sensitive of all detectors excepting the audion and the valve detectors. It consists of a carbon cup connected to a binding post and an adjustable standard which holds a very small hair-like platinum wire which dips into a 20% diluted solution of nitric acid. The high resistance of this acid detector is somewhat reduced by incoming wireless waves and when a telephone is shunted around it, the varying resistance is sufficient to vibrate the diaphragm but not strong enough to work a telegraph relay. When a potentiometer and battery are connected with the electrolytic detector and telephone, the sensitiveness is increased. The electrolytic detector is capable of operation with about three hundred micro-ergs; the magnetic detector is capable of operation with about four hundred micro-ergs; the silicon and most crystal detectors with about one thousand micro-ergs, and the manufactured carborundum detector with about nine thousand micro-ergs. Notwithstanding this very considerable difference in the sensitiveness of the electrolytic and carborundum detectors as measured by the C. G. S. system of units, in the actual practice of wireless telegraphy the receptive difference is hardly perceptible over similar distances. A great deal depends upon the adjustment of the detector which is a "cut and try" procedure until the most sensitive point is arrived at which will best respond to incoming signals.

The audion is the invention of Dr. De Forest and used only by the Radio Telegraph and Telephone Co., and the valve detector is used only by the Marconi Wireless Telegraph Co.

Fig. 3,174 shows a diagram of the complete Marconi sending and receiving system where the valve detector is used with a straight way aerial.

Ques. Describe construction and operation of the Marconi valve.

Ans. It consists of an oblong glass globe, inside of which is sealed a filament and a metal wing. The filament is heated and

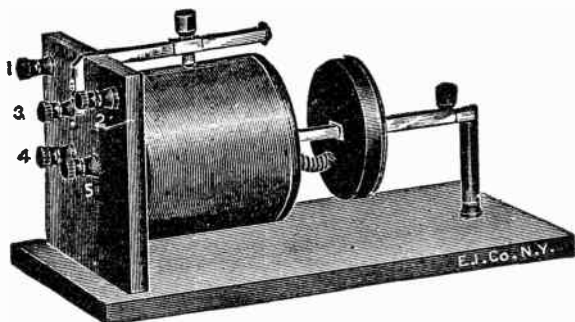

FIG. 3,171.—Inductively coupled tuner or "loose coupler." This is practically a receiving transformer which serves to increase the intensity of wireless signals by varying the primary and secondary coupling. The primary inductance is variable but the secondary is not, but is withdrawn from the primary by sliding on a contact rod.

made to glow by storage battery current controlled by a rheostat, and the incandescent filament liberates gaseous *ions*. If, by throwing the switch, oscillating electricity be made to surge through the "valve tuner" or receiving transformer, the current is rectified and the disturbed ions are detected by the telephones which are supplied by battery current through the potentiometer.

Ques. How is the valve detector connected?

Ans. Connect one filament terminal to the aerial and the

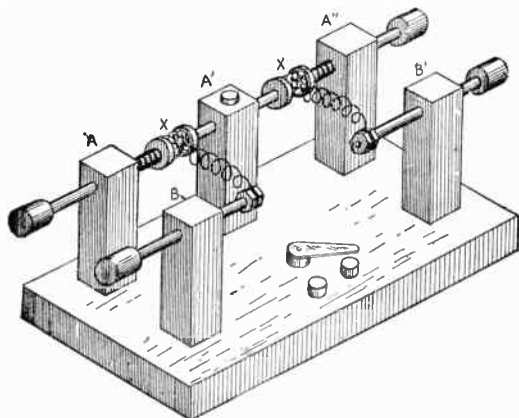

FIG. 3,172.—Combination galena detector. This detector is used in case a quick change is necessary. If one of the points of this detector happen to be knocked out of adjustment by static or other means, the other detector can be easily thrown in the circuit by making use of the two point switch. The arm of the switch is connected to one side of the circuit while the points are connected to B and B'. The base of this detector, or A, A', A'', are all connected together and led to the other side of the circuit. The detector can be adjusted to the highest degree of sensitiveness, and is easy to construct. Make uprights of one-half inch square brass rod, each one inch high. The distance between A and A' is $1\frac{3}{4}$ inches, and one inch between A and B. The springs between X and A will hold the mineral in tight adjustment, while the check nut in A' holds the other rod from slipping.

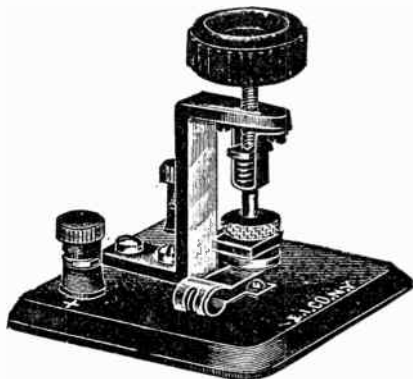

FIG. 3,173.—Peroxide of lead detector. A flat piece of peroxide of lead is clamped between a platinum surface and a flat piece of lead. Binding posts connect to these two electrodes and are marked + and -. The positive pole of a battery is connected to the platinum electrode at the binding post marked +.

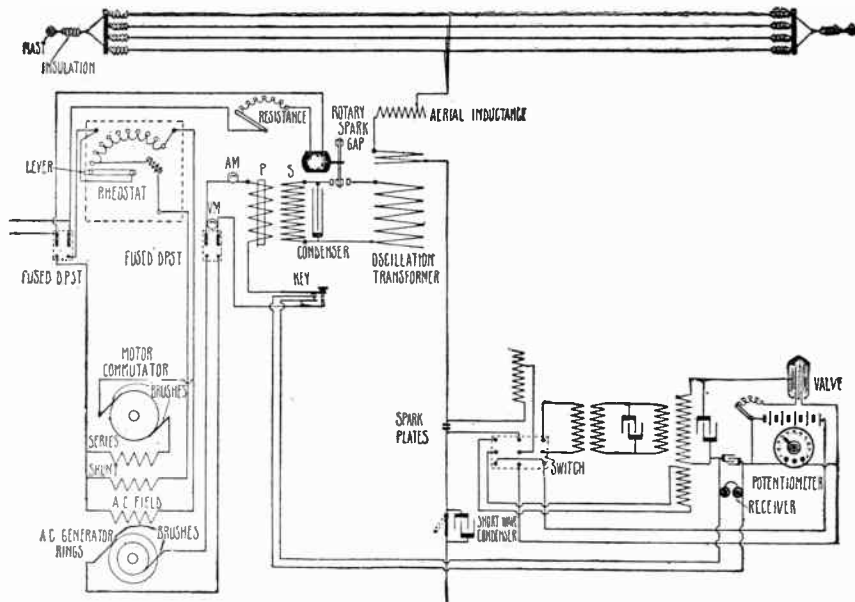

FIG. 3,174.—Diagram of complete Marconi sending and receiving system with valve detector. The spark gap will be noticed to vary from the usual form of spark gap, and is known as the rotary spark. A disc, insulated from and revolved by a shunt wound motor, cuts in the spark gap and breaks up the spark and at the same time cools it. The quenched spark is another form of a cooled spark gap. The valve receiving switch also differs from that of the loop aerial system, and it will be noticed that the key is different which makes it a "break-in" system, whereby the operator can send and receive at the same time. When the key is depressed the receiving apparatus is short circuited but as the key springs back into normal position the receiving circuit is automatically connected and the operator can hear any B K (break) or other signals provided he has the 'phones to his ears. The receiving circuit is connected between two spark plates which form a sort of anchor-gap space through which the spark jumps to ground during transmission. The valve tuner is a loose coupling combination with a plurality of windings and variable condensers for selective receiving. A small fixed condenser is shunted around the telephones to intensify the oscillation discharges.

wing to the ground. Then connect a storage battery and rheostat in series with the filament terminals. Thus, the circuits in which the oscillations are to be detected are joined in series with telephones, wing, and filament.

A rheostat such as shown in fig. 3,175 would be suitable for use in the valve detector circuit.

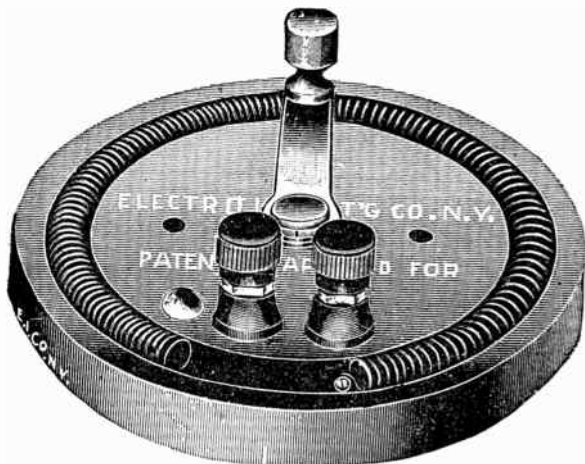

FIG. 3,175.—“Electro” air cooled rheostat. This consists of a wire spring set in a groove in a wood base. One end is connected to a binding post and the other end is free. A lever connected to a second binding post varies the spring wire resistance when moved over its surface.

Ques. Describe the De Forest audion detector.

Ans. It consists of a tantulum lamp with a wire *grid* and a flat metal plate or *wing* sealed inside the glass bulb with the *filament*.

Ques. What is its principle of operation?

Ans. Its operation is due to the fact that when a filament and metal wing are sealed in an evacuated glass globe, a current

of electricity will cause a flow of ions to pass from the filament to the wing while the filament is heated, but they will not pass from the wing to the filament.

Accordingly, if the filament be heated and made to glow by a storage battery supply of current and a grid and wing are connected, one to the aerial and the other to the telephone, any change in the flow of

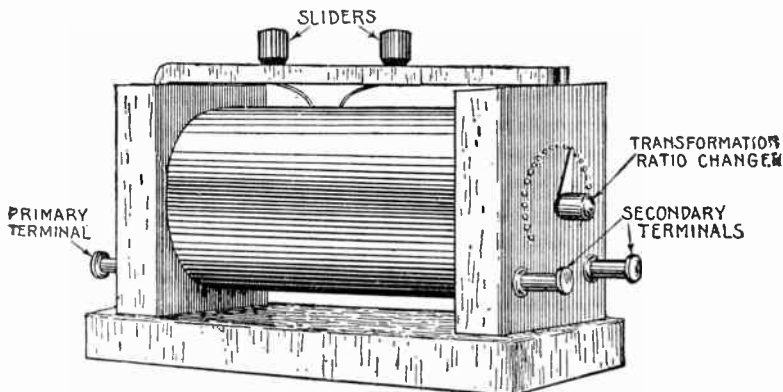

FIG. 3,176.—D and W tuner. This tuner is not loosely coupled, but has primary and secondary wires wound side by side throughout its length, the primary being varied by sliding contacts running along brass rods and the secondary tapped every few turns and varied by the lever which glides over the button contacts. This has its merit in that there is a maximum induction because the primary and secondary have direct relation to each other. But there is still that loss of accurate variance which makes tapped secondaries questionable. And it is next to impossible to have a separate sliding contact to glide over the secondary without bringing primary and secondary in contact. The coil is shown with the winding covered, an open space being left only where the sliders make contact on the wire.

gaseous *ions* caused by oscillating discharges of electricity between the antenna and the ground, to which the filament is connected, will be detected by the telephones.

How to Establish a Small Station.—The necessary apparatus required for a small wireless telegraph station is as follows:

Porcelain or corrugated composition insulators, which may vary in size.

Aerial wire, which may be No. 14 gauge aluminum.

Switch, SPDT or DPST or DPDT.

Ground clamp, to hold ground wire.

Spark coil for sending.

Spark gap for sending.

Telegraph key for sending.

High tension condenser.

Helix, or transmitting tuning coil.

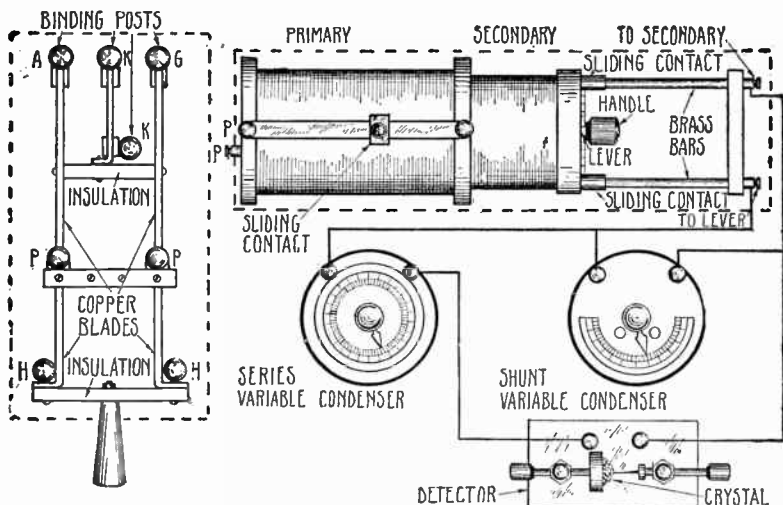

FIG. 3,177.—Diagram showing inductively coupled receiving tuner and connections. A variable condenser is connected in series with the detector and secondary coil and another variable condenser connected in parallel with this receiving circuit. The primary binding posts marked P P are connected to the upper posts of the switch which are marked the same. A variable capacity is, however, connected in shunt around the secondary inductance. This gives most accurate tuning by establishing absolute syntony or resonance. Capacity and inductance are directly opposite in their effects upon either a sending or receiving circuit when the capacity and inductance are connected in parallel. If the value of one be decreased, the value of the other is increased because the oscillating pressure does not always keep in step with the current. Where there is too much inductance in the circuit the current will lag behind the voltage, and where there is too much capacity, the pressure will lag behind the impulses of the current. Perfect resonance in receiving is therefore accomplished by varying both the inductance and the capacity.

- Receiving tuning coil.
- Detector.
- Telephone receivers with head band.
- Variable condenser.
- Fixed condenser.
- Storage battery, or dry cells.

The aerial switch—This may be but a single blade knife switch which throws both ways, called a single pole double throw switch, or it may be even a double point switch mounted on a wooden base if the station is to be used only for receiving.

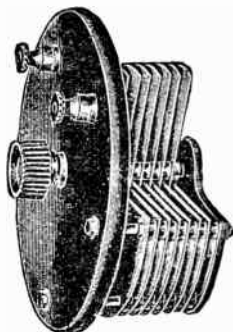

FIG. 3,178.—Variable condenser. One set of plate, as shown, are arranged so that they can be rotated about a central axis by means of the swiveled thumb nut, thus interleaving more or less of the plate area with the other set of plate which are attached rigidly to the circular cover. The condenser is placed vertically in a circular case, not shown.

For practical purposes a double pole single throw (D P S T) switch or a double pole double throw (D P D T) switch should be used.

From the preceding descriptions of commercial apparatus it will be evident to an experimenter that any manner of "hookup" or connecting of switches and apparatus is possible.

The antenna or group of aerial wires may be of any shape, some of which are shown in figs. 3,179 to 3,185. The antenna should extend as far as possible above the ground. It may be copper or aluminum wire, about No. 14 gauge, bare or insulated, for wireless waves will creep through the insulation as easily as they will go through a frame house.

It is very necessary that the aerial be kept from touching any metal or other conductive body which will cause the waves to dissipate and go to ground. Therefore, the insulators are used to separate the

wires from the "spreaders" and all conductive bodies. This aerial may even be strung inside a building, providing it is some distance from the ground and well insulated. When it is of very large proportion and an outside equipment, it should be connected to the ground during an electric storm with a one hundred ampere switch which is required for lightning protection by fire underwriters.

The **ground clamp** is another important piece of apparatus. The water pipe to which it should be fastened must be scraped clean. Then wrap the metal ribbon around it and fasten tight by screwing down the

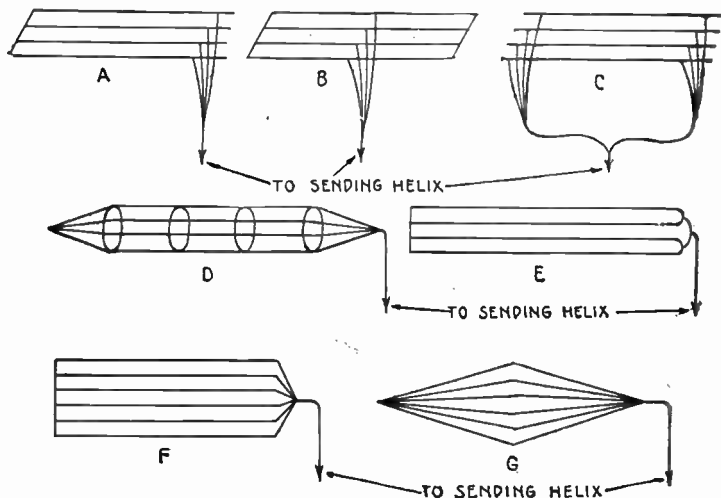

FIGS. 3,179 to 3,185.—Common types of aerial. A, L, aerial; B, T aerial; C, double T aerial; D, cage aerial; E, Marconi aerial; F, Massie-Stone aerial; G, diamond aerial.

binding screw. Underneath the brass nut fasten a comparatively heavy wire and connect this with the aerial switch. Bring the aerial "lead in" wire through loom or a hard rubber tube or through a hole cut in a frame of glass, and connect to the aerial switch.

The **receiving apparatus** should include both a detector and a telephone receiver which is shunted around it. A pocket wireless telegraph or telephone receiver may be made as follows: First unscrew the cap of an electric bell push button, and connect a short wire to each contact spring, allowing these wires to come out through holes in the base of the push button. Fasten to each wire a metal clip. Then place a silicon crystal between the contact springs and replace the cap.

To a telephone receiver connect long wire cords equipped at the ends with metal clips. Snap the push button detector clips on the receiver posts, and snap one telephone cord clip on one line connection of a telephone or telegraph or on any wire going over a house or stretched in the air. Hold the other clip in the palm of the hand. Thus, by using the human body as a capacity, wireless telegraph or telephone messages can readily be heard without interference.

Do not connect the clip held in the hand to any grounded pipe or connection without using a condenser.

A **tuning coil** is necessary to separate messages when several stations are sending at the same time, but a good operator can sometimes read through interference without it.

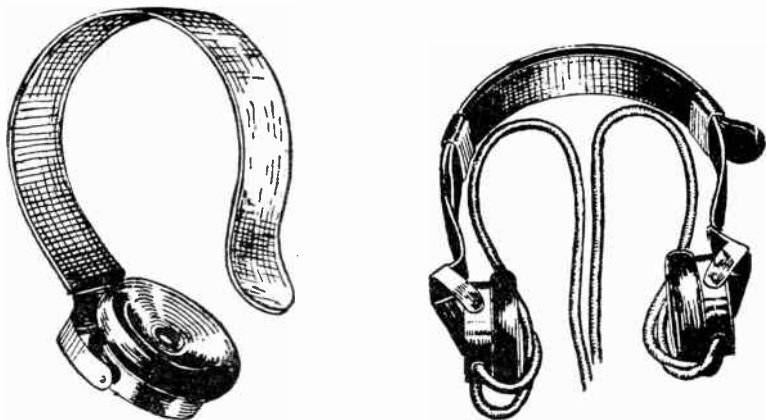

FIGS. 3,186 and 3,187.—Single and double wireless receivers. These are not necessarily different from any head telephone or watch case receiver except that they are constructed so as to be most sensitive. The thinnest ferrotype diaphragms are used and the smallest copper wire. Where two are used they are connected in parallel and their cases held by a leather head band.

A **variable condenser** may be connected in series between the detector and the tuning coil inductance or the fixed condenser may be used in this way and the variable condenser shunted around the inductance. If an inductively coupled tuner be used, one variable condenser may be connected in parallel around the primary and another shunted around the secondary and the fixed condenser connected in series with the variable secondary inductance and the detector. **The telephones** should be equipped with a head band and shunted around either the condenser or the detector.

It is even possible to receive without a ground with a crystal detector. For this purpose a four wire aerial is used, two wires of which are connected to telephone receivers and the other two wires

connected to a detector stand. The other side of the receivers and the detector stand are connected in series with a battery and rheostat.

For sending, a spark coil and key and some source of battery supply of current are all necessary. The helix may or may not be used for short distance work, but when there is liable to be government or commercial interference the transmitted wave must be tuned to a definite wave length. Any transmitting set that is capable of sending messages into another state must be licensed by the U. S. Government.

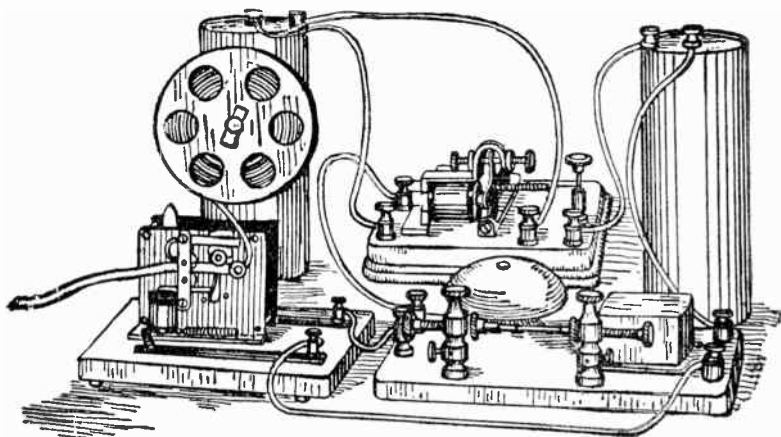

FIG. 3,188.—Wireless recorder outfit. This shows the picture of a coherer connected to a telegraph relay. This will close a local circuit when the relay armature is drawn against the inner contact and will operate the telegraph ticker shown or any other apparatus, even to the lighting of lights or the starting of machinery. In this way torpedo boats and submarines may be controlled by a wireless transmitting station if the boats be equipped with a coherer set for receiving and closing the circuit. Also a decoherer is used to tap the coherer and break the circuit. This has not been developed to a commercial success because of the delicate adjustment required for the coherer and the liability to interference by foreign disturbances. In the European war the system has played no important part.

In order to get a white hot spark across the spark gap a high tension condenser must be used. If more than one condenser be used the condenser units or banks should be connected in parallel.

The battery and key are connected to the primary winding of the spark coil and the spark gap is connected across the secondary winding, as is also the condenser. Then if the helix be used, it is connected between the aerial and one end of the secondary, the other end being

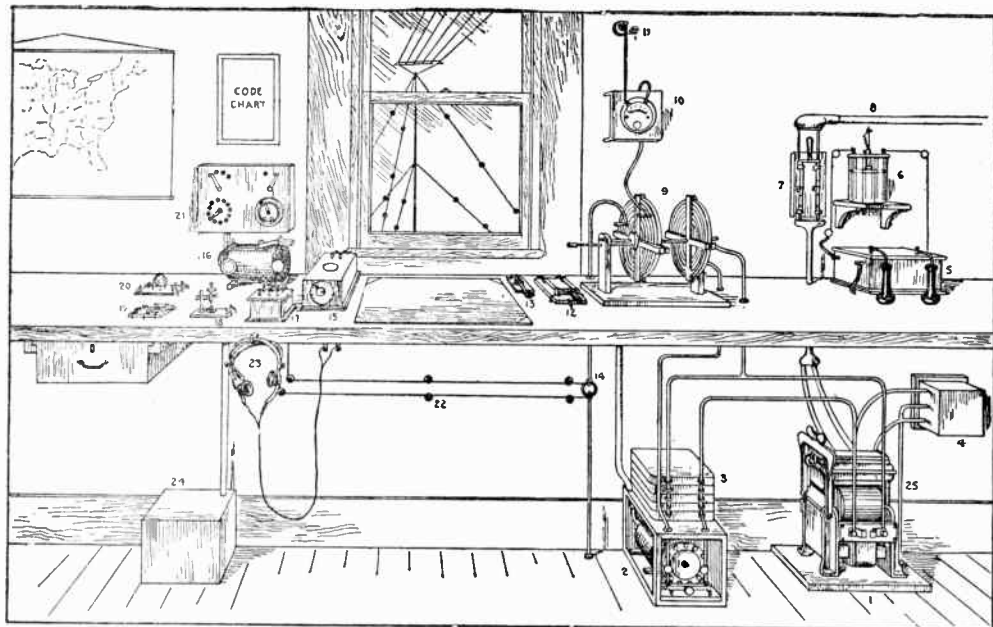

Fig. 2,3189.—Modern amateur wireless station. 1, Thordarson flexible transformer on slate base; 2, rotary spark gap in box with glass side and end; 3, Murdock moulded sending condenser units; 4, Clapp-Eastman kickback preventer; 5, Electro Importing Co.'s $\frac{1}{2}$ kw. transformer; 6, Gernsback electrolytic interrupter; 7, 25 ampere D P S T power switch; 8, power supply, A. C. or D. C. (in conduit); 9, oscillation transformer; 10, Brandes hot wire ammeter; 11, Electrose lead-in insulator; 12, 25 ampere D P S T switch controlling current to transformer and rotary spark gap motor; 13, Marconi wireless key; 14, anchor gap in ground wire circuit; 15, Gernsback rotary variable condenser; 16, Clapp-Eastman navy type tuner; 17, fixed condenser; 18, silicon detector; 19, 10 ampere 3 P D T switch for detectors and receivers; 20, De Forest audion detector bulb; 21, battery switchboard for audion; 22, leads from anchor gap to receiving set; 23, head receiver set; 24, battery box containing battery cells for audion lamp and head telephone receivers; 25, kickback ground wire.

connected to the ground. This gives an open circuit. But the closed circuit is more effective and consists of the same apparatus differently connected.

The **spark gap** is placed in series between the helix and one end of the secondary and the other end is connected to the helix adjustable clip. The condenser is hunted across the secondary winding. The helix is also connected between the aerial and ground. This gives a closed circuit with sustained oscillations.

In operation, the telegraph key is depressed which sets up a transforming action between the primary and secondary windings of the coil. The high tension current flows through the helix and charges the condensers. One side of the condenser receives the greater amount of the charge and the other side the lesser, until the strain becomes too great for the condenser capacity and the discharge takes place across the spark gap. Thus an oscillatory charging action is kept continually surging back and forth.

These oscillations surge up and down the aerial and disturb the ether of space. Where the helix is connected in series with the aerial the oscillations are unsustained and have very short range since they are only set up by one crash of the spark, but where the helix is connected across the transmitting set between the aerial and ground, the circuit is said to be a closed circuit and the oscillations are sustained. These are capable of breaking down the more distant detecting device and susceptible of tuning.

Apparatus for experimental work can be purchased for so small an amount that it is unnecessary to give directions for the construction of home made apparatus.

Wireless Telephony.—Various experiments have been made from time to time to make wireless telephony a practical success, and for distances of about one hundred miles articulate speech has been transmitted by several different experimenters, but so far it has not come into commercial use. Much more experimenting is necessary before it will be possible to use the wireless telephone to any great extent.

De Forest was perhaps the first experimenter to develop a complete wireless telephone transmitting and receiving system, but previous to that A. F. Collins had worked out an "arc" telephone which permitted communication for some miles without wire connections.

The Marconi Company has combined the various schemes of wireless talking and developed a commercially practical wireless telephone system which may be used by the public in the near future.

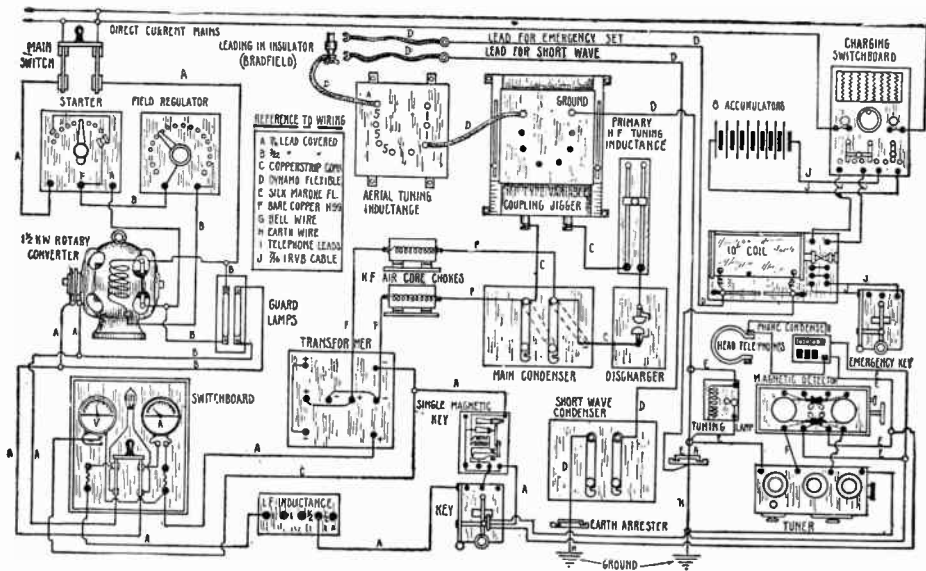
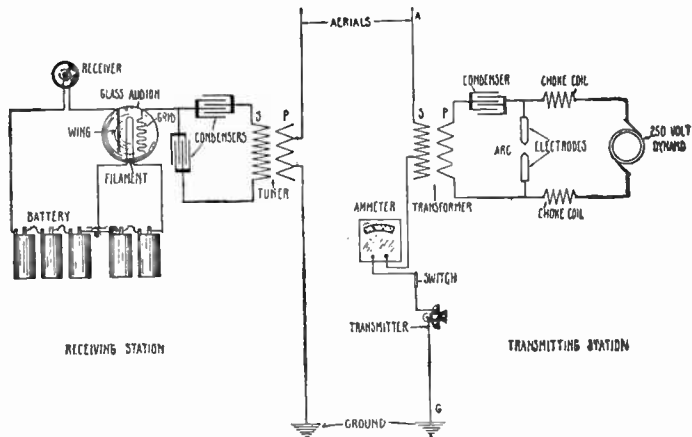

FIG. 3,190.—Marconi break-in system with parallel receiving tuner. For transmission a rotary converter supplies alternating current. The direct current motor circuit consists of a motor, starter and field regulator and connecting switches. The low tension alternating current circuit consists of primary of the transformer, special break-in key, ampere meter and impedance coil. The high tension alternating current circuit consists of secondary of the transformer, two air core choke coils, spark gap and condenser. The primary high frequency circuit consists of condenser, spark gap, primary of oscillation transformer and variable inductance all connected in series and forming a closed oscillation transformer circuit. The main condenser units are changed from parallel to series connections by throwing the double connecting blades according to the dotted lines. As shown they are in parallel for 600 meter wave length. As per dotted lines they are in series for 300 meter wave length. The secondary high frequency circuit consists of variable tuning inductance, secondary of oscillation transformer, antenna and ground circuit in which is interposed a special form of spark gap called an earth arrester. Across this the receiving circuit is connected. For receiving use is made of the magnetic detector in connection with its condensers which makes it a parallel tuner. Near this tuner is the emergency key which operates the emergency set. This consists of spark coil, key and storage battery. The storage battery is charged by manipulating the charging switchboard.

In many respects the wireless telephone resembles the wireless telegraph, but the actual operation is quite different.

With wireless telegraphy the key is depressed and a cycle of transformation produced whereby a wave motion is set up in the ether, but this wave motion is inadequate for wireless telephone transmission owing to its periodic damping character. The human voice, or sound waves produced thereby, range from 5,000 to 10,000 variations a second, and if it be attempted to impress these on a damped oscillation wave, the periodic character would destroy all characteristics of speech.



FIGS. 3,191 and 3,192.—Diagrams showing receiving and transmitting wireless telephone stations. The dynamo supplies direct current to the transmitting arc which produces high frequency oscillations in the transformer. A telephone transmitter and hot wire ammeter are connected between the ground and the transformer secondary coil. By talking into the telephone transmitter undamped oscillating waves are transmitted and recorded in the audion receiver. By placing the telephone receiver to the ear the sounds produced in the telephone transmitter can be heard.

Hence, it is necessary to produce a sine wave, or one that will remain constant and undamped, for wireless telephony, on which the voice can be impressed, the break being sufficiently rapid to keep synchronous with the vibrations of the human voice.

It is necessary to use the fastest rotated generator possible, as a supply of current; one with a frequency of more than 10,000 cycles per second is admirably adapted for wireless telephone transmission and should be of direct current output. This direct current flows through choke coils as indicated in fig. 3,192 to two electrodes between

which an arc is formed. One electrode is carbon and the other is copper, and the arc works best when burnt in the vapor produced by the flame of an alcohol torch.

The high frequency currents produced pass through the primary of the transformer, a condenser being interposed in the circuit. The secondary of the transformer is connected with the antenna and through a special telephone transmitter and ammeter with the ground. A switch is interposed in this ground circuit to cut out the sound produced in the transmitter.

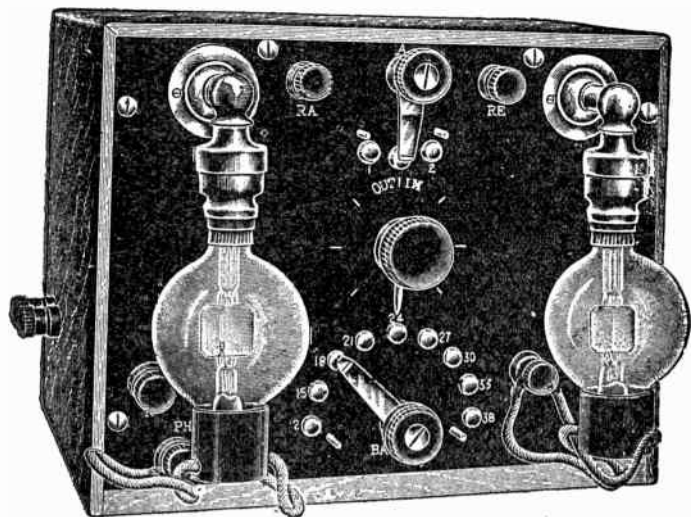

FIG. 3,193.—Professional type of audion detector. It is provided with two super-sensitive Audion Bulbs, high voltage local battery, potentiometer switch graduated to show voltage at any point, switch to change from one bulb to the other, and rheostat to change brilliancy of filament. This detector is used by the U. S. Army and navy, and is furnished in oak and hard rubber; size, 9¼ by 9 by 7 inches. Three dry cells to light filament are necessary.

In receiving, the audion detector is used, although crystal and electrolytic detectors are capable of receiving wireless telephone messages. Almost any wireless telegraph receiving system is capable of receiving wireless telephone conversation, so that it is the transmitting apparatus that must still be developed.

Fig. 3,193 shows a picture of an audion receiving set. It may be used in connection with any other kind of detector and with one or two individual audion bulbs.

Transmission of Pictures by Wireless.—When it becomes commercially practical to write and send pictures by wireless it is possible that typewriting and typesetting may be accomplished in the same way. But unfortunately the coherer has to be resorted to in these experiments and is liable to too much interference to properly work the relays.

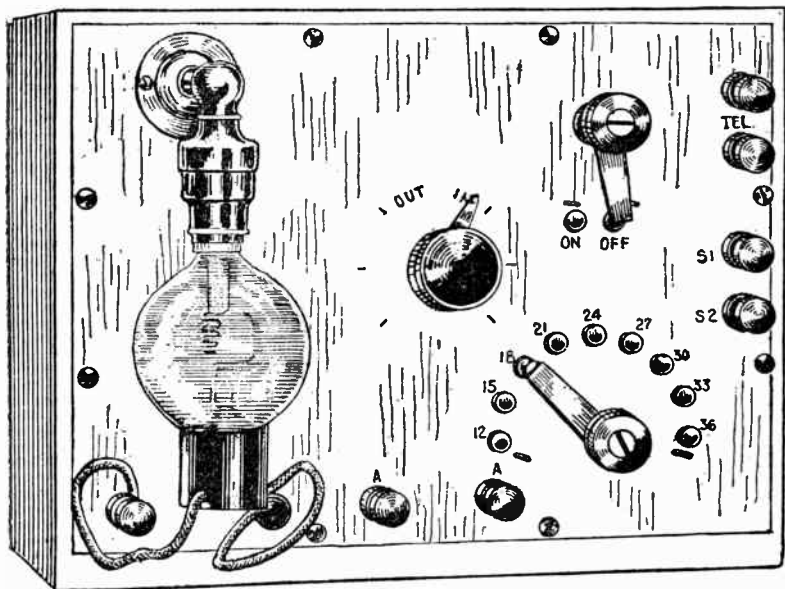

FIG. 3,194.—Amateur type of audion amplifier. This is an instrument which is used in connection with any detector, preferably an audion detector, for increasing the intensity of received signals from 5 to 10 times. It is not a detector itself in any way. Through its use, messages can be read clearly which otherwise cannot be even heard. Its use enables the operator to receive over ranges which are not otherwise possible. This type of audion amplifier will remain in adjustment indefinitely, like the audion detector, and is not appreciably affected by mechanical vibration.

However, it is possible to send pictures by sending wireless dots and dashes.

A series of dots following one another closely or some transmitted dashes represent a dark line, and dots further apart, a

light line, so that a revolving cylinder at the receiving station, when covered by paper and brought in contact with a soft pencil may reproduce a picture transmitted.

It is apparent that some time and also some interference must be encountered, and difficulty in keeping the automatically operated stations in synchronism.

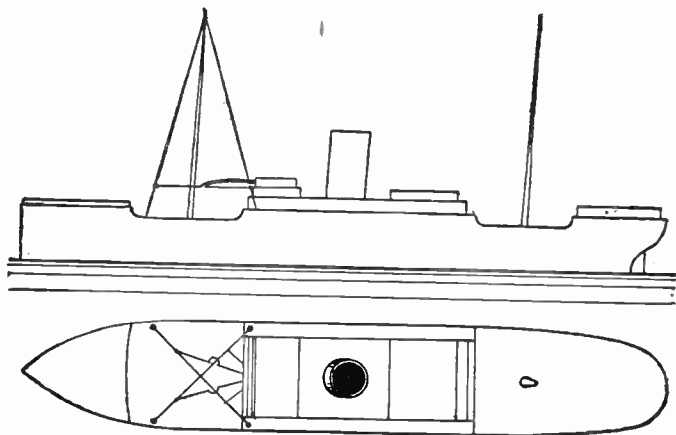

FIGS. 3,195 and 3,196.—Elevation and plan of ship showing receiving aerials of wireless compass. The receiving aerials consist of two equal triangles, each formed by a single wire, placed so their planes are exactly at right angles.

Marconi Wireless Directive System.—The Marconi Co. has installed on some boats equipped with a directive wireless system which makes it possible to tell the exact direction from which distress signals or other radio messages are sent out. This set consists of a *radio-goniometer*, the circuit of which is shown in figs. 3,195 and 3,196 an *angle divider*, a *tuned receiver* and a *test buzzer*.

Aerial wires distinctly different from the regular antennæ are required for this "wireless compass." Two loops of wire of equal size, suspended

vertically and crossing each other at right angles, as shown in fig. 3,197, are essential. The four ends of these wires are fastened with insulators to stanchions at the sides of the ship. Four connecting wires are taken to the instruments from the centers of the four vertical wires and connected by a switch to the binding posts of both the sending and receiving sets.

The radio-goniometer transmitter consists of two equally wound coils of wire fixed vertically and at right angles. In the open center space between these stationary coils is fitted a single movable coil, circular in shape and revolving on a vertical axis.

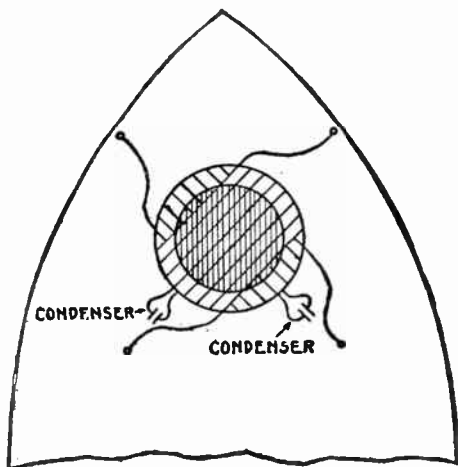

FIG. 3,197.—Radiogoniometer of the wireless compass. This consists of two equally wound coils fixed vertically and at right angles. In the space enclosed by these coils is fitted a single movable coil working on a vertical axis, which is called the exploring coil.

A circular scale calibrated from 0 degree which means "ahead" to 180 degrees, which represents "astern" shows the position of the center exploring coil.

The two condensers shown inserted in the centers of the stationary coils which are divided to receive them are used for tuning the aerials to the required wave lengths.

The angle finder is of a similar construction and is used for receiving. It does not give one absolute direction, for the position of a station but two possible directions which are exactly opposite to each other.

Each triangular loop of the aerial makes it directive both for sending and receiving.

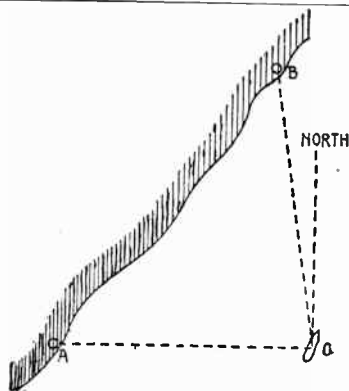

FIG. 3,198.—Method of locating ship, two coast stations being within range: The direction of the stations having been found and read as angles to the ship's axis, a line representing the course is drawn on the chart and with this line the two read angles are drawn so as to pass through the land stations, A and B; the intersection of the line gives the ship's position.

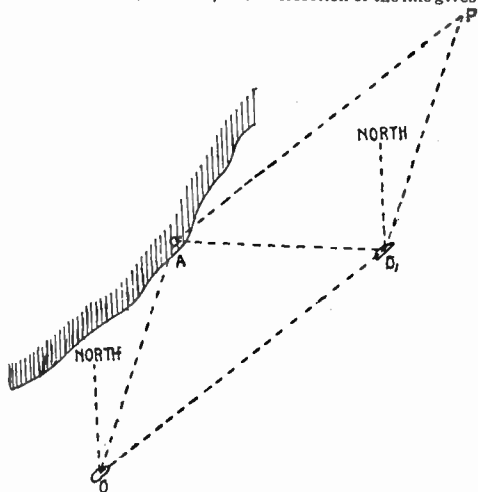

FIG. 3,199.—Method of locating ship, one station being within range: The direction OA is found as an angle with the ship's course, the ship then proceeds for, say half hour at a known speed in the direction OO_1 . A second reading is now taken, and the position worked out as follows: A line to represent the course is drawn on the chart; a line, AP is drawn parallel to the course and equal to the distance covered in the intervening time between the readings. Lines for the station A , making the read angles with the course as drawn, then from P , a line is drawn parallel to the first line OA . The intersection of this line with the second line AO_1 , gives the required position.

The system is based on the principle that *only when two wires are in the same plane does electromagnetic induction take place*. It not only allows a vessel to locate the position of another boat but also enables a vessel to locate its own position.

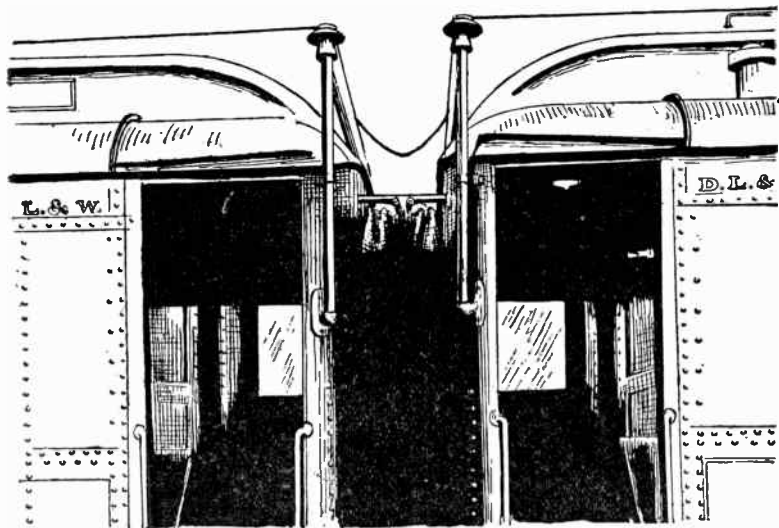

FIG. 3,200.—Train dispatching by wireless. The Marconi Wireless Telegraph Co., has installed three radio stations along the Lackawanna Railroad and equipped the train known as the Lackawanna Limited with wireless for train dispatching. One of the stations is at Scranton, Pa., another at Binghamton, N. Y., and another at Hoboken, N. J. The latter is within instant communication with Marconi stations in New York City day or night. All of these are equipped with regular land-station apparatus and their construction did not involve the difficult problems that presented themselves in the train equipment. The illustration shows a picture of the way the aerial wires are strung from car to car, which may easily be disconnected. The ground connection was a problem solved by connecting it to the frame of the trucks and sending the ground current to the rails through the wheels.

Gen. Squier's "Wired Wireless."—Gen. Squier of the U. S. army some years ago gave to the public a system of "wired wireless" which he had developed whereby it is possible to telegraph or telephone on a single wire for any distance.

The wire is like a single wire aerial connected to a high frequency generator. Since high frequency current travels on the surface of a wire there is practically no resistance to the circuit and telephone conversation may be carried on over an unlimited distance providing a single wire connects the two stations.

Although this has been developed into a duplex telephone system it is hardly adaptable to the commercial telephone system of today and so has not been used by the public. It offers a field for new inventions and improvements in the electrical industry.

CHAPTER LXXI

ELECTRIC BELLS

This subject is an important one, considering the multiplicity of bells in use, and the varied uses to which they are put, also the numerous ways in which they may be connected in circuit.

To meet the various requirements, several forms of electric bell have been devised, and accordingly they may be classified:

1. With respect to the ringing feature, as

- a.* Trembling or vibrating;
- b.* Single stroke;
- c.* Combination vibrating and single stroke;
- d.* Continuous ringing;
- e.* Buzzers.

2. With respect to the magnet winding, as

- a.* Series winding;
- b.* Shunt winding;
- c.* Differential winding;
- d.* Combined differential and alternate winding;
- e.* High voltage winding;
- f.* Alternating current winding (polarized).

3. With respect to the form of the interrupter, as

- a.* Contact breaker;
- b.* Contact maker.

4. With respect to the magnet, as

- a. Single magnet;
- b. Double magnet;
- c. Four magnet (double acting).

5. With respect to the frame, as:

- a. Skeleton;
- b. Iron box;
- c. Wooden box.

6. With respect to the mode of operation, as

- a. Single acting;
- b. Double acting;
- c. Electrical-mechanical;
- d. Relay.

Trembling or Vibrating Bells.—This form of bell is perhaps more extensively used than any other. It consists, essentially, of: 1, an electromagnet, 2, pivoted armature, 3, hammer, 4, contact breaker, 5, bell, and 6, frame, as shown in fig. 3,201.

Ques. Explain the operation of the series bell.

Ans. When the terminals are connected to a cell or other source of electricity, current flows through the magnet and attracts the armature, causing the hammer to strike the bell. During this movement, the contact breaker spring moves out of contact with the contact screw, thus breaking the circuit and demagnetizing the magnet, whereupon the hammer, influenced by the hammer spring moves back to its initial position, thus completing the cycle. This series of events is repeated with great rapidity so long as the terminals are connected to the cell, thus producing rapid vibrations of the hammer.

The cycle thus described may be briefly stated as follows:

1. *Current magnetizes the electromagnet;*

2. Magnet attracts armature causing hammer to strike bell;
3. Circuit breaker breaks the circuit;
4. Magnet loses its magnetism;
5. Hammer returns to its initial position.

Ques. What governs the rapidity of vibration of the hammer?

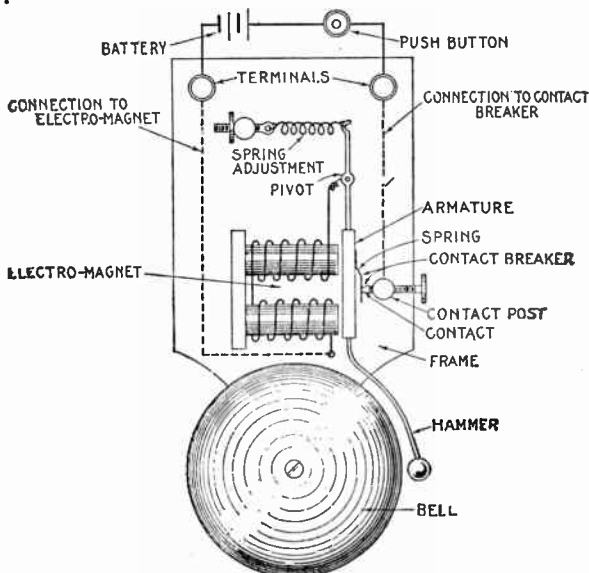

FIG. 3,201.—Elementary series vibrating bell. It consists of an electromagnet, armature, contact breaker, pivoted hammer, bell, and frame. *In operation*, when the terminals are connected with a cell or other source of electricity, the current energizes the magnet which attracts the armature causing the hammer to strike the bell, but before it reaches the end of the stroke, the contact breaker breaks the circuit and the hammer, influenced by the tension of the armature spring rapidly moves back to its initial position thus completing the cycle.

Ans. The adjustment of the contact.

When the contact is so adjusted as to give a large amplitude, the rapidity of vibration is small as compared with close adjustment giving less amplitude and more rapid vibration.

NOTE—The series of cuts representing various elementary bells are intended to illustrate *principles*, metallic circuits being shown for simplicity. *It should be noted that in construction*, the metal frame of the bell is used as a "ground" or return instead of a separate wire.

Ques. What is the object of the contact breaker spring?

Ans. It prolongs the contact, absorbs the momentum of the armature on its outer swing, and returns it to the armature in the form of a kick which assists the magnetism in attracting the armature.

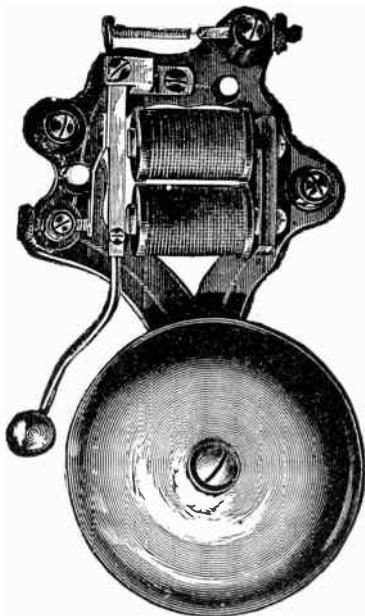

FIG. 3,202.—Bunnell vibrating bell. It has a skeleton type frame, pivoted armature, cast gong, and platinum contacts. Made in sizes 2½ inch to 12 inch.

Proportion of Parts.—The table given on the next page conveys a general idea of the proportions which should be adopted in the construction of bells of various size. It should be noted that if they are to be used for longer than the usual distances, the magnets should be wound with a finer gauge of wire than specified in the table, unless relays be used.

TABLE SHOWING PROPORTION OF PARTS OF ELECTRIC BELLS

Diameter of bell	Length of magnet cores	Diameter of magnet cores	Length of bobbin	Diameter of bobbin head	B. W. G. of wire on bobbin
2½"	2"	$\frac{5}{16}$ "	1¾"	$\frac{3}{4}$ "	24
3	2¼	$\frac{3}{8}$ "	2	$\frac{7}{8}$ "	24
3½	2½	$\frac{7}{16}$ "	2¼	1	22
4	2¾	$\frac{1}{2}$ "	2½	1⅛	22
4½	3	$\frac{9}{16}$ "	2¾	1¼	20
5	3¼	$\frac{5}{8}$ "	3	1⅜	18
5½	3½	$\frac{11}{16}$ "	3¼	1½	16
6	3¾	$\frac{3}{4}$ "	3½	1⅝	16
6½	4	$\frac{13}{16}$ "	3¾	1¾	16
7	4¼	$\frac{7}{8}$ "	4	1⅞	16
7½	4½	$\frac{15}{16}$ "	4¼	2	14
8	4¾	1	4½	2⅛	14
8½	5	$1\frac{1}{16}$ "	4¾	2¼	14
9	5¼	$1\frac{1}{8}$ "	5	2⅜	14
9½	5½	$1\frac{3}{16}$ "	5¼	2½	14
10	5¾	$1\frac{1}{4}$ "	5½	2⅝	14
10½	6	$1\frac{5}{16}$ "	5¾	2¾	12
11	6¼	$1\frac{3}{8}$ "	6	2⅞	12
11½	6½	$1\frac{7}{16}$ "	6¼	3	10
12	6¾	$1\frac{1}{2}$ "	6½	3⅛	10

Single Stroke Bells.—This type of bell, as its name implies, is one which gives only a single tap each time the battery is connected in circuit. Such operation is often desirable, as in signalling with a code.

Ques. How does the single stroke bell differ from the vibrating bell?

Ans. It differs in the mode in which the electromagnet is connected to the terminals, and also in the fact that there is no interrupter, there being two limiting stops.

Ques. Explain the operation of the single stroke bell.

Ans. When the terminals are connected with the battery,

the current energizes the magnet and attracts the armature causing the hammer to strike the bell. The armature remains in the attracted position so long as the current flows through the magnet. When connection with the battery is broken, the hammer spring pulls the armature back against M, as in fig. 3,203.

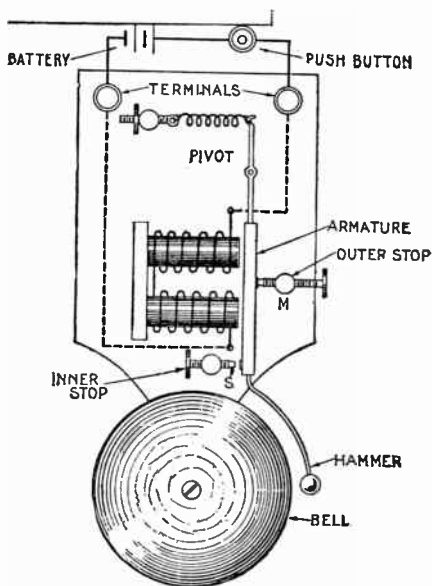

FIG. 3,203.—Elementary series single stroke bell. It is identical with the vibrating bell as shown in fig. 3,201, excepting that the magnet winding is connected direct to the terminals, and that there is no interrupter. The latter is not needed because the circuit is not broken during operation.

Ques. How is the hammer prevented remaining in contact with the bell during the time the armature is attracted by the magnet (fig. 3,203)?

Ans. A stop S is so adjusted that it arrests the motion of the armature before the hammer strikes the bell, the momentum attained at the instant the armature strikes the stop being

sufficient to cause the hammer to overcome the spring action of the lever and hit the bell, the lever causing the hammer to spring back out of contact with the bell.

As sometimes constructed, the stop S is made non-adjustable, or is omitted, in which case adjustment is made by pressing the armature up against the stop, or the cores, and then bending back the hammer lever until the hammer just clears the bell.

Ques. What names may be given to the stops to distinguish them?

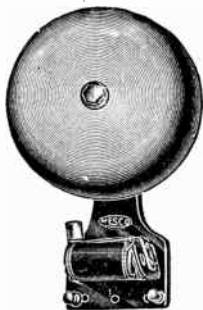

FIG. 3,204.—Mesco single stroke bell. The hammer rod has a short leverage but a long sweep, thus enabling it to give rapid and powerful blows. A stiff flat spring causes the hammer to leave the bell immediately after striking. The magnets of this bell are regularly wound for 6 ohms, and special for incandescent lighting circuit. Sizes 3 to 18 inch.

Ans. The stops M and S (fig. 3,203) may be called the *outer* and *inner* stops respectively.

Combination, Vibrating and Single Stroke Bells.—This type of bell is simply a combination of the two bells just described, as the classification indicates. Any vibrating bell may be made single stroke by bringing out a third connection so that the current may pass through the magnet without traversing the interrupter.

Ques. Describe a combination vibrating and single stroke bell.

Ans. All the essential features are shown in fig. 3,205. A combination vibrating and single stroke bell is simply a vibrating bell with a third connection and an inner stop as shown.

Ques. How may a vibrating bell be made single stroke for temporary use.

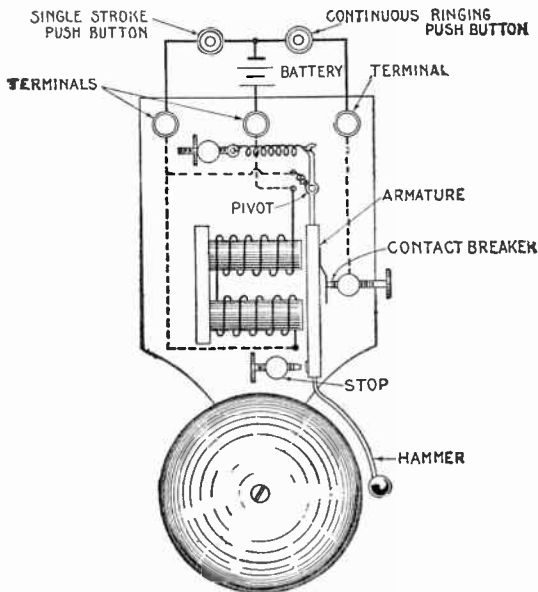

FIG. 3,205.—Elementary combination vibrating and single stroke bell. It is essentially a vibrating bell as shown in fig. 3,201 with a third terminal, and a stop to prevent continued contact of the hammer with the bell when working single stroke.

Ans. By adjusting the contact breaker spring so that it does not open the circuit.

Shunt or "Short Circuit" Bells.—In this form of bell the current, during operation, is not broken, but as the magnet

attracts the armature, the current is shunted or short circuited, and thus being offered a path of very little resistance as compared with that of the magnet winding, most of the current flows through the short circuit.

Since this reduces the magnetism to such a small amount that the attraction of the magnet becomes less than the pull of the hammer spring, the hammer swings back to its initial position.

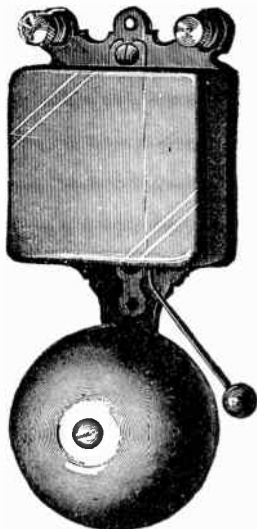

FIG. 3,206.—Bunnell iron box bell. The protection thus secured excludes dust and protects the working parts from injury in exposed places. The armature is pivoted and has adjustable contacts. The resistance of the winding is 4 to 5 ohms.

Ques. Name the essential parts of a shunt bell.

Ans. 1, An electromagnet, 2, armature, 3, pivoted hammer, 4, contact maker, 5, outer stop, 6, bell, and 7, frame.

Ques. Explain in detail the operation of a shunt bell.

Ans. The parts are assembled and connected as in fig. 3,207. In operation, when the terminals are connected to a cell, current energizes the magnet and attracts the armature, causing

the hammer to strike the bell. During this movement the contact maker makes contact and short circuits the current. The short circuit, thus established, being of very low resistance as compared with the resistance of the magnet, practically all the current flows through the short circuit and the magnet loses

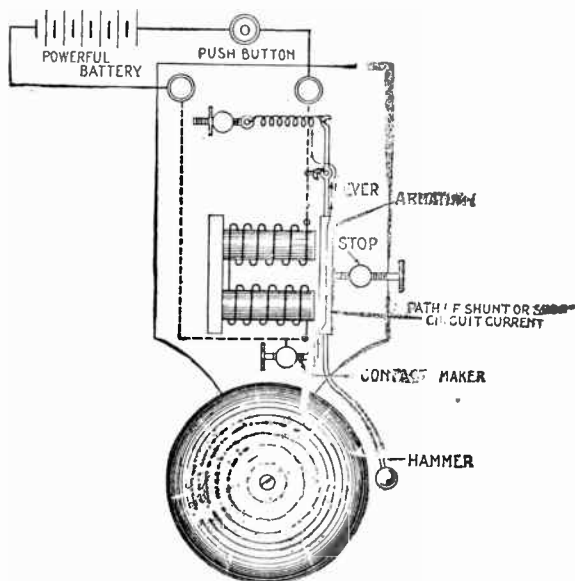

Fig. 3,207.—Elementary shunt or "short circuit" bell showing path through contact maker, armature, and lever of shunt or short circuit current. This bell differs from the simple vibrating bell of fig. 3,201, in that it has a contact maker instead of a contact breaker, an outer stop, and modified connections as shown to shunt or short circuit the current.

practically all of its magnetism, thus the pull of the hammer spring overpowers the magnet and the hammer returns to its initial position. During this backward swing, the contact maker breaks the short circuit completing the cycle. These series of events are repeated with rapidity so long as the terminals are connected to the cell, thus producing rapid vibrations of the hammer.

The cycle thus described may be briefly stated as follows:

1. *Current magnetizes the electromagnet;*
2. *Magnet attracts armature;*
3. *Contact maker short circuits the current;*
4. *Magnet loses practically all of its magnetism;*
5. *Momentum acquired by moving element causes hammer to strike bell;*
6. *Tension of the hammer spring overcomes weak magnetism of magnets and pulls armature away from magnet;*
7. *Near end of outward swing, contact maker breaks circuit;*
8. *Current again magnetizes the magnet;*
9. *Momentum acquired by the moving element causes it to continue its outward swing (against the attraction of the magnet) to the stop.*



FIG. 3,208.—Partrick and Wilkins emergency gong. It operates single stroke by hand, and vibrating by battery; used by hand in emergency in giving alarms or signals. This style of bell is used for school house work.

Ques. For what conditions of operation is the shunt bell suitable, and why?

Ans. It is suitable for higher voltage than is used on the ordinary vibrating bell because it will operate with less sparking.

Ques. For what kind of circuit is the shunt bell suitable?

Ans. For circuits in which other resistances prevent any great rise in current.

Ques. For what services are shunt bells adapted?

Ans. They are often used when two or more are to be connected in series.

Ques. What modification is necessary to render an ordinary shunt bell both single stroke and vibrating?

Ans. A switch is added and the circuit wired as in fig. 3,209.

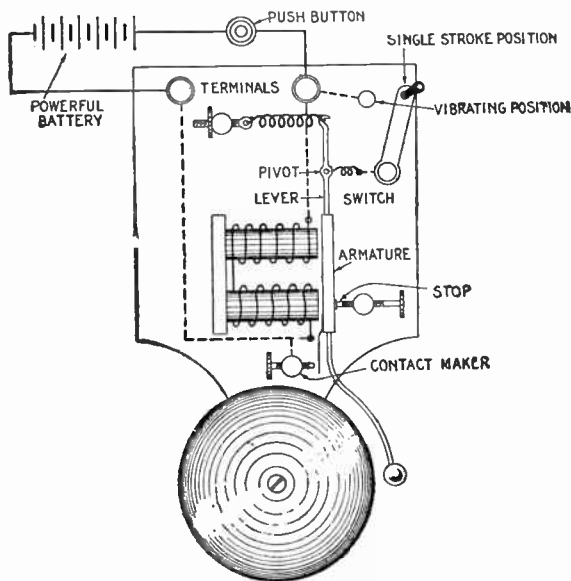

FIG. 3,209.—Elementary shunt or short circuit, combination vibrating and single stroke bell. This is simply an ordinary shunt bell with a switch arranged so that the short circuit through the contact maker, armature, and lever may be cut out, thus restricting the current to the magnet winding.

Continuous Ringing Bells.—This classification represents a form of vibrating bell, provided with a suitable attachment for maintaining the circuit after it has been once established by pressing the push center, regardless of the fact that the latter may be only momentarily held in the closed position.

There are three types of continuous ringing bell, classified with respect to the circuit maintaining device, as those with

1. Mechanical circuit maintainer;
2. Electrical circuit maintainer;
3. Combination mechanical and electrical circuit maintainer.

Ques. Of what does the first mentioned form of continuous ringing bell consist?

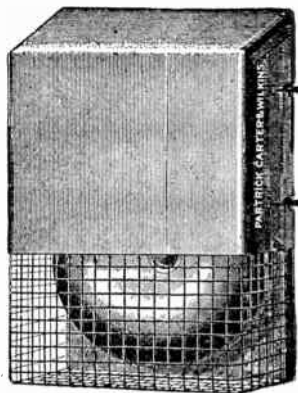

FIG. 3,210.—Patrick and Wilkins outside bell cover; used for the protection of large bells when they are located in exposed places. Made suitably for use with skeleton bells from 8 to 12 inches.

Ans. It comprises a simple vibrating bell fitted with a mechanical circuit maintainer and connections as in fig. 3,211.

Ques. Describe its operation.

Ans. When the external circuit which includes a battery is closed by a momentary pressure on the push button, the path of the current is via terminals B and C. On the swing of the armature toward the magnet the circuit maintainer trips and its spring causes it to move to the continuous ringing position, thus switching terminal A wire to contact breaker via trip

lever. With this circuit it is evident that the bell will continue ringing irrespective of whether the push button be held down or released, and also that the ringing will continue until the circuit maintainer is reset in its initial or open position by a pull on the manual control cord.

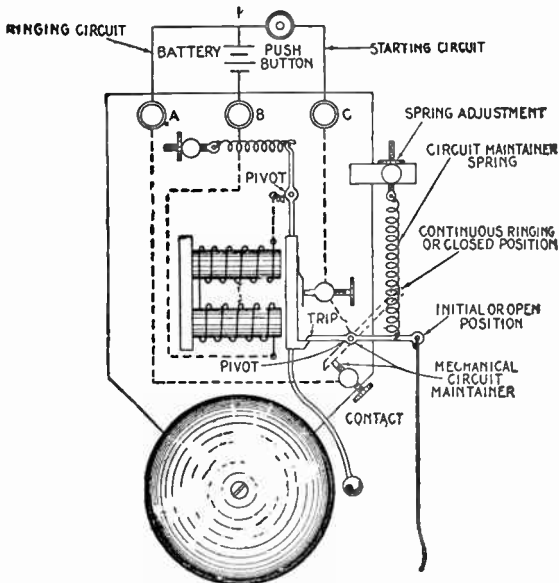

FIG. 3.211.—Elementary continuous ringing bell with *mechanical circuit maintainer*. It is essentially an ordinary vibrating bell fitted with a mechanical circuit maintainer and connections as shown. The circuit maintainer consists of a lever pivoted at its center and engaging with a lug on the armature, the two forming a trip which is released by a movement of the armature, a spring being provided to cause the lever to quickly move to the dotted or closed position. The circuit maintainer is simply an automatic switch controlled by the bell armature and whose function is to connect the bell directly with the battery and maintain the connection until reset by pulling the manual control cord.

Ques. For what service is the continuous ringing bell desirable?

Ans. It is used for burglar alarms, watchman's alarms, etc.

In the latter case the continued ringing gives notice that the watchman is not attending to his duty.

Ques. Describe the operation of a continuous ringing bell with an electrical circuit maintainer.

Ans. The essential parts are shown in fig. 3,212. In operation, when the *starting circuit* is closed by depressing the push button, current flows through the solenoid and draws down the plunger, thus **closing** the ringing circuit. The bell will now ring until the ringing circuit is broken by pushing up on the manual

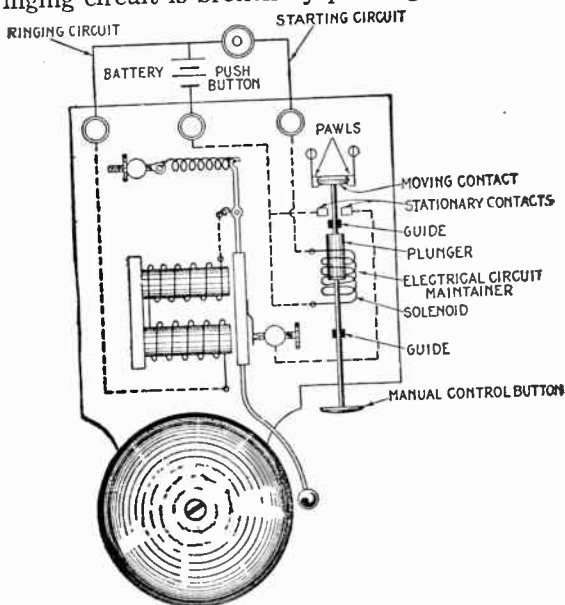

FIG. 3,212.—Elementary continuous ringing bell with electrical circuit maintainer. It consists of an ordinary vibrating bell fitted with a solenoid operated switch which remains in the closed position until reset by hand.

control button. To reset the circuit maintainer the manual control button is pushed upward until the moving contact rises above the pawls and the latter spring back to their normal (vertical) position, then the weight of the moving element is held by the pawls.

The circuit maintainer is shown in several positions in figs. 3,213 to 3,216, which illustrate in detail the action of the pawls.

Ques. Of what does the third mentioned class of continuous ringing bell consist?

Ans. It is simply an ordinary bell with a mechanical circuit maintainer which is controlled by a separate magnet instead of by the bell magnet.

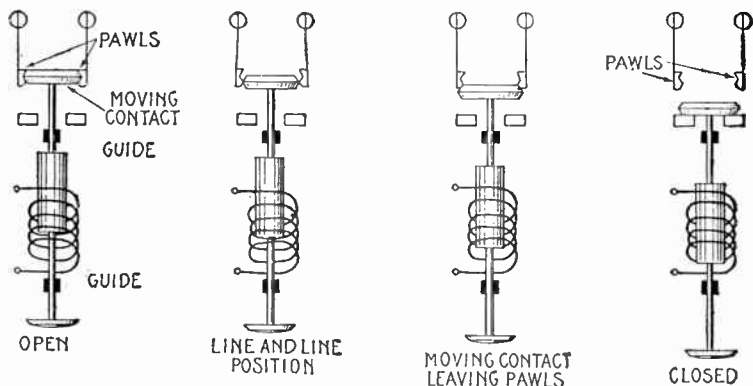

FIGS. 3,213 to 3,216.—Detail of electrical circuit maintainer showing progressively its action. Fig. 3,213 shows the moving contact engaged by the pawls. In Fig. 3,214, the solenoid has pulled the moving contact downward to the *line and line* position, that is to say, to a point where the edge of the moving contact registers with the lower contact edge of the pawls, which have been moved to the limit of their outward travel. As the motion continues past this point, the spring action of the pawls assists the solenoid in pushing the moving contact downward, as shown in fig. 3,215, the pawls returning to their original position as the moving contact slides past the pawls. In fig. 3,216 the moving contact has dropped into contact with the stationary contact, the motive force being due to both gravity and the pull of the solenoid. By considering the illustrations in the reverse order, the operation of resetting the device by pushing upward on the manual control button is clearly depicted.

Fig. 3,217 shows a design for a continuous ringing bell with an electro-mechanical circuit maintainer. The details and operation of this bell are clearly described under the figure and the operation of the controlling device is progressively shown in figs. 3,218 to 3,220.

Buzzers.—A buzzer may be defined as *an electric call signal which makes a buzzing noise caused by the rapid vibrations of it*

contact breaker. It operates on the same principle as the electric bell and can be adjusted to emit a pleasing musical hum.

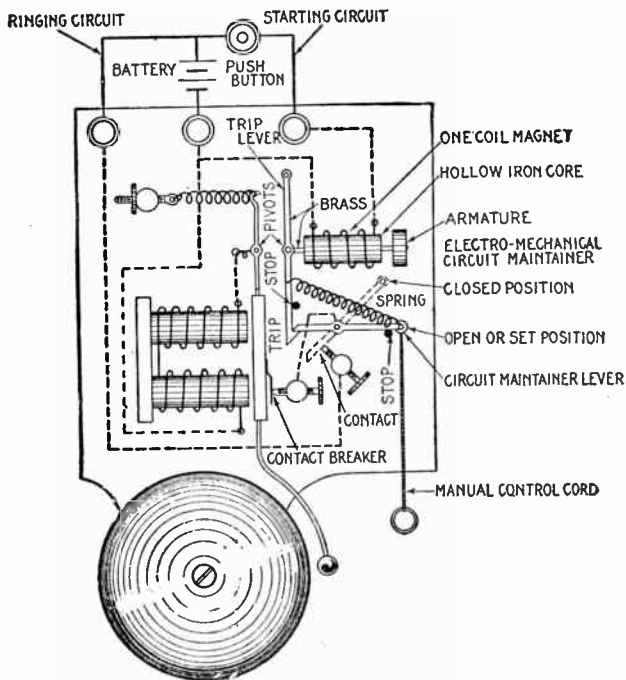
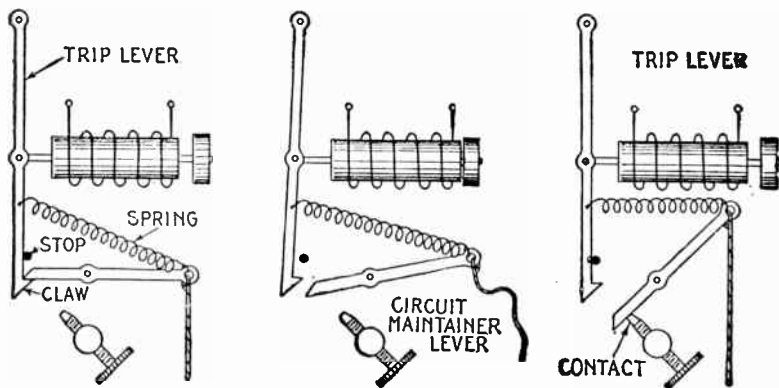

FIG. A,217.—Elementary continuous ringing bell with *electro-mechanical circuit maintainer.* The electrical part of the circuit maintainer consists of a single coil electromagnet which is connected to a tripping device as shown. The armature of the single coil magnet is mounted on a brass rod which passes through the center of the core and is pivoted to the trip lever also of brass. The trip lever, when the device is in the open or "set" position engages with one end of the circuit maintainer lever, being held in this position by a spring connected to the two levers as shown. *In operation,* when the starting circuit is closed by depressing the push button, current energizes this one coil electromagnet attracting the armature which disengages the trip. The spring snaps the circuit maintainer lever over to the closed position as shown by the dotted lines, the trip lever being drawn back by the spring against the stop when the push button is released. The bell beginning to ring as soon as the circuit maintainer lever closes the circuit through the contact breaker and bell magnet. *To reset,* the manual control is pulled down until the circuit maintainer lever strikes the stop, the trip end will then engage with the claw of the trip lever.

Ques. What is the difference between a buzzer and a bell?

Ans. A buzzer is simply a vibrating bell *without* a hammer and having the armature and magnet placed under the bell as shown in fig. 3,221.



Figs. 3,218 to 3,220.—Detail of electro-mechanical circuit maintainer, showing progressively its action. Fig. 3,218 shows the mechanism in its *initial* or "*set*" position. When the magnet is energized, the trip lever claw is pushed out of engagement with the circuit maintainer lever and the latter, influenced by the spring moves toward the contact. Fig. 3,219 shows the relative positions of the two levers just after the claw disengages the circuit maintainer lever, and fig. 3,220, the final position of the two levers due to the action of the spring. The trip lever (in fig. 3,220) has moved back against the stop (this occurs when the push button is released demagnetizing the magnet), and the circuit maintainer lever, against the contact thus establishing circuit through the contact breaker and bell magnet; this position corresponds to that shown in dotted lines in fig. 3,217.

Differential Bells.—This type of bell represents one of the numerous schemes to eliminate sparking at the contacts of the interrupter.

The electromagnet is provided with two windings which, for convenience to distinguish their function, may be spoken of as:

1. The magnetizing winding;
2. The demagnetizing winding.

In order to get the desired effect, a *contact maker* is used instead of a *contact breaker*, it operates to control the current in the demagnetizing winding only.

Ques. How are the various parts arranged?

Ans. The essential elements are shown in fig. 3,222, the diagram being so drawn as to clearly illustrate the necessary connections and principles of operation rather than actual construction.

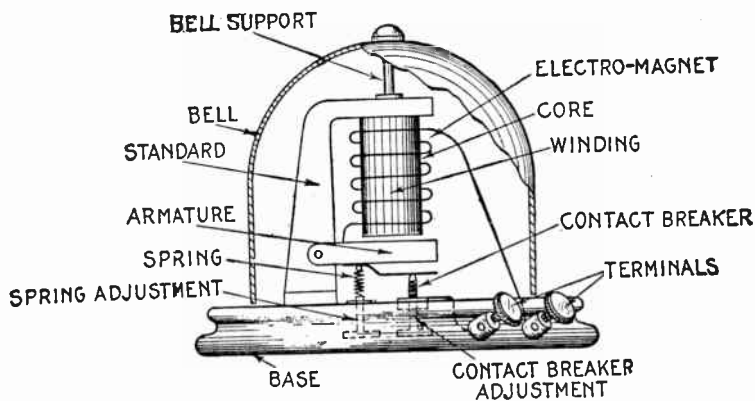

FIG. 3,221.—Sectional view of a buzzer. *In construction*, the armature is pivoted to the lower part of an upright soft iron shield or standard from the top of which the magnet is firmly suspended. The armature being pivoted to the shield, vibrates between the magnet and wooden base and is regulated by adjusting screws underneath. The mechanism is enclosed in a bell or brass shell.

The chief difference between the cut and construction is the amount of winding on the magnet coils; with a sufficient number of turn, the illustration would represent a good design for a differential bell.

Ques. Describe the operation of the bell.

Ans. When the push button is depressed, closing the circuit, current flows through the magnetizing coils and energizes the magnet which attracts the armature. Near the end of its

movement the contact maker closes the circuit through the demagnetizing coils, which being wound to oppose the other coils, the magnetism due to the magnetizing coils is neutralized, that is to say, the magnet is demagnetized, and the armature, influenced by the armature spring, swings back against the stop thus completing the cycle of operation.

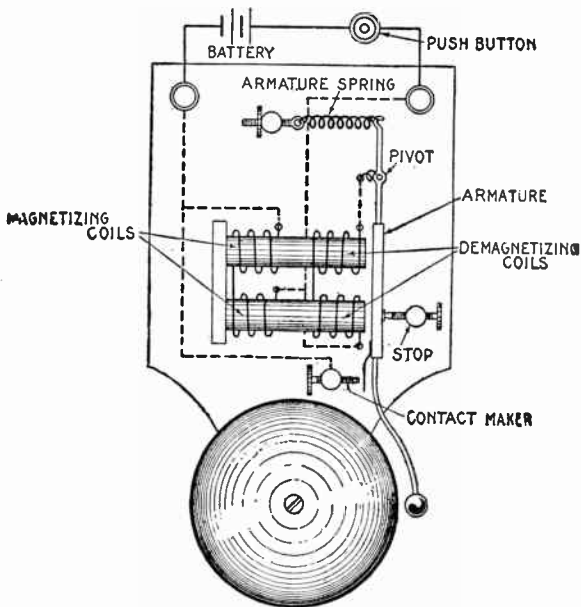

FIG. 3,222.—Elementary differentially wound vibrating bell. It is essentially an ordinary vibrating bell whose magnets have two equal and oppositely wound sets of coil, and which is fitted with a *contact maker* instead of a *contact breaker*, and so connected that during the "closed periods" of the contact maker, the two sets of coil are switched in parallel, and one set cut out of circuit during the open periods.

It should be noted that current flows through the magnetizing coil continuously during operation, and that the demagnetizing coils are only in operation during the periods in which the contact maker is in the closed position.

The cycle of operation of the differential bell may be briefly stated as follows:

1. Current flows through the magnetizing winding and energizes magnet;
2. Magnet attracts the armature;
3. Contact maker closes circuit through demagnetizing coils;
4. Demagnetizing coils demagnetize the magnet;
5. Armature spring pulls armature back against the stop, while
6. The contact maker breaks the circuit through demagnetizing coils.

Ques. How is sparking reduced or overcome by the differential bell?

Ans. Since both sets of coil are connected in parallel at the

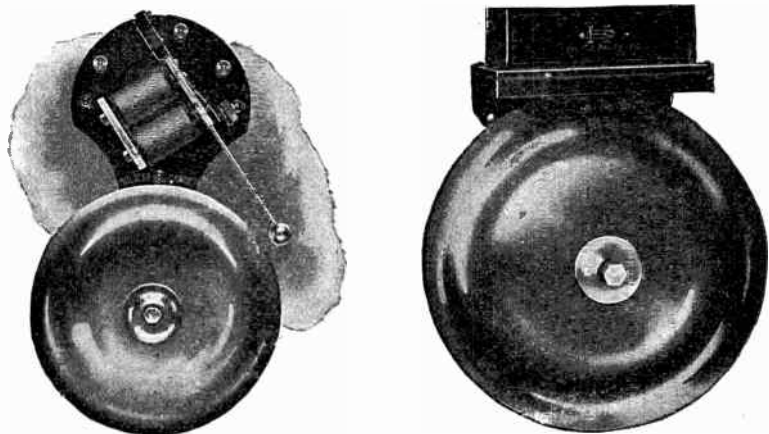

FIGS. 3,223 and 3,224.—Holzer-Cabot bells. Fig. 3,223 plain vibrating skeleton frame bell; fig. 3,224 water tight bell for marine service and outdoor use in places where water and dampness are prevalent. It is made for 6 to 220 volt circuits without external resistance. This bell is of the vertical plunger type. In operation the plunger strikes a button passing through the metal diaphragm which seals the bottom of the bell box, the button in turn delivering the blow to the bell.

instant of "break," only half of the current supplied to the terminals passes through the contact maker during the closed periods.

Combined Differential and Alternate Bells.—In this type of bell there are two separate electromagnets, and an armature pivoted centrally between them, so that it is alternately attracted, first by one magnet, then by the other. Fig. 3,225

shows the essentials of a differential and alternate bell. In the figure F and G are the two magnets of which M and D are the two windings of F, and S the single winding of G.

Ques. Describe the operation of the differential and alternate bell.

Ans. When the circuit is closed by depressing the push button, magnet F (fig. 3,225) is energized by the magnetizing coil

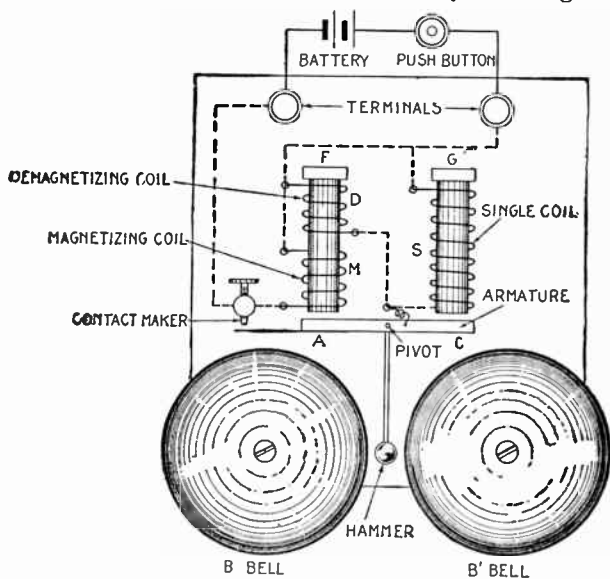
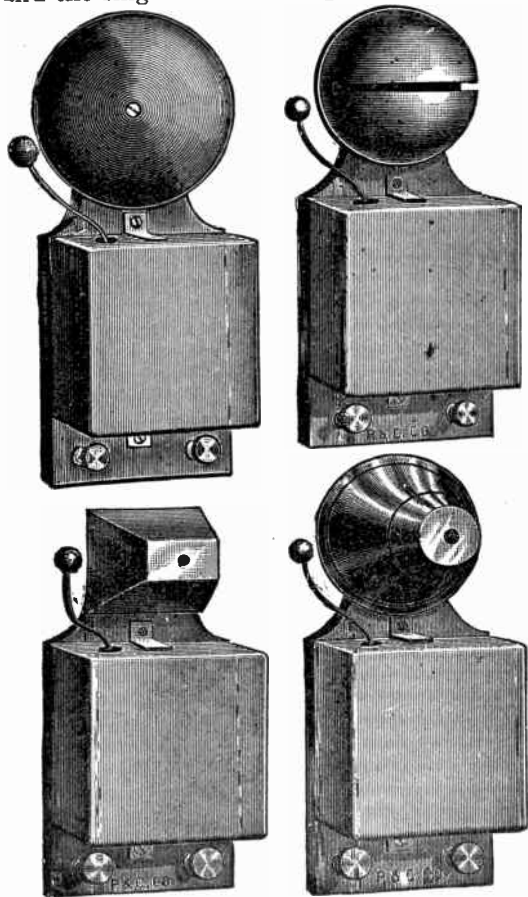

FIG. 3,225.—Elementary differential and alternate bell. It employs two separate magnets F and G, of which F has a magnetizing coil M, and a demagnetizing coil D, and G has a single coil S. The magnetizing coil M is connected direct to the terminals, while the demagnetizing coil D, and single coil S are connected in parallel with each other and in series with the contact maker. The operation is explained at length in the accompanying text.

M, and the end A of the armature is attracted, striking bell B. Near the end of the movement the contact maker closes its circuit and current flows through the demagnetizing coil D, which demagnetizes magnet F; at the same time, current also flows

through coil S and magnetizes the magnet G. Accordingly the armature is attracted at the end C, and the hammer strikes bell B'. During the movement, the contact maker breaks the circuit, cutting out both the demagnetizing winding D of magnet F, and the single coil S of magnet G, thus completing the cycle.



Two or more such bells will work quite satisfactorily in series, without sparking at the contacts. *In operation*, it should be noted that current only flows through the magnetizing winding M during the "open periods" of the contact maker, and that it flows through all three windings during the closed periods.

The cycle of operation may be briefly stated as follows:

1. *Current flows through the magnetizing winding M and energizes magnet F;*

FIGS. 3,226 to 3,229.—Partrick and Wilkins wood box type bells. Fig. 3,226, regular gong; fig. 3,227, sleigh gong; fig. 3,228, cow gong; fig. 3,229, dinner gong. *In construction*, the frame is stamped out in one piece, with the exception of the gong post, and it is impossible for the bell to get out of adjustment by the warping of the wood. The contact points are riveted on the spring. The wood boxes are made with lock attachment so there is no danger of the cover falling off.

2. Magnet *F* attracts end *A* of the armature;
3. Contact maker closes circuit through demagnetizing coil *D*, and single coil *S* (of magnet *G*);
4. Demagnetizing coil demagnetizes *F*, and
5. Magnet *G* attracts end *C* of the armature;
6. Contact maker breaks the circuit through demagnetizing coil *D* and single coil *S* (of magnet *G*).

High Voltage Bells.—In designing a bell for operation on high voltage currents, that is to say, on circuits of voltages

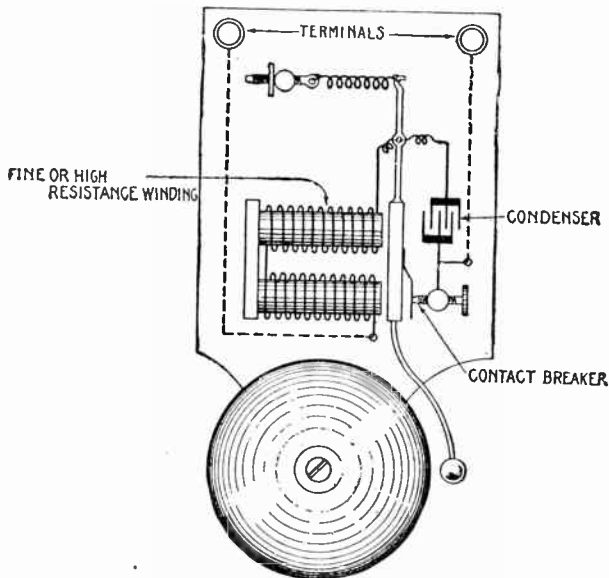
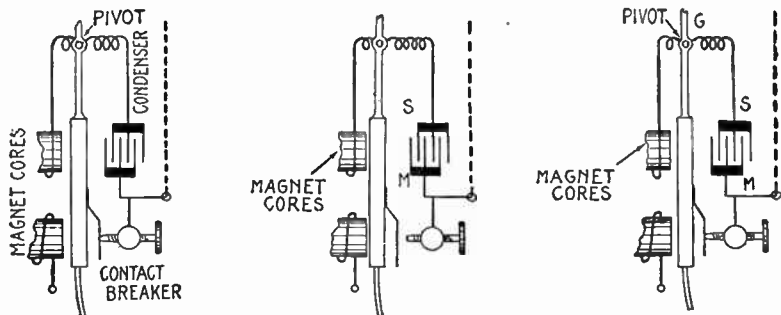

FIG. 3.230.—Elementary heavy duty high voltage bell. The figure shows a winding of finer wire and more turns than that of the low voltage bell illustrated in fig. 3,201. This indicates higher resistance to keep down the current to proper value, and an increased number of *ampere turn* to secure the additional energy required for heavy duty service. Increasing the ampere turns augments the self-induction, which increases the tendency of sparking. Accordingly, in a bell of this kind, sparking may be avoided by connecting a condenser across the contact breaker as shown. The action of the condenser is shown in figs. 3,231 to 3,233.

higher than is usual in ordinary battery installations, provision must be made:

1. To limit the current to the proper value;
2. To secure the proper working conditions at the interrupter.

The first requirement is met by proportioning the magnet winding so as to avoid an undue amount of current. Thus, it is evident that a magnet wound for say six volts, would not be suitable for a 110 volt circuit, because it would pass too much current. Accordingly, a magnet must be substituted having a sufficiently high resistance (that is to say a wire of sufficiently small size) that the amount of current will remain the same.



FIGS. 3,231 to 3,233.—Detail showing part of the elementary heavy duty high voltage bell illustrated in fig. 3,230, and illustrating the action of the condenser in preventing sparking. In fig. 3,231, current has just begun to flow, to energize the magnets. Fig. 3,232 shows the circuit broken by the contact breaker. Since an electric current cannot be *instantly* stopped, it will, when its path is suddenly interrupted, as here shown, jump the air gap resulting in a spark, unless another path be provided to gradually bring it to rest. This is accomplished by the condenser as indicated in the diagrams—electricity “piling up” on one set of plate M, increasing the pressure thereon, and leaving the other set of plate S, reducing the pressure thereon. When contact is again made by the contact breaker, as in fig. 3,233, the excess pressure on plates M assists the battery pressure in starting the electricity, the current thus started dividing at the junction G, part flowing back into the plates S, until the pressure is equalized, that is to say the outflow at M and inflow at S reduces the difference of pressure between M and S to zero. This action may perhaps be clearer shown by aid of the pneumatic analogy, figs. 3,234 to 3,237.

For large heavy duty bells, where an unusually large number of ampere turn would be necessary on the magnet to secure very loud ringing, the increased inductance due to the extra ampere turns may necessitate the use of a condenser to prevent sparking at the interrupter. An elementary diagram of a heavy duty high pressure bell, embodying the features just described is shown in fig. 3,230.

Figs. 3,231 to 3,233 show the action of the condenser in preventing sparking, and figs. 3,234 to 3,237, a pneumatic analogy of same. Some suggestions of the author on the prevention of sparking at the interrupter

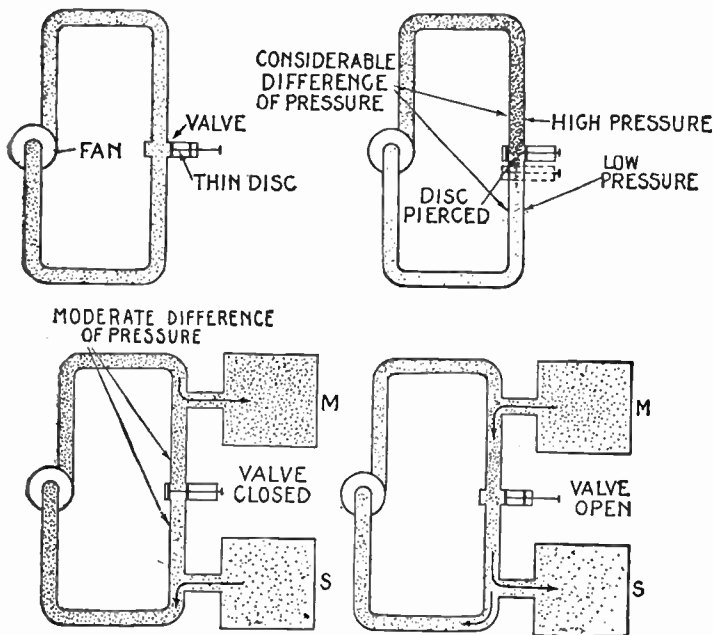

FIGS. 3,234 TO 3,237.—Pneumatic analogy illustrating the action of a condenser as applied to a bell. Consider a centrifugal fan connected to a closed pipe loop having a gate valve with a disc so constructed that it will burst in case of much difference of pressure, and suppose the system to contain a very heavy gas (*amperes*); also, that the pump be speeded up so that the gas is flowing around the loop at high velocity. Now imagine the valve to be *instantly* closed (interrupter opened). *The momentum* acquired by the gas (*amperes*) will cause a sudden rise of pressure (*volts*) on one side of the valve and a decrease in pressure (*volts*) on the other side which will puncture the thin disc (*spark jumps the air gap*), as shown in fig. 3,235, the high and low pressure being indicated by the heavy and light shading. The conditions shown in fig. 3,235 is, in analogy, just what happens when a spark jumps the air gap when a circuit is broken by an interrupter. Now, if two reservoirs (*a condenser*) as M and S (*in the electric circuit M and S represent plates of the condenser*) fig. 3,236 be provided, one on each side of the valve, the rise and decrease in pressure on suddenly closing the valve will be considerably less, because the current is not immediately brought to rest but can flow into M against a gradually rising pressure, while the gas (*electricity*) in S, flows out which prevents a sudden decrease of pressure such as took place in fig. 3,235. In this way the current is "*slowed down*" or gradually brought to rest, instead of being abruptly stopped by a sort of "hammer blow action." When the valve is opened (*interrupter closed*) as in fig. 3,237, the excess of gas in M flows back into the pipe, while a return flow takes place in S thus equalizing the pressures. The action in fig. 3,235, of course only represents, in analogy, the electric action during the passage of the spark; if the reader imagine another valve represented in dotted lines (fig. 3,235) to be immediately closed at the instant the disc is pierced, it will be equivalent to the increasing resistance interposed by the progressive opening of the interrupter, and will show the current brought to rest as the spark is extinguished. Figs. 3,236 and 3,237, correspond, in analogy, to figs. 3,232 and 3,233.

of special bells to meet severe requirements are illustrated in figs. 3,238 to 3,240, which show, in part, desirable construction for medium, heavy, and extra heavy duty bells.

Alternating Current Bells.—A type of bell used extensively in telephone work, to operate on the alternating current furnished by the magneto is shown in fig. 3,241, and its operation illustrated in figs. 3,242 to 3,244.

In construction, the armature is polarized, that is, it is permanently magnetized so that it has a permanent north pole at one end

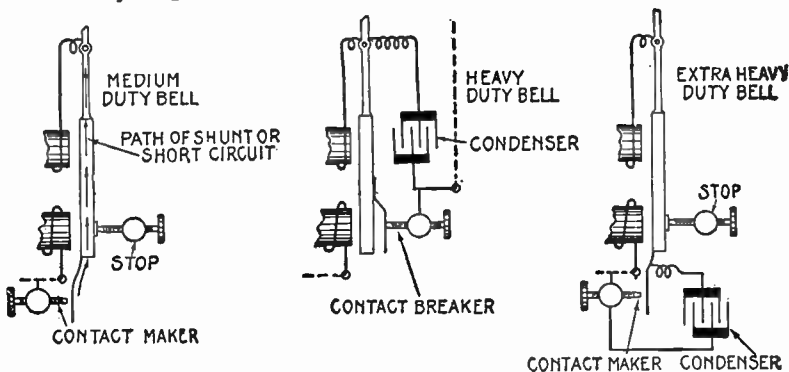

FIGS. 3,238 to 3,240.—Suggestions for the prevention of sparking on special bells. Fig. 3,238 contact maker and shunt circuit for medium duty bell; fig. 3,239 contact breaker and condenser for heavy duty bell; fig. 3,240, contact maker and condenser for extra heavy duty bell

and a permanent south pole at the other. It is pivoted at the center and has a stem projecting from this point to which the hammer is fastened as shown. This hammer strikes the bells on either side when it moves to and fro. The two electromagnets are wound in the same direction so as to produce like poles.

In operation, when the current flows in the direction indicated in fig. 3,242, north poles are produced at the upper end of the electromagnets; these respectively repel and attract the *n* and *s* poles of the armature causing a swing of the stem to the left as shown. When the current reverses as in fig. 3,243 the magnetism of the electromagnet is reversed and accordingly the south poles produced at the upper end

respectively attract and repel the *n* and *s* poles of the armature, causing the stem to swing to the right as shown.

Ques. Will the polarized bell just described work on a regular alternating current circuit of high frequency?

Ans. No.

Ques. Why?

Ans. If the frequency be much greater than that of the

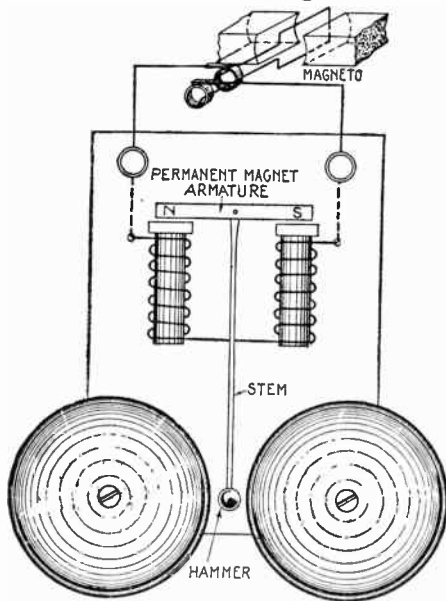

FIG. 3,241.—Elementary alternating current bell with permanent magnet armature. In construction the electromagnets are wound similarly, that is, *in the same direction*, so as to produce like poles which simultaneously repel and attract the armature ends. The operation is illustrated in figs. 3,242 to 3,244.

ordinary hand operated telephone magneto, there will not be sufficient time to overcome the inertia of the moving parts (armature, stem and hammer) and cause the hammer to strike during an alternation.

Ques. What will be the effect of a high frequency current on the moving part?

Ans. It will not remain stationary but will move to and fro with a reduced arc of vibration, which becomes less and less as the frequency increases.

Ques. How may the weight of the armature be reduced?

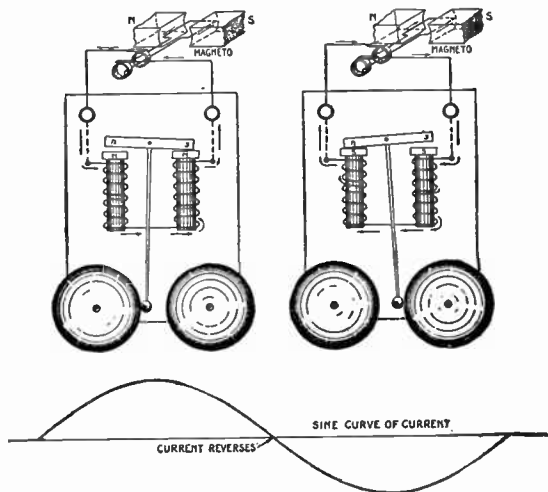

Figs. 3,242 to 3,244.—Diagrams and sine curve illustrating operation of the elementary alternating current bell shown in fig. 3,241. The path of the current during each alternation is, in figs. 3,242 and 3,243, easily traced through the elementary alternator and magnets, and the similar induced poles determined by the right hand rule for polarity. Figs. 3,242 and 3,243 show the hammer at the end of its left and right swing respectively. Assuming the movement of the hammer to be in phase with the current, the sine curve as drawn would show this relation. Of course, in actual operation, the movement of the hammer would lag somewhat behind the current, because of its inertia.

Ans. By polarizing the armature by the method of magnetic induction as in fig. 3,245.

Ques. Describe its operation.

Ans. In fig. 3,245, the effect of the permanent magnet is to magnetize the magnet cores of the electromagnet and the

armature by *magnetic induction*. Thus, the N pole of the permanent magnet induces south polarity *s* at the middle part of the yoke and north polarity *n*, *n* at the poles of the electromagnet. The S pole of the permanent magnet induces north polarity at the middle of the armature, and south polarity *s* *s'* at its two ends. The magnet cores and the armature are

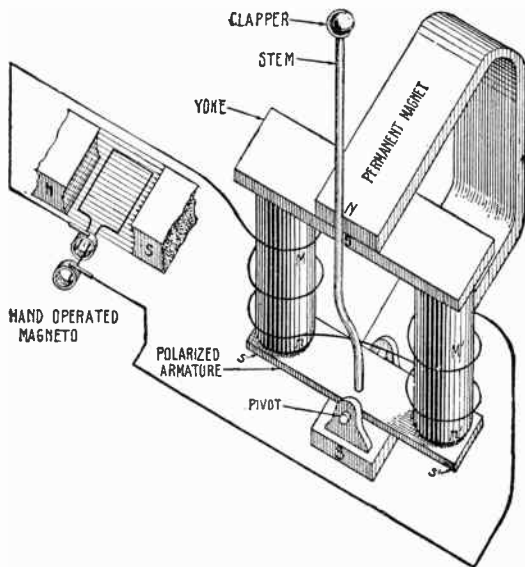
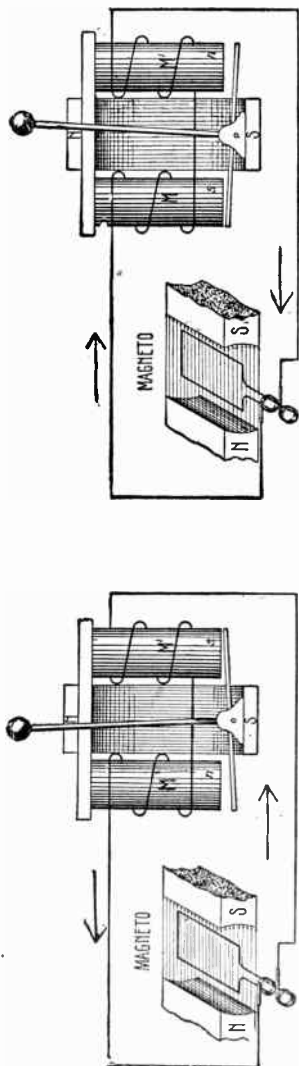

FIG. 3,245.—Elementary alternating current bell polarized by magnetic induction. The letters N and S represent the permanent magnet poles, and the italics *n* and *s* the poles induced by the permanent magnet. The kind of current on which the bell will work satisfactorily is suggested by the elementary magneto connected in the circuit, indicating an alternating current of low frequency, but not necessarily of low pressure.

accordingly said to be *polarized*, and the direction of movement of the latter depends on the direction of the current around the electromagnet. In fig. 3,246, suppose the current to flow through the electromagnets as indicated by the arrows; this will make the pole of M, north, and that of M'. south. Then the induced



FIGS. 3,246 and 3,247.—Diagrams illustrating the operation of the elementary alternating current bell polarized by magnetic induction as shown in fig. 3,245. The figures show the induced poles and movement of the armature during one cycle of the low frequency alternating current supplied by the hand operated magneto. The operation is explained in detail in the accompanying text.

n polarity is strengthened, while that at n' is destroyed, the pole for the time being south. The right hand pole of the armature will thus be attracted and the left hand pole repelled. Similarly, when the current reverses, as in fig. 3,247, the polarity of M and M' respectively becomes south and north and the armature turns over the other way. Thus the clapper will vibrate in synchronism with the reversals of the current.

Double Acting Bells.—This type of bell is desirable for railroad signals or any place where an extra loud alarm is desirable.

In the arrangement shown in fig. 3,248, there is a centrally pivoted armature having attached at one end the hammer stem, and at the other a spring contact of a two way switch.

Four magnets are arranged two on either side and symmetrically with respect to the pivot as a center. The magnets are so connected that, in operation, when the two way switch is on the B contact, coils F and G' , act to swing the armature counter-clockwise.

As the armature moves in this direction the two way switch contacts with A , thus bringing into action the magnets F' and G , causing a

clockwise swing of the armature. The object of the light spring is to insure contact of the two way switch when the current is off; its tension is only sufficient to hold it in contact with B.

The armature, when in operation strikes a strong spring stop so that the hammer rebounds from the bell after delivering the blow.

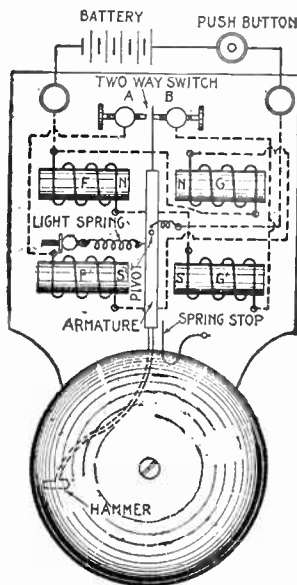

FIG. 3,248.—Elementary double acting bell, consisting of a centrally pivoted armature, four symmetrically arranged magnets, and a two way switch as shown. *In operation*, magnets F G', and P' G, are alternately energized. Assuming the current to flow first through P' G' and then through G P', F and G' will have N and S poles, and G and P' S and N poles; these will induce unlike poles in the ends of the armature attracting it at both ends.

Motor Driven Bells.—This type of bell is desirable for use where a loud ringing alarm or signal bell is required. It consists essentially of a motor having a double striker mounted at the armature shaft as shown in fig. 3,249, giving two strikes to each revolution.

Bells of this description are designed to operate on battery pressures of six volts and higher, also lighting circuits of 110 volts alternating and direct. A powerful blow is obtained by the revolving stroke of these bells, because of the amplitude of the stroke, which permits the hammers to acquire considerable *momentum* between blows.

Electro-Mechanical Bells.—Where a very powerful bell is required to operate at a distance with little battery capacity

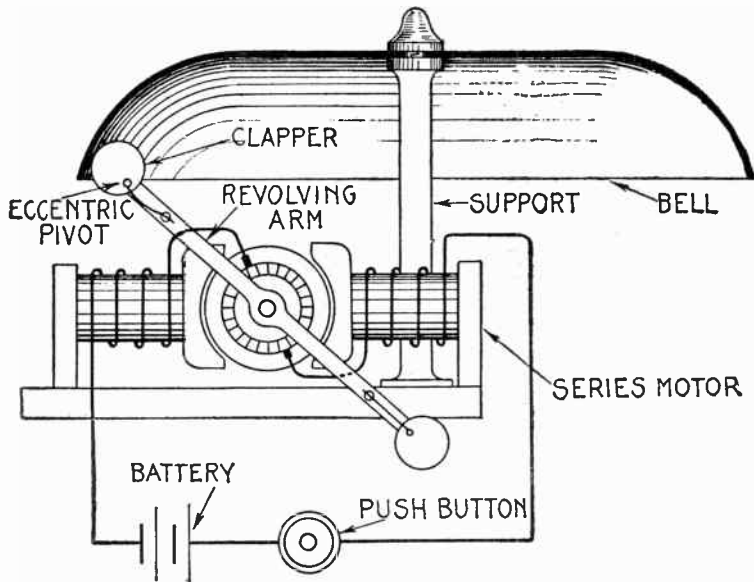

FIG. 3,249.—Elementary motor driven, or revolving strike bell. The series motor has a revolving member attached to the shaft and an eccentrically pivoted clapper at either end, which in operation delivers two blows to the bell at each revolution of the motor. A desirable type of bell for use where a very loud ringing alarm is required. Construction details of the clapper are shown in figs. 3,250 to 3,253.

the electro-mechanical bell is well suited. In this type of bell, *the electric current is used simply to control a spring operated mechanism which supplies the energy to ring the bell.*

A form of electro-mechanical bell is shown in fig. 3,254. It consists essentially of a large and small gear as shown, the large gear having rigidly fastened to it, a ratchet and pawl wheel and main spring for

operating the gong, a control lever operated by the electromagnet governs the movement of the two gears by pawl and detent device, and the small gear has attached to its shaft an air vane to prevent too rapid rotation of the gears. There is also a control handle by which the bell is rendered either single stroke or continuous ringing.

Ques. Describe the operation of the electro-mechanical bell shown in fig. 3,249.

Ans. The main spring having been wound up, a momentary push on the push button will energize the electromagnet,

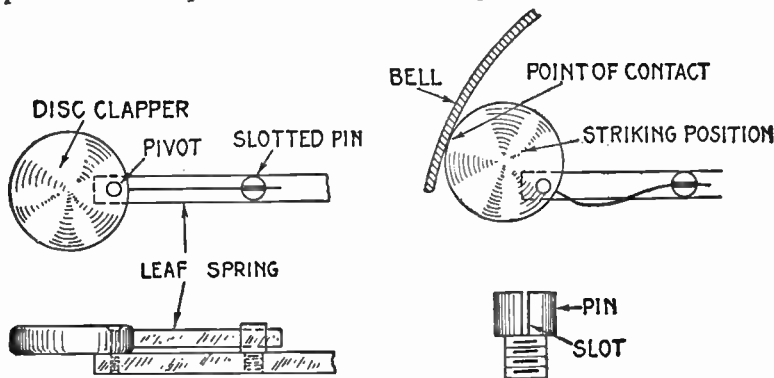

FIGS. 3,250 to 3,253.—Construction details of clapper for motor driven bell, and view showing action of clapper on striking the bell. Figs. 3,250 and 3,251, elevation and plan of arm end; fig. 3,252, clapper in contact with bell, showing clapper turned to one side by contact with bell; fig. 3,253 slotted pin which permits movement of spring.

attracting the control lever and raising the pawl out of engagement with the pawl wheel and also the detent clear of the detent wheel, allowing the gears to revolve. If the push button be now released, the pawl will ride on the pawl wheel, keeping the detent out of engagement with the detent wheel. As the large gear turns counter-clockwise, the finger A rides on the ratchet, gradually drawing the hammer away from the bell against the tension of the hammer spring. As the finger rides off the point B, the hammer is suddenly released and strikes the bell a powerful

blow. At the same instant the pawl falls into the depression C on the pawl wheel and the detent engages with one of the numerous depressions in the detent wheel, thus stopping the

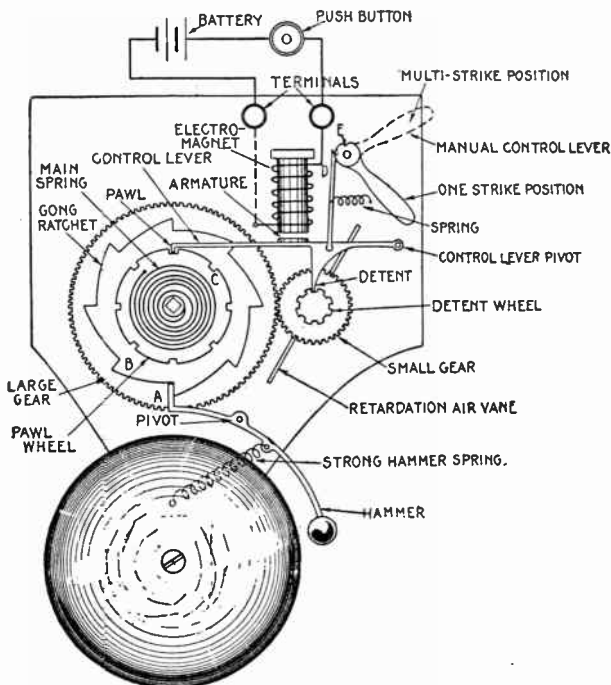

FIG. 3,254.—Elementary electro-mechanical bell or gong. In this bell an electrically controlled clockwork actuated by a strong main spring serves to draw the hammer away from the bell and to suddenly release same, whereupon a strong hammer spring causes the hammer to strike the bell a powerful blow. The operation and construction are fully explained in the accompanying text.

mechanism. A moderate velocity of rotation of the gears is obtained by means of the retardation air vane.

Ques. How is the bell set for continuous operation?

Ans. By placing control lever in multi-strike position.

In this position when the control lever is raised by the electromagnet the pawl engages with the V shaped depression, thus holding the control lever out of engagement with the pawl wheel.

Ques. What prevents the clapper remaining in contact with the bell?

Ans. The finger A which rests on the ratchet and which is of such length that the clapper just clears the bell.

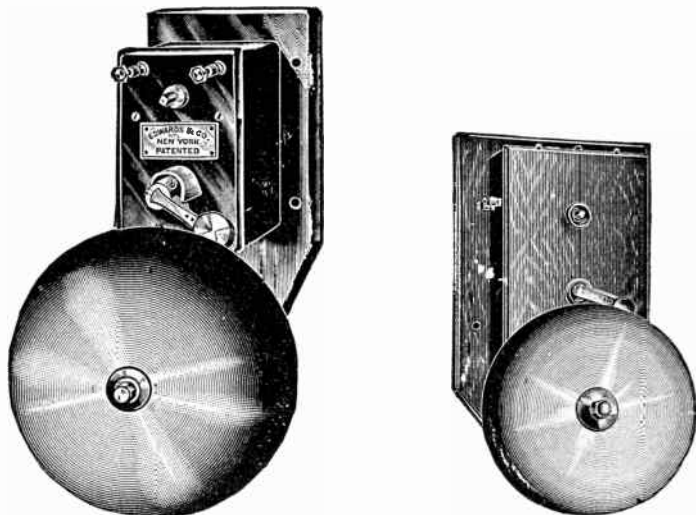

FIG. 3,255.—Edwards electro-mechanical weather proof gong for exposed places. Entirely enclosed and gives 350 blows to each winding. This gong can be used either on open or closed circuits and can be arranged to operate as a single stroke or continuous ringing gong, or to ring continuously until run down, on make or break of circuit. It is adapted for 110 volt alternating or direct current.

FIG. 3,256.—Electro-mechanical gong for use indoors. The mechanism gives 300 blows to each winding, and can be used either on open or closed circuit; it can also be arranged to operate as a single stroke or constant ringing gong, or to ring continuously until run down, on make or break of circuit.

Relay Bells.—Where bells are to be operated at a considerable distance a relay is usually employed, especially in the case of large heavy duty bells requiring considerable energy to operate them.

Ques. What is a relay?

Ans. A relay is: *A device which opens or closes an auxiliary circuit under pre-determined electrical conditions in the main circuit.*

Ques. What is the object of a relay?

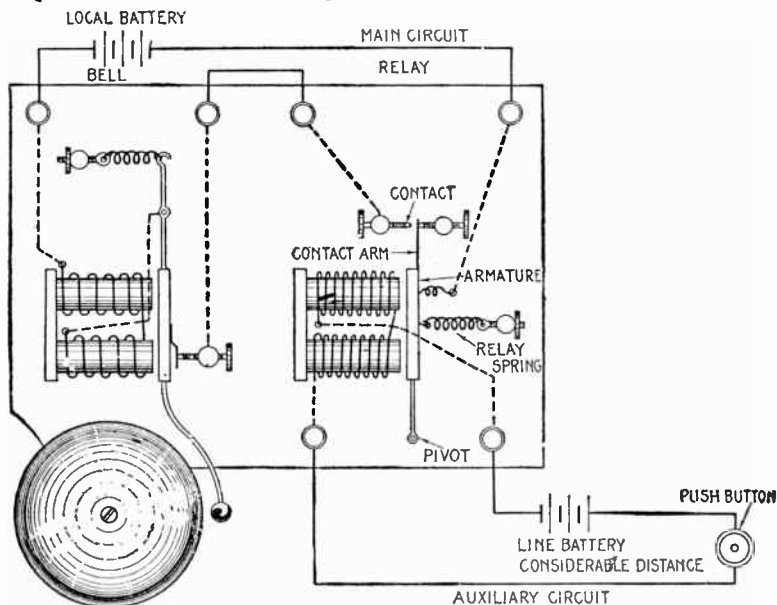

FIG. 3.256.—Elementary relay bell and connections. The relay here shown is in principle identical with the telegraph relay. *In operation*, when the push button is depressed current for the line battery in the auxiliary circuit energizes the relay magnets which attract the armature, moving the contact arm against the contact, thus closing the main circuit and ringing the bell. Clearly the operation continues until the push button is released, that is, when current ceases to flow in the auxiliary circuit, the relay magnets lose their magnetism, the relay spring pulls the armature to the right moving the contact arm against the stop, thus breaking the main circuit.

Ans. Its function is to act as a sort of electrical multiplier, that is to say, *it enables a comparatively weak current to bring into operation a much stronger current.*

This is very clearly seen in the operation of a telegraph relay, where a very weak long distance transmission current is used to operate a

relay, which synchronously controls a strong local current to operate a "sounder."

The term relay has been used erroneously to a considerable extent, perhaps both through ignorance and abuse; thus, bells fitted with electrical, or electro-mechanical controlling devices, the equivalent of those shown in figs. 3,212 and 3,217 are often spoken of as "relay" bells. This error will be avoided, by remembering that *the object of a relay is to enable a weak current to bring into action a strong local current*, and thus reduce the size of battery required; *this involves two distinct circuits each having a separate source of current.*

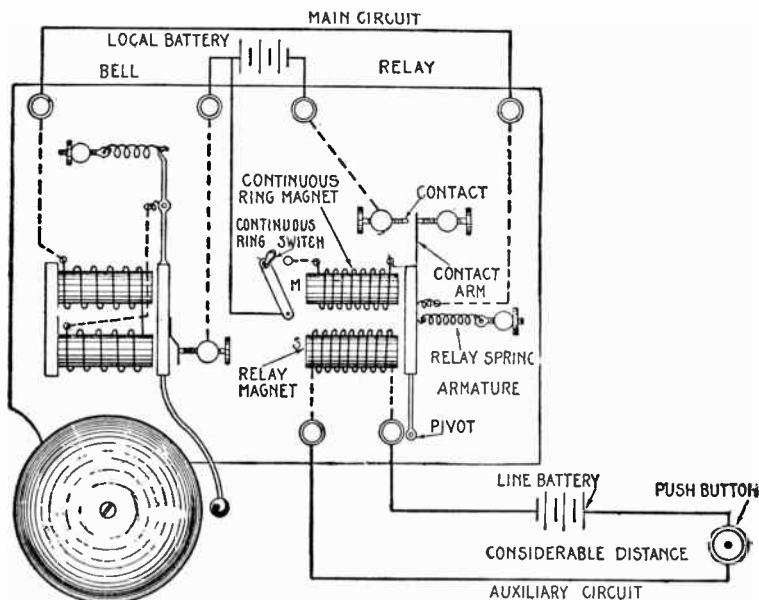
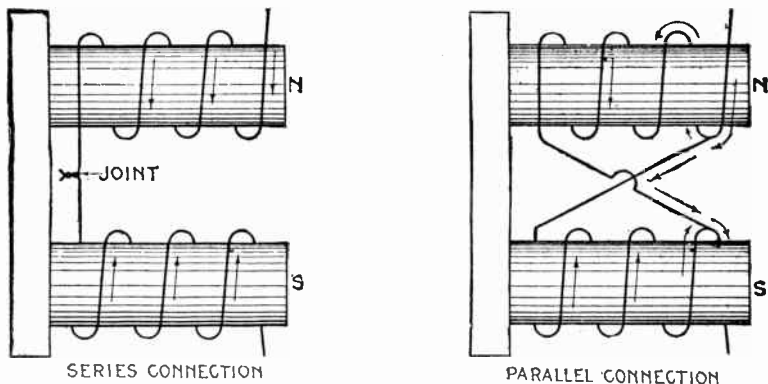

FIG. 3,257.—Elementary relay bell with relay having *continuous ring device*. The relay has two independent magnets M, and S, the latter performs the same service as the two magnets of the relay in fig. 3,256, while M is for continuous ringing. *In operation*, when the push button is depressed, magnet S is energized and the same action takes place as in fig. 3,256. Now if the continuous ring switch be closed, magnet M also becomes energized as soon as the main circuit is closed by magnet S. Since M is now connected with the battery, it will hold the contact arm in the closed position, irrespective of whether the pushed button be depressed or released, causing a continuous ringing of the bell until the continuous ring switch is opened by hand. *In construction*, the winding of M and S should be proportioned properly for the service required of each. Clearly the resistance of M should be great enough that the minimum amount of current only will be used because it keeps the battery short circuited during the interval of continuous ringing, whereas the current used in the main circuit is intermittent and hence not so much is used, as would be if it were a continuous flow.

Fig. 3,256 shows a simple bell with relay, and fig. 3,257, a simple bell with relay having a continuous ring magnet and manually operated control switch. In either figure both the relay and bell could be mounted on one frame, or mounted separately; when both are mounted together the combination is properly called a *relay bell*, but when mounted separately, it should be called a *relay operated bell*.

Reducing the Resistance of Bell Coils.—It is often desirable to reduce the resistance of the magnet coils of a bell, either for working the bell over a short line with a small battery, or,



FIGS. 3,258 and 3,259.—Method of reducing the resistance of bell coil so that a high voltage bell may be adapted to low voltage. *The point to be noted in changing the connection of the coils from series to parallel is that it should be so done that the current will flow through both coils in the same relative position as when connected in series.* The method is clearly shown in the figures and explained in the accompanying text.

if the coils be wound with fine wire for a high voltage and a long line, to adjust it to a lower voltage.

This may be readily accomplished by connecting the bell coils in parallel, as shown in fig. 3,259. Untwist the joint of the magnet wire near the yoke to which the spools of wire are attached. With short pieces of insulated wire, join each of the ends of the untwisted wires to the wires at the armature ends of each of the opposite spools. With this arrangement, the whole current instead of going through the two coils successively, will divide, one-half the current going through each coil. Since the resistance of one coil is one-half that of two coils, the current carrying capacity of each coil is doubled and the same size

battery will send four times the current through coils arranged in parallel, than through coils in series.

Push Buttons or Pushes.—These are made in a variety of form, with wood, metal, hard rubber, or porcelain bases. The general construction of an ordinary push button is shown in figs. 3,260 and 3,261. The contact parts consist of the metal

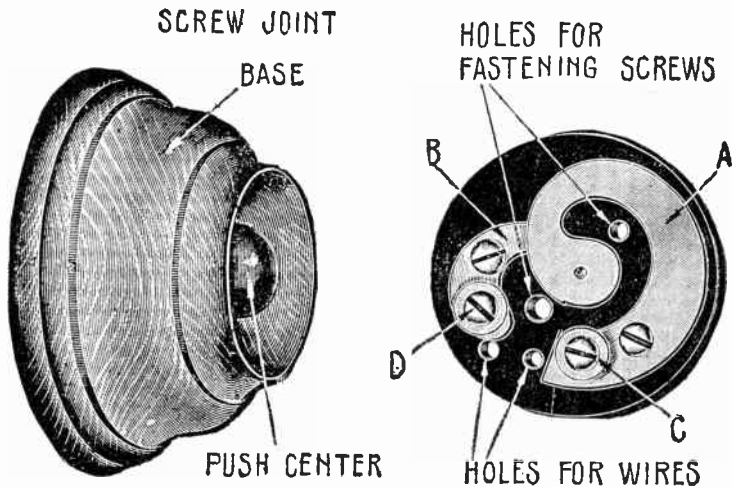

FIGS. 3,260 and 3,261.—General construction of an ordinary push button. Fig. 3,260 exterior view; fig. 3,261 interior view. In the figure four holes are seen in the base; the wires pass through two of these and the other two are for screws to secure the button in place.

strips A and B, attached to the base plate. Their arrangement is such that when the push center is in the *out* position, A and B remain separated. When the push center is pressed, A is pushed against B, and the circuit completed. The circuit wires are led in through the holes in the base plate and attached to the contact parts by means of the screws C,D.

In attaching the leading in wires to these screws, great care should be taken to scrape and sand paper their ends until they are bright and clean,

then bend each end into a loop, place each loop under its proper screw head, and tighten the screws to insure a good contact with the wires.

Fig. 3,262 shows a type of desk push, designed to fit a three-quarter inch hole, no screws are needed for fastening, as the spring clips A, A, press against the sides of the hole with sufficient force to hold the push securely in place. The centers cannot turn around, and therefore, may be lettered if desired. The wire connections will take any size of bell wire.

Fig. 3,263, shows a common type of name plate push; these are often made with two or more push centers.

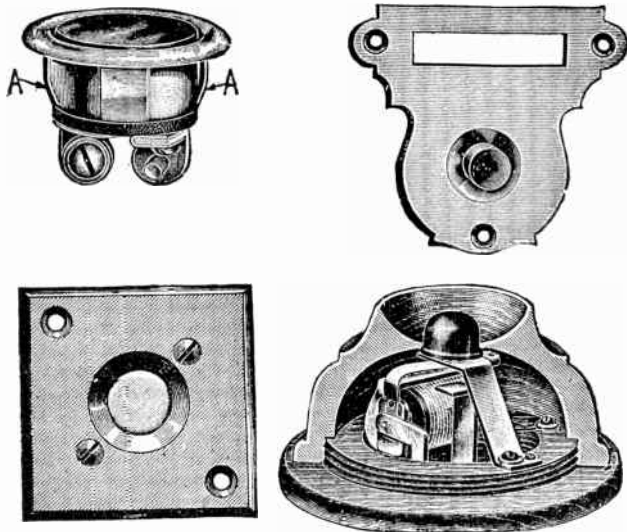

FIGS. 3,262 to 3,265.—Various forms of push button. Fig. 3,262 desk push button; fig. 3,263, name plate push button; fig. 3,264, flush plate push button; fig. 3,265, indicating push button. The indicating push button shown in fig. 3,265 has a small buzzer inside the push button which will indicate whether or not the bell rings. If the bell do not ring, the buzzer will not vibrate; it is a useful push for any system where the caller desires to know positively that the bell has given the signal.

Fig. 3,264, shows a common form of *flush plate push*, suitable for outside doors or where projecting pushes are objectionable.

Fig. 3,265 shows how a midget buzzer may be concealed in a push button. This may be connected to another buzzer or in a bell circuit in which case it will buzz if the circuit be closed and will not buzz if the circuit be open. As such it is known as an *indicating push button*. When connected only to a battery it may be used to practice the telegraph codes or for other experimental purposes.



FIG. 3,267.—Return call and indicating push button.

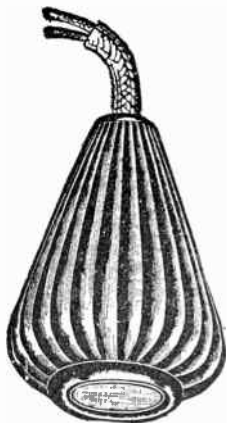

FIG. 3,266.—Pear shaped metal portable push button.

Fig. 3,266, shows a form of metal pear push. It consists of an ordinary push enclosed in a pear shaped box of either metal or wood, attached to the end of a cord, having two insulated conductors branched in it.

The cord usually leads to some form of wall rosette, and for convenience permits the push being changed in position from place to place.

Pear pushes are often provided with parallel push centers.

Fig. 3,267, shows a type of *return call and indicating* push. It is arranged with three wires for call and return call.

When the bell rings an electromagnetic sounder operates to indicate that the bell is ringing and the fact that the call is answered is indicated by a rapid sound.

Fig. 3,268, shows a *paper weight compound push*, suitable for desk use requiring a number of call.

It is made of metal with white push centers, marked with black letters. Wires are inserted in the holes in the side.

Fig. 3,269, shows a dining room push button outfit consisting of a *floor push and a table push*. The latter represents a very efficient and durable type of construction.

The central metal rod is divided into two parts A and B, and insulated from each other by a piece of hard rubber C.

Normally, this rod is held in the position shown, by the tension of a spiral spring located within the hard rubber block D.

When the rod is depressed by the foot, the upper part A, passes by the contact spring E, thus connecting the latter with the contact spring F, and completing the circuit.

The table push is connected to the central rod of the floor push, by means of a cord containing two insulated wires, one of which connect with the part A of the rod, while the other connects with the part B.

When the push center of the table push is pressed, A and B are short circuited, thus completing the circuit.

Bell Wire.—The size of wire most suitable for bell wiring is either No. 16 or No. 18, B. & S. gauge copper wire. In some cases No. 20 and 22 wire may be used, but a wire smaller than No. 18, is not strong enough mechanically, and its resistance is so great that it requires too much battery pressure.

The various kinds of covered bell wire are commonly known as *office wire*, *annunciator wire*, *weather proof wire*, etc. Office wire is covered with two layers of braided cotton, the inner layer being filled with a moisture repelling compound. Annunciator wire is provided with two layers of cotton merely wrapped around the wire and saturated

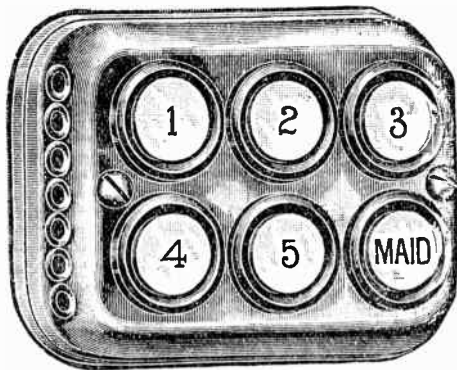

FIG. 3,268.—Paper weight type multi-push button suitable for desk use.

with paraffine. The weather proof wire is the same as that used for electric light wiring. For the general line of bell work, the braided office wire is the best, as the annunciator wire is too easily injured, while the weather proof wire has a larger outside diameter, which renders it much more difficult to conceal.

Wire Joints.—In the wiring of bell circuits, special care should be taken to make effective joints, as when made loosely or improperly, they greatly increase the resistance of the circuit. All joints should be soldered.

Figs. 3,270 to 3,272, show the proper method of making a joint in covered wire. First, strip off about three inches of the insulating

covering on the end of each wire; scrape the bared copper wire until it is bright and clean; bend these wires into the position shown in fig. 3,270; and then firmly twist them around each other as shown in fig. 3,271. Second, cut off the projecting pieces *d, d*, close to the joint, and then solder the latter to prevent corrosion. This corresponds to a Western Union splice. Third, wrap a piece of adhesion or friction tape around the joint over about half an inch of the insulating covering of each wire, as in fig. 3,272.

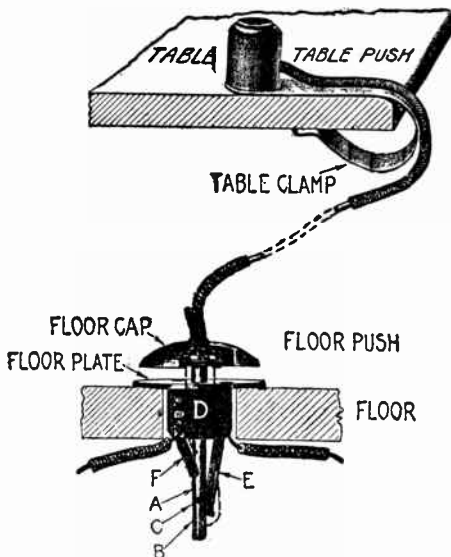
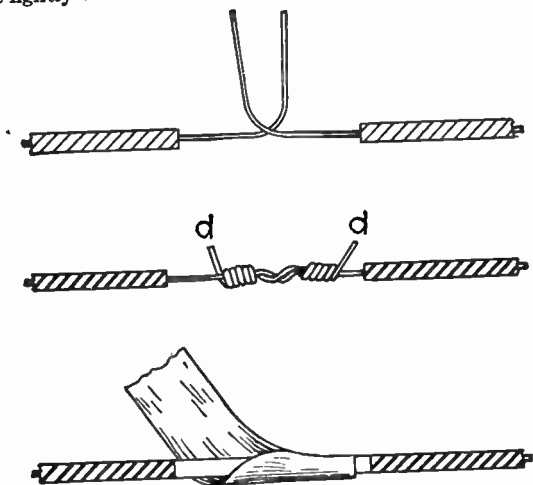

FIG. 3,269.—Combination floor and table push button suitable for dining room. The table clamp renders the push portable, permitting it to be moved at any time.

Bell Wiring.—The method adopted for running the wires of bell circuits will depend upon the character of the installation, involving the complexity of the system, the number of bell, the number of push button, the manner in which they are to be operated, etc. In the case of an ordinary door bell system, the push button is usually located at the front door, the bell in the

kitchen or back hall and the battery in the cellar or basement. Such a system requires three wires, one from the push to the bell, one from the push to the battery, and the third from the bell to the battery. In running these wires, always start at the push, and run the wires from the push to the bell, and to the battery.

Allow a foot of each wire for connection and slack, then proceed and fasten each wire lightly to the woodwork with staples or double pointed tacks.



FIGS. 3,270 to 3,272.—Proper method of making a joint in covered wires.

In driving the staples or tacks, take care that they do not cut the insulating covering of the wire, and never put two wires under one staple. The wires should be concealed wherever practicable, in the angles between mouldings, and in walls, in the grooves of mouldings, etc. When running along a skirting or base board, it is often practicable to conceal the wires by pushing them out of sight in the space between the base board and the floor.

In some cases the wires may be laid under a carpet without the use of staples, and for additional protection and concealment they may be placed in the crack between two floor boards. In crossing doors, the wires may either be run up one side of the door frame, over the top, and down the other side, or laid under the carter on the sill.

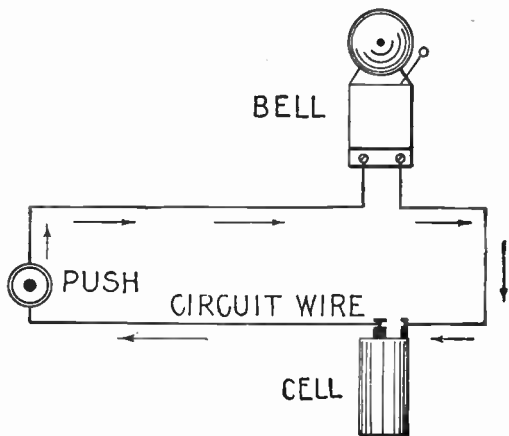

FIG. 3,273.—Simple bell metallic circuit. It includes the bell, the battery, the push button and the circuit wires, the return wire may be done away with by grounding the terminals of the circuit as shown in fig. 3,274.

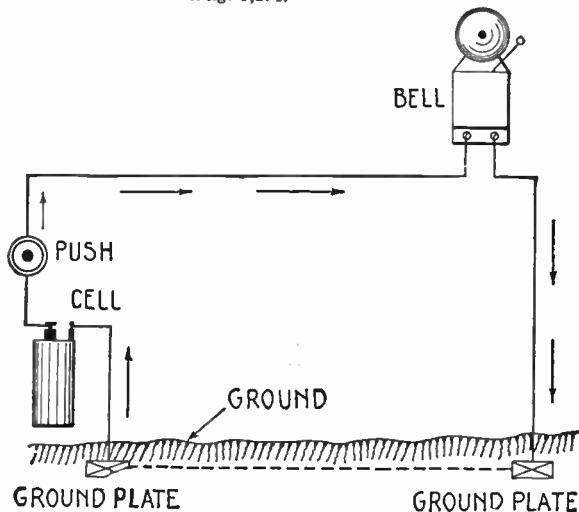

FIG. 3,274.—Simple bell circuit with ground return. In making the ground connection the wires are attached to ground plates as shown. Instead of using ground plates, a more convenient method consists of connecting the ground wires to a gas or water pipe.

The wire from the push to the battery may be run through holes bored in the floor directly under the push, but inside the front door, then along the cellar beams to the battery. In many houses the wire from the push to the bell may also be run along the cellar beams. In such cases, a second hole should be bored in the floor by the side of the one accommodating the wire from the push to the battery, for the wire from the push to the bell.

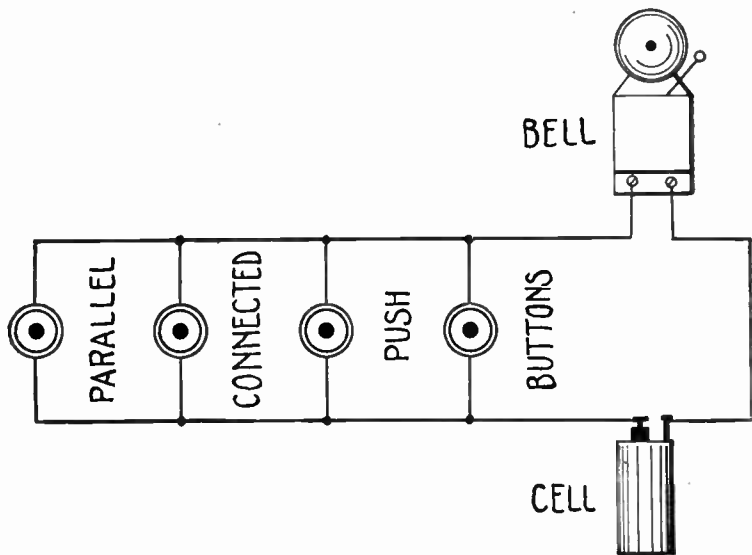

FIG. 3,275.—Parallel connected push buttons for ringing one bell from several points. It is obvious that if the push button were connected in series, all would have to be closed to complete the circuit.

Bell Circuits.—The connections of various types of bell are shown diagrammatically, in the accompanying diagrams. In general, it makes no difference whether the positive or the negative pole of the battery connects with the bell or the push button, except where a ground return is used. In the latter case the negative pole should connect with the earth.

It should always be remembered that the positive pole of the

battery is at the top of the negative plate, and the negative pole is at the top of the positive plate.

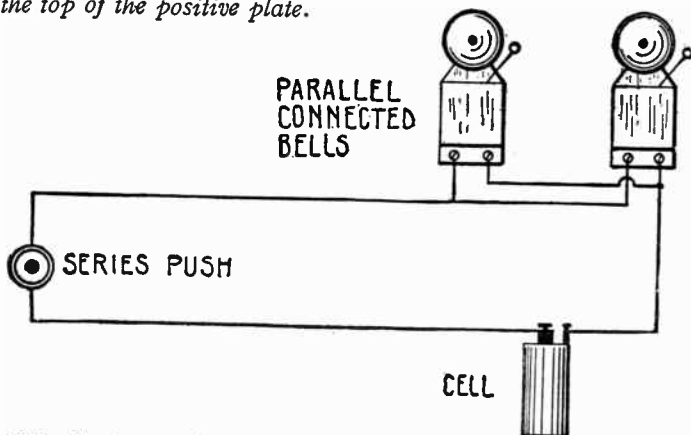

FIG. 3,276.—Circuit connections for ringing two bells from one push button. This method of connection requires more current or more cells of battery than does the series method. In the case of the series connecting system, one of the bells must be a single stroke bell, for if both of them be of the trembling type, their armatures would not vibrate in unison with each other, and the consequent irregular contact breaking would result in the intermittent ringing of the bells. For this reason bells are generally connected in parallel.

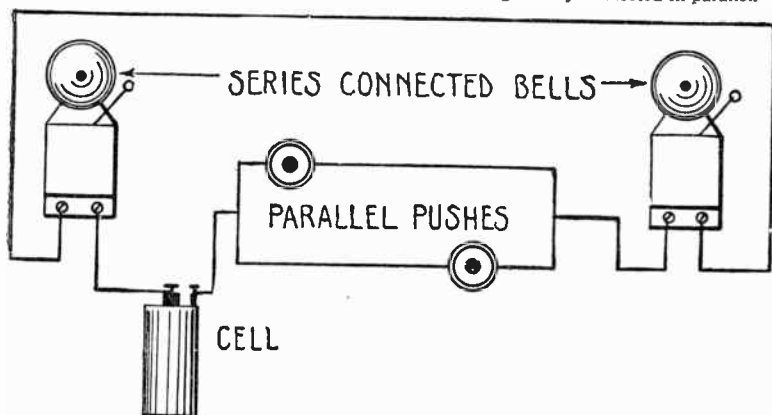

FIG. 3,277.—Series circuit connections for ringing two bells from either one or two push buttons. In this diagram the bells are in series, and one of them must be arranged for single stroke.

For instance, in the case of a Leclanche cell, or dry cell, the positive pole is at the top of the carbon (negative) element, and the negative pole is at the top of the zinc (positive) element. In the case of a gravity Daniel cell, the positive pole is at the top of the copper (negative) plate; and the negative pole is at the top of the zinc (positive) plate.

Within the cell the electric current always flows from the positive plate to the negative plate, while in the external circuit, the current always flows from the positive pole to the negative pole of the cell or of the battery.

Annunciators.—An annunciator is a device for indicating by visual means, signals transmitted over electric bell circuits. They

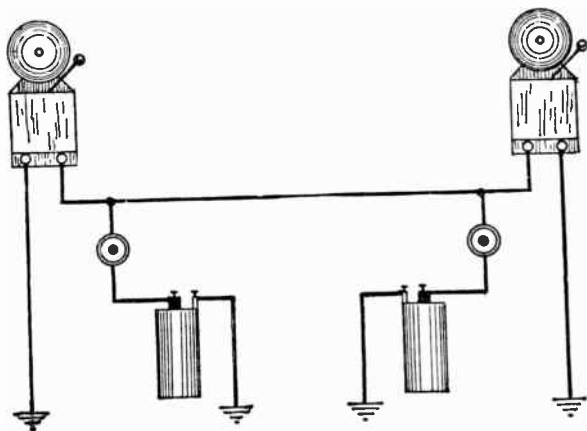

FIG. 3,278.—Parallel circuit connections for ringing two bells from either one or two pushes.

are most extensively used in connection with elevator, office, hotel, and residence call bell service. The mechanism of an annunciator consists of an arrangement of electromagnets the energizing of which, when the circuit is closed by the depression of the various pushes, allows shutters to drop, thereby exhibiting the circuit numbers painted thereon, or causes arrows to move and point to the numbers of the circuits marked close to them on the indicator panel.

Ques. How does the shutter drop work?

Ans. It is released from closed position by the action of an electromagnet, "drops" by gravity, and accordingly remains down until reset by hand or other means.

The operation of a shutter drop is illustrated in fig. 3,279. Another form of drop called the arrow or needle drop is shown in fig. 3,281.

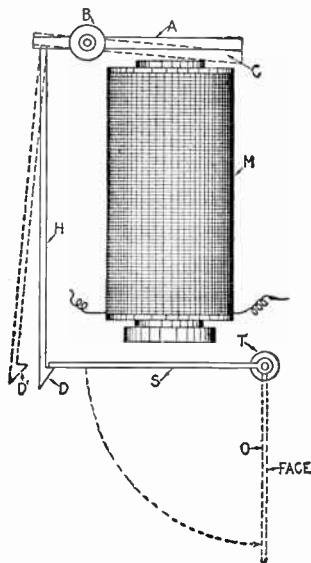

FIG. 3,279.—Shutter or gravity annunciator drop. *In operation*, when the circuit is completed by the depression of a push center, the current flows through the coils of the electromagnet *M*, and energizes its core, and the latter attracts the armature *A*, pivoted at *B*. When the armature is drawn to the position *C*, the claw *D* is thrown to the position *D'*, thereby releasing the shutter *S*, pivoted at *T*, allowing it to drop by gravity to the position *O*, thus displaying the number marked upon its face. The shutter may be reset by either mechanical or electrical means. An annunciator having a number of gravity drop is shown in fig. 3,280.

Ques. How are the drops arranged in annunciators usually employed in hotels, residences, and elevators?

Ans. The arrows are arranged to move through an angle of 90 degrees, as shown in figs. 3,284 to 3,286.

Pendulum Signals.—These are used to a limited extent in annunciator service where the ordinary gravity drop arrangements are subject to the liability of failing to reset. The indications given by such arrangements are very satisfactory and require no attention as they automatically reset. The pendulum indicator consists of an electromagnet with a projection at the free end on which is delicately pivoted a soft iron armature. From the center of this armature hangs a light brass rod carrying

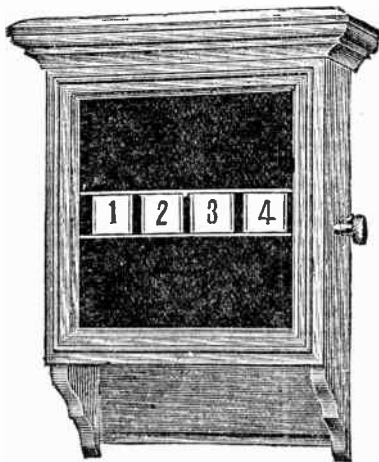

FIG. 3,280.—Gravity drop annunciator. In operation the shutters are reset by turning the knob seen on the side of the case.

a vane of fluted silver glass or a numbered card. The vane or card swings in front of an aperture in the indicator frame. When the electromagnet is magnetized, the armature is pulled suddenly to one side and the pendulum then swings backward and forward in front of the aperture for some time, until it finally comes to rest in its normal position. The bell rings when the current first attracts the pendulum and will continue ringing as long as the distant push is pressed.

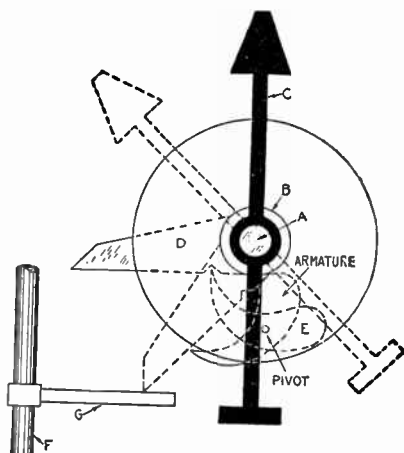

FIG. 3,281.—Arrow or needle annunciator drop. *In construction*, the shaft A, passes through, and is free to turn in a hole or axially through the electromagnet core B. The arrow or needle C, is rigidly attached to the front end of the shaft A, near the face of the annunciator. The notched arm D, is rigidly attached to the rear end of the shaft A, and is held in a horizontal position by the end of the armature E. *In operation*, when the current flows through the coils of the electromagnet, the armature E turns on its pivot towards the magnet core A, thereby releasing the arm D, which in falling rotates the arrow to the position shown in dotted lines. The arrow is reset by pressing a button, which raises the rod F, carrying the arm G. Needle drops arranged to move through an angle of not more than 45 degrees, are suitable for automatic annunciators and registers such as those shown in figs. 3,282 and 3,283.

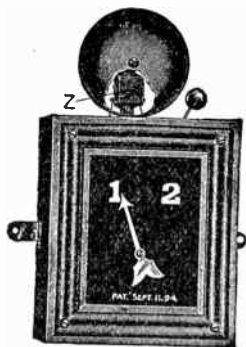

FIG. 3,282.—Automatic annunciator, especially suitable for residence service; it serves the purpose of two bells, one at the front door, and one at the back door. It can be readily converted into a three point annunciator by the addition of the buzzer Z, as shown, which can be operated from the dining room in place of the bell.

Annunciator Circuits.—A general method of wiring an annunciator is shown in fig. 3,287. The wire A, runs from one terminal of the battery to one terminal of each push; the wire B, runs from the other terminals of the battery, through the bell, and thence to one terminal of each of the drop magnets M1, M2, etc. The other terminals of each of the magnets M1, M2, etc., and pushes 1, 2, etc., are connected as shown.

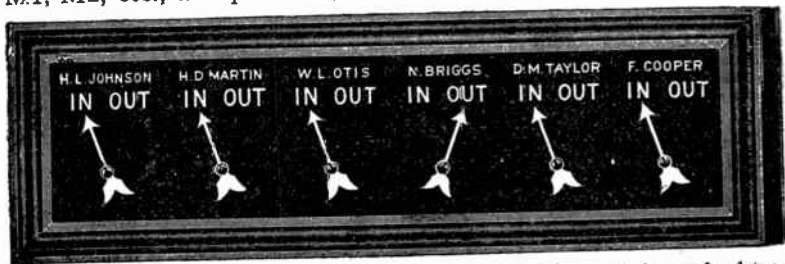
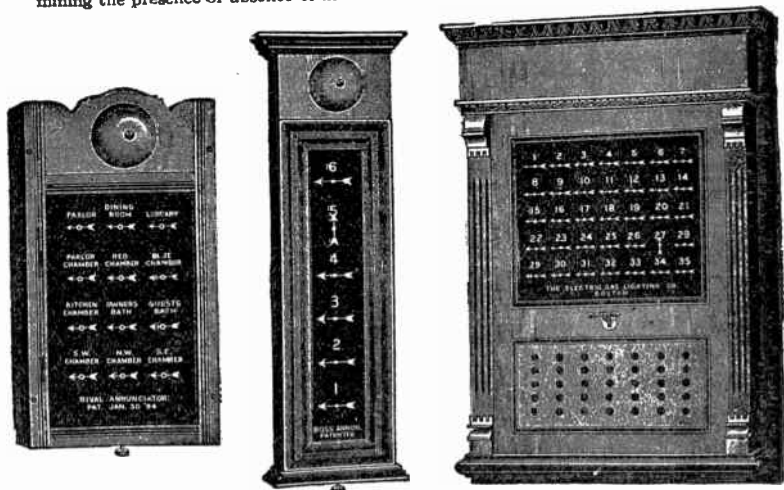

FIG. 3,283.—Automatic register suitable for use in factories and mercantile houses for determining the presence or absence of individuals.



FIGS. 3,284 to 3,286.—Various annunciators. Fig. 3,284, automatic residence annunciator; fig. 3,285, elevator annunciator; fig. 3,286, hotel return call annunciator.

With this arrangement, the pressing of any push button does not affect any of the other drops except the drop controlled by that particular push. For instance: when push button 3 is pressed, the circuit is completed only through the drop magnet M3, as shown.

The use of the common battery wire B B, and the common return wire A, obviate the necessity of running two wires from each push. These common wires should be larger than the other wires, however, and No. 16, B. & S. gauge copper wire will be found suitable for the general run of annunciator work.

Ques. What precautions should be taken in wiring an annunciator?

Ans. All the wires should be properly installed before they

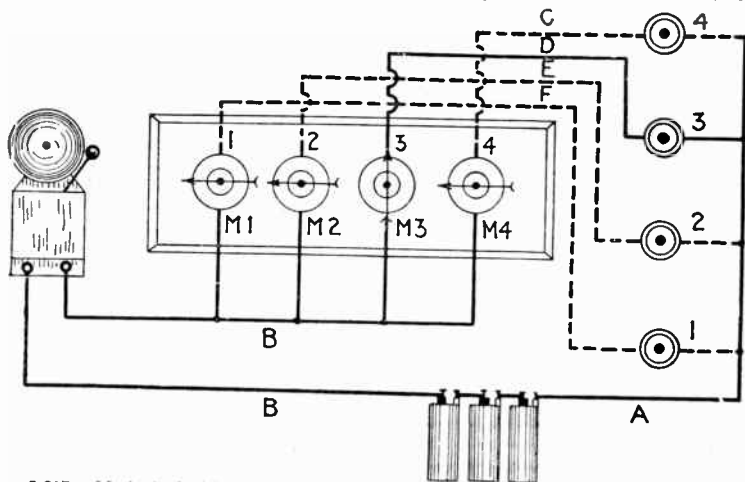

FIG. 3,287.—Method of wiring an annunciator; diagram shows the various circuits, bell, battery, push button, drops, etc.

are connected up to the corresponding drop magnets and pushes. The simplest method is to connect the wires C, D, E, and F (fig. 3,287), to the drops in any order. Then have an assistant press the different push buttons, make a note of the drops affected, and make changes in the annunciator connections accordingly, in case of error.

Elevator Installations.--All passenger and freight elevators should be fitted with electric bells and annunciators. And all dumb waiters should be announced by electric buzzers as they are brought up to the floors of apartment houses.

The insulated wires used in such installation should be laced together or a wire cable should be run up along one side of the shaft, care being

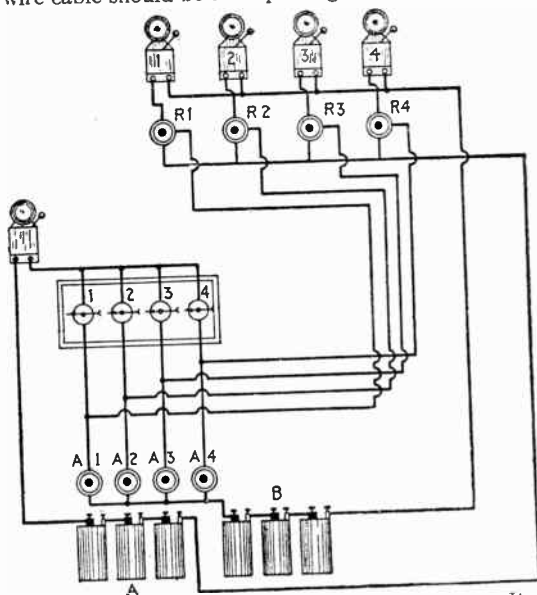

FIG. 3,288.—Western Electric return or fire call annunciator system. It employs two batteries and two return wires. Battery A, is for the annunciator circuit, and battery B, for the return or fire call circuit. The pushes are of the three point type, and in each room their top contacts and push center spring contacts remain normally together. When one of the annunciator pushes A1, A2, etc., is pressed, battery B, becomes connected in series with the bell 1 or 2, etc., as the case may be. When one of the room pushes R1, R2, etc., is pressed, its corresponding bell is cut out and the circuit becomes similar to an ordinary annunciator circuit.

taken that these wires are stretched taut, so that they will not be caught and torn. Fig. 3,289 shows how dumb waiter wires should be connected.

For the installation of the elevator announcing system, a well insulated flexible wire cable is required which is connected to the annunciator or the moving elevator car.

There must be as many wires in this cable as there are floors in the building plus an additional wire which is to serve as the battery feed wire.

An elevator wiring diagram is shown in fig. 3,290 which represents a four story elevator building with a push button at each floor. Fig. 3,291 shows the combined wiring for two elevators in the same house. Of course, it is assumed that both are either passenger elevators or both are for freight, for it would be confusing if one was for freight and the other for passengers because the bells and annunciators of each would indicate at the same time.

Door bells and buzzers are necessary in an apartment house to announce callers as well as a means by which the downstairs door can be opened by the pressing of a push button from the floor at which the bell rings.

The circuits of such a system for a four family house are shown in fig. 3,292. In the vestibule there is a door opener, which consists essentially of a magnet and armature, and four push buttons. A battery of three dry cells is located in the basement or cellar. This may be disconnected and a bell ringing transformer substituted in its place connected as shown in fig. 3,293.

Faults in Bells.—These are due to a variety of cause, which may be easily rectified. When the armature sticks to the magnet cores and fails to make contact with the screw, the

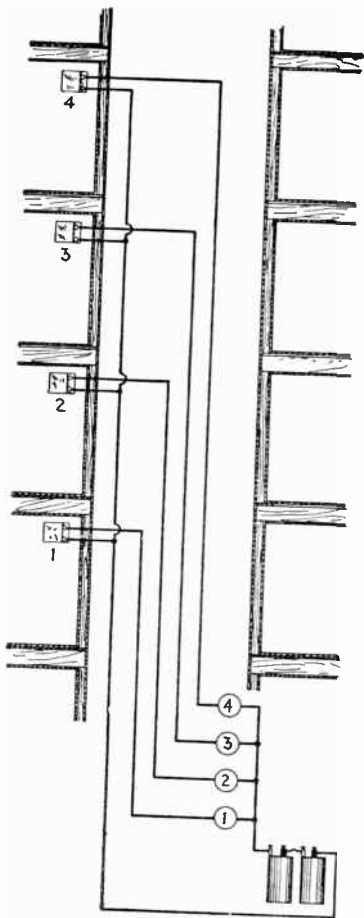

FIG. 3,289.—Dumb waiter buzzer circuit.

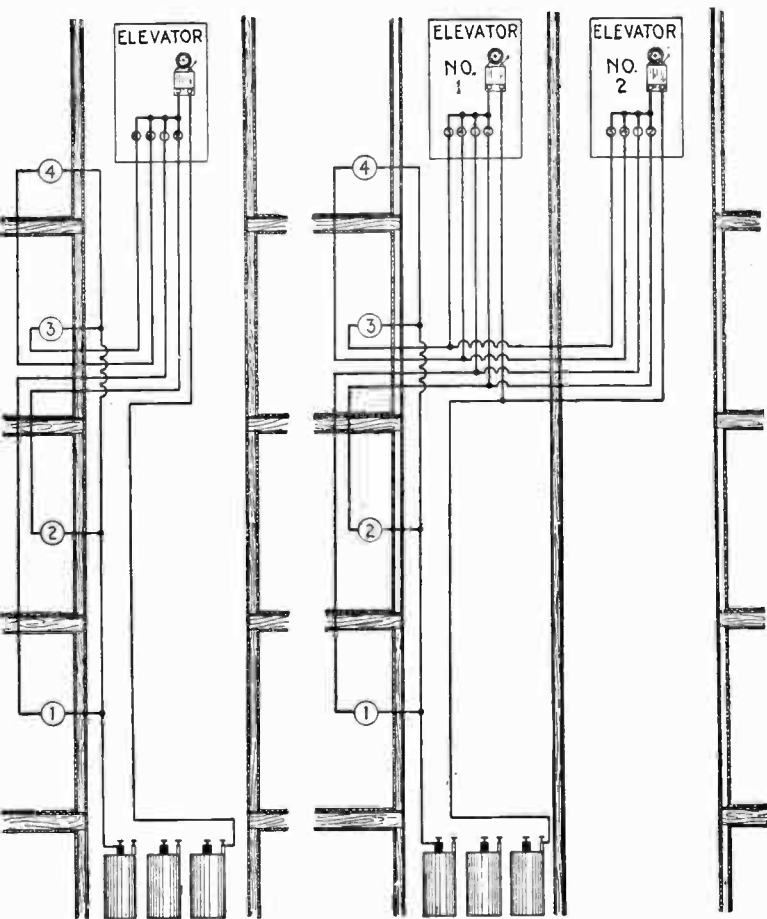

FIG. 3,290.—Annunciator circuit for single elevator.

FIG. 3,291.—Annunciator circuit for two passenger elevators, or two freight elevators. It should not be used in the case of a passenger and a freight elevator.

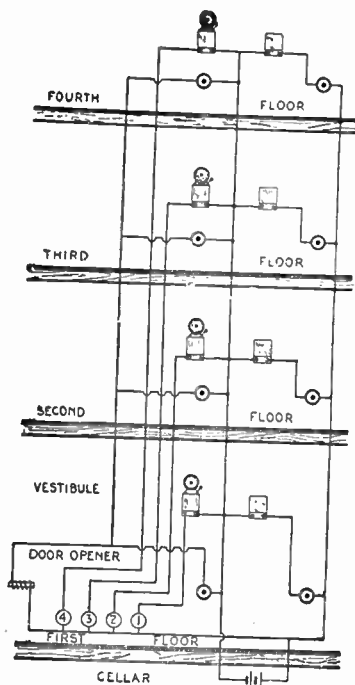

Fig. 3,292.—Diagram showing bell and buzzer circuits for an apartment house.

should not be readjusted unless it
of loosened screws.

trouble is generally due to weak spring, or to the loss of brass pieces, which are inserted in the ends of the cores to prevent actual contact with the armature. A piece of paper stuck over the ends of the cores will often serve as a satisfactory remedy.

When the bell makes a screeching sound, the trouble may be due to a too rapid vibration of the armature; too much battery power; or to the fact that the contact screw is too far forward. If the excessively rapid vibration is caused by too little play, or too much battery power, the fact will be indicated by violent sparking.

Dirty contacts and loose contact screws increase the resistance of the circuit, tend to decrease the current allowed to pass through the magnet coils, and often prevent the bell ringing at all. It should be noted that the contacts are of platinum, as German silver and other similar metals are soon corroded away by the sparking. The contact screws be found necessary to do so because

Faults in Bell Circuits.—Faults, other than those caused by weak push and bell springs, dirty and loose contacts, and impoverishment of battery current are generally due to crossed wires, or broken wires. Fig. 3,294 shows the method of making a simple test for a cross. Disconnect the wire from one terminal of the battery; connect a short piece of wire B, to that terminal, and place the two ends C and D, on the tongue. If the circuit

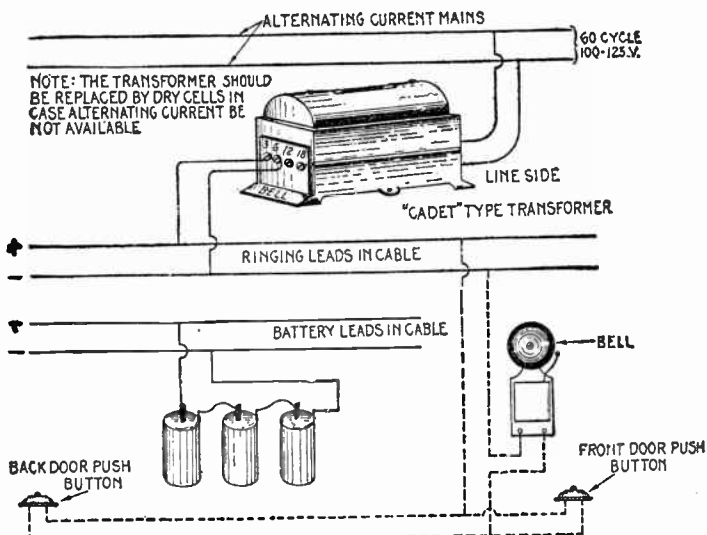

FIG. 3,293.—Diagram showing method of connecting a bell ringing transformer for ringing inter-phone bells and door bells. Dotted lines show wiring for door bell using same source of ringing current.

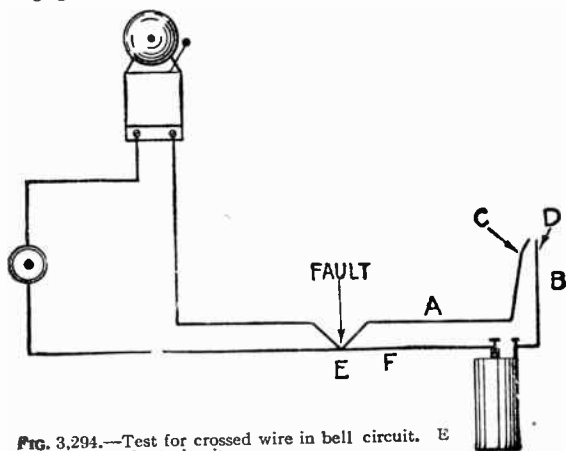

FIG. 3,294.—Test for crossed wire in bell circuit. E represents short circuit.

wires be touching each other at some bare spot E, the current will flow from the battery along F, to the point of contact E, thence along A, to the tongue, and along B to the battery.

The flow of current will be indicated by a metallic taste upon the tongue, or by connecting a telephone receiver between C and D the diaphragm will be made to vibrate. Without this indication, or the absence of the metallic taste on the tongue, it is probable that the trouble is due to a break.

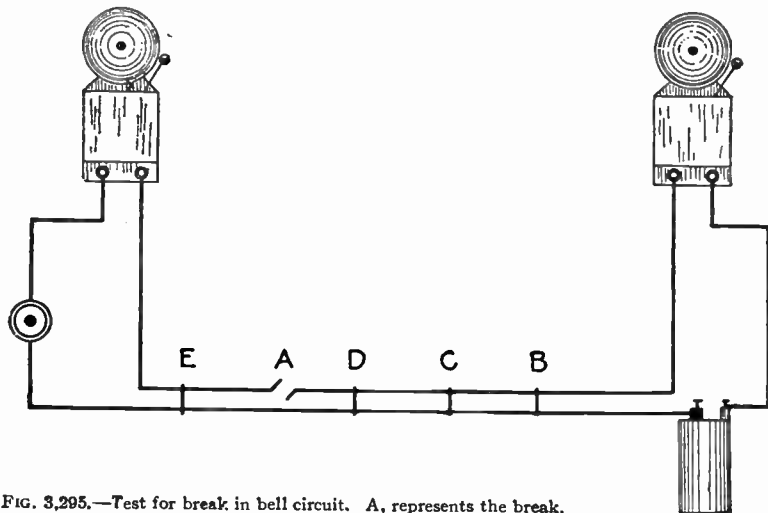

FIG. 3,295.—Test for break in bell circuit. A, represents the break.

Fig. 3,295, shows a simple method for determining the location of a break. Take a bell to the battery and connect it between the circuit wires and the battery at the points B, C, D, and E, working towards the push. At each of the points cut away a little of the insulating covering of the wires, and short circuit the latter, beyond the bell and the battery with a knife blade. If the bell ring at the points B, C, and D, but fail to ring at the point E, the break will be located at A, somewhere between D and E.

Ques. What is usually the cause of short circuits?

Ans. They are often caused by double pointed tacks and

small staples cutting through the insulation and injuring the wire. This is often the result of carelessness and too much haste in tacking up the wires.

No more than one wire should be placed under one staple. Even if the staples be saddled, as shown in figs. 3,296 to 3,300, this is a safe rule to observe.

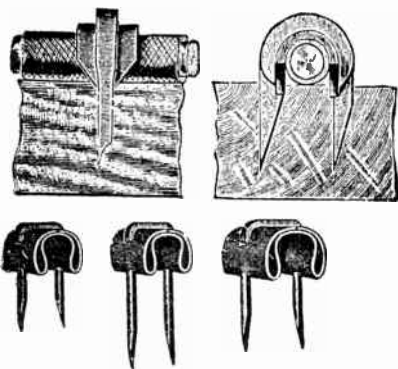

FIGS. 3,296 to 3,800.—Saddled staples for securing bell wires.



FIG. 3,301.—Roll of insulating tape for covering the joints of bell wire.

Waterproof saddled staples have a double thickness of insulating material protecting the metal and preventing it cutting through the wire. Insulating pin tacks are sometimes used where twisted wire is to be tacked. These fibre head tacks are called "milonite" tacks.

Insulating tape such as friction tape is always used to cover soldered joints and should be used at any other place where the wire insulation is worn off or is liable to become worn. Fig. 3,301 shows a roll of insulating tape.

Current Supply for Bell Ringing.—Dry cells are generally used for a battery source of electrical supply with which to ring bells of the vibrating type. While there is not much economy in restoring them after they have become weak, it is possible to do this. They will generally outlive the zincs of the liquid batteries and are smaller and lighter and less expensive than salamoniac cells, hence well suited for the battery source of supply.

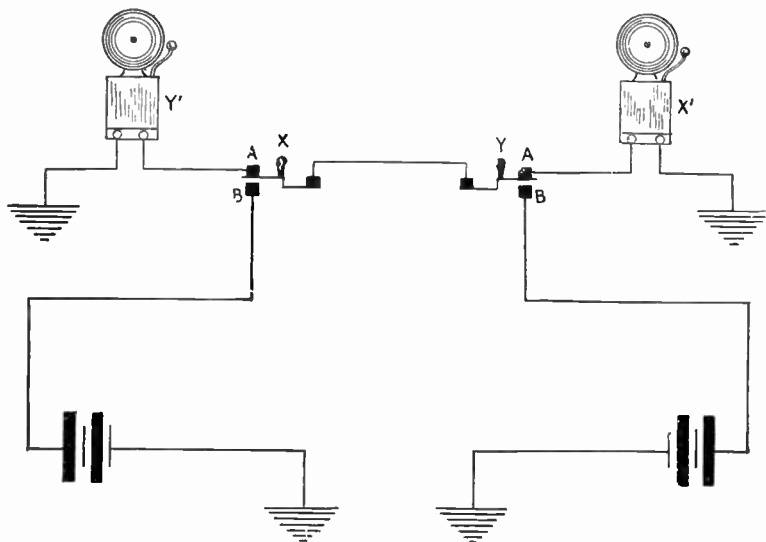

FIG. 3,302.—Circuit connections for ringing the more distant one of two bells from either one or two push buttons. Two batteries, one or more cells each, are required, but only two wires or one wire and ground return. The pushes are of the double contact type. When depressed they make the contacts B, B, but maintain the contacts A, A, when in their normal position or not touched. Depressing the push center X, rings the bell X'; depressing the push center Y, rings the bell Y'.

Dry cells are made with moist chemically filled centers sealed with a compound which gives them the appearance of being dry. The fact that they become weak is generally due to a leakage of moisture in a corroded zinc which soon causes them to become dry inside. By boring holes in the compound and allowing them to become saturated with acid or even water, they may be revived.

In the manufacture of these dry cells, the zinc cylinder is lined on the inside with blotting paper. Then the exciting fluid is poured in and left for ten or fifteen minutes to thoroughly soak into the blotting paper. This fluid or electrolyte is then poured out and the carbon plate inserted, the space between it and the blotting paper being filled with the oxide of manganese mixed with granulated carbon, which is moistened with the electrolyte. A layer of dry sand is spread over the top of this cell onto which is poured hot pitch. When this has cooled and hardened the cell is ready for use.

Ques. What is the best method of connecting cell terminals of a battery?

Ans. In order to insure the connections remaining tight,

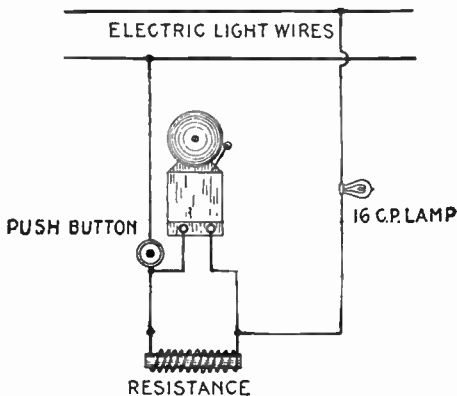

FIG. 3,303.—Method of operating a bell from electric light circuit. The resistance across the terminals of the bell, when the push is depressed, in about 7 ohms, corresponding to the resistance of about 25 feet of No. 21, German silver wire. The lamp in circuit is an ordinary 16 candle power incandescent lamp. Another method of ringing a bell from a lighting circuit consists in connecting several 16 candle power lamps in series on one side of the bell circuit. If the resistance of the bell be twenty ohms and it will safely stand .1 ampere it will require about two volts. Five lamps connected in series, each having a resistance of 220 ohms (the average resistance of carbon lamps) will bring 110 volts down to two volts and about .1 ampere. Or two thirty-two candle power lamps connected in series will do in place of the five of sixteen candle power where the bell is connected by a long stretch of wire. In this system no German silver wire resistance is required.

especially when the cells are subjected to vibration, spring snap connectors should be used as shown in fig. 3,304.

For large buildings the most economical bell ringing current supply is alternating current stepped down by means of "reducers" or *step down*

transformers. It should be remembered that electric bells will ring with a supply of alternating current, sixty cycles frequency such as is used for lighting purposes, as easily as with direct current supply. The former

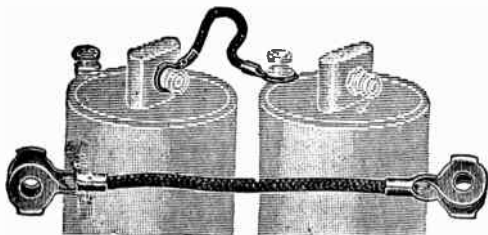

FIG. 3,304.—Spring snap connectors and view showing connector in connecting two terminals. The use of this device insures permanent and perfect electrical connection between battery cells at all times. It is placed in position by pressing the spring clips together and placing same over the binding screws. The tension of the spring is sufficient to maintain a perfect contact even if the nuts should work loose and become lost. The spring contacts are of phosphor bronze and are securely fastened to the conductor cord.

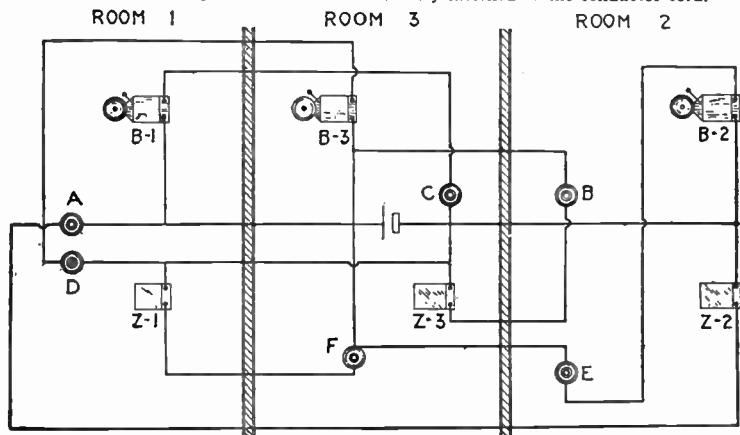

FIG. 3,305.—Circuit connections for a system of bell and buzzer, for sending signals from any one of the three rooms to any of the other rooms in such a manner as to indicate from whence the signal comes. It will be understood that a buzzer is merely a trembling bell minus the hammer and gong. The vibrations of its armature makes a buzzing noise, which does not carry as far as the ringing of a bell. It is principally used for a desk call, or where the attraction of general attention to the signal is not desirable. The method of connections shown requires the use of only ordinary bells, buzzers, pushes, and a minimum amount of circuit wire. The numerals 1, 2 and 3, represent the equipment in the three rooms or offices. The bells are properly designated as B1, B2, and B3; the buzzers as Z1, Z2, and Z3; and the pushes as A, B, C, D, and E, F. Push A, controls the buzzer Z2; push B, controls the buzzer Z3; push C, controls the bell B1; push D, controls the bell B3; push E, controls the bell B2, and push F, controls the buzzer Z1.

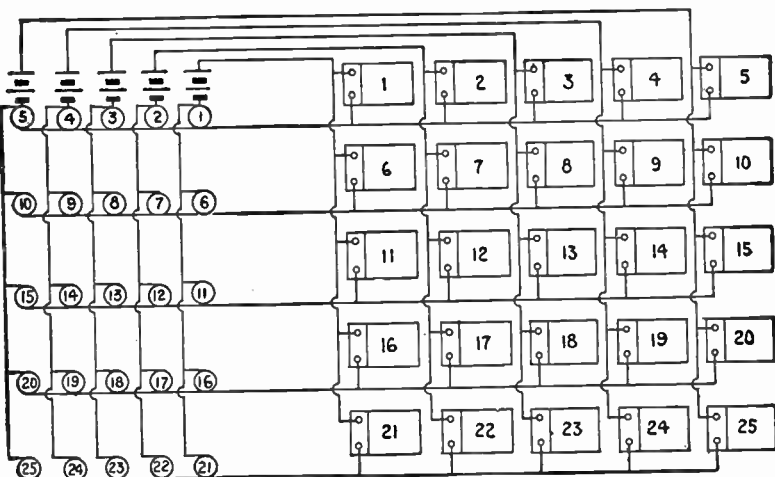

FIG. 3.306.—Wiring diagram for 25 buzzers and 25 push buttons with ten wires. This installation requires five batteries. Five of the ten wires lead from the batteries to the buzzers, each wire being connected in parallel to a vertical row of buzzers. The other five wires connect horizontal rows of pushes to horizontal rows of buzzers.

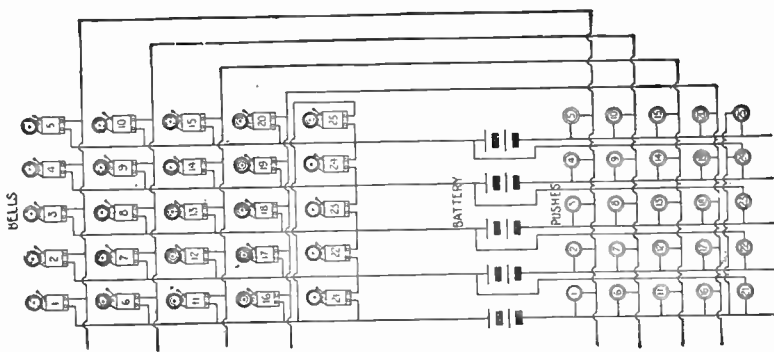

FIG. 3.307.—Wiring diagram for 25 bells and 25 push buttons with nine wires. This is the minimum number of wires that can be employed so that any push will ring the corresponding bell and no other. The diagram plainly shows the connections. It will be noted that for the last five bells, 21 to 25, inclusive, leads cutting out one battery are necessary extending from one battery terminal to push.

must be reduced by step down transformers but the latter can only be reduced by the insertion of resistances. The direct current resistances may be electric lamps connected in series or they may be coils of wire.

Fig. 3,308 shows a step down transformer used to ring bells and buzzers. It seldom has to be replaced and consumes very little current and always gives a standard output of electricity.

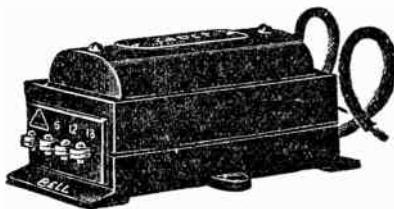

FIG. 3,308.—Western Electric bell ringing transformer. A self contained unit for use on 60 cycle alternating circuit of 100-125 volts. Delivers current at 6, 12, or 18 volts.

Burglar Alarms.—A burglar alarm equipment consists of most of the apparatus required for regular electric call bell outfits and the general scheme of wiring is, with two exceptions,

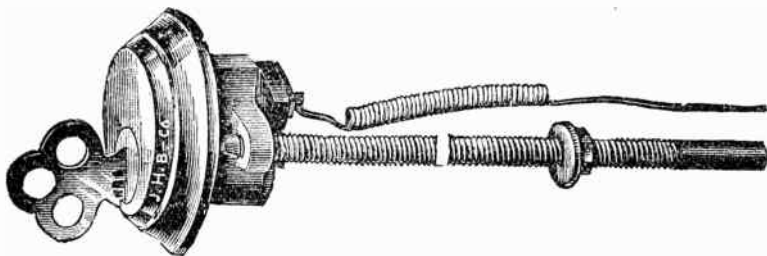

FIG. 3,309.—Yale lock burglar alarm switch. These switches are placed on the doors of stores, residences, and other buildings connected with Burglar Alarm Systems, so that persons having the proper keys can go in or out of the buildings without ringing the alarm.

about the same. Instead of push buttons, however, switches and floor treads or floor mats are used and the wiring is either concealed as much as possible, or so arranged that if cut at any place an electrical circuit will be formed and a bell or buzzer will operate and call the owner.

Fig. 3,309 shows a form of alarm lock used in burglar alarm circuits. A floor tread such as is shown in fig. 3,310 will complete an electric circuit and ring a bell as long as one stands on the tread. A matting made of several switch contacts connected in parallel will act like several floor treads all connected in parallel. This is one way of closing a burglar alarm circuit and indicating the presence of an intruder. Another way is by equipping the windows with spring contact making device or window spring such as that shown in fig. 3,311. When the

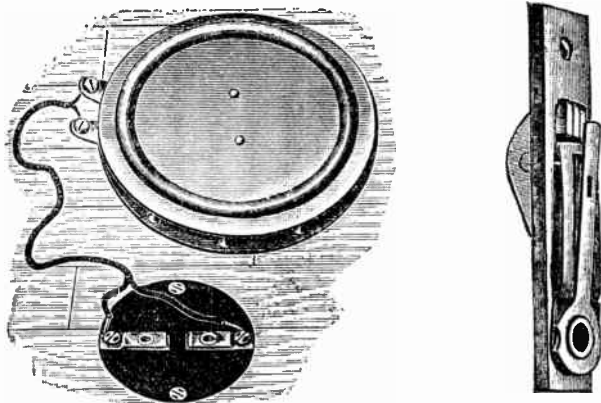

FIG. 3,310.—Floor tread and floor connector for office or dining room floor or any place where it is desirable to operate a signal on the floor. A slight pressure of the foot will close the contact. Its construction is simple; its action perfect. When placed under rug or carpet it will not become short circuited. The felt covered bottom protects the floor from being scratched. It is but $\frac{1}{4}$ inch thick and very easy to wire.

FIG. 3,311.—Window switch or spring used to close a burglar alarm circuit when the window is opened.

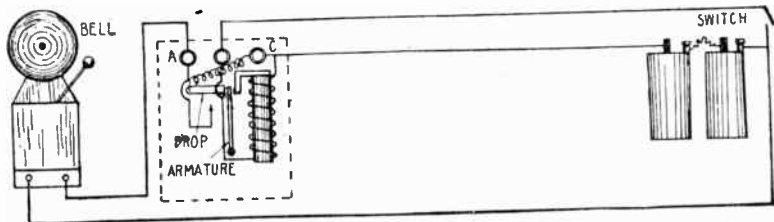

FIG. 3,312.—Automatic burglar circuit with gravity drop circuit maintainer to give continuous ringing. The circuit maintainer would be properly called a relay if the bell circuit have an independent battery. The operation is described in the accompanying text.

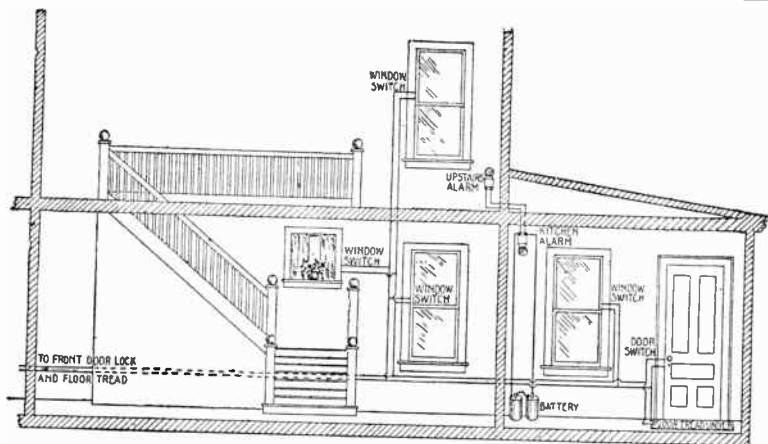

FIG. 3,313.—House equipped with burglar alarm system. The spring contact switches are all connected in parallel. The door switches may be like that shown in fig. 3,309 in which the insertion of a key closes switch contacts in the lock. The battery and bells are connected in parallel to the main wires going to the battery and switches. The back stoop has a floor tread fitted with contacts connected in parallel to ring an alarm. Regular push buttons may be connected at each door, in parallel so that the same system may be used to announce a caller as well as an intruder.

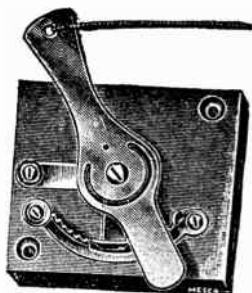

FIG. 3,314.—Burglar alarm trap. This trap is so constructed that when the contact lever is off the bridge it cannot be returned to its original position except by hand. When set, a pull on the string draws the lever from the bridge on to the contact points. If the string be cut, broken or burned apart, a coiled spring throws it the other way on to the contact points. The bridge, which is higher than the contact points, is so constructed as to catch and hold the lever, which cannot be returned to its original position except by hand. Consequently the circuit remains closed and an alarm will be continuously sounded.

window is closed the contact points remain open but when the window is raised enough to push against the spring, the contact is closed and the bell is made to ring.

Bells of the continuous ringing type should be used so that they will continue ringing when once started by the window spring irrespective of whether the window spring remain in the closed position or be opened by closing the window.

Fig. 3,312 shows a gravity drop circuit maintainer circuit. In operation, when the switch is closed, the circuit maintainer magnet winding is connected in series with the battery and the armature is drawn up

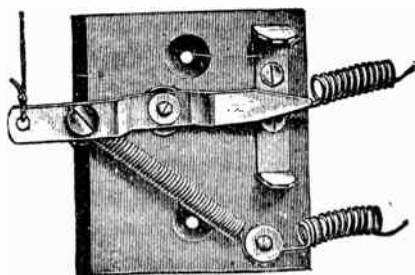

FIG. 3,315.—Burglar alarm trap with string balance. The illustration shows the trap balanced between the contact points by the use of a string, which can be stretched in any room or hallway of the building to be protected from intruders. A slight disturbance of string draws the needle to the right and closes bell circuit, and if the string be broken the spring draws needle to the left. When the circuit is completed bell gives an alarm. If a constant ring be desired, an automatic constant ringing drop should be connected in circuit, as this type of trap will not make permanent contact unless the cord be broken.

against the core of the magnet so that the drop is released and allowed to fall against the contact point connected with the A binding post.

The drop, which is connected with C binding post, thereby closes the bell circuit and allows the bell to ring until the drop is again raised to its normal position.

Ques. How are burglar alarm wires installed?

Ans. In wiring burglar alarm systems the main wires are generally concealed. This may be done under floors or behind

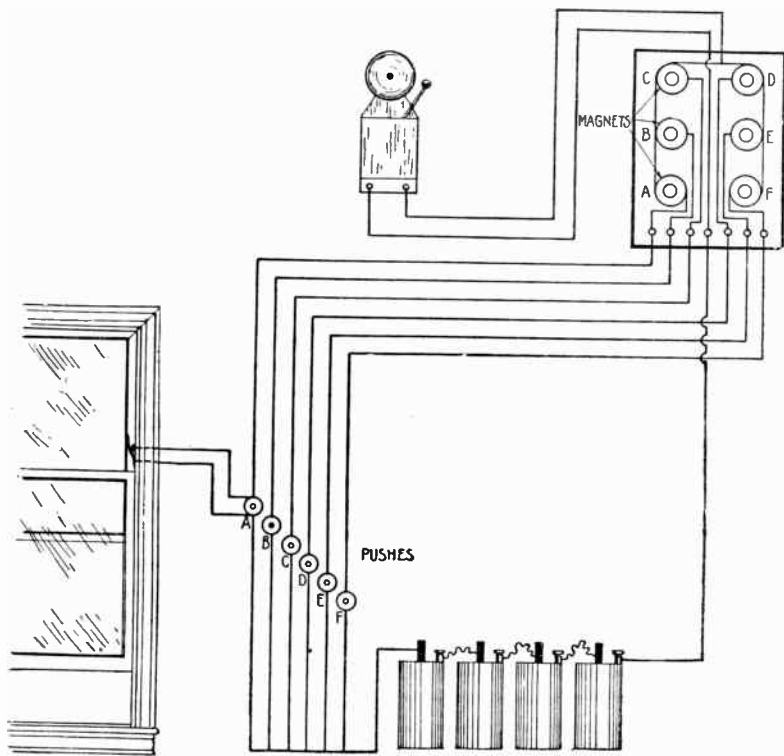
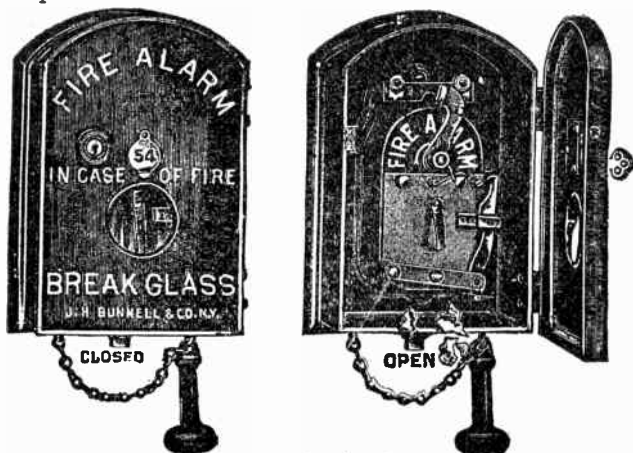
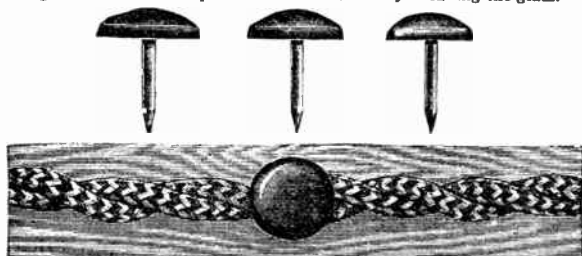

FIG. 3,316.—Six drop annunciator circuit showing one burglar alarm switch. The six annunciator magnet windings are each connected on one side to a common wire connecting with one bell binding post and the other ends of the magnet wires are each connected to separate binding posts in the annunciator. Distant push buttons are connected with a common battery wire and with the annunciator in such a way that by pressing push button A, the bell will ring and drop A will indicate; pressing B will ring the bell and drop B will indicate; similarly for the other drops. A burglar alarm window switch is connected with one annunciator drop, showing the way in which a raised window will close the circuit. As many open switches as desired may be connected to any of the circuits so long as they are all in parallel.

baseboards or in metal moulding. The latter cannot be molested without making some noise and is easily run along the floor. If the wires be not concealed they may be tacked down by milonite nails with insulated heads as shown in fig. 3,322, or placed under fibre cleats



Figs. 3,317 and 3,318.—Jupiter fire alarm box closed and open with glass broken and alarm going in. *In operation* when glass is broken the mechanism acts automatically, sending in the number of the box four times. Once starting, the alarm cannot be interfered with. By means of a special key the circuit and mechanism may be tested or a single round of the box sent in as a watchman's signal without disturbing the glass or interfering with the regular fire alarm setting of the box. The inner box contains the signal movement. On the front of the inner box is mounted the trip and latch that engages the pull lever of box holding it in set or wound position until released by breaking the glass.



Figs. 3,319 to 3,322.—Milonite nails and method of tacking two insulated wires. The heads are colored to match insulation and the wires can be taken down without cutting or injuring the insulation.

Ques. What provision is made to preserve the continuity of the circuit against the cutting of wires?

Ans. Two *soft lead wires* with light insulation may be run together and further protected by a heavy insulation so that when an attempt is made to cut the protected feeder, the soft lead wires will go together and make contact and keep the circuit closed until they are pulled apart.

Ques. When a large house is to be equipped with burglar alarms what should be included in the system?

Ans. It should include an annunciator such as shown in fig. 3,316 so that the position of the system molested with may be determined at a glance.

CHAPTER LXXII

ELECTRIC LIGHTING

The term *electric lighting*, as generally employed, means *the art of producing artificial illumination by means of electrical energy*.

The first production of electric light in a practical way is attributed to Otto von Guericke, who made the first electrical machine about the middle of the seventeenth century and with which he produced sparks sufficiently powerful and frequent as to produce a perceptible amount of illumination.

The real foundation of electric lighting, however, is due to Davy, who in 1809 and 1810 realizing the possibilities of the primary battery invented by Volta in 1800, constructed a large battery of 2,000 pairs of plate and with this source of current, produced a continuous and brilliant electric light, which was practically identical in principle with the arc light of to-day. The following description is from Davy's account of the experiment:

"When pieces of charcoal about an inch long and one-sixth of an inch in diameter were brought near each other, within a thirtieth or fortieth part of an inch, a bright spark was produced, and more than half the volume of charcoal became ignited to whiteness, and by withdrawing the points from each other, a constant discharge took place through the heated air, in a space equal to at least four inches, producing a most brilliant ascending arch of light."

It should be noted that the discharge was maintained between horizontal charcoal points, and assumed the form of a bow or arch on account of the current of heated air created by the intense heat generated by the passage of the current through the air space between the charcoal points. This feature led to the application of the term *arc* to a continued discharge of electricity across a break in an electric circuit, as

distinguished from the term *spark* which signifies a disruptive discharge of short duration. It is well to know, however, that even when an arc is sprung between two carbon rods placed vertically as in the case of an arc lamp, the action of the earth's magnetic lines of force causes the arc to assume the form of a bow.

The intense brilliancy and whiteness of the light emitted by the arc naturally induced great efforts to utilize it practically.

Although Davy demonstrated that electricity could be used for lighting, the expense of the battery and maintenance of same was prohibitive, hence no further progress was made until a suitable method was discovered of producing a more powerful current of electricity at small cost.

The problem was solved by Faraday in 1831, who succeeded in producing a current by mechanical instead of chemical means.

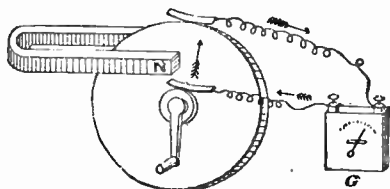

FIG. 3,323.—Faraday's dynamo which embodies his discovery in 1831 of *electro-magnetic induction*, the principle upon which all dynamos work, as well as induction coils, transformers, and other electrical apparatus.

All dynamos or alternators are based on Faraday's discovery, which may be stated as follows: *Electric currents are induced in conductors by moving them in a magnetic field, so as to cut magnetic lines of force.* Faraday's own description of his discovery is as follows:

"Two hundred and three feet of copper wire in one length was coiled around a large block of wood; another two hundred and three feet of similar wire was interposed as a spiral between the turns of the first coil, and metallic contact everywhere prevented by twine. One of these helices was connected with a galvanometer, and the other with a battery of one hundred pairs of plate, four inches square, with double coppers, and well charged. When the contact was made, there was a sudden and very slight effect at the galvanometer, and there was also a similar slight effect when the contact with the battery was broken."

After various experiments Faraday made his "new electrical machine," consisting simply of a copper disc arranged to turn between a horseshoe magnet with bushes contacting with the shaft and the periphery of the disc to collect the current. This was the first magnet.

Faraday's "new electrical machine" was quickly developed by various other experimenters, such as Pixii, Dal Negro Saxton (1833), and Clark 1835.

All of the machines produced at this time were of the permanent magnet or magneto type, the chief defect being the small output due to the weak field produced by the permanent magnet.

Of these magneto machines, the most important was the Alliance machine, due to Nollet 1849. This machine was fairly well developed in 1863 and was applied to lighting the lighthouses of the French coast, this being perhaps the first commercial application of the electric light.

The substitution of electromagnets for permanent magnets was due to suggestions and experiments made by Brett, Sin-steden, and Wilde during the years 1848 to 1863.

Subsequently, Siemens and Wheatstone were actively engaged in developing machines embodying this principle,—thus the origin of the *dynamo*, or direct current generator with electromagnets.

Wheatstone is better known, *though erroneously so*, as the inventor of the so called Wheatstone bridge. *The credit for this invention properly belongs to Christie*; all that Wheatstone did was to use Christie's invention for the measurement of resistances.

Electric lighting, broadly speaking, is a large subject and covers several branches of engineering. A full treatment of the subject would accordingly include:

1. Generation;
2. Transmission;
3. Utilization.

Under this scheme of presentation, the subjects to be considered would be

1. With respect to **generation**,

- a. Boilers;
- b. Steam engines;
- c. Steam turbines;
- d. Gas Engines;
- e. Water wheels;
- f. Wind mills;
- g. Dynamos;
- h. Alternators;
- i. Primary and secondary batteries.

2. With respect to **transmission**,

- | | | |
|----------------------|---|--|
| a. Various systems | { | series;
parallel;
series parallel;
parallel series;
etc. |
| b. Line construction | { | overhead conductors;
under ground conductors;
inside wiring;
etc. |
| c. Control devices | { | transformers;
regulators;
circuit breakers;
arresters;
etc. |

3. With respect to **utilization**

- a. Arc lamps;
- b. Incandescent lamps;
- c. Vacuum tube lamps;
- d. Illumination.

To follow this outline would involve considerable repetition of matter contained in the other Guides, besides the treatment of subjects outside the field of electrical engineering, and which accordingly cannot with propriety be included in a general work on Electricity, that is to say, to satisfactorily treat the main subject, and give the reader a reasonable amount of information thereon, would fill the book, leaving no space for any extended discussion of foreign subjects such as prime movers, etc.

It is to be supposed that when a reader procures a book on a certain subject, he wishes to concentrate on that particular subject, and with this idea in view the author believes that the necessarily limited number of pages at his disposal should be confined strictly to the main subject, without any lengthy discussion of items foreign thereto, it being assumed that if the reader desire to post himself on related subjects, as for instance, steam engines, he will get a book on that subject. The earnest student will adopt this method of study.

Sources of the Electric Light.—Electric lighting is accomplished by means of the electric arc, incandescent filaments of various materials, and vacuum tube containing various kinds of gas or metallic vapor. The great variety of apparatus employed for this purpose may be conveniently divided into two general classes

- 1 Arc lamps, including vacuum tube lamps;
- 2 Incandescent lamps, including non-carbon filament lamps.

The Electric Arc.—If two carbon rods be connected electrically to the terminals of a dynamo and the free ends of the rods brought together, the current from the dynamo will flow through the closed circuit thus established. Now, if the carbon rods be drawn apart so as to form a slight break of one-eighth of an inch or less in the circuit, the current will jump from one rod to the other and the arc thus formed will be maintained across the gap in the circuit.

Ques. How is the arc maintained?

Ans. By the conductivity of a bridge of carbon vapor allowing a continuance of current.

Ques. How is the carbon vapor produced?

Ans. By the vaporization of the carbon rods due to the intense heat evolved by the spark at the instant the circuit is first broken, and which is subsequently continued so long as the supply of current is uninterrupted.

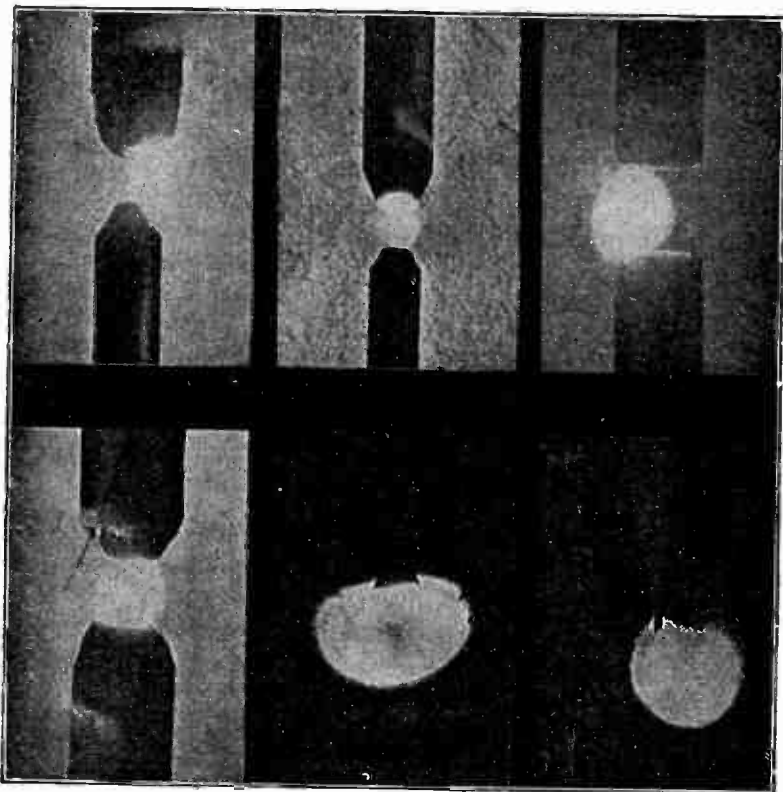

FIGS. 3,324 to 3,329.—Various electric arcs. Fig. 3,324, normal shape of direct current open arc; fig. 3,325 direct current open arc with a rounded top on the negative carbon; fig. 3,326 enclosed arc with solid carbons; fig. 3,327 alternating arc; fig. 3,328 direct current flame arc burning normally; fig. 3,329 direct current flame arc of short length and in act of feeding.

General Characteristics of the Electric Arc.—An electric arc may be maintained by means of either direct or alternating current. Ordinarily the two carbon rods or electrodes must be first brought into contact with each other and then separated in order to establish the arc, otherwise a pressure of several

thousand volts would be required to make the current jump the air gap.

Ques. Upon what does the intensity of the light given out by the arc depend?

Ans. On the temperature to which the electrodes can be heated before being vaporized.

Ques. What is the appearance of the arc when observed through a smoked glass?

Ans. It is plainly seen passing from the positive to the negative carbon.

In general, taking a distance of about one-eighth of an inch between the carbons, and an arc giving pure white light as the starting point, if the length of the arc be increased or the strength of the current decreased, the arc will give a violet light; while on the other hand, if the length

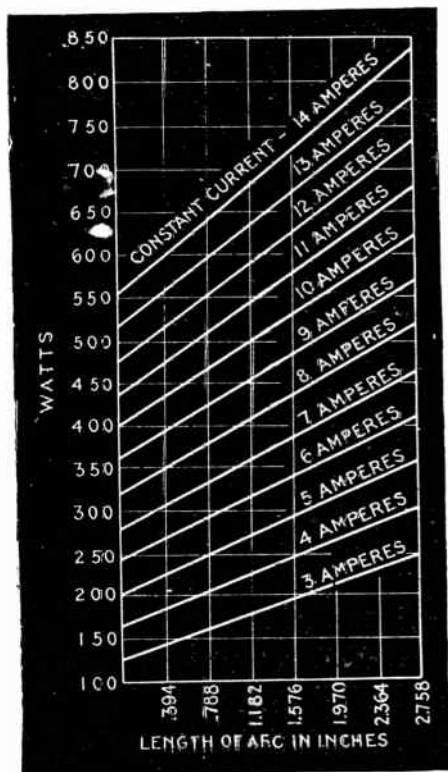

FIG. 3,330.—Diagram showing watts consumed for different lengths of arc. For example, with a constant current of 10 amperes, the watts at the arc will increase from 430 for an arc length of .394 inch to 620 for an arc length of 2.758 inches.

of the white arc be decreased, it will first give a yellowish, and then a reddish light.

The Arc Stream or Flame.—The portion of the arc which lies directly between the tips of the electrodes is called the *arc stream proper* or *flame*. The inner portion of this stream consists of a hub of violet non-luminous portion of dark flame where

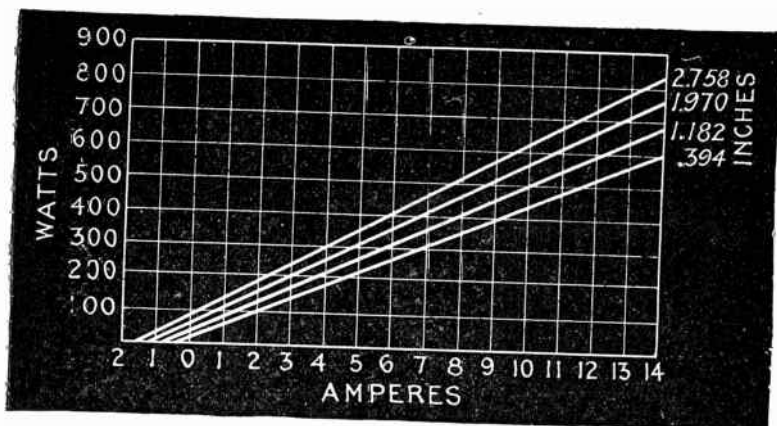

FIG. 3.331.—Diagram showing watts consumed by different current strengths, that is, if the length of arc be kept constant and the current be increased, the watts will vary, as indicated.

the vaporized carbon combines with the oxygen of the atmosphere to form carbon monoxide. This portion, in turn, is surrounded by a layer of luminous flame in which the carbon monoxide burns to carbon dioxide.

It is important to note in this connection that the increased efficiency and illuminating power of the various types of the so called flaming arc lamp is obtained by so modifying the limits of the arc stream proper as to increase the luminosity of its dark or non-luminous portions.

Ques. How much energy is usually consumed by the arc?

Ans. About 10 amperes at 45 volts or 450 watts.

The energy consumption for arcs of various lengths is shown in fig. 3,330.

Ques. What temperature is produced by the arc?

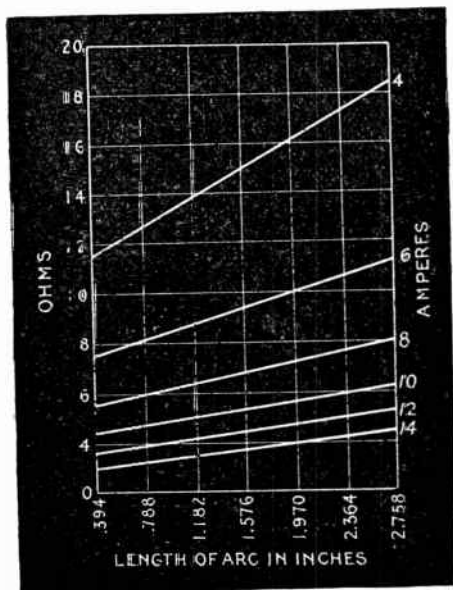

FIG. 3,332—Diagram for resistance of arcs of different lengths with solid carbons.

Ans. About 6,300° Fahr*.

Resistance of the Arc.—With regard to its resistance, the arc is totally unlike solid or liquid conductors. This is due to the fact that the amount of carbon vaporized at the crater of the

*NOTE.—The intensity of the heat generated by the arc (6,300° Fahr.) may be more fully appreciated when it is noted that the melting point of platinum is 3,195° Fahr. The crater has the appearance of a boiling substance which, in fact, it is.

positive electrode, and forming the arc steams, will vary with the current, and therefore, the resistance of the arc, which varies inversely with its cross section will vary inversely with the current. Under these conditions Ohm's law in its general form cannot be applied to the arc stream.

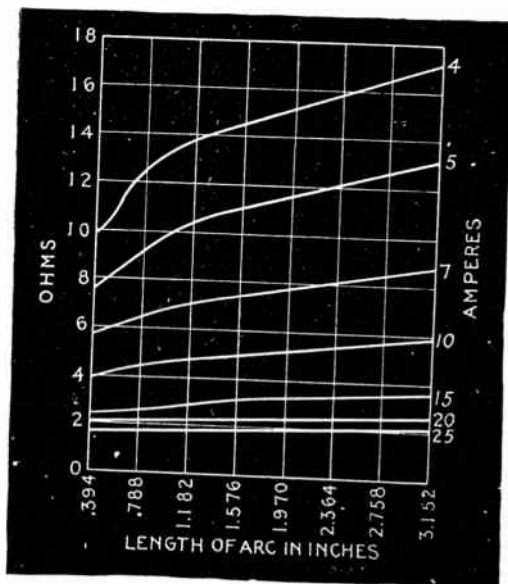

FIG. 3,333.—Diagram for resistance of arcs of different lengths with cored carbons.

*NOTE.—The temperature of the negative carbon (except at its extreme point) as previously mentioned, is considerably lower than that of the positive. This difference is due to the fact that the larger part of the energy is transformed into heat at or near the surface of the positive carbon. This is evident from the relative appearance of the two electrodes and is demonstrated experimentally by measuring the distribution of pressure between the carbons. The most reliable observations show that about 40 volts drop occurs between the positive and the arc stream, with only $2\frac{1}{2}$ volts in the stream and $2\frac{1}{2}$ volts between the stream and the negative carbon. The temperature of the space between the carbons may be much higher than that of the surface in the same way that steam can be superheated above the point at which it is evaporated, there being, in fact, no limit to the possible rise in temperature. Since the current is conducted by the highly heated vapor present, it is to be expected that such a conductor will be heated by the passage of a current the same as a solid or a liquid.

Furthermore, since the carbon vapor can be re-converted into a solid state by condensation, the phenomena at the arc are more or less reversible and point to the existence of a constant drop at the arc.

The resistance of an arc, as in the case of any other conductor, increases with its actual length and decreases with its cross section. The resistance of the 10 ampere arc is one-tenth to one-half an ohm for arc lengths from one-sixteenth to one-eighth of an inch in length. About 5 ohms per inch may be safely assumed as a rough general value.

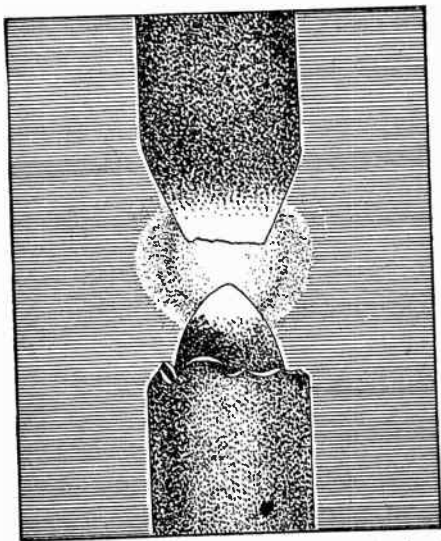

FIG. 3,334.—The electric arc. View of the two carbon electrodes showing the pointed end of the negative electrode and the hollow formation or "crater" on the end of the positive electrode.

The Electrodes or Carbons.—When an arc is established between two carbon rods placed vertically one above the other and separated from each other at a distance of about one-eighth of an inch, with a constant current of about 5 to 15 amperes, the tips of the two carbon rods will burn to the shapes shown in fig. 3,334, the positive carbon, usually the upper one, burning into a hollow or *crater*, and the negative remaining pointed.

This is due to the fact that a large proportion of the carbon particles are detached on the tip of the negative carbon, thereby building it up and partly compensating the waste due to combustion.

Ques. Where is the most luminous portion of the arc?

Ans. In the crater of the positive electrode.

Both carbons appear to be luminous some distance from the tips. The negative or pointed tip is much cooler than the positive tip and therefore less luminous.

Ques. What action takes place in operation?

Ans. Both carbons are consumed, the negative carbon about one-half as rapidly as the positive carbon.

Ques. What is essential for the proper operation of an arc lamp?

Ans. The wasting away of the carbons necessitates the continued adjustment of their relative positions, so as to maintain the distance between their tips practically constant.

Ques. If the distance between the carbon tips be not maintained constant, what is the effect?

Ans. The light emitted will change in color according to the length of the arc, or the distance between the carbons will increase, until finally the high resistance of the air gap will prevent the arc jumping across and maintaining itself between the carbons.

Ques. Why does an arc sometimes "hiss"?

Ans. Hissing is due to too much current, that is to say, to a current of higher value than that required for the length of arc employed.

Classes of Carbon.—Two classes of carbon are used in arc lighting: *solid carbons*, and *cored carbons*. They may be of any

diameter, but the sizes usually employed have an average resistance of .15 ohm per foot.

The solid carbons differ according to their purity, structure, and hardness.

The cored carbons are similar to the solid carbons except for the hole running longitudinally through the axis of the carbon, and filled with some material, such as a mixture of carbon and the salts of the earth metals, which is softer and more volatile than the carbon electrode itself.

Ques. What is the object of the core?

Ans. To reduce the voltage required to maintain the arc by lowering the boiling point or the vaporizing temperature of the crater of the positive electrode.

ANNUAL COST OF OPERATING ARC LAMPS

Type	Open direct current	Open direct current	Enclosed alternating current	Enclosed direct current	Enclosed alternating current	Mag-netite	Mag-netite
Amperes	9.6	6.6	7.5	6.6	6.6	4.0	6.6
Electrodes.....	\$5.50	\$5.50	\$1.50	\$1.20	\$1.20	\$1.55	\$2.85
Trimming.....	6.00	6.00	2.00	2.00	2.00	1.00	2.00
Repairs.....	2.50	2.50	1.00	1.00	1.00	0.75	0.75
Inner globes.....	0.45	0.45	0.45
Outer globes.....	0.30	0.30	0.30	0.30	0.30	0.50	0.50
Renewals of station equipment.	1.50	1.50	1.50	2.00	3.00
Energy 1.5 cts. per kw-hr.....	50.00	32.70	34.50	42.90	30.30	22.80	38.82
Totals.....	\$65.80	\$48.50	\$39.75	\$49.35	\$35.25	\$28.60	\$47.92

The above costs do not include fixed charges. Interest may properly be taken at 6 per cent. and depreciation at from 7.5 to 10 per cent.

Comparative operating costs of flame arcs are given by Blake (General Electric Rev., Dec. 1911) for 1,000 hours of operation as follows:

Type.....	Open flame 17 hours	Enclosed flame 100 hours
Life per trim.....	\$0.15	\$0.20
Cost of electrodes per trim.....	0.04	0.04
Cost of labor per trim.....
Maintenance per 1,000 hours:
Electrodes.....	8.81	2.00
Trimming.....	2.35	0.40
Globes.....	0.09	0.22
Totals.....	\$11.25	\$2.62

In addition to these costs allowance may be made for repairs at \$1. per annum and for energy at a suitable cost per kw hour. Interest and depreciation must be allowed as before stated.

It also affords a plentiful supply of vapor, which tends to maintain a stable condition of the arc, and prevents it *wandering* irregularly around the electrode in its natural effort to find the path of least resistance, thus shifting the shadow of the carbons in different directions and causing objectionable flicker of the light.

Cores of various materials are used also for modifying the color or the light. A familiar example of this is the yellow light of the sodium flame given by various types of enclosed arc lamp used for show window illuminations.

Ques. According to manufacture, how are carbons classified?

Ans. They are known as *moulded carbons* and *forced carbons*.

The two varieties differ from each other in many important respects. The moulded carbons are characterized by a loose granular structure running lengthwise through the carbon. Usually, they are not perfectly cylindrical, and are not as uniform in texture as the forced carbon; moreover, they contain more impurities. They are improved, however, in many ways by being *copper plated*. This process increases their conductivity at the point of contact with the clamp, thereby prolonging their life, and also serving to prevent the carbon near the arc oxidizing so rapidly. As a general rule a 12 inch coppered carbon of five-eighth inch diameter will burn about 14 hours in a 10 ampere lamp, while a plain carbon of the same quality and make will not last longer than 12 hours.

Ques. For what service are moulded carbons generally used?

Ans. For constant current series arc circuits where the cost is of importance.

Ques. What are the characteristics of forced carbons?

Ans. Forced carbons, especially those made in Germany and Austria, are, usually, superior to any grade of the moulded variety; they have a finer texture, are made of softer material, and, having a grain running transversely to the line of pressure, have a comparatively high conductivity.

The method of manufacture permits of their being made of uniform structure, diameter, and straightness; these are valuable qualities where

the carbons are held by small clamps far from their active ends. Forced carbons are never copper plated, and they are particularly suitable for cored carbons. The highest grades of forced carbon very nearly resemble lamp black. They will mark on paper like a pencil, but the hard carbons will not mark unless they have been previously burned. Forced carbons are particularly necessary for use with constant pressure or alternating current arc lamps.

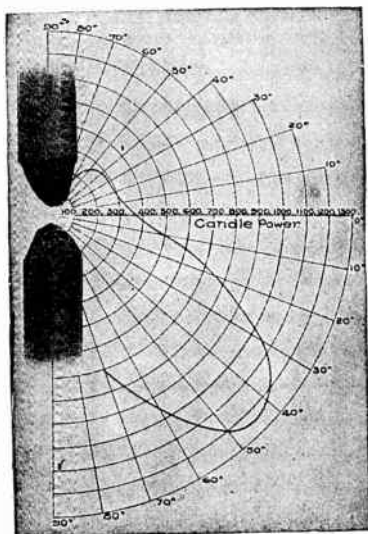

FIG. 3.335.—Candle power distributing curve for arc lamp as given by Fort Wayne Electric Co.

Proper Sizes of Carbon.—In order to cut a carbon to any desired length, all that is necessary is to nick it all around at the proper point and then break like a glass tube. In enclosed arc lamps and alternating current arc lamps, both carbons are the same size.

In focusing high tension lamps, and in all open low tension lamps the upper carbon is usually one-eighth of an inch greater diameter than the lower carbon. Copper plated carbons are the only kind used in high tension series constant current lamps.

Voltages and Currents for Arc Lamps.—In the operation of an arc lamp the ordinary consumption of current ranges from 6 to 10 amperes according to the amount of light required, the values usually employed being 9.6 amperes and 47 volts.

The use of a greater voltage reduces the number of arc that can be placed in one series, increases carbon consumption, and produces flaming. The use of a lesser current than 6 amperes gives too little light from a lamp on a series circuit. The use of small open arcs of low current has been attempted on constant pressure systems, but they have not been very successful.

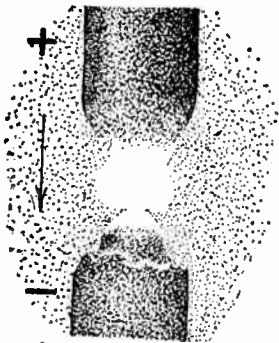

FIG. 3,336.—General appearance of an electric arc between two carbon electrodes when maintained by direct current passing from the upper carbon to the lower carbon, indicated by the arrow and signs. Most of the light issues from the tip of the positive carbon, and this portion is known as the *crater*, the temperature of which is from 5,432° to 6,332° Fahr., giving 80 to 85% of the total light. The negative carbon becomes pointed at the same time that the positive one is hollowed out. Between the carbon there is a band of violet light, the arc proper, and this is surrounded by a luminous zone of a golden yellow color. The arc proper does not furnish more than 5% of the total light. The carbons are consumed by the current, the positive carbon being consumed about twice as fast as the negative. If alternating current be used, no crater is formed, both carbons emitting the same amount of light and being consumed at about the same rate.

Efficiency of the Arc.—The efficiency of the arc is *the ratio of the luminous flux to the total amount of heat and light radiated*. About 13 per cent. of the energy supplied to the arc appears as light, the remaining 87 per cent. being converted into heat; yet the electric arc is by far the most efficient source of illumination known.

For the purpose of comparison the efficiencies of other sources of artificial light may be taken as follows: the magnesium light 12 per cent; the incandescent electric light 5 per cent; the Welsbach light 2½ per cent; the candle 1½ per cent; and the gas flame 1 per cent.

Classes of Arc.—A classification of the various types of arc is made, as in numerous other instances, from several view points:

1. With respect to the current, as
 - a. Direct;
 - b. Alternating.
2. With respect to the placement of the arc, as
 - a. Open;
 - b. Semi-enclosed (*intensified arc*);
 - c. Enclosed.
3. With respect to the electrodes, as
 - a. Solid carbon;
 - b. Cored carbon.
4. With respect to the arrangement in circuit, as
 - a. Series;
 - b. Parallel.
5. With respect to the control, as
 - a. Differential;
 - b. Shunt.
6. With respect to the arc, as
 - a. Luminous;
 - b. Flaming.

Operating Conditions of Carbon.—In any practical arc lamp, not only must the carbons be properly secured to supports but suitable mechanism must be provided to meet certain conditions essential in operation. This mechanism should be of such nature that 1. The carbons are brought into contact when the current is turned off; 2. The carbons are separated a proper distance so that an arc may be formed when the current is turned on; 3. The carbons are fed to the arc as they are consumed:

4. The circuit is made or broken when the carbons are consumed.

The control of the carbons is effected by various feed mechanisms as here described.

Carbon Feed Mechanisms.—There are two classes of mechanism for feeding the carbons to the arc.

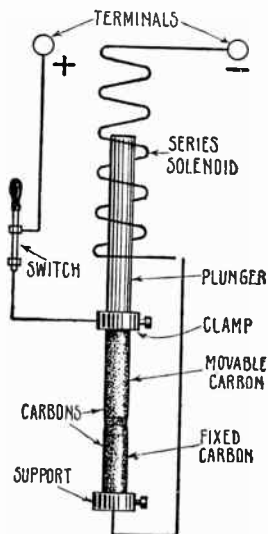

FIG. 3,337.—Elementary series control arc lamp. The lamp must be so connected that the current flows from the top carbon to the bottom carbon. The solenoid which controls the movement of the upper carbon is in series with the arc. *In operation*, gravity tends to keep the carbons in contact while the pull of the solenoid tends to keep them apart. Equilibrium is established between these two opposing forces because of the weakening of the solenoid pull due to increasing resistance interposed as the upper carbon is drawn away from the lower or fixed carbon. The weight of the carbon and plunger, or the ampere turns on the solenoid must be so adjusted that an arc of proper length is established when equilibrium is reached.

1. Manually operated;
2. Automatic.

The feeding of carbons may be done by hand, as is the case in some stereopticons using an arc, but for ordinary illumination

the control must be automatic. There are numerous kinds of automatic feed; they may be classed as

1. Series feed;
2. Shunt feed;
3. Differential feed.

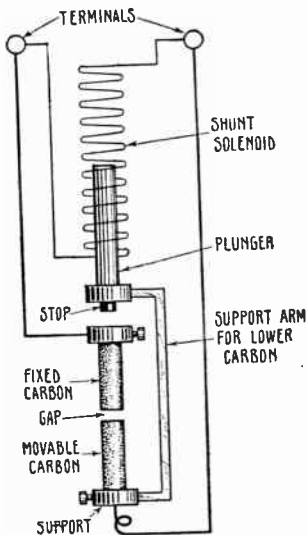

FIG. 3,338.—Elementary shunt control lamp. In operation most of the current flows through the heavy wire connected in series with the carbon, the balance flowing through the shunt solenoid. Normally, when the current is off, gravity causes the plunger to drop against the stop, thus separating the carbons. When current is turned on it flows through the shunt solenoid and pulls up the plunger, and with it the lower carbon opposed by gravity. On contact, the current is short circuited around the shunt coil, the solenoid, thus weakened, allowing the plunger to recede and break contact of the carbons, lengthening the gap until equilibrium is established.

Ques. Describe the series feed.

Ans. The connections are as in fig. 3,337. The carbons are initially in contact, but as soon as current flows in the series coil, the carbons are pulled apart and an arc is formed. If the arc were too long, the resistance is increased and the current lowered so that the pull of the solenoid is weakened and the gap reduced.

Ques. On what kind of circuit is the series feed used?

Ans. On constant pressure circuits only.

Ques. Describe the shunt feed lamp.

Ans. Fig. 3,338 shows the connections. The carbons are held apart before the current is turned on, and the circuit is closed through a solenoid connected across the gap so formed.

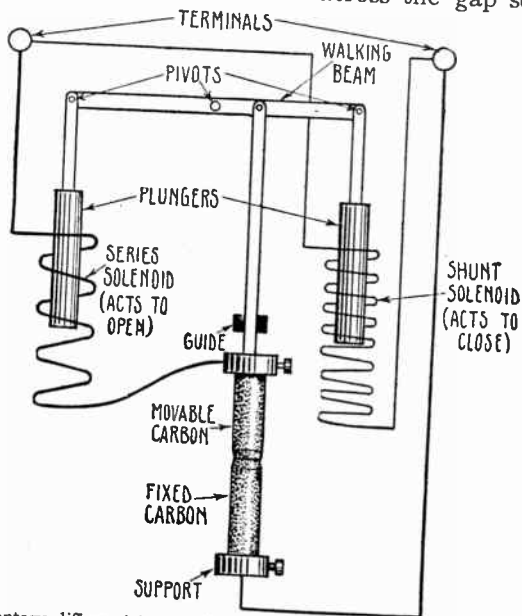

Fig. 3,339.—Elementary differential control lamp; this is a combination of a series and a shunt lamp. The differential action is the resultant due to the difference between the force due to the series solenoid, tending to separate the carbons, and forces due to gravity and to the shunt solenoid tending to keep the carbon in contact.

All the current must pass through this coil at first, and the plunger of the solenoid is arranged to draw the carbons together. The pull of the solenoid is opposed by the force of springs or gravity, etc. In operation, on turning on the current, a high voltage exists across the gap between the electrodes, and the

solenoid; this overcomes the opposing force, and thus brings the carbons together. When the carbons touch, the voltage drops, and the opposing force, overcoming the weakened solenoid, pulls the carbons apart, thus lengthening the arc. When the voltage rises too high, the shunt coil again reduces the gap till equilibrium is restored.

Ques. What points should be noted with respect to the shunt lamp?

Ans. The carbons are held apart when the lamp is not in operation.

Ques. What difficulty does this introduce?

Ans. The high resistance thus interposed makes it difficult to start the average arc dynamo.

Ques. Describe the differential lamp.

Ans. This is a combination of the series and shunt types of lamp as shown in fig. 3,339. There are two solenoids, series and shunt connected. The series solenoid tends to draw the carbons apart which is *opposed* by gravity or a spring, assisted by the shunt solenoid which tends to bring them together. When there is no current gravity brings the coils together. In starting, current passing through the carbons and series solenoid energizes the latter to pull the carbons apart, opposed by gravity, because the shunt coil is short circuited when the carbons are in contact. The shunt coil is brought into operation as soon as the carbons break contact, gradually increasing its effect so that equilibrium is established before the series solenoid increases the length of arc beyond normal.

When the voltage rises the shunt solenoid feeds the carbons exactly as in the shunt lamp, an increase in current resulting in a sharp pull, which will draw the carbons apart, until the increased voltage, acting through the shunt coil again establishes equilibrium; less current will weaken the series solenoid and allow the carbons to approach.

Ques. What effect have differential lamps on dynamo operation.

Ans. They increase the apparent resistance of the arc as the current rises, and correspondingly assist the dynamo in maintaining the current constant.

For a given variation in current, however, they show a greater variation in light, since they increase the arc voltage with the current, so that the watts rise faster than the current strength.

Ques. What is the effect of the carbons being in contact at starting?



FIG. 3,540.—Adams-Bagnall clutch as used on series arc lamp. The clutch proper is of porcelain, and is placed loosely in a steel container, which is connected to the walking beam by means of an adjustable hook of substantial design. To prevent the carbon jarring through the clutch, the dash pot plunger is mounted by means of the stem directly on the clutch retainer. This produces a pinching effect, on the carbon. The carbon, however, is readily released from this grip when the feeding point is reached.

Ans. Since this short circuits the shunt solenoid, it insures a rapid and positive opening of the arc.

Clutches.—The feed mechanism includes, besides the magnets for controlling the length of arc, a device called a **clutch** for “feeding” the movable carbon in the direction of the fixed carbon to compensate for its consumption.

To accomplish this a clutch must be so constructed that it will release the carbon and move freely over its surface when moved

in one direction, and grip it securely when moved in the other direction.

Ques. How is a clutch usually arranged to operate in an arc lamp?

Ans. It is arranged to grip the carbon or rod so that it cannot

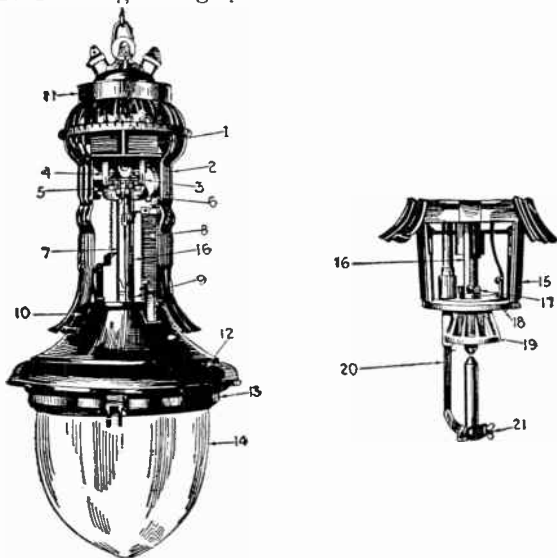

FIGS. 3,341 and 3,342.—Mechanism of Adams-Bagnall series circuit alternating current regenerative flame lamp (focusing type), for 7.5 and 10 amperes. Fig. 3,341, view of clutch mechanism and lower carbon holder of Adams-Bagnall series circuit alternating current regenerative flame lamp; fig. 3,342 view with condenser and globes removed. 1. series solenoids; 2, shunt solenoids opposite series; 3, walking beam; 4, series solenoid armature; 5, adjuster weight on walking beam; 6, series cut out; 7, slotted center tube; 8 starting resistance; 9, air pot; 10, copper case, removable panels; 11, ventilated top; 12, condenser; 13, outer globe band; 14, outer globe; 15, bowl casting; 16, clutch rod; 17, clutch; 18, blowing coil; 19, economizer; 20, lower carbon holder rod; 21, lower carbon holder.

slip until the clutch has been opened by descending far enough to touch a release.

Ques. Name two arrangements of clutch feed.

Ans. Carbon feed, and rod feed.

Ques. Describe the two feeds.

Ans. The clutch may be arranged: 1, to act directly on the carbon (carbon feed), or 2, to act on a rod to which the carbon is attached, as shown in figs. 3,346 and 3,347.

Fig. 3,348 shows an elementary series lamp having carbon feed.

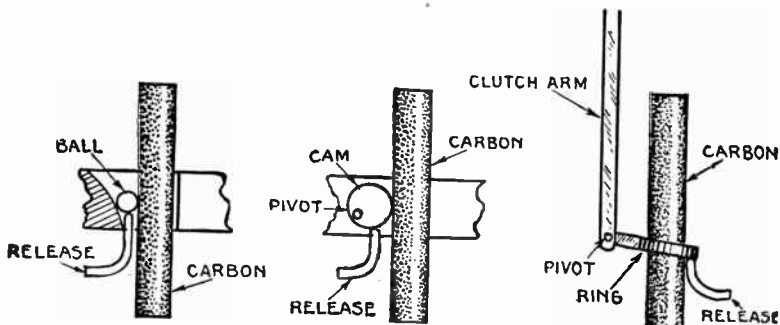

Figs. 3,343 to 3,345.—Various forms of clutch for feeding the carbon to compensate for its consumption. Fig. 3,343, ball clutch; fig. 3,344, cam clutch; fig. 3,345, ring clutch.

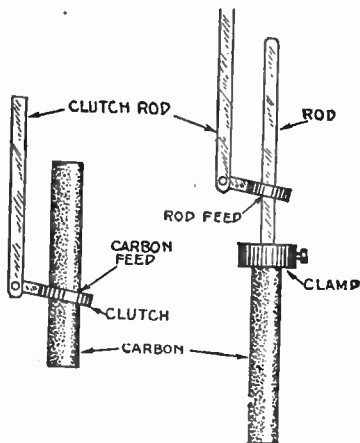

Figs. 3,346 and 3,347.—Carbon and rod feed. In the first instance the clutch operates the carbon direct, as in fig. 3,346. Sometimes the carbon is secured by a clamp at the end of a rod, the clutch operating the carbon through contact with the rod as in fig. 3,347.

Dash Pots and Adjusting Weights.—Anyone familiar with releasing valve gears, such as, for instance, those used on Corliss engines, knows what a dash pot is, and what it accomplishes. Dash pots are not only used on Corliss engine valve gear but on many mechanical and electrical contrivances including arc lamps.

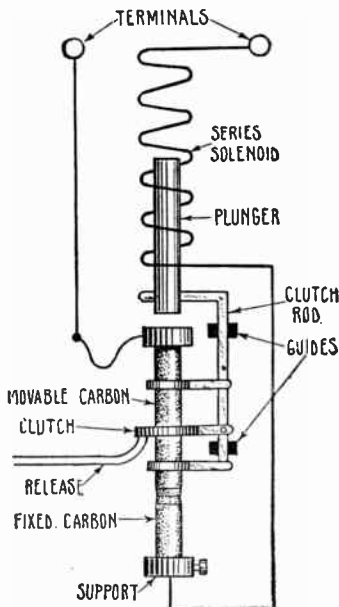

FIG. 3,348.—Elementary series control lamp with ring clutch rod feed. *In operation*, when the current is turned on, the plunger pulls up the clutch rod and the angular position assumed by the clutch causes it to grip the movable carbon separating it from contact with the fixed carbon. As the carbon is consumed the arc becomes lengthened which increases the resistance, cutting down the current and weakening the solenoid allowing the plunger to move downward. During the movement, when the end of the clutch strikes the release, its angular position is changed, causing it to release the carbon and allowing it to "feed" or fall thus reducing the arc. Since the resistance decreases as the arc length is reduced a stronger pull is exerted by the solenoid which overcomes the weight of the parts and raises the clutch rod freeing the clutch from the release and causing it to again grip the movable carbon pulling it away from the fixed carbon and restoring the arc length to normal.

A dash pot may be defined as a device for preventing too sudden motion in some part of an apparatus, that is to say, it **be-**
numbs or slows down the action of an over sensitive part.

One can easily imagine that in the operation of an arc lamp the control of the movable carbon by the action of the magnets alone would result in an unsteady arc, that is, a species of "hunting" would be set up in the attempt of the magnets to vary the arc to correspond with varying circuit conditions; in the attempt to maintain equilibrium, the carbon would be moved too far one way or the other, thus shortening or lengthening the arc too much and resulting in flickering or unstable action.

In construction a dash pot consists of a cylinder or "pot" in which is fitted loosely a piston or plunger so that in moving from one end of the cylinder a resistance or retarding effect may be secured by allowing the retarding medium such as oil, air, etc.,

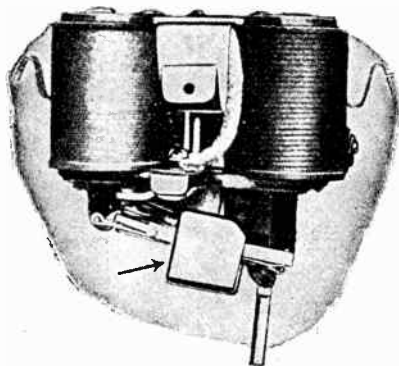

FIG. 3,349.—Adams-Bagnall adjusting weight as used on alternating current series circuit differential control arc lamp. The weight is of composition metal, to which a heavy phosphor bronze spring is attached, and by means of which adjustment may be had in connection with the toothed metal bar, often called "key bar," which is a part of the walking beam. **By means of the weight adjustment, the lamp can be accurately adjusted for a proper arc voltage, with a range of current adjustment of about one ampere.**

to leak past the plunger or piston, the extent of retardation depending upon the medium employed and the closeness of the fit, that is, upon the amount of leakage. The retarding medium employed for arc lamp dash pots is air. Dash pots may be either

1. Single acting, or
2. Double acting.

Fig. 3,350 shows a single acting dash pot on a series lamp arranged to act on the up stroke, also an adjusting weight to secure proper balance of the system.

Cut Out and Substitutional Resistance.—In a series arc light circuit, it must be evident, that if anything happen to one lamp the entire system will be affected, unless some provision

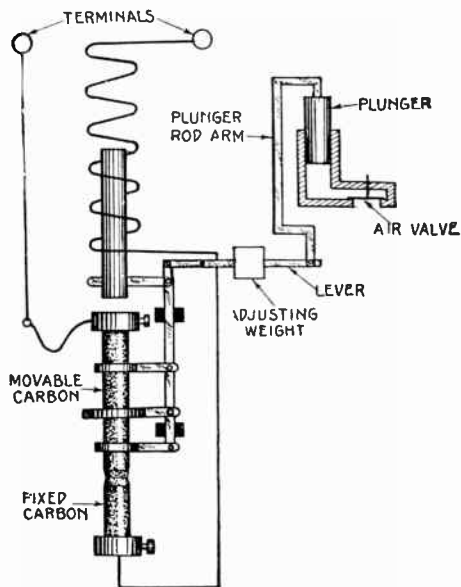

FIG. 3,350.—Elementary series control lamp showing air dash pot and adjusting weight. The dash pot, as clearly shown in the illustration, is single acting and so connected that it operates on the up stroke of the solenoid. A suitable and simple valve prevents any dash pot action on the down stroke of the solenoid (up stroke of the dash pot plunger). The result of this arrangement is that the lamp, while free to feed and regulate, cannot flicker or chatter. The difficulty of flickering, especially on the start is an important one in arc lamp construction. *In operation*, before the carbons get hot, the sudden motion of the magnet draws them apart, breaking the circuit, and they fall together again, the result being a vibrating action exactly like that of a vibrating bell. To secure equilibrium, it is necessary to retard the upward motion of the movable carbon, and this is what the dash pot accomplishes. Thus as the solenoid separates the carbons, the dash pot plunger which is connected to the adjusting weight lever, moves downward, compressing the air which slowly leaks past the plunger, thus retarding the upward movement of the carbon. The function of the air valve is to admit air on the up stroke of the dash pot plunger, otherwise a partial vacuum would be formed which would retard the upward movement. It must be evident to any one that refinement in adjustment may be obtained by the addition of an adjusting weight by which gravity can be contracted to any desirable extent, regulating the arc voltage to a desirable working value.

be made to short circuit the disabled lamp and at the same time introduce into the circuit resistance of the same value as that of the lamp. There are various conditions necessitating the cutting out of a lamp such as

1. When the carbons are broken off or consumed;
2. When the clutch fails to operate;
3. When carbons are renewed.

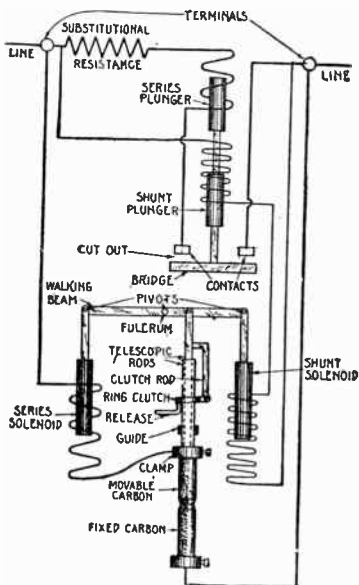

FIG. 3,351.—Elementary differential control lamp having ring clutch rod feed, and automatic cut out and substitutional resistance. The cut out consists of a pair of contact and a bridge operated by a compound wound solenoid. For clearness the series and shunt windings are shown separated, the plunger being in two sections. The substitutional resistance is connected in series with the series cut out winding and the shunt cut out winding is connected in series with the shunt solenoid coil as shown. **In operation,** under normal conditions the current flowing through the shunt cut out winding is quite insufficient to raise the bridge against gravity, but if the resistance of the main circuit through the carbon suddenly increase beyond proper limit, the current through the shunt cut out winding will increase considerably raising the bridge and short circuiting the lamp. The entire line current will now flow through the series cut out winding causing the bridge to be held firmly against the contacts, and since this current must pass through the substitutional resistance, which in value is the same as the normal resistance of the lamp, it must be evident that the current and pressure in the external circuit will not be changed when the lamp is cut out in this manner.

The cut out and substitutional resistance is usually a part of the lamp and is illustrated and fully explained in fig. 3,351 which shows the elementary differential lamp of fig. 3,339 fitted with the above features and also ring clutch rod feed.

Enclosed Arcs.—The enclosed arc is the result of various attempts to reduce the rapid consumption of the carbons in the case of open arc, by enclosing the arc in a globe bulb of refractory glass protected by a large outer globe.

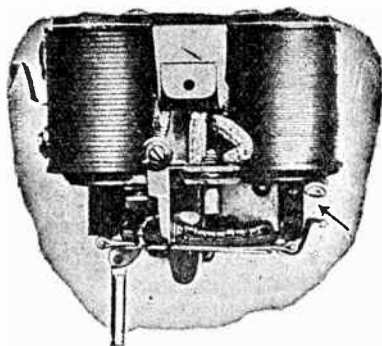

FIG. 3,352.—Adams-Bagnall cut out as used in alternating current series circuit differential control arc lamp. The cut out has four rubbing contacts of coin silver. One member is loosely hinged to the lower yoke. The two contacts are set in a plate, properly insulated from the hinged portion. The other member is of phosphor bronze, in which the two coin silver contacts are securely set.

The inner or enclosing bulb is, usually, about $5\frac{1}{2}$ inches in length and $2\frac{1}{2}$ inches in diameter partially closed above and tightly sealed below and fitted to the lower carbon.

When the arc is sprung, the oxygen in the bulb is rapidly consumed by combination with the carbon, and in a short time (5 to 10 minutes) the bulb is filled with highly heated nitrogen, carbon monoxide, and carbon dioxide, which shortens the long arc existing at the beginning with about 80 volts across to about three-tenths of an inch and greatly reduces the combustion of the carbons by the oxygen of the air. Under these conditions, the positive carbon burns flat ended and the negative carbon tends to become slightly convex. In fact, were it not for the small quantity of air which is allowed to enter through the partially

closed upper end of the bulb, the negative carbon would not be destroyed at all, but would receive a deposit of carbon from the positive and assume the form of a fragile tip. Furthermore, a lack of the little amount of air thus introduced will tend to greatly increase the highly colored deposits, due to the impurities in the carbon, which in time forms an opaque coating on the inside surface of the bulb. When the bulb becomes thinly coated it should be replaced by a new one.

Direct current enclosed arc lamps are made for currents of from 3 to about 7 amperes, the usual sizes being 5 to 6.5 amperes. Lamps smaller than this lose greatly in efficiency unless slender carbons are used and these for more than 6.5 amperes are a little too hot for any inner globes yet commercially obtainable.

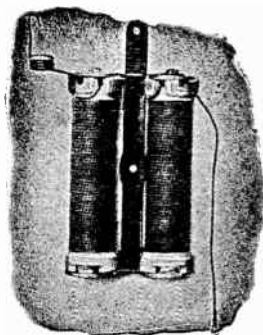

Fig. 3.353.—Adams-Bagnall starting resistance for series lamp. It is wound on two grooved porcelain spools, substantially supported by a bracket, by means of which it is attached to the lower part of the case in the back, the resistance being sufficiently removed from the lamp mechanism; it is only in circuit when the lamp is cut out.

The life of the carbons on enclosed carbon lamps is about 100 hours or more, so that the cost of trimming is greatly reduced. The yearly saving in carbons and labor over open arcs is generally estimated as being \$7 to \$10.

Good carbons are required for enclosed carbon lamps but enclosing considerably improves the steadiness, and the noise is somewhat reduced by the inner globe.

Enclosed arcs give a better light distribution at points distant from the lamps than do open arcs. Enclosed arcs consume approximately 1 watt per candle power with clear globes.

Ques. How are the carbons arranged on enclosed arc lamps?

Ans. The lower carbon is usually fixed in the bulb, and the upper carbon slides down upon it by gravity.

For quiet operation, the gap must be about three-eighths inch where the current is 5 amperes.

Semi-enclosed or Intensified Arc Lamps.—This classification includes those lamps having a fairly tight fitting globe of

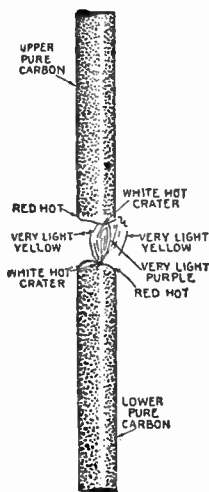

FIG. 3,354—Enclosed carbon alternating current arc. Electrode life 100—125 hours; arc about $\frac{3}{8}$ inch long and requires 70 to 80 volts; electrode ends nearly flat. There is drawn no marked crater and less light is produced per watt.

moderate dimensions, the carbons used are of small diameter. Semi-enclosed arcs consume carbons much slower than open arcs and take about 75 volts at the arc.

The Alternating Current Arc.—This is not a continuous flame like the direct current arc, but is lighted and extinguished at every reversal of the current. When the lighted and

extinguished states follow each other at a rate exceeding 50 cycles per second, the flickering of the light is not appreciable to the eyes of most people. On account of the reversal of the direction of the current each electrode acts, alternately, as a positive and a negative, consequently, in the case of carbon electrodes, no crater is formed on the end of the upper carbon and both of them assume a pointed form. However, as in the direct current arc, the upper carbon is consumed more rapidly than the lower carbon by receiving the ascending heat, the rate of waste being about 10 per cent. greater.

Under ordinary commercial conditions, alternating arcs maintained between cored carbons operate with a current of about 15 amperes at 30 to 35 volts or consume about one-half kilowatt of electric power. This is a great deal less than the amount of power that would be consumed by direct current arcs using the same carbons, and is due to the fact that an alternating current of 35 volts has a maximum pressure of about 50 volts at the top of the wave.

It will be noted that the alternating arc requires a larger current and the use of cored carbons. This is due to the fact that unless some means were employed for providing a continuous path for the current between the separated carbons, extinguishment of the arc when the current passed through zero in the first reversal would put out the light. The larger current and the cored carbons furnish this path in the form of a bridge of incandescent carbon vapor until the voltage of the current flowing in the opposite direction reaches a substantial nature.

Characteristics of the Alternating Current Arc.—The following characteristics of the alternating current arc have been determined by experiment and observation.

The actual watts consumed are about 85 per cent. of the watts obtained by multiplying the volts and the amperes. This is due to the fact that the current and pressure are not in phase, or in other words, since the apparent resistance of the arc varies with the current, the current lags behind the pressure. A lamp taking 15 amperes at 30 volts consumes 450 (apparent) watts, or 382.5 actual watts.

The efficiency is slightly increased by an increase of frequency, and is greatly affected by the form of the current wave, the latter being largely determined by the form of the waves of the pressure. A wave with a flattened top gives a higher efficiency than a peaked wave. With

equal energy and similar carbons, the mean spherical candle power of the a. c. open arc is about one-half that of the d. c. open arc.

The humming sound peculiar to alternating current arcs is due to the expansion and contraction of the arc stream caused by the rise and fall of the current. These variations produce corresponding vibrations in the adjacent air, and produce a hum variable in pitch with the frequency.

The hissing sound of an alternating current arc is due to a short arc length as in the case of the direct current arc. In both cases the voltage

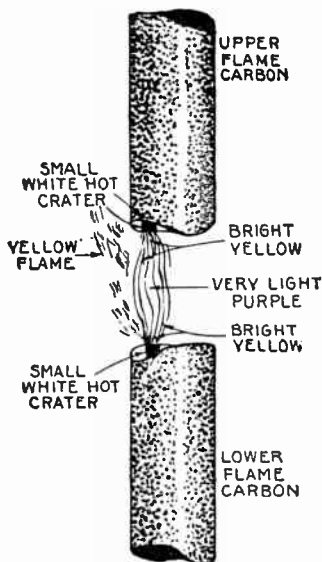

FIG. 3,355—Long burning flame arc. Electrode life 100 or more hours. Electrodes are about $\frac{3}{8}$ inches diameter by 14" long, arc placed within a globe which restores the arc supply. The unused portion of the upper electrode is used for trimming the lower. 10 ampere arcs with "white" electrodes consume .74 watts per mean spherical candle power.

falls, but less abruptly with the former than with the latter, while the current lag is increased to such an extent that the actual watts become only 75 per cent. of the apparent watts.

The light emitted by the alternating current arc at any moment lags a little behind the instantaneous value of the actual watts, but it never passes through zero on account of the heat which is always retained by the carbons and keeps them luminous.

On account of the more equal wasting away of the two carbons, alternating current arc lamps require a focusing mechanism for finding both carbons so as to retain the arc in the same place. This may be

accomplished by connecting the lamp to the secondary of a transformer wound to deliver a constant current.

The use of economy coils largely compensates for the low efficiency of the alternating current arc

Alternating Current Arc Lamps.—The construction of lamps for alternating current is very similar to those designed

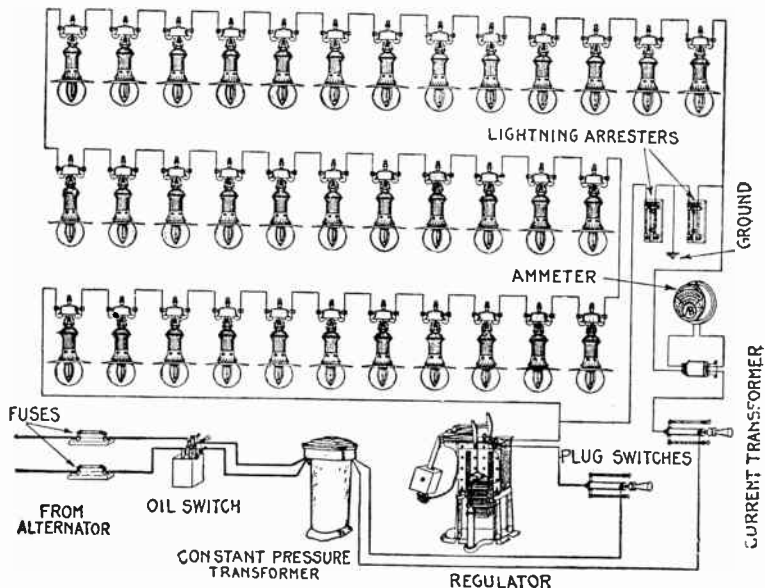

FIG. 3,356.—The Adams-Bagnall alternating current series circuit arc lighting system, consisting of "A-B", alternating series lamps with differential control, constant pressure transformer, regulator, current, fuses, oil switch, plug, switches, current transformer, ammeter, and lightning arrester. The diagram shows the complete external circuit up to the alternator.

for direct current. When iron or other metal parts are used in the controlling mechanism, they must be laminated or so constructed as to keep down induced or eddy currents which might be set up in them. To accomplish this, the metal spools on

which the solenoids are wound, are slotted at some point to prevent them forming a closed secondary. On constant pressure circuits a reactance is used in place of a part of the resistance for cutting down the voltage at the arc.

Arc Lamp Circuits.—Arc lighting apparatus is to-day successfully operated on both direct and alternating current. It

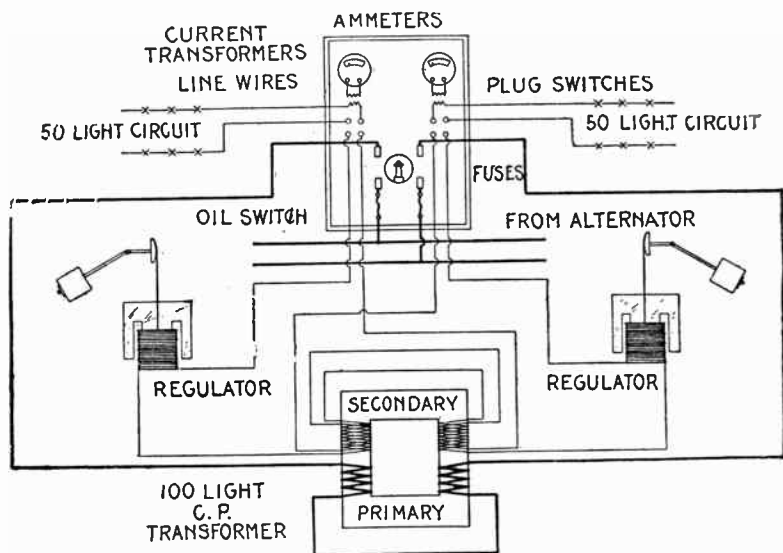

FIG. 3,357.—Wiring diagram of 100 light transformer with two 50 light regulators for two circuit series arc lighting system.

is not necessary here to discuss the relative copper economy of the various systems of distribution as this has already been treated at length. It suffices to point out the various ways of connecting the lamps in circuit and the modifications necessary to adapt them for same. Accordingly lamps may be classified with respect to the kind of circuit for which they are adapted, as:

1. Series;
2. Parallel;
3. Series parallel;
4. Parallel series.

Series Arc Lamps.—Lamps connected in series are in satisfactory service both on direct and alternating current circuits

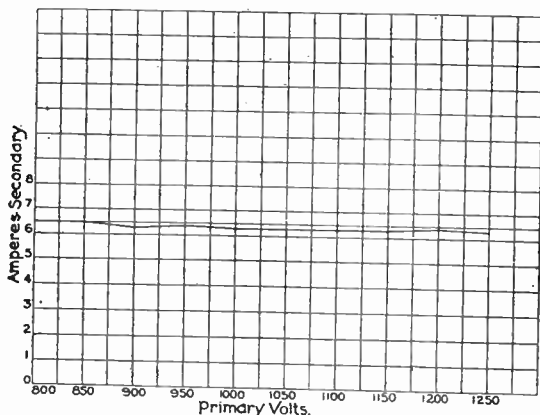
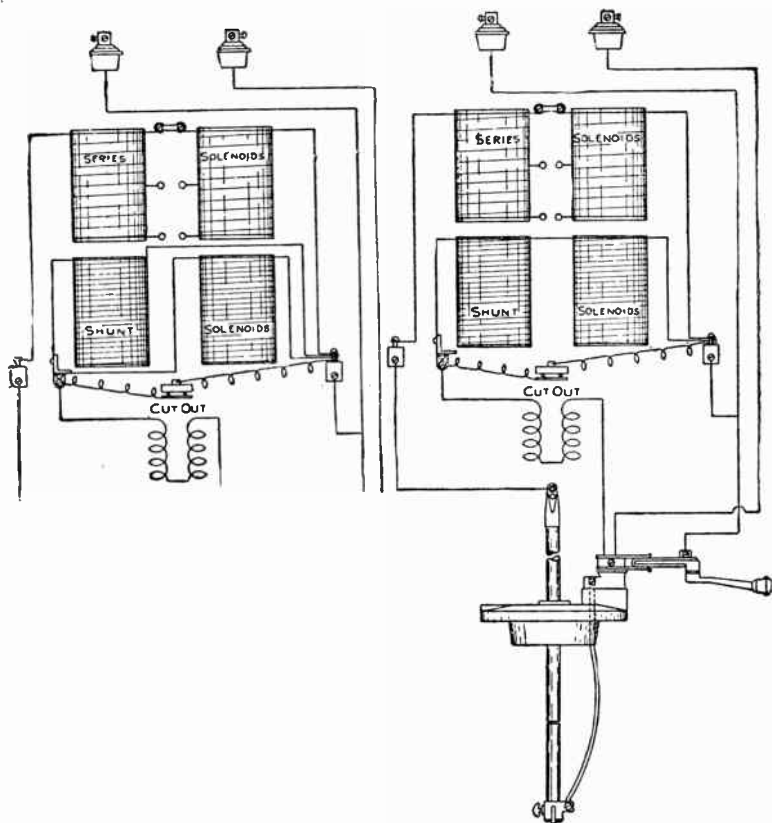
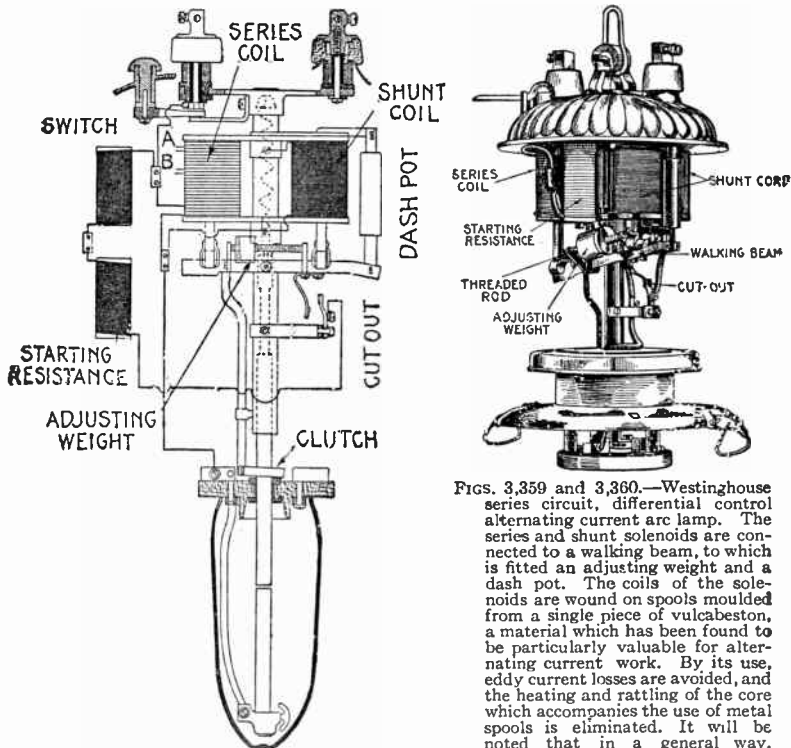

FIG. 3,358.—Fort Wayne regulation curve of type MA transformer with variation of primary voltage. Type MA transformer is designed with a single primary coil wound for 1,050 or 2,100 volts and a separate secondary coil furnishes a ratio of transformation from constant primary voltage of a constant secondary current for the arc lamp. The 1,050 volt transformer will operate satisfactorily on circuits from 1,000 to 1,100 volts and, the 2,100 volt transformer on circuits from 2,000 to 2,200 volts without any further adjustment. The transformer can also be furnished for circuits of 2,300 volts. When adjusted for operating conditions with the lamp in circuit and 6 amperes in the secondary, the transformer supplies about 77 volts at the lamp terminals. All standard transformers of this type are wound for a current of 6 amperes when properly adjusted for the lamp terminal voltage and either of the two standard frequencies. The regulation is an inherent quality and is such that a practically constant current is maintained in the secondary throughout the range of primary voltage variation from 800 to 1,250 volts as shown in the diagram. It will regulate from open to short circuit with a rise in secondary current not exceeding 10 or 11 amperes. This makes the transformer especially valuable as a protection to the regulation of the incandescent lighting circuit, preventing possible short circuit in the lamp affecting the primary voltage.

In a series system evidently all the lamps must be designed to work with the same amount of current, and accordingly since the current is said to be "constant," meaning that the same



FIGS. 3,361 and 3,362.—Diagram showing connections of Adams-Bagnall alternating current series circuit differential control arc lamps. Fig. 3,361, connections for 133 cycles; fig. 3,362, connection for 60 cycles. When the frequency is 60 cycles, the shunt solenoids should be connected in series; if 133 cycles, in parallel. When operated with a current of 6.6 amperes, the average arc voltage is 72 volts, with a terminal voltage of approximately 75 volts. An adjusting weight of special design is provided, which permits a close adjustment over a wide range. The method employed prevents any liability of the weight sliding along the key bar at the time of adjustment or later. By means of this arrangement, the lamp may be accurately adjusted for the proper arc voltage. The best high grade carbons should be used to obtain proper results; the upper carbon being 12 inches long, the lower, 6½ inches long, the maximum diameter .52 inch, and the minimum diameter .505. The upper carbon of one trim can be used for the lower carbon of the next, from which it will be noted that only one 12-inch carbon is required for each trim. One carbon must be cored, the other solid. If desired, lamps can be had using a 10 inch upper carbon and a 4½ inch lower carbon. These lamps are commonly termed "short-trim."



FIGS. 3,359 and 3,360.—Westinghouse series circuit, differential control alternating current arc lamp.

The series and shunt solenoids are connected to a walking beam, to which is fitted an adjusting weight and a dash pot. The coils of the solenoids are wound on spools moulded from a single piece of vulcabeston, a material which has been found to be particularly valuable for alternating current work. By its use, eddy current losses are avoided, and the heating and rattling of the core which accompanies the use of metal spools is eliminated. It will be noted that in a general way, this lamp very closely resembles the series direct current lamp and the series parallel direct current lamp. This similarity extends to the construction and arrangement of the dash pot, the rocker arm, the gas check, the upper and lower carbon clutches, the side rod, the automatic cut out, the lamp switch, the adjusting weight, and the inner and outer globes, supports and stirrup. It differs, however, from the lamps mentioned in the following particulars: **The starting resistance** is wound on two spools which are placed on opposite sides of the lamp, thus preventing the localization of heat and giving good radiating surface and insulation. For convenience of representation, both of these spools are shown on one side. **The cut out** always stands closed when the lamp is not burning. The two contact pieces are made of coin silver and are attached by coin silver rivets, thus preventing arcing, sparking, or loosening by continued use. They are designed to carry five times the normal current of the lamp. **The adjusting weight** is made from a circular brass rod and mounted on a smaller threaded brass rod along which it can be screwed, and to which it may be clamped at any point by a clamp screw. By its means the lamp can be accurately adjusted for the proper arc voltage with line currents of from 0.5 to 7.5 amperes without rewinding the magnet coils. This lamp uses *one solid*, and *one cored carbon*, the relative position of the cored and solid carbon changing with each trim, as the upper carbon of the trim is used for the lower carbon of the next. The diameter of

amount at any given time is flowing through all the lamps, series systems are often called constant current systems, though ill advisedly so.

Ques. How is the so called constant current obtained in direct current series arc lighting?

Ans. This is accomplished by designing the dynamo so that it will automatically generate a nearly constant current. Regulating devices are provided which either shift the brushes or vary the strength of the field, or both, to keep the current at a constant value.

In addition to these special regulators, such machines are so designed that they have considerable self-inducting resistance and armature reaction, all of which tend to prevent the current rising to a high value even if the machine be short circuited.

Ques. How is the proper size of wire determined on series arc circuits?

Ans. Custom and strength consideration require that the wire should not be smaller than No. 8 A. W. G., and it is not usually necessary to employ a conductor larger than No. 4, because the voltage being high, and the current small, the loss of energy is not great, even in a wire several miles in length.

Ques. For what service is the series system suitable?

Ans. It is used mostly for street illumination.

Ques. What are its advantages?

Ans. Simplicity and saving in copper.

FIGS. 3,359 and 3,360.—Description continued.

the carbons must be between .505 and .520 inch. New upper carbons should be 12 inches long, and new lower carbons 7 inches long. The lamp requires retrimming after about 100 hours of burning. The normal performance of the lamp may be briefly stated as follows: When operated with a current of 6.6 amperes the average arc voltage is 72 volts, the drop in the magnet coils increasing this to about 76 volts at the terminals, giving an apparent wattage of 500 watts. The average power factor obtained is 82 per cent., therefore, the actual energy consumed mechanism, giving about 390 watts at the arc, or an efficiency of arc watts or compared to total watts of 95 per cent. The arc lamp cut out used with this lamp is suspended just above the lamp which is hung from it, the hanger loop of the lamp engaging a hook in the center of the case of the cut out.

Ques. What are its disadvantages?

Ans. Dangerously high voltages necessary; limited number of lamp for given voltage; whole system affected by single break in circuit.

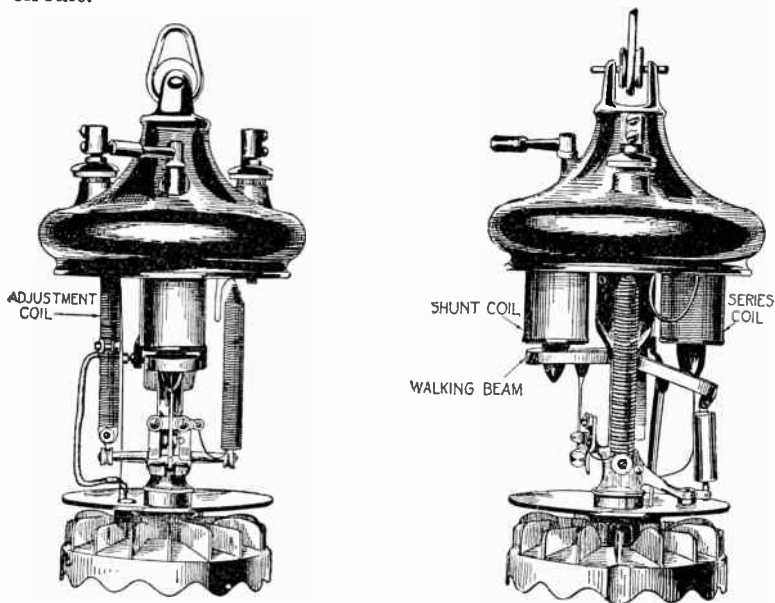

FIGS. 3,363 and 3,364.—Fort Wayne series circuit differential control enclosed direct current arc lamp. The series and shunt coils are wound on separate cores to gain additional radiating surface. The walking beam of the lamp when in operation lies practically in a horizontal position beneath the two coils. One side of the walking beam carries a brass rod on which is suspended the upper carbon clutch below the radiator, the latter being located between the mechanism chamber and the globe holder and serving to dissipate the heat and protect parts located beneath it from the weather and parts above it from the heat of the arc. The adjustment coil is wound on an iron tube covered with asbestos insulation and mounted with porcelain insulation on the lower bracket casting. The adjustment of the length of the arc is made by loosening the adjusting clamp and moving it up and down over the adjustment coil. This coil is connected in parallel with the series magnet, and raising or lowering the clamp decreases or increases the amount of current passing through the series magnet and produces a shorter or larger arc as desired. The starting coil is seen opposite the adjustment coil. This lamp operates at 75 volts at the arc and is normally adjusted for $6\frac{1}{2}$ amperes, but can be adjusted to operate satisfactorily with any current between 5 and 8 amperes. The maximum range of voltage at arc under normal operating condition is 10 volts, the lamp striking an arc cold at 65 volts, and operating continuously at 75 volts at the arc. The normal life of one set of high grade carbon is 100 hours when the lamp is adjusted for a current of $6\frac{1}{2}$ amperes.

Ques. What devices must be provided on lamps for series operation?

Ans. There must be a combination cut out and substitutional resistance, and a starting resistance.

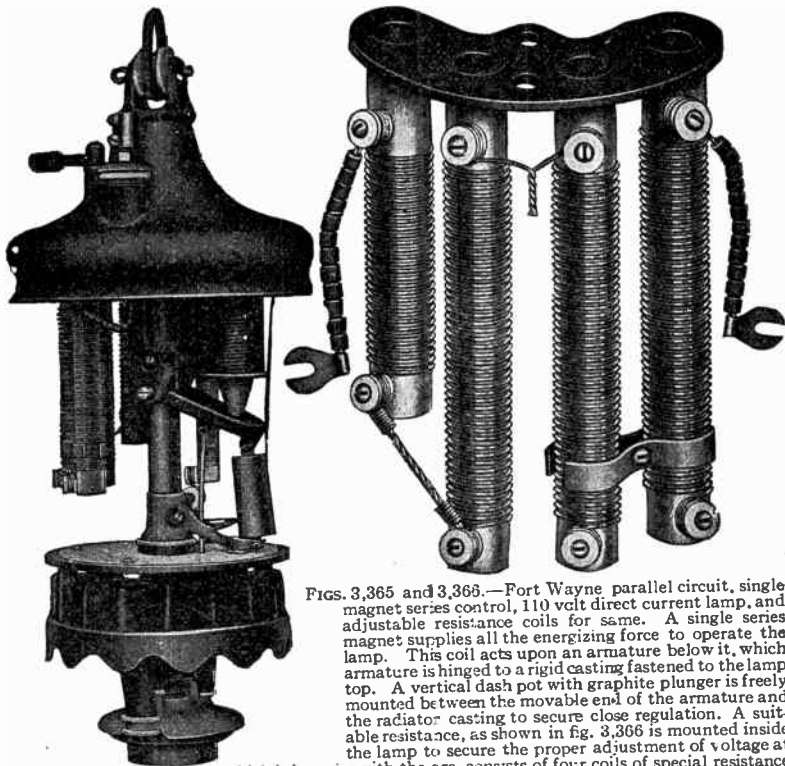

Figs. 3,365 and 3,366.—Fort Wayne parallel circuit, single magnet series control, 110 vclt direct current lamp, and adjustable resistance coils for same. A single series magnet supplies all the energizing force to operate the lamp. This coil acts upon an armature below it, which armature is hinged to a rigid casting fastened to the lamp top. A vertical dash pot with graphite plunger is freely mounted between the movable end of the armature and the radiator casting to secure close regulation. A suitable resistance, as shown in fig. 3,366 is mounted inside the lamp to secure the proper adjustment of voltage at

the arc. This resistance, which is in series with the arc, consists of four coils of special resistance wire wound on asbestos insulated tubes and connected in series. The coils are mounted on a common base and are supported from the lamp top. Adjustment is made by a brass screw clamp moving over the turns of the coils to raise or lower the resistance. The normal voltage at the arc is 80 volts for the 110 volt lamp and 140 volts for the 220 volt lamp when operating at normal current. The current adjusting resistance is similar to the voltage adjusting resistance except that only one coil is necessary. This coil is connected in shunt with the series magnet and adjustments are made by means of a copper screw clamp. The 110 volt lamp operates normally at 5 amperes, but is made also for $3\frac{1}{2}$ amperes. The 220 volt lamp operates normally at 3 amperes.

Ques. What methods of control are used for series operation?

Ans. Shunt control is sometimes used but more frequently the differential control.

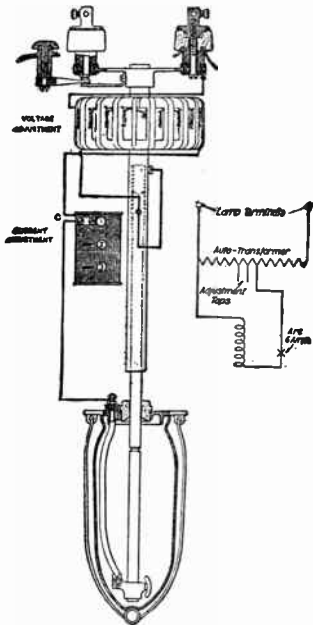

Figs. 3,367 and 3,368.—Westinghouse parallel circuit, series control alternating current enclosed arc lamp, designed to operate on 200 to 230 and 420 to 460 volt circuits supplying a light equal to that secured on 110 volt circuit with an equal consumption of power. The only difference consists in the arrangement of the connections and the use of an auto-transformer instead of a choke coil as shown in fig. 3,368. The lamp is designed for 60 cycles but can be used on 50 cycle circuits. In the latter case the current range will be slightly increased and there will be a reduction in the nominal voltage. The **auto-transformer** consists of a number of small separate coil mounted upon a ring shaped core of soft laminated iron. The core is attached directly to a portion of the lamp frame, designed for this purpose, in such a manner that it is supported directly from the lamp hanger. The **voltage adjustment** is made by means of taps leading from one of the transformer coil to which a flexible lead from the current adjustment coil can be connected. Where sufficient variation of the voltage is not obtainable by means of these taps, the connection from the lamp terminal can be shifted to a different coil and the finer adjustment is then made as before stated. The voltage adjustment can be easily reached through the door in the lamp casing. The **current adjustment**, 5.5, 6, or 6.5 amperes, is made by connecting through one of the three taps to the magnet winding, the variations obtainable being designated as follows:

Terminal volts	Current adjustment			Description
	Tap 1	Tap 2	Tap 3	
200-230	5½	6	6½	Double globe
200-230	5½	6	6½	Single globe
420-460	5½	6	6½	Double globe
420-460	5½	6	6½	Single globe

The values in the table are for 7,200 alternations only.

Parallel Arc Lamps.—The disadvantages of more than one system of distribution for electrically lighting factories, store-rooms, warehouses, freight yards, mills, shops, etc., are clearly obvious without making a detailed investigation of the conditions.

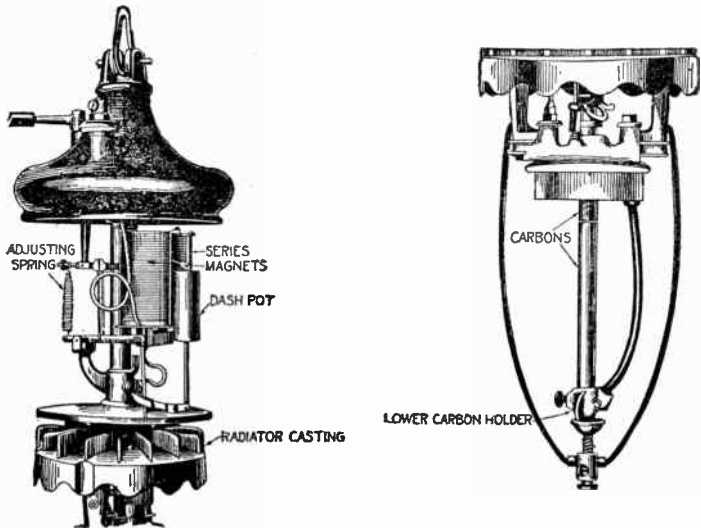

FIGS. 3,369 and 3,370.—Fort Wayne (special transformer type form C) parallel circuit, series, spring control, alternating current enclosed arc lamp, especially designed for service with small transformer. There are two series magnets. The clutch is suspended from the dash pot lever, the motion of which is steadied by the dash pot. Upward motion of the carbon is produced by the magnets acting through the adjusting spring which is opposed by the dash pot. This results in a slow, gradual separation of the carbons and an easily established arc. Feeding of the carbon is produced by a downward motion of the magnet armature producing a positive action of the carbon unopposed by the dash pot. The slow separation and quick feed give steady and quiet operations. The lamp is assembled on a brass carbon tube as a foundation. On the upper end of the carbon tube is clamped a brass frame to which the suspension hood is bolted by means of the binding post studs. On the lower end of the carbon tube is mounted the radiator casting to which is attached all the lower parts of the lamp. The suspension hood is made of cast iron, japanned. The cylindrical case which encloses the mechanism chamber is made from sheet copper and is strong, durable and weather proof. The radiator on the lower end of the carbon tube protects the arc chamber from moisture from above, shields the mechanism from the heat of the arc below by the air space between the arc chamber and the mechanism chamber. The corner and upper carbon holder consists of a long brass tube in which travels the upper carbon holder. The upper end of the tube is threaded on the inside to receive the brass screw plug which screws down flush with the top of the tube, and to which is soldered a copper spiral cable, which provides a path for the current to the upper carbon. To the other end of this copper spiral cable is connected the stem of the carbon holder by means of a set screw, the stem protecting the cable from damage when trimming the lamp or replacing the carbons. The travel of this carbon holder is checked by the head of the set screw sliding in the slot of the tube, which screw also prevents carbon holder turning. The gas cap is composed of two parts: an upper dish shape casting and a lower ring casting separated by asbestos and mica insulation and clamped together to form a rigid support for the lower carbon holder and inner globe. The gas cap contains an equalizer chamber through which expansion of gases takes place. This chamber is of such proportions that no cold air penetrates to the interior of the arc chamber. The opening in the center of the gas cap through which the carbon passes is lined with a lava bushing which supplies a high insulating and heat resisting separation.

The incandescent lamp has become so absolutely essential a factor in all electric lighting installations that it determines largely the limitations of the successful lighting system.

For electrically lighting large interiors of such places as just mentioned the enclosed arc lamp is very often the most satisfactory method on account of its acknowledged ability to produce a light that approaches more nearly to natural light than most other artificial illuminants.

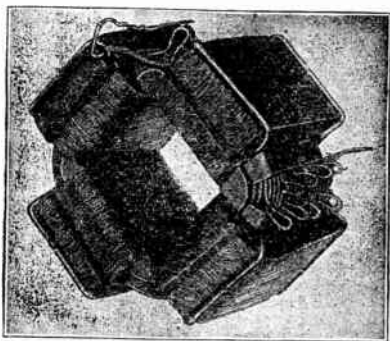
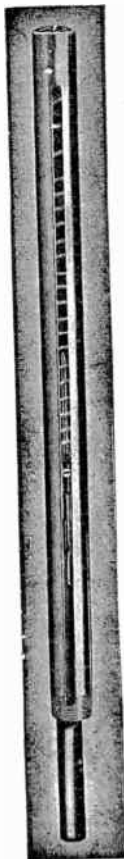

FIG. 3,371.—Impedance coil for Fort Wayne 104 volt parallel circuit, series control alternating current enclosed arc lamp. The function of an impedance coil in an alternating current arc lamp corresponds to that of a steady resistance in a constant pressure, direct current arc lamp. The additional resistance supplied by the coil to that of the arc and series magnet coils serve to steady the arc voltage and furnishes means of adjusting the lamp for various voltages, while the reactance introduced into the circuit by the iron enclosed coil affords means for adjusting the lamp for various frequencies by changing the number of turns of wire in the circuit. The magnetic circuit is given greater reluctance by interposing an air gap filled with a fibre spacing strip, as illustrated in the cut, which shows the coil and core mounted with temporary clamps on the core. A series of taps are brought out from the coil, giving nine adjusting steps for various line voltages, and four leads are available for adapting the lamp to 60 or 140 cycle circuits with a variation of 10 per cent. either way from each frequency. The range of voltage adjustment covered by the standard impedance coil is from 100 to 120 volts.

NOTE.—The upper carbon holder with carrier of Fort Wayne 104 volt parallel circuit alternating current arc lamp consists of two semi-cylindrical phosphor bronze jaws attached to the lower end of the carbon holder stem, and having some elasticity of grip. Thus while the cylindrical contact with the carbon is kept firm, free alignment, even of a crooked or irregular carbon is unfailingly secured. The lower end of therolley body projects downward between the two jaws and serves as a stop for the upper carbon and limits its entrance into the holder to the proper amount. No part of the holder can be affected by the weather, or heat from the arc. It is easily detached when necessary by removing two screws. The upper carbon holder and the stem combined are several times heavier than a single carbon. This excess weight causes the percentage change in the weight supported by the carbon clutch and armature as the carbon is consumed to be comparatively small and consequently the adjustment of the lamp will be less affected by the consumption of the carbon.

FIG. 3,372.—Carbon holder carrier of Fort Wayne 104 volt parallel circuit alternating current arc lamp. It consists of a long brass tube in which travels the upper carbon holder. The upper end of the tube is threaded on the inside to receive a brass screw plug which screws down flush with the top of the tube, and to which is soldered a copper spiral cable which provides a path for the current to the upper carbon. The other end of this copper spiral cable is connected to the stem of the carbon holder by means of a set screw, the stem protecting the cable from damage while trimming the lamp or replacing the carbon. The object of this plug in the top of the tube is to form a guide, by means of the counter sunk hole in the plug into which the stem of the carbon holder enters, automatically centering the carbon in the holder. The travel of this carbon holder is checked by the head of the set screw sliding in the slot of the tube, which screw also prevents the carbon holder turning.



FIGS. 3,373 and 3,374.—Carbon clutch of Fort Wayne 104 volt parallel circuit alternating current arc lamp. Fig. 3,373 tripping lever side of clutch; fig. 3,374 shoe side. The standard clutch is the pivoted shoe type, and is plainly shown in the accompanying illustrations. It is composed of five parts—the body, trip lever, shoe, and two pivots. The body of the clutch has four contact points, so that the clutch may be termed a five point clutch, the shoe constituting the fifth point. This clutch permits proper feeding at all times, regardless of the size or condition of the surface of carbon.

NOTE.—The upper carbon holder consists of two semi-cylindrical phosphor bronze jaws making annular contact on the carbon and attached to the lower end of the trolley body by means of two screws. The lower end of the trolley body projects downward between the two jaws and serves as a stop for the upper carbon which limits its entrance into the holder to the proper amount. The lower carbon holder consists of a ring casting with a thumb screw for lighting the carbons in the holder and set screw for clamping holder on supporting rod and a small wire bail underneath the holder which prevents the carbon falling out in case the thumb screw should become loosened. The supporting rod carrying the lower carbon is clamped to the gas cup and, although rigid and in proper alignment, may be easily removed.

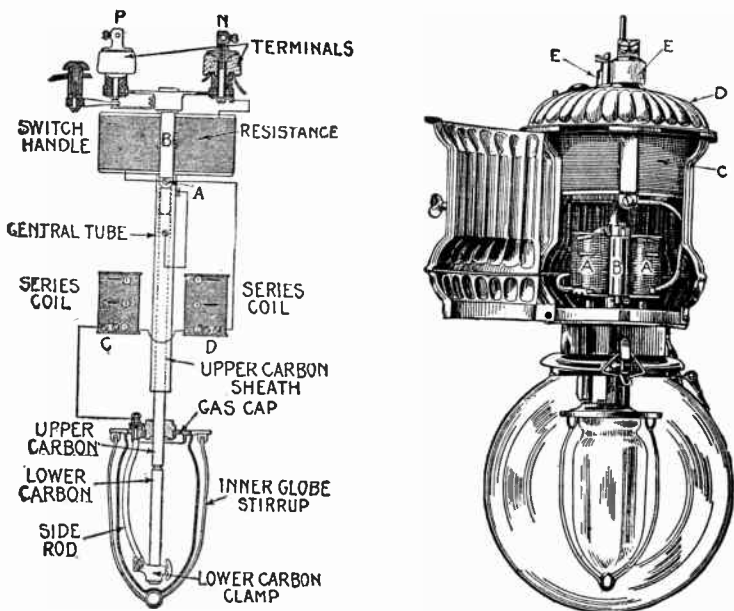

Figs. 3.375 and 3.376.—Westinghouse parallel circuit, series control direct current enclosed arc lamp. There are two series coils, a U shaped soft iron rod forming the plungers. The coil spools are of brass and provided with suitable projections by which they are attached to the central tube. The coils are proportioned to give an even pull over the whole length of the lift; a feature which enables the use of the same mechanism in the 110 and 220 volt lamps, with the exception of the windings in the series coils and the resistance coils. The dash pot is of the vacuum type. The upper part of its movable shell is fastened to a projection of the series coils. The plunger is hollow and made of graphite and of such construction that it cannot stick under extreme conditions of heat, cold, or moisture. The resistance spool consists of a short, heavy tube or ring of porcelain, with the outer surface grooved to receive a continuous winding of resistance wire. The grooves are of sufficient depth to allow the wire to expand under the influence of a high temperature without leaving its place. The porcelain spool is fastened to the body of the lamp without the use of screws or bolts which might tend to bind when expanded by heat and cause a breakage of the spool. The lamp cut out switch is located in the case cap, as shown. It has a handle of pressed brass and provided with a petticoat, where it enters the case to prevent leakage. The blade is of vulcabeston with a copper stud embedded in its outer end and so placed that a movement of the handle brings it in contact between the lower end of the binding post bolt and the heavy piece of spring brass connected to the lamp circuit, thus connecting it to the mains. The terminal binding posts are set in square recesses in porcelain insulators. The upper carbon sheath is electrically connected to the central tube by flexible stranded wire which is attached to a screw in the sheath that passes through a slot in the tube, thus placing the connecting lead wholly outside the tube. The lower carbon clamp is provided with a steel wire stirrup to prevent the carbon slipping down through the holder if the clamping screw become loosened. The gas cap consists of a metal plate with a lava bushing in the center through which the upper carbon

It is essential, therefore, that the arc lamp be designed to operate satisfactorily on the same circuits with incandescent lamps. This means that the arc lamp must be so designed that it will work on a 110 or 220 volt circuit parallel connection. Accordingly the direct current lamp must include a suitable resistance because the working pressure at the arc (75 to 80 volts) is less than the pressure across the mains (110 volts). For 220 volt circuits additional resistance is necessary.

The accompanying cuts illustrate the features of direct current parallel lamps for 110 and 220 volt circuits.

Figs. 3,375 and 3,376 show a Westinghouse parallel circuit, series control direct current enclosed arc lamp. The adjustments of this lamp are simple:

For current adjustment three taps are brought out from each of the series coils at 1, 2, and 3, shown in fig. 3,375, which give the following current values:—

Tap	110 volt lamp	220 volt lamp
1	4.50 amperes	3.00 amperes
2	5.00 "	3.25 "
3	5.50 "	3.50 "

In order to secure the desired current, the connectors shown at C and D, must be attached to the proper taps, care being taken to connect both connectors to taps having the same numbers.

The current adjustment should always be made before making the adjustment for voltage.

The voltage adjustment is made by varying the amount of resistance in the lamp circuit. This is accomplished by lightly moving the sliding contact B up and down upon the surface of the resistance coil. To increase the arc voltage the resistance is reduced by raising the contact;

Figs. 3,375 and 3,376.—*Descriptions continued.*

passes, and suitable bushings for the side rod and the supports of the stirrups for the inner globe. The upper carbon of this lamp is 12 inches long and the lower one, $5\frac{1}{2}$ inches for the 110 volt lamp, and 5 inches for the 220 volt lamp, with a maximum diameter of .520 inch and a minimum diameter of .505 inch. **In trimming**, the unconsumed portion of the upper carbon of one trim can be used for the lower carbon of the next, thus requiring only one new carbon at each trim. The carbons used are solid, and from lamps will burn without retrimming for 125 to 175 hours on a 110 volt circuit, and from 125 to 160 hours on a 220 volt circuit depending on the exposure of the lamp. An indoor lamp located where the drafts are slight will burn a greater length of time on a single trim than an outdoor or indoor lamp placed where there is a strong current of air.

to reduce the arc voltage the resistance is increased by lowering the contact. The contact can be removed by loosening the adjusting screw *A*.

The parallel alternating current system of arc lighting serves to fill a very frequent demand for a simple and inexpensive method of lighting small towns or isolated sections of larger cities.

The wiring diagram fig. 3,377 shows the connections and features of this system.

Ques. State some advantages of the system shown in fig. 3,375.

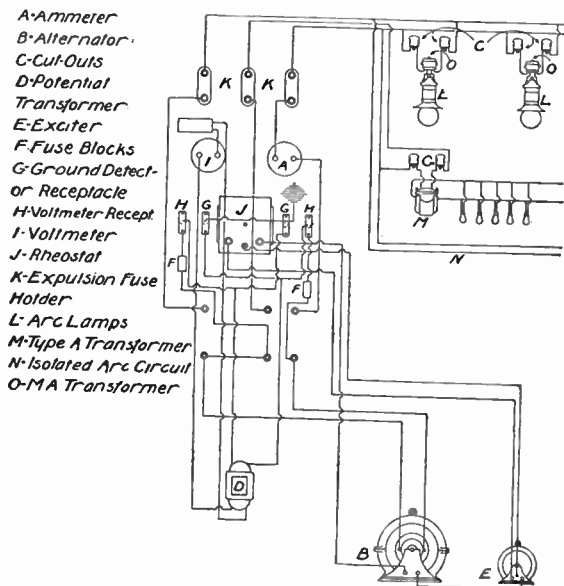

Fig. 3,377.—Wiring diagram of parallel alternating current system of arc lighting, with three wire single phase high tension transmission, including two or three wire secondary distribution for incandescent lighting. The diagram shows the back of a Fort Wayne switchboard. The incandescent lighting circuits are supplied from ordinary transformers having a ratio of 10 to 1, or 20 to 1, giving standard secondary voltage for the operation of the house circuit. The arc lighting circuit consists of one of the incandescent mains and an additional or third wire connected at the switchboard to the other side of the incandescent lighting circuit through a single pole single throw switch as shown, which switch controls the arc lighting circuit. Each lamp is connected to the secondary terminals of a small transformer (such as described in fig. 3,358), having primary coil connected between the third wire and a common wire of the incandescent circuit. The primary terminals of each transformer are connected to the line through fused cut outs or switches. These cut outs are mounted on a cross arm of the pole on which the transformer is installed. They are made of porcelain and are such shape that they may be used as leading off insulators for the line wire running to the transformer.

Ans. Lamps of different candle power or current can be used by employing a suitable transformer.

Thus low energy arc lamps for interior lighting may be used on the same circuit with lamps consuming higher current and giving stronger light for out door service; this cannot be done in a series circuit without wasteful shunt resistance.

In many instances it is desirable to locate arc lamps in places where arc circuits are not installed, such as when municipalities require additional arc lamps for lighting newly acquired suburban districts. In

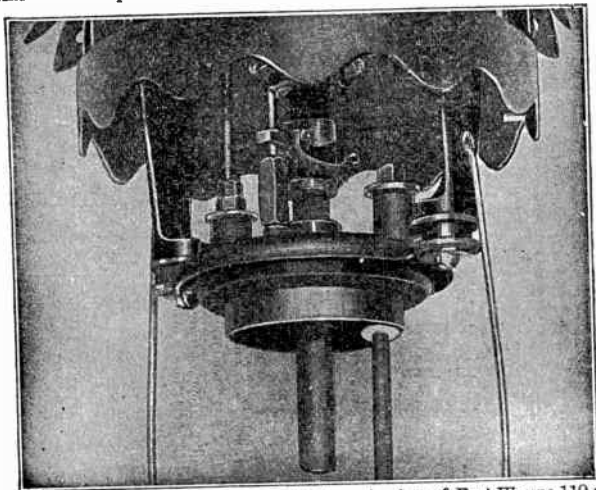
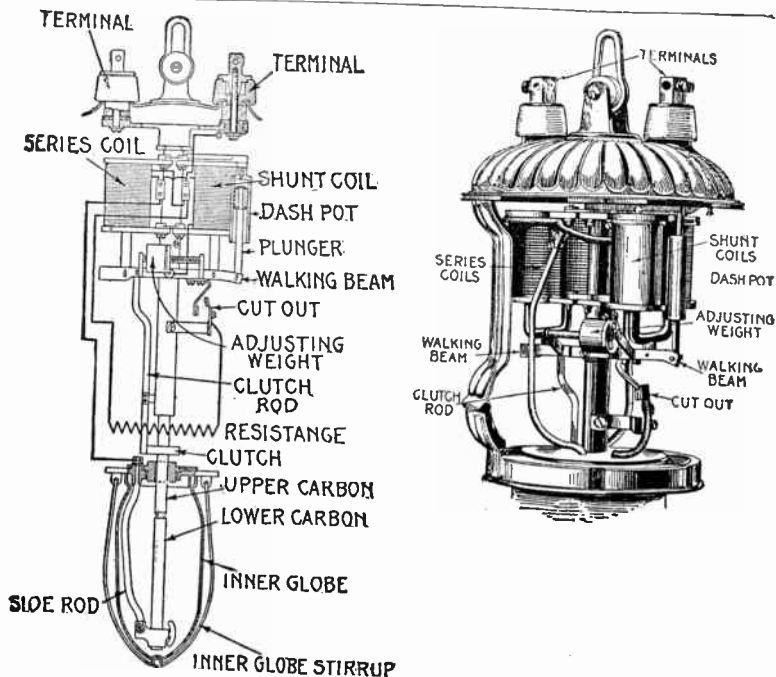

FIG. 3,378.—Detailed view of gas cap and clutch mechanism of Fort Wayne 110 volt enclosed direct current parallel arc lamp. The gas cap is an upper dish shaped casting and an under ring casting insulated from each other by asbestos and mica and rigidly clamped together to form a support for the inner globe. The lower part, on which the inner globe is seated, is only slightly larger in diameter than the globe, and, therefore, is almost entirely protected by the globe against sudden changes in temperature. This keeps the glass and metal at nearly the same temperature continuously, resulting in less breakage of globes. The special construction of this gas cap, with its arrangement for admitting nothing but heated air to the arc, secures long carbon life. The average life of one set of high grade solid carbon is said to be 150 hours when the lamp is adjusted for normal current and voltage. A lava bushing is inserted in the center of the gas cap through which the upper carbon passes. The carbon clutch is between the radiator casting and the gas cap and is operated by the clutch rod fastened to the movable armature of the mechanism above.

such cases the above mentioned type of transformer and arc lamp can be installed directly on the incandescent wiring net work. This does not require any additional expenditure for installing the extra wiring or extending an existing arc light circuit. In this way the system utilizes



FIGS. 3,379 and 3,380.—Westinghouse series parallel circuit differential control direct current enclosed arc lamp. The U shaped armature for each set of coil is made from one piece of round iron bent into the form shown. The shell of the dash pot is secured to the lamp frame, and the stem of the plunger is attached flexibly to the walking beam. The dash pot is of the vacuum type, with graphite plunger, which is self-lubricating, its action not being affected by changes of temperature. The upper carbon holder is in the form of a split sleeve with a short stem attached to its upper end. It slides freely upwards and downwards in a brass tube slotted at one side nearly its entire length. This tube is connected in turn to the positive side of the lamp circuit. The lamp is of the differential control type. As shown in fig. 3,379, the armature of the series magnet is attached to one end of the walking beam by a flexible connection, the armature of the shunt magnet being attached to the opposite end. Connected with the end of the rocker arm near the series coil is the clutch rod. The clutch consists of a porcelain ring, secured flexibly to the clutch rod by a copper band. **In operation**, if for any cause, the arc become extinguished, the increased current passing through the shunt coils will cause them to raise their end of the rocker arm to its maximum height, thereby closing the cut out contacts. This action in turn closes a circuit through a resistance equal to that of the lamp when it is in operation and throws its mechanism out of circuit without disturbing the other lamps in the circuit. The gas cap, globes, shades, carbons, and insulation used with this lamp are essentially the same as those used with parallel direct current lamps. A regulating resistance is provided having several steps. One resistance is used with two lamps in series on circuits of 200 to 250 volts, and two resistances with five lamps in series on circuits of 400 to 600 volts. By means of the adjustment at the bottom of the regulating resistance, lamps may be operated two in series on circuits from 200 to 250 volts and five in series from 400 to 600 volts.

the advantages of an incandescent lighting system, at the same time retaining the valuable features of a parallel arc lighting system.

In installing the system, it is only necessary to run one additional wire along with the two incandescent lighting mains wherever these mains are installed, or extend one of the incandescent lines and add the third wire for the arc circuit return wherever it is desired to install arc lamps outside the territory covered by the incandescent mains.

In general this system can be installed in any locality requiring street lighting but the particular cases where its application is most profitable are in small towns and suburban sections already supplied with an alternating incandescent lighting system.

In such cases the demand for arc lights is not usually such as to warrant an outlay of capital sufficient to provide a separate set of arc lighting mains and the accompanying switchboard and station equipments.

Series Parallel Arc Lamps.—In many localities, the only source of current for illuminating purposes is for direct current power circuits nominally of 220 or 550 volts to which the ordinary forms of direct current lamp are not adapted. This condition is often encountered in factories, foundries, mills, etc., where power is usually supplied at 220–250 volts, and the small number of lamp does not warrant the installation of separate lighting circuits.

The electrical illumination of street railway tracks, race tracks, pleasure resorts, etc., is often dependent upon a 550 volt trolley circuit. Inter-urban railways often supply small suburban and country towns, located along their lines, with current for lighting at the voltage of their feeder and trolley wires. It is to meet such conditions that lamps have been designed for series parallel working and known as series parallel lamps. Series parallel lamps are usually designed to operate two in series across 220 or 250 volt circuits, or five in series across 500 or 550 volt circuits.

The essential features of series parallel direct current and alternating current arc lamps are shown in the accompanying cuts.

Luminous Arcs.—In the case of an electric arc maintained between ordinary carbon electrodes, almost all of the light comes from the tips of the electrodes and comparatively little from

the arc stream itself. In the development of arc lamps various attempts have been made to increase the luminosity of the arc stream by introducing some substance not carried by the ordinary carbon electrodes.

In the latest types of arc lamp this is accomplished in one of two ways: by using in direct current lamps, negative electrodes

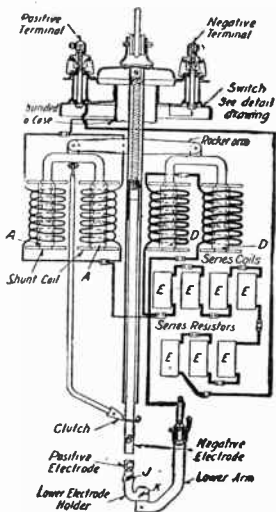
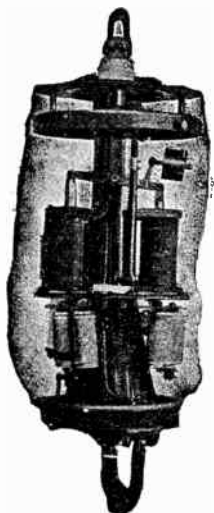

FIGS. 3,381 and 3,382.—Westinghouse parallel circuit, metallic flame arc lamp with cover removed showing mechanism, and circuit diagram of same. In operation, fig. 3,382, when current is turned on, it flows from the positive terminal and energizes the shunt coils A, which bring the electrodes B and C together. Current then flows through the series resistance E, and the series coils D, to the positive electrode C, thence to negative electrode B, and negative terminal. The series coils D, now being energized, pull electrodes apart striking the arc. The shunt coils A, being connected across the arc are pulled apart, and the series coils D will separate the electrodes until the voltage across the arc (approximately 65 volts) which is impressed on the shunt coils D, is high enough to energize the shunt magnet coils sufficiently to balance the pull of the series magnet coils when 5 amperes are flowing.

of a material the incandescent vapor of which gives a highly luminous spectrum; or by employing electrodes of such refractory material as will give a very high arc temperature, by the effects of which certain materials carried by the positive

In operation, the burning of the negative electrode produces a fluffy red oxide which would stick to everything it touches, and accumulates very rapidly on the globe and reflector unless some suitable means were employed to get rid of it. This is accomplished by means of air currents the directions of which are shown by arrows in fig. 3,385.

In order to prevent the deposit on the negative electrode where it would hang down like a curtain and obscure the arc, a current of air is directed downwards so as to surround the electrode with a wall of air, and a similar wall of air is provided for preventing the oxide

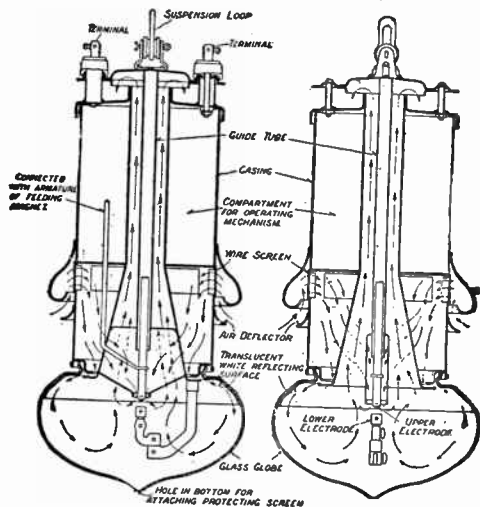
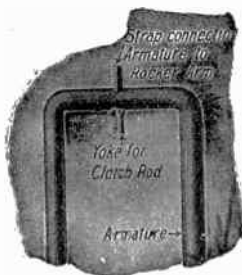
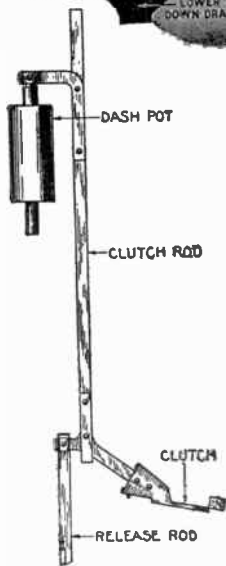
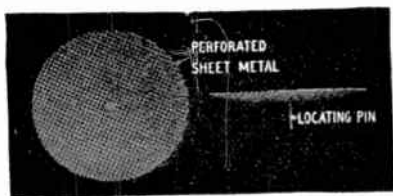

FIG. 3,385.—Diagram showing air circulation of Westinghouse metallic flame lamp. Air currents, as indicated by the arrows, sweep the inner surface of the globe and past the electrodes up the chimney and out into the air and carry with them practically all of the condensed vapors. The air currents steady the arc and prevent it climbing the side of the negative electrode.

collecting on the reflector or globe. These two currents of air meet and pass upwards through the chimney tube, thus carrying all the products of oxidation to the outer air.

Ques. What are the principal advantages of the metallic oxide arc over the carbon arc?

Ans. It requires less energy and gives a satisfactory light with a greater drop in the arc voltage.



FIGS. 3,386 to 3,390.—Construction details of Westinghouse metallic frame arc lamp. Fig. 3,386, chimney; fig. 3,387, view looking into chimney tube; fig. 3,388, globe screen; fig. 3,389, dash pot, clutch rod, clutch and release rod; fig. 3,390, armature.

Usually it operates on 4 amperes with a drop across the arc of 65 to 70 volts, giving an illuminating effect superior to that of the enclosed carbon arc operating on a current of 6.6 amperes with an arc voltage of 75 to 80 volts. Ordinarily, the carbon arc does not give a satisfactory light when the arc voltage drops below 65, while the metallic arc will give good results when the drop across the arc is less than 55 volts.

Another advantage of the metallic arc lies in the increased length of the life of the electrodes over that of the enclosed carbon arc, thereby increasing the number of lamp that can be cared for by one trimmer. A 12 inch electrode has an average life of 150 hours. Furthermore, the omission of the inner globe reduces the cost of maintenance materially.

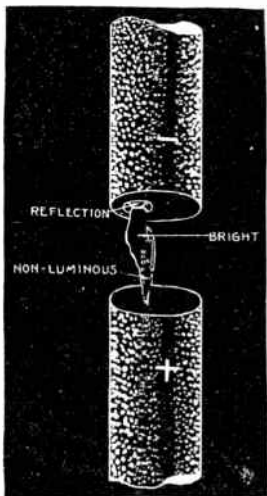

FIG. 3,391.—Electrode arrangement of Westinghouse metallic flame arc lamps. As shown, the larger portion of the light comes from the flame which always surrounds the negative electrode and the natural light distribution results when the negative electrode is arranged above the positive. This distribution, shows a maximum intensity at about 25 degrees below the horizontal. The length of the negative electrode is not limited except by the height of the lamp.

Flaming Arc Lamps.—In the various forms of flaming arc lamp, both the positive and the negative electrodes are of carbon. In the direct current lamp, the arc is made luminous by impregnating the positive carbon, or providing it with a core of calcium fluoride or borate, which when heated to the arc temperature becomes highly luminous. In the alternating current

lamp, both carbons are provided with cores of calcium salts. In the former the efficiency of light production depends upon the temperature of the positive electrode which controls the vaporization of the luminescing material.

If the amount of carbon in the positive electrode be large and it consume slowly, the light efficiency decreases, but if the core of calcium salts be large and the electrode consume rapidly, the light efficiency increases proportionately.

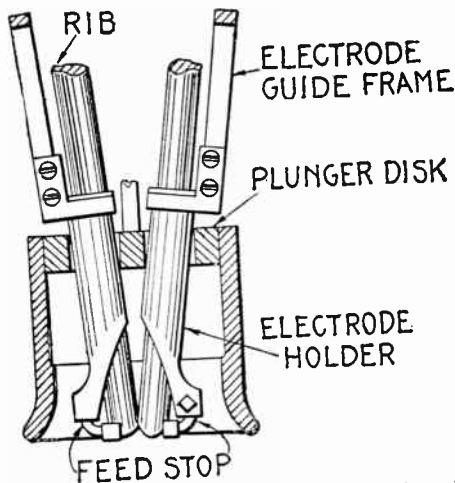

FIG. 3,392.—Lower mechanism of Beck flaming arc lamp, showing electrode holders, feed stop, plunger disc and electrode guide frame.

The electrodes of these lamps are placed, usually, in a conveying position pointing downward, and the arc is sprung by means of a plunger disc or other suitable device operated by a series magnet which forces the carbons apart. As the carbons waste away, the ribs waste away also, the carbons being fed downward by gravity with the ribs against the feed stops. This action maintains the arc always in the same place.

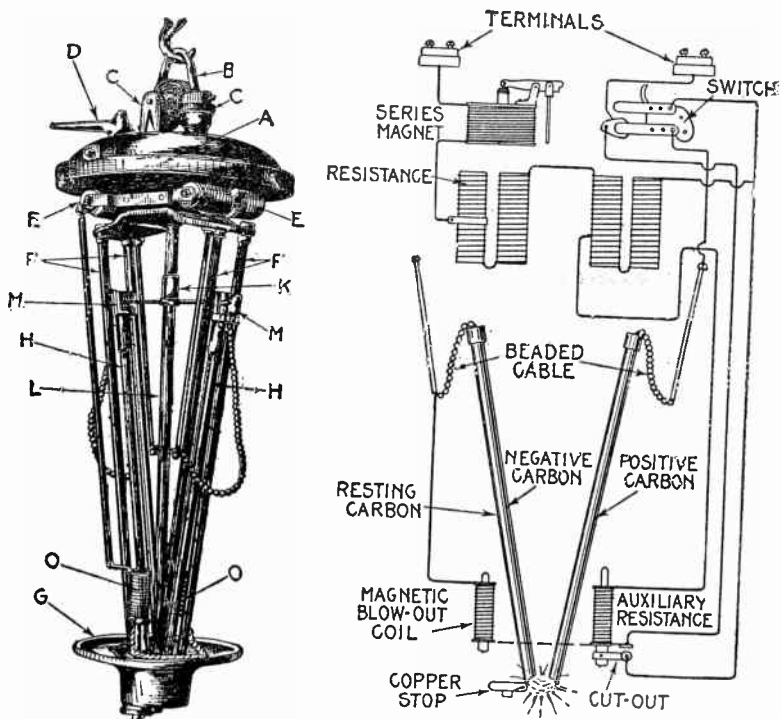

FIG. 3,393—External view and diagram of connections. As here shown, the top casting A is of iron, and is provided with an insulated hanger B, two binding posts C C, with screws to secure the lime wires, and a hand switch for cutting out the lamp from the circuit. From the resistance spools E, E, which are supported by a cast plate secured to the top, two pairs of rod F, F, converge to the bottom casting G. These rods form the slides for the upper and lower portions of the lamp. A socket K, is arranged to slide freely on the central tube L. This socket carries two arms which engage the carbon holder supports M, M. The bottom casting is provided with a copper stop on which one of the carbons rests at all times; while the other carbon is supported by the socket arms, engaging the carbon holder supports. **In operation**, as the resting carbon wastes away the free carbon feeds downwards, thus maintaining the arc exactly in the same place. The bottom casting is recessed to hold a resisting plate which protects the upper part of the lamp and also increases the life of the carbons. The blowing magnets O, O, are mounted on the bottom casting, and the magnetic field is so disposed that the arc is maintained in its proper position relative to the cores of the carbons. The series magnet which operates the mechanism for separating the carbons is located above the central tube. By means of a plunger and lever this magnet operates a rod which passes completely through the central tube, and terminates in a device arranged to operate a pressure foot which serves to move the free carbons away

In some forms, the rib on the carbon is omitted and the feeding is accomplished by a suitable mechanism. In the alternating current lamps, a starting resistance or inductance coil is included in the circuit to avoid a dead short circuit in starting. In some forms, magnetic blow out coils with properly located cores serve to repel the arc downwards from the electrodes in the shape of a fan or bow. In the accompanying cuts the construction and features of flaming arc lamps are shown.

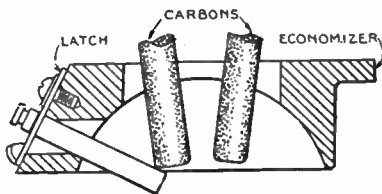
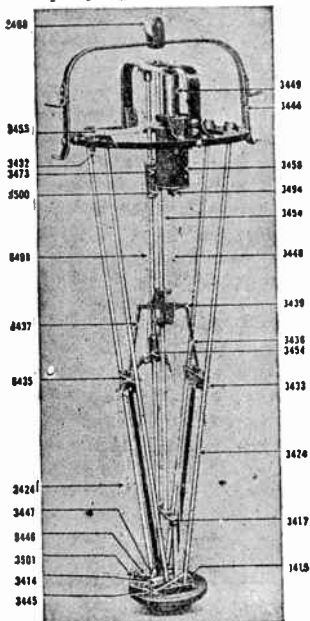

FIG. 3,394—Lord flaming arc lamp for direct or alternating current and detail showing economizer. In the view at the left the parts are: 3,414 insulating block (grooved); 3,415, insulating block (plain); 3,417, bridging bar; 3,424, bond wire (with beads); 3,432, binding posts; 3,433, thumb nut; 3,435, carbon holder (complete); 3,436, connecting rods ($4\frac{3}{16}$ " long); 3,437, connecting rods ($4\frac{1}{16}$ " long); 3,439, center guide; 3,444, hanging frame; 3,445, shutter lever; 3,446, insulating link; 3,447, shutter; 3,448, dash pot rod; 3,449, dash pot; 3,454, connecting wire and blow down coil; 3,455, bond wire (with beads); 3,458, solenoid; 3,468, hanger insulator; 3,473, resistance adjuster; 3,494, armature; 3,498, connecting wire (with beads); 3,500, resistance (wire and spool); 3,501, bell crank. The composition rest pin is subjected to a particularly intense heat and slowly burns away. When, after several times, this happens, so that the carbon is not supported, it is not necessary to insert a new pin, as all that is needed is to unlock the latch and advance the pin another notch. This is the equivalent of the lamp mechanism.

FIG. 3,393.—Description continued.

from the resting carbon, thus springing the arc. When the carbons have been consumed, the sliding socket on the central tube reaches a stop which checks its downward movement, and at the same time the weight of the moving parts operates the automatic cut out, throws the auxiliary resistance into circuit, short circuits the arc and extinguishes the light. The operation of renewing the carbons resets the cut out device. At the right is a diagram of the internal connections and shows the method by which the lamp is arranged to operate in series, so that when the carbons in one lamp are consumed that lamp will be automatically cut out of the circuit without interfering with the operation of the other lamps. The current passes from one binding post to one of the resistance spools, thence to one of the carbons through a glass beaded insulated cable, thence through the arc to the other carbons, then through the blowout magnet coils to the second resistance spool, thence to the switch and opposite terminal. As no shunt magnets are used, and as the voltage is fixed, it can be operated on either direct or alternating current. The carbons used for direct current will not operate satisfactorily, however, for alternating current, therefore the carbon holders are so constructed that either of those kinds of carbon may be used.

Inverted Arc Lamps.—Such lamps are usually arranged to feed the negative carbon which is the upper one. The negative carbon is made a little larger, and the positive carbon a little smaller than usual, as the ascending heat of the arc increases the rate of consumption of the negative instead of the positive carbon.

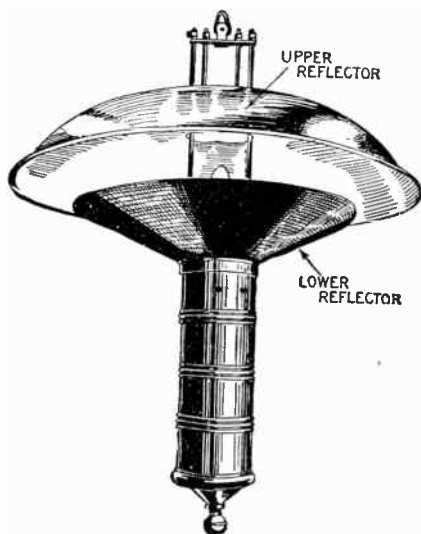

FIG. 3,395.—Exterior view of Toening inverted arc lamp, suitable for use where the indirect system of illumination is desired.

For the same reason the length of an inverted arc is at least a third shorter than that of an ordinary arc, for the same voltage and consequently has a diminished efficiency, since it requires more energy to maintain the heat of the crater when it is underneath than when it is on top.

Fig. 3,395, shows an inverted arc lamp. It is especially adopted for the illumination of draughting rooms, color printing works, textile mills, clothing manufactories, schools, silk mills, dye houses, etc., where a diffused white light is essential.

Special Forms of Arc Lamp.—The more important of the special forms of arc lamp designed for various purposes are the focusing lamps and the search lights.

Focusing lamps are made in both the automatic and the hand feed type. They are used for photographic, lantern and theatrical work. Fig. 3,396, shows a lamp of the automatic feed type with tilted carbons, and fig. 3,397 hand feed lamp for lantern work.

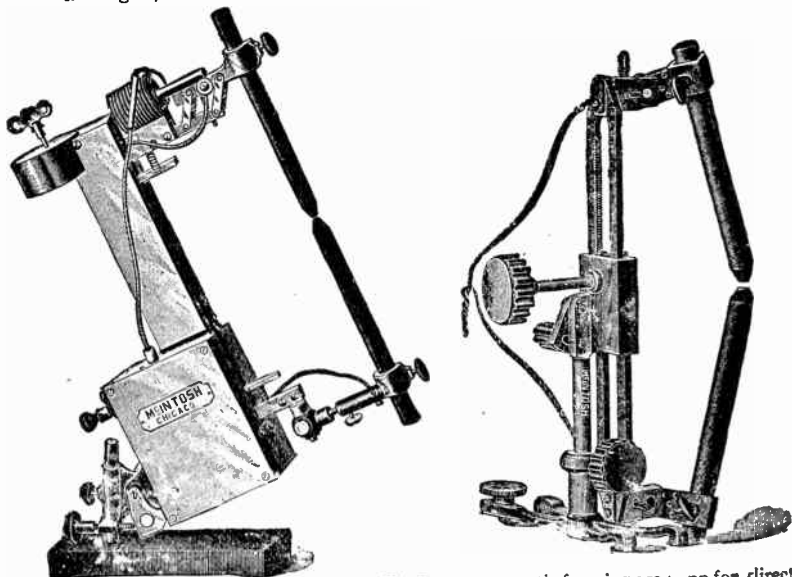

FIGS. 3,396 and 3,397.—Special arc lamps. Fig. 3,396, automatic focusing arc lamp for direct current only; fig. 3,397, hand feed arc lamp for lantern work adjusted for alternating current. These lamps give from 2,000 to 3,000 candle power with a consumption of from 10 to 15 amperes of current. On account of the current strength required, they cannot be attached by means of a cord plug to a socket from which an incandescent lamp has been removed, but must be connected with a large supply wire, which is usually most accessible at a fuse box. They do not require constant attention or feeding during operation for if the arc be first struck with the shortest air gap, the lamps will burn without any attention for four or five minutes, giving practically the same results on the screen while the arc length increases from one-eighth to three-eighths of an inch. At the end of four or five minutes, a slight movement of the handle at the back of the lamp will move the carbons closer together and shorten the arc. During operation the carbons are usually tilted away from the object illuminated so that the maximum light emitted by the lamp at an angle of 45° from the axis of the positive carbon will fall nearly horizontally on that object. In some lamps the positive carbon is set back out of alignment with the negative carbon, thereby causing the crater to form at an angle without requiring the tilting of the carbons.

Search Light Projectors.—In the various forms of arc lamp designed for search lights, the carbons may be either inclined or horizontal, but the arc is always directed towards the reflector and away from the object illuminated. By this arrangement

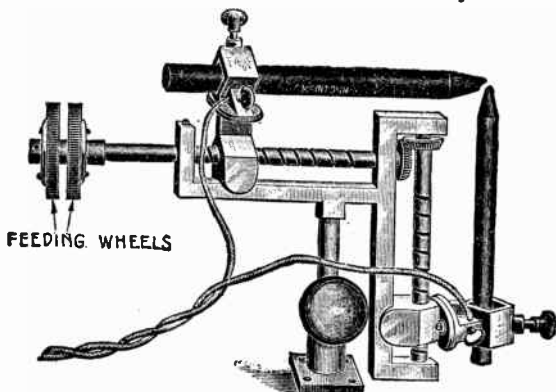

FIG. 3,398.—Hand feed arc lamp with carbons at right angles. The carbons can be fed separately or together, depending on the manner in which the feeding wheels are manipulated. With direct current, this type of lamp will give more light for the same amount of current than the tilted form, but it requires a little more attention in feeding.

all the projected rays of light are made parallel to each other as shown in fig. 3,399 and the intensity of the beam of light maintained the same theoretically at any distance from the lamp. It is evident that if the crater of the positive carbon

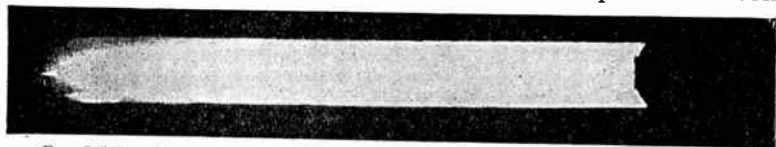

FIG. 3,399.—Beam of parallel rays of light as produced by a search light projector.

were turned toward the object illuminated all of its rays that did not strike the reflector would be divergent instead of parallel, and would not reach the object to be illuminated. In other words the beam of light composed of parallel rays represents the

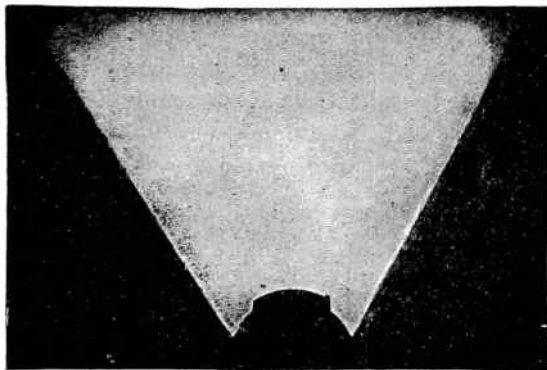

FIG. 3,400.—Beam of radial rays of light projected from search light with dispersion lenses.

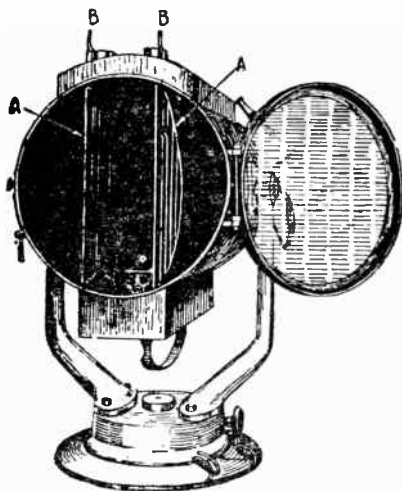

FIG. 3,401.—Front view of a search light showing arrangement of dispersion lenses. The object of these lenses is to project the rays radially as in fig. 3,400 instead of parallelly as in fig. 3,401. The dispersion lenses as here shown are arranged in two semicircular brass rings A, A, so pivoted that they can be swung around on a vertical axis by means of the handles B, B. This arrangement permits of readily bringing the dispersion lens into use whenever necessary without the opening of the front door of the lamp as is the case in the older forms of searchlights. When two parts of the lens occupy the position shown, the light is projected parallelly as in fig. 3,399. The arc is kept stationary either by feeding the carbons at different rates of speed, or by the use of suitably proportioned carbons, the positive being corcd and given a larger diameter than the negative.

full illuminating power of the lamp, has greater penetrating qualities, and is the most suitable for picking out objects on land or sea.

Again there are many cases such as making landings, picking up tows of barges, etc., where it is very desirable to have the

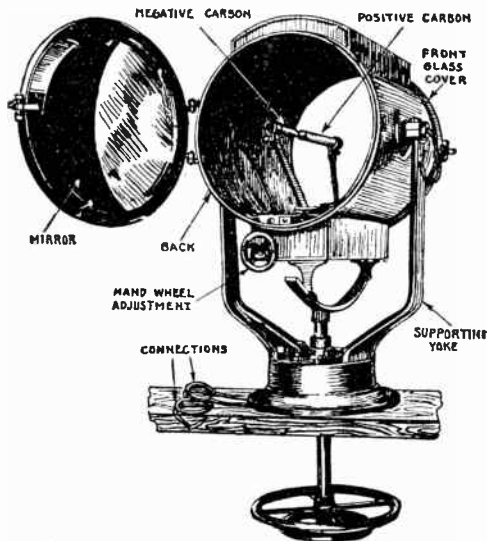

FIG. 3,402.—Marine search light for pilot house; view showing the feeding mechanism in position within the cylinder of the projector. It will be noted that the positive carbon is located in front of the negative carbon, and therefore, all the light emitted from the crater is thrown on the reflecting mirror. The mirror may be of the aplanatic or parabolic type. The aplanatic or Mangis mirror has two spherical but not concentric surfaces. On account of its unequal thickness it is more liable to crack under the influence of heat than the parabolic mirror. The parabolic mirror consists of a piece of silvered glass about one-quarter to one-half inch in thickness throughout, and having the shape of a true parabola. The front cover of the search light is usually composed of plate glass, thereby avoiding breakage by heat, and permitting the easy renewal of any strip that might happen to become broken. The control gear consists of two hand wheels which connect with the projector by means of two vertical shafts, one within the other. The outer shaft is attached directly to the yoke supporting the cylinder, and gives motion in a horizontal plane. The inner shaft terminates in a small pinion which meshes with a segment of a gear attached to the cylinder, and serves to elevate or depress the light.

light cover a greater area. This result is obtained by the use of dispersion lenses which disperse or spread out the light radially as shown in fig. 3.400.

Some details of search light construction and operation are shown in the accompanying illustrations. The average current required by search lights of various size, and their nominal candle power are given in the following table.*

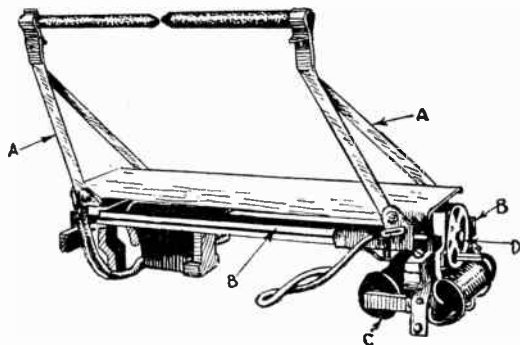

FIG. 3,403.—Carbon feeding mechanism for search light. This is usually motor driven and hence positive in its action. The carbon carriers A, A, are supported on two parallel brass rods B, B, and are moved toward each other by means of a right and left screw. This screw is actuated by the shunt magnet C, and maintains an arc of uniform length regardless of the position of the mechanism. Any deviation of the arc from the focal position may be corrected by means of the hand wheel D, using the colored windows for the purpose of observation.

CURRENT AND CANDLE POWER OF SEARCHLIGHTS

Diameter of case in inches.	Current in amperes	Candle power	Approximate price
14	10-15	3,000	\$360
14	20-25	5,000	380
19	35-40	8,000	530
19	45-50	10,000	550
24	55-60	12,000	950
24	75	15,000	970
32	90	18,000	1,650
38	120	24,000	2,100

*NOTE.—In the table it should be clearly understood that the prices quoted are merely a rough approximation which serve to give only a very general idea of the high cost of this class of apparatus.

Installation and Care of Arc Lamps.—The methods employed in the installation and care of arc lamps depend largely upon the type of lamp and the character of the service. Usually complete instructions accompany each lamp, and should be carefully followed. The following general instructions are applicable however to all arc lamps.

Unpacking.—When removing a lamp from its packing box be very careful not to strain any part of its mechanism, and after it has been removed, if possible, hang it up at once. Never allow the lamp to rest on any part of its mechanism, and if it cannot be hung up at once, lay it down on its side. After hanging the lamp remove the case by letting it down the full length of the chains, or otherwise as provided, and carefully wipe all dust and dirt that may have worked into the mechanism during shipment.



FIG. 3,404.—Carbon pliers. Carbons may be cut to any desired length by simply nicking them all around and breaking them like a glass tube. For this operation the carbon is placed in the circular opening of the pliers in such position that the nicking comes flush with the side of the pliers.

The glass globes for the lamps are usually shipped separate in order to avoid breakage. They should be removed from their packing cases and thoroughly cleaned.

Connecting.—In ordinary direct current lamps the lower carbon is usually the negative and the upper carbon is the positive. In flaming arc lamps the resting carbon is usually the negative and the free carbon the positive. Therefore, it is necessary that a direct current lamp should be properly connected to the circuit, otherwise, it will operate badly, and very soon go out entirely. Usually, one of the binding posts on the top of a direct current lamp is marked with the letter "P" meaning positive. The positive wire should be put into this post, and the negative wire should be securely fastened to the remaining post.

If the positive wire cannot be identified, connect the lamp to the wires any way and throw on the current. Allow the lamp to burn for about five minutes, then cut off the current and it will be noted that

one of the carbons will remain bright a little longer than the other. If the lamp be properly connected the positive carbon will remain bright the longer. On the other hand if the negative carbon remain bright longer than the positive carbon it is a sure indication that the lamp is improperly connected.

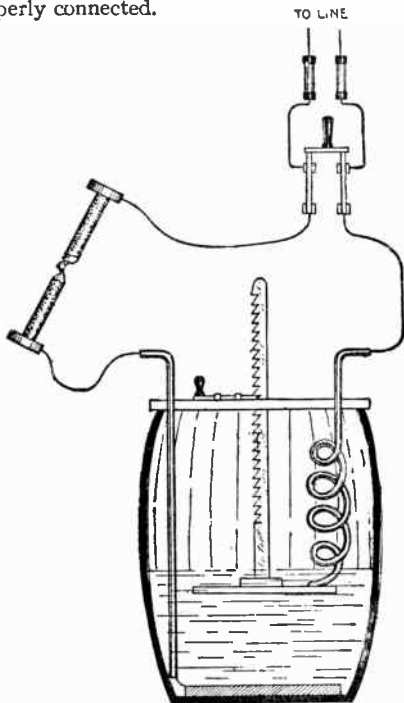

FIG. 3,405.—Emergency water resistance for use with an arc light. Where a resistance unit of the ordinary rheostat type is not available, it is possible to manufacture for quick use a resistance unit which is composed of a barrel with a metal plate at the bottom, to which is attached a rubber covered cable forming a terminal, and a second metal plate arranged to be moved up and down, and to which is attached the other lead, the device being connected in series with the lamp as shown. When the barrel is filled with salt water, it will allow current to pass from one plate to the other, in amount depending upon the distance between the plates. Such an arrangement is called a water rheostat and is useful, especially for high voltages in case of emergency, and it operates fairly satisfactorily, although the water becomes heated in a short time.

These precautions are not necessary in the case of alternating current lamps for they have no positive or negative sides and may be connected up with either binding post toward either supply wire.

Adjusting.—After the carbons have been put in place it is advisable to test the lamp to determine whether or no the factory adjustments have been changed accidentally during shipment. The test for current may be readily made by putting an ammeter in series with the lamp, and allowing the lamp to burn for about five minutes. If the reading of the ammeter indicate a higher or lower amperage than that specified for the lamp, the resistance of the lamp circuit should be increased or diminished by properly moving the sliding contact on one or more of the resistance coils usually located in the upper part of the lamp. If two or more lamps be connected in series, the current adjustment

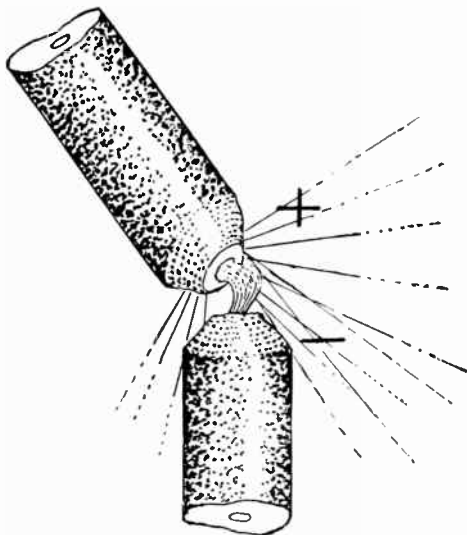

FIG. 3,406.—Light distribution of alternating current arc with inclined electrode. Case I, *upper carbon positive*. When the upper carbon receives a positive impulse the upper crater gives maximum illumination and the lower crater a comparatively small amount of light.

should be made on each lamp so that all of the resistance spools will receive a proportionate share of the heating, thus effecting a saving in their life. The normal current in amperes and the volts at the arc are usually marked on the name plate of each lamp.

As a rule, the factory adjustment for the proper arc voltage should never be changed; but whenever necessary the voltage at the arc can be measured very readily by attaching leads from a voltmeter to the lamp connections leading to the carbon holders. It is important to remember that flaming arc lamps will not operate satisfactorily unless the amperage be fully up to the value marked on the name plate.

Retrimming.—Whenever new carbons are placed in the lamp, the mechanism of the lamp should be carefully cleaned by means of a small brush, and the inside of all globes should be relieved of all deposits. In flaming arc lamps the steadiness of the light depends largely upon the copper shoe which supports the negative carbon, therefore, the scale of deposit which forms thereon should be carefully scraped off whenever a new carbon is put in place.

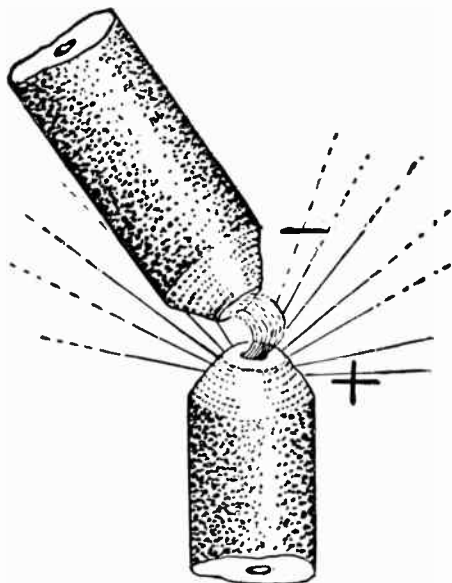

FIG. 3407.—Light distribution of alternating current arc. Case II, *upper carbon negative*. At this instant, during each cycle of the alternating current, a condition the reverse of that depicted in fig. 3,406 takes place, that is, the lower crater gives the greater amount of light.

Defective Carbons.—Occasionally a lamp which is properly adjusted cleaned and connected, will flicker badly or cease to burn entirely. In such cases the trouble is usually caused by defective carbons. The only remedy is to insert a new pair of carbon.

The interval of time allowable between two successive trims depends entirely upon the life of the carbons or other electrodes in the various types of lamp. A general idea of this value may be obtained from the foregoing descriptions of standard arc lamps.

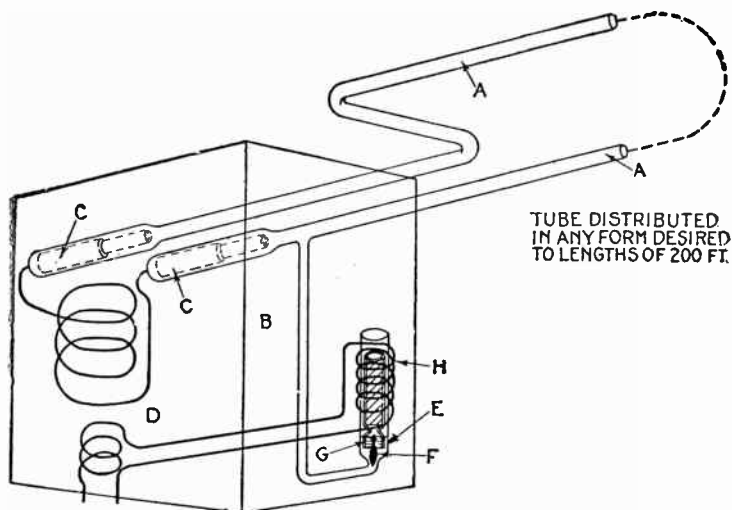

FIG. 3,408.—Diagram showing the arrangement of essential parts of the Moore vacuum tube lamp. The vacuum tube consists of a continuous glass tube A, $1\frac{1}{4}$ inch in diameter, and any desired length up to 200 feet supported near the ceiling by brackets and encircling the area to be lighted. This tube is made *in place* in the lengths from 6 to 8 feet, which are subsequently joined to form a continuous tube, by means of blow pipe joints. The ends of the tube are then brought to a steel box B, and large carbon electrodes C, C, are placed in each end and connected to the outside by platinum wire sealed in the glass. The completed tube is exhausted in position by means of a portable mechanical vacuum pump to a pressure claimed to be about .000367 lb., absolute per square inch. The necessary high tension current is obtained from a simple induction coil or transformer D, located in the steel box. Experiments with Geissler Tubes showed that as the rarefaction of the gas was steadily increased, the resistance of the tube increases until it becomes too great for the passage of the discharge at the working voltage, thereby destroying the luminous effect of the tube. This difficulty is overcome by means of a regulating valve F, consisting of a piece of $\frac{3}{8}$ -inch glass tubing supported vertically, with its lower end contracted to a $\frac{3}{8}$ -inch glass tube, which extend to the main lighting tube. A $\frac{1}{4}$ -inch carbon plug F, is cemented in the tube E at the point of contraction, and a sufficient quantity of mercury poured in to completely submerge it. The porosity of the plug is such that while it allows gases to percolate through it easily, it is not sufficient to allow the passage of the mercury. Within the tube E, partly immersed in the mercury and concentric with the carbon plug, there is another glass tube called the displacer. This tube is movable and its upper part carries a bundle of soft iron wires H, which form the transformer. In operating a vacuum tube for luminous phenomena, there is a critical point of rarefaction at which the conductivity is a maximum and the tube normally works at a point a little below this, therefore, as the rarefaction is increased, allowing current to flow through the solenoid, thereby lifting the displacer, the level of the mercury is lowered, and the tip of the carbon plug exposed. Immediately, a minute quantity of gas passes into the vacuum tube until the vacuum falls to the critical point and thus restores the condition of equilibrium mercury for the working voltage. If the regulating valve admit atmospheric air, (oxygen or nitrogen) the tube gives a rose colored light. If nitrogen alone be admitted the light is yellow, and when carbon dioxide is admitted it becomes a close imitation of daylight. The rose colored tubes consume 0.65 watt per candle power, and the white light tubes, about $1\frac{1}{4}$ watts per candle power.

Vacuum Tube Lamps.—The feasibility of employing vacuum tubes for purposes of illumination was described by Hauksbee in a treatise published about 200 years ago; but practical lamps of this class are among the most recent productions in the line of light givers, the Moore and Cooper-Hewitt lamps being commercially available only since 1903. Their peculiar characteristics may be best explained by descriptions of the lamps themselves.

Ques. Describe the Moore tube lamp.

Ans. The Moore tube lamp (shown in fig. 3,408) is the result

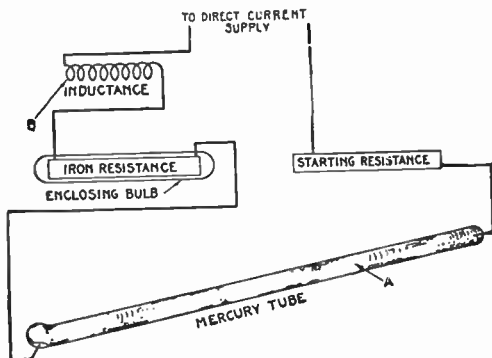

FIG. 3,409.—Connections of Cooper-Hewitt direct current mercury vapor lamp. It consists of a glass tube A, and a small set of inductance and resistance coils B, connected in series with the tube. The latter is made of special glass, and carries an iron electrode at its upper or positive end, and a mercury electrode at its negative or bulb end. These electrodes are connected with the outside by platinum wires sealed in the glass. The tubes for all lamps have a uniform diameter of 1 inch, but vary in length for different candle powers. At the present time they are made in lengths of 21 and 45 inches for candle powers of 300 and 700 respectively for the general groups of voltages around 110 and 220 volts respectively. Tubes can be adopted, however, for any commercial voltage, but the candle power will change slightly for different voltages. These tubes are exhausted and sealed, and only a small quantity of mercury is placed in the bulb at the negative end. The mercury tube has the peculiar characteristic that it experiences momentary increases of resistance which are of sufficient magnitude to break the continuity of the vapor arc. This peculiarity disappears, however, when the current strength is over 4 amperes, and with weaker currents when the negative electrode becomes heated. In the case of 3.5 ampere commercial lamp it has been found necessary to introduce inductance in series with the tube for the purpose of storing sufficient magnetic energy to oppose and overcome the tendency to reduce the current. It has been found that this effect of increasing resistance has a tendency to become cumulative, or in other words, if an inductance of a certain size be required to maintain the vapor arc or stream for a few seconds, a larger inductance would be necessary to maintain it for a few minutes or hours, and a still larger one to maintain it continuously. Approximately, a tenfold increase of inductance in the circuit increases the continuity of action about 1,800 times.

of the development of Geissler tubes for commercial purposes. Geissler tubes are sealed tubes of glass containing highly rarefied gases and provided with platinum electrodes which, usually, extend through the glass to a short distance beyond its interior surface.

Ques. Describe its operation.

Ans. When a static discharge of electricity is passed through a tube, luminous effects are produced, which vary with the degree

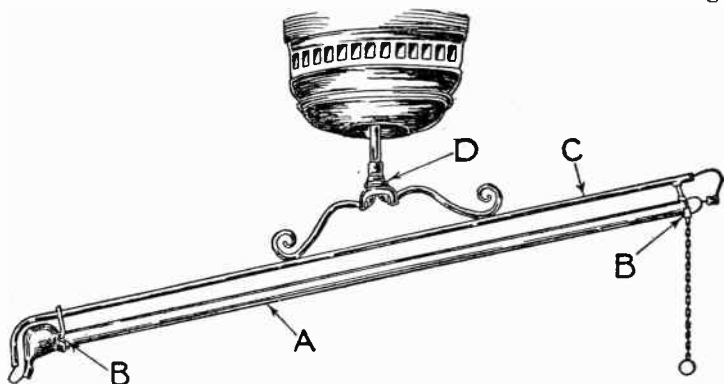

FIG. 3,410.—Cooper-Hewitt direct current lamp. The tube A is supported by two clamps B, B, attached to a lamp rod C fixed parallel to the tube and pivoted at D to the main stem which is screwed into the ceiling crowfoot. The inductance and resistance coils, etc., are also supported by the stem and covered by a metal canopy. In some cases a suitable reflector is attached to the lamp rod. To light the tube, it is tilted downwards by means of the chain attached to its positive end and the mercury allowed to flow in a small stream between the electrodes. The tube is then returned to its normal position, thereby breaking the circuit and starting the arc which puts the lamp in operation. In some forms of the lamp the act of tilting is accomplished by means of a solenoid attached to the stem at the pivot joint of the lamp rod. Since mercury is an electrode material with which the voltage required to maintain an arc is much less than the sparking voltage at the temperature of the arc, the direct current tube lamp cannot be used with alternating currents.

of exhaustion, the character of the gas in the tube, the character of the glass itself, or the solutions surrounding it.

Ques. What is the principal advantage of the Moore vacuum tube?

Ans. It gives a low intrinsic brilliancy, (about 12 candle power

per linear foot) which makes it easy on the eyes; it has a high efficiency and gives good diffusion of the light.

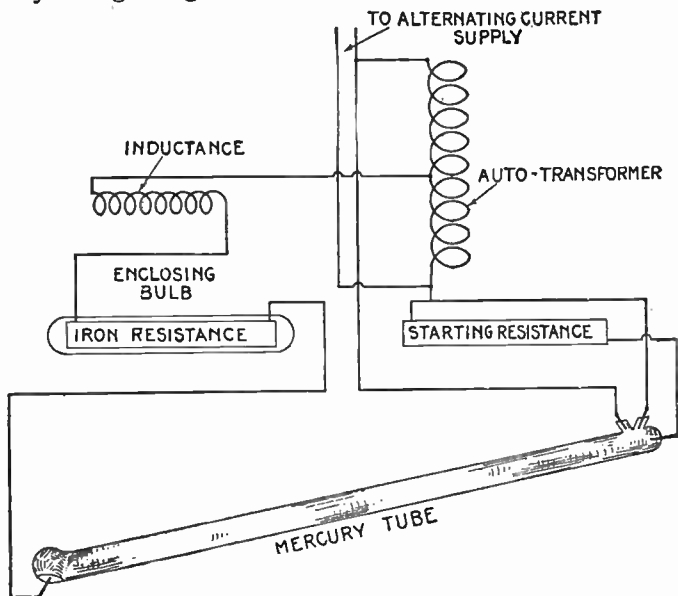

FIG. 3,411.—Connections of Cooper-Hewitt alternating current mercury vapor lamp. Its tube is similar in all respects to that of the direct current lamp, with the exception that the upper end carries two positive electrodes and one small starting electrode, the latter being connected through the starting resistance to one of the positive electrodes. The lamp is lighted by tilting the tube as described in fig. 3,410, and the mercury allowed to flow out of the bulb towards the positive end of the tube until it strikes the starting electrode. It will be noted that the arrangement of the positive electrodes in pockets on the upper side of the tube prevents the mercury coming in contact with them. Now, since the flow of mercury around the starting electrode is quite irregular, it makes and breaks the circuit, and if the resulting arc is started at such a point in the alternations of the current that the mercury column becomes the negative electrode in pockets on the arc will continue, alternately, between the mercury when the starting electrode is not connected. When the lamp has been restored to its normal position the resistance connected between the starting electrode and the temporarily inactive positive electrode is not permitted to be maintained on the former, but alternately on both of the positive electrodes. The candle power of the mercury vapor arc varies considerably with variations of voltage. This difficulty is overcome by including in the circuit a ballast or resistance quite similar to that employed with the Nernst lamp. It consists of an iron wire wound on a porcelain pencil, and the whole sealed in a glass tube through which the terminals are brought out. The resistance of iron is greatly increased by the passage through it of a relatively small current; the ballast is worked at temperature of at least 900 degrees Fahr. This resistance coil is placed in series with the arc and is so designed that a slight decrease of current causes a decrease in the volts drop across the terminals of the coil that the remainder of the voltage impressed on the lamp remains more nearly constant.

Ques. What are the disadvantages?

Ans. Incomplete elimination of shadows; difficulties of repair; high initial cost, and lack of flexibility.

Ques. What are the features of the Cooper-Hewitt mercury vapor lamp?

Ans. It is extensively used in various industrial and commercial plants where large candle powers, a low operating cost, and

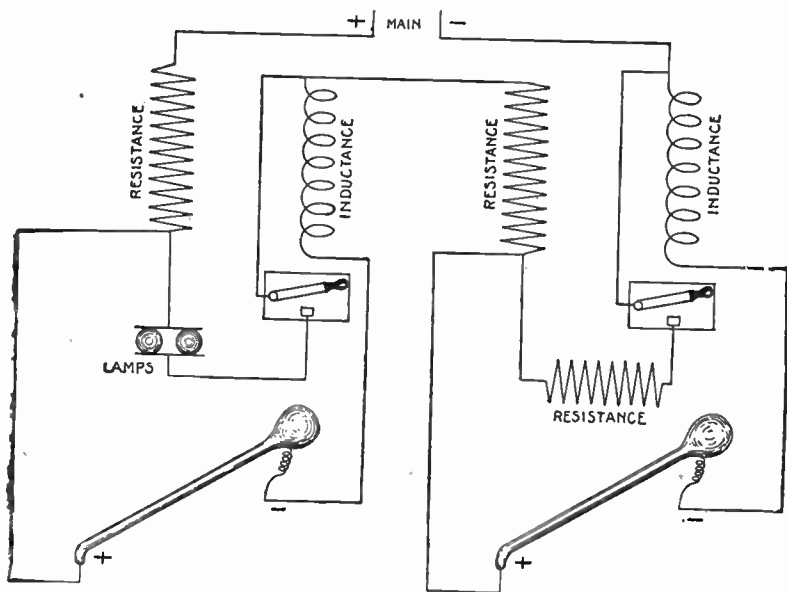

FIG. 3,412.—Diagram illustrating the method of operating Cooper-Hewitt lamps in series.

a tubular form with low intrinsic brilliancy and good diffusion are more important than the natural color value of illumination. It has been observed that those who have never worked under the light of this lamp are the strongest objectors to its green

color, but those who have used it for various purposes assert that the eyes apparently are less fatigued by it when applied to fine work than by those illuminants which yield more of the red rays.

The lamps are of very high efficiency, the watts consumed per candle power being about one-half that of open arcs, one-third that of enclosed arcs, and one-sixth of the ordinary carbon filament incandescent lamps. The life of the tubes is about 5,000 hours.

The first cost of the tubes is high, varying from one-half to twice that of other forms of electric lighting, but it is claimed by the makers that the economy attained in the reduced operating cost will be sufficient to counterbalance the entire cost of installation of considerable size.

Incandescent Electric Lamps.—In an incandescent electric lamp the light is produced by passing a current of electricity through a continuous conductor having a high resistance, the current employed being sufficiently strong to raise the temperature of the conductor to the point of incandescence.

In construction, a slender filament of some conducting refractory material is enclosed in a glass chamber and connected to lead wires fused through the base of the chamber or "bulb." The bulb is exhausted of air as completely as possible and the exhaustion duct sealed. The object of placing the filament

*NOTE.—In the earlier lamps made by Edison the conductor consisted of platinum in the form of a *filament* or loop of wire. The high cost of platinum proved a serious objection and led to the substitution of carbon in the form of filament of carbonized bamboo. Subsequently, other manufacturers employed, thin strips of cardboard and other organic substances which were carbonized by heat. Further progress in this direction led to the manufacture of the "squirted filament." This was produced by dissolving cotton in a solution of zinc chloride. The gelatinous material thus obtained was forced or squirted through a small orifice into a vessel containing alcohol, which caused it to set and harden sufficiently for subsequent handling and washing. After washing, this product, resembling cooked vermicelli, was wound upon a large drum and dried until it looked somewhat like cat gut string, and like it, possessed considerable strength. In this form it was cut up into lengths suitable for filaments and carbonized at a high temperature. The great superiority of the squirted filament over that of carbonized bamboo or other solid organic material lies in the fact that it is perfectly homogeneous, it can be made easily and accurately of any desired length and cross section, and it carbonized at such a high temperature that it more nearly resembles a metal in the behavior of its electrical resistance at different temperatures. On account of these quantities, there is a general tendency at the present time to use them universally in preference to any other form of carbon filament.

in a vacuum is to prevent oxidation. The various types of incandescent lamp may be classed as

1. Carbon filament lamps;
 - a. Plain carbon;
 - b. Treated carbon.
2. Metallized carbon filament lamps.
3. Non-carbon filament lamps;
 - a. Osmium;
 - b. Tantalum;
 - c. Tungsten;
 - d. Iridium.

The incandescent lamp is perhaps simpler than any other type of electric lamp and its general construction is shown in figs. 3,413 to 3,415.

Ques. What is the object of exhausting the air for an incandescent lamp bulb?

Ans. The chief object is to prevent the rapid oxidation or combustion of the filament.

It is evident that if the filament were heated to incandescence in air, the oxygen in the latter would combine with the carbon of the filament, cause its combustion, and result in its complete destruction. Furthermore, the vacuum reduces the wear on the filament due to air washing; diminishes the loss of heat from the filament, and decreases the flow of current in the space around the filament, commonly known as the "Edison effect." These facts serve to explain the reason why the temperature of an ordinary incandescent bulb is only about 150 degrees, while that of the incandescent filament is about 2,900 degrees Fahr.

In spite of all these precautions it is a fact, however, that the intense heat at which the lamp is worked results in the slow but certain destruction of the filament. This is not to any extent due to the combustion as the vacuum generally attained is very nearly perfect, instead, the destruction appears to be due to a disintegration of the filament by some unknown process, with the result that particles of carbons are deposited on the interior surface of the bulb, causing a gradual blackening of the bulb.

Ques. What is the peculiarity about the resistance of a carbon filament?

Ans. Its resistance *decreases* very rapidly with an increase in temperature up to the point when it begins to redden; from this point to that of white heat its resistance continues to decrease, but at a slower rate.

This is just the reverse of the behavior of almost all other conductors of electricity. The ordinary carbon filament when raised to its working temperature has about one-half the resistance that it has when cold. It is obvious that the working is the more important value, and is the one that determines the current and power that the lamp will consume at a given voltage.

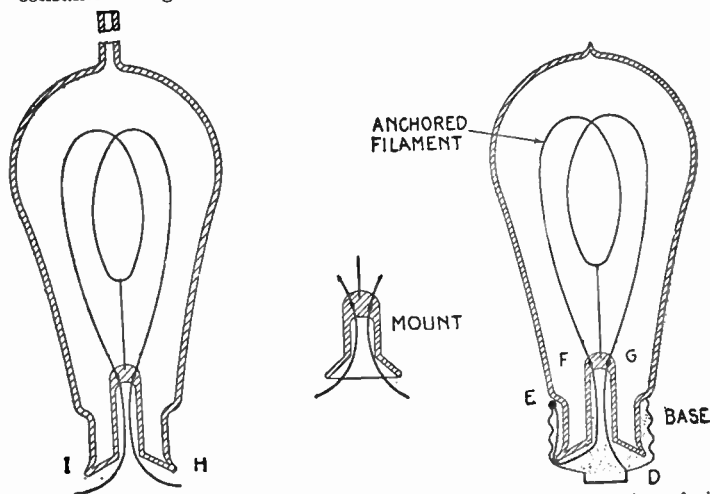

FIGS. 3.413 TO 3.415.—Construction details of incandescent lamp. It consists of closed glass bulb, containing a carbon filament, and having two terminals D and E on the outside to which the filament is connected by the *leading in wires* F and G, of platinum which pass through the glass, which is sealed around the wires. Fig. 3.414 shows the stump of glass into which the leading in wires are sealed, and which ultimately becomes the enclosing part of the neck of the bulb; fig. 3.413 shows the bulb ready to have the air exhausted, and fig. 3.415 the complete lamp and base. Platinum being very expensive, even the small amount required for the leading in wires of an incandescent lamp becomes an item of considerable magnitude in their cost, therefore, for economy the greater portion of the lengths, such as H and I of the leading in wires are composed of copper, platinum being employed only where they pass through the stump of glass in the mount. The leading in wires are made of platinum because that metal has the same coefficient of expansion by heat as that of glass. If the coefficient of expansion of the wires were higher than that of glass, they would expand more than the glass when heated and crack it, thereby letting in the air; while on the other hand if their coefficient of expansion were lower than that of the glass, the latter would expand more than the wire, and allow the air to leak into the bulb around the wires. The air thus admitted would cause the combustion of the filament.

The following table gives approximate values of the relations between volts, watts, and candle power for 16 candle power carbon filaments requiring normally 3.1 and 3.5 watts per candle power respectively, at a normal or working pressure of 100 volts.

Table showing effect of voltages lower and higher than that for which an incandescent lamp is intended, upon the candle power, watts consumed, and the life of the filament.

Voltage at terminals of filament	Candle power	Watts		Per cent. of normal life	
		3.1	3.5	3.1	3.5
96	12.6	45.5	51.7	220	247
97	13.4	46.5	52.7	179	195
98	14.2	47.5	53.8	146	153
99	15.1	48.5	54.9	121	126
100	16	49.6	56	100	100
101	16.9	50.7	57.2	82	84
102	17.9	51.7	58.4	68	70
103	18.9	52.7	59.5	56	58
104	19.9	53.6	60.5	45	47
105	20.8	54.5	61.4	37	39

For example: if a 3.1 watt, 16 c.p. lamp intended for a normal pressure of 100 volts, be operated at 105 volts or an excess voltage of 5 per cent., it will give 20.8 candle power or about 30 per cent. more candle

NOTE.—The size of the filament of an incandescent lamp must be such as to satisfy the two following conditions: 1, its resistance must be such that it will take the proper current and power at the voltage for which it is designed, 2, the power lost by the filament in the form of heat radiated from it at the working temperature should exactly balance the power supplied. Filaments may be either rectangular, elliptical, or circular in cross section. Usually, they are circular or slightly elliptical, and their actual sizes depend to a great extent upon the proportion of carbon deposited. The specific resistance of carbon is about .12 to .16 that of the untreated filament, therefore the diameter is increased, usually, about 10 to 20 per cent. by the carbon deposit. The diameter of a filament depends solely upon the current to be carried, therefore the diameter of the filament of a 200 volt lamp should have about one-half the cross section of that of a 110 volt lamp of the same candle power, since the former takes only one-half as much current at twice the voltage in order to consume the same number of watt per candle power, as the latter. Since the hot resistance of a filament increases directly with its length, the voltage required between the terminals of a filament is directly proportional to its length, therefore the filament of a 220 volt lamp, should be twice the length of that of a 110 volt lamp. A 220 volt lamp can be made, however, by doubling the length of a 110 volt filament. In this case the current will be the same in both, but the 220 volt lamp will consume twice the number of watt, and as the candle power is directly proportional to the watts, it will give twice the candle power of the 110 volt lamp.

power for an increase of about 10 per cent. of electrical power. The lamp will have a higher efficiency, the watts being reduced to 2.6 per candle; but its life will be shortened 63 per cent. or to $450 + .63 = 283$ hours. This great reduction of the life is the principle condition which operates against any attempt to obtain abnormally high efficiency.

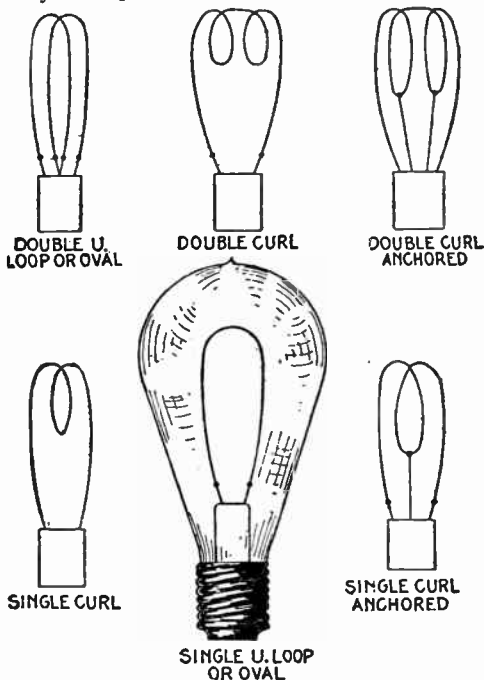

Figs. 3,416 to 3,421.—Forms of incandescent lamp filament. The standard filament is one that gives an average illumination of 16 candle power at right angles with the axis of the lamp from a very reliable spirit lamp. The 16 candle power 110 volt lamp consumes about one-half ampere and has a resistance of about 220 ohms. A filament having this resistance and sufficient cross section for mechanical strength, should be 8 or 9 inches in length. In the earlier lamps this filament was made in the shape of an U (fig. 3,420), but its excessive length which not only caused it to droop, thereby requiring a large bulb, also gave a poor distribution of light and various other forms of filament, such as those here shown were almost universally adopted. The curl forms are common in lamps for 100 to 125 volts and from 8 to 50 candle power. The U forms are generally used for large lamps from 100 to 300 candle power. In these cases the cross section of the filament is much greater as the current in a 100 candle power lamp is about six times greater than that in a 16 candle power lamp at the same voltage. Anchored filaments are used, when, owing to their length on account of the form of the bulb, the filament is liable to touch the glass and crack it, resulting in the destruction of the filaments by combustion. Anchored filaments are almost a necessity in the case of long tubular bulbs.

The reason why a 5 per cent. increase in voltage produces a 10 per cent. increase in watts is due to the fact that the resistance of a carbon filament decreases with an increase in its temperature. It will be understood, however, that the temperature does not increase directly with the current, and that the resistance does not decrease in proportion to the increase in temperature for if they did, a carbon filament incandescent lamp would be a physical impossibility.

High Voltage Incandescent Lamps.—The use of high voltage lamps operating at 200 to 250 volts is very extensive at the present time. Prior to 1901, such lamps were limited to low efficiency, averaging 4 watts per candle power, and had a useful life about 50 per cent. longer than the 100 volt 3.1 watt lamp. They required, however, about 20 per cent. more power in station capacity for the same output, an important feature, which proved a great drawback to their use for some length of time. The superior distributing advantages of the 200 volt system, however, created a great demand for these lamps, and great efforts were made by the various lamp manufacturers to improve their efficiency. These efforts resulted in the production of 250 volt lamps having an initial consumption of 3.4 watts per candle power for the 16 c.p. and 20 c.p. lamps, while 3.1 watts per candle for higher candle powers are now made, which have an average useful life as good as that of the 100 volt 3.1 watt lamps, which is equal to about 450 hours.

NOTE.—It is well known that high efficiency lamps are preferable for central station service, since their use secures a greater capacity of machinery and conductors, and a lower cost of light production. The 3.5 watt lamp has a useful life of about 400 hours. Therefore, in order to secure the lighting service rendered by one 3.5 watt lamp it is necessary to use two 3.1 watt lamps; but the latter saves about 0.4 watts per hour in power consumption, or a total saving of 5,120 watts for a period of 800 hours. This saving must be compared however, with the cost of an additional lamp. Assuming the price of the additional lamp at 18c., the figure per kilowatt hour at which the cost of the two lamps is equal (18 cents divided by 5.12 kilowatts) is 3½ cents per kilowatt hour. Below this figure the 3.5 watt lamp is cheaper; but above it the 3.1 watt lamp is cheaper. Furthermore, the 3.1 watt lamp has the advantage of compelling timely renewals by burning out a comparatively short time after the end of the period of useful life. According to the experience of the Lamp Testing Bureau, in the majority of the 3.1 watt lamps, which were allowed to continue to burn after the candle power had diminished to 80 per cent. of the rated candle power, the filaments broke after burning about 500 to 600 hours. Other advantages of the 3.1 watt or high efficiency lamp over the low efficiency lamp are, its greater brilliancy and whiteness; it is more attractive in appearance; and its higher temperature increases the power of its light to bring out colors, thus making it more suitable than the low efficiency lamp for the illumination of show windows, stores, picture galleries and most branches of modern lighting.

Varieties of Incandescent Lamp.—Incandescent lamps are made in a great variety of form, differing from each other in voltage, candle power, size, shape and color of bulb, and type of base.

The standard voltages are 50 to 60, 100 to 120 and 200 to 240, for central station isolated plant, and general illumination. The standard sizes supplied for each voltage are 8, 16, 24, 32, 50, and 100 candle power, but other sizes are used very extensively. The general list

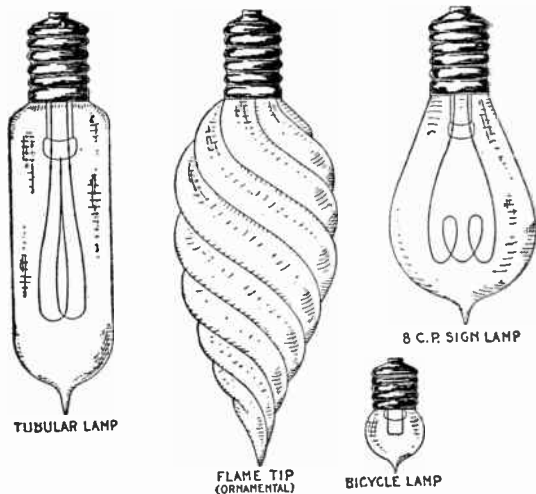

FIGS. 3,422 to 3,425.—Various forms of incandescent lamp. Fig. 3,422, tubular or elongated bulb lamp; fig. 3,423, ornamental flame tip; fig. 3,424, sign lamp; fig. 3,425, bicycle lamp.

includes a great variety of low voltage lamp. These range from 3 to 12 volts and are operated from storage or primary batteries. Some of the smallest lamps are the *bicycle lamp* consuming 5 amperes at 4 volts and giving 3.4 candle power and the surgical lamp which requires 1 ampere at 3 volts and gives one-half candle power.

Figs. 3,422 to 3,425 show several special forms of lamp and figs. 3,426 to 3,433 various forms of base.

Metallized Carbon or Gem Lamps.—The so called metallizing process as applied to carbon filaments consists in heating

the filaments to a very high temperature both before and after flashing, using a carbon tube electric furnace for the purpose.

The term *metallized* is applied on account of the positive temperature coefficient which the filaments acquire in the process. The useful life of the metallized filament lamps at $2\frac{1}{2}$ watts per candle is said to be the same as that of the ordinary carbon lamp at 3.1 watts per candle.

Metallized filaments have been applied with satisfactory results to series incandescent lamps used for street lighting. They are made for 1.75, 3, 3.5, 5.5, and 6.6 amperes and candle power generally of 25, 30, 40 or 50. The lamps of the smaller amperages are of decidedly the better quality.

Treated Carbon Lamps.—A lamp filament under the name of “helion” for which great claims are made has been produced in this country. Its exact composition has not been made public, but it is known that it is silicon or compound thereof on a carbon base. It is produced by “treating” a carbon filament with a volatile silicon compound instead of the usual hydrocarbon. However this may be, the material has the very curious property of apparently having a temperature of maximum efficiency at an approximate temperature of $3,270^{\circ}$ Fahr. Beyond this the light does not increase and added energy apparently must go into the production of physical or chemical change. The temperature coefficient at first negative, becomes positive at about $2,475^{\circ}$, and then as the critical temperature is approached becomes again negative.

The radiation from a helion filament is claimed to be somewhat selective so that a high efficiency is given at a relatively low temperature. To what extent this condition exists and whether it appear to a material degree at a low enough temperature to be useful remains to be determined. The interesting and promising feature of this lamp is that it opens the way to a new class of incandescent body more likely to have high specific resistance than true metals, and hence more likely to yield filaments of moderate length and conservative cross section. The Helion lamp after several years' of experimentation is not yet made commercially.

Osmium Lamps.—Osmium is a rare metal which appears as a by-product of the platinum industry. It is far from possessing typical metallic properties, being a strong acid forming element obtainable only in the form of a blackish powder. It has, however, a very high melting point, and when formed into a filament by the process of union with a suitable binding material, squirting and heating, it possesses considerable endurance.

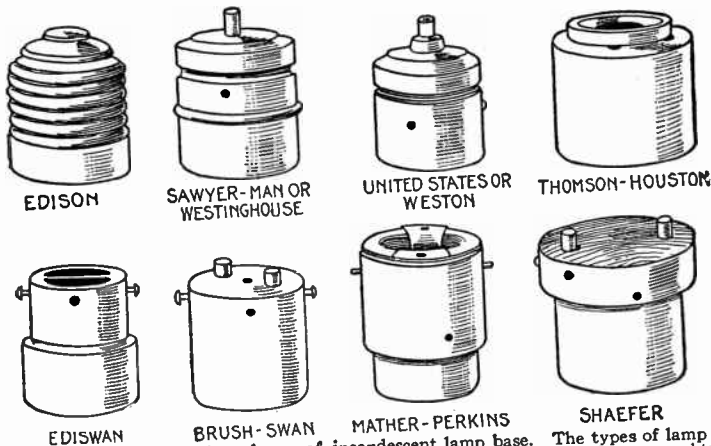

Figs. 3,426 to 3,433.—Various forms of incandescent lamp base. The types of lamp base used, varies among the different makes, but all may be classified into three general types: the screw, the clip, and the bayonet bases. The Edison or the screw type is the one most commonly used in this country. Its principal advantages are simplicity, reliability, and cheapness, also its capability of permitting the lamp to be lighted or extinguished by simply screwing it in or out about one turn, an advantage not possessed by the other types. It is provided with contact points similar to the Edison, but the lamp is held in place in the socket by means of spring clips which press against it on all sides. The Edison and other swan bases are of the bayonet type. They are provided with small pins on the sides which fit into corresponding slots in the sockets. After being inserted, they are turned slightly around and thus securely locked in place.

As with other metallic filaments its low specific resistance makes the production of lamps of low candle power or high voltage very difficult and the commercial 16 candle power Osmium lamps have usually been for 40 to 55 volts, being adapted to burn two or three in series on ordinary circuits. The specific consumption is about 1.5 watts per m. h. c. p., and the light is very white and brilliant as compared with ordinary incandescents. Life of lamp at this efficiency about 1,000 hours.

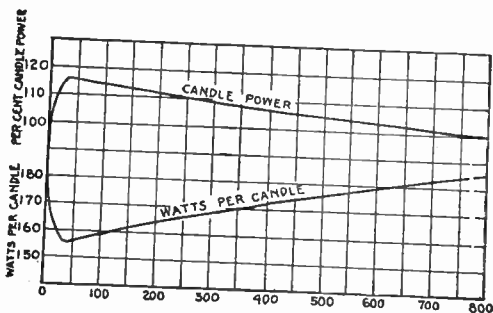
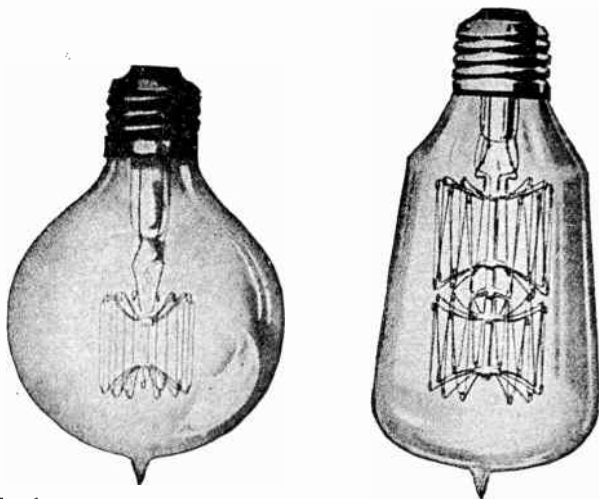

FIG. 3,434.—Life curves of tantalum lamps. These lamps operate at about two watts per mean horizontal candle power, or 5 lumens per watt. From the curve in it will be noted that for a large portion of the life of the lamp, the efficiency is even higher than at the beginning.



FIGS. 3,435 and 3,436.—Tantalum lamps. Fig. 3,435, round bulb 25 watt, 100–125 volt lamp; fig. 3,436 elongated bulb 50 watt, 220–250 volt lamp. The Tantalum lamp burns in any position and in ordinary lighting causes little or no trouble due to the strands of the filament touching and welding. This makes a rugged lamp which has proved well adapted for use under the severe conditions of shop, mill, steamship and train-lighting service. As regularly shipped, tantalum multiple lamps are selected for the specified voltage. However, if it be desired to burn lamps in series, a special selection can be made.

When hot, the filament is very plastic, so that the lamp must be burned tip downward to prevent the three loops which usually form the filament touching and short circuiting, which they will do in spite of anchor hooks. If the loops touch, they do not weld together as in the case of most other metallic filaments, but the lamp soon blackens almost as it would do with an over-run carbon filament.

The extreme rarity of the material, and the inconvenience just noted have prevented this interesting lamp coming into anything more than tentative use and it is doomed to be superseded by later and cheaper forms of metallic filament lamps.

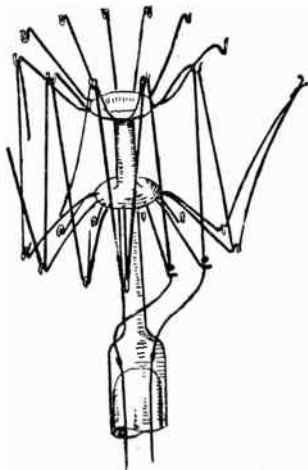

FIG. 3,437.—Tantalum filament which has been renewed. The tantalum lamp is not necessarily worthless as a lamp when the filament is broken or burned out. The wires often come in contact or can be brought into contact by jarring, thereby immediately welding them and reestablishing a circuit. Such a renewal may be accompanied by an increase in candle power. The figure represents the filament of a lamp which has been burned out several times. For clearness the back spans of the filament have been omitted.

Tantalum Lamps.—The filament used in the manufacture of tantalum lamps is composed of the metal tantalum drawn into a fine wire. This wire is wound back and forth over a supporting framework which is fastened to the stem of the lamp as shown in the lamp cuts.

In the lamps designed for 250 volts, there are used 25 and 40 watt filaments, twice as long as those in the 100-125 volt lamps. The wire is wound on two spiders, one above the other, as may be seen in the cut.



FIGS. 3,438 to 3,440.—Behavior of tantalum filament. Fig. 3,438, unburned tantalum filament; fig. 3,439 tantalum filament after burning 1,058 hours on direct current; fig. 3,440, tantalum filament after burning 800 hours on alternating current. The new filament is smooth and without regular structure, while after burning for some time, it begins to take on a crystalline appearance. This change takes place less rapidly with direct than with alternating current, so that the life of the lamp is somewhat greater in the former case. When the filament finally burns out, it is supposed to be due to the change from the amorphous to the crystalline state, as indicated in the illustrations.

Pure tantalum as used in the manufacture of incandescent lamps is very ductile and has a high tensile strength, equal, in fact, to that of mild steel.

Ques. What should be considered in the selection of tantalum lamps, and why?

Ans. Where the exigencies of the case demand, the location of units within the field of vision, either bowl frosted or all frosted lamps should be used. This is necessary in order to protect the eye from the unpleasant and harmful effects of exposure to the relatively high intrinsic brilliancy, or candle power per square inch, of the tantalum filament.

Tungsten Lamps.—Tungsten is a somewhat scarce metal of the chromium group, somewhat used for hardening steel, especially steel for permanent magnets. It is fusible only at the highest temperatures of the electric furnace and has in fact only recently and with extreme difficulty been obtained as a true metallic mass. It is thus far practically unworkable as a metal and appears only as a black powder which is somewhat unmanageable.

Ques. How is tungsten formed into a filament?

Ans. The Kuzel process, one of the earliest, consists in forming a colloidal solution of the metal by maintaining an electric arc between tungsten terminals under water. This solution is then brought to a pasty consistency and squirted into a filament which is afterward treated by heating with the electric current.*

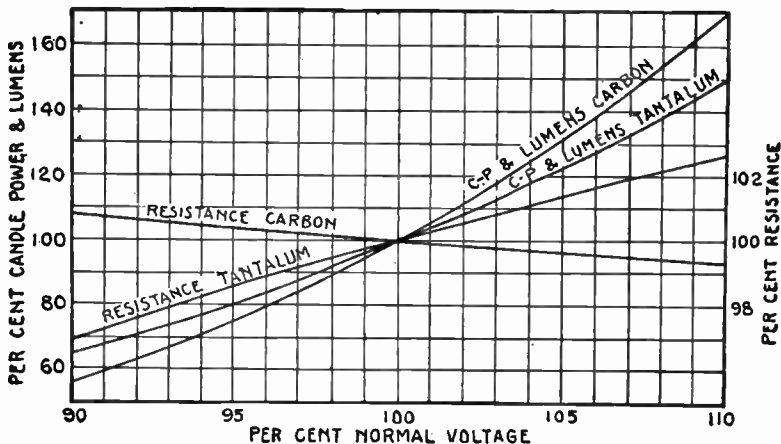

FIG. 3,441.—Performance curves of tantalum lamps. The tantalum lamp operates at a higher temperature (due to its high melting point and low vapor tension) than either the carbon or gem filament lamp, and consequently produces a light which has a color value nearer that of daylight. Lamps are frequently burned on circuits which are subject to appreciable fluctuations in voltage. In consideration of this fact, one should choose lamps which are not seriously affected by slight changes in voltage. The curves here shown indicate that the candle power of a tantalum lamp is less affected by a variation in voltage than that of a carbon lamp. This is due to the fact that tantalum has a positive and carbon a negative temperature coefficient of resistance, so that a change in voltage (which is accompanied by a similar change in temperature) causes a greater variation in the current of a carbon than of a tantalum lamp. Although there is a slight saving in total cost by operating tantalum lamps on *middle* or *bottom* voltage for low rates of power, it is usually advisable to burn them on *top* voltage on account of the increased intensity and better quality of light. In ordering tantalum lamps always give the voltage of the circuit on which the lamps are to be used and also (except in the case of 200–250 volt lamps) specify whether it be desired to burn them at “top,” “middle” or “bottom” voltage. When this is not specified, “top” voltage lamps will always be shipped.

*NOTE.—Several other processes are in use, some of them secret, but they all depend on the agglomeration of very finely divided tungsten into a filamentary form, and so far as is known nothing approaching very remotely a metallic tungsten wire has yet been commercially produced although true wire has been made experimentally. It is therefore extremely difficult to get a tungsten filament of good mechanical properties especially since the specific resistance of the material is low enough to necessitate a filament of extreme tenuity for use on ordinary circuits.

Ques. Mention some of the features of tungsten.

Ans. Tungsten has such a high melting point (about 5,792° Fahr.) that when it has been worked into filaments, the lamps so produced can be operated at very high efficiencies. A tungsten filament will weld itself after a break, though with very uncertain strength. It will however weld itself instantly to the glass of the bulb or support, generally without breakage, and since it is extremely plastic when hot the lamp is best used tip downward, although the present commercial tungsten lamps may be and are burned in any position at some added risk of shortened life.

The most favorable condition of operation is at about $1\frac{1}{4}$ watts per candle, which is the point most commonly selected by makers in this country. Even at this low value the rate of deterioration in candle power and efficiency is very slow until near the end of the life when it may become very rapid.

Ques. What difficulty is experienced because of the high conductivity of tungsten?

Ans. This renders it impracticable to make 100 volt lamps of lower than 25 candle power, but tungsten lends itself admirably to the construction of heavy current low voltage lamps for use in series on constant current street lighting circuits.

For 110 volt circuits the tungsten lamps are commonly of 20 to 40 candle power or more and even so the filament formed in four long independently anchored loops is scarcely .002 inch in diameter. Thus

NOTE.—The present standard American tungsten lamps are rated at 25, 40, 60 and 100 watts and at 125 watts per mean horizontal candle power. Their average useful life at this initial figure is not far from 800 hours and it is not uncommon to find lamps enduring 2,000 hours or more, although, on the other hand, early blackening and breakage is not uncommon. Some large lamps of 250 watts and upwards are in use. The usual voltage is 100–125, although the larger sizes are made also for the 200–250 volt circuits, and a good many lamps of 30–36 volts are made for use with special transforming devices. These low voltage lamps are less fragile than the others and may be had in smaller candle powers. Tungsten lamps can readily be made in the large units of 100 to 200 candle power that are needed to replace the smaller arcs, and as a series lamp for street lighting, in both of which functions it is proving very valuable. Its efficiency is so much better than that of the tantalum lamp as to suggest that the latter can survive if at all only in small units. The tungsten lamp can be used on alternating circuits with success. Its life on alternating circuits seems to be unimpaired and the effect found in tantalum is happily absent in tungsten.

far they have proved to be fragile and the filament is quite likely to be broken in shipment or in ordinary handling. But the efficiency is great so that extraordinary efforts are being made to improve the manufacture.

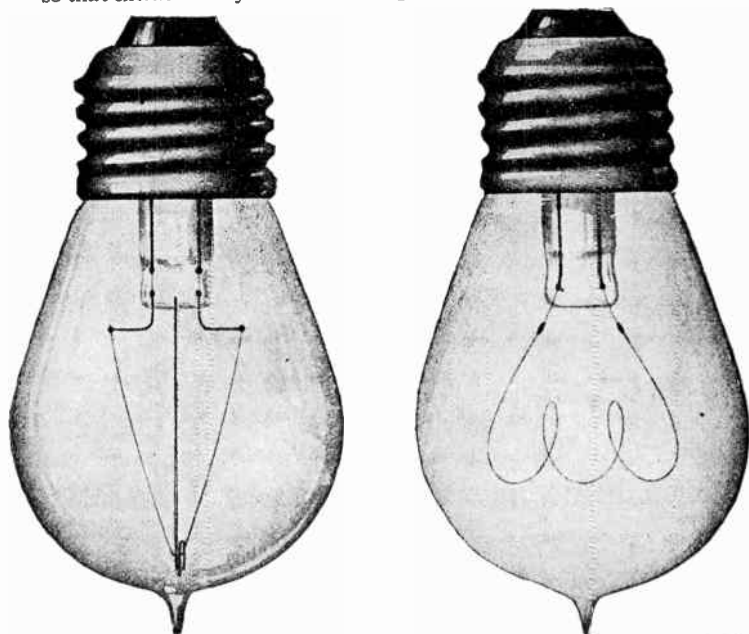

FIGS. 3,442 and 3,443.—Incandescent lamps for electric sign lighting. Fig. 3,442, "Mazda" sign lamp; fig. 3,443, carbon sign lamp. The Mazda sign lamp consists of substantial V-shaped tungsten filament, mounted in the regular sign lamp bulb. It burns at an efficiency of 1.31 watts per candle with a total power consumption of 5 watts. Its rated life is 2,000 hours. The results obtained in actual service show this average rating to be conservative. On flashed signs, some of the lamps may burn for longer periods than others, and it is to be expected that these lamps will have to be renewed before the others. Other factors which affect the life of the lamp are: 1, the voltage drop in the sign wiring, which varies with the distance of the lamp from the feeding point, and 2, the regulation of the transformer, which determines the excess voltage to which the first lamps lighted are subjected. On all signs burn-outs should be replaced promptly. Nothing detracts so much from the favorable appearance of a sign as burned out lamps. It is claimed that for all energy costs above eight cents per kw. hour, the Mazda lamp is less expensive to operate than the equivalent carbon lamp.

Iridium Lamps.—A lamp with a filament prepared from finely divided iridium has also been tried, but the rarity and high cost of this metal which like osmium is a by-product of the

platinum industry, would seem to forbid its commercial use. Its specific consumption is about the same as that of the others just described.

“Turn Down” Incandescent Lamps.—These are designed to satisfy conditions where it is advantageous or necessary

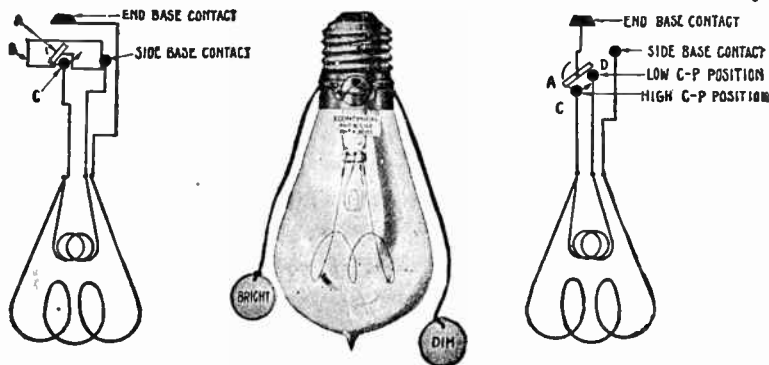

FIGS. 3,444 to 3,446.—Hylo turn down incandescent lamps. Owing to the difficulty of manufacturing a mechanically strong one or one-half candle power filament for direct operation on voltages as high as 110, the two filaments are connected in series for the dim light. The drop over the large filament is approximately 20% of the voltage across the lamp. The wattage consumed in each filament is of course proportional to the voltage drop across each, and the “apparent” watts per candle of the small filament is therefore numerically increased. Nevertheless, the ratio of total watts consumed by the lamp on the high and low candle power steps respectively, is about 6 to 1. The full candle power of the lamp is obtained by operating a switching device which either short circuits or open circuits the small filament. In type No. 1 lamp, figs. 3,444 and 3,445, the switch consists of a pivoted metal segment A (attached to the base B), which may be rotated slightly by means of the cords so as to touch an auxiliary contact C, thus short circuiting the small filament and lighting the high candle power filament. By shifting the segment off the contact C both filaments are in series, but only the small filament is lighted. The cords operate only to change the candle power from high to low, or vice-versa, and in order to put out the lamp the key or switch should be used. In type No. 7 lamp, shown in diagram only, fig. 3,446, there is a switch A concealed in the base, which provides three changes in candle power; namely, 16, 1, and out, all obtained by operating the string alone. This switch is pivoted at its center B, and the lamp circuit is completed when connection is made at either of the contacts C or D. The switch makes contact at only one of these points at a time. When connection is made at D both filaments operate in series and the small filament is lighted. When the switch is pulled over to C the small filament is open circuited and the high candle power filament burns alone. By pulling the switch clear of both C and D, the lamp is put out.

to vary the amount of light, or diminish it temporarily or permanently. Ordinarily this may be accomplished in several ways, as:

1. By double filament;
2. By inserting resistance in direct current circuit;
3. By inserting inductance in alternating current circuit;
4. With suitable shades, globes, reflectors, etc.

Ques. Describe the two filament arrangement.

Ans. The bulb is provided with a high and a low candle power filament which are arranged with a controlling switch so that either may be used separately, in parallel, or series, etc., thus obtaining various candle powers.

Ques. In the other methods, how is the resistance placed?

Ans. It is placed in a special socket and controlled by a key or pull.

The Nernst Lamp.—This lamp is the invention of Professor Walther Nernst, of Göttingen. In it the light giving body or "glower" consists of a short strip of material composed of a mixture of oxides of magnesium, zirconium, thorium, or cerium which is an insulator at ordinary temperatures but becomes a fairly good conductor when its temperature is raised to about 1,750° Fahr. Since the material of the glower is not combustible, it is not necessary to enclose it in a vacuum. These lamps are made in two types, the automatic and the non-automatic, either of which may carry one, two, three, six or thirty glowers, giving from 25 to 2,000 candle power with a power consumption of 1.5 to 2 watts per candle.

The action of the automatic lamp is diagrammatically shown in fig. 3,447.

In the non-automatic lamp the preliminary heating of the glower prior to lighting is accomplished, usually, by means of a match. Both forms of lamp are usually provided with globes, a closed, but not

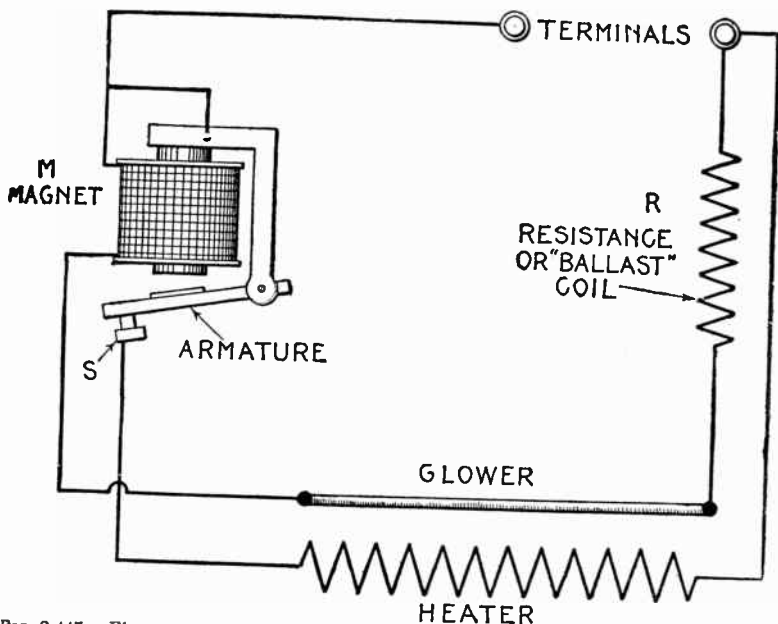

FIG. 3,447.—Elementary diagram of Nernst lamp. The light producing part of this lamp consists of a glower with an insulator of electricity at ordinary temperature and therefore necessitates the employment of some means to raise its temperature up to a point at which it will become a conductor. This is accomplished by means of a heater coil of fine platinum wire wound on a thin porcelain tube and embedded in cement to protect it from the intense heat of the glower when the latter becomes white hot by the passage of the current. The glower and the heater coil are connected in parallel in operation, and when the lamp is thrown into circuit for lighting, the current flows through the heater coil and raises its temperature to such a degree that the latter, in about 20 seconds, heats the glower to the conducting point. The current now passes through the glower and, raising its temperature to a white heat, makes it luminous. At this moment a sufficient amount of current passes through the glower to make it begin to light. The magnet M, which is in series with the glower is energized strongly enough to attract its armature A, thereby breaking contact with the screw S and throwing the heater coil out of circuit while the glower is left in circuit. Whenever the lamp is turned off by opening the circuit, the armature falls back by gravity into the position shown in readiness for action when it is necessary to relight the lamp. Since the resistance of the material of the glower decreases as its temperature increases, it is necessary to provide some means to prevent the resistance falling to a point at which a considerable current would flow and destroy the glower and its connections. This is accomplished by inserting a resistance coil in series with the glower. This resistance called "ballast" consists of iron wire which increases in resistance as its temperature increases, and thus compensates for the decrease in the resistance of the glower. It is evident that in consequence of the high temperature coefficient of iron, a point is soon reached, in this matter of compensation, at which any increase of current would increase the resistance of the ballast more than it would decrease the resistance of the glower, and since the lamp is invariably used on a constant pressure circuit, no increase of current can occur when this condition is reached.

necessarily air tight globe for the automatic, and an open globe for the non-automatic lamp, the opening in the latter facilitates the lighting of the lamp with a match.

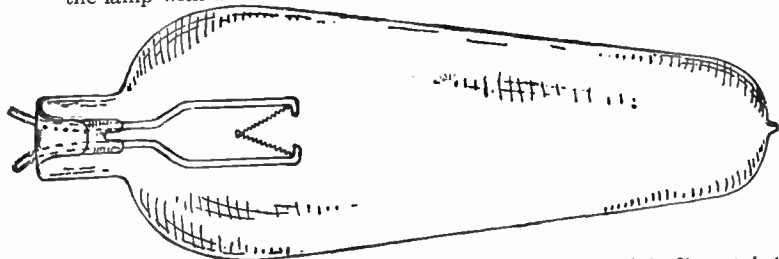

FIG. 3,448.—Nitrogen filled lamp. Tungsten lamps fail not by breaking of the filament, but by reduction in light giving value due to blackening of the inner globe surface. With attempts to increase efficiency of lamp operation, this blackening process has been found to be greatly accelerated, thus heretofore placing a limit on the consumption efficiencies obtainable consistent with reasonable lamp life. Such blackening has generally been attributed to disintegration of the filament caused by traces of residual gas in the bulb, although in the case of lamps run at over-voltage evaporation of the filament was assigned as the cause. From analysis of possible sources of gas within lamp bulbs, the following gases were found by the investigators: water vapor, carbon dioxide, carbon monoxide, hydrogen, nitrogen and hydrocarbon vapors. Further tests showed that water vapor is the only gas which produces perceptible blackening. Its part in this cyclic process is that of a carrier, the water oxidizing the tungsten and being itself reduced to atomic hydrogen. The tungsten oxide meanwhile becomes volatilized and deposits on the glass bulb, where it is reduced by the atomic hydrogen back to metallic hydrogen with the formation of water vapor again. To prevent such blackening, due to evaporation, two methods are available: (1) to reduce the rate of evaporation by introducing into the bulb at atmospheric pressures such gases as nitrogen and mercury vapor, and (2) to change the location of the deposits by means of convection currents in gases inside the bulb, so that the glass opposite the filament will not darken. At atmospheric pressure this localized darkening effect of the convection currents in the gas becomes very striking, the globe on a level with the filament remaining perfectly clear, while a dark deposit gradually forms on the parts directly above the filament. Thus the introduction of an inert gas into the bulb at atmospheric pressure not only decreases the rate of filament evaporation, but by proper design of the lamp parts, the presence of this gas may be made to prevent blackening of those glass surfaces through which light is transmitted, the result being to make possible increased lamp life at high efficiencies. The evaporation of tungsten in nitrogen is largely a diffusion process, and is nearly independent of the size of the wire. The rate of evaporation per unit area is thus inversely proportional to the diameter. Relative lives of very small wires in nitrogen are therefore nearly proportional to the squares of their diameters. But filaments of large diameter require very large currents to maintain them at the operating temperature, 2,850 deg.; hence unless very low voltages be used, the power consumed by the larger wires is so large that only lamps of high candle power could be made. To increase the effective diameter of the filament without decreasing its resistance, a tubular section might be used, but the more practical construction, and the one adopted, takes the form of winding the filament into a tightly coiled helix.

The life of a glower ranges from 400 to 800 hours with an alternating current, and from 200 to 300 hours with a direct current. Fig. 3,447, shows the various parts of a single glower lamp. These lamps can be

NOTE.—Although the glower is not subject to combustion or oxidation, it deteriorates rapidly on a direct current owing to electrolytic action, a black deposit forming on the negative and extending gradually to the positive end. As this deposit increases the resistance increases, but the candle power and efficiency decreases. This action does not occur with a. c. current

connected in parallel to the ordinary 110 and 220 volt circuits. They give a light much whiter than the ordinary incandescent lamps, and since the filament is much shorter for corresponding candle power 25, 50, 100 and more, they produce a dazzling effect on the eyes, unless shaded by either ground glass or other similar globes.

Illumination.—The term “illumination” may be defined as *the density of light flux projected on a surface*, and by extension, it denotes *the art of using artificial sources of light*, that is to say the problem of illumination involves **the selection and arrangement of these artificial sources of light** so that the objects to be lighted will show up to the best advantage and with the minimum amount of artificial light.

The subject is naturally divided into several sections, as

1. Nature of light;
2. Nomenclature;
3. Measurement of light;
4. Selection and placement of light units.

Nature of Light.—By definition: *Light is a rapid vibratory motion which is transmitted in the form of waves on the ether*; in other words, *light is a sensation received through the organ of sight and is caused by waves which are transmitted on the ether.*

In nearly all cases, those bodies which give out light are also very hot. The light waves and the heat waves are the same in character but different in length. The light waves are shorter. The heat waves are not visible because the eye is so constructed that only waves of a certain length will produce the sensation which is called vision.

Ques. How is light propagated?

Ans. Light waves move out in every direction from a luminous point.

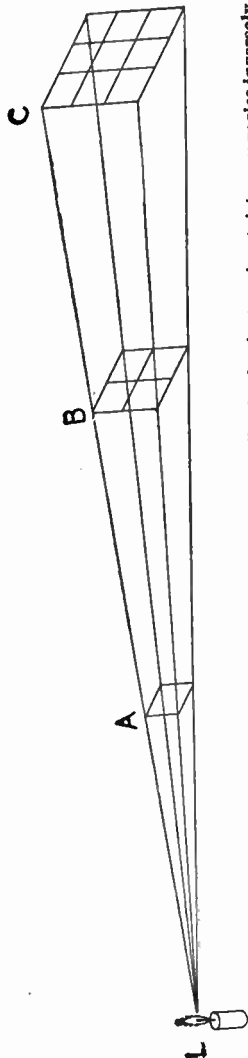

FIG. 3,449.—THE LAW OF INVERSE SQUARES: *The intensity of the illumination due to a given point source varies inversely as the square of the distance from the source.* Let L represent a point source of light and let A be a screen 1 ft. square placed at a distance of 5 ft. from L. Since light travels in straight lines the shadow which the screen casts on a wall B 10 ft. from L will have an area of 4 sq. ft. If now the screen A be removed the light which will then fall upon the 4 sq. ft. occupied by the shadow must be exactly the same as that which before fell upon the screen 1 ft. square. Since this light is now spread over 4 sq. ft. each square foot can receive but one fourth as much light as fell upon the screen A. If the wall were at C 15 ft. from L instead of 10 ft., precisely the same reasoning would show that each sq. ft. would receive but one-ninth of the light which fell upon A.

The portion of the ether which is affected by the waves is spherical in shape provided there be no obstacles in the way.

Nomenclature.—The following definitions of terms used in illumination should be carefully noted.

Ray.—The direction in which a light wave is advancing.

Beam.—Several parallel rays.

Pencil.—Several rays converging to a point.

Medium.—Any space or substance which light can traverse, such as a vacuum, air, water, glass, etc.

Absorption.—The absorption of light rays by a body through which they are passing, as illustrated by the effect upon the intensity of an electric light by the globe of the lamp.

Diffraction.—A modification which light undergoes when passing the edge of a body in virtue of which the luminous rays appear to become bent and to penetrate into the shadow.

Luminous Bodies.—Those which give out light to other bodies.

Non-luminous Bodies.—Those which are not the origin of light waves but may become visible when the waves from luminous bodies fall upon them and are reflected thence to the eye.

Fluorescence.—The property possessed by some transparent bodies, of giving off, when illumined, light of a color differing from their own and from that of the incident light.

The light given off is usually of greater wave length than the incident light, and the violet and ultra-violet rays are the best exciters of it.

Phosphorescence.—A manifestation of luminescence, in which light, previously absorbed, is emitted by a body for a considerable time after the original source of light has ceased to act upon it.

Phosphorescence is mostly due to slow oxidation attended with light as in phosphorus, or by the molecular vibrations causing the emission of light after the source of light has been removed.

Opaque.—Not having the power of transmitting light; impervious to light rays.

Transparent.—The quality of a body through which light may freely pass and objects may be distinctly seen.

Translucent.—The quality of a medium which has the power of transmitting light, without permitting clear vision through it, as distinguished from transparent.

Shadow.—A deficiency of light within an illuminated region, caused by the interception of the light by an opaque body.

Candle Power.—A unit for the measurement of the intensity of all lights.

Measurement of Light.—*Brightness* is the name of a sensation, as is loudness in the case of sound. The degree of brightness depends upon the intensity of the light, but the eye is not capable of measuring the intensity with any degree of accuracy. The eye is, however, able to detect very slight differences in the illumination of two surfaces which are side by side.

Ques. On what does the intensity of light depend?

Ans. On the amount of energy in the light waves.

The amount of light which falls upon a given unit of area is called the *intensity of illumination*.

Ques. What standard is employed for measuring light?

Ans. The candle power.

Ques. What is one candle power?

Ans. The amount of light emitted by a sperm candle seven-eighths inch in diameter and burning 120 grains (7.776 grams) per hour.

International Candle.—This is the present unit and is derived from the mean intensity of a group of incandescent electric lamp, maintained by the U. S. Bureau of Standards, in cooperation with similar custodians in France and Great Britain.

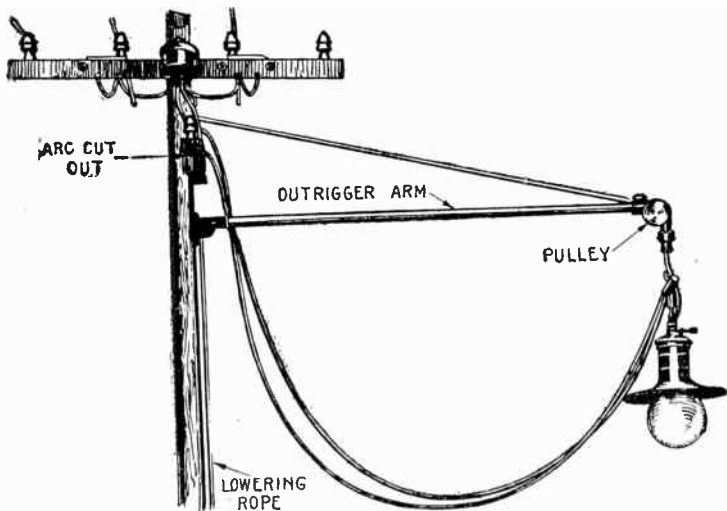

FIG. 3,450.—Out rigger suspension for arc lamp. The suspension rope is protected from the weather when it passes over the pulley by being enclosed in the out rigger arm.

Pentane Standard.—A standard of illumination employing a lamp with a specially constructed burner consuming a mixture of 7 parts of pentane gas and 20 parts of air at the rate of a half cubic foot per hour.

Hefner Standard.—The light unit adopted in the United States and Germany. It is the light given by an amyl-acetate flame adjusted until its tip is 40 mm. above the top of the wick tube. Its standard intensity is .9 international candle.

The lamp of the Hefner standard consists essentially of a cylindrical base for holding the amyl-acetate which is drawn up through a German silver tube by means of a specially prepared wick. The objections to the Hefner standard are its low intensity, its reddish color, its flabby flame and its sensitiveness to variation in flame height. The element of uncertainty associated with it at best is not less than 2 per cent.

Carcel Standard.—The Carcel lamp used in France. It has a central draught rug burner filled with a wick of the light house type burning 42 grams of pure Colza oil or rape seed oil per hour. Its standard intensity is 9.61 international candles.

Comparison of Standards.—The relative intensity of the several standards are given in the following table:

COMPARISON OF CANDLE POWER STANDARDS

	International candle	Hefner	10 C. P. pentane	Carcel	Bougie decimale	English candle	German candle
International candle.....	1.00	1.11	.1	.104	1.	.96	.95
Hefner.....	.9	1.	.09	.0936	.9	.864	.855
10 c. p. pentane.....	10.	11.11	1.	1.04	10.	9.6	9.5
Carcel.....	9.61	10.66	.96	1.	9.6	9.24	9.19
Bougie decimale.....	1.	1.11	.1	.104	1.	.96	.95
English candle.....	1.04	1.154	.104	.1	1.04	1.	.98
German candle.....	1.055	1.17	.105	.109	1.055	1.02	1.

NOTE.—In the early days of electric lighting the standards of light employed by the different countries were so diverse and indefinite, that in 1884, the International Conference of Electricians in Paris adopted an international unit of light the *violle*, which was defined to be the light given out perpendicularly from 1 square centimeter of platinum at the temperature of its solidification. This unit was found to be rather large, however, and the International Electric Congress of 1899 adopted the "*bougie decimale*," which was defined as one-twentieth of the *violle*. For various unforeseen reasons, however, this international decimal candle also proved unsatisfactory, and was abandoned by all countries except France which still holds to the bougie decimale which she maintains through the medium of her carcel lamp and not by means of the *violle* and its square centimeter of glowing freezing platinum. As claimed by carcel lamp experts, this flame standard can be reproduced without a greater variation than 1 per cent. About the time that France adopted the colza oil standard, England adopted the pentane flame standard, and Germany the amyl-acetate flame standard. Each of these standards has its advantages and disadvantages, but it is generally agreed that as the best of the three flame standards is liable to vary at different times with the same observer to the extent of one per cent., and much more with different observers, suitably selected and aged incandescent lamps can be relied on to a greater extent as standards for reproducing a given candle power than any flame standard. In 1893, American incandescent lamps become commercially standardized in terms of the nominal British Parliamentary candle of spermaceti seven-eighths inch in diameter; weighing six to the pound, and burning away at the rate of 120 grains per hour. Measurements made at Charlottesburg established a mean ratio of one hefner amyl-acetate standard equal to 88 per cent. of the British parliamentary candle, and this ratio was accepted by both the American Institute of Electrical Engineers and by the National Bureau of standards. In England, however, the parliamentary candle has been superseded by a new standard which is equivalent to the tenth part of the Vernon-Harcourt 10 candle pentane flame standard, so that the new standard of the British candle is about 4 per cent. feebler than the spermaceti candle subjected to the measurement at Charlottesburg. The gas photometric standard used in America are also Vernon-Harcourt pentane flame standards, and an incandescent lamp of 16 mean horizontal candle-power corresponds to about 16.5 candles as rated by the gas industry.

Ques. What is a lumen?

Ans. The standard of luminous flux, being the light sent out from a unit source through a unit solid angle.

Ques. What is a lux?

Ans. The unit of illumination proposed by the Geneva Congress in 1896.

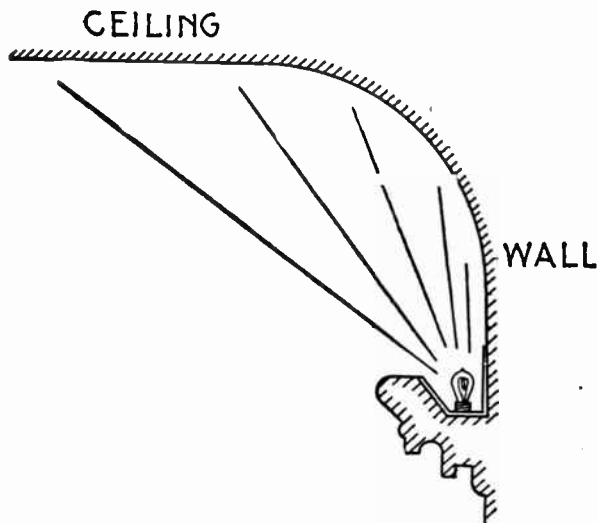

FIG. 3,451.—Diagram illustrating the indirect system of lighting. This system, though somewhat extravagant produces pleasing effects. As shown in the cut the lamps are entirely out of sight, and so that the light from the lamps may fall upon the ceiling of the room. The illustration shows the essential features of such an arrangement. The lamps are placed in a cove within a few feet of the ceiling and are hidden from view by a high moulding as indicated. The indirect system of illumination gives an extremely diffused light which is itself beautiful and pleasing, but it does not give the shadows which are essential for the visual perception of form. This system is satisfactory for auditoriums and draughting rooms, but it is not satisfactory where the perception of form is of great importance. It should never be used where the walls and ceiling are liable to become even slightly discolored by dust or smoke. A modification of the indirect system of lighting is to place arc lamps or very high candle power tungsten lamps with reflectors to throw the light upwards against the ceiling or against a white diffusing surface.

A lux is the sectional intensity of a one candle power beam at a distance of one meter from the source of light, that is, it is a *meter candle*, since 1 meter = 3.1 foot, one meter candle = $1 \div (3.1)^2$ candle foot.

Ques. What is a candle foot?

Ans. The illumination produced by a light of one candle power at a distance of one foot.

An intensity of one candle foot is produced by the light from a standard candle at 1 foot from it, in the same horizontal plane as the flame, at 2 feet distance the intensity is $\frac{1}{4}$ candle foot, at 10 feet $\frac{1}{100}$ candle foot. A 32 candle electric lamp at 6 feet produces an intensity of $\frac{8}{9}$ candle feet, etc.

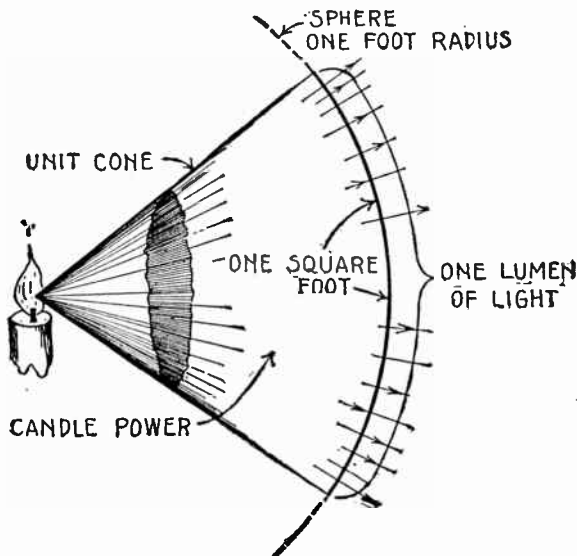
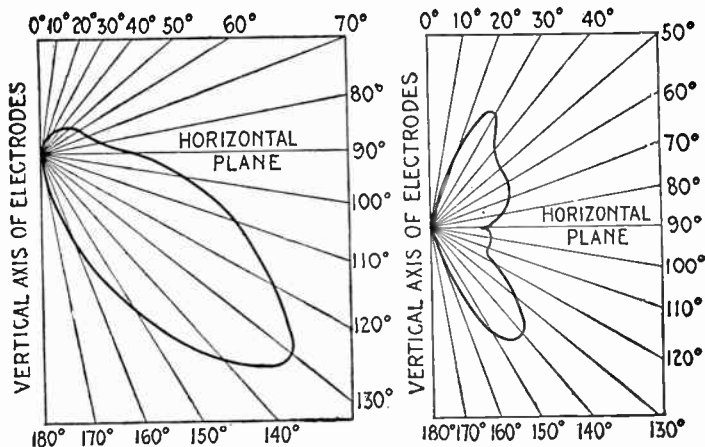

FIG. 3,452.—A unit cone. Imagine a standard candle as shown in the figure and a sphere of one foot radius with its center at the candle. One square foot of the surface of this sphere is contained inside of a unit cone, and such a unit cone contains one lumen of light flux. Therefore, one lumen of light flux passes through each square foot of the surface of the sphere; that is, the light which radiates from the given lamp has a sectional intensity of one lumen per square foot at a distance of one foot from the lamp. This sectional intensity is sometimes called the foot candle. That is to say, the foot candle is the sectional intensity of a one candle power beam at a distance of one foot from the lamp. The meter candle is the sectional intensity of a one candle power beam at a distance of one meter from the lamp. The meter candle is one lumen per square meter and it is sometimes called the lux.

A candle foot is also defined as the illumination produced by one candle power falling perpendicularly on a surface at a distance of 1 foot.

Ques. Define mean conical candle power.



FIGS. 3,453 and 3,454.—Photometric characteristics of the arc. In an ordinary arc lamp, the greatest amount of light, about 85 per cent. of the total light, is given out by the highly heated crater at the tip of the positive carbon. The arc stream is almost non-luminous and gives out only about 5 per cent. The tips of the negative carbon give out about 10 per cent. On account of the usual arrangement of the carbons, with the positive uppermost, the greater portion of the light is thrown downwards. The exact distribution of light varies, however, with the current; the quality, character and arrangement of the electrodes; and the use of various forms of diffusers, globes, reflectors, etc. The general distribution of light from a direct current open arc is shown in fig. 3,453, and that from an alternating current open arc in fig. 3,454. In the figures, the lengths of the lines radiating from the arcs to the candle power curve represent the relative candle power at different angles. It will be noted that in the case of alternating current arc, the distribution of light both above and below the horizontal plane is nearly equal. For this reason a white reflector is usually employed immediately above an alternating current arc to throw the light downwards, otherwise nearly one-half of the light would be wasted. A study of the diagrams indicates that the term candle power is a misleading one, inasmuch as the luminosity varies with the angle at which the light rays are emitted. In fact, candle power may be measured in four different ways, giving the values commonly called the mean horizontal candle power, the mean hemispherical candle power, the mean spherical candle power and the maximum candle power. All these terms are defined in the text with the exception of **maximum candle power**, which is determined by making observations in all directions for the greatest candle power. In the case of direct current arcs, the maximum candle power is found at angles from 30 to 40 degrees below the horizontal, and in alternating current arcs, about 50 degrees below the horizontal. The term **nominal candle power** is commonly used, but misleading. For instance, an arc consuming 450 watts is generally assumed to have 2,000 nominal candle power. Under the most favorable conditions this value may correspond closely with the maximum, but in practically all cases it greatly exceeds the spherical candle power. This is due to the fact that the relation between the watts and candle power is very variable. For instance, Carhart found that an arc consuming 450 watts (10 amperes and 45 volts), gave a maximum candle-power of 450, while an arc consuming the same number of watts of 8.4 amperes and 54 volts gave 900 maximum candle power. Other experiments show, however, that the candle power is greatest when the pressure at the arc is below 4.5 volts. The different results are probably due to the differences in the quality and character of the carbons employed, as it is an undoubted fact that there is a certain current density for each of a particular kind and quality which will give the greatest candle power. These experiments serve to demonstrate the importance of dividing the watts at the arc into current and voltage, with the two factors having the proper relation to give the best results.

Ans. This unit, sometimes called the mean zonal candle power, is the mean of the candle power in all directions making a given angle θ with the equatorial plane of a lamp; it is the mean conical candle power at the angle θ .

All these directions lie on a cone the vertex of which is the center of the lamp and the axis of which coincides with that of the lamp. The

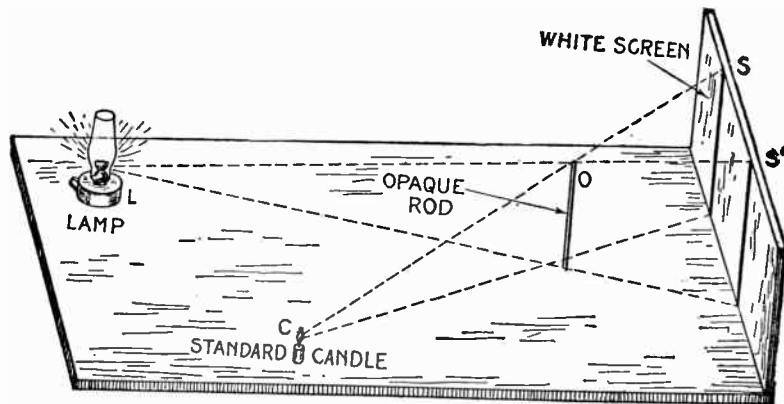

FIG. 3.455.—Principle of Rumford's photometer. A screen is equally illuminated by each of two sources of light whenever the two shadows cast by the same object are equally illuminated, that is, have the same depth of shadow. In the diagram L and C are the two sources of light, L being a lamp, and C a standard candle. An opaque rod is placed near the white screen. Two shadows will be formed on the screen side by side. The light from the candle falls upon the shadow S' and the light from the lamp falls upon the shadow S. The distances of L and C from the screen may be adjusted so that the two shadows will look exactly alike. Since the intensity of any light varies inversely as the square of the distance increases, then the comparative power of two sources of light must vary directly as the squares of their distances from the screen which they illuminate equally. Thus if C in the figure be 50 cm., L 290 cm. from the screen, and the shadows be alike, the distances are as 1 to 4. The illuminating powers are then as 1 to 16. If C be 1 c.p., then L is 16 c.p.

semi-vertical angle is $90^\circ - \theta$. If the mean conical candle power at certain angles be measured, the average of the results is the mean spherical candle power.

Ques. Define mean spherical candle power.

Ans. If there be drawn from a source equally in all directions lines whose lengths are proportional to the candle power in these

directions, then the mean value of the lengths of all these lines is the mean spherical candle power.

Ques. Define mean hemispherical candle power.

Ans. If there be drawn from a source equally in all directions either below or above the equatorial plane, lines whose lengths are proportional to the candle power in these directions, then the mean value of the lengths either above or below is the mean hemispherical c. p. of the upper or lower hemisphere respectively.

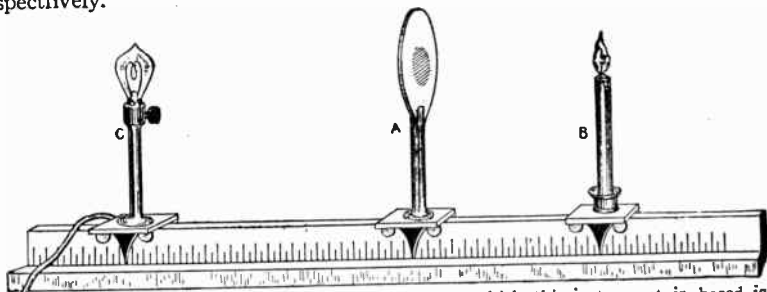

FIG. 3,456.—Bunsen's photometer. The principle upon which this instrument is based is that a translucent spot in the center of a white screen will have the same appearance as the rest of the screen when the illumination on the two sides is equal. A spot in a sheet of white paper may be made translucent by means of a little grease or oil. If this sheet be then held between the eye and a window or other source of light, the grease spot will appear brighter than the surrounding paper. On the other side of the paper the spot appears much darker than the paper. That is to say, when the paper is viewed from the side of greater illumination, the oiled spot appears dark, and when it is viewed from the side of lesser illumination the spot appears light. Accordingly when the two sides of the paper are equally illumined, the spot ought to be of the same brightness when viewed from either side, which, in fact it is. Hence to find the candle power of any unknown source it is only necessary to set up a candle on one side, and the unknown source on the other, as in the figure, and to move the spot to the position of equal illumination. The candle power of the unknown source will then be $CA^2 \div BA^2$.

NOTE.—Precautions in Photometric Observations.—The eyes of the observer should be constantly shaded from bright light to maintain their sensitiveness in a state of dark adaptation. For best photometric sensibility a screen illumination of about 2 foot candles is desirable. At low intensities the Purkinje may prove disturbing. The precision of photometric settings may often be improved by a process of narrowing down between points equally out of balance. Many good photometricians reject their first observation in a set as untrustworthy. As the best conditions cannot reduce the uncertainty of observations below .2 per cent (in many cases it is 3 per cent or more) not more than three figures in the result are significant. A photometer bar should be at least 100 inches long for good results with ordinary illuminations. The distance from a large unit to the screen should not be less than ten feet if the inverse square law is to be applied. The voltage of electric lamps, or current, in the case of series lamps, should be measured by the most accurate device obtainable. In life tests of incandescent lamps, exact regulation of voltage is important, and a sensitive automatic regulator is desirable. In measurements of illumination by portable photometers the sources of error to be guarded against are: occlusion of light from the test plate by observer or instrument; uncertainty of standard lamp due to poor electrical regulation; faulty diffusion by the test plate; low sensibility and Purkinje effect in weak fields. In tests of illuminants in place, the voltage, current or power, or the gas consumption and pressure should be ascertained and recorded if possible.

Ques. Define mean horizontal candle power.

Ans. If, from a source of light there be drawn lines equally in all directions in a plane, and their lengths be made proportional to the candle power in these directions then the sum of all these lengths, divided by their number, gives the mean candle power in that plane.

When the axis of the lamp is vertical, the mean candle power in the horizontal plane is called the mean horizontal candle power.

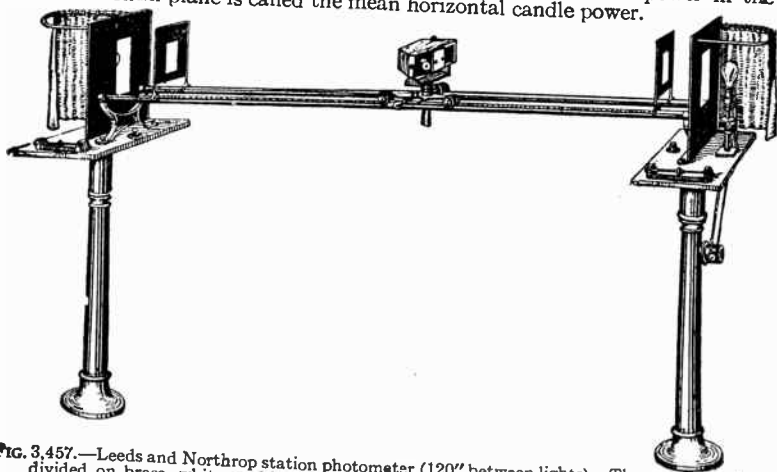

FIG. 3.457.—Leeds and Northrop station photometer (120" between lights). The scale is engine divided on brass, white on black background—and in inverse squares—reading directly in candle power. On one bench is the rotator, while the other carries the socket for the standard incandescent lamp. Binding posts are provided for tapping off voltmeter connections from the lamp. On the front of each pillar top is a finely adjustable sliding rheostat varying the voltage of the two lamps. The motor driving the rotator is mounted on the pillar as shown; it has a rheostat for varying its speed. Both rotator and standard lamp holder have vertical adjustments for the lamps, by means of which their centers of illumination may be brought into the axis of the observing screen. The screen is an improved Bunsen screen with specially ground mirror. It is reversible so as to eliminate difference errors of the two eyes, the two sides of the screen, mirrors, etc. A small shaded lamp just over the index lights up the scale momentarily upon depressing the little key at its side. The combination of screens cuts off all light except that which goes straight down the track to the observing screen.

Ques. What is photometry?

Ans. Photometry is the process of measuring the intensity of light. The instrument by which the candle power is determined is called a photometer.

Ques. What is an integrating photometer?

Ans. A photometer which gives directly, by one reading, the average light emitted around a meridian line.

If the source of light be turned about a vertical axis through definite angles, and candle power readings be taken in each meridian, the mean spherical candle power can be obtained by taking the average of these.

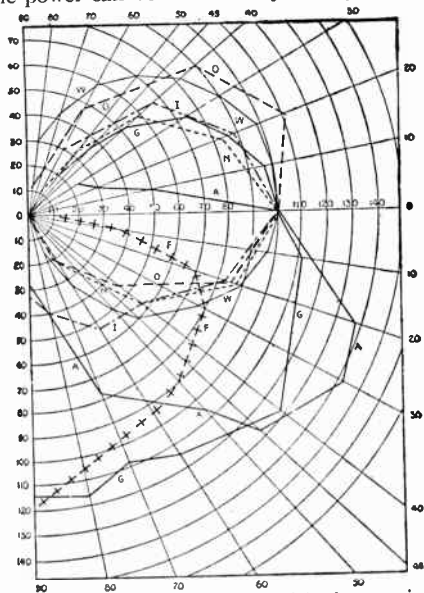

FIG. 3,458.—Light curves showing the distribution of light from various sources. Of the several curves W represents the Welsbach light, O the Osmium lamp, N the Nernst lamp, A the electric arc, I the electric incandescent carbon filament lamp, F the electric flaming arc, and G the inverted incandescent gas burners.

Comparative Distribution of Light from Various Sources.—The diagram fig. 3,458 gives a number of curve showing comparatively the distribution of light from various sources of illumination as determined by photometric measurement by Professor H. Drehschmidt of Berlin. For purposes of comparison the horizontal intensity is 100 heftners for each source.

It will be observed that the incandescent osmium and Nernst lamps send about as much light upward as downward, and therefore, require the use of reflectors. The electric flaming arc sends all of its light downward, but it gives very poor lateral illumination and strongly illuminates only a limited region below the lamp.

According to these measurements the electric arc is best at about 30 degrees below the horizontal, but pretty poor immediately beneath. These curves indicate that the distribution from the inverted incandescent gas lamp is better than that from any of the other sources. It should, however, be carefully remembered that the exact distribution from electric arcs varies with the current, carbons, and other conditions, and it should be also remembered that the matter of distribution has only an indirect relation to that of efficiency.

Globes for Arc Lamps.—These are made in a great variety of style for adapting them to varying conditions of service. Inner globes of enclosed arc lamps are blown from glass having special heat resisting qualities so that they will not soften under the influence of the intense heat of the arc. Consequently, the particles of incandescent carbon which might be projected against the globes do not adhere to or become embedded in their surfaces. These globes are usually made in dense opal, or clear glass or as desired.

The light opal is the most suitable for interior illuminations as it absorbs some of the superfluous violet rays without materially decreasing the illuminating power. Where a very even distribution of light is essential, the dense opal globe gives the most satisfactory results. Both the light opal and the clear glass globes can be employed for outdoor lighting although the light opal globe is preferable on account of its superior light distributing qualities.

Outer globes can also be obtained in dense opal, light opal, or clear glass. Almost all indoor lamps except those of the metallic arc or flaming arc type do not require outer globes, but their use is imperative with all types of outdoor lamp.

Reflectors and Shades for Arc Lamps.—In general, since the greater portion of the light of a direct current lamp is emitted from the crater of the upper or positive electrode in a downward

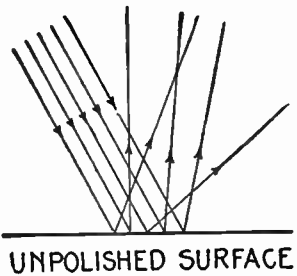
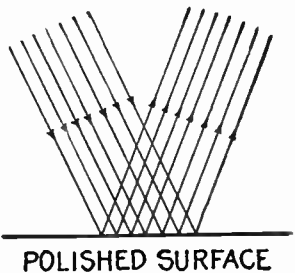
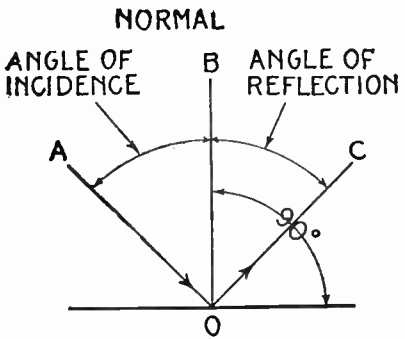

Figs. 3,459 to 3,461.—Diagrams illustrating reflection and diffusion of light. When light waves meet an obstacle in their path, they are reflected according to the following law: *The angle of reflection is equal to the angle of incidence.* That is to say, in fig. 3,459 if a ray of light strike a surface at an angle AOB it will be reflected from the surface at an equal angle BOC, the common side OB being a normal or perpendicular to the surface. When light is reflected from a smooth surface, such as plane polished metal or glass, the reflected rays continue in the same relation to each as before reflection, as in fig. 3,460. If the surface be not polished, the rays are reflected from a countless number of small surfaces which are not in the same plane. Each ray is reflected according to the law given above, but since the small surfaces from which they are reflected are at every possible angle to each other, the reflected rays will be in every possible direction, as in fig. 3,460. Such light is said to be *diffused*. Most objects are seen by diffused light. A perfectly plane polished reflector can not be seen at all.

direction; such lamps do not require the use of reflectors, except perhaps for special purposes. On the other hand, since one half of the total amount of light from an alternating current lamp is thrown upwards, the use of suitable reflectors to throw this light downwards is very essential. The reflectors usually employed for this purpose with series alternating arc lamps, are made of metal, lined with porcelain enamel, which gives a surface having good reflecting properties. For interior lighting, enclosed arc lamps of both direct and alternating current type are often used with reflectors.

Diffusers.—One of the important requirements for interior lighting is the proper diffusion of the light so as to produce a soft even illumination, free from strong contrasts and deep shadows on the surface illuminated. The distribution of light from enclosed arc lamps is much improved by the use of diffusers for either the concentric or inverted type.

The concentric diffuser consists of a metal reflector having properly designed corrugations for distributing downwardly the light thrown by the arc above the horizontal plane. As shown by fig. 3,462, it is attached

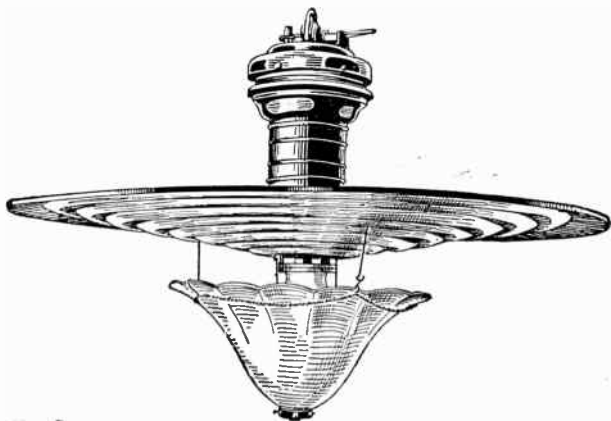

FIG. 3,462.—Concentric diffuser and lower shade as attached to an enclosed arc lamp.

to the lamp casing in a manner similar to an ordinary reflector or shade and in the place of an outer globe, a screening shade is used for subdividing the light directly under the lamp, and for reflecting a portion of it on to the diffuser.

Holophane Globes and Reflectors.—The holophane system of illumination embodies the most scientific principles governing the utilization of artificial light, and by means of accurately calculated prismatic globes and reflectors, affords the most

practical solution of the three problems involved: 1, the proper diffusion of the light, 2, the redirection of the rays of light in useful direction, and 3, the prevention of the loss of light by providing a minimum absorption.

Construction of Holophane Globes.—In general, these globes are composed of a series of internal and external prisms.

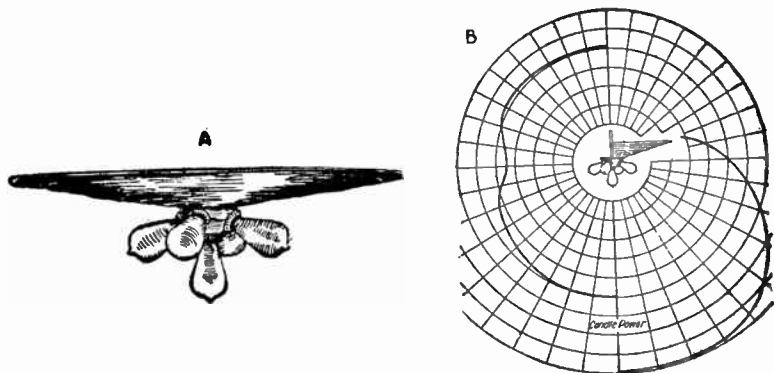

FIGS. 3,463 and 3,464.—Concentric light diffusers suitable for either single meridian incandescent lamps or for meridian clusters installed on low ceilings, and curves showing candle power distribution lamps. As shown by the diffusion curves that on the left corresponding to the light from a cluster without diffusers, and that on the right, to the light from a cluster with a diffuser, the use of the diffuser results in a 40 per cent. increase of illumination in the lower hemisphere.

The sole function of the internal prisms, which are arranged in the form of ribs on the inside of the globe, and which follow the law of cosines, is to diffuse the light.

Requirements of Good Illumination.—The term good illumination implies that the light units have been so selected and distributed that objects may be clearly seen with a minimum

of fatigue. To obtain this result certain conditions must be fulfilled, as follows:

1. There must be sufficient illumination. Since objects are seen by means of the light which they reflect, more light must be thrown on dark objects than on light ones.
2. There must not be too much illumination. Too strong a light tires the eye, partly due to the muscular effect of contracting the iris, and partly because of the strong light reaching the sensitive retina.
3. Intensely bright lights in the field of vision should be avoided. The iris closes somewhat in order to afford a protection from such

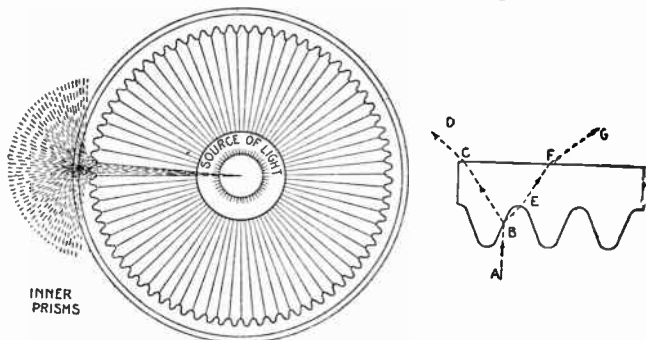

FIGS. 3,465 and 3,466.—Horizontal section through center of holophane globe, and magnified cross section view of three adjacent internal prisms. In fig. 3,466 the single ray of light A is diffused by being broken into two components—B E F G by reflection and refraction, and B C D by refraction alone. The external prisms are arranged in a series of longitudinal grooves on the outside surface of the globe. In order to secure the best distribution of the light each groove is constructed according to the principle of geometrical optics, with reference to its position relative to the source of light. Therefore no two grooves are exactly alike, but the dimensions of each of the four faces of a groove or prism do not divide more than one thousandth of an inch from their calculated dimensions. This great accuracy is absolutely essential in the construction of the globes; for otherwise, the light is liable to be thrown back into the globe, thereby tending to decrease its efficiency.

lights and the amount of light received from illuminated objects is thereby so reduced that they cannot be seen clearly.*

*NOTE.—This accounts for the well known dazzling effects of search lights and of many head lights. The intrinsic brilliancy, or candle power per square inch of luminous area should therefore be kept as low as possible; it should not ordinarily be higher than 4 to 6, if the source of light be in the field of vision. The intrinsic brilliancy of various sources of light is shown in the accompanying table. It will be noticed that the figures for incandescent filaments are from 375 to 1,000 candle power per square inch, which indicates that the lamps should either be shaded or frosted. Clear bulbs should certainly never be used where the filaments are continuously in view. When reflectors are used it is generally desirable to "bowl frost" the lamps, that is, frost only the lower portion of the bulbs.

TABLE OF INTRINSIC BRILLIANCY OF LIGHT SOURCES

	Candle power per sq. in.
Moore tube.....	.3 — 1.75
Frosted incandescent.....	2 — 5
Candle.....	3 — 4
Gas flame.....	3 — 8
Oil lamp.....	3 — 8
Cooper Hewitt lamp.....	17
Welsbach gas mantle.....	20 — 50
Acetylene.....	75 — 100
Enclosed A. C. arc.....	75 — 200
Enclosed D. C. arc.....	100 — 500
Incandescent lamps	
Carbon 3.5 watts per candle.....	375
Carbon 3.1 watts per candle.....	480
Metallized carbon 2.5 watts per candle.....	625
Tantalum 2.0 watts per candle.....	750
Mazda 1.25 watts per candle.....	875
Mazda 1.15 watts per candle.....	1,000
Nernst 1.5 watts per candle.....	2,200
Sun on horizon.....	2,000
Flaming arc.....	5,000
Open arc lamp.....	10,000-50,000
Open arc crater.....	200,000
Sun 30° above horizon.....	500,000
Sun at zenith.....	600,000

4. Flickering lights should be avoided. Poorly regulated circuits, such as those having varying power loads, cause disagreeable flickering. However, the metal filament lamps, as for instance the "Mazda" have an inherently better regulation than the carbon filament lamps; a change of 3 volts on a Mazda lamp alters the candle power no more than 2 volts on a carbon lamp.

5. Lamps should be so placed that the light is not regularly reflected into the eye.

6. Streaks or striations in the illumination are undesirable. Arc lights with clear globes show this phenomenon. Open reflectors having smooth interior surfaces should be used only with frosted lamps.

7. A satisfactory light must be of a proper quality. It should have a continuous spectrum, that is, one containing every color, in order that the relative color values of objects illuminated may be the same as when seen by daylight.

NOTE.—A desk lamp should be placed to one side rather than directly in front of the person using it, to avoid the glare from the surface of the paper. Smooth reflecting surfaces on the desk, such as plate glass, are undesirable from this standpoint.

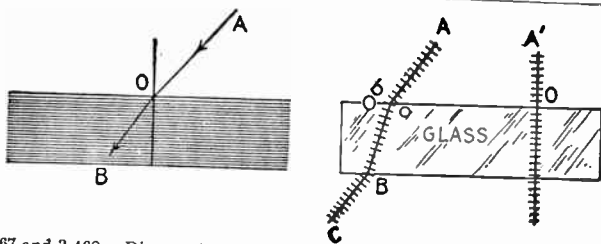

Figs. 3.467 and 3.468.—Diagram illustrating the refraction of light. Refraction is the bending which occurs when rays of light pass from one medium into another. Ray A O, passes straight through the air to the surface of water, but on entering the water it is bent, so that it passes along O B. The ray is refracted at O. Some media will refract light much more than others. In general it may be said that the more dense a medium is, the more the rays will be refracted when they pass into it. **Cause of Refraction.** Light moves with less speed through a dense medium than through a rarer one. The speed is less in air than in the ether space beyond the atmosphere. It is less in water or glass than in air. In fig. 3.468, let A O represent a ray of light, that is, the direction in which the waves of light advance. Let the short lines drawn across the ray represent the waves. The wave *ab* is just entering the glass. The end *a* enters first and its speed is checked, while the end *b* continues its speed until it also reaches the glass. Thus the wave is caused to swing about, just as a line of soldiers is swung around when the men at one end of the line do not walk as rapidly as those at the other. The wave will then advance through the glass in a straight line but in a direction O B. At B the wave will again pass into the air. The part which was first to enter at O, is the first to emerge at B. The direction of the wave is again changed and it passes on along B C. In case the ray be perpendicular to the surface of the glass, the speed is checked but there is no refraction, for as shown both ends of the lines on A' O' enter the glass at the same time.

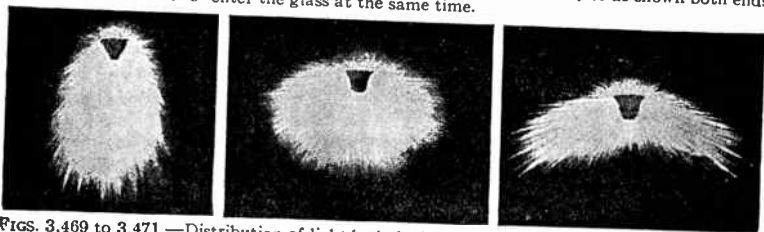

Figs. 3.469 to 3.471.—Distribution of light by holophane globes. Globes of the type shown in fig. 3.469 throw a maximum light at an angle of 45 degrees downward and are used principally for general illumination. The globe in fig. 3.470 throws the light around, and the arc in fig. 3.471 general illumination. Class C globes throw a maximum light at 10° to 15° below the horizontal and are intended for lighting large areas, streets, etc. For the purpose of actual installation, these three classes of globe can be readily distinguished from one another by noting the following characteristic features: In fig. 3.469, each of the prisms gradually diminish in size until they almost disappear, and then begin again slightly near the bottom of the globe; in fig. 3.471 the globe has the same characteristics as in fig. 3.470, except that the lower prisms slope in the opposite direction from the upper prisms, thereby throwing the light more upward in direction. In using these globes it is important to distinguish between the pendants and the uprights. This may be accomplished by any one of the following methods: In general, since the greater portion of the light is thrown from the long flat surfaces of the prisms, the globes should always be used with those surfaces pointing downward. Another simple rule is to run the thumb nail up and down the outside surface of the globe. If the nail catch when running from the neck to the top, it is an upright; while if it catch when running from the top to the neck it is a pendant.

For matching delicate tints as in silk and paper mills, the light should be as white as possible, while for general illuminating purposes a "warm" light is best; "cold" glary lights, too rich in green and blue, are to be avoided.

Calculation of Illumination.—The basis of illumination calculations is the foot candle, already defined, and which is here illustrated in figs. 3,472 and 3,473.

As the computation is more or less involved, these are given in a table on page 2,526, values of the illumination on horizontal

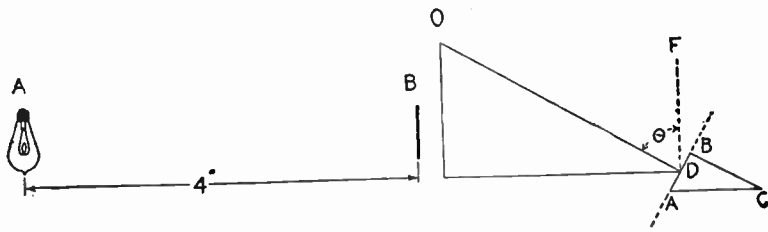

Figs. 3,472 and 3,473.—The foot candle. If A be a lamp giving 16 candle power in a horizontal direction, the illumination at the point B, four feet distant, would be $16 \div 4^2 = 1$ foot candle, since the intensity of light varies inversely as the square of the distance. To get the normal illumination at any given point, the candle power in the proper direction must be divided by the square of the distance to the point illuminated. If the surface illuminated be not at right angles to the direction of the light, the value of the illumination obtained as above must be multiplied by a reduction factor, taking into account the angle at which the rays strike. A beam of light coming in the direction OD, fig. 3,473, falls upon a plane AB, illuminating it with an intensity of 1 foot candle. Then the illumination on the plane AC, which intercepts the same amount of light as AB, would be less than 1 foot candle (as the light is spread over a larger surface) in the ratio of AB to AC, which is the cosine of the angle ODF. Thus the illumination effective on any plane at a given point will be (candle power \div distance²) \times cos θ , where θ is the angle between the direction of the ray and a perpendicular to the plane considered.

planes at different heights and at different horizontal distances from a 1 candle power light and also the corresponding angles made by the light rays with the perpendicular to the plane.

The basis of most illumination calculations is the distribution curves of the lighting unit, some of which have been shown. The distance from the center to any point on the curve is directly proportional to the candle power in that direction, which may

conveniently be read off by the aid of the equally spaced concentric circles on the diagram.

One of the first points to be considered in designing a lighting installation is the desired intensity of illumination. The table here given shows the proper illumination for various classes of service.

TABLE OF REQUIRED INTENSITY OF ILLUMINATION

	Foot candles required		Foot candles required
Auditoriums, theatres.	1 to 3	General offices.....	3 to 4
Bookkeeping.....	3 " 5	Offices with desk lights.	1½ " 2½
Corridors, halls.....	½ " 1	Post offices.....	2 " 5
Depots, halls, churches	¾ " 1½	Reading.....	1 " 3
Draughting rooms....	5 " 10	Residences.....	1 " 3
Desk lighting.....	2 " 5	Stores (light goods)....	2 " 3½
Engraving.....	5 " 10	" (dry goods).....	4 " 6
Factories (individual drops).....	2 " 3	" (clothing).....	4 " 7
Factories (no individ- ual drops).....	4 " 5	Store windows.....	5 " 20
Hotel halls.....	1 " 1½	School rooms.....	2 " 3
" rooms.....	2 " 3	Saloons, cafes.....	2 " 5
Offices, waiting rooms.	1¼ " 2½	Stations (waiting rooms)	1½ " 2½
Private offices.....	2 " 3	Train sheds.....	1½ " 2
		Ware houses.....	1½ " 2

Point by Point Method of Calculating Illumination.—

When considering the use of any luminant or unit, it is frequently desirable to determine the illumination which would result (neglecting reflection from ceiling or walls) at a number of point in the horizontal plane in which the required illumination is to be obtained.

To use this method, first select a point at which to determine the illuminating, and then proceed as follows: 1, obtain the distribution curve of the lamp with its reflector, 2, take from the table on page 2,526 the value (in foot candles) of illumination which a 1 candle power light

source would produce at the point selected, 3, note the corresponding angle, 4, determine from the distribution curve the candle power at the angle noted, 5, multiply the candle power thus found by the value of illumination corresponding to 1 candle power, as found in the table on page 2,526. The result will be the foot candles illumination produced at the point under investigation by the given lamp or unit. An example of the point by point method of calculation is given in fig. 3,474.

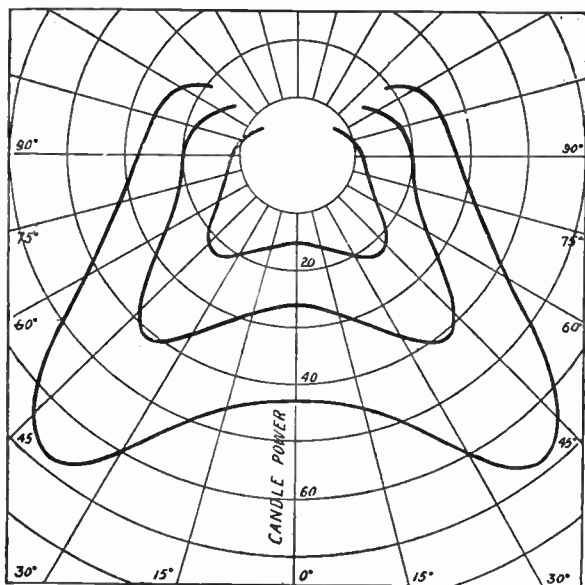

FIG. 3,474.—Illumination curves for "Mazda" 25, 40, and 60 watt 100-125 volt bowl frosted lamps with extensive reflectors, to accompany the example of "point by point" method of calculating illumination here given. **Example:** Let it be required to determine the illumination given by a "Mazda" 40 watt bowl frosted lamp with extensive holophane reflector, at a point 12' below and 8' to one side of the lamp. From the table on page 2,526, the illumination obtained from a light of 1 candle power at the point considered would be .004 foot candle. The corresponding angle is $33^{\circ} 42'$; at this angle, according to the distribution curve here shown, the intensity is 38.6 candle power. Now $38.6 \times .004 = .15$, which is the illumination in foot candles at the point investigated (neglecting reflection from ceiling and walls).

Color of Walls and Ceiling.—The effect of the color of the side walls and ceiling is one which must be considered in designing illumination. There is always some reflected illumination in

Intensity of Illumination in Foot Candles on Horizontal Planes for Points at Various Distances from a Light Source of 1 Candle Power. Angle Between Light Ray and Line Perpendicular to Plane Illuminated

		Horizontal Distance in Feet from Point Directly Under Light Source to Point Where Intensity of Illumination is Desired.																				
		0	1	2	3	4	5	6	7	8	9	10	11	12	13	14	15	16	17	18	19	20
Height of Light Source in Feet Above Plane Illuminated	4	0° 0'	14° 2'	26° 34'	36° 52'	45° 0'	51° 20'	56° 19'	60° 15'	63° 26'	66° 2'	68° 12'	70° 1'	71° 34'	72° 54'	74° 3'	75° 4'	75° 56'	76° 46'	77° 28'	78° 7'	78° 42'
	0° 0'	0.6260	0.5707	0.4472	0.3200	0.2210	0.1524	0.1066	0.0784	0.0559	0.0419	0.0320	0.0249	0.0198	0.0159	0.0130	0.0107	0.0090	0.0075	0.0064	0.0055	0.0047
	6	0° 0'	11° 19'	21° 48'	30° 58'	38° 40'	45° 0'	50° 11'	54° 28'	58° 0'	60° 57'	63° 26'	65° 24'	67° 23'	68° 58'	70° 21'	71° 34'	72° 39'	73° 37'	74° 29'	75° 16'	75° 56'
	0° 0'	0.4000	0.3771	0.3202	0.2522	0.1904	0.1414	0.1050	0.0785	0.0580	0.0437	0.0328	0.0249	0.0198	0.0159	0.0130	0.0107	0.0090	0.0075	0.0064	0.0055	0.0047
	8	0° 0'	9° 28'	18° 26'	26° 34'	33° 42'	39° 48'	45° 0'	49° 24'	53° 8'	56° 19'	59° 3'	61° 23'	63° 26'	66° 13'	66° 48'	68° 12'	69° 27'	70° 34'	71° 34'	72° 28'	73° 18'
	0° 0'	0.2778	0.2673	0.2372	0.1987	0.1600	0.1260	0.0932	0.0706	0.0530	0.0407	0.0312	0.0249	0.0205	0.0170	0.0142	0.0120	0.0102	0.0088	0.0076	0.0066	0.0056
	10	0° 0'	8° 8'	15° 57'	23° 12'	29° 45'	35° 32'	40° 37'	45° 0'	48° 49'	52° 7'	55° 1'	57° 31'	59° 45'	61° 41'	63° 26'	64° 59'	66° 23'	67° 37'	68° 45'	69° 46'	70° 43'
	0° 0'	0.2041	0.1980	0.1814	0.1585	0.1336	0.1100	0.0893	0.0722	0.0583	0.0473	0.0385	0.0316	0.0261	0.0218	0.0183	0.0164	0.0131	0.0113	0.0097	0.0084	0.0074
	12	0° 0'	7° 8'	14° 2'	20° 33'	26° 34'	32° 0'	36° 52'	41° 10'	45° 0'	48° 22'	51° 20'	53° 59'	56° 19'	58° 24'	60° 15'	61° 55'	63° 26'	64° 48'	66° 2'	67° 10'	68° 12'
	0° 0'	0.1563	0.1527	0.1427	0.1283	0.1118	0.0953	0.0800	0.0667	0.0552	0.0458	0.0381	0.0318	0.0267	0.0225	0.0191	0.0163	0.0140	0.0121	0.0105	0.0091	0.0080
	14	0° 0'	6° 20'	12° 32'	18° 26'	23° 55'	29° 3'	33° 42'	37° 52'	41° 38'	45° 0'	48° 0'	50° 42'	53° 8'	55° 18'	57° 16'	59° 3'	60° 38'	62° 6'	63° 26'	64° 40'	65° 46'
	0° 0'	0.1238	0.1212	0.1148	0.1054	0.0943	0.0825	0.0711	0.0607	0.0515	0.0437	0.0370	0.0314	0.0267	0.0228	0.0195	0.0168	0.0146	0.0126	0.0110	0.0097	0.0085
	16	0° 0'	5° 43'	11° 13'	16° 42'	21° 48'	26° 34'	30° 68'	35° 0'	38° 50'	41° 59'	45° 0'	47° 43'	50° 11'	52° 26'	54° 28'	56° 19'	58° 0'	59° 32'	60° 57'	62° 14'	63° 26'
	0° 0'	0.1000	0.0985	0.0943	0.0879	0.0801	0.0716	0.0621	0.0530	0.0446	0.0411	0.0350	0.0305	0.0263	0.0227	0.0196	0.0171	0.0149	0.0130	0.0115	0.0101	0.0089
	18	0° 0'	5° 12'	10° 18'	15° 15'	19° 59'	24° 27'	28° 37'	32° 28'	36° 2'	39° 17'	42° 16'	45° 0'	47° 30'	49° 46'	51° 50'	53° 45'	55° 37'	57° 6'	58° 34'	59° 56'	61° 12'
	0° 0'	0.0826	0.0816	0.0787	0.0742	0.0688	0.0623	0.0559	0.0496	0.0437	0.0383	0.0335	0.0292	0.0255	0.0223	0.0195	0.0171	0.0150	0.0132	0.0117	0.0104	0.0092
	20	0° 0'	4° 46'	9° 28'	14° 2'	18° 26'	22° 37'	26° 34'	30° 15'	33° 42'	36° 52'	39° 48'	42° 31'	45° 0'	47° 17'	49° 24'	51° 20'	53° 8'	54° 49'	56° 19'	57° 43'	59° 3'
	0° 0'	0.0694	0.0687	0.0668	0.0634	0.0593	0.0546	0.0497	0.0448	0.0400	0.0356	0.0315	0.0278	0.0246	0.0217	0.0191	0.0169	0.0150	0.0133	0.0119	0.0106	0.0094
	22	0° 0'	4° 24'	8° 46'	13° 0'	17° 6'	21° 2'	24° 46'	28° 18'	31° 34'	34° 42'	37° 34'	40° 14'	42° 44'	45° 0'	47° 6'	49° 5'	50° 54'	52° 36'	54° 10'	55° 38'	56° 59'
	0° 0'	0.0592	0.0587	0.0571	0.0547	0.0517	0.0481	0.0447	0.0404	0.0366	0.0329	0.0295	0.0263	0.0235	0.0209	0.0187	0.0166	0.0148	0.0133	0.0119	0.0106	0.0094
24	0° 0'	4° 5'	8° 8'	12° 6'	15° 57'	19° 39'	23° 12'	26° 34'	29° 45'	32° 44'	35° 32'	38° 9'	40° 37'	42° 53'	45° 0'	46° 58'	48° 49'	50° 31'	52° 7'	53° 37'	55° 1'	
0° 0'	0.0510	0.0506	0.0495	0.0477	0.0454	0.0426	0.0396	0.0365	0.0334	0.0304	0.0275	0.0248	0.0223	0.0201	0.0180	0.0162	0.0146	0.0131	0.0118	0.0107	0.0096	
26	0° 0'	3° 49'	7° 36'	11° 19'	14° 56'	18° 26'	21° 48'	25° 1'	28° 4'	30° 58'	33° 42'	36° 15'	38° 0'	39° 43'	42° 53'	45° 0'	46° 58'	48° 49'	50° 31'	52° 7'	53° 37'	
0° 0'	0.0444	0.0442	0.0433	0.0419	0.0401	0.0380	0.0356	0.0331	0.0305	0.0280	0.0256	0.0233	0.0212	0.0192	0.0174	0.0157	0.0142	0.0129	0.0117	0.0106	0.0096	
28	0° 0'	3° 35'	7° 08'	10° 37'	14° 2'	17° 25'	20° 33'	23° 38'	26° 34'	29° 23'	32° 0'	34° 30'	36° 52'	39° 6'	41° 10'	43° 9'	45° 0'	46° 46'	48° 22'	49° 56'	51° 20'	
0° 0'	0.0391	0.0388	0.0382	0.0371	0.0357	0.0341	0.0321	0.0300	0.0280	0.0260	0.0240	0.0220	0.0200	0.0183	0.0167	0.0152	0.0140	0.0126	0.0115	0.0105	0.0095	
30	0° 0'	3° 22'	6° 42'	10° 0'	13° 15'	16° 31'	19° 26'	22° 23'	25° 12'	27° 54'	30° 28'	32° 6'	34° 30'	36° 52'	39° 6'	41° 10'	43° 9'	45° 0'	46° 46'	48° 22'	49° 56'	
0° 0'	0.0346	0.0344	0.0339	0.0331	0.0319	0.0309	0.0296	0.0283	0.0274	0.0262	0.0250	0.0238	0.0226	0.0216	0.0209	0.0200	0.0191	0.0184	0.0174	0.0166	0.0158	
32	0° 0'	3° 11'	6° 20'	9° 28'	12° 32'	15° 32'	18° 26'	21° 14'	23° 55'	26° 34'	29° 3'	31° 26'	33° 42'	35° 49'	37° 52'	39° 48'	41° 38'	43° 27'	45° 0'	46° 33'	48° 0'	
0° 0'	0.0309	0.0307	0.0303	0.0297	0.0287	0.0276	0.0264	0.0250	0.0236	0.0221	0.0206	0.0192	0.0178	0.0165	0.0152	0.0140	0.0134	0.0124	0.0115	0.0106	0.0099	
34	0° 0'	3° 1'	6° 0'	8° 58'	11° 53'	14° 45'	17° 31'	20° 13'	22° 50'	25° 21'	27° 45'	30° 4'	32° 17'	34° 23'	36° 23'	38° 17'	40° 8'	41° 49'	43° 27'	45° 0'	46° 29'	
0° 0'	0.0277	0.0276	0.0273	0.0267	0.0260	0.0251	0.0240	0.0229	0.0217	0.0205	0.0192	0.0180	0.0167	0.0156	0.0145	0.0137	0.0128	0.0124	0.0115	0.0106	0.0099	
36	0° 0'	2° 52'	5° 43'	8° 32'	11° 19'	14° 2'	16° 42'	19° 17'	21° 48'	24° 14'	26° 34'	28° 49'	30° 58'	33° 2'	35° 0'	36° 52'	38° 40'	40° 22'	41° 59'	43° 27'	45° 0'	
0° 0'	0.0250	0.0249	0.0246	0.0242	0.0236	0.0228	0.0219	0.0210	0.0200	0.0190	0.0179	0.0168	0.0158	0.0147	0.0137	0.0128	0.0119	0.0111	0.0103	0.0095	0.0088	

a room and every object assumes the color of the light which it reflects. Hence, the colored rays reflected from the walls tend to tint all the objects in the room. Since the lighter colors reflect more light, the resulting illumination will be thereby considerably increased.

The following table gives approximate coefficients of reflection from wall papers, that is, the amount of reflected light expressed as a proportion of the total light received by the surface. These figures are based on the use of incandescent lamps.

TABLE OF REFLECTION COEFFICIENTS

Kind	Color	Coefficient of reflection K	$\frac{1}{1-K}$
Plain ceiling	Faint greenish53	2.13
	Light yellow49	1.96
	Faint pinkish43	1.75
	Pale bluish white31	1.45
	Light gray green23	1.30
Crepe	Medium green19	1.23
	Medium red08	1.09
	Deep green06	1.06
Cartridge	Medium light buff44	1.79
	Light blue20	1.25
	Pale pink19	1.23
	Light green18	1.22
Striped ("two-toned")	Deep cream silvery57	2.32
	Light strawberry pink43	1.75
	Light green26	1.35
	Medium red08	1.09
Miscellaneous	Light gray38	1.61
	Light green and gold (minute (much gold) figuring)	.28	1.39

For practical problems, the increase in illumination over that calculated from the distribution curve or illumination table for the unconsidered is about as indicated in the table on page 2,529. These data are deduced from tests reported by Messrs. Lansing and Rolp before the Illuminating Engineering Society.

Rapid Method of Calculating Illumination.—A shorter way of computing illumination than the "point by point" method is based on the fact that a certain definite quantity of light is required to illuminate one square foot of surface with an intensity

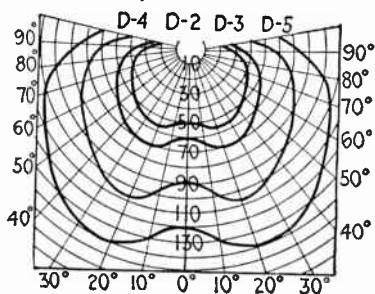
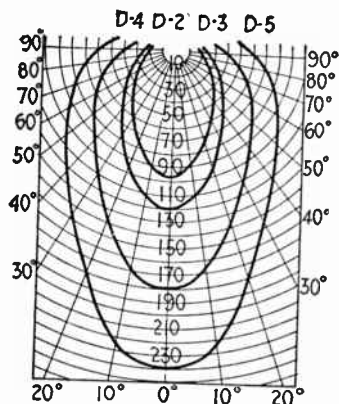

Figs. 3,475 to 3,478.—Frosted incandescent lamps with holophane reflectors and curves showing candle power distribution.

of one foot candle. This unit is known as the lumen; when a lamp is capable of illuminating 400 sq. ft. with an average intensity of one foot candle it may be rated at 400 (effective)

lumens. Therefore to find the number of lamp needed for a given installation, *multiply the area in square feet by the required*

TABLE SHOWING INCREASE OF ILLUMINATION*

Ceiling	Walls	Increase over calculated
Very dark.....	Very dark.....	0%
Medium.....	Very dark.....	15%
Medium.....	Medium.....	40%
Very light.....	Very dark.....	30%
Very light.....	Medium.....	55%
Very light.....	Very light.....	80%

intensity in foot candles, thus obtaining the total lumens, and then *divide this product by the effective lumens per lamp*, that is, the lumens per lamp reaching the plane to be lighted, as given in the table which follows.

TABLE OF PROPERTIES OF VARIOUS LAMPS

	" MAZDA "						Tantalum	Gem	Carbon 3.1 w.p.c.
Watts per lamp.....	25	40	60	100	150	250			
Effective lumens per lamp.....	95	160	250	420	630	1090			
Lumens per watt.....	3.8	4.0	4.2	4.2	4.2	4.3	2.5	1.8	1.5

The expression which determines the number of lamp given above, is, expressed as a formula

$$\text{Number of lamp} = \frac{\text{square feet} \times \text{required foot candles}}{\text{effective lumens per lamp}}$$

in which the numerator = total lumens.

*NOTE.—Example to illustrate the use of the table of properties of various lamp: A store 60' x 150' x 14' is to be lighted with "Mazda" lamps. Considering the goods to be sold (crocker-ery, toys, notions, etc.) table on page 2,524 shows that 3.5 foot candles is sufficient illumination. If clear holophane reflectors be used the values for lumens effective on the plane, given in the table on this page may be increased by 10%, due to reflection from fairly light walls. Total lumens = 60 x 150 x 3.5 = 31,500.

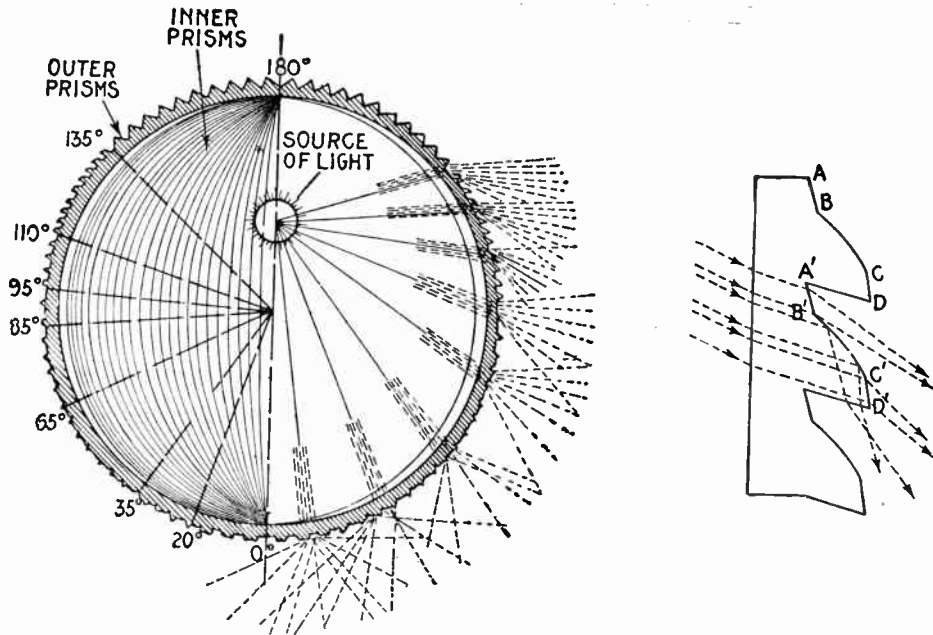

FIGS. 3,479 and 3,480.—Vertical section of holophane globe and magnified section showing three prisms and the manner in which the beams of light coming from the source of light are distributed by refraction and reflection in the desired direction. The external part of a prism consists of four faces. The face A'B', throws the beam falling upon it below its original direction by refraction. The beam falling upon the face B'C', strikes it at a greater angle than the critical angle, and therefore, is reflected downward and passes out through the face D', where it is distributed in different directions by refraction. The face C'D', serves the same purpose as the face A'B', but as the beam strikes it at a different angle it passes out in a different direction. The combined effect of the two systems of prisms on the light passing through a globe is to cut down the amount of light passing the upper part of the globe and to increase the light on a horizontal plane and at all angles below the plane; while the space vertically beneath the globe is also well illuminated.

Ques. How should the size of units be determined?

Ans. By considering the characteristics of the building or place to be lighted.

Choice of Reflector.—Where the light from a single lamp must be spread over a relatively great area, it is advisable to use an *extensive* form of reflector. This reflector is applicable to general residence lighting, or store lighting where a single row



FIGS. 3,481 to 3,485.—Various incandescent lamp filaments. Fig. 3,481 single loop or "U" filament; fig. 3,482, double loop filament; fig. 3,483, single coil filament; fig. 3,484, double coil filament; fig. 3,485, oval single coil anchored filament. The distribution of light from an incandescent lamp depends almost entirely upon the shape of the filament. Single loop or "U" filaments emit only about 5 candle power in the direction of the tip, while the single coil filament, having the same mean horizontal candle power emits about 6.6 candle power from the tip. Since incandescent lamps are usually placed with the tip downward it is evident that the amount of light emitted from the tip constitutes what may be called the "useful light," and it is, therefore, of greater importance than the amount of light emitted in any other direction. It is obvious that the "U" shaped filament emits less light in the direction of the tip than the coil filament for the reason that it exposes less surface in that direction than the latter, therefore, in order to increase the candle power in the direction of the tip, it appears necessary only to increase the number of coil of the filament. It will be noted in this connection, that in the case of the double coil filament, the distribution of light in the vertical plane is 8 candle power from the tip. It must be clearly understood, however, that in practical illumination, incandescent lamps are arranged not only with their tips pointing vertically downwards, but also in many other directions, and that in such cases various kinds of reflector, globe and shade are employed to throw all the light emitted by the lamp in a given direction, or to aid in giving a uniform distribution.

of lights must illuminate a narrow area and the shelves and walls as well; also uniform lighting of large areas where low ceiling or widely spaced outlets demand a wide distribution of light.

Where the area to be lighted by one lamp is smaller, the *intensive* reflector is used. Such cases include brilliant local illumination, as for a card table; single united lighting of rooms with high ceilings such as pantries, and uniform lighting of ballrooms, restaurants, and the like. In the latter case, the units are placed in squares and suspended at the height given in the table on page 2,532.

Where an intense light on a small area directly below the lamp is desired, a focusing reflector is used. The diameter of the circle thus intensely lighted is about one-half the height of the lamp above the plane considered. Focusing reflectors are largely used in show windows, high narrow vestibules and other rooms of unusual height of ceiling. The height of these units for uniform illumination is given in the following table.

TABLE OF SPACING OF UNITS FOR UNIFORM ILLUMINATION

Clear holophane reflectors	Heights above plane to be lighted
Extensive	$\frac{1}{2}$ D
Intensive	$\frac{2}{3}$ D
Focusing	$\frac{3}{4}$ D

D = distance between units = side of square, when units are placed in squares = average side of rectangle, when units are placed in rectangles.

TABLE SHOWING CONSUMPTION OF VARIOUS LAMPS

	"MAZDA"						Tantalum		Gem			Carbon			
												3.1 watts per candle		3.5 watts per candle	
Watts per lamp.....	25	40	60	100	150	250	40	80	40	50	80	50	100	56	114
Candle power at rated efficiency.....	18.8	32	50	83.3	125	217.3	20	40	16	20	32	16	32	16	32
Amperes per lamp at 110 volts.....	.23	.36	.55	.91	1.09	2.27	.36	.73	.36	.45	.73	.45	.91	.57	1.04
Permissible number of lamp per cut out...	26	16	11	6	4	2	16	8	16	13	8	13	6	11	5
Candle power per cut out.....	490	510	550	500	500	435	320	320	255	260	255	210	190	175	160

HAWKINS PRACTICAL LIBRARY OF ELECTRICITY

IN HANDY POCKET FORM

PRICE, \$1 EACH

They are not only the best, but the cheapest work published on Electricity. Each number being complete in itself. Separate numbers sent postpaid to any address on receipt of price. Catalog of series will be mailed free.

GUIDE No. 1 Treating on electrical signs and symbols—static and current electricity—primary cells—conductors and insulators—resistance and conductivity—effects of the current—magnetism—electro-magnetic induction—induction coils—dynamo principles—classes of dynamo—field magnets—Armatures—armature windings—armature theory—commutation and the commutator—brushes and the brush gear—armature construction.

GUIDE No. 2 Motor principles—armature reaction in motors—starting a motor—motor calculations—brake horse power—selection and installation of dynamos and motors—performance curves—location—foundation—belts—auxiliary machines—Galvanometer—standard cells—current measurement—resistance measurement—Christie bridge—tapping sets—loop tests—potentiometer—armature voltmeter and wattmeter—multipliers—electro-dynamometers—demand indicators—watt hour meters—operation of dynamos—lubrication—troubles—coupling of dynamos—armature troubles—care of commutator and brushes—heating—operating of motors—starters—speed regulators.

GUIDE No. 3 Distribution systems—boosters—wires and wire calculations—inside, outside, and underground wiring—wiring of buildings—sign flashers—lightning protection—storage battery—rectifiers—storage battery systems.

GUIDE No. 4 Alternating current principles—alternating current diagrams—the power factor—alternator principles—alternator construction—alternator windings.

GUIDE No. 5 Alternating current motors—synchronous and induction motor principles—construction of alternating current motors—A. C. commutator motors—power factor of induction motors—transformers—transformer losses—transformer construction—transformer connections—transformer tests—converters—rectifiers—alternating current systems

GUIDE No. 6 Transformation of phases—switching devices—circuit breakers—relays—lightning projector apparatus—regulating devices—synchronous condensers—indicating devices—meters—power factor indicators—Wave form measurement—switchboards.

GUIDE No. 7 Alternating current wiring—properties of copper wire power stations—power station calculations—turbine practice—management—embracing: selection, location, erection, testing, running, care and repair—telephones.

GUIDE No. 8 Telegraph—simultaneous telegraphy and telephony—wireless—electric bells—electric lighting—photometry.

GUIDE No. 9 Electric railways—electric locomotives—car lighting—trolley car operation—miscellaneous applications—motion pictures—gas engine ignition—automobile self-starters—and lighting systems—electric vehicles.

GUIDE No. 10 Elevators—cranes—pumps—air compressors—electric heating—electric welding—soldering and brazing—industrial electrolysis—electro-plating—electro-therapeutics, X-rays, etc. This number contains a complete ready reference index of the complete library.

Theo. Audel & Co., Publishers.

72 FIFTH AVENUE,
NEW YORK