

RADIO

ELECTRA

THE

MIRACLE

OF THE

20TH CENTURY





Copyright, Underwood & Underwood, N. Y.
**LOFTY AERIALS OF A POWERFUL RADIO BROADCASTING
STATION**

Photo shows one of the two aerial towers, 133 feet high, mounted on a five-story building of the Schenectady (N.Y.) works of The General Electric Company, which supports the antennae. Daily they send forth programs to the thousands of radio fans in Eastern America.

Note the two steepiejacks at top of tower and compare sizes.



Copyright, Underwood & Underwood, N. Y.

SHE SINGS 100,000 CHILDREN TO SLEEP EVERY NIGHT

Have you listened to sweet lullabies that come floating over the radio? If not, you are missing something. Almost every night she sends out her lullaby music over The Westinghouse Electric Company's radio at Chicago. Photo shows Miss Forster singing for her audience of a hundred thousand.

RADIO

MIRACLE OF THE 20TH CENTURY

BEING

A Vivid, Authentic and Intensely Interesting Story of
Radio Communication and the Remarkable
Accomplishments of Men Who Have
Made It Possible to Talk
Through Space To
People Miles
Away

A STORY OF HUMAN ACHIEVEMENT THAT
STANDS UNRIVALLED IN THE HIS-
TORY OF HUMANITY

TOGETHER WITH

A Colorful Portrayal, Giving a Broad, General View of the Whole
Subject of Wireless Telegraph and Telephone and
Its Marvelous Development

By the well-known Authors and Editors

FREDERICK E. DRINKER JAMES G. LEWIS, M. E.

Profusely Embellished With

Half-tone Illustrations From Photographs, Pen and Ink Drawings,
Diagrams, Etc., Made Expressly for the Book, Showing Phases of
Construction and Visualizing Essential Details.

Entered according to Act of Congress, in the year 1922, by
National Publishing Co., in the Office of the Librarian
of Congress, at Washington, D. C.

PREFACE

IN presenting this volume for public consideration the editors have endeavored to provide the average reader with a vivid picture of the vast realities and possibilities of the marvelous radio as they have and may in the future affect all men in their daily lives; and to trace inception and growth of wireless communication through the fields of science and mechanics to a brilliant climax which has cast a halo around the heads of a dozen men and sent its rays far out into the world.

No attempt has been made to compile a highly technical or scientific volume dealing with electricity and radio communication or to provide a textbook on the subject, but to give in as interesting and simple way as possible a measure of understandable information that will help anyone answer in a general way the questions which every uninitiated person asks: "What is radio?" "How does the lecture or music come through space without wires to carry it?" "Why could I never hear the sound waves before?" and "Who discovered radio?"

Nothing that has been given to the world by science in a century can compare with the radio in the range of possibilities that it opens to man, and no imagination can conceive of the influence it may have upon our lives and the future of the world. A new use and a new application of the principle is being developed almost daily. Its popularity is growing by leaps and bounds. Nothing but the limit of man's genius seems to restrict the field to which it may not in some way be applied.

In the complicated scheme of civilization it may serve as a protector of human life, a companion of the pioneer,

PREFACE

an aid to education, a world-wide entertainer and perhaps a means of communication through which other worlds may be reached. The more you learn about it the more marvelous it seems, and so the editors have tried to convey to you this impression of bigness, of power, of unlimited scope with which the radio seems to be invested in a way that will prove entertaining and reward you for having perused its pages.

THE EDITORS.

CONTENTS

	PAGE
Preface	
CHAPTER I.	
Romance and Marvel of the Wireless—Radio the Sensation of the Age—Most Spectacular Electrical Development in all History—A New World of Science	17
CHAPTER II.	
Simple Facts about Radio—Equipment—Transmitting and Receiving—Functions of Various Parts—Commonplace Definitions—Antenna, Receiver, Detectors	24
CHAPTER III.	
The Wireless Machine—The Telegraph and Telephone—A Million Users in a Year—The Medium of Universal Communication—Useful and Amusement Providing	32
CHAPTER IV.	
Effects and Influence of Wireless Communication on Civilization—International Relations—Educational Possibilities—Future Developments	42
CHAPTER V.	
Scientists and Wizards Who Helped Develop the Wireless—Marconi—Edison—Fleming—DeForest—Squier—Poulsen—Alexanderson—Steinmetz	51
CHAPTER VI.	
Sound Waves—Amplifiers—Condensers—The Vacuum Tube and the Part It Plays—Alternating and Direct Impulses	68

CHAPTER VII.

PAGE

Electricity—What Is It?—Electrons—Atoms—Matter and Its Component Parts—The Valve Theory—What Has Made Wireless Telephony Possible?	68
--	----

CHAPTER VIII.

What Air Really Is—Atmospheric Pressure and How It Was Discovered—Three Forms of Matter—Molecular Attraction —How Big Is a Molecule?—Moisture in the Air—Measure of Humidity	77
---	----

CHAPTER IX.

Radiation—Radiant Energy—Intensity of Radiation—Reflection —Refraction—Diathermancy—Obscure Rays—Absorption— Radiation and Absorption—Distribution of Radiant Energy	86
--	----

CHAPTER X.

Heat Waves—Conduction—Convection—Wave Motions—Har- monic Waves—Interference of Waves—Medium Necessary to Transmission of Waves—The Ether the Medium for Radio Waves	95
--	----

CHAPTER XI.

Magnetism—Lodestone—The Compass—Hard and Soft Iron— Effect on Nickel, Silver, Gold—How to Make a Magnet— —Magnetic Fields	105
---	-----

CHAPTER XII.

What Is Electricity?—The Amber Rod—Glass Rod—Sealing-Wax Rod—Vitreous and Resinous Electricity—Laws of Attrac- tion and Repulsion—The Proof Plane—The Electroscope ..	117
---	-----

CHAPTER XIII.

Electrical Machines—Newton, Hawksbee, Ramsden, Von Guericke —Wimshurst Machine—Leyden Jar—Strain in the Air— Can Electricity Pass Through Glass?	127
--	-----

CONTENTS

7

CHAPTER XIV.

PAGE

- Franklin and His Famous Experiment—What Is Lightning?—
Effect of Atmospheric Change on Electrical Conditions—
Electro-magnetism in Wires, Coils and Spirals—Effects of
Thunderstorms—First Use of Wires for Telegraphic Trans-
mission—The Wire Eliminated 136

CHAPTER XV.

- How We Hear Sounds—Sounds Exist Only Where There Is
Someone to Hear Them—The Telephone Transmitter and
Receiver—In Radio Vibrations Are Reduced to Bring Them
Within the Scope of the Human Ear 144

CHAPTER XVI.

- How to Make a Simple Receiving Set—Aerials—Details of Con-
struction—Great Fun Receiving 151

CHAPTER XVII.

- Radio in the World War—Radio Control and Direction of Ships
at Sea—Airplanes Directed from Land 165

CHAPTER XVIII.

- Radio Regulation—Government Control in Peace and War—
Rules 172

CHAPTER XIX.

- Radio as an Agent of Mercy and the Protector of Man—Heroes
of the Wireless—The Titanic and Carpathian 182

CHAPTER XX.

- Broadcasting—How It Affected the Development of Radio—
Big Electrical Company Pioneers in the Field—Colleges—
Telephone Companies and Amateurs 189

CHAPTER XXI.

- The Theory of Radio—Basic Principles Explained with Dia-
grams—Transmitter—Aerial—Tuning—Receiving Set—De-
tector—Vacuum Tube 196

CONTENTS

	PAGE
CHAPTER XXII.	
Hook-ups an Interesting Study—Same Principles Involved in All—Amplification and Refinements	207
CHAPTER XXIII.	
Vacuum Tube Detector Set Next Step of Progress in the Building of a Radio Set—Back to Simple Principles of Radio Communication	217
CHAPTER XXIV.	
How to Change Inductance and Capacity Energizing an Inductance—Capacity Circuit—The Potential—A Simple Transmitting System	230
CHAPTER XXV.	
A Typical Spark Transmitting Circuit—Spark Gaps—Oscillation Transformers and Coupling—Tuning of a Circuit—Damping	247
CHAPTER XXVI.	
Other Methods of Coupling—Why Tuned Circuits Are Necessary—Resistance—Interference	263
CHAPTER XXVII.	
Now We Come to Vacuum Tube—Electric Action—The Batteries—Grid Action—Vacuum Tube as a Detector—As an Amplifier	279
CHAPTER XXVIII.	
Vacuum Tube as a Generator of Undamped Oscillations—Summary of Radiotelephony—Receiving	297
Radio Dictionary	315

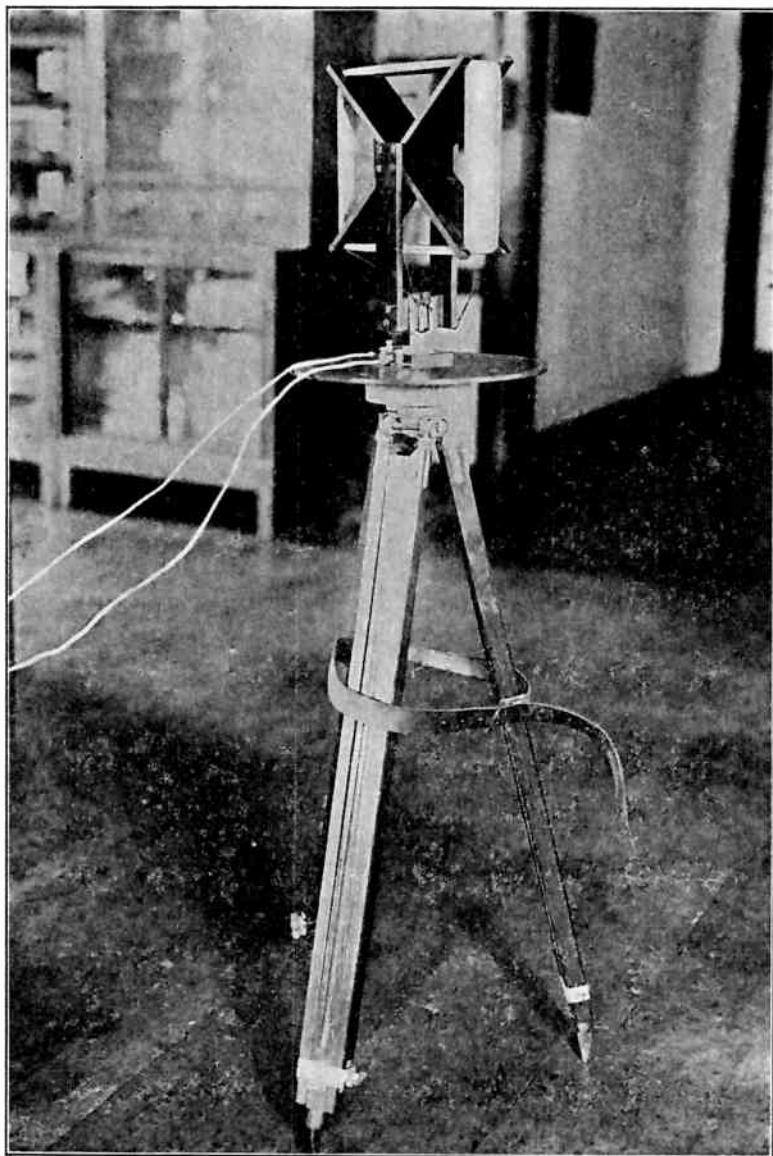

Copyright, Underwood & Underwood, N. Y.
NINE-INCH ANTENNA PICKS UP EUROPEAN RADIO MESSAGES

Photograph shows a coil antenna nine inches square, yet powerful enough to receive wave lengths of many thousand meters. This coil when connected to an extremely delicate receiving apparatus will detect radio signals from European stations. This was made at the Bureau of Standards, Washington, D. C.



Copyright, International

FLORIDA FARMER GETS DINNER CALL BY RADIO

Here's Daniel Talbot, a farmer of Florida, whose immense acreage takes him for some distance from his farmhouse and out of the range of sound of the dinner call. So he's rigged up a small radio set which he attached to his plow. When it's time to eat, Mrs. Talbot, at their home, sounds the call through the transmitter, which Farmer Talbot picks up while at work.

CHAPTER I.

Romance and Marvel of the Wireless—Radio the Sensation of the Age—Most Spectacular Electrical Development in all History—A New World of Science.

OVER our heads there streams day and night throughout the country an invisible traffic more dense than the surging motor cars and vehicles in our busy city streets. There are voices and music "in the air" and a new and marvelous world has been discovered for mankind to explore, through the development of radio-communication—the wireless telegraph and telephone.

To what end the explorations may lead no one knows and few care to venture an opinion. What seemed to be true yesterday may not be true tomorrow. The radio has changed it all. Theories that were held to be good a short while back are found to be fallacious, and rules that were once laid down for the strict guidance of the technician in the field of electricity must now be disregarded.

That a man in New York could project his voice into space so that his song or his message could be heard in Chicago or San Francisco—in London or Paris—without resorting to the use of a wire to convey the sounds of his voice would have been regarded as preposterous a few short years ago, and the man who had the temerity to claim that he could do such a thing would have been regarded as a fit subject for observation in a sanitarium.

And yet, men are talking not merely from one city to another through space, but they are talking to thousands all over the face of the universe at one time and with one effort and one voice because of radiotelephony.

It would require the imagination of a Scheherazade, who entertained her king with marvelous tales on a thousand and one Arabian nights, to conjure up the wonderful things that may be accomplished through the medium of radio communication, and to describe the effects upon the world of the discoveries that have been made in the field of electricity within a few short years.

For several years prior to and during the great war there had been the ripping crash of the wireless telegraph in the airplanes overhead, but it was only after the war that the radiophone came into its own, opening up a revolutionary field of human achievement. Almost in a day radiotelephony became the rage in America. The wireless telegraph with its great sparks possessed many seemingly mysterious and spectacular qualities viewed from the popular standpoint, but it made no such appeal to the imagination as did the radiophone when some realization of its possible uses became known.

EVERY HOME AN AUDITORIUM.

The fortunate owner of a radio set was privileged to enter the new world of the air. Men of science made several important discoveries and perfected devices which made it possible for the veriest novice to pick out of the air words, messages or music sent broadcast over the face of the earth from powerful electric stations.

The radio owner was enabled not only to enjoy news and entertainment furnished daily by broadcasting stations in his own city or near-by centres, but he had entree to the radio amusements of cities hundreds of miles away and the cozy radio room in any radio-equipped residence might easily become the auditorium for an orchestra playing in a city 300 or 500 miles away.

The fact that such things were possible with any sort of

a device would have been sufficient to arouse world-wide interest, but the fact that any intelligent boy can for a few dollars devise a radiophone with which he can hear the mysterious messages and waves of music that he knows are floating somewhere overhead, adds to the intensity of the interest and causes the radiophone to gain a portion of popularity within a few short months that has probably never been attained by any other device in the history of the world.

It is not the purpose at this point to describe the wireless telegraph or telephone, but it is important to note that the amateur radio enthusiast may for as little as \$3 or \$4 construct a receiving outfit with which he can "listen in" on messages and hear music broadcast from stations within ten or twenty miles of him.

But once he is able to hear the station within a short distance of him his ambition grows; he wants to hear one at a greater distance, and his demand for more efficient equipment becomes insistent. When he gets a better receiving set and hears Pittsburgh, or Chicago, he wants to hear San Francisco, the next day Honolulu and then he wants to get Mars.

RADIO DEMANDS ENORMOUS.

All this is natural because human desire is a progressive ailment, and out of it there develops the spirit of competition and rivalry. The boy with the \$10 receiving set who heard a station further away than did his neighboring boy friend with a more expensive set, had achieved something, and he had something to be proud of and of which he could boast to his friends.

A gauge of the intense interest aroused in the new science-sport is provided by the records of factories engaged in turning out parts for the construction of radio

sets. During the latter part of 1921 and the first half of 1922 it was impossible for the makers to keep up with the demand. This was especially true of those manufacturing vacuum tubes used as detectors, amplifiers and also as transmitters.

In England crystal detectors were chiefly used in the early stages of radiotelephony, and this was true in America for a time, but with the increasing knowledge and experience of the amateur there came a sweeping demand for better results which the vacuum tubes give and the makers were swamped with orders. In the first eleven months of 1921 factories working for one of the largest radio corporations made an average of 5,000 a month. Then broadcasting became popular and the calls for tubes jumped to unforeseen proportions.

DEMANDS HELP BUSINESS.

By the end of December, 1921, the factories had increased their output to 40,000 tubes a month. Then the schedule was jumped to 60,000. With the establishment of every large broadcasting station came increasing demand and the output jumped to 100,000, then 150,000 a month and finally to 175,000—all within a period of about half a year. That the makers were confronted with difficulties in meeting this increase in business goes without saying, when it is understood that the tubes are made principally by hand.

The sweep of radio enthusiasm over the country naturally had a very salutary effect from an economic and commercial standpoint. The world of industry was suffering from stagnation and business was "slow" when the wave swept over cities and towns causing unusual activity in all concerns dealing in or having to do with electrical equipment and supplies and thousands found occupation who had been in idleness.

Great department stores and musical houses found in the radio a loadstone that drew thousands into their places and commercial reports seem to indicate that the general improvement in business conditions in the first half of 1922 was in part caused by the interest in the radio.

RADIO BOON TO FARMER.

There is political significance too, in the advent of the radio, for everyone knows the power of personal appeal to the voter and the sometimes difficulty experienced by political candidates and spellbinders in reaching the right individuals. The radio opens a new field of possibility in this direction for the candidate who has a message to deliver to his constituents can send his own voice into their homes. He can to all intents and purposes make a call and talk directly to people who have never been available to him, putting actual personality into his message. Moreover he can talk to thousands of voters at one time, and since it is necessary to reach the woman in the home, because of their recent enfranchisement, the radio will solve one of the problems which has been puzzling the political aspirants and bosses everywhere. A number of candidates in various parts of the country have made good use of the radio and with the increasing number of receiving sets in operation its use will become effective. In keeping with this thought Senator New, of Ohio, when faced with the impossibility of keeping an engagement in which he was to deliver an address to women in his own state, kept his promise by arranging to have an adequate receiving set installed for the women and broadcast his address from Washington.

Where the ordinary means of communication are lacking is where the radiophone reigns supreme and it is proving a boon to the farmer, not merely as a source of

information from the wide world, or of amusement but as a convenience. On one great farm in the west, the owner rigged up a small receiving set and installed a small transmitting station so that his wife could send messages to him wherever he might be on the big acres that comprise his farm. The Chicago Board of Trade also installed a station from which to send out reports, market quotations and similar matter to farmers of the west.

In some of the major hotels of the country efforts have been made to connect up various rooms in the hotel to a single receiving station so that any guest who desires to hear might do so without leaving his room. In other places a radio room has been equipped so that the guests can assemble and hear the concerts and talks sent through the ether.

AN AUDIENCE OF 100,000 PERSONS.

We are accustomed to regarding an audience of 3,000 or 4,000 persons as representing a very large gathering, but if one can picture a mass of probably 100,000 persons listening to one opera, it will give some conception of what the radio accomplishes where no other device could serve.

One of the first picturesque steps of the Westinghouse Company in Chicago was to broadcast the opera of "Samson and Delilah" from its set on the Commonwealth Edison Station in the western metropolis over an area approximating 700,000 square miles through the middle west. The opera was heard by people scattered from New York to Kansas and from Minnesota to Kentucky.

Unlike many other broadcastings this one was made under actual operatic conditions. It was begun with an address by Mary Garden, the Director of the Chicago Opera Company and was followed by the rendition of major parts of the opera. The transmission of the opera

was secured by placing small transmitters high up in the wings of the auditorium stage of the Chicago Opera House, from whence the tones were carried to the Westinghouse station.

Notices regarding the test had been previously sent abroad and broadcast to wireless stations throughout the west, and on the night of the first wireless opera thousands listened-in. The Westinghouse Company and the Opera Company received letters from Texas, North Carolina, Vermont, Minnesota, and even Canada.

The significance of this is greater when it is realized that until the advent of the radiophone the opera, except on rare occasions, was a closed book to thousands of farmers and ruralites scattered over the broad lands of the middle west.

The demonstration is proof that science has bridged another epoch and humanity is richer. Edward Bellamy's dream, presented in his memorable "Looking Backward," published in 1888, is realized. He visualized a great coöperative commonwealth of the twenty-first century in which nobody need leave their homes to hear the great musical concerts. Mr. Bellamy painted a picture of family groups gathered in the home, where they pressed a button and concerts commenced which lasted for a considerable period each afternoon and evening.

CHAPTER II.

Simple Facts about Radio—Equipment—Transmitting and Receiving—Functions of Various Parts—Commonplace Definitions—Antenna, Receiver, Detectors.

BEFORE one can comprehend the vast possibilities of the radio and the intricacies of the new science in electricity it is necessary to have a general understanding of what it all involves and some idea of how and with what means and devices scientists have obtained the wonderful results.

Radio communication involves three definite operations: First, there must be a suitable source of radio energy, which is designated the "transmitter" capable of imparting the energy to space, or the ether, as the scientists call it. Next, the radio energy converted into vibrations of the ether, is projected through space in wave circles over the surface of the earth. The waves, naturally gradually lose their power as they extend farther and farther away from the source, just as the waves produced in a body of water by the throwing of a stone, decrease in height as the circles increase in size and the distance from the centre becomes greater. The third step is to intercept the ether waves at any desired point—to catch whatever message has been projected. For this purpose a receiving set is used.

It is obvious that the more powerful the transmitter the further the circle of ether waves will extend, and that the more sensitive the receiving set, the further away from the original point of transmission the waves will be felt. For this reason waves that may be felt by one re-

ceiving set at a distance, of say, two hundred miles will not be detected by another set less sensitive.

Effective radio service, therefore, resolves itself into the matter of distance from the transmitting station, and the receiving set employed. To the individual interested in the newest science the receiving set is the one big thing. To this there are five essential parts. The antenna, the lightning switch, ground connection, the actual receiving set or device, and the phone.

The received signals or waves come into the actual receiving set through the antenna and ground connection. The antenna is therefore a highly essential factor in the big system. This is simply a wire or set of wires suspended between two highly elevated points.

If you are at all familiar with ants you will have some idea of what the antenna is. The electric experts have taken the word antenna from entomology. The wires are "sensitive feelers" which detect the waves that strike them in the air or ether space. The waves are projected from the transmission station and when they reach the antenna extending up into space they impart to it the identical wave motion.

If you lay a block of wood on the surface of a small pool near the bank or shore, and strike it sharply, it will bob up and down on the waves. A similar block of wood laid quietly on the water at the opposite side of the pool will have imparted to it the same motion when the waves created by the striking of the first block have extended across the pool. Both blocks will follow the wave undulations and move together. This is precisely what happens in radiotelephony. The antenna when struck by the ether waves moves precisely as do the waves projected from the transmission station.

The antenna and the ground wire with the lightning switch constitute a protective device when used together. When the switch is closed the antenna and the ground form a lightning rod to protect the building to which they are attached as well as the sensitive receiving set.

AN ADJUSTABLE SENSITIZER.

The principal parts of the actual receiver are the "tuner and detector." Stripped of its technical description the tuner is a knob or lever which modifies or amplifies the sensitive qualities of the machine so that it is susceptible to the wave motions which it is desired to receive. It might be termed an adjustable sensitizer.

If one wore a pair of spectacles which permitted only a given shade of pink light to pass through them it might be said that the wearer was tuned for that shade of pink light. Other shades of light would not be seen by the wearer.

In radio this same situation is found. Radio waves are of different values or wave lengths, which are referred to as lengths in meters. One station uses a wave 360 meters long; that is the transmitter is keyed up to send out ether waves of this length. When the knobs on the tuner are manipulated to catch this wave they must be turned to a point where in effect the machine vibrates to these wave lengths.

Nearly everyone has heard a violin, guitar, mandolin or other stringed instrument standing or lying in the room, suddenly vibrate in sympathy with a note struck on a piano. The same effect is produced when the radio receiving set gets in tune with the transmitting station.

So it is that if the receiver is tuned down to waves of a hundred or two hundred meters, the message or music carried on the waves, is heard from some point closer at hand. If the machine is tuned higher the vibrations from

a high powered station that sends across the Atlantic may be felt.

This tuning of the transmitter and of the receiver is what will make it possible to have what is known as selectivity in radio communication. The machine that is tuned to three hundred and sixty meter waves will not record those sent out in waves of two hundred meters. And so finely adjusted are the more pretentious radio sets that it is possible to shut off waves of a very small percentage of difference in variation. A wave of 200 meters length may be received and one of 205 meters length shut out.

By standardizing the use of wave lengths it is proposed to prevent confusion in the great ether channels of traffic above. It is planned that music shall be sent out in waves of one length, business reports in waves of another length, lectures in a third length, weather reports in still another, and so on.

WAVE LENGTHS FOR NATIONS.

The Government will reserve for itself the right to use waves of a specified length for all official communications and statements, and in international affairs if we wish to hear London or Liverpool we shall tune to one wave length, and if we wish to hear Paris we shall tune to another. The range of wave lengths is almost unlimited, in so far as variations are concerned and for this reason it would be possible for every Nation to have its own wave length.

This plan will of course prevent one message from interfering with another, and the program in this direction is being worked out. Something about this is discussed elsewhere. But to return to the physical aspects and qualities of the actual receiving apparatus.

Technically the process of tuning is accomplished by varying the induction and capacity. Inductance may be

defined as the transferring of a current from an electrified to an unelectrified conducting body without actual contact. The possibility to do this is one of the phenomena of electricity which has made the radio possible.

WHAT CAPACITY MEANS.

Capacity is a term used largely in connection with condensers and refers to the ability of the condenser to store up energy. In common usage the inductance variation is obtained by what are termed steps—by taking taps at every so many turns of wire wound on a large tube, the taps being connected to the points of a switch or binding posts, or again by what is known by a sliding contact. That is a coil of wire through which the current must flow, and which is arranged so that a point or finger can slide along the surface of the coil and establish an electrical contact at any preferred point. This is called a tuning coil. In the finer apparatus there is used what is termed a variometer. In this movable coils are arranged to rotate within a fixed coil, so that the electric current may be made to flow in the same direction in both coils or in opposite directions. When the windings are in the same direction the inducements are greatest; when arranged in opposite directions, they are in what is known as “bucking” position and the inducement is lowest.

The condenser is a device which determines the capacity as already indicated. The commonest type consists of a group of fixed aluminum or brass plates and a set of movable plates which pass in and out between the stationary plates when a handle or lever is turned. The plates do not touch each other and the surrounding air serves as what is technically known as a dielectric or non-conductor.

Besides tuning to the proper wave length it is necessary for the receiver to have a detector and a telephone

receiver. The detector may be of what is termed the crystal type, or the vacuum tube type. The former is the simplest and least expensive, though probably not as efficient. Still there are many fine machines constructed with this type of detector.

CRYSTAL DETECTORS.

It has been discovered that many crystals possess the qualities essential to make a detector—i. e. the property of suppressing one of the impulses of an alternating current of electricity. It is absolutely necessary that this be accomplished to make radiotelephony possible for the vibrations set up in a receiving set are so rapid—have such a high frequency—that they cannot be heard in the ordinary telephone receiver.

The crystal makes it possible to separate one alternation from another and thus produce spurts of electricity in one direction only. The crystal might be called a deterrent. Certain forms of carbide of silicon, (carborundum), molybenite and hessite are among the best known crystals of this sort. There are also crystals which when used in pairs—in contact—are better conductors in one direction than others, and serve the same purpose as the vacuum tube, described elsewhere. Among these are galena, graphite and zincite.

The purpose of the detector is obviously to transform the signals or waves, which have been tuned in, into audible sounds in the telephone receiver. They slow them down. In use the crystal detector is kept in contact with a metal point, or another pointed crystal. A sensitive spot is found on the larger crystal, but the detector must be adjusted as the larger crystal from time to time loses its sensitiveness. For this reason the vacuum tube is more efficient, for it is constant in its service, more easily adjusted and many times more sensitive.

The part played by the antenna—frequently called the aerial—has already been stated, but its physical relation to the outfit should be thoroughly understood. It may be anything from a single wire to a group or great series of parallel wires reaching out and up into space.

For the radio equipped to receive the ordinary broadcasting, a wire about 100 feet long stretched between the house and a tree or a high pole may serve, but two wires will generally prove more effective, and if more than 100 feet long the chances are that there will be a higher degree of efficiency. The wires must be insulated.

Such an aerial would not of course, serve for a great broadcasting station. The radio Central at Rocky Point, L. I., by way of comparison, uses an aerial one and one-half mile long and 410 feet high and is composed of 16 wires. For amateur receiving the size and kind of an aerial depends upon several things. With a better grade of receiving apparatus results may be obtained with a short aerial that could not be obtained with a poor receiving set, and conversely the longer antenna should be used with the less efficient receiver.

As in almost everything else that has to do with radio, the changes that take place are very rapid and one of the later forms of antenna developed is called the "loop." Instead of employing an aerial with the ordinary connection, a simple frame of wood, sometimes square, like a window frame, but more often in the form of a letter X, with half a dozen turns of wire around it, is employed. Such a loop may actually be used by suspending from the ceiling in the house, but since it cannot intercept as much energy, the deficiency in the amount of energy absorbed must be made up by the higher efficiency of the receiving apparatus—one with more powerful amplification.

The loop is considered one of the wonders of radio development because it not merely intercepts the waves, but can be used as a direction finder. It will indicate the direction or source of the waves. The wire is wound around the outside of the frame.

LOOP LOCATED GERMAN SHIPS.

During the World War the British fleet located the German fleet by tracing the source of the wireless messages sent out from the German flagship by using the loop as a direction finder. The loop acts best when turned in the direction of the oncoming waves—that is when the edge of the frame is turned toward the source of the wave centre. It is less efficient when the frame is sidewise or at right angles to the waves.

This being so, it is plain that by turning the frame the source of the waves can clearly be determined. Some interesting things have been accomplished by the use of the loop as a finder as will be shown in another chapter.

In the technical discussion of the wireless two terms that may perplex the uninitiated are "audio-amplification" and "radio-amplification." A clear understanding of what is meant by these expressions may be gained from the statement that audio-amplification is the amplification of the sound waves after detection—the use of devices which make the wave sounds more audible after they are picked up. Radio-amplification, in a general sense, is amplification of the waves before detection—the use of amplifiers which makes the feeble waves more easily detected in the receiver. The understanding of these facts is highly essential in the operation and construction of receiving sets and should be carefully studied by anyone desiring to go into the theoretical or practical sides of the subject.

CHAPTER III.

The Wireless Machine—The Telegraph and Telephone
—A Million Users in a Year—The Medium of Universal
Communication—Useful and Amusement Providing.

MEASURED in units of time the world is now about one-tenth of a second wide. Radio is the new instrument with which we measure the world's width in this astonishing fashion. Viewed through this magic reducing glass created by man the earth, for all its eight thousand miles diameter, seems to have shriveled into a ball so small that it might be held in the hand of a playful child.

San Francisco no longer is three thousand miles distant from New York. It is within speaking distance. The whole world has become one vast auditorium in which the speech of one man may be heard by all. Chinese and Patagonians, Esquimaux and Africans, and Japanese and Americans have become next-door neighbors and may hear together the speech of the Parisian, the Londoner, the New Yorker or the Mexican at one time. And all of this because of the wireless—the Age Miracle.

With the strides that wireless has made it is no idle dream to picture a woman comfortably ensconced in her boudoir sipping her morning coffee and listening to a tempting list of offerings at her favorite shop. The wireless has formed the connecting link between grand opera as rendered in Chicago or New York or Philadelphia and the farmer's daughter sitting at her father's fireside. Train orders now are sent miles through the chartless ether to the swiftly-flying train. And the end is not yet.



Copyright, Underwood & Underwood, N. Y.

CHIEF OF ARMIES USING RADIO TELEPHONE

With practically every member of the President's Cabinet making use of a radio telephone, General John J. Pershing, chief of the armies, has become interested. Photo shows the famous general at his desk using the radio phone.

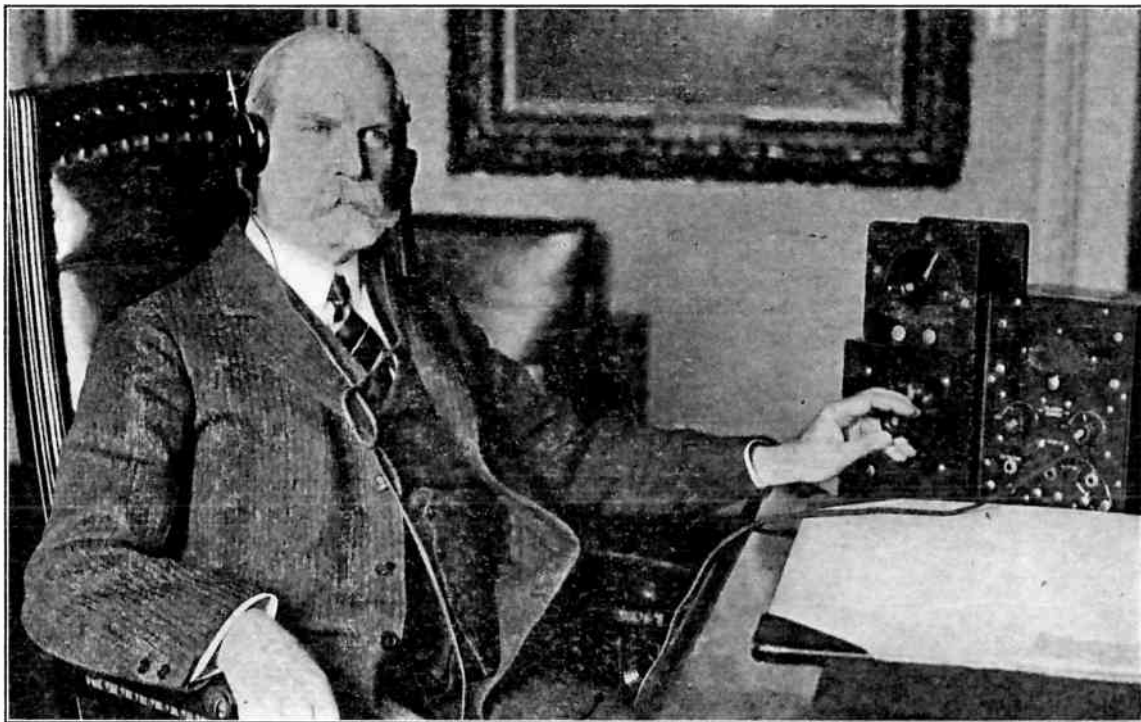

Copyright, Underwood & Underwood, N. Y.

HUGHES INDORSES RADIO TELEPHONE

Secretary of State Hughes has agreed on the value of the radio telephone and was photographed in his office sending a message. Practically every member of the Cabinet now has a radio telephone in his office.

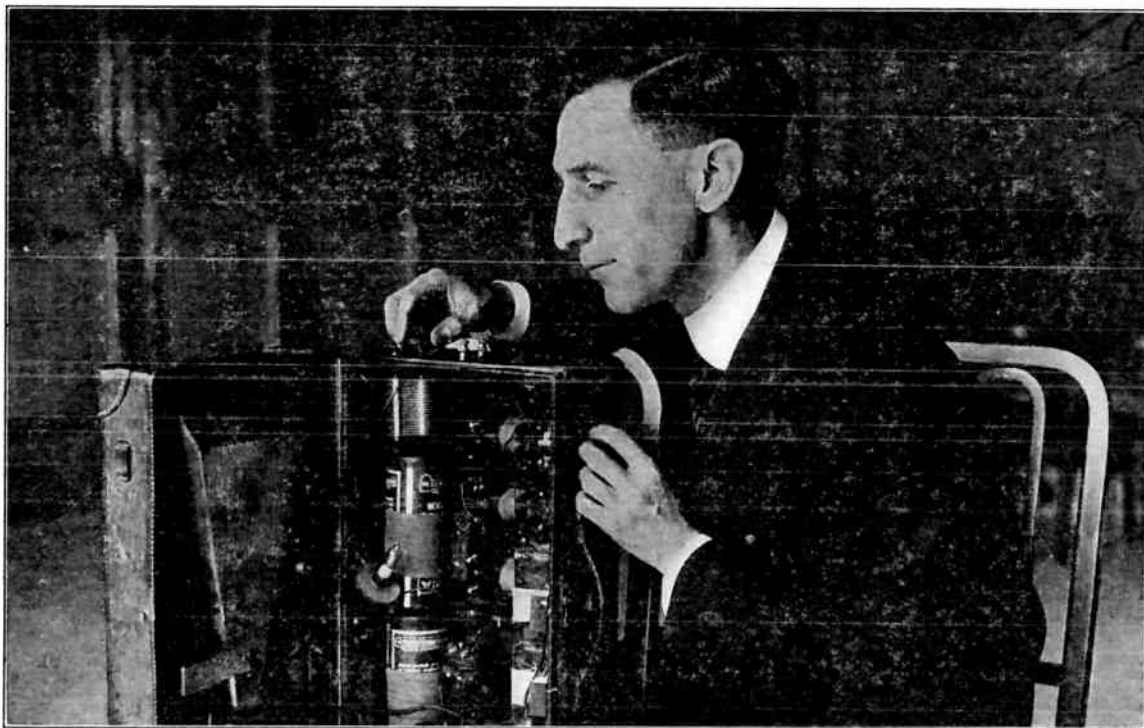

Copyright, Underwood & Underwood, N. Y.

"THE SINGING VALISE," OR "TALKS-AS-IT-WALKS"

This photograph shows one of the most compact Radio sets ever assembled. F. W. Dunmore, of the Radio Laboratory of the U. S. Bureau of Standards, was walking around the lobby of a hotel in Chicago while market reports, grand opera and other sounds came from his valise, which is about one-third the size of an average suitcase.

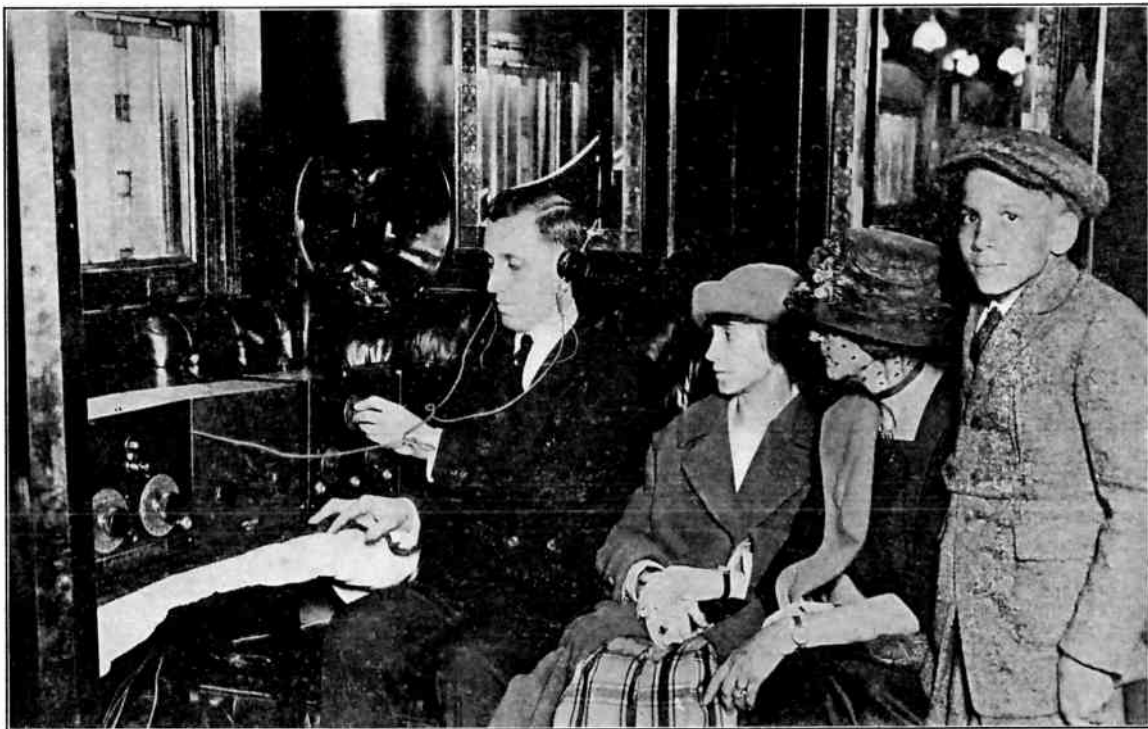

Copyright, Underwood & Underwood, N. Y.

RADIO IS INSTALLED ON CRACK FAST TRAIN

The "Pioneer Limited," the fast train on the Chicago, Milwaukee & St. Paul Railway, has installed Radio in their Club Car. Passengers who have "listened in" pronounce it one of the most complete sets.

Man is but beginning to realize the possibilities of this most wonderful of inventions.

Manufacturers of electrical supplies—and more especially those who are foremost in the development of radio equipment and parts—have had from the beginning but one story to tell, and that was that they were more than swamped with orders. Distributors of apparatus, asked about radio, have assumed a bored air, and remark quite nonchalantly, “Oh, yes, we could sell hundreds of outfits but—try and get them. They are sold the minute they hit our store.” One large company had more than fifteen million dollars worth of orders on hand and was refusing to accept more until production had to a definite extent caught up with the ever-increasing demand. The Electrical World is sponsor for the statement that within a year instruments in use increased from fifty thousand sets to more than a million in constant use. In many cases business men have added their wireless call and their wave length to their letterheads.

GLOBE DOTTED WITH STATIONS.

But even as this industry—this wonderful invention—gets momentum and begins to spread its usefulness to all corners of the earth immediately there arises a difficulty and a very serious one. Who shall decide what is to be done about distributing? Which nation is to be given prior rights to a certain wave length; For, it is easy to see that immediately there have been all sorts of complications occasioned by the sending out of wireless impulses in all directions into the trackless air. There must be traffic rules, even as there now are traffic rules for the use of the air by airplanes.

Every region of the globe is becoming dotted with sending equipments installed at an expense of several hundreds of millions of dollars. Even experts are finding

themselves from day to day very much at sea concerning wireless, so fast its progress has been, so wide its scope has become and so limitless is its field. What may be done in the future is merely a matter of conjecture. Already automobiles have been equipped with receiving apparatus and already there has been found a way for individuals to carry along with them apparatus which will permit them to pluck from the air a "message from home."

All of this leads to a consideration of several complicating angles of the problem. What effect will the perfecting of the radio equipments have upon the present method of transmission of power, and of transmission of messages themselves: Surely, the recent work that has been done by Dr. Steinmetz the electric wizard with artificial lightning would tend to indicate that there is possibility of the wireless transmission of power. Think of the tremendous possibilities of that one item alone! Is there any limit to what will grow out of this invention? And, then, what after all *is* wireless?

ELECTRO-MAGNETIC WAVES.

Wireless actually is nothing more nor less than the sending and receiving of electro-magnetic waves through the ether. Think of the earth as being a great big ball surrounded by *space*. Remember that when we say *space*, we refer to the scientific meaning of that term and include all interstices between the molecules or atoms that go to make up a mass. Thus, there is *space* in a brick, in a tree, in a piece of coal, for in each case the matter is made up of constituent parts which are formed together according to the wonderful laws of cohesion and adhesion—but which have between them a certain amount of *space*.

We have mentioned electro-magnetic waves. What are they? They actually are disturbances, vibrations if you

will, traveling through the ether surrounding this great big earth of ours. The sunlight that lights our daily activity—and, indirectly by moonlight, our nightly movements—is nothing more nor less than the result of electro-magnetic waves. However, the waves of the sunlight are of such length that they are discernible to the human eye. Then, too, we know that the sun generates heat and that Man generates heat by other and artificial means. This heat is discernible by us through what is known as heat waves. These heat waves are simply electro-magnetic disturbances of such length as to be discernible by the human body through the sense of feel.

WAVE LENGTHS UNLIMITED.

Both light and heat are the same thing as the phenomenon with which we are dealing when we think of the wireless or radio. They are simply electro-magnetic waves or disturbances. The wave length of light is about one-fifty-thousandth part of an inch. The wave length of heat is five times as long—one-ten-thousandth part of an inch. The wave length of wireless varies from 100 feet to two miles or more. Thus, you see that these waves are beyond the recognition of the human system and have to be converted or “tempered down” to the human mechanism before they make their true impression. This is done through the radio receiving sets that have been perfected. Wireless, therefore, is simply the creation of artificial wave lengths of such vastly greater lengths than heat waves and light waves as to be readily distinguishable, and the ejecting of these waves out into the ether so that they may be intercepted or picked up by other men.

The variety of lengths that may be sent or “broadcasted” is without number. Thus, waves 500 feet long or 2,000 miles long may be sent out and man can inter-

cept and interpret them, and any two persons or any group desiring to communicate can "tune" or adjust their sets to receive only the waves of the length in which they are interested and thus eliminate or weed out all other waves or impulses. Thus it is possible for an amateur to broadcast on a comparatively short wave length at the same time that a larger public sending station in the same city is sending out its daily program. Due to the difference of the wave lengths, there is no conflict. This is what is referred to as selective receiving.

DIFFICULTIES WITH WAVE LENGTHS.

It is not now possible to refine closer than one per cent, so it may be seen readily that waves of 5,000 feet would interfere with waves of 4,950 or 5,050 feet. In other words we cannot detect the difference between waves of these lengths. Since it is these long waves that are used to transmit messages over longer distances (inter-continental messages, etc.) it will be of great interest to the whole world to know how and what international regulations will be possible to control the sending of these waves which, it would seem, would be bound to give rise to international complexes. It readily is seen how fundamentally important the radio is to become to corporations owning and operating ships, in keeping in touch with their vessels during the course of their voyages. The refinement of the process of selective receiving and perhaps some equitable arrangement of the wave lengths of the various nations may serve as a solution to the present big problem—not to say tangle. Perhaps one single invention may increase the possibilities and usefulness of the radio tenfold.

Wireless radio communication may be said to be at the present time of two distinct types. There is the original form of the wireless, which is based upon practically the

same principle as brought forth by Marconi. This is what is known as the true wireless, or so-called "universal" wireless. Then there is the type known as "wired wireless." This latter type perhaps of the two presents the greater possibilities for future development. It is based on the scientific work that has been done by Major-General George O. Squier, of the United States Army.

"Universal" wireless is sent out broadcast by means of a mechanical device which launches into the ether electro-magnetic waves of uniform and exact, as well as predetermined, length. The length of the impulse and the amount of time that elapses between them determines the message. In other words, the code is based upon these two features. The dots and dashes of the Morse telegraphic code, so familiar because of the years of general use, are obtained by variance of the duration of the wireless impulses.

The distinctive feature of this method of sending (and perhaps its cardinal drawback) is that impulses sent out in this manner are impelled or scattered in all directions. The message is imparted in every direction impartially. In other words, radiation takes place, just as every corner of a room would be warmed by rays from a round stove placed in the center of the room. This makes it possible for any message to be picked up at any point, providing the receiving set is properly "tuned." The wide difference between the amount of energy required for this type of broadcasting and for receiving of messages broadcasted in this way is readily conceivable. At the present time it requires well over a trillion times as much energy to send forth a message that will "carry" across the Atlantic or the Pacific as it will require to pick up that message on the other side.

And so it readily can be seen that this universal method

of transmission is very costly, relatively speaking. Necessarily, the simple rules of mechanical economics show this fact. The impulses traveling as they do in all directions around the circle of 360 degrees, must of necessity develop a tremendous amount of waste energy, sending forth the impulses that travel in every direction other than the one particularly desired. Then, too, it readily may be seen that any message sent forth in such a fashion immediately becomes the property of anyone who can "tune in" with that message and hence there is absolutely no secrecy possible in connection with this method.

RADIO FOR TRANS-OCEANIC WORK.

When radiotelephony first became known to the public in general a great deal of speculation was indulged in as to what the effect of this invention and of the improvements incident to it would be upon commercial enterprises such as Transatlantic cables, long-distance telephony, etc. Especially in connection with Trans-oceanic communication it would seem that the likelihood of the wireless method of communication becoming a serious competitor of the present cable system is very small indeed. The high cost of installation of plants sufficiently large to take care of transmission of the waves and the high overhead expense incident to the maintenance of these plants preclude such a possibility. The laying of an oceanic cable seems to be practically the first and the last cost. Comparatively speaking the cost of the energy necessary to drive a message across the ocean through a laid cable is a bagatelle as compared with the present cost of wireless impulse. Then too, the item of privacy will have a large consideration for a period of time, or at least until further refinements are possible. The theory of wired wireless, as advanced by General Squier, seems to have proved itself out as being very sound and its

practical application has been accomplished. General Squier has proven the fallacy of the belief that wireless and wired telegraphy and telephony are separate and distinct propositions.

GENERAL SQUIER'S DISCOVERY.

General Squier came into the wireless field at an extremely fortunate time, when certain other improvements that were being constantly effected, dovetailed in beautifully with the experiments that he made. He went ahead without bias on the theory that there might possibly be a real connection between wired and wireless communication. And his reasoning along this line was prompted by a very simple fact. In sending out wireless impulses, the waves are conducted along wire antennæ, from which they are led off into the air and projected into space. In other words, they are guided those initial few feet by the wired antenna, much as the rifle bullet is given its initial direction and mode of flight by the rifling or spiral grooving of the barrel. Wireless waves, although there are projected in the "universal" method in broadcast fashion, nevertheless follow the curve of the earth. This they must do because of the trend of the ether surrounding the earth. What held those waves parallel to the earth's surface instead of permitting them to fly off into thin ether at a tangent to the earth's surface? Surely, reasoned General Squier, it must be the attraction of the earth or some other effect similar to that of gravity. Could not a substitute for this attraction be effected? His first comprehensive experiments were conducted in 1910, showing the time and thought that has been put into the development of his theories—theories which are just now actually finding a really big place in practical radio work—or commercial radio?

Briefly as possible, General Squier proved to his own satisfaction, and later on to the satisfaction of other scientists and experimenters along the lines of radio communication, that wave impulses set up along a wire or parallel to a wire would follow the wire along its full length, as far as the energy behind the impulse would permit. The wire acts as a sort of chaperon to the waves and conducts them along through the air in the way they should go. At the time General Squier began his experiments long-distance telephone messages were conducted over strung wires and were sent *One Message at a Time*. However, General Squier's discovery made it possible to transform this one carrying wire into a sort of guide wire making possible the transmitting of more than one message—in some cases as high as forty or fifty—through the use of the one wire. This does not mean in any sense of the word that more than one message can be sent *Through* a wire at one time but it does mean that the wire can be used to guide messages so that more than one message can be sent at one time, the wire guiding those messages and seeing to it that they stay in the narrow path which they were intended to travel. It now is possible to carry between New York and Chicago over one wire five distinct and separate telephone conversations and as high as eighty telegraph messages, General Squier's theories or rather the developments that have grown out of them have been styled multiple telegraphy, meaning the telegraphing at one time of more than one message or impulse. Thus the wireless in this case has greatly aided the well-established and essentially correct method of wired telegraphic communication, but that for the several reasons outlined it will not supplant the wired system.

The possibilities of wireless communication may readily be seen. Messages which do not of necessity have to

be made strictly private can be "broadcasted" efficiently by means of the radio. Messages which are strictly private in their nature cannot as yet be handled with this feature of privacy intact. Later, refinements might overcome even that point. Nothing seems impossible in this age. Any person or group of persons with a message which lends itself properly to broadcasting will find in the radio, even as far as it has been developed, a wonderful medium of communication. Already organizations like department stores, lecture organizations, etc., are broadcasting programs of amusement or education aspect. The scope of this type of communication for extension of our present educational features is without limit. Think of being able to sit in your home at night and by simple adjustments to "tune out" until you have coming in to you in distinct and easily discernible speech a lecture on engineering, or bookkeeping, or salesmanship or advertising or what not.

The government is sending out the official time, announcing weather reports, giving out crop statements and advice to farmers. The Public Health Service figures that it is reaching a total of approximately 700,000 receiving sets through this medium of communication, with a series of comprehensive and educational lectures on general health. Many other fields of usefulness are being developed from day to day and to enumerate the possibilities is but to recite a list which would be all too patent to the average reader. Suffice it to say that nothing has been given Mankind to date that is so full of promise for future benefit and growth and improvement as is radiotelephony at the present moment.

CHAPTER IV.

Effects and Influence of Wireless Communication on Civilization—International Relations—Educational Possibilities—Future Developments.

THE history of radio is a striking example of how scientists laboring in the field of pure research to accumulated knowledge and imagination can spur reach conclusions and make discoveries of vital importance to the world.

As early as 1867, James Clark Maxwell, an English mathematical physicist, laid one of the foundation stones for modern wireless telegraphy when he adopted and proved the theory that light is an electro-magnetic effect—not mere mechanical motions of the ether, but consists of electrical undulations. Twenty years later Heinrich Hertz, a German professor in physics, proved that Maxwell's theory was correct by actually producing electro-magnetic waves in such a manner that their propagation through space could be examined. His experiments showed that they possessed many of the properties of ordinary waves of light but that the waves were longer. The waves he produced are the waves of radiotelegraphy sometimes referred to as "Hertzian waves," and are the waves that transmit signals or human speech in radio communication.

But neither of these great men realized that these waves could be used to signal through space without wires, and Guglielmo Marconi in 1894 was the first person to actually utilize the Hertzian waves to signal a short distance. Within a few years he had succeeded in using the waves to signal several miles.

Now many thousand commercial wireless stations dot the face of the earth. Warnings are flashed to ships far out at sea, daily time signals are sent out from Government stations, and weather reports are flashed across the land. In the midnight hours when the multitude is asleep press dispatches are whispered from wireless stations throughout the land and picked up by the ocean greyhound far out at sea, so that the cabin passenger on the boat finds on the breakfast table when morning comes a newspaper that contains important news found in the great daily newspaper on shore.

The Navy Department issues an order and a few minutes later it is in the hands of the commanding officer of a fleet of war ships a thousand miles away. Wireless links cities, countries and continents and wireless telegraphy and radiotelephony are part of the order of established things.

WILL BRING NATIONS TOGETHER.

It is not conceived that the radiophone can ever take the place of the regular telephone, because, for one thing, it is impossible to restrict a private message to the hearing of the one person for whom it may be intended. Any person who has a receiving set of sufficient efficiency may pick up the message if he sets his machine to attune with the radio sending machine from which the message emanates, but it is destined to serve a world of purposes which the ordinary telephone cannot fulfill.

The President of the United States may use it to address a message to the people. Speaking in an ordinary tone of voice he could talk to millions of people at one time. Had there been in use the radiotelephone during the great war the Secretary of the Treasury might easily have appealed to millions everywhere to lend their money to the Government for war purposes—to purchase bonds

—It would not have been necessary for him to travel about the country and make repeated addresses to tell of the needs of the Nation.

And what might have been the relationship of America to the other countries during the great war had the radiophone been perfected to a point where it were possible to converse directly across the vast ocean! There are those who see in the development of radiotelephony a new era in international affairs and relations. They believe that there can be no isolation of any nation when the whole world is but a score of seconds wide in point of time as measured by the speed with which the spoken message will travel around the sphere.

A WONDERFUL FIELD FOR THE RADIO.

Viewed from the standpoint of mechanical possibilities economy engineers hold that there is a wonderful field for long-distance work with the radiophone. The existing systems of long-distance wires are expensive to construct and to maintain. They are subject to the whims of the elements—torn by the storms—and also wrecked by accident and the depredations of thieves.

The wireless telephone will transmit the speech as well if not better than the wire phone and it has the distinct advantage that the initial cost is much lower than that of wire lines, while depreciation is smaller. The number of employees required is less and there is no necessity for purchasing franchises or right of way to put up poles and wires. The wireless telephone also has a distinct advantage in the marine service because it requires no operator. Any officer on a vessel could take a message—anybody can operate the radiophone—and it is much quicker than the wireless telegraph with its code that must be read and translated. Moreover, the wireless telephone

on shipboard will permit a passenger to talk direct to his home.

As an aid to education the use of the radio promises to open a field of vast possibilities. Tuft's College broadcasted some of its lectures early in 1922, and the day may not be far off when the young man desiring to take a course in college can hear all of the required lectures without being compelled to leave his own home. Why may not the student in music receive instruction from the great singer in a distant city? So vast are the possibilities that they are almost beyond comprehension.

AN ADJUNCT TO THE HOME.

In many homes the radiophone has become as much an integral part of the family equipment as its brother of the wire. It has been tried and accepted until the luxury stage is a thing of the past, and it has become an essential for those who would keep well informed on world affairs.

Varying atmospheric conditions on different nights make it all the more fascinating, for the most humble and inexpensive radiophone set may suddenly find itself receiving from a station hundreds of miles distant for which more powerful stations have tried in vain on less favorable occasions.

In one of his talks broadcast from the big General Electric Company Station at Schenectady, N. Y., Mr. M. P. Rice, manager of the station declared that when all the people of the United States possess or have access to receiving outfits it will be possible for a speaker to address the entire population of the country at one time.

This possibility he said made the radiophone the greatest publicity agent of all times for its broad scope made it reach as many people as all other publicity agents combined, but radio, in the very nature of things, accord-

ing to Mr. Rice, can only exert a powerful influence on the press, the pulpit, the schools and the theatre and not supplant them.

The newspapers, by way of illustration, early in March coined a very interesting story of how Dr. Charles P. Steinmetz, electrical expert of the General Electric Company had manufactured lightning in his laboratory at Schenectady, N. Y. Few more picturesque incidents have come to the attention of the public and nearly everybody had heard about it, but the newspaper stories did not compare in point of interest, or influence with the talk of Dr. Steinmetz himself about lightning which was broadcast from Schenectady a few nights later, on March 23, 1922.

STEINMETZ TALKS OF LIGHTNING.

Lightning, with its beauty and its pranks, has always been a subject of deep interest to the human race, not merely because it is feared, but because of the deep mystery that surrounds its origin. Dr. Steinmetz's talk, probably heard on the radiophone by many who will peruse these pages, explained much that has not been generally understood and was as follows:

“Of all the phenomena of nature, lightning is the most terrifying and, therefore, the thunderbolt always has been the attribute of the highest God. Until Ben Franklin showed that lightning is nothing but an electric discharge, like those of our electric machines, only vastly more powerful. Little further advance was made in the understanding of the nature and origin of lightning until recent years, when finally our knowledge had advanced far enough to solve the problem of lightning and its origin.

“In summer, when the air is warm, water rapidly evaporates. Warm air can hold a large amount of moisture as

water vapor. Thus during the summer days, the warm air covering the surface of the earth becomes moisture-laden, saturated with water vapor. Warm air is lighter, and therefor this warm, moist surface air begins to rise, Often also it is forced upward by two air currents or winds meeting. In rising, the air gets cooler, because the higher up you go, the lower is the temperature. When cooling, the air cannot hold the moisture which it held when warm, and much or even most of the water vapor of the air condenses to minute water drops, so very small that they keep floating in the air as clouds, without falling. But these minute water particles of the cloud conglomerate, thousands of them gradually, by their mutual attraction, come together into one larger drop, and when the drop has become too large to float in the air it falls down as rain.

HOW LIGHTNING IS LET LOOSE.

“Now each of these minute drops which form by the condensation of the water vapor contains a minute amount of electricity, as there is always some electrification of the air. It is too little to be noticeable. But when a thousand of such minute drops conglomerate into one larger drop, the electricity of the thousand small drops is collected in the one large drop. But the large drop does not have 1,000 times the capacity for holding electricity, but only ten times, and as it has to hold the electricity of the thousand drops from which it was formed, the electricity is crowded together on it a hundredfold, therefore it has one hundred times the electric pressure, or voltage. Thus by conglomeration of numerous small moisture drops into large raindrops the electric pressure or voltage of the drop rises until it is high enough so that the air cannot hold it back, and it jumps to the next raindrop, and to the next and next, gathering in force by col-

lecting the electricity of the numerous raindrops, until a powerful lightning flash is formed, which passes through the cloud until it reaches regions where there are so few raindrops, or so little electricity on them that the lightning flash again decreases and gradually fades out.

“Thus lightning is an electric discharge within the cloud, and very rarely does such a lightning flash, when reaching the lower edge of the cloud, gather so much energy as to enable it to jump the gap from the clouds to the ground and to ‘strike.’ In other words, only a small percentage of the lightning discharges are between cloud and ground; most of them are harmless fireworks within the cloud and very pretty to look at.

“Now whenever a lightning flashes in the cloud or from cloud to ground, it sends out an electric wave, and when such electric wave reaches an electric circuit, a transmission line, etc., it produces a miniature lightning discharge in this circuit, by what we call electric induction. If the electric pressure or voltage of this induced lightning in our electric circuit is high enough, it breaks down the insulation and shuts down the circuit and ‘the lights go out.’ Therefore, we have to install lightning arresters in all electric circuits to protect them against this induced lightning.

POWER OF LIGHTNING.

“From the action of the induced lightning in our electric circuit we can calculate its voltage, and from the voltage of this induced lightning in our circuits, which was produced by the electric wave sent out by the lightning flash in the clouds, we can calculate back the voltage or electric pressure of this lightning flash in the clouds, and find that the voltage of the lightning flash averages about fifty million volts. It may be as low as twenty millions, or may go as high as one hundred million volts, and even



Copyright, International

ONE INCH SQUARE RADIO SET

Alfred Giovanni, a fourteen-year-old freshman in the United High School at Knoxville, Pa., with his one inch square radio receiving instrument, probably the smallest of its kind in the world. The instrument is capable of picking up radio messages for a distance of more than fifteen miles, and is complete in every detail.



Copyright, International
RECEIVING CROP REPORTS BY WIRELESS

No science in recent years has had such strides as has the science of radio. The Chicago Board of Trade has just inaugurated a system of broadcasting market reports for the information of farmers and those interested in the production and marketing of America's foodstuffs. The photo shows Charles Daugherty, who is a farmer in Champaign, Ill. receiving crop reports by the radio way.

higher in the interior of very large thunderclouds. In a big lightning flash the current may be some ten thousands of amperes. But it lasts only a very short time, one ten-thousandths' of a second or less. Therefore, the power of the lightning flash is enormous, from hundreds to thousands of millions of horsepower, many times larger than that of Niagara. But it lasts only such a very short time, less than one ten-thousandths' of a second, so that its energy is very small, less than that of a pint of gasoline. The destructiveness of lightning, therefore, is not due to its great energy, but that its energy is let loose all at once, in an extremely short time, just as a pound of dynamite is more destructive than a pint of gasoline, though the pint of gasoline contains more energy."

"WHAT IS ETHER?"

But to return to our major subject the radio, most people imagine that "ether" is the atmosphere or a component part thereof. But this is not what the technicians say. The term is used to designate the medium used by radio energy to pass from its initiative or point of origin out into the world and home again. And it is one of the startling things that the average person does not pretend to understand, that the ether may mean air, water or a solid body and that these same waves starting out on their course do not stop on their way, but pass through what we call solid bodies—even human bodies—if they happen to be in their way.

They pass through the room in which you may be sitting and through your own body, and you can pick them up in your own home and without going out of doors by using a "loop" to feel the waves, instead of an ordinary aerial or antenna, though they may not be quite as strong in the room as they might be out in the open. It is because of this that anywhere in range of a broadcasting

station with the proper sort of a receiving set one may "listen in" and be answered, entertained or interested.

One of the highly interesting things that broadcasting has given the country is a true service. The great government station at Arlington sends out every morning at 11:55 and every night at 9:55 the correct time, and every broadcasting station pauses to tick off the seconds so that watches and clocks may be adjusted to official time.

The method of doing this is quite interesting. At 9:55 p. m. the wireless station sends out on a wave length of 2,500 meters a series of signals. Every tick of the standard clock in the Naval Observatory, Washington, is transmitted as a dot, omitting the twenty-ninth second of each minute, the last five seconds of the first four minutes and finally the last ten seconds of the last minute, after this ten seconds pause there is a dash which is promptly on the hour of 10 p. m. and 12 noon. Amateurs all over the East tune in for this and wait to tick off the seconds, and all along the Atlantic Coast wireless operators on vessels pick up the time and set the "ship's clock" accordingly.

CHAPTER V.

Scientists and Wizards Who Helped Develop the Wireless—Marconi—Edison—Fleming—DeForest—Squier—
Poulsen—Alexanderson—Steinmetz.

UNLIKE most great discoveries or marvelous patents which have proved a boon to mankind the credit for bringing the radio to its present high state of efficiency and usefulness cannot properly be credited to any one of the great men in the field of science or electricity.

A number of great principles are involved and applied in assembling of an adequate radio set and the discovery of one principle has been followed by another until a complete scheme of transmitting and receiving wireless messages has been built up.

It was Michael Faraday, an Englishman, who first discovered magneto-electric induction in 1831. Long before much was known about electric waves he found that a current of electricity in one wire can make an electric current flow in another wire some distance away—or induce the other current, but he did not know about the medium through which the electromagnetic effect was produced. James Clerk Maxwell, a Scotch physicist, was the one who reached the conclusion that the medium by which or through which the electromagnetic effect was transmitted in Faraday's experiments was the "ether." This was nearly half a century ago.

But Maxwell only advanced a theory and proved it to a point of scientific acceptance without practical demonstration. It remained for Heinrich Hertz, a German professor, to invent a "sparker" or means by which he could

see the electromagnetic waves. He created a miniature flash of lightning in laboratory, making the electric waves radiate from a spark-gap, and because he first devised a means of seeing these waves, which travel at the rate of 186,000 miles a second they became known in the realm of science as Hertzian waves—the waves which now transmit signals or speech in the radio.

WHAT THE WORLD OWES MARCONI.

It was Guglielmo Marconi, a twenty-year-old Italian boy, who first actually used the waves to transmit signals or messages. Marconi, one of the most picturesque figures in the wireless world, was born in Bologna, Italy, in 1874 and attended the University of Bologna where under the direction of one of the professors he became interested in and began experimenting with electric waves, and in 1894 he succeeded in signaling a few hundred feet.

He devised a wireless telegraph but could not interest the Italian government in his scheme and went to England where he made successful tests for the British Postal authorities between Penarth and Wiston. His work was approved by Sir William Preece, of the English Telegraph System, who however limited its application. However, as a result of Marconi's demonstrations the Marconi Wireless Company, Ltd., was formed and in 1899 he had wireless stations on opposite sides of the great English Channel, and in 1901 had succeeded in signaling across the Atlantic from Cornwall to New Foundland and a little later from Poldhu to Nova Scotia.

In the meantime he had demonstrated his ability to maintain communication with vessels at sea and succeeded in signaling the steamship Philadelphia a distance of 2,000 miles from his station and to actually transmit messages to it when 1,500 miles out at sea. By 1903 he

had established wireless communication between London and New York and within a short time transatlantic steamships were printing daily morning newspapers containing news received by wireless. By 1907 his system had developed to a point where a limited commercial wireless service was established between London and New York.

In the development of his projects Marconi invented the first electrolytic detector—used to detect the sound waves. He called it a “coherer.” It was a tube filled with iron filings which was affected by the wave oscillations. It was, of course, neither so efficient nor sensitive as the modern detectors, required frequent readjustment and was much slower—so slow in fact that but fifteen or twenty words a minute could be received by the wireless telegraph operator.

The advancement of Marconi's wireless in England, it might be mentioned incidentally, aroused some antagonism and there was a near sensation when charges were brought that the then Premier Asquith and Chancellor Lloyd George had corruptly favored the Marconi Co.

MARCONI'S WORK IN THE WAR.

During the war Sig. Marconi returned to Italy and took command of the government wireless service. His work was recognized in civilized countries everywhere and he received many honors. A degree was conferred upon him by Glasgow in 1904 and in 1907 he won the Nobel prize in physics. In 1914 he was awarded the British A.C.V.A. and in 1915 made Senator of the Kingdom of Italy.

In the development of radio it is somewhat startling to find that Thomas A. Edison, the great electrical wizard, has had little to do with the actual perfecting of the art though many of the things he discovered have been applied. It was Edison, for instance, who first discovered

one of the facts or principles of electro activity that has been used in and makes effective the electron tube so essential to radio communication—particularly radiotelephony. Long before radio was discovered Edison in his experiments with the incandescent lamp which he discovered and invented, found that when a small metal plate was mounted in an incandescent bulb beside the light film, and the current of electricity was turned on the electricity leaped from the heated film across space to the metal plate. The significant thing about this was that when the film was connected with the negative pole of a battery and the plate with the positive, the current leaped the space between the film and plate but when the connection was made with the positive attached to the film and the negative to the plate there was no flow. In other words he discovered the principle of what might be termed the one-way valve as applied to the flow of electric currents. But Edison made no use of his find. The result he produced became known in the electrical world as the “Edison Effect,” but it was not until scientists reached the fixed conclusion that everything in the world is composed of electrons and that an electric current is simply the flowing of a stream of electrons that the nature and value of what Edison discovered—the Edison effect—was made apparent.

THE FLOW OF ELECTRONS.

Hot objects emit electrons. The film in an electric lamp being white hot it emits electrons which are small particles of negative electricity. And since they are negative they flow toward the cold positively charged non-heated metal plate in the vacuum bulb, because the electron principle is that in two negatively charged bodies the electrons repel—do not flow—and in two positively charged they are practically in the same relation, but

when one is positively charged and the other negatively charged the electrons will flow from one to the other—from the negative bodies.

Mr. Edison was born in Milan, O., in 1847, and though it is not generally known began his career as a telegraph operator. Early in his life his parents moved to Port Huron, Mich., where he was a newsboy and published a small weekly newspaper.

He became interested in qualitative analysis and fixed up a laboratory in an old baggage car, where during an experiment with phosphorus he set fire to the car and destroyed his small newspaper plant.

He then took up telegraphy and the study of electricity, acting in the meantime as an itinerant operator. Following the lines of the telegraph he finally found his way to New Orleans where he made one of his earliest patents—an automatic repeater, later developing the duplex and vibratory telegraph.

THE "WIZARD OF MENLO PARK."

About 1872 he became superintendent of a telegraph company in New York and invented the "printing telegraph" for recording stock quotations, which he sold for \$40,000. Shortly thereafter he opened his first experimental laboratory at Menlo Park, N. J., and began the development of electric devices and apparatus which marked him the most prolific and ingenious man of the age. He gave to the world the incandescent lamp, now used the world over, and the first phonograph, the patent rights for which he sold for \$1,000,000.

His first phonograph was exhibited at the Paris Exposition where a feature was a display of "electric lighting." He gave a similar exposition at the Crystal Palace in London in 1885. About this time he removed his

laboratory to Llewellyn, N. J., constructing the largest at that time private laboratory in the world. He also organized the Edison General Electric Company with \$12,000,000 capital. In 1906 he established a village in Edison, N. J., a centre of iron ore deposits and invented a magnetic separator to remove the ore from the rock.

It has been stated that there are on record in the patent office at Washington, D. C., more than 700 patents taken out in the great inventor's name. Among these were the duplex and quadruplex telegraph which made possible the sending of several messages in both directions over a single wire at one time; the autographic, harmonic, multiplex, automatic and photo flex telegraph; the Edison dynamo, Edison microphone, incandescent lamps, electric pen, Edison mimeograph, Edison-Sims torpedo boat, telephone transmitter, telephonograph, kinoscope, vito-scope and flourescope, the phonograph, dictaphone and electric ore separator.

"EDISON EFFECT" INSPIRED SCIENTISTS.

While "the Edison effect" discovered by the great inventor was never used by him Prof. J. A. Fleming, engaged by Marconi after he formed his English company, saw possibilities in it and first utilized it to create what he termed an oscillation valve or "flap valve" to detect wireless waves—technically a rectifier. It only permitted the waves to flow in one direction and suppressed half of the oscillations. Fleming applied the idea for the first time in radio communication and took the first big step toward solving the wireless telephone problem.

After Fleming came Dr. Lee De Forest, who added the improvement to the oscillating valve or vacuum tube, which has come to be known as the Aladdin's lamp of the electric world.

Dr. De Forest, who was born at Council Bluffs, Ia., in

1873 and was educated at Sheffield Scientific School, Yale, went to Chicago and was employed in the experimental laboratory of the Western Electric Company, about 1899. There he became interested in wireless telegraphy and began experimenting with a new type of electrolytic detector. While on this work he mounted a grid of wire between the filament and plate in the electron tube such as Edison had devised and Fleming developed. This grid was attached to a battery and he noted that the slightest change in the current to the grid powerfully affected the current that passed from the filament to the plate. The scheme provided a marvelously sensitive method of *controlling the current received*. He invented a device which would not only detect the exceedingly weak currents that oscillate back and forth in the receiving antenna but a telephone receiver that would respond more readily than with the Fleming oscillating valve. He called his valve the "Audion" which is the great amplifier—the wonder of the age, which by multiplied use—by installation in series can so magnify sensitive waves that the ticking of a watch sounds in the ears like the blows of a hammer and the walking of a fly becomes audible to human ears. Later it was discovered that the "Audion" could be used as an alternating current generator. By changing the size of the "grid" in the tube any desired frequency—alternations of current could be secured, and an expensive element of transmitting—the installation of high frequency generators or dynamos was eliminated in part for sending.

THE "WIRED WIRELESS."

Another picturesque American figure in the radio field is Major-General George O. Squier. As head of the United States Signal Corps, he originated the "wired wireless" the principles of which are referred to else-

where. During the World War the Signal Corps had difficulty in getting necessary braiding machines for making or finishing insulated wire. There was wire and cotton thread but not enough machines. All the machines in the United States could not supply braided covering for more than 10,000 miles of twisted pair insulated wire in a year and the Corps wanted about 100,000 miles a month. It could not be had.

General Squier tried the use of electron tubes. He sunk a bare copper wire in the Potomac river opposite the war college. A standard Signal Corps radiotelephone and telegraph set was connected to each end of the wire—one set to serve as transmitter and the other as a receiver. At the receiving end the wire was connected to the “grid” terminal of an electron tube. The wire was tuned to a high frequency and it developed that excellent telephony and telegraphy was obtained. The waves followed the wire—not through it. Subsequent tests were made with buried wires and wires in the open air—all of which proved successful and assured the “wired wireless.”

General Squier was born at Dryden, Mich., in 1865 and was graduated from West Point in 1887. He was assigned to the Third Artillery, U. S. Army as second lieutenant and commissioned a captain of the Signal Corps, United States Army in 1901. He was made a major in 1903 and commander of the cableship Burnside during the laying of the Philippine cable-telegraph system in 1902. He became chief signal officer of the army in 1917, with rank of Brigadier-General and appointed Major-General, Signal Corps, U. S. A. in the latter part of the same year. He was representative of the War Department and technical adviser to the American delegation at the International Conference on Electrical Communications in Washington in 1920, also the State Department at the sessions

of the Provincial Technical Committee of International Conference on Electrical Communications in Paris in the following year.

During the war he organized the Aid and Signal Service of the United States Army and was decorated with the insignia of the Order of Knight Commander of St. Michael and St. George by Field Marshal Sir Douglas Haig, at London, in September, 1919. He also was awarded the Italian decoration Com. of the Order of the Crown, and the Distinguished Service Medal of the United States Army, and twice Franklin Institute awarded him medals for contributions to science as related to telephony and telegraphy.

One less well known, perhaps, than some of the other experts in the radio field is Dr. Valdemar Poulsen, of Denmark.

RADIOED MUSIC IN 1906.

Dr. Poulsen was one of the first to experiment with radiotelephony; he used his arc as a source of continuous waves and devised several means of modulating the output. He particularly raised the arc to the status of a practically operative generator of radio frequency energy by placing the entire arc in an atmosphere of hydrogen, or a hydrocarbon vapor, using a carbon electrode for the negative side and a copper anode for the positive side. He also improved the functioning of the arc.

In 1906, he established radiophone communications over a distance of 600 feet using antenna only fifteen feet high. In 1907, with a regular equipment, communication was established between Esbjerg and Lyngby, a distance of 170 miles. The antenna height was 200 feet, the wave length 1,200 meters and the antenna power 300 watts. A little later, phonograph music sent from Lyngby was heard in Berlin, a distance of about 300 miles, although

the modulating system did not allow the whole output to be modulated.

Dr. Poulsen's researches along the radio line were especially on continuous wave transmission and reception. He designed a system of radiotelegraphy and telephony using arcs burning in different gases as a source of high frequency oscillations and succeeded in developing a practical system, which was used in commercial stations.

Dr. Poulsen was born in Copenhagen, Denmark, November 23, 1869. He studied at the University of Copenhagen and entered the Technical Department of the Copenhagen Telephone Co., where for a number of years he superintended the electrical testing operations. He collaborated with Professor Pedersen for many years and carried on extensive researches in telephony and telegraphy. He was a member of the Board of the Telegrafonen, Ltd. (Poulsen Patent), from 1902 to 1916 and the Poulsen Wireless Telephone and Telegraph Co., U. S. A., from 1909 to 1911.

EXPERT HIGHLY HONORED.

Dr. Poulsen holds the medal for merit in gold, with crown. He is a fellow of the Danish Society of Science and he received, in 1900, the Grand Prix of the International Exhibit in Paris. He was official reporter at the International Congress of Electric Applications in Torino, Italy, in 1911, and at Copenhagen in 1912. Dr. Poulsen is a member of the American Institute of Radio Engineers.

Ernst F. W. Alexanderson, consulting engineer of the General Electric Company and chief engineer of the Radio Corporation of America, is another whose accomplishments in the field of wireless have placed him among the foremost in this line.

Mr. Alexanderson was born at Upsala, Sweden, Jan. 25, 1878, the son of a university professor, A. M. Alexanderson, and Mrs. Amelie von Heidenstam Alexanderson. He was graduated from the high school of Lund in 1896, and afterward studied a year at the University of Lund. He then entered the Royal Institute of Technology, Stockholm. This was followed by post-graduate work at the Koenigliche Technische Hochschule, Berlin.

Recognizing that greater opportunities for advancement of young electrical engineers were to be found in America, he came to the United States in 1901 and his first position was as electrical draftsman with the C. & C. Electric Company of New Jersey. In 1902, he accepted employment with the General Electric Company in Schenectady. He soon became a consulting engineer of the company. In November, 1919, he was appointed chief engineer for the Radio Corporation of America, the company combining the radio interests of the General Electric Company and the Marconi Wireless Telegraph Company of America.

Mr. Alexanderson's radio researches have greatly extended the efficiency of radio transmitting apparatus as well as radio receiving apparatus. During the World War, he evolved a system of radio reception which has become the foundation of the modern "directive method of radio reception." The immediate object of this receiving system, first known as the barrage receiver, was to eliminate malicious radio interference of the enemy, who might send out waves of the same or nearly the same wave length as those which it was desired to receive.

Through an ingenious combination of receiving aerial systems and special apparatus, he was not only enabled to eliminate such interference, but also to receive signals from European stations nearby to a high-power transmit-

ting station in the United States, which operated on the same wave length as that of the signal being received.

One of his developments consisted in the evolution of a complete duplex radiotelephone system by which a subscriber to a land line telephone could establish connection with a radiotelephone station and conduct a two-way conversation with the facility of an ordinary land-line circuit. Among other things he created a type of high frequency alternator especially efficient for radio transmission.

One of those who have done much in the field of practice for radio, but who never got into the great lime-light is Michael I. Pupin, head of the Electro Mechanical Department being sold to the Westinghouse Co.

Dr. Charles P. Steinmetz, of the General Electric Company, one of the stellar figures in the electrical world was born in Breslau, Germany, in 1865. He was educated at Breslau, Zurich and Berlin, specializing in mathematics, electrical engineering and chemistry. He became consulting engineer of the General Electric Company in 1903 and was Professor of Electro-physics at Union University. He has written voluminously on electrical subjects and his technical and scientific works are regarded as standard. Degrees of honor have been conferred upon him by numerous colleges and universities—among them Harvard and Union and he is Past President of the American Institute of Electrical Engineers and the Illuminating Engineering Society.

CHAPTER VI.

Sound Waves—Amplifiers—Condensers—The Vacuum Tube and the Part it Plays—Alternating and Direct Impulses.

THE great round world on which we live is surrounded to a depth of many miles with a substance which for want of a better term we designate "atmosphere." Imagine, if you can, a perfect condition of nothingness—in other words, a vacuum. Then fill that vacuum with particles of oxygen, nitrogen, helium and other gases. There you have the atmosphere. Radio engineers call this "nothingness" the *ether*. To this ether it is possible to impart a wave motion similar to that which occurs in water.

You know what happens when you hurl a rock into a still body of water. The same sort of thing takes place in the ether. To transmit radio signals it is necessary to first create waves of varying groups and in varying strengths and then to intercept these waves (at the desired receiving end) with apparatus capable of changing them to sound waves.

The actual creation of the waves takes place by the forming of an electrical pressure between two surfaces separated by a distance of from ten to several hundred feet. This electrical pressure is directed toward first one and then the other of these two surfaces, the change of direction taking place several hundreds of thousands of times each second. In common practice the ground is used as one surface and the other surface is provided by erecting a structure composed of one or two wires, insulated from the earth and suspended a good many feet

above it. Between these surfaces an electrical pressure of from one to twenty thousand volts is created. (All electrical terms defined in subsequent chapters.) This starts waves radiating out in all directions.

These pressure waves are, however, only a part of the radio wave. Any wire through which electrical current is flowed creates what is known as electromagnetic waves and it is the combination of electrostatic waves with these electromagnetic waves that creates the radio waves. The amperes of current put into the antennæ correspond to the size of the rock that we just hurled into our imaginary pool and the volts of electrical pressure correspond to the force with which the rock was hurled. The larger the rock and the bigger the boy who throws it the greater the waves. Just so it is with the radio waves. The more amperes of current flowing in the antenna circuit and the greater the pressure between antenna and ground, then the stronger the waves that are radiated.

RADIO SOUND WAVES.

Radio waves are very similar to sound waves. If you strike "C" on the piano the sound waves vibrate 256 times per second, and either a "C" tuning fork or a wire tuned to "C" and in the immediate vicinity will vibrate 256 times per second, also. These two wires are technically described as being in resonance. Just so the radio waves have a definite number of vibrations per second and in order to hear a certain station the receiving equipment must be put in resonance with the waves radiated by the transmitter. This is properly called tuning.

An electrical current changing its direction of flow is known as an alternating current. The frequency with which it changes its direction gives it its nomenclature. By high frequency is meant a current which changes its

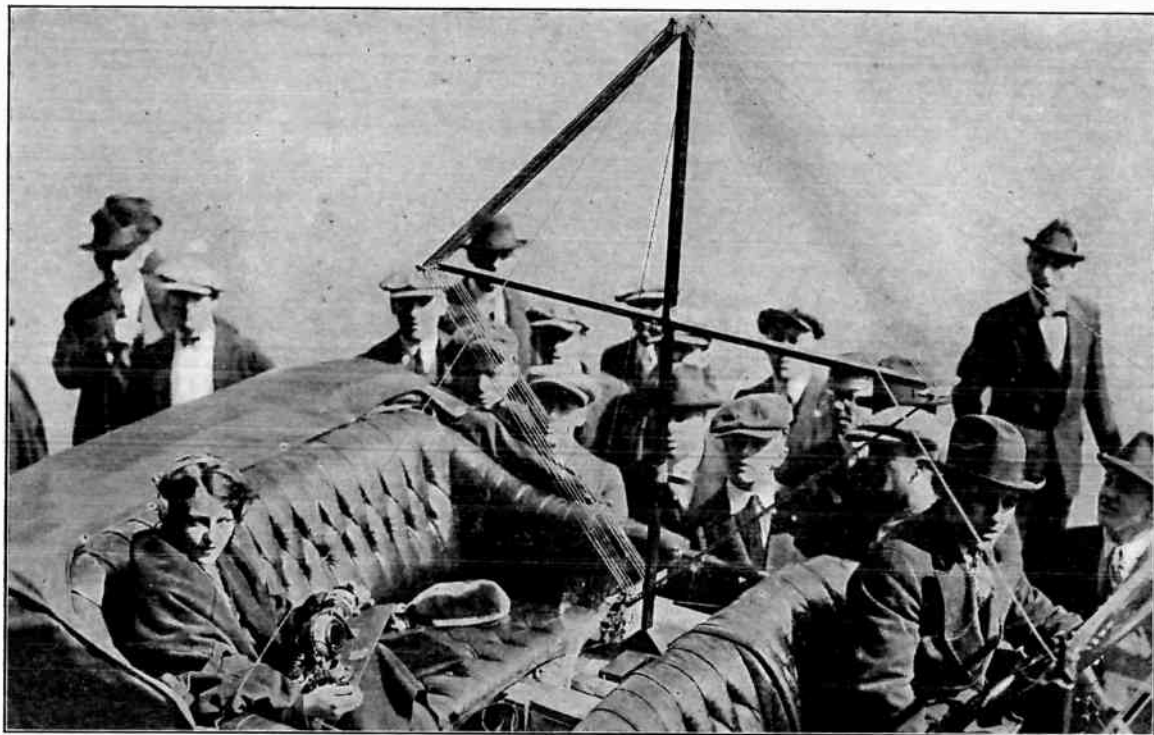

Copyright, Underwood & Underwood, N. Y.

NEW TYPE RADIO FOR AUTOMOBILES

This photograph shows a young lady "tuning in" in the new automobile radio set. The test was made from a touring car and a concert was heard distinctly.



Copyright, Underwood & Underwood, N. Y.

USING RADIO TO DIRECT MILITARY MOVEMENTS

Orders are given in the office of the Lane Technical High School of Chicago and conducted through a receiving set to the field and there relayed to the officer of the field through means of a megaphone.

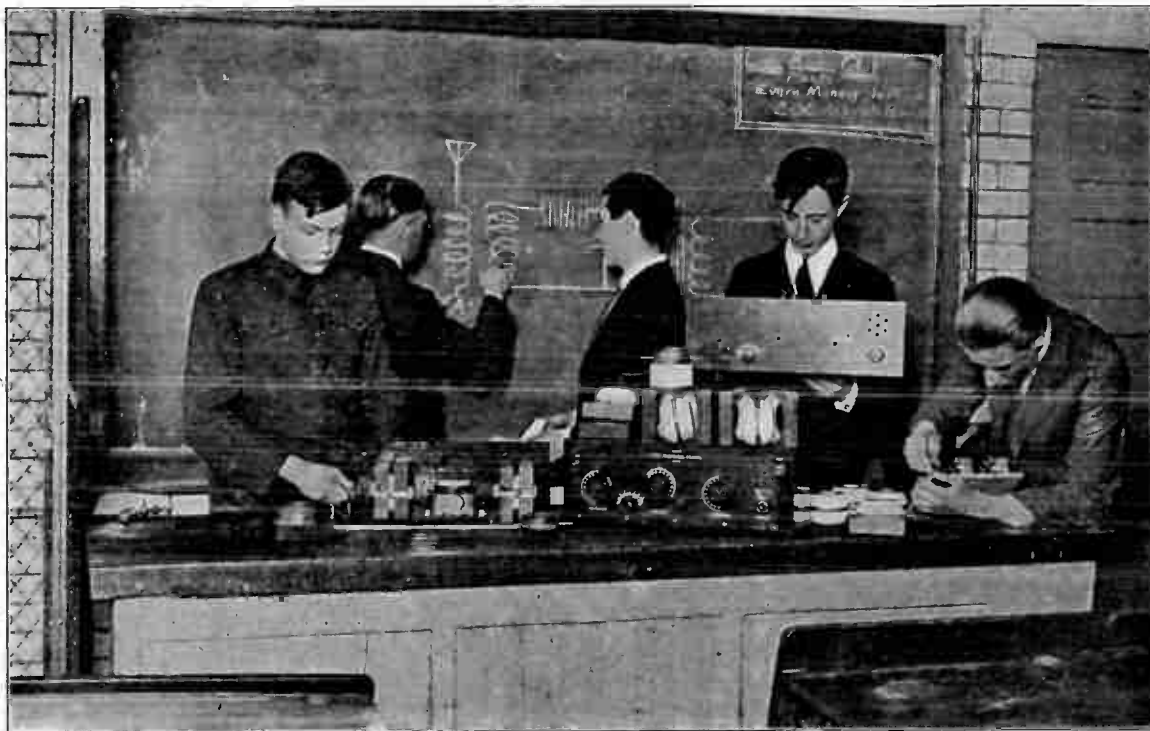

Copyright, Underwood & Underwood, Chicago.

A CLASS STUDYING A RADIO SET

The Lane Technical High School of Chicago not only teaches radio, but instructs the pupils how to manufacture instruments. The school authorities say they are swamped with applications from the students.



Copyright, Underwood & Underwood, Chicago.

A RADIO HOME IN A TREE

A young radio fan in St. Paul, Minn., wanting to enjoy concerts undisturbed, built a small shack on a tree back of his home, where he can "listen in."

direction of travel in the wire from several thousand to several million times each second. The continuous wave transmission seems to be the popular mode, as differentiating from what is known as the spark type of transmission.

Vacuum tubes of large size are used to generate continuous waves and also modulated continuous waves. By means of these tubes there is created a vibration of current in a circuit in which there are a coil and an instrument called a condenser. The coil of wire provides what is known as inductance and the condenser provides capacity, these two factors being necessary to a vibrating circuit. The condenser invariably is made up of brass, aluminum, copper or tinfoil separated by sheets of insulating material known as mica—or by air. Between these sheets of metal there is created a static pressure similar to that generated in the antenna circuit. To control the vibrations of this circuit and, in turn, the waves radiated from the antennæ ground circuit, we employ either a key or a microphone transmitter into which one talks. This transmitter takes the human voice.

SIMPLE DEVICES WORK WONDERS.

A radio equipment for transmitting consists of four principal parts; vacuum tubes, inductance coils, condensers and either a key or a microphone. These are the essentials and, in addition, there must be numerous controls of current, controls of the tubes and controls of the vibrations.

For receiving, four essential parts may be listed—coils, for inductance, condensers, for capacity (to tune), a “detector” and telephone receivers. The human ear is not responsive to vibrations of a rate higher than a few thousand per second. The detector changes the high fre-

quency waves to impulses traveling in one direction in the circuit to the number of from one hundred to a few thousand per second. Two types of detectors are used—one the crystal and the other the audion or vacuum tube detector. Certain minerals permit current to pass in one direction but not in another. Such minerals (galena, silicon, and carborundum) are ideal for radio work.

THE "ALADDIN LAMP" OF RADIO.

The vacuum tube is one of the best advances on radio work. It is one of the most sensitive instruments known to modern science and yet it may be handled with good results by the amateur. It consists of a glass bulb, similar in shape to an electric light bulb, evacuated to a high degree and containing three elements—the filament, the plate and the grid. The filament is a piece of high-resistance wire which is heated to brilliancy by current, just as is the case in the electric light. This heated filament throws off millions of little electrical units known as negative ions. Around the filament is constructed a small sheet of metal (the plate) to which the ions go, and so return to the circuit. These ions can travel only from the hot filament to the comparatively cold plate and cannot reverse and go in the opposite direction. Thus, the radio waves are changed to direct impulses. The grid is inserted to control the number of ions which pass from the filament to the plate. This grid is a closely wound spiral or a finely woven screen of wire surrounding the filament and through which the ions must pass to reach the plate. Interposed in the path from filament to plate, any electrical change put upon it from the antenna circuit will either increase or decrease the ions reaching the plate and so vary the current through the head receivers. The vacuum tube is used also to amplify signal strength. A

tube, when properly connected, will not change the form of signals passing through it but will add current, from a battery connected in one of the circuits, to the signals, making them much louder when passed through head receivers or a loud speaking horn.

The vacuum tube is used in yet another way, for transmitting. In receiving we change the incoming high frequency current to direct current. For transmitting, we reverse the procedure and use large tubes to change 350, 500, 1,000 or 2,000 volts direct current into alternating current, vibrating at rapid frequencies of 50,000 to 2,000,000 per second.

One of the great fundamentals in putting together a receiving equipment is to remember that each additional part added means additional loss of current. Do not sacrifice energy for flexibility of control. Simple receiving sets should be easier to handle and less apt to get out of order.

The instruments necessary for receiving radio may either be purchased individually by the amateur who wishes to experiment with various combinations and hook-ups, or they can be bought in handsome cabinets with antennæ and ground equipment, ready to be put into operation. Great strides are being made in the production of complete equipments and in various parts used in conjunction with the receiving of radio impulses. In fact, so rapid are these strides that at the moment of writing it were difficult to suggest any single equipment or type of equipment that would be more desirable or effective from any angle than others that constantly are being brought forward. It is well to reiterate, however, that the simpler the equipment the more efficient it will be found to be and the least costly in the long run.

CHAPTER VII.

Electricity—What is it?—Electrons—Atoms—Matter
and its Component Parts—The Valve Theory—What
Has Made Wireless Telephony Possible?

WITHOUT doubt the most wonderful single force—
or is it actually a combination of forces?—that has
been given to man for his use is that of electricity.
But what is electricity? That is a question that dates
back to the first experiments made by Ben Franklin with
his little silken kite and his brass key and silk thread, and
his little collecting jar. The progress that has been made
since then in the development of this most wonderful of
God-given forces is more than miraculous but who shall
say what the end will be? Surely, in electricity man has
the greatest possibility for future development, both me-
chanically and theoretically. Much that is inexplicable
even to scientists today may one day be an open book,
through the agent of electricity. Who can tell?

Today we are nearer than ever to an exact knowledge
concerning electricity. Scientists believe that the whole
world, including the table from which you eat your daily
bread, the bed upon which you take your rest, your own
body—all are composed of what they have called “elec-
trons.” Electricity is also measured in or composed of
electrons. Therefore, electricity and matter cannot be
easily differentiated. First we have the molecule as a
measure of matter. It of itself is unbelievably small and
so small in fact as to be almost beyond the comprehension
of the average individual. But then there is the atom, of
which the molecule is composed. And this unit, the atom,
is more than infinitesimal in its proportions. But even

beyond this smallest of small units we find the electron. For instance, an atom of gold is like a solar system. It consists of a central nucleus, like our sun, around which revolve electrons, much as if they were planets.

Each atom of matter—be it copper or rubber or water—has so many electrons and no more. Just so long as it contains its proper number of electrons it is possessed of no electrical effect. That is why the table from which you take your meals, or the bed upon which you take your rest, seem to exert no electrical action—and the same applies to your own body, except under abnormal conditions. But, take away from any one substance a portion of its electrons or give to it more than its proper share and immediately you begin to see electrical action. If a body contains fewer electrons than it properly should have, then it is said to be positively charged. If it contains more than its proper number then it is said to be negatively charged. The plus sign is used to designate bodies that are positively charged and the negative, or minus sign, to designate bodies that are negatively charged.

WHAT BATTERIES AND DYNAMOS DO.

The battery and the dynamo are but elaborations of this broad principle. They contain ability to push electrons out at their negative pole or exit while at the same time taking electrons in at their positive pole or entrance. The thing we term electrical current is nothing more nor less than *flow* of electrons in a definite circuit, such as a wire or conductor of any sort. When an electric spark is “jumped” or flashed across from one terminal to another—bridging a gap—the electrons surge back and forth, trying to distribute themselves so that there shall be no more on one side of the gap than on the other. So long as the equation is unbalanced and one side has more than

the other the electrons continue with their work of trying to balance things, and keep leaping across the gap. The rapidity and momentum of their flow gives them a certain impetus which means that even after they have bridged the gap in sufficient numbers to balance the equation they *still* continue to bridge the gap and cross over in numbers larger than is necessary to reestablish equilibrium. This surging back and forth continues for an almost imperceptible part of a second and does not cease until each side has exactly the same number of electrons.

The electron theory just outlined is the fundamental underlying principle upon which the actual mechanics of the radiotelephone are based. Probably the outstanding keynote of the principle of the wireless telephone is the vacuum tube, which frequently is called the electron tube. Thus we clearly see the importance of a grasp of this all-important electron theory if wireless telephony is to be properly understood and correctly applied.

EDISON'S DISCOVERY PRECEDED HERTZ.

Certain it is that the miracles of wireless telephony cannot be traced to any one definite thing any more clearly than to the perfection of the vacuum tube. You are familiar with the incandescent light bulb. In other words, you know what makes the glow of an electric light—a filament heated to white heat in a glass enclosure which has been exhausted of its oxygen content—or nearly so, there being no such thing as a perfect vacuum.

For the better part of a generation this filament glowed and glowed and no one suspected that it performed any more useful or definite function than to shed light. Edison's first classic experiment with the filament bulb was conducted before Hertz made his experimentation. Edison took an incandescent bulb and mounted a small plate

near to the filament. The plate was put in so that it did not come into direct contact with the filament. It formed part of a local circuit of its own, in which a galvanometer, or current indicator, was included.

The current was turned on and the filament made to glow. Then a curious phenomenon took place. Despite the fact that there was no physical contact between the filament and the plate the galvanometer needle was seen to be deflected. This proved clearly that electric current had leaped over the gap between the plate and the filament. This was dubbed by scientists the "Edison effect." It went without explanation for perhaps twenty years.

WHAT IS AN ELECTRIC CURRENT?

Then came the discovery of X-rays and radio-activity. It was not until scientists reached the conclusion that all matter is composed of electrons and that electric current is nothing more nor less than a steady flow of electrons that a satisfactory solution of the "Edison effect" was reached.

Hot objects emit electrons. A filament in a lamp is white hot and it therefore emits electrons. Electrons may be called infinitesimal particles of negative electricity. Their tendency is to flow constantly toward a cold, positively charged plate or piece of metal. Two negatively charged bodies repel each other. Two bodies charged oppositely (one positive and one negative) have attraction for each other. No reason for this could be assigned until the electron theory was formulated.

Excess electrons from one body try to supply the lack of electrons in another body. Two bodies that are negatively charged contain an excess of electrons and therefore there is no need of more in either body. Hence, there is no physical attraction. Two bodies that are positively

charged contain each a deficiency of electrons. Therefore they repel each other, much like a pair of jealous children, each afraid that the other will attempt to take from it its own supply of candy or what not. But when excess electrons have a chance to flow from a body which is negatively charged to a body which is positively charged (the latter therefore being in need of electrons), then there is presented the phenomenon of attraction. Thus we get the fundamental underlying principle of the vacuum incandescent lamp.

HOT BODIES THROW OFF ELECTRONS.

Hot bodies are constantly expelling or exuding electrons. Why, therefore, has their function, their presence, their properties not been discovered before? Because the atmosphere acts as a check or absorber and stops their flow. The absence of air from the incandescent bulb makes it possible for the electrons to leap across the gap between the filament and the plate. If the air were not expelled the electron, being so very, very much smaller than the atom, is physically checked just as a stone is checked in its flight if hurled up against a blank stonewall. These electrons are excess and leap from the red-hot filament as they are pumped through it with the ever-flowing electric current.

Professor J. A. Fleming has done a great deal toward the perfection of wireless telephony and making it a workable principle. He was engaged originally by Marconi as chief engineer, soon after Marconi organized his English company. Fleming saw the possibilities in the thing that Edison had discovered. Here was a container in which a steady stream of electrons could be induced, always flowing in *one* direction, passing from the hot to the "cold" plate. These electrons could not flow back whence they came. Here, it seemed to Fleming, was a

possibility for the working out of a physical means of receiving messages without the aid of wires intervening between the point of origin and the point of reception of the message.

In those days telegraph signals were still sent by sparks instead of by arcs or dynamos. The oscillations that constitute a spark come in groups or trains, corresponding with a spark. There may be from 50 to 500 sparks per second. Hence we find from 50 to 500 radiated wave groups, each of which in turn may contain from 20 to 100 oscillations or waves. Between alternations or changes of direction in flow of the current in the oscillations or waves there may be only about one-millionth or half-millionth part of a second. The human ear is capable of absorbing not more than 32,000 vibrations per second. The telephone diaphragm responds to more, but the human ear will not absorb them from the telephone diaphragm. Even the telephone diaphragm has a limit which is well short of several hundred thousand a second, the number of vibrations used in transmitting wireless wave impulses.

"EDISON EFFECT" USED IN FLAP VALVE.

Now, suppose that these movements of electricity were transferred into one steady stream, all in one direction. Gushes would be received at the spark frequency of about 50 to 100 per second and would be heard and distinguishable in a telephone.

And now we come to Fleming's development.

He knew that there were certain valves called "flap valves" that prevent water or gas in a pipe or main from flowing back again in the direction from whence it came. These flap valves are capable of opening in only one direction. Fleming desired just this sort of a thing for

electricity. At this stage his attention was directed to the Edison development, known as the "Edison effect," whereby electric impulses were passed from the hot filament to the cold plate and did not return, maintaining a stream in one direction. If this filament and plate formed part of a telephone circuit the receiver at his ear would be affected by impulses flowing in only one direction. Hence, the rapid oscillations of electrons were converted into gushes of electricity, passing all in one direction through the telephone. These gushes came at intervals of from 50 to 100 per second and therefore were discernible to the human ear. The plate was charged first negatively and then positively as the waves came in. When it was charged positively the electrons flowed over to it from the filament and when it was negatively charged there was no stream at all. Thus, half the oscillations were suppressed.

THE OSCILLATING VALVE.

So long as a radio signal was coming in there would be a one-way current through the tube and through any apparatus connected directly in series (continuously in line) with the tube. Half the vibrations were suppressed and therefore the diaphragm of the telephone receiver could respond and this it did in the form of a high-pitched musical note instead of in the form of clicks. The clicks are received at the rate of about five hundred a second when the transmitting station uses a spark. Fleming called his valve an oscillating valve, because it acted like a "flap valve" to permit the passage of current in one direction only. This suppression of oscillation of an alternating current is called rectification.

The extraordinary sensitiveness of the oscillating valve immediately won a place for itself as a receiver in long-distance telegraphy. The advance made by radio as a re-

sult of this invention was truly remarkable. Then on the heels of the Fleming valve came the improvement of Lee De Forest, known as the "Audion."

De Forest inserted between the filament and the plate a grid connected with a battery. He found that the slightest change in the current to the grid powerfully affected the current that passed from the filament to the plate. Thus, he perfected a marvelously sensitive method of control of the impulses. The grid serves as a control throttle and chokes down the oscillations or impulses just as the throttle valve of a locomotive chokes down the flow of live steam to the piston. It takes a very slight pull of the locomotive throttle to release against the driving rod a tremendous amount of energy and thus set in motion a heavy and inert train of fully-laden freight cars. De Forest perfected a device which not only would detect the exceedingly weak currents that oscillate back and forth in an antenna but also cause the telephone receiver to respond more markedly than was possible with the oscillation valve perfected by Fleming.

EFFECT AMPLIFIED TEN TRILLION TIMES.

The effect picked up by one oscillation can be magnified by a second valve and the combined effect of the second magnified by the third and the third by a fourth and so on. Valve can be piled upon valve until the original effect is amplified as much as *ten trillion times*, if that proves necessary. To give a concrete idea of what that would mean the walking of a fly across a ceiling magnified ten trillion times would become a tremendous volume of sound. The ticking of a watch, thus magnified, would become as a boiler foundry. When we say "amplification" in radio we merely mean magnification. It takes but little current to set up a flow of electrons from the hot filament

to the plate. This may be accomplished by a small storage battery or by a few cells.

In modern vacuum or electron tubes the filament is surrounded by a sheath-like grid and a sheath-like plate. The electrons are shot out in all directions in every incandescent lamp that is constructed of the so-called vacuum type. The introduction of an electrified plate causes the electrons to flow toward it. The battery current gives them speed and direction, literally pulling them across, if that figure may be used.

It is the vacuum valve that has made possible the wonderful things that already have been accomplished with wireless telephony. For instance, it now is possible to call San Francisco on the telephone from New York and it is the vacuum valve that has enabled us to combine wireless telephoning with wire telephoning. It is not a far distant flight of fancy to picture a man comfortably esconced at his desk in his library easy chair talking over the wireless telephone, from Chicago to London. Within a very short time it is entirely probable that all the fast liners and limited trains will be equipped with wireless sets, for the receiving of radiotelephone messages.

CHAPTER VIII.

What Air Really Is—Atmospheric Pressure and How it Was Discovered—Three Forms of Matter—Molecular Attraction—How Big is a Molecule?—Moisture in the Air—Measure of Humidity.

WITHOUT shadow of doubt the greatest agent of power, the most wonderfully plastic and limitless fund of energy that yet has been worked upon by scientists of all ages is *Electricity*. And of course electricity is the agent which has made radio possible. The possibilities of this most remarkable of all sources of energy (or is it more properly described as energy itself?) are staggering. Think of the progress that has been made in the last few dozen years in development of electrical man-aids and then cast the picture a score of years ahead and it is most difficult to reason out just what may be brought forth. Certain it is that this statement rings true:—electricity has given mankind more in the way of real progress and development than has perhaps any one other agent as yet discovered.

Right here it might be well to take to pieces to some extent the findings of the scientists and the course of reasoning they follow in leading up to their discoveries and formulæ. After all, expressed in terms a little more readily understandable by the average person, there is no more delightfully interesting story than that of electricity as it is known to scientists of today.

First of all, we must consider *Matter*. There are three different states of matter—solid, liquid and gas. Different bodies may possess different properties even

though they be made of the same substance or *kind* of matter. As we are accustomed to think of it, iron is a much harder substance than wood. And yet iron may be drawn into fine wire or rolled into thin plates. And the iron-wire mattress certainly is more comfortably to sleep on than is the hard woden plank. By certain treatment iron may be reduced to a porous, spongy condition. It may be melted and if it is heated *beyond* the melting point it becomes a gas. Iron is known to exist in the sun in gaseous form. Think of the many different forms of this one material, iron, and yet it is fundamentally the same in each case, no matter what form it has been led into. Here a fairly fine distinction must be drawn. The changes that we have described as taking place in iron are what are properly classified as physical changes and come under the laws of Physics or Natural Philosophy. We may place a bar of iron in the open, moist air and it will begin to rust almost at once. That rust that appears on the surface of the iron is in no sense a physical phenomenon and the change does not come under the head of laws of Physics but rather under the realm of Chemistry.

THE THREE FORMS OF MATTER.

Think for a moment of water. Here we have a substance which can exist in three distinct forms:—ice, water and vapor—solid, liquid, and gas. It is a substance which can take on three different forms and which in each of these three different forms performs very differently. Ice can be cut. It has definite shape and can be handled. Water cannot and it offers very little resistance to a shearing stress. Water, vapor, or steam, cannot be handled and has no permanent volume or shape. A solid has a definite mass, volume and shape and it opposes any stress. We have, however, two classes of solids—rigid

and elastic. A perfectly rigid solid retains its shape permanently no matter what stress is brought upon it. A perfectly elastic solid regains its original shape in spite of any stress. All bodies can be divided up into very small particles. Gold, for instance, can be hammered out until 300,000 leaves of it are only an inch thick. Platinum wire 1-3,000,000 of an inch in diameter has been drawn.

Then, we have powdered chalk, used largely for polishing. If powdered chalk be mixed with water and the larger particles allowed to settle, the cloudy liquid being poured off, this cloudy liquid will evaporate and leave behind it an extremely fine powder. So very fine is this powder that it cannot be perceived by touch. And yet if metal is polished with it, it is found to leave behind it on the metal very fine marks, showing conclusively that the particles of the powder are possessed of a very definite shape though they are of such very extraordinary minuteness.

HOW SMALL ARE PARTICLES OF MATTER.

Back in 1823 Leslie advanced the statement that a single grain of musk had been known to perfume a room for the space of twenty years. He estimated that "this single grain of musk contained 320 quadrillions of particles." There must be a limit to the extent to which this subdivision can be carried. Apparently that limit is the human ability to comprehend and measure the minuteness of the particle after the matter has been subdivided.

If we consider again the very smallest particle of matter—the gold leaf, the fine platinum wire, the grain of precipitated chalk—it must invariably have a definite shape. Its molecules cling together. That is true in the case of solids. In the case of gases, however, the molecules behave differently. They will expand and fill any

space, no matter how great the space, opening as they do so the distance between themselves. This is what is meant by rarefied air. And, incidentally, it is the real reason why no such thing as an absolutely true vacuum is possible. Molecules in turn are formed of atoms combined in definite proportions. A molecule of water is always a molecule of water no matter whether the substance takes the form of water or steam or ice.

MOLECULES CONSTANTLY IN MOTION.

Even with the aid of the most powerful of microscopes a cube whose side is the 4,000th of a millimeter may be taken as the minimum visible for observers of the present day. A cube of this sort would contain from 60,000,000 to 100,000,000 molecules of oxygen and nitrogen. The best microscopes can be made to magnify from 6,000 to 8,000 times. A microscope which would take *that* result and magnify it *as much again* would show the molecular structure of water. For instance, if a globe of water the size of a football (6 1-4 in.) in diameter were magnified to the size of the earth the molecules or granules would be hardly greater than small shot and certainly less than footballs in size. If we magnify a cubic inch of water to a cube whose side is the diameter of the earth, in the enormously magnified cube there will be one particle to every cubic inch.

The action of molecular constituents of a gas is well to note at this point. In a gas no force is needed to separate the molecules from one another. The molecules are in motion constantly. And the same applies to the molecules of *all* bodies. This is what is known as molecular motion. In a gas the molecules rush hither and thither, colliding with one another and with the sides of the containing vessel. In the atmosphere the number of col-



Copyright, Underwood & Underwood, N. Y.

NEW COMPACT RADIO DEVICE CARRIED IN SUITCASE

Brent Daniel, of Washington, is here shown with his supersensitive radio receiving device, so compact that it can be carried in an ordinary suitcase. The new radio device is capable of receiving messages within a radius of 400 miles. This radio set was one of the most prominent exhibits at the Radio Convention held in Washington.

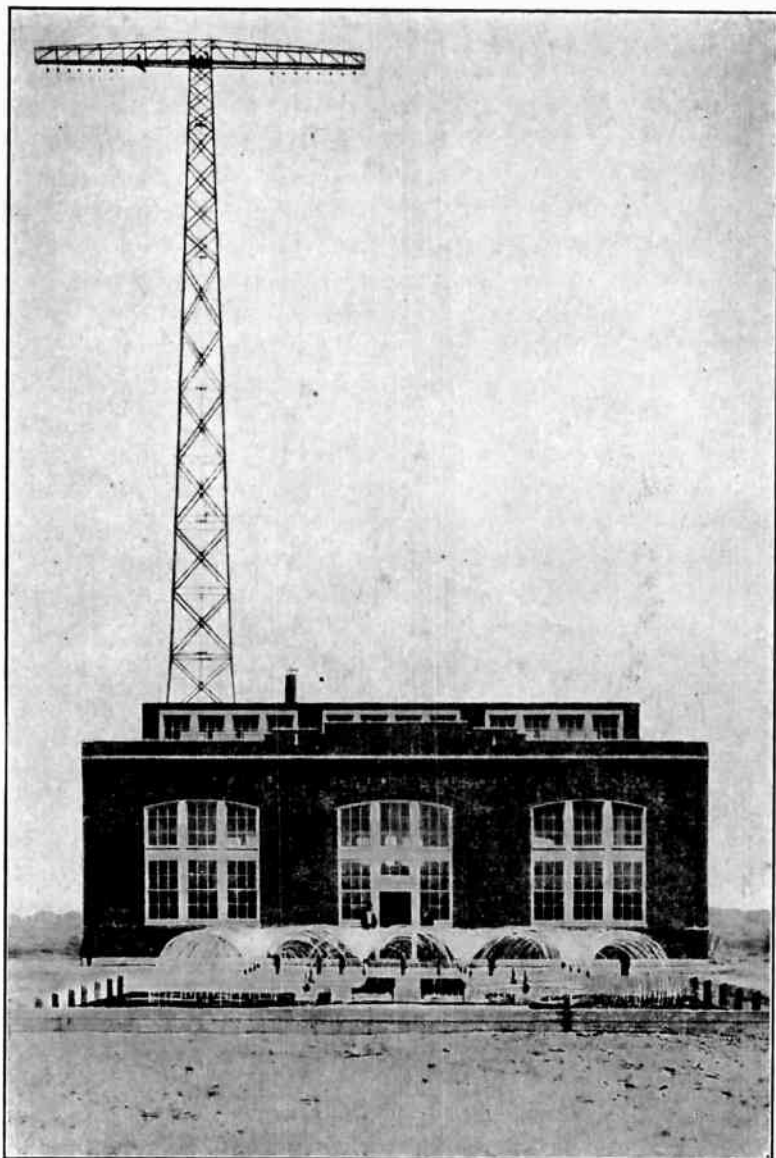

Copyright, Underwood & Underwood, N. Y.

THE WORLD'S LARGEST RADIO STATION ON LONG ISLAND

Photo shows the powerhouse and cooling pond at "Radio Central"—the world's largest wireless station—plant of the Radio Corporation of America, at Rocky Point, near Port Jefferson, L. I.

lisions per second between particles is infinite and a molecule travels on an average 1,000 times its own diameter without colliding with another. If the air be rarefied the collisions of necessity become less frequent. It is interesting to note in passing that scientists have estimated that in an incandescent bulb, the air being so rarefied as to be nearly as possible a perfect vacuum, the free path of a molecule, or the distance it will travel without colliding with another, is about 35 feet.

MOLECULAR ATTRACTION.

Thus we have an idealized picture of infinitesimally small particles rushing madly about in the very substance of which they are a component part, colliding with one another, simply through reason of their mutual attraction. Experiments made with an idea of determining at what distance molecular attraction is felt show that their influence has been detected through a film of silver two-millionths of an inch thick. What application has all this to practical consideration of every-day facts and occurrences? Simply this: Substances such as steel get their high tensile strength from the force of the attraction of the molecules which go to make it up. In a substance such as steel, where the tensile strength is as high as 30 tons per square inch, the molecular attraction can be seen to be remarkably high. On the other hand, in liquids, the molecular forces are relatively small. In a gas at ordinary pressure there is practically no molecular attraction.

Just in passing it might be of interest to illustrate how this law of molecular force acts in the case of solids. Two balls, one of glass and one of steel, are allowed to fall upon a smooth steel plate which has been slightly greased. After their impact it is found that well-defined circles

have been left on the surface of the steel plate, proving that the balls were compressed. That they recovered their original shape is proof of their elasticity and of the action of their molecules. The exactness to which science has been developed may be emphasized at this point by remarking that in the case of the glass and steel balls it is perfectly possible to photograph and measure their momentary distortion.

The pressure of the atmosphere is the most widely extended of all fluid pressure and yet its existence was not suspected by the early philosophers and its discovery has a personal history. Certain effects of atmospheric pressure had been noted but their cause had not been correctly assigned. For instance, the fact that water will rise in a pump, following the plunger, was held to show that "nature abhors a vacuum." In 1642 the philosopher Galileo was appealed to for an explanation of the failure of certain pumps which were erected in the gardens of the Duke of Tuscany. They were designed to draw water from a depth of 50 feet. The water would rise about thirty feet but no higher. Apparently, there was a limit to which the "abhorrence of Nature" would go. Galileo evidently indicated to his pupil Torricelli the probable explanation but he died without having been able to prove it. Torricelli took up the question. He argued that if a column of water would rise to a height of about 30 feet, mercury, being 13 1-2 times as heavy, must rise to a height of about 27 inches. The Torricellian experiment was the result. Here we have a glass tube closed at one end and filled with mercury. This tube is inverted in a basin of the same substance. The mercury sinks in the tube until the column is about 30 inches above the surface of the mercury in the basin. What holds that column of mercury, apparently unsupported? In what way did

the surface of the mercury inside the tube differ from the surface of the mercury outside of it? Only in one feature—there was no air in contact with it. Then, it must be the pressure of the air to which the support of the column of mercury is due. Then along came Pascal. He took the Torricellian tube to varying heights and he found that the length of the column of mercury supported by the atmosphere decreased as he ascended. In 1648 he made two observations. One of these was at the bottom of Puy de Dome and the other at the top, a height of 3,565 feet. At the bottom the mercury column stood 27 inches and at the top it had fallen to 24.7 inches. As he came down again he saw the mercury gradually rise in the tube until it was the same height as formerly. Thus, in a space of six years, three men, all following one after another and upon the death of the other, worked out one of the most important principals of natural philosophy. And from that time on the belief was abandoned that "Nature abhors a vacuum."

ATMOSPHERIC PRESSURE AFFECTS RADIO.

This subject of atmospheric pressure has a very great bearing upon radiotelephony. It may be seen at a glance just why this is so. If a series of waves, broadcasted through the ether at a certain pressure, strike high and low spots, or in other words, places where the atmospheric pressure is greater or less, then compensation for this difference must be made and the general result is a tendency toward interference. Many refinements of the radio doubtless will be made to take care of this as well as to get around the element of temperature (the receiving of impulses being more difficult upon hot, sticky nights than at other times). Refinements of this sort will have to follow along with many other improvements which will regu-

late the sending and receiving to bring both to more and more of an exact science.

We might well say that the universal pressure of the atmosphere was utilized long before it really was known to exist. When a boy uses a "sucker" he calls in the aid of atmospheric pressure. A piece of leather is thoroughly softened in water and a piece of string is attached firmly to the middle of the leather. It will fit closely on a stone or any smooth object. When the string is pulled a vacuum is created underneath and the atmospheric pressure presses the edges firmly against the stone, making them adhere sufficiently for the string to lift the stone. The limit to the force that can be applied is the product of the atmospheric pressure and the area of the leather, for this is the force which the pressure of the air exerts to make the stone follow the "sucker."

ATMOSPHERIC MOISTURE.

The weather often affords a topic of conversation in our variable climate because of the way in which its changes influence our life. The warmth or cold, the dryness or dampness of the atmosphere affect our feelings and our health so much that they attract our attention. That there always is a considerable amount of water in the atmosphere is shown by the simplest of experiments. The moisture condensed on a tumbler of cold water is evidence that there is water in the air which cannot be seen. If a saucer containing sulphuric acid is left open to the air it imbibes moisture from the air and therefore increases in weight. Both sulphuric acid and calcium chloride possess this property of absorbing moisture from the air. Thus, they can be used to absorb all the water from air which is closely adjacent to them. The density of water vapor in the air is called the humidity.

It varies from one grain per cubic foot on a cold day to ten grains per cubic foot on a day of tropical heat and dampness. It is a common remark to make, "The air is very dry," when water evaporates freely. Consequently, on such a day clothes dry rapidly. We call the air dry when it is far from saturation and call it damp when it is nearly saturated. The relative humidity and the drying power of the air are numerical estimates of what our senses feel as to the dampness and dryness of the air.

The water vapor in the air exerts a pressure which depends upon its quantity and on the temperature. If the air become warmer and the vapor pressure remain the same the vapor expands and becomes less; the same occurs if the temperature remains the same and the vapor pressure decreases. In either case, the amount of water vapor in the cubic foot is decreased and the air becomes "unsaturated." The vapor pressure is then not the maximum for that temperature or, in other words, it is the maximum pressure for a temperature below that of the air. The dew point is the temperature at which dew is formed. The dew point depends upon the prevalent pressure of water vapor alone. If the dew point and the temperature are known, the amount of water vapor in the air can be ascertained. All of this has its own peculiar effect upon radio transmission and influences the extending ether waves and our ability to detect them.

CHAPTER IX.

Radiation—Radiant Energy—Intensity of Radiation—
Reflection—Refraction—Diathermancy—Obscure Rays
—Absorption—Radiation and Absorption—Distribution
of Radiant Energy.

HOW many of us ever really stop to consider why there is a difference between day and night? Do we not, most of us, go along from week to week and month to month taking for granted the wonderful workings of Nature just as we find them? What, after all, gives us light? The sun, of course. Its rays pass through millions of miles of intervening space and finally register themselves upon our optic mechanism. But the sun functions in another way to provide us with a necessary quantity. It furnishes us with heat. Some light rays, such as moonlight, impart no *perceptible* heat. On the other hand, there are heat waves which can be felt at some distance from the emanating object (as in the case of a stove, etc.) and yet there is no *visible* radiation. Heat is transmitted through a distance by radiation.

Here it is that we have the underlying thought of radio—radiation. The fundamentals underlying the radiation of heat are the same as those from which the radio has been developed. Radiation of heat is the transmission of heat from a hotter to a colder body by means of vibrations of the luminiferous ether. Here the laws of light and heat overlap each other, the principle of transmission of radiant heat being the same as those of transmission of light.

Were we to be a bit technical for the moment it might be said that radiation is defined as the transmission of

heat energy through a medium, but without heating that medium. In this case, by "medium" is meant the ether through which the heat waves are transmitted. The term "medium" here actually applies to the intervening substance—gas, vapor, liquid or solid, which always is heated more or less by radiation through it. The transmission of heat also is accomplished by what is known as *induction*. Here a warmer particle comes into contact with a colder particle and transmission of heat takes place. Through radiation, however, the temperature of the intervening substance does not come into the question. An analogy might be drawn here, with the radiation representing the new wireless telephone and induction representing the older and perhaps better-known wired system.

RADIATION OF LIGHT AND HEAT WAVES.

In radiation of light or heat waves, heat energy is transformed at the surface of the radiating body into energy of vibration of the luminiferous ether, which is again transformed into light or heat on meeting some other body, but which upon the way is not what ordinarily may be termed *either* light or heat. From a source of light there proceed also rays which do not cause light but which produce heating effects. These rays are technically known as "obscure" rays and to detect them and measure their intensity the "thermopile" is used.

In order to prove that both heat and light rays proceed in straight lines the following experiment was worked out by scientists. An upright stand is provided and a heated ball placed on it. Also there is provided a double heat screen which has a square hole through it. On the other side, and at an equal distance, there is placed a plain screen. Now, if a candle be placed on the stand so that its flame occupies the same position the heated ball

will occupy, a square of light is traced on the plain screen, proving that the rays of light proceed in straight lines through the hole. Then the ball is heated and placed on the stand. The eye no longer can detect any rays but if a thermopile be brought to the place where the square of light was seen on the plain screen the thermopile instantly registers an effect, while at other places there is no effect. This shows that the "obscure" heat rays as well as the light rays proceed in straight lines.

In experiments of this sort, in order to intercept radiation, a double screen is used. This consists of two parallel sheets or plates of tin or wood standing vertically, with a space between them for the circulation of air. The plate nearer to the source of heat may become heated but the currents passing up between the two plates carry away the heat and prevent any heating of the further plate. This, therefore, does not receive any of the radiant heat from the source and the radiant heat is intercepted entirely.

We all know what it is to scorch one's shins before an open fire. It is dangerous to get too close to a fire. The intensity of radiant heat diminishes with the distance from the source of heat. The ratio at which this diminution takes place is an exact law. Suppose that the hole in the double screen be exactly one inch square and that this screen be placed halfway between the further screen and a candle. The patch of light on the further screen is exactly four inches square or in other words four times the area of the hole. The energy passing through the square inch at the hole has, in double the distance, spread itself over the four square inches. Radiation in every case is a wave motion, as will be explained in greater detail later.

In the earlier days when roasting meat before an open

fire was done more frequently than perhaps now is the case it was the custom to place a bright tin screen around the meat to reflect the rays of heat back onto it. The laws of radiation of heat are exactly the same as those of radiation of light. The rays in each case are cast in straight lines (known technically as rectilinear propagation), and the reflection of each is the same.

LIGHT RAYS AND HEAT.

We all can remember back to boyhood days and the use of the burning glass. We all remember having glowed over fiction (and in some cases true) stories of how marooned sailors have maintained life and heat by kindling fire through concentrated heat obtained by the use of a watch crystal filled with water, to focus the light rays and *concentrate* them upon a given point. But very recently the police department of a certain city was puzzled by repeated occurrences of fire in a certain dwelling. Invariably the fire was started in the living room and almost without exception the carpet and hangings were badly damaged. After repetition three or four times it finally was discovered that a globe filled with water, for goldfish, was acting as a "burning glass" and focusing the light rays down upon one definite spot with such force that conflagration took place. This principal has been highly developed and used by scientists in exact recording work. The instrument in mind is known as Campbell's Sunshine Recorder. It consists of a glass ball which concentrates the rays of the sun onto a card-board, on which the principal focus of the sphere falls. So long as the sun is shining it leaves a trace of charred paper. Later work with this instrument proved that the glass absorbed much of the heat which fell upon it so that it was not a suitable material with which to experiment

on infraction, as this branch of Physics is known. Still, these two examples serve to show that heat radiation is refracted under certain conditions and that in this respect they behave in much the same manner as does light.

Diathermancy is literally the capacity of any given body for transmitting radiant heat. Experiments conducted by Melloni proved that solids vary widely in their capacity for transmitting radiant heat. For instance, the following substances are listed in the order of their relative diathermancy:—rocksalt, sulphur, iceland spar, glass, gum, alum, sugar.

To test the diathermancy of liquids a thin glass cell for holding the liquid is used. By using this it is seen that water intercepts the "obscure" rays from the source of radiation, though, like glass, it is clear and transparent to light rays. On the other hand, carbon disulphide transmits the invisible heat rays freely.

And now we come to the diathermancy of gases, which perhaps is the keynote of the particular branch of Physics we have been just considering as far as its application to radio is concerned. In all the experiments mentioned thus far it has been assumed that the radiation passes through the air without hindrance. Dry air and the permanent gases transmit radiation, from whatever source of heat, without hindrance, and behave practically as a vacuum as far as the transmission of rays of heat is concerned. Vapors, however, vary very much in their diathermancy among one another and with the nature of the source of radiation.

The water vapor surrounding the earth forms a screen, which tempers the rays of the sun and also prevents the heat of the earth from radiating into space. Regarding the earth as a source of heat, at least ten per cent of the radiation from it is intercepted within ten feet of the

ground. The amount of vapor present in the air is varying continuously. Even on a clear night the cooling of the earth's surface by radiation is checked by the vapor-screen which surrounds it. In the same way the rays of the sun are tempered by our vapor-screen. Mountaineers suffer very intensely from their heat. The quantity of vapor diminishes very rapidly as they ascend and on a mountain inside the pressure of water vapor may be very small. In such cases the sun's rays are almost intolerable. Explorers and mountain climbers frequently complain bitterly of the oppression of the heat. A graphic story has been recounted by an acquaintance of the editor's who says that in climbing Mont Blanc, though he was at many points in snow up to his waist, the sun blazed against him with almost unendurable force. Mariners frequently have reported that they have seen the pitch in the seams of a vessel boiling while the air about the ship was below the freezing point. The early morning in the summer generally is the time of least humidity and the scorching heat of the sun then is very evident. The paint on doors which face eastward often is blistered by the untempered rays of the morning sun, though the temperature of the air may be very moderate.

The sun's rays, before they reach the earth, have to pass through our vapor-laden atmosphere and this cuts off a great deal of the obscure radiation. However, in the solar spectrum the heating effect of the obscure rays is twice that of the visible rays. The spectrum of the solar beam, analyzed at the high observatories, where the vapor layer is much thinner, shows a much greater proportion of obscure rays.

Professor Langley's bolometer aids in testing the presence of radiation of small intensity. It is an instrument of great delicacy. With its aid the obscure rays

of the ultra-violet spectrum have been mapped out and lines of no radiation detected in the solar beam there, similar to the Fraunhofer lines of the visible spectrum. Iodine is very opaque to light. It is used, therefore, in making a filter which allows the obscure rays of a luminous beam to be isolated. Iodine is very diathermous or transparent to the obscure rays. By placing a filter of iodine before the opening of an electric lamp a beam of radiant energy, intensely powerful though quite invisible, may be projected and experimented upon. These rays are of sufficient power to set paper alight and even to raise platinum to the point of incandescence.

RADIANT HEAT AND RADIANT LIGHT.

Radiant heat is identical with radiant light. It differs from red light as red differs from blue. Just as different substances absorb rays of light from different parts of the spectrum and so have different colors, so different substances absorb some of the rays of heat which sources of heat are radiating, in different proportion. For example, glass transmits heat rays from a lamp to a considerable extent but none from a copper ball at the temperature of boiling water, because it is opaque to rays from the invisible part of the spectrum.

Take for instance, the case of greenhouses. Here the rays of the sun traverse the glass because they are from the luminous part of the spectrum and they heat the solid objects in the house, the walls, floor, etc. The obscure rays which these heated objects give out cannot penetrate the glass, which thus is "a trap to catch a sunbeam." Although the air and the permanent gases offer little or no obstruction to the passage of the heat rays, vapors as well as liquid and solid substances vary in their diathermancy. What happens to the heat rays when they stop?

They must of course heat the substances which stop them. For example, the glass of the greenhouse, although it permits the luminous portion of the sun's rays to pass through, stops obscure rays and becomes very hot.

The transformation of the heat energy into energy of vibration of the light-ether takes place at the surface of the hot body. As might be supposed, the character, nature, texture, or "grain" of the surface affects the amount of energy which is transformed into vibration. It is a well-known fact that radiation takes place slowly from bright surfaces. Steam pipes, teapots, hot-water jugs, if kept very bright, do not lose heat so quickly as do dull surfaces. In everyday work we have become accustomed to speaking of radiation in referring to loss of heat from the surface of the bodies whereas in more scientific work the term is used for the ether vibrations themselves. The word absorption is used inversely. That is, it applies to the transformation of energy of ether vibration into heat energy. This takes place at the surface of the body which is being heated by radiation and the grain or texture of this surface affects its power of absorbing vibrations in the form of heat. A bright body takes up less heat from radiation which falls upon it than does a dull body. The bright fire irons remain cool for some time after a fire has been lighted, whereas a dull fender becomes intensely hot. This process is called absorption. Both the radiation and the absorption of dull bodies is greater than is the case with bright bodies.

In connection with the foregoing, remember that:—

Good radiators are good absorbers.

Bad radiators are bad absorbers.

An experiment which is due to Franklin has led many people erroneously to conclude that the color of a sub-

stance alone influences absorption. Several cloths of different color were laid out on the snow in the sunshine and as they did not sink at the same rate in the snow Franklin concluded that they absorbed heat differently because of their difference in color. A red cloth is red because it absorbs the green rays and a violet cloth in a similar way absorbs the radiation of the heating portion of the spectrum. In this way dark clothing becomes hot while light clothing reflects much of the sun's rays and remains cool. So long as radiation consists wholly or chiefly of obscure rays, absorption is independent of color, but the sun's rays so far as they come from the luminous part of the spectrum, are more absorbed by dark bodies than by light ones.

When the vibrations of the light-ether reach the surface of a body they are partly reflected and partly absorbed, or transformed into heat energy. If the substance be diathermous most of them pass on and are reflected back from the inner surface. The part of them which is absorbed raises the temperature of the body, which then emits radiation in turn. So, then, there are only four ways in which radiation falling on a body is disposed of and we have these axiomatic statements:—

Good absorbers are good radiators and bad reflectors.

Good reflectors are bad absorbers and bad radiators.

In diathermous substances more radiant energy is refracted and less is absorbed and reflected.

In substances which are the opposite of being diathermous more radiant energy is reflected and absorbed and little or none is refracted. The sum of the radiation which falls upon the surface must be equal to the total of the radiation which enters the substance, whether absorbed or refracted, together with that which is reflected.

All of these fundamental laws form the basis of radio work, as will be explained in detail later.

CHAPTER X.

Heat Waves—Conduction—Convection—Wave Motions
—Harmonic Waves—Interference of Waves—Medium
Necessary to Transmission of Waves—The Ether the
Medium for Radio Waves.

HOW often we have heard the common expression, "How cold it is. The cold in this part of the country is very *intense*." And yet, do you realize that there is no such thing as *cold*? Heat is a definite thing, but the thing we speak of as "cold" is merely an absence of heat. It is common knowledge that heat flows from point to point, always from a hotter to a colder point. The matter of heat radiation was taken up in chapter nine. That is one of the ways in which heat is transmitted from one point to another. As we stand before a fire and spread out our hands to the crackling logs we feel the sensation of heat. That heat is transmitted to us by radiation. But how about the sensation we get when the coffee happens to be too hot and raises a little blister on the end of the tongue or when we put our hands into the shaving water in the morning? That is the sensation of heat. We have felt heat because heat has been transmitted. But the transmission took place not through radiation but through definite contact—and this is what is known as conduction. If the water is cooler than the hands we place in it, the reverse action takes place and the heat is transmitted from the hands to the water, but by conduction as in the other case. It may be said in more definite language that heat is transmitted by conduction when any particle of a body is raised to a higher temperature owing to its contact with a particle which is

hotter than itself. But all substances do not conduct heat in the same fashion. For instance, if we place a silver spoon in a cup of coffee the handle of the spoon becomes hot very rapidly. But if that spoon were made of bone we would find no sensation of heat transmitted to the handle, comparatively speaking. Why is it that housewives for generations have used things they call "iron holders"? Because the flat irons with which they finish their laundry transmit heat very rapidly up into their handles and to grasp the bare handle would be to burn the flesh. But a little later an iron with a wooden handle which was detachable and fit the irons universally was invented and the hot irons now may be picked up and used with the iron holder and without danger of burning the hands.

BEARING UPON RADIO.

All of this has a definite bearing upon radio. Radio is possible through the application of the laws of radiation and conduction to the element electricity. The fundamental laws that govern the action of heat and light waves actually apply to the radiation of electrical disturbances. In radio, however, many elements have to enter into our problem. For instance, the nature of the ether, the tendencies of various metals used in the appliances, etc.

In passing it might be well to point to the fact that a substance like water is, for instance, a very poor conductor of heat. To prove this one can take a long narrow test tube (glass) and place in its bottom a piece of ice, weighted down with some heavier substance to keep it from floating to the top. By applying a flame to the upper part of this test tube the water in this portion of the tube may be boiled, the steam or water vapor will carry



Copyright, International

DOCTOR'S RADIO

Dr. David Cottrell, the first Chicago physician to own an automobile, has established a reputation for being first among Chicago professional men to adopt the inventions and improvements of modern science. His car is equipped with a radio outfit and important messages are relayed to him from his own office to any place where he may be in the process of making calls. The aerial is strung from the radiator shell over the top of his coupe to the tire rack in the rear. Photo shows Dr. Cottrell seated in his coupe conversing with his office by means of his auto radio.



TUFTS COLLEGE, MASSACHUSETTS, HAS FIRST WIRELESS COLLEGE FACULTY

The first wireless college in the world—this is the distinction that Tufts College, Massachusetts, has. Thirteen of the leading members of the faculty have volunteered to give lectures on their subjects through the wireless radio at the American Radio and Research Corporation plant. The lectures will reach as far west as Wisconsin and as far south as Florida.

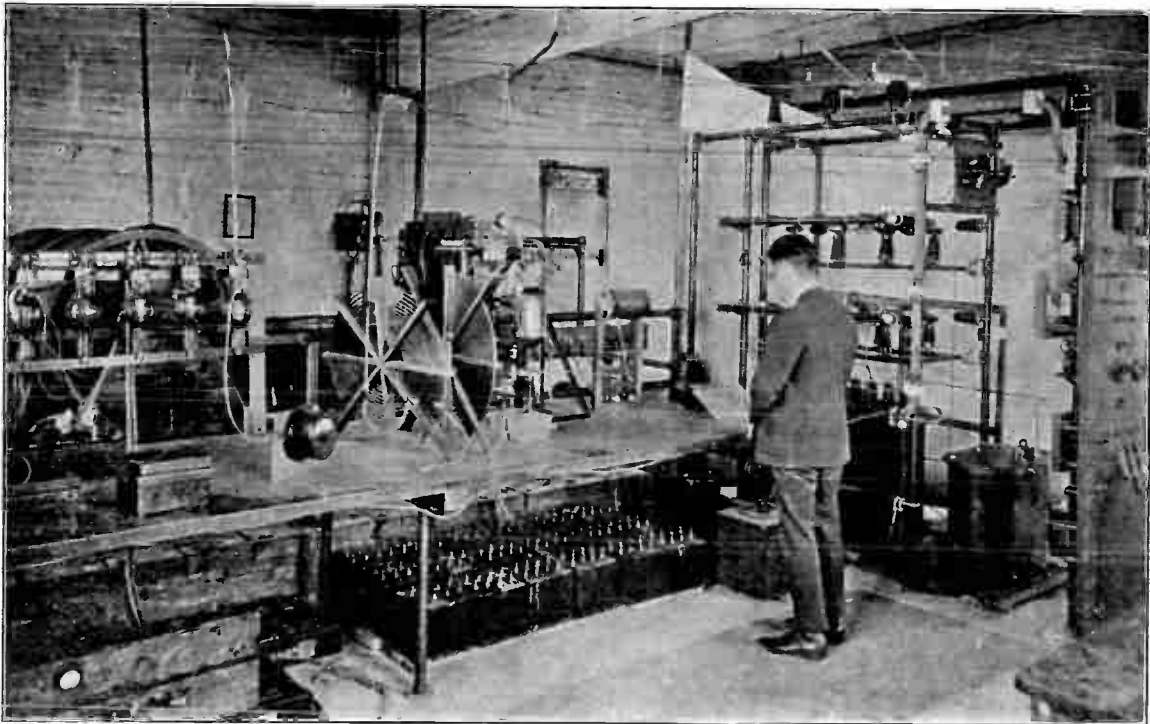

Copyright, Underwood & Underwood, N. Y.

A POWERFUL RADIO BROADCASTING STATION

An interior view of the new wireless broadcasting plant of The General Electric Company at Schenectady, N. Y., showing the apparatus which amplifies the voice or music several thousands of times, then hurls it out into space at the rate of 186,000 miles per second. Recently its tests were heard 1,450 miles away, in Santa Clara, Cuba. "Don't stop your music, we're dancing to it down here," read a cablegram received from a hotel in Santa Clara.

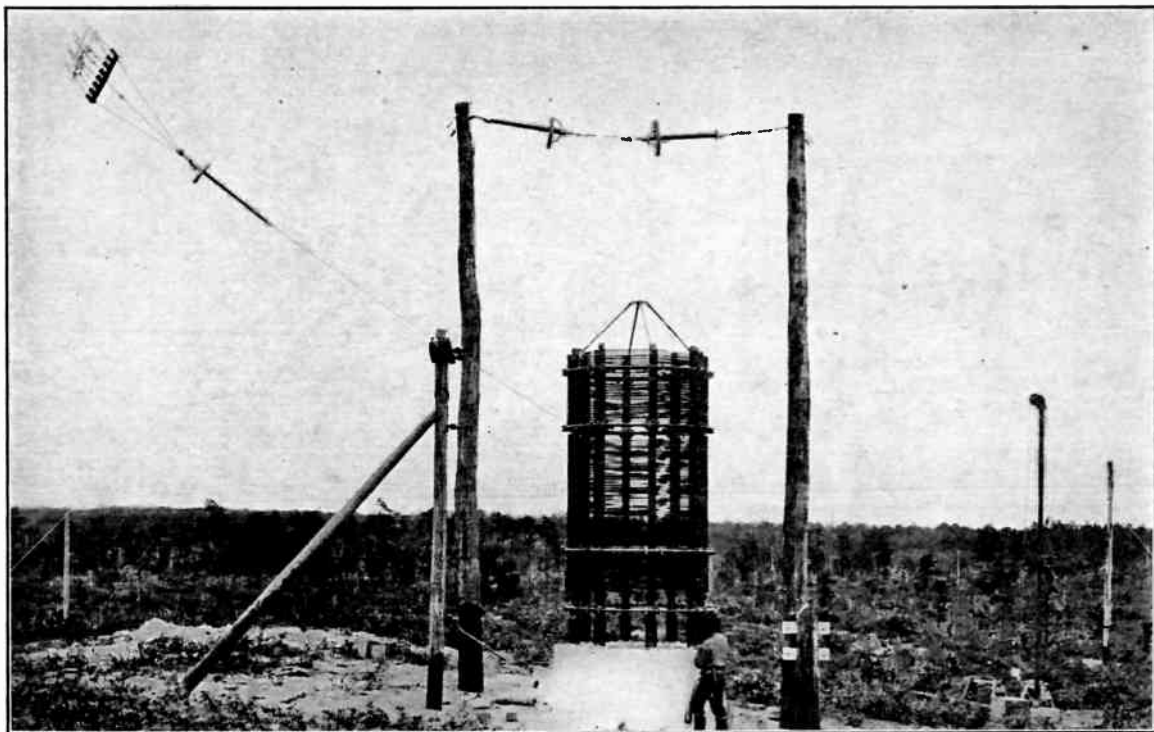

Copyright, Underwood & Underwood, N. Y.

THE TRANSFORMER AND TUNER OF THE RADIO STATION ON LONG ISLAND

Photo shows the giant transformer and tuner outside the world's largest radio station, "Radio Central," at Rocky Point, near Port Jefferson, L. I. This large plant of the Radio Corporation of America sends and receives messages from European stations with remarkable clearness.

off the tremendous amount of excess heat up and into the air and the ice at the bottom remains in its original state unmelted.

CONDUCTION.

Then, let us for a moment consider this subject of conduction as applied to solids. To prove that different solids have different conductivity the following experiment was evolved. A long copper trough is constructed with several short tubes projecting into it near the bottom. Into these, corks are inserted. Through the middle of each cork there is passed a rod of metal, slate, glass or other substance, one end of which is projected into the trough and the other end allowed to extend about eight to ten inches outside. The outer part of each rod is dipped in paraffin wax, which melts at 140 degrees F. When this wax cools on the rods it forms a solid coating. The trough is then filled with oil and heat applied to boil the oil. This heat is carried along the different bars by conduction, melting the wax coating to a different extent in each case, thus indicating the relative conductivity of the metals tested. The wax is seen to melt, probably to the end of the copper rod, which proves that copper is an excellent conductor of heat. The wax on the brass and iron rods melts for a considerable distance but the wax on the bone or glass and slate melts for a very short distance indeed. On the wooden rod it is melted only so much as it is affected by the radiation of heat from the sides of the trough itself. Except in the case of the best conductors the heat is radiated or carried off by the air more easily than conducted by the rod and so the end does not reach the melting temperature.

Did we need any further and more familiar demonstration of the application of these physical laws of conduction and radiation we might point to the teapot and to

the woolen "cosy" which the good housewives were wont to put over them to *keep their heat in*. The non-conducting properties of animal and vegetable substances are put to use in handles of utensils which are exposed to heat and in clothing the body with flannel. Why do we wear winter underwear? To keep the cold out? No. To keep the heat in. Clothing maintains next to the body a layer of air which is at the temperature of the body and so avoids its cooling by radiation, evaporation or convection. Wisps of straw are wound around trees and pipes to keep them from freezing. Ice is packed in flannel or sawdust to keep the heat away from it. Steam pipes and boilers are covered with hair felt and bone meal or asbestos packing to keep them from losing heat. Asbestos is a fibrous substance and a bad conductor for the same reason that furs and feathers keep their owners warm in cold weather. The fibers are bad conductors and there are interstices between the fibers over which the heat does not pass by conduction. Fur or down keeps the heat of the body from escaping. A swan or duck will float for hours on water little above the freezing point because its feathers and down prevent its heat from escaping to the cold water.

Water may be boiled in a paper bag. The heat is conducted through the bag so that the temperature of the paper is never very much above the boiling point. A cylinder is built up, half of copper and half of wood. If this be wrapped round with paper and held over a lamp the paper next the copper remains while that touching the wood is burned. The copper, being a good conductor, carries off the heat of the flame and the paper remains cool, while the wood leaves the paper to its fate.

Convection is the transmission of heat from one place to another by means of the actual motion of the heated

particles of a heated fluid. The fluid is heated by conduction and becomes lighter so that it rises as a result of its expansion and carries the heat off with it. The great ocean currents, as well as the steady and variable winds, are nothing more nor less than gigantic examples of the law of convection. Heat expands or extends in all directions, always trying to effect a uniform temperature of all surrounding elements. This tendency to effect an equilibrium of temperature is going on habitually.

WAVE MOTION.

Let us now hark back more definitely to the thought of radio in its practical aspects. What makes it possible? Wave motion. The electrical disturbances of the ether are of the form of wave motions. We are all more than familiar with the old parable of the stone and the still pond, how the stone dropped into the still pond sets up a wave motion and actually a series of waves which widen out from the central point where the stone fell. Does the water really take part in this apparent motion? Does it really move outward from this center? We can decide this best by noticing the motion of some stick or leaf upon the surface of the pond. As one of the successive circles reaches it, it rises and then falls again. But it does not move outward with the wavelet. It keeps its old place on the pond. This proves to us that the *water itself* is not moving outward from the point where the stone fell, for if it were the leaf would move with it. The motion that actually takes place is merely each portion of the pond's surface is rising and then falling, with perhaps a slight motion from side to side.

Watch a river when the wind is blowing upstream. The motion of the little waves will fool you into believing that the stream actually is flowing backwards. But observe a

bubble on the stream and it will be found to be moving steadily down stream, rising and falling as it meets each wave. A person in a small boat or swimming in the sea will notice the motion imparted to the boat, or to himself as the case may be, with each successive wave. Imagine for a moment that you are in the ocean getting your summer coat of tan. Imagine yourself in the trough between two wave crests facing the advancing wave. As the wave comes, you are carried forward and upward until halfway up its face. Then the forward motion ceases and a backward and upward motion follows until you are on the crest of the wave. The backward motion continues until you are halfway down the slope of the retreating wave and you are carried forward again (though downward) until you are in the trough once more. No doubt you have described something of a circle and your movements have been copied by every portion of the surface of the water in front of you and will be copied by every portion of the surface of the water behind you. The steady onward movement of the waves is not an actual onward movement of the water itself. What we do see moving onward is a state of things, a shape, a wave form. It is well to bear this law in mind, for on it hangs the fundamental principle of radio. The waves propelled in radio transmission are not actual movements of matter but are merely *a form or a state of things*.

You will remember when you were a child what pleasure you used to get out of nothing more elaborate in the way of a plaything than a bit of rope. Stretch that rope out on the ground and when you jerk one end of it a wave will travel the length of it, caused by each particle of the rope transmitting that energy to its neighboring particle. Another familiar instance of this is the barley or wheat field. With a wind blowing smartly across a field of

grain a beautiful wave motion is provided. Here, however, the waves are furnished not by each stalk or ear forcing its neighbor down but the successive impacts of the air on one stalk or ear after another.

Here we come then to a fresh consideration. But let us always bear in mind that a motion of a state of things is distinctly different from a motion of a material body. One further example that will clear this difference is the motion that follows along the path of a procession or a parade. In every procession there is one outstanding high light that produces more enthusiasm from the audience than any other. As the procession moves along we may notice the movement of a disturbance in the crowd, first one man cheering and waving his hat, then the man next to him, and this state of things traveling along the crowd, keeping always parallel, or nearly so, to that enthusiasm-producing high point in the parade. Actually what takes place is that a wave of excitement travels along at the same pace with the carriage or whatever be the high point of excitement. We must emphasize here that if there were no crowd there would be no wave of excitement. If there were no parade there would be no wave of excitement. The crowd is the medium through which this wave of excitement is carried. In radio the ether takes the place of the crowd and the electrical impulse which sends forth the wave takes the place of the parade.

Remember, then, that heat, light and sound all travel by wave motion. In the case of light we have another example of wave transmission and since light travels from the sun to the earth it follows that interstellar space must be filled with some medium capable of transmitting the disturbance which, when it affects our eyes, we call light.

We have several forms of wave motion. There is the periodic motion. By this we mean the motion which brings the oscillating body back to the spot from which it started, at regular intervals. The length of the periods of time which elapse between the return of the body to its original condition is known as the period of the motion. Oscillations, vibrations, swings are other names for periodic motion. The simplest and most familiar example, perhaps is the pendulum. The phase of a moving particle may be defined in simplest possible terms as the fraction of a period that has elapsed since it last passed through the central point in the positive direction. This is well to remember, since *phase* is a term which figures largely in electrical work, especially when we begin the consideration of alternating current. And of course radio work is possible only with alternating current, since that current is the only kind which will effect a disturbance in the ether.

HARMONIC WAVES.

Simple harmonic motion is what the term implies—a motion which is as nearly perfectly harmonic as is possible under natural conditions. Many times a simple harmonic motion is combined with a uniform rectilinear motion. An instance of this would be a pendulum swinging and tracing its path along a board being drawn along at a uniform rate of speed under the point of the pendulum.

It may be seen at a glance how great are the possibilities of combination of these motions. We have the simple pendulum and the compound pendulum and then also we have the various wave forms made possible by combination of these with rectilinear motion. If we have a system of particles in line at equal distance and those particles are a fixed distance ahead of each other

and are put in motion the result is a wave form, a simple harmonic curve, which appears to move steadily along. If each particle performs one of these composite movements that we have been considering the wave form will be the composite complicated curve resulting and it will appear to move steadily along in the direction of the line of particles.

WAVE INTERFERENCE.

Longitudinal waves of compression and rarefaction, transverse vibration, circular waves, primary and secondary waves, plane waves, spherical waves as *reflected* on a plane surface, spherical *waves* as *refracted* on a plane surface—all of these are terms more or less technical, each of which describes a definite element entering into the science with which we are dealing. It is unnecessary to go into their technical ramifications here, however. Their very titles indicate to the casual reader their story. However, there is one other branch of this very broad subject of waves which is worthy of attention and that is *interference* of waves.

Let us go back to that same little pool of water and this time let us drop in two stones instead of the proverbial one. Let us drop them simultaneously but from different points, not very far, however, from each other. We shall then have two sets of circles spreading from the two centers. What happens when a circle from one center meets and crosses a circle from the other? Where the two crests meet there is a double elevation of the surface of the water and where the two troughs meet there is a doubly deep trough. But where the hollow of one wave crosses the crest of the other the two opposite forces neutralize each other and the surface of the water is neither raised nor lowered. Then there is a patchwork of crests and hollows and neutral spaces. This principle

of interference applies to all cases where similar sets of waves are sent out from two or more different sources. The effect produced at any given point will be the algebraic sum of the effects of each wave separately.

In cases where waves (of any sort) meet with an obstruction and there is an aperture in that obstruction the resulting effect differs depending upon the nature and length of the wave. If the wave be long compared with the size of the aperture the distance will be transmitted obliquely. In this way we account for the transmission of sound *around the corners*. In very small waves (such as light waves) the effect of the screen will be to cut off the effects of the waves from all points except those opposite the aperture.

In the next chapter we will take up magnetism, the measurement of magnetic forces, the fundamentals of electricity and the general foundation upon which radio is built. The study of heat and sound and light wave transmission will be found to have a close parallel to the transmission of the electrical impulses through the ether, which make the radio possible. There are other interesting things in connection with the general study of waves, such as the refraction and reflection of light and sound waves, etc., but for the needs of this work the fundamental facts that have been given in the foregoing chapter will be sufficient for a basic understanding of the laws which govern the operation of the radio and all that enters into it.

CHAPTER XL

Magnetism—Lodestone—The Compass—Hard and Soft Iron—Effect on Nickel, Silver, Gold—How to Make a Magnet—Effect of Vibration—Induction—Time Lag—Magnetic Dip—Magnetic Fields.

NO more interesting—and shall we not also say mystifying?—phenomenon exists in nature than that of magnetism. And, since magnetism is so fundamentally tied up with the underlying principles of electricity, and because electricity is the wonderful medium which has made the Age Miracle, Radio, possible, it is necessary to consider next the many sides of the subject of magnetism.

To everyone the word lodestone is a more or less common thing. The lodestone is found in Nature and it actually is a natural magnet. Magnets are constructed by artificial means but they do exist in Nature in an elemental state which is quite capable of attracting bodies. The lodestone is literally iron ore found in the form of irregular stones, which attract to them and hold or support small pieces of steel or iron. To the early Greeks this stone was commonly known and was called “magnes,” from which comes its name or derivative “magnet.” The stones were found first near Magnesia, in Lydia. Very ordinary specimens have been found which were capable of supporting a few grains. It is said, however, that that most famous of scientists, the man from whom came our knowledge of gravity, Sir Isaac Newton, possessed a ring containing a lodestone which weighed only three grains but which could support a dead weight of more than three ounces. The specimen of lodestone which is in

keeping at the University at Edinburgh will support a weight of more than 200 pounds.

The lodestone, or magnet, as reproduced by man consists of a piece of hard steel which is rubbed with a lodestone or another magnet (artificial) or magnetized by electricity. Usually these artificial magnets are made in the form of a horseshoe. You undoubtedly remember in your boyhood days of performing all sorts of weird "stunts" with a concealed magnet. Now, a magnet is a peculiar thing. Its two ends differ from each other. And either end exerts a much stronger magnetic influence than does the middle. To prove this take an artificial magnet and dip it into a heap of iron filings or shavings. You will find that these iron filings or shavings cluster themselves thickly around the edges and ends of the magnet and leave the middle quite free. In other words, the extreme end of any magnet exerts the most powerful influence of any spot on the magnet. For that reason the ends are called poles.

Mariners chart their way over the trackless seas with what is known as a compass. Foresters use the same thing. The artillery and other branches of the army use the compass for "orienting" themselves, or finding out where they are, in relation to the map or in relation to other objects. This is possible for the following reason: The magnet, if supported so that it can turn horizontally with ease, will persistently set itself so that its end points toward the North, the other end of course pointing toward the South. If you mark that end which points toward the North at the first "try," then you will find that same end will always swing around toward the North. This is due to the effect upon the magnet of the poles of the earth. The end which points toward the North is called the "North Pole" of the magnet. It is often called the

“North-seeking Pole,” “The Marked End” or the “Red Pole,” since most magnets have the north-seeking pole indicated as being such by means of a file mark or by being colored red. The practice of coloring the north-seeking pole red and the south-seeking pole blue was introduced by Sir G. Airy, a noted astronomer.

NEWTON'S LAW.

One of Sir Isaac Newton's most important laws is “To every action there is an equal reaction.” This you can clearly see is the case with the magnet. In no case is there a tendency for the magnet to move bodily toward either pole. It merely swings on its center until the north-seeking pole points to the *magnetic* north and the opposite pole to the magnetic south. When the ends of the magnet have properly pointed themselves to their respective poles the magnet comes to rest. You can see from this that, the red pole being swung around to the North and the opposite pole to the South, there is being exerted upon the magnet a combination of forces or, as it is described in technical language, a “couple.” These forces that affect the position of the magnet are properly termed the Earth's “Directive Couple.” When the magnet has been swung about so that it lies due north and south that force or couple is exactly zero and the magnet comes to rest. Should the magnet be swung around forcibly so that it lies due east and west the Directive Couple is then at its maximum power.

A magnet will act upon a piece of unmagnetized iron or steel at all points with equal intensity. For instance, the ends and the middle of a bar of unmagnetized iron or steel will be attracted with equal intensity. This case is different, however, when a magnet is presented to another magnet. Then you find that the *red* pole of one magnet

attracts the *blue* pole of the other magnet and vice versa, the law being that like poles repel and unlike poles attract. Whether it be the blue pole repelling the other blue pole or whether it be the blue pole of one attracting the red pole of the other makes no difference, the result being the same and the law that like bodies repel and unlike bodies attract holding good in every case. This is the law upon which magnetism and, out of it, electricity is formulated.

MOTION IN MAGNETISM.

Experiments have been devised to prove that repulsion *does* take place, as for instance when a bar magnet is slung by means of strings so that it cannot turn and then is slowly approached, at its red pole, by the red pole of another magnet. The suspended magnet will be repelled to a very considerable and visible extent (sometimes as much as two or three inches).

With the possible exception of nickel and cobalt, both of which are slightly susceptible to magnetism, iron and steel are the only two substances which are attracted by magnets with any very considerable force. The relation of the magnetism of copper, silver, gold, etc., to that of iron is shown by the fact that an electromagnet which can lift fourteen pounds of iron cannot lift one grain of copper, silver or gold. The experiments conducted through a considerable space of time by Faraday show that all substances are to some extent affected by magnetism, either positively or negatively. Some substances are to a slight extent repelled by the magnet. Among these are bismuth, phosphorus, antimony and zinc.

Magnetism plays queer pranks occasionally. To show its imperviousness to common insulation, it is quite possible to pick up a piece of iron or steel by means of a magnet acting through a plate of glass or a board or a

brick. Frequently scientists have been bewildered by the peculiar actions of the very delicate instruments with which they have been at work. Trouble may be caused in one room with a very highly sensitive instrument by a charwoman carrying iron buckets in another room, or by bicycles in a *neighboring* playground. Frequently difficulty was experienced in the laboratories of King's College, until at last it was found that the steamers plying back and forth on the neighboring Thames river (with their steel hulls) were having an effect upon the instruments. Often a careful experimenter has thoughtfully removed from his person all iron or steel articles, such as pocketknives, keys, etc., and still found an inexplicable deviation in his instruments, which after careful process of elimination was traceable to a corset steel of an assistant, the wire stiffening of a woman's hat or many unusual things.

MAGNETISM OF METALS.

A piece of iron or steel placed in contact with or even brought near to a magnet becomes itself a magnet. An ordinary piece of soft iron ceases to be a magnet immediately on removal. So does hard iron or steel, providing the magnetization has been comparatively feeble. However, hard iron or steel, after having been at all strongly magnetized, retain their magnetism upon being removed from contact with the original magnet and they will in turn act upon other pieces of iron or steel. The difference between soft iron and hard iron lies chiefly in the fact that the former can be filed with comparative ease whereas this is not true of the latter. Also, a soft iron becomes magnetized easily and loses its magnetism easily whereas the reverse is true of hard iron. The mechanical qualities depend in a complex manner, not only on their chemical composition, which is to say their percentage of carbon

and other substances, but also upon the processes of hardening, tempering and annealing, and upon the strains which they have undergone. The magnetic qualities depend in an equally complex manner upon these self-same conditions.

It is interesting to note the effect of a magnetized bar *upon itself*. When a bar has been magnetized its own poles, being unlike, attract each other and hence they at once set up a force which tends to demagnetize the bar. Obviously, this tendency will be much greater when the poles are brought closer together, as is the case in a short bar. If a bar is less in length than fifty times its own diameter, or thickness, the demagnetization takes place very rapidly. Even when the length is fifty times the diameter the magnetism remaining in the bar is only one-tenth of that which would remain in a very long rod.

EFFECT OF TEMPERATURE.

The effect of vibration upon magnetization is of great interest to us, especially as it connects closely with the subject of radio. If a bar of annealed soft iron is subjected to a magnetizing force and is then subjected to vibration the magnetization is tremendously multiplied. On the other hand, with hard iron or steel, which has been magnetized but is separated from its source of magnetization, the act of smartly tapping the bar or rod reduces its residual magnetism to an unbelievable extent.

In magnetization work there is an element which frequently is spoken of and that is Time Lag. This is nothing more nor less than a lapse of rapidity of magnetization after a certain percentage of the full magnetization has been accomplished. On one experiment it was found that a piece of soft iron under weak magnetization forces underwent during the first five seconds an increase of from

30 to 50 per cent of its instantaneous value and then increased only 20 per cent in the next full minute. In hard iron and steel, however, Time Lag is very rarely perceptible.

Temperature has a very marked and very interesting effect upon magnetism of any given specimen. If the temperature of soft iron be raised while it is subjected to a weak magnetization force the first effect is to increase the magnetization. After passing a temperature of about 1,200 degrees F. the increase is very rapid and may be ten- or twentyfold. Then, upon approaching a critical temperature, which differs with the specimen under consideration, (varying all the way from 770 to 800 degrees C.) the magnetism falls very rapidly and the whole of it is lost while the temperature is further rising ten or twelve degrees. Under moderate magnetizing force very little increase of magnetism is caused by a rise of temperature and under powerful forces no increase occurs. But in all cases the magnetism entirely disappears at the critical temperature. In general, the harder the specimen the lower is its critical temperature.

TWO KINDS OF MAGNETISM.

There actually are two kinds of magnetism. First there is the kind which has just been described—and which may very readily be called “red and blue” magnetism, referring to the red and blue poles and the application of the laws of attraction and repulsion. Then there is the phenomenon which is known as Magnetic Induction. If you suspend a horseshoe magnet from a height and fasten a wire nail to a peg by a string just long enough so that the nail, if held up straight toward the magnet just misses touching it, then the wire nail will be drawn toward the magnet by what is known as induction. It is thus held

suspended in the air, being attracted *toward* the magnet but never quite touching it by reason of its retention at the end of the string. Thus we have a magnet magnetizing another piece of metal without being in actual contact with it.

You can easily make a magnet for yourself. Take a knitting needle or long sewing needle, or if desired a long steel bar. Mark the end which you desire to become the north pole with a file mark or scratch. Then lay the needle down on the table. Take a magnet and place its north pole on the end of the needle which you marked A, to become the north pole of the new magnet. Pressing gently on your magnet draw it several times from A to the opposite end, always in the same direction. Then take the south pole of your magnet and place it on the B end of your needle (opposite from A). Be sure that you carry the magnet from one extreme end of the needle to the other at each stroke and always see to it that north pole of the magnet is contacted with the north pole of the needle and vice versa.

NORTH AND SOUTH POLES.

Another way to make a magnet is to place the needle on the magnet, the desired north pole of the needle coinciding with the north pole of the magnet and vice versa. Then hammer on the needle or bar repeatedly with a wooden mallet. The same result may be obtained by selecting a bar just long enough to bridge across to both poles of an electromagnet. The bar is tapped as was the case before.

If a magnetized knitting needle be broken at its middle point each half of the needle is found to be a magnet. The ends which were north and south poles before breaking remain north and south, while the broken ends become



Copyright, Underwood & Underwood, N. Y.

CHIEF OF NAVAL OPERATIONS USES RADIO TELEPHONE

Rear Admiral Robert E. Coontz, Chief of Naval Operations and a member of the Joint Board, is popularizing the use of the radio telephone in the Navy Department. He has a set in his office which he says he uses to great advantage.



Copyright, Underwood & Underwood, N. Y.

ATTENTION! THE STAR SPANGLED BANNER VIA WIRELESS AT THE RADIO SHOW AT THE HOTEL PENNSYLVANIA

Photo shows Private Adrian Bennett at attention while listening to the Star Spangled Banner being played by a band miles away. Miss Katherine Fingar is shown holding a Marvel receiving radio set with a horn attached to throw the sound.

north and south poles alternately. The half needles may be broken again into equal or unequal portions and this process continued, the result being the same each time. The poles of every short piece of the needle appear weaker than the original poles. This is due chiefly because the poles are so much nearer together and the repulsion of one pole nearly equals the attraction of the other pole and therefore it nearly counteracts. Hence, you may think of a magnet as being built up of an immense number of particles, each having a north and a south pole. In the body of the magnet the north pole of one particle being so closely in juxtaposition with the south pole of the next particle the effect is neutralized. But the unneutralized poles at the ends of the magnet form the true poles.

There is such a thing as reaching the "saturation point" of magnetism. This is nothing more nor less than the point beyond which it is impossible to produce further magnetization in a given body. It is a recognized theory that in iron or steel the individual molecules are minute magnets, each with a north pole and a south pole. If the iron be unmagnetized the molecules are arranged at random so that, there being on the average equal numbers of molecules facing in all directions, the iron as a whole does not behave as a magnet. When the iron is subjected to a magnetizing force the molecules are twisted around more or less so that a large number face in the same or nearly the same direction. The iron then behaves as a magnet. When all the particles are set exactly in the proper direction it is impossible to magnetize the iron more strongly, which has been discovered by Joule to be the case (the same Joule from whom was named the unit of electrical measurement). When powerful electromagnets are employed to magnetize a body a limit to the

magnetization soon is reached. Here we have the saturation point.

VARIATION OF THE COMPASS.

The direction in which a magnet points varies with the true north and south in different parts of the world. If undisturbed by magnets or iron bars near to it, the red pole of a magnet actually points to what is known as the magnetic north and the vertical plane passing through magnetic north is called the plane of the magnetic meridian, just as the plane passing through the true north is called the plane of the true meridian. The angle of variation between the true meridian and the magnetic meridian is called the magnet declination and mariners call it the variation of the compass. Magnetic dip is the inclination of the red pole (in the northern hemisphere) and the blue pole in the southern hemisphere toward the earth's surface. In England this magnetic dip amounts to as much as seventy degrees. At the equator there is no dip. This is known as the magnetic equator.

Since the earth behaves like an enormous magnet all bodies of iron or steel which are near to it are magnetized by induction. You know what happens to a magnet if it be hammered. The induction is greater. Thus, hammer heads and pokers are almost invariably found to be magnetized. They are not, as a rule, powerful enough to pick up filings but their poles are very decided and they can be detected very easily by their action on a pocket compass. In the northern hemisphere, in which of course these United States of ours are located, a vertical column or strut or steel mast will have a red pole at its lower end and a blue pole at its upper end.

The unit of measurement in determining strength of magnetism is the unit pole. A unit pole is one such that when placed at a distance one centimeter from another

unit pole it exerts a force of one dyne. The force exerted by one pole upon another is of course affected by the distance. Accurately this relationship varies inversely, as the square of the distance between the poles.

MAGNETIC FIELD.

A magnetic field is that space which surrounds a magnet. It can be seen that the area about a magnet differs from that which surrounds a space where no magnet is present. In the one a force acts upon any small magnet or piece of iron which may happen to be present, and in the other no force acts. Anywhere near the earth there is bound to exist a magnetic field which is due to the earth's magnetism but which is very weak as compared with the field of a common steel magnet.

You can very easily trace the normal outlines of a magnetic field for yourself by the following experiment. Take a magnet and place it upon a sheet of paper. Sift some fine iron filings through a piece of gauze so that they are sprinkled evenly over the paper, tap the paper gently and you will find that the filings arrange themselves in a series of curved lines from pole to pole and the space above the magnet itself is left almost free from filings. The intensity of a magnetic field at any given point is measured by the force which would act on a unit pole if placed at that point. As a rule the intensity changes as we go from one point to another. At any point near to a magnet there is a magnetic force acting in some direction or other. Hence, the whole space surrounding a magnet is densely packed with an infinite number of lines of force. At some points these lines are packed together more densely than at others. Where they are crowded, as near the poles of a magnet, the magnetic force is great. Wherever the lines are sparse the force is slight.

These lines of force and the principles of magnetism which have been drawn in this chapter play a large part in connection with electricity, directly, and radio indirectly. The fundamentals of electricity will be dealt with in the next chapter.

CHAPTER XII.

What Is Electricity—The Amber Rod—Glass Rod—
Sealing-Wax Rod—Vitreous and Resinous Electricity
—Laws of Attraction and Repulsion—The Proof Plane
—The Electroscope.

WHAT has made Radio, the Marvel of the Ages, possible? Electricity. And what, after all, is electricity? Electricity goes very far back into history for its discovery and yet those who first discovered it did not realize what it was they had come into contact with. The Greek word for amber when translated into English spells *electron*, a word which modern scientists have usurped and applied to a certain unit of measurement of electricity. Amber it was that first made plain the fact that there was in existence a certain subtle force which exerted peculiar effects under certain conditions. For instance, generations and generations ago it was common knowledge that a piece of amber when rubbed would attract straw, dry leaves, and other light bodies. History proves that this fact was mentioned as early as 600 B. C., the authority being Thales of Miletus. Other "Before-Christ" works which have mentioned this phenomenon are Theophrastus (B. C. 321) and Pliny (70 A. D.). Then there came a wide gap and no great further experimentation seems to have been done until along about the sixteenth century, when the celebrated Dr. Gilbert of Colchester found that almost *all* bodies when rubbed behave in a similar manner.

A glass rod rubbed vigorously with a silk handkerchief, or a stick of sealing-wax rubbed with flannel or catskin or chamois will, if held two or three inches above

a little heap of pounded glass or snips of paper or bran meal or any other small and light pieces of matter attract them vigorously. But immediately upon touching the rod they are as vigorously repelled, scattering the heap in all directions. It is true that one or two small scraps of the paper or whatever is used may get flat on the rod and cling to it for a minute or two before being repelled. Small pieces of gold leaf may be lifted five or six inches and they will dance up and down between the rod and the table.

ELECTRICITY NOT PRODUCED, BUT LED.

The attraction of the glass rod and the sealing wax after they have been rubbed is due to nothing else than their electrification. The attraction is caused by the electricity produced in the rubbed object. Here, however, is a point that it is well to bear in mind. "Produce" as used here does not imply the literal sense of the word. Electricity is not actually *produced* but it is rather "led forward," not being created but merely adapted to the existing condition, caused by the friction. Heat will flow from a hot body to a colder one and yet heat is not a fluid. In many cases you even yet hear the expression "electrical fluid." That is incorrect because electricity, although it undoubtedly does flow, is *not* a fluid. In fact, it is not a substance of any sort. There is no "stuff" in it as there is in air or in water. Your experiments with the rubbed glass and sealing-wax rods proved to you, if carried on a bit further, that there are two kinds of electricity—vitreous or positive and resinous or negative. The electricity generated in the glass rod is of the vitreous or positive type and that generated in the sealing-wax rod is of the resinous or negative type.

Bodies which readily allow electricity to flow through

them are called conductors and bodies which prevent its flow are called nonconductors or insulators. A body which has been electrified must be insulated or cut off from other bodies which might take away their "charge." This is done by means of glass supports or ebonite supports, or by means of suspension with silken thread. Bodies thus suspended in the air, free from physical contact with other bodies which would rob them, retain their electricity. Thus it is shown that the air is a good insulator. It is found that all dry gases at the ordinary atmospheric pressure are good insulators.

THE ELECTROSCOPE.

The electroscope is a delicate little instrument designed to detect and designate feeble changes of electricity, as to their nature. The same thing may be accomplished by means of what is known as a proof plane. This is simply a small piece of tinfoil (or almost any other metal) attached to a glass or ebonite handle. If an electrified body be touched with the proof plane a specimen of the electricity of that body is taken away by the proof plane, which in turn becomes charged. Suppose, then, you suspend a small pith ball, which has been charged positively, from a silken string. If the proof plane be presented to this ball the latter will be found to be attracted or repelled according to whether the plane is charged positively or negatively.

If you take a rod which has been charged with positive electricity and bring it near to an uncharged insulated metallic body, you will find by means of the proof plane that the end of the body nearest to the rod becomes charged with negative electricity and the part furthest from the rod charged with positive electricity, the middle parts being neutral. These charges of electricity are said,

as in magnetism, to be induced and the phenomenon is called induction.

The law of magnetism whereby like bodies repel and unlike bodies attract likewise holds good in electricity. But where does electricity come from? It is intangible. You cannot reach out and touch it. You cannot wrap it up in a paper parcel and sell it over the counter like a pound of sugar; but as modern science makes one step after another along the line of electrical development this intangible aspect is more and more overcome. For the present let us think of all unelectrified bodies as containing an unlimited supply of positive and an equally unlimited supply of negative electricity (whatever those two quantities may be). The attractions and repulsions of these two neutralize each other. A body which has an excess of positive electricity (or a deficit of negative electricity) is said to be positively electrified and vice versa.

TWO KINDS OF ELECTRICITY.

It may be a difficult thing to imagine a single body as being possessed of two different kinds of electricity, each exactly opposed in nature to the other kind. Franklin's suggestion was that there is but one kind of electricity, that all unelectrified bodies contain a certain normal amount of this electricity and that positively charged bodies are those with more than the normal amount. This still leaves to be considered the difficulty that the normal amount of electricity in a body must be practically unlimited, for to produce a very intense negative charge a very great amount of electricity would have to be withdrawn from any given body.

Here you have three simple rules which may help you to visualize the general theory of electricity. An unelectrified body with its equal amounts of positive and nega-

tive electricity may be charged positively in three ways:—first, by being given more electricity; second, by taking electricity away; and third, by both giving and taking electricity away simultaneously.

On the other hand, a positively electrified body may have its charge weakened in three ways:—first, by taking away positive electricity; second, by giving it negative electricity and, third, by taking away the positive and giving it the negative electricity simultaneously. Any one of these ways, if pursued far enough, will equalize the amounts of positive and negative electricity in the body and then give it an excess of negative electricity.

ALL PAIRS OF BODIES ELECTRIFIED.

The gold-leaf electroscope is an extremely delicate little instrument used to detect the existence of feeble charges of electricity. The electroscope is arranged with two leaves of gold forming the terminal of a brass wire which leads from a brass contact plate. If this brass contact plate is touched with a body charged positively, negative electricity is driven into the plate and positive electricity is repelled through the wire into the gold leaves. The leaves, being similarly electrified, repel one another and open out. Thus, since you know whether it is negative or positive electricity that produces the divergence of the gold leaves, the instrument may be used to detect the nature of any charge of electricity, even the most feeble.

The gold-leaf electroscope has proved conclusively that all pairs of bodies are electrified when rubbed together, one becoming charged negatively and the other positively. In the case of metals and other conducting bodies this might appear to be untrue. The reason is that any electricity which is produced upon them immediately escapes to the earth if the conductor be handled during an experi-

ment in the same way as we handle the sealing-wax rod or the glass rod, etc. If, on the other hand, a brass rod be stuck into an insulating glass handle the rod, on being rubbed or flipped briskly with dry silk, becomes electrified. Sometimes this experiment fails, due to the fact that the handle insulation is not altogether perfect. A sure way of illustrating the fact that brass actually can be electrified is to uncharge an electroscope and then flip with a piece of silk the brass plate of the electroscope. If the electroscope be perfectly dry before you start the experiment it will be necessary to make but a very few strokes of the silk before you notice wide divergence of the leaves. In several places the substance ebonite has been mentioned. This is a combination of sulphur and India rubber.

The wonders of electricity never cease and as you go more and more deeply into the subject you cannot help but marvel at the seeming miracles that may be performed with it. For instance, you have seen how there is a very definite distinction between negative and positive electricity. And yet you will now see how it is possible to charge a body negatively and then take from that body a positive charge. This is accomplished by means of what is known as the electrophorus.

THE ELECTROPHORUS.

The electrophorus is an instrument consisting of a thin cake (about one-eighth of an inch thick) of some resinous material, such as shellac, sealing wax, etc. This thin cake is cast in a shallow metal dish or sole. On the resinous cake there lies a disc of brass, or any other metal, which is known as the cover. This cover is furnished with an insulating glass or ebonite handle and is slightly smaller in diameter than the sole.

In many cases a small knob is fixed by a short stem on the top of the cover. The cake is electrified negatively by rubbing with flannel or striking briskly with catskin. The cover now is placed on the sealing-wax cake and since neither of them can be absolutely flat they come into contact only at a limited number of points, the greater part of their surfaces being separated by a minute air gap. At the few points where contact is maintained the sealing wax gives up its negative electricity to the cover but the negative electricity distributed over the rest of the surface is unaffected, being unable to escape along the nonconducting sealing wax. The cover is affected by induction, from the negative electricity, and it becomes electrified, positive electricity being attracted to its lower surface and negative electricity driven to its upper surface. Now, if you touch the cover with your finger the negative electricity will escape through your body to the earth. This is the principle of "grounding" which plays such a large part in all electrical construction work. Finally, if you lift the cover by the insulating handle, being careful to take hold at the extreme end, the positive electricity, being no longer attracted to the under surface, is free to distribute itself over both surfaces and the cover is found to be charged with positive electricity throughout. If you now present it to the electroscope you will find that it causes a very decided reaction from the instrument.

STRANGE FACTS ABOUT ELECTRICITY.

If the knuckle of the hand be presented to the knob, the charge escapes from it to the hand just before actual contact takes place. In other words, the spark "jumps." As a result, a slight tingling prick is felt, a faint but de-

cided crack is heard and the spark itself actually may be seen.

At this point it might be well to emphasize the fact that a charge of electricity rests entirely upon the surface of a charged body and does not penetrate it beyond the surface. Definite and interesting experiments proving this conclusively to be true have been worked out but they are more or less complicated. Suffice it to say that it has been proved that a charge of electricity does not penetrate a body more than one one-hundredth of an inch below the surface.

If you have ever talked to anyone who worked in a paper mill you will know that this principle *does* work out in practice. The newly-made paper, being damp, is passed between several heated rollers to dry it, which process electrifies it feebly. But as the continuous strip is wound around and around into an immense roll and the electricity of each turn passes to the outside as soon as it is covered by another fold, the surface of the roll soon becomes powerfully electrified by the accumulated charges. If the knuckle now is presented to the paper a brilliant spark is the result and often a more than severe shock is produced.

ELECTRO SURFACE DENSITY.

Naturally, since electricity is seen to confine itself to the surface of a body, you would expect that it would spread itself out evenly in all directions. In bodies of symmetrical shape this is true. But in bodies which have protuberances, the electricity is accumulated on the more prominent parts of the surface and almost absent from any depressed parts. Electro surface density is a term used to express the intensity of accumulation of electricity at any part of the surface. The surface density is

greatest at all points, edges or corners. Electro surface density at any point is the number of units of electricity per square centimeter at the point.

You know that electricity leaves the interior of a conductor and distributes itself on the surface. The same repulsion makes it endeavor to disperse more widely still. This is prevented by the fact that the surrounding air is a nonconductor. However, the tendency on the part of the electricity toward further dispersion puts the surrounding air under what is called "electrical tension." Whenever the surface density is sufficiently increased (which may be done either by giving a very strong charge to a conductor of moderate curvature or a moderate charge to a conductor with points or parts sharply curved) the tension becomes too great for the air to withstand and it gives away with a disruptive discharge, the discharge being accompanied by a smart crack and a visible spark. Here, then, is at least one instance where we can see electricity.

HEARING ELECTRICITY.

From a sharp point on a charged conductor electricity will escape continuously with a hissing sound and in a dark room a faint glow is visible around the point. If there be no other conductor near the point to which the electricity can escape it will charge even the air itself near the point. The charged air then is repelled from the point and, streaming away, it forms a wind. This may be proved by holding a lighted candle before the discharging point of an electrical spark machine. Hence, you can see at a glance that any conductor intended to retain a charge for a considerable length of time should be free from sharp angles or points.

In the next chapter will be discussed the various

types of electrical machines, showing just how electricity is produced and the various elements which enter into its handling. Also, it will be shown just how the elementary principles of electricity are developed and applied specifically and practically to radio, making the radio the most wonderful development or invention of many generations.

CHAPTER XIII.

Electrical Machines—Newton, Hawksbee, Ramsden,
Von Guericke—Wimshurst Machine—Leyden Jar—
Strain In the Air—Can Electricity Pass Through
Glass?

ELECTRICITY, although it is a most intangible force, is at the same time a force with which man so far has been able to do more than perhaps with any other. And, though it is apparently so very intangible, man has harnessed it and regulated it and actually produced it—we might say, artificially. If we lay aside the scientific data and proof which modern scientists have given us and permit our minds to rest on electricity in the abstract we cannot help but think of the very intangible, elusive “substance” which Franklin and his kite tied up with civilization. And yet electricity is a very definitely tangible thing and its control is a very positive proposition. It might be of more than passing interest to delve for a short space into the ways of producing electricity by means of so-called “machines.”

The earliest machine was invented about 1640 by Otto von Guericke, who was also the inventor of the air pump. His machine consisted of a ball of sulphur of rather large proportions mounted on an axle. This ball of sulphur was rotated and while one man turned the axle another man held his hands against the sulphur. The friction thus produced brought forth electricity, which was led away to a “conductor” by means of a chain hanging against the ball.

Various other experiments were conducted by Newton, Hawksbee, Ramsden, Winter and others. Newton, for in-

stance, used a glass globe instead of the ball of sulphur. This was the origin of the *frictional* machine. Development has led to the supplanting of the frictional machine by the induction machine, in which only a slight amount of friction is necessary to produce an initial charge and the subsequent supply is obtained by induction, as is the case in the electrophorus.

PLATE ELECTRICAL MACHINE.

You undoubtedly have heard of the plate electrical machine. This consists of a circular plate about 20 inches in diameter which is mounted firmly on an axis and can be turned by a handle. At the top and bottom of the plate are pairs of cushioned rubbers through which the plate passes. These rubbers are made of silk or leather tacked on to wooden blocks and stuffed with horsehair. They are so arranged that they can be adjusted to vary the pressure on the glass. Then, we have a pair of combs, formed by brass rods which are bent around the edge of the plate and fitted with a number of points or needles directed toward the plate.

The plate in being rotated between the rubbers develops positive electricity. As the parts charged with the positive electricity pass between the combs they act inductively, repelling positive electricity into the remote parts and attracting negative electricity into the points. You know that electricity is repelled from points, hence this negative electricity is thrown off from the points of the combs to the plate and there it neutralizes the positive electricity under the points themselves. The continued rotation of the plate brings fresh supplies of positive electricity to be neutralized by the withdrawal of more and more negative electricity from the combs; the conductor, having a greater and greater deficiency of negative elec-

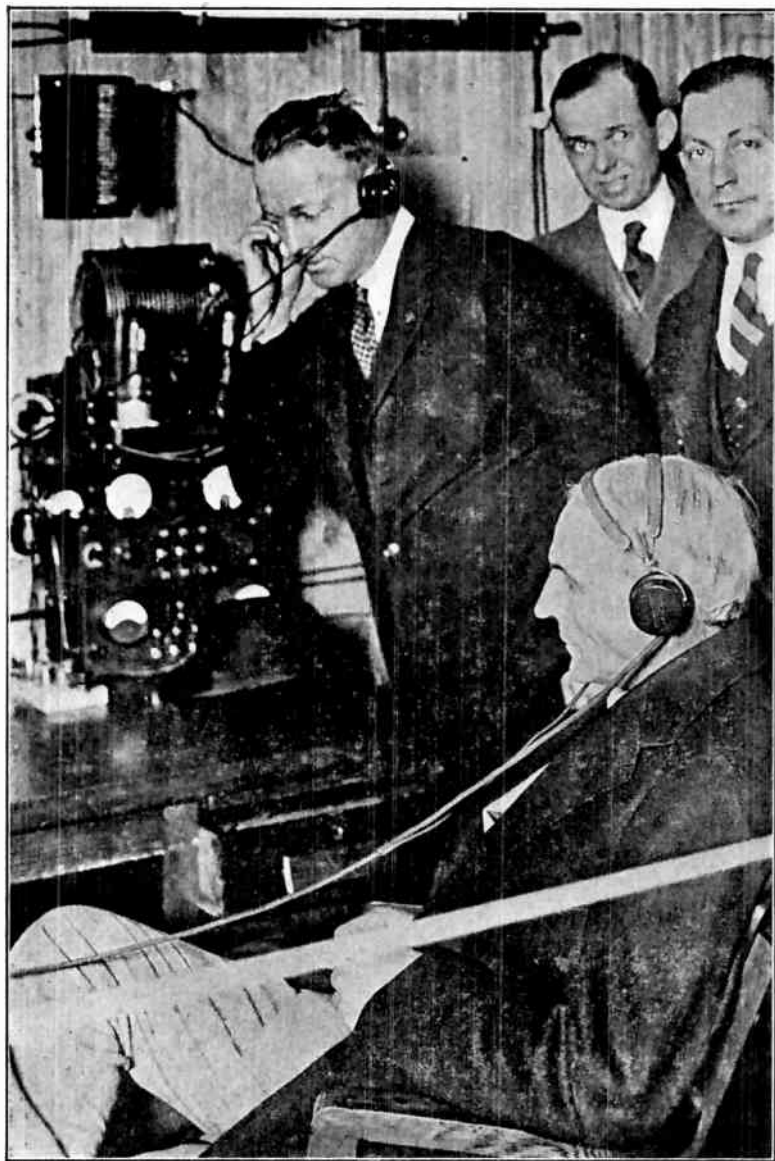

Copyright, Underwood & Underwood, N. Y.
HENRY FORD PUTS ON THE RADIO PHONE RECEIVERS
Henry Ford dropped into an Atlanta (Ga.) newspaper office and listened in on the radio phone receiving set installed by the newspaper.



Copyright, Underwood & Underwood, N. Y.
GOOD MORNING GREETING

This young lady is seen at the window of her room in the McAlpin Hotel, New York, as she gets a greeting from a young man in Brookline, Mass. She is able to send and receive messages.

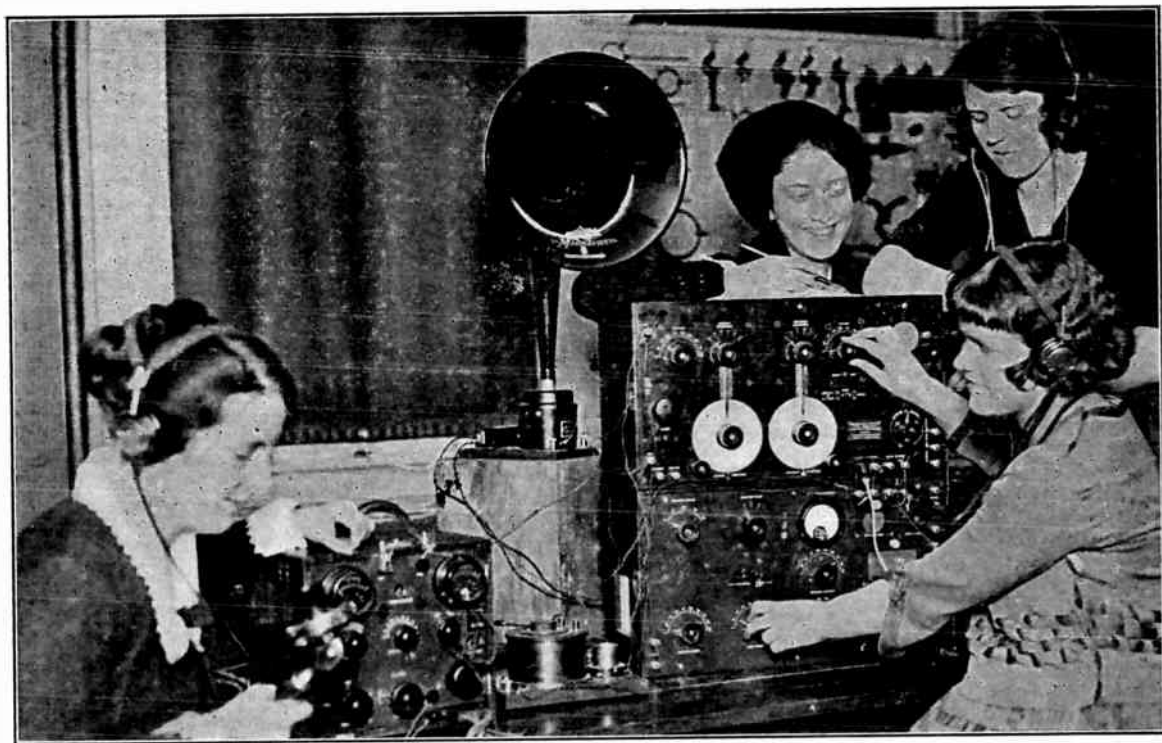

Copyright, Underwood & Underwood, N. Y.

COLLEGE GIRLS OPERATING RADIO STATION

These students are sending messages to their parents in various parts of the country by radio phone from Radcliffe College, Cambridge, Mass. Girl at right is "tuning in" while the one at left is speaking into the transmitter. Girls at the back, one is taking down a message and the other is listening in.

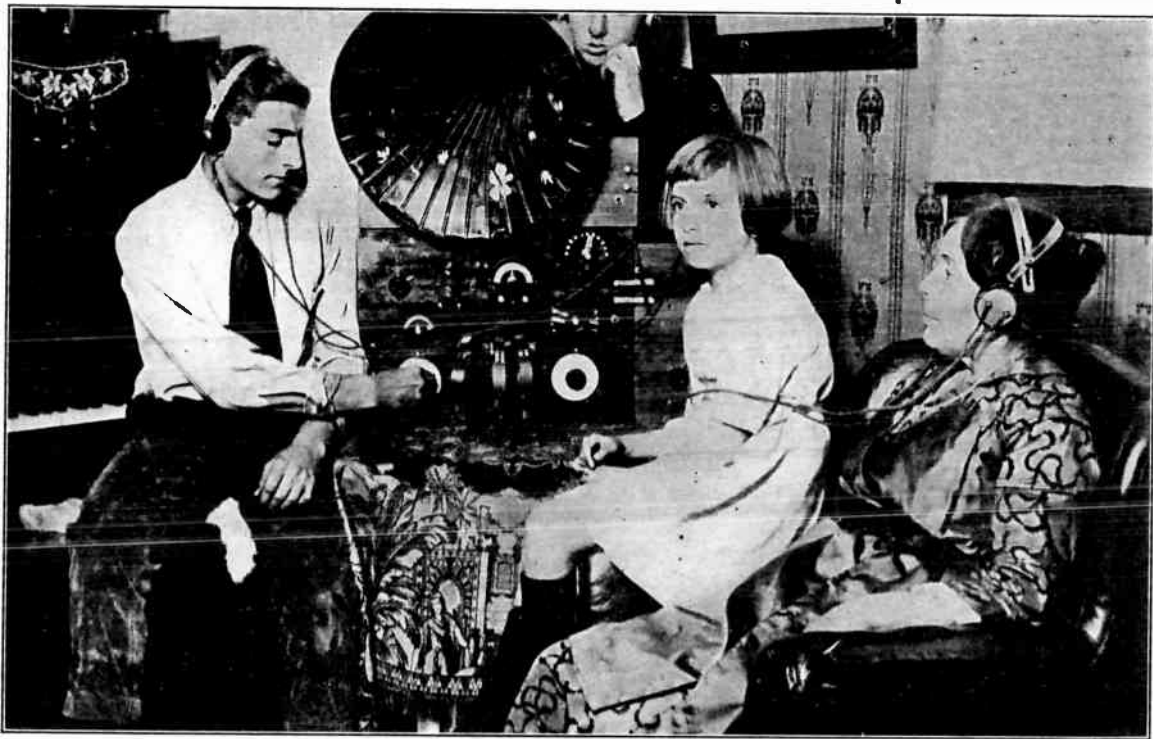

Copyright, International

THE FAMILY RADIO REPLACES THE FAMILY VICTROLA

No more does the family gather in the parlor to enjoy the tunes of music from a victrola alone. The present-day radio telephony places that novelty within the reach of all, and in thousands of homes just such a scene as is pictured here is to be seen. Here's a family gathering in San Francisco "listening in" on the radio concert broadcasted from the "Examiner" building.

tricity, is charged more and more powerfully with positive electricity.

Still another form of electric machine is derived from the principle of "electric wind," which was explained in a preceding chapter. This machine consists of five or six brass wires radiating from a central cap which can be balanced on the top of a pivot. The wires have their ends sharply pointed and bent to point in the same way around a circle. When the pivot is connected with the electrical machine electricity makes its way to the points of the wires and there escapes into the air. The electrified air is repelled from the points but by reason of Newton's third law there must be an equal reaction on the points. Therefore they are driven backwards and so long as the machine is working well the wheels spin rapidly. A still further experiment with this machine was effected by inverting over it a bell jar. After a few minutes the air in the jar became so highly electrified that further escape of electricity from the machine was prevented and the machine came to rest.

THE WIMSHURST MACHINE.

The Wimshurst Electrical Machine is the simplest and most perfect of the machines worked by induction. It consists of two circular glass plates, about 20 inches in diameter in a medium-sized machine, mounted on a substantial frame. The plates are geared so that they rotate in opposite directions, with the smallest possible clearance between the plates. On the outer face of each plate there are stuck an even number of strips of brass or tin-foil. The spaces between these strips, as is also the case with the rest of the surface of the plates, are varnished well to prevent electricity from leaking over the surface. At each end of the horizontal diameter of the plates is

placed a conductor with branches upon which there are placed combs or rows of points directed toward the plates. These conductors are supported by glass or ebonite handles. These conductors terminate in discharging rods which have knobs at their ends. These discharging rods can be adjusted, even while the machine is in operation. A conducting rod with a small brush of very thin brass is placed so that it contacts with the front plate; and a similar brush touches the back plate.

In practical use, there is always a sufficient charge of electricity present in the machine, left over from the preceding use, to work up a powerful electrification from a few turns of the plates. However, if there be absolutely no electrification left it is a simple matter to touch against the back of the plate an electrified ebonite rod.

If the machine be worked in the dark a beautiful glow is seen on the plates. This glow is caused by the electrical leakage over the plates. From all of the little points delicate brushes of violet light may be seen. These violet brushes are due to the streaming of electricity from the points themselves. A series of brilliant sparks will be forced across the gap between the adjustable knobs, even when those knobs are as far apart as four or five inches.

DISCOVERY OF LEYDEN JAR.

The Leyden jar was discovered in 1746. Cuneus, a student at Leyden, in Holland, seeking to electrify water, took in his hand a glass flask half filled with water and let dip into the water the end of a chain hanging from the conductor of a "glass-globe machine." Some time having been allowed to get the water well charged he attempted to lift the chain from the flask and received a violent shock in the arms and chest which caused him to drop the flask. It took him two days to recover from the

effects of his experience. This discovery caused great excitement in the scientific world, it being the first electric shock ever experienced, with the exception of theretofore unrecognized lightning strokes. Improvements were made soon and the result was the discovery of the Leyden jar.

The Leyden jar is a thin glass jar coated about half-way up both inside and outside with tinfoil. These tinfoil coatings act as plates or conductors. The Leyden jar originally was given the appropriate name "Accumulator" but this name unfortunately has fallen into disuse, owing to its having been misapplied to secondary batteries. The name "Condenser" is more properly used but care must be taken to distinguish here between the condensation which takes place with steam and that which takes place with electricity.

PREVENTION OF SERIOUS SHOCK.

On the inner coating of the Leyden jar there is a brass rod which is terminated by a knob. In some of the more usual forms this rod is passed through a wooden lip or cap and from its lower end hangs a piece of chain which makes contact with the inner coating. The cap keeps out the dust but it *does* admittedly furnish in itself a possible leak which is obviated in the form which has no cap. There insulation is pretty nearly perfect because leaking electricity would have to pass up the surface of the glass on the inside and down the outer surface. The Leyden jar is provided with a discharger which prevents serious shocks. This discharger consists of a pair of brass rods, fitted with knobs at one end, jointed together at the other and mounted on a glass handle. One knob placed in contact with the outer coating and the other up to the knob of the jar, discharges the jar.

We have described the shock experienced by a single individual. The same shock may be felt simultaneously by any number of people provided they join hands so as to make a continuous chain. The man at one end must hold the jar by its outer coating while the man at the other end touches the knob. In some French experiments made during the excitement which followed the discovery of the Leyden jar a severe shock was thus given to a whole regiment of about 1,500 soldiers.

SHOCKS FELT AND NOT FELT.

Shocks also may be given from Voltaic Batteries, Ruhmkorff Induction Coils and Dynamos. No shock whatever is felt when we touch the terminals or wires connected with the terminals of a battery containing two or three cells. If the number of cells be increased to ten a slight pricking sensation is felt when a wire from a terminal is held very lightly in the hand. The effect is more evident if the hands have previously been soaked in water to which a trace of acid has been added. It is then accompanied by a slight twitching of the muscles. These sensations become much more marked as the number of cells is increased to 40 or 50 and are felt to a similar extent with a low pressure dynamo—one giving a difference of potential of 50 to 100 volts. A nasty shock is given by 100 to 150 cells or 200 to 300 volts and anything above this is distinctly dangerous. A shock from a dynamo working at 600 to 1,000 volts is as a rule fatal even if given by a momentary accidental contact with a wire. The danger arising from the enormous potentials (ten to twenty thousand volts) often employed in electric lighting stations is very great and the utmost caution has to be observed in their use.

If the knobs of the Wimshurst machine be separated by

a short distance (half an inch or less) the spark usually consists of only a single bright line of light which on examination shows at the negative knob a very brilliant point separated by a stretch of purplish violet light from a longer brilliant line which extends to the positive knob. If the distance be increased to two or three inches or more the discharge breaks up into a number of sparks similar to the last, side by side and slightly bowed outward, as though they repelled one another.

The spark from the Leyden jar is much brighter, stouter and gives a sharper sound than the direct spark between the knobs of the machine. This is due, of course, to the greater quantity of electricity which passes. If the conductors of a Wimshurst machine be connected with the inner coats of two Leyden jars the outer coats of which are connected together, then a spark only passes between the knobs when each jar is fully charged. It, therefore, has all the characteristics of a Leyden jar spark.

STRAIN BY ELECTRICITY.

You have seen that the jar around an electrified body is strained by the electricity and when the strain at any point becomes too great a passage for the electricity is torn through the air and the whole charge rushes through. The sound of the spark probably is due to the tearing asunder and subsequent closing in of the air. Heat is produced by the friction of this sudden rush of air and therefore the spark is able to ignite charges of gunpowder or spirits and to produce an explosion in a mixture of oxygen and hydrogen.

It may seem strange that any "strain" can exist in so mobile a substance as the air but it must be remembered that although ordinary matter passes readily through the

air and therefore cannot cause strain on it the passage of electricity is opposed in air just as much as the passage of ordinary matter through some such substance as glass. Electricity causes strain in other insulating materials and the strain amounts to an actual rupture or piercing, in any case where a spark passes through the material. The spark from a Wimshurst machine will puncture a card placed between the knobs of the machine. The hole thus made has a slight burr on each side as though it were burst outward from the middle. A sheet of glass may be pierced by the spark but unless it be very thin a powerful spark from a battery of Leyden jars is necessary. Here, however, it is necessary to take the greatest precautions to guard against the spark leaping *around* the glass instead of through it.

HEATING EFFECTS OF ELECTRICITY.

To demonstrate the heating effect of electricity a fine wire placed in the path of the electricity when a spark is taken from a battery of Leyden jars is heated and becomes red hot, white hot or even melts, according to its fineness. Gold leaf placed in the circuit is raised to a high temperature owing to its extreme thinness and it is not merely melted but volatilized, or converted into vapor. It has been proved very conclusively and concisely by Coulomb, with the help of his torsion balance, which we will not describe here in detail, that like electricity repels and unlike electricity attracts. But he went further than that and established a law covering the *force* with which this attraction or repulsion takes place. This law is that "the force between two small electrified bodies varies inversely as the square of the distance between them." From Coulomb the unit of electrical measure, the Coulomb, was named.

The next chapter will discuss electricity as it is found in the air, touching upon the history of Franklin's experiment, and the developments that have followed that experiment. This, with a short study of electro-magnetism, brings us into the actual working conditions surrounding the practical application of these principles that have been discussed in the last four chapters, to the broad and ever interesting subject, Radio.

CHAPTER XIV.

Franklin and His Famous Experiment—What is Lightning?—Effect of Atmospheric Change on Electrical Conditions—Electro-magnetism in Wires, Coils and Spirals—Effects of Thunderstorms—First Use of Wires for Telegraphic Transmission—The Wire Eliminated.

JUST six years after Cuneus had his painful and startling experience with the Leyden jar, whereby he was severely shocked and the scientific world of that day was awakened to the potentialities of electricity, there came the experiments of the great Benjamin Franklin (1752) which are pretty well known because of their constant preachments in the public schools of the country. The similarity of the jagged lightning flash and the smart spark obtained from the frictional machine and the Leyden jar suggested to Franklin, among others, that lightning was nothing more nor less than a gigantic spark leaping about in the heavens from one cloud to another or from a cloud to the earth. Franklin and his contemporary experimenters were quick to perceive the similarity between the lightning "stroke" and the shock of the Leyden jar. And these men recognized that a peal of thunder was but a magnification of the cracking of the spark from a machine.

Franklin's original experiment consisted of flying a kite near the clouds during a storm and attempting to draw electricity down to him along the string. At the end of the string he hung a key, from which to draw the sparks if any came. He held the string by means of a silk ribbon in order to insulate it. At first the string was dry and no

result was obtained but as soon as rain fell the string became wetted and conducted an abundant supply of electricity to the key, which then yielded powerful sparks. This type of experiment was extremely dangerous because on occasions sparks as long as nine feet were produced. In 1753 Richmann, a Russian physical experimenter, was killed by a shock.

Having established the general truth that clouds generally are electrified we are confronted with the problem of "how do they become electrified"—in some cases to such an enormous potential that they can yield sparks possibly a mile long? The problem is one upon which eminent scientists have been working more or less unsuccessfully until now. Doubtless the electrification is due largely to friction of the wind against the surface of the earth while another agent may be the evaporation of water from the sea, from rivers and from moist land, which evaporation is taking place continually.

HOT WEATHER AFFECTS RADIO.

Wireless telephony, or as it is destined to be known more popularly—*radio*, seems to be largely affected during hot weather. The condition of the atmosphere has a great effect upon the daily results that can be obtained with it. Hence, the following brief discussion of the action of dry air as related to electricity will undoubtedly be of interest at this point.

Dry air is one of the best known insulators. Hence, during a very dry spell there is little or no opportunity for electricity to escape from the air to the earth. Therefore, we logically might expect that the upper strata of the atmosphere would gradually accumulate the electricity which is continually being produced by friction and by evaporation. Remember, however, that the air may *feel*

dry because it is hot and capable of holding a great amount of water vapor and yet it is continually drinking up more moisture, a process to which sooner or later an end must come when the air becomes nearly saturated. Ultimately some slight fall of temperature causes these upper strata to become moist, the water vapor within them begins to condense into minute particles, and clouds are formed whose conductivity may be fairly good. The electricity which, before the condensation, was distributed throughout the volume of the air makes its way to the surface of the cloud and being thus packed more densely together it has a greater tendency to escape in sparks.

Previous to a thunderstorm the clouds are in great commotion, great masses being torn asunder, others uniting together. Now these clouds become electrified, some more or less strongly, and they act inductively on one another and if a piece happens to be torn away while more than its fair share of electricity has been induced into it, it may soar away intensely electrified. Several such pieces may unite to form a big cloud charged to the enormous potential necessary to produce a flash of lightning. Necessarily, we can see at a glance what "interference" with radio impulses will take place under conditions such as these.

WHY BIG RAINDROPS FOLLOW THUNDER.

You undoubtedly have noticed that just after a clap of thunder the drops of rain are very considerably larger. This is due to the fact that when drops of rain strike together when slightly electrified they come together into big drops but that when they are unelectrified they generally rebound on one another. Just before a thunder clap the drops are kept apart by the strong electrification

and just after the clap the feeble charge remaining causes them to coalesce into big drops.

Franklin it was who first advocated and devised the lightning conductor. This consists, as you must well know, of stout copper conductors led down from the highest possible point of the building to a "ground," which may be effected by attaching to water pipes (*never* gas pipes) underground or by leading away into a damp spot and attaching to a metal plate, covered with coke. Why does a lightning conductor work? If a cloud strongly charged with positive electricity be floating above the building it induces negative electricity on the part of the earth immediately below and into the conductor itself. The negative electricity attracted into the points very readily escapes from them into the air and so long as the charged cloud remains overhead there will be a silent but potent stream of negative electricity flowing steadily into the air from the point of the conductor. Thus the electricity of the cloud is gradually neutralized without the passage of a violent spark.

DISCOVERY OF VOLTAIC CELL.

During fine weather the air is almost always at a positive potential. During wet weather it is sometimes positive, sometimes negative. During snow it is almost always positive and if the wind be high the potential is about twenty-five times the fine weather potential. During thunderstorms it may be positive or negative and sometimes as strong as fifty times the normal potential. Also the height affects the potential; the higher we go the more the potential increases.

In 1790 Galvani, a professor of anatomy at Bologna, observed curious convulsive movements in the muscles of a recently-killed frog when touched at different points by

iron and copper which were in contact. These movements, resembling the muscular contractions experienced when a shock is taken from a Leyden jar, naturally suggested the thought that some electrical action was taking place. And the fact that Galvani observed similar action in the muscles of dead frogs when affected by ordinary electrical machines justified the assumption.

Volta very soon thereafter proved by means of the "condensing" electroscope that certainly some electric action occurs when two different metals—for instance zinc and copper—are placed in contact. His experiments led to the discovery and application and improvement of the so-called voltaic cell. Currents thus produced have for many years been called Voltaic Electricity, Galvanic Electricity, but really there is no essential difference between this and Frictional Electricity.

You know that, if you are right-handed, the motion of driving a screw into a piece of wood with a screwdriver is a perfectly natural one. The screw being threaded in a right-hand direction there is but one course that your motion can follow and that is to the right. Now, imagine an electric current in the same fashion. Consider a wire carrying an electric current. This wire will be surrounded by circular lines of (magnetic) force and the direction of the current and of the lines of force are connected in the same way as the turning and driving in of the ordinary right-hand screw. This can be proved to your satisfaction by passing a powerful current, say ten amperes, along a stout wire which has been stuck at right angles through a sheet of paper—or, better yet, through a hole drilled in a sheet of glass. You will find that iron filings sprinkled on the sheet arrange themselves, when the sheet is tapped, in circles with the wire for their center.

Now, consider a wire bent into a loop. Here you will find that an electric current flowing around such a loop is equivalent to a flat magnetized disc of the same size as the loop, the north pole of the disc being on that face around which the current appears to flow *anti-clockwise*.

ELECTRICAL EFFECTS IN SPIRALS.

Now, if you bend the wire conveying the current into a spiral shape each turn of the spiral is practically such a loop as that just described and therefore is equivalent to a magnetized disc. The whole spiral is equivalent to a set of such discs all with their north poles facing to the left and the south poles facing to the right. The alternate north and south poles neutralize each other as far as external action is concerned and there remains an unneutralized north pole at one end and an unneutralized south pole at the other end. Such a spiral wire carrying a current is called a solenoid and it is equivalent to a magnetized rod so far as concerns its action on bodies outside the spiral. The location of the north pole and the south pole is done not from the way of winding the spiral but by observing which way the current flows around. If the current be reversed the poles are reversed, although the spiral itself is unchanged.

A circuit carrying a current tries to move so that as many lines of force as possible (due either to a magnet or to another current) pass through it in the same direction as its own lines of force. Thus, electric current can make magnets and behave like magnets. Then the question naturally presents itself "Can magnets or currents behaving like magnets produce currents of electricity?" Faraday's researches, conducted in 1831, answered the question in the affirmative and from the facts discovered by him the knowledge which renders possible the con-

struction of the gigantic dynamos of the present day has been gradually built up.

As soon as it was discovered, more than a century ago, that electricity could be made to travel along a damp string or wire, which had been carefully suspended from insulating supports, the fluttering of the gold leaves of the electroscope and the movements of the pith balls at once suggested the idea of giving signals at a distance by means of electricity.

THE FIRST ELECTRICAL MESSAGES.

In 1747, at Shooters Hill, near London, Bishop Watson sent the shock from a Leyden jar through two miles of wire hung from wooden poles but this was a rather violent method of signalling. In 1774 Lesage, at Geneva, arranged twenty-four long wires side by side and connected each to an electroscope at the far end. Each electroscope indicated a letter and therefore by charging the wires in proper order words could be spelled out. Owing to the uncertainty of all work with frictional electricity, especially before the days of the Wimshurst machine, these attempts at telegraphy were of no practical use.

The discovery of the voltaic battery put the matter on a different footing. In 1811 Sommering, of Munich, constructed a workable telegraph but it was not until late in 1837 that the telegraph was made capable of commercial use, as a result chiefly of the efforts of Steinheil, of Munich, Morse, of America, and Wheatstone and Cooke, of England. From Wheatstone comes the Wheatstone Bridge, a method of electrical measurement very largely experimented with by electrical students.

'As early as 1860 an instrument which bordered on the fundamental principle of telephony was designed by Reis. This was capable of conveying musical sounds but it was

incapable of transmitting properly, the complicated sounds of the human voice. The receiver designed by Reis was fairly perfect but the transmitter was the inefficient part of the apparatus. The year 1876 brought from Alexander Gramhm Bell the instrument that became practically the parent of the modern telephone. The microphone transmitter, designed by Hughes in 1878, took the place of the Bell transmitter, although the original form of receiver continues to be the type of all receivers.

Wireless telegraphy has been known in one form or another for a good many years. In 1859 Lindsay sent signals across the Tay where it was three-quarters of a mile wide. In 1882 Sir W. Preece sent messages across the Solent from Portsmouth to the Isle of Wight. In 1886, when the cable to the Scilly Isles was broken down, messages which were passing in the neighboring French Atlantic cable were readable on the broken-down Scilly cable. In 1892 Sir W. Preece sent a message a distance of three miles without wires. His signalling depended on electro-magnetic induction.

Hertz (deceased in 1894), Branly, Prof. Oliver Lodge, Marconi—all played their part in the development of this most wonderful of all modern invention—the *Radio*. The history of their experimentations is too complicated to permit detailed discussion here but out of their experiments has come the greatest thing modern science has given humanity.



CHAPTER XV.

How We Hear Sounds—Sounds Exists Only Where There is Someone to Hear Them—The Telephone Transmitter and Receiver—In Radio Vibrations are Reduced to Bring Them Within the Scope of the Human Ear.

CONTRARY to the general impression the transmission of messages or words by radio does not constitute the sending of "sounds" but the passage of wave impulses which are in exact accord with every phase of the atmospheric waves produced by the voice.

Scientists have long said that "sounds do not exist except where there is someone to hear them." This of course means that wave motions of any sort, whether they be waves in the atmosphere or water, or the electric waves of radio, only exist so far as humans are concerned when the delicate ear vibrates in accordance with the wave motions and the consequent sounds are conveyed to the brain. There are no sounds to the absolutely deaf man.

The waves on entering the ear excite the sensation of sound; the more rapid the vibrations the higher the pitch of the note or sound, and the greater the amplitude the louder the sound. The ear is especially adapted to receive these vibrations and transform them into nervous impulses. In its construction it is divided into three parts for the purposes of simplified description.

The outer ear consists of what the anatomists call the expanded *pinna*—which is really the external portion of the structure which all the world recognizes as "the ear," plus a tube along which the vibrations pass inward to the drum—scientifically known as the *tympanic membrane*.

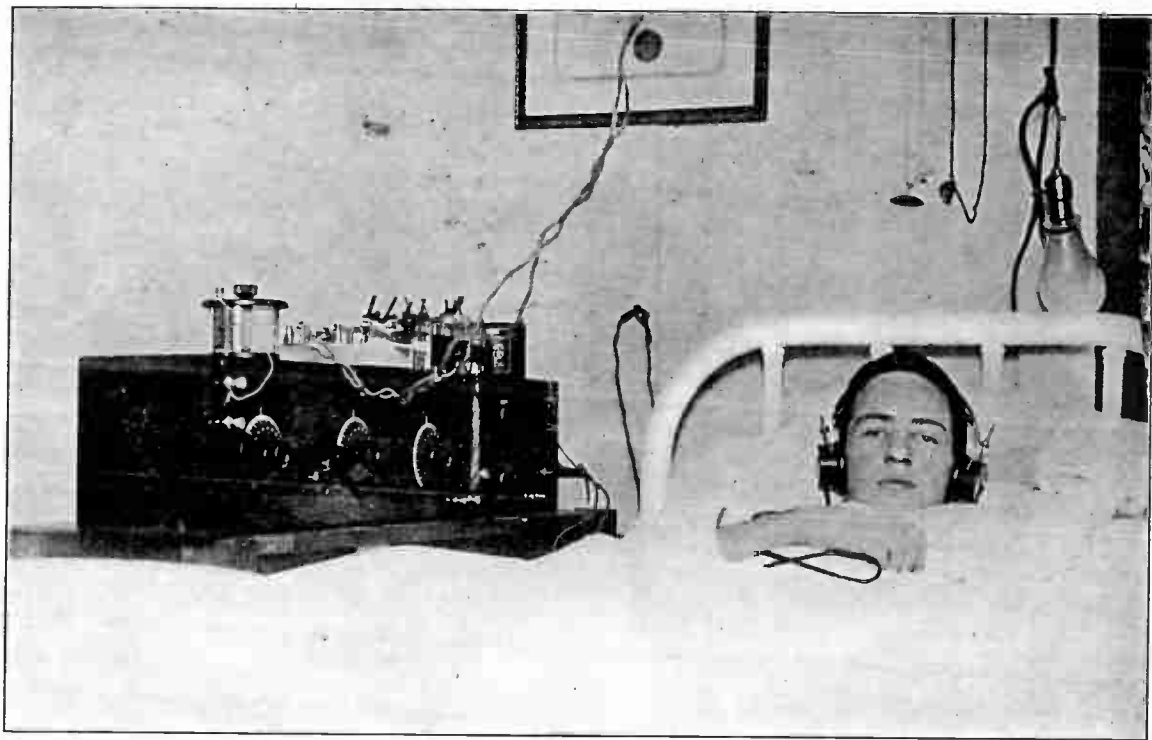

Copyright, Underwood & Underwood, N. Y.

CRIPPLED BY FALL WHILE PUTTING UP AERIAL

Lester Picker, aged 16, of San Diego, Cal., fell 55 feet while erecting his Radio aerial and suffered a broken back. He is seen lying in bed "listening in." His Radio broadcasting station is 6AJH.

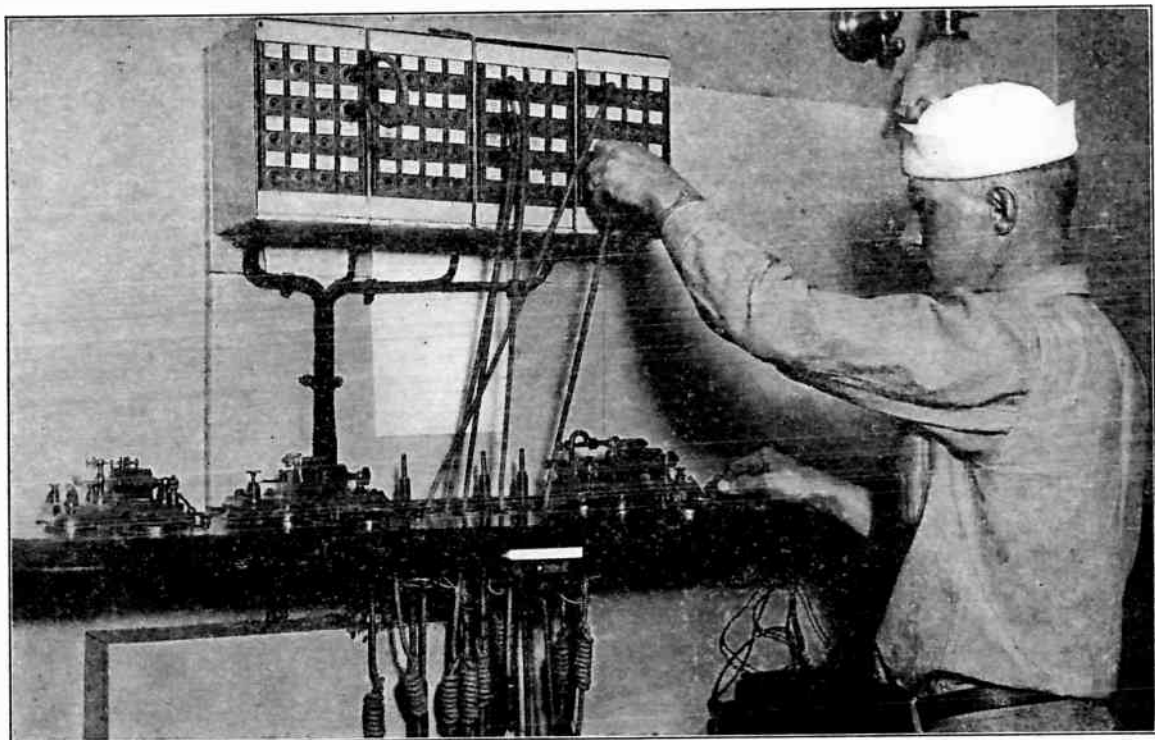

Copyright, Underwood & Underwood, N. Y.

SENDING OUT THE SIGNALS AT NAVAL RADIO STATION, ARLINGTON, VA.

Chief Wegand is connecting up the relay to send out the time signals from the Naval Observatory clock. The signals are sent automatically beginning at 11.55 A. M. until 12 Noon, and 9.55 P. M. until 10 P. M.

Glands along the tube or canal secrete wax which guards the approach to the drum and protects it. As frequently happens, through injury or illness there is an inflammation which interferes with the flow of the secretion and there is an excess of wax which hinders or prevents hearing and we send for an expert to remedy the condition—the physician or surgeon.

The middle ear is called the tympanum, and is separated from the outer ear by the drum. The tympanum is a small cavity in the temporal bone of the skull communicating with the throat by the Eustachian tube. This tube is in reality a valve which controls the air pressure on the inside of the drum, which is exactly equal to the pressure on the external or outside under normal conditions.

ALL SOUNDS ARE VIBRATIONS.

The structures of the inner ear lie in the temporal bone on the side of the tympanum directly opposite the drum. They are made up of a system of small bony spaces and tubes called the *bony labyrinth*, inside of which is a corresponding *membranous labyrinth*. A part of this arrangement is called the cochlea, because it is shaped something like a curled shell or “conch.” It resembles a snail’s shell or spiral stairway.

In the middle ear is a series of three small bones, constituting *the ear ossicles*, or what every schoolboy knows as the hammer, anvil and stirrup of the ear. The malleus (hammer) is attached to the drum membrane, next comes the incus (anvil) then the stapes (stirrup) which is joined to the membrane covering the fenestra ovalis or opening into the inner ear. These bones are held together by ligaments and so arranged that when the sound waves set the tympanic membrane in vibration the motions are transmitted by the ossicles to the cochlea—of the inner ear.

Part of the membranous labyrinth of the inner ear consists of two small sacs filled with a fluid, which themselves are surrounded by another fluid. Within the small sacs or bags are also tiny atoms of substance like fine sand which bounce up and down when wave vibrations are sent against the drum. To the membrane there extends from the brain a myriad of tiny nerves and through these nerves the movements of the tiny atoms, called otoconia, are transferred to the brain and we hear.

Whenever we hear, therefore, there has been produced a vibration in some substance, whether it be a solid, a liquid or a gas—the ring of the bell, the splash of the water, the explosion of the gas. What really occurs is the passing out from the place in which sound originates of a rythmical motion of air particles. These motions manifest themselves in changes of pressure spreading out in enlarging circles or spheres through the atmosphere.

MECHANISM OF SPEECH.

The force that disturbs the atmosphere may produce almost any sort of vibration. The musical notes of an orchestra, and the notes of the individual instruments differ. When the fluctuations are regular they may be pleasing to the senses; if irregular or intermittent they are to our trained senses “noise.”

The tuning fork has long been the favorite device used to demonstrate the fact that sound is produced by wave motions. When the fork is struck the tines or prongs vibrate for several seconds. The sounds produced by the vibrations are caused by wave motions set up in the atmosphere. If a small wire or bristle is attached to the end of a tuning fork and during its period of vibration after being struck, it is drawn along a surface of smoked glass the trace of the fine wire or bristle will show a wavy line in the sooty coating.

The mechanism of our speech consists of a box in the throat called the larynx, across the top of which is spread two membranes, called vocal chords so arranged and controlled by muscles that their tension may be changed at will. When we breathe, the air passes between the chords to and from our lungs, and when we speak we tighten the muscles controlling the chords, and the edges of the chords are brought close together. They then vibrate because of the air passing between them, just as the reed in a clarinet or similar musical instrument may vibrate. The variations in tone are in accordance with the tensesness of the chords and the amount of air which is forced between them. The tighter the chords the shriller the note because the vibrations are more rapid. Lower sounds and heavier notes are produced by lax chords.

The control of these sounds in speech is through the use of the teeth, tongue, lips and the cavity of the mouth. It is no figure of speech to say that we create an atmospheric disturbance every time we talk. The wave motions we set up carry into the ear of our hearer and the little otoconia dancing around in the sacs in the inner ear in accordance with the vibrations on the drum of the ear telegraph the result into the brain—through the auditory nerve.

In speaking into the telephone we talk against a thin metal plate which vibrates in accordance with the wave motions produced by the mouth and lips. The plate or diaphragm vibrations are transmitted by force of electricity along the wire. The plate against which we talk does not itself transmit the sound, but its vibrations are changed into electric waves.

Technically the sounds directed into the mouthpiece strike the diaphragm, which causes pressure to be exerted upon a small cup containing particles of carbon. When these particles of carbon are loose and free they set up a

great resistance to the flow of electricity, but when they are compressed their resistance is lowered and they permit the electric current to flow. Thus the pressure exerted by the voice in speaking into the transmitter actually is translated into terms of electricity. The variation in pressure determines the flow of electricity and the consequent waves.

THE TELEPHONE RECEIVER.

The receiver consists of a thin metal disc, set close to the end of a magnetized bar of steel, which has around it a coil of insulated wire. The ends of the coil are attached to the wires attached to the battery and the transmitter, and the varying currents of electricity as produced through the pressure exerted in speech, generate similar changes in the magnetism of the receiving instrument, and by alternately repelling and attracting the diaphragm vibrations are set up and given off as sounds. There are improvements in wire telephony but the principles involved are the same.

Experiments have shown that the velocity of sound in the air is about 1,090 feet a second, but that in some liquids it is much greater—in water four times as great—while in inelastic substances like lead and wax it is very small, and in wood and steel very great, traveling at the rate of three or four miles per second. In order to be heard by the ear vibrations must be as numerous as 24 per second—and they cannot exceed 30,000 to 40,000 per second. Above this point the vibrations are so rapid that they cease to produce any sensation upon the ear.

The alternating current waves of radio, as has previously been stated, are of such frequency—make so many oscillations per second—that they would not be audible to the ear, nor could they be heard with an ordinary tele-

phone receiver. Some form of rectifier was needed to so subdue the waves or slow them to a point that would make them audible before radio could be successful.

It is perfectly obvious from the foregoing explanation that in order to have any sounds reach our ears there must be wave motions of some sort. Electricians found that the only sort of an electrical current that moved in waves was the alternating, and consequently it was the only form which could be used for wireless telephony.

CURRENTS HAD TO BE RECTIFIED.

The difficulties to be overcome were reducing the rapid wave motions to a point where the ear could hear them and so rectify the current as to make it a continuous wave, for in the alternating current the oscillations surge back and forth and were in the early attempts at radiotelephony found to be *damped*, as the electricians term it. In other words parts of the waves were lost and messages or signals came in broken waves that were only partly intelligible.

Rectifiers solved the problem. They turned the alternating waves into what is sometimes called *continuous waves*. Of the devices that helped solve the problem the electron tube, as originated by Fleming, De Forest and others, and described elsewhere, is the most efficient.

With all the wonders of the radio, and what it is doing for us and the world at large, it cannot surpass the wonders nor the efficiency of nature. What would we do if our ears were so sensitive that the wave motions stirred up in every city of the country—yes, and of the world—were audible to the naked ear? Who could stand it if the waves produced by the commotion in our own streets were carried to us in our homes at all times? What if the motions stirred up everywhere had force enough behind

them to drive them around the world before they died into nothing? or what if the human ear were as sensitive as the "artificial ear" which the radio experts and scientists have made for us?—for after all the electron tube is practically an artificial ear in the sense that it enables us to be conscious of wave motions set up in the ether that never were heard by man before.

CHAPTER XVI.

How to Make a Simple Receiving Set—Aerials—Details of Construction—Great Fun Receiving.

HUNDREDS of combinations and arrangements have been devised in creating amateur receiving sets and an army of boys and girls are at work continuously building up ingenious contrivances out of which some excellent things are expected to develop. One of the great hopes of the future, according to the radio experts is the fact that thousands of youths are receiving a technical training, or some experience that will prove a benefit to the nation as a whole.

Nearly every body has read some sort of a description of a small easily constructed receiving set and no one knows precisely which one of the devices may suddenly prove most efficient, but it is safe to assume that instructions issued by the government for making a small radio receiving set may be regarded as efficient as any that can be produced at a relative cost. Those who wish to experiment therefore in an inexpensive way may accept the following instructions as worthy of consideration, since they are based on a plan prepared by the United States Bureau of Standards for the Use of Boys' and Girls' Clubs.

The station is designed to receive messages from medium power transmitting stations within a small radius and high powered stations up to perhaps 50 miles, providing the stations have wave lengths ranging from 200 to 600 meters, though a greater distance may be covered at night. If they construct the coil and other parts as directed the cost of making the set may approximate \$6,

but if it is desired to make a more highly efficient set the price may mount to about \$15.

As outlined previously in the elementary chapter on equipment, the five essential parts are the aerial or antenna, lightning switch, ground connections, receiving set and phone. The latter may be either one or a pair of telephone receivers worn on the head of a listener.

The antenna need be only a wire stretched between two elevated points. It should be not less than 30 feet above ground nor less than 75 feet long. It is well to have the furthest end from the house as high as possible. A lead-in wire—that is the wire running from the antenna to the house should drop as directly as possible into the lightning switch.

If the distance between the adjoining building or tree or pole should be greater than the 75 feet required for the antenna, the antenna can still be held to the required length by increasing the length of the anchor rope at the far end of the antenna. The rope anchorage at the end of the antenna next to the house should not be lengthened because it would necessitate the lengthening of the lead-in wire. The accompanying diagram will show how the antenna is attached.

Details of Parts—The essential parts are hereafter mentioned by reference to the letters as shown in Diagrams (Fig.) 1 and 2.

A. and I. are screw eyes which must be strong enough to anchor the antenna at the ends.

B. and H. are sections of rope $\frac{3}{8}$ or $\frac{1}{2}$ inch in diameter, just long enough to permit the antenna to swing clear of the two supports.

D. is a piece of $\frac{3}{8}$ or $\frac{1}{2}$ inch rope of sufficient length to make the distance between the insulators E. and G. about 75 feet.

C. is a single block pulley that may be used if readily available.

The insulators E. and G. may be constructed of any hard wood strong enough to withstand the strain of the antenna. Blocks of $1\frac{1}{2} \times 2 \times 10$ inches will answer the purpose. Holes should be bored at either end far enough from the ends to give sufficient strength. If wood is used it is best to boil them in paraffin for about an hour.

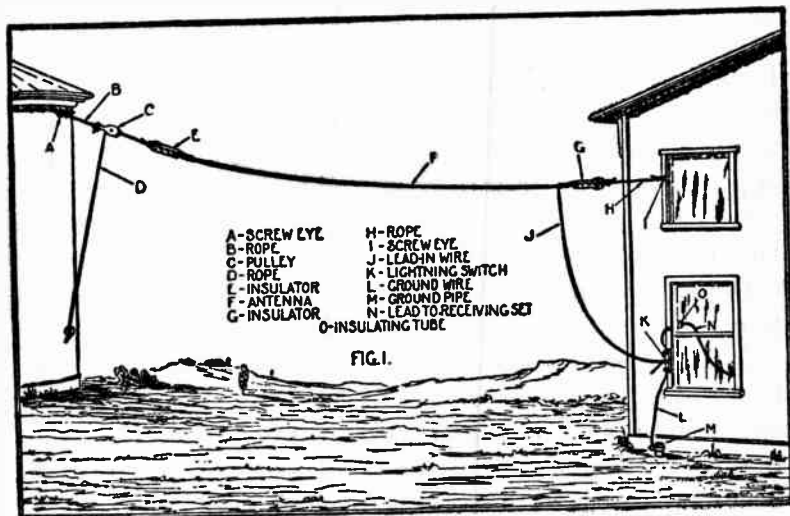

Porcelain wiring cleats may be used instead of the wood, if they are available, but if unglazed porcelain is used it should be boiled in paraffin the same as wood.

The antenna is indicated by the letter F. suspended from or between the insulators E. and G. Either insulated or bare copper wire No. 14 or 16 may be used for the antenna. The end of the antenna furthest from the receiving set may be secured to the insulator E. by any substantial method, but great care should be used not to kink the wire. The other end of the antenna wire should be drawn through the insulator G. to a point where the in-

sulators are about 75 feet apart. The wire should be bent back and the insulator twisted to form a shank of the antenna as shown in Figure 1. The loose end of the antenna will be the drop or lead-in wire and should be just long enough to reach the lightning switch.

K is the lightning switch. For the purpose of a small antenna this switch may be the ordinary porcelain-base, 30 ampere, single-pole double-throw battery switch. These switches as ordinarily available, have a porcelain base about 1 by 4 inches. The "lead-in" wire (J) is attached to this switch at the middle point. The switch blade should always be thrown to the lower clip when the receiving set is not actually being used, and to the upper clip when it is desired to receive signals.

L is the ground wire for the lightning switch; it may be a piece of the same size wire as used in the antenna, of sufficient length to reach from the lower clip to the lightning switch (K) to the clamp on the ground rod (M).

M is a piece of iron pipe or rod driven 3 to 6 feet into the ground, preferably where the ground is moist, and extending a sufficient distance above the ground in order that the ground clamp may be fastened to it. Scrape the rust or paint from the pipe before driving in the ground.

N is a wire leading from the upper clip of the lightning switch through the porcelain tube (O) to the receiving set binding post marked "antenna."

O is a porcelain tube of sufficient length to reach through the window casing or wall. This tube should be mounted in the casing or wall so that it slopes down toward the outside of the building. This is done to keep the rain from following the tube through the wall to the interior.

Fig. 2 shows the radio receiving set installed in some part of the house.

P is the receiving set which is described in detail below.

N is the wire leading from the "antenna" binding post of the receiving set through the porcelain tube of the upper clip of the lightning switch. This wire, as well as the wire shown by Q, should be insulated and preferably

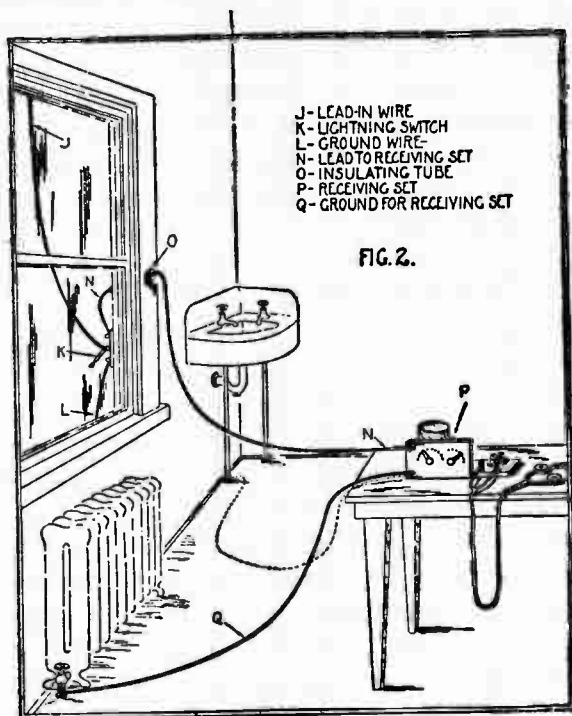

flexible. A piece of ordinary lamp cord might be unbraided and serve for these two leads.

Q is a piece of flexible wire leading from the receiving set binding post marked "ground" to a water pipe, heating system or some other metallic conductor to ground, except M, Fig. 1. If there are no water pipes nor radiators in the room the wire should be run out of doors and connected to a special "ground" below the window, which

shall not be the same as the "ground" for the lightning switch. It is essential that for the best operation of the receiving set this "ground" be of the very best type. If the soil near the house is dry it is necessary to drive one or more pipes or rods sufficiently deep to encounter moist earth and connect the ground wire to the pipes or rods. This distance will ordinarily not exceed six feet. Where clay soil is encountered this distance may be reduced to three feet, while in sandy soil it may be increased to ten feet. If some other metallic conductor, such as the casing of a drilled well, is not far away from the window, it will be a satisfactory "ground."

TUNER, DETECTOR AND PHONE.

The detector and phone will have to be purchased. The tuner and certain accessories can be made at home.

Tuner (R, Fig. 3)—This is a piece of cardboard or other nonmetallic tubing with turns of copper wire wound around it. The cardboard tubing may be an oatmeal box. Its construction is described in detail below.

Crystal Detector (S, Fig. 3)—The construction of a crystal detector may be of very simple design and quite satisfactory. The crystal, as it is ordinarily purchased may be unmounted or mounted in a little block of metal. For mechanical reasons the mounted type may be more satisfactory, but that is of no great consequence. It is very important, however, that a very good tested crystal be used. It is probable also that a galena crystal will be more satisfactory to the beginner.

The crystal detector may be made up of a tested crystal, the wood screws, short piece of copper wire, a nail, set-screw type of binding post, and a wood knob or cork. The tested crystal is held in position on the wood base by brass wood screws as shown at 1, Fig. 3. A bare copper

wire may be wrapped tightly around the three brass screws for contact. The assembling of the rest of the crystal detector is quite clearly shown in Fig. 3.

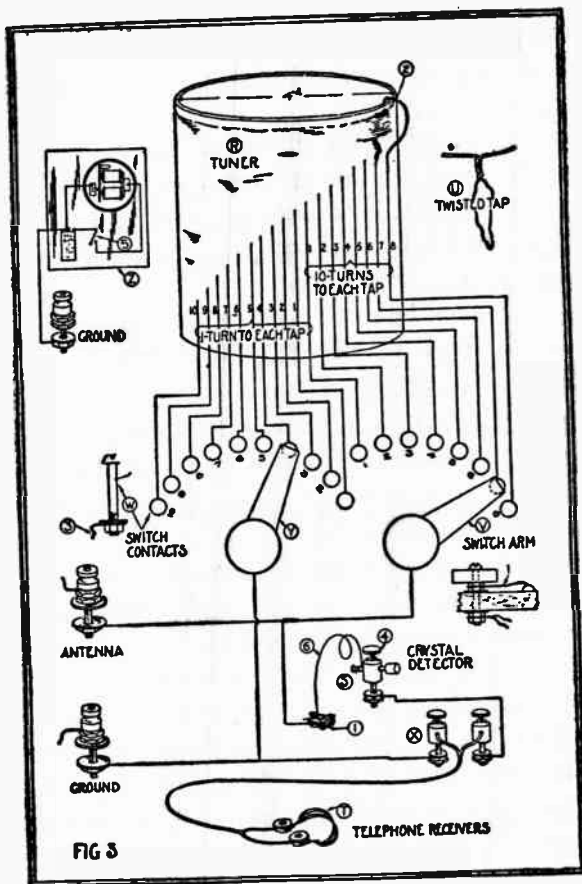

Phone (T, Fig. 3)—It is desirable to use a pair of telephone receivers connected by a head band, usually called a double telephone headset. The telephone receivers may be any of the standard commercial makes having a resistance of between 2,000 and 3,000 ohms.

The double telephone receivers will cost more than all the other parts of the station combined, but it is desirable to get them, especially if one plans to improve his receiving set later. If one does not care to invest in a set of double telephone receivers, a single telephone receiver with a head band may be used; it gives results somewhat less satisfactory.

Accessories—Under the heading of accessory equipment may be listed binding posts, switch arms, switch contacts, test buzzer, dry battery, and boards on which to mount the complete apparatus. The binding posts, switch arms, and switch contacts may all be purchased from dealers who handle such goods, or they may be quite readily improvised at home. There is nothing peculiar about the pieces of wood on which the equipment is mounted. They may be obtained from a dry packing-box and covered with paraffin to keep out moisture.

DETAILS OF CONSTRUCTION.

The following is a detailed description of the method of winding the coil, construction of the wood panels, and mounting, and wiring the apparatus.

Tuner—See R, Fig. 3. Having supplied oneself with a piece of cardboard tubing 4 in. in diameter and about 1-2 pound of No. 24 (or No. 26) double cotton-covered copper wire, one is ready to start the winding of the tuner. Punch two holes in the tube about 1-2 in. from one end as shown at 2, Fig. 3. Weave the wire through these holes in such a way that the end of the wire will be firmly anchored, leaving about 12 inches of the wire free for connections. Start with the remainder of the wire to wrap the several turns in a single layer about the tube, tightly and closely together. After 10 complete turns have been wound on the tube hold those turns snugly

while a tap is being taken off. This tap is made by making a 6 in. loop of the wire and twisting it together at such a place that it will be slightly staggered from the first tap. This method of taking off taps is shown quite clearly at U, Fig. 3. Proceed in this manner until 7 twisted taps have been taken off at every 10 turns. After these first 70 turns have been wound on the tube then take off 6 inches twisted tap for every succeeding single turn until 10 additional turns have been wound on the tube. After winding the last turn of wire anchor the end by weaving it through two holes punched in the tube much as was done at the start, leaving about 12 in. of wire free for connecting. It is understood that each of the 18 taps is slightly staggered (or stepped away) from the one just above, so that the several taps will not be bunched along one line on the cardboard tube. See Fig. 3. It would be advisable, after winding the tuner as just described, to dip the tuner in hot paraffin. This will help to exclude moisture.

Upright Panel and Base—Having completed the tuner to this point, set it aside and construct the upright panel shown in Fig. 4. This panel may be a piece of wood approximately 1-2 in. thick. The position of the several holes for the binding posts, switch arms and switch contacts may first be laid out and drilled. The "antenna" and "ground" binding posts may be ordinary 1-8 in. brass bolts of sufficient length and supplied with three nuts and two washers. The first nut binds the bolt to the panel, the second nut holds one of the short pieces of stiff wire, while the third nut holds the antenna or ground wire as the case may be. The switch arm with knob shown at V, Fig. 3, may be purchased in the assembled form or it may be constructed from a thin slice cut from a broom handle and a bolt of sufficient

length equipped with four nuts and two washers, together with a narrow strip of thin brass somewhat as shown. The switch contacts (W, Fig. 3) may be of the regular type furnished for this purpose or they may be brass bolts equipped with one nut and one washer each, or they may even be nails driven through the panel with an

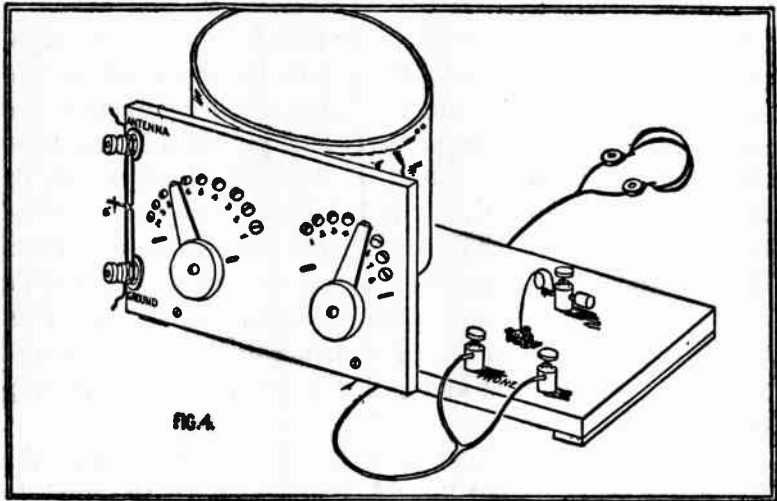

individual tap fastened under the head or soldered to the projection of the nail through the panel. The switch contacts should be just enough that the switch arm will not drop between the contacts, but also far enough apart that the switch arm can be set so as to touch only one contact at a time.

The telephone binding post should preferably be of the set screw type as shown at X, Fig. 3.

INSTRUCTIONS FOR WIRING.

Having constructed the several parts just mentioned and mounted them on the wood base, one is ready to connect the several taps to the switch contacts and attach



Copyright, Underwood & Underwood, N. Y.

INVENTS SMALLEST RADIO SET IN THE WORLD

Photo shows Alfred Rinehart, 19-year-old Elizabeth, N. J., youth, who has invented what he claims to be the smallest radio receiving set in the world. It is somewhat smaller than an ordinary domino and can pick up out of the air concerts and messages many miles away.



Copyright, Underwood & Underwood, N. Y.

THE MAN WHO SENDS GOVERNMENT STATEMENTS OVER THE RADIO FROM WASHINGTON

The thousands of radio fans who nightly listen in to the weather reports, crop reports, the messages from Secretary Mellon and other important governmental statements, will be interested in meeting this man, Mr. T. C. Gale, whose voice reaches them over the radio phone each evening. This shows Mr. Gale at work with his set in the Post Office Department broadcasting messages throughout the country.

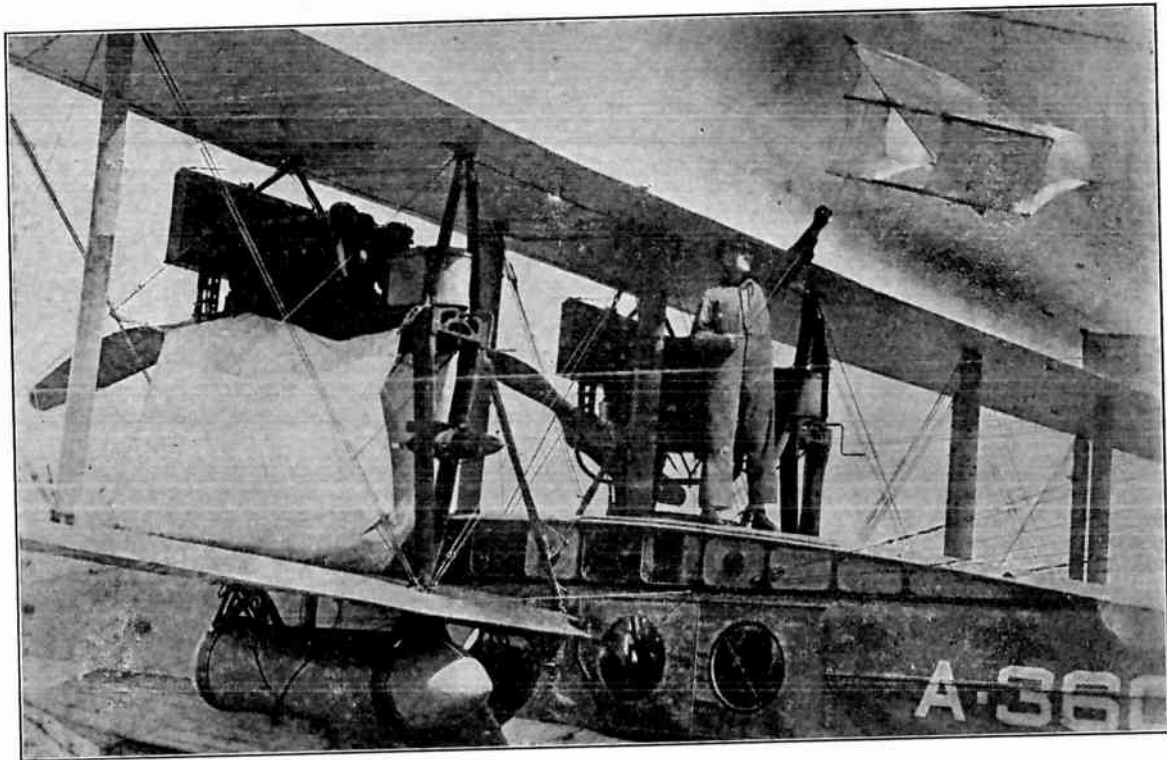

Copyright, Underwood & Underwood, N. Y.

LOST FLYERS MAY USE KITE RADIO DEVICE

Through a new radio invention, lost airplanes hereafter will be able to signal through an antenna trailing from a flown kite. The equipment for the new radio is simple and there are two kites, for strong and light winds. This new invention solves the problem for flyers landing in remote places and messages can be sent for great distances. Photo shows the device being tested out on the plane belonging to Secretary of the Navy Denby at the Naval Air Station near Washington by Chief Petty Officer Pete Ryan.

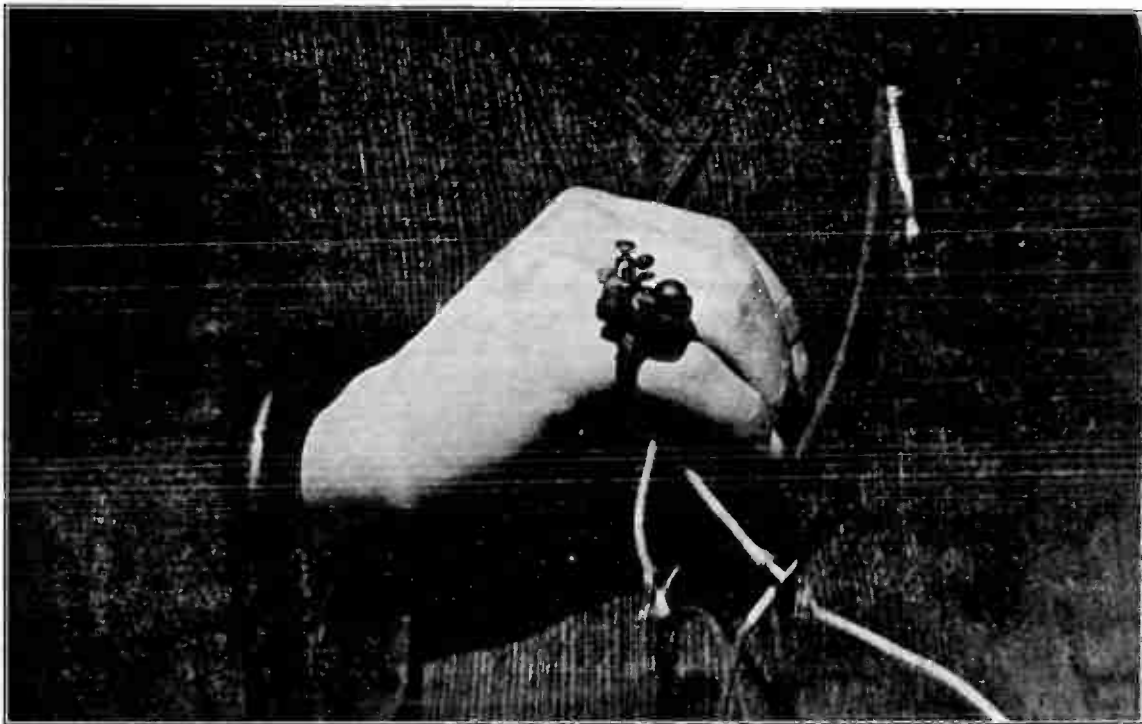

Copyright, Underwood & Underwood, N. Y.

RADIO SET MADE INTO RING

Photo shows the radio ring, built by Alfred G. Rinehart, 19, of 527 Morris Avenue, Elizabeth, N. J. This small instrument is a practical radio receiving set. It will receive messages, radio concerts or anything that is in the air, miles away. It measures one inch long, five-eighths of an inch wide and seven-sixteenths of an inch in thickness. An ordinary umbrella is used as a ground for the set.

Copyright, Underwood & Underwood, N. Y.

the other necessary wires. Scrape the cotton insulation from the loop ends of the sixteen twisted taps as well as from the ends of the two single taps coming from the first and last turns. Fasten the bare ends of these wires to the proper switch contacts as shown by the corresponding numbers in Fig. 3. One should be careful not to cut or break any of the looped tags. It would be preferable to fasten the connecting wires to the switch contacts by binding them between the washer and the nut as shown at 3, Fig. 3. A wire is run from the back of the binding post marked "ground" (Fig. 3) to the back of the left-hand switch-arm bolt (Y), thence to underneath the right-hand binding post marked "phones," to underneath the binding post (4, Fig. 3) which forms a part of the crystal detector. A piece of No. 24 bare copper wire about 2 1-2 in. long, one end of which is twisted tightly around the nail (the nail passing through binding post 4), the other end of which rests gently by its own weight on the crystal. (1). The bare copper wire which was wrapped tightly around the three brass wood screws holding the crystal in place is led to and fastened at the rear of the right-hand switch arm bolt (V), thence to the upper left-hand binding post marked "antenna." As much as possible of this wiring is shown in Fig. 3.

DIRECTIONS FOR OPERATING.

After all the parts of this crystal-detector radio receiving set have been constructed and assembled the first essential operation is to adjust the little piece of wire, which rests lightly on the crystal, to a sensitive point. This may be accomplished in several different ways; the use of a miniature buzzer transmitter is very satisfactory. Assuming that the most sensitive point on the crystal has been found by method described in paragraph below,

“The Test Buzzer,” the rest of the operation is to get the radio receiving set in resonance or in tune with the station from which one wishes to hear messages. The tuning of the receiving set is attained by adjusting the inductance of the tuner. That is, one or both of the switch arms are rotated until the proper number of turns of wire of the tuner are made a part of the metallic circuit between the antenna and ground, so that together with the capacity of the antenna the receiving circuit is in resonance with the particular transmitting station. It will be remembered that there are 10 turns of wire between each of the first 8 switch contacts and only one turn of wire between each 2 of the other contacts. The tuning of the receiving set is best accomplished by setting the right-hand switch arm on contact (1) and rotating the left-hand switch arm over all its contacts. If the desired signals are not heard, move the right-hand switch arm to contact (2) and again rotate the left-hand switch arm throughout its range. Proceed in this manner until the desired signals are heard.

It will be advantageous for the one using this radio receiving equipment to find out the wave frequencies (wave length) used by the several radio transmitting stations in his immediate vicinity.

The Test Buzzer (Z, Fig. 3)—As mentioned previously, it is easy to find the more sensitive spots on the crystal by using a test buzzer. The test buzzer is used as a miniature local transmitting set. When connected to the receiving set as shown at Z, Fig. 3, the current produced by the buzzer will be converted into sound by the telephone receivers and the crystal, the loudness of the sound depending on what part of the crystal is in contact with the fine wire. To find the most sensitive spot connect the test buzzer to the receiving set as directed, close

the switch (5, Fig. 3) (and if necessary adjust the buzzer armature so that a clear note is emitted by the buzzer), set the right-hand switch arm on contact point No. 8, fasten the telephone receivers to the binding posts marked "phones," loosen the set screw of the binding post slightly and change the position of the fine wire (6, Fig. 3) to several positions of contact with the crystal unit until the loudest sound is heard in the phones, then tighten the binding post set screw (4) slightly.

APPROXIMATE COST OF PARTS.

The following list shows the approximate cost of the parts used in the construction of this radio receiving station. The total cost will depend largely on the kind of apparatus purchased and on the number of parts constructed at home.

Antenna—

Wire—Copper, bare or insulated, No. 14, 100 to 150 feet, about75
Rope— $\frac{3}{8}$ or $\frac{1}{2}$ inch. 2c per foot.	
2 insulators, porcelain20
1 pulley15
Lightning switch—30 ampere battery switch30
1 porcelain tube10

Ground connections—

Wire (same kind as antenna wire.)	
1 clamp15
1 iron pipe or rod25

Receiving set—

$\frac{1}{2}$ pound No. 24 copper wire double cotton-covered75
1 cardboard box.	
2 switch knobs and blades complete	1.00
18 switch contacts and nuts75
3 binding posts—set screw type45
2 binding posts—any type30
1 crystal—tested25
3 wood screws, brass, $\frac{3}{4}$ in. long03
Wood for panels (from packing box.)	
2 pounds paraffin30

Lamp cord, 2 to 3c per ft.		
Test buzzer50	
Dry battery30	
Telephone receivers	4.00	to \$ 8.00
	<hr/>	
Total	\$11.00	\$15.00

If nothing but the antenna wire, lightning switch, porcelain tube, crystal, telephone receiver, bolts and buzzer are purchased this total can be reduced to about \$6.00.

Sets of the kind described above cannot be used satisfactorily with a loud talker; that is an amplifying horn or similar device for making the messages audible in an open room, but for individual use, where the set is sufficiently sensitive to catch the music or message of the air the amateur can have lots of fun and learn much.

Many cheaper devices (sets) have been constructed for receiving short distance waves. In one recently described set a boy used an ice cream container of pressed paper, with brass paper fasteners for switch contacts and succeeded in making the entire set at a cost of a couple of dollars. Such sets however are mere toys and it would be impossible to build them up or develop them into anything of much greater efficiency.

CHAPTER XVII.

Radio in the World War—Radio Control and Direction of Ships at Sea—Airplanes Directed from Land.

HOW the radio enabled the British Navy to locate the German war fleet and follow its movements just before the battle of Jutland is one of the picturesque and thrilling incidents of the World War which will go down in history to prove the value of the wonderful wireless as an aid to man in his warfare against his enemies.

The marvelous "loop" antenna, now identified by nearly everybody as part of the equipment which may be used to make up a receiving set in radiotelephony was the magic device which enabled the British to trace the German war vessels and give battle to the latter's disadvantage.

When the instructions from the German flagship were sent by wireless to the vessels of the fleet, the message was heard at several of the English stations along the British coast and the bearings of the German vessel giving the signals were accurately determined. A little later, the same vessel wired another lot of instructions and the English stations again determined the bearings of the vessel. These locations showed that the German vessel had moved about seven miles down the river. This was recognized as of sufficient importance by Sir H. B. Jackson, the First Sea Lord, to justify ordering out the British Grand Fleet and clearing the North Sea, with the result that the British were able to pursue the Germans even before they were really at sea. The "loop" made

it possible for the British to locate and anticipate the action of the Germans.

Prior to the war the public knew but little about the almost idolized "loop," which on shipboard has sometimes been called a "Radio compass" or a "direction finder." The ships at sea determine their positions by listening to the signals sent from what are termed "radio compass" stations along the coast, and during the war the mysterious messages carried on ether waves served battleships, torpedo boats and passenger steamships during many tense moments in the darkness of the night.

The use of the loop, or radio compass, to direct assistance to a wrecked ship at sea and to guide a vessel into port through fog or storm, is now regarded as its most valuable field of usefulness. The neighboring ship may be located in the fog and passed in safety. Radio stations on the coast may direct the oncoming vessel, which with a radio finder may follow a true course. Life boats adrift in fog or storm, if equipped with even the simplest type of transmitting apparatus, could be located and picked up and those on board saved. Wherever it is necessary for one vessel to locate another under any condition the finder or compass can be used to solve the problem.

It was the wireless stations along the coast which gave warning during the tense period of the war of the approach of the German submarines to our coast, and it was the call of the wireless operator that summoned the torpedo boat destroyers and chasers to protect passenger steamships when German raiders were at work on the high seas. Hundreds, yes, thousands of lives were saved by the wireless operators along the shores of England, France and America.

Most of this work was actually done by the wireless telegraph, for the radiophone did not actually come into its own until the end of the war—until in actual fact broadcasting began. But the radiophone was actually in existence and was used by the Signal Corps and other branches of the government service long before the public took it up as an amusement and a study, and one of the early public demonstrations was that in which Secretary Daniels of the Navy talked from the ground to the pilot of a seaplane in mid-air.

RADIO IN THE WAR.

The "direction finder" or loop was proved of great value on the seas long before the great bulk of the people had any idea of its existence, and before the close of the war it was shown that the same possibilities that are open to vessels in determining direction and getting their bearings by its use, apply in the case of aircraft.

The type of finder generally used on shipboard is that of the wooden frame shaped like the letter X, and wound with wire as previously described. In connection with its use the United States Bureau of Standards has developed a system in which the finder on shipboard is so connected with a radio receiving set that when the finder in picking up the ether sound waves is turned upon its axis the direction from which the message or signal comes is indicated either on the card of a magnetic compass or is read and determined according to a fixed scale.

Another type of finder was, however discovered by General Squier in connection with his development of "wired wireless." It is a consonance wave coil—a wire closely wound around a tube or core about four inches in diameter and two feet long. Over the coil is a metal ring connected to the grid of the electron tube of a receiving

set, constituting what is known to radio students as a capacity coupling. With this coil, or as it has been termed "dividing rod," the source of ether waves may actually be determined, and it can be used not only as a direction finder, but as a tuner and as an antenna.

RADIO STEERS BATTLESHIP.

As a matter of public interest the United States Government through various branches of service has done more to advance radio than any other country. The Army and Navy are steering airplanes and seaplanes without pilots by radio, and steering the course of ships by wireless from afar.

In April, 1922, the grand old battleship Iowa, having ended its days of usefulness as a fighting machine, was sent out of the Philadelphia Navy Yard to a watery grave under its own steam, and directed and guided by radio. The big ship went to serve as a target for the Atlantic fleet off the coast near Cape Henry, there to be sunk by the shells from sister ships.

The Iowa was built in 1893, and for a long time was the crack ship of the navy. "Fighting Bob" Evans was its commander at the battle of Santiago, when the Spanish Cape Verde fleet, under Admiral Cervera was destroyed without the loss of an American vessel.

At one time there was talk of selling the Iowa to Greece, along with the Lemnos and Kilkis, formerly Idaho and Mississippi. With the outbreak of the World War the Iowa was used as "coast patrol battleship No. 4," its crew being made up of naval reserves.

The radio control installed in it is the invention of John Hays Hammond, Jr., who has achieved success with wireless controlled torpedoes and small craft. Although secret, the device is known to be in the form of a seg-

mented disc, each segment of which sends out a different radio "wave" or signal. On board the controlling ship, which keeps several miles distant, is a similar disk. Each segment controls some piece of apparatus aboard the Iowa, and is brought into use much as a motorman by turning his controller handle utilizes different speeds for a trolley car.

Thus one segment may control the throttle which gives steam to the battleship's engines, while another may reverse the engines. Each segment aboard the ship only responds to its own particular wave or signal through the atmosphere. In addition to this, by automatic devices, the Iowa by radio informs those aboard the distant controlling ship of whether more fuel is needed, what the steam pressure is, etc.

GUIDE TORPEDOES BY WIRELESS.

Accurate drawings and the possible existence of duplicates of this intricate apparatus insure that radio control of battleships shall remain for the navy despite the sinking of the first example of it.

Uncle Sam is similarly guiding torpedoes through the water by radio and in an experimental way is communicating with submarines under water. The Navy alone has more than fifty radio compass, or beacon radio stations along the coast and its island possessions, and during 1921 bearings were given to upward of 25,000 vessels at sea. This does not include the stations and the operations of the Lighthouse Service. In addition to the beacon stations there are about 600 Naval ship stations, Naval airplane and shore radio stations. Moreover the Army has a very complete radio service through which it connects and can communicate with all of its artillery, aviation and other posts and in coöperation with the

Navy service and organization can cover the whole country and transact Trans-Atlantic business as well.

The Post Office Department is using wireless in connection with the air mail service and the Department of Commerce which controls the licensing of all sending stations is one of the most active agents in the development of radio that the country affords.

The relation of radio to the Government is even not indicative of the possibility that hereafter not humans, but radio operated mechanical devices will form the basis of our combatant forces on the sea and in the air and perhaps on the land.

It does not require a great stretch of imagination to make it seem possible that if warships and airplanes can be directed and controlled from afar, even to the point of fueling the engines, putting water in the boilers and turning the great guns to point of action, the same thing may be true of the big caterpillar tanks that proved such effective weapons of offense and defense during the war. And could not great guns be fired by radio, torpedoes launched and every other activity directed from airplanes in the sky or shore radio stations?

AMERICA BUILT FRENCH RADIO STATION.

It is significant, too, that the greatest radio station in France—The Lafayette—was constructed by Uncle Sam during the World War. The truth is that while the big telephone and electric companies did a great deal to develop radio and visualize its possibilities by establishing radio stations, the United States Navy actually did the first broadcasting from its Naval Air Station at Anacostia, near Washington.

The United States Coast Guard, too, has incorporated the radiotelephone in its service equipments and has in-

stalled radio sets in its boats so that direct communication may be had with the shore. In developing the idea a test was made at Atlantic City where one life boat was able to talk to the shore station at a distance of six miles out at sea. A receiving and transmitting set were installed well forward in the boat and the connections were so arranged as to make the steel keel of the boat serve as sort of an antenna.

The United States Public Health Service, too, is using the radio and where there is no physician on board a ship at sea and medical service is required, emergency instructions are sent by wireless. The Seaman's Church Institute, N. Y., was one of the first institutions to utilize the radio for this purpose, and the Department of Commerce quickly granted the institution a special commercial license for radio sending. Arrangements were made with a New York City Hospital to furnish essential medical directions and service was rendered to persons ill on a number of vessels. The work proved so valuable that the Public Health Service has taken up the work to develop a complete Marine medical service from stations all along the coast.

CHAPTER XVIII.

Radio Regulation—Government Control in Peace and War—Rules.

ONE of the difficult problems presented by the spread of the "radio craze" is that which had to do with the regulation by the Government of all forms of wireless communication. In England private individuals were not permitted to have radios during the war, or operate them, and as the order was not rescinding after peace was declared the popular use of the wireless has not kept pace with that in America.

Here anyone has been permitted to have a wireless and the restrictions have principally been directed toward the sending of messages and the length of the waves which amateurs might use. So when the demand for the radiophone swept over the country and the use grew from a few thousands into millions the United States Government found itself swamped in its attempts to meet the situation.

The office of W. D. Terrell, Chief Radio Inspector for the Government in Washington, was figuratively speaking flooded overnight with applications for licenses to operate wireless machines, and install broadcasting stations. Enthusiasts wrote for information and hundreds of complaints were received from persons who objected to having the messages and music received from large broadcasting stations, interfered with by unimportant wave messages sent out by some amateur who selected the same length of waves as that the larger station happened to be using.

The wireless telegraph has of course been in use for a score of years and when the rules for wireless operation were originally drafted they were intended to govern radiotelegraphy—there was no radiophone. The country was dotted over with amateur operators who frequently amused themselves by relaying messages from one to another all across the United States. Some of these amateurs were very efficient and belonged to the National Amateur Wireless Association which maintained a national traffic organization to relay messages across country without charge.

During the war all of these stations were under close inspection, but the force of inspectors and those whose duty it is to deal with wireless operation for the Government did not keep pace with the increased volume of business and problems presented themselves faster than they could be solved.

The big problem already referred to—that of regulating or restricting the use of wave lengths so as to prevent interference—grew into a great National and International question and a general conference was held in Washington to adopt some plan of regulation for the United States.

The conference was held at the Department of Commerce in Washington, by members of a Radio Commission appointed by Secretary Hoover, and consisting of Dr. S. W. Stratton, chairman, director of the Bureau of Standards of the Department of Commerce. Major-General George O. Squier, of the War Department; Capt. S. W. Bryant, U. S. N.; J. C. Edgerton, Superintendent Radio Service, Post Office Department; W. A. Wheeler, Bureau of Markets and Crop Estimator, of the Department of Agriculture; Wallace H. White, Jr., of Maine; R. B. Howell, Omaha; Dr. Alfred N. Goldsmith, Secre-

tary Institute Radio Engineers, N. Y.; Hiram P. Maxim, American Radio Relay League, Hartford; Prof. L. A. Hazeline, Stevens Institute, Hoboken; D. B. Carson, Commissioner of Navigation, Department of Commerce; Prof. C. M. Janshy, University of Minnesota, and Edwin H. Armstrong, of Columbia University.

SECRETARY HOOVER ON RADIO.

The principal recommendation of the commission had to do with the allocation of twenty bands of waves between 150 to 6,000 meters in length and the suggestion that control and regulation of the radio be vested in the Department of Commerce and that radiotelephony be given the status of a public utility.

Secretary Hoover in his address to the commission outlined the situation in a way that shows what the Government regards as essential and is interesting. In essence Secretary Hoover said:—

“We are indeed today upon the threshold of a new means of widespread communication of intelligence that has the most profound importance from the point of view of public education and public welfare. The comparative cheapness with which receiving stations can be installed, and the fact that the genius of the American boy is equal to construction of such stations within the limits of his own savings, bid fair to make the possession of receiving sets almost universal in the American home.

“I think that it will be agreed at the outset that the use of the radiotelephone for communication between single individuals as in the case of the ordinary telephone is a perfectly hopeless notion. Obviously if ten million telephone subscribers are crying through the air for their mates they will never make a junction; the ether will be filled with frantic chaos, with no communication of any

kind possible. In other words, the wireless telephone has one definite field, and that is for spread of certain predetermined material of public interest from central stations. This material must be limited to news, to education, to entertainment, and the communication of such commercial matters as are of importance to large groups of the community at the same time.

“It is therefore primarily a question of broadcasting, and it becomes of primary public interest to say who is to do the broadcasting, under what circumstances, and with what type of material. It is inconceivable that we should allow so great a possibility for service, for news, for entertainment, for education, and for vital commercial purposes, to be drowned in advertising chatter, or for commercial purposes that can be quite well served by our other means of communication.

WHY STATIONS WERE LICENSED.

“Congress some few years ago authorized the Secretary of Commerce to license radio sending stations, and to impose certain conditions in the licenses designed to prevent interference between the stations and to serve the public good. This legislation was drawn before the development of the telephone was of consequential importance. Until the last four or five months there has been but little difficulty in handling these regulations, because sending purposes have been largely confined to radiotelegraph, and to a very small extent to the radiotelephone. The extraordinary development of the radiotelephone, however, has brought us face to face with an entirely new condition upon which licenses should be issued. It raises questions to to what extension in the powers of the department should be requested of Congress in order that the maximum public good shall be secured from the de-

velopment of this great invention. During the last five months, while this extraordinarily rapid installation has been in progress, I and my colleagues in this department have seen that we should take a very conservative attitude on the issuance of sending licenses and I am able to inform you that there are today, outside of government broadcasting stations and the field authorized to the American boy, but few licenses outstanding—and these are limited to a small proportion of the number of the available wave lengths. We have therefore kept the field clear for constructive development. The experience gained indicates that the time has arrived not only when this large mass of subscribers need protection as to the noises which fill their instruments, but also when there must be measures to stop the interferences which have already grown up between even the limited number of sending stations which threaten to destroy them all.

“The problem is one of most intensely technical character, but is not one without hope of fairly complete solution. Fortunately, the sending of radiotelephone messages can be arranged in wave lengths sufficiently far apart so as not to interfere with each other, and receivers can at their option tune their receiving instruments to the different wave bands. With the improvement in the art and in the delicacy of instruments, the distance between wave lengths may eventually decrease and thus the number of layers of messages increase. Furthermore, it is possible to increase the number of sending stations and thus the variety of material, if the power applied to certain wave lengths is limited so as to circumscribe the area of distribution from a given station. Beyond this again certain times a day may be set aside within certain wave-lengths for certain types of information.

“With the permutations possible to work out in differ-

ent wave lengths, in different geographical areas, in different times of day, we should be able to make it possible for the owner of a receiving instrument, by tuning his instrument to different wave lengths, at different times, to possess himself of a great variety of entertainment, information, news, etc., at his own option. Even if we use all the ingenuity possible I do not believe there are enough permutations to allow unlimited numbers of sending stations.

MUST LIMIT SENDING STATIONS.

“One of the problems that enter into this whole question is that of who is to support the sending stations. In certain countries, the government has prohibited the use of receiving instruments except upon payment of a fee, out of which are supported government sending stations. I believe that such a plan would most seriously limit the development of the art and its social possibilities and that it is almost impossible to control. I believe that we ought to allow anyone to put in receiving stations who wishes to do so. But the immediate problem arises of who will do the broadcasting, and what will be his purpose. It is at once obvious that our universities, our technical schools, our government bureaus, are all of them willing and anxious to distribute material of extremely valuable order without remuneration. Also judging from the applications we have had, any number of merchants are prepared to distribute entertainment provided they are allowed to interlard discussion as to the approaching remnant sale. Many of the larger newspaper publishers are asking for licenses to install broadcasting sets in which news and entertainment will be distributed, and the commercial companies are requesting licenses for the establishment of systematic distribution of news and entertainment conditional upon their being

given permission to undertake commercial broadcasting of one kind or another.

CAN ACCOMMODATE DEMANDS.

“It is my belief that, with the variations that can be given through different wave lengths, through different times of day, and through the staggering of stations of different wave lengths in different parts of the country it will be possible to accommodate the most proper demands and at the same time to protect that precious thing—the American small boy, to whom so much of this rapid expansion of interest is due.

“It is, however, a problem of regulation, if we are to get the maximum use. It is one of the few instances that I know of where the whole industry and country is earnestly praying for more regulation. Regulation will need to be policed, if there is not to be great prejudice to the majority, and thus the celestial system—at least the ether part of it—comes within the province of the policeman. Fortunately the art permits such a policeman by listening in to detect those ether hogs that are endangering the traffic.

“There is involved, however, in all of this regulation the necessity to so establish public right over the ether roads that there may be no national regret that we have parted with a great national asset into uncontrolled bands.”

As an evidence of the necessity for control on the part of the Government it was stated that if all the Department stores in the United States were to request permission to install transmission or broadcasting stations there would not be enough waves to go around.

The general recommendations as to the allocation of waves were:—

- Below 150 meters—Reserved.
- 150 to 200 meters—Amateurs, exclusive.
- 200 to 275 meters—Schools and amateurs.
- 275 to 285 meters—Police broadcasting.
- 310 meters—Special amateur telegraphy.
- 310 to 435 meters—Private and toll broadcasting.
- 500 to 525 meters—Aircraft telephony and telegraphy.
- 525 to 650 meters—Mobile radiotelephony.
- 650 to 700 meters—Mobile radiotelephony.
- 700 to 750 meters—Government and public broadcasting, 700 miles inland.
- 750 to 800 meters—Radio compass, exclusive.
- 850 to 950 meters—Aircraft telegraphy and telephony.
- 950 to 1050 meters—Radio beacons, exclusive.
- 1050 to 1500 meters—Government and public broadcasting.
- 1500 to 1550 meters—Aircraft telephony and telegraphy.
- 1550 to 1650 meters—Fixed stations, nonexclusive.
- 1850 to 2250 meters—Government broadcasting, nonexclusive.
- 2500 to 2660 meters—Mobile service, nonexclusive.
- 2850 to 3300 meters—Fixed service, radiotelephony.
- 5000 to 6000 meters—Trans-oceanic radiotelephone experiments.

GOVERNMENT RULES AND REGULATIONS.

The original Government rules and regulations for radio operation provide:—

The owner of an amateur radio transmitting station must obtain a station license before it can be operated if the signals radiated therefrom can be heard in another state; and also if such a station is of sufficient power as to cause interference with neighboring licensed stations in the receipt of signals from transmitting stations outside the state. These regulations cover the operation of radiotelephone stations as well as radiotelegraph stations.

Station licenses can be issued only to citizens of the United States, its territories and dependencies.

Transmitting stations must be operated under the supervision of a person holding an *Operator's License* and

the party in whose name the station is licensed is responsible for its activities.

The Government licenses granted for amateur stations are divided into three classes as follows:

Special Amateur Stations known as the "Z" class of stations are usually permitted to transmit on wave lengths up to approximately 375 meters.

General Amateur Stations which are permitted to use a power input of 1 kilowatt and which cannot use a wave length in excess of 200 meters.

Restricted Amateur Stations are those located within five nautical miles of Naval radio stations, and are restricted to 1-2 kilowatt input. These stations also cannot transmit on wave lengths in excess of 200 meters.

Experimental stations, known as the "X" class, and school and university radio stations, known as the "Y" class, are usually allowed greater power and also allowed the use of longer wave lengths at the discretion of the *Department of Commerce*.

MUST NOT SEND FAKE CALLS.

All stations are required to use the minimum amount of power necessary to carry on successful communication. This means that while an amateur station is permitted to use, when the circumstances require, an input of 1 kilowatt, this input should be reduced or other means provided for lowering the antenna energy when communicating with near-by stations in which case full power is not required.

Malicious or wilful interference on the part of any radio station, or the transmission of any false or fraudulent distress signal or call is prohibited. Severe penalties are provided for violation of these provisions.

Special amateur stations may be licensed at the discre-

tion of the *Secretary of Commerce* to use a longer wave length and higher power than general amateur stations. Applicants for special amateur station licenses must have had two years' experience in actual radio communication. A special license will then be granted by the *Secretary of Commerce* only if some substantial benefit to the science of radio communication or to commerce seems probable. Special amateur station licenses are not issued where individual amusement is the chief reason for which the application is made. Special amateur stations located on or near the seacoast must be operated by a person holding a commercial license. Amateur station licenses are issued to clubs if they are incorporated, or if any member holding an amateur operator's license will accept the responsibility for the operation of the apparatus.

Applications for operator's and station licenses of all classes should be addressed to the *Radio Inspector* of the district in which the applicant or station is located. *Radio Inspectors'* offices are located at the following places:

First District	Boston, Mass.
Second District	New York City
Third District	Baltimore, Md.
Fourth District	Norfolk, Va.
Fifth District	New Orleans, La.
Sixth District	San Francisco, Cal.
Seventh District	Seattle, Wash.
Eighth District	Detroit, Mich.
Ninth District	Chicago, Ill.

No license is required for the operation of a receiving station, but all persons are required by law to maintain secrecy in regard to any messages which may be overheard.

There is no fee or charge for either an operator's license or a station license.

CHAPTER XIX.

Radio as an Agent of Mercy and the Protector of Man—
Heroes of the Wireless—The Titanic and Carpathian.

THE sensationally rapid development of radiotelephony has naturally been followed by many weird theories, and much speculation as to its future availability to man and hundreds of prophecies have been made as to things that would be accomplished through or by it within a few years.

Because of the simplicity with which a message can be broadcast to thousands of places with one operation the possibilities of radiotelephony as an aid to state and local governments and the police in running down criminals seeking to avoid the consequences of their acts was quickly seen and sending and receiving sets were early installed in the police headquarters or municipal buildings in a number of cities.

With the radio, not only could all of the police stations in the city at once be notified to be on the lookout for a suspect or criminal whom it was desired to arrest, but the message would at the same time be received in any adjacent or distant city toward which the criminal might be expected to flee.

The radio, too, makes it possible for the head of a department, if he chooses, to address his entire force of officers in all the station houses of a city. All that is necessary for this is to have radio receiving sets equipped with amplifiers or "loud speakers" installed in each station, so that the officers in the room can hear the message without using the ordinary headpiece designed for

service where the sound is not amplified sufficiently to be heard in an open room or chamber.

But speculations as to the future use of the radio, in some form or another, in criminal detection goes much further than this.

It has been suggested by Edouard Belin, of Paris, and others that since it is now possible to transmit pictures by telegraph, a similar picture might be transmitted by means of an electric wave passing through the ether without wires.

The method by which it is thought this can be accomplished is through the simple expedient of synchronizing the existing machinery at each end of a current that is now adapted to the recording of visual impressions. Portrait photographs have already been telegraphed between New York and Chicago and New York and St. Louis and the pictures reproduced in the daily newspapers, and it is held that such photographs may ultimately be sent by wireless.

SEND FINGER PRINTS BY WIRELESS.

The system by which this has been accomplished and known as the Belin process has been improved to such an extent since its original creation as to enable M. Belin to transmit over a wire in France a reproduction of finger prints made by the Bertillon system for identifying criminals sought by officials.

The apparatus has been adopted by the French government and has been installed in some of the frontier cities in France. The transmission of the finger prints by telegraph from Paris to one of these frontier points, perhaps a hundred miles distant is said to be accomplished in about fifteen minutes.

The instrument is called a "teletrograph" and works

on the principle of those originally devised for telephotographic reproduction. A copper cylinder is operated by a clock attachment. There is what is termed as an interrupted holding a needle. When the current passes through the machine as the cylinder turns around the needle lifts every time it meets a line on the picture being sent. The circuit is broken by this action and the breaks register at the other end of the line and on a receiving machine the permit is registered just like it is sent. The photograph is finished like an ordinary photograph from the negative thus produced. The same process is used in producing the lines of the finger print.

The contention is that the radio can be used to send pictures and prints through the medium of this machine, and the finger prints of a wanted criminal could be in the hands of every police department in the world in short time.

In places where the Belin system has been installed both photographs and finger prints of the criminals are being telegraphed and every police station is shortly provided with the perfect identification marks of the man sought. The one serious obstacle to the use of the wireless for this system is that bane of the radio operator's existence—the condition known as static. It is a condition of the elements that makes it difficult or impossible for the operator to work his machine.

Every amateur operator of a radio knows what is meant by static. His machine is working smoothly and he is delighted. Suddenly there reaches his ears a sputtering and then all is silent. Nature has intervened. Experts are working to overcome such difficulties, and they will do so but up to this point the radio is unsteady and the telegraph wire is dependable, so the latter is best

for photographic reproduction where things must be as nearly perfect as possible.

But there is every reason to believe that the "static" which is now such an obstacle may be turned to the account of man and prove of inestimable value. Nikola Tesla has already lighted electric lamps at a distance of several hundred feet by wireless and has expressed his belief that power will some day be radiated from a gigantic station to transmit light and power for commercial purposes to distant communities by wireless.

Since "static" is the natural electric discharges in the atmosphere, and they are being picked up by every radio operator, it is held that this electric energy which permeates the atmosphere and sends out waves into the ether may be purposely taken up by man and literally harnessed and put to commercial uses. The flashes of lightning are the result of nature's "broadcasting station" transmitting electric energy, and men with vision see in the future a world running its factories and lighting its cities with electricity drawn from the atmosphere.

MAN MAY TALK FROM THE WILDERNESS.

There is a new phase developing almost daily. One of the very late experiments showing the progress and possibilities of radio was that in which Mr. H. B. Thayer, president of the American Telegraph and Telephone Company, conversed from his home in Canaan, Conn., to Captain Rind, of the Ocean liner *America* 360 miles at sea, through the medium of the ordinary telephone and the radio. The remarkable feature about the demonstration was that it was a two-way conversation. That is Captain Rind and Mr. Thayer talked just as they would over an ordinary telephone, although part of the conversation was carried on through the "ether."

To make such a conversation possible it was necessary to broadcast Captain Rind's salutation and com-

ments 120 leagues to the wireless station at Elberon, N. J. The radio message was then so modified and rectified that the waves became audible over the land wires running from Elberon to Mr. Thayer's home. When Mr. Thayer replied to Captain Rind his voice was carried over the land telephone wires to the wireless transmitting station at Deal Beach, N. J., from where they were broadcasted and received on the *America* by the commander.

On the land there were, as indicated, two stations used to make the two-way communication possible. One to receive the messages from the ship and to forward them by land wire, the other to receive the messages over the land wire and relay them by radio to the vessel, but on shipboard Captain Rind carried on the conversation by the use of duplex devices familiar in telegraphy and radio work. He was thus able to carry on the conversation and hear the broad cast messages from Mr. Thayer at one and the same time.

Some idea of how this might be accomplished may be gained by the amateur who has seen the operator of a radio receiving set place the radio receiving phone to the transmitter of an ordinary telephone so that the person at the other end of the telephone line could hear the music. The significance of the experiment is tremendous when considered with relation to men compelled to enter isolated parts of the world where there are incomplete lines of communication. It shows how radio can be linked up with existing lines, and messages relayed around the globe.

The vast forests and the wildernesses which man could not enter without being cut off from the civilized world may be invaded with the consciousness that calls for aid may be sent out from the most desolate, uninhabited places. The tragedies of the north and south poles will

be things of the past and the fastness of the jungle will be robbed of its terrors for the explorer because of radio.

Livingstone, the African explorer, could have told the world of his whereabouts when lost in the jungle had the radio been available to him, and Peary at the north pole could have summoned his relief ship and avoided much hardship. Robert Scott, the English explorer, whose frozen body with those of four of his officers was found in the ice of the Antarctic region after he had reached the south pole, might have been saved had the radio been in existence. The party was lost because of their inability to communicate with the outside world or the main portion of their own party.

With the radio the pioneer hunter or explorer may now keep in touch with his fellowmen a thousand miles or more away and summon assistance by airplane. The missionary in an isolated and lonely territory may have a radiophone which will serve to entertain him in his cut-off portion of the world, even if the device were not used to protect or save him.

RADIO MIGHT SAVE EXPLORERS.

But far and beyond even this the radio and the airplane together will make it possible to chart and map parts of the great world as yet uncharted. Not much of the big sphere remains untouched by modern man, but many places have not been charted because the knowledge of precise time is essential to the work. Where wire communication is had with Greenwich, the information obtained from that centre is used to determine both time and space, but Greenwich could not heretofore be reached from the north pole or the great frozen zones at the ends of the earth.

The wireless will make it possible for the geographer to obtain the time and necessary information from

Greenwich and make exact scientific reports that will eliminate all question of doubt as to the precise location of any portion of the earth he may have reached.

Pioneers in the great gold or oil fields in South America or Africa, or any undeveloped portion of the world can use the wireless in some degree to communicate with outposts, now days away from the seat of their operations. This is not mere theory and hope. Already mountain climbers are using wireless to report their whereabouts to the headquarters from which they operate and stories of what the radio has done at sea are legion.

AN AID TO PIONEERS.

It was the wireless telegraph which called the Carpathian to rescue the passengers from the great steamship Titanic when it struck an iceberg and sunk off the coast of Nova Scotia in 1912, and now the "loop" of the radio has been turned to account as a direction finder, through the agency of which vessels may be brought into dangerous harbors at night and safely anchored without the aid of a pilot.

And if speculations may enter into our calculations they may carry us to other realms and the effort to communicate with Mars, which has been going on for years, may be solved by the radio. There are those too, who accept the proof of wireless communication as evidence that the contentions of the spiritualists are correct and that it is possible to communicate with the spirits beyond the Styx—the other world—and that a new science is being developed which will open wide to the world a book that has for centuries been a closed volume.

CHAPTER XX

Broadcasting—How It Affected the Development of
Radio—Big Electrical Company Pioneers in the Field—
Colleges—Telephone Companies and Amateurs.

WHATEVER of interest there may be in radio-telephony for the man of science or invention, the mechanic, the one who finds delight in delving into the mysterious and the unknown, or the person who sees in it an opportunity for commercial gain, its sudden and overwhelming popularity had its inception in broadcasting.

It is true that the discovery of the electron tube and development of the mechanical apparatus used in radio-telephony to a point of comparative efficiency have to be effected before it could ever become popular or of wide practical use, but wireless telephony has been in existence for a dozen years. Why did it suddenly spring into popularity?

The answer is broadcasting. For half a score of years government experts, radio engineers, the geniuses of the great telegraph and telephone companies and men of science and vision in the great electrical laboratories, plus a small group of amateurs, made up the little army that found interest in the idea of talking through space without wires to carry the sound.

The public heard about the marvelous experiments that were being made and how some radio engineer talked through space—perhaps 50 or 100 miles—and that was all. Radio was viewed as a thing of science, and not a thing in which the public could find interest.

The idea appealed to the imagination, and there were

some who capitalized this and used their knowledge of the progress being made by experimenters as the basis of stock promotion schemes in which many persons lost money, but in general radio was regarded as a seven days wonder.

Then came the now famous vacuum tube with its unlimited capabilities. Not only could it be used as a rectifier or regenerator, to transform alternating currents into a direct current, but as a generator of alternating currents for radio, a device for charging storage batteries from an alternating current, an amplifier of a weak current of electricity or a modulator of a strong current, as well as a relay repeater for regular telephone use—applied in long-distance telephoning so that the voice currents growing weaker after traveling hundreds of miles over the wires are given new impetus and travel on their way.

TELEPHONES HELPED DEVELOPMENT.

Telephone engineers saw the possibilities of the little device and they took it for their own. They used it for transcontinental service and to multiply the capacity of their wires, for the electron tube, incidentally made it possible to send a large number of messages over a single wire at the same time.

It was the engineers of the great telephone and telegraph companies that telephoned from Arlington, Va., to the Eiffel Tower in Paris, a distance of more than 3,000 miles back in 1915, and it was the electron tube—or rather a battery of them (for several hundred of them were used) which made this feat possible.

Then came broadcasting. The United States Navy first made successful attempts in this direction as indicated elsewhere in this volume, but it was the Westinghouse

Company that saw in this phase of the art the possibilities which have since been, and are being realized.

This great commercial company first broadcast from its Pittsburgh experimental station in the latter part of 1919 or early part of 1920. They first sent out music from phonograph records. Amateurs were at work with radio outfits in all parts of the country, and after several experiments the company began getting notes from persons in various sections of the country telling them that the music had been picked-up—heard.

The development was rapid. The operators learned what type of music reproduced or carried best on the waves and how to talk into the transmitter to get acceptable results. When desirable things were sought to fill up the, at that time, hit-or-miss programs, it was suggested that a church service be sent out.

CHURCH SERVICES POPULAR.

Early in January, 1921, the first church service in the history of the world was broadcast from the Westinghouse wireless station in Pittsburgh. It was the service of the Calvary Episcopal Church. In order to broadcast the service wires were connected with the church and microphones were installed within the church to catch the voice of the rector, the choir and even the chimes.

This portion of the broadcasting program struck the popular fancy and many letters of appreciation were received and the service was made a regular feature of the broadcasting. Incidentally out of this experiment grew another. One of the Presbyterian churches was without a pastor, and someone suggested that the service being sent out by the Westinghouse Company be received in the church. A receiving set was installed in the church with a phonograph horn attachment—or what is now com-

monly referred to as a loud speaker and the members of the Presbyterian congregation assembled to hear an Episcopal service by radiophone.

Singers and speakers were substituted for phonograph music. Then came the broadcasting of news items, weather forecasts, crop reports, grand opera, concerts, bedtime stories and educational talks. The demand for radio sets outgrew all anticipations. Other broadcasting stations were established at Chicago and Newark and also at Springfield, Mass.

The American Radio and Research Corporation, with an experimental station at Medford Hillside, Mass., and the General Electric Company of Schenectady opened stations and the popularity of the radio was more than assured. The demand for sets became a craze. The commercial possibilities were recognized as were the scientific, educational and publicity values.

MILLIONS HEAR CONCERTS.

Broadcasting stations were established by colleges and by municipalities and the department stores came into the field. The average radio receiving set, made by amateurs, or sold within range of the purse of the youth of the land, would not pick-up messages beyond a range of twenty-five or fifty miles, and the establishment of transmission, or broadcasting stations by the department stores and those interested in the sale of radio sets opened a field of possibilities for the person who did not wish to invest a large sum of money in a new plaything, no matter how interesting it might be. The local broadcasting stations made it possible for millions to hear concerts, music, lectures, talks on popular and current topics and receive the news of the day, as well as information about radio.

The broadcasting station of a department store in a city like Philadelphia, New York or Chicago could be

picked up by boys and girls with receiving sets costing probably from \$15 to \$25, or with sets made at home that involved only a few dollars and a little ingenuity.

Every day brought forth something new. The Bell Telephone Company saw in the broadcasting a possibility not even yet fully capitalized in the commercial field. They established a broadcasting station in New York, not for the purpose of sending out regularly prepared programs of music, lectures and whatever might be popular, but for the purpose of leasing the service or the broadcasting privilege to those who might wish to address the millions who reside within range of the electric waves the station could transmit.

ITS USE IN POLITICS.

If a politician had a message he wished to deliver to the millions within the territory, he could by paying for the privilege address the thousands of people in the homes and institutions where radio receiving sets were installed. Newspapers could secure the services of this broadcasting station to send out election returns, or to announce the result of some great boxing match.

How far this sort of thing can go is still a matter of conjecture because the situation can only be met as it develops, but the government, which has fostered radio-telephony in America, quickly saw the evils that might result from permitting everyone to operate a broadcasting station and the restrictions that held during the war, of licensing all broadcasting stations and grading them, was adhered to, and in addition the business people were given to understand that it was desired they not use the broadcasting privilege to force owners of radio receiving sets to listen to purely advertising talks—statements regarding the prices of silks, or shoes, or hats or what not.

Fortunately the radio was largely a one-sided affair with the public taking no part in the broadcasting, because they could not be equipped to send out messages, and listeners-in were spared the necessity of listening to the ramblings of some amateur more interested in his own plaything than in providing amusement for thousands around him.

The natural restrictions placed upon broadcasting is primarily one of cost because it requires some sort of an efficient and powerful alternating current generator for transmission, and the installation of this adds largely to the cost of the fun. In addition the operator is compelled to pass an examination before the government will issue a license for broadcasting.

In this connection it should be remembered when the call letters of a broadcasting station are heard or seen in print, that the letters are assigned to these stations by the government so that their calls can be identified and any message that comes from them can be checked up should they transmit anything of which the people complain or to which the government might object.

A WONDERFUL DEVELOPMENT.

Throughout the country there are amateurs who are among the leaders in radio work, and they have developed some interesting things. One of these in Philadelphia during the latter part of April, announced that he would permit listeners-in to hear their own voices if they would phone to him when he was broadcasting. He had the receiver of his regular telephone fixed close to the transmitter of his radio set. Some of his listeners-in took him at his word and called him on the phone and all of those who were receiving his waves heard the telephone calls as they were made including the persons who made them.

The idea took and within a short time he was compelled to ask the listeners-in to desist from calling him. The telephone lines were congested and the operators could look after no other business on the trunks. The telephone company asked him to stop the proceeding declaring that they had several hundred calls on the phone waiting for him.

There is not, however, in broadcasting, the element of interest that is found in receiving, for there is something almost uncanny about talking into a machine which does not give you any applause, request an encore or tell you whether they even heard you or not. Of course there could be a receiving apparatus to bring your own message back to you, but you have no way of knowing what the other fellow thinks of your solo or talk.

Those who have for the first time sung or talked into the radiophone say that the impression is uncanny. No sea of faces to look down upon, no familiar stage, none of the things which one is accustomed to see and to feel are about. A talk with no one to give back a hint that you are understood, no smiles, no frowns, no suggestion of approval or disapproval. Your speech begins in a silent room in which a large disc hangs before you. Some radio apparatus is near at hand and perhaps a director or announcer stands by. You are alone and you might, so far as your consciousness of results are concerned, be declaiming in some sound proof studio of practice. Because this fact is recognized, a group of minstrels singing in the Pittsburgh station paused when their melody had passed out on the waves, and announced that because they knew the audience could not applaud they would make up for the deficiency in their program by encoring themselves. Their handclapping was heard by thousands of listeners-in and then the minstrels gave their encore.

CHAPTER XXI.

The Theory of Radio—Basic Principles Explained with
Diagrams—Transmitter—Aerial—Tuning—Receiving
Set—Detector—Vacuum Tube.

IT has repeatedly been stated and with distinct purpose in previous pages that wireless telegraphy and telephony consists of communication carried on through the medium of the ether with electricity as the agent of transmission.

The process of communications consists of setting in motion a train of electric waves in one place and detecting them at another. The point at which the waves are started is called the "transmission station" and the point at which they are detected the "receiving station." The apparatus used to generate and send forth the electric waves is the "transmitter" and that at the receiving end the "receiver."

The train of waves set up in the transmission station travel in the same fashion as water waves travel from a spot where a stone or heavy object is thrown into a pool of water. It is not possible, therefore, to direct (except in a general way) the waves toward any receiving station. All receiving stations, consequently, will detect the waves from all transmitting stations within the range of sensitivity of their apparatus. It is possible, therefore, to set up a receiving station and detect radiotelegraph and telephone signals from all over the globe, the only limit on the distance from which they may be received being the sensitivity of the receiving apparatus.

The transmitter of the radio set creates the disturbance

in the ether setting up the train of waves. In order to fully understand the action it is necessary to digress a little and consider the two kinds of electrical currents available. Electrical current exists in two general forms: direct current, which flows continually in the same direction in the wire and alternating current which flows first in one direction and then in another, changing the direction of the flow so many times per second. Each change in direction in an alternating current is known as a cycle and the number of changes or cycles per second is known as the frequency. A current which changes sixty times a second is called a sixty cycle current and the frequency is stated to be sixty.

THE TRANSMITTER.

Investigation has shown that the direct current makes no waves, and *only alternating currents create a disturbance in the ether*; consequently, this is the current used in radio transmitting sets. Careful experiment has proved that all electric waves travel with the same velocity through space, the *velocity* being 186,000 miles or 300,000,000 meters per second. If an alternating current is created of 50,000 cycles per second and the circuits so arranged that the current causes a disturbance in the ether of that frequency, each cycle or individual disturbance will travel through space at the rate of 300,000,000 meters per second. As there are 50,000 disturbances or cycles per second, the first disturbance will be 300,000,000 meters away by the time the last disturbance is complete. We have in the 300,000,000 meters, therefore, 50,000 separate disturbances separated by the distance that 50,000 divided into 300,000,000 will give, which is 6,000 meters. It is the actual distance in meters between the separate disturbances and is known as the "wave length."

All radio transmitters consist of a combination of cir-

cuits and apparatus capable of creating alternating currents of high frequency. This frequency is impressed on the ether and the disturbance created; common practice designates the disturbance not by the number per second but by the actual length of the waves created, calling each disturbance, or the frequency of the disturbance, the "wave length" of the transmitter. Amateur stations are limited to wave lengths of 200 meters. Their transmitting apparatus must therefore be capable of producing alternating currents of 200 divided into 300,000,000 or 1,500,000 cycles per second.

There are numerous ways of producing alternating currents of this frequency and a complete consideration is not possible or necessary to this explanation. Perhaps the simplest one to consider is the one first used in the art:

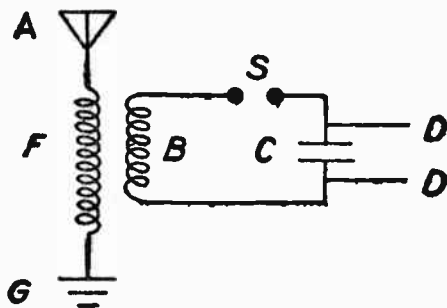

Fig. 1.

The diagram in Fig. 1 shows the elementary *radiotelegraph transmitter*. The wires "D" "D" lead to a source of high voltage such as a spark coil or transformer operating on alternating current used for lighting. The transformer charges the condenser "C," which is connected to the coil "B" and the gap "S," to a voltage sufficiently high to jump between the two terminals. On the passage of the spark there is an interchange of energy between

the coil "B" and the condenser "C," the exchange taking place at a frequency determined by the size of "B" and "C." By properly regulating the sizes, the frequency (and hence the wave length) may be made as high or as low as desired. A circuit of this type is called an "oscillating" circuit, since the energy present "oscillates" between the coil and the condenser. It is universally used in one form or another in radio transmitting and receiving sets. The coil "F" placed in close proximity to the coil "B" will have alternating currents induced in it when properly adjusted and will convey them to the "aerial" which will create the disturbance desired in the ether. This is the simplest form of circuit. It is still quite generally used by the beginner, and, with modifications, by practically all the vessels equipped with radio sets. The most modern and best method of creating the high frequency necessary for radio work employs vacuum tubes. This method will be considered later.

THE AERIAL.

Although any alternating current will cause a disturbance in the ether regardless of the size or shape of the circuit, in order to create the maximum disturbances possible with the power available, it is necessary to erect an "aerial."

The aerial or antenna consisting of wires stretched above the surrounding objects and connected to the radio set is used for both transmitting and receiving, a switch or other transfer means being used to connect it to one or the other according as the station is sending or receiving messages.

The wires used in aerials is either bare copper, phosphor-bronze or copper clad steel. The ends of the wires are insulated with special insulators and the wire lead

into the house through an insulating tube known as a "bulkhead" insulator.

Where only reception is desired the aerial may be strung inside the house. It should be at least thirty-five feet long and consist of four wires. Surprising results may be obtained by an aerial of this kind and its convenience makes it popular with amateurs living in apartment houses.

Equally important is the ground connection. This is generally made to the water pipe system in a house. It may be further improved by burying a series of wires in the ground under the antenna. One form is known as the "counterpoise" which is a replica of the antenna but placed beneath the ground. A common form of aerial or antenna is shown in Figure 2.

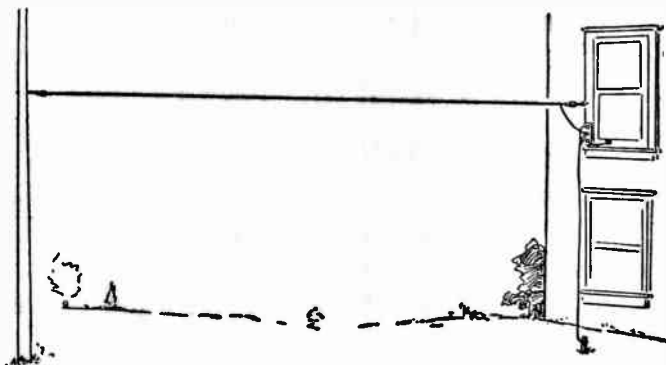

Fig. 2.

TUNING.

This operation has always been a puzzling one to beginners. It is, however, very simple. Under the preceding section dealing with transmitting sets the relation of the "wave length" and the "frequency" of the alternating current was explained. It was stated that by varying the size of the coil "B" and the condenser "C" the fre-

quency of exchange of electrical energy between them, and hence the wave length, could be regulated. Consider the circuit shown in Figure 3.

Assume that the wires "KK" are connected to a source of electrical energy the frequency of which is varied by changing "B" and "C." Vary "C" leaving "B" fixed until a frequency of 1,000,000 cycles or a wave length of

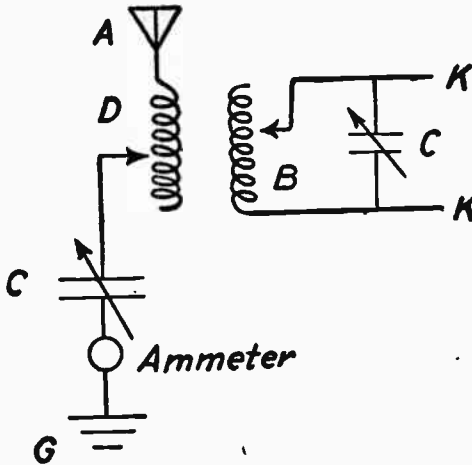

Fig. 3.

300 meters is obtained; now vary "C" and "D" and it will be found that for a certain point, and that point only, that ammeter measuring the current gives a reading. This process is known as tuning and the point at which the ammeter gives a reading is known as the "resonant" point.

All transmitting and receiving sets operate in the above manner, the difference in the sets being due to the methods used in varying "B" and "C," and "C" and "D". The operation of "tuning" just explained applies to transmitting sets; *the action must be reserved for receiving.*

Condenser "C" and coil "D" are first adjusted; and then "B" and "C" varied. High frequency alternating current will be obtained from the wires "KK" but the voltage and current will be in the order of millionths of a volt or ampere. A meter cannot be used and a device known as a "detector" is employed which, with telephone receivers, makes the currents audible.

RECEIVING SET.

From what has already been stated the reader should be able to conceive some idea of what a receiving set ought to consist. Reduced to essentials the diagram of connection is shown below in Fig. 4.

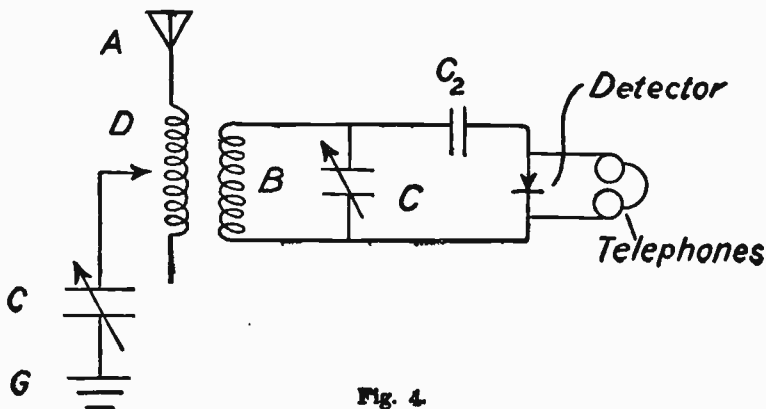
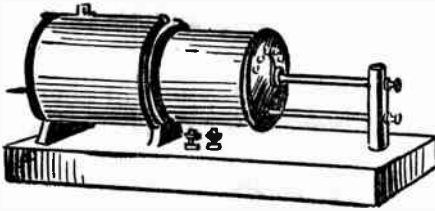

Fig. 4

It should be noted that the scheme of connection is almost similar to the transmitting set with the one exception that a detector and telephones have been added.

The operation has already been explained; the various "wave lengths" are obtained by varying the frequency of the circuits and the alternating current obtained from the distant transmitting station is impressed on the "detector."

The wave motions are felt in the antenna "A" and enter through the coils "D" and "B," usually combined in a loose coupler, an instrument constructed of two coils of wire and so arranged as to permit of ready variation of "D" and "B" and to permit of variation of one coil with



LOOSE COUPLER.

reference to the other. The coupler in its commonest form consists of one coil wound on a fibre or other tube probably three inches in diameter, with a secondary coil wound on a similar tube of smaller size, so that the secondary coil may slide within the first. The condenser "C" is an instrument that stores up electric energy and discharges the full charge at once and under high tension. It usually is made of alternate layers of a conductor and nonconductor so that the layers or plates may be turned to have a greater or lesser amount of surface adjacent to each other—the plates do not come in actual contact. Condensers collect the energy and are also used to put the circuits into resonance for tuning.

THE DETECTOR.

This is one of the most important parts of the receiving set. From what has been said of wave length and frequency the reader has probably gathered that the frequencies employed in radio are extremely high. Frequencies lower than 20,000 are seldom used and if they were impressed on the telephone receivers, the note, even if the

receivers would respond, would be inaudible, since the ear will not record frequencies much above 15,000 cycles. The problem now is to reduce the frequency used in radio to one audible in the telephone receivers. This is done in the detector. This instrument groups together a number of the cycles of high frequency current and delivers them as one cycle of low frequency audible in the telephone receiver.

The detector may be of any one of several shapes and types, but the commonest forms is the crystal of galena

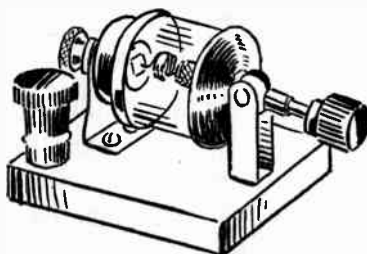
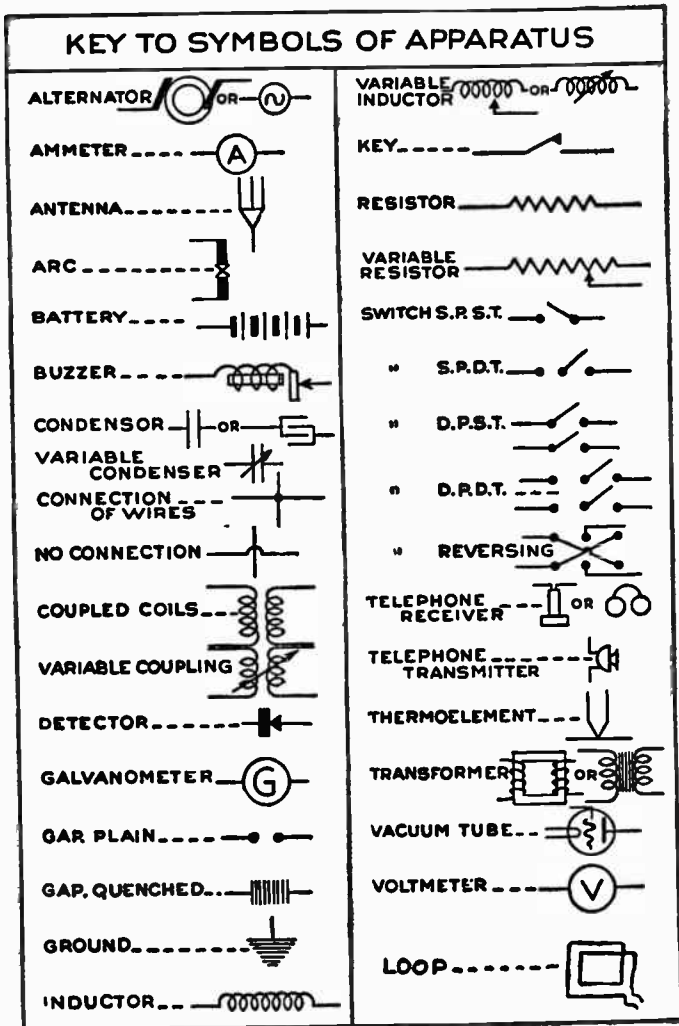

Fig. 5.

(sulphide of lead) and a contact point of fine wire. One type is shown in Figure 5.

When the wire is lightly brought into contact with the surface of the galena the signal received by the antennæ is changed from alternating current to direct current in a series of pulsations that act on the telephone receiver as a low frequency alternating current. This low frequency current corresponds exactly to the impulses sent out by the transmitting station and the audible signals are copied as the message. They may, of course, be in code or radio-telephone conversations.

The foregoing outlines the operation of a simple radio station. It is given with the idea of fixing the fundamental principles in the mind of the reader rather than of



THESE SYMBOLS ARE USED IN DIAGRAMS TO INDICATE THE VARIOUS PARTS OF RADIO APPARATUS.

showing the actual construction and operation of the station.

All radio sets are based upon the plans just given and their efficiency is merely increased by the additions of refinements in the way of amplifiers, rectifiers, condensers, form of antenna, telephone head sets and loud speakers which have been developed.

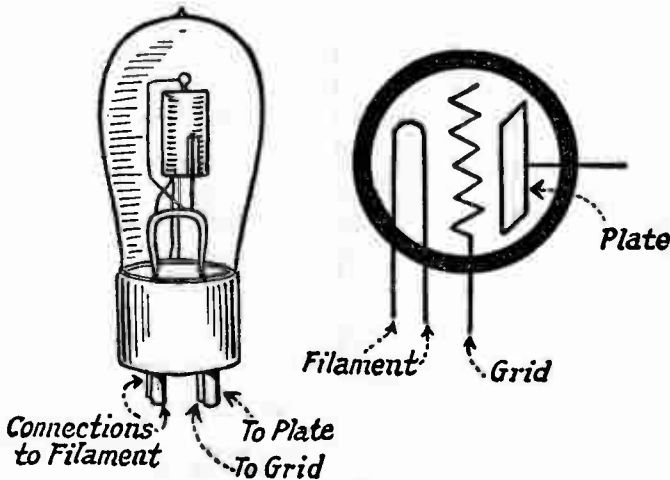

Fig. 6.

The most important of these is the vacuum or electron tube, which involves but one principle of construction though made in variable forms and degrees of efficiency control and power. It has previously been described but the diagram (Figure 6) will make clear the general relation of the filament, the grid and plate. The illustration at the right in Figure 6 is a large reproduction of the "symbol" used in working diagrams to denote the electron tube. It plainly shows the relation of posts.

CHAPTER XXII

Hook-ups an Interesting Study—Same Principles Involved in All—Amplification and Refinements.

THROUGHOUT the preceding pages radio has been discussed mainly with relation to its rapid development and the reason for its remarkable popularity. For those who are more interested in radio from a practical standpoint a summary of facts and some simple working analyses will be taken up.

In the chapter just ended a few diagrams showing the basic principles of a radio hook-up have been given and it is well to repeat that in all radio work diagrams are used to show systems of circuit connection, just as blue prints are used in all working plans in the industrial or engineering fields. Instead of drawing pictures of the various parts of a radio set, the relative positions of such parts are indicated in the circuit by symbols, of which the principal ones are shown in the chart at the back of this volume.

There are hundreds of combinations used in connecting up circuits—making “hook-ups”—and nearly every experimenter will from time to time change his method of making connections to find what he believes will prove a more efficient system. The fact that a slight change will frequently make a big improvement in the efficiency of a set is one of the things that makes radio hold particular interest for the youth or man who is mechanically or scientifically inclined.

It is not necessary for one to know anything about electricity or the scientific side of radio to be able to operate an ordinary receiving set, yet nearly every person who

starts to work in radio ends by delving to some extent into the "whys and wherefores" and becomes an experimenter. He is not satisfied to turn a knob or adjust a tuning coil and take what he receives. He wants to know more so that he can improve his apparatus and get better results. There follows in logical order a study of hook-ups, the purchase of additional standard parts, or the making of substitutes at home, and the effort to properly incorporate them in a circuit.

Anyone reaching this stage must understand some of the principles and practices involved in the building up of receiving sets. To begin with it should be remembered that the aerial in every case forms one end of a circuit and the ground the other. The waves are intercepted by the antenna or aerial and pass down the lead-in wire to the receiving set. Here they first strike the tuner. This is a coil of some form which by adjustment permits the waves to be received clear and strong.

THREE FORMS OF CIRCUIT.

After the waves are "tuned-in" their presence is detected. The now famous vacuum tube or a crystal detector is used for this purpose. The tube or crystal, as the case may be, is adjusted so that the waves are detected in their passage from the aerial through the tuner and thence to the ground. What actually happens is that the detector rectifies the rapid wave vibrations or motions and slows them down to a point where they will affect the diaphragm of a telephone receiver and they become audible.

So far all seems simple, but in coupling up circuits it must be remembered that there are three basic forms of coupling: i. e. "direct," "inductive" and "capacity." There are in these couplings primary and secondary cir-

cuits. The primary circuit is that which forms the natural wire path from the antenna to the ground. It may have incorporated in it coils, condensers or other bits of apparatus, but there is a direct path along which the waves

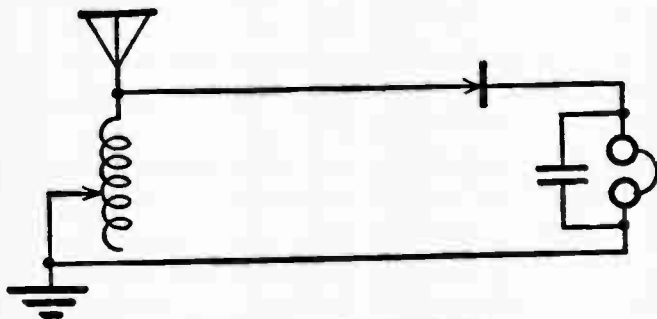

EXAMPLE OF DIRECT COUPLING.

or current would naturally travel to the ground. The secondary circuit is that by which the waves or current are deployed or diverted from the primary so that they travel around the secondary and back again to the main circuit, and thence over their natural course to the ground. In

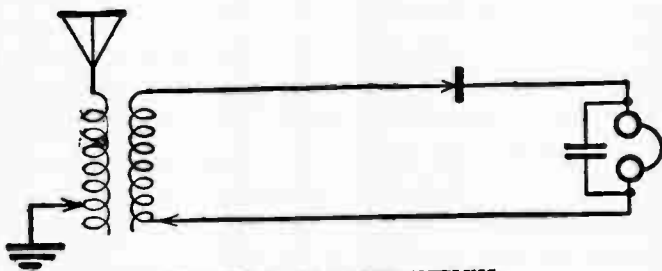

EXAMPLE OF INDUCTIVE COUPLING.

direct connection the secondary circuit is tied into the primary forming two junctions with the primary—one where it begins and the other where it ends. In an inductive coupling the primary circuit is physically undis-

turbed. The secondary circuit is arranged in proximity to the primary in such a manner that the current or waves are carried through it by inductance and not because of direct contact. Induction coils arranged side by side—one in the primary circuit, the other in the secondary—make such a hook-up operative.

In a capacity coupling there are really two segments or half circuits with a condenser incorporated in what would logically be the direct or primary to serve as the coupling element. The diagrams herewith show the principles involved.

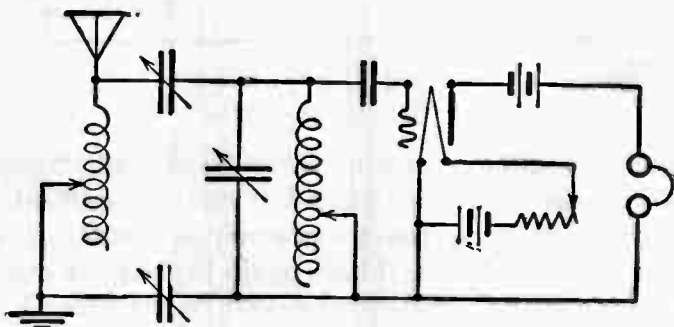

EXAMPLE OF CAPACITY COUPLING.

The simplest circuit of any considerable effectiveness is one which consists of the aerial, single or double slide tuning coil, crystal detector, condenser and head telephone receivers. It has been noted before, but is worth repeating that such a set cannot be used with any marked degree of success for receiving beyond 20 or 25 miles, and the amateur who anticipates hearing concerts or addresses sent out from stations at a much greater distance will be disappointed except under unusual conditions. Nor can a loud talker be used on such a set with any degree of satisfaction. The element lacking for this is some system of amplifying the waves to make them more pow-

erful and pronounced when they reach the receiving phones. The diagram shows such a circuit.

Almost every article written on the principles of radio describe such a set as that referred to above though some of them omit the condenser. In such sets however, the antenna and the earth beneath it form two opposing elements of a condenser, having what is technically termed

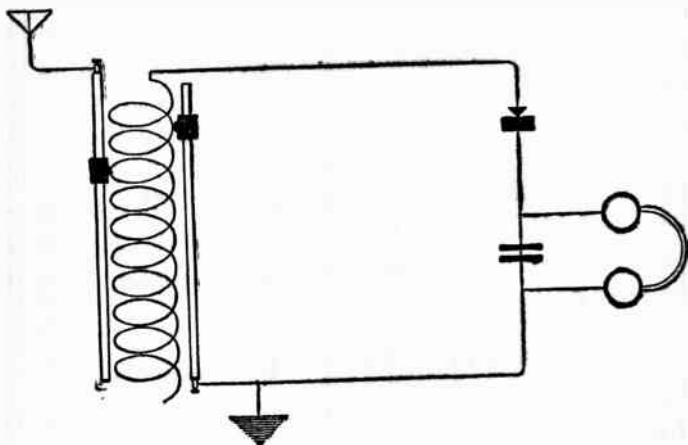

CIRCUIT OF RADIO RECEIVING SET WITH DOUBLE SLIDE TUNING COIL,
CRYSTAL DETECTOR AND SIMPLE CONDENSER.

an air dielectric between, but the set without the condenser is less efficient.

With the foregoing facts in mind and remembering that the waves have been led into the tuning coil it is worth while dwelling on what takes place here. Specifically the tuning coil has the effect of cutting out all of the waves save those desired. There are innumerable appliances or devices used for this purpose including the single and double slide coils, loose couplers, one of which is illustrated in a preceding chapter; vario-couplers, vario-meters and variable condensers made in varied form.

One of the commonest forms is the double slide tuning coil which it may be well to describe because it is a type that the experimenter can easily make. It consists of a pasteboard, fibre, or wooden tube about 8 inches long by 3 inches in diameter, wound from end to end—or over 7 inches of its surface with 24 B & S gauge single cotton or silk covered, or enameled copper wire. The wire must be wound tightly so that the coils have no side play, and one end of the wire is fastened to or imbedded in the tube. The wound tube is mounted between two blocks of wood about 5 inches square. The most satisfactory way of holding the tube in place is to cut holes in the blocks 3 inches in diameter so that the tube ends may be forced tightly into them. The experimenter will now have a wire-wound tube with a block on each end. It would be well to glue the tube to the blocks and to shellac the entire thing, wire and all.

ATTACHING TUNING COIL SLIDES.

The next step is to fasten from block to block—one over the top and the other across the front—two brass rods. These can be secured to the blocks at either end. On each rod there should be a snug fitting slide, to the bottom of which there must be a contact point that will touch the coil on the tube beneath. Such rods and “sliders” may be obtained from any dealer in radio supplies or they can be made. Where the sliders touch the wire as they are moved along its surface from end to end the insulation should be scraped off so that the slider point makes a perfect contact.

With the tuner coil in this shape it is next necessary to attach binding posts for the circuit connections. Two binding posts must be fastened to the block at the end where the wire coil is attached to the cardboard tube.

One of these posts, preferably the one at the front is to be connected to, or with the lead-in wire from the aerial. It must also be connected to the sliding rod with a piece of wire. The twin binding post at this end is hooked-up or connected with the upper sliding rod with a piece of wire and is known as the detector connection.

One single binding post is attached to the opposite end of the tube in the square block. To this post is fastened the end of the wire coil that was permitted to remain loose or extended away from the tube after the winding. In hooking-up this binding post is connected with the ground

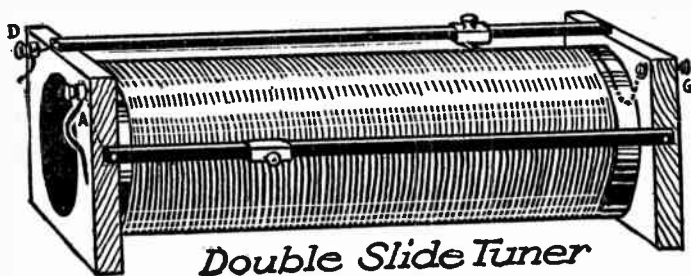

wire in the circuit. The variations required to tune-in on waves are secured by operating the sliders. It is obvious of course that the waves coming down to the tuner pass through the binding post connection to the sliding rod, down through the slide contact point and out through the end of the coil through the binding post connection at the opposite end and off to the ground, and the manipulation of the sliders will regulate and control the waves in their passage. A sketch of such a finished tuner is printed herewith.

It is possible for the amateur to make the finer type of tuning device, such as the vario-coupler or variometer, but great accuracy is necessary and it is much safer to purchase them. While on this subject it should be noted

that the elemental difference between a vario-coupler and a variometer is that while both consist of two coils so arranged that one turns within the other, in one type the two coils are not connected and effect is produced by variation of inductance while in the other device the two coils are physically connected.

It is generally stated that the crystal detector of the small radio set is a very simple device but there are a number of points not to be forgotten by those attempting to make their own detectors. Its construction and function may be more readily understood if the direction of the current or waves is kept in mind. Assuming for the sake of simplicity that the direction of the incoming waves is from left to right, the detector is cut into the circuit at some point in the line after the tuning coil, or between the tuning coil and the head phones.

A SIMPLE HOMEMADE DETECTOR.

A familiar form of the crystal detector is illustrated in the preceding chapter, but the type that can be made at home must be of a character more easily constructed. A popular form consists of a block of wood or hard rubber about 4 inches long, by two inches wide and perhaps one-quarter of an inch thick, to which is attached a binding post at either end. In use the left binding post is attached to the circuit wire running from the tuner. The binding post at the right is connected to a section of wire running toward the head phones. Between these two posts on the block are mounted at the left a post supporting a sensitive contact point or device called a "cat's whisker," and at the right of it, and adjacent to the right hand binding post is mounted a silicon or galena crystal. A dozen methods may be employed to construct the cat's whisker and its support, but the simplest is to use a large size

binding post through the wire hole of which at the top is fastened a piece of heavy copper wire, that should be bent in such shape that it can conveniently be turned on its circumference in the binding post hole. To the right end of this heavy wire there must be soldered a piece of fine wire—a section of fine mandolin wire about one and one-half inches long will serve.

The crystal is mounted on a brass or copper seat of some sort attached to the base block. A brass ferrule will serve the purpose. The delicate crystal may be held firmly by packing it in tin foil. With these mechanical

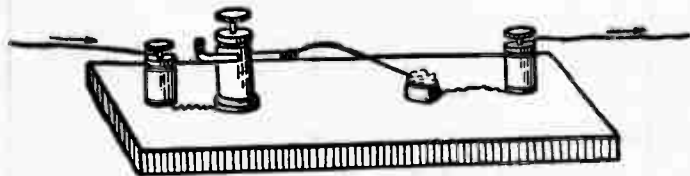

A Home Made Crystal Detector

parts thus assembled, the post holding the "cat's whisker" must be connected to the left hand binding post with a bit of the regular circuit wire, and the metal base support of the crystal must be similarly connected to the left binding post. In operation the copper wire with the "cat's whisker" must be adjusted so that the fine end of the "whisker" comes in contact with the sensitive face of the crystal.

Now when the waves are properly tuned-in and travel through the circuit to the detector, the fine cat's whisker vibrates, in keeping with the wave motions, but the crystal possesses the property of only permitting a certain portion of the rapid oscillations to pass on through and out at the opposite side into the wire connected with the head phones. This description may be said to be not wholly correct, technically, but it will convey a better idea of the

mechanical functions of this type of detector than might some other description. The accompanying illustration will give a clear idea of how such a detector is set up.

The condenser is the other essential part of such a receiving set as is under discussion. This is incorporated in the circuit between the detector and the head phones. Any number of condensers of simple type have been de-

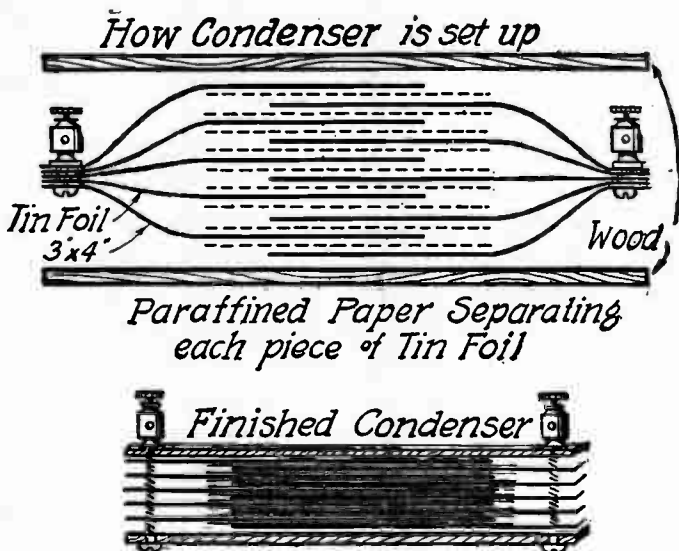

signed, but the simplest is built up of alternate layers of tin foil and paraffined paper cut in strips. There should be ten strips of foil about four inches long by three wide, arranged as shown in the accompanying diagram. The strips of paraffined paper between should be slightly wider than the foil sheets. When arranged as shown, the paper and foil strips are pressed tightly together with pieces of cigar box wood on either side to hold them firmly. The diagrams are self explanatory.

CHAPTER XXIII

Vacuum Tube Detector Set Next Step of Progress in the Building of a Radio Set—Back to Simple Principles of Radio Communication.

IT is possible to utilize the crystal detector radiotelephone set at greater distance than the amateur is frequently given to understand by simply including certain cores and tubes, but the next step of progress for those who wish to have a reasonably efficient set is to make or secure one with a vacuum tube detector.

The same simple hook-up that is shown in the previous chapter for building a detector set with the crystal might form the basis for a vacuum tube set with certain modifications. It would require the incorporation of a variable condenser in the primary circuit as well as one in the secondary, together with a grid condenser, an "A" storage battery of 4 to 6 volts to furnish current to the filament, together with a "B," or dry cell battery of 22½ volts connected with the plate of the tube. A rheostat is necessary to control and operate the tube.

Before going into any further discussion of the practical operation of a vacuum tube detector set we shall go back to first principles. In the early chapters considerable attention was given to the rudimentary principles of electricity with but little stress upon their application and effects in radio operation, particularly with reference to telegraphy the thought being that those who found sufficient interest in radio to desire to instal a set or experiment with the waves transmitted through the ether, would later be better prepared to absorb what at first might seem to be too highly technical.

In radio as in everything else, we learn by repetition and the presentation of a subject from a new angle, and there is no better way of making clear the relation of the vacuum tube to wave detection than beginning with the waves themselves.

Probably the best informed body of men on the entire subject of radio in the country are those identified with its use in the army and navy, and the simplest and most comprehensive treatise on the elementary principles of radiotelegraphy and telephony that has been offered for public consideration has been prepared in the office of the Chief Signal Officer of the United States Army in Washington.

It makes clear so many points that are frequently puzzling to even the reasonably well informed that the major facts and explanations are incorporated here, beginning with the basic statement that "radio communication is the art of sending information from one point to a distant point by means of free electric waves. The study of radio communication, therefore, embraces three separate subjects: The production of these waves, the waves themselves, and the reception of these waves.

THE WAVES.

Every one is familiar with waves, especially with those that appear on the surface of water. Let us study these water waves. We can represent them by a line as in figure 1, where the curving line represents the surface of the water with waves on it and the straight line, AB, represents the surface of the water when there are no waves. The first thing we notice about a wave is its height. The stronger the breeze the higher the waves. The correct way to measure the height of a wave is to measure from the crest of the wave to the surface of the water when it

is smooth. In figure 1 this would be represented by the line *cd*. A better term for this measurement is *amplitude* of the wave. Hereafter we will refer to the amplitude of the wave and not to the height.

If we have been in a boat or in swimming when there were waves, we are familiar with the fact that the waves have energy. In other words, they have power to move objects that are in the water or that they may strike. It is seen that the bigger the waves the more energy they have. Another way of saying this same thing is to say that the energy of a wave increases as its amplitude increases—a large amplitude gives a large amount of en-

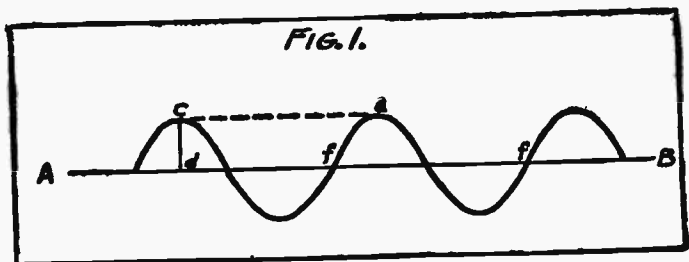

ergy—a small amplitude gives a small amount of energy. In radio we use the energy of the radio wave.

If we watched water waves we would soon notice that besides height, the waves have length also. There would be a certain distance from one wave to the next. This distance can be measured from the highest part of one wave (called the crest) to the highest part of the next wave. This distance is the *length* of the wave. In figure 1 it is represented by the line *ce*. Also *ff* shows the length of the wave. The wave length then is the distance from any part of one wave to the *corresponding* part of the next wave.

If we stood on the shore and watched the wave go by we would notice that waves, besides having amplitude and

length, passed us at regular intervals of time. Count the number of waves passing per second. You have counted the *frequency* of the waves. Frequency, then, is the number of waves passing any point in a *second*. It is represented by the letter "f."

FREQUENCY AND WAVE LENGTH.

Suppose now that we wished to know how fast the waves are traveling. We could find this out in different ways. The easiest way to find it out is to figure it out as follows: Suppose each wave is 10 feet long and there was one wave passing per second. The wave must be traveling 10 feet per second, then, in order to get by. If two waves per second passed, then the waves must be traveling 2×10 feet = 20 feet per second. If there were 12 waves per second and each wave was 10 feet long then the waves must be traveling $12 \times 10 = 120$ feet per second, which is the rate of travel (velocity) of a wave. Velocity is always represented by the letter "v."

Now we have a very good idea of what water waves are. We can sum it up by saying that water waves are *recurring* displacements of water, traveling at a definite velocity and having definite *amplitude*, *length*, and *frequency*. These waves carry energy. This is true of water waves, and if we say "disturbance" instead of "displacement of water" it would be true of any kind of a wave. Waves are recurring disturbance, traveling at a definite velocity and having definite amplitude, length, and frequency. Waves carry energy.

Each different kind of wave has a definite velocity. The velocity of a radio wave is so great that it would go around the earth seven times a second if it could keep on going. It is 186,000 miles in a second. In radio we do not measure distances in miles—we use meters (a meter is a

few inches longer than a yard). The velocity of radio waves is 300,000,000 meters per second.

This velocity is *constant*, so that in measuring radio waves, if we can find either the frequency or the length, we know the other. This is true because the velocity is always equal to 300,000,000 meters per second. So if we know either the frequency or the wave length, the other one can always be obtained by dividing the known one into 300,000,000.

Examples: (1) What is frequency if the wave length is 2,000? Frequency is 300,000,000 divided by 2,000=150,000 waves per second. (2) What is wave length if frequency is 50,000? $300,000,000 \div 50,000 = 6,000$ meters. Sometimes one is stated and sometimes the other. Both are known when one is, as we have just shown.

THE ETHER OR MEDIUM.

In order to have a wave it is evident that there must be some material to carry the wave. This thing in which the wave travels is called the *medium*. The medium that carries water waves is water. Sound is carried by waves in air. Air is the medium for sound waves. So in radio waves there is a medium which carries them. The medium is called the ether. Not much is known about the ether except that it will carry certain waves very rapidly. Besides carrying radio waves, it carries light waves and also heat waves. Another fact that is known about the ether is the fact that it is *everywhere*. It is between you and every other object. It is between the earth and the sun, the moon and the sun, etc. It is in everything, as well as in the space outside. It is in the pamphlet you are reading—it is in your body. It is *everywhere*. There is no exception to that. You cannot think of a place where there is no ether—for there is no such place.

The radio waves then are carried by ether. Just what are these radio waves? In elementary electricity we studied about the *magnetic lines of force* and showed them by iron filings between magnets. A radio wave consists of these magnetic lines of force and something else. That something else is electrostatic lines of force. Electrostatic line of force are what cause a positively charged body to attract a negatively charged body. They go from a positive to a negative charge and are quite similar to magnetic lines of force. They are caused by a charge of electricity and are always present when a body is charged.

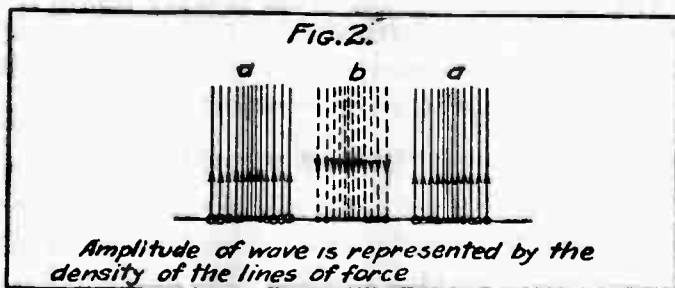

A radio wave then is composed of electromagnetic lines of force and electrostatic lines of force.

A radio wave is represented in figure 2. This figure shows a radio wave moving from left to right. The electrostatic lines of force are represented by lines, the electromagnetic line of force represented by little circles at the end of the lines. It must be remembered that these are *lines*. They extend at right angles to the electrostatic lines of force. They cannot be shown on this diagram as lines, so are represented by circles. This wave is usually represented by a curved line similar to figure 1. Figure 3 shows the usual representation.

Figures 2 and 3 are labeled the same and they show how one accurately represents the other. *a* is the crest of one

wave and a' the crest of the next. The distance from a to m in figure 3. In figure 2 this amplitude is shown by the closeness of one line to another. If the amplitude was greater, there would be more lines packed in a given space.

There is one other thing about a wave that we should observe. In the water wave we see that part of the water in the wave is above the level of the water when it is smooth and the other part of the wave is below the level. This is true of all kinds of waves—part of the wave disturbance is on one side of the usual (waveless) condition,

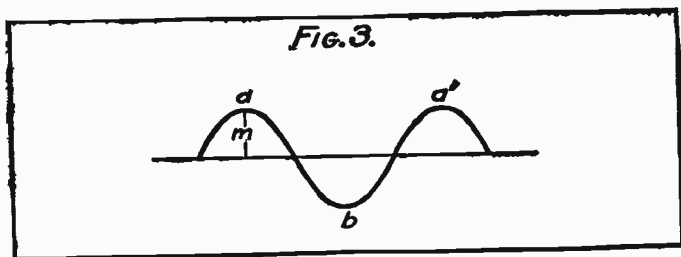

and the other part of the wave disturbance is on the opposite side of the usual (waveless) condition. This is true of the radio waves. Look at figure 2 and note that the arrows show that the electrostatic lines of force are directed upward in one part of the wave and downward in another part. This is also true of the electromagnetic lines of force. The open circles represent those that are directed toward you; the solid circles represent those that are directed away from you.

It must be clearly understood that this wave travels onward just as a water wave travels onward. This means that any point in the path of the wave is swept by lines of force, magnetic and electrostatic, directed in one way and an instant later the same point is swept by lines of force

directed in the opposite way. Between each reversal of these lines of force there is a brief instant in which no lines of force sweep the point. As we have noted the velocity of these waves is 300,000,000 meters per second. (They may be of any length; for example, as short as 50 meters or as long as 50,000 meters.)

PRODUCTION OF WAVES.

We can produce waves in water by various methods. But whatever method we use, it is always done by something that will cause the surface of the water to move up and down. In other words, we must have some contact between a moving body and the water. For instance, wind will produce waves in water. The moving air comes in contact with the water and imparts motion to the water. Now, radio waves in ether must be produced in a similar way—by something moving capable of affecting the ether. The only known thing that is capable of affecting the ether is the electron. The only way that electrons can produce waves in the ether is by moving rapidly to-and-fro.

Thus to get a radio wave we must have a rapid to-and-fro movement of electrons. These moving electrons produce radio waves and the radio waves produced are similar in every respect to the motion of the electrons producing them. Thus, many electrons moving mean that the radio wave has large amplitude (carries much energy). The number per second of to-and-fro movements of the electrons determines the number per second (frequency) of the waves. The wave length is, of course, determined by the frequency. The velocity of the wave is always the same; 300,000,000 meters per second.

Thus in order to produce a radio wave we must produce a rapid to-and-fro movement of electrons. In an

alternating current, such as we use for electric lighting, the electrons move first in one direction and then in the opposite direction; that is, to-and-fro. But these changes in direction occur only a comparatively few times per second—sixty times in most alternating currents. This is not rapid enough for the electrons to start a wave, containing useful energy, in the ether. To start such a wave we must have the alternations (to-and-fro movement) occur 6,000 or more times per second. Alternating currents having 6,000 or more alternations per second are said to have *radio frequency*. The study of the production of these high frequency alternating currents comprises the greater part of the study of producing radio waves.

OSCILLATIONS DEFINED.

If we take a weight and hang it on a spiral spring, such as is found in ice scales, we can get a vibrating motion of the two. By pulling down on the weight and letting go, the weight will oscillate (move to-and-fro) up and down. We can change the frequency (number per second) of these vibrations by changing the stiffness of the spring or by putting on various weights. A study of this motion will show that it is the spring that pulls *it* back to its normal position and it is the weight which makes it move beyond its normal position. In other words, once we have stretched it further than its normal length, the spring starts it in motion—and the weight keeps it in motion.

We can get the same effect in another way. Take the blade of a hack saw and fasten it in a vise, allowing some of it to project. Pull the end to one side and let it go. It will vibrate back and forth. By some means fasten a weight on the end and watch it vibrate. Notice the change

in the frequency of vibrations. Change the stiffness of the blade (by substituting a different sized blade or by shortening or lengthening the blade). Try different sized weights fastened to it. You will note that it is the combination of weight and stiffness which determines the frequency of vibration. Changing either one or changing both will change the frequency. You will note, too, that once drawn aside (given energy) it is the stiffness of the blade which starts the motion toward the point of rest, and it is the weight which keeps it moving beyond the point of rest.

EFFECTS OF INDUCTANCE.

Thus you see we can start vibration or oscillation in anything if we have these two factors present; that is, if we have something that will start a movement to a point of rest (when it has been moved from the point of rest) and something that will keep its movement going beyond the point of rest. In electricity we have these two factors, and it is by using these that we can get radio frequency alternations (oscillations) in a circuit.

Inductance in an electrical circuit has the property of resisting any change in the current flowing in that circuit. Consider a circuit which has a large self-inductance. A current is started in the circuit, and the self-inductance of the circuit opposes the building up of that current. When the current is flowing if we stop it or diminish it in any way, the self-inductance of the circuit opposes the stopping or diminishing of the current. In other words, inductance opposes any change in the current flowing in a circuit. This is exactly the effect of the weight of any moving object. An automobile truck is hard to start because its weight opposes the starting of it. When the truck is in motion and an attempt is made to stop it, it is

the weight of the truck which opposes the stopping of it. Inductance in electricity plays the same role as weight in objects. In the same way as the weight made the hack saw pass beyond its point of rest, the inductance of a circuit will make a current pass beyond its point of rest (zero current).

Capacity in an electric circuit has the property of urging a current to the point of rest (zero current) when it has flowed beyond the point of rest. Consider a circuit containing a condenser (capacity) and a source of electromotive force. When the circuit is made the condenser

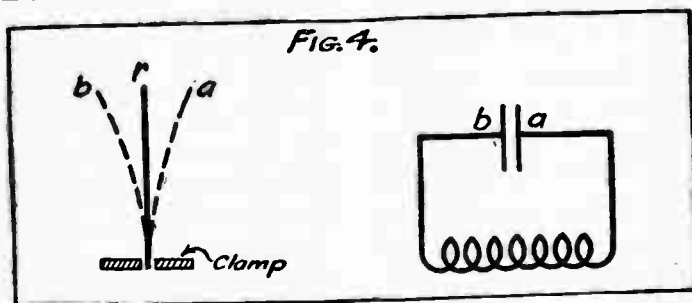

gradually charges up from a zero potential to a potential equal to that of the charging instrument. When the potential of the condenser and the charging instrument are the same, the current stops flowing because the potential of the condenser is urging the current in the opposite direction to that of the charging instrument. If the source of electromotive force is removed and the circuit completed the condenser will, because of its potential, cause a current to flow in a direction opposite to that of the first current. The condenser potential will act until it has been all used up; that is, until the condenser has zero potential. Thus capacity plays the same part in an electric circuit that a spring (elastic body) does in a material body.

It is seen, then, that weight and inductance are similar and also that elasticity (springiness) and capacity are similar. When both inductance and capacity are in a circuit they will act exactly as a spring and weight act in a material body. That is, if they are furnished with electrical energy and then freed from outside influence they will oscillate in exactly the same way as the hack-saw blade vibrated, due to its stiffness and weight. A study of figure 4 shows this similarity.

HACK-SAW BLADE.

"Furnish energy by displacing the hack-saw blade to position at *a*.

"Free the hack-saw blade by removing the hand.

"The stiffness (elasticity) of the hack-saw blade makes it move from its position of displacement, *a*, toward the point of rest, *r*.

"When the blade reaches the point of rest, *r*, it has its greatest speed.

"Just at the point of rest the stiffness of the blade ceases to move the blade.

"The weight of the blade causes the blade to move beyond its point of rest.

"The further the blade moves beyond its point of rest, the more the stiffness of the blade opposes the motion.

"When the blade reaches the furthest displacement, *b*, on the other side, there is no motion.

INDUCTANCE AND CAPACITY.

"Furnish energy by charging the condenser so that electrons gather on plate of condenser marked *a*.

"Free the inductance-capacity circuit by removing source of charge.

"The potential of the condenser causes the electrons to move away from *a* to the point of rest. (Point of rest is that point where there are no excess electrons on either plate of condenser.)

"When the electrons reach their point of rest the current has the greatest value.

"Just at the point of rest the capacity of the circuit ceases to act. (There is no potential.)

"The inductance of the circuit causes the current to keep on moving beyond the point of rest. (Zero potential.)

"The longer the current flows beyond the point of rest the more the capacity of the circuit opposes the current. (Because the condenser is acquiring, by the current flowing into it, a potential opposing the flow of current.)

"When the electrons have reached their furthest displacement (charged *b* to its highest potential) there is no current in the circuit.

“The stiffness of the hack-saw blade makes it move from this position of displacement toward the point of rest. This movement is opposite in direction to the first movement.

“Events repeat themselves as explained.

“The frequency of vibration of the blade depends upon the values of both the weight and elasticity of the blade.

“The potential of the condenser causes the electrons to move away from b to the point of rest. This movement, and therefore the current, is opposite in direction to the first movement.

“Events repeat themselves as explained.

“The frequency of oscillation of the current depends upon the values of both the inductance and capacity of the circuit.

“Thus it is seen that a current will oscillate in a circuit if the circuit has both inductance and capacity. By these to-and-fro movements of the electrons, ether (radio) waves are started. The length of these radio waves, as has been shown, depends upon the number of the oscillations in the circuit. Increasing either the amount of inductance or capacity in a circuit gives a longer wave length. Increasing both gives a longer wave length. To increase the wave length, increase either the inductance or capacity or both; to decrease the wave length, decrease either the inductance or capacity or both.”

CHAPTER XXIV.

How to Change Inductance and Capacity Energizing an Inductance—Capacity Circuit—The Potential—A Simple Transmitting System.

THERE are various methods of changing the inductance in a circuit. A straight wire has very little inductance. Make a coil of the same wire and the inductance is greatly increased. The coil can be made either by winding it smooth over a form, such as a broomstick, or by winding it spirally in the same plane. This is the way electricians tape comes in the roll. The inductance of a coil is changed by changing the number of turns of the coil in the circuit. This is the most common way.

There are various methods of changing the inductance in a circuit. A straight wire has very little inductance. Make a coil of the same wire and the inductance is greatly increased. The coil can be made either by winding it smooth over a form, such as a broomstick, or by winding it spirally in the same plane. This is the way electrician's tape comes in the roll. The inductance of a coil is changed by changing the number of turns of the coil in the circuit. This is the most common way.

There are also various methods of changing the capacity in a circuit. One method is by changing the number of condensers in the circuit. A second method is by changing the capacity of a single condenser. This is done by having the two sets of plates that make up a condenser movable with respect to each other. When every part of the plates in one set is opposite to the plates in the other the capacity is the greatest. The capacity is made smaller

by having only a part of each plate in one set opposite to the plates in the other.

The inductance and capacity needed in an oscillating circuit is contained in the antenna of a radio transmitting set. The antenna of a radio set is that part of the set which radiates the energy by setting up the waves in the ether as explained above. The wires making up the antenna give both the capacity and inductance. It, however, is very usual to add extra inductance in the shape of a coil which may be varied. Capacity also is sometimes added by throwing condensers in the aerial circuit.

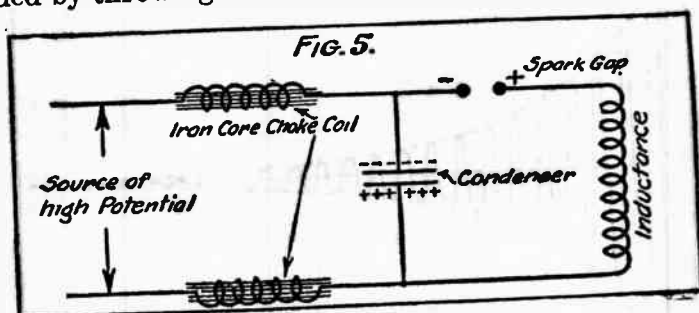

In order to have radio waves, the electrons must oscillate at the rate of 6,000 or more times a second. That is, to start a radio wave there must be an alternating current alternating at the rate of 6,000 or more times per second. Up until recent years, there was no generator built capable of producing alternations of so high a frequency. Only a very few such machines are in use to-day and those only at the very high-powered stations.

As has been shown, an inductance-capacity circuit will oscillate and it is in this way that the radio frequency oscillations are secured. In order to get such a circuit to oscillate, it is only necessary to furnish it electrical energy. This energy must be furnished, then the source of energy removed from the circuit, and the inductance

and capacity thrown in series in the circuit. This is done by the use of a spark gap.

In figure 5, the source of high potential is charging the condenser as shown in the diagram. The two terminals (electrodes) of the spark gap (they are usually metal plates) are also being charged as they are in electrical connection with the source of potential. As the charging goes on both the condenser and the electrodes of the spark gap rise to a higher and higher potential. When

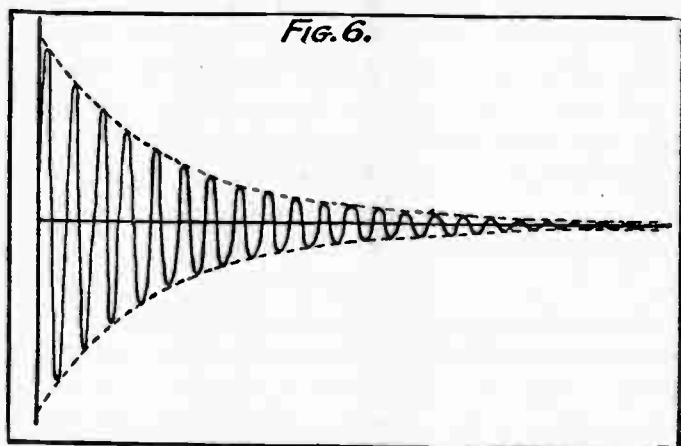

this potential reaches a certain high value it is strong enough to cause a spark to jump across the air gap of the spark gap. The instant this spark passes, the air gap changes its electrical character. Instead of being a very good insulator it becomes a fairly good conductor. The condenser and inductance therefore are thrown in series and oscillations take place in the circuit.

The oscillations are confined to the condenser-spark-gap-inductance circuit, as the iron-core choke coil prevents their passage through that circuit. The choke coil has a very high self-inductance, due to its iron core. The

current of an oscillation changes very rapidly. As this rapidly changing current attempts to enter the choke coil the inductance of the coil opposes the flow of the current. So great is this opposing force of inductance that it altogether chokes off the oscillation. In a great many sources of high potential the inductance of the instrument giving this high potential is so large that no choke coil is needed.

The oscillations that occur in the condenser-spark gap-inductance circuit are damped oscillations. That is, the oscillating current grows smaller with each oscillation. If we draw the hack-saw blade aside and then free it, the distance that it moves from the point of rest becomes smaller with each vibration until finally the blade ceases to move. This is because the moving blade loses energy in various ways. In exactly the same way the current of the oscillation dies away until there is no current, because the current loses energy. The way in which energy is lost will be shown later. The actual oscillations of the circuit are represented in figure 6. This represents a damped oscillation. As has been stated, a radio wave is exactly similar to the oscillations which produce it, therefore figure 6 also represents a damped radio wave. The amplitude of a damped wave becomes smaller with each succeeding wave.

SOURCES OF HIGH POTENTIAL.

The usual way of furnishing the high potential to the condenser in the spark-gap circuit is by the use of an induction coil, or a transformer supplied by an alternating current generator. An induction coil works on a direct current. Figure 7 shows a diagram of the induction coil. The vibrator makes and breaks the primary circuit, thus inducing a high voltage in the secondary which is wound

with many turns of fine wire. The vibrator contacts are adjustable by means of the set screw. The condenser across the vibrator contacts produces a higher voltage in the secondary than would be produced if it were not there. It also tends to prevent an arc forming at the vibrator when the circuit is broken there.

When an induction coil is used to charge a condenser in a spark-gap oscillating circuit, the condenser is charged to a potential high enough to break down the spark gap each time the vibrator breaks the electrical circuit. The

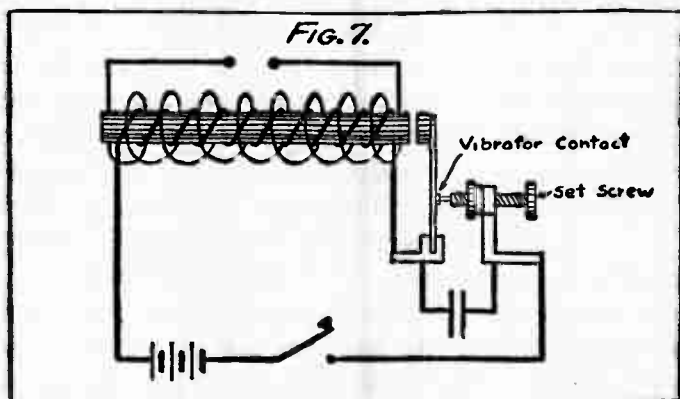

sudden stopping of the current in the primary produces a surge of high voltage in the secondary, thus charging the condenser. Figure 8 shows the relations of current and voltage in the primary and secondary.

To read such diagrams it must be remembered that two things are always shown on such a diagram, and that moving to the right means an increase in one thing and moving upward means an increase in the other thing. In this case (fig. 8) moving to the right means an increase in time and moving upward means an increase in current in the upper part of the diagram, which represents the

primary current, and an increase of voltage in the lower part of the diagram, which represents the secondary circuit.

A study of this figure shows that at the "make" the primary current gradually rises until it reaches a value great enough so that the electromagnet core pulls the vibrator from the contact, thus causing the break. Meanwhile the secondary voltage has risen to a maximum in the negative direction, and has fallen nearly to zero value.

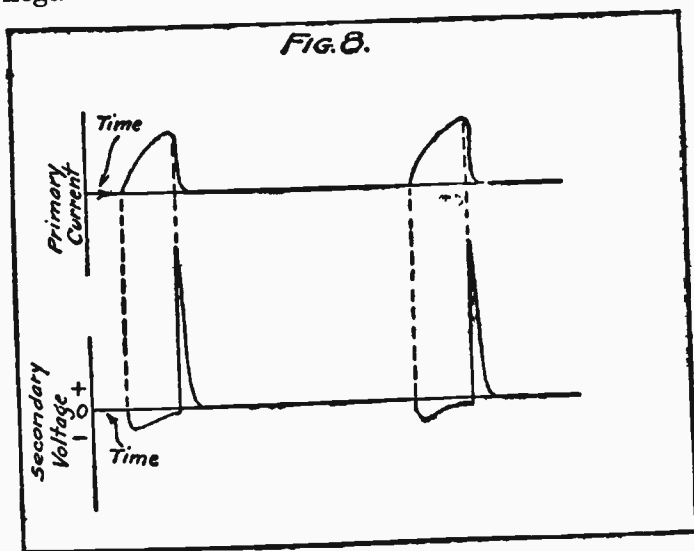

At the break the primary current falls suddenly to zero. This sudden change in the magnetic lines of force cutting the secondary produces a very high voltage in the secondary as shown in the figure. This voltage is the voltage that charges the oscillating circuit to a potential high enough to break down its spark gap. Figure 8 represents the action of an induction coil with no capacity shunted across the vibrator and a high noninductive resistance connected across the secondary circuit. The action with

a condenser across the vibrator, and with the secondary terminals connected to an oscillating spark-gap circuit, is more complex but similar in major details.

A type of induction coil known as the buzzer transformer is lately coming into use to charge the oscillating circuit from power derived from a low voltage direct current. Figure 9 shows a diagram of the connections of such a buzzer transformer.

The buzzer, B, is attached to an electromagnet, NSN', which is pivoted and free to move. The circuit from the

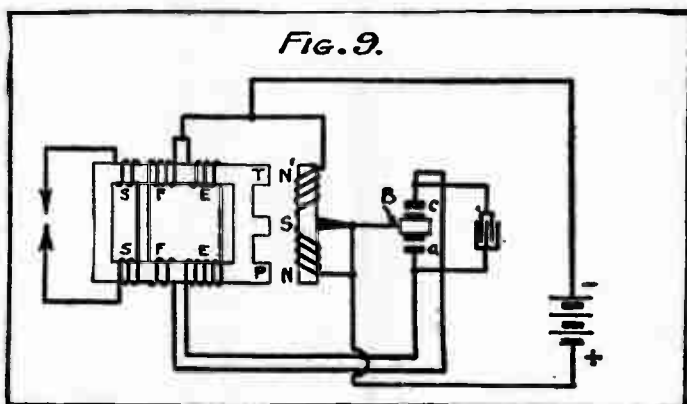

battery is divided, so that part of the current passes through the electromagnet, NSN', at all times, and a part of the current passes through the vibrator, B, and thence through either one of the two primary windings, EE or FF. The electromagnet, NSN', has the direction of its windings reversed at the middle point of the core, so that at each end of the magnet there is a north pole.

There are two primary windings, one being wound so as to produce magnetic effects opposite in direction to the other. Each primary winding is split in two parts, as is also the single secondary winding. The iron core

on which the primary and secondary windings are wound has three projections, as shown, one near each end of the electromagnet and one near its center. The secondary, as usual, has a large number of turns while the primaries have a comparatively few number of turns.

ACTION OF BUZZER TRANSFORMER.

The action of the apparatus is as follows: Consider the vibrator B to rest on contact *a*, thus completing that part of the circuit. The current then flows through *a*, through the primary winding EE and from there back to the battery. This flow of current in the primary establishes a magnetic field in the iron core on which it is wound. This magnetic field does two things: it passes through the secondary coil, thus inducing a high voltage in the secondary. It also has the effect of making the core projections P and T poles of a magnet, P being an effective north pole, and T, a south pole. Like poles repel and unlike attract, so that P pushes the N end of the electromagnet away from P and T pulls the N' end of the magnet toward T. The magnet, being pivoted, turns and carries with it the vibrator, B, which thus breaks the circuit at *a* and makes the circuit at *c*. When the circuit is made at *c*, the current flows through the other primary winding, FF, which it must be remembered is wound opposite in direction to EE.

The magnetic field established by this current is opposite in direction to the one established by the first primary winding and therefore the high voltage induced in the secondary is *opposite* in direction to the first induced voltage. It is of *equal intensity* because the electrical characteristics of the two primary coils are the same. The magnetic field makes T an effective north pole and P an effective south pole, thus turning the

magnet so that it pulls the vibrator B away from the contact *c* and makes the contact at *a*. It is to be remembered that the part of the current flowing through the electromagnet, NSN', is a steady uninterrupted current. The condenser is connected across the vibrator to increase the efficiency of the apparatus and to reduce sparking or arcing at the break.

ADVANTAGES OF A BUZZER TRANSFORMER.

The buzzer transformer has many advantages over the induction coil. It is more than twice as efficient. It is capable of making and breaking each primary circuit 500 times per second. The movement of the vibrator can be made to be exactly regular so that the high voltage in the secondary is induced at regular intervals of time. Also the induced voltage rises to the same values, both positive and negative.

The alternating current generators used to charge the condenser in an oscillating circuit system are built to give a higher number of alternations per second than the alternators used on power lines. The frequency (complete cycles consisting of a rise to a maximum of voltage in one direction, a gradual fall to zero voltage, and then a rise to a maximum voltage in the opposite direction, followed by a fall to zero voltage) of the former is most commonly 500 per second, while that of the latter is usually 60 per second.

A special machine for the purpose is the inductor type alternator. In figure 10, *ab* and *cd* are iron forms. *W* is a disk, which has been cut away at the edges to leave the iron projection *p*. The distance between *b* and *p* and *p* and *c* is only a fraction of an inch. The disk *W* revolves so that the space between *b* and *c* is alternately filled with a projection, *p*, and a slot *s*. A direct current passes

through the coil wound on ab . This direct current sets up a magnetic field whose complete circuit is b, p, c, d, p, a, b . Thus it cuts through the coil Y wound on cd . As the wheel revolves, the magnetic circuit is changed as the projections, p , and the slots, s , come between b and c . The projections, p , being iron, allow a strong magnetic flux (field) to pass, the slots, s , being air or a nonmagnetic metal, permit only a weak magnetic flux to pass. This change in the magnetic flux passing through the coil Y induces in it an alternating current.

The advantage of this type of machine lies in the fact that the revolving part can be made of solid metal so that

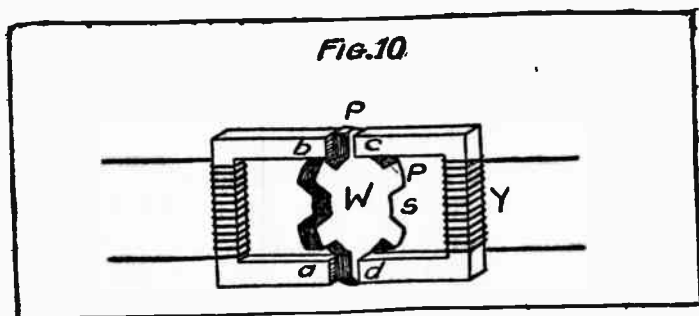

it can be turned at a high rate of speed without danger of flying apart. By use of this style of generator, Alexanderson has produced a machine which gives a frequency of 100,000 cycles per second. There are 300 slots in the inductor (wheel, W) which turns at a speed of 20,000 revolutions per minute. The particular use of the Alexanderson alternator will be shown later. Although the Alexanderson alternator is not used to charge a condenser in a spark gap oscillating circuit, an inductor-type alternator giving a moderate frequency (around 500 per second) is often used.

It has been shown so far what a wave is and the various terms used in describing waves; that a wave takes its characteristics from its source; that a radio wave is a wave in ether traveling with a velocity of 300,000,000 meters per second; that radio waves are produced by rapid to-and-fro movements of electrons (high frequency oscillations of current); that these oscillations will be produced in an electrical circuit containing inductance and capacity; that the frequency of the oscillations in the circuit, and hence the frequency of the resulting wave, can be varied by varying either the inductance or capacity (or both) in a circuit; that a change in frequency of a radio wave makes a corresponding change in wave length so that the wave length is varied by varying either the inductance or capacity (or both) in the radiating circuit.

It has also been shown that in order to add effective electrical energy to a capacity inductance circuit, it is necessary to open the circuit while the condenser (capacity) is being charged and then to close it; that this opening and closing of the circuit is done automatically by means of the spark-gap. Various instruments used in charging the condenser have also been described.

THE ANTENNA.

A high frequency oscillating current in a circuit will radiate waves, but it has been discovered that some forms of circuit will radiate much better than other forms. An air-cooled gas engine, such as on a motor cycle, has a specially formed cylinder so that it will radiate heat well; the radiator of a water-cooled-engine automobile has a special form so that it will radiate heat well. In the same way specially formed circuits are made to radiate the electric waves. They are of various types, but are all called antenna. The antenna then of a trans-

mitting station is that part specially built to radiate the waves.

An antenna usually consists of a ground connection and one or more wires elevated above the ground and insulated. The usual forms are the inverted L, the T, the V, and the umbrella, each of these terms being descriptive of the method of arranging the wires in the antenna. As it has been found that the wire arranged as antenna has capacity, another condenser in the antenna circuit is not a necessity. The antenna wire has inductance also,

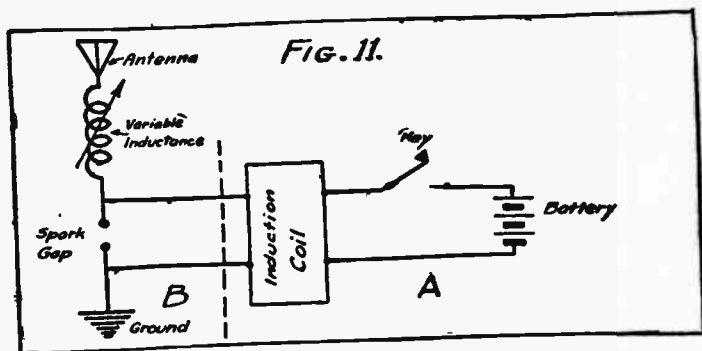

but it is usual to add variable inductance in the form of a coil so as to be able to control the wave length.

Lately there is coming into use antenna in the form of loops which are from 1 to 2 meters across their diagonal. Another form of antenna is a cylindrical coil of large dimension compared to the coils used in other parts of a radio set. Both the coils and the loops are less effective than the common form of antenna, and must be specially designed to give even fair radiation.

It has been found that some forms of antenna radiate more energy in one direction than in another. This is similar to the fact that when a man uses a megaphone more sound energy is radiated in the direction in which

the megaphone points than in any other direction. In the inverted L antenna more energy is radiated in the direction along which the horizontal wire or wires extend and toward the lead-in wire in that direction than in any other direction. In the V antenna more energy is radiated in the direction in which the V points than in any other direction. In the T antenna most energy is radiated in both directions along the line of the horizontal wires. In the loop most energy is radiated in both directions along the plane of the loop.

It is well to think of the wires in the antenna (except in the loop and coil types) as one plate of a condenser. The other plate is the earth. Thus it is just as necessary to have the antenna wires *well insulated* as it is to have condenser plates well insulated.

A SIMPLE TRANSMITTING SYSTEM.

A transmitting system is shown in figure 11. The symbols used are standard. This is the simplest type of a transmitting equipment. The broken line divides the apparatus into two parts. Part A is the apparatus necessary to charge and control the charging of the condenser in the spark-gap circuit. Part B is the radio frequency circuit. The arrow through the inductance denotes that the inductance can be varied in value. It is to be remembered that the antenna furnishes the capacity in the spark-gap circuit.

A study of the action of this apparatus will clarify ideas up to this point. Figure 8 depicts what happens in an induction coil when it is in action. It is to be remembered that the high peaks of voltage in the secondary occur each time the vibrator breaks the circuit, which is usually about 400 times per second. As the secondary voltage of the induction coil mounts higher and higher,

it charges the antenna circuit to a higher and higher potential. The potential finally becomes high enough to break down the spark-gap which allows the inductance-capacity circuit of the antenna to oscillate. This oscillation takes place as shown in the lower part of the dia-

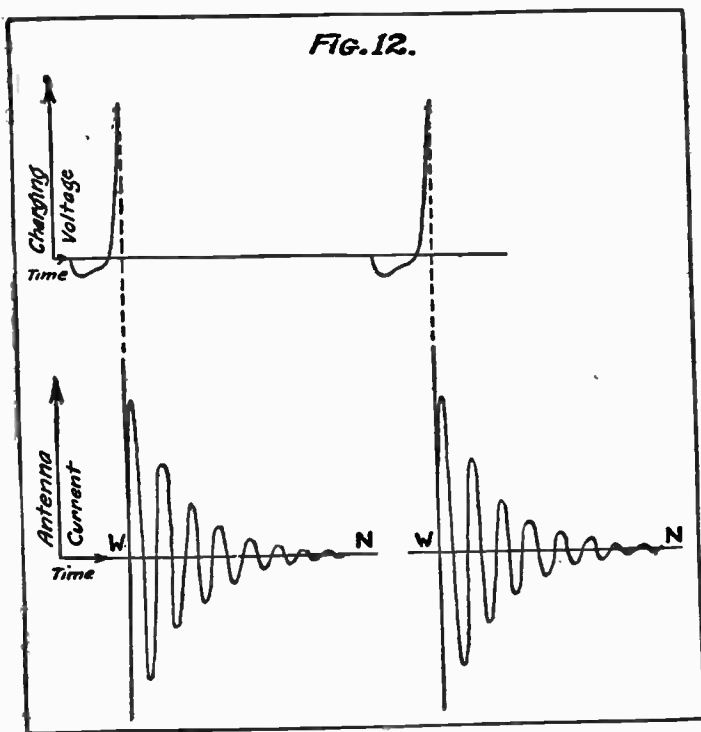

gram. Notice that the oscillations and hence the waves are highly damped.

The unbroken series of waves W-n is called a *wave train*. Immediately after the last wave of the wave train passes the spark-gap regains its nonconductive property, and hence when the next surge of high voltage from the charging apparatus begins to charge the spark-gap cir-

cuit it must raise it to the same high voltage necessary in the first case to break down the gap. Events repeat themselves as long as the key is pressed down.

Thus it is seen that when the key is pressed in part A, figure 11, there are 400 wave trains per second radiated from the antenna. If the buzzer contacts were changed so as to make the vibrator move 700 times per second, there would be 700 wave trains per second. This applies to any rate of vibrations. The number of wave trains per second is the same as the number of vibrations.

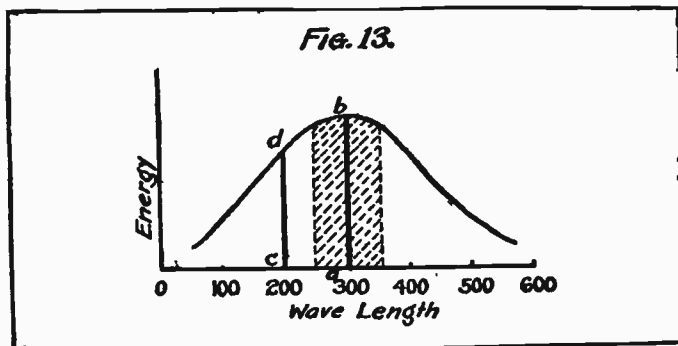

If an alternating-current generator were used as the source of power (used in A, fig. 11), the number of wave trains would be twice the frequency of the alternations, for the spark-gap would break down at the highest positive voltage and again at the highest negative voltage—that is, twice in one cycle. (NOTE.—Using an alternator it is possible to arrange circuits so that the breakdown does not occur is indicated above; hence that statement is not *always* true.)

In figure 12 the time scale used in the upper part of the diagram is vastly different than that used in the lower part. This has to be done or otherwise the whole train of waves would be represented by a figure no larger than

a pencil dot. Figure 12 does not show the action in the charging voltage after the spark gap has broken down.

A radiating circuit arranged as shown in figure 11 radiates a great amount of energy, but it radiates a broad wave. This statement means that the radiant energy is not carried by a single wave length, but is carried by a broad band of wave lengths. Figure 13 shows this graphically.

The wave length 300 carries the most energy which is

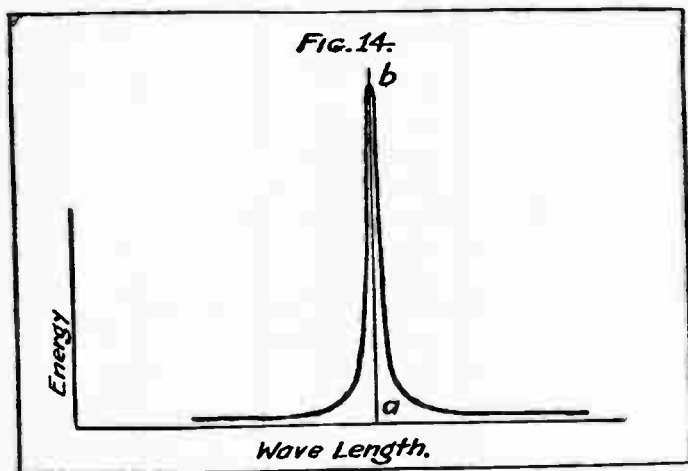

represented by the length of the line *ab*; but in addition to that wave, there is a continuous band of waves having all possible wave lengths near the wave length of 300. Thus the wave whose length is 200 is radiated with an energy represented by the length of the line *cd*. Now, as only the energy represented by a very narrow band of wave lengths (shaded area around *ab*) can be received, all the other energy is wasted.

For this reason and for another which will be taken up later it is very desirable to radiate all the energy at a

single wave length. No way has as yet been found to do this, but a method has been found to radiate waves so that a great part of the energy is at a single wave length and the rest of the energy is radiated in wave lengths very close to the main wave length. The curved line in figure 14 shows the practical result that can be obtained.

The straight line shows the ideal kind of wave. Of course, if all the energy were put into this single wave, it would contain a very large amount of energy. To represent this, the straight line would have to be drawn longer.

The production of an impure wave (the broad band of wave length is sometimes spoken of as an impure wave) is not uncommon. A person gets a cold and becomes hoarse. His voice sounds hoarse because his vocal cords produce an impure wave. A man who is not a musician blows a cornet and produces a disagreeable sound. He has produced an impure wave. Training and practice will enable him to produce a pure wave. Allow a bell to fall, it make a noise, that is, it gives forth an impure sound wave. Strike the bell with a clapper and it gives forth a clear musical sound—a pure wave.

CHAPTER XXV.

A Typical Spark Transmitting Circuit—Spark Gaps—Oscillation Transformers and Coupling—Tuning of a Circuit—Damping.

To produce a nearly pure wave, it has been found necessary to add another circuit in a radio transmitter to the one shown in figure 11 in the preceding chapter. This is shown in figure 15, which is a typical diagram of a transmitter. It shows three distinct circuits which have been divided by broken lines in the diagram. Circuit A

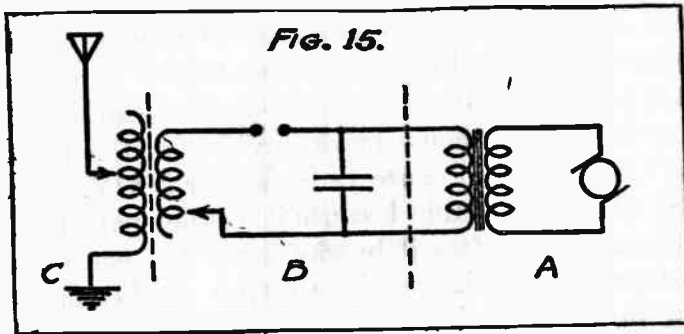

is the power circuit. Circuit B is the spark-gap circuit. Circuit C is the radiating circuit.

Note that the inductance in both circuits B and C is variable as shown by the method of having an arrow point on the wire leading to it. This method of showing variable inductance, and also variable resistance is frequently used.

Circuit C is coupled to circuit B by means of the inductance in circuit C, which is shown opposite to the inductance in circuit B. These two inductances together

form an oscillation transformer. The name is given because it transfers oscillations from one circuit to another. In an oscillation transformer the *oscillations* in one circuit are transferred to the other circuit. There may or may not be a change in voltage. Thus, in circuit C there is induced, by means of the oscillation transformer, oscillations of the same frequency that occur in B.

A study of the action of the circuits in figure 15 shows more clearly the function of each. A *special* spark-gap is supposed to be used in circuit B. Circuit A furnishes the power to circuit B, which acts as a trigger circuit. It stores up the energy until the spark gap breaks down and this breaking down allows the oscillations to occur. These oscillations are transferred to circuit C where they are radiated. Figure 16 shows this.

It is to be noted that the radiated wave train shown in figure 15 contains many more waves than the radiated wave train shown in figure 12 in chapter XXIV. Circuit C has a long wave train because it has no spark gap. A spark gap, even after it breaks down, has considerable resistance, and resistance in a circuit quickly dampens out a wave, thus giving only a few waves to a wave train.

SPARK GAPS.

Figure 16 shows the action in the circuits when a special spark gap is used. If there were not a special spark gap the oscillation transformer would be in action all the time, and having transferred the oscillations from circuit B to circuit C, would retransfer them back to circuit B and thus reduce the energy in circuit C. This transfer and retransfer would take place several times before the waves died out. If this happens, of course a great deal of

the energy is wasted in the spark-gap circuit instead of being radiated from the antenna circuit.

There are two types of spark gaps in common use which prevent this retransfer of energy. Eenergy can not get back in the B circuit if that circuit is broken immediately after it has transferred its energy to the antenna circuit. In other words, no oscillations can be set up in a broken circuit. Both types of spark gap work on this principle.

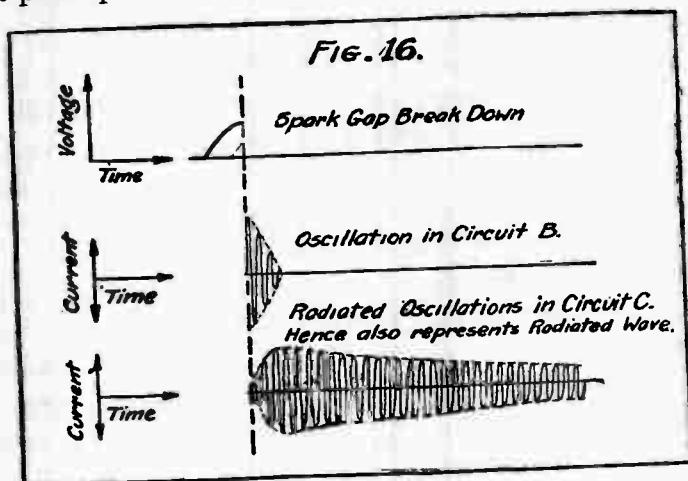

One type does this by electrical action. Instead of only one gap, there are a number of gaps placed in series. The electrodes of the gap are broad pieces of metal accurately ground to a smooth, even surface. There is a groove around each plate, and the plates are separated by the mica rings. Figure 17-A shows this type of gap. The flange assists to keep the plates cool. Sometimes a fan is used also for this purpose. This arrangement is called a quenched spark gap, and it has the property of recovering its nonconductance in a very short time, that is, after only a few oscillations have passed.

The other type is the rotating spark gap. Figure 17-B shows the principle of such a spark gap. There is a rotating metal wheel carrying the metal projections *a*. As the projections approach the ends *b* of the circuit, they get near enough for the spark to pass. The rotation of the wheel carries the projections past *b* and gradually make the gap longer, so that it soon becomes too long to carry the oscillations. Thus only a few oscillations are permitted to pass. If the wheel is made to rotate at such a speed that *a* approaches *b* each time the secondary of the changing circuit (A, fig. 15) reaches its high voltage,

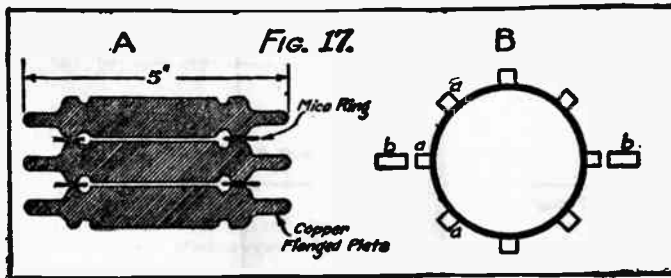

the gap is said to be synchronized. If no provision is made to obtain this, the gap is called a nonsynchronous gap.

In practical operation the appearance and sound of the spark gap when the spark is passing tells much about the operation of the set. Spark gaps are usually adjustable. The spark should occur regularly (told by the sound) and should give bluish-white stringy sparks. A yellowish color indicates an arc instead of a spark. If an arc is established in the gap, the efficiency of a set is much reduced. A set works best when the longest gap giving regular sparking is used.

As has been noted, an oscillation transformer transfers by electromagnetic induction oscillations from one circuit

to another. Whether or not there is a change in voltage of these oscillations depends upon the capacity, inductance, and resistance of each circuit. There are various types of transformers in use. However, they have the same general characteristics, that is, an induction in one circuit always acts upon an inductance of the other circuit. Figure 18 shows some of the types in use. A represents two coils of wire, one larger than the other, and both mounted on the same axis, along which one is mov-

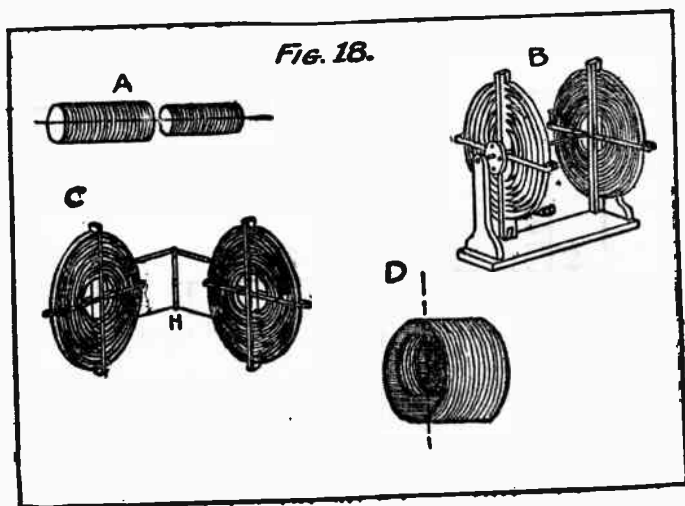

able. The smaller one can be slid into the larger one. It is commonly termed a loose coupler. B shows a flat, spiral type whose coils can be made to approach each other. C shows an arrangement for mounting the flat spirals and moving them on a hinge at H. D shows two coils, the small one mounted inside the other. The inside one can be rotated around an axis, so that it can be made to be at any angle with the outside one.

When one circuit acts in any way upon another circuit, the two circuits are said to be coupled. In figure 15 cir-

cuits B and C are coupled. An oscillation transformer always couples two circuits together. Another method of coupling circuits is shown in figure 19. An arrangement such as this is called an autotransformer. Other methods of coupling are used in receiving circuits and will be discussed later.

It is to be noted that each type of transformer shown above contains a variable factor. This variable factor is for the purpose of varying the degree of coupling. If one circuit acts with considerable force upon another circuit, the coupling is said to be *close* or *tight*. If one circuit acts

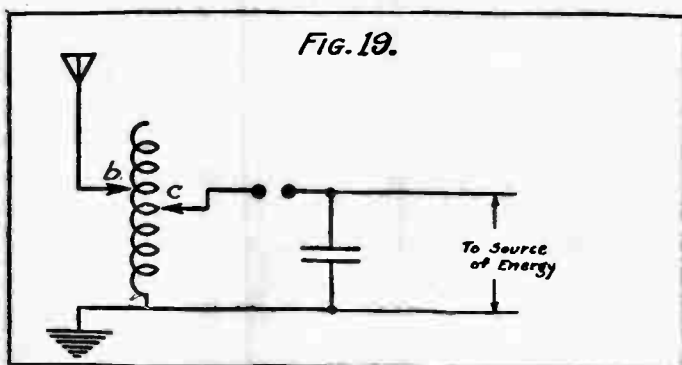

with very little force upon the other circuit, the coupling is said to be *loose*. All degrees of coupling between close and loose are possible.

The following example will illustrate more fully how various degrees of coupling are possible. Suppose it was desired to swing an occupied hammock. This could be done by attaching a cord to the hammock and pulling the cord at the proper time. The cord acting upon the hammock acts with considerable force—it represents a tight coupling. Instead of using a cord, replace it with a light elastic band. Pulling upon the elastic band at the

proper time will cause the hammock to swing, but it will take many more pulls than with the cord, for the force acting upon the hammock at each pull is very small. This represents a loose coupling.

In the oscillation transformer the degree of coupling is varied by moving the inductances with respect to each other. Coupling is the tightest when the coils are parallel and as close together as possible. If the coils are moved farther apart, or if they are moved at an angle with each other, the coupling is made looser. The loosest coupling is obtained when the coils are at right angles, or when the coils are as far apart as the design allows. In the autotransformer the coupling is varied by varying the position of the contacts *b* and *c* (fig. 19). The fewer coils between these points, the looser the coupling.

A change in the amount of inductance in either part of the coupling transformer varies the degree of coupling, as does also a change in the rapidity with which the oscillations of either circuit are damped. But these factors are not taken into account, because the latter is a part of the design of the apparatus and the former, if changed at all, is done for the purpose of tuning, and not for the purpose of varying the degree of coupling.

TUNING OF CIRCUIT—RESONANCE.

It has been shown that the frequency of oscillations occurring in a circuit depends upon the values of the capacity and inductance of the circuit. A change in either or both will change the frequency of oscillations. The frequency referred to is the natural frequency of the circuit. It is possible to produce oscillations in a circuit with a frequency other than the natural frequency, but these are forced oscillations, the force coming from without the circuit. In the same way a suspended ball has a natural

frequency of swing, but it is possible to cause it to swing at another frequency by an outside force—moving it back and forth with the hand, for example.

To change the natural frequency of a circuit it is necessary to change either the capacity or inductance, or both. When this change is being made in a circuit to make its frequency agree with that of another circuit, it is called *tuning* the circuit. If one circuit is tuned to another, resonance exists between them. Resonance, then, exists between two circuits if their natural fre-

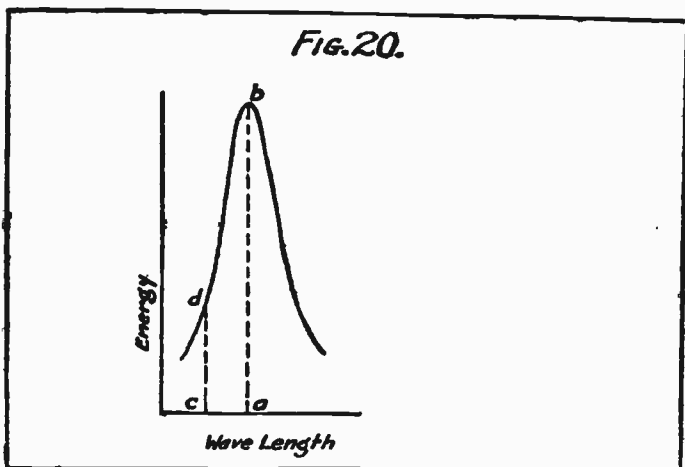

quencies are the same. This condition of resonance must exist between circuits coupled together in any way if there is to be an efficient transfer of energy.

The fool who rocked the boat understood the principle of resonance. He found that by swaying his body from side to side at a certain frequency he could set the boat rocking through a wide arc. In other words, he made the frequency of his swaying equal to the natural frequency at which the boat rolled and thus secured a large effect. In the same way, in making a child's swing move, if it is

pushed at the proper time it can be made to swing very high, but only by properly *timed* pushes. Being properly timed (in resonance) each push adds its energy to the energy already in the swing. Another example is in practicing with the punching bag. If each blow is timed the bag is kept moving in a regular way. Get out of time (out of resonance) and the bag will move irregularly.

So in circuits that are coupled together. If they are not in resonance the effect of one on the other is very little. If the circuits are in resonance very much energy is transferred from one to the other. So that, when circuits are coupled it is necessary to have them tuned to each other in order to transfer energy from one to the other.

A study of figure 20 shows clearly how the energy will vary in a circuit as it approaches resonance. The curve shows the energy in the secondary circuit as its LC value (induction capacity value) was being changed. At *a*, it had the same LC value as the primary circuit, therefore was tuned to that circuit. The energy transferred to the circuit is the greatest at that point. It is represented by the length of the line *ab*. At *c* the circuit was slightly out of resonance (tuning not exact) and the amount of energy it received is represented by the length of the line *cd*. The circuits used in obtaining the data for this curve were loosely coupled.

DAMPING—EFFECTIVE RESISTANCE.

An oscillating current once started in a circuit would continue oscillating indefinitely if it did not lose energy. But a loss of energy always takes place and hence the oscillations die away—it is a damped oscillation and gives rise to a damped wave. The measurement of this damping is called the decrement of the wave. Thus a

wave having a decrement of 0.2 dies away much more quickly than a wave having a decrement of only 0.01.

The losses in the antenna circuit are due to the ohmic resistance of the wires; to the fact that currents are induced in the earth near the antenna and in neighboring circuits; to the leakage of the charges of electricity, and to the energy expended in radiating the waves. The latter is of course desirable, as it is the purpose for which the antenna is constructed. All the other losses mean wasted energy, so it is desirable to make these losses as small as possible.

SET RADIO STATION AWAY FROM TREES.

The loss by induced currents in neighboring circuits should be taken care of in the design of a transmitting set. The use of a quenched spark reduces this loss as the quenching effect quickly breaks the primary circuit. Presence of trees and other objects may make a circuit which will absorb energy by having induced currents established in them. Aside from this, trees absorb energy from the radiated wave so that it is well not to set up a radio station near a tree or trees.

A certain amount of electricity will leak off the wires. This can be cut down by having no sharp ends and by taking great care to have proper insulation. A frequent source of such leakage in portable sets is in the wires themselves, where they become frayed and the loose ends of strands project.

The ohmic resistance is the resistance of the wire itself which gives rise to heat. It is oftentimes called the Joulean resistance—Joulean referring to heat. It has been found that when oscillations at radio frequency are flowing in a circuit, the ohmic resistance is much greater than when a direct current flows in the same wire. An increase

in frequency of the oscillations gives an increased resistance. The explanation of this increased resistance lies in the fact that the self-induction of the high frequency currents allows a current to flow only on the surface of the wire. This is, in effect, the same as reducing the cross section of the wire, thus increasing the resistance. For this reason a wire used in a radio circuit should have a large surface. Wire made up of small strands gives a large surface without materially increasing the diameter of the wire. Stranded wire is, therefore, generally used.

It must not be overlooked that the ground is a part of the antenna system. Therefore the ground resistance is a part of the antenna resistance. Thus great care must be taken to keep the ground resistance as low as possible. This is done by driving into the ground a number of metal stakes and connecting them together; by burying metal mats; and by the use of a counterpoise. A counterpoise of an antenna consists of a number of conductors stretched under the wires forming the antenna, and insulated from the ground. This is used instead of the ground. In an airplane, the metal parts of the plane are connected electrically and form a counterpoise. In a ship, the metal plates of the ship form the counterpoise. In some cases in land station, no precaution is taken to insulate the counterpoise wires from the ground.

RECEPTION OF DAMPED WAVES.

It has been shown that radio waves consist of ether waves having electrostatic and electromagnetic lines of force. A method of producing damped waves of this character has been described. These waves travel through space and are detected by means of special apparatus. Much of this special apparatus is similar to that used in the transmitting station as will be noted. The ac-

tion that takes place at a receiving station may be briefly summed up as follows: The received waves set up an oscillating current in the receiving circuit that has the same frequency as that from which the wave started. These oscillations are changed in character so that they will actuate a telephone receiver, thus making an audible signal.

In the circuit which receives the waves is the antenna. It is exactly like the antenna used in the transmitting station, and in most stations the antenna that is used for transmission is used also for reception. Considering only the electromagnetic lines of force in the wave, the oscilla-

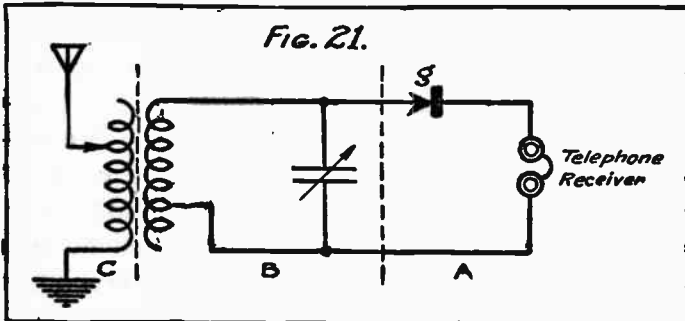

tion induced in the receiving antenna is caused by electromagnetic induction. This is the same phenomena that occurs in the induction coil, the transformer, and various other instruments.

Considering the electrostatic lines of force, it must be remembered that these lines are the result of potential and that they will induce a potential on any conductor which they sweep. They sweep the antenna and thus induce a potential on it. As the intensity of the impinging electrostatic lines of force varies and changes in direction, the resulting potential varies and changes in direction; that is, it is oscillating and has the same frequency as the

impinging wave. The electromagnetic and electrostatic lines of force are inseparable in a wave and it is their combined effect which produces the oscillation in the receiving antenna.

A simple type of receiving circuit is shown in figure 21. Note that circuit C is the same as circuit C in the transmitting circuit. (See fig. 15.) That circuit B is also the same except that it contains no spark gap. Circuit A is the circuit distinctive of the receiving apparatus.

OPERATION OF TELEPHONE RECEIVERS.

A telephone receiver transforms alternating currents or pulsating direct currents into sound. It does this by means of a small electromagnet placed in rear of a thin round piece of iron, called the diaphragm, which is held around its edge. As each pulse of current (or each alternation in an alternating current) passes through the electromagnet the electromagnet pulls the center of the diaphragm inward. As the pulse of current passes the stiffness of the diaphragm causes the diaphragm to spring back. Another pulse of current again pulls the diaphragm inward, and so on. Thus the diaphragm vibrates with a frequency equal to the frequency of the pulses of current. This vibration of the diaphragm causes the air to vibrate, thus giving rise to sound. These vibrations must have a frequency within the limits 30-3,000 per second in order to be plainly heard. Thus frequencies within these limits are called *audio* frequencies.

A telephone receiver cannot be inserted directly in a radio-frequency oscillating circuit for the reception of signals. The reason for this is that the diaphragm of the receiver is not capable of vibrating with the rapidity of a radio-frequency oscillation which it has previously been stated must equal 6,000. Even if it were capable of this

high rate of vibration, the human ear would not respond to such a high frequency. Thus some method of changing the oscillations is necessary. This is done by means of a detector.

It has been discovered that certain materials—galena crystal, for example—have a peculiar electrical property. They allow the passage of a current of electricity through them in one direction, and will not allow a current to pass

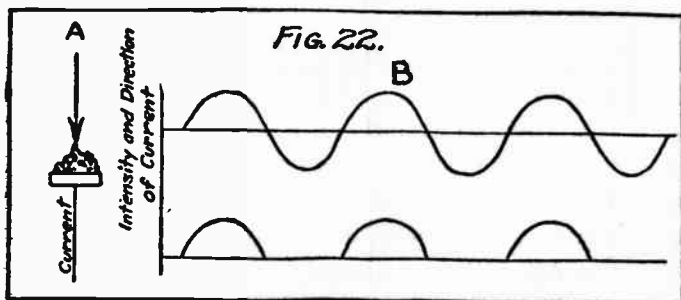

in the opposite direction. Thus in figure 22-A the detector will allow a current to pass downward through it as shown by the arrow but will not allow a current to pass upward through it. If a detector is put in a circuit having alternating current of the usual form (upper part of B, fig. 22) the resulting current passing through the circuit would be as shown in the lower part of B (fig. 22). This is because that part of the current which would usually flow in the direction represented below the line is not allowed to flow because of the action of the detector. Thus in figure 21 the impinging waves set up oscillations in circuit C. These oscillations are transferred to the circuit B, which contains inductance and capacity, and will therefore oscillate when tuned to circuit C. Therefore at *g*, in circuit A, there is an alternating voltage as that point is directly connected with circuit B. This al-

ternating voltage agrees in frequency with the frequency of oscillations in circuit B, since it is produced by these oscillations. As has been noted in the above paragraph, the detector allows the passage of a current in only one direction and hence only the voltage in this direction is effective. The result is that there is a pulsating direct

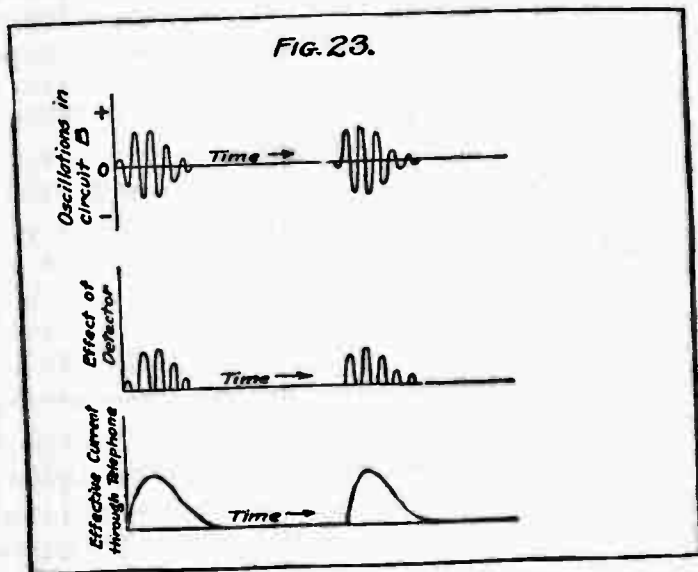

current flowing in circuit C. The pulsations occur at the radio frequency of the oscillation in circuit B.

A study of figure 23 will aid in understanding the action of the receiver. The upper curve represents the oscillations that occur in circuit B and, as has been stated, the voltages that present themselves at point *g* in circuit A. Because of the action of the detector, one-half of the oscillations are cut out so that there remains a pulsating direct current as shown in the middle curve. The telephone has a very high inductance. This inductance and the inertia of the telephone receiver causes this pulsating di-

rect current to act as a single surge of current as shown in the lower curve. Each surge of current pulls the telephone diaphragm inward. Figure 23 shows only two surges of current, but in a dot of the Morse code there are from 30 to 50 surges, thus causing the diaphragm to vibrate from 30 to 50 times. This produces a sound.

It is to be particularly noted that it takes a *complete* wave train to give *one* vibration of the telephone diaphragm. For example, for a certain moderate damping, there are 40 effective waves in the wave train. These 40 waves establish one surge of current through the telephone receiver. Thus the radio frequency waves give rise to audio-frequency pulses of current.

A small condenser is sometimes shunted across the telephone receiver. This condenser is charged with every pulse of the high frequency current shown in the middle curve of figure 23. It discharges through the telephone receivers in the interval between pulses. This has been found to increase the effect upon the diaphragm of the telephone receiver. However, such a condenser is not a necessary part of the receiving apparatus and is sometimes omitted with special kinds of telephone receivers.

CHAPTER XXVI

Other Methods of Coupling—Why Tuned Circuits Are
Necessary.—Resistance—Interference.

IN addition to the methods of coupling described with relation to transmitting circuits, in the last chapter there is also another type sometimes used in receiving circuits. This is called electrostatic coupling, as it depends upon the linking of electrostatic lines of force in two circuits to transfer the oscillations instead of the linking of electromagnetic lines of force. In electrostatic coupling, one set of plates of a condenser is in one circuit

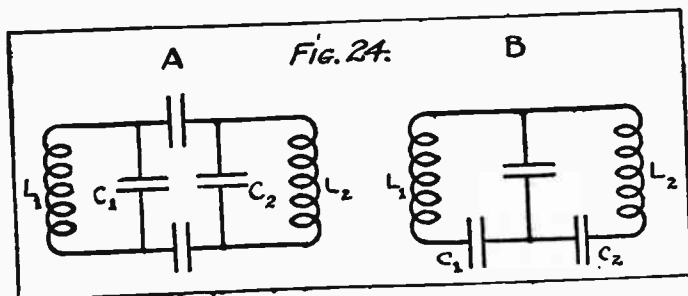

and the other set of plates of the same condenser is in the other circuit. Figure 24 shows two methods of electrostatic coupling. The inductance and capacity of each circuit is marked; the unmarked condensers are the condensers used in coupling the circuit. There are various other methods besides those shown. Electrostatic coupling takes the place of an oscillation transformer. Such an arrangement of circuits may be called an electrostatic transformer.

A radio wave is started by the transmitting apparatus. This transmitting apparatus has two distinct radio circuits—B and C as given in figure 15. Both must be tuned to the same wave length (frequency) to give the best results. The radio wave travels through space and induces an oscillation in any antenna which is tuned to that wave length—that is, the receiving antenna must have its inductance and capacity adjusted so that its natural frequency of oscillations is equal to the frequency of the wave which it receives. The oscillations in the receiving antenna are then transferred by some form of coupling to another oscillating circuit, which in turn must be tuned

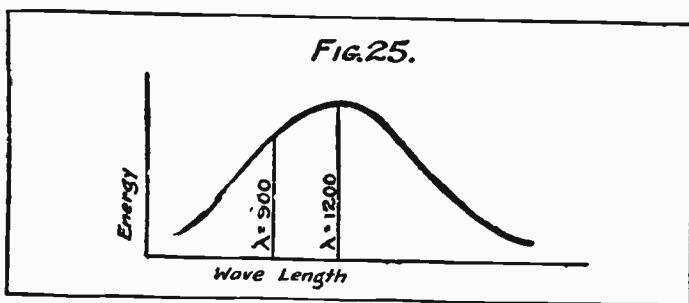

to the antenna receiving circuit. The detector and telephones are shunted on this second circuit.

Thus the total number of tuned circuits in the transmitting and receiving instruments is four. The desirability of two circuits in the transmitter has already been partly explained. Additional reasons for these two circuits and for two receiving circuits are shown in the discussion below.

It has been stated that a circuit containing a spark gap radiates a broad wave. The broad wave contains a great deal of energy, much of which is useless, inasmuch as it cannot be utilized by the receiving station. Hence stations are designed to transmit as sharp a wave as possi-

ble. Another very important reason for designing stations to transmit a sharp wave is to prevent interference between stations. This is very important, as the number of radio stations is constantly increasing. The sharper the wave radiated the less interference it gives to stations not desiring to receive this wave.

SHARP WAVES IN TRANSMITTING.

This is illustrated in figure 25. A station is radiating a broad way of the shape shown. The most energy is contained in a wave whose length is 1,200. Figure 25 also represents the distribution in wave lengths of the energy of the wave. This energy reaches the receiving station of this set. But it also reaches and affects all other receiving stations. Suppose, now, that two entirely distinct stations were trying to work on a wave length of 900 meters, at the same time the 1,200-meter station was transmitting. They could not do it, because the station working on 1,200 is also radiating at 900. Hence the receiving station for the 900 is picking up energy from both sending stations. Of course the result is a jumble of dots and dashes in the receiver with no meaning to them. That is, the receiving station is hearing the dots and dashes of the two transmitting stations and cannot distinguish between them.

This condition would apply not only to the 900-meter station but to all stations trying to work with a wave length anywhere near 1,200 meters. Thus it is desirable to transmit the very sharp wave shown in figure 14, Chapter XXIV. This is a sharp wave and carries most of its energy at wave lengths very close to the peak wave length represented by the vertical line—1,200 in this case. With such a wave it is possible for stations to work without interference on wave lengths very close together. In

practice the wave lengths must be separated at least by a 5 per cent. difference. That is, two stations, one at 1,200 meters and one at 1,120 could work without interference, but it would be impossible for two stations, one at 1,200 meters—the other at 1,195 meters to work without interference. The narrower the curve (fig. 14) the nearer together in wave lengths can stations work without interference.

AVOIDING INTERFERENCE.

The main reason that two circuits are placed in the receiving station (as shown in circuit C and B, fig. 21) is to avoid interference. Each circuit makes a selection of wave-length energy from the received waves and thus the final energy is nearly all of one wave length. A comparison of this action would be as follows: It is desired to pick the best drilled squads from a company. One inspector watches the company drill and eliminates certain squads. The remainder of the squads appear before a second inspector. This inspector eliminates certain squads and hence the retained squads are the best drilled squads as a result of this double selection. So in the receiving station each circuit eliminates the energy of certain wave lengths and the result is that only the energy of a very narrow band of wave lengths arrives at the detector.

The curves shown in figure 26, in addition to the curves of previous figures, will give a more comprehensive view of the whole subject of interference, resonance, and coupling. The three curves shown in figure 26-A show the variation of the energy received at different wave lengths with a variation in coupling. Thus the lengths of the lines *ab*, *a'b'*, and *a''b''* represent the energy received at the wave lengths 1,120, 1,200, and 1,280, respectively, when the

coupling is correct. The length of the lines ac , $a'c'$, and $a''c''$ represents the energy received at the same wave length when the coupling is too close. The double hump curve marked "Coupling too close" would be obtained with close coupling in any receiving set. Note that there are two frequencies (wave lengths) that receive a large

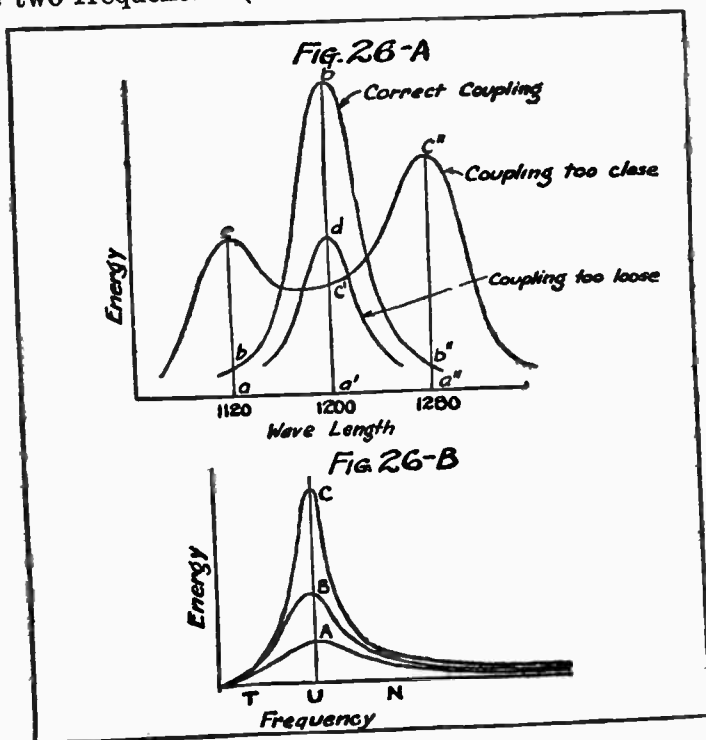

amount of energy. The explanation of this lies in the fact that an oscillating circuit coupled to another oscillating circuit is affected by the circuit to which it is coupled. It has two frequencies at which it will oscillate well. One of these frequencies is slightly higher and the other slightly lower than its natural frequency when oscillating alone. The closer the coupling the farther apart are these two

frequencies of oscillation. These circuits are tuned to each other; that is, the inductance-capacity value of one is equal to the inductance-capacity value of the other.

As is shown in the figure, the result of this double oscillation is to give the circuit a wide band of wave lengths from which it will absorb energy. This band can be narrowed by making the coupling just right. The result is shown in the curve marked "Correct coupling." Care must be taken not to make the coupling too loose or the full energy will not be transferred from one circuit to the other. This is shown in the curve marked "Coupling too loose."

Figure 26-B shows the resulting energy absorbed by a circuit as it was tuned to another circuit to which it was coupled. At T it was out of tune—at U it was tuned—at N it was out of tune. The closer to U, the nearer tuned it was. Thus any of the three curves shows that the greatest energy was absorbed when the circuit was in tune with the circuit from which it received its energy.

RESISTANCE HINDERS SHARP TUNING.

The three different curves in B represent the same thing for three different circuits just alike except that A has a high resistance, B a medium resistance, and C a low resistance. Thus it is seen that the circuit having the least resistance has a sharp well-defined point at which it is tuned. Resistance in a circuit decreases the possible sharpness of tuning in the circuit as well as making a damped wave when the circuit is radiating.

The curves in A and B of figure 26 represent energy absorbed by a circuit when coupled with another circuit. The same identical curves would represent the energy radiated by the same circuits. Thus a circuit closely coupled with another circuit would radiate a broad band of

wave lengths with two prominent wave lengths. If a quenched spark is not used in a damped-wave transmitting station, this condition applies. A circuit of high resistance will radiate a broad band of waves, as has already been noted in a radiating circuit containing a spark gap.

To sum up, it is desirable to radiate energy confined to nearly a single wave length for (a) only this energy is useful in reception; (b) in order to avoid interference with other stations. This is done by having two tuned circuits, one with a quenched gap. These two circuits should have the proper degree of coupling. They should have as low resistance as it is possible to attain. It is desirable to have two circuits in the receiving station, in order to eliminate the effects of other waves than those which it is desired to receive. This elimination is best effected by two loosely coupled tuned circuits, with resistance as low as possible.

CAUSES OF INTERFERENCE.

In receiving there may be interference due to other causes than transmitting stations. This is due to the antenna being swept by waves caused by the forces of nature (thunderstorms, etc.). Also the antenna may receive direct static changes due to the presence of charges upon surrounding objects including the air. All of these *strays* cause oscillating currents in the antenna and thus produce noises in the receiver. Their effect upon the antenna is similar in character as the effect of a heavy blow upon a child's swing. A heavy blow would cause the swing to swing back and forth even though it were not timed to the period of the swing. A circuit caused to oscillate in this manner is said to receive "shock" excitation. Having a second circuit in the receiving station

considerably reduces the noise in the receivers caused by these strays. The term static is oftentimes used to include the cause of all sounds in the receiver not due to a transmitting station.

DISTANCE AFFECTS INTERFERENCE.

Whether or not interference will occur among stations depends not only upon the factors outlined above but also upon their distance apart. For instance, a small-powered station in Kansas would not interfere with stations in New York even if it were working on the same wave length. This is because the radio waves get weaker the further they travel. They eventually become too weak to affect a receiving station. There are many factors affecting the distance to which a radio wave will carry its energy. It will carry energy further over sea than over land; further over some kinds of soil than over others. A radio wave casts shadows. If a transmitting station is at the foot of a hill or mountain, a receiving station on the other side of the hill or mountain will receive very faint signals because of this shadow effect. Trees and buildings absorb the energy of the wave so that the placing of either a receiving or transmitting station among them reduces the distance at which communication may be maintained. Other factors, such as the time of day, and the climatic conditions have various effects upon the distance at which communication can be maintained.

DAMPED AND UNDAMPED WAVES.

A damped wave is originated by an oscillating body whose oscillations are gradually fading out. In radio this gradual fading out of an oscillation means that the current of the oscillation gradually decreases in value. An undamped wave is originated by an oscillating body

whose oscillations always retain their maximum value. In radio this means that the current of the oscillation always retains its maximum value. Thus in an undamped radio set the oscillation, and hence the wave generated by the oscillation, is continuous as long as power is applied (as long as the key is held down). *This means that there are no wave trains in undamped waves as there are in damped waves.* An undamped wave is also a *continuous wave*, but a continuous wave is not necessarily an undamped wave. Any unbroken wave is a continuous wave. This continuous wave may vary in amplitude. Continuous waves are those used in radiotelephony.

ADVANTAGES OF UNDAMPED WAVES.

To produce an undamped wave it is necessary to add energy to an oscillating body as fast as that body loses energy. For example, a child's swing once started will gradually come to rest. It loses energy due to the friction of the air; the friction of the ropes where they are attached to the support, etc. If it is desired to keep it swinging through a constant arc, a push must be given it at each swing; this push adding just the same amount of energy as was lost during the swing. So in electric oscillation the current decreases because it loses energy by radiating some in the wave; by the resistance of the wire causing heat losses, and by losing energy to other circuits and objects. To keep the current constant, it is necessary to furnish just the same amount of energy during each oscillation as is lost in that oscillation. There are various methods of doing this and these will be described later.

Undamped waves have certain advantages over damped waves for use in radio communication. They carry much more energy in the same amount of time. For instance, suppose a dot used in radiotelegraphy last one-twentieth

of a second. Using a wave length of 1,500 meters, there would be in undamped wave transmission, 10,000 waves in this dot. If this dot was sent by damped waves there would be, if a spark discharge occurred 1,000 times a second, 50 wave trains in the dot. If each wave train consists of 40 waves—a reasonable number—the total number of waves in a dot would be 2,000. Thus there are five times as many waves in the undamped wave dot as in the damped wave dot. But the damped wave has only one of its waves at maximum amplitude and the rest gradually die away while the undamped waves have every wave at maximum value. For this reason, the energy of each undamped wave is in this case about five times the average energy of the damped wave, providing the maximum amplitude of the damped wave has the same value as the undamped wave's amplitude. Thus the energy in a dot carried by the undamped wave is 25 times the energy in a dot carried by the damped waves. This is a great advantage especially as it does not take much more power to generate the undamped waves than it does to generate the damped waves.

An undamped wave is a very pure wave and therefore has none of the disadvantages of a broad wave. These disadvantages have already been discussed. Because of the reasons stated in the preceding paragraph, the maximum steady energy of an undamped wave need not be nearly so large as the initial energy of a damped wave to establish communication over the same distance. A direct result of this is the fact that voltages used in undamped waves are not nearly so high as in damped waves, thus making easier the design of the instruments. Still another advantage is in receiving, as will be explained later.

One method of generating an undamped wave is by the use of the Alexanderson alternator described in Chapter XXIV. This alternator is capable of generating alternating currents of radio frequency. The energy lost in each oscillation is therefore supplied direct by the generator. There are other generators that are capable of generating radio-frequency oscillations. Prominent among these are the Goldschmidt's machines. As the output of these generators are radio-frequency oscillations, the output current may be fed directly to the antenna. However, this is not usually done because of the necessity to control the radiation from the antenna in order to give the dots and dashes used in telegraphy. The arrangement for doing this varies in different sets and is usually more or less complex. There must be some special arrangement to control the speed of rotation of these machines. The speed of rotation controls the frequency, and if this varies it changes the wave length, hence the speed *must* be kept constant. As the speed is very great, the speed-control system is quite complex. Owing to the great expense, these alternators are not used except at high-powered stations, and only a few of each type are in use at the present time.

ARC TRANSMITTERS.

Another method of generating undamped waves is by means of the arc. The arc transmitters are less costly than the alternators mentioned above, and there is no difficulty in controlling the wave length, as this is determined by the inductance-capacity value of the circuit. This also will be explained later. The sets are easily designed to give any power required. Those in use range from a power of 2 kilowatts to 1,000 kilowatts.

When a current passes continuously or nearly continuously through a small break in a circuit which is filled with air or other gas at atmospheric or greater pressure it is said to form an arc. This differs from a spark in that a spark is a disruptive discharge and the current passes only intermittently. A familiar example of an arc is the arc light used for lighting streets, etc. An arc has an unusual feature in that it seemingly does not obey Ohm's law. It differs in the fact that it takes less voltage to cause a heavy current to pass across the arc than it does to cause a small current to pass.

HOW THE ARC CIRCUIT WORKS.

If capacity and inductance of proper value are shunted around the arc under proper conditions (shown by dashed lines in fig. 27), there will be radio-frequency oscillations produced in the circuit. These oscillations are produced because of the characteristics of the arc stated in the preceding paragraph. This comes about as follows: Consider the circuit to the arc formed and fed from a *constant* current source and the condenser uncharged. The current feeding the arc will now also feed the condenser, thus charging it.

But the current charging the condenser has been subtracted from the current passing through the arc, thus making the arc current less. The smaller arc current makes a higher voltage across the arc because of the arc characteristic mentioned. This higher voltage causes more current to pass into the condenser. This process goes on until the potential across the arc no longer rises rapidly with a decrease in current. Thus there is no higher potential available to charge the condenser, and hence part of the total current stops flowing into the condenser and the total current now flows through the arc. This lowers the potential across the arc, and hence across

the condenser. This lower potential allows the condenser to discharge and add its current to the feeding current of the arc. The inductance in the circuit causes the condenser to be charged in the opposite direction. It immediately begins to discharge, and this time opposes the current flowing through the arc. These opposing currents neutralize each other, whereupon the first condition is brought about. In good operation the back discharge of the condenser is great enough to stop the arc current

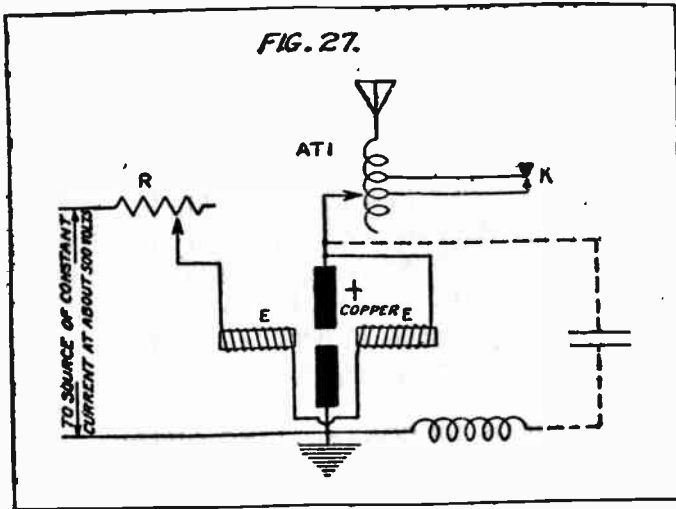

from flowing. This extinguishes the arc, which, however, immediately re-forms.

The frequency of the cycle described above can be varied by varying the inductance-capacity value of the shunt circuit around the arc. Thus the wave length may be changed. The oscillations are undamped because the source of current feeding the arc also supplies energy at each oscillation to the oscillating circuit, as has been described.

Figure 27 shows a diagram of such an arc set. The circuit shows the conditions under which the arc will work. The first condition is that the arc must be between copper and carbon electrodes, the copper being the positive electrode and being kept cool by a stream of water. The carbon must be slowly rotated around its own axis. The mechanical arrangement for doing this is not shown. The second condition is that the arc must be subject to a strong magnetic field. This magnetic field is furnished by the electromagnets EE. The third condition is that the arc is formed in a gas containing hydrogen. Therefore the arc is inclosed and this gas is furnished to the inclosure. In practice this can be done by dropping a few drops of alcohol in the arc container at regular intervals. This is accomplished by an arrangement similar to the oil dropper used on many machines. The fourth condition is that the value of the capacity and inductance of the shunt circuit must have a proper ratio. In the diagram of figure 27 the antenna is the condenser and the antenna tuning inductance, ATI, furnished the inductance. The dashed circuit shows the equivalent of these.

METHODS OF CONTROLLING OUTPUT.

Various arrangements of the key for controlling the output are possible. It has been found that the dots and dashes cannot be made by interrupting the source of constant current supply. This would extinguish the arc, which would have to be struck again by hand; that is, by touching the carbon to the copper and then withdrawing it to make the arc. In the arrangement shown in figure 27 the key cuts out some of the inductance in the antenna circuit. This changes the wave length radiated and the receiving antenna is not affected by this changed wave length, as it is tuned to the proper wave length. The key

is so arranged that when it is closed the proper inductance is in, and when it is open the inductance is changed from the proper value. Another method of controlling the output is by having a nonradiating circuit in addition to the antenna. Closing the key throws the output of the arc to this nonradiating circuit. Other methods are also used.

RECEPTION OF UNDAMPED WAVES.

The reception of damped waves has already been described. It was possible to receive them in that manner, because each signal (dot or dash) contained a number of wave trains and each wave train produced a vibration of the telephone diaphragm. The successive vibrations produced by successive wave trains made the tone heard in the telephone receiver. As has been noted, an undamped wave signal is not broken up in wave trains but consists of an unbroken series of waves of the same amplitude. The effect upon the diaphragm of the telephone receiver would then be to distort it at the beginning of a signal and release it at the end of the signal. This would result in a click being heard in the receiver, but this would not be distinctive enough to be recognized. Therefore, some other method must be employed.

A common method where only a crystal detector is used to receive undamped waves is by making use of an interrupter in the receiving circuit, as shown in figure 28-A. This is ordinarily a buzzer which is arranged to vibrate at suitable frequency. The vibration of the buzzer interrupts the circuit at P and thus breaks up into pulses the current flowing through the telephone. Each pulse produces a vibration of the diaphragm and the successive pulses produce the note heard.

Another method is by the use of the tikker. The circuit is shown in figure 28-B. The condenser, C', shunting the

telephone receiver has a very large capacity compared to the variable condenser at C. The tikker is a specially designed interrupter. No detector is needed. The action of the tikker circuit is as follows: When the tikker "makes" the circuit, only a very small part of the current passes through the telephone. Most of the current passes

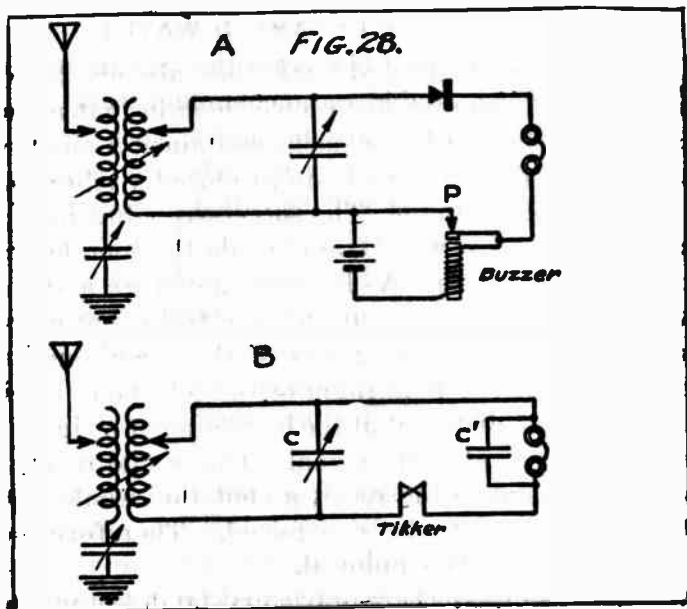

into the condenser C', thus charging it. When the tikker opens the circuit, the charge condenser discharges through the telephone. As the condenser has a large capacity, the discharge gives a current large enough to actuate the telephone diaphragm. A discharge occurs each time the tikker interrupts the circuit. This is at audio-frequency, so that a note is heard in the receiver. Other methods of receiving undamped waves will be discussed under vacuum tubes.

CHAPTER XXVII

Now We Come to Vacuum Tube—Electric Action—The Batteries—Grid Action—Vacuum Tube as a Detector—As an Amplifier.

WITHIN the past few years the vacuum tube is being much used in radio communication. This device is called various names, such as vacuum valve, special lamp, audion, ionic tube, thermionic tube, plotron, and others. It will be called a vacuum tube in this volume. Vacuum tubes are used to generate undamped radio waves; to detect waves; to amplify oscillation both at radio and audio-frequencies; and in radiotelephony. They are very important and are gradually supplanting other radio apparatus because they are very light and portable, and because they are more efficient than other devices.

A vacuum tube consists of a container, usually glass, from which the air has been pumped out. In this glass tube is mounted the filament, the grid, and the plate. Each of these elements is separated from the other by a space. The filament has two outlets, the grid one outlet, and the plate one outlet. The filament is surrounded by the grid, which in turn is surrounded by the plate. One type was illustrated in Chapter XXI.

To understand the action of a vacuum tube it is necessary to remember the following facts: A current of electricity is simply a flow of electrons, the electrons flow in one direction, which makes a current which is said to flow in the opposite direction. Electrons are small charges of negative electricity. All material contains electrons.

There are two kinds of electricity—positive and negative. Like electricity repels and unlike attracts. These facts are already known to the reader. The following additional facts must be grasped before the action of the vacuum tube can be understood. It has been discovered that metals, if heated, will throw off into space some of the electrons which the metals contain. Also it has been discovered that the hotter the metal, up to a certain degree of heat, the more electrons it discharges. These electrons travel at a high rate of speed. If air or any other gas is present in the space around the metal, the

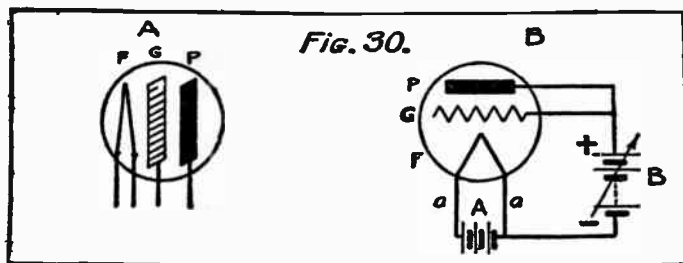

electrons strike the minute particles of the air or gas and are soon stopped.

The facts stated above are applied in the vacuum tube. The air is pumped from the tube (hence the name vacuum) so that the passage of the electrons will not be stopped. The filament, marked F in figure 30-A, is heated so that it becomes red or white hot. This is usually done by an electric current furnished by a battery. G represents the grid and P the plate. These are represented in the method shown in figure 30 for ease of explanation. Suppose that the filament is hot and the grid and plate are not connected to outside circuits. The electrons are thrown off from the filament and strike both the grid and the plate. These acquire a negative charge, as they have

acquired electrons. The space inside the tube has also a negative charge as the space is filled with electrons. Like electricity repels and hence the negative charge on the plate, the negative charge on the grid, and the negatively charged space inside the tube are all repelling the electrons which the hot filament is trying to throw off. As each electron is thrown off of the filament it adds its charge, either to the plate, grid, or space. The stronger charge causes a stronger repulsion of the escaping electrons. In a very short while the repulsion is strong enough to prevent the escape of any more electrons from the filament.

EFFECTS OF BATTERIES.

Figure 30-B shows a battery, "A," used to heat the filament and a battery, "B," with its positive terminal connected to the plate and its negative terminal connected to the filament. The grid is shown connected to the plate, so that in effect it is a part of the plate. This is done for sake of clarity in explanation. The use of the grid will be shown later. By connecting the battery as shown in the figure, two things have been done. First, a positive potential has been placed on the plate; second, a metallic circuit containing a battery has been made outside of the tube from the plate to the filament. This leaves only the space between the filament and the plate inside of the tube to complete the circuit. The battery marked A is used merely to heat the filament.

The heated filament throws off electrons. The plate is positive and attracts the electrons which are negative. The electrons travel through the space (no air or gas particles being present to hinder them as it is a vacuum) from the filament to the plate. Thus there is a flow of electrons from the filament to the plate—and a flow of

electrons is an electric current. Thus the combination of the heated filament, the vacuum, and the positively charged plate has caused a current to flow; that is, in effect, it has completed the circuit which contains the battery, B. This complete circuit is (fig. 30-B) B a F P B.

The action of the battery, B, is, as well known, comparable to a pump. When it forms part of a circuit it pumps electrons out of its negative terminal and into its positive terminal. In the tube just described it pumps the electrons coming from the filament, from the plate to the battery and out of the battery to the filament. The filament again throws them off and they go to the plate—being attracted by it as it is positive. Thus the electrons flow around the circuit. This flow of electrons is a current of electricity. It can be measured by an ammeter placed at any convenient point in the circuit.

BATTERY CONTROLS FLOW OF ELECTRONS.

Consider the effect of changing the number of cells in the B battery. Changing the number of cells in the battery would change the positive potential on the plate. If the positive potential on the plate became greater it would have a greater attraction for the flying electrons in the tube, and hence in a given time more electrons would arrive at the plate and be pumped around the circuit by the battery. An increased flow of electrons means an increased current. In the same way a decreased potential on the plate would cause a smaller current to flow. This change in current with a change in potential *does not* follow Ohm's Law. That is, doubling the potential does not double the current as it does in a wholly metallic circuit. Figure 31-A shows how the current varies with varying potential on the plate. Figure 31-B shows how the current varies with varying temperature of the filament.

In A the filament temperature has been kept at a constant value and by means of a milliammeter the current passing through the plate circuit has been measured when the plate potential has a certain value. The value of the plate potential has then been changed and the plate current again measured. The curved line shows the result of a large number of these measurements. Note that a change of plate potential from value A to value B changes the current from value C to value D; a change of potential from value B to value E changes the plate current from value D to value F. In the case of this particular tube the exact figures are as follows: Raising the plate potential 20 volts, starting at 40 volts, increases the plate current 16 milliamperes; raising the plate voltage 20 volts, starting at 60 volts, increases the plate current only 2 milliamperes. If the circuit obeyed Ohm's Law, the same change of potential would always *produce* the same change in current.

EFFECT OF TEMPERATURE ON CURRENT FLOW.

In figure 31-B, the plate voltage has been kept at a constant potential (85 volts) and the filament temperature varied. The plate current has been measured at each value of the filament temperature. The curve shows the result of a large number of measurements at different temperatures. It is seen that at a temperature of about 1,800° (dull red glow) very little current flows. This means that at that temperature very few electrons are thrown off by the filament. From that point up to a temperature of about 2,050 (white hot) there is a rapid increase in the rate of emitting electrons with an increase in temperature, thus giving an increased current. An increase in temperature after this point has been reached does not increase the rate of emissions of the electrons.

Fig. 31.

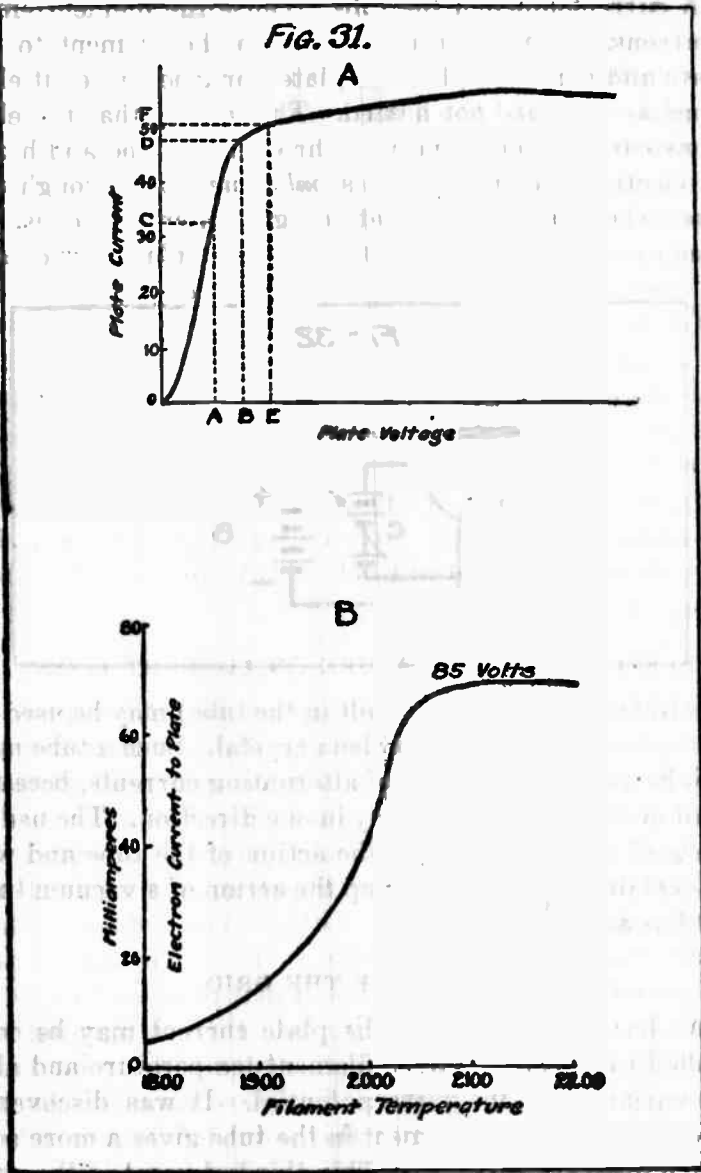

A current flows in the tube because the filament emits electrons. The electrons pass from the filament to the plate and grid. Neither the plate nor grid can emit electrons as they are not heated. This means that the electrons can pass only one way through the tube and hence an electric current can pass *only one way* through the tube. This is exactly what the galena crystal does. A vacuum tube with only a filament and plate (grid con-

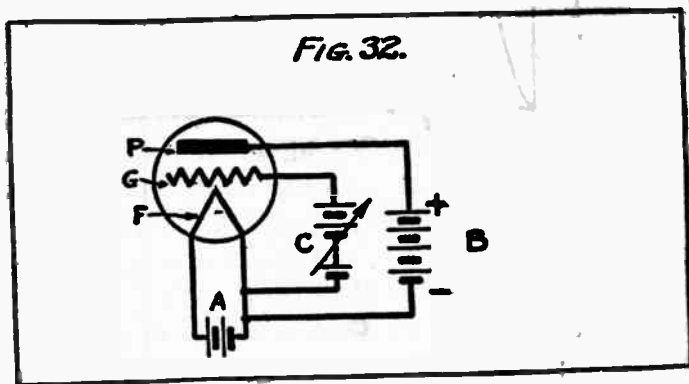

nected to the plate or not built in the tube) may be used as a detector in place of the galena crystal. Such a tube may also be used as a rectifier of alternating currents, because it allows current to pass only in one direction. The use of the grid greatly improves the action of the tube and will be explained before taking up the action of a vacuum tube used as a detector.

ACTION OF THE GRID.

As has been explained the plate current may be controlled by variation of the filament temperature and also by variation of the plate potential. It was discovered that putting a third element in the tube gives a more sensitive method of control. This third element is the grid

which has already been described. In the discussion above the grid has been connected with the plate, and hence really formed a part of the plate. In *actual use* it is in a *different* circuit from the plate. A study of figure 32 will show the action of the grid. It must be remembered that the grid is of latticelike construction and is placed very near the filament and between the filament and the plate.

The battery, C, allows a potential to be placed on the grid. This can be made stronger or weaker by changing the battery. It can be made positive or negative by reversing the connection of the battery. Suppose a positive potential be placed on the grid. This attracts the electrons just as the positive potential on the plate did. Making the potential of the grid higher causes it to attract the electrons with more force, and thus causes a greater current to flow in the tube. The grid itself has a very small surface and does not catch many of the flying electrons. Most of the electrons therefore go past the grid and reach the plate. Thus the *plate* current is increased by an increase of potential on the grid. Putting a negative potential on the grid causes the grid to repel the electrons and thus decreases their rate of flow to the plate, as they cannot get through the grid. If this negative potential is made large enough, its repulsion of the electrons will entirely stop their flow and hence stop the passage of any current in the tube. Because of the nearness of the grid to the filament, a slight change in the potential on the grid makes a large change in current to the plate. The effect of changing the grid potential is much greater than obtained by changing the plate potential.

It is important to understand this action of the grid, for upon it depends the use of the vacuum tube. The fol-

lowing mechanical device illustrates the action of a vacuum tube. F, G, and P are all mounted in an inclosure from which most of the air has been pumped. The pipes are filled with flour—each particle of which represents an electron. A is a blower which is just strong enough to keep a fountain of flour, F in the diagram, in the space above its opening. A corresponds to the battery A in figure 32, which heats the filament causing it to throw off electrons. B is a suction pump with a large funnel-like opening at P. B *sucks* the flour in at P and forces it

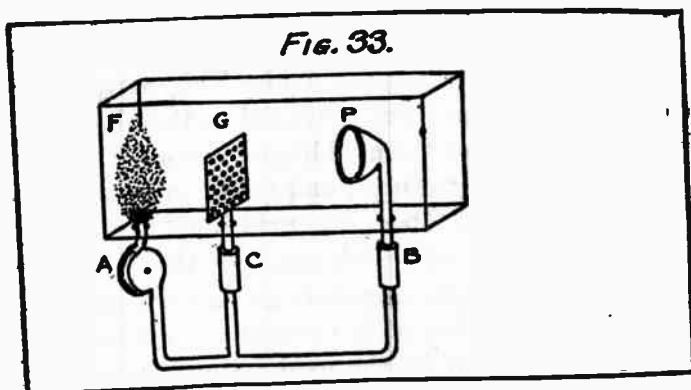

through the pipe back to A. The pump B corresponds to the battery B in figure 32; the funnel P corresponds to the plate. It is evident that the stronger the suction at P, the more flour will be attracted. In the same way in the vacuum tube, the stronger the positive potential of the plate the more electrons will be attracted. If the pump B was reversed it would blow at P and no flour would enter, as it would be repelled. So in the vacuum tube, if the B battery is reversed it would put a negative potential on the plate and no current would flow, for the electrons would be repelled.

The pump C corresponds to the battery C of figure 32. The inlet, G, corresponds to the grid of the vacuum tube. It consist of a large number of small openings connected to the pump. There is nothing between these openings so that the flour can pass directly from F to P without meeting any obstacles except at the openings themselves. With the pump B maintaining a uniform suction at P, let the pump C be started, starting a suction at G. G is much nearer to the fountain of flour than P and its effect is much greater. It sucks the flour towards it with great

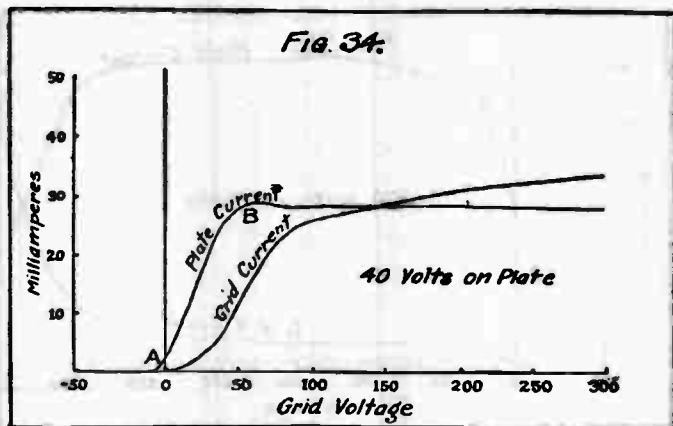

speed. Most of the flour does not enter the openings of G as they are so small, but pass right by them and enter the funnel at P, thus increasing the amount entering P.

In the same way placing a positive potential on the grid attracts the electrons and these fly past the grid to the plate. An increase of suction at C gives an increased flow of flour through P, in the same way as an increased potential on the grid causes an increased current of electricity through the plate circuit. If the suction at C is made strong enough, however, the particles of flour are sucked with such force that, instead of flying past the

openings at G, they are drawn from their straight path and made to enter them. They do not get to P and hence the flow to the plate is decreased. In the same way placing too great a potential on the grid causes the electrons to fly to the grid instead of the plate, and hence the plate current is decreased at such high potential of the grid. Reversing the pump at C has the same effect of stopping the flow of flour as reversing the pump at B. If the pump C were reversed so that it acted as a blower it would tend to prevent any flour passing from F to P, as it would tend

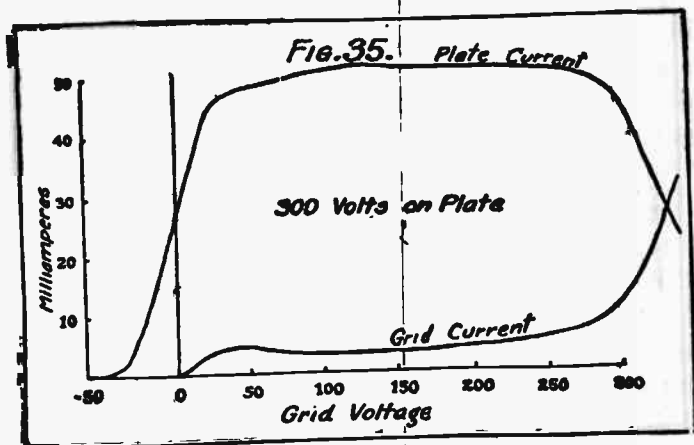

to neutralize the effect of the pump B. The blower action would not have to be very strong to completely overcome the effect of the pump B. In the actual tube, giving the grid a negative potential has the same effect as making the pump, C, a blower.

The actual change in current in the plate circuit due to change in potential on the grid is shown in figure 34 by the curve marked "Plate current." This was taken by measuring with a millimeter the amount of plate current passing when there was a definite voltage on the grid.

The grid voltage was changed and the plate current again measured. The curve shows the result of a large number of these measurements. The plate potential was kept constantly at 40 volts during the measurements. Note that the curve has two distinct bends, one at A and one at B. These bends are sometimes spoken of as the knees of the curve. It is to be noted that a rise of grid voltage starting at B does *not* make the same change of plate current as an equal lowering of grid voltage starting at the same point. The same fact holds for point A.

In figure 34 the curve marked "Grid current" was obtained by taking a series of measurements of the value of the grid current with different values of the grid potential. Note that when the grid potential becomes nearly equal in value to the plate potential (40 volts) the grid current rapidly rises, as it attracts the electrons so strongly that they go to the grid rather than the plate. Figure 35 shows the same series of measurements, except that the plate voltage was kept constantly at 300 volts.

All the curves except that in 31 B are taken from actual measurements made on the same vacuum tube. This vacuum tube was designed to have 300 volts on the plate and to be used as a generator of oscillations in a manner to be explained later. It would not be efficient using 40 volts on the plate, as the grid current is too large for small values of its potential. Some vacuum tubes are designed to have 40 volts on the plate and to have very small values of the grid current with this voltage.

First method.—In this method a small condenser e , which is shunted by a very high resistance, r (about 1,000,000 ohms), is inserted in the lead to the grid. The high resistance is called the grid leak. Figure 36 shows the circuits. Note that the circuits to the left of the vertical dashed line are exactly like the receiving circuits de-

scribed previously. The vacuum tube has the battery A (about 4 volts) to heat the filament. The plate battery, B, is connected through the telephone receivers to the plate. A variation in plate current therefore means a variation in the telephone current. There is no battery in the lead to the grid. The antenna is caused to oscillate by the incoming signal waves. These oscillations are transferred to the secondary circuit. The terminal, *d*, of the condenser is directly connected to the secondary circuit and hence it alternately becomes positive and negative.

With no oscillation in the circuit the grid maintains a steady value, and therefore the plate current maintains a steady value. Let the oscillation begin and let the terminal, *d*, become positive. The positive electricity on that side of the condenser attracts the negative electricity to the other side and repels positive electricity so that "e" becomes negative and the grid becomes positive, or rather less negative than it was. This takes place because the "e" side of the condenser and the grid are practically insulated from any other conductor—the grid leak has such a high resistance that no loss of electricity occurs through it in the short time taken by one oscillation—and any gain of electrons by the "e" side of the condenser must be compensated by an equal loss of electrons by the grid. Thus, as explained, the grid becomes positive (less negative) when the "d" side of the condenser becomes positive. The grid being positive now attracts the electrons coming from the filament and some of these electrons are added to the grid. These electrons are *trapped* on the grid and cannot escape. When the second half of the oscillations reaches *d*, *d* becomes negative, causing the grid side of the condenser to become positive and the grid itself to become negative. The grid being negative no electrons are added on this half of the oscillations. The

net result of one complete oscillation is that the potential of the grid has been lowered, as electrons were added during the first half of the oscillation. Each succeeding oscillation adds its effect to the preceding one and hence the result of a *complete wave train* is to considerably reduce the potential of the grid.

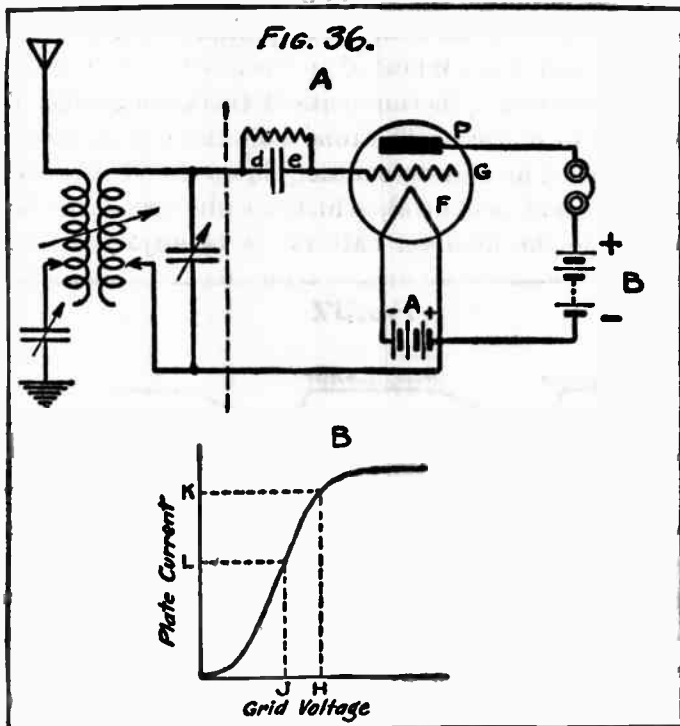

The result of reducing the potential of the grid is to reduce the plate current flowing in the valve. In figure 36 B, the steady potential (with no oscillations) is represented at H. This gives a steady value of the current represented by the point K. The wave train reduces the grid potential to J which reduces the plate current and there-

fore the telephone current to L. Between each wave train there is sufficient time for the electrons on the grid to leak away through the grid leak. The grid therefore rises to its steady potential and hence the plate current rises to its steady value.

The actual current is shown in figure 37. Each pulse of the current actuates the telephone diaphragm and hence a note is heard whose tone corresponds to the frequency of the received wave train.

Second method.—In this method the knee of the plate current curve is used. The tube is connected as shown in figure 38 A. The sliding contact, P, on the resistance, R, allows the grid potential, which results from its being connected to the filament battery, to be adjusted so that

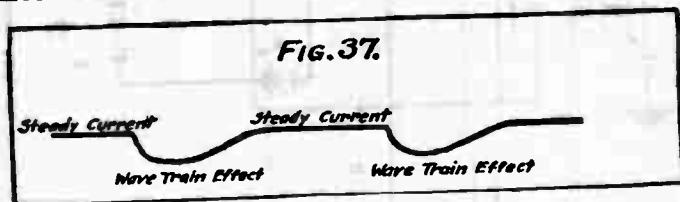

its steady potential is at the knee of the curve. (A device allowing potential to be varied in this manner is called a potentiometer.) The variation of potential due to the oscillations set up in the oscillating current is communicated to the grid, whose potential therefore alternately rises and falls.

Suppose the potentiometer has been adjusted so that the steady potential of the grid is at A (fig. 38 B). The oscillations cause the potential to rise to D and to fall to F; the rise and the fall being equal to each other. When the grid has a steady potential at A, the steady plate current is represented by the point E; when the first half of the alternation raises the grid potential to D, the plate current is increased to H; when the second half of the

oscillation reduces the grid potential to F the plate current is reduced to G. It will be seen that the increase in current due to one half of the oscillation is much greater than the decrease due to the other half, for EH is much longer than EG and these two lengths measure the change in current. The result of this is that the current flowing through the telephone receiver is increased by an oscilla-

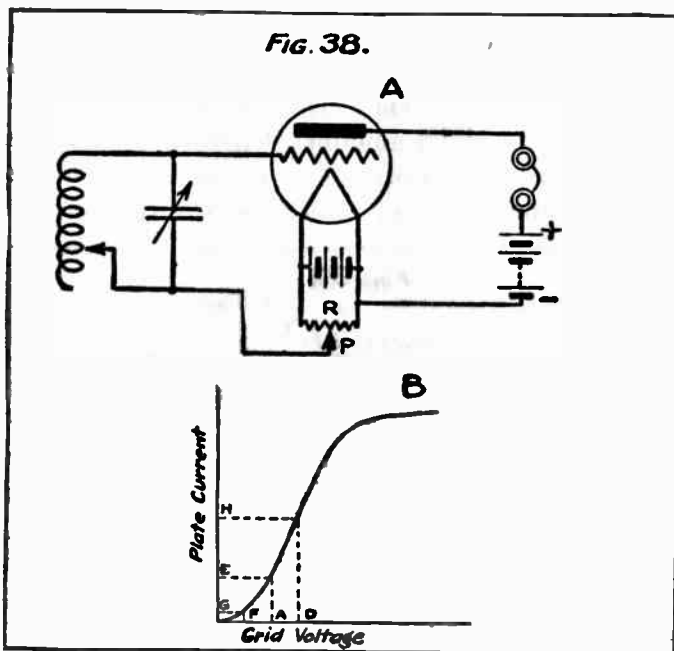

tion. This increase of current lasts through one wave train, after which the current drops to its steady value. This is illustrated in figure 39. Each pulse actuates the telephone as previously described. In the explanation of both methods of detecting it is assumed that the telephone smooths out the pulsation that would otherwise occur at each oscillation.

It is possible by use of the vacuum tube to receive oscillatory currents at one strength and send them out at a much higher strength. When a tube is used for this purpose it is said to be used as an amplifier. The energy added by the use of the tube is furnished by the batteries connected to the tube. The amplification effected by one tube is considerable, in some cases the output energy of the tube being 100 times the input energy.

A vacuum tube acts as an amplifier because, as has been noted, a small change of voltage on the grid makes a large change of current in the plate circuit. This is comparable to the fact that a small amount of pressure used by an engineer upon the throttle of a locomotive releases a large amount of pressure in the cylinders of the engine.

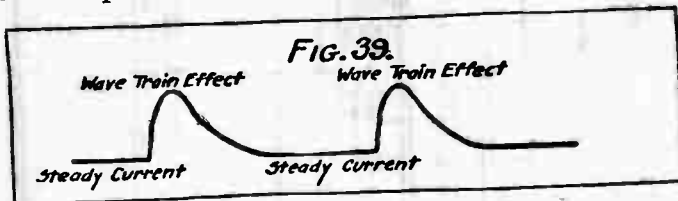
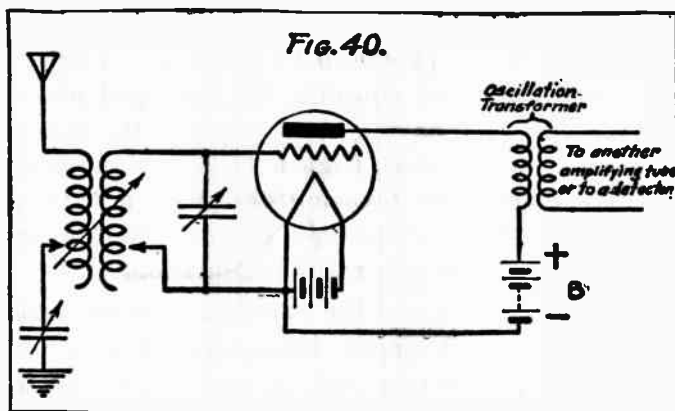

Figure 40 shows the type of connection necessary for use of a vacuum tube as an amplifier. This arrangement differs from that of a detector mainly in the fact that there is no grid condenser or grid leak, and the steady voltage of the grid is at neither the upper nor lower knee of the curve (fig. 38 B), but is between the two. It is to be noted that this part of the curve is practically straight. The oscillating circuit communicates its oscillating potential to the grid. As the grid potential increases more electrons pass from the filament to the plate; as the grid potential decreases fewer electrons pass from the filament to the plate. Thus the grid acts as a valve which turns on and off the current passing through the plate and furnished by the battery, B. The current oscillates with the

same frequency as the grid potential, but carries much more energy than that acting upon the grid, because the battery, B, has added energy to the oscillation.

A vacuum tube will amplify oscillations at any frequency, so that in radio apparatus some tubes are used to amplify radio frequency oscillations before they are detected, and some tubes are used to amplify oscillations after they have been acted upon by a detector and have been changed to audio frequency. The design of the circuits for both radio-frequency and audio-frequency oscil-



lations requires minute attention to details which are beyond the scope of this pamphlet.

Tubes used as shown in figure 40 are said to be connected in cascade—the output of one tube being the input of another tube. This transfer of energy is usually made by means of an oscillation transformer having either an iron or an air core. The energy may be transferred by means of an electrostatic coupling which has been previously described. Still another method much used in Europe is to have the output of one tube lead to the next tube through a high resistance.

CHAPTER XXVIII.

Vacuum Tube as a Generator of Undamped Oscillations —Summary of Radiotelephony—Receiving.

VACUUM tubes may among other things be used to generate undamped waves. It has been noted that undamped waves are produced by adding energy to the oscillations at each oscillation. The batteries connected to a vacuum tube are the source of the energy when undamped waves are produced by the tube. A tube may be made to oscillate by coupling the grid and plate circuits of the tube and having in each circuit the necessary capacity and inductance. Figure 41 is a simplified circuit of a vacuum tube transmitter. B is a battery of 320 volts. S and R are the coils of an oscillation transformer. K is a key to control the oscillations.

Before the key is closed the grid has a slight negative potential due to electrons from the filament being trapped on it. Therefore only a very small current is passing from the plate to the filament. Close the key and:

- (1) The grid acquires a zero potential (being connected to the ground) which
- (2) Increases the current in circuits B-R-F-P-B. (The grid, having a zero potential, does not prevent the passage of electrons through the tube.) The increasing of the current through coil, R, of the oscillation transformer.
- (3) Builds up a potential in coil, S, so that the grid end of the coil and the *grid itself* become negative, which

- (4) Decreases the current in circuit B-R-F-P-B. The *decreasing* of the current through coil, R,
- (5) Builds up a potential in coil, S, so that the grid end of the coil and the grid itself become strongly positive, which
- (6) Greatly increases the current in circuit B-R-F-P-B, which is the beginning of another cycle. (See 2 above.)

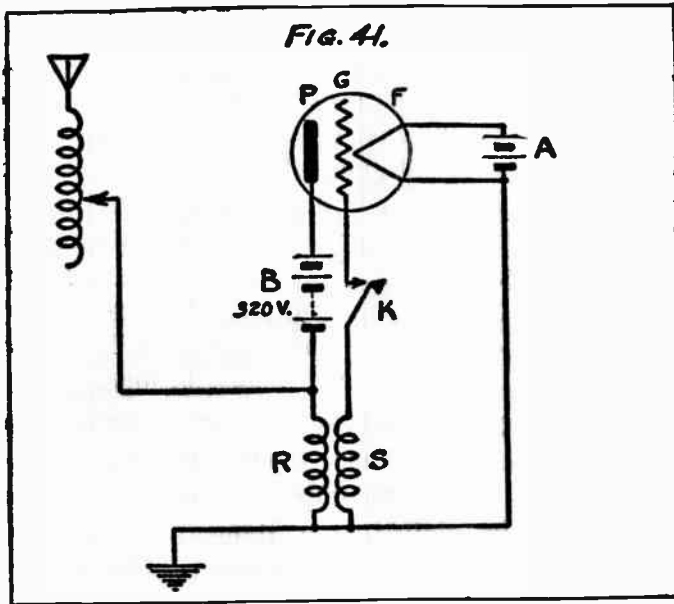

The oscillations are generated as long as the key is closed. It is to be noted that the oscillations have energy from the battery, B, added. Hence, they are undamped oscillations. The circuit containing the antenna determines the frequency of the oscillations. The coupling between R and S must be close enough to cause the voltage of the grid to vary over a range sufficient to keep the oscillations flowing in the circuit.

Thus a vacuum tube will generate undamped waves

when the grid and plate circuits are coupled together. It is, of course, necessary that the degree of coupling be great enough for the reaction between grid and plate to continue as long as power is supplied or the coupling maintained. The circuits may be coupled by any means. A capacity coupling is often used, as is also a combined capacity and inductance coupling.

REGENERATIVE AMPLIFICATION.

It is possible to use the same vacuum tube as a detector and amplifier simultaneously. There are numberless methods of arranging the circuits of a tube and each different arrangement is designed to accomplish some object. A knowledge of the principles of radio circuits and the action of the tube itself, as heretofore described, will enable one to explain the action of any particular circuit. An example of an ingenious circuit is shown in figure 42. This is the same arrangement as shown in figure 36, where the tube was used as a detector, except that the coil, R, and the condenser, C, have been added.

The coil R is coupled with the coil S, which is the secondary of the oscillation transformer. When radio waves start oscillations in coil S, they are communicated to the grid as explained in connection with figure 36. The effect of the wave train upon the grid is to lower the potential of the grid as has been explained. The grid varies in potential with the radio frequency of the received oscillations. This radio-frequency variation in potential of the grid causes a radio-frequency variation of plate current strength (that is, an oscillation). This is in addition to the lowered potential produced by the wave train considered as a whole. Figure 42-B shows the combined results. The radio-frequency variation of potential in the grid superimposed upon the audio-fre-

quency change in potential produces both a radio-frequency oscillation and an audio-frequency pulse in the plate circuit. The audio-frequency pulse gives rise to the tone heard in the receiver. The radio-frequency oscillations, in passing through the coil, R, which is coupled to coil S, react upon coil S and strengthen the oscillations already existing in that coil. Thus the effect of the regenerative amplification is to strengthen the original os-

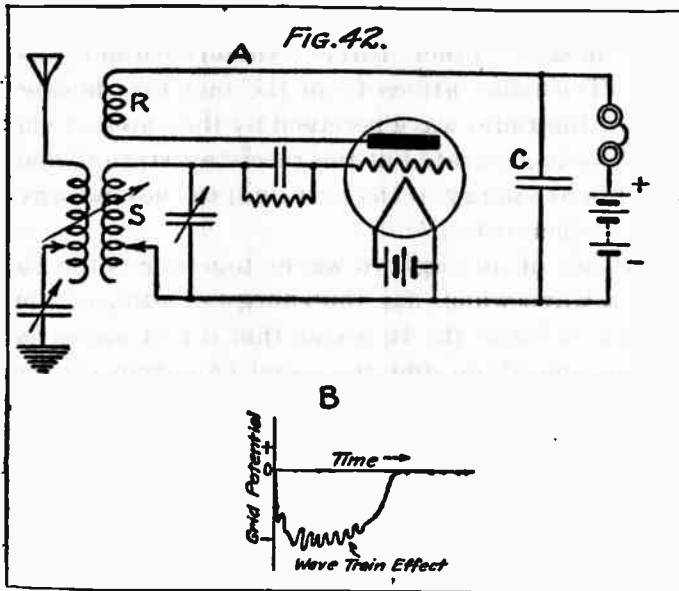

cillations and because of this strengthening make them persist longer than they otherwise would.

The condenser, C, is used to allow the high frequency oscillations to by-pass both the receiver and the battery used. It offers a low resistance path to high frequencies while the high inductance of the receiver offers a high resistance to the high frequencies. It is a common practice in radio to use a condenser for such a purpose. A condenser is oftentimes used in a circuit to permit alter-

nating currents to flow and at the same time to stop the passage of a direct current. In much the same way a large inductance is often used to stop the passage of high frequency variation in the current, as it offers a very high resistance to such oscillations.

In addition to the methods of receiving undamped waves previously explained the heterodyne method is used. As this is the most sensitive method known it is gradually displacing all other methods. The word "heterodyne" means "other force" (hetero—other; dyne—force). The name arises from the fact that besides the energy of the radio wave received by the antenna another radio wave is generated at the receiving station, and this wave adds its energy to the first one; the second wave being the "other force."

The result of adding two waves together is the formation of a wave which has the energy of each of the two waves which forms it. It is seen that if two waves having the same amplitude and the same frequency are added together, the result may be either the formation of a wave having double the amplitude of either one of the waves or the complete neutralization of the waves. The first result will be obtained when the two waves are in phase, i. e., when the crest of one coincides with the crest of the other. The second result will be obtained when the two waves are exactly opposite in phase, i. e., when the crest of one coincides with the trough of the other.

Now, if we combine two waves of different frequencies, both conditions will be brought about, for if the crests coincide at one point they can not coincide at adjacent points because the waves have different frequencies and therefore have different wave lengths. The result is that the wave formed has varying amplitudes. These variations in amplitude occur at regular intervals. Figure 43

shows the type of wave obtained. Notice that the wave varies from a large amplitude at L to a small amplitude at S and that this variation of amplitude repeats itself in a regular manner. These waves travel with the same velocity as ordinary waves. It has been found that the number of times per second the amplitude waxes and wanes when two waves are combined is equal to the difference in frequencies of the two combined waves. Thus if a wave having a frequency of 350,000 is combined with a wave having a frequency of 351,000, the resulting wave will wax and wane 1,000 times per second (351,000—350,000). The result of this waxing and waning of amplitude is, after being acted upon by a detector, to give the effect of another wave shown by the dotted line in figure 43. This is sometimes called the beat wave and follows the variation in amplitude of the wave from which it results. This beat wave therefore has a frequency equal to the difference in frequencies of the two simple waves forming the varying amplitude wave.

The oscillations set up in the receiving circuits have the same characteristics as the waves. The detector eliminates that part of the oscillation shown below the line, giving a pulsating direct current which is represented by the dotted line in figure 43. This beat oscillation is made to occur at audio frequency and hence can be heard when passing through the telephone receivers. The frequency of the beat oscillation is easily controlled. The antenna receives the wave sent out by the transmitting station. This has a definite frequency. The other wave is generated at the receiving station and its frequency may be changed at will. As explained, the difference in the two frequencies determines the frequency of the beat wave and hence this latter can be made any frequency by varying the frequency of the local oscillation.

The pitch of the note heard in the receivers depends upon the number of beats, so that the pitch may be varied by varying the number of beats.

The local oscillations are usually generated by a vacuum tube. Figure 44 shows the circuits of an instrument used to generate such local oscillations. This instrument is usually called a heterodyne. Compare the circuits of figure 44 and figure 41, both of which are designed to generate oscillations. The main oscillating circuit is the circuit containing L and C, and the frequency of this circuit determines the frequency of the oscillations. This frequency may be varied by the condenser, C. The grid circuit and the plate circuit react through the oscillation transformer composed of the coils L and P. The output

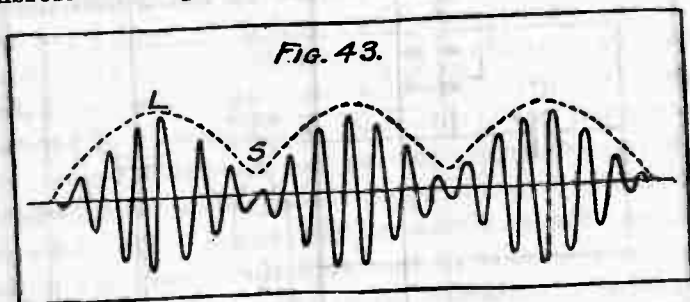

oscillations are fed into the regular receiving circuits by means of a few turns, K, of the antenna lead-in wire, which make the coupling with the coil L. In many heterodynes no special arrangements are made for coupling the heterodyne to the other circuits, as it is found that it is sufficiently simple to place the heterodyne near the other circuits.

The practice of radiotelephony involves the elementary principles of radiotelegraphy previously described, and in addition new principles by which transmission of speech is made possible between radio stations.

through which the alternating current passes, and a permanent magnet which forms the core of the electromagnet. Mounted in front of the poles of this combination magnet is a flat piece of metal containing iron. This is also called a diaphragm. The alternating current causes the diaphragm to vibrate, thus producing the sound made at the transmitter.

In radiotelephony methods are employed to produce at the transmitter and reproduce at the receiver a sound

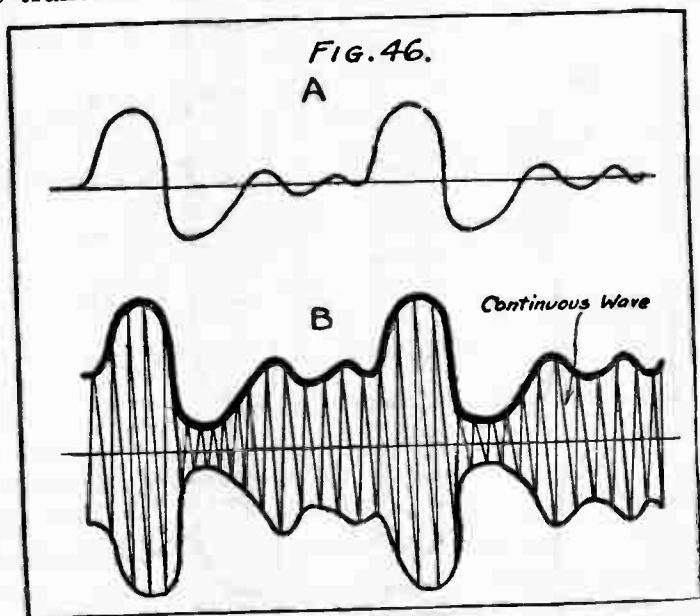

wave, that is, a wave similar in character to that of figure 45. It has been possible to do this by varying the amplitude of the radiated high-frequency waves so that this variation in amplitude follows in detail the wave variation produced by the sound. In figure 46, curve A represents a simple sound wave. By means of methods to be described later, the amplitude of a *continuous* radio wave

The pitch of the note heard in the receivers depends upon the number of beats, so that the pitch may be varied by varying the number of beats.

The local oscillations are usually generated by a vacuum tube. Figure 44 shows the circuits of an instrument used to generate such local oscillations. This instrument is usually called a heterodyne. Compare the circuits of figure 44 and figure 41, both of which are designed to generate oscillations. The main oscillating circuit is the circuit containing L and C, and the frequency of this circuit determines the frequency of the oscillations. This frequency may be varied by the condenser, C. The grid circuit and the plate circuit react through the oscillation transformer composed of the coils L and P. The output

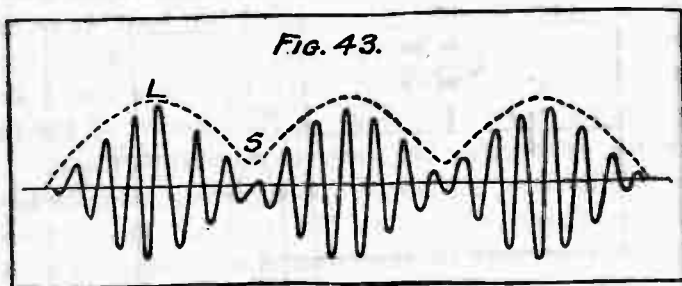

oscillations are fed into the regular receiving circuits by means of a few turns, K, of the antenna lead-in wire, which make the coupling with the coil L. In many heterodynes no special arrangements are made for coupling the heterodyne to the other circuits, as it is found that it is sufficiently simple to place the heterodyne near the other circuits.

The practice of radiotelephony involves the elementary principles of radiotelegraphy previously described, and in addition new principles by which transmission of speech is made possible between radio stations.

In ordinary wire telephony the sound waves produced by the voice are caused to produce, by means of a transmitter, a variation in a direct current; the variation in the current being identically similar in amplitude and frequency to the sound waves which produce it. This variation in direct current is usually converted, by means of a transformer, into a variation in alternating current which is similar to the variation in direct current. The variation in alternating current is then by means of a receiver converted into sound waves, the sound waves being identically similar in amplitude and frequency to the

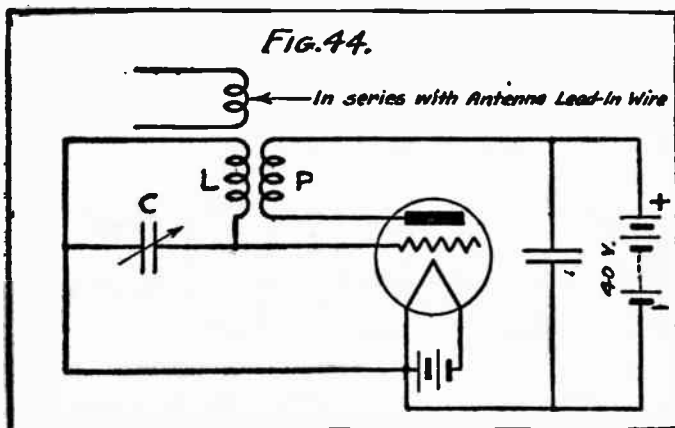

alternating current which causes them. As this identical similarity of amplitude and frequency has been maintained throughout the complete cycle, the sound waves produced by the receiver are identical with those originally produced by the voice. The series of events outlined above are represented by the curves of figure 45.

The instruments peculiar to wire telephony are the transmitter and the receiver. The transmitter, sometimes called a microphone, has two conductors separated by granules of carbon. The sound waves strike a flat

piece of metal, called a diaphragm, and cause it to vibrate. The diaphragm acts upon the carbon granules, alternately increasing and decreasing the pressure of the granules upon one another, as it vibrates to-and-fro. This

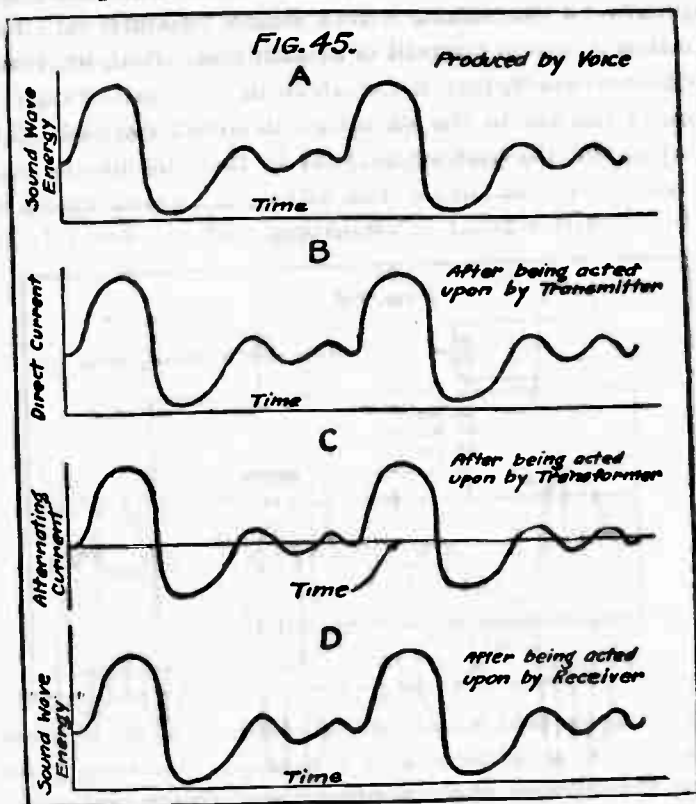

variation in pressure between the carbon granules varies the resistance of the granules. A direct current which is flowing through the granules is varied by this varying resistance. This varying direct current is changed into a varying alternating current by means of a step-up transformer. The alternating current acts upon the receiver. This receiver consists of an electromagnet

through which the alternating current passes, and a permanent magnet which forms the core of the electromagnet. Mounted in front of the poles of this combination magnet is a flat piece of metal containing iron. This is also called a diaphragm. The alternating current causes the diaphragm to vibrate, thus producing the sound made at the transmitter.

In radiotelephony methods are employed to produce at the transmitter and reproduce at the receiver a sound

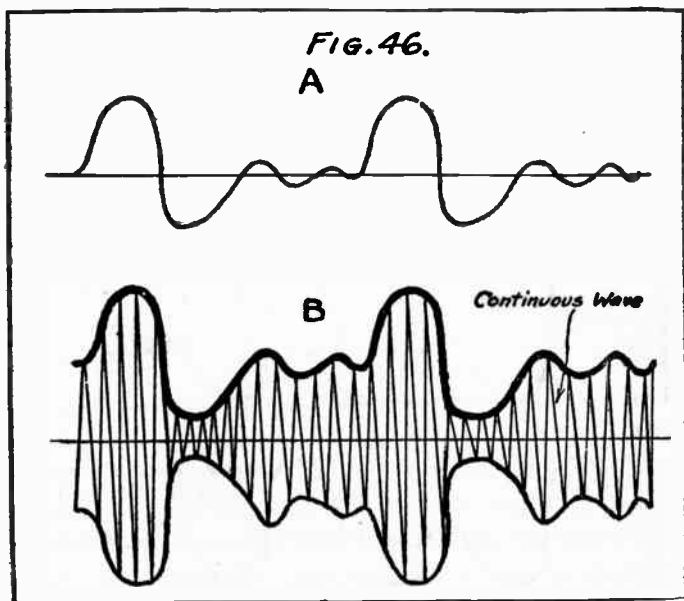

wave, that is, a wave similar in character to that of figure 45. It has been possible to do this by varying the amplitude of the radiated high-frequency waves so that this variation in amplitude follows in detail the wave variation produced by the sound. In figure 46, curve A represents a simple sound wave. By means of methods to be described later, the amplitude of a *continuous* radio wave

is varied so that the variation in amplitude follows identically the amplitude and frequency of the sound wave. This is shown by the heavy line in B of figure 46. This line, together with lower inclosing line, is called the envelop of the radio wave. Note that the upper and lower inclosing lines have the same shape. This wave establishes oscillations identical with it in the receiving antenna. When these oscillations are rectified by the detector and passed through a telephone receiver the

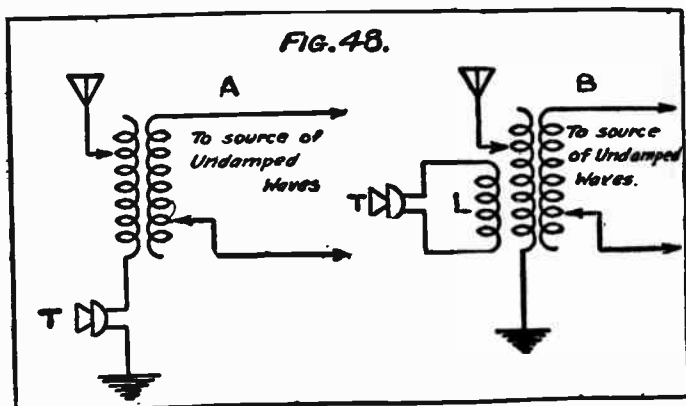

rectified current is similar to the heavy line of the envelop. This is necessarily so as the *rectified* telephone current does not follow the change in each individual radio frequency oscillation, but follows the change in the amplitude of these oscillations. This change is represented by one of the envelop lines as stated.

When a radio wave has its amplitude varied so that its envelope is made to assume any desired curve the wave is said to be modulated. The instrument or apparatus that accomplishes this object is called a modulator.

The simplest way of modulating a radio wave is by changing the resistance of the antenna. This change in resistance changes the intensity of high-frequency cur-

rent in the antenna. This changes the amplitude of the oscillations as the amplitude varies with the intensity of current in the oscillation. Figure 48-A shows this simple arrangement where T is a microphone transmitter.

Speech in the mouthpiece of the microphone varies the resistance of the aerial circuit, thus causing a variation in the current. A modification of this method is to have the microphone shunt a condenser in the antenna circuit

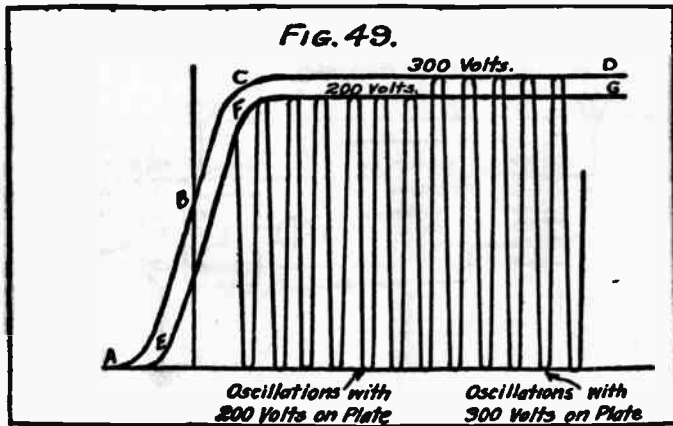

or a part of the inductance in the circuit. By this method not only is the resistance varied but the antenna has its natural period of oscillation varied by the action of the microphone. This change in natural period throws the antenna circuit out of tune with its primary and hence changes the amount of current in it. This change in resonance can be made to add its effect to the change in resistance caused by the microphone. The methods of modulating described in this paragraph are not used very much because both of them waste a great deal of energy.

Another method of modulation is called the absorption method. Figure 48-B is a schematic (simplified) diagram

of the circuits. When the antenna is oscillating a part of its energy is absorbed by the circuit LT which is coupled to it. The amount of energy absorbed by this LT circuit depends upon its resistance. The resistance of this circuit is changed by the action of the microphone when its diaphragm is caused to vibrate by sound waves. The total energy in the antenna circuit is constant and hence any energy absorbed by the LT circuit is taken away from the radiated energy. Therefore the radiated energy is varied by the varying absorption of the circuit in which the microphone is placed.

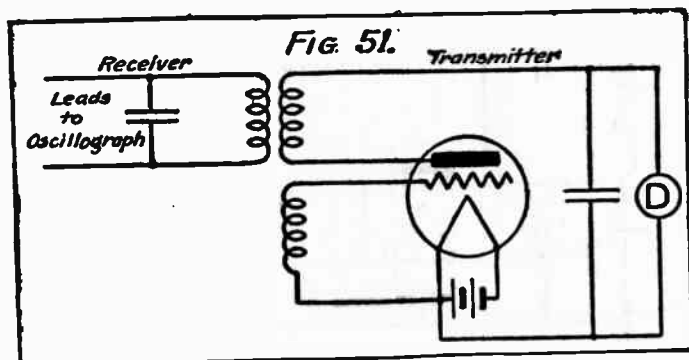

Referring to figure 31-A and its accompanying discussion, it is shown there that a variation of plate potential produces a variation in plate current. The following method of modulation depends upon that fact. In figure 49 the line ABCD represents the characteristic curve of a vacuum tube with a plate potential of 300 volts; the line EFG represents the characteristic curve of a vacuum tube with a plate potential of 200 volts. Start the tube oscillating when the plate potential is 200 volts. The oscillation would be as shown in the figure. Let the plate potential be increased to 300 volts. The oscillations then increase in amplitude as shown in the figure.¹

The circuits for modulating a radio wave by means of varying the plate potential with a microphone are shown in figure 52. The coils marked R, F, C, are inductances of values large enough to prevent the passage of radio frequency oscillations. RFC_1 , prevents the oscillation from passing through the plate battery. The grid and filament are connected by the resistance, R, and the choke coil, RFC_2 . As the filament is connected to the negative terminal of the plate battery, the grid, being connected with the filament, acquires through the resistance, R, the

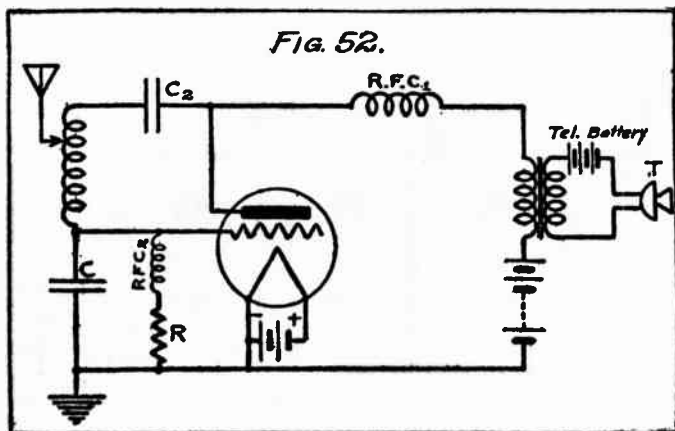

proper negative potential at which it works efficiently. The choke coil in this circuit forces the oscillations to pass through the condenser, C, to which the filament is also connected. The condenser, C, assures the proper oscillating voltage between the filament and the grid. The condenser C_2 , prevents the positive potential of the plate battery from reaching the grid through the coils of the autotransformer which couples the grid and the plate circuits.

Speech into the microphone which is in circuit with a battery and the primary of a transformer varies the

current passing through the circuit. This varying current in the primary induces a varying potential in the secondary. This varying potential in the secondary is impressed on the plate, thus varying the amplitude of the oscillations as has been explained. This arrangement is very simple but has the disadvantage of being limited in the amount of variation that can be produced in the plate potential. This limits the degree of modulation so that the set is not very effective. This method of modulation is very effective, however, when modified as explained below.

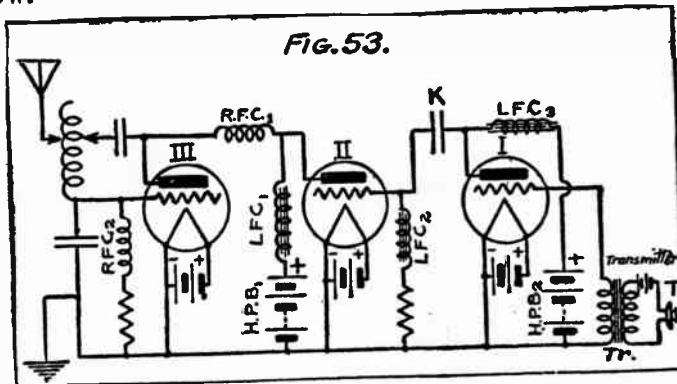

Figure 53 is a simplified diagram of a complete radio-telephone set. LFC are inductances of such values as to choke out not only radio-frequency oscillations, but audio-frequency oscillations as well. They prevent the passage of audio-frequency oscillations or of audio-frequency variations in direct current through the circuit in which they are located. HPB₁ and HPB₂ are high-potential batteries feeding the plates of the vacuum tubes. T is a microphone, Tr is a step-up transformer.

Speech into the microphone varies the current in its circuit. This varying current, passing through the primary of the transformer, induces a varying potential in

the secondary. This varying potential in the secondary is impressed upon the grid of tube I. Tube I is a low-frequency amplifier. The plate current passing through tube I is therefore an amplified reproduction of the microphone circuit current. This current has audio-frequency variations in current which pass to the condenser K and through the condenser to the grid of tube II. They can not take any other path as the low-frequency choke coil in other paths reject them. The condenser K is in the circuit to prevent the current and positive of HPB₂ from reaching the grid of Tube II. By action of the condenser K, the low-frequency variations of the direct current reaching it from the plate circuit, tube I, are changed into low-frequency alternating current, which is the current that reaches the grid of tube II.

Tube III generates continuous oscillations (compare with fig. 52). Its plate is connected with the plate of tube II. The high-potential battery, HPB₁, feeds both the plate of tube II and the plate of tube III. It furnishes a *constant* current because it has a low-frequency choke coil in series with it and this choke coil prevents any variation in current that takes place in either of its branch circuits from affecting the battery. As noted in connection with figure 52, the high-frequency choke coil, RFC₁, stops all radio oscillation in its circuit.

No radio-frequency oscillation, therefore, can reach the plate of tube II. The audio-frequency variation in the potential of the grid of tube II produces an audio-frequency variation of current in the plate circuit. This variation of current can not come directly from the battery, as the low-frequency choke coil prevents; it must come from tube III. When the current in tube II is increased, the current in tube III is decreased; when the current in tube II is decreased, the current in tube III is

increased. Thus the amplitude of oscillation in tube III is modulated by this increase and decrease of current. It is the output of tube III which is radiated by the antenna.

Figure 54 illustrates the transfer of energy between tubes II and III. The battery, B, furnishes a constant current passing through K. This current divides, half of it going through tube A and half of it through tube D when both have the same resistance. If the resistance of D is decreased, more current will flow through it. But K does not allow any variation in current, therefore the extra current passing through D must come from the circuit in which A is located. In other words, the cur-

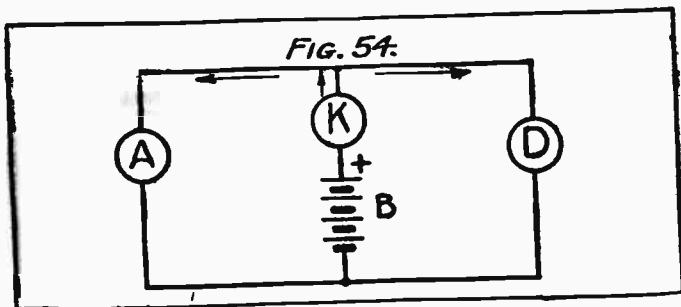

rent passing through K does not split 50-50, but, say, 80-20, the larger part going through the D circuit. When the resistance of D is increased the reverse of this takes place, the larger current passing through A. A and D represent the tubes and K represents the low-frequency choke coil of figure 52. The varying potential on the grid of tube II has the effect of changing the resistance of that tube.

A variation of the above method is to make the sum of the *potential* of the plates of tubes II and III constant, instead of having the sum of their currents constant. This is done by replacing LFC₁ (fig. 53) by a transformer, as shown in figure 55. This transformer has a ratio

of 1 to 1; that is, the voltage produced in the secondary is the same as the voltage in the primary. A variation in the current passing through the plate of tube II takes a path through the primary of the transformer and through the battery. The transformer is so arranged that an increase of current through P reacts through the transformer to produce a decrease in voltage at the plate end of the secondary. An increase or decrease in potential of the plate of tube II is therefore compensated by an equal decrease or increase in potential of the plate of tube III.

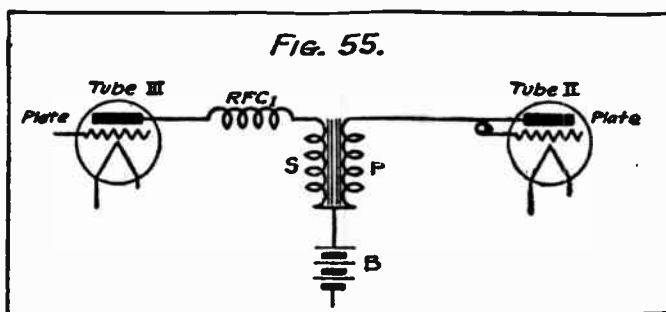

A radiotelephone transmitting set is readily adapted to send telegraphic signals by means of the buzzer modulator method. An ordinary buzzer replaces the telephone transmitter. The buzzer, by making and breaking the circuit, modulates the output of the transmitter in much the same way as is done by a microphone. The effect is to chop up the output into groups of waves, each succeeding group differing in amplitude from the preceding one but each alternate group having the same amplitude. As there are a number of such groups in the time it takes to make a dot or dash, such transmission can be received by any method suitable to damped wave radiotelegraphy.

THE RADIO DICTIONARY

Aerial—The wires or wire by or which the electric energy is radiated into the ether in transmission, or through which the waves motions are felt and carried into the receiver.

Alternating Current—A current of electricity which changes its flow of direction at regular alternating periods. It flows first in one direction and then in the opposite. One complete alternation is called a "Cycle."

Amplifier—A term used to describe any device which increases or adds energy to an incoming wave. It may be an electron tube or an amplifying unit.

Amplitude—The maximum value of a wave is its amplitude. This is determined by measuring the height of the wave crest. Every wave increases from zero upward to the maximum, just as waves on the ocean have their lowest and highest points.

Ampere—The unit of measurement in electricity used to describe and determine the strength of a current.

Antenna—The correct name of the receiving or transmission wires frequently called *aerial*. In later day radio sets the *antenna* is not necessarily "up in the air" in the sense that it was when *aerial* was first used to describe it.

Audibility—The measure of strength of an incoming signal.

Audion—The trade name of a vacuum or electron tube. It is an incandescent bulb containing the filament, a metal plate and a grid, or wire screen, which is attached to a battery. It is variously called *vacuum*

tube, thermionic valve, oscillating valve and electron tube. It can act as a generator of waves, an amplifier and a detector.

Battery—A device for holding in reserve and exerting through chemical action, electrical energy. It consists of a series of perforated lead-plates, each one insulated from its neighbor. Half the plates are positive. The other half negative. They are connected as a unit but arranged alternately—first a positive and then a negative plate. Over and between the plates is a fluid called “electrolyte” consisting of sulphuric acid and pure water, usually in parts of about one to four. When the battery is charged with electricity a chemical action takes place and small particles of lead are taken up from one plate and carried to the other, thus converting electrical energy.

“B” Battery—A dry cell battery used to supply current to the grid in a vacuum tube. Has high voltage running from 15 to 22 volts, but with low amperage.

Broadcasting—The sending of telephone or telegraph communications, messages, concerts or speeches through the ether so that they may be picked up by any number of stations simultaneously.

Capacity—A term used principally with relation to condensers. It refers to the amount of energy which a condenser will store up.

Cascade Amplification—A system of amplifying received radio signals whereby the sounds or waves pass through vacuum tubes one after another.

Cat's whisker—A term used to describe the fine wire contact point on a crystal detector. So called because it looks like a “cat whisker.”

- Circuit*—A complete metal path used for conveying an electric current—the course covered by a current from its source of origin back to its original source.
- Close-coupling*—Refers to the method of mounting a primary and secondary tuning coil to cause inductance. When the coils are close together they are “close-coupled.”
- Condenser*—A device for storing up electrical energy. It consists of alternating layers of conductors and nonconductors and in radio is used for collecting energy and for bringing circuits into resonance so as to tune them.
- Counterpoise*—A series of wires placed at the ground directly beneath the antenna—sometimes buried—to insure better ground connection. Frequently it is in replica of the antenna above it.
- Crystal Detector*—A device used to rectify radio frequency currents to direct impulses which effect the diaphragm of the receiver.
- C. W.*—Continuous Waves.
- Detector*—A device which transforms the electrical vibrations set up in the aerial or antenna into visible or audible vibrations.
- Direct Current*—A current of electricity which flows in one constant direction. The alternating current alters or reverses its direction.
- Electron*—The electric atom—the elementary corpuscle of electricity.
- E. M. F.*—The sign used to indicate electromotive force in electricity. The unit of E. M. F. is the volt.
- Ether*—A compressible substance that is supposed to fill the space between all molecules of material throughout the universe, whether it be water, gas, air or what to us are “hard” substances. It is the medium

through which radio messages are transmitted. They are carried on ether waves.

Frequency—A term used to indicate the number of oscillations a second which an alternating current makes.

Grid—The small wire screen placed between the film and the plate in a vacuum tube, and which serves as control of the electric energy which passes from the heated film to the plate. The discovery of its power and influence made possible the really efficient wireless telephone.

Ground—The term used to designate a connection made to the earth, river or sea in completing an electrical circuit.

Harmonics—A secondary or overtone—usually several degrees higher than the original vibration. In music they are familiar to nearly every one. They are vibrations of greater intensity than the fundamental vibrations and are clear and bell like. They are frequently annoying in radio operation.

Henry—The name given to the unit of inductance.

Hertzian Waves—The electromagnetic waves in the ether named after the man who discovered their existence, or rather who proved they existed.

Hook-up—A term used in describing the system of making up the circuit of radio set. By common practice applied to diagrams showing the "hook-ups."

Impedence—A term used to describe a form of resistance offered to the flow of a current by a wire on account of back electromotive force.

Inductance—A term used to designate that phenomena by which a current from an electrified wire or body can be made to flow in an adjacent wire when there is no actual contact between the wires.

Lead-in—The wire connecting the antenna with the receiving set in radio.

Loop—Loop-antenna—A small frame around which wires are stretched and which is sensitive to the ether waves. It is used in place of outside overhead straight wire aerials or antenna.

Loud Speaker—A device used to magnify the received messages or signals so that they can be heard without resort to telephone head pieces.

Negative Pole—The side of an electric circuit opposite to the positive and indicated by the minus sign (—). It is the side surcharged by electrons, and from which they flow to the positive.

Meter—A unit of distance equal to 39.37 inches. A unit of the metrical system of measurement universally used in scientific work.

Microphone—A sensitive type of telephone transmitter.

Mfd—An abbreviation used to designate the Microfarad—the one-millionth part of a Farad, and the practical unit of capacity.

Positive Pole—The side of a circuit indicated by the plus sign (+). The side with a deficiency of electrons and to which they flow from the negative side.

Radio Frequency—An arbitrary term used to indicate frequencies that are beyond the range of audibility. In radio all frequencies that are beyond about 10,000 per second are above audibility—so rapid they cannot be detected normally.

Rectifier—A device which suppresses one of the impulses of an alternating current, so that it is actually transformed into a current consisting of a series of spurts in one direction. That this could be done was one of the essential discoveries of radio.

Resistance—The opposition offered to the flow of a current.

Rheostat—A variable resistance used to regulate the flow of electric current.

Selectivity—The ability to choose any wave length to the exclusion of all other waves lengths in receiving.

Static—Natural electric discharges or interference by the elements of nature which are heard in radio receiving and which are the bane of all radio operators.

Transformer—A device used to change electric energy from one state to another—either from alternating to direct or direct to alternating under varying conditions.

Vacuum Tube—The electron tube consisting of incandescent bulb with film, grid and plate already described. See Audion.

Volt—The unit of electrical pressure.

Wave Length—The distance from the crest of one ether wave to another, which is always computed in meters.