

The RADIO DEALER

Vol. 2 No. 5 FEBRUARY, 1923 One Dollar The Year

Published monthly at 1133 Broadway, New York, N. Y., by The Radio Dealer Company. Entered as Second Class Matter, at the Post Office at New York, N. Y., under the Act of March 3, 1879

The AUDIOPHONE Jr.
Loud Speaker



BRISTOL'S ONE STAGE
POWER AMPLIFIER



The AUDIOPHONE Sr.
Loud Speaker

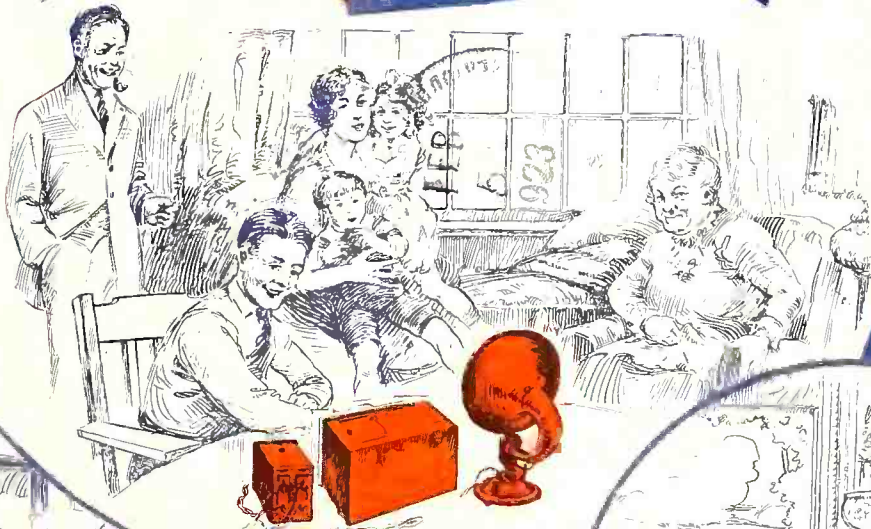

AT HOME

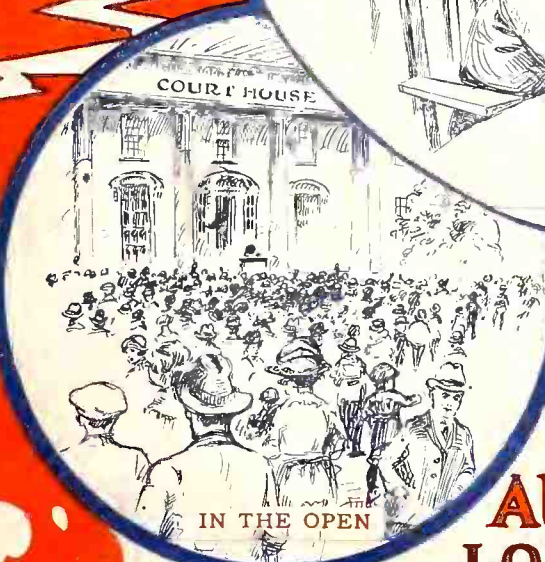

IN THE OPEN

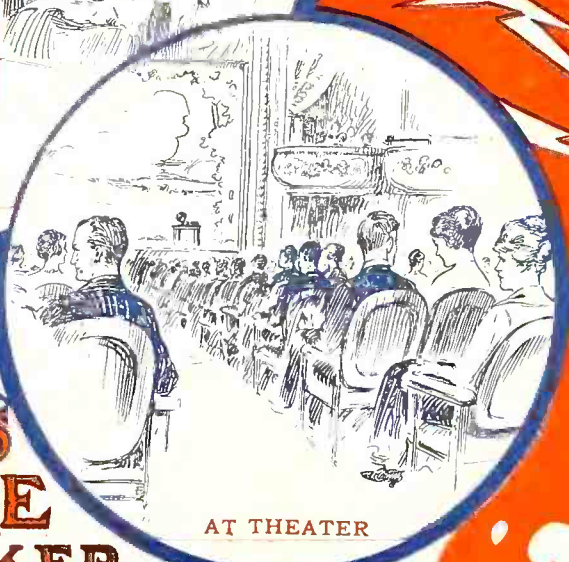

AT THEATER

ALL LISTEN IN

BRISTOL'S AUDIOPHONE LOUD SPEAKER

Wonderful results in Radio-Phone Receiving are secured by the complete Loud Speaker combination unit, including Bristol AUDIOPHONE Loud Speaker and Bristol One Stage Power Amplifier. The AUDIOPHONE gives a large volume of tone sufficient to be heard by everyone in a room seating several hundred persons. The quality is round and full, entirely free from mechanical distortion, and faithfully reproduces the original broadcasting. No Auxiliary Batteries are required to operate.

Constructed on a new principle of Audio Frequency, the Bristol One Stage Power Amplifier uses a circuit which does not require a C battery to maintain the grid

negative. So designed and constructed that no distortion of tone quality can be detected.

This equipment is designed and manufactured by The Bristol Company, an established engineering firm for over 30 years; and internationally known for their Recording Electrical Instruments and other power plant instruments of precision.

AUDIOPHONE, SR., Loud Speaker.....List \$40.00
AUDIOPHONE, JR., Loud Speaker.....List 22.50
Bristol ONE STAGE POWER AMPLIFIER....List 25.00

Write for Bulletins and Trade Discounts

THE BRISTOL COMPANY

WATERBURY, CONN.



NEW!

The RED SEAL Radio Sparker

for operating WD-11 Tubes

A Special Dry Battery that lasts nearly 3 times longer

THE introduction of the Red Seal Radio Sparker a month ago proved a sensation, both in the trade and to the public.

The Radio Sparker is a special battery designed for operating the WD-11 dry battery tube. It is composed of special cells intended for radio work. Radio Sparkers will give longer service and better satisfaction operating WD-11 vacuum tubes than a single dry cell. For instance, a two-cell Radio Sparker operating one WD-11 tube will last, not twice as long, but nearly three times as long as a single cell.

The Red Seal Radio Sparker is a light weight, complete unit. The internal connections between cells are soldered thus increasing their efficiency.

The Radio Sparker is distinguished by a new label of striking design and brilliant color. The reverse side of this label contains simple diagrams and instructions showing the proper method of connecting Radio Sparkers to receiving sets.

Everyone wants to use this new convenient method of operating tube receiving sets. Phone, write or wire your jobber for an assortment of Red Seal Radio Sparkers now. Every day's delay means lost sales.

The New Manhattan Genuine Bakelite Variocoupler, Variometer and Dials



Manhattan Variocoupler

The primary winding is provided with 12 taps—giving complete control up to a wave length of 700 meters. (List price \$6.50.)

"pigtales," making connection with the rotating member. This insures positive contact and quiet operation. Sufficient friction is provided to permit easy turning of the rotor and just sufficient binding to have it stay put in the position desired. A strong stop limits its movement to 180 degrees.

The stator of both the Variocoupler and Variometer is provided with a 1/4-inch collar, permitting the attachment of a standard 3-inch bakelite tube for constructing the

BOTH the Variocoupler and the Variometer are made of moulded, genuine reddish brown bakelite and have that fine attention to detail so much sought after by the critical buyer.

The amount of metal used in the instrument has been reduced to a minimum to keep the electrical losses as low as possible. Variocouplers and variometers are frequently mounted on "shielded" panels. Realizing this fact, we have provided a bakelite mounting block permitting the use of the variocoupler and variometer on a metal panel, thus eliminating all insulation difficulties. These are two distinctive features of Manhattan Variocouplers and Variometers.

Both instruments are provided with heavy braided



Manhattan Bakelite Dial

familiar "long wave" coupler. The demand for these new Manhattan instruments is piling up fast. Your order should be sent your jobber at once to avoid delay.



Manhattan Variometer

As commonly connected in a receiving set has a wave length of 140 to 420 meters. (List price \$6.50.)

MANHATTAN BAKELITE DIALS

The Manhattan line of genuine non-warping bakelite dials will appeal to those who desire precision and quality. The brass bushings for the shaft are accurately centered and insure perfect alignment. The engraving on the dials is extremely fine and clear. Manhattan Bakelite dials are made in 2", 3" 4" diameters for both 3/16" and 1/4" shafts and list at 60c, 75c and \$1.25 respectively.

M

MANHATTAN

ELECTRICAL SUPPLY CO. INC.

Makers of the famous Red Seal Dry Batteries, Radio Sparkers and Manhattan Radio Products

New York Chicago St. Louis San Francisco

CONDENSITE CELORON STANDARD RADIO PANEL

CONDENSITE
CELORON
STANDARD RADIO PANEL
Dielectric — easily worked — uniform quality

No. _____ Size _____
Manufactured by
DIAMOND STATE FIBRE COMPANY
Bridgeport, near Philadelphia, Pa., U.S.A.
London, Eng. Toronto, Canada

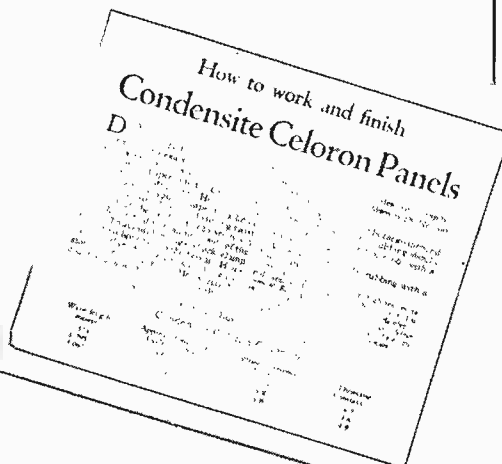

Put your panel troubles behind you

Do you cut your radio panels yourself? Or do you have them cut to your order?

In either case you are wasting time and energy and testing the patience of your customers. Save the delay, extra cost and trouble of having radio panels cut according to many different needs by selling Celoron Radio Panels cut in standard sizes, ready for immediate sale.

Each panel is a separate article, wrapped in glassine paper to protect the surface. On every one are size, number, and full instructions for working and finishing. You carry an article that is easily merchandised, has quick turnover, and admits of substantial profit.

Stock these Celoron panels before the height of the radio season passes. Let your customers know you carry them. When they buy, show them how to make their templates and drill their boards. Then sell them the other parts for a complete set.

Celoron is a leader among radio

insulations. It is easily worked, machine drilled and tapped and will engrave evenly without feathering. It has high insulation resistance, high dielectric strength, and low dielectric losses. These qualities have gained for it the approval of the U. S. Navy Department Bureau of Engineering and the U. S. Signal Corps.

You can obtain these panels in the following sizes, which have been selected because they meet practically every need of the radio set-builder.

- | | |
|------------------|-------------------|
| 1.—6 x 7 x 1/8 | 5.—9 x 14 x 3/16 |
| 2.—7 x 9 x 1/8 | 6.—7 x 21 x 3/16 |
| 3.—7 x 12 x 1/8 | 7.—12 x 14 x 3/16 |
| 4.—7 x 18 x 3/16 | 8.—7 x 46 x 3/16* |

* This strip for cutting special sizes. Not wrapped in glassine.

For your convenience we have made up two assortments of panels after a careful study of dealer requirements, and can ship them through your jobber immediately.

Put your radio panel troubles behind you. Send in your order today, designating by number the sizes you want. We will also be glad to send you on request, dealer helps in the shape of display cards and window strips for your store.

Diamond State Fibre Company

BRIDGEPORT (near Philadelphia) PENNSYLVANIA

BRANCH FACTORIES AND WAREHOUSES

BOSTON CHICAGO SAN FRANCISCO

Offices in Principal Cities

In Canada: Diamond State Fibre Company of Canada, Limited
245 Carlaw Avenue, Toronto

ATWATER KENT

Radio Receiving Sets and Parts

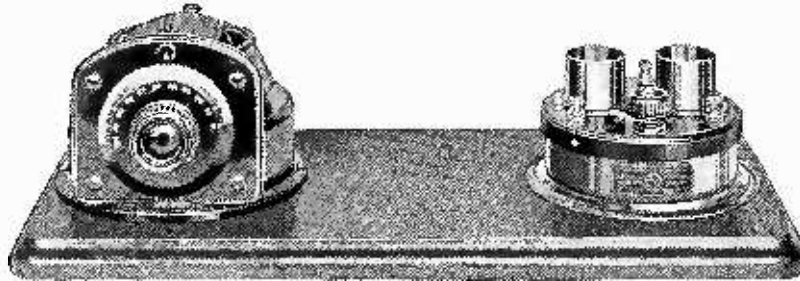

Complete Receiving Set—Coupled Circuit Tuner and Detector 1-stage Amplifier
A similar set is furnished with Detector 2-stage Amplifier



Mounted Variometer



Mounted Variocoupler



Detector Unit

ATWATER KENT products sell on appearance; they stay sold on quality of performance.

This is the reason for the popularity of ATWATER KENT Radio Equipment.

Look over the illustrations. They show a portion of the line, which includes complete sets, as well as parts from which the radio fan may build his own receiver.

There are various sets all mounted on mahogany bases and wired ready to attach to antenna and battery. No bothering with hook-up.

Use a set as *YOUR* demonstrator



Detector 1-stage Amplifier
A similar unit is furnished in a 2-stage Amplifier



Detector 2-stage Amplifier



Standard Tube Socket



1/2-Volt Tube Socket

ATWATER KENT MANUFACTURING COMPANY, PHILADELPHIA, PA.
Radio Department 4941 STENTON AVE. Write for Literature

ATWATER KENT

Radio Receiving Sets and Parts



Complete Receiving Set—Coupled Circuit Tuner, Detector Unit and 2-stage Amplifier
This Set is also furnished without Amplifier

THESE sets are attractive enough in appearance to be installed in the most "exclusive" home or club; moderate enough in price to be within reach of anyone; and excellent enough in operating qualities to satisfy the most particular.

For the fan who wants to experiment with varying hook-ups there are parts which will meet every requirement.

ATWATER KENT Radio Sets and Units sell readily and are a very profitable line.

They're always SEEN in the show windows



Unmounted Variometer



Unmounted Variocoupler



Condensite Dials
in 50 or 100 pt. graduations
for $\frac{3}{16}$ " or $\frac{1}{4}$ " shafts



Type L Transformer A.F.



Transformer A.F.

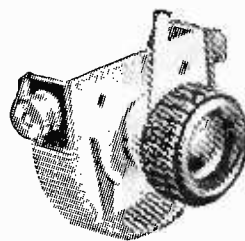

Panel Rheostat



Table Rheostat

ATWATER KENT MANUFACTURING COMPANY, PHILADELPHIA, PA.

Radio Department

4941 STENTON AVE.

Write for literature

"WD 12"

The Only AMPLIFIER TRANSFORMER Especially Designed for Use With WD 11 TUBES

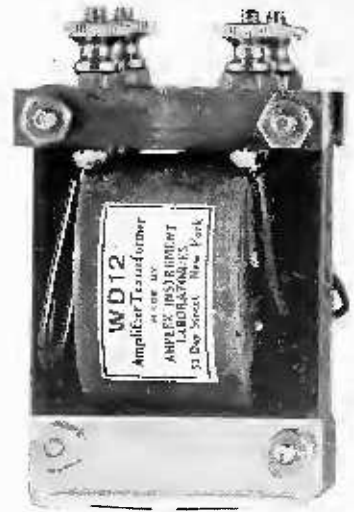

Over 200,000 WD 11 tubes sold within the past two months and "WD 12" the ONLY transformer especially designed for their use

"WD 12" makes the volt and one-half set "Speak Up" like a 6 volt set

List Price, \$5.00

Endorsed by engineers and thousands of fans. Used and recommended by leading manufacturers
Send for our special introductory offer

AMPLEX INSTRUMENT LABORATORIES, 57 Dey St., New York, N.Y

Self Deception Is The Worst Deception

Are you fooling yourself?

Do you know that you can make a better product at less cost?

Do you know how your product ranks by comparison with American standards of simplicity, efficiency and cost?

Do you know that the facts regarding your product can be impartially and authoritatively determined?

GREGG and COMPANY, through their Radio Testing Laboratory, which has no connection with any manufacturing enterprise, can enable you to answer these questions to your satisfaction.

GREGG and COMPANY

165 Broadway

New York

Newark, N. J. Washington, D. C. St. Louis, Mo. Los Angeles, Cal. Mexico City, Mexico

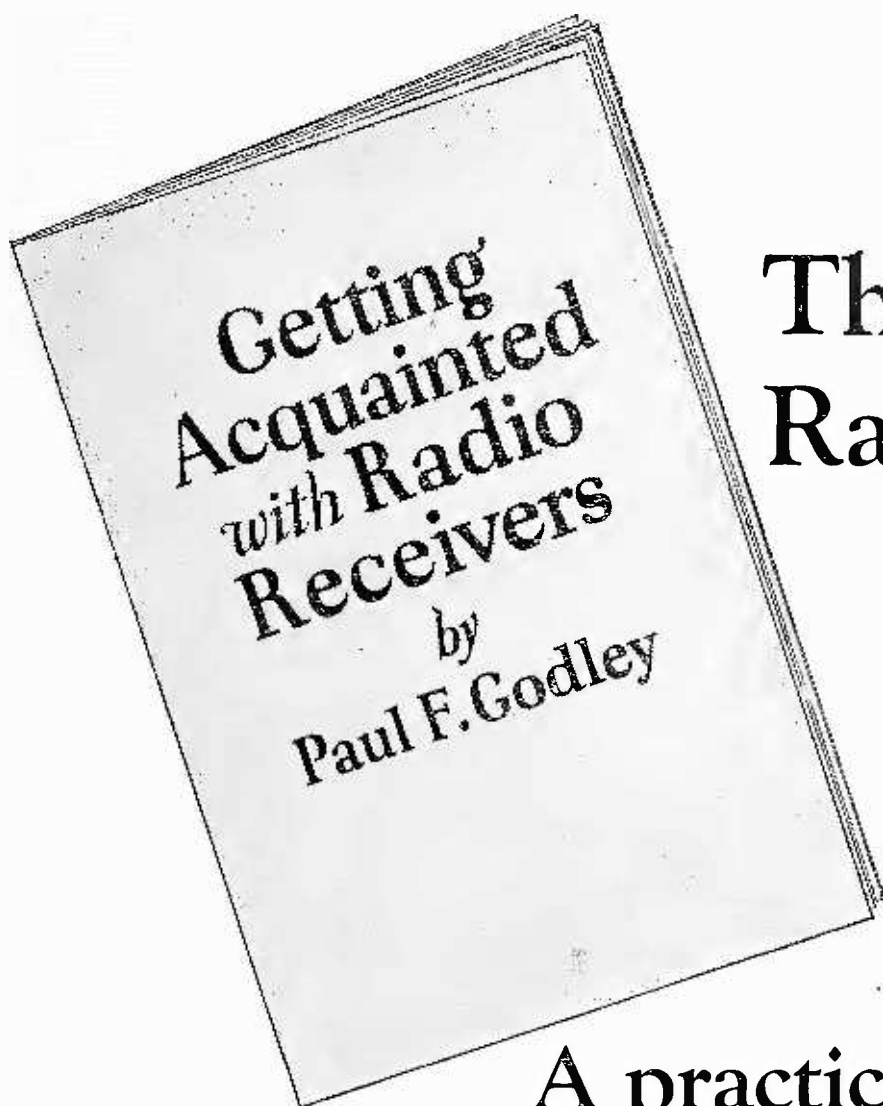

This Booklet on Radio Receivers Free to Dealers

A practical help in giving
the service that means more sales

PAUL F. GODLEY has written a booklet on radio receivers that every dealer who wants to give good service should send for at once. In simple, non-technical language it describes radio receivers, their functions, installation, operation and maintenance.

Everything is clearly explained with illustrations, circuit diagrams, plans for antennae, lay-out of apparatus, etc. It gives a *complete* and *correct* answer for every question a purchaser of a receiver is likely to ask.

Among the points covered are the following:

The Functions of a Radio Receiver

- Tuning Regenerative Receivers
- Why the "Tuner" Tunes
- What the Vacuum Tube Does
- The Vacuum Tube as an Amplifier

Installation

- Types of Antennae
- Ground Connections
- Lightning Protection

Locating the Receiver

- "A" Battery and Its Care
- "B" Battery and Its Selection
- Loud Speakers

Operation

- Adjusting the Vacuum Tubes
- Testing the Circuits
- Adapting the Receiver to the Antenna
- Wave Length Calibration

Maintenance and Tests for Faults

The Adams-Morgan Company believes that this booklet will prove of such great practical value to enterprising radio dealers who *want* to give service that it has arranged for a special edition to be supplied *free* to the trade. So long as this edition lasts a complimentary copy will be sent to any radio dealer on request. To the general public the price will be 25 cents a copy. As the special edition is for dealers only and limited in number, we suggest that you write promptly on your business letterhead.

ADAMS-MORGAN COMPANY, 12 Alvin Avenue, Upper Montclair, N. J.

FEBRUARY SPECIAL

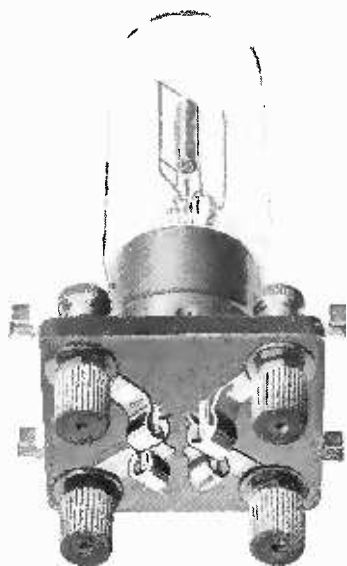

Every Dealer Can Profit By Selling the
Horton W D 11 Socket

The Only Socket With The
Bull Dog Grip Double Contact

Guaranteed Efficient

Sold To The Trade In Lots Of 50 Or More At

35 cents net

Retail Price, One Dollar

*Write for
Weekly
Special List*

HAROLD M. SCHWAB, Inc.
419 West 42nd Street New York
"Headquarters For Radio Bargains"

BRU PRODUCTS ELIMINATE STORAGE BATTERIES

BRU No. 6

Two Stage Amplifier
operates with *ANY*
detector unit—Crystal
or Tube. Very compact
List - - \$30.00



BRU No. 8

Tuner and Detector
permits sharp tuning.
Normal wave length,
200 to 550 meters:
List - - \$25.00

BRU No. 10
DETECTOR AND
TWO STAGE AM-
PLIFIER WITH
SUB-BASE.

List, \$65.00

The most compact
receiving set
made. All bat-
teries necessary are
concealed in sub-
base.

Only two con-
trols.

Will operate
good Loud Speaker
without distortion.

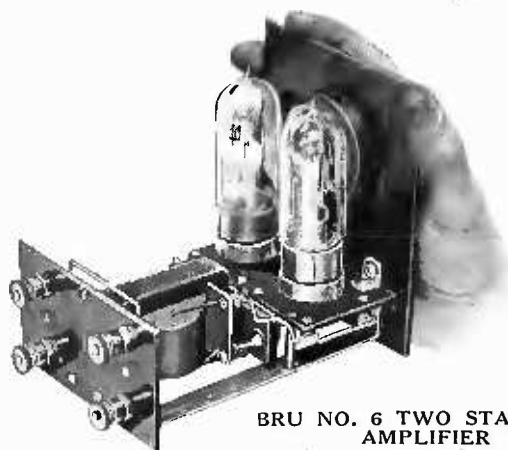

BRU NO. 6 TWO STAGE
AMPLIFIER
(cabinet not shown)

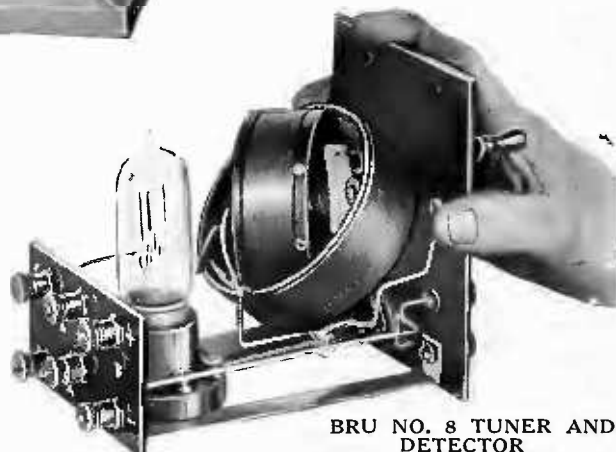

BRU NO. 8 TUNER AND
DETECTOR
(cabinet not shown)

BRUNO RADIO CORPORATION, 152 W. 14th St., New York, N. Y.

Wide Range Proves Crosley Efficiency

Sebring ~
Florida
Hears
Honolulu ~
Hawaii

HONOLULU

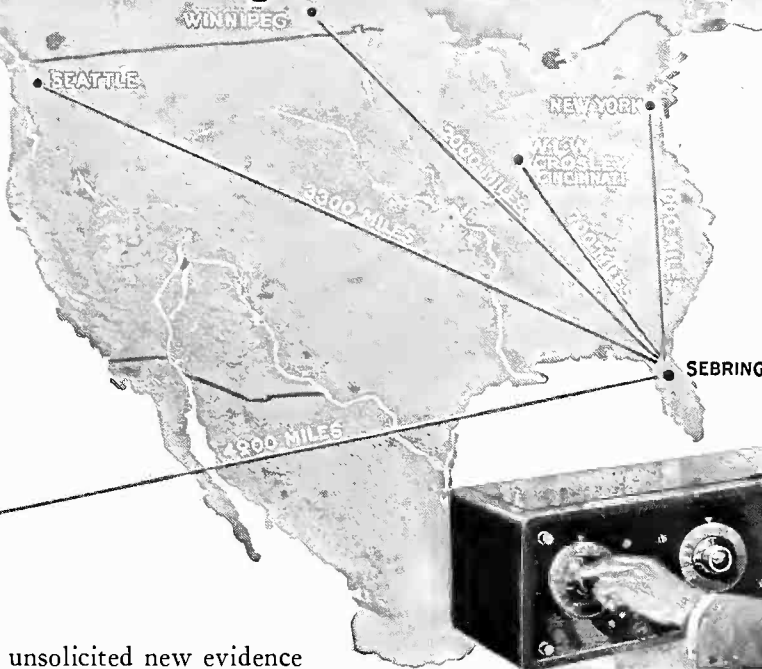

Every day there comes to us unsolicited new evidence of the remarkable results achieved with various models of Crosley Radio Receiving Sets.

Sebring, Fla., using a Model X Crosley Receiver — price only \$55 for this four-tube set — “Clearly hears three selections and two announcements from KDYX at Honolulu, 4,900 miles away.”

Centerburg, Ohio, receives 1,920 miles from Los Angeles, Calif.; 950 miles from Fort Worth, Tex.; 1,200 miles from Havana, Cuba; and 750 miles from South Dartmouth, Mass. A Crosley Model VI, a two-tube set that costs but \$28, was used.

With a Crosley Harko Senior, \$20 — a man from Rock Valley, Iowa, had these very satisfactory results: “I have tested out the Harko Senior and am ready to agree that you made no overstatements. We have heard Winnipeg, Canada; Dallas, Tex.; and many other points.”

Wide-awake radio dealers everywhere are making large profits handling the Crosley line.

They know that every Crosley Model does everything claimed for it — and more besides. They have found by experience that they are building a clientele of satisfied customers by pushing Crosley instruments.

From our smallest complete receiving outfit at \$25, including other sets incorporating Crosley radio frequency tuned amplification at \$28, \$48, \$55, and up to our beautiful Console Model XXV, price \$150, Crosley instruments offer the highest efficiency at the lowest cost.

We also manufacture a complete line of parts for those who wish to make their own outfit. Among these are Variable Condensers, Knobs and Dials, V-T Sockets, Variometers, Vario-Couplers, Rheostats and the well-known Crosley Radio Frequency Amplifying Tuner.

Write for Complete Catalog

CROSLEY
Better — Cost Less
RADIO RECEIVERS

CROSLEY MANUFACTURING COMPANY
232 ALFRED STREET CINCINNATI, OHIO

The Three Most Popular Receivers on the Market

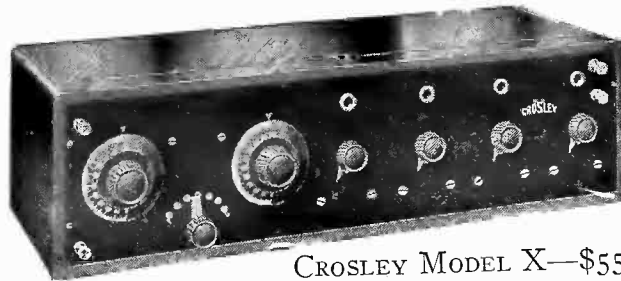

CROSLEY MODEL X—\$55.00

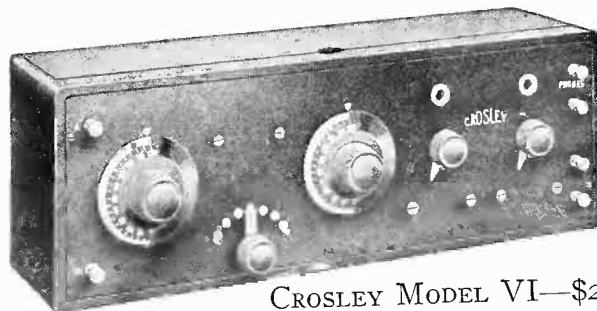

CROSLEY MODEL VI—\$28.00

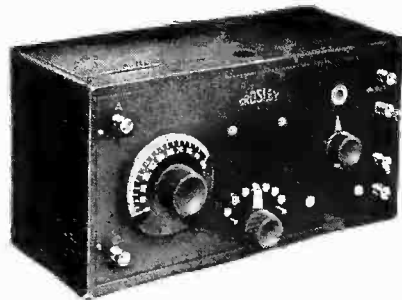

The Crosley Harko Senior, a one-tube non-regenerative receiver, of which thousands have been sold — retail price, \$14, \$15 and \$16. Similar instruments, but using Armstrong Regenerative Circuit, manufactured under license under Armstrong Patent No. 1,113,149, dated October 6, 1914, can be obtained from the manufacturers, The Precision Equipment Co., Powel Crosley, Jr., Pres., Cincinnati, Ohio. Write them direct.



KING QUALITY SWITCH LEVER

With perfect mechanical and electrical features. Mirror finish. Bakelite knob with polished knurl that glows like a diamond. 3 sizes: 1 in., 1 1/4 in., 1 1/2 in.



KING QUALITY
ALL THE NAME IMPLIES
RADIO APPARATUS

R-74 R-73 R-75 R-70
R-72 R-71 R-72 R-73 R-74 R-75 R-76 R-77 R-78 R-79 R-80

AN attractive dealer "help" —counter display— King Quality Binding Posts and Contact Points. Furnished on request — write for details.



KING QUALITY VACUUM TUBE SOCKET

Base of black or mahogany finished genuine moulded Bakelite with mirror finish; tube and terminal binding posts of brass nickel plated and highly polished.



KING QUALITY "UNIVERSAL" ADAPTER. R-10 designed to fit all tubes and valves.

NOT our claim of quality alone, but the opinions of some of the largest radio jobbers in the country are responsible for the widespread acceptance of the King Quality Line as the "best on the market." King Quality Radio parts look good, they sell better, but finally they prove Best in operation.

Have YOU stocked this fast-selling quality line? Write for catalog and prices—or send for samples to convince yourself.

RADIO APPARATUS DIVISION
King Sewing Machine Co. Buffalo, N. Y.
Lower in Price—Highest in Quality

Every Dealer

Every Manufacturer

Every Jobber

in

THE RADIO TRADE

Should be a member of

The Radio Trade Association

Full details may be obtained at headquarters

The Radio Trade Association

1133 Broadway, New York City

Officers and Directors are:

Henry M. Shaw, Shaw Insulator Company, Newark, N. J., president.

Hugh H. Eby, H. H. Eby Company, Philadelphia, Penna., treasurer.

Laurence A. Nixon, The Radio Dealer, New York City, secretary.

W. B. Curtis, Curtis Sales Company, Newark, N. J., first vice-president.

Laurence I. Mott, San Francisco, Calif., second vice-president.

R. P. Clarkson, Radio Mica Products Company, New York City, third vice-president.

Raymond Francis Yates, Permanent Radio Fair, New York City, fourth vice-president.

Chauncey P. Carter, trade mark attorney, Washington, D. C., fifth vice-president.

W. L. Sayre, Sayre Level Company, Philadelphia, Pa., sixth vice-president.

The Board of Directors is composed of the following:

Paul F. Johnson, Altadena Radio Laboratory, Pasadena, Calif.

Arthur Halloran, publisher, Radio, San Francisco, Calif.

J. H. Smith, Virginia Radio Company, Charlottesville, Va.

Wm. A. Debold, Oklahoma City Radio Company, Oklahoma City, Okla.

Bert B. Barsook, jobber, Chicago, Ill.

Powell Crosley, Jr., Crosley Manufacturing Company, Cincinnati, Ohio.

F. Clifford Estes, The Clapp-Eastham Co., Cambridge, Mass.

F. D. Pitts, F. D. Pitts Company, Boston, Mass.

Harold M. Schwab, Harold M. Schwab, Inc., New York City.

M. B. Sleeper, Jr., Sleeper Radio Corp., New York City.

W. M. Kunkel, Pittsburgh Radio & Appliance Company, Pittsburgh, Pa.

C. H. Love, L. F. Grammes & Sons, Allentown, Pa.

F. H. Pruden, F. H. Pruden Co., Jersey City, N. J.

Mortimer Salzman, Wholesale Radio Equipment Co., Newark, N. J.



THE RADIO DEALER—A MERCHANT

THE business of the Dealer in Radio parts is to sell merchandise. He should not be called upon to act as a consulting engineer to buyers of Radio parts who are building their own sets.

Every responsible Dealer is quite willing to advise his customers in the selection of units which will give satisfaction. His function should end there. "Giving service" does not mean that his time should be consumed in going into the details of lay-out and wiring.

Dealers have learned that radio parts of unquestioned merit do not give satisfaction unless properly applied. The correct physical location of units, in their relation one to the other and proper wiring are essential in order that good results may be obtained. The numerous requests to exchange parts, which every Dealer receives, emphasizes this fact.

We believe the parts and panels, which we are now offering, solve many of the Dealer's problems.

All parts are of advanced design. There is no tap switch to be mounted, as an internal switch is provided in the variocoupler. Binding posts, properly located, are placed on each unit. The necessity for complicated wiring and cross-leads is eliminated.

Aluminum panels in four stock sizes make unnecessary all drilling of holes and use of shielding. Proper spacing of units is assured. Uniform size openings in panels permit mounting of all parts interchangeably.

DESCRIPTIVE FOLDERS ON REQUEST

EISEMANN MAGNETO CORPORATION

WILLIAM N. SHAW, *President*

DETROIT

BROOKLYN

CHICAGO

First In The Field

The Radio Dealer (monthly edition) leads the field of Radio publications *because it has the circulation.*

The following analysis is of PAID Circulation, note printer's statement of press run.

Circulation By States THE RADIO DEALER

Alabama.....	21	East Orange....	10
Arizona.....	11	Elizabeth.....	17
Arkansas.....	5	Jersey City....	44
California.....	286	Newark.....	191
Los Angeles....	34	Paterson.....	19
Oakland.....	13	Trenton.....	27
San Francisco..	67	New Mexico.....	2
Colorado.....	28	New York.....	1094
Denver.....	14	N. Y. City....	710
Connecticut.....	185	Brooklyn....	144
Bridgeport....	12	Buffalo.....	28
Hartford.....	17	North Carolina....	27
New Haven....	12	North Dakota....	5
Waterbury....	12	Ohio.....	236
Delaware.....	11	Cleveland....	34
Wash., D. C....	34	Cincinnati...	18
Florida.....	25	Columbus....	13
Georgia.....	42	Toledo.....	22
Idaho.....	13	Oklahoma.....	15
Illinois.....	537	Oregon.....	11
Chicago.....	337	Pennsylvania....	240
Indiana.....	87	Pittsburgh...	84
Indianapolis..	18	Philadelphia..	68
Iowa.....	35	Rhode Island....	14
Kansas.....	33	Providence...	12
Kentucky.....	5	South Carolina...	9
Louisiana.....	23	South Dakota....	2
Maine.....	12	Tennessee.....	14
Maryland.....	10	Texas.....	75
Massachusetts..	224	Dallas.....	43
Boston.....	88	Utah.....	13
Michigan.....	183	Vermont.....	12
Detroit.....	109	Virginia.....	20
Minnesota.....	41	Washington.....	37
Mississippi.....	14	West Virginia...	19
Missouri.....	195	Wisconsin.....	106
Montana.....	18	Milwaukee...	63
Nebraska.....	24	Wyoming.....	2
New Hampshire..	10	Canada.....	41
New Jersey.....	662	Foreign.....	185
Atlantic City..	19		
Camden.....	18		

Tot. Pd. Circ't'n..4958

The Williams Printing Company

Complete Manufacture of Publications

Eleventh Avenue, 36th to 37th Streets

New York City

October 2, 1922.

The Radio Dealer
1133 Broadway,
New York City.

Attention Mr. L. A. Nixon

Dear Sir:

I, Roy L. Atwood, Manager of The Williams Printing Company, hereby testify that we have printed and bound Eight Thousand (8000) copies of the current issue of the "Radio Dealer".

Very truly yours,

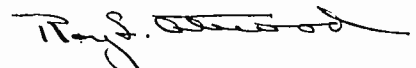

for THE WILLIAMS PRINTING COMPANY.

State of New York)
) Se;
County of New York)

On this second day of October 1922, before me came Roy L. Atwood to me known to be the person who subscribed the foregoing instrument and acknowledged that he executed the same freely and for the purposes therein set forth.

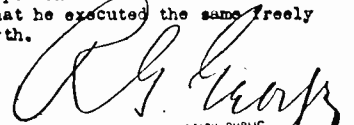

NOTARY PUBLIC
N. Y. COUNTY CLERK'S N. 1224
N. Y. COUNTY REGISTER N. 1224
BY COMMISSION EXPIRES MARCH 31, 1923

First In The Field

THE RADIO DEALER

1133 Broadway, New York, N.Y.

35 South Dearborn St., Chicago, Ill.

LIST OF ADVERTISERS

(Advertisers Indexed by Products will be found on Pages 16 and 17 of this issue.)

A		Federal Tel. & Tel. Co..... 47	M. P. M. Sales Co..... 48	Spiro Brothers 67	
Adams-Morgan Co. 7	Fiber Products Co..... 38	Mu-Rad Laboratories, Inc.... 41	S. S. Novelty Co..... 40	Standard Appliance Mfg. Co.. 66	
Ajax Radio Corp..... 56	Fischer & Co., G. H..... 66	Mydar Radio Corp., The..... 53	Standard Crystal Co. 67	Standard Metal Mfg. Co..... 39	
Allen-Bradley Co. 69	Ford Mica Co., Inc..... 48	N			
American Hard Rubber Co.. 46	French Battery & Carbon Co. 60	National Vulcanized Fibre Co. 16	Stanton Co., Frank T..... 44	Standard Mineral Co..... 68	
Amplex Instrument Labs.... 6	Freshman Co., Inc., Chas.... 61	New York Coil Co..... 5	Star Mfg. Co..... 41	States Electric Co..... 44	
Andrae & Sons Co., Julius... 46	G				
Aremco Mfg. Co..... 70	General Merchandise Co..... 20	New York Hard Rubber Turn- ing Co. 64	Steinmetz Wireless Mfg. Co... 42	Strauss & Blum, Inc..... 62	
Arrow Radio Co.....60, 64	Gibbons Dustin Radio Mfg. Co. 70	New York Radio Dial Co..... 44	Stuckeman Bros., Inc..... 42	Superior Products Mfg. Co... 68	
Astorloid Mfg. Co., Inc..... 60	Goetz Co., The Edw. J..... 56	New York Testing Labora- tories 67	T		
Atlantic & Pacific Radio Co.. 56	Gould Storage Battery Co... 56	North Ward Radio Co..... 65	T. B. H. Corporation..... 50	T. F. Radiophone Co..... 62	
Atwater Kent Mfg. Co.....4, 5	Gregg & Co..... 6	Novo Manufacturing Co..... 66	Thornton Transformer Co.... 62	Thresher Radio Corp..... 64	
Automatic Electrical Devices Co. 43	H				
B		Hafner Manufacturing Co... 64	O		
Bathgate, Walter E..... 66	Hammarlund Mfg. Co., Inc... 66	Orange Research Lab..... 69	T. B. H. Corporation..... 50		
Bayley Condenser Co..... 61	Harris Laboratory, The..... 62	Oranola Radio Corp..... 56	T. F. Radiophone Co..... 62		
Bel-Canto Corp..... 57	Heinemann Electric Co. 45	P			
Betts & Betts..... 43	Holloway Elec. Supply Co., Inc. 56	Paramount Machine Co..... 70	Thornton Transformer Co.... 62		
Box M 21..... 54	Hudson-Ross62, 64	Permanent Radio Fair..... 49	Thresher Radio Corp..... 64		
Bremer-Tulley Radio Co..... 70	Hyman & Co., Inc., Henry... 52	Pittsburgh Radio & Appliance Co., Inc. 42	Trade Circular Addressing Co. 44		
Briggs & Stratton Co..... 18	I				
Bristol Co., The.....Front Cover	Inter-Ocean Radio Corp..... 45	Planet Radio Corp. 79	True-Tone Radio Mfg. Co.... 27		
Bruno Radio Corp..... 8	J				
C		Jackson, P. D..... 66	U		
Carbon Products Co., The.... 38	Jewett Corp Co..... 35	Q. T. Light Co..... 54	Union Radio Corp..... 60		
Central States Eng. Co..... 70	K				
Chaslyn Co. 46	Kern, Emil Alexander 64	V			
Clapp-Eastham Co. 64	King Sewing Machine Co.... 10	V-De-Co Radio Mfg. Co.... 40	Victor Radio Corp..... 46		
Commercial Screw Machine Co. 66	Kramer Radio Co..... 46	Viking Radio Co..... 66	Virginia Radio Corp..... 50		
Continental Fibre Co., The.. 51	L				
Copper Clad Steel Co., The.. 42	LaFrance Import & Sales Co., Inc. 52	W			
Cozzone & Co., John A..... 70	Lewis & LeRoy Radio Corp... 66	Wald Elec. Co..... 64	W. B. L. Radio Co.....62		
Crosley Mfg. Co. 9	M				
Crown Radio Mfg. Corp..... 37	Maclite Storage Battery Co... 44	W. E. Supply & Service Co... 46	Western Rubber Mold & Batty. Co. 50		
Culin, Curtis C..... 66	Magna Instrument Co..... 47	Weston Elect. Instrument Co. 17	Westphal Mfg. Co..... 65		
D		Magnovox Co. 33	White Radio Co..... 79		
Diamant Tool & Mfg. Co., Inc. 56	Manhattan Electric Supply Co. Inside Front Cover	Rauland Mfg. Co..... 52	Wilcox Laboratories 42		
Diamond State Fibre Co.... 3	Manufacturers Patent Co.... 64	R-C Outlet, The 64	Wilmington Electric Specialty Co., Inc. 57		
E		Marle Engineering Co..... 59	Z		
Eagle Radio Co. 36	Mercury Radio Products Co... 40	Ross-Gould Co. 56	Wilson, Inc., A. M..... 46		
Eby Mfg. Co., The H. H..... 67	Mica Insulator Co. Inside Back Cover	Royal Electric Laboratories. 66	Winkler, Inc., Chas..... 64		
Egyptian Lacquer Mfg. Co.... 58	Milliken Bros. Mfg. Co., Inc. 49	Rusonite Products Corp..... 70	Zwingenberger, Otto K..... 64		
Eisemann Magneto Corp.... 11	Mills Radio & Elec. Co..... 46	S			
Electric Service Supplies Co. 63	Mitchell-Rand Mfg. Co..... 66	Saturn Mfg. & Sales Co., Inc. 54	Save Sales Co..... 63		
Electric Products Co..... 56	Moon Radio Corp..... 55	Save Sales Co..... 63	Schwab, Harold M., Inc..... 8		
Ell-Ess Radio Exchange.... 66	N				
Eshoo Cabinet Works, E..... 44	National Vulcanized Fibre Co. 16				
Essex Mfg. Co..... 64	New York Coil Co..... 5				
European Radio Co.....44, 46	New York Hard Rubber Turn- ing Co. 64				
F		New York Radio Dial Co..... 44			
Fallgatter, Marvin B..... 46	New York Testing Labora- tories 67				
F		North Ward Radio Co..... 65			
F		Novo Manufacturing Co..... 66			
F		Nuloid Corporation 46			

Let Our Free Service Bureau Help You Supply Your Needs

Tell us your needs and we'll put you in touch with reputable firms to the end that you will receive information on the latest and best equipment. A post card will do or use the coupon below.

- | | | | | |
|---|---|---|--|---|
| <p>A</p> <p>1 "A" Batteries
2 Aerials
3 Aerial wire
4 Aerial protectors
5 Aerial switches
6 Aerial insulators
7 Aerials, loop
8 Air condensers
9 Adapters
10 Amplifiers
11 Amplifying units
12 Aluminum wire
13 Ammeters
14 Amplifying tubes
15 Amplifying horns
16 Amplifying transformers
17 Antennae, cage
20 Antenna light wire plugs
18 Audio frequency transformers
19 Automatic transmitters</p> <p>B</p> <p>21 "B" Batteries
22 Batteries, "A"
23 Batteries, dry
24 Batteries, storage
25 Battery chemicals
26 Battery chargers
27 Battery testing instruments
28 Battery switches
29 Battery rheostats
30 Battery clips
31 Battery handles
32 Battery potentiometers
33 Binding posts
34 Books
39 Boxes
35 Brass parts
36 Bushings
37 Bulbs
38 Buzzers</p> <p>O</p> <p>41 Cabinets
42 Cam switches
43 Carbon potentiometers
44 Change-over switches
45 Charging rectifiers
46 Choke coils
47 Cat whiskers
48 Cap nuts
49 Carbon walls
50 Cardboard tubes
78 Charts
51 Chopper, rotary
52 Clamps
53 Clips
54 Coils
55 Coil mountings
56 Coil plugs
57 Coils, spark
58 Condensers
59 Condensers, fixed
60 Condensers, variable
61 Condensers, air</p> | <p>62 Condensers, mica
63 Condensers, loading
64 Connection blocks
77 Contract work
65 Control panels
66 Condenser parts
67 Copper wire
68 Cords
69 Cord tips
70 Crystals
71 Crystal detector units
72 Crystal receiving sets
73 C. W. Transmitter sets
74 C. W. Filament heated transformers
75 C. W. Inductances
76 C. W. Power transformers</p> <p>D</p> <p>81 Detectors
82 Detector panels
83 Detector tubes
84 Detector minerals
85 Detector units
86 Dictionary, Radio
87 Dials
80 Dial switches
88 Dry batteries
89 Drawings
90 Diagrams</p> <p>E</p> <p>91 End mountings (tubes)
92 Engraving
93 Electrotypes</p> <p>F</p> <p>95 Fibre spools
96 Fan switches
97 Filter reactors
98 Fixed condensers
99 Fire extinguishers
100 Filament rheostat
101 Filter coils
102 Flashlights
103 Fuse terminals</p> <p>G</p> <p>106 Gaps, Spark
107 Generators
105 Glass
108 Grid condensers
109 Grid leaks
110 Grid leaks, variable
111 Grid coils
112 Ground clamps
113 Ground wires
114 Ground switches</p> <p>H</p> <p>116 Headsets and bands
117 Honeycomb coils
118 Honeycomb mountings
119 Honeycomb plugs
120 Hook switches
121 Horns
122 Hydrometers</p> | <p>I</p> <p>126 Indicators
127 Inductances, C. W. Transmitting
128 Insulators
129 Insulation
130 Invention developments</p> <p>J</p> <p>131 Jacks</p> <p>K</p> <p>132 Knock down units</p> <p>L</p> <p>136 Lead-in wire
137 Lead-in switches
138 Lead-in bushings
139 Lead-in insulators
140 Levers, Switch
141 Lightning arrestors
142 Lightning switches
143 Loading coils
144 Loading inductance
145 Loose couplers
146 Loud speakers
147 Locked lever switches
148 Lock nuts
149 Loop aerials
150 Lugs</p> <p>M</p> <p>313 Mailing lists
314 Metals
151 Magnetic modulator
152 Modulation transformers
153 Machine screws
154 Magnet wire
155 Magazines, Radio
156 Mica
157 Mica diaphragms
158 Mica condensers
159 Mica diaphragm transformers
160 Microphone transformers
161 Milliammeters
162 Milli-voltmeters
163 Motors
164 Motor generators
165 Mounting coils
166 Minerals
167 Mountings</p> <p>N</p> <p>171 Name plates
172 Nickel parts
173 Nuts</p> <p>O</p> <p>176 One stage amplifier units
177 Oscillation transformers</p> <p>P</p> <p>178 Panels
179 Panel plugs
180 Panel controls
181 Paper tubes
311 Patent registration</p> | <p>182 Patent wire
183 Patent wire terminals
184 Plans
185 Phonograph attachments
186 Plate condensers
187 Porcelain
188 Porcelain cleats
189 Porcelain insulators
190 Porcelain mountings
191 Porcelain tubes
192 Porcelain V. T. receptacles
193 Porcelain V. T. sockets
194 Precision instruments
195 Polarity indicators
196 Plate connectors
197 Paste solder
198 Phosphor-bronze wire sheets</p> <p>Q</p> <p>307 Quenching spark gaps</p> <p>R</p> <p>308 Radio books
309 Radio schools
310 Radio publications
199 Radio frequency transformers
200 Reactor, plate circuit
201 Reactor, filter
202 Receiving sets
203 Receiving head sets
204 Receiving transformers
205 Receptors
206 Receiver magnets
207 Rectifiers
208 Rectifying tubes
209 Regenerative sets
210 Rheostats
211 Rheostat wire
212 Rods
213 Rotary lever switches
214 Rotary spark gaps
215 Rotary variable condensers
216 Rubber parts
217 Rotors</p> <p>S</p> <p>221 Safety switches
222 Safety fuses
223 Sliders and rods
224 Sockets
225 Soft metal
226 Shielded dials
227 Short wave sets
228 Solder
229 Solder, bar
312 Soldering irons (electric)
230 Spark transformers
231 Spark coil selectors
232 Spaghetti tubing
233 Special apparatus
234 Spark gaps
235 Spring clips
236 Storage batteries
237 Sectional receiving sets</p> | <p>238 Switches
239 Switch levers
240 Switch points
241 Symbols</p> <p>T</p> <p>246 Tapes
247 Telephone cord
248 Telephone plugs
249 Telephone receivers
250 Telegraph keys
251 Telegraph teachers
252 Testing instruments
253 Testing clips
254 Terminals
255 Thermometers
256 Tools
257 Trade marks
258 Transformers
259 Transmitters
260 Transmitting sets
261 Towers
262 Three coil mounting
263 Tin foil
264 Tuning coils
265 Tubes, amplifier
266 Tubes, detector
267 Tubing, flexible
268 Tube sockets
269 Tubes
270 Tuner and detector cabinets
271 Two stage cabinets
272 Two stage amplifier unit</p> <p>U</p> <p>276 Unit type receiving sets
277 Unassembled sets</p> <p>V</p> <p>281 Vacuum tubes
282 Vacuum tube sockets
283 Variable condensers
284 Variometers
285 Vario couplers
286 Variable grid leak
287 Vernier adjusters
288 Vibrators
289 Vocalouds
290 Voltmeters
291 Vulcanized fibre sheets
292 V. T. receiving sets
293 Variogrid leak
294 V. T. detector units
295 V. T. control units
296 V. T. receptacle</p> <p>W</p> <p>297 Washers
298 Watch case receivers
299 Wattmeters
300 Wavemeters
301 Wave tuner
302 Wire
303 Wire, aerial
304 Wire phosphor bronze
305 Wire, copper clad
306 Wire, magnet</p> |
|---|---|---|--|---|

Note the number of the item you want to buy—then check the corresponding number in the coupon below and mail to us.

-----TEAR OFF HERE-----

1	2	3	4	5	6	7	8	9	10	11	12	13	14	15	16	17	18	19	20	21
22	23	24	25	26	27	28	29	30	31	32	33	34	35	36	37	38	39	40	41	42
43	44	45	46	47	48	49	50	51	52	53	54	55	56	57	58	59	60	61	62	63
64	65	66	67	68	69	70	71	72	73	74	75	76	77	78	79	80	81	82	83	84
85	86	87	88	89	90	91	92	93	94	95	96	97	98	99	100	101	102	103	104	105
106	107	108	109	110	111	112	113	114	115	116	117	118	119	120	121	122	123	124	125	126
127	128	129	130	131	132	133	134	135	136	137	138	139	140	141	142	143	144	145	146	147
148	149	150	151	152	153	154	155	156	157	158	159	160	161	162	163	164	165	166	167	168
169	170	171	172	173	174	175	176	177	178	179	180	181	182	183	184	185	186	187	188	189
190	191	192	193	194	195	196	197	198	199	200	201	202	203	204	205	206	207	208	209	210
211	212	213	214	215	216	217	218	219	220	221	222	223	224	225	226	227	228	229	230	231
232	233	234	235	236	237	238	239	240	241	242	243	244	245	246	247	248	249	250	251	252
253	254	255	256	257	258	259	260	261	262	263	264	265	266	267	268	269	270	271	272	273
274	275	276	277	278	279	280	281	282	283	284	285	286	287	288	289	290	291	292	293	294
295	296	297	298	299	300	301	302	303	304	305	306	307	308	309	310	311	312	313	314	315

Service Bureau The Radio Dealer,
1133 Broadway, New York City.

We are interested in buying radio equipment and have circled the numbers on this coupon of the items we are ready to buy now. Please have manufacturers of these lines quote us dealers' prices.

Name.....

Address.....

.....

..... We are
---Retailers
---Jobbers

..... 1923

Radio Trade Pictures



This photograph was taken at a meeting of the district managers and sales department of C. Brandes, Inc., that was recently held in New York City. The following offices of the organization were represented: Boston, Chicago, Minneapolis, San Francisco, Pittsburgh, Huntington, Atlanta and Washington. At the meeting, the general opinion expressed was that business is rapidly stabilizing, and will broaden on a firmer foundation. Increased business is looked for in 1923 over 1922.

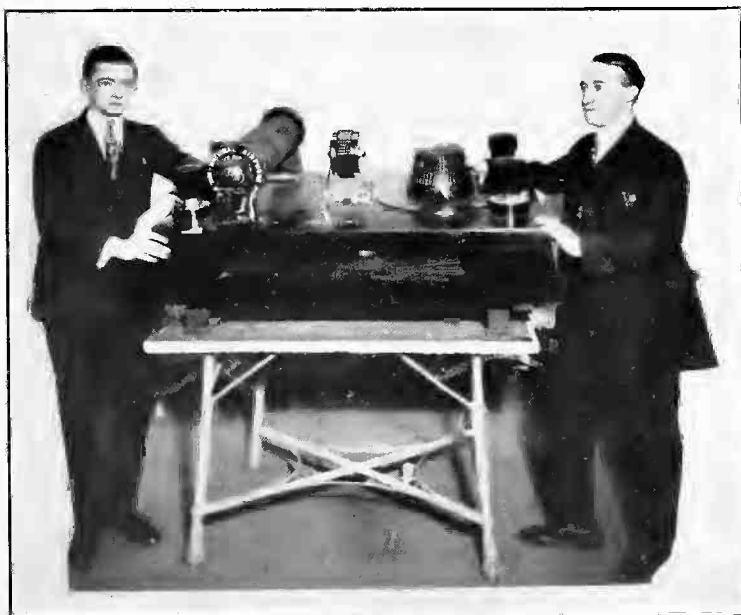

This is the monster National Airphone, Model G, that was recently exhibited. It is over five feet long, and weighs over 200 pounds. It is probably the largest crystal set that was ever manufactured. It was made by the National Airphone Corp., 16-22 Hudson Street, New York.



The giant Rico headset was one of the exhibits at the New York Radio Show. The cord is 50 feet long, the receiver weighed over 150 pounds, and all parts were of proportionate size. It is said that this big headset actually worked. This apparatus was made by the Radio Industries Corp., 131 Duane Street, New York.

ANNOUNCING
the consolidation
of the

**National Fibre &
Insulation Co.**

the

Keystone Fibre Co.

and the

**American
Vulcanized Fibre Co.**

In order that we
may unify our efforts
to better serve our
customers and
through them the
public—we have con-
solidated and in the
future will be known

as the

**National
Vulcanized
Fibre Co.**

of Wilmington, Delaware



Where to Buy

A Handy Guide For The Convenience of Our Readers

AMPLIFIER UNITS		CRYSTAL DETECTORS	
Magna Instrument Co.....	59	Culin, Curtis C.....	66
Steinmetz Wireless Mfg. Co...	42	European Radio Co.....	46
AMPLIFIERS		M. P. M. Sales Co.....	48
Standard Metal Mfg. Co.....	39	CRYSTAL RECEIVERS	
Arrow Radio Co.....	60	Holloway Elec. Supply Co., Inc.	56
AMPLIFYING TRANSFORMERS		CUSTOM BUILT SETS	
Rauland Mfg. Co.....	52	Lewis & De Roy.....	66
ANTENNA WIRE		DETECTOR-AMPLIFIER TUBES	
Copper Clad Steel Co.....	42	La France Import & Sales Co., Inc.	52
BATTERY CHARGERS		DETECTOR STANDS	
The Automatic Elec. Devices Co.	43	Box M 21	54
BATTERY TESTERS		DIALS	
Chaslyn Co.	46	N. Y. Radio Dial Co.....	44
Hafner Mfg. Co.....	64	DISTRIBUTORS	
Western Rubber Mold & Batty. Co.	50	Andrae & Sons Co., Julius....	46
" B " BATTERIES		Ell-Ess Radio Exchange.....	66
French Battery & Carbon Co..	60	Goetz Co., The Edw. J.....	56
Gould Storage Battery Co....	56	Hudson-Ross	62
Novo Mfg. Co.....	66	Kramer Radio Co.....	46
BATTERIES		North Ward Radio Co.....	65
Carbon Products Co.....	33	Radio Distributing Co., Back Cover	
Manhattan Electric Supply Co. Inside Front Cover		Radio Shop of Newark, The..	62
BESTONE PRODUCTS		Radio Stores Corporation....	64
Henry Hyman & Co., Inc....	52	Schwab, Harold M.....	8
BINDING POSTS		Virginia Radio Corp.....	50
The H. H. Eby Mfg. Co.....	67	Wilmington Electrical Spe- cialty Co., Inc.....	57
BOOKS		DRY CELL SETS	
Central States Engineering Co.	70	Q. T. Light Co.....	54
CABINETS		ENGRAVING	
E. Esho Cabinet Works.....	44	Paramount Machine Co.....	70
Marvin B. Fallgatter.....	46	EXPOSITIONS	
COIL MOUNTINGS		Permanent Radio Fair.....	49
Astorloid Mfg. Co.....	60	HEAD SETS	
Crown Radio Mfg. Co.....	37	Royal Electric Laboratories... 66	
COMPLETE LINE		Superior Products Mfg. Co.... 68	
Adams-Morgan Co.....	7	Thresher Radio Corp.....	64
Atwater-Kent Mfg. Co.....	4, 5	True Tone Radio Mfg. Co.... 51	
Briggs & Stratton Co.....	18	HORNS	
Hudson-Ross	64	Fiber Products Co.....	38
Mills Radio & Elec. Co.....	46	INDOOR AERIALS	
Signal Radio & Elec. Corp.... Inside Back Cover		Short Cut Radio Corp.....	20
COMPOSITION		INSULATION	
Nuloid Corp.	46	National Vulcanized Fibre Co. 16	
CONDENSERS		Diamond State Fibre Co.....	3
Freshman Co., Charles	61	JACKS	
Spiro Bros.	67	Saturn Mfg. & Sales Co., Inc.. 54	
CRYSTALS		Union Radio Co.....	60
Gibbons-Dustin Radio Mfg. Co.	70	LIGHTNING ARRESTERS	
Harris Laboratory	62	Electric Service Supplies Co.. 63	
M. P. M. Sales Co.....	48	LOOP AERIALS	
Radio Apparatus Co. (Pitts- burgh)	44	Eagle Radio Co.....	36
Rusonite Products Corp.....	70	V-De-Co	40
Standard Crystal Co.....	67	LOOSE COUPLER SETS	
Standard Mineral Co.....	68	T-F. Radiophone Co.....	62

Alphabetical Index to Advertisers on Page 13

Where to Buy

A Handy Guide For The Convenience of Our Readers

LOUD SPEAKERS		SHIELDS	
Atlantic & Pacific Radio Co..	56	Orange Research Lab.....	69
Bel-Canto Corp	57	SOCKET AERIAL	
Bristol Co., The.....Front Cover		Star Mfg. Co.....	41
Inter-Ocean Radio Corp.....	45	SOCKET RHEOSTAT	
Magnavox Co.....	33	Ajax Radio Corp.....	56
States Electric Co.....	44	SOCKETS	
LACQUER		Bruno Radio Corp.....	8
Egyptian Lacquer Mfg. Co...	58	Commercial Screw Machine	66
MAILING LISTS		Co.	66
Ross-Gould Co.....	56	SOLDERING IRONS	
Trade Circular Addressing Co.	44	Post Electric Co.....	65
MERCHANDISE WANTED		Strauss & Blum, Inc.....	62
Jackson, P. D.....	66	SPAGHETTI TUBING	
R. C. Outlet, The.....	64	Mica Insulator Co.....	
MICA		Inside Back Cover	
Mica Insulator Co		STOCK BROKERS	
Inside Back Cover		Stanton & Co., Frank T.....	44
MICA CONDENSERS		SWITCH LEVERS	
European Radio Co.....	44	King Sewing Machine Co....	10
MICA DIAPHRAGMS		TESTING LABORATORIES	
Radio Mica Products Co.....	37	Gregg & Co.....	6
MICROMETER DIALS		N. Y. Testing Laboratories....	67
Myder Radio Co.....	53	TOWERS	
PANELS		Milliken Bros. Mfg. Co., Inc..	49
American Hard Rubber Co...	46	TRANSFORMERS	
Bremer-Tully Radio Co.....	70	Amplex Instrument Labs.....	6
Continental Fibre Co., The....	51	Federal Institute of Radio	
Eisemann Magneto Corp.....	11	Tel.	47
New York Hard Rubber Turn-		Ford Mica Co.....	48
ing Co.	64	Marle Engineering Co.....	59
Pittsburgh Radio & Appliance		Radio Center	57
Co.	42	Radio Courses, Inc.....	40
Poster & Co.....	42	Superior Products Mfg. Co...	68
PAPER CONDENSERS		Thornton Transformer Co....	62
Walter E. Bathgate.....	66	UNIT TYPE SETS	
PATENTS		Heinemann Elec. Co.....	45
Kern, Emil Alexander.....	64	VARIABLE CONDENSERS	
Manufacturers Patent Co....	64	Bayley Condenser Co.....	61
Wilson, Inc., A. M.....	46	Diamant Tools & Mfg. Co....	56
Zwingenberger, Otto K.....	64	Standard Appliance Mfg. Corp..	66
PHONE PLUGS		Stuckeman Bros., Inc.....	42
S. S. Novelty Co.....	40	United Mfg. & Dist. Co.....	55
PHONES		VARIO-COUPERS	
T-B-H Corporation.....	50	Essex Mfg. Co.....	64
RADIO FREQUENCY SETS		G. H. Fischer & Co.....	66
Mu-Rad Laboratories	41	General Merchandise Co.....	20
RECEIVING SETS		Maclite Storage Battery Co...	44
Arrow Radio Co.....	64	Shamrock Radio Co.....	41
Atwater Kent Mfg. Co.....	4, 5	VARIOMETERS	
Betts & Betts.....	43	Aremco Mfg. Co.....	70
Clapp-Eastham Co.	64	Atwater-Kent Mfg. Co.....	4, 5
Crosley Mfg. Co.....	9	Radio Products Mfg. Co.....	59
Jewett Mfg. Co.....	35	VERNIER CONDENSERS	
Mercury Radio Products Co..	40	Cozzone, John & Co.....	70
Magna Instrument Co.....	47	Electric Products Co.....	56
Moon Radio Corp.....	55	VERNIER RHEOSTATS	
Oranola Radio Corp.....	56	Viking Radio Co.....	66
Radio Outfitting Corp.....	64	VOLTMETERS	
Save Sales Co.....	63	Weston Elect. Instrument Co.	17
United Specialties Co., Inc..	58	RHEOSTATS	
Victor Radio Corp.....	46	Allen-Bradley Co.....	69
W. B. L. Radio Co.....	62	Radiola Wireless Corp.....	46
W. E. Supply & Service Corp.	46	Wald Electric Co.....	64
Winkler, Inc., Chas.....	64	Wilcox Laboratories, The....	42

Alphabetical Index to Advertisers on page 13



Make Two Profits Instead of One



THE Weston Voltmeter is advertised regularly in all the leading Radio Magazines. Regardless of the kind of tubes or Voltage used—a Weston Ammeter should be on every tube set to prevent premature tube burnouts, unnecessary depletion of battery or cells—to make tuning and duplication of results possible more quickly.

Render YOUR tube customers a real service by drawing the Weston Voltmeter to their attention—and make a profit, not only on tubes, but a liberal voltmeter profit as well.

Write for descriptive circular covering this and other important Radio instruments

Weston Electrical Instrument Co.

178 Weston Ave. Newark, N. J.
Makers of Electrical Indicating Instruments Since 1888

WESTON
THE SUN NEVER SETS ON THE WESTON
STANDARD The World Over
ELECTRICAL INSTRUMENTS
An Indicating Instrument for Every Individual, Need and Industrial Purpose



Their Deep, Natural-Voiced Pitch Is Rapidly Selling Thousands

ACTUALLY — thousands are being snapped up on the strength of their pleasing voice tone and keen sensitiveness. The same hair-line refinement of design which for over eleven years has been so sharply pronounced in hundreds of Basco electrical units, here again shows itself in these skillfully constructed

RADIO Head Phones "Hear" More and Cost Less

We also make the Basco Radio Frequency Transformer, Vernier and Plain Rheostat, Variable Air Condensers, Tube Socket, Dials and a Complete Crystal Outfit.



Put up in attractive orange and black cartons

They are built **right**, pitched **right** and priced **right**. Close examination is convincing proof. They embody every high priced quality — perfect balance, clear, scratchless reproduction. Coils encased in aluminum shell—light weight, easy on the head. Employ solid horseshoe magnet—no laminations. Bus-bar connections, no loose hair-like wires.

Light, extra sensitive diaphragm, set to thousandths-of-an-inch accuracy from magnet poles. Clean cut, rugged design throughout. Compare them with any other head set—irrespective of price—then you'll be convinced they're what you want. Ask your dealer to show you Basco Head Phones. If he hasn't them, write us direct

Jobbers and Dealers! Write for our exceptional discount proposition and name of our nearest factory representative.

Briggs & Stratton Co.
Milwaukee  Wisconsin

THE RADIO DEALER

The Radio Trade Journal

For The Radio Retailer

CONTENTS FEBRUARY, 1923

SPECIAL ARTICLES

Advertise the Stellar Broadcasting Programs.....	By R. C. Hull	23
Costs of Conducting a Radio Business.....	By Henry L. Seidman	26
Cut Prices to Consumers Menace to Rural Dealers.....	By H. S. Webster	32
Development of Wire for Radio Antennas.....	By L. N. Allen	30
Economic Sales Factors in Radio Industry.....	By Alexander Eisemann	27
Insulation Facts the Dealer Should Know.....	By O. B. Carson	31
Jones Helps the Dealer.....	By H. G. Cisin	62
New York Stater Has a Novel Way of Selling Radio Sets.....	By Harvey Gordon	25
Psychological Elements in Salesmanship.....	By Edward H. Lerchen	24
Radio Trade Is Subject to Natural Laws.....	By Bernard Freedman	25
Receiver Interferences.....	By W. B. Schulte	52
Reception Noises Are Not Caused by "B" Batteries.....	By Bernard J. Farrell	36
Retailers Should Test Their Head Phones.....	By Thomas H. Mullen	23
Selling Apparatus with Cut-Out Sections.....	By Herbert E. Metcalf	32
Standardization Will Advance Industry.....	By Amplifier Al	21
Standardization of Radio Panels.....	By J. F. McKerchar	22
Thomas A. Edison Announces New WD-11 Dry Cell Battery.....	By William Coleman	68
Trade Marks Should Receive Federal and State Protection.....	By Chauncey P. Carter	30

DEPARTMENTS

Book Reviews.....	By Bernard J. Farrell	55
Editorials.....		28, 29
Radio Trade Pictures.....		15
Service Bureau.....		14
What the Manufacturers Are Doing.....		34

THE RADIO DEALER, THE RADIO TRADE JOURNAL, published monthly on the first, at 1133 Broadway, New York, N. Y., by THE RADIO DEALER COMPANY, in the interest of dealers in Radio Supplies. HARRY M. KONWISER, Publisher; LAURENCE A. NIXON, Managing Editor; HERBERT M. WILLIAMS, Editor; A. L. KONWISER, B. S., ALBERT E. SONN, R. E., Technical Editors; N. B. ZIMMERMAN, BERNARD FREEDMAN and EUGENE J. SCANLON, Associates; C. HOPPE, Circulation Manager; M. JAY KLEIN, Research Manager; B. B. STERN, Manager Service Bureau.

REPRESENTATIVES IN THE TRADE: ELMER W. MOORE, JOHN R. HALL, H. E. BENNETT, WM. B. WILKINSON, JR., J. MAURICE CASPER, H. L. KRENZ, M. A. CLARK, C. L. GESEY, C. C. MINIER, J. L. PECK, M. P. MCNEELEY, W. H. OKE, C. B. CABINISS, R. C. HULL, BERNARD J. FARRELL.

PUBLICATION OFFICE
1133 Broadway, New York, N. Y.
Telephone Watkins 8926-8927

SOUTHERN STATES
610 Barome Street,
New Orleans, La.

CANADIAN OFFICE
23 Lily Street, Winnipeg, Manitoba

PITTSBURGH
Suite 570, Union Arcade, Pittsburgh, Penna.
PACIFIC COAST
Suite 511, 456 S. Spring St., Los Angeles, Calif.
Telephone Los Angeles 12050
512 Pacific Building, San Francisco, Calif.
Telephone Sutter 954

BRITISH OFFICE:
Walter Dandie Company, Ltd.
173-175 Great Portland Street
London, W. I., England

CENTRAL STATES
35 South Dearborn Street, Chicago, Ill.
Telephone Dearborn 4053

NEW JERSEY
845 Broad Street, Newark, N. J.
Telephone Market 4659

CLEVELAND
1389 West 87th Street,
Cleveland, Ohio

Advertising Rates and detailed statement of circulation and other information for advertisers furnished on application. Advertising forms close the 15th of the month prior to date of issue.

Circulation restricted to manufacturers, jobbers and retailers in wireless equipment. Subscription in the United States, one dollar the year, payable invariably in advance. Subscription in foreign countries, two dollars the year, payable invariably in advance.

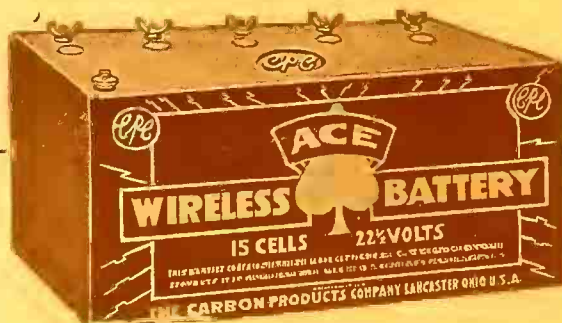

To Those Who Haven't Made The Most of Radio Opportunities

Radio merchandising's success depends largely on separating the riff raff articles that have flooded the market from the products which sell on merit.

We have produced a better battery for radio receiving, not only because of our 30 years' experience, but because our research work began before the pell-mell radio epidemic swamped the country.

Added to this we have worked out a successful plan of selling these batteries. This is not manufacturer's theory, but real, honest-to-goodness "back of the counter" merchandising.

Ask for the complete story. It's worth the time to investigate.

Ace No. 6 Cell

An ideal battery of special characteristics that make it valuable for WD-11 Westinghouse sets.

THE CARBON PRODUCTS COMPANY

Lancaster, Ohio

Ace Radio Books

Give away these useful books free to your customers.

ACE BATTERY

for Radio Success

EVENTUALLY! The FIBER HORN Replaces All Others

Because: It is scientifically developed to produce only true, mellow tones.

Indestructible: So constructed that it will not crack, chip or dent.

Seamless: No unsightly glued joints or rivets to loosen or come apart.

Finish: Attractively finished in black crystalline; enhances appearance of set.

Sizes: No. 1, 10" Bell, 23" high.

No. 2, 14" Bell, 28" high.

Dealers: Write for Attractive Proposition

FIBER PRODUCTS CO.

No. 10th St. and
Bloomfield Avenue
Newark, N. J.



Manufacturers:

Horns built
according
to your own
designs.

The Radio Dealer

THE RADIO TRADE JOURNAL

Edited and Published at

1133 Broadway, New York, N. Y.

FOR THE RADIO RETAILER

VOL. 2. NO. 5

FEBRUARY, 1923

ONE DOLLAR THE YEAR

Standardization Will Advance Industry

Selection of Committee to Formulate Plans for Eliminating Waste and Duplication an Important Step

By AMPLIFIER AL

Standardization is in the air!

The biggest advance in radio will be made when apparatus, nomenclature sizes, designs, capacities and materials will be put on a uniform basis in the industry. Realizing this truth, the Bureau of Standards called a meeting recently in New York at which prominent radio engineers, and representatives of the Bureau of Standards, the Army and Navy attended. Leading trade associations and firms in the industry were also represented, and the meeting lasted through one day.

The result of this meeting was the appointment of a permanent committee to conduct the work of standardization. This body is under the joint sponsorship of the American Institute of Electrical Engineers and the Institute of Radio Engineers.

The radio industry may look with confidence toward the work which this committee will do. They may rest assured that the men who form this committee will do their part. What is required of *every man in the industry*, however, be he dealer, jobber, manufacturer or engineer, is co-operation.

Co-operation is a word that is so commonly used that it seemingly calls forth little response. Co-operation in the work of standardization may imply a certain amount of self-sacrifice. But when the alternatives before the industry are a chaotic array of parts, materials, and capacities, and, on the other hand, an orderly development, with waste, duplication and disorganization reduced to the minimum, it is plain to see which alternative the men who have the true interests of radio at heart will choose.

No one will deny that standardization will benefit the industry and what benefits the industry will reflect itself on the individual radio man.

It is significant proof of the paramount necessity for standardization that many manufacturers have already taken steps to standardize their respective branches of the business. The meeting on January 12 was inspired by the manufacturers which shows the public spirited interest with which one has come to consider the radio men. The industry that can offer to the people the widespread benefits of broadcasting as a free public service will do even more to enable radio to take its logical place in the life of the community.

The Badge of the Radio Trade



Members of the Radio Trade Association can now display the insignia of their organization on letterheads, circulars and the like. The Secretary of the Association is now ready to distribute cuts similar to those illustrated here to members at cost. Cost price in this case is the nominal sum of thirty-five cents. The design may be had in other sizes as well, at varying prices.

The design of the cut is neat and simple and carries with it wherever it may appear the assurance that its user is an alert, public-spirited and conscientious member of the radio trade. Requisitions for cuts and applications for membership in the Radio Trade Association should be addressed to the Secretary, Radio Trade Association, 1133 Broadway, New York.



Standardization of Radio Panels

Prominent Manufacturer Is Now Supplying Trade with Panels Cut to Standard Sizes Which Reduce Waste and Facilitate Sales

By J. F. McKERCHAR

The question of the standardization of radio parts is arousing more interest at present than ever before in the history of the radio industry. This means that radio men are at last awake to the vital importance for concerted action to eliminate duplication and waste.

No one is more alive to the need for standardization than L. T. McCloskey, general sales manager of the Diamond State Fibre Company of Bridgeport, Pa. Mr. McCloskey is the man who is responsible for one instance of standardization; perhaps the first in the radio industry. The fibre panels put out by the company he represents are now in definite sizes, which it is likely that the whole industry will adopt.

"Up to the present, standardization," said Mr. McCloskey in a recent interview, "has been more or less a subject for discussion rather than an object for any definite action. Radio interests have been too busy, perhaps, satisfying the demands made upon them by the public even to consider the subject of standardization.

"But if one regards the condition of the industry at the present time," he went on to say, "he cannot help but feel how much of the confusion that exists could be eliminated if there were some order established in the manufacture of radio products. Whether standardization will come late or soon depends entirely upon the initiative and willingness of radio men. One feature of the question must be pointed out and that is that certain radio parts will be standardized before others.

"I am thinking particularly of radio panels. I am proud to say that the branch of the radio manufacturing business which manufactures panels is showing the way for the rest of the industry."

Mr. McCloskey then told of the Condensite Celeron panels manufactured by the Diamond State Fibre Company. Celeron is the black, shiny, lustrous insulating material on which instruments and controls in high grade transmitting and receiving sets are mounted.

Up to the present this product has been supplied in sheet form to radio manufacturers and to jobbers and

dealers who cut it to order for amateurs and set constructors. To handle this business properly, many dealers found it necessary to install special saws. Those who were not equipped to do their own cutting and who were indisposed to put in expensive equipment had to send the work out. The dealer was frequently forced to make his customer wait a day or more for the size of panel desired. Some dealers because of this fact have refused to handle panels at all.

All this is now in the process of being changed. Manufacturers, jobbers and dealers have realized the deplorable waste and uncertainty of cutting panels to the single order and in as many sizes as there are divisions on a yard-stick. To handle this panel business, they are beginning to realize, some standardization is necessary. To meet this situation, some time ago several of the representative dealers decided to carry a few sizes of cut panels in stock. This was a step toward efficiency, but their efforts were not organized and, consequently, the standardized idea was not applied.

This was a case of the spirit being willing but the flesh weak, so the Diamond State Fibre Company stepped in to do what it could to help things along.

"We surveyed the entire country first," Mr. McCloskey explained, "and worked out a plan of standardizing and merchandising panels. I am glad to say that the plan was received with favor by radio dealers the country over."

This survey proved that the bulk of the set builders' requirements could be satisfied with a few carefully worked out sizes designed for the popular sets and circuits which are commonly used. This was found to be correct. As a result, Celeron is now sold in the following standard sizes:

Panel Number	Size	Net Weight per Panel
1	6x 7x1-8	.2625
2	7x 9x1-8	.394
3	7x12x1-8	.525
4	7x18x3-16	1.18
5	9x14x3-16	1.18
6	7x21x3-16	1.38
7	12x14x3-16	1.575
8	7x46x3-16	3.00

These sizes are designed to meet present-day needs. Perhaps future developments will show the necessity for additional sizes. If the demand is large enough, it will be a simple matter to supply them. Each panel is trimmed, neatly finished, enclosed in a glassine wrapper, marked and numbered, and full instructions go with each for working and finishing a panel.

Thus, the Diamond State Fibre Company has created a convenient packaged and trademarked article out of a commodity formerly obtained only in bulk. The advantages to both manufacturer and dealer are obvious. To the dealer, especially, substantial benefits accrue. Inconvenience of cutting is eliminated, handling and delivery facilitated, increased turnover, and profits attained and, what is most important, better service is offered to the customer.

"But standardization, to be a success, ultimately depends upon the consumer," Mr. McCloskey said. "Will the amateur appreciate and approve this innovation? Does he know what is being done? Our company is not only standardizing but merchandising as well. We are advertising the step that we have taken. It has received the backing and support of organizations, publications and radio departments of newspapers. All welcome it as an aid to the set builder.

"We are following up on the idea by educating the dealer in the program of sales enlargement. Standard layouts are prepared, templates and wiring diagrams presented which utilize the standard size panel best adapted to each set."

The sales value of such standardization cannot be over-estimated. The dealer is advised to start the purchaser off with the proper panel, then sell him the parts and equipment necessary to complete the set. If a question is raised as to size of panel, the dealer can dismiss it immediately by saying, "This panel has been especially designed and finished for this set."

There is no doubt that standardization is going to pay in the radio industry.

Retailers Should Test Their Head Phones

By Assuring Customers Every Instrument Works Perfectly, Dealers Will Satisfy Customers and Enhance Their Reputations

By THOMAS H. MULLEN

Mr. Retailer! How do you test a head-set?

Did you ever stop to realize the possible damage your stock may encounter on its way from the factory?

Perhaps a reason for your drop in sales is because some of your goods were not in perfect condition when they left the store. Most frequently the public places the blame on radio instead of on you. It must be the dealer's first aim to encourage the advancement of radio and thereby help build up his trade.

It is recognized that a dealer has a responsibility to his customers. In too many cases have dealers sold apparatus that would not work properly—sometimes would not work at all. This has injured the cause of radio by producing discouragement and dissatisfaction. It has also lost many a customer. Head phones are one of the things that must be good. Otherwise, the whole receiving set is apt to be condemned.

Any dealer can test his phones and then have confidence that they will give satisfaction. Felix Wyner, director of a radio firm in New York City, is testing all the phones that he sells. For this purpose he uses a home-made head-set tester, which, after extensive trial of more complicated and expensive apparatus, has convinced him that this simpler tester is the more efficient.

To be sure that nothing has gone wrong with a phone in handling and to make certain that both phones of a head-set are in perfect accord both in tone and intensity, he gives them a final test. Presumably an audio-oscillator would serve the purpose, but unfortunately that is an expensive and somewhat complicated arrangement. The ultimate aim is to have the phone give the best possible results from the radio set. To attach the head-set to the receiving set, therefore, as a last test, would seem the most practical method. This has been proven to be far from true, because with the varied sounds broadcasted, it is impossible for anybody but one with a highly trained ear, to detect the difference between a perfect phone and one which would ordinarily be rejected. Nothing but a very marked difference between the two pieces

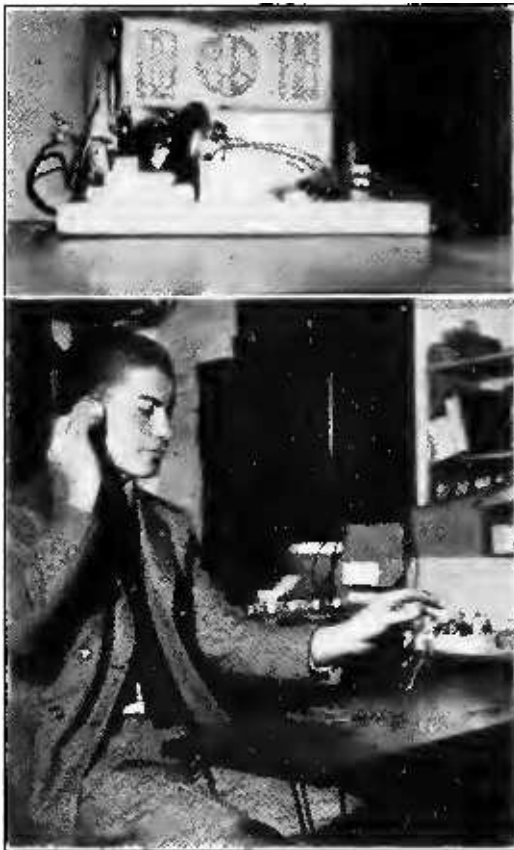

Above—Phone Testing Outfit
Below—Testing Phones

could be detected in this manner.

The simple buzzer has proved to be a solution to the problem. The one here illustrated was photographed in Mr. Wyner's office. The apparatus consists of nothing but dry batteries,

a small buzzer, one telephone receiver and several small pieces of felt.

The batteries are joined together in series and are then bound to a flat board of convenient size. Several pieces of felt are laid on the board next to the batteries, one on top of the other and the buzzer is placed on top. A small block of wood is then nailed to the board immediately in front of it. Resting between this and the buzzer is an ordinary radio telephone receiver. The felt is placed beneath the buzzer in order to prevent vibration. Any other material that will have the same effect may be used.

The apparatus is then complete except for the wiring. So that no sound may be heard, it is wise to place it in a drawer at the farthest end of the room from the testing table. A four-wire cable is strung from the apparatus to this table and the two ends from the battery-buzzer circuit are attached to two of the four wires of the cable. This makes it possible to operate the buzzer from the testing table. The other two ends of the cable are joined to the phone of the apparatus, thus completing one end of the tester.

At the testing table, an ordinary switch is screwed down. To this are attached the two leads from the buzzer circuit. There are also fastened to the table two double-spring binding posts.

(Continued on page 39)

Advertise the Stellar Broadcasting Programs

By R. C. HULL

Radio is no longer a novelty and must be sold to the great mass of people for their homes.

Better broadcasting has developed this, bringing radio up from a business with young people who acclaimed radio for its novelty. Now that radio is something the public should want, the dealers in this field must make proper effort to acquire the business of the general public.

The current broadcasting programs

are the best selling points for the dealer and to sell radio apparatus successfully the dealer will tie up his selling campaign with the programs.

Do you know that the Chicago Opera, for instance, is being broadcasted regularly and that the City Symphony Orchestra of New York is having its concerts broadcasted?

Every music lover in the land ought to know these things and they can

(Continued on page 39)

Psychological Elements in Salesmanship

The Real Salesman Utilizes Them While the Order Taker Fails to Appreciate the Value of These Important Selling Helps

By EDWARD H. LERCHEN
Of Orange Research Laboratories

You have no doubt heard the old saying that "Salesmen are born not made." I for one doubt this statement very much. I believe any healthy, intelligent human being can become a real salesman if he can only learn the value of psychology in connection with the selling of merchandise.

We all know or should know, that a sale always first takes place in the buyer's mind before it reaches your order book and as psychology is that branch of science which deals with the mind you will therefore understand why psychology in connection with selling goods is so essential. There never was a successful salesman who was not a psychological salesman whether he was aware of the fact or not; he may not even know the meaning of the word psychology.

All men selling merchandise are not salesmen; some are order-takers, not salesmen. There is as much difference between an order-taker and a salesman as day is from night. Anyone can be an order-taker, but it takes a salesman to sell goods.

You, perhaps, wonder just what the particular difference is between an order-taker and a salesman. I will endeavor to explain in a very few words: An order-taker only sells a customer those goods which the customer wants; a salesman sells his customer that which he needs but which the customer thinks he doesn't need. Every time you make a sale on that basis you are a real psychological salesman.

You often hear of a man who boasts of having loaded so and so up with merchandise; that kind of a sale is not good salesmanship; it is not psychological salesmanship. When a salesman does that or can do it, it is simply because his mind and will are stronger than the buyer's while in his presence, but immediately the salesman departs that same buyer is figuring on how he can return most of the goods when they arrive—and selling goods that are sold only to be returned is not salesmanship. This condition exists because the merchandise was sold without the salesman creating in the buyer's mind the desire to possess these goods at the time the order was taken which would cause him to keep them after they were received.

An example of this is where a sales-

*Study Your Customer
Salesman or order-taker?
Which are you? Which do you
want to be?*

The writer of this article cleverly tells the difference between them and supplies suggestive pointers for the salesman's guidance.

The psychological side of the question is discussed and principles for guidance are laid down which should be helpful in effecting sales.

man takes a large order for goods on the strength of the argument that John Smith & Co., and Brown & Co., are using same and find them O. K. That is a poor argument to use in selling as your buyer has a large amount of pride in his firm and also his ability to know the value of good merchandise and he does not like to have his judgment placed secondary to John Smith & Co. Furthermore, he is not interested in what Smith & Co. are using. He is only interested in something which will benefit his particular business and it is up to the salesman to give him the real possibilities of the article he is selling.

It is mighty poor policy to knock your competitor and his goods. Many a salesman does this, but it is wrong. It is much better to say, "Yes, I know them and they make a very fine line of merchandise." Then say no more but go on and explain the merits of your own particular line and forget about your competitor. The world loves a fighter, but also fair play, so play the game fair even with your competitors. It will pay you in the end.

As first impressions count for a great deal a salesman should always be neatly but not over-dressed and always a gentleman and not too much of a talker. Many a man has talked himself out of a sale. If you don't know when to stop talking study your buyer's face and actions, you will then find your cue. Don't talk until he starts to shift from one foot to the other. If he does this you may rest assured you have said enough and your chances of

selling any goods to that man are nil, for that day at least.

It is all right for a salesman to be friendly and sociable with his customers but he should not become familiar with them. No truer words were ever uttered than that "familiarity breeds contempt." I once knew a salesman who boasted of his familiarity with a certain buyer and how this buyer was giving him all of his business, but the salesman was only "kidding" himself. I overheard this same buyer at a club one night remark how much he admired a certain young salesman who called on him and how businesslike he was, adding that he was giving this young man all of the business that he possibly could as he seemed to know his line so well and was all business. This certain young salesman happened to be selling a competitive line of goods to those which the fellow who had boasted of getting all of this buyer's orders, so you see you never can tell just where you stand. But, it might be well to remember that it is better to be all business than too familiar.

When selling goods to a buyer, always be positive in your answers when asked a question. Say, "yes" or "no" without hesitation in a straightforward manner. Don't say, "I guess so," "I think so," and above all never say "I don't know" because you should know. If you don't know, it is somebody's fault, either your own or the firm you are working for. You should, therefore, never try to sell any article until you are thoroughly familiar with it and the uses for which it is intended.

Your own confidence in knowing that you understand your line will inspire you with enthusiasm and you cannot sell merchandise unless you are enthusiastic about what you are selling. Learn to know your buyers likes and dislikes in general. Learn not only to think with him, but ahead of him.

Now remember, a salesman does not sell goods, but the goods sell themselves. This sounds somewhat revo-

(Continued on page 48)

Radio Trade Is Subject to Natural Laws

As in Other Lines Inefficiency and Dishonesty Will Ultimately Vanish to Leave Clear Field for Reputable Dealer

By BERNARD FREEDMAN

"What is the future of the radio industry?" is the question I have been asked time and time again by friends of mine. Indeed, so common is this question that I am sure that every man in the radio business today has at some time or other been confronted by the same query.

I put the question of radio's future to two men in the industry, Myron G. Studner and A. E. Pollock, of the Inter-Ocean Radio Corporation, New York. And they dictated the statement which follows:

"When most people ask 'What is the future of radio?' they really mean, 'How long is it going to last?' They think that it is a fad.



MYRON G. STUDNER
General Manager, Inter-Ocean Radio Corp.

"Of course radio is not a fad. The tremendous radio buying last Christmas and the steady buying since then amply prove this, for it means that once a customer becomes acquainted with radio he sticks to it. But the reason radio impresses so many people as being a fad is because of the sudden rush of men from every other field of business into this "royal gold field," the radio trade. Many people argued from this that the radio business could not be very stable or enduring for this reason.

"Fortunately the natural law of water reaching its own level is applicable to the radio industry. Applied to this business of ours it means that men expecting positions or engaging in a business for which they are not fitted soon reach the level for which they are fitted. In some cases this is oblivion.

"The process of elimination has been working slowly but surely, and the so-called radio men who have been either grossly inefficient or unbelievably corrupt are gradually finding out that the time has come to pay for these two cardinal sins of business. The men handling inferior merchandise made by men who did not know how to make any better instruments, have at last awakened to the sad truth that in order to keep a business intact you must deliver the type of merchandise that will be creditable to the business and satisfactory to the ultimate user.

"Radio instruments are so constructed that each part is dependent upon the other for working efficiency. A whole outfit may be put out of commission by a cheap coupling. An inefficient condenser leads to just as bad results as an inefficient amplifier. Con-



A. E. POLLOCK
Sales Manager, Inter-Ocean Radio Corp.

sequently it is apparent that in the industry the vigilance of every one concerned must be exercised if the
(Continued on page 43)

New York Stater Has a Novel Way of Selling Radio Sets

By HARVEY GORDON

In Binghamton, N. Y., there is a firm that appreciates the fact that radio requires ingenuity and salesmanship than most other lines to make it a success. The concern is the Radio Testing Station, of 25 Sturges Street. C. L. Reynolds, the manager, describes what they have done to introduce radio in rural districts.

"First," he says, "we select the community that is least interested in radio. We make arrangements with some amateur to erect a one-wire

aerial on the church, school or whatever building in this community that may be suitable. In most cases we have hand-bills printed, and hire men interested in radio to distribute them. We place an advertisement in a country newspaper, and also have a news item or two written at the same time and see that it is printed in the papers.

"After all these plans are formulated," he continues, "we install a loud-speaking receiving set which is
(Continued on page 42)

Costs of Conducting a Radio Business

Statement of Plain Facts That Should Guide Every Business Man Who Expects to Make Success in Radio

By HENRY L. SEIDMAN
Certified Public Accountant

Men in business have a way of shirking unpleasant discussions. We have found it to be especially true where their own frailties have been called to their attention. And yet, neither the future of radio as an industry nor the future of any other industry is at all assured unless that industry is capable of making money for those who are engaged in it.

Successful executives have long realized that knowing how to figure costs is essential to the success of every business and that it is not a theory advanced by professional accountants for the purpose of making work for themselves, although to the untrained man, the simplest schemes of cost accounting have long been veiled in deepest mystery.

We have wondered for a long time whether it is not such a mental attitude that accounts for the fact that, according to the statistics prepared by the Federal Government, more than half of the 250,000 business corporations in this country work year in and year out without a profit, and that not more than 5 per cent. of the entire 250,000 corporations have any sort of system by which they can record what it actually costs them to make their goods.

In our work we find that the small margin of profit existing in so many of our industries is due almost entirely to ignorance of what the merchandise actually costs. This ignorance causes the making of unprofitable selling prices which forces the business man who does know what his costs are to sell at the same prices in order to meet competition and the entire field becomes unprofitable.

Formerly the necessity for the determination of true costs was not as imperative as it is today. Margins between costs and selling prices were larger. Costs could be ignored except in a general way and a good return still be made on the investment; but today competition is so keen, and new firms are being organized so rapidly, especially in the radio field, that margins of profit in this line as well as in most lines of trade are much more narrowed than formerly, and the necessity for

Making a Profit

At the recent meeting of the Radio Trade Association, Henry L. Seidman, the well-known accountant, made an address in which he warned the members concerning the hazards of not knowing their business costs and in selling their merchandise under cost. Extracts from this address are reproduced herewith, so that the radio trade may avail itself of Mr. Seidman's helpful advice.

the most efficient management and closest analysis is felt as never before.

The beginning of every new industry seems to have been attended by unpleasant occurrences to say the least, and by unpleasant occurrences in the radio field, I mean to call your attention to the bankruptcies and the business interruptions that have taken place. We learned a great deal from these bankruptcies but the results are no different from what has gone before.

An examination of these bankruptcies revealed to us some rather astonishing facts. After we had assembled these facts and interpreted them, we found that 90 per cent. of the men who had failed did so, not because they were such terribly poor business men, but rather because they sold their merchandise for prices which were at cost or below. Those who sold at cost succeeded in avoiding bankruptcy a little longer than the others, but they went. In every case we found that the main reason for selling their merchandise below cost was that they didn't know what their cost of doing business was.

The general practice was to add to the net cost of the merchandise 50 per cent of its cost, and that, in turn became the selling price. The 50 per cent. was supposed to cover all of the overhead charges. If he was a manufacturer, it consisted of all costs of manufacturing such as repairs, depreciation, expenses in the factory gener-

ally; his selling expenses, such as advertising, salesmen's commissions, the traveling expenses of salesmen; his administrative expenses consisting of the salaries of his office force, stationery, printing, telephone and electric light; his cost of financing the business, such as interest on indebtedness, insurance, rent, the various classes of taxes that we have with us today, the cash discounts to customers and dozens of other things.

In no case was 50 per cent. the proper amount. Some cases were down as low as 10 per cent., and we had one flagrantly bad case where a man thought he was making money when he sold the merchandise for what it cost him, but he kept the cash discount of 5 per cent. as a profit.

We made an examination of approximately twenty of these bankruptcies and we found that the average percentage which should have been added to the cost of the merchandise was $83\frac{1}{3}$ per cent. If these men had sold their merchandise for what it cost them plus $83\frac{1}{3}$ per cent, of that cost they would have averted bankruptcy.

A further examination convinced us at that time that $83\frac{1}{3}$ per cent. of their costs was too high. It was too high because their methods and their practices in business were inefficient, so grossly inefficient as to make it so high. Since that time, we have found in our work with the business men in the field today that 50 per cent. is about the right figure.

It has come down from $83\frac{1}{3}$ per cent. because of the fact that the men who had good business training before they entered the radio field brought that business training with them and their past experience taught them where and how to economize to eliminate this economic waste that goes on day after day right under our very eyes, and which is so greatly ignored.

New methods have been introduced and improved machinery installed in the factories every day with a view of reducing costs either by the elimination of waste or the increasing of efficiency. It is impossible, however, to know whether the introduction of

(Continued on page 40)

Economic Sales Factors in Radio Industry

Selling Parts to Amateurs Does Not Produce Satisfaction to Users as Do Properly Designed Complete Sets

By ALEXANDER EISEMANN
Treasurer of Freed-Eisemann Radio Corp.

An analysis of the elements in the radio buying public would appear to divide the public into three classes.

1. The radio experimenter who builds his own set and who rushes eagerly to buy new devices which he thinks will improve its reception.

2. The section of the general public which is temperamentally inclined to purchase a new article before its use has become general. This element buys complete radio sets because it wants to have in radio or in any other field, the satisfaction of knowing that it belongs to a class of progressives always ready to try out a new article.

3. The vast majority of the public that buys only after it has been convinced that the new article is necessary, useful or desirable.

From present indications this third class is not yet awakened to the usefulness and desirability of having a radio receiving set at home and the line of least resistance for the manufacturer and the dealer is to supply whatever element the public is buying. Therefore, the business in parts and accessories done with the amateur who builds his own set, far exceeds in volume the business done with the average man-on-the-street who would never think of trying to construct his own set. The average man on the street, however, is to a certain extent, supplied by thousands of individuals who have become competitors to the ultimate manufacturers.

John Jones builds himself a radio set. He shows it to a dozen or more of his friends and while the home made set is frequently indifferent in its operation, nevertheless, the vanity of John Jones is flattered when his friends ask him whether he will build them a set like his. In every community there are hundreds of John Joneses whose friends pay for the parts and whose compensation for his labor is the satisfaction which his vanity receives in doing something for his friends which they could not do themselves. An investigation, however, discloses that this source of supply is one which seldom gives a good reputation to the radio art.

It stands to reason that these individuals who compete with dealers and



Alexander Eisemann

manufacturers, while they are doing the best they can, have caused the impression to be gained by a tremendous number of prospective radio buyers that, to quote the average phrase, "*It is very interesting but I will wait until something is developed which will be less noisy and more entertaining before I put it in my home.*" Thousands of prospective buyers are "*waiting for radio to be perfected.*" They do not know the degree of excellence to which the apparatus of the larger and more stable manufacturers has attained.

Among their circle of friends you may find one who has a well built and properly designed manufacturers' set to perhaps a dozen sets built by amateurs, of varying degrees of efficiency and audibility.

A friend of the writer who is president of one of the largest banks in Philadelphia, strolled into the office not long ago and remarked jokingly, "I want one of these things when I can understand what is being said, after it has been strained through that complicated looking noise maker." He had listened in on three or four sets built by friends of his sons and considered it an interesting toy for the chil-

dren and was amazed when he heard broadcasting on a properly designed set.

The dealers and the manufacturers have a different problem to overcome in this regard. Radio started with the amateur experimenter and hundreds of newspapers throughout the country are almost daily showing prospective radio buyers how to enter the experimenter class by showing them diagrams, etc., with complete instructions of how he can build his own set.

They do not show him how he could build his own phonograph, nor his own bicycle, nor his own automobile, but they do show him how he could build his own radio set. It would appear that, in spite of the fact that all of us are doing a more or less satisfactory business in radio parts, which we sell at satisfactory profits to these amateurs, nevertheless, the future of our industry is at stake if radio does not gain in popular esteem.

Many of our dealers are already pointing out to prospective customers that, while they can build their own radio sets and get fairly good reception, if built properly, nevertheless, these sets must be designed by a skilled radio engineer in order to get results that will please those who are interested in radio for *results* only, and for whom nothing is of any value except clear and undistorted reception.

Another economic factor in the radio business is that of the maintenance of the list price. I submit that there is but little reason for keeping the list price on an article when the manufacturer hasn't the means or the facilities for maintaining that list price. I do not refer to illegal combines. I merely regard the matter from a strictly commercial viewpoint. All manufacturers would like to see their list prices maintained, but it would appear to be a hopeless task with bankrupt stocks thrown on the market and with manufacturers' surplus sold at or below cost, to endeavor to maintain a list price on some competitive article.

It is ruinous for the manufacturer to buy up all his merchandise which is offered below the list price, and results show that even those who have

(Continued on page 44)

From the Editorial Viewpoint

Proof of the Pudding Still in the Eating

THE RADIO DEALER offers slight apology for talking about itself, but the truth of the matter is that if you don't say a word for yourself the other fellow is apt to take the same viewpoint and presto!—you have a lot of old ground to cover.

THE RADIO DEALER points with pride to its activity of almost one year and wants its newer friends to make mental note of the fact that this paper is the pioneer radio trade paper in the field; that this paper has never sold advertising, except for cash, and that this paper leads the field—in advertising printed and in circulation.

THE RADIO DEALER believes there is a logical reason for the fact that this paper is legitimately the leader in the field.

THE RADIO DEALER believes the radio trade has approved of our efforts to develop a better spirit of commercial endeavor in the radio trade.

THE RADIO DEALER believes that the trade approves of our 100 per cent. constructive attitude.

THE RADIO DEALER firmly expects to maintain its present policy of trade improvement and we reiterate our statements to the effect that the fakirs in the radio industry will *not* be permitted to purchase space in this paper.

THE RADIO DEALER holds no plea for the self-avowed believers in the divine-right theory—as applied to the radio industry.

THE RADIO DEALER welcomes the continued support of the honest tradesmen and those who believe in the future of radio

Trade-marks Are Pirated In Many Foreign Countries

According to the American Manufacturers' Export Association, firms doing business in foreign lands are the victims of unrestrained trade-mark pirates to an extent unknown to the average American concern making effort to do business in other countries.

During the past twelve months no less than 430 American trade-marks were pirated and of this total Cuba appropriated forty-seven trade-marks. France came next with forty, Japan adopted thirty-nine and Germany thirty-four. Other countries came in this order: Argentina, 33; Great Britain, 32; Uruguay, 25; Canada, 24; Australia, 21.

These figures must be of interest to manufacturers aiming to establish foreign business and the situation makes it almost imperative for American manufacturers to take proper steps to protect their brand names.

Manufacturers who expect foreign business should be willing to make some attempt to protect their business, and

the very best plan is to consult some reliable patent attorney.

The foreign countries have regulations for safeguarding foreign trade-marks and while some of these lands exact unfair taxes, the prospective exporter should learn just what he is to contend with by investigating before exporting.

Secretary Hoover Expected To Solve All Air Troubles

If the White Bill, now before Congress is enacted into law, Secretary Hoover will be given great powers and it is expected that this noteworthy business-like Cabinet official will correct some of the present broadcasting difficulties developed from the lack of sufficient legal supervision.

Secretary Hoover will probably suggest methods of avoiding air conflicts, now in evidence, and it may be that Secretary Hoover will suggest proper plans that will not only remove air conflicts, but will develop better air concerts for the millions of listeners-in.

The possibilities for better broadcasting arrangements are evident—to any intelligent bystander and the great mass of citizens really look forward to Mr. Hoover to straighten out the broadcasting stations conflicts—to the end that the public shall best be served.

There is no fear on the part of the radio industry that Herbert Hoover will mismanage the ether situation. The public has great faith in his ability to solve the world's latest problem and while this work may not be as well advertised—in the press—as have some of Mr. Hoover's other activities, the esteemed statesmen can feel assured that the radio enthusiasts can be expected to remember him and to praise him for work well done.

Electrical Men Are Attracted to Radio

Significant is the fact that the electrical men are beginning to evince a real interest in radio and its possibilities. They are putting their ears close to the ground, and at practically every convention of electragists, as they are now calling themselves, the question is discussed as to the part the electrical dealer will play in the radio development. This is generally from the interested viewpoint which resolves itself into the query of "How will radio aid the electrical man?"

The strongest argument in favor of having electrical men take up radio seriously has been advanced by George Patterson, of Stanley & Patterson, of New York. He asserts that the electrical business as at present constituted

is too limited to provide a steady and profitable income for the electrical man. There are not enough lines to insure a year-around business according to Mr. Patterson, so that the advent of radio may be compared to the discovery of a spring of water in the desert, from the electragist's point of view.

So far it seems that electrical men regard radio merely as a side-line. Those who have the most faith in radio regard it as quite capable of establishing a permanent and distinct form of retail trade—radio retailing. Radio as a side-line of the electrical store obviously can not experience the same development and prestige that radio, in the hands of men who devote all their energy and their time to it, will achieve.

The field is at present being developed for the exclusive radio trade. Radio advertising and radio organization are directed to the exclusive radio specialist, because he has the true interests of the radio industry at heart.

Summer Appeals Should Create Fans

Selling radio sets or equipment is like starting perpetual motion. The splendid results experienced by radio dealers the country over during the Christmas buying season are a cause for congratulation, for they will insure steady buying during the Winter and Spring months.

Once the potential customer has been bitten by the "radio bug," the desire for radio spreads, and expresses itself in the purchase of additional equipment, improved parts, the switching from one style of set to another, and above all, in the ceaseless attempt to listen in on greater and greater distances.

Radio dealers may confidently expect to profit from the introduction, this Christmas, of radio into many homes, where it was previously unknown. The effects of this will be felt all through the winter and spring months.

But what of the Summer? Is radio to experience a slump in 1923 similar to the one felt last June? Not if radio dealers are awake to their opportunities and responsibilities.

Looking ahead now to what may possibly happen next June seems like crossing a bridge before coming to the stream. But it may be said that without some pretty deep thinking and planning now, radio may possibly experience a slump this coming Summer.

Fortunately the fate of radio is largely in the hands of the radio dealer. The old alibi that "static" ruined any chance of Summer trade has been discounted since Perce B. Collison tore it to pieces in an article in *THE RADIO DEALER* of last June.

The big obstacle that the radio dealer must work against during the Summer is the desire of folks to be outdoors. Radio's great selling-point during the Winter is that it is "the center of the cozy fireside," "the magnet that draws the family circle together" or that "it brings the achievements of the world to your living room." These points are not so appealing during the Summer time. It is the duty of the radio dealer to induce the prospective purchaser to take radio out of doors with him.

The Storm Has Passed

The storm came last Summer with but little warning; with the force of a hurricane it swept destruction on right and left. In its wake many a business was wrecked.

But it left its lesson behind.

Those that builded on a firm foundation survived, but the many that went into radio without capital, experience or appreciation that honestly made goods are essential to success, did not endure.

It is well they did not.

When a garden is planted, many seeds are put into the ground that are destined not to survive. Some do not germinate; they are too weak. Others are killed by the hot sun or from lack of moisture; they lack strength. Still others, that appear strong and healthy, are plucked by the Gardener; they must needs be weeded out so that the plants may mature and bear fruit. So it was in the radio business.

More manufacturers and dealers started in than were needed by the industry. The slump came; some were killed, and conditions weeded out others until now a much more healthy situation exists than before.

The outlook is brightening rapidly; business is increasing, and reports from all over the country indicate better business and encouraging prospects. While recovery has been slow, from all appearances it is to be continuous, for now the radio is settling down to be a stable industry that is endeavoring to manufacture and sell products that are of merit and of value.

Fight Arguments Opposed to Radio

Enemies of radio, including politicians who fear radio's power to transmit the truth, and others hurt by radio, are not far to seek. It is in their interest to say that radio is a "fad," and to cast slurs on its efficiency and appeal.

There are many ways of combatting this vicious propaganda and the radio dealer should not be slow to take the measures in his power to prove to the public, if proof is necessary, of the desirability of radio.

It is to be regretted, however, that many dealers do not help radio by their selling methods. We have particularly in mind the system of placing a loud speaker above the entrance to the store and filling a whole street with loud, confused and indeterminate shrieks. The person, who is not acquainted with radio, will be repelled rather than attracted by this demonstration, thinking that no better results than this continued howling can be obtained.

It is true that the radio dealer using this device is taking advantage of out-door publicity, but there are two kinds of publicity, helpful and injurious. There can be no doubt as to which category the street loudspeaker belongs.

How much better is the private demonstration in a specially-constructed demonstration room, similar to the ones found in any up-to-date phonograph shop. Copy from the phonograph dealers? Why not? The successful business man is always learning from others.

Development of Wire for Radio Antennas

Story of Wire Drawing from the Earliest Crude Methods to the Molten Welded Process with Hot Rolling and Cold Drawing

By L. N. ALLEN

Early in the history of man, almost in prehistoric days, wire was made. The story of its development is most interesting and culminates in the production of a steel wire covered with copper which, when stretched from home to tree, catches something that cannot be seen that is transferred into human song and laughter.

The manufacture of metallic filaments or shreds, known as wire, dates back to the early ages of man. According to excellent authority, evidences of it can be traced to early Egypt. Gold wire is mentioned in connection with the decorations of the robes of Aaron, while metallic shreds have been discovered that date back to about 1700 B. C. Homer and Pliny in their early writings made reference to similar products. Metal heads, having imitation hair made of wire were recovered from the ruins of Herculaneum.

From these remote times up to the Fourteenth Century, wire was made by hammering out strips of metal, inasmuch as the modern process of drawing had not then been invented. The first advance in the process of wire manufacture was made when the die was introduced. This consisted of a flat block of metal, having a hole, slightly tapered, bored through it.

The die was securely fastened to one end of a table, or bench, as it was later called, in such a position that the hole was in a horizontal position and longitudinal to the bench; the smaller end of the tapered hole towards the far end of the table.

A round rod slightly larger than the smaller end of the die hole was previously hammered out from a small casting while still hot. It was sufficiently tapered at one end, so that when inserted in the die, a few inches protruded from the opposite side. When this rod became entirely cold, the tapered end was inserted in the die. The protruding end, gripped in a clamp securely fastened to a chain, was pulled from the far end of the table. The rod was drawn through the die and by this simple process became wire.

Smaller sizes were obtained by re-tapering the end of the wire, inserting it through a smaller die, and again

drawing it. The reduction in diameter elongated the wire. The length of wire obtained in this manner was limited to the length of the table.

This difficulty was later overcome by coiling the wire around a power driven drum instead of pulling it the length of the bench. This permitted the use of longer rods, therefore giving a greater length of wire. The introduction of the rolling mill, taking the place of the laborious hand hammering of rods, was a boon to the wire industry.

Present methods of rolling rods and the drawing of them into wire have increased the wire lengths from the few feet of the Fourteenth Century to the several miles of today.

Practically every metal known can now be drawn, due to the many refinements in the art of wire drawing. Larger sizes are drawn through steel or chilled iron dies, while very small sizes of wire are usually drawn through dies made from diamonds or hard semi-precious stones.

The hot rolled rods have but a small percentage of the tensile strength induced by subsequent cold drawing. This cold drawing hardens the metal while reducing its diameter. Hardening it gives strength. However, there is a point of hardness at which the metal becomes brittle and again loses its strength. Before this point of brittleness is reached, drawing must be stopped. Hard-drawn copper is weak when compared to steel, and aluminum

has less than half the strength of copper.

The two metals commonly used for wire are copper and steel. Both have serious limitations. Copper, used mostly for electrical purposes, being weak stretches and breaks, so cannot be used for long spans. Steel wire is strong but a very poor electrical conductor. It rusts rapidly even when protected by a galvanized coating.

The need of a high strength non-corroding electrical conductor was seen some forty years ago. Many attempts have been made to combine these metals with their ideal characteristics into a single wire. Wrapping steel wire with copper strip was tried with disastrous results, due to electrolytic action between the two metals. Plating was tried with similar results.

Finally after years of research the molten welding process was developed whereby a thick layer of highly heated copper is cast around a large steel billet, previously heated to a white heat. The two metals weld together and cannot be separated. This welded billet is hot rolled and cold-drawn into wire as previously described. This wire is known as Copperweld.

Aerials for radio stations is one of the uses to which Copperweld is particularly adapted. Its conductivity at radio frequencies is equal to that of pure copper and is much stronger, due to its high strength steel core. It is the recognized wire for commercial and amateur radio stations.

Trade-Marks Should Receive Federal and State Protection

By CHAUNCEY P. CARTER

The trade-mark committee of the American Bar Association has just completed a draft of a uniform state trade-mark law which will be submitted to the legislatures of the different states for enactment at an early date by the association's committee on the uniformity of state legislation.

This action of the national association of attorneys serves to emphasize to many and to bring to the attention

of others the fact that in addition to the Federal trade-mark registration law, there is in practically every state a state law providing for registration of trade-marks.

Trade-mark specialists are often asked, "What is the value of necessity of state trade-mark registrations?" and "Isn't my federal registration sufficient without the necessity" (Continued on page 45)

Insulation Facts the Dealer Should Know

Synopsis of Educational Talk Advocating the Use of Hard Rubber Products That Was Recently Broadcasted from WEA F

By O. B. CARSON
Of the American Hard Rubber Company

The tremendous interest of the general public in radio has developed an entirely natural thirst for information on every phase of radio construction and the materials used. Sometimes this takes a humorous turn—for instance. One puzzled radio fan asked his favorite New York newspaper if it was necessary to remove the mattress, blankets, and other bed coverings in order to use the bed spring as an antenna on a crystal set. The editor's answer is unknown.

But for the most part questions of a practical and serious nature are asked and the dealer is the logical man toward whom to turn for authoritative information. Familiarity with materials and why they are peculiarly adapted for certain purposes enables the dealer to generate good will through service to his customers and exercise a powerful sales advantage.

One of the substances which has established its peculiar adaptability for radio insulations is Radion. It consists essentially of a compound of rubber and sulphur into which other ingredients are incorporated and which when vulcanized or "cured" will produce a material best suited to the purpose for which it is to be used.

Other than Radion there are a great many hard rubber compounds. Some of them are more suitable than others for radio insulations. However, in general, hard rubber compounds possess in a high degree those characteristics most necessary for insulating materials employed in making radio panels and such molded parts as dials, knobs, sockets, insulators and the like.

It is a fact generally known that high frequency currents are difficult to control, and consequently radio receiving apparatus is best which is designed and made of materials which permit the smallest possible electrical losses.

Radio engineers have determined that there are four most important characteristics to be considered in panel or other insulating material. These are phase angle difference, dielectric constant, resistivity, both volume and surface, and the tendency to absorb moisture.

Phase difference is a property which expresses the heating of the material and at radio frequency largely determines the radio frequency voltages the material will stand without injury and power loss in insulating parts. It introduces resistance in the circuit and diminishes selectivity. The phase difference should be the lowest possible.

Dielectric constant is an important factor in the material used in making the condenser. It determines the amount of alternating current which flows when an alternating voltage is impressed on the condenser. It also helps in determining how much the condenser heats and the high frequency voltage at which the insulating material is injured.

Surface and volume resistivity determine the resistance to the passage of an electric current across the surface or through the insulation. The higher the resistivity the better the insulation.

Absorption of moisture has a most

important effect on many of the electrical properties of the material, especially on phase difference and resistivity. Insulating material should therefore absorb no moisture and have a high surface finish to produce the best results throughout all seasons and in climates where humidity is a serious factor.

Radio insulations commonly used may be divided into three classes: Special hard rubber compounds, phenolic compounds, which include also the laminated phenolic material sold under various names; and compositions of shellac, tar and similar materials.

Shellac and similar compounds are the cheapest and do not possess to a very high degree the essential characteristics cited in the preceding paragraphs.

In the laminated phenolic compounds the base consists of sheets of paper, fabric or fibre, and the binder is a phenol, or, as commonly known, a condensation product of carbolic acid. These materials possess characteristics for phase difference, dielectric constant, surface and volume resistivity to a much higher degree than the shellac compounds.

Now a hard rubber compound best suited for radio use, besides possessing these necessary electrical characteristics, must be non-porous, non-absorbent, permanent, easily, quickly and accurately moulded and machined with ordinary tools without danger of chipping. It must also be low in free sulphur content, and the sulphur must be fixed in the compound so that it will not come to the surface or "bloom," as it is called. Radion is a compound which has been developed particularly for radio panels and insulations, which meets the most important requirements.

Results of investigations by the Bureau of Standards show that Radion has a phase difference of one-fourth, a dielectric constant of one-half, and an absorption of moisture of one-fourteenth of these same characteristics for phenolic and laminated phenolic materials.

Experts have produced this mate-
(Continued on page 46)



O. B. Carson

Selling Radio Apparatus With Cut-Out Sections

By HERBERT E. METCALF

Sales Department, The Magnavox Company

If you were to visit the majority of the high-grade automotive agencies in the cities today, each of them would be sure to have somewhere in their shop or display room a recent model of their machine, which had been cut so as to show the action of the engine and various other moving parts.

More than likely when a prospective customer calls he or she is conducted to the sectionalized machine where the salesman with convincing evidence in front of him can show the customer just where the superior qualities of his merchandise lies. At almost any place where the public in general, or, as it might better be stated, prospective customers, congregate such as, for instance, automobile shows, such sectionalized models are greatly in demand.

Particularly will such demonstration machines be valuable for the demonstration of any unique principle, or one which is different from the ordinary run of machines and different from those with which the general public is familiar.

Radio is a new art, one in which the merchandising plans and methods are new, and yet there are many things which can be learned by a study of some of the older and better established industries such as the automotive field. Magnavox radio is a loud speaking reproducer, differing greatly from any other. At first it was difficult for the average customer, whether he be jobber, dealer or consumer, to visualize its action and inward construction.

Even though taken apart, exposing the various units, it is hard to see just what makes it go. So, by taking a lesson from the time-tried and successful custom of the automotive industry, all Magnavox radio salesmen who visit the jobbers and dealers have been equipped with a sectionalized electro-dynamic receiver.

This receiver is simply a standard radio reproducer which has had a section cut out of it exactly the same way as one cuts a section from a piece of pie. In this manner every moving part in the instrument is exposed to view. The field coil within the case is shown with its many turns wound with mathematical regularity. The entire magnetic field circuit can be seen and a customer can at once visualize just how the magnetic air gap



Cut-Out Section of Magnavox Sample

is energized. In this air gap rests the little coil which generates so much power. The fine wire wound on the little bakelite coil frame in a depression bit by a diamond tool, is easily visible and one can immediately see how the power and energy of this little coil is transmitted by means of a conical support to the diaphragm.

The corrugations of the diaphragm explain how the soft nickel-silver is made stiff enough to withstand the heavy push and pull of the coil and yet be soft and pliable enough to withstand crystallization from millions of tiny reversals of motion. The observer can see at once the peculiar shape of the sound box whereby the air displaced by this diaphragm is passed into the horn.

As this is brought directly to the customer's view there are no more questions asked as to what is actually inside of this instrument. They can see for themselves that the field coil fills the entire base, that it serves a most useful purpose, and that the can is not there just to make the instrument look larger than it really is.

The salesman who is equipped with an instrument of this sort has a powerful advantage when it comes to influencing the purchaser. He can demonstrate with standard equipment the performance of this machine, and then show the buyer just how his demonstration was superior because of the unique construction of the instrument. He can show him so that he will forever remember it by means of the sectionalized samples.

It always pays to take a tip from other industries, and the radio industry today is no exception. Numerous other opportunities to make use of the time-tried selling helps developed by other industries are constantly available. Let us keep our eyes open for them and use them for radio, for it is certain that the radio is now an industry of its own and before long will be having other industries looking to it for ideas in selling and merchandising problems.

Cut Prices to Consumers Menace to Rural Dealers

By H. S. WEBSTER

Radio Dealer, Lyndon Center, Vt.

The rural radio dealer is confronted with his own problems. In the country districts some dealers cover territory extending over three counties, yet with a combined population of not more than a closely populated city block.

In order to cover this extended territory, the country dealer is confronted with large expense, as his prospects are widely scattered, and to reach them miles of poor roads must be traveled.

One of the latest problems with

which the rural dealer is forced to contend is that certain department stores and jobbers in the larger places are selling new and up-to-date apparatus and sets at what appear to be wholesale prices. Recently a gentleman in our territory purchased a complete set at one of these reduced price stores. He set the apparatus up himself, and naturally fails to get good results. The outfit was accordingly condemned as being no good.

Shortly after this the country dealer
(Continued on page 50)



This publication offers useful selling suggestions.

Building Business with the MAGNAVOX Radio

AS an alert and well posted dealer you have not failed to follow Magnavox National Advertising as it has appeared month after month in Saturday Evening Post, Literary Digest, Country Gentleman, American Magazine and other publications of character and influence.

On the right of this column we show the illustration used in the Magnavox advertisement for the current month.

From the beginning of Radio, the position of Magnavox products has been unusually favorable and secure.

A word of friendly advice to dealers is this—do not overlook the tremendous value to your business of using the splendid selling helps furnished all those who carry the Magnavox Radio and Power Amplifier in stock.

Magnavox selling helps popularize the entire "radio idea" wonderfully, and bring customers to your store for all radio supplies.

The whole story of our free dealer service is told in THE MAGNAVOX, illustrated above. Be sure your name is on our list to receive every copy as published, and be sure that your Magnavox stock is adequate. Write us today.



No Wireless Receiving set is complete without



WHEN your boy points to the Magnavox trade mark and says "Dad, that's the real reproducer," he sums up pretty much the whole story of Magnavox supremacy and radio enjoyment.

To enjoy all that radio offers, ask your dealer for a receiving set equipped with Magnavox Radio, the Reproducer Supreme and the Power Amplifier.

R-2 Magnavox Radio with 18-inch horn: for those who wish the utmost in amplifying power; for large audiences, dance halls, etc. . . \$85.00

Model C Magnavox Power Amplifier insures getting the largest possible power input and volume for your Magnavox Radio. 2 stage . \$80.00
3 stage . 110.00

R-3 Magnavox Radio with 14-inch horn: the ideal instrument for use in homes, offices, amateur stations, etc. \$45.00

Combination R-3 Reproducer and 2 stage Power Amplifier
Price \$125.00

Magnavox Products can be had from good dealers everywhere. Our interesting new booklet (illustrated in three colors) will be sent on request.

The Magnavox Co., Oakland, California
New York: 370 Seventh Avenue

MAGNAVOX

Radio

The Reproducer Supreme

What the Manufacturers Are Doing

New Manhattan Instruments

Performance and appearance are the keynotes in the construction of the Manhattan bakelite vario-couplers and variometers. These instruments display in their careful finish and attention to detail the painstaking design



Manhattan Vario-Coupler

upon which their construction has been based.

The material used, for instance, is moulded bakelite, reddish brown in color and neat in appearance. The amount of metal used in the instrument has been reduced to a minimum to keep the electrical loss as low as possible. Bakelite is used as extensively as is practicable because its electrical qualities are well known and its strength insures a rigid construction.

Since both vario-couplers and variometers are frequently mounted on "shielded" panels, the Manhattan instruments are mounted on a bakelite block. By this simple device the vario-coupler or variometer can be used on a metal panel without the



Manhattan Variometer

usual difficulties connected with insulation.

The makers of the Manhattan instruments claim additional features for their products. Both instruments are provided with heavy braided "pigtailed" making connection with the rotating member. This is said to insure positive contact and quiet operation.

Both instruments have a stator with a one-quarter inch collar, permitting the conversion into a long wave coupler by attaching a standard three inch bakelite tube.

The Manhattan vario-coupler has a primary winding with twelve taps with control of wave lengths up to 700 meters. The variometer has a wave length of 140 to 420 meters as connected in an ordinary hook-up.

These instruments are made by the Manhattan Electrical Supply Company, Inc., 17 Park Place, New York City.

Robbins Air Condensers

One of the pioneer makers in the condenser field, the Robbins Electric Co., 830 Liberty Ave., Pittsburgh, Pa., have now standardized on four capacities of variable air condensers which have 3, 11, 23 and 43 plates.

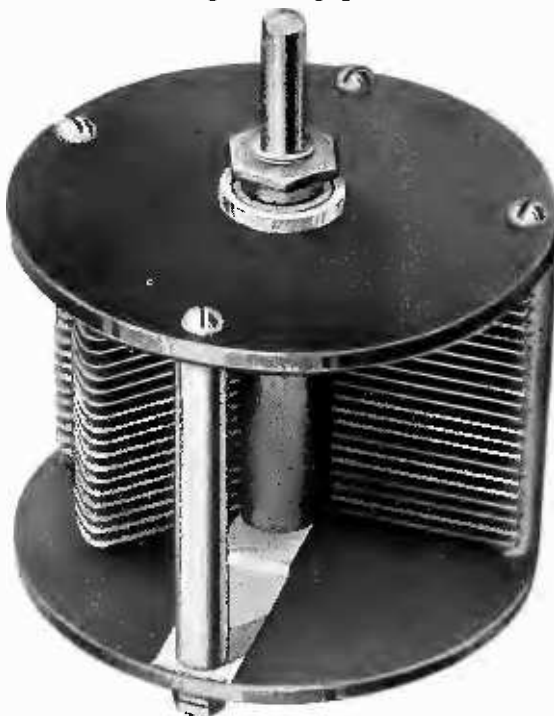

Robbins Condenser

Some of the advantages claimed for these Robbins condensers are: Single hole mounting, for if one hole is bored in the panel the mounting of the condensers is only the operation of a fraction of a minute. The single hole mounting is also said to eliminate twisting strain on stationary plates. There are no steel parts, the instruments being entirely constructed of aluminum, nicked brass, lead alloy and bakelite. The ends are of sheet bakelite, and full circle disks add to the rigidity of construction and protection of plates in all positions.

The plates are not of the washer type, but are anchored by lead alloy in slotted brass tubes, slotted with accuracy on milling machines. Spacing is thus held to the correct limit, and constant alignment is assured.

Readily Adjustable Grid Leak

The adjustable grid unit that has just been placed on the market by the Central Radio Laboratories of 303 Sixteenth street, Milwaukee, Wis., consists of an adjustable grid leak and a grid condenser, the latter being



Adjustable Grid Unit

mounted between the outer ends of the grid leak binding posts.

The high resistance of the leak can be gradually and smoothly changed to any desired value between one-half and four megohms merely by turning the operating knob. The point of maximum sensitiveness can be definitely and quickly ascertained.

Mounted on the bakelite base is a fabric strip, the ends of which are connected to the binding posts shown in the illustration. The fabric strip is impregnated with a high resistance compound of tested permanence. The current from the grid leaks along this strip, the amount being regulated by adjusting the area of contact of the strip with a curved phosphor-bronze spring that is held in place by a compression block. The compression block is operated by the screw attached to the operating knob. As the knob is turned to compress the spring, a larger area of the spring comes into contact with the fabric strip and the resistance between the binding posts is decreased. More current leaks across and the potential of the grid is decreased. Turning the knob in the other direction decreases the area of contact and cuts down the current leakage and permits a higher potential between the grid and the plate. The potential that provided the maximum signal strength is thus obtained with ease and certainty.

The entire unit, which is mounted through a single hole in the panel, takes up a space $2\frac{3}{4}$ inches long and $\frac{3}{4}$ of an inch wide.

Wide Range Condenser

According to the Bureau of Standards, an ideal condenser would have constant capacity under all circumstances, with zero resistance in the leads and the plates and no absorption in the dielectric. The Magnus Electric Company, Inc., 17 Desbrosses Street, New York City, are offering the Magnus Wide Range variable condenser as filling the specifications for



Magnus Wide Range Condenser

this ideal condenser as closely as possible.

The Magnus condenser differs from the general trend of instruments in that instead of using a large number of plates for high capacity, two heavy plates are used. By means of a differential screw, the two plates can be separated by infinitesimal degrees, the two plates being separated by one-hundredth of an inch through turning the dial once. The dial has 360 scale divisions so that turning it one division would mean separating the two plates by $1/36,000$ of an inch. Thus a very high capacity is obtained.

The plates used are heavy die-castings instead of the familiar semi-circular sheets now on the market. This gives a very low resistance in the plates of the condenser. Circular plates are also superior from a mechanical point of view, the makers assert, since there is no chance of buckling or bending of such plates. Their permanence and rigidity and high electrical efficiency are thus secured.

Kester Wire Solder

The Kester Acid-Core wire solder is made of hollow wire of genuine tin and lead containing pockets which hold an acid fluid and is sold by many wholesalers, to the radio trade. Kester Solder is put up in one pound cartons, and on one, five and ten-pound spools. This solder is made by the Chicago Solder Co., 4201 Wrightwood Ave., Chicago.

With twelve features of superiority, yet within the reach of every radio user.

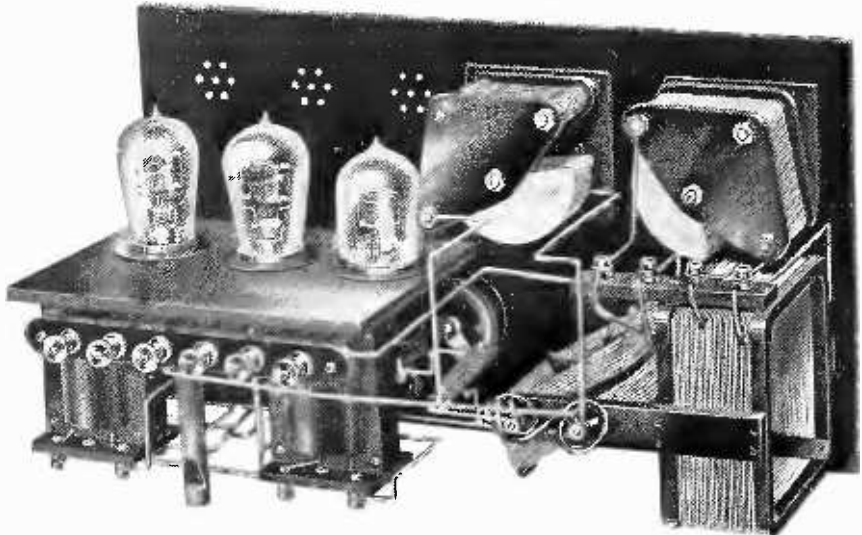

Rear View

JEWETT SUPER - TWELVE SELF CONTAINED VACUUM TUBE RADIO RECEIVER

Meets the demand for a complete receiver, combining good range, extreme sensitiveness and selectivity, with moderate price and economical operation.

The Jewett Super-Twelve has a double circuit tuner, constructed with new Jewett coupler of extreme selectivity, designed by Professor J. H. Morecroft of Columbia University. The adjustments are unusually simple and easy, requiring no special technical knowledge to insure success.

Two steps of amplification are furnished which give an increase of signal strength equal to that obtained from three or four steps employing ordinary transformers. The high quality of the incoming speech or music is sustained through uniformly high amplification over the entire musical scale.

Operated with W. D. 11 Tubes and Dry Cells or storage battery; also with indoor aerial or loop.

PRICE, \$75.00

In Kodak, Mahogany or Walnut Cabinet

JEWETT MANUFACTURING CORPORATION

Herbert F. L. Allen, *President*

NEWARK

NEW JERSEY

The Loop's the Thing

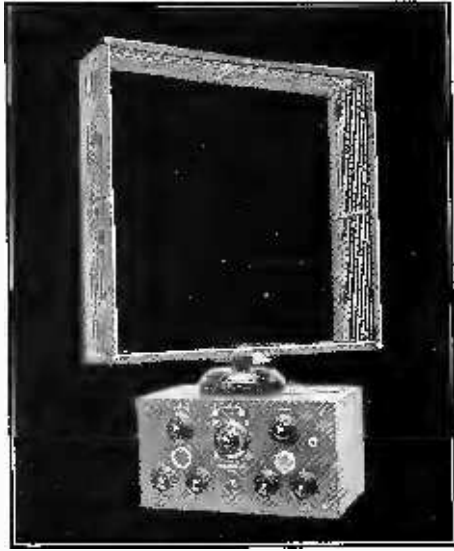

As the
Vacuum Tube
has Replaced
the Crystal
so the
PORTABLOOP
is Replacing
the Outside
Antenna

Stock up
Before the
Spring Rush
Makes a
Shortage



210 Central Avenue

Reception Noises Are Not Caused by "B" Batteries

By BERNARD J. FARRELL

Assertions that the "B" battery is the cause of noise in radio reception have been made and refuted since radio began to experience national popularity. The latest argument in defense of the "B" battery is contained in a statement recently issued by the National Carbon Company, Inc., of Long Island City, N. Y.

"The truth about the matter," this publication states, "is that there is no such thing as a noisy 'B' battery. What is more," it adds, "there never was one and there never will be one. It does not matter whether it is a dry 'B' battery or a storage 'B' battery. It simply cannot produce noise on its own account.

"Of course," it proceeds, "if there is a loose or faulty connection in the battery, the connection may cause noise; a poor contact will do that anywhere in a radio set. But there is nothing in the cells themselves which can produce noise.

"Noise in radio receiving sets," the statement continues, "is always the result of irregular fluctuation in 'B' battery current. Anything which can set up these irregular fluctuations becomes a source of noise. If we carefully analyze the average receiving set, we find literally dozens of places where noise may originate. Why, then, should we indiscriminately blame the 'B' battery?"

"It has been observed that the tendency for certain factors to produce noise is aggravated by sub-normal 'B' battery voltages. This is why batteries are believed to become noisy when nearly exhausted. Substituting a new battery for the old one will stop the noise, not because the old battery was noisy, but because this procedure restores the voltage to normal, under which conditions noises are less likely to occur."

The statement goes on to state that there are so many diverse causes of noise in radio reception that radio engineers are still at a loss to explain them all. And yet, it asserts, the local "radio expert" is willing to lay all the blame upon the "B" battery. Even today radio engineers are at work trying to eliminate noises from reception.

"This elimination will not be accomplished suddenly," the statement resumes. "It will come as the consequence of evolution. It takes years to

perfect any new device. The radio receiving set of today will doubtless pass through several stages before final perfection is reached." As an illustration, the evolution of the telephone to its present perfection is cited:

"It took many years of intensive study and development work before the telephone became a reliable instrument. And one of the big difficulties encountered in the early days was what telephone engineers thought to be noisy batteries. This was a real problem, and the best minds of the time unhesitatingly blamed the batteries for certain otherwise unexplainable noises. Yet time has proven that those troublesome noises did not originate in the batteries. As the telephone went through its natural period of evolution, the noises gradually ceased, and today, a noisy telephone battery is unheard of, although there are millions of dry cells in telephone use.

"The refinement of radio receiving sets will follow much the same lines as in the refinement of the telephone. One by one the things that now cause noise in a radio receiving set will be eliminated and eventually, we hope soon, all talk about noisy 'B' batteries will be as extinct as talk about noisy telephone batteries.

"Select your 'B' battery carefully. Any manufacturer's claim of noiselessness should be considered only with respect to the quality and permanency of the connections between the cells in the battery. Consideration should be given to the reputation of the manufacturer. Choose a 'B' battery made by a manufacturer of established reputation whose products are backed by extensive research laboratories."

Value of R. T. A. Membership

That membership in the Radio Trade Association is a valuable asset in business is shown by the fact that it appears to be the vogue for members to make the fact known that they connected with this organization. One of the first of the distributors to do this is R. R. Garrick, 126 North Redfield Street, Philadelphia, Pa., who carries at the foot of his new letterheads the line, "Member of the Radio Trade Association."

ALL PRODUCTS GUARANTEED



The MICAPHONE

Money Back Guarantee

Trade **KODE KILLER** Mark

- (1) Kills code—both amateur and commercial.
- (2) Separates interfering broadcast stations.
- (3) Gives sharper tuning.
- (4) Does NOT cut down signal strength.



Mica Diaphragms made for all phones

Scientific Construction Rubber Mounting

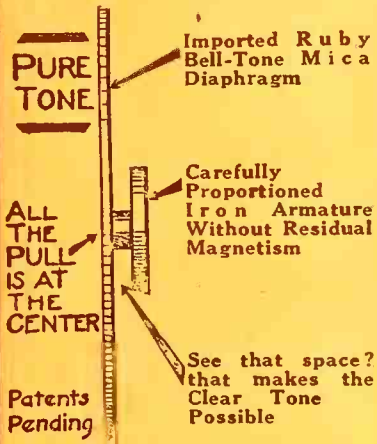

Send \$13.75 for trial dozen pair assorted sizes to fit all phones.

Mounted on attractive counter display easel. Complete with size list, circulars and window display easel.

They make all phones better.

Send \$5.75 for trial sample. Big discounts in quantities.

LISTS AT **\$7.50**

2 Big Profits for You!

List \$2.00 Per Pair

RADIO MICA PRODUCTS CO.
156 EAST 43d STREET, NEW YORK

KNOWN FAVORABLY EVERYWHERE

CROWN Triple Coil Calibrated Mounting

There is nothing more fascinating than the reception of Radio messages from high power stations located thousands of miles away. These stations use wave lengths between 1,000 and 25,000 meters. This is far above the receiving range of the average receiver designed for amateur broadcast reception.



This "Crown" Mounting has the following special features:

1. Made of Thermoplas, a high grade insulating material; it possesses the advantage over rubber of resisting heat to a far greater degree. It has high dielectric and mechanical strengths, is non-hygroscopic, is unaffected by atmospheric agents and will not deteriorate with age.

2. Special Locking Device to keep the coil in place, thus preventing it from being thrown out of adjustment.

3. Special Adjustable Bearing feature.

4. Special constructed Bushing, preventing wear on top and bottom plates.

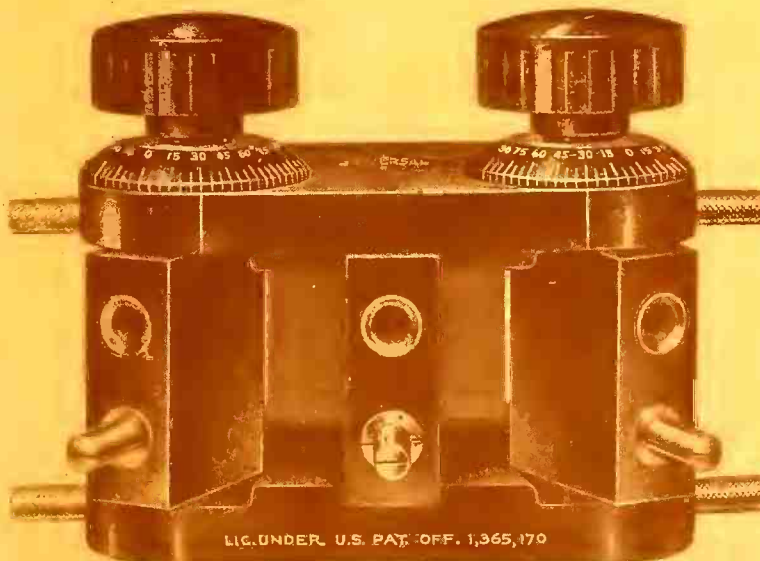

LIC. UNDER U.S. PAT. OFF. 1,365,170

Licensed under DeForest U. S. Patent, No. 1,365,170

5. Special constructed Calibrated Dial, showing the stations tuned.

6. Positive Connections on rear of blocks.

7. Complete with Flexible Leads.

8. All Metal Parts of brass and highly nickel plated. Its high polish and fine finish give it a very attractive appearance.

9. The simplest Mounting to install on your set.

List Price

- Triple Coil Mounting \$5.00
- Single Coil Mounting50
- Telephone Plugs 1.00
- Telephone Jacks . . 65c, 80c, 95c
- Dials 2", 3", 3 1/2" . .35c, 50c, 75c

DISTRIBUTORS WANTED. WRITE FOR OUR PROPOSITION AT ONCE.

CROWN RADIO MFG. CORPORATION

78 FIFTH AVENUE

NEW YORK

Good bye Aerials!

This ingenious cylinder (SHORT-CUT ANTENNA)—just perfected by radio engineers—takes the place of aerials, loops, plugs, etc.—and makes the radio set PORTABLE!

Eliminates lightning dangers, landlords' objections, static interference—brings clearer signals and greater reception. Fits all standard sets—simply connect to aerial and ground terminals of set.

One New York department store sold dozens in a single day—what an opportunity for you!

To be nationally advertised—think of the demand. Sells for \$5—satisfaction guaranteed.

SHORT CUT RADIO CORPORATION

243 West 54th Street
New York

DEALERS!

Write for our attractive proposition on SHORT CUT ANTENNA.

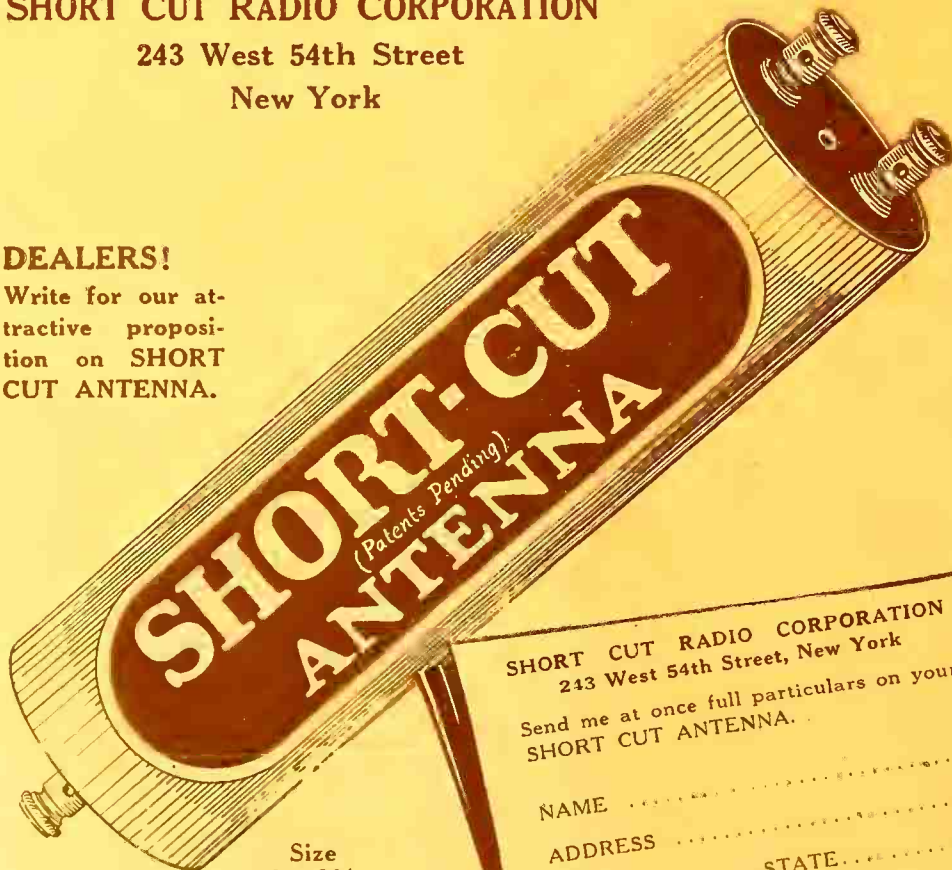

Size
2 x 6 1/2
inches

SHORT CUT RADIO CORPORATION
243 West 54th Street, New York
Send me at once full particulars on your
SHORT CUT ANTENNA.

NAME
ADDRESS
CITY STATE.....

G-M

GUARANTEED RADIO APPARATUS



VARIOCOUPLER

Reinforced taps, Cellulac tubes, full 180° rotation

List Price, \$4.00

WRITE FOR PRICES ON

- Antenna Plugs
- Antenna Wire
- Honeycomb Coils
- Insulators
- Insulite Panels
- Jacks
- Planet Loud Speakers
- Plugs
- R. F. Transformers
- Sockets
- Socket Rheostats
- Variable Condensers
- Variocouplers
- Variometers

NATIONAL DISTRIBUTORS
OF
QUALITY PRODUCTS

GENERAL MERCHANDISE CO.

6 Academy St., Newark, N. J.

Manufacturers and Distributors

Phone Mitchell 2746

Dealers Should Test Their Head Phones

(Continued from page 23)

The two wires leading from the phone are attached to the two nearest springs of the binding posts. To the other two springs are joined the ends of a single telephone cord. Everything is now ready for the testing.

The person testing takes the master phone (one that is beyond reproach) in his right hand and with his thumb, presses the tips of the cord attached to the posts into their place in the phone. With his left hand he throws the switch. A loud steady "buzz" should be heard. He immediately replaces the master phone for one that is to be tested and in this manner a comparison is easily made.

If two phones do not have exactly the same tone, it does not necessarily mean that one of them is useless. However, it is imperative that two phones possessing different tone qualities be not put into the same head-set. Phones, to give the best results, must be "matched." After a short time, at operating the apparatus, even a novice will be able to hit an average point above which phones will be accepted and below which they should not be used.

Advertise the Stellar Broadcasting

(Continued from page 23)

only know this when the facts are presented in a proper manner.

Every dealer can capitalize on the wonderful programs now available in the air every day. Every person in the land ought to be told of the rare opportunity of listening in on real concerts in the most comfortable manner, in an easy chair at home.

All of us cannot attend the opera as often as we would like, but it can be done by radio at practically no cost.

The radio dealer naturally uses his windows to display radio apparatus—but why not go a step further? Send forth publicity on the programs.

Take any week's program and have a few signs printed, reading as follows:

Tonight Via Radio
at Your Home
The A B C Receiver
Brings You
Chicago Grand Opera

Many people do not know this great thing about radio—that it brings programs of real quality to the home for the asking.

STANDARD RADIO HORNS

Are
Fundamentally
Right

That's Why
They Sell

ALSO MAKING

7-inch Bell, 19 inches
High

Rubberoid finish only. Will take all makes of receivers. No air pocket. Designed to give proper amplification. Heavy material to avoid blast.

No. 17, price \$7.50

5-inch Bell, 14 inches
High

Rubberoid finish only. Will take all makes of receivers. Specially designed for Radio purposes. Heavy brass. No vibration.

No. 15, price \$5.00

The line of Standard horns is now complete. The dealer who stocks Standards is thus able to supply correctly made horns for any Radio need—at popular prices.

We can furnish a single high-grade loud phone with cord—to fit any of these horns—to make a complete loud speaker.

Price, \$7.50 Extra

STANDARD
METAL MFG.
CO.

237 CHESTNUT ST.,
NEWARK, N. J.



14 Inch Bell, 24 Inches High

Rubberoid finish only. Will take all makes of receivers. No air pocket. For use where extra large horns are desired. Heavy material. No vibration.

No. 114, price \$12.00



11 Inch Bell, 14 Inches High

Here's a new design in Radio Horns—will take all makes of receivers. Surprisingly clear reproduction. Grained Mahogany or Black Rubberoid Enamel finish.

Gem, price \$7.50



Mercury Radio Sets

A PROFITABLE line to handle, from the dealer's standpoint. A reasonably priced line to buy from the consumer's standpoint.

The low price is made possible by quantity manufacture in our large factory where every part is **MADE**, not merely **ASSEMBLED**.

Write for details and trade prices.

MERCURY RADIO PRODUCTS CO.

LITTLE FALLS NEW JERSEY

PHONE PLUGS

Standard Type

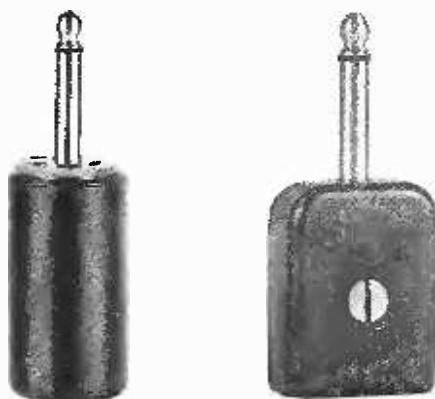

35^c each

22^c each

in lots of 100 or more

The above plugs can be used with pin, spade, or plain wire ends.

No soldering necessary

S. S. NOVELTY CO.

255 Bowery, New York, N. Y.

Costs of Conducting a Radio Business

(Continued from page 26)

these improvements will reduce costs unless the business man knows what his total costs are and exactly what items make up the total. Items of cost are frequently lost track of when the total only is considered, but if these items were properly segregated so as to show what they were, they could be materially reduced and in some instances eliminated altogether.

For instance, we had a case where a man figured the cost of his material to be \$10.00, and the cost of his labor \$5.00, and the cost of his overhead to be 50 per cent. of the sum of these two making his total cost at this point \$22.50. Then, he knew that he must allow customers a discount for cash of 5 per cent. on \$22.50, amounting to \$1.13, and this he added to \$22.50, making his selling price at least \$23.63. To this sum he added 10 per cent for profit, which brought the selling price up to \$26.00.

He did not stop to realize, however, that when the customer remitted the cash payment he deducted 5 per cent of \$26.00, amounting to \$1.30, from his check, and that, therefore, he was losing from his profit of 10 per cent., seventeen cents on each article he sold so that his profit instead of being \$2.36 was \$2.19.

The proper segregation of all the expenses of a business means that the business man can tell just how much it costs him to manufacture the article, how much it costs him to sell the article, how much it costs him to administer his business and how much it costs him to finance it. It can be plainly seen that the act of segregating these articles is in itself highly important, because it would never do to charge to, say, selling expenses, the salaries of a bookkeeper or stenographer whose sole function is administration.

Only a week ago, a jobber right here in New York City said to me one Saturday morning, "Seidman, did you see my advertisement in the newspaper today." I said, "Yes, how much did it cost you." "\$250.00," he told me. And then he added, "advertising is certainly a cheap way of selling merchandise, isn't it? Here! If I sell \$250.00 of merchandise today, I have the money to pay for my advertisement."

That man did not stop to realize that for every penny of expenses he had along such lines he had to add, in his particular instance, 66 $\frac{2}{3}$ per cent. of the cost of the merchandise that he was selling before he could have re-

Warren Radio Loop Un-Covered



The Warren Radio Loop

Monopolizes Profits

Safe to stock and profitable to handle because it is the only loop with all its advantages on the market. Your customers can't buy anything at any price anywhere that will do the trick as well.

Loops are now a necessity in many places. Their advantages are recognized by all. The dealer that handles *Warren Radio Loops* is getting the bulk of the business.

Type A-737 (300-700 meters) 6 inches square—non-directional	\$10.00
Type A-7236 (175-1000 meters) 6 inches square—non-directional	12.00
Type B-2537 (300-700 meters) 18 inches square—directional	20.00
Type BL-2520 (200-18,000 meters) with honeycomb coil, 18 inches square—directional	25.00

Send for Bulletin P-102

V-DE-CO RADIO MFG. CO.

ASBURY PARK, N. J.

Dept. D

"W. D. SPECIAL"

Transformer for use with W.D. 11 Tubes



Get Your Share!

Meet the big demand with this specially wound transformer—for use with WD 11 and all other 1 $\frac{1}{2}$ volt tubes.

Perfect Results—No Distortion—Full Volume. \$5.00 list—Extra Liberal Discounts to Dealers and Jobbers. Immediate Deliveries. Place full order or we will send one C. O. D.

WIRE, WRITE OR PHONE ORDER

Radio Courses, Inc.

552M Seventh Ave.

New York City

turned to him not only the cost of his merchandise but his \$250.00, as well as his other expenses for the day.

We have operated in practically every line of business in existence today, and during the past ten years we have gathered, for statistical purposes, the average sales of all the businesses, the cost of doing business, and the profits derived from them, and we have found that the average percentage of overhead that must be added to the cost of the merchandise before a concern can begin to make a profit amounts to, for manufacturers, 55 2/3 per cent. of the cost of the labor and the material alone, for jobbers 44 per cent. and for retailers 51 per cent.

Let me at this moment caution you very, very strongly, not to leave here with the impression that when you get back to your businesses that if you add these percentages to your costs of material, you will have arrived at a figure at which you can safely sell, and break even. You cannot do this; you must not do this, for we have found that averages of an industry as a whole may be entirely different from the percentage of some one individual business where we tried to apply them. The truth of this can be readily seen in the case of rent alone, where the average of factory rent for the industry amounts to \$250.00 per month, and your rent amounts to \$350.00 a month. Your percentage must necessarily be higher.

Gentlemen, your calculations must be somewhere around the figures mentioned. You cannot do business by adding 10 per cent. or 15 per cent. or 25 per cent. to the cost of the merchandise and make a profit from the selling price that results. If you are to stay in the manufacturing or jobbing of apparatus, you must know what the cost of doing business to your particular firm is.

Not only does accurate cost accounting give to the manufacturer complete information for establishing selling prices, but it also assists him in meeting new industrial conditions as they arise from time to time.

While statistics show that the peak in prices of basic commodities and labor was passed some time ago, yet the recent decline in prices has been checked to a large extent and the manufacturer is again confronted with demands for higher wages and better labor conditions, and these in the face of keen competition in marketing his product.

I spoke to you of averages a few minutes ago. Certain trades have established bureaus for the tabulation and distribution of trade statistics relating to business conditions and of

WABASH RAILWAY COMPANY

TRAFFIC DEPARTMENT
311 STATION
PASSENGER TRAFFIC MANAGER ST. LOUIS

November 30 1922

Mu-Rad Laboratories, Inc.
800 Fifth Avenue
Asbury Park, N. J.

Gentlemen:

It is a pleasure to report the result of the tests which were recently conducted on Wabash trains No. 2 and 5 with one of your Mu-Rad Radio Receivers.

The Mu-Rad Receiver with a 2' loop aerial was set up in all-steel club car placed in the middle of a train of fourteen cars which left St. Lo for Kansas City at 11:00 P.M. on the night of November 28th. Some forty persons were present in the car and were very elated at hearing on the horn the signals from the St. Louis Post Dispatch broadcasting station and from the Kansas City Star. The signals were very clear and strong up to the time the broadcasting shut down.

On the morning of November 29th a second test was made on the train running from Kansas City to St. Louis, the Mu-Rad equipment of this test being set up in the observation car. On this return trip, three stations in Kansas City, one in Wichita, Kansas, one in Jefferson City, Mo., two at Atlanta, Ga., and one in St. Louis, and the Schenectady, N.Y. station, were all picked up very clearly.

Persons who witnessed the tests considered the performance the most wonderful radio achievement they had ever seen expressing surprise at the clarity and strength of signals received on a small loop and particularly within an all steel car during daylight.

Yours very truly,
H. E. Wata
Passenger Traffic Manager

*The New
Star in
the Radio
World*

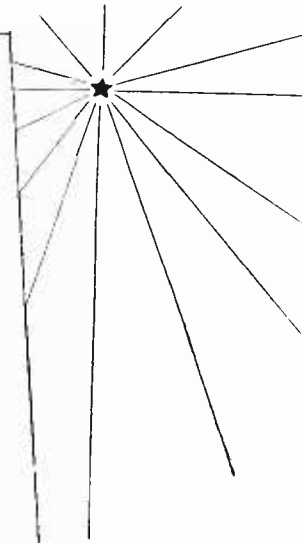

What the Railroad said about the performance of the Mu-Rad Set on the Wabash Express

MU-RAD Radio Frequency Amplification

*Triumphs
in Test on Express Train*

*They copied all they could copy,
But they could not copy our mind;
We left them tearing and swearing
A thousand miles behind.*

—Kipling

THE entire radio world is agog at this latest supreme achievement—the reception of radio programs inside a steel car, with no outside aerial or ground, moving at express speed—the severest test ever given any receiving apparatus.

Such striking superiority is the finest guarantee of profits on Mu-Rad Apparatus. Your cash register is missing this money. Let us give you the details.

Type MA-12
3 Stages R. F. and
Detector
\$128

Type MA-13
3 Stages R. F., and
Detector and 2
Stages A. F. \$160

DEALERS: Write for interesting proposition.

Mu-Rad Laboratories, Inc.
800 Fifth Ave. Asbury Park, N. J.

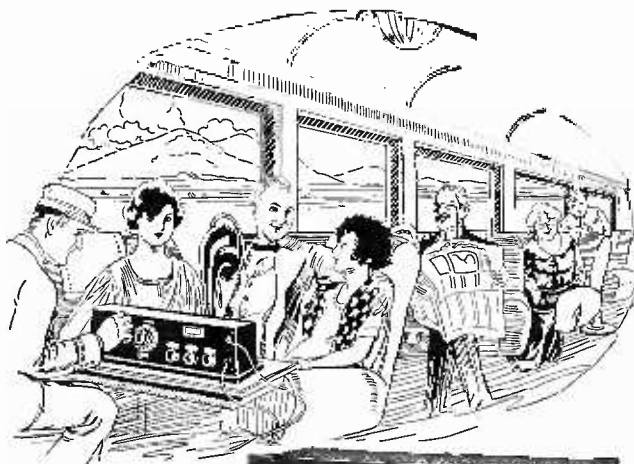

AEROPLUG—THE SOCKET AERIAL

A Fast Seller



Screwing the plug into any lamp socket makes a wonderful aerial of the house lighting circuit. No current used. No danger. Nothing to get out of order. Lasts indefinitely.

Aeroplug sells on sight. All are guaranteed. A small trial order will prove its possibilities. Write NOW.

\$1.50

LIST

*Used for Crystal Sets Only
When Close to Stations.*

Write for Attractive Discounts

STAR MANUFACTURING CO. 868 BERGEN STREET
NEWARK, N. J.

A QUALITY CONDENSER

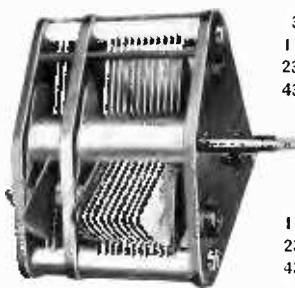

3 plate.....\$1.60
 11 " 2.30
 23 " 2.75
 43 " 3.25

With 3 plate Vernier "Built In"

11 plate.....\$3.80
 23 " 4.25
 43 " 5.00

Bakelite end plates, moulded posts with brass reinforcing rod running through each post. Adjustable spring tension. Accurate spacing and alignment.

SPECIAL Fiber end plate, "Old construction"
 3 plate.....\$1.25
 11 " 1.30
 23 plate.....\$2.00
 43 " 2.50

ADAPTERS

\$1.50 Polished and nickel plated, threaded to screw on your Receiver. Made for any combination of phone and phonograph. Specify desired combination.



STUCKEMAN BROS., Inc.
 18 Ruth St. Pittsburgh, Pa.

"COPPERWELD"

TRADE MARK REG. U.S. PAT. OFF.

ANTENNA WIRE

50% stronger than either solid or stranded copper

ELIMINATES SAGGING

Adopted by Largest Radio Manufacturers
 100, 150, 200 ft. per Carton

LEAD-IN and GROUND WIRE

has the Underwriters' O. K.
 Rubber Insulated—Brown Braid
 25, 50, 100 ft. per Carton

BUY IT IN CARTONS

with construction directions

COPPER CLAD STEEL COMPANY

New York Chicago
 Braddock P. O., Rankin, Pa.

POSTER'S PERFECT PANELS

XX Bakelite—Dilecto Radio Panels

Manufacturers and dealers: immediate delivery—any quantity—cut to size.

Engraving and Drilling

Sharp white lettering, clean accurate work, quantity production at surprisingly low cost. Write today for Sample and prices.

POSTER & CO., INC.

552 Seventh Ave., New York
 Phone: Penn. 5385

special value to the respective trades. When the executive studies the trend of business as evidenced by his own comparative statements and sees, perhaps, that his own business is falling off, he is also able to view his results in comparison with those of the trade as a whole.

If he knows that his own business has been maintained as to volume at a relatively higher ratio to normal than general business has been maintained in his line, he may have reasonable grounds for satisfaction in believing that he has continued to secure at least his share of the available orders, provided, however, that he has not sacrificed profits in obtaining the business; but if he finds that he has not maintained his relative proportion of business done, he has a compelling reason for searching inquiry in order to ascertain the cause of such a condition.

New York Stater's Novel Selling Plan

(Continued from page 25)

capable of producing sufficient volume. After our audience has gathered around, we give a short talk, starting from the advent of wireless to the broadcasting stage. We end this talk by tuning in different stations.

"After our concert is over, we request all those interested to stay for a short time, and all nearly always do. We then talk the cost of radio sets, and allow those interested to tune the demonstrating outfit, which in almost every case makes a sale. There is no charge whatever to those who are interested enough to come to these demonstrations, as we meet all the expenses incurred, such as advertising and erection of the aerial."

Mr. Reynolds calls this plan "stimulating trade." It might also be called "using one's brains."

Issue Guide and Catalog

A little guide and catalog of the products made by the Parkin Manufacturing Company, San Rafael, Cal., was recently issued, showing some of the radio novelties made by this firm.

Among the varied radio parts the firm has to offer are several recently patented devices, including the Parkin knob type rheostat, the Parkin .001 variable condenser and the Parkin dial-type rheostat. Other lines included in the catalog are Parkin bakelite knobs, switch levers, fixed condensers, switch contacts, tube sockets, and crystal detectors. All are made in the Parkin factory, within sight of Mount Tamalpais.

Praco Panel Service

We offer to the amateur and dealer

REAL PANEL SERVICE.

Our panels are cut to your order. Only genuine Condensite and Formica used.

1/8" per square in. 2c
 3/16" per square in. 2 1/2c
 1/4" per square in. 3c

We also carry a complete line of radio essentials. Dealers will find it profitable to have our latest price list and discount sheet.

PITTSBURGH RADIO AND

APPLIANCE CO., Inc.

"Pittsburgh's Radio Shop"

Desk D

112 Diamond St., Pittsburgh, Pa.

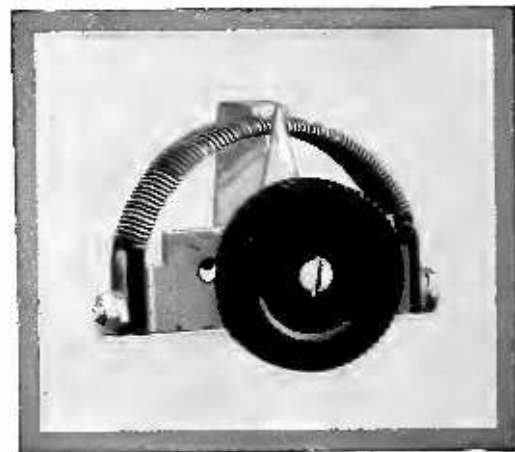

A BETTER RHEOSTAT

A nicer looking, smoother working and better made rheostat than you have ever seen before.

Furnished with or without vernier this instrument will improve the operation of any radio equipment.

The many valuable features coupled with national advertising make this an instrument every dealer and jobber should stock—liberal discounts give ample margin of profit and low list means quick turnover. Order now.

List Prices
 123A Plain..... 80c
 Type 123B Vernier.....\$1.40

THE WILCOX LABORATORIES
 LANSING MICHIGAN

LOUD SPEAKER FOR ANY CRYSTAL SET

The Steinmetz Amplifying unit selling for \$8.50 will enable you to hear any crystal set all over the room. No storage battery required. All Steinmetz equipment is thoroughly guaranteed.

STEINMETZ 3000
 Ohm Phones.....\$6.50
STEINMETZ 2000
 Ohm Phones..... 5.00
STEINMETZ 1000
 Ohm Phones..... 1.75
 Equal to any \$10.00 or \$12.00 Phones Made

"Superior" Crystal Set, \$4.75
 Complete catalogue 50 at your dealer or
STEINMETZ WIRELESS MFG. CO.
 5706 Penn Ave. Pittsburgh, Pa.

Radio Trade Subject To Natural Laws

(Continued from page 25)

best interests of radio are to be served.

There is nothing more abhorrent in the practice of genuine business than the desire of unscrupulous merchants to "put one over." It is cause for some rejoicing, therefore, that the natural law of any business is working to put these same merchants "out of the running." In the radio industry this class of outlawed merchants are in their own tempestuous haste to accumulate quick return, succeeding only in destroying themselves.

The house-cleaning era of the radio industry is almost over. There are signs everywhere, in the scope of our advertising, in the trend of our organization, and in the appreciation of the general public and the press, that radio is here and here to stay. The coming months cannot but reflect the growing importance of radio as far as the people of the United States are concerned.

The past experience of the radio industry is but an indication of what the future holds in store. In the past dishonesty in methods and manufacture proved unprofitable. The same will be true of the future. To acquire a permanent name in any business requires adherence to a single proposition: "Make the Best."

CSE Service

Service for the radio dealer, as outlined by the Central States Engineering Company, of 234 North Halsted street, Chicago, Ill., embodies three things: An intelligently conducted engineering bureau, a sales service worthy of consideration and an active service bureau for the use of the radio retailer. This is known as "CSE" service.

The Central States Engineering Committee Company's engineering bureau is under the direct supervision of a former Army Signal Corps engineer assisted by men of proven ability, who are ready to aid the dealer in matters of a technical nature. The sales service handles the lines for which the Central States Engineering Company are distributors. These include more than twenty-five standard makes including the R-W line. The CSE service bureau, among other things, distributes monthly trade letters, outlining conditions in various sections of the country, and broadcasting trade tips, etc. Listings in this trade letter for quick turnover of stock are made gratis, but a small charge is made when sale is completed.

BETTS SPECIAL RECEIVER

Specially designed for receiving broadcasts at 300-400 meters
—highly efficient and selective within this range.

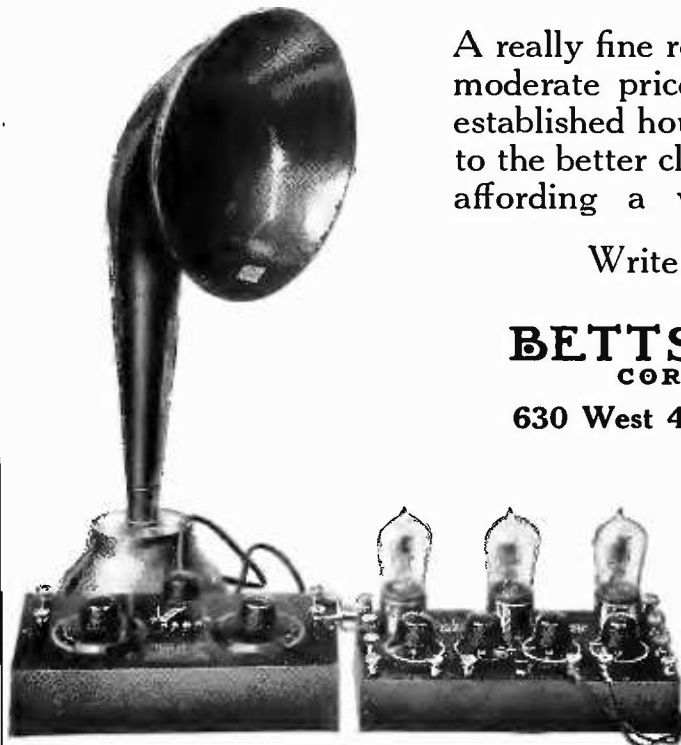

A really fine receiving set sold at a moderate price. Made by a long established house, and offered only to the better class of trade on terms affording a white man's profit.

Write for terms.

BETTS & BETTS
CORPORATION

630 West 43rd St., New York

Betts Special Tuner,
type RC11 \$24.50

Betts Visible Detector-
amplifier, type D2A
without tubes \$38.50

Betts Loud Speaker
\$24.50

Three together \$81.50

Sell a HOMCHARGER With Every Radio Set



No Radio Set using batteries is complete without a HOMCHARGER. "A" Batteries must be charged *at least once a week* and the home is the only practical and economical place to do it.

THE
HOMCHARGER

is the most profitable rectifier for you to handle, leading all others in popularity and volume of sales—over 70,000 NOW in use.

It quickly, quietly and efficiently charges Radio "A" or "B" batteries without trouble, fussing, or muss AT HOME for a NICKEL.

IT'S MERCHANDISED

NONE but the HOMCHARGER combines ALL of these necessary features:

1. Nationally Advertised in 30 publications.
2. Dealer Helps and Dealer Cooperation to the limit.
3. It's SELF-POLARIZING.
4. Has a HIGH CHARGING RATE.
5. It's APPROVED BY UNDERWRITERS.

Retail price \$18.50—complete with ammeter, etc. See your jobber or write TODAY for our proposition in detail.

The Automatic Electrical Devices Co.

144 West Third St.

:: Cincinnati, Ohio

LARGEST MANUFACTURERS OF VIBRATING RECTIFIERS IN THE WORLD

"Euraco" Products

"Euraco" Mica Condensers are of the Cartridge Type, glass enclosed, and are composed of COPPER SHEET and BEST GRADE INDIA RUBY MICA—ENTIRELY HAND MADE.

Compact, Interchangeable, Most Efficient.

(.000025-.0001-.00025-.0005 Mfd. Capacities)

PRICE .60 PER UNIT

Bakelite Base with Single Mounting... .40
 Bakelite Base with Double Mounting... .60
 Bakelite Base with Triple Mounting... .80

Interesting Proposition for Dealers

Shipowners Radio Service, Inc., Distributors

80 Washington Street New York

Mfd. by European Radio Co.
 1342 E. 22nd St.
 Brooklyn, N. Y.



WITH ORIGINAL NATHANIEL BALDWIN

Type C PHONES

Headset, complete, \$17.00
 Unit 11.00

Write for discounts

STATES ELECTRIC CO., Agents
 469 BROAD STREET
 NEWARK, N. J.

Maclite Vario-Coupler

Price \$5.00

Is, in the opinion of experts, the most efficient on the market.

All Other Maclite Parts are equally efficient, including the Maclite Variometer, Double Slide Tuner, Variable Condensers and Crystal Detectors. The Maclite Single Tube set at \$25.00 is the best buy we have ever seen. Let us tell you more about this set, also all other Maclite parts.

Dealers and Jobbers Write for Discounts
MACLITE RADIO CO.
 701 Maclite Bldg., Claredon St.
 Boston, Mass.

COMPOSITION

LIST PRICE

DIALS 50^c DIALS

Adjustable Switchlevers
 Knobs

NEW YORK RADIO-DIAL CO.

316 Holden Bldg. Detroit, Mich.

Economic Sales Factors in Radio Business

(Continued from page 27)

made strenuous efforts to maintain the published retail price, have expended their efforts in vain. What then is the solution? It simply narrows down to the fact, in my opinion, that the dealers are beginning to realize that building up their good will on *price* basis alone instead of a quality and service basis will only result, in the long run, in an unsatisfactory and unprofitable situation.

In some sections the dealers have already come to the conclusion that it is necessary to add a fair margin of profit to their merchandise irrespective of whether or not some other dealer tries to capitalize the situation by selling some well-known article at cost. No one dealer can get *all* the business in his town, and the dealer is certainly entitled to a fair profit. He is beginning to realize that the advertisements offering standard merchandise at little or no profit merely to create public good will toward his store at the expense of his competitors, is a short-sighted policy which in the long run will not result in any benefit either to himself or his dealer competitors, who in self-defence, retaliate by more price cutting.

There are already on the horizon, signs of the awakening of the man-on-the-street to the fact that there is a vast difference between one radio set and another and particularly between the amateur built sets and the sets built by the manufacturers after long research and experiment

However, so long as the newspapers continue to create enthusiastic amateurs by showing them how to build their own sets, there will be an increasing business in the sale of parts. From our own standpoint, however, we would prefer to forego this profitable business if some way could be found to prevent the increase of the experimental amateur class, so that we could sell them complete sets behind which we and other manufacturers are glad to place their names and reputations.

By pointing out the situation to the man behind the counter and instructing them to convey the message to the buying public. I believe that the dealers will sell more complete sets and create in the public mind a much more favorable opinion toward radio in general, to say nothing of the prospective business from thousands who are waiting for an improvement in radio reception and whose procrastination is due to noises which they have heard emanating from a set built by some enthusiastic amateur.

RADIO CABINETS

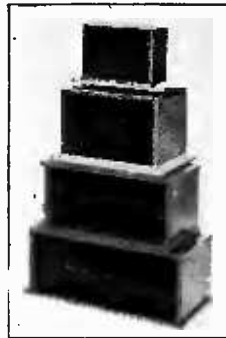

We manufacture a complete line of radio cabinets, of mahogany, walnut, oak, and white wood, in all sizes, and in any finish. Best of construction. Dirt, dust and moisture proof. Quick deliveries—quantity production prices. Send us your specifications, or a sample of your cabinets, and get our prices. We also make indoor loop aerials.

Cabinet Work Since 1900

E. ESHOO CABINET WORKS

635 Herkimer St.
 Brooklyn, N. Y.

Telephone
 Lafayette 2324

Do You Know

We are the recognized authorities on wireless securities. Our Information and Analytical Departments are unexcelled. Let us know what company you are interested in and we will furnish without obligation, detailed information and opinion respecting its merits.

FRANK T. STANTON & CO.

Specialists in Wireless Securities
 Since 1915

35 Broad St. New York
 Phone: Broad 1670-3641-5819

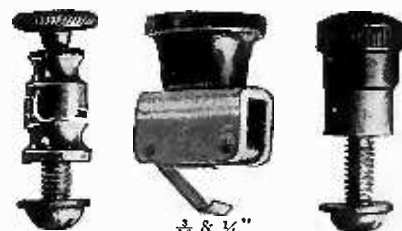

CRYSTALS **GALENA SILICON**

CRYSTAL DETECTORS List \$2.00

CRYSTAL RECEIVERS List \$9.00

RADIO APPARATUS CO.

6600 Hamilton Ave. Pittsburgh, Pa.

RADIO MAILING LISTS

- 12,400 Radio Dealers, covering U. S. by States, per M..... \$7.50
- 1,614 Radio Manufacturers, covering U. S. by States, per list..... 15.00
- 1,757 Radio Supply Jobbers, covering U. S. by States, per list.. 15.00
- 260 Radio Stations, per list..... 4.00
- 257 Manufacturers who make and assemble complete Radio Sets, per list..... 4.00
- 25,000 Radio Amateurs and Managers of Radio Stations, per M.... 7.50

Ask for price list covering Canada and England. Send remittance with order.

TRADE CIRCULAR ADDRESSING CO.
 166 W. Adams Street Chicago

Federal and State Trade-Mark Protection

(Continued from page 30)

of any state registrations?" Such questions more often than not result from an ignorance of the meaning and effect of trade-mark registration in this country. Too many of our traders have the opinion that the registration of a trade-mark at Washington is like the grant of a patent and thereafter gives them the right to the exclusive use of the mark anywhere in the country. This is not so. Registration in the United States, whether under a state law or under the federal law, is merely evidence of the registrant's claim.

The federal government, being constitutionally limited to jurisdiction over commerce among the states, with the Indian tribes, and with foreign nations, cannot have anything to do with the use or ownership of a trade-mark within the confines of any one state. It is quite possible for John Smith to have the right to the exclusive use of a certain trade-mark in commerce among the states, with the Indian tribes, and with foreign nations, and for Richard Roe to have the right to the exclusive use of the same mark within the state of New York.

Such rights, however, are not granted either by the state of New York or by the federal government. They arise automatically out of the use of the trade-mark and accrue to the earliest user. One who is the owner of a trade-mark within the state of New York by reason of having been the first to make use of same within that state may have at hand at all times legal evidence of such ownership by registering his trade-mark under the New York state trade-mark law. So, one who is the owner of the right to the exclusive use of a given trade-mark in interstate commerce may have at hand at all times legal evidence of that fact by securing registration at Washington under the federal trade-mark law.

Now let us see of what value to the national advertiser is registration under a state law. Suppose this national advertiser is located in Connecticut and another merchant in Connecticut places on sale only in that state similar products bearing the national advertiser's mark.

Can the national advertiser sue him under the federal trade-mark law? No, because the infringement took place wholly within the state. Can he sue him under the Connecticut state trade-mark law? No, because he has not registered his mark under that law. If he had registered his mark



Complete with Special Attachment for use in Connection with any Phone.

"WOODEHORN"

LOUD SPEAKER

\$7.50

List Price

STANDS
26" High
10" Bell

MOST STARTLING LOUD SPEAKER
AT A
MOST AMAZING PRICE

"WOODEHORN" suggests without much effort the character of the Loud Speaker—"it's the wood that makes the tone good."

If you would have the tones of a rare violin then do not hesitate to try a "WOODEHORN" Loud Speaker.

"WOODEHORN" was the hit of the American Radio Exposition, New York. Hear "WOODEHORN" before you stock loud speakers.

Manufactured by

INTER-OCEAN RADIO CORPORATION

1140 BROADWAY, N. Y. C.

Liberal Discounts
To Recognized
Distributors and
Dealers.

ESTABLISHED 1888



SENSORY CABINET UNITS



HEINEMANN - ELECTRIC - COMPANY

Manufacturers

Radio Division

Philadelphia, Pa.

"Euraco" Products

EURACO Mica Condensers, cartridge type, (.00025; .0001; .00025; .0005 mfd.).....	\$.60
" Single Mount (Bakelite base)40
" Double Mount (Bakelite base)60
" Triple Mount (Bakelite base)80
" Crystal Detector (Glass encl.)	1.40
" Crystal Detector (Open type)60
" Moulded Socket60
" Semi-metal Socket70
" Potentiometer (240 ohms) ..	1.30
" Rheostat (Bakelite base) ..	.85
" Rheostat (Cold Moulded base)70
" Switch lever complete....	.30
" Series-Parallel Switch45

Send for Descriptive Circular
 Interesting Proposition for Dealers
EUROPEAN RADIO COMPANY
 1342 East 22nd St., Brooklyn, N. Y.

Radio Cabinets

Made to your specifications in any quantity, style, wood, or finish. Submit specifications for quotation.

Standard models, all common sizes, in Mahogany, Walnut, and Quarter-sawn Oak. Descriptive material and prices on application.

Better Cabinets

for

Manufacturers and the Trade at Large

MARVIN B. FALLGATTER

Wauapaca Wisconsin

under the Connecticut law, he might have sued him under that law and had he won the suit the infringer could be fined five hundred dollars and be imprisoned for thirty days!

So we see that there is often considerable value to registrations under state trade-mark laws and the owners of all valuable trade-marks should not fail to register them under the law of their own state at least, in addition to securing registration under the federal law when this can be obtained.

Insulation Facts the Dealer Should Know

(Continued from page 31)

rial with beautiful satin-like finish and in various colors. These panels are made in three colors—black, brown, and mahogany. The last named is particularly beautiful, as it effectively represents the grain and color of highly polished mahogany.

As interest grows in radio reception from far distant stations, and the application of the theory of radio frequency becomes correspondingly more general, the importance of protecting all apparatus against slight leaks and losses, due to ineffective insulation, is more and more appreciated. This condition will gradually bring about the use of panels, dials, and other parts having smooth polished surfaces free from small pits and furrows, and having unusual freedom from inherent and surface moisture.

Nassau Loop-Tuner

To rid the radio fan of the bugbears of interference and static, against which the outdoor aerial is helpless, the Nassau Radio Company, Inc., of 60 Court Street, Brooklyn, N. Y., have introduced the Nassau loop-tuner.

This device is a loop aerial and something more. Mechanically it has the appearance of a loop aerial, strong and rugged in construction. But its distinctiveness lies in the fact that it is provided with a variable condenser installed in such a way as to overcome much of the body capacity effects.

The Nassau loop-tuner can be used with any vacuum tube set, but as its name implies, it is a tuner in itself, and with a detector and an amplifier will make a complete receiving outfit. Besides the advantages of the indoor aerial, such as elimination of unsightly outside apparatus, absence of lightning hazard and insurance inspection, this device is said to do away with static. It is easily portable and can be turned in any direction to cut out a station not desired and bring in the maximum signal from the desired station.

FREE Radio Catalog



Our big stock of standard makes of radio sets, parts and supplies, fully illustrated. Play safe—buy standard equipment from a reliable house. We ship from stock.

Send \$6.50 for genuine Westinghouse WD-11 "peanut" tube—no storage battery needed. 60 cents extra for signal socket. \$1.00 for Bradley adapter. Wonderful results.

JULIUS ANDRAE & SONS CO.
 In business since 1860
 114 Michigan St. Milwaukee, Wis.

15 STOCK SIZES RADION PANELS

Radio fans everywhere are scrapping their old panels and buying RADION panels. They know why it's better. Keep your customers. Have a RADION supply.

AMERICAN HARD RUBBER CO.
 11 Mercer St. New York City

ATWATER KENT MIDWEST DISTRIBUTORS

Immediate Deliveries

KRAMER RADIO CO.
 4713 Sheridan Road, Chicago, Ill.
 Jobbers Standard Lines



The Radio Tube Set **WESSCO QUALITY** That Made Good In a Night

W.E. Supply & Service Corp. 18 Murray St., N.Y., U.S.A.

YOU SHOULD KNOW ABOUT OUR



THE MILLS RADIO & ELECTRIC CO.
 INCORPORATED
 1008 Springfield Ave. Irvington, N. J.

NULOID

Scientific Chemical Compound for Radio Parts and Panels

NULOID CORPORATION
 119 Chambers St. New York

PATENTS

PROTECT YOUR INVENTION TODAY

Write for 1922 illustrated book free Radio-Electrical, chemical and mechanical experts; over 20 years' experience.

A. M. WILSON, Inc. (Radio 3 ARH)
 309-20 Victor Building, Washington, D. C.
 (Successors to business established 1891 by A. M. Wilson)

You'd walk a mile for a
RADION Panel if you
 knew how much better
 results you'd get.

A Million Set Owners Need The Chaslyn 'Sink or Swim' Ball Battery Tester

And they buy on sight, because it's just what they have been wishing for. What's more, every buyer becomes a "bug" telling all his friends about it. Set consists of

1. BATTERY TESTER, with three balls of different colors and weights. The way they sink or swim shows condition of acid instantly.

2. Depth Gauge for determining depth of acid.

3. Air Controlled Bottle Stopper for adding distilled water. Price of Set \$1.00.

Special Offer to Dealers—Write on your business stationery: Enclose one dollar for TWO of the above sets. This is below wholesale price. Only two sets sold to each dealer at this price.

THE CHASLYN COMPANY
 4315 Kenmore Ave., Dept 2
 Chicago, Ill.



"VICTOR JUNIOR"

Our Latest Model
 Write for Catalog
Victor Radio Corp.
 795 East 125th St.
 New York City

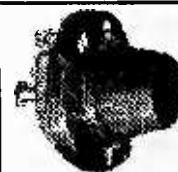

RHEOSTATS

and Other
STANDARD PARTS
 FOR TUBE and CRYSTAL SETS
 Dealers: Write for Price List and Proposition.

The Radiola Wireless Corp.
 208 W. 17th St. New York City

Wave Lengths Searched

Scientists Make Investigations and Report on Radio Wave Lengths

Many matters of scientific interest were discussed at the recent meetings of the American Association for the Advancement of Science, held at Cambridge, Mass., and of particular interest to the radio industry was the scientific paper on wave-lengths.

This report was made by Dr. Ernest Fox Nichols, Director of Pure Science at the Nela Research Laboratory, and Dr. T. J. Tear. Dr. Nichols is a well-known scientist, formerly president of the Massachusetts Institute of Technology.

They made an almost unbroken search of wave lengths from the wireless waves, which have a length up to fifteen miles or more, down to the X-rays whose lengths are to be described in fractions of billionths of an inch and down to the still shorter gamma rays of radium.

Hitherto there have been gaps or blank spaces representing unidentified wave lengths between the ultra-violet rays and the X-rays, between the X-rays and the gamma rays and between the long wave length infra-red or heat rays and the electric waves used in radio.

The discovery reported by Dr. Nichols and Dr. Tear fills in the spectrum from the longest wireless waves to the ultra-violet, while other work has recently been reported recording almost the last of the missing wave lengths in the gaps between the ultra-violet and the gamma rays.

While it has been generally supposed that electric waves, light waves and heat waves differed only in wave lengths, this was definitely proved, it was announced by Drs. Nichols and Tear.

Small Rheostat Is Handy

Due to its small size, the filament rheostat made by the Radio Engineering Company, of New Rochelle, N. Y., adapts itself readily to the construction of receiving sets, detectors, amplifiers, and other apparatus employing the vacuum tube. The diameter of the rheostat is but two inches, and is so constructed as to be used on back or front of a panel.

The base of this filament rheostat, type R-101, is constructed of a composition said to possess great heat resisting properties. The resistance wire is wound on a fibre strip mounted so as to give maximum radiating surface and this permits considerable current carrying capacity without excessive heating.



Lift the switch and this **MAGNA-TONE** Two stage Amplifier is in operation with filaments under fixed control. Circuit is automatically rearranged for one stage by lifting the first tube—at the left. Size, 13 x 5 x 5½ inches. Ebony finish.

JOBBER AND DISTRIBUTORS—There's a big demand for this radio essential. Write at once for our special proposition.

List Price **\$24**

MAGNA INSTRUMENT COMPANY

340 West 42nd Street, New York City

MAGNA-TONE Vacuum Tube Receiver—a radio set without fussy adjustments. Only two adjustments necessary. Provided with Fahnestock terminals which insure positive connections throughout. Size, 13 x 5 x 5½ inches. Ebony finish.

DEALERS—Radio fans want simpler apparatus. Here it is. Discounts are generous. Big sales reported. Get in touch with your Jobber.

List Price **\$16**

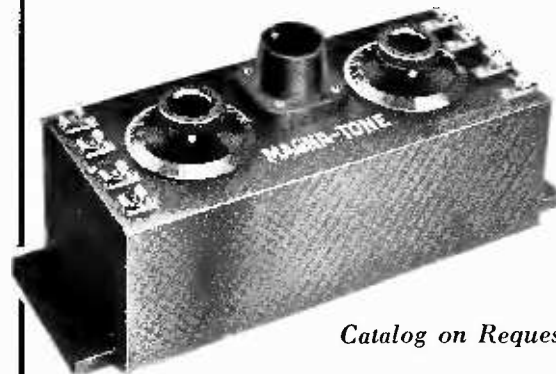

Catalog on Request

“Amplification without Distortion”

3 Y Q Transformers

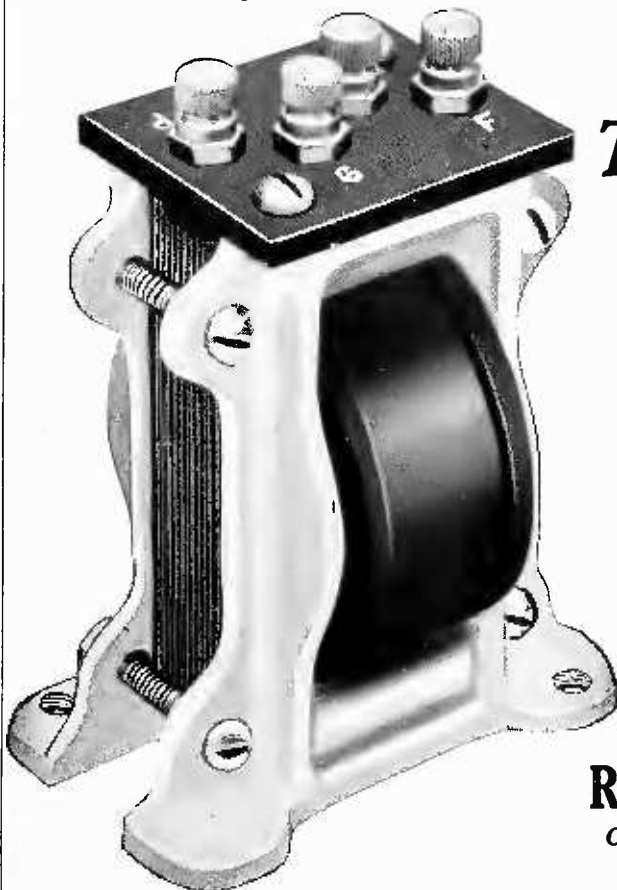

The reputation that the 3 Y Q has gained with jobbers, dealers and users is evidence that there is no other Transformer giving such reliable service in amplifying without distortion. The 3 Y Q is made right and priced right. It is a Transformer all jobbers and dealers can back to the limit.

The 3 Y Q Transformer is distributed through the regular jobbing and retail channels.

RETAIL PRICE \$6.00

ORDER FROM YOUR JOBBER

Federal Institute of Radio Telegraphy
Second and Federal Streets
CAMDEN, N. J.

RADIO DEALERS:

Are You In Position to Get the Benefit
of the National Advertising Campaign Now Running on

M. P. M.

Million Point Mineral

THE WORLD'S GREATEST RADIO CRYSTAL

Makes a Crystal Set 100% efficient.
Will not burn out or corrode.
Sensitive at practically every point.
Increases radius and audibility.
Concerts heard over 600 miles.

The introduction of M. P. M. is revolutionizing the business in crystal sets. Don't take our word. Send for sample and test it.

M. P. M. SALES COMPANY

Dept. RD

247 So. Central Ave., Los Angeles

Psychological Elements In Salesmanship

(Continued from page 24)

lutionary, but is a fact just the same. The only thing the salesman can do is to create the desire in the buyer's mind to possess the goods and then the goods must sell themselves. Therefore, if you do not create the proper desire in your buyer's mind to possess a certain article you can never hope to sell it to him simply by showing the merchandise.

Three things are required to sell goods, a salesman, a sample or a catalogue. Now the next statement will no doubt astonish you, especially if you who read this happen to be a salesman and not an order-taker.

Merchandise can be sold in large quantities without either the help of a salesman or samples. Millions of dollars worth of goods are sold annually by the large mail order houses throughout the United States with no selling medium except a catalogue and the necessary postage. How is it accomplished you ask. It could not be done, if it were not for that little element of psychology which enters into the transaction. If these catalogues only contained a picture of the article which they have to sell they would never sell any goods, but underneath each picture is a wonderful little short story describing the article, but only in a few simple words.

Why don't they tell all about the article in the catalogue? Here is just where psychological salesmanship comes in. If they were to describe each article fully, they would leave nothing open for the buyer's mind to dwell on. Curiosity once killed a cat, they say, and it is that same curiosity which causes the reader or buyer in this case to enclose a post office money order to Chicago, New York or elsewhere for a shirt, pair of shoes, stove, lawn mower or something else. It is that curiosity to see whether or not the goods when they arrive will be as pictured and described and woe be unto the publisher of that catalogue or the writer of the article describing it if the goods when they arrive are not as represented, for you may rest assured they have lost a customer for life.

But the writers of these descriptions are students of psychology and they have learned to underrate the article rather than overrate it and also they know how to create the desire for the purchaser to possess the goods even before they have seen them.

Here are some pointers for a salesman carrying samples which may help from a psychological standpoint:

RADIO DEALERS & JOBBERS

WE ARE MANUFACTURERS OF THE

F. M. C. AUDIO TRANSFORMERS



Try them with your W. D.
11 Tube Sets and note
the increase in your sales.

Stock them up and watch
them move.

LIST PRICE, \$5.00

For Test Reports and Discounts
Write to Dept. R. S.

FORD MICA CO., Inc.

14 CHRISTOPHER ST.

NEW YORK CITY

Never show your sample until you have told your story to the prospective purchaser and have created in his mind the desire to possess the article in question and in describing the article to him do not bring out all of the good points, rather underrate it. If you tell all about the article before you show your sample, you will leave nothing for you to talk about when you produce your sample.

Furthermore, if there are any good points about the articles which you have not touched upon your purchaser may notice the good points when you produce the sample which will naturally cause the article to appear even better to him than you had pictured.

Remember, your sample must be in first class condition when produced for inspection. First impressions always count and no matter how good your merchandise may be you could never hope to take an order or make a sale if you brought forth a soiled, or damaged sample no matter how much you had talked about the goods before you produced the sample and you do not want to be placed in the position of having to make apologies for the condition of your sample.

My advice to any young man who expects to become a salesman and not an order-taker is to spend a few evenings each week in some public library reading up all the good books on psychology he can get hold of and then apply himself accordingly. Also to make a study of human nature when and wherever possible, know and talk to every and all classes of people from the messenger boy on the street to the president of the biggest corporation you can find, and when you do, try to put yourself on the same level with that person you can never hope to learn anything. If you put yourself above the messenger boy, he won't tell you all he knows and he sometimes knows a great deal more than you give him credit for. At any rate always use common sense.

Grebe Regenerative Sets

Two receiving sets designed specially for amateur relay work are made by A. H. Grebe and Company, Richmond Hill, New York. These two types, CR-8 and CR-3 are made on the lines of the Armstrong regenerative tuned grid and plate circuit. The use of continuously variable inductances in the grid and plate circuits gives maximum selectivity and a high degree of regenerative amplification.

Each unit has been effectively shielded by grounded aluminum plates, thus eliminating annoying external capacity effects. Type CR-8 includes a vacuum-tube control unit while CR-3 is made without this feature.

BUYERS of RADIO

MERCHANDISE can see the exhibits of nearly one hundred leading representative manufacturers of Radio Products at the



RADIO FAIR

Don't miss the RADIO SENSATION of the world at the

PERMANENT RADIO FAIR, Inc.

HOTEL IMPERIAL—RED ROOM

Broadway and 32nd St.

New York

Milliken Radio Towers

These towers are suitable for broadcasting and receiving stations, large and small. Numerous installations are in service in all parts of the country. Towers are of galvanized steel, self-supporting, standard types. Economical.

AGENTS WANTED

We have an interesting proposition for local agencies. Send for full information. Illustrated Catalog mailed on request.

MILLIKEN BROTHERS
MFG. CO., INC.

Woolworth Building
New York, N. Y.



STATION WVP



STATION WBZ

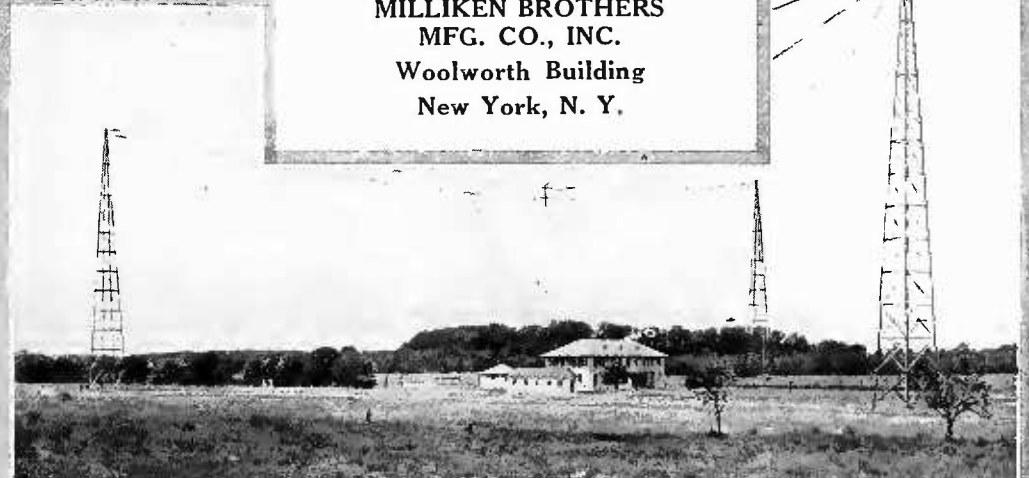

STATION 2XJ

"THE BEST IN RADIO" ATTENTION! FORWARD! MARCH

Let's go for a Better and Bigger
RADIO INDUSTRY

By Selling only
STANDARD ADVERTISED

Radio Apparatus of Merit

Let us put you on our mailing list for our Monthly Price Bulletin

AT YOUR SERVICE

VIRGINIA RADIO CORPORATION

Distributors
Charlottesville, Virginia

**J
O
I
N

T
H
E

R.
T.
A.**



THE LABORATORY TECHNICIAN SAYS:

- Audibility Plus
- Matching Perfect
- Volume Plus

T-B-H PHONES SPEAK FOR THEMSELVES

Pure Natural Tones—Light Weight Ornamental Appearance.

A Sturdy Reliable Head Set That Will Sell and Stay Sold. 17500 Turns (2200 Ohms)—\$7.00.

Substantial Discounts to Jobbers and Dealers.

THE TELEPHONE BOOK HOLDER CORPORATION
Dansville, New York, U. S. A.

District Agents and Warehouse:
Central States Engineering Company
Chicago, Illinois

WESTERN HOME BATTERY CHARGER

NOW \$6.85

Charges your Radio Storage Batteries from 110 volt alternating or direct current lighting socket, of any cycle.

Keep your Battery fully charged and receive the maximum range from your receiving set.

Charges Battery over night for a few cents—absolutely noiseless.

Has no delicate bulbs to break or burn out; no moving parts of any kind to get out of order; no adjustments to make, and will charge as many as six 6 volt batteries at one time if necessary.

Will also charge Automobile starting and lighting batteries. Shipped anywhere in the United States and Canada for \$6.85. Send 25% with order; balance C. O. D., or 2% may be deducted if full cash accompanies order.

"Note":—We have a large quantity of high grade Radio Storage Batteries of all sizes, which we are selling at bargain prices.

Radio Dealers should send at once for our distributors proposition. Description of our line of Chargers and Radio Storage Batteries sent upon request.

WESTERN RUBBER MOLD & BATTERY CO.

321-323 N. Crawford Ave.

Chicago, Ill.

Cut Prices Are Menace to Rural Dealers

(Continued from page 32)

called on a neighbor of this party who had purchased his set in the city. In reply to a question, the dealer mentioned a set that would give satisfactory results for the location, but was promptly informed that he knew that this set was a fake and would not work because his neighbor had one.

The dealer then volunteered to put this set in order for the neighbor so as to prove that it is good and reliable. This was quickly done and the prospective customer was thoroughly satisfied with the set until he was quoted the standard price. The would-be customer thought this too high, threw the dealer down and sent to the city for one at the cut price. When it arrived, he set it up just as the dealer had set up the neighbor's, and, of course, it worked satisfactorily.

But, where were the dealer's profits?

Should not the manufacturers cooperate with the rural dealers and relieve this condition? The dealer on the ground must develop this trade, and he cannot afford to do this under the existing conditions.

The country dealer must secure the profits to which he is entitled if he is going to continue in business and the manufacturer has no right to expect a dealer to sell products of a manufacturer who permits unfair competition by allowing other dealers to cut the retail prices. Manufacturers who permit price cutting do not deserve the support of reputable dealers. Some of the best makes of apparatus are being sold regardless of what price the dealer sells them. This is unjust.

In our section of the country, where we are at a considerable distance from broadcasting stations, the general demand is for high-class receiving sets, and these must be maintained in good order to obtain satisfactory results.

The rural dealers must be given support for developing radio reception on the farms and in the small villages, or the benefits of broadcasting will be practically restricted to the cities, where they are least needed.

In our part of the country, several dealers have been forced out of business by the competition of firms that have been selling to individuals at wholesale prices. This condition should not be permitted to exist. Of course, there should not be too many dealers in a given territory, but dealers are the only ones who will develop radio in the rural communities, and they should not be forced out of business by unfair competition. It is up to the radio manufacturers to protect

the rural dealers if they want to promote the radio development in the country.

In order to make it worth while for the rural dealers to push the expansion of radio, it is essential that the manufacturers—

1. Standardize retail prices.
2. Select reputable dealers.
3. Prevent wholesalers from selling to others than legitimate dealers.
4. Make prompt shipments to dealers.

The observance of the above conditions would have made the last Christmas season a profitable one for the radio dealers, instead of having it spoiled by those who sold at wholesale prices, without making any profit either for themselves or permitting the legitimate dealers to make any.

Hutchison Phono-Phane

A detector operating on a new principle has recently been placed on the market, under the name of Phono-Phane, by the Hutchison Radio Company, 342 Madison Avenue, New York City.

It has been found that the Phono-Phane is more sensitive than the aver-



Hutchison Phono-Phane

age crystal and it is not susceptible to either physical or electrical disturbances. They are adjusted at the factory and once adjusted they cannot be disturbed even with the most violent treatment.

They are also able to withstand heavy discharges of static and it has been found that these charges in no way effect the sensitivity of the device. It is only necessary to insert the Phono-Phane in the circuit in place of the crystal detector. The sensitive element is encased in a heavy fibre tube with nickel-plated brass ends. The retail price is \$3.50.

New Rasco Catalog

The eighth edition of the Rasco catalog, published by the Radio Specialty Company, 96 Park Place, New York, is just off the press and is more complete than ever. More than one hundred different radio parts are listed with illustrations. The present catalog also includes diagrams for seventy-five hook-ups.

“True-Tone”
SUPERSENSITIVE
3000 Ohms

\$ 5.00
List
3000
Ohms

\$ 5.00
List
3000
Ohms

Cord Connections concealed within phones, eliminating losses from effects of body contacts.

Worth More—Cost Less

Cups and caps lustrous black moulded; caps designed to comfortably fit the ears.

EMBODYING every factor of Scientific design. High sensitivity attained by maximum wire turns.

\$ 5.00
LIST
3000
Ohms

PERFORMANCE and Appearance—backed by a positive guarantee of Quality. Tungsten Magnets; noiseless Tinsel Cords.

Write or Wire for Name of TRUE-TONE Jobber in Your Territory

TRUE-TONE RADIO MFG. CO.

186 No. La Salle Ave. CHICAGO, ILLINOIS

A Wonderful Pair
SHAMROCK
180°
Vario-Coupler
and
Variometer

All Tubes Are GENUINE BAKELITE
wound with green silk covered wire

Distributors, Jobbers and Dealers write for
ATTRACTIVE PRICES

SHAMROCK MANUFACTURING CO.

314-322 Market St. Dept. T. Newark, N. J.

RADIO PANELS

And other insulation for Wireless Work

BAKELITE-DILECTO

Grade XX Black was used by the Government during the war for this purpose. It is the

Standard of the World

THE CONTINENTAL FIBRE COMPANY

NEWARK, DEL.

New York, 233 Broadway
Pittsburgh, 301 Fifth Ave.
Los Angeles, 411 S. Main St.
Seattle, Wash., 1927 First Ave., South

Chicago, 332 S. Michigan Ave.
San Francisco, 75 Fremont St.
Rochester, N. Y., 85 Plymouth Ave., South



Just Off the Press

the New

BESTONE RADIO CATALOG

A Compendium of Radio Information

Sent Free Upon Request.

The New, two-color Bestone Radio Catalog we have just issued is one of the most elegant catalogs yet produced.

This catalog is profusely illustrated with the latest types of Bestone radio equipment, and contains considerable technical information that will prove of exceptional value and interest to every radio Jobber, Dealer and Amateur.

Send for the Bestone Catalog—NOW

HENRY HYMAN & CO., INC.

Manufacturers

Executive Offices:
476 Broadway
New York City

Branch:
212 W. Austin Ave.
Chicago, Ill.

Receiver Interferences

Dealers Should Recognize Causes That Hinder Reception

By W. B. SCHULTE

Of the Burgess Battery Company

Dealers should bear in mind that atmospheric conditions affect radio reception and therefore influence their sales. They should keep informed on the atmospheric conditions and be prepared to explain them to their customers. The progressive dealer is a radio fan himself and will keep posted through his own experience. If he cannot do this, he should inquire frequently of his customers as to the conditions of the broadcast signals.

It is generally known that after a few days of good clear weather, when many receiving sets have been hearing distant broadcasting stations, there is an intense interest in radio and radio sales increase. When conditions are poor, many listeners become suspicious of their sets and make unwarranted complaints to their dealers.

Recently, in a Western city, there was an unexpected request for the recharging of storage batteries and an increased sale of "B" batteries. The night before, the broadcasts had been decidedly fading in and out, and every receiver thought that the trouble was in his instruments or that his batteries were low. The dealers who knew of the atmospheric conditions were able to explain the troubles and thus warded off complaints and established themselves with their customers as giving "radio service."

Another source of annoyance to receivers is interference from a broken city lighting circuit. Such interference usually is noticed as a sixty-cycle hum in the set. If the dealer has several complaints about such noises, he can feel quite sure that there is a nearby break in a power or lighting circuit. He should then locate it approximately by taking a number of sights with a loop antennae and after he has approximately located it, the power company will usually be glad to find it and repair their break.

Other sources of unexpected interference are receiving sets which radiate energy while their tubes are oscillating. Dealers should explain that an oscillating tube radiates energy and interferes with nearby stations, and all new customers should be warned against tuning their sets to cause this interference. The new purchaser should be taught to recognize the tones from his neighbor's set so he won't

WE PRESENT 2 in 1 DETECTOR-AMPLIFIER

NEW PRICE, \$4.50 EACH

A proposition that will appeal to business-getters and win approval from the cautious fellows is open to Jobbers and Dealers everywhere. Write for territory and discounts.

LA FRANCE IMPORT & SALES CO., Inc.
280 Madison Avenue, at 40th St., N. Y. C.

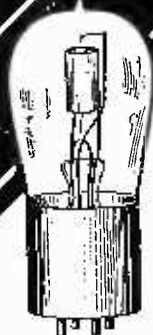

A SUPER TUBE
IN DESIGN AND
CONSTRUCTION

"ALL-AMERICAN" AMPLIFYING TRANSFORMERS (Radio and Audio Frequency)

Are wonderful *Business-builders* for all who handle them. They so broaden the range and improve the tone-quality of radio-reception that every sale made to a set-owner stimulates numerous other sales.

Like an endless chain, the good news of *scientific amplification* spreads, in constantly-widening circles.

No advertisement ever written equals, in selling-force, the enthusiastic praise of users of All-American Transformers.

This is why

IT PAYS TO HANDLE THE
"ALL - AMERICAN" LINE

Send for Bulletin No. 22, prices and discounts.

RAULAND MFG. Co.
35 So. Dearborn St., Chicago, Ill.



Audio Frequency
Transformer



Radio Frequency Transformer

think that it is coming from his own outfit.

Experimental stations or broadcasting stations when testing or tuning sometimes cause an interference which fortunately is not continuous, but if it is not modulated, it can not be always recognized. Broadcast receivers should be warned that such interference is possible, and that when they get a continuous hum or whistling more or less intermittent, they should bide their time until the station is through testing.

Live dealers will frankly warn their customers of these conditions and will keep in touch with them themselves, so that they can give the right information and avoid many complaints which might otherwise be charged against the receiving apparatus.

Oranola Six-Tube Cabinet

The Oranola Radio Corp., 228 Seventh Avenue, New York has produced an upright six tube cabinet set, which is proving a revelation to the radio public. It functions without either aerial or ground and gives very pure signals of great intensity. These are sold as straight radio or in combination with the talking machine feature. The price is lower than most three tube sets with loud speaker attachments. Three steps of radio frequency, and two of audio comprise the radio unit which causes a specially designed loud speaker to function. Distant stations are easily heard without aerial. On a Saturday night in the office of a corporation located in a still building in downtown New York, Chicago and Atlanta, Ga. signals could be heard at least sixty feet from the set.

Homcharger Instruction Book

The Automatic Electrical Devices Company, 120 West Third Street, Cincinnati, Ohio, manufacturers of the Homcharger, has recently issued a revised instruction book, which will prove valuable to any radio enthusiast.

This booklet, besides containing the simple directions for operating the Homcharger, contains a paragraph devoted entirely to storage battery maintenance. The information contained in this chapter will enable one to obtain the best service from his battery at minimum expense.

The novel feature of the book, however, is its incorporation of a complete list of all the radio broadcasting stations in the United States, Canada and Cuba. Copies may be secured by any one interested for 10 cents to cover cost of postage.



This seal is accepted by the discriminating purchaser everywhere as an unconditional guaranty of excellence of design, material, workmanship, and performance.

ON JANUARY 25th, 1923

we commenced deliveries to

AUTHORIZED DISTRIBUTORS

of the

ACCURATUNE
MICROMETER DIAL

PATENT PENDING

in which a positive, yet delicate micrometer adjustment is incorporated within the dial itself, resulting in

ABSOLUTE TUNING PRECISION
ABSENCE OF CLAP-TRAP AND
UNCERTAIN VERNIER ATTACHMENTS
EXCEPTIONALLY ATTRACTIVE APPEARANCE

Simultaneously we will offer a Rheostat Dial and a Fixt-Post Inductance Switch to match—an unusual combination to attract the discriminating trade.

Distributorship franchises on these truly extraordinary articles are now being allotted.

We also take pleasure in announcing

GREATLY INCREASED PRODUCTION
of the
BURKE ADAPTER FOR WD-11 TUBES

The adapter which is outselling all others because

"IT DOES NOT RAISE THE TUBE"



845 BROAD STREET

NEWARK, N. J.

Saturn **TRADE**  **Products**
MARK



The Saturn Automatic Radio Plug

The Plug with the RED SEAL

No Screwdriver required!
Not necessary to dissemble!

To make connection just insert terminal tips, and contact is made. The more you pull, the better the contact.

To take terminals out, just press the release lug and the tips fall out.

Every plug sealed and fully guaranteed. Sells for \$1.50

The Saturn "PERFECT" Jack

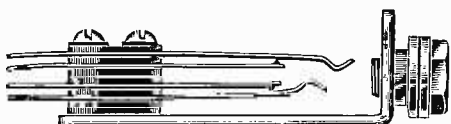

An improvement on all others. **Crowfoot offset:** Allows easy soldering.

Bracket, the mainstay of every jack, made of specially rolled Brass, with rounded edges. This insures uniformity, strength, appearance.

Blades: Spring temper German Silver, enforced where needed.

Contact Points: Genuine Sterling Silver.

Nipples: Shoulder type, with two 1/16" washers, insuring perfect fit to the panelboard.

All parts, except Blades, nicked and highly polished.

- No. 1. Single Circuit, Open. . \$0.65
- No. 2. Single Circuit, Closed. 0.75
- No. 3. Double Circuit, Closed 0.90
- No. 4. Single Filament Control 1.00
- No. 5. Double Filament Control 1.25

The Saturn Mfg. & Sales Co., Inc.
 Dept. D
 48 Beekman Street
 New York, N. Y.

Double Head Set

A head set that two can use as conveniently as one was recently put on the market by the Premier Accessory and Specialty Company, of 31 Congress Street, Newark, N. J. The device permits the double head-band to be split into two separate head-bands with one phone attached to each and with each having a padded friction clamp for height adjustment.

The padded clamp is also a desirable feature for it can be adjusted up or down with a slight pressure of thumb and forefinger without scratching the nickel plate, and without the use of the ordinary thumb nut or screw.

The phones themselves consist of a drawn aluminum shell, rust-proof diaphragm of special quality iron, enamelled copper wire coils, cores of Norway iron, varnished cambric insulation and magnets of tungsten steel. The cords used on the Premier Duplex are of equal length, and a distance of five feet is possible between the two halves when the set is split.

Specialists in Mineral

The Gibbons Dustin Radio Manufacturing Company, of 518 West Ninth street, Los Angeles, Cal., are making an intensive effort at present to make their Magnetite radio crystal better known. This company also makes the watch case head phones, and the radiotrola.

Magnetite radio crystal is said to be different from any other crystal used in a crystal detector in that the operator may place the cat's whisker anywhere upon its surface, every spot being sensitive. The makers claim that Magnetite radio crystals are unaffected by handling or moisture and that they will render efficient service indefinitely. Window and counter display posters featuring Magnetite crystals may be had from the Gibbons Dustin company who are ready to distribute them to all dealers handling their specialty.

California Leads Ohio

The *Crosley Radio Weekly*, published by the Crosley Manufacturing Company, Cincinnati, Ohio, is developing into a periodical full of information and news. Among the articles contained in a recent issue was one listing the number of broadcasting stations in each state and in Canada.

Being an Ohio concern, the Crosley Manufacturing Company takes a great deal of pride in the fact that Ohio is now second of all the states in the Union in the number of radio stations with 34, California being first with 66.

Nearly half of our orders for the DRY CELL SET THAT SELLS

are

REPEAT ORDERS

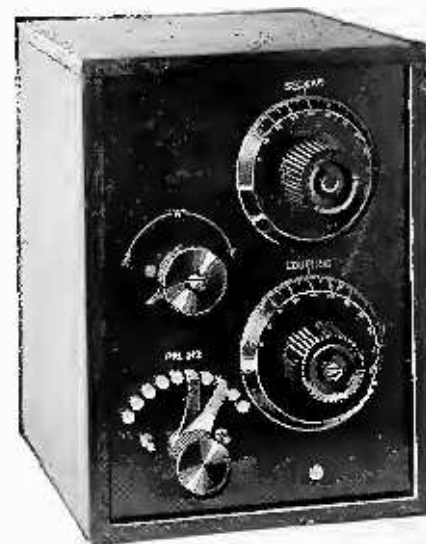

Q. T. DRY CELL SET

\$8.50

NET TO THE DEALER

Can be sold at \$25.00 with phones, tube and batteries at a good profit.

SPECIFICATIONS—

Mahogany-stained cabinet, engraved Radion panel, Ajax socket-rheostat, 21 plate variable condenser, 180° vario-coupler, no external binding posts, busbar wiring, all connections securely soldered.

Write for Full Information

The Q. T. Light Co.
 East Orange N. J.

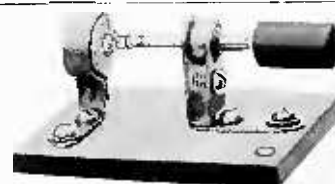

CLOSING OUT

Manufacturer will sell AT COST several hundred detector stands — Celon Base, Nickel-Plated Brass Parts.

\$18.00 per hundred

Box M21

RADIO DEALER

Book Reviews

By
BERNARD JEROME FARRELL

The Editors of the RADIO DEALER will be glad to review new publications in this field as they may be issued. Address them attention BOOK REVIEW EDITORS, THE RADIO DEALER, 1133 Broadway, New York City.

LETTERS OF A RADIO-ENGINEER TO HIS SON. By John Mills. Published by Harcourt, Brace & Company, New York. 265 pages.

A radio book with a sense of humor is the distinctive description that must be applied to the work of a member of the engineering department of the Western Electric Company. Mr. Mills has succeeded in simplifying the theory of radio as well as making it interesting.

This result he achieved first by his plan of presentation—a series of letters to his son, each progressively more informative and technical than the preceding. The book begins with an explanation of how a battery works and ends with amplification. And in every letter-chapter there is humor.

“Letters of a Radio-Engineer to His Son” is more than a current book on radio which becomes out-of-date almost as soon as printed, owing to the rapid advances in the science. This book will be of value almost indefinitely because it discusses and reveals the foundations of radio and these are everlasting.

ACOUSTICS AND THE TELEPHONE. By G. B. Crouse. Published by the Connecticut Instrument Company, Stamford, Conn.

This pamphlet deals with a new theory of sound based on the principle that all sound waves consist in alternate expansions and compressions of air.

From this theory the writer goes on to the development of sound reproducers showing how distortion arises, by means of an explanation of the difference between musical and unmusical sounds. How a non-metallic diaphragm in a radio phone filters noise and how it produces a restful effect is also explained.

Publish Hook-Up Book

A book of construction plans and hook-ups which is designed to appeal to the average radio enthusiast, who is always on the lookout for something that will enable him to increase his knowledge and radio efficiency, is now being issued by S. Newman &

If you want more business, handle the

NEW MOON RECEIVING SET

Model C-1—“Satterlee Antennaless”



Works without any aerial whatsoever. For short or long distance reception.

A LONGFELT WANT
THE NEW

NATURALTONE LOUDSPEAKER

A loudspeaker with a clear non-metallic tone—at the right price—
\$27.50

DEALERS AND JOBBERS
write for discounts



MOON RADIO CORPORATION

12 Diagonal Street, Long Island City

“UNITED” RADIO PRODUCTS

Give a Quick Turnover

The retailer who gets them started enjoys the tremendous advantage of the word-of-mouth “advertising” by every user.

The uniformly satisfactory performance of

“UNITED”

AMPLIFYING TRANSFORMERS

and

VARIABLE CONDENSERS

has already given these instruments a national reputation that speeds up their sale everywhere. Dealers repeat because their customers boost.



“UNITED” VARIABLE CONDENSERS

43 plate.....	\$4.50	5 plate.....	\$2.75
23 plate.....	4.00	3 plate.....	2.25
11 plate.....	3.50	without dial or knob	

“UNITED” TRANSFORMER

Audio-frequency, amplifying, magnetically shielded. A beautiful piece of workmanship. Gives loud, clear signals without howl or distortion.

Best Value on the Market, \$4.50.



Pat. Appd. For

“UNITED” PRODUCTS

have been adopted as standard equipment by leaders in the radio industries.

UNITED MFG. & DISTRIBUTING CO.

536 Lake Shore Drive Chicago, Ill.

ATLANTIC & PACIFIC
RADIO
COMPANY

131 West 37 St. (NEAR BWAY) New York

The Volume of the Atlantic
and the Smoothness of the
Pacific

A & P
Loud Speaker

makes a theatre of your home. Every note will sing out as if the Broad-caster were right in your Speaker. Why listen to stuff that sounds like a tired phonograph record when the A & P LOUD SPEAKER gives faithful reproduction—with triple volume, clear and sweeter than very expensive speakers.

\$4.95

POSTAGE PREPAID
MONEY BACK GUARANTEE

Dealers and Jobbers write for Proposition.

Note: The A & P Loud Speaker owes its quality to the Special Alloy used and to the peculiar Acoustic Properties of its design.

**WE CARRY A COMPLETE
LINE OF STANDARD
PARTS AT REDUCED RATES**

"The Little Wonder"
FOR BOYS AND GIRLS
CRYSTAL SETS

Unassembled - Net **\$1.75**

Catches distinctly everything broadcast within 30 miles. We also manufacture the "Little Wonder" assembled set to retail at \$4.00.

**GUARANTEED
TESTED CRYSTALS**

Galena 7½¢ Radiosite 8½¢
Dealers and Jobbers Write for Free
Catalog

It lists all our radio parts and supplies.

Holloway Elec. Supply Co., Inc.
238 Third Ave. New York City

Free Mailing Lists
Will help you increase sales
Send for FREE catalog showing
details covering names of your
best prospective customers.
Counts and prices are given on
thousands of different Mailing Lists.

99% Guaranteed 5¢ each
by refund of
588 N
10th
Street

Ross-Gould Co. St. Louis

Company, 47 Dey street, New York.

The book, attractively printed, gives not only hook-ups for crystal sets, tube sets, audio-frequency and radio frequency arrangements, but also gives full particulars as to the capacity, design, and construction of each of the parts going into the respective hook-ups.

True-Tone Advises User

Efficient merchandising includes seizing every advantage to impress the quality of one's goods on the prospective purchaser as well as keeping him satisfied once these goods are purchased.

The True-Tone Radio Mfg. Co., of 186 North La Salle street, Chicago, Ill., have grasped these merchandising truths, as evidenced by the carton in which each True Tone head set is packed and sold. The cartons are sealed with a green slip on which are printed directions for use and a guarantee.

The guarantee assures the purchaser that the True-Tone phones, "if not tampered with, will be replaced with a new one within ten days from date of purchase, if defective in manufacture. This guarantee must be presented for replacement."

But to reduce any returns to the minimum, the green slip also gives some valuable advice to the purchaser on the care of head phones. "The True-Tone head set is designed according to advanced scientific principles; it is essentially a very delicate instrument. Handle it as such. Do not touch or remove any part of the inside of phones, as you may alter the adjustment and decrease efficiency. Lift phones only by the head band. Avoid jerking the cords."

Fiber for Horns

What should be the material for making the bell of a loud speaker, wood, metal or fiber? The Fiber Products Company, of Bloomfield Avenue and North Tenth Street, Newark, N. J., have the conviction that fiber will be the finally accepted medium for construction of amplifiers.

The Fiber horn, the product of the Fiber Products laboratory, is seamless, without unsightly glued joints or rivets to become loose, and it is practically indestructible, since it will not crack, chip or dent. As for the sounds produced by this instrument, the makers claim that it produces only mellow tones, without distortion or tinny effects. The firm is prepared to build horns for other manufacturers according to their own designs, the capacity and equipment of their factory being ample for such service.

SOCKET-RHEOSTAT

Registered U. S. Patent Office

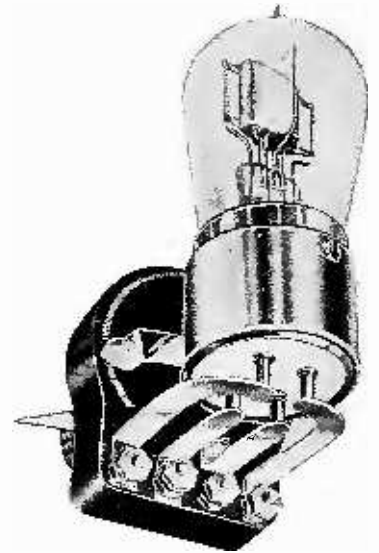

Type A-5 ohms, suitable for detector bulb
Type B-2 ohms, suitable for power bulb
\$2.00

TWO IN ONE. A socket and rheostat so combined as to form a single unit. No more unnecessary leads between socket and rheostat. Just connect your leads to the four posts marked P F-F G and you are hooked up as far as the SOCKET-RHEOSTAT is concerned.

MANUFACTURED BY

Ajax Radio Corporation

Telephone: Bigelow 4097
538 SOUTH 10th STREET
NEWARK, N. J.

Gould

Radio "A" and "B" Batteries

Write for Dealer Plan
Gould Storage Battery Co.
30 East 42d St., New York City

**WE WILL MAIL
ONE**

VERNIER CONDENSER
for \$3.50 C.O.D.; Parcel Post Paid
To any address outside of New Eng.

To introduce our line
ELECTRIC PRODUCTS CO.
11 Pemberton Sq. Boston

**Complete Receiving Sets
of Merit**

Write for descriptive circular
Oranola Radio Corp.
228—7th Ave., N. Y. C.

Have You Our New Price List?

"EDGCO"
RADIO
PRODUCTS

Save money by our prices; save time by our prompt shipment. Successful dealers sell "EDGCO."

The EDW. J. GOETZ CO.
608 Race St., Cincinnati, O.

DIAMANT

**VARIABLE CONDENSERS
AND CRYSTAL DETECTORS**

Electrically and Mechanically Guaranteed

Diamant Tool & Mfg. Co., Inc.
93 Runyon Street Newark, N. J.

Soldering Iron

By pressing a button located in the handle of the new Sabco two-heat electric soldering iron, the instrument is increased in wattage and temperature from twenty to thirty per cent. The user of a Sabco soldering iron is thus practically in the possession of two distinct irons of different heats, either



2-Heat Soldering Iron

of which may be used for the work for which it is best adapted.

This two-heat feature is a new development in soldering-iron construction and a patent is pending. In Model B-100, 90 watts is low heat, while by the pressure of the button 120 watts are consumed. Similar increases in wattage are possible on the two other models. These three models have tips specially designed for radio use and will appeal to the radio fan who uses an electric soldering iron.

Other features of the Sabco two-heat iron are: low wattage consumption as compared to other soldering instruments; neat appearance; simplicity of operation; and a guarantee for a period of one year against factory and material defects. The Strauss & Blum, Inc., of 254 W. 41st Street, New York City, manufacturers of the Sabco two-heat soldering iron, are backing their product with free distribution of folders and striking cut-outs.

Standard Metal Horns

The new problems in horn construction presented by radio have met with the serious consideration of the Standard Metal Manufacturing Company, of 237 Chestnut street, Newark, N. J., a company which has been making phonograph, telephone and automobile horns for twenty years.

As a result of their experimentation, they now offer several types of radio horns under the trade name of Standard. Four of these horns are finished in rubberoid only. No. 114 Standard will take all makes of receivers, and is designed for use where extra large horns are desired without vibration. No. 17, gracefully designed, is calculated to give proper amplification, while its heavy construction prevents blast. Made of heavy brass, Standard No. 15 does away with vibration. The New Gem taking all makes of receivers is said to give surprisingly clear reproduction. It is made with a grained mahogany or black rubberoid finish.



WALCON

Radio Frequency Transformer

THE BEST YOU CAN BUY

A Transformer that Guarantees Results Particularly suited for W. D. 11 Tubes.

List Price \$4.00

Manufactured by
THE RADIO CENTER

2 West Broadway

New York

Dealers and Jobbers write for our attractive sales proposition backed by National Advertising.



Endorsed by PADEREWSKI

The Magic of the Living Voice

Clear, resonant, mellow-toned as an old violin, the BEL-CANTO AMPLIFIER gives in its original richness, the living voice of the artist, or the most delicate tones of an orchestra. Designed on the principle of the human throat, and built of reeds and metals that will not vibrate, it entirely eliminates all harshness and sound distortion, amplifying to unparalleled perfection.

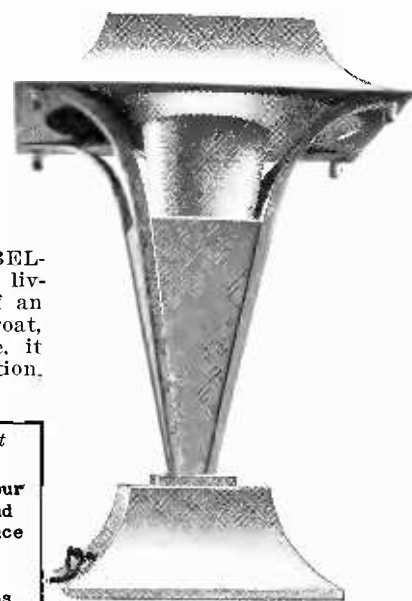

Patent Applied for

Facsimile of congratulatory letter from the World's Most Famous Pianist

It was with great pleasure that I heard your Bel Canto loud speaker, the other day. The clarity and volume of tone transmitted, and particularly the absence of sound distortion make it a remarkable device.

While listening to different radio stations, some of them far away, I heard music and lectures with surprising distinctness, and the reproduction of Victor records sounded to me as if the performance were taking place in the same room.

You are indeed to be congratulated upon your ingenious invention.

Truly yours,

BEL-CANTO is adjusted for the following circuits: Regenerative two stages of amplification for stations within 50 miles. For long distance reception 5 tube radio and audio frequency circuit. Special extra sensitive phone unit, ample cord and plug. Price \$30.00 F.O.B. New York.

At your Dealer or Direct from Maker

BEL-CANTO CORPORATION

417 East 24th Street New York City



← THE SIGN OF GOOD SERVICE AND GUARANTEED SATISFACTION

IMMEDIATE DELIVERIES ON:

- | | |
|--------------------|--------------------------|
| CLAPPE-EASTHAM | RADIO CORP. OF AMERICA |
| BALDWIN PHONES | MURDOCK APPARATUS |
| THORDARSON | DRAGON STORAGE BATTERIES |
| NOVO BATTERIES | FADA APPARATUS |
| GREBE and MAGNAVOX | CHELTON APPARATUS |

And All Other Standard Lines

EXCEPTIONAL DEALER'S DISCOUNTS—WRITE AT ONCE

WILMINGTON ELECTRICAL SPECIALTY CO., Inc.
912 ORANGE STREET Dept. A-10 WILMINGTON, DEL.



ELIMINATE COIL SUPPORTS BY THE USE OF RADIO-LAC

Radio-Lac is a liquid cement which can be applied to covered wire coils to hold them rigidly in shape without additional support.

Radio-Lac is moisture proof, non-conductive and is not affected by climatic changes. Its use will permit close coupling insuring greater efficiency of units and will lower cost of production of these various parts.

Radio-Lac is particularly adapted for use on winding Rotor or Stator of Variometers, Vario-couplers, etc. Samples and additional information furnished upon request.



**The Egyptian
Lacquer Mfg. Co.**
Dept. R.
5 East 40th Street
New York, N. Y.

Indoor Aerial Results

The Bruno Radio Company, 152 West 14th Street, New York City, were pleased to receive the following letter from a customer at New Brighton, N. Y. The cheery letter is reprinted here because we believe that our readers will be pleased to read it too:

"For a long time I have listened to what I had supposed were 'radio dreams' from different customers, to whom I had sold 'Bruno No. 3' receivers. These customers were always talking about what distance they were getting. I was absolutely content with the way my own Bruno was working both at home and in our store getting WJZ, WEA, WAAM, WRW, WHN on indoor aerials, the one in the store being 34 feet and the one at home 18½ feet across the parlor (one wire, no loop). But the whole business of distance finally got on my nerves last Saturday night, when three real radio bugs were discussing the marvels of the Bruno and what it had done for them. They didn't claim Europe but with the list of stations each one had, I don't see how any station in this good old country of ours was missing.

"Was on the verge of calling an ambulance because I surely thought they were completely 'gone.' So, just to find out for my own satisfaction I went to work last night at home on my little 18½ foot straight wire parlor aerial and this is what happened to me from 6:20 on:

"KDKA (Pittsburgh), WWJ (Detroit), WDAP (Chicago), WSB (Atlanta), and two other stations. I could not get call letters on, one saying 'Minnesota came in fine last night.' On the other I caught a piano solo. I could tune out WJZ for KDKA at will. Frankly I would not have believed it myself only I have my wife to verify all I claimed. Remember this is on an 18½ foot straight indoor aerial, one wire. As Coué says, 'Every day in every way, I'm getting better and better.'
J. A. VAN DAM."

Mr. Van Dam is a member of the firm of G. F. Van Dam & Son, 467 Richmond Terrace, New Brighton, N. Y.

All U. S. Via Radio

The day is not far distant when the President of the United States will address the people of the nation directly by radio, Otto B. Blackwell, transmission development engineer of the American Telephone and Telegraph Company, told members of the American Society of Civil Engineers at the

LITTLE GEM

**PRICE
\$6.50**

(Canada \$10.00)

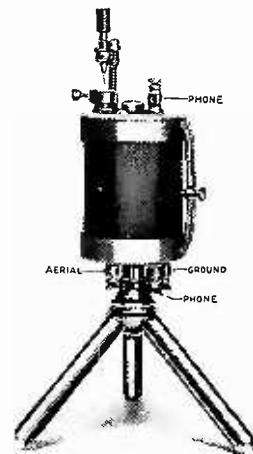

**Simple, Clear, Efficient and
Beautiful**

The LITTLE GEM presents a unique design combining compactness with efficiency. Unusually large receiving radius. Voice and musical tones come in with wonderful clearness and volume.

All metal parts are brass, nickel plated and polished. The instrument is beautiful in appearance, well made and practically indestructible. Nothing to get out of order or give trouble.

WHAT DISTRIBUTORS AND DEALERS SAY ABOUT THE LITTLE GEM:

"It will probably interest you to know that from our location at Columbus Circle, New York City, we are able to hear distinctly the broadcasting from WEA, WJZ and WOR."

"We are enclosing an order for 100 more and trust you will be able to ship them before the 24th as specified. We also ask that you book us for 200 more." From a Troy, N. Y. distributor.

"Enter additional order for 100."—From Winnipeg, Canada.

"Last shipment of Little Gems all sold. Rush order enclosed. The Little Gem is proving to be a wonderful seller with us."—From a Tenn., dealer.

*Attractive Proposition for
Jobbers and Dealers*

United Specialties Co.
Incorporated
57-59 Spring St., Newark, N. J.

seventieth annual meeting held at New York.

The A. T. and T. expert, who has conducted a research into radio development, explained to the engineers the field to which radio can be devoted.

"It is of inestimable service in the marine field, for talking with airships and guiding them, and for sparsely settled regions," Mr. Blackwell said.

Dubilier Micadon Type 610

The Dubilier Micadon, type 610, is of the usual Dubilier construction, with only the best grade of India mica used as a dielectric material. The condenser element itself is constructed under a patented and controlled process which assures permanency of capacity. The importance of this fea-

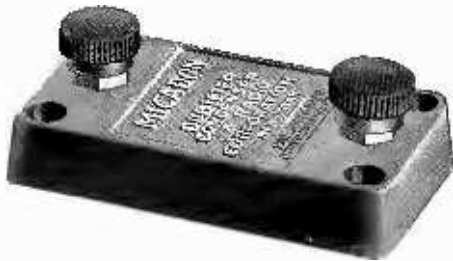

Dubilier Micadon

ture is usually overlooked by the radio novice.

Permanency of capacity means the elimination of many of the distorting noises that are audible in the average radio circuit. In the Dubilier product the conducting surface of tinfoil is held so closely to the surface of the dielectric (mica) that it is practically a part of it. As a final precaution against changes in capacity the entire condenser element is held tightly in a special clamping device.

The Micadon type 610 may be had in capacities ranging from .001 to .02. The molded composition case, which encloses the condenser element is provided with two composition covered binding posts and four small holes for holding-down screws. It is manufactured by the Dubilier Condenser & Radio Corp., 48 West 4th St., New York City.

Testrite Battery Testers

The increasing attention given to the condition of radio batteries indicates that the radio public is alive at last to the fact that the battery is the heart of the receiving set.

The makers of the Testrite hydrometer believe that the demand for battery testers will continue to grow at a rapid rate from now on, since radio fans are aware of the importance of

MARLE

AUDIO FREQUENCY



TYPE A4
RATIO 3 3/4 to 1
LIST PRICE \$3.75
TYPE A6
RATIO 5 to 1
LIST PRICE, \$4.25

RADIO FREQUENCY



TYPE R1
LIST PRICE, \$4.00

MODULATION



TYPE M1
LIST PRICE, \$5.00

TRANSFORMERS

SUPERIOR QUALITY TRANSFORMERS USED AND RECOMMENDED BY LEADING REPUTABLE MANUFACTURERS OF RADIO APPARATUS

MANUFACTURED BY

MARLE ENGINEERING CO., Orange, N. J.

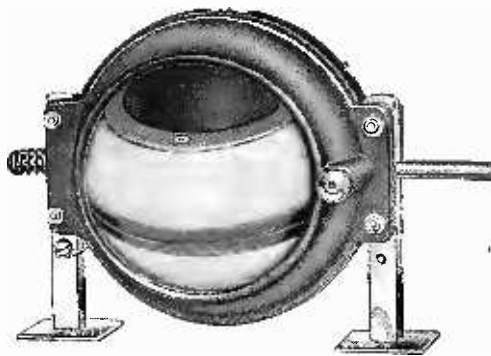

VARIOMETER

List Price \$6.50



The Finest Radio Apparatus

On the Market

The apparatus manufactured by the Radio Products Mfg. Co. is recognized as the very highest grade, designed to meet the most exacting requirements. Each unit is made complete in our own plant from the Redmanol moulding to the winding, assembling and final testing of the completed instrument.

Twenty years in the electrical manufacturing field gives us the wide experience, equipment and specialized organization necessary to produce the highest grade equipment to be had in this line.

Write us for full information.

**Radio Products
Manufacturing Co.**

667 W. Fourteenth St.
CHICAGO, ILL.

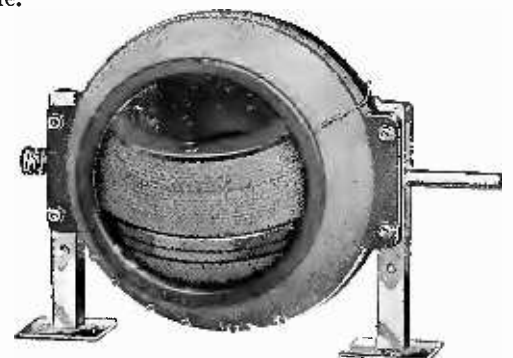

VARIOCOUPLER

List Price \$6.50

Mister Ray-O-Lite
Your Guide to Guaranteed
Batteries



Satisfied Customers,
Quick Turnover

On

RAY-O-VAC "B" BATTERIES

Thousands of owners know that their radio sets operate better when equipped with Ray-O-Vac Batteries. Ray-O-Vacs are built from special cells, perfectly insulated and bound into one solid block by a rubbery, acid-proof insulating compound. This construction overcomes the receiving noises present when using ordinary "B" Batteries. The current is steady, strong and long-lived. Spring clip terminals insure perfect contacts.

Radio fans have proved the facts for themselves and recommend Ray-O-Vacs to their friends. Dealers carrying stocks secure a quick turnover and build a solid list of satisfied customers. Send for Bulletin No. 225.

French Battery & Carbon Co.

Madison, Wisconsin

Chicago Dallas Atlanta New York
Denver Minneapolis Kansas City

RAY-O-VAC "B"
Batteries

ADD-A-STEP

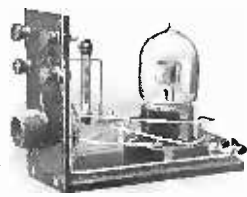

DETECTORS AND AMPLIFIERS

Awarded Mail's Certificate of Excellence
See them at the RADIO FAIR

ARROW RADIO CO.

Manufacturers of Quality Plus
Instruments

HACKENSACK NEW JERSEY

keeping the "A" and "B" batteries in condition. Testrite hydrometers are made in three styles, each of which are guaranteed to register the condition of the battery accurately. The Testrite Instrument Company recently moved into new quarters at 101 Fifth Ave., New York City.

Radio Golf a New Game

"Radio golf," is the new game invented by Frank Jones of Tuinucu, Cuba. The object of the game is to see which of the competitors can catch the greatest mileage of stations within a stated time. Each competitor keeps his own score card.

Higher score cards may have been turned in, but the card of Robert H. Anthony, of Needham, Mass., seems to have established the record at present. His best score is 3,576 miles per hour. This speed was maintained December 30 and 31 over a period of six hours and twenty minutes. Among the cities visited (by radio) were San Francisco and Long Beach, Cal.

The broadcasting of all cities heard totalling 45 in all, was received during 14 hours and 20 minutes operating time on the evenings of December 24, 25 and 30, and the early morning of December 31. The total number of miles covered during this time was 39,345, which establishes Mr. Anthony's claim to a radio golfer of high rank.

Mr. Anthony is New England manager for R. Thomas-Sons Co., manufacturers of electric porcelains. A standard Amrad radio frequency receiver 3,500, employing one stage of radio frequency, and two stages of audio frequency amplification was used. San Francisco was heard clearly through a loud speaking horn.

"B" Battery Construction

The complete line of Burgess "B" batteries, made by the Burgess Battery Company, Harris Trust Bldg., Chicago, Ill., have all been designed with a view to radio efficiency. Some of the features peculiar to each type are: Heavy moisture proof container; triple top seal, united with wax between the cells, completing a solid block construction; reinforcing webbing in the top seal; moisture proof insulating and reinforcing partitions between the cells; wax between cells which insulates and combines them into a solid unit; double moisture proof wrapper, an important factor contributing to "noiselessness"; and finally a one piece "jointless" zinc can for each cell battery which permits no leaks.

Burgess "B" batteries are made in styles with voltage ranging from 22.5 to 113. The weight of these batteries ranges from one pound to 28 pounds.

UNION RADIO PHONE TIP JACKS

(Pat. Applied For)

25 cents A PAIR

These convenient Phone Tip Jacks replace the old fashioned binding post. They assure positive contact and quick operation at all times. Accommodate any standard round phone tip and several sizes of bare wire. Great for W D II connections and coil mountings. Ideal for experimental circuits. Packed in

1/12 1/2 and 1 Gross
Counter Display Cartons

We make a complete line of Variable Condensers, Rheostats, Tube Sockets, Condensite Dials, Tip Jacks, Receiving Sets and Two Step Amplifiers.

Write today for our liberal dealer proposition, samples and prices.

Catalogue K on request.

UNION RADIO CORPORATION
200 MT PLEASANT AVENUE, NEWARK, N.J.
NEW YORK OFFICE 116 WEST 32ND STREET.

DISTANT STATIONS BROUGHT IN FOR LONG WAVE RECEPTION

USE AMCO ADJUSTABLE, 1, 2
AND 3 COIL MOUNTINGS



Licensed Under DeForest U. S. Patent,
No. 1,365,170

Triple Coil Mounting List \$4.00
Double Coil Mounting List \$3.50
Single Coil Mounting List \$0.50

Adjustable locking device, a patented feature, holds the coil firmly in place. Readily mounted on front of panel in any position.

Constructed of the highest grade insulating material; polished and attractively finished.

All metal parts heavily nickel plated
NOT A MOULDED AFFAIR

Astorloid Mfg. Co., Inc.

Tel. Williamsburg 5104

416 Marcy Ave. Brooklyn, N. Y.

Moon Naturaltone Speaker

Experiments are being endlessly conducted these days to discover what gives the human voice its rounded, vibrant tones, and how these may be reproduced in a loud speaker. Engineers of the Moon Radio Corporation, manufacturers of the Moon Naturaltone



Moon Naturaltone Speaker

Loud Speaker, claim to have made the biggest advance in recent times in horn construction by modeling the horn of the Naturaltone loud speaker after the shape of the human mouth.

The horn itself is made of wood pulp composition, in keeping with the idea that the nearer one approaches nature the more likely one is to obtain natural effects. From time immemorial wood in various forms has been used to make musical instruments with resonance and timbre, from the marimba of the Peruvian Indians to the sweetest instrument of all—the violin that Stradivarius made.

The Naturaltone loud speaker is set in a mahogany finished cabinet, which is designed to make an attractive addition to any receiving set. The Moon Radio Corporation, also makers of the Satterlee antennaless receiving set have offices at 12 Diagonal Street, Long Island City, N. Y.

Transformer of Unique Design

The audio-frequency amplifying transformer put out by the Radio Supply Company, of Hornell, N. Y., comes as a distinct relief to the dealer and to the radio enthusiast. It is of unusual design in that it is unusually simple and neat in appearance. This transformer is said to produce volume of sound without distortion, and the makers say that three stages of amplification may be used with practical results.

The Radio Supply Company also make a loud speaker unit and a radio headset that are attractive both in price and design. Each instrument manufactured by the company carries with it a money-back guarantee.

FRESHMAN PRODUCTS—ACCURATE AND DEPENDABLE



“MICON” Tested Mica Condensers

Size	Price
.00025\$0.35
.000535
.00140
.00240
.002550
.00575
.006 1.00
.01 1.50



Variable Resistance Leak

With .00025 Mfd.
Micon Condenser
Combined

\$1.00

Without
Condenser

75c

Unbroken range—Zero to 5 Megohms, Clarifies signals, lowers filament current, increases battery life, eliminates hissing.

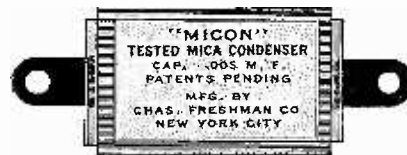

Assure absolute noiselessness—clarity of tone—accuracy—constant fixed capacity.

.006 Micons with Variable Resistance Leaks, especially adapted for Flewelling Circuit.

ANTENELLA

No antenna or aerial needed. Eliminates all the inconveniences in radio, operates from any light socket. Price only—

\$2.00

CHAS. FRESHMAN COMPANY, Inc.

97 Beekman Street, New York City

Dealers: Discount 33 1/3% on all orders \$15.00 and over. We pay parcel post, express or freight charges. Literature and display cards free on request.

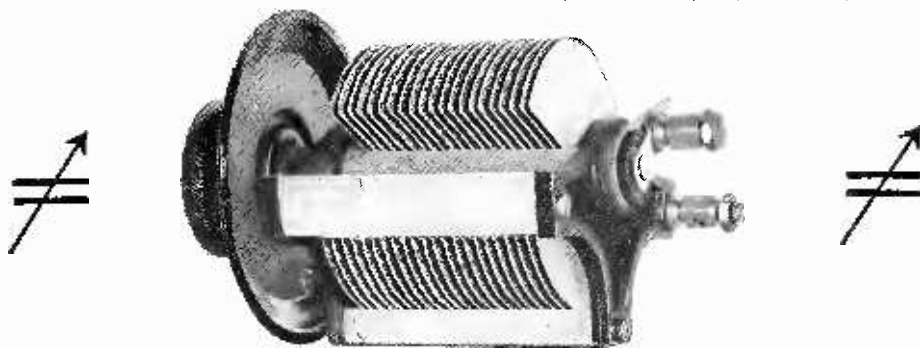

Radio Finds a Better Condenser

Bayley's 23-0005 and 43 Plate 0011 Variable Condenser is what Radio has found.

Its plates spaced close give it the finest tuning qualities.

It is a die-cast product, the stationary plates are cast solid, accurately and permanently spaced, on three upright supports, while the movable plates are cast on the centre revolving spindle. It is impossible for plates to loosen in service.

Solid rubber end pieces finished like black morocco leather make it beautiful. It is of good design and high grade workmanship. In an official test measures up to 0011 M.F.D. capacity and is uniform, it does not vary.

Each condenser has our guarantee, backed with a manufacturing record of more than forty years.

A sample order will convince you of its value.

And Make You, Certainly, A BAYLEY CONDENSER BOOSTER

We want business from houses that appreciate real value. It will give satisfaction and stay sold

Price, 23 Plates \$3.25 each. 43 Plates \$3.75 each

TO JOBBERS AND DEALERS A SPLENDID PROPOSITION

BAYLEY CONDENSER CO.

105-109 Vanderveer Street

Brooklyn, New York

The
SABCO



2
HEAT
PAT. PENDING

**ELECTRIC
SOLDERING
IRON #**

MODEL
B-100
LIST PRICE **6.00**

DISCOUNTS & CATALOG
SHOWING COMPLETE LINE
ON REQUEST

MFD. BY
STRAUSS & BLUM, INC.
256 1/2 West 41 St.
New York.

Jones Helps the Dealer

Shows Him How to Utilize His Window as a Salesman

By H. G. CISIN

Jones, the jobber's salesman, walked into Boyd's radio store the other day with a cardboard package under his arm.

"I want you to see this new window display," he said.

"Sure, I'll look at it," said Mr. Boyd, "but that's as far as I'll go. You fellows don't seem to realize that I get tons of that stuff in every mail. Just look back here." He led Jones to a closet filled with cardboard displays, counter cards, posters, circulars, etc. "Enough stuff there to fill the store to the exclusion of my entire radio stock," he said.

"No doubt about that," said Jones, and proceeded to open up the window display. "But say, Mr. Boyd, did you ever stop to consider that you could put a lot of that so-called stuff to work for you selling goods and making money? Now just take this display, for instance. It doesn't take much imagination to realize that it must have cost the manufacturers quite a sum of money. It was made by experts for just one purpose—to speed up the sale of Dictograph head sets and loud speakers. A fine chance it would have of doing that if placed in your back room. Get that loud speaker out of the carton and put it on this center platform, and take those two Dictograph head sets from that collection in your showcase. You see, the head sets fit one on each side panel of the display."

"The display does set them off," agreed Boyd, "but I'm not entirely sold on the idea."

Just then a customer interrupted. "That's the Dictograph loud speaker, isn't it?" he asked. "I saw it advertised. Would you mind hooking it up a moment?"

Boyd connected the loud speaker to a two-stage receiving set and tuned in WJZ. "Oh, boy, that's some speaker," said the customer, "I'll take it along with me." At this point Jones edged into the conversation. "How about distant stations?" he queried. "do you like to get them?"

"I'll say I do," said the customer, "I'd stay up all night to get Havana or Frisco."

"In that case," said Jones, "you'd better take along a Dictograph head set with the speaker. You'll also find that it will simplify tuning in the loud speaker, no matter what station you are trying to get. Here's the way to use it: Just plug in the head set, tune

GANAERITE Detector Crystals

Twenty years of practical mineralogy gave us the material to produce the highest quality crystal.

We are now undertaking the largest single order for mounted crystals in the market.

We test and *guarantee* to replace or refund on any unsatisfactory Ganaerite crystal.

The Harris Laboratory
26 Cortlandt St., New York City



TYPE 209 DETECTOR | TYPE 309 AMPLIFIER
LIST \$18.00 | LIST \$30.00
RADIO RECEIVING SETS FOR 1 1/2 OR 6 VOLT
TUBES
IMMEDIATE DELIVERY
Distributors, Jobber and Dealers Write for
ATTRACTIVE DISCOUNTS
W. B. L. RADIO CO.
22 Norfolk St. Newark, N. J.

Leading Attraction at Recent
New York Radio Show
COMPLETE UNASSEMBLED
TITAN-O-TONE
LOOSE COUPLER RECEIVING SET
Including two wired coils
List Price \$4.00

Attractive Dealers Display Board
LIBERAL DISCOUNT
Manufactured by the
T-F RADIOPHONE CO.
667 Coney Island Ave. Brooklyn, N. Y.

FLEWELLING

All Parts necessary

Dealers: Write for Discounts.

HUDSON-ROSS
123 W. Madison St. Chicago

THORNTON
AUDIO FREQUENCY
AMPLIFYING TRANSFORMERS
Supreme Test Transformer

These transformers are supplied in either mounted or unmounted types. Special attention paid to the manufacturer of receiving sets.

THORNTON
TRANSFORMER CO., Inc.
30 Church Street, New York City

DEALERS!

If the Holiday Sales have depleted your stock—reorder now for mid-winter sales. Prompt deliveries are absolutely guaranteed—and our discounts are the most liberal.

We Are Jobbers For
Grebe Receiving Sets
Federal, Fada and
Radio Shop Products
Murdock Products
Baldwin Phones

Write For Our Special Proposition "Z"

THE RADIO SHOP
—OF NEWARK—
76 SPRINGFIELD AVENUE
NEWARK, N. J.

in your station to the maximum volume and then plug in the loud speaker. That's the idea. After listening-in on that head set, I guess you don't have to be told the other reasons why you should own it. I listen-in every night. After enjoying the loud speaker for a while, I plug in the head set and try for distance. I've heard stations from Canada to Cuba and from the Atlantic to the Pacific, and what's more that phone can't be beat for clearness and musical tones."

"Wrap up a head set with the speaker," said the customer. As the man left the store Boyd turned to Jones and said: "Say, old man, I wish I could afford to hire a salesman like you."

"You can," said Jones; "that display is the best little salesman you ever saw, and what's more it doesn't cost you a cent in salary."

"Right you are," said Boyd. "I'm going to put it to work at once in the center of the front window."

Hydrometers for All

Bringing the battery tester within the reach of every radio fan, the Stader Manufacturing Company, 123 South Jefferson Street, Chicago, Ill., is now offering the Stadco Jumbo hydrometer at a reasonable price.

This hydrometer is distinguished by several features besides good appearance. The Jumbo has an extra large bulb which protects the glass barrel from breakage. It also provides large capacity when used as a battery filler. The prongs on the float prevent sticking to the sides of the barrel. Projections on the nozzle prevent rolling.

Only high grade materials are used in the construction of this instrument. The glass used in moulding the barrel is of extra strength and free from defects. High grade rubber is used in the bulb and nozzle. The Stadco Jumbo hydrometer comes in an attractive two-color telescope box. The Stader Manufacturing Company also makes a standard instrument at a lower price than the Jumbo.

Sells Known Brands

R. R. Garrick, of West Philadelphia, Pa., is a distributor who believes in handling only nationally-known and nationally-advertised radio accessories, among which are the "K-N" helix antenna, made by Walter S. Krenz; the Pramco Unit crystal set, made by the Premier Radio Mfg. Co., of Philadelphia; the Ajax socket-rheostat, made by the Ajax Radio Corp., and the S. & S. variometer, made by the Sunday & Scholtz Co.



The "Melco Supreme" Radio Frequency Amplifying Receiver can be used with indoor or outdoor aerial, loop or lighting plug. It is a new departure in radio, non-reflex, non-regenerative, tuned radio-frequency. Amplification of this instrument is extremely high per stage, without loss of tone quality. **IT DOES NOT DISTORT THE WAVE NOR INTERFERE WITH OTHER MEMBERS OF THE RADIO AUDIENCE.**

This new system permits of single tuning adjustments that result in a high degree of selectivity and long distance reception.

PRICE \$125.00

**A complete line of high grade parts are also available
For quality merchandise, price cannot be equalled**

SAVE SALES COMPANY

Sales Engineers

City Hall Building

New York City

(Broadway and Warren Street)

MELCO SUPREME

Write Now for Literature, Attractive Discounts and Distributor's Proposition

KEYSTONE Lightning Arresters

Listed as standard by Underwriters' Laboratories (362 A-4)

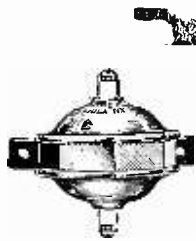

Type B. Retail Price, \$2.00

Keystone Radio Arresters last indefinitely because they have no vacuum to lose nor fuses to blow. They are enclosed in heavy porcelain, sealed and tested. Installed outdoors where an arrester belongs. Take the place of a lightning switch.

Buy them from your Jobber or direct.

For sale by Jobbers everywhere.

ELECTRIC SERVICE SUPPLIES CO.

Manufacturers of Lightning Arresters for 30 years.

SIMPLEX PANEL UNITS

Write for catalog on these Simplex products.

Simplex Variometers, mounted or unmounted.

Simplex Vario-Couplers, mounted or unmounted.

Simplex Condenser Panels

Simplex Detector Panels

Simplex Amplifier Panels

Simplex Type RF Receivers



17th and Cambria Sts., Phila.

Distributors for SIMPLEX RADIO CO.



Essex 150-500 meter
180° Vario-Coupler—
Green Wire with 3"
molded dial.
Price \$1.25 net
Special Essex WDFI
Audio Transformer de-
signed for dry cell
tubes. Price \$2.55.

ESSEX BUS WIRE NO. 14
Square Tinned—Specially Pre-
pared and Will Give Entire
Satisfaction. \$1.00 Per Hundred
Feet.

Send for Dealers' Quantity Prices

ESSEX MANUFACTURING CO.
117 Mulberry St., Newark, N. J.

REINARTZ

All Parts necessary

DEALERS: Write for discounts

HUDSON-ROSS

123 W. Madison St. Chicago



Head Sets, V.T. Sockets, Rheostats and
Condensers

THRESHER RADIO & MACHINE CORP.
476-482 Eighteenth Ave.
Newark, N. J.

KNOCK-DOWN RADIO RECEIVING SET



Neatly packed in an attract-
ive hinged cover box. Makes
a wonderful display. A
child can assemble this set.
Practical and instructive.
Complete instructions for as-
sembly included.
RETAIL PRICE, \$4.50.
Liberal Discounts to Jobbers.
(Established 1871)

CHAS. WINKLER, INC., 178 Emmett St., Newark N. J.

Radak

Reg. U. S. Pat. Off.

RELIABLE RADIO EQUIPMENT
made by America's oldest and largest manufacturers
of radio equipment exclusively. Sold by the best
electrical and radio dealers.

CLAPP-EASTHAM CO.
133 Main Street Cambridge, Mass.

RADION HARD RUBBER PANELS

Cut to Any Size

DISCS, WASHERS, BUSHINGS, ETC.

Made to Order

New York Hard Rubber Turning Co.
212 Centre Street, N. Y. C.

Recommended for Reliability

RADIO STORES CORP.

VARIABLE CONDENSERS—
PLUGS—RESISTANCE UNITS, ETC.
222 West 34th Street, New York

Hydrometer Is Well Known

Nationally advertised in such publi-
cations as the *Saturday Evening Post*
the Hafner hydrometer, one of the
specialties of the Hafner Manufac-
turing Company, 3128 Carroll Street,
Chicago, Ill., is one of the best known
brands of radio equipment.

The Hafner hydrometer is a heavy
one-diameter barrel designed for easy
reading and hard wear. A correct
reading is always easy for the float
can not be held against the barrel by
capillary attraction. Glass beads on
the float keep it floating freely. Rub-
ber connections are of soft, acid-proof
stock, protecting the hydrometer from
breakage and preventing loss of suc-
tion and leakage of acid.

Besides being one of the lowest-
priced hydrometers on the market the
Hafner hydrometer is backed by na-
tional advertising and dealers' helps,
such as eye-compelling window cards
and folders which may be slipped into
every radio purchase.

Amplifier for Speaker

A one-stage amplifier for use with
a loud speaker has been introduced by
the Bristol Company, of Waterbury,
Conn. This device is used in connec-
tion with a detector and one or two
stages of amplification.

The instrument known as the Bris-
tol power amplifier, is neat in appear-
ance, resembling a unit of a high grade
set. It is constructed on a principle
that uses a circuit which eliminates the
need for a "C" battery to maintain
the grid negative. High voltage may
be used on the Bristol power amplifier,
being limited only by the capacity of
the tube.

The Bristol Company especially
recommends its use with the Bristol
line of audiophones, a list of loud
speakers upon which the company is
at present placing stress.

Sales Helps for Tubes

Free electros and mats for the ex-
ploitation of Cunningham tubes is one
method adopted by the Audiotron
Manufacturing Company, 35 Mont-
gomery Street, San Francisco, Cal.,
to increase sales.

These electros and mats are designed
for use with the dealer's name in
newspapers. There are six different
styles for the use of the dealer and
each graphically calls the attention
of the reader to the Cunningham tube
and its advantages.

The Audiotron Manufacturing
Company is also distributing attrac-
tive folders to dealers for store ad-
vertising. Dealers are asked to state
on their business stationery the num-
ber of folders and electros they can use.

NOTICE!

We have an extremely
profitable and timely
proposition for live
Jobbers, Distributors,
and Buyers. Immedi-
ate action is necessary

WRITE AT ONCE

ARROW RADIO CO.

Hackensack New Jersey

PATENTS

on radio inventions apply to

OTTO K. ZWINGENBERGER

38 Park Row, New York
Cortlandt 3207

PATENTS

ELECTRICAL MECHANICAL
RADIO

SEND SKETCH AND DESCRIPTION
FOR OPINION

EMIL ALEXANDER KERN
328 SOUTH SEVENTH STREET
NEWARK, N. J.

PATENT

your ideas. Protect your rights by U. S. and Foreign
Patents and Trade-Marks. Moderate rates. CALL,
WRITE or send us your invention.

Free booklet and inven-
tion recording blank.

FREE
CONSULTATION

Phone: Vanderbilt 7212.

FREE MANUFACTURERS
PATENT CO., INC.
BOOK 520 FIFTH AVE.
NEW YORK

HAFNER FOR HYDROMETERS

Guaranteed instruments to sell for 75c with
a good profit margin for dealers. Ask your
jobber or write us direct.

HAFNER MANUFACTURING CO.

3130 Carroll Ave., Chicago, Ill.

"Have a Hafner Handy"

Vario-coupler

180 Degrees—Bakelite tubing, green
silk wire.

Write for prices and discounts.

WALD ELECTRIC CO.

101 Varick St. New York City

We will furnish immediate Cash for
Radio Stocks or Material

In making offerings state full details as to
quantity and lowest price acceptable.

THE R-C OUTLET, 30 E. 23 St., N. Y. C.

A National Clearing House for the Mutual
Benefit of the Industry

MANUFACTURERS OF
Receiving Sets Complete

Unites Mounted and Unmounted

Send for Description and Prices

RADIO OUTFITTING CORP.

Mfg. High Grade Radio Apparatus

410-412 East 34th St. New York, N. Y.

International Phones

With a total weight of cord and phones of eleven ounces, the International K-17 phones, made by the International Radio Telephone Apparatus Company, of 395 Broadway, New York City, form one of the lightest head-sets on the market.

The makers claim that every detail which would add to the acoustic qualities has been carefully studied and weighed in its relation to the object to be attained. The diaphragm is of standard ferrotype metal, and is so supported in the cap as to allow for correct reproduction of music, without the transposition of certain high pitched notes common to many telephones. The pole pieces are of Swedish iron, laminated to reduce eddy currents. The permanent magnets are of tungsten steel, quadruple laminated and lacquered. A six-foot mercerized cord is provided with pin tips to connect to the receiving apparatus with concealed terminals at the telephone ends. Each phone has a resistance of 1,500 ohms. The phones are put up in two styles, one with mercerized cord and the other in a velvet lined case, with a silk cord.

Fenstermaker Switches

A line of radio switches, and screws that are attractive in appearance and efficient in operation is now being put on the market by C. B. Fenstermaker, 43 Green Street, Lancaster, Pa., under the trade name of Mars.

The feature of the Mars line is a ball-bearing switch, S-3, for which patents have been applied. Other parts in the Mars output are contacts, switch stops, bushings, binding posts, washers, nuts and screws. The Fenstermaker company is now merchandising these products by means of attractive showcards on which the products are displayed in dozen lots. The company is also equipped to manufacture special brass turned and stamped parts from samples or blue prints.

Long Distance Essentials

Three instruments designed to secure fine control for the radio fan are made by F. A. D. Andrea, of 1581 Jerome Avenue, New York City. They are the FADA potentiometer, vernier rheostat and vernier attachment.

The FADA potentiometer and vernier rheostat are said to insure an extremely delicate control of receiver circuit and tube filament currents. The FADA vernier attachment can be quickly applied to practically any make of rheostat having three-sixteenths of inch shaft, for purposes of converting it into a vernier rheostat.

DELICATE SOLDERING

Both the manufacturers' and amateurs' problem on all fine work is readily solved by the instrument constructed for this particular purpose.

THE POST SOLDERING IRON

Platinum Heating Unit—Interchangeable Tips—Universal Current
(Large and Small)



One Half Actual Size

LISTS AT \$6.00

Dealers' and Jobbers' discounts on request

Awarded Certificate of Excellency, N. Y. Evening Mail Radio Institute

POST ELECTRIC COMPANY, (Office 509) 30 E. 42nd St., New York

Westphal's
**FLEXIBLE
Spaghetti**

WESTPHAL'S SPAGHETTI

Black or Yellow
Grade "A" Grade "B"

10,000 feet lots, per ft. . . 3 cts.	10,000 feet lots, per ft. . 1¼ cts.
5,000 feet lots, per ft. . 3¼ cts.	5,000 feet lots, per ft. . 1½ cts.
1,000 feet lots, per ft. . 3½ cts.	1,000 ft. lots, per ft. . 1¾ cts.
500 feet lots, per ft. . 3¾ cts.	500 feet lots, per ft. . 2 cts.
Less than 500 ft., per ft. 4¼ cts.	Less than 500 ft., per ft. 2½ cts.

Write for Samples
The WESTPHAL ADAPTER fits all phonographs and headphones. Constructed in one unit and does not require bushings. Resonance chamber with single phone produces tones and volume not found in other adapters.

Write for our attractive discounts.
Samples sent postpaid \$1.85.

Westphal Manufacturing Laboratory
224 So. Michigan Ave. Chicago, Ill.

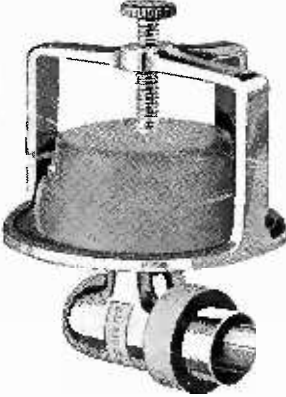

A representative line OF STAPLE MERCHANDISE

DeForest Equipment (New D. V. Tubes)
Saturn Products, Perfect Jacks and Saturn Automatic Radio
Plugs

Rico Loud Speaker Phones—Brandes Phones
Tungar Battery Charger, Extra Attachment for Storage
"B" Batteries

Dayton Fan and Motor Co. Variometers and Variocouplers
Woodehorn Loud Speaker—Magnavox

NORTH WARD RADIO CO.

Phone Mitchell 1463

236 Halsey Street

Newark, N. J.

FISCHER

180° Coupler

"Look For The Diamond"

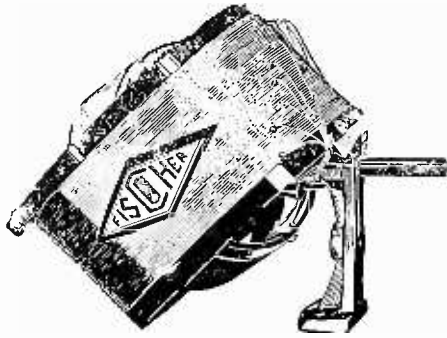

An absolute range of 600 meters guaranteed.

Complete with soldered leads.

Positive Pigtail connections.

Genuine Bakelite tubing and Fahnestock clips.

We also manufacture a complete line of Variometers and Variocouplers.

Dealers—write for prices, catalog and discounts

G. H. FISCHER & CO.

317 Cypress Hills Rd.
Glendale, L. I., N. Y.

Howard Micrometer Rheostat

Among the numerous features of the Howard micrometer adjustment rheostat, which the Howard Radio Company, Inc., of 4248 Western Avenue, Chicago, Ill., has introduced into the field of radio specialties, are the single knob control, and the automatic instantaneous adjustment of the micrometer section.

The delicate balance so necessary for the most efficient operation of gas content detector tubes, necessitates the use of an instrument with fine control.

The wire used in the Howard rheostat has for all intents and purposes a zero temperature co-efficient, making the adjustments stable and constant. The micrometer attachment and rheostat dial are also sold separately

"SAMCO" PRODUCTS

VARIABLE CONDENSERS



11	Plate .00025 M. F. Capac.	List \$2.25
23	" .0005 " " " " " " " " " " " "	2.85
43	" .001 " " " " " " " " " " " "	3.60
68	" .0015 " " " " " " " " " " " "	5.50



Rheostats
6 ohms. List .50
Potentiometers
300 ohms.
List, \$1.50

WE HAVE
A SPECIAL
PROPOSITION
TO DEALERS
AND
JOBBER



Inductance
Switches
List .50

STANDARD APPLIANCE MFG. CORP.
428 EAST 71st STREET, N. Y. CITY

VIKING RADIO CO.

26 D Cortlandt St. New York City

Distributors for

F. A. D. ANDREA CO.
ALDEN NAPIER CO.
CHAS. FRESHMAN CO.

Wholesale Only

Distributors and Jobbers Write for Discounts

COMSCO PRODUCTS

W. D. II-SOCKET
U. V. SOCKET Single, Double & Triple
JACKS All sizes

Manufactured by

Commercial Screw Machine Products Co.
427-435 E. 102 St. New York, N. Y.
Telephone: Lenox 0256

NOVO "B" BATTERIES

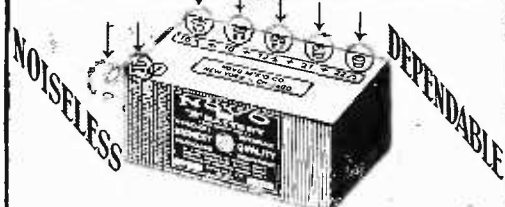

NOTE THE INSULATED BINDING POSTS AND 7in. WIRE CONNECTOR

NOVO MFG CO.
424 W. 33rd ST. NEW YORK
531 SO. DEARBORN ST. CHICAGO

RADIO DEALERS

We are fully prepared to furnish you with Standard Radio Products at attractive discounts.

Prompt delivery and unlimited service
ELL-ESS RADIO EXCHANGE

DISTRIBUTORS

for

Enco Electric Novelty Co. (B. Battery)

Inter-Ocean Radio Corp. (Woodehorn)

Jaynyxon Laboratories (Sellinite crystals)

At unusual Discounts

Crystal Sets
Variometers
Vario Couplers
K. D. Glass Crystal Detector
Tubular Grid Leaks
All Capacities

Also other Standard Products

Write, call or phone

ELL-ESS RADIO EXCHANGE

Tel. Cortlandt 0405
57 Dey St., New York, N. Y.

A Phone For Every Set



Try One and You'll Buy One

Royal Electrical Laboratories

Manufacturers of

Electrical and Radio Equipment

NEWARK, N. J.

Royalfone

M-R FLEXIBLE VARNISHED TUBING
THE GENUINE

"SPAGHETTI"

TWO STYLES—BEST GRADES MADE—ALL

SIZES—ALL COLORS

Varnishes, Waxes, Compounds, Papers, etc.

MITCHELL-RAND MFG. CO.
14 VESEY STREET NEW YORK, N. Y.

CONTAINA

The Adjustable Double Surface Crystal Setting Awarded Evening Mail Certificate of Excellence.

Minimum Cost

Maximum Service

CURTIS G. CULIN

366 Broadway

New York City

Have Outlet For SURPLUS STOCKS Radio Supplies

Price and Goods Must Be Right

P. D. Jackson, 1441 So. State, Chicago

CONQUEROR

Custom-built, One-knob Control
RECEIVING SETS

LEWIS & DeROY RADIO CORP.
560 Seventh Ave. New York

PAPER CONDENSERS

Manufacturers, Jobbers, Dealers

We will manufacture any one standard size condensers in thousand lots only with your own label for \$25.00 per 1,000

Standard sizes: .00025, .0005, .00058½ Meg. G. L., .001

Special sizes: .002, 35.00 per 1000; .005, .006—60.00 per 1000

WALTER E. BATHGATE
65 West Broadway New York City

General Insulate Products

The General Insulate Company, 1008 to 1024 Atlantic avenue, Brooklyn, N. Y., reports that the year that has just closed has shown a volume of sales of more than double that of the previous year and that 1922 was the second largest in volume of sales in the history of the company, since its establishment nearly twenty years ago.

This company is known as moulders of insulate, black shellac composition and of Hi-Heet, a phenol composition parts for the radio and electrical trades. It has recently introduced a new product called Star Insulate, a material that is said to have great mechanical and dielectric strength, combined with resiliency. It can be moulded into almost any shape, thick or thin and in any color, either opaque or translucent.

Radio Trade Mailing Lists

For the radio manufacturer and retailer desiring mailing lists reaching certain distinct classes of potential buyers, the lists compiled by the Trade Circular Addressing Company, 166 West Adams Street, Chicago, can be secured.

This company is at present making a specialty of radio lists and have compiled twelve distinct radio rosters containing some 40,000 names. There are separate lists containing the names of radio dealers, radio manufacturers, radio supply jobbers, all by states, radio stations makers of complete sets. The list of chief interest to the radio retailer is one containing the names of 25,000 radio amateurs and managers of radio stations. The company guarantees the lists with a money-back policy.

Loud Speakers Aid Rehearsals

Directing rehearsals in New York's largest theater and in one of the largest in the world is not an easy task, but Samuel L. Rothafel, directing the productions at the Capitol Theater, New York, has found the Western Electric Company's public address system of great help.

Sitting at the back of the immense theater, Mr. Rothafel can now talk into a microphone in ordinary tones and can be heard in the projection room, on the stage, by the men in charge of the lighting system and by the conductor of the orchestra. He can move ten feet away and give directions and still the sensitive microphone will pick up his words and transmit them to the persons interested. The system involves the use of loud speaking projectors in various parts of the auditorium, and a vacuum tube amplifier.

DAY-BY-DAY—IN-EVERY-WAY

EBY SERVICE

is getting
BETTER
and
BETTER
and
BETTER



Commander



Ensign



Sergeant "SS" Corporal

Notwithstanding the tremendous demands being made upon us from all parts of the country, for our popular line of quality products, we are maintaining a 24-hour service. Anticipate your requirements and be assured of a supply of EBY posts.

THE H. H. EBY MANUFACTURING CO., PHILADELPHIA, PA.

ELECTRICAL TESTING

Of all materials entering into Radio Construction.
Meters and apparatus calibrated and repaired.

CHEMICAL ANALYSES
STRENGTH TESTS

Investigation or Development of New Apparatus and
Materials. Routine Tests at Special Rates.

NEW YORK TESTING LABORATORIES
80 Washington Street, New York City
Bowling Green 7016

STANDARD SPECIAL CRYSTALS

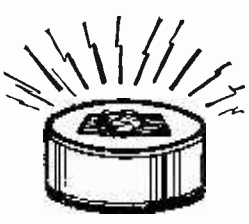

The Guaranteed Crystal

Are you selling Standard Special Crystals? They are recognized as the most efficient crystals on the market, and are sold in every country where wireless is being used. Every Standard Special Crystal is specially treated and tested on a radio wave, and is absolutely guaranteed. They will last longer and give better service than the ordinary kind.

STANDARD CRYSTAL CO.
274 S. Halsey St. NEWARK, N. J.

Canadian Agents: Sterling Specialties
213 Somerset Building, Winnipeg, Man., Canada

Western Representative: Engineering Sales Company, 220 North State St., Chicago, Ill.

STOP-LOOK-WRITE

DEALERS, JOBBERS AND MANUFACTURERS

Before placing orders, write us first and get samples and our big discount sheet.

	List		List
Condensers 43-Plate.....	\$3.50	Turney Head Sets.....	\$6.50
“ 23- “	2.75	Dials 3”75
“ 11- “	2.25	Variometers	3.50
“ 7- “	2.00	Variocouplers	3.50
“ 3- “	1.50		

SPIRO BROTHERS, Manufacturers and Distributors
519 Real Estate Trust Building Philadelphia, Pa.

Thomas A. Edison Announces New WD-11 Dry Cell Battery

By WILLIAM COLEMAN

That the importance of the dry cell battery operating vacuum tubes is being recognized is evidenced by the action of manufacturers who are now introducing improved batteries for

this purpose. Proof that the dry cell tube is one of the most important innovations in radio in years is furnished by the announcement that Thomas A. Edison has recently brought to per-

fection a battery for exclusive use with the WD-11 tubes.

That such an eminent inventor should devote his time to this problem is not surprising, since the advent of the WD-11 tube has made possible the successful operation of radio sets



Thomas A. Edison

CRYSTALS Unconditionally GUARANTEED

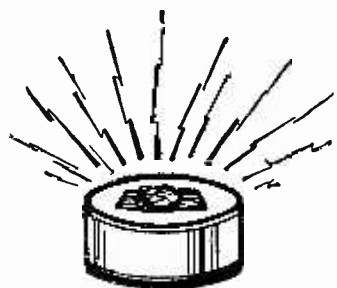

Standard Brand Special Radiocite

Crystals are unconditionally guaranteed to give satisfaction—we tie no strings to our offer, they must be right.

Packed in Neat Containers
Samples and Prices Upon Request

STANDARD MINERAL COMPANY
216 Market St. Newark, N. J.

“SUPERIOR PRODUCTS”

The Rolls-Royce of Radio



Headsets
Loud Speaker Phones
Variometers
Variocouplers
Variable Condensers
Tait Dials

Electrical efficiency plus handsome appearance.

Ratio $4\frac{1}{2}$ to 1. Primary reactance 30,000 ohms. Secondary, random wound and untuned gives a flat top amplifying characteristic from 150 to 2,000 cycles. Exceptionally tight coupling. Moisture proof. Uniform operation under all conditions. Will not burn out. A quality product used and recommended by successful manufacturers of radio sets. Another “Superior Product” which reflects credit upon the radio industry.

SUPERIOR PRODUCTS MANUFACTURING CORPORATION
1078-80 Springfield Avenue, Irvington, N. J.

without the trouble and annoyance of the storage battery. The great number of these tubes sold is an indication of a desire on the part of the radio buying public to discard the storage battery and presages to a certain extent the universal popularity which is certain to be accorded the low voltage tube set.

In rural districts the use of this



Edison Radio Primary Battery

type tube is almost compulsory. Where no available means of charging is to be had, or where storage batteries must be laboriously carted to and from charging stations for recharging, the WD-11 tube comes into its own.

The dry cell, which has heretofore been used in the operation of these tubes, has, however, to be replaced fre-

quently. This fact has led Thomas A. Edison to make available for radio use a battery having voltage characteristics similar to the dry cell but with an extraordinarily long life. This new battery known as the Edison radio primary battery has a life of 250 ampere hours and means are provided for repeating this life indefinitely and at slight cost by renewing the elements and solution.

The battery will operate one, two or three tubes. When operating one tube the life of each renewal is 1,000 hours, or approximately the life of the tube itself. A battery which lasts as long as the tube requires no attention during that time and which may then be renewed, repeating this performance indefinitely, is certain to enjoy a large and wide demand.

The cell used in the new battery is not new in itself. It has been used for over twenty-five years in the operation of telephone and telegraph circuits, fire alarm systems, railway signal operation and other fields, in which absolute dependability, long life and un-failing service are prime essentials.

The renewal feature is interesting to the dealer, as it insures further and continued business to him in the form of renewal sales. Each battery sold means further business in renewals.

The Edison radio primary battery is made by Thomas A. Edison, Inc., Primary Battery Division, Bloomfield, N. J., and the makers state that they are now about ready to begin the active marketing of the unit and are making connection with jobbers in all parts of the country.

Radio Stocks

By FRANK T. STANTON

Conditions governing radio securities were never more favorable than at present. The leading concerns in the field were never in a stronger physical or financial condition than today.

Following are quotations for the principal radio stocks:

Stock.	Bid.	Asked.
All American Cables	\$119	\$120
Amer. Tel. & Cable.....	60	61
American Tel. & Tel.	123½	124
Am. Marconi Stamped	5c	20c
Am. Marconi Unstamped ...	\$7	\$9
Canadian Marconi	2½	3¼
De Forest Radio	8	11
English Marconi, com.	11	14
English Marconi, pfd.	10½	13½
Federal Tel. Co. Cal.	7	8
Federal Tel. & Tel.	11	12
General Electric, com.	181	182
Gen. Elec. 6% new stk.	11½	12
Inter. Tel. & Tel.	58	60
Mackay Co., com.	104	105
Mackay Co., pfd.	68	70
Man. Elec. Supply	53	54
Marconi Int. Marine	9	11
Radio Corp., com.	3⅝	3¾
Radio Corp., pfd.	3⅝	3¾
Spanish Marconi	1	3
Western Union	110	111
Westinghouse E & M.....	59	60

YOUR CUSTOMERS

are asking us for Vac-Shields: We want you to sell them.

The invention eliminates linking up the magnetic fields between vacuum tubes, does away with inter-stage electro-static coupling, overcomes stray capacity effects that are always troublesome, which make it so difficult to tune in distant stations.

Trial Order—One Dozen, by mail, post paid, \$8.00, sent C.O.D. Order today. See our ads in Wireless Age, Radio Broadcast, Radio World, etc.

ORANGE RESEARCH LABORATORIES

East Orange, N. J.

HIGH GRADE SALESMEN WANTED

TRADE
"VAC-SHIELD"
MARK



PATENT-PEND

Price \$1.00

Stop-Look-Read!

DETROIT ELECTRIC CO.
ESTABLISHED 1883
PHONE MAIN 7830
RADIO SUPPLIES
113 E. JEFFERSON AVE.
DETROIT, MICH.

Allen-Bradley Co.,
1918 Ford Building, Detroit, Mich

Gentlemen:—With reference to the Bradleystats, we wish to say that we have sold a great number of them. We have watched the Bradleystat with particular interest because we were one of the first to have a supply.

We have sold them to manufacturers who positively refuse to use any other rheostat. One of the talking points has been the length of time which the Allen-Bradley Company have manufactured rheostats. This has proved of enormous worth from a selling standpoint and we assure you that we are more than pleased with the results obtained.

We have not had any returned for any cause, and assure you that we will stock them continually.

Respectfully yours,
DETROIT ELECTRIC COMPANY



Retail Price
\$1.85

Get your quota of Bradleystat sales
by sending this coupon NOW!

Allen-Bradley Co., 487 Clinton St., Milwaukee, Wis.

We are interested in your sales plan for the Bradleystat. Please send prices and discounts.

CONDENSITE CELORON

Is recognized as the highest type of insulation for

RADIO PANELS

We are authorized distributors and can fill any order for standard panels or special sizes, plain or shielded.

Write for information.

BREMER-TULLY MANUFACTURING COMPANY

Canal and Harrison Sts.

Chicago

"CSE" SERVICE

has grown considerably—hence its removal to new quarters was necessary, so note carefully our new address—also the

"CSE Buyers Handbook of Radio"

is ready. Your request for it on your business letterhead will bring you 60 pages (Loose-Leaf) of the most interesting Radio Reading known. Incidentally its use by you will save you many dollars. Better ask for it now.

CENTRAL STATES ENGINEERING CO.

9 South Clinton Street

Chicago, Illinois

Hit it anywhere!

Magnetite Radio Crystal

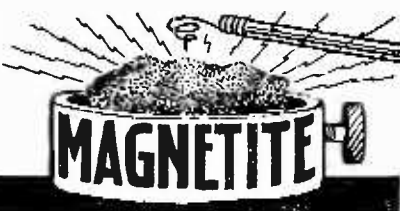

The most sensitive Crystal Detector on the WORLD market. Unaffected by handling or moisture and will render efficient service indefinitely—GUARANTEED—Display posters supplied to the Trade. Being advertised nationally—List 50 cents per Crystal.

JOBBER AND DEALERS WRITE IMMEDIATELY

GIBBONS-DUSTIN RADIO MFG. CO

Owners and National Distributors

518 West 9th St.

Los Angeles, Calif., U. S. A.

FINAL PERFECTION AND DOWN TO A PRICE "KING" SR., VARIOMETER

Qualifications:
All capacity loss eliminated by elimination of hardware

New attachment method of wires eliminates wires loosening.

Pigtail connection

Fahnestock Clips
for
Hook Up Connections

Size **\$1.60 Each**
4 3/4 x 4 3/4 x 3 Price to the Trade

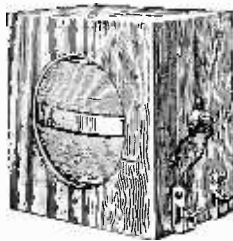

Advantages to Consumer.
A Price Within the Reach of All.

Rough usage and unprofessional handling cannot harm this variometer.

A guarantee slip packed with each variometer makes the manufacturers responsible direct to consumer.

Beautiful Natural Oak Finish.

The biggest sensational value of 1923. Smaller type "King Jr." Costs Less

THE AREMCOE MANUFACTURING COMPANY

Sales Office: 30 E. 23rd St.

Gramercy 1586

New York City

Beautiful Loud Speaker

Resembling in appearance the finest cabinet phonograph, the Whiteland radio loud speaker, made by the Whiteland Manufacturing Corp., of Washington Avenue, Long Island City, N. Y., has been put on the market to satisfy the demand for beautiful as well as efficient radio apparatus.

The Whiteland loud speaker is made in two styles. Model A is for direct connection to the receiving set and Model B is used with a magnetic amplifier operated from a local battery.

Both models have an adjustable series of wooden strips reflecting the sound waves and thus controlling the volume of sound. This device is similar to those used in the sound boxes on the most efficient phonographs.

RUSONITE

CRYSTAL RECTIFIER

MULTIPOINT (Patent Pending)

A SYNTHETIC CRYSTAL DETECTOR
Sensitive Over Entire Surface

GUARANTEED

Unequalled Clearness; Unequalled Volume; Unequalled Distance. The Standard Crystal Endorsed by Experts, Press and Trade

Manufacturers are increasing efficiency by equipping their Crystal sets with Rusonite Crystals.

List Price 50c.

RUSONITE CATWHISKER

(Patent Pending)

14 Karat Gold—Supersensitive

List Price 25c

Attractive Discounts to the Trade

RUSONITE PRODUCTS CORP.

Dept. D., 15 Park Row, New York, N. Y.

THE PARAMOUNT ENGRAVING MACHINE for Radio Panels

Greatest Production—Lowest in Price

PARAMOUNT MACHINE CO.

207 Market Street Newark, N. J.

JOHN A. COZZONE & CO.

61 Arlington Street, Newark, N. J.

VERNIER CONDENSERS

Kellogg-White Bill in House

The House of Representatives at Washington failed to pass upon the report on the Kellogg-White Bill, designed to regulate broadcasting, when it came before the house in committee on Tuesday, January 23rd.

This report on the bill, which was drawn up by the Committee on Merchant Marine and Fisheries, indicated that the Kellogg-White Bill was merely an amplification of the regulatory powers granted to the Government by the existing act, passed in 1912.

The Kellogg-White Bill, during the debate in the House of Representatives was attacked by two Democrats, Marvin Jones and Blanton of Texas, who argued that the bill would place too much control in the hands of the Secretary of Commerce. They admitted that they were generally opposed to the extension of federal control.

Representative Wallace N. White, Jr., of Maine, who drew up the bill, defended it on the grounds of expediency, stating that there were at present only 191 wave lengths, and 122 of these were used by 279 government stations, leaving but 69 wave lengths for use by private stations. When the presence in the United States of between one and a half to two and a half million private radio sets is considered, he argued, the need for some regulation resulting in organized and non-interfering broadcasting was obvious.

"TRIUMPH" COMBINATION COUPLER-METER



The "Two-in-One" Instrument

The "Triumph" Combination Coupler and Vario-meter fills the urgent need for a simple and efficient instrument to serve the purpose of both Coupler and Meter. We have solved the Problem. Our Coupler Meter is simple and efficient. There are no taps, no soldering and no complications. List Price, \$6.50 with Dial.



We are headquarters for Phone, Grid and Grid Leak Condensers. Price and quality are right. Free sample upon request.

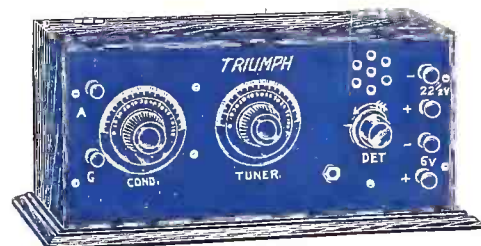

"TRIUMPH" A1 V. T. Receiving Set
List Price \$30.00
Embodies the Triumph Coupler-Meter
So simple that a child can operate it
Triumph 2 Stage Unit \$35
Best Value in the Radio Market To-day

Samples will be sent on memorandum to any rated concern upon request

SIGNAL RADIO & ELECTRIC CORP. 64 UNIVERSITY PL. NEW YORK CITY

EMPIRE OILED TUBING *sometimes called spaghetti*

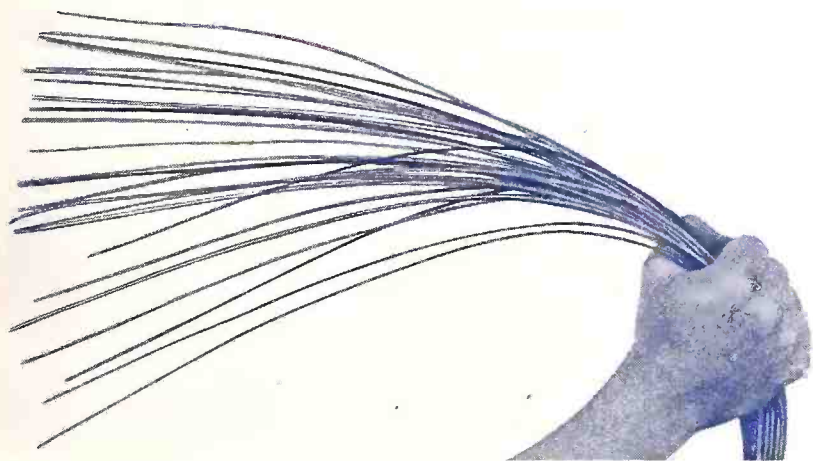

EMPIRE PERFECT INSULATOR
Empire Tubing builds solid business for Radio Dealers. It brings both amateur and professional back for more, because the purchaser and his friends like its superior flexibility, durability, smoothness, high dielectric strength and insulating value. Empire Tubing is a standard product among engineers throughout the electrical industry. Made in black and white, yellow and other colors, in all radio sizes, 36 inch lengths.

Send today for Empire Tubing samples and quotations on 500, 1,000, 5,000, 10,000, 20,000 foot lots. Get acquainted with our other time tested radio insulation products

MICA INSULATOR COMPANY

68 Church Street, New York. 542 So. Dearborn Street, Chicago. Works: Schenectady, N. Y.
Agencies—The Monroe Brass & Wire Co., Cincinnati; G. Arthur Morrell, Cleveland; Electrical Specialty Co., San Francisco and Los Angeles

2022-F

“ I do the very best I know how, the best I can, and I will keep doing so until the end.”—Lincoln



WHETHER rendering service to a nation or to an individual, the fundamental principles are alike. In simple words of one syllable, Abe Lincoln has aptly expressed the thought of SERVICE.

However hard we have labored to achieve our reputation for service, we are working harder than ever to hold and enhance it.

And our reward for good service, plus right prices, plus quality merchandise is a dealer confidence that we are proud to acknowledge.

We carry ample stocks of
ACME
BRANDES
MURDOCK
CLAPP-EASTHAM
WESTERN ELECTRIC
RADIO CORPORATION
and many
other makes

RADIO DISTRIBUTING COMPANY
8 West Park Street Newark, N. J.
A. H. CORWIN, General Manager

RADISCO