

ELECTRONIC INDUSTRIES

THE STATE-OF-THE-ART MAGAZINE

44 ft. Space
Communications Antenna

B54
21
B-6
83

F. W. Preziosi Grp Hd
2921 Soutter Ave SE
Cedar Rapids Iowa
126500 Collins Radio

13th ANNUAL
MICROWAVE
ISSUE

NOVEMBER 1965



Chilton Company



TOMORROW'S PRODUCTS TODAY...

**TRANSFORMERS
INDUCTORS
TOROIDS
ELECTRIC WAVE FILTERS
HIGH Q COILS
MAGNETIC AMPLIFIERS
SATURABLE REACTORS
REFERENCE UNITS
PULSE TRANSFORMERS**

Design and application engineers with unique requirements have utilized UTC's advanced research and design capabilities for over 30 years. These engineering services are supported by the most complete manufacturing facilities for military and commercial production. Both stock and special custom built iron core components are available in long and short run quantities.

SUBMINIATURE AUDIO TRANSFORMER

Plug-in and weldable transistor type audio transformer hermetically sealed to MIL-T-27A, Grade 4, Class R, Life X. Leads spaced on .1 radius circle to conform to "TO-5" cased semiconductors and micrologic elements. Primary impedance: 10K CT ohms; secondary impedance 2K CT ohms. Size: 5/16 dia. x 3/8" h; weight: 1/15 oz.



ACTUAL
SIZE

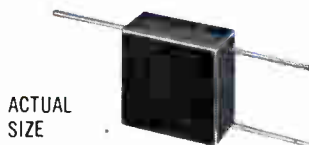

ACTUAL
SIZE

SUBMINIATURE MOLDED AUTOTRANSFORMER

Specially designed for application where space requirements were limited to a slot less than 1/4" high. Molded unit with straight pin terminals. Designed to MIL-T-27A for 6400 cycles, 250 ohms to 1K ohms. Size: 17/32" square x 7/32" tall; weight: 0.1 oz.



ACTUAL
SIZE

SUBMINIATURE PULSE TRANSFORMER

Unique subminiature PIP construction to MIL-T-21038 type TP6SX4410CZ with weldable and solderable gold plated Dumet leads. Used for transistor blocking oscillator applications. Pulse width .05 μsec, 3 windings. Size: 5/16 dia x 3/16" h; weight: 1/20 oz.

CHOPPER TRANSFORMER



Has magnetic plus electrostatic shielding. Electrostatically shielded for voltage isolation of 2 x 10⁵. Shielded cable leads. Frequency range 60 cycles to 500 cycles. Primary impedance 200K ohms CT to within .1%. Secondary impedance 50K ohms.



BAND PASS FILTER

Designed to MIL-F-18327A in a flat construction for use in printed circuits. Unit has a source and load impedance of 600 ohms. Attenuation ratings are: 100 cycles to 3 KC, ± 0.5 db; 60 cycles and 4 KC, 3 db; 4800 cycles more than 30 db. Size: 4 x 4 x 7/8" h.



THREE PHASE HIGH VOLTAGE POWER TRANSFORMER

Primary jumper hardware for easy conversion from delta to wye inputs. Made to MIL-T-27A specifications. Primary: 440 V 60 cycles delta or wye 3 phase input. Secondary: 2100 V line to line or 1215 V line to line @ 242 ma. Full load voltage ± 2% maximum regulation 5%. Electrostatically shielded to give 20:1 ratio per MIL-T-27A test @ 20 KC. Maximum ambient 70°C, temperature rise 35°C. Size: 10 x 10 x 6"; weight: 66 lbs.

...THROUGH ADVANCED RESEARCH & DESIGN

Write for catalog of over 1,300 STOCK ITEMS with UTC High Reliability IMMEDIATELY AVAILABLE from your local distributor.



UNITED TRANSFORMER CORP.

150 VARICK STREET, NEW YORK 13, N. Y.

PACIFIC MFG. DIVISION: 3630 EASTHAM DRIVE, CULVER CITY, CALIF.
EXPORT DIVISION: 13 EAST 40th STREET, NEW YORK 16, N. Y. CABLES: "ARLAB"

Circle 116 on Inquiry Card

ELECTRONIC INDUSTRIES

The State-of-the-Art Magazine

3-G Computers

Dear Reader:

It seems like only yesterday that "second generation" computers were the talk of the industry. But here we are today well into the "third generation" types. These "3-G" computers have much more to offer than their predecessors. And that brings us to next month's issue of E.I.—which will feature computers and related equipment.

State-of-the-art reports on 3-G computers, modern memory devices, optical character recognition, display equipment and one of the "hottest" subjects—time-sharing—will supply answers to many oft asked questions. The impact that these techniques and equipment have had, and will have, on the industry is emphasized.

Recent trends toward multiprogramming and integrated circuits will be discussed. Thin-film, cryogenic, semiconductor and other memory devices will be reviewed with respect to their application to present and future memories. How time-sharing will benefit the user, and how it operates, are covered.

Optical character recognition, while commercially available for almost 10 years, has yet to enjoy widespread use. But recent developments may change this. These new trends are outlined and their significance discussed.

Then, there is the question of computer software—those programs that make computers "tick." Can they be protected by patent? By copyright? One of the articles next month covers the basic legal approaches for protecting rights in software. As the importance of computer software is constantly increasing—investment in this area having now passed the billion dollar mark—this article is particularly timely.

We believe you will find the December issue both interesting and stimulating. We shall be glad to provide you with extra sets of tearsheets for those articles in which you have a special interest.

*Sincerely,
The Editors*

1965-1966 EDITORIAL FEATURES

- DECEMBER**
- Switches, Part 1, Specification Chart
 - Memory Devices for Modern Computers
 - Some Thoughts on Time-Sharing
 - Annual Index of Articles
-

- JANUARY**
- 1966 Review & Forecast for the Electronic Industries
 - Potentiometers, Part 3, Specification Chart—Trimmers
-

- FEBRUARY**
- Switches, Part 2—Push-button
 - The Expanding Role of SCR's
-

- MARCH**
- 1966 IEEE Show Coverage
 - Potentiometers — General purpose
-

- APRIL**
- Special Purpose Tubes, Part I
 - Switches—Rotary & Stepping
-

- MAY**
- Switches—Slide & Snap Action
 - Special Purpose Tubes, Part II
-

Expanding Microwave Markets

THE MICROWAVE INDUSTRY is on the threshold of an evolution in technology, applications and markets! The past two years have been difficult for manufacturers, but now, things are looking up. Statements from industry authorities, starting on page 72 in this, our 13th Annual Microwave issue, promise an exciting future.

New government contracts are stimulating the industry's business. Several contracts for Nike-X systems have recently been awarded to Western Electric. This major anti-missile system is providing many sub-contracts which include development of phased antenna arrays and related equipments. In addition, our aerospace program has produced contracts for satellite microwave communications systems. Most promising is a dual communications and tracking system utilizing S-band microwaves.

In commercial communications, a forerunner of things to come is the aptly-named Early Bird Satellite system sponsored by COMSAT. It promises the expansion of the electromagnetic spectrum from 5 to 30GHz,—five times the present bandwidth.

Microwaves are steadily moving into industrial areas. More devices are being used for electronic cooking and baking. Precision controlled heating and drying of materials is another promising industrial application.

International markets are being expanded on two different fronts. Microwave systems, for example, are helping many underdeveloped nations to build up their telecommunications almost overnight. Moreover, many developed countries in Western Europe are refining their telecommunications and color-TV systems through the use of microwave communications.

As new microwave devices are developed, associated test and measuring apparatus must also become more sophisticated. Greater stability, higher accuracy and broader bandwidths are among requirements being placed on new instruments. The emphasis is on swept-frequency measuring equipment and designs that provide continuous display of wideband response. Spectrum analyzers and spectrometers also are in increasing demand.

Technologically, the biggest inroads on electron tubes are being made by the new solid-state microwave devices in the low power ranges. (See solid-state devices chart starting on page 77 in this issue.) These units cost less, weigh less, are smaller and are more reliable. And these devices can perform some operational functions that previously could not be done with tubes.

Obtaining substantial power from solid-state devices at microwave frequencies continues to be a problem, but there have been improvements. Recently CW powers up to 5 watts at S-band and 1 watt at X-band have been demonstrated. It has been estimated that these powers will easily be doubled within the next two years. Also, there will be many solid-state integrated circuits which will combine two or more functions in each "building block."

Even radar systems are undergoing an evolution. A most significant development is the portable, electronically-scanned radar. Soon there should be solid-state microwave radars that will incorporate no tubes, except in the display devices.

The recent past has been a trying period for microwave manufacturers but the future now looks much more promising for this important segment of our industry.

Bernard F. Obahn

Now from Sprague!



POWERLYTIC® CAPACITORS IN 42 CASE SIZES...

for maximum capacitance in minimum space!

Type 36D Cylindrical Case

Designed specifically for space economy, in applications such as computer power supplies, industrial controls, high gain amplifiers, etc. Case sizes from $1\frac{3}{8}$ " x $2\frac{1}{8}$ " to 3" x $5\frac{3}{8}$ ". Improved temperature capabilities—may now be operated at 85 C. Low equivalent series resistance, low leakage current, excellent shelf life, high ripple current capability. Superior seal employs molded cover with recessed rubber gasket. Reliable safety vents. Solder lug or tapped terminals. Standard ratings from 3 to 450 VDC, capacitance values to 270,000 μ F.

Type 39D Tubular Case

Smaller companion to proven 36D capacitor, possessing same outstanding performance. Case sizes from $\frac{1}{2}$ " x $1\frac{1}{8}$ " to 1" x $3\frac{3}{8}$ ". Designed for operation at temperatures up to 85 C. Unique construction—anode and cathode terminals are welded—no riveted or pressure connections—prevents open circuits, even in microvolt signal range. Improved molded phenolic end seals contribute to unusually long life (expectancy, 10 years or more). Low effective series resistance, low leakage current. Standard ratings include capacitance values to 18,000 μ F, voltages from 3 to 450 VDC.

For complete technical data on Type 36D or Type 39D Powerlytic Capacitors, write for Engineering Bulletins 3431B and 3415, respectively, to Technical Literature Service, Sprague Electric Co., 233 Marshall Street, North Adams, Mass. 01248.

Popular ratings are now available for fast delivery from your Sprague Industrial Distributor.

SPRAGUE COMPONENTS

CAPACITORS
TRANSISTORS
RESISTORS
INTEGRATED CIRCUITS
THIN-FILM MICROCIRCUITS
45C-5131

PULSE TRANSFORMERS
INTERFERENCE FILTERS
PULSE-FORMING NETWORKS
TOROIDAL INDUCTORS
ELECTRIC WAVE FILTERS

CERAMIC-BASE PRINTED NETWORKS
PACKAGED COMPONENT ASSEMBLIES
BOBBIN and TAPE WOUND MAGNETIC CORES
SILICON RECTIFIER GATE CONTROLS
FUNCTIONAL DIGITAL CIRCUITS



'Sprague' and '®' are registered trademarks of the Sprague Electric Co.

Editorial: Expanding Microwave Markets 1

STATE-OF-THE-ART FEATURES

A Practical Component Packaging System W. A. Koenig 46
Microwaves—Past, Present & Future 72
1965 Survey of Microwave Semiconductors 75

DESIGN/DEVELOPMENT

Understanding Plasma Diodes and Amplifiers L. Zelby 64
Design Technique for Wideband Microwave Links J. E. Cole 58
1965 Survey of Potentiometer Specifications
Part II: Special Purpose Potentiometers 90

MEASUREMENT/TEST

Photoconductive Detectors for Infrared Measurements G. F. Giggey 118

PROFESSIONAL OPPORTUNITIES

Market for Microwave Components Turns Upward S. Feldman 132

WHAT'S NEW

New Coaxial Switch Concept 35 Close Support for Troops 138
Self-Renewing Contacts on New Mercury Relay 35

DEPARTMENTS

Highlights	4	New Tech Data	100
Radarscope	8	International News	112
Coming Events	14	Microelectronic Developments	114
Washington Trends	18	Measurement & Test	117
Electronic Snapshots	22	Editor's Notebook	124
Marketing: Fact & Figure Round-up	26	Books	125
Letters	30	Professional Guidelines	131
New Products (in Color)	38	New Products	140

COVER: Transmitting and receiving system at the Fucino, Italy earth station was designed, manufactured and installed by Societa Generale di Telefonica ed Elettronica S.p.a. of Milan, Italian subsidiary of General Telephone & Electronics Corp. Smaller dishes connect the station with Rome and European communications networks.

*STATE-OF-THE-ART: up-to-the-moment capability in each area of electronic technology





Microwave Component Market



Microwave Semiconductors

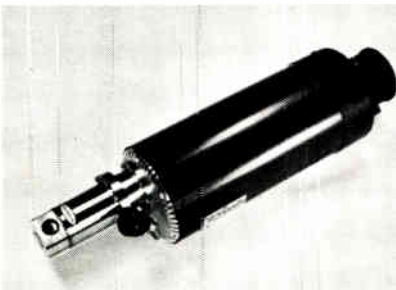

Photoconductive Detectors

Special Purpose Potentiometers

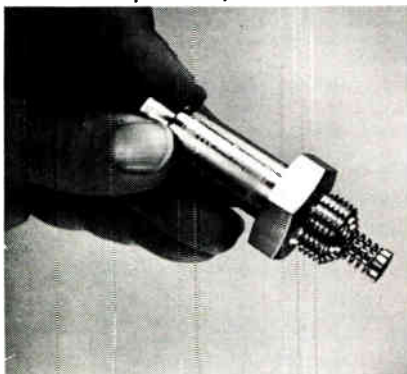
**A PRACTICAL COMPONENT PACKAGING SYSTEM 46**

The packaging system described provides for the compatible use of integrated circuits, thin film circuits, and conventional components in spaceborne digital command and data handling equipment. Design of this system allows for the incorporation of new component types without obsoleting the system.

MICROWAVES—PAST, PRESENT & FUTURE 72

Statements are presented concerning various aspects of microwave technological developments as viewed by some of the key leaders in the industry. The purpose is primarily to acquaint engineers with advances in technological areas outside their particular specialties. Trends revealed point the direction to new devices, equipment and systems made possible by the advancing state-of-the-art.

UNDERSTANDING PLASMA DIODES AND AMPLIFIERS 64

Plasma devices are gaining in popularity as a result of improvements in technology and better understanding of gaseous discharges. Two new devices, representing two diverse uses of gaseous plasmas, are described and the principles of their operation are discussed.

DESIGN TECHNIQUE FOR WIDEBAND MICROWAVE LINKS 58

Newer design aspects of FM equipment intended for conventional point-to-point work are discussed in detail. Methods of calculating and thence overcoming this noise are given. Finally a complete 1,800 channel two-way repeater system is described.

1965 SURVEY OF MICROWAVE SEMICONDUCTORS 75

Listing the technical specifications for Snap-off Varactors, Varactor Tuning Diodes, Varactor Harmonic Generators, Silicon Varactor Diodes—General Purpose, Limiter Varactors, High Power Varactors, Gallium Arsenide Varactors, Parametric Amplifier Varactors, Amplifier & Oscillating Transistors, Switching Diodes, Pin Diodes, Gallium Arsenide Tunnel Diodes, Gallium Antimonide Tunnel Diodes, Germanium Tunnel Diodes.

**PHOTOCONDUCTIVE DETECTORS
FOR INFRARED MEASUREMENTS 118**

Small changes in temperature, often encountered in electronic equipment, can be measured using currently available fast detectors. New cryogenic cooling methods make this method practical.

**MARKET FOR MICROWAVE
COMPONENTS TURNS UPWARD 132**

Microwave market mix continues to shift in emphasis. Events of recent years reduce firms through shake-out, merger or acquisition. Survivors expect bigger market portions because there will be fewer competitors. Biggest market area is still defense radar.

1965 SURVEY OF POTENTIOMETER SPECIFICATIONS 90

Part II of this series presents Special Purpose Potentiometers

• A REPRINT of ANY ARTICLE in this issue is available from ELECTRONIC INDUSTRIES Reader Service Department, 56th & Chestnut Streets, Philadelphia, Pa. 19139

Did you know Sprague makes...?

UNICIRCUIT® RCTL INTEGRATED CIRCUITS

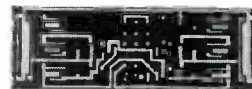

(8x actual size)

Sprague Series US-0100 . . . a complete line of monolithic digital building blocks featuring low power consumption (2 mW typ.)

Circle 2 on Inquiry Card

UNICIRCUIT® RTL INTEGRATED CIRCUITS



TO-5 CASE

Types US-0708 through US-0721 . . . Fully interchangeable mW digital building blocks featuring power consumption of 4 mW/node and propagation delay of 40 nanoseconds.

Circle 3 on Inquiry Card

DIFFERENTIAL AMPLIFIER TRANSISTOR PAIRS

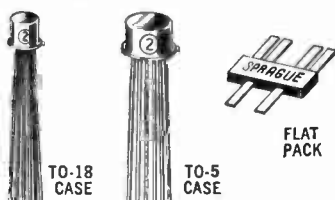

NPN or PNP • Matched characteristics.
 $h_{FE} = 10-20\%$. $\Delta V_{BE} = 5-20$ mV.
 $\Delta V_{BE}/Temp = 5-20$ $\mu V/^\circ C$.

Circle 4 on Inquiry Card

MULTIPLE TRANSISTORS (NPN-PNP PAIRS/QUADS)

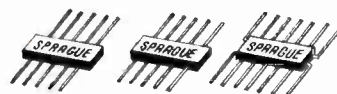

AMPLIFIERS SWITCHES CHOPPERS

Pairs		Quads	
2 NPN		4 NPN	
2 PNP		4 PNP	
1 NPN—1 PNP		2 NPN—2 PNP	

Circle 5 on Inquiry Card

UNICIRCUIT® CUSTOM HYBRID CIRCUITS

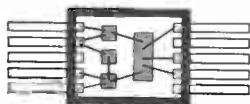

Combine monolithic silicon circuits with Ni-Cr alloy resistors. Close resistance tolerances, low temperature coefficient, $\pm 2\%$ resistor matching.

Circle 6 on Inquiry Card

LOW-COST HERMETICALLY- SEALED PLANAR TRANSISTORS

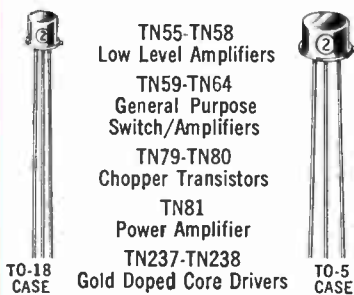

TO-18 CASE TO-5 CASE

TN55-TN58
Low Level Amplifiers
 TN59-TN64
General Purpose
Switch/Amplifiers
 TN79-TN80
Chopper Transistors
 TN81
Power Amplifier
 TN237-TN238
Gold Doped Core Drivers

Circle 7 on Inquiry Card

SILICON ALLOY REPLACEMENT TRANSISTORS

FULL PLANAR RELIABILITY

2N327A	2N945	2N1026
2N328A	2N946	2N1469
2N329A	2N1025	2N1917

Sprague makes 82 standard high-emitter-voltage full planar silicon alloy replacement types.

Circle 8 on Inquiry Card

DUET® HIGH-VOLTAGE DUAL-EMITTER TRANSISTORS

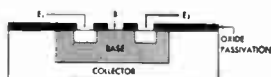

New Type 3N123 low-cost transistor with 25-volt rating now available.

Sprague makes more dual-emitter chopper transistors than any other source.

★Trademark

Circle 9 on Inquiry Card

TWIN DUET® DUAL-EMITTER TRANSISTORS IN FLAT PACKS

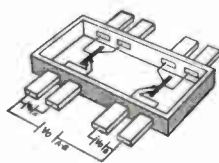

Sprague leads again with two dual-emitter chopper transistors in one flat-pack case, with tight V_{OFF} matching of both devices.

★Trademark

Circle 10 on Inquiry Card

For complete technical data on any of these products, write to Technical Literature Service, Sprague Electric Company, 233 Marshall Street, North Adams, Massachusetts 01248.

ASS-5152

SPRAGUE®

THE MARK OF RELIABILITY

®Sprague and ® are registered trademarks of the Sprague Electric Co.

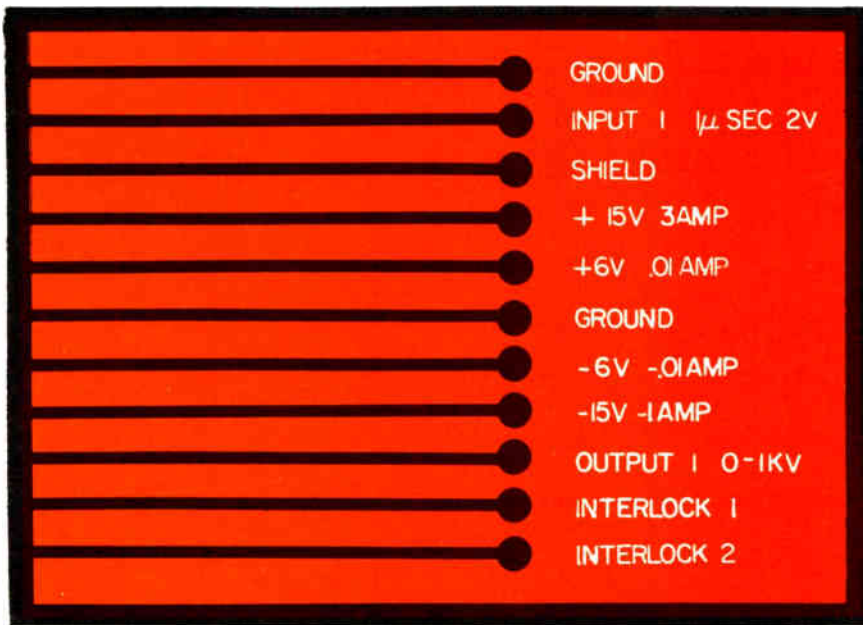

3:1 REDUCTION . . . a bonus factor of reliability! Most aci systems drastically reduce modular interfaces by, at least, 3:1, and many achieve an even greater reduction. aci engineers systems for you . . . to meet your requirements . . . with unique innovations for today's demanding and sophisticated wiring packages.

. . . new connective dimensions



DIVISION OF KENT CORPORATION
 206 Center, Princeton, N.J. 08540

Send for descriptive
 brochure—Bulletin E-5.



No soldering, crimping, welding
 or assembling . . . just plug
 into aci system. Exploded view
 shows aci's functional use of the
 conductor itself as contact
 (reducing modular interfaces 4:1)
 in a p.c. board application.



SHELBY A. McMILLION,
 Publisher

BERNARD F. OSBAHR,
 Editor

CREIGHTON M. MARCOTT
 Executive Editor

JOHN E. HICKEY, Jr.
 Managing Editor

SMEOLEY B. RUTH
 SIDNEY FELDMAN
 Associate Editors

JOHN J. HUNTER
 ROBERT J. BRAMLETT
 Assistant Editors

DR. ALBERT F. MURRAY
 Consulting Editor

ELMER KETTERER, Art Director
 ANNE AXE, Editorial Assistant
 ANN LAVENDER, Research Assistant
 MAE MOYER, Reader Service
 IDA GOOD, Editorial Secy.

EDITORS-AT-LARGE

Eastern Region

ELMER T. EBERSOL,
 100 East 42nd St.
 New York 17, N. Y.
 (Area Code 212) OXford 7-3400

Western Region

I. PHILIP GEDDES,
 1543 W. Olympic Blvd.
 Los Angeles, Calif.
 (Area Code 213) DUnkirk 7-1271

Defense/Space

CHARLES R. WILHIDE,
 4400 Brookside Drive
 Alexandria, Va.

WASHINGTON NEWS BUREAU

1093 National Press Bldg.
 (Area Code 202) 393-3474
 TWX—710-822-9509

GEORGE BAKER, Mgr.
 NEIL R. REGEIMBAL

BUSINESS DEPARTMENT

ELMER DALTON
 Advertising Promotion
 & Circulation Manager

EDWARD G. SHAUD, Jr.
 Marketing Manager

ARA H. ELOIAN
 Production Manager

See Advertisers Index on page 167 for
 Regional Sales Managers.

Chilton Company Officers: G. C. BUZBY,
 Chairman of the Board; R. E. McKENNA,
 President. Executive Vice President: G. T.
 Hook. Vice Presidents: P. M. Fahrendorf,
 L. V. Rowlands, M. E. Cox, E. B. Terhune,
 Jr., R. W. Case, Jr., J. H. Kofron. Treasurer:
 Stanley Appleby. Secretary: J. A.
 Montgomery. Other Directors: C. A. S.
 Heinle, T. C. Campbell, H. W. Barclay,
 W. A. Phair, L. F. King, C. W. Hevner.
 Assistant Treasurer: J. Miades. Assistant
 Secretary: I. C. Holloway.

JOHN H. KOFRON
 Chilton Research Director

ELECTRONIC INDUSTRIES, December,
 1965. Vol. 24, No. 12. A monthly publica-
 tion of Chilton Company. Executive, Editor-
 ial & Advertising offices at Chestnut &
 56th Sts., Phila., Pa. 19139. (Area Code
 215) Sherwood 8-2000. Controlled circula-
 tion postage paid at Philadelphia, Pa. \$1
 a copy; Reference issue (June), \$5.00 a
 copy. Subscription rates U. S. and U. S.
 Possessions: 1 yr. \$10.00; 2 yrs. \$18.00.
 Canada 1 year \$12.00; 2 yrs. \$20.00. All
 other countries 1 yr. \$18.00; 2 yrs.
 \$30.00. Title Reg. U. S. Pat. Off. Repro-
 duction or reprinting prohibited except by
 written authorization.

© Chilton Company 1965

The most advanced oscillograph is now available with the DataDigit^{T.M.} Character Generator

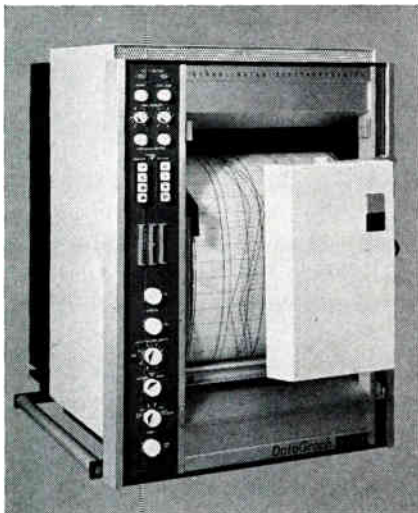

5-133 - BENCHMOUNT CONFIGURATION

CEC's 5-133 DATAGRAPH® has long been accepted as the world's finest recording oscillograph for those applications where no compromise is acceptable.

However, the state-of-the-art is constantly changing. As a result, a companion instrument has been perfected which gives the 5-133 an additional capability undreamed of a short while ago. And that is . . .

DataDigit—the new Datagraph Accessory

When used with the 5-133 or any CEC oscillograph, the new DataDigit Accessory literally provides a new dimension in data recording. Speed, accuracy and flexibility that were previously unattainable can now be realized even at moderate and slow paper speeds.

The DataDigit is virtually a quantum jump in recording technique, combining the features of the fastest digital printer and an analog light beam oscillograph in *one* instrument. And, being a completely

self-contained accessory, this instrument can be used with existing oscillographs *without modification*.

Fundamentally, this accessory generates the necessary waveforms to print decimal data on standard photographic papers. Up to 26 columns can be printed at speeds to 1600 lines-per-second. So economical is this instrument, it soon pays for itself in paper savings alone.

Compared to the best previous methods, recording capabilities with DataDigit become impressive indeed.

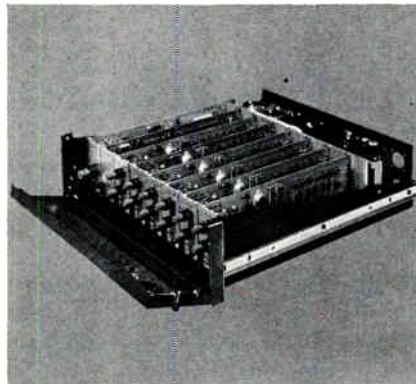

DATADIGITTM CHARACTER GENERATOR

Specifications:

Print-Out — 0 thru 9 • **Input Data Format** — 10 line decimal • **Input Voltages** — Select command + 5 v min. to + 70 v max. • **Input Impedance**—Select command signal 20 k ohm resistive min. • **Print Command** — rise time 1 μ sec; duration 2 μ sec min. — 400 μ sec max.; voltage + 5 v min. to 25 v max.; input impedance 550 pf • **Power Requirements** — voltage 90 — 135 v or 180 — 270 v; frequency 48 — 420 cps; wattage 120 max. • **Physical Characteristics** — 5¼" H x 19¾" D x 19" W. Mounts in standard EIA rack, slide rackmount available.

	Conventional	DataDigit
Accuracy	1.5% to 2%	0.01% or better with digital techniques
Frequency Limit	15 kc	1 mc with digital techniques
Channel Separation	Visual	Digital identification
Channel Capability	52	Unlimited
Timing	Paper speed	Digital clock
Data	Continuous	Continuous or multiplexed

Other important accessories:

The Remote Control Unit operates the 5-133 from distances up to 1000 feet. Complete remote *control* of all electrical functions is possible — including all *speed selection*, power ON/OFF and recording lamp ON/OFF.

The Latensification Lamp Assembly uses four 8-watt cool white fluorescent lamps to latensify slow-speed recordings. A readable record is immediately available when recorded at low speeds up to 4 ips.

The Ambient Light Shield permits recording with no latensification, allowing the record to be chemically processed for maximum contrast needed for oscillograms of archival quality.

For complete information on DataDigit, plus the 5-133 and its other accessories, call your CEC Sales and Service Office, or write for CEC Bulletins 5133-X9 and 30100-X4.

CEC

Data Recorders Division

CONSOLIDATED ELECTRODYNAMICS

A SUBSIDIARY OF BELL & HOWELL/PASADENA, CALIF. 91109
INTERNATIONAL SUBSIDIARIES: WOKING, SURREY, ENGLAND
AND FRIEDBERG (HESSSEN), W. GERMANY

Developments and trends affecting the State-of-the-Art of technologies throughout the electronic industries



SPACE ANTENNA

Engineer Edgar R. Bourke examines inflatable antenna developed by Raytheon Company for use in space programs. Antenna is carried aloft in collapsed form only 2 ft. in size. In use it is inflated to 8 ft. inside and 10 ft. outside diameters. Weight of this prototype C-Band Cassegrain model is less than 8 pounds.

COLOR TV DEMAND is exceeding the industry supply according to RCA. It is estimated that by Christmas the demand will exceed the industry supply by about 350,000 sets. The sale of color TVs is expected to be at least 2.5 million for 1965. Last year's sales were 1.3 million.

MASER has been operated by Westinghouse Aerospace Div. without the usual dc magnetic field about the crystal. Aluminum nitrate was used as the active material. The aluminum nitrate was used in single crystal, polycrystalline, and powder forms. Experiments showed a power gain of 25 db. The experimental maser operated at 9.35 GHz. Not using the magnetic field reduces the maser's size.

PARAFFIN WAX is being used by Sperry Rand for producing modules. In assembling cordwood welded modules the parts are temporarily encapsulated prior to welding. After welding, the paraffin is melted for removal and a permanent encapsulant used. Using the paraffin and pre-cutting parts leads has reduced packaging costs about 40%.

COSMIC NOISE is being used by ITT for measuring the noise figure of DEW Line ionospheric scatter propagation receivers. Every day the antenna patterns of the northernmost communication stations sweep through the center of the galactic plane. Knowing the noise level in the 40 MHz band, an estimate of the receiver noise figure was made to detect deterioration. In the Arctic, a cosmic noise measured by a 40 MHz receiver in a 600 Hz band has a median value of 0.04 microvolt into a 50 ohm impedance.

SHARPENING THE MEMORY of a spacecraft attitude control system for NASA is the object of a study being made by Douglas Aircraft. The study is to find ways of improving operation of the attitude system so that it will learn from its past performance in the changing environment of space. The concept is based on electronic intelligence methods and seeks to develop a system which not only adapts to changes, but also learns from them.

CONTINUOUS SOLID STATE LASER beam operating at a power level in excess of 40 watts has been achieved by Union Carbide's Linde Div. The laser crystal used is a neodymium-doped yttrium aluminum garnet (YAG). The CW laser wavelength was 1.06 microns.

A DIGITAL COMPUTER is being used by scientists at The Jet Propulsion Laboratory to help refine and improve the photographs of Mars relayed by the Mariner IV spacecraft. A Digital Equipment Corp. PDP-7 computer is reworking the transmissions in a variety of ways. For example, values of the 40,000 dots that make up each photo are juggled so that contrasts will stand out more clearly.

PRODUCTION DESIGN STUDIES for an all-weather landing system for the 158-ton C-141 StarLifter aircraft have been completed by engineers of the Lockheed-Georgia Co. Sponsored by the Air Force and Federal Aviation Agency, the studies were aimed at enabling the StarLifter to land at zero-ceiling and zero-visibility. Current FAA regulations require a pilot to have ½-mile visibility and 200-ft. ceiling to continue an approach for a landing. Studies are for a system for ¼-mile visibility and 100-ft. ceiling. Lockheed's design uses, within the landing system, a device called a "vertical navigational computer." This would assist the pilot during periods of low visibility at airfields which aren't equipped with electronic aids. A feature of the proposed system is a provision for manual back-up of the automatic system. Current systems don't coordinate manual back-up with automatic operations.

AMPLIFICATION as well as variable delay of microwave signals by a miniature device is closer to reality due to work done by physicists at Sperry Rand Corp. Company physicists recently demonstrated net gain amplification of delayed signals in an experimental C-band solid state delay line operated at room temperature. Net gain of 15 db as high as C-band was generated.

SMALL COMPUTER is used to monitor information from aircraft controls. This is in a system being made by Elliott Brothers Ltd. of London, England. Data is then projected, in the form of symbols, onto a reflection glass, focused at infinity, in the pilot's line of vision. Thus, "suspended" in space in front of him, it allows him to keep his head up while reading it. The "Head Up" unit relieves the pilot of some of the stress of watching complex instrumentation systems.

SONAR SYSTEM developed by the Pacific Division of The Bendix Corp. is to be used by the state of Alaska to solve one of its chief problems—that of counting salmon as they swim upstream to spawn. The salmon industry contributed \$86 million to the state's economy in 1964. So it can be seen why proper regulation is important. The system can operate unattended. It was designed on the idea that the air bladder of a salmon is a good target for a sonar beam.

SPEEDS PRODUCTION

New technique developed by Sylvania speeds production of printed circuit cards. Technique combines a standard welding process and precise, microscopic pre-positioning of components. Here, a tiny component is positioned on an adhesive card. Components are then welded to form a "virtually indestructible" circuit card.

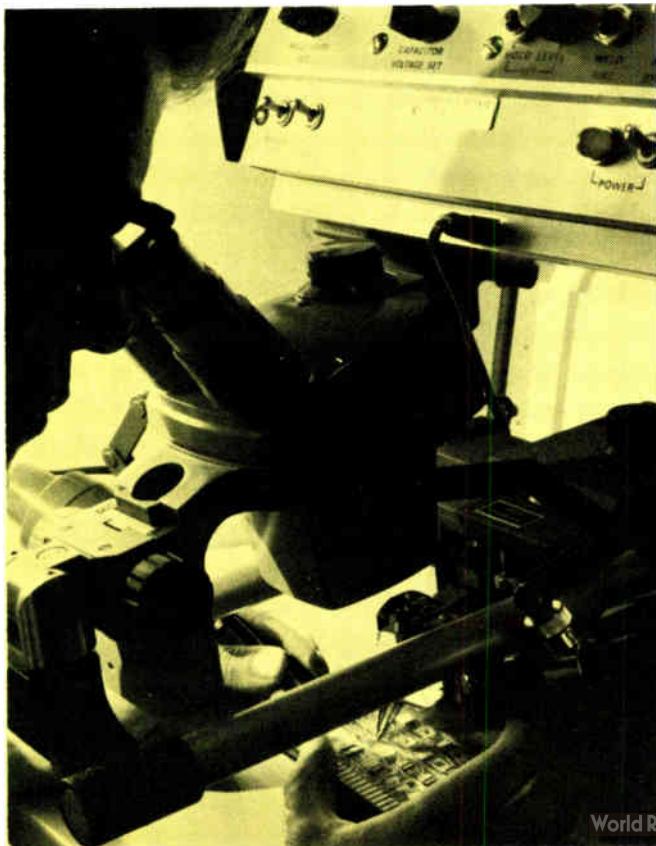

PROBE DETECTS FAULTS

Intermittent faults in almost any kind of equipment, from microcircuits to the tubes shown here in this oscilloscope, can be detected by this new RF probe built by Honeywell, Inc. Engineer Patrick O. Harvey taps the tubes with a rod and listens to the signals transmitted to his earphones from the pick-up in his right hand.

MICROELECTRONIC WELDING is being done with a laser. An automatic system for laser welding of integrated circuit modules uses a tape-controlled micropositioner developed by Arvin Systems, Inc. This is mated with a Westinghouse laser welder. The connection is automatically positioned and the laser beam is triggered. The developmental laser at Westinghouse Defense and Space Center in Baltimore now makes welds at a rate of 20 per minute. Work is being done to increase the firing rate.

CONTINUED RESEARCH on a new method which converts dozens of laser light frequencies into a narrow single frequency beam capable of transmitting signals more clearly than any existing method is the object of an Air Force contract awarded to Sylvania. The method, known as the "super-mode laser" was developed by Sylvania. It preserves and exploits all of the original power.

IC CORE MEMORY series with an operating speed of 1 microsecond full cycle and access time of less than 500 nsec. has been developed by Computer Control Co. The coincident current, random access core memory is 5¼ inches high. It permits word capacities to 16,384 and fits into a standard relay rack.

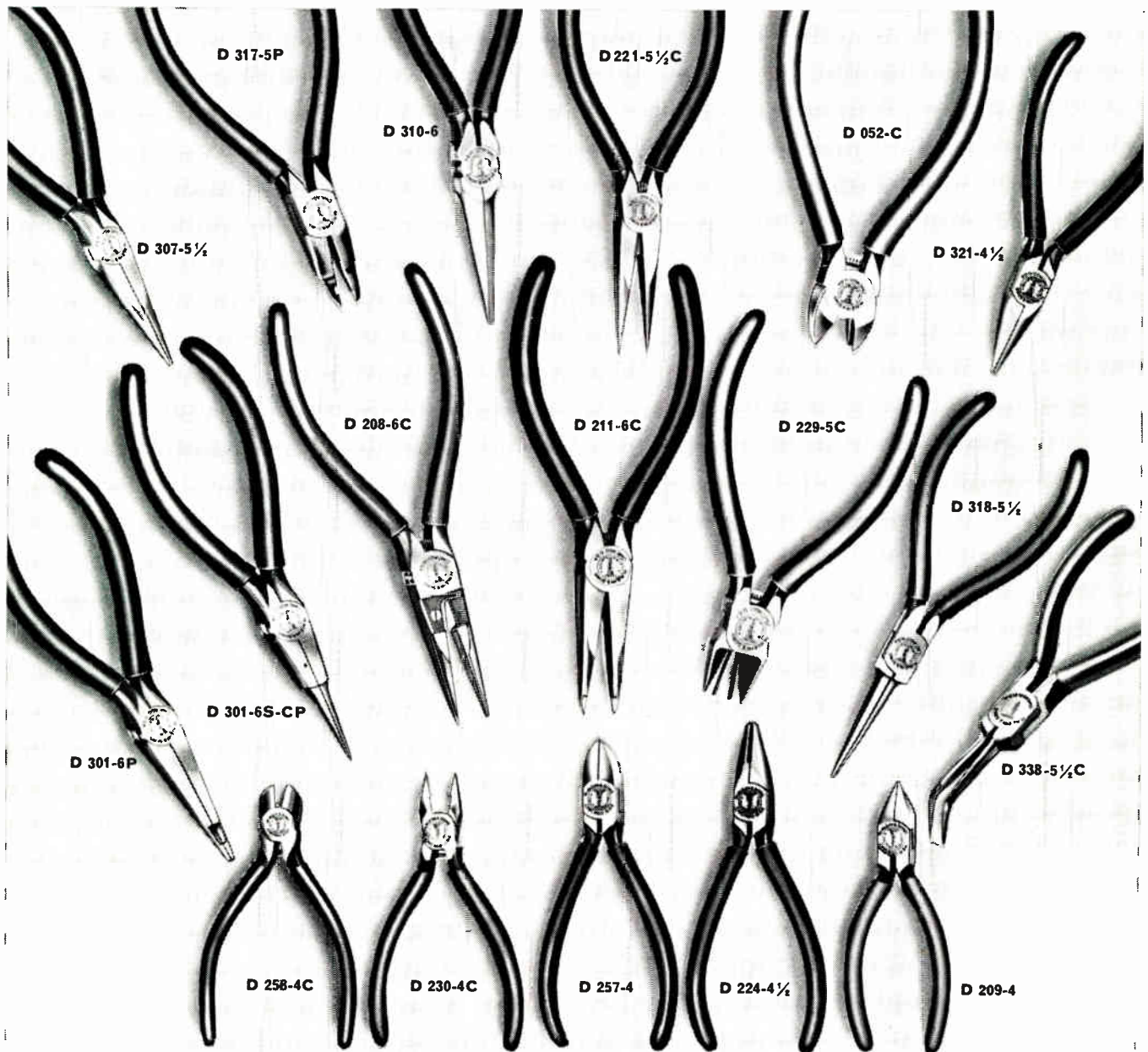

Midgets and specials for electronic assemblies

A cutter that cuts clean and holds the crimped end . . .

One that cuts and crimps wiring on a printed circuit for efficient dip soldering . . .

A trimming plier, flush cutting . . .

A needle nose plier that reaches deep into miniature assemblies . . .

These and dozens of other pliers are available from stock in the complete Klein line. In fact, here you will find pliers exactly designed for any electronic system where clean cutting accuracy, crimping and bending are necessary in extremely confined space.

The Klein line of specially designed electronic pliers offers a plier exactly designed for each specific job—saving time, speeding assemblies, assuring a better product. For complete information write for the Klein catalog on electronic pliers.

See Your Distributor • Foreign Distributor: ITT Export Corporation, New York



Mathias KLEIN & Sons
 Established 1857 Chicago, Ill., U.S.A.
 INCORPORATED
 7200 McCORMICK ROAD, CHICAGO 45, ILL.

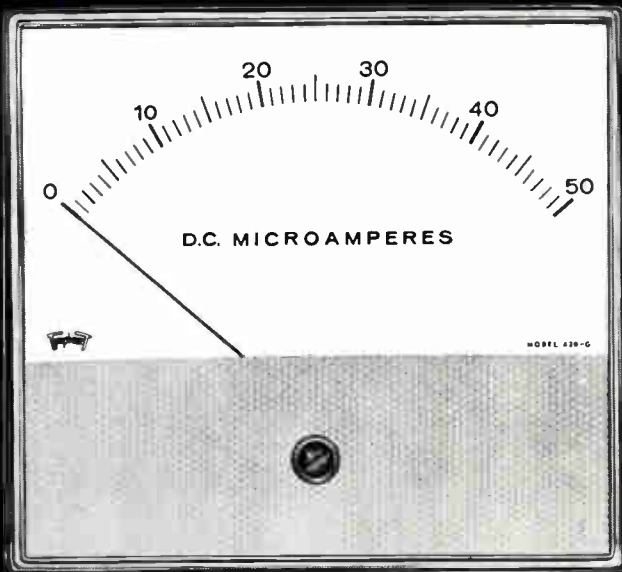

now you see it

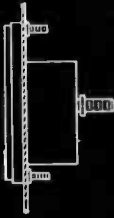

now you don't



THE PANEL INSTRUMENT WITH BUILT-IN FLEXIBILITY

New Triplet G-Series Panel Instruments offer a modern design that features a greater degree of flexibility and interchangeability.

- 1** Two types of mounting are available—conventional flush type or behind-the-panel with a bezel for modern picture window appearance.
- 2** The insert shield on the front of the meter can be custom painted or printed to meet customer's requirements.
- 3** Triplet's famous self-shielded Bar-Ring magnet, with one-piece die-cast frame, all DC and DC suspension type instruments.

Available in three popular sizes: 2½", 3½" and 4½" models with black molded dustproof cases and clear molded plastic fronts.

TRIPLET



TRIPLET ELECTRICAL INSTRUMENT COMPANY, BLUFFTON, OHIO



awkward situations



easy carrying



tight squeezes



small spaces

portability

The Type 422 is dimensionally proportioned for comfortable portability and on-the-job convenience.

Small Size — with maximum overall dimensions of 6 $\frac{3}{4}$ " high x 10" wide x 17 $\frac{1}{2}$ " deep, including panel cover and handle, making it easy to carry anywhere, even through a revolving door.

Light Weight — ~21 pounds, with panel cover and included accessories.

Low Power Requirements—for AC model, ~40 watts; for AC-DC model, ~28 watts AC, ~22 watts DC; power drain on external DC is constant for 11.5 V-35 V range.

Rugged Construction — designed and tested to meet Tektronix environmental requirements:

Storage (without batteries) —55°C to +75°C, to 50,000 ft.

Operating (without batteries) —15°C to +55°C, to 15,000 ft.

Storage (with batteries) —40°C to +60°C

Operating (with batteries) —15°C to +40°C, to 15,000 ft.

No fan used. Runs cool and stays clean.

Versatile Performance—with bandwidth of dc-to-15 MHz, sensitivity to 10 mV/div, sweep speed of 0.5 μ sec/div to 0.5 sec/div, and dual-trace operation in a compact instrument. Ch 2X10 to 1 mV/div (AC only).

Sharp, bright displays—even under high ambient light conditions. Rectangular 4" CRT provides 8 X 10 div display area (0.8 cm/div).

Quality — same \pm 3% calibration accuracy, value engineering, careful manufacture, strict quality control, and international engineering support as other Tektronix laboratory oscilloscopes.

Type 422 Oscilloscope (AC only) \$1325

Type 422 Oscilloscope (AC-DC) \$1750

(Includes set of 20 NiCd cells)

U.S. Sales Prices f.o.b. Beaverton, Oregon

For a demonstration—call your Tektronix Field Engineer

Tektronix, Inc.

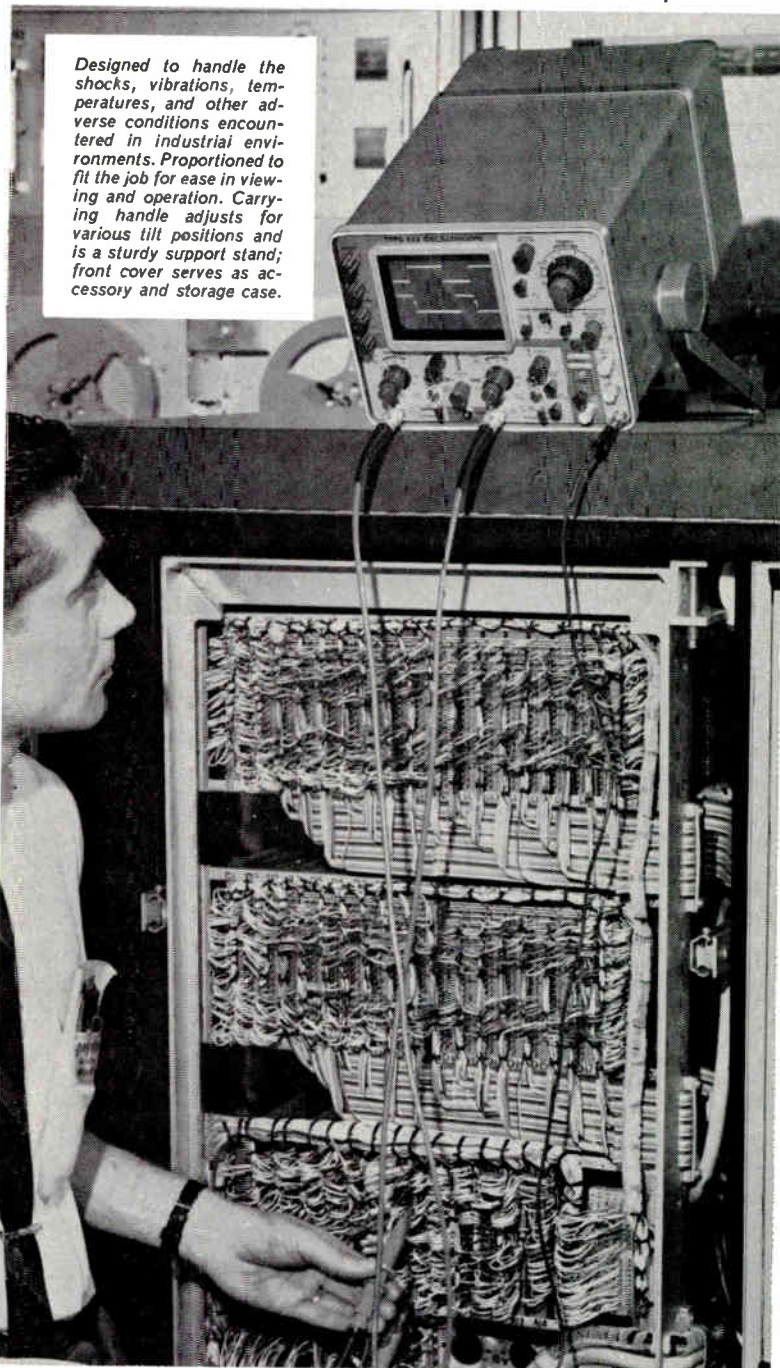

Designed to handle the shocks, vibrations, temperatures, and other adverse conditions encountered in industrial environments. Proportioned to fit the job for ease in viewing and operation. Carrying handle adjusts for various tilt positions and is a sturdy support stand; front cover serves as accessory and storage case.

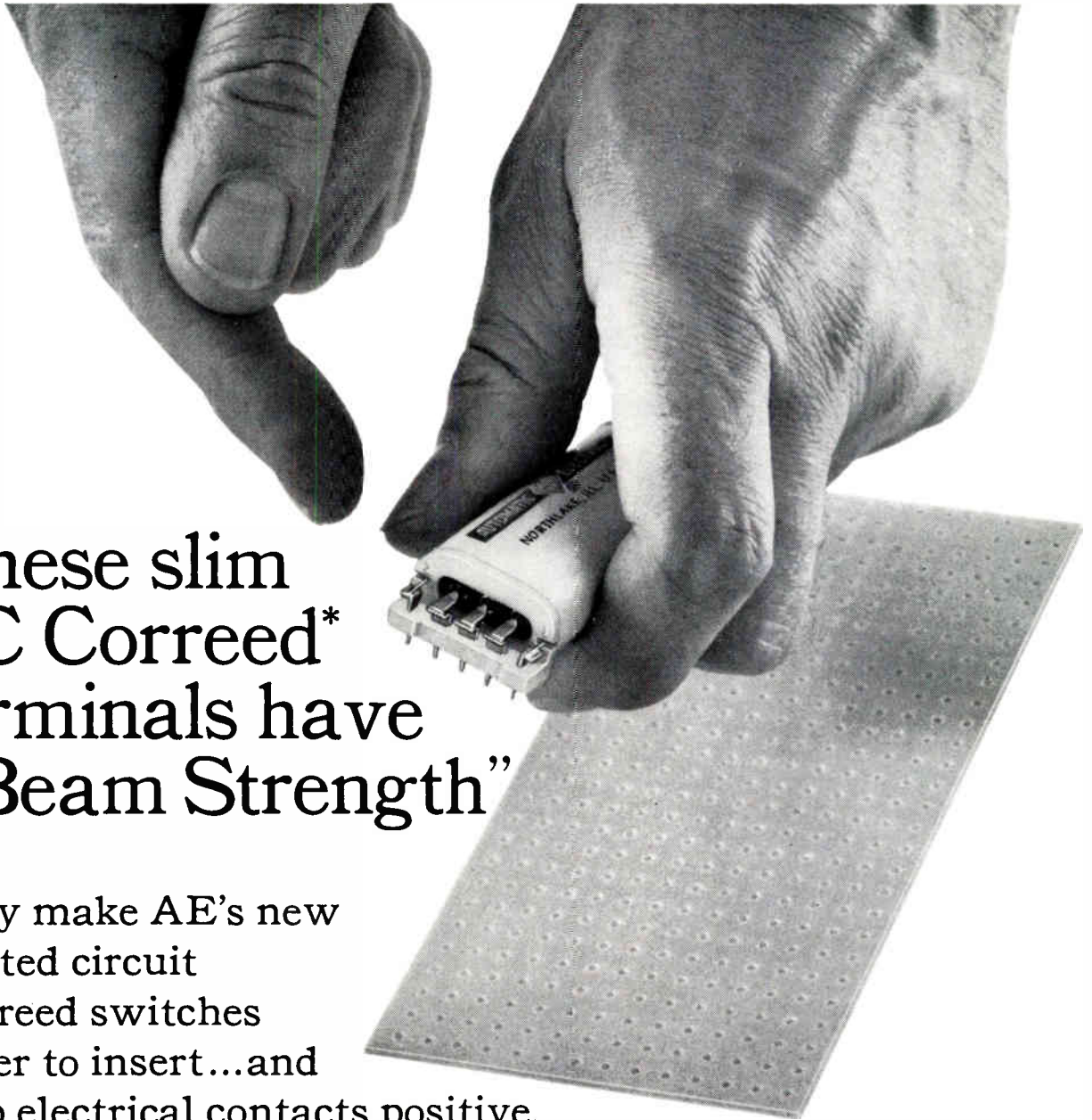

These slim PC Correed* terminals have “I-Beam Strength”

They make AE's new
printed circuit
dry reed switches
easier to insert...and
keep electrical contacts positive.

For extra strength and rigidity, the terminals are “ribbed” like an I-Beam.

Why? Because new PC Correeds are specifically designed for direct insertion into standardized grids. Terminals are spaced in multiples of 0.200 inches—for compact wiring pads and high packaging density. Magnetic shields surround the coils, preventing interaction. Diodes can be soldered directly to the upper side of terminals.

*U.S. patent applied for.

And for an extra measure of moisture resistance, AE uses glass-filled plastic bobbins. It's a practical way to prevent electrical failures.

What's more, the terminals in PC Correeds are separate from the leads. They're welded to the leads—not soldered. This takes the strain off the glass capsules.

Want some helpful information? Get fully detailed data on new AE Printed Cir-

cuit Correeds. See how they meet the needs of modern electronic circuitry. Simply write to the Director, Electronic Control Equipment Sales, Automatic Electric Company, Northlake, Illinois 60164.

2-capsule
(Forms 2A, 1B, or
1A Mag. Latch)

3-capsule
(Forms 3A,
2B, or 1A-1B)

5-capsule
(Forms 5A
or 2A-2B)



AUTOMATIC ELECTRIC
SUBSIDIARY OF
GENERAL TELEPHONE & ELECTRONICS **GTE**

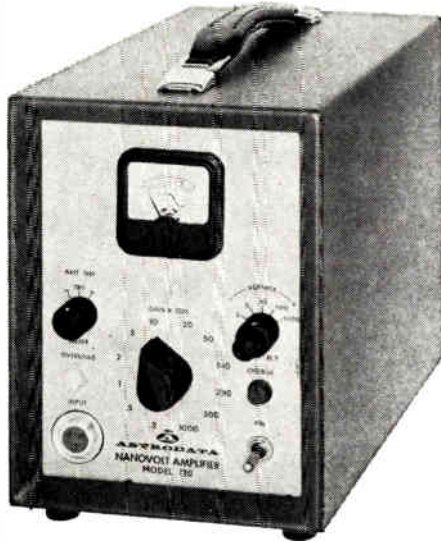

ULTRA SENSITIVE NANO-VOLT AMPLIFIER

Never has a dc amplifier provided more versatile performance with as precise amplification for signals as low as 100 nanovolts. The completely transistorized Model 120 is specifically engineered for low-level, low frequency transducer outputs typifying geophysical, seismographic, bolometer, cryogenic, cellular, Hall-effect, and related applications. Gains from 200 to 1 million, selected by front panel switch. Operated directly from ac power line or by battery, thus eliminating 60-cycle hum interference and providing floating amplification. Built-in battery charger and front-panel monitor. Just 14 pounds light.

SPECIFICATIONS

Gain Steps . . . 200 to 1 million in 1, 2, 5, etc. sequence
 Input Resistance Greater than 1 megohm
 Bandwidth From dc to greater than 100 cps
 Gain Accuracy $\pm 1\%$ at dc
 Gain Stability . . . $\pm 0.01\%$ /day, $\pm 0.1\%$ /6 months
 Linearity $\pm 0.02\%$
 Noise $< 0.05\mu\text{v}$ pk to pk referred to input
 Drift $< 0.05\mu\text{v}$ /hour referred to input
 Output ± 5 volts at 5 ma
 Size . . . $6\frac{3}{4}$ "w by $8\frac{3}{4}$ "h by $10\frac{1}{2}$ "d portable cabinet
 Power . 115VAC or self-contained rechargeable batteries



ASTRODATA

P. O. Box 3003 ■ 240 E. Palais Road, Anaheim, California ■ 92803

COMING EVENTS

November

- Nov. 16-18: 4th Annual Symp. on Physics Failure in Electronics, ITT Research Institute, Rome ADC; Chicago, Ill.
- Nov. 16-19: Annual Conf. on Magnetism & Mag. Materials, AIP, IEEE; Hilton Hotel, San Francisco, Calif.
- Nov. 18-19: Mid-America Elect. Conf. (MAECON), IEEE; Continental Hotel, Kansas City, Mo.
- Nov. 22-23: Int'l Conf. on UHF Television, IEE, IEEE, IERE; London, England.
- Nov. 30-Dec. 2: Fall Joint Computer Conf., IEEE ACM; Convention Center, Las Vegas, Nev.

December

- Dec. 1-3; 1965 Ultrasonic Symp., IEEE; Hotel Kenmore, Boston, Mass.
- Dec. 2-3: 16th Vehicular Commun. Conf., IEEE; Sheraton Park Hotel, Washington, D.C.

'66 Highlights

- IEEE Int'l Conv., Mar. 21-24; Coliseum, New York Hilton, New York, N.Y.
- WESCON, Western Electronics Show & Conv., Aug. 23-26, WEMA, IEEE; Sports Arena, Los Angeles, Calif.
- Nat'l Electronics Conf., Oct. 3-5, IEEE; McCormick Place, Chicago, Ill.

January 1966

- Jan. 25-27: 12th Annual Symp. on Reliability, IEEE, ASQC, et. al; Sheraton Palace Hotel, San Francisco, Calif.
- Jan. 30-Feb. 4: IEEE Winter Power Meeting, IEEE; Statler-Hilton Hotel, New York, N.Y.
- Jan. 31-Feb. 2: Int'l Symp. on Information Theory, IEEE; UCLA, Los Angeles, Calif.

February

- Feb. 2-4: 7th Western Conv. on Aerospace & Electronic Syst., IEEE; Los Angeles, Calif.
- Feb. 9-11: Int'l Solid-State Conf., U of Penna., IEEE; Univ. of Penna., Sheraton Hotel, Phila., Penna.

March

- Mar. 2-4: Scintillation & Semiconductor Counter Symp., IEEE; Shoreham Hotel, Washington, D. C.
- Mar. 21-24: IEEE Int'l Convention, IEEE; Coliseum & New York Hilton Hotel, New York, N.Y.

April

- Apr. 4-5: Rubber & Plastics Industries Tech. Conf., IEEE; Sheraton-Mayflower Hotel, Akron, Ohio
- Apr. 12-15: 4th Quantum Elect. Conf., IEEE; Towne House, Phoenix, Ariz.

WHATEVER YOUR NEEDS MAY BE . . .

FORMICA MAKES A LAMINATE TO MEET NEARLY EVERY PRINTED CIRCUIT 'SPEC'

Basic properties of three of the most-used FORMICA® brand copper clad laminates are shown on the chart. We have seven other grades, with a wide range of electrical and mechanical properties. Chances are that your "special" application can use a standard grade of FORMICA®. We're printed circuit pros, and we welcome every opportunity to prove it.



Even the best p.c. laminate is of little value to you unless it is readily available. Standard sheet sizes of FORMICA® FR-45, FR-200, and XXXPN-36 laminates are in our "Streamliner" inventory. Controlled by computer analysis, this inventory of grades reflects your day-to-day needs. You are assured of fast, steady deliveries, in time, on time to maintain your production schedules.

FORMICA® FR-45 glass-epoxy laminate	FORMICA® FR-200 paper-phenolic laminate	FORMICA® XXXPN-36 paper-phenolic laminate
A single material which does the job of 4, eliminating quadruple stocking, purchasing, record-keeping. Flame retardant.	Flame retardant version of grade XXXPN-36. Flame retardant. Punching grade laminate at no premium price.	Allows plating in alkaline (cyanide) bath and 500° F. soldering with high bond strength. Translucent for ease of registration.
Available copper clad or unclad.	Available copper clad or unclad.	Available copper clad or unclad.
Meets MIL-P-18177, type GEE & GEB; MIL-P-13949C, type GE, GB, GF, GH (copper clad).	Meets MIL-P-3115C, type PBE-P (natural color only); MIL-P-13949B, type PP (copper clad).	Meets MIL-P-3115C, type PBE-P (natural color only).
Meets property requirements of NEMA G-10, G-11, FR-4, FR-5.	Meets property requirements of NEMA FR-2.	Meets property requirements of NEMA XXXPC.
Insulation resistance: avg. value 1,000,000 megohms.	Insulation resistance: 500,000 megohms.	Insulation resistance: 500,000 megohms.
Flexural strength 1/4" length (flatwise): 75,000 psi.	Flexural strength 1/4" length (flatwise): 21,500 psi.	Flexural strength 1/4" length (flatwise): 15,000 psi.
Thickness: 1/32" to 1".	Thickness: 1/32" to 3".	Thickness: 0.015" to 1/2".
Color: off white to light tan.	Color: natural.	Color: natural.
Finish: semi-gloss.	Finish: semi-gloss.	Finish: semi-gloss.

WRITE FOR DATA SHEETS WITH COMPLETE TECHNICAL DETAILS. SPECIFY GRADE.



Industrial plastics

This mark is your assurance of quality. Avoid imitations. Insist on FORMICA brand products.



FREE CATALOGS AVAILABLE . . .

There are many grades of FORMICA Industrial Plastics. For your convenience, we've grouped details on the various grades into the following catalogs:

- Mechanical Grades • Copper Clad Laminates
- Electrical/Electronic Grades • Engraving Stock

FOR FREE COPIES, WRITE TO . . .

FORMICA CORPORATION

subsidiary of **CYANAMID**

DEPT. S-69 • CINCINNATI, OHIO 45232



DIVISION OF THOMAS A. EDISON INDUSTRIES

precision wire wound

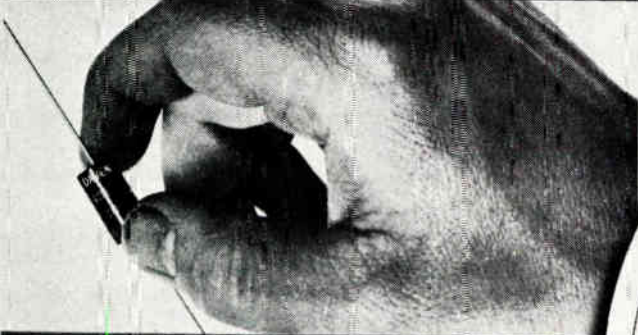

resistors & networks



What this brand new catalog won't tell you...

this brand new calculator will.

BOTH FREE

Between the new Daven catalog on precision wire wound resistors and networks... and the new Resisto-Dial... you've got the most complete, concise, *usable* data published today. Both are designed to provide just the information you want, just the way you want it—fast!

The 16-page catalog is the "Bible" on precision resistors... high reliability, encapsulated, subminiature, printed circuit, fuse, power, instrument grade, high frequency, and unencapsulated resistors. Also covered: DAV-Pak Prepackaged Networks.

The Resisto-Dial *instantly* calculates resistor styles based on requirements; calculates failure rate based on unit hours at a given confidence level; and many other computations. Both are yours free, just for the writing.



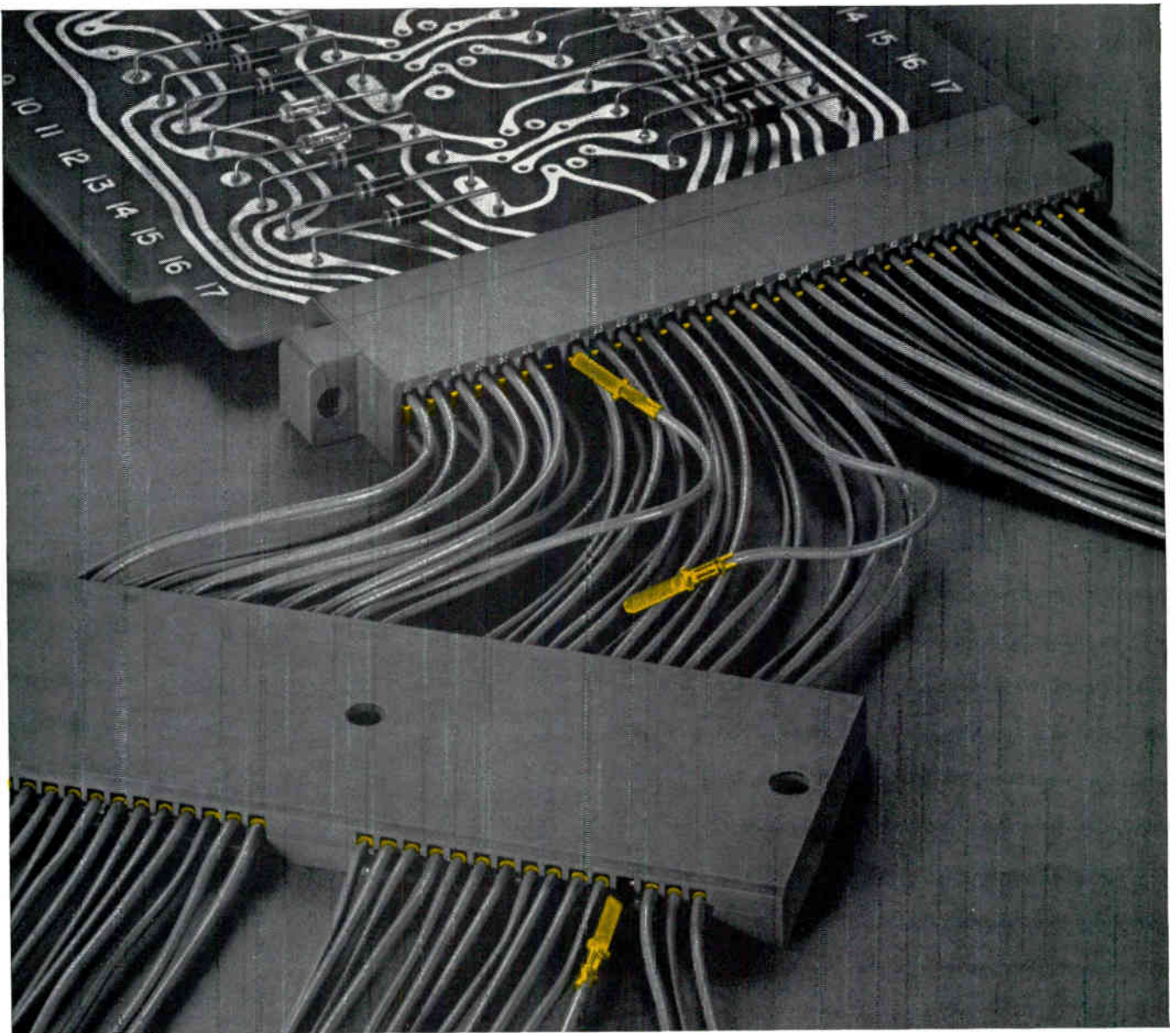

Keep tabs on the ins and outs of wiring

Now you can modernize your wiring . . . use only tab terminals on your leads. Employ harnessing techniques using tab terminals on each end; snap one end to our AMP-TAB* Printed Circuit Board Connector, the other to the AMP-TAB Feed-Thru Block.

Our new Feed-Thru Block was designed as a companion to the popular AMP-TAB Printed Circuit Connector. By using the same contact on both ends of the wire, you can assemble your racks at the lowest installed cost. And . . . you need no insertion tools to do it! Gold-over-nickel plated tab terminals are not only hand insertible, they require only one-third the space of other terminals.

It all adds up to one of the most practical ways we can think of to solve your wiring problems. And . . . look at these bonus features:

- Hand inserted contacts—no insertion tool required
- One tool crimps entire wire range
- High density—.100" mounting centers
- "Egg crate" housing design eliminates need for contact sleeves
- Built-in keying slots for stacking blocks
- Contacts available in strip form for high production

Whether you are commoning, distributing or simply feeding-through your leads, let our Feed-Thru Block pick up the tabs. Write today for complete information.

*Trademark of AMP INCORPORATED



AMP* products and engineering assistance are available through subsidiary companies in: Australia • Canada • England • France • Holland • Italy • Japan • Mexico • West Germany

SLOW CHANGE TO METRIC SYSTEM—Congress saw no need for haste in 1965 in converting to the metric system. A bill providing for a study of the problems likely to result from a change from inches to meters has been laid aside until 1966. Secretary of Commerce John Connor has urged that such a study be started without delay. With the decision of Britain to “go metric” within 10 years, the U.S. will be the last major hold-out of the inch-pound-gallon school of measurement.

ELECTRONICS AND GRAPHIC ARTS—“Growth of electronic communications is overtaking conventional methods of printing.” What’s likely to emerge is a new “communications industry” that will include all existing forms of publishing and broadcasting. These predictions come from Elmer Brown, president of the International Typographical Union (ITU). “Eventually, the entire field of communications—graphic arts, radio frequency, electronics, electrostatics, and the application of other energies—will come under the same business control,” he believes.

U.S. ALLIES BUY SURPLUS—Our allies have purchased \$9,200,000,000 worth of U.S. military surplus equipment since June 1961. Defense Secretary McNamara points out that disposal of this surplus equipment (including electronic) to our allies permits them to buy at low prices, while U.S. manufacturers gain by selling new equipment to DOD. Germany and Britain account for more than \$6,100,000,000 of the total. About \$930,000,000 worth is sold to Canada, Australia, New Zealand, and Japan. The balance is sold to allies scattered throughout the world.

EDUCATIONAL TV FOR PUERTO RICO

One of 1,800 educational TV sets ordered by Commonwealth of Puerto Rico from GE. Specially designed sets are now installed and being used by P.I.'s Department of Education in an effort to improve the quality of education by offering a richer curriculum to more students.



SMALL FIRMS, MORE CONTRACTS—Smaller manufacturers are now being awarded more contracts than they were a year ago. The Defense Dept. says smaller companies received \$5,305,000,000 in prime contracts in the year ended June 30, which is \$463 million more than in the previous year. Enforced set-asides of defense contracts to smaller firms was of measurable help. Such contract awards rose from \$643 million (1959) to \$1,642 million (1965).

TRITIUM RULES RELAXED—Use of tritium on dials and pointers is to be exempted from government licensing. Atomic Energy Commission is proposing the exemption. Basis of the proposal is a petition from Canrad Precision Industries, Inc., New York, N.Y. Interested parties should submit written comments to the Secretary, Atomic Energy Commission, Washington, D.C. 20545, by Nov. 17.

BAN ON CATV PROGRAMMING—National Association of Broadcasters urged FCC to prohibit community antenna television (CATV) systems from originating any kind of programming and from extending their signals by artificial means. NAB asserts that CATV should be limited to receipt and retransmission of broadcast signals without any “insertions or deletions” of any kind. Such a policy, it said, would be consistent with CATV claims that the system is merely a “master antenna service.”

LAG BLURS WORLD TV—U. S. officials are uneasy over lack of action by the 13-member international consortium which controls all activity involving the proposed global communications system. So far, the failure of the group to do much more than talk hasn’t slowed progress—but U. S. officials are beginning to wonder if agreements will come when they are needed. First approval will be needed within a year for the launching of the first Pacific Early Bird satellite scheduled to give Hawaii its first live TV coverage.

WHERE THE BUSINESS IS—California has moved into a still-larger share of military prime contracts. A Defense Dept. study shows that 22.1% of prime contracts are placed in California—up from 21.0% a year ago. New York is second, with 9.6% of primes, down somewhat from the 10.00% share of a year earlier. In terms of dollars, this means that \$5.1 billion is spent in California; \$2.2 billion in New York, \$1.4 billion in Texas, and \$1.1 billion each in Connecticut and in Massachusetts. Georgia, a fast comer, pushed out Washington State for its first appearance among the top 10 states.

While you weren't looking...

We just converted your **Polarad** CFI RI/FI Meters and TR Receivers into dozens of fully-automated, 1.0-21.0 GC Spectrum-Signature/Surveillance Systems...or into push-button all-band spot-frequency (or sector-scan) production test sets ...or into spectral-energy-distribution recorders...or into whatever else we can mutually cook up; and it's all done with a trio of inexpensive Adaptor/Control/Interface Modules. Think of it—overnight we've converted what used to be merely the world's finest **Solid-State Receivers & RI/FI Meters into Microwave & RFI Systems**. How? It's simple—like All really good ideas. Here's how...

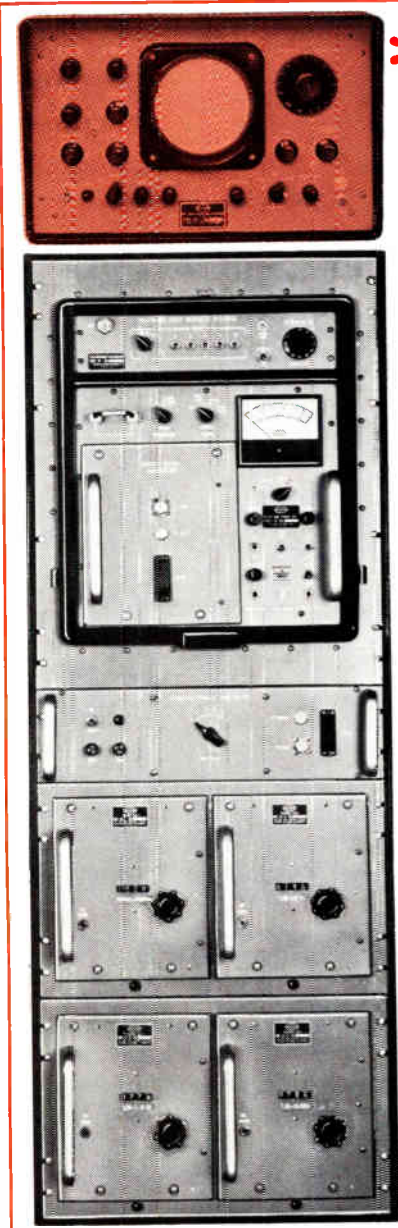

*** Model DM-1**

Mount your CFI or TR basic unit in this Adaptor Panel (CFI-AM or TR-AM)

Then add this Switching Module (CFI-SM or TR-SM)

finally, add one, two, or three of these Tuning Unit Adaptor Modules (CFI-TUM or TR-TUM) ... plug in your tuning units, and you're on the air!

***for that first-class feeling ... add a DM-1 Spectrum Signature Monitor!**

WHAT? You don't own a CFI or a TR? Good Grief, don't waste another moment! Call (212) EX 2-4500 for immediate relief—from a demonstration to delivery, from (naturally!) the busiest production line in the industry.



World Leader in Microwave Instrumentation

POLARAD

ELECTRONIC INSTRUMENTS

A Division of Polarad Electronics Corporation
34-02 QUEENS BOULEVARD
LONG ISLAND CITY, NEW YORK 11101

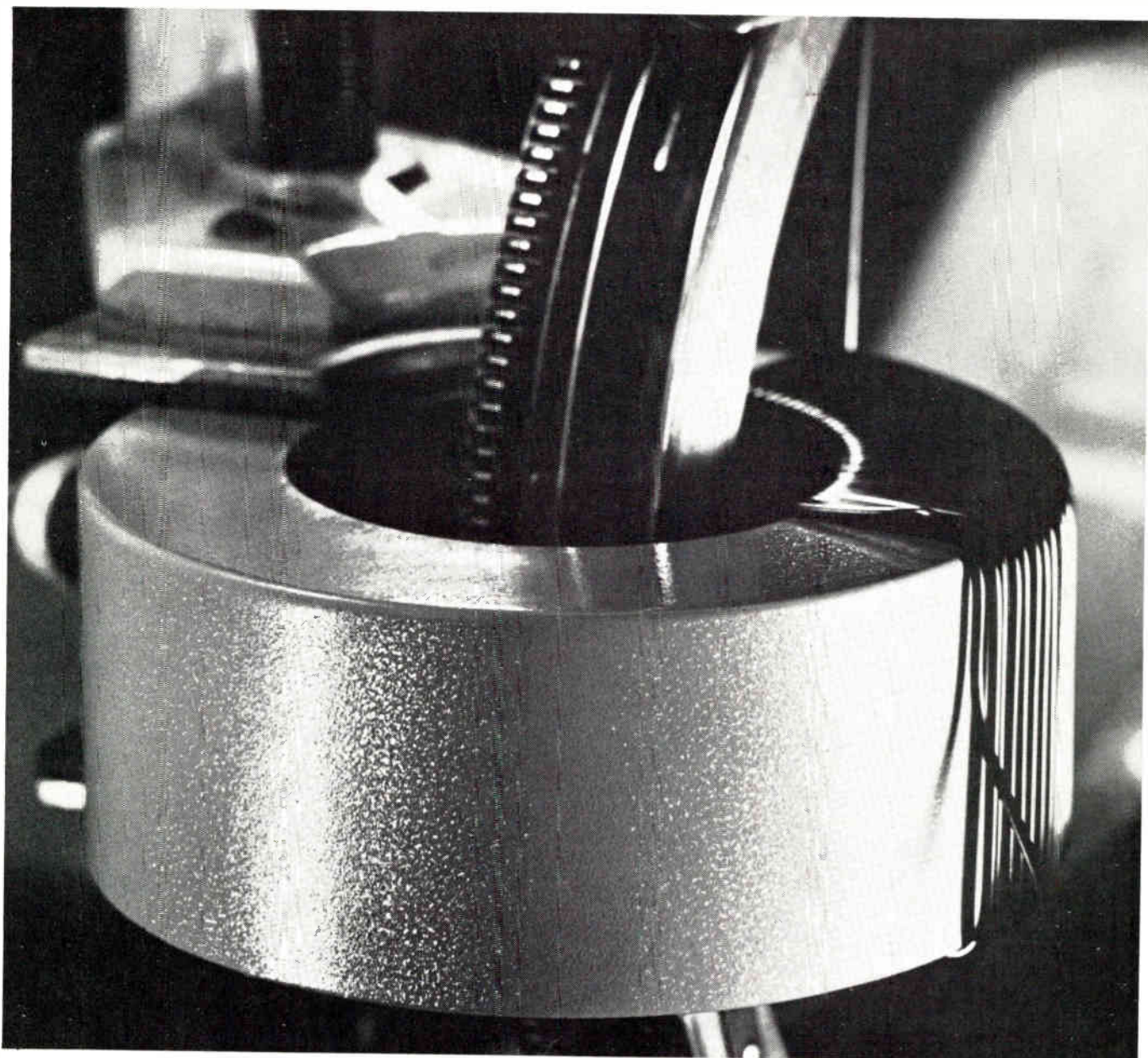

ROUGH WITH A REASON

Unique GVB finish cuts core winding costs

GVB encased cores mean fewer production delays because GVB does much more than seal the core box against potting material. Its matte finish provides a resilient, non-slip base for winding, and the tough epoxy skin prevents the wire from cutting through to the core box. Guaranteed not to fail, even when wound with heavy #6 wire, GVB surface also eliminates abraded wire problems. No prior taping of the core is required, so another winding operation is wiped out.

Magnetics doubles the normal guarantee on core box finishes by expressing it in this unique way: The guaranteed voltage breakdown (GVB) finish seals the box

and is capable of withstanding at least 1,000 volts at 60 cycles *between a bare winding and the aluminum case*. Quality control monitors the application and curing of GVB to assure dimensional and voltage breakdown fidelity. Performance characteristics are maintained between -65 and 200 degrees C.

To reduce production costs on your winding operations, try Magnetics' tape wound cores with GVB. Eight material types, in a wide range of sizes from $0.375''$ to $4.0''$ inside diameter, are stocked for immediate delivery. More information? Write *Magnetics Inc., Dept. EI-27, Butler, Pa.*



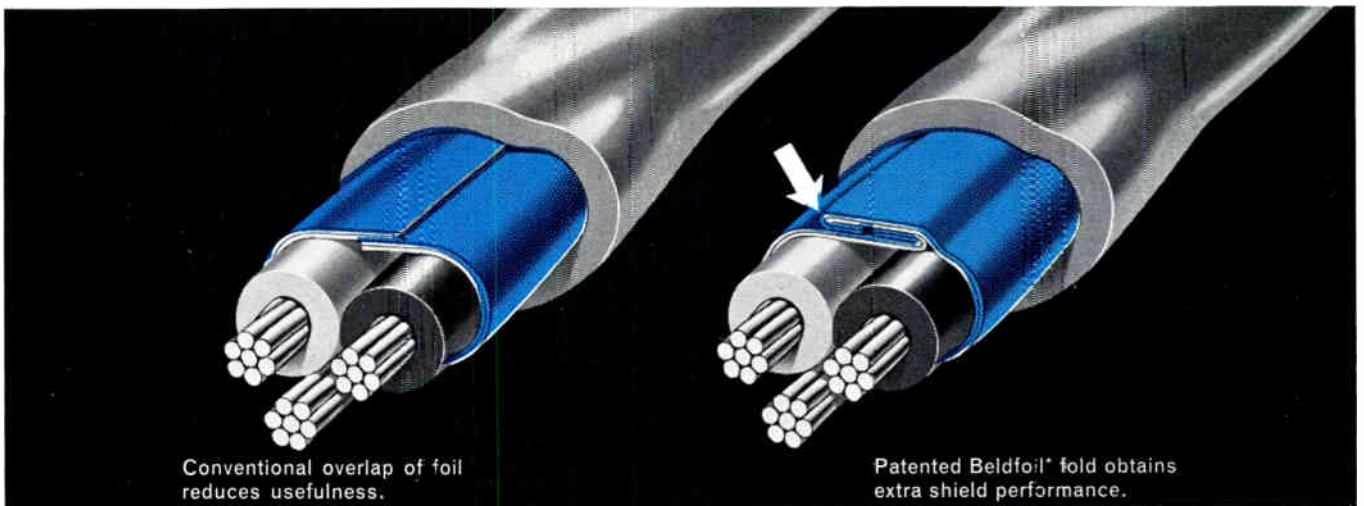

It's in the fold!

By Frank Timmons, Chief Engineer, Electronics Division, Belden Manufacturing Company

There are a number of cables on the market today which utilize Mylar® Aluminum Shielding to eliminate noise, hum and cross-talk. These cables have been developed to meet the needs of equipment engineers who have found that standard braided and spiral shields are inadequate in reducing pick-up and transmitted noise.

There is a big difference in the various cables available . . . and the big difference is in the manner by which the Mylar Aluminum Shielding is applied to the cable. The cable which does the most effective job of eliminating noise, hum and cross-talk uses a unique, patented wrapping process that "folds back" one or both edges of the Mylar Aluminum Shielding. It provides "total shielding" and was introduced in 1957 by the Belden Manufacturing Company under the trade name, "Beldfoil."

It is evident that many interested persons do not completely understand the manner in which Mylar Aluminum Shielding is used in the manufacture of Beldfoil cable. Therefore, Frank Timmons, Chief Engineer of the Electronics Division at Belden's Richmond, Indiana plant answers some of the more frequently asked questions, and points up some of the more important benefits offered by Beldfoil.

Q. You talk about a patented process wherein the Mylar Aluminum Shielding is folded back . . . on one or both edges. Just how is this done?

A. First, let us define Mylar Aluminum Shielding . . . it is a lamination of Mylar insulation film from 0.0005" to 0.001" thick and aluminum foil of .00035" to .001" thickness, applied spirally around the shielded conductor or conductors to give 100% shield coverage.

In some instances the wires are wrapped with the metal foil on the outside as shown in the cross-sectional drawing Fig. 1.

Fig. 1

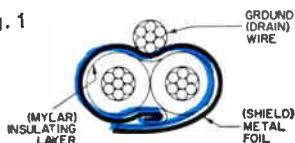

Note the heavy black line showing the foil edge folded back so that a full layer of Mylar "bonus insulation" is provided between the conductors and the foil shield, increasing the reliability of the cable.

Cables to be used at radio frequencies, or sensitive to radio frequency interference, may need the fold shown in Fig. 2. This fold creates a metal-to-metal connection which eliminates any possible inductive effect, and makes the shield the electrical equivalent of a solid aluminum tube.

Fig. 2

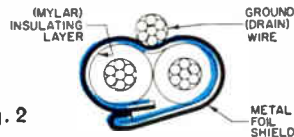

Shields shown in Fig. 1 and 2 are used for cables with one pair of conductors.

For cables carrying multiple pairs of conductors, a different technique is used. On each pair, the aluminum foil is placed on the *inside*, with the Mylar layer on the *outside* (See Fig. 3). This is important because if the aluminum surface were on the outside we would have random metallic contact between the shields on the different pairs of wires. This would permit the voltages existing on one shield to generate currents in the adjacent shield, creating a transfer of energy or cross-talk between circuits.

Note that the outer edge of the shield is folded to tuck the edge of foil out of the way where it cannot short to the adjacent shield.

Fig. 3



The inner fold again provides the electrical equivalent of a solid aluminum tube. Belden calls this combination of two folds in one shield a "Z" fold because an end view of the unwrapped tape looks like the letter "Z".

Q. How much signal isolation results between pairs, when aluminum foil is on the inside, and Mylar layer outside?

A. This type of construction obtains isolation of more than 100 db between pairs, per thousand feet of cable, at 10 Kc. The short-circuited tape shield makes the cable quite suitable for use at frequencies ranging from audio to RF.

Q. Do any contact-resistance problems arise between the drain wire and the aluminum foil shield on Beldfoil?

A. No. Belden design and field service experience on millions of cable-feet in wide service environment have proved this point of reliability.

Q. Can Beldfoil shields be used over small single conductors as well as over large complex cables?

A. Yes. Belden applies it on groups from .050" to 1.25" OD.

Q. Design engineers are constantly faced with miniaturization problems. What about the size of Beldfoil shielded cables?

A. Beldfoil definitely reduces the diameter of multi-conductor cables . . . in some instances by as much as 66 $\frac{2}{3}$ %. The small diameter provides design engineers with extra conduit space, extra raceway, extra console and rack space.

Q. How can I determine which type of shield I should choose for a given cable?

A. Belden application engineers are available for engineering assistance. Or, you can obtain preliminary printed information by writing to Belden Manufacturing Company, Advertising Department, P.O. Box 5070-A, Chicago, Illinois 60680.

Better Built... Better Buy...



8-7-5

*Belden Trademark Reg. U.S. Pat. Off. 'duPont Trademark

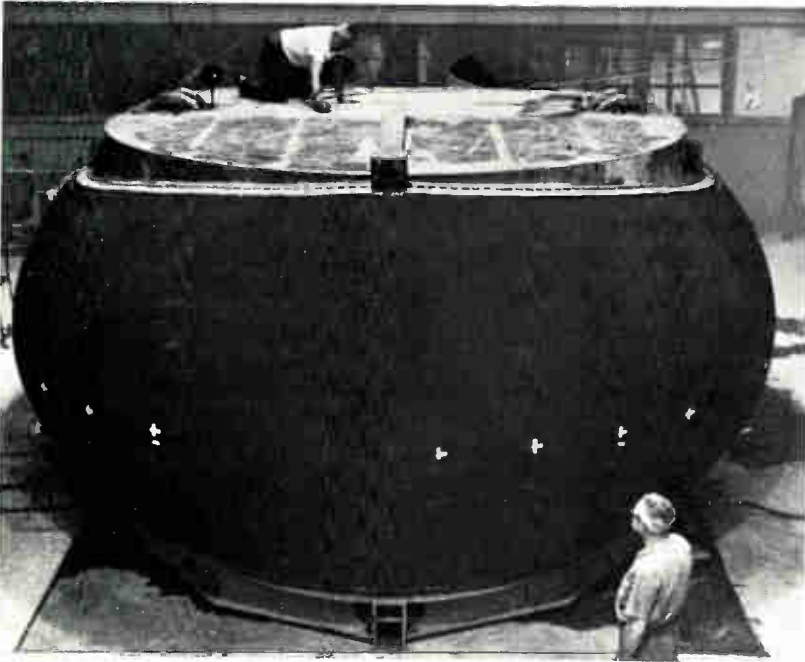

ELECTRONIC SNAPSHOTS

The Changing
STATE-OF-THE-ART
In the electronic industries

▲ BIG BULGE FOR NAVY SONAR

Acoustical "window" for a bow dome that will be mounted below the water line on bow of Navy destroyer Willis A. Lee to house sensitive sonar equipment. Window, made by B. F. Goodrich, has acoustical properties similar to sea water.

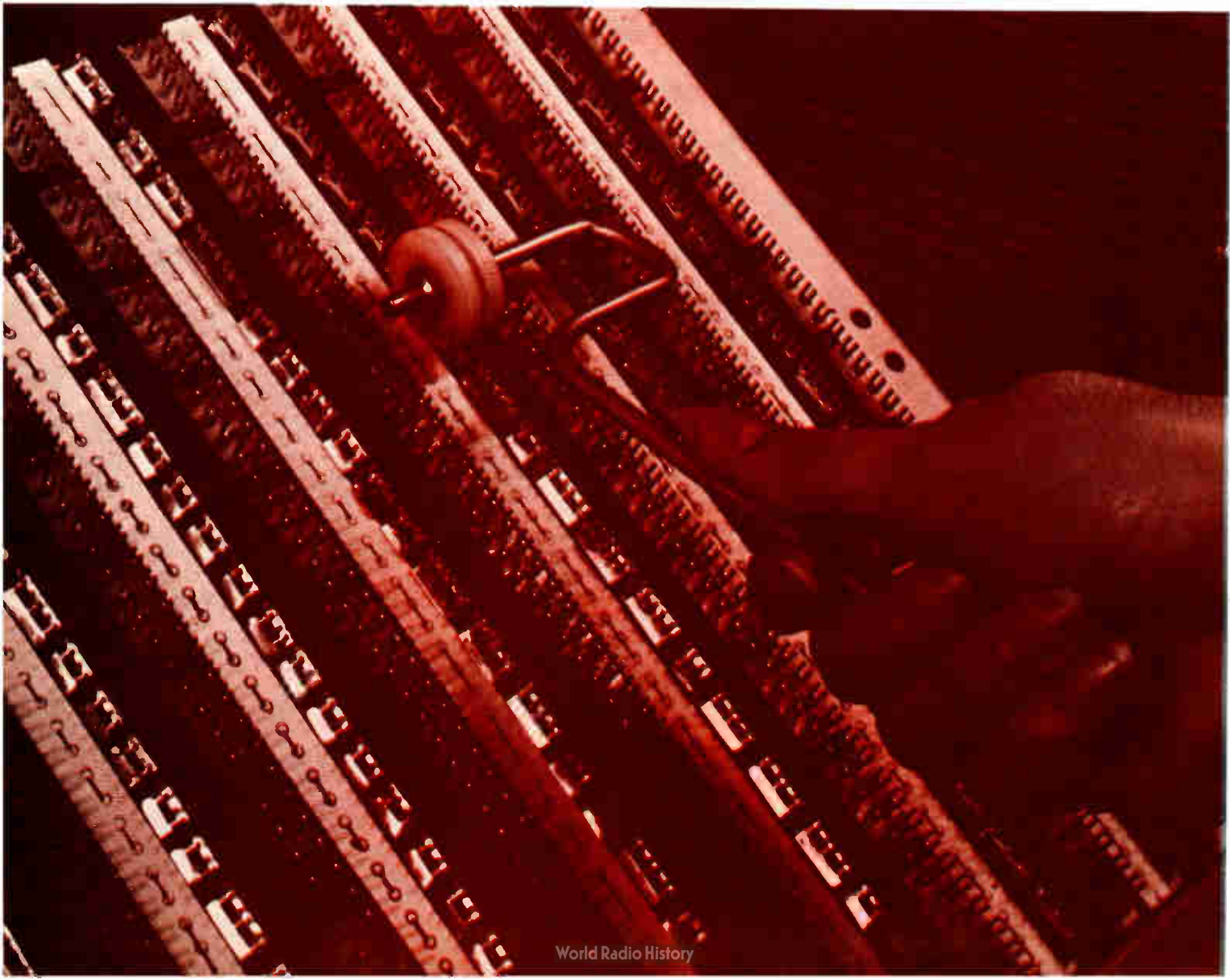

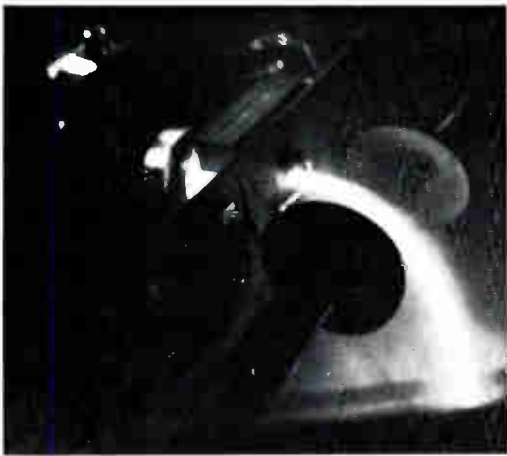

▲ BEAM DEFLECTOR

Photo shows path of an electron beam being aimed by Consolidated Vacuum Corporation's new beam deflection system. Path of beam is controlled by deflection coils and separate controls permit easy aim of beam spot.



▲ COMPACT COMPUTER MEMORY FOR ROCKETS

Baseball-size experimental computer memory—"one of most compact ever developed"—designed by IBM to store data for rocket and missile guidance. Device, produced for aerospace use, has only one moving part and can hold 600,000 separate bits of data.

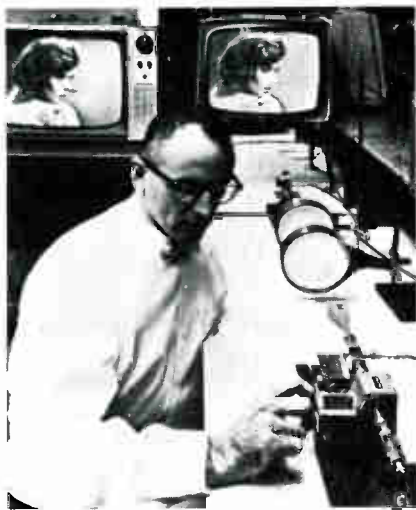

▲ TV BANDS ON MM WAVE

Entire radio frequency channel of a TV station superimposed on millimeter-wave signal by semiconductor device called injection modulator developed by GT&E Labs. Dr. Richard Harrison adjusts small mm-wave system.

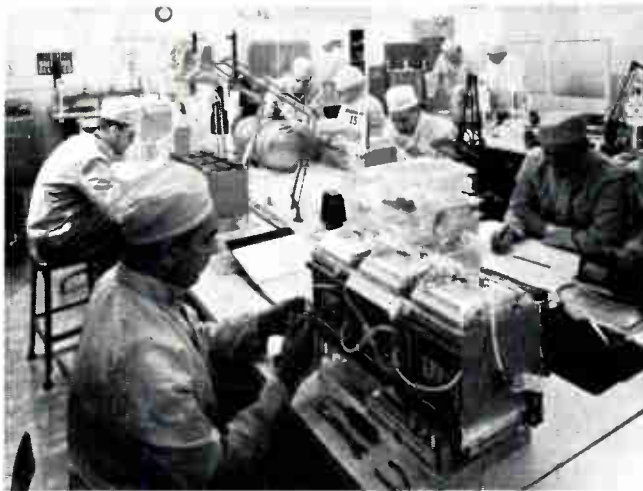

◀ FUEL CELL BATTERIES

Final assembly of GE fuel cell batteries includes careful check-out of individual fuel cell modules shown here before being enclosed in their cannisters.

◀ CRIMPER FOR LOGIC BOARDS

New production technique used at Bunker Ramo Corp. Following diagrams on special aluminum "fingers" between terminal pins on logic board, assembler crimps pre-cut bus into place with special roller.

▶ FLUID BINARY COUNTERS ▶

Four glass plates (photosensitized and etched) when stacked and sealed, make up 10 identical four-layered binary counters. Fluid amplifiers are used to recognize instruction signals in counting or switching systems.



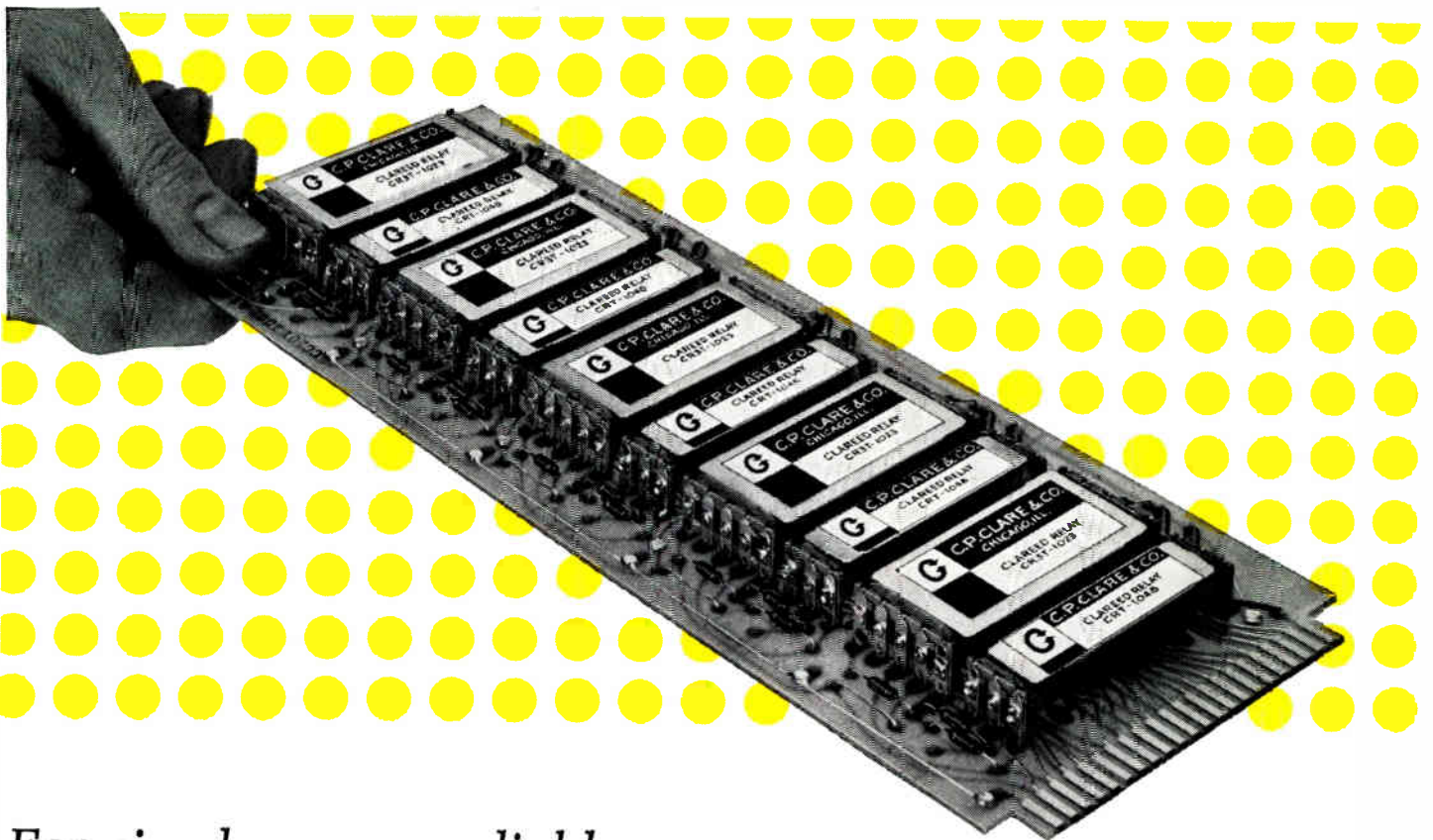

For simpler, more reliable

digital control circuits...

CLAREED®

CONTROL MODULES

pre-packaged counting, selection and logic devices

■ Counting, selection and logic switching problems are readily solved with Clareed Control Modules. Pre-packaged (or custom-designed if your problem is a new one), these modules combine speed, simplicity, and reliability ...at lower cost than comparable solid state circuitry, and without unnecessary design delay.

Counting. Pre-packaged printed circuit board modules in wide variety, for assembly to perform as decimal ring counters, radix ⁽ⁿ⁾ counters, bi-directional counters, shift registers, etc. Typical applications include scanning systems, digital clocks, data tracking and data transmission systems.

Selection. Pre-packaged printed circuit board modules in wide variety, for interconnection to perform as selection matrices. Typical applications include more versatile equivalents of traditional cross-bars, selection matrices capable of individual memory, and check-out matrices which can be operated with all contacts either normally open or normally closed. (Combining these Selection Modules with Clareed Counting Modules, the designer can readily provide a wide variety of scanners.)

Logic. Pre-packaged units for printed circuit board assembly in custom-designed logic modules, which efficiently perform such logic functions as AND, inclusive OR, exclusive OR, NAND, NOR, exclusive NOR, etc. These standard Clareed units, in Clare-customized systems, provide master control circuitry which greatly reduces complexity and cost of digital control systems.

Take a look at these Clareed advantages! You'll see how this versatile switching concept can fit into your plans for industrial or commercial systems.

- multiple input and output capabilities, making possible logic at both input and output
- switching capabilities from low level up to 15 va, ac or dc, automatically available at all points without additional output circuitry
- complete isolation between input and output. The output is the contact closure
- immunity to transient and external noise
- data handling speeds up to 120 bits per second, 250 bits as special
- modular printed circuit board construction compatible with modern electronic assembly techniques...meets the requirements of almost any application

TYPICAL CLAREED CONTROL SYSTEM APPLICATIONS

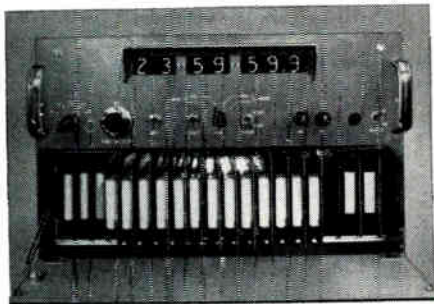

Digital Clocks using Clareed Control Modules as ring and binary counters, illustrate a variety of solutions for basic counting circuits in application for timed events, testing and systems control. Counting is performed by flux operated flip-flop elements; switching in the high-rate counter is done by Clare mercury-wetted contacts. This design provides:

- Greenwich time output
- elapsed time output
- local and/or remote visual readout
- local and/or remote control
- 7 digit capability

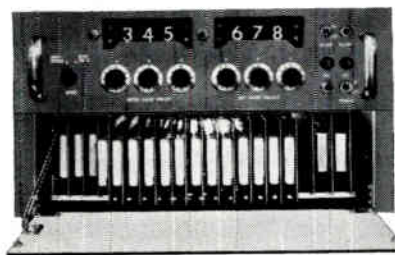

Industrial Preset Counters demonstrate production counting and control applications which provide a wide range of switching functions. Clareed flip-flop Modules are the basic switching elements used to provide this more versatile control. This design provides:

- low-cost anti-coincidence circuit for multi-channel operation
- preset 3 digit or 6 digit capability
- multi-channel input
- batch mode operation
- preset unit and batch operation
- special packages available to meet NEMA general purpose, explosion-proof, gas-tight, and water-tight enclosure requirements

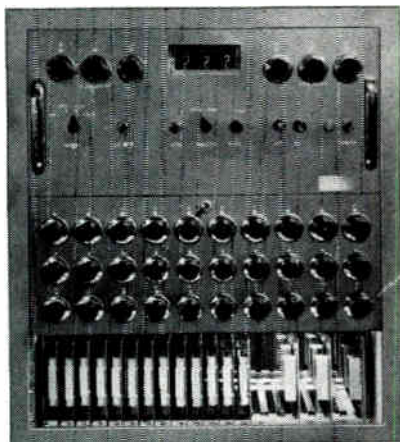

Scanners exemplify flexible sub-systems for instrumentation sampling, data logging and control systems requiring multiplexing. In the example shown, the driver is a three-decade counter composed of Clareed flip-flops; the control section uses flux and contact logic to control the driver and provide strobe drive to the matrix. A broad range of scanning options is possible:

- scan rate up to 100 crosspoints per second
- any number of crosspoints
- any number of poles per crosspoint
- special crosspoints for low level scanning
- contact forms A, B, C, or D at any crosspoints
- sequential scan with stop and recycle modes
- random scan of any 10 points in any sequence

Clareed Control Modules can be applied to the switching requirements of most systems. Proven Clareed solutions span many completely different application areas, including:

- machine tool numerical control
- telephone peripheral equipment
- engine test cell scanning systems
- psychological testing equipment
- process counting and recording
- missile checkout systems
- supervisory control and alarm annunciator systems

What's more important is how can Clareed Control help with your switching problems? Take another look at the Clareed advantages. Then, ask your Clare engineer how these plus features apply to your system. Write for Manual 400, Clareed Control Modules, or ask for specific data on Clare Industrial Preset Counters, Digital Clocks and Scanners. C. P. CLARE & CO., Group 11D4, 3101 Pratt Boulevard, Chicago, Illinois 60645.



relays and related control components

**HEAVY INCREASE REPORTED
IN COMPONENTS INDUSTRY**

Value-added-by-manufacture in the 1963 electronic components industry amounted to \$1.4 billion, an increase of almost 93% over the value-added for 1958, according to a preliminary report of the 1963 Census of Manufacturers just issued by the U. S. Dept. of Commerce, Bureau of the Census. "Value-added . . ." approximates the value of the products shipped less the cost of the materials used to manufacture the products.

Manufacturers shipments of electronic components and accessories (not elsewhere classified) were valued at \$2.46 billion in 1963, an increase of 98% over 1958, last previous year of the Census.

Most significant increase was in components and accessories other than capacitors, resistors, coils, transformers, reactors, and chokes for electronic applications, not elsewhere classified. Shipments in that category increased from \$608 million in 1958 to \$1.42 billion in 1963.

**HOLLAND EXPORTS SCORE
19% GAIN FOR 1964**

Holland's exports of electrical and electronic products in 1964 advanced by nearly 19% over 1963, it was revealed by the Institute of Dutch Electrical Engineering Works at the Hague.

In 1964, the monetary total of Dutch electrical exports throughout the world reached \$605,300,000 as compared to \$509,500,000 for the preceding year.

Radio and TV equipment and accessories outpaced all other categories of electrical products in exports. The total value of such shipments abroad in 1964 stood at \$233,556,000 as against \$185,361,000 in 1963.

Electron tubes, photocells, transistors and similar products took second place in 1964 with an export total of \$98,150,000. The 1963 export volume in this area came to \$78,945,000.

**TAPE RECORDERS IN JAPAN
MAY HIT 7.5 MILLION OUTPUT**

Japan's tape recorder industry has increased production rapidly, and the demand for such items, especially in Japan, during 1965 is expected to reach 7.5 million units. Of this, about two million recorders will in all probability go to the home market, as reported in the magazine "Japan Electric Industry."

Production of tapes in 1964 held value at \$8,106,300, and exports amounted to about \$830,600.

**ACTIVE COMPONENTS
FORECAST**

(In Millions of Dollars)

SEMICONDUCTORS	1965	1969
Transistors	\$333	\$221
Diodes	123	84
Rectifiers	95	96
Microwave Diodes	14	19
Zener Diodes	42	45
Tunnel Diodes	2	2
SCRs	32	53
Selenium Stack Assemblies	18	8
Integrated Circuits	60	170
Other	16	23
Total	\$735	\$721

VACUUM TUBES

Receiving Tubes	255	140
B & W Tubes (excl. Rebuilt)	150	74
Color Tubes	260	489
Power & Trans.	250	165
Total	915	868
TOTAL ACTIVE	\$1,650	\$1,580

(Source: Sylvania Electronic Components Group)

**BILLION-DOLLAR MART SEEN
FOR U. S. IN SCANDINAVIA**

The stable and prosperous economics of Scandinavia offer attractive opportunities for U. S. exporters, reports an officer of a New York bank.

John Fox, international department, Meadow Brook National Bank, noted that Scandinavian countries (Denmark, Norway, Sweden, Finland) have one of the world's highest standards of living and that their rates of economic growth show a relatively steady upward trend. The gross national product of all four countries increased 5% or more (at constant prices) last year.

"The industrial progress of Scandinavia," Fox observed, "has created substantial markets for sophisticated equipment and products of the type produced in the U. S."

He listed the following among U. S. products with market opportunities in Scandinavia; scientific and industrial instruments; electronic apparatus, instruments and systems; automation control equipment; traffic and safety equipment; industrial chemicals; industrial training aids; packaging machinery; and home appliances.

BETTER FORECASTS NEEDED, SAYS BATTELLE ECONOMIST

Executives, though reluctant to admit it, need forecasts of technology. However, such forecasts must be improved to be of real value, reports William L. Swager, Battelle Memorial Institute.

In a paper delivered during a symposium of the Engineering Economy Division of the American Society for Engineering Education, he said, "Today, few executives in American industry acknowledge clearly and specifically their need for forecasts of technology."

Mr. Swager, associate manager of the Department of Economics and Information Research at Battelle's Columbus (Ohio) Laboratories, said that, fewer are willing to admit that such forecasts may be of practical value. Still fewer recognize that every investment decision made by industry is made with an assumed or estimated, conscious or unconscious, good or bad technological forecast.

Misleading forecasts have stemmed, he commented, from estimating advances in one technology and ignoring advances in another. Forecasters have ignored such pertinent questions as: "What technologies should be forecast?" "What specific areas of these technologies deserve closest scrutiny?" "What are the competing technologies and what changes will occur in them?" and "Do all technologies need to be forecast in the same detail?"

"My thesis," Mr. Swager explained,

"is that technological forecasting will be practical and will have a major impact on business when we place somewhat more emphasis on the question: 'What should be forecast?' and somewhat less on 'What methods should be used for forecasting?'"

He pointed out that by answering the question "What should be forecast?," forecasters can limit the options from which valid decisions are possible. The answers guide forecasters in the selection of methods to be used for forecasting and provide a foundation for communicating the decisions and the logic to both non-technical executives and to research scientists and engineers.

**MARKET LOOMS IN MEXICO
FOR SOPHISTICATED GEAR**

A market for the more sophisticated of electronic equipment has been reported growing in Mexico. According to a report from the U. S. Commercial Attache in Mexico City, this new market should provide opportunities to U. S. exporters.

As the report states, proximity of U. S. suppliers is a favorable factor. Prices for sophisticated equipment apparently are not a great determinant, as compared to prices for simpler electronic items, especially consumer products. The report warns that vigorous competition can be expected from other nations interested in this new market.

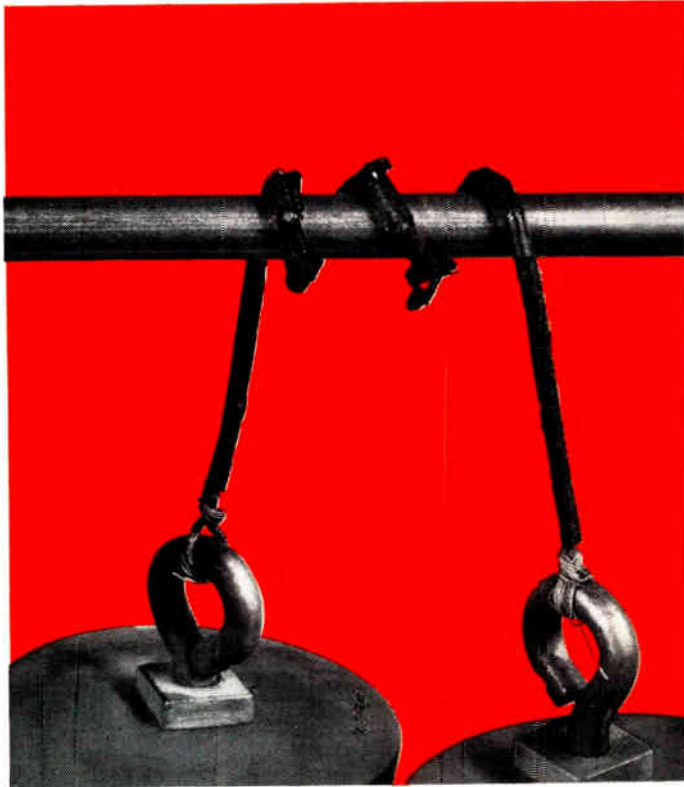

PVC/nylon after 9 hours at 200°C, sample weighted to compress insulation and tense conductor per MIL-W-81044.

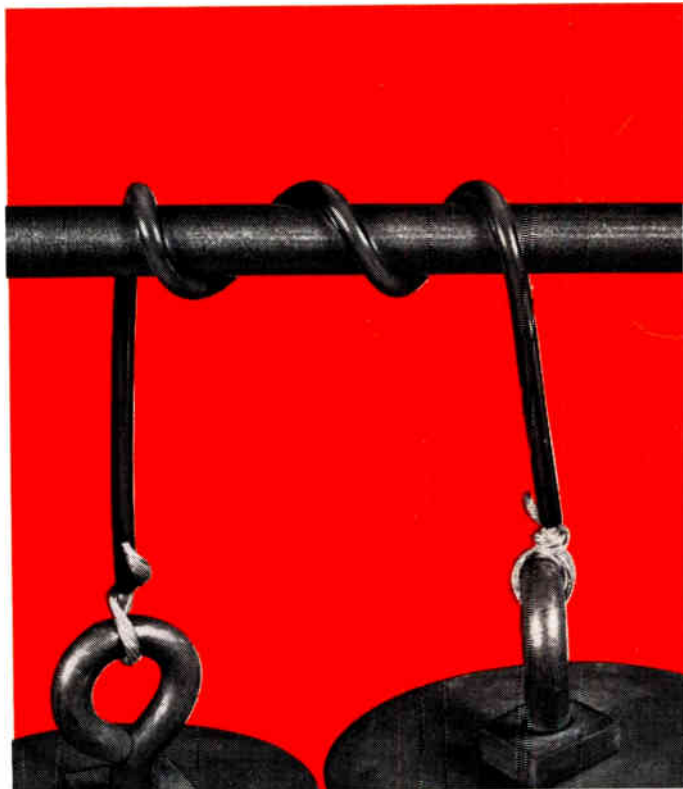

Poly/Kynar after 120 hours at 200°C

Vinyl goes to pieces, Poly/Kynar* looks like new

Heat, abrasion have little effect on tough new MIL-W-81044 aircraft wire

High-temperature capability—Poly/Kynar wire is rated at 135°C for continuous operation. Each lot is acceptance-tested for six hours at 225°C, followed by stringent bending and dielectric tests. The self-extinguishing, nonflowing insulation and jacket are radiation cross-linked for maximal high-temperature form stability, which imparts Poly/Kynar's unique resistance to soldering iron damage.

Poly/Kynar is absolutely nonwicking, since it contains no glass or nylon braid. And the tough Kynar jacket is highly resistant to abrasion, cut-through, solvents and fuels—including Skydrol and jet fuels.

Its light weight and smaller diameter make it ideal for airborne and space applications.

Four types are available: Types 1 and 2 for 600-volt, heavy-duty aircraft and hookup work; Types 3 and 4 for lightweight hookup, instrumentation, black boxes. Want details or engineering samples? Write Dept. EI, ITT Wire and Cable Division, International Telephone and Telegraph Corporation, Clinton, Massachusetts. In Canada, write or call ITT Royal Electric Company (Quebec) Limited, Pointe Claire.

*Kynar is a Pennsalt Chemical Corp. trade name.

wire and cable division **ITT**



MAC Panel Plugboard Programming Systems are total engineered

MAC Panel's total engineering guarantees that the system specifications meet all of your requirements for circuits, space limitations, environmental conditions, signal levels, frequency range, and reliability. From the precise handwork necessary for contact spring placement to the silk-screening of general purpose or

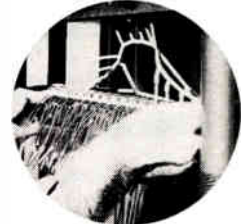

multi-color special legends, you are assured of receiving only top quality, precision products. MAC Panel offers eleven standard sizes of Plugboard Programming Systems and a wide variety of standard Plugwires.

We can also provide custom designed systems and wires for special applications. Find out how MAC Panel can give you a reliable, low-cost method of flexible program control in your equipment. See your MAC Panel representative or write today.

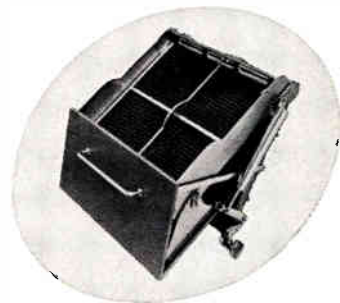

MAC

O.E.M. Division

MAC PANEL COMPANY, High Point, North Carolina

Representatives Throughout the World

Once you take the measure of Helipot trimmers, you'll use them as a rule



Here are some of the rules for measuring

What do you look for in trimming potentiometers? Probably the same things that Helipot has established in 20 years of leadership in precision pots. By almost any standard of measure, you get more in the broad line of Helitrim® trimmers. If force of habit has caused you to overlook the important facts below, take a minute to brush up. You'll be doing yourself a favor.

Measure for Mounting Styles. Sizes and shapes to meet any application. Leads, pins, solder lugs and various panel mounts. All pin configurations, too, so they'll fit anywhere any other trimmer will.

Measure for Resistance Range. From 10 ohms to 2 megohms in every model, widest range in the industry. Rugged cermet resistance element, too, that has it all over wirewound or carbon elements. The cermet element is im-

mersible, shock resistant, free from sudden failure and offers essentially infinite resolution. **Measure for Price.** Helitrim trimmers stretch to fit any requirement and price, from military models to commercial trimmers priced *below a dollar* in quantity. They're *all* priced competitively or *below* trimmers you may currently be using.

While you're measuring, don't forget availability. Helitrim trimmers are available from stock in large quantities, and there are 32 Helipot sales offices to serve you. Ask one for the new Helipot trimmer catalog.

Beckman®

INSTRUMENTS, INC.

HELIPOT DIVISION

FULLERTON, CALIFORNIA • 92634

INTERNATIONAL SUBSIDIARIES: GENEVA, SWITZERLAND;
MUNICH, GERMANY; GLENROTHES, SCOTLAND; PARIS, FRANCE;
TOKYO, JAPAN; CAPE TOWN, SOUTH AFRICA

LETTERS

to the Editor

Reprint Permission?

Editor, ELECTRONIC INDUSTRIES:

I would like to request permission to reprint 35 copies of the article entitled "A Survey of Commercial Semiconductor Photosensitive Devices" by R. D. Kaus, which appeared as IBM Technical Report 07.062. I understand you have purchased copyrights to this article from Mr. Kaus, who is an IBM employee at our Rochester, Minnesota facility. With your kind permission we would use this article as a hand-out in an upcoming Engineering Education class at IBM Kingston.

R. A. Reynolds
Eng'g Education Mgr.

IBM
Data Systems Div.
Neighborhood Rd.
Kingston, N. Y.

Ed. Note: Permission granted provided source of the information is clearly shown on the reprint.

We Like Him . . .

Editor, ELECTRONIC INDUSTRIES:

I have just received my copy of the September issue of your magazine and I find that the Wire & Cable Reference Chart which you included is an outstanding compilation, in fact the best that I have seen of this nature. I consider it so good that I would like to be greedy enough to request up to 50 reprints from you so that I can distribute them to all the electrical engineers and certain key mechanical engineers in our Division of McDonnell Aircraft Corporation.

Let me express my thanks now for the valuable magazine which you publish. Within it we are greatly assisted in keeping up with the state of the art, and sometimes just a little ahead of that. As a matter of fact, in my opinion the greatest means of an engineer continuing his education lies in the magazines such as you publish.

J. Spruce White, Supv.
Materials and Process Corp.
Dept. 957, Bldg. 101B

McDonnell
Electronic Equipment Div.
Box 516
St. Louis, Mo. 63166

pick a signal

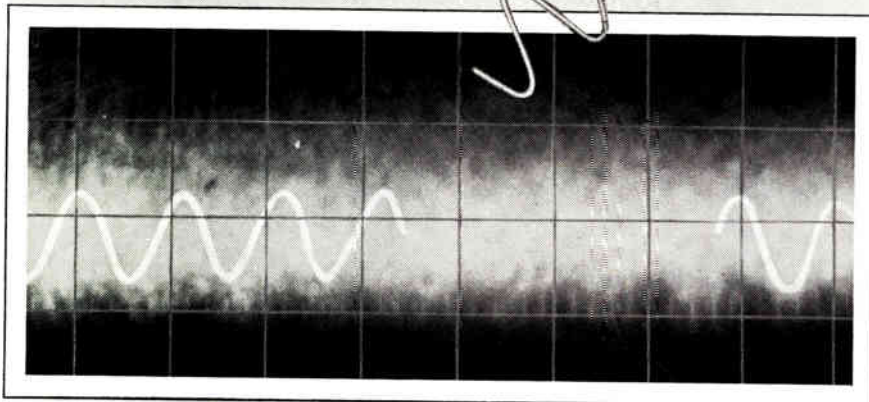

out of a 38 db noise background and reproduce it clean at 1v rms. with INTERSTATE'S AUTOMATIC SIGNAL TRACKING FILTER

■ Automatic Bandpass Filter ■ AM and FM Demodulator ■ Automatic Doppler Signal Tracker ■ Variable Bandpass: 2.5 to 100 cps ■ Wide Frequency Range ■ Solid State ■ Third Order Filter ■ Reliable.

This all solid state variable bandpass filter picks a signal out of -38db signal: noise. Its center frequency locks to the frequency of the signal to be tracked, then tracks it anywhere through a 100 cps to 120 kc spectrum. Output is a clean replica of the tracked signal. Send for brochure.

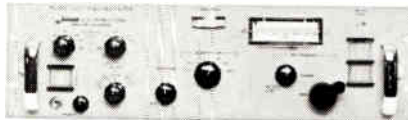

INTERSTATE ELECTRONICS CORPORATION

707 EAST VERMONT AVE., ANAHEIM, CALIFORNIA 92805
Regional Offices: Atlanta, Georgia • Washington, D. C.
Subsidiary of INTERSTATE ENGINEERING CORPORATION



MS-3110

MS-3112

MS-3114

MS-3116

MS-3118

MS-3120

MS-3122

MS-3124



**Solder
Terminals**



**Crimp
Terminals**

26482 CONNECTORS

Methode "Midgets" are available in all standard shell sizes and insert configurations with solder or crimp type terminals.

Removable and replaceable one piece contact retention clips have been proved reliable in over 10,000 insertions and withdrawals.

Methode's unique contacts provide positive contact sooner upon entry of pin; lower insertion force and higher retention without millivolt drop variation.

Methode can provide complete assembled connectors with solder pot terminals or unassembled connectors or will supply contacts only.

Specials? Try us.

Write for catalog 482-A and crimp contact folder right away.



Methode Electronics, Inc.

7447 W. Wilson Ave. • Chicago, Illinois 60656 UNDERhill 7-9600

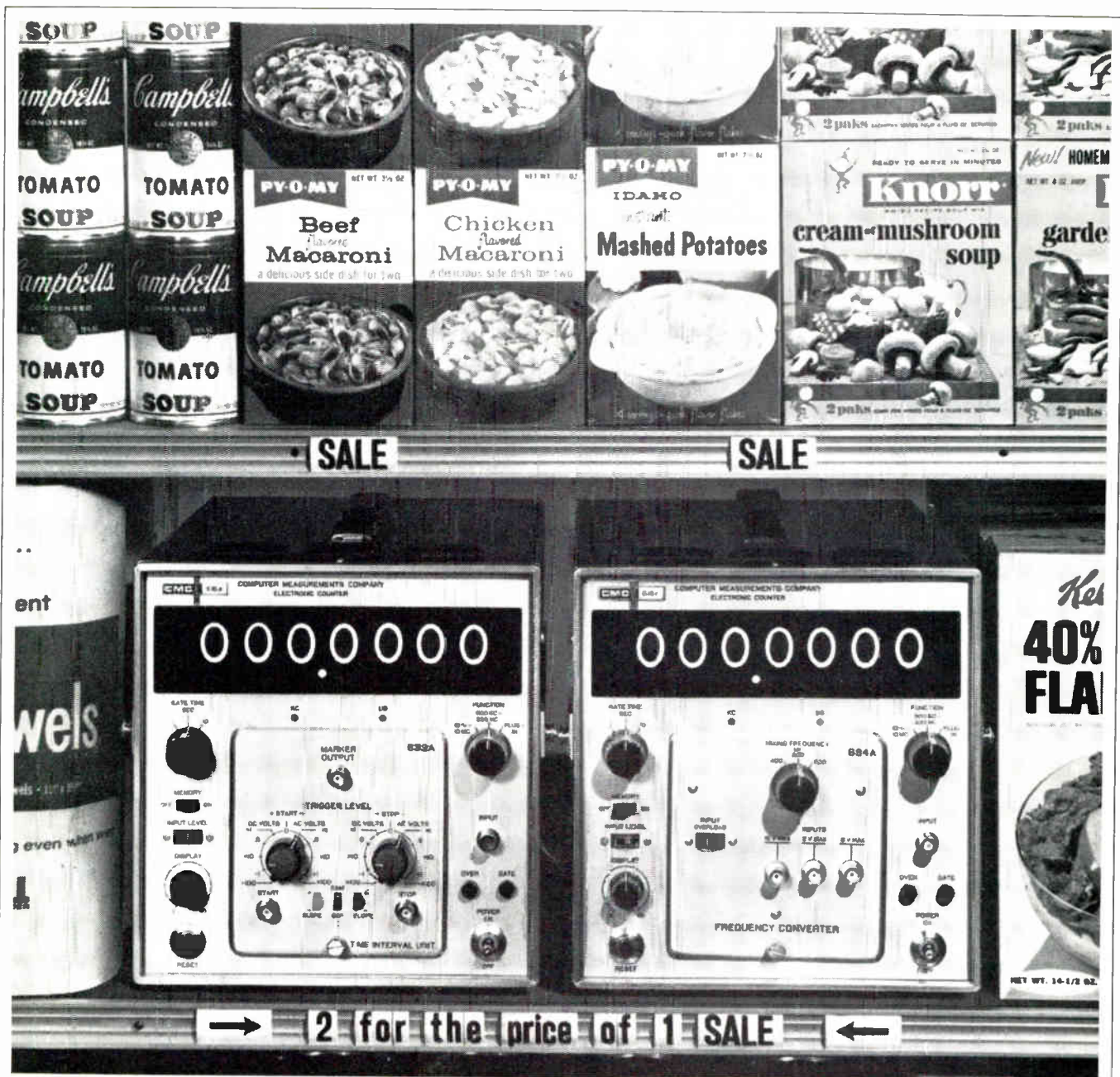

No, it's not the start of a price war. We're simply demonstrating that our new solid-state Model 616A frequency meter costs about half the price of any other comparably performing instrument now available. But, since the 616A is so versatile, who needs two of them anyway? This clever little instrument, with all silicon semiconductor insides, gives you direct frequency measurement through the entire 225 Mc telemetry band, and as high as 12 gigacycles with one plug-in. That's because we cunningly built in the prescaler.

But Hewlett-Packard and Beckmar didn't. Theirs is a plug-in to a counter, and the total cost is twice that of our 616A. Then they sell you a second

plug-in to measure above 400 Mc. Speaking of plug-ins... the 616A comes well equipped! Slip in a frequency converter or other special CMC frequency extender plug-ins, and your frequency measurements can soar to 1,000 Mc, 3,000 Mc, and even a phenomenal 12 gigacycles! Or, with our time interval plug-ins, measure time from .1 μ sec. to 1 sec., or 1 μ sec. to 10 sec.

Not only is the Model 616A half the price, but notice, it's half-rack size too! One reason is because, like others in the 600-Series, it features



an advanced "mother board" technique. Lost are excess size, weight, and components; gained are new shape, reliability, and ease-of-maintenance. Button it up with its front cover and this rugged 28-pound wizard goes right out in the field.

All this for just \$2,185. Interested? Then send now for the complete specs. And, if you're new at comparing our specs to high-powered H-P and big, bad B, you can earn a glorious Crusading Engineers' medal which reveals to everyone that you had the guts to look at somebody else for a change. It's also a great conversation opener for sweet young things you want to dazzle at your next T. G. I. F. party!

12976 Bradley · San Fernando, California · Phone (213) 367-2161 · TWX 213-764-5993

COMPUTER MEASUREMENTS COMPANY IS A LEADING DESIGNER AND MANUFACTURER OF ELECTRONIC INSTRUMENTATION TO COUNT, MEASURE, AND CONTROL.

You have no idea of the many uses in which Allen-Bradley permanent magnets are doing "a better job!"

For instance, HAMILTON BEACH uses Allen-Bradley MO5C oriented ceramic magnet material in the motor of their new electric knife, which has "taken the country by storm." It made possible a reduction in the size of the motor, enabling an improvement in styling and "balance" of the knife.



CONTROLS COMPANY OF AMERICA specified the toroid size and shape, along with the desired magnetic force for the biasing magnet in their new Model 84 low voltage thermostat. Allen-Bradley was able not only to furnish a ceramic permanent magnet to fit these exact specifications, but also provide greater consistency than obtained with the metallic magnets previously used.



BRIGGS & STRATTON'S new ignition system greatly improved coil plug, and point life. Allen-Bradley MO5B permanent magnet material met all the requirements for magnetic strength, coercive force, and temperature coefficient.



BADGER sanitary meter for liquid foods employs a magnetic drive consisting of permanent magnets on either side of the chamber wall, which eliminates the need for a packing gland. Allen-Bradley ceramic permanent magnets provide the required long service life.



Allen-Bradley ceramic permanent magnet materials cover such a broad range of specifications, that they should be able to satisfy new and unusual design problems that may be baffling your engineers. Oriented, as well as nonoriented materials, are available. And of these, you'll find the new MO5C permanent magnet material especially interesting.

MO5C is an oriented ceramic permanent magnet material that can open entirely new areas of permanent magnet applications. Outstanding is the fact that it can be produced in shapes previously limited to nonoriented materials. It also has a high energy product—2.6 times that of nonoriented materials. Then, too, there's a high coercive force and high residual induction. With these properties, this MO5C material has given engineers a new design flexibility—and an economic edge—with the permanent magnet motors which they have developed.

Allen-Bradley engineers will gladly work with your designers in the selection and application of the exact magnetic material for your project. For more complete information, please write: Allen-Bradley Co., 222 W. Greenfield Ave., Milwaukee, Wis. 53204. In Canada: Allen-Bradley Canada Ltd., Galt, Ont. Export Office: 630 Third Ave., New York, N.Y., U.S.A. 10017.



Allen-Bradley ceramic permanent magnets are available in a wide range of sizes and shapes.



ALLEN-BRADLEY

QUALITY MOTOR CONTROL
QUALITY ELECTRONIC COMPONENTS

here are the resistors
you've been looking for
to use in your miniaturized circuits

ALLEN-BRADLEY Type BB 1/8-watt and
Type CB 1/4-watt hot molded resistors
shown approximately 4 times actual size

■ Here are two resistors that are ideally suited for your miniaturized circuits—the Allen-Bradley Type BB 1/8-watt and the Type CB 1/4-watt units. While extremely small, both have integrally molded insulated bodies and are full-fledged members of the Allen-Bradley hot molded resistor family.

This is made possible by employing the same exclusive hot molding process as used for the higher ratings of A-B resistors. The use of special automatic machines removes the element of human error, assuring complete uniformity of physical and electrical properties from one resistor to the next—from one billion to the next. And catastrophic failures are absolutely unheard of with Allen-Bradley hot molded resistors.

Be sure you have full specifications on both of these A-B hot molded resistors on hand. Please send for Technical Bulletin 5050 on the Type CB and Technical

Bulletin B5005 on the Type BB: Allen-Bradley Co., 222 W. Greenfield Ave., Milwaukee, Wis. 53204. In Canada: Allen-Bradley Canada Ltd., Galt, Ont. Export Office: 630 Third Ave., New York, N.Y., U.S.A. 10017.

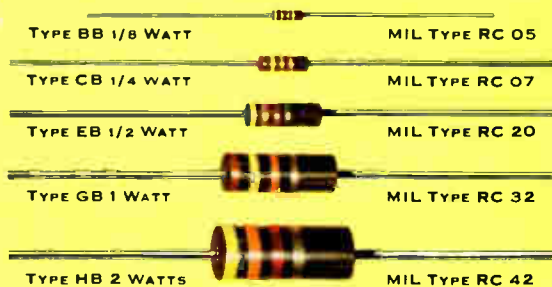

HOT MOLDED FIXED RESISTORS are available in all standard EIA and MIL-R-11 resistance values and tolerances, plus values above and below standard limits. Shown actual size.



ALLEN-BRADLEY
QUALITY ELECTRONIC COMPONENTS

NEW COAXIAL SWITCH CONCEPT

THE HIGH-COST, LONG-DELIVERY annoyance normally associated with custom bladed-type switches is gone, thanks to a new method of coaxial switch construction developed by Amphenol RF Div., Danbury, Conn. Now design engineers can receive extremely prompt delivery of an almost infinite variety of bladed-type switches.

Called "Dynaform," the new switch line uses standard modules to produce hundreds of different combinations. Special designs that required extended delivery time are now, in effect, standard items with off-the-shelf delivery. Modular construction of the units permits tighter control over tolerances and necessary adjustments which contribute to the switch's ultimate electrical performance. This same degree of control and resulting performance would require most conventional switches to be manufactured as precision devices at higher cost.

The switches feature completely-enclosed dust-proof construction with rigidly-mounted coil terminals extending through the cover. They are uniform in size and appearance no matter what terminations and operating coils are used. Excluding connector and coil terminal projections, SPDT and transfer types form $\frac{3}{4} \times 2\frac{3}{8} \times 1\frac{11}{16}$ in. rectangle. DPDT types are $\frac{3}{4} \times 2\frac{3}{8} \times 3\frac{1}{2}$ in.

The switches are designed and tested to exceed the requirements of classes B2b and B3b of Mil-S-3928B.

Their operating temp. range is -55° to 100°C . Depending on type of connectors, terminations, and operating freq., switch vswr ranges from 1.03 to 1.35. Insertion losses range from 0.06db for shorting SPDT types operating up to 0.5gc to 0.50db for resistor terminated SPDT's in the 3.0 to 6.0gc range. RF power rating varies from 500 w. CW (5 kw peak) at 0.5gc to 50 w. CW (2kw peak) from 3.0 to 6.0gc. RF voltage rating for all units is 1000v. peak. Mechanical life rating is a minimum of 1 million cycles.

Standard module produces hundreds of different combinations.



SELF-RENEWING CONTACTS ON NEW MERCURY RELAY

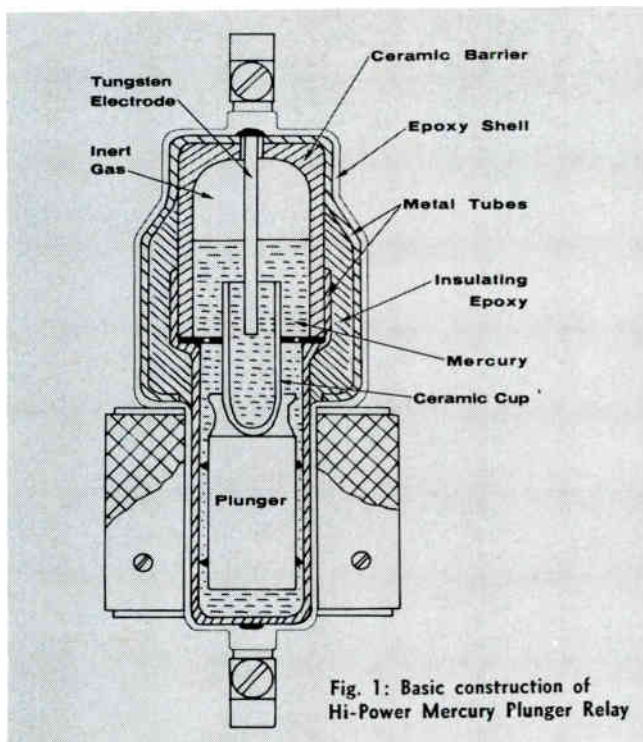

A NEW LINE OF MERCURY PLUNGER-TYPE RELAYS is designed for maximum reliability through a technique whereby the contacts renew themselves each time a contact is made.

When the coil is energized, the magnetic field pulls the floating plunger into the lower pool of mercury. The displaced mercury flows up into the upper contact chamber and joins with the mercury in the ceramic cup, completing the circuit. When the coil is de-energized the plunger moves up, allowing the mercury level to drop, breaking the contact. The liquid mercury-to-mercury contact continuously renews itself on each make, thus eliminating the major causes of relay failure—contact deterioration or sticking and change in contact resistance.

The relays are housed in non-contaminable hermetically sealed steel shells, with the two electrode chambers electrically isolated by a specially formulated, high dielectric epoxy barrier. Fragile glass-to-metal seals are thus eliminated.

A complete catalog of the Hi-Power line of relays is available. Manufacturer is Ebert Electronics Corp., 130 Jericho Turnpike, Floral Park, L.I., New York.

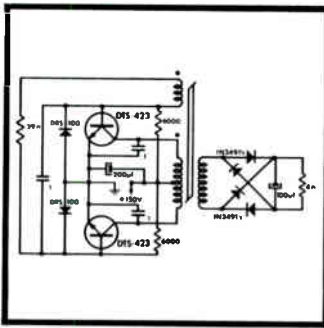

HIGH EFFICIENCY DC-DC CONVERTER

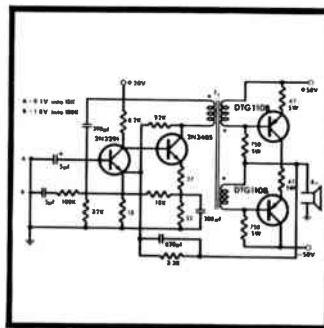

100-WATT AUDIO POWER AMPLIFIER

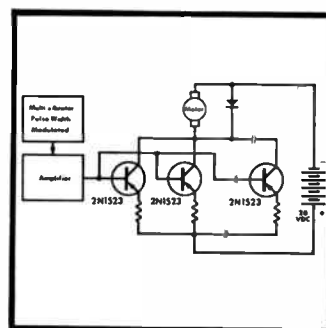

PULSE-WIDTH MODULATED SPEED CONTROL

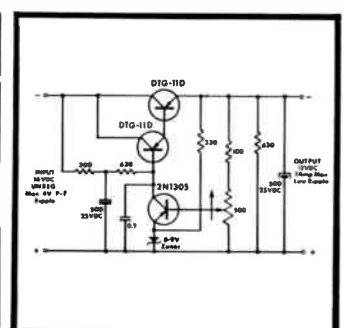

LOW-COST VOLTAGE REGULATOR

Delco's got the solution for every one of them.

HIGH VOLTAGE SILICON TRANSISTORS.

These 400-volt V_{ceo}-rated semiconductors come at less than 3 cents per volt even in sample quantities, have fast switching speeds, good current gain and high power dissipation. You operate them directly from rectified line voltage. They come in TO-3 packages for video deflection output (vertical and horizontal), audio output, inverters and converters, low frequency R. F. amplifiers, fluorescent light inverters, high voltage regulators, and other applications.



HIGH POWER GERMANIUM NU-BASE TRANSISTORS.

This is the family of Delco transistors to consider if you need high betas, high power dissipation and very good high voltage high current sustaining characteristics. V_{ce} ratings up to 325V with low thermal resistance. Very rugged and they come in the solid copper TO-3 package. Among applications are auto ignition systems, video horizontal and vertical deflection systems, high efficiency inverters and converters, fluorescent light inverters, voltage and current regulators, and high current control circuits.



HIGH CURRENT GERMANIUM TRANSISTORS.

Delco makes them available to you in 25-, 35- and 50-ampere ratings, and with a minimum beta of 12 at 50 amperes. V_{ce}-rated to 60V with low saturation and thermal resistances, high power dissipation and in the TO-36 package. Pulse-width modulated speed control is one application. Others you'll consider them for are: high power DC to DC converters, power conversions from low voltage sources, high current control circuits and general switching circuits.



MEDIUM POWER GERMANIUM ALLOY TRANSISTORS.

Very high beta ratings with proven reliability and low cost. These germanium alloy transistors also have linear transconductance and low thermal resistance features, are available in the TO-3 package. The Delco resident engineer in your nearby field sales office will be happy to talk over such applications as hi-fi audio amplifiers, audio output, voltage regulators, medium power inverters and converters, video vertical deflection, medium current control circuits.



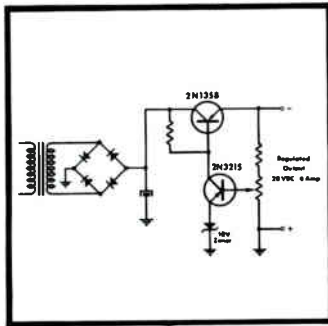

MEDIUM CURRENT HIGH RELIABILITY REGULATOR

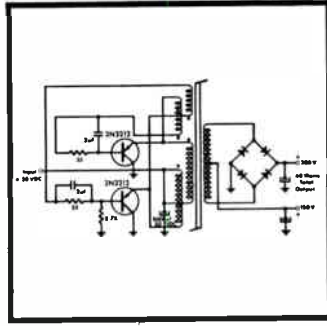

40-WATT DC TO DC CONVERTER

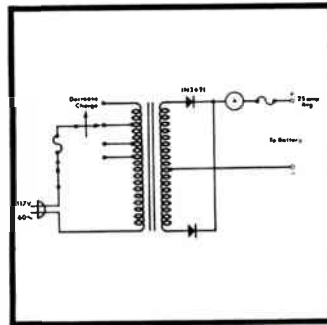

MEDIUM CURRENT BATTERY CHARGER

HIGH POWER GERMANIUM ALLOY TRANSISTORS.

This extremely reliable family of semiconductors comes in the TO-36 package with many beta and voltage ratings (up to 100V). You get 15-ampere switching capability, high power dissipation, low saturation resistance. Consider them when you're working on designs for high efficiency inverters and DC to DC converters, voltage and current regulators, single-ended audio output, control and switching circuits and high power communications modulators.

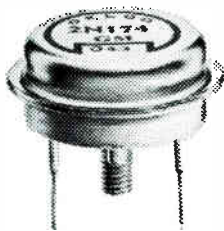

MEDIUM POWER GERMANIUM NU-BASE TRANSISTORS.

Need fast, high voltage switching capability in a small package? This family of Delco transistors brings you both at low cost. Plus high current ratings and good beta to 7 amperes. Get them in TO-37 packages for use in 40-watt DC to DC converters with high efficiency, print-out hammer drivers, portable fluorescent light supplies, audio drivers and output stages, regulator circuits, light flashers, and many others.



RECTIFIERS.

Here's a family of extremely rugged, low-cost rectifiers. They come in either negative or positive, press-fit or stud packages. Half-cycle surge current is rated at 300 amperes with average current ratings to 18 amperes. Uses? A few are auto AC generators, battery chargers, high current bench supplies, general purpose high current rectifying, polarity protection applications. And maybe that problem that came into your office this morning.

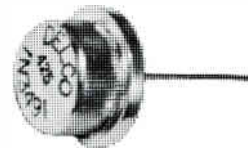

DELCO RADIO

DIVISION OF GENERAL MOTORS, KOKOMO, INDIANA

Our customers report that Delco power semiconductors have performed exceptionally well in all of the applications listed. For an economical solution to your circuit problems, call or write our nearest sales office. They'll provide you with detailed data, prices and applications assistance.

General Sales Office: 700 E. Firmin, Kokomo, Ind., (317) 457-8461—Ext. 500. **Detroit:** 57 Harper Avenue, (313) 873-6560. **Syracuse, N.Y.:** 1054 James St., (315) 472-2668.

A resident engineer and field lab are ready to work for you in:

Union, N.J.: Box 1018, Chestnut Station, (201) 637-3770. **Chicago:** 5151 N. Harlem Ave., (312) 775-5411. **Santa Monica, Cal.:** 726 Santa Monica Blvd., (213) 870-8807.

TWENTY-POLE RELAY

Multi-pole relay provides 15a. at 250vac and 10a. at 100vdc.

Type FEB provides contact configurations up to 20 poles. Contactors are supplied with any ac coil voltage from 6 through 550v. Standard coils are 24, 110-120, 208-240, 440-480, and 550v., 50/60 CPS. Standard dc voltages are 15, 24, 28 to 30, 48 to 50, and 60v. The Rowan Controller Co., Box 306, Bethel Rd., Westminster, Md.

Circle 140 on Inquiry Card

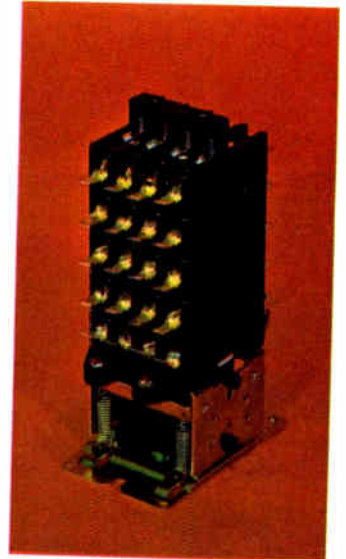

AUDIO TRANSFORMERS

Measures 5/16 in. dia. x 3/16 in. high and weighs 1/20 oz.

The PIL-50 is metal encased, hermetically sealed, and manufactured and guaranteed to Mil-T-27B by full environmental testing. The DO-T type structure used overcomes inherently poor electrical characteristics found in miniature audio transformers. Units are subjected to a 500v dielectric strength test, instead of the usual 100v, for higher safety margins and reliability. These ruggedized units, with a complete rigid cylindrical bobbin, eliminate wire movement and stress. The turns are circular, effecting uniform wire lay and eliminating corner stress. United Transformer Corp., 150 Varick St., New York, N. Y. 10013.

Circle 141 on Inquiry Card



FOUR-DIGIT VOLTMETER (below)

Constant high impedance; accuracy of ±0.01% of full scale.

Model 4000 is an integrating-type DVM which provides controllable, fast readings from 10 readings/sec. to 15 sec./reading. It operates without stepping switches, high precision resistors, and few reed relays. Stability results from a unique freq.-to-voltage comparator. By checking the correlation of the output freq. of the VCO with the input voltage, the freq.-to-voltage comparator corrects for any degree of nonlinearity, and for both short- and long-term drift. Hughes Aircraft Co., Vacuum Tube Products Div., 2020 Oceanside Blvd., Oceanside, Calif.

Circle 142 on Inquiry Card

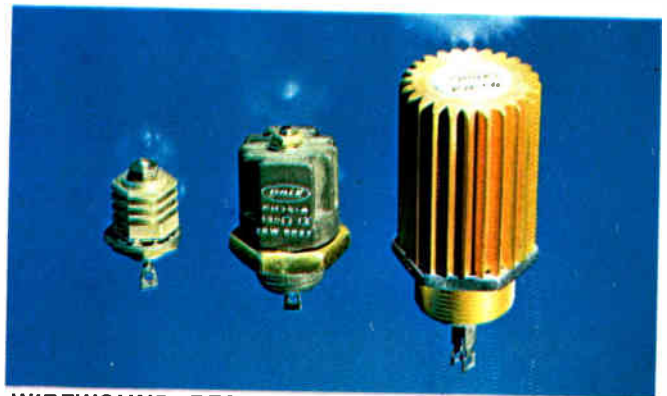
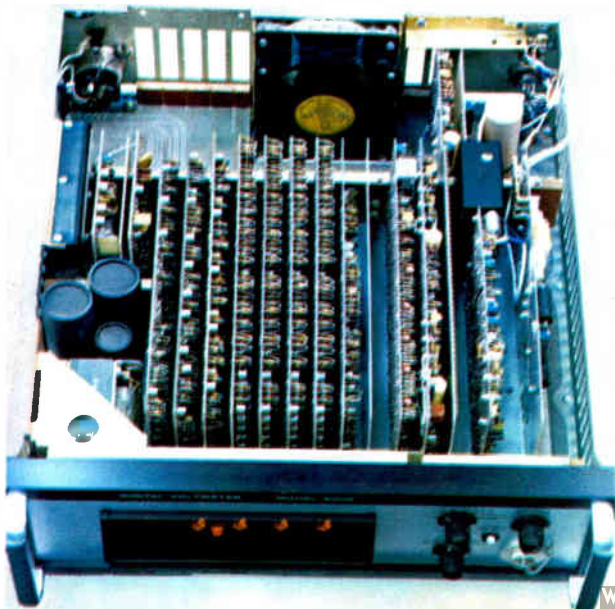

WIREWOUND RESISTORS (above)

Finned aluminum housing contacts the chassis next to hot spot.

This expanded line of PH housed wirewound resistors adds a 50 watt (PH-50) model, and makes two single-termination, non-inductively wound models (PH-10-5 and PH-25-8) available for specialized applications. Three termination methods are provided. Model PH-10-1 has axial spade terminals; models PH-25, PH-50 and PH-100 have side-by-side terminals. Models PH-10-5 and PH-25-8 have a single terminal with one side of the resistor common to the grounded case. The latter termination method cuts assembly time and provides a non-inductively wound low-reactance resistor. This is useful in applications such as high-speed core memory systems. Power rating is 10 to 100w.; resistance range, 0.1Ω to 95.2KΩ; operating temp. range, -55°C to +275°C; tolerances, 3, 1, 0.5, 0.25, 0.10, and 0.05%; temp coefficient, ±50, ±30, and ±20 ppm, dependent on resistance value. Dale Electronics, Inc., P. O. Box 488, Columbus, Nebr.

Circle 143 on Inquiry Card

TWO AXIS ACCELEROMETER

Acceleration-measuring for low-cost inertial guidance systems.

The C70 2414 001 accelerometer is a fluid-damped 2-axis device which measures accelerations up to $\pm 50G$. It has a threshold of less than $10^{-6}G$, and a linearity error of less than $2 \times 10^{-5}G/G^2$. The sensitive element is a pendulum which displaces less than 10 microradians/G of acceleration input. This feature contributes to negligible cross-coupling errors. A novel Hooke's joint flexure precisely defines the pendulum's pivotal point, has low creep and hysteresis effects, and provides good bias stability. General Precision, Aerospace Group, 1150 McBride Ave., Little Falls, N. J. 07424.

Circle 144 on Inquiry Card

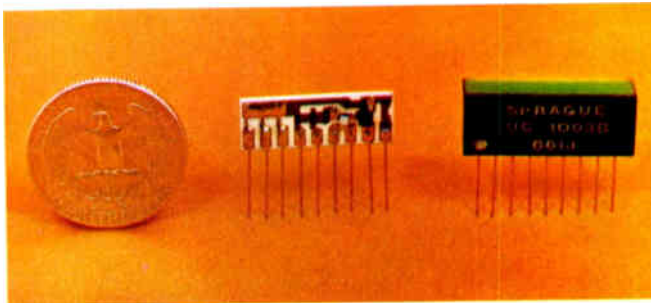

DTL NETWORK

This Ceracircuit DTL logic network is one of a line of 5MC logic modules all housed in a case $1 \times 0.4 \times 0.2$ in. It uses small epoxy-encased transistors and miniature glass diodes bonded to the screened basic circuit with screened passive elements. Sprague Electric Co., No. Adams, Mass.

Circle 145 on Inquiry Card

LIGHT-WEIGHT OSCILLOSCOPE

Uses less than 15w.; has 0.75 μ sec. trigger delay; flat 3 in. CRT.

The Knight® KN-5005 has a dc response of dc to 6MC (± 3 db) at 2 divisions amplitude. At 4 divisions the response is dc to 3MC. AC response is 10 CPS to 3MC at 4 divisions; 10 CPS to 6MC at 2 divisions. The rise time is 0.75 μ sec. at 2 divisions; 0.1 μ sec. at 4 divisions. The horizontal system sweep speeds are 1 μ sec./div. to 100msec./div. in 6 steps. Accuracy is within 3%, 1 μ sec. to 50msec./div.; within 10% from 100-500msec. Allied Radio Corp., 100 N. Western Ave., Chicago, Ill.

Circle 146 on Inquiry Card



X-RAY MASS INSPECTION

NASA is using an instrument to detect faults in relays, capacitors, semiconductors, and other components. Called Searchray, it eliminates the slow and costly X-ray film methods previously used. The new system uses a special vidicon which picks up the X-ray image directly. Because the film and fluorescent screens are eliminated, the picture on the TV monitor is instantaneous and clearer. The Searchray is made by Philips Electronic Instruments, 750 So. Fulton Ave., Mt. Vernon, N. Y.

Circle 147 on Inquiry Card



Permanent Threads Resist Pull Out, Push Out, Torque Out!

National Captive Hardware can improve designs, simplify assembly, and enhance the appearance of your finished product.

Hex-head design resists torque. Recessed cavity accepts cold-flow of parent material. Result: They never push out, pull out, or torque out of the parent material. They can be installed easily without special tools, even in cramped chassis locations. (Just drill hole, insert hardware, and press in . . . even with

an arbor press.) They provide permanent threads for otherwise soft and easily-stripped materials. They are inexpensive.

National Captive Hardware is **the** answer to your fastening or assembly problems. Shown below are just nine possible applications for National Captive Hardware, but many others exist. Why don't you investigate the many uses available?

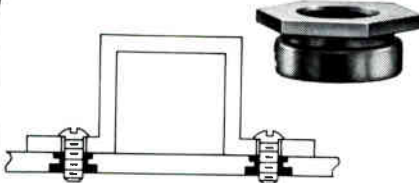
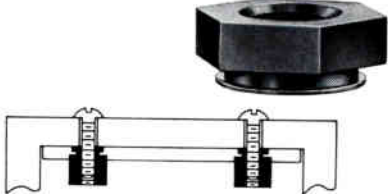
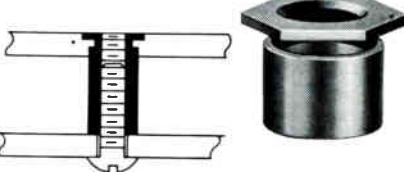
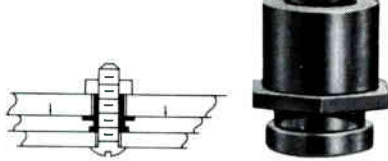
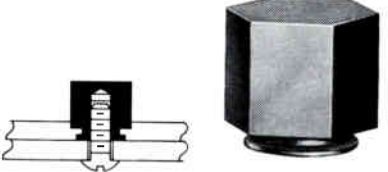
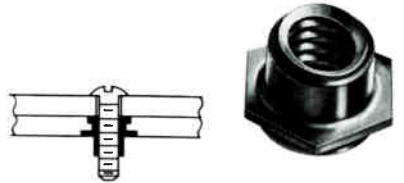
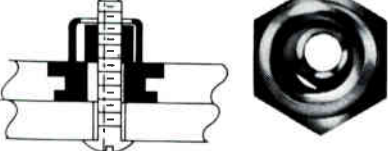
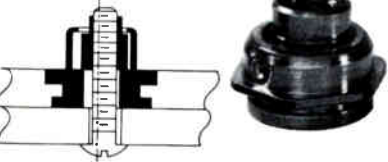
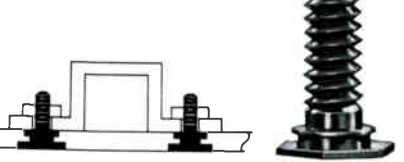
 <p>Back of panel inaccessible, no extensions allowable: Type 1 National captive nut fits flush on both sides. Can be used for mounting bracket or component or in cases when top and bottom are closed.</p>	 <p>Extra threads required, or possibly to stand off compression load: Type 2 National captive nut extends hex-head above parent material, gives extra holding power for thin materials.</p>	 <p>Tensile load spacer needed: National's Type 3 meets several requirements with cylindrical barrel which projects from parent material.</p>
 <p>Compression load stand-off required, need orientation guide for second plate: Type 4 National captive nut meets these requirements while it provides extra threads.</p>	 <p>Need water-tight or short-circuit-proof nut: National's Type 5 do not have through taps, but end in a blind hole, preventing water seepage or shorting of chassis components. Can also stand off compression load.</p>	 <p>Components subject to vibratory or cyclic motion: Type 6 self-locking National captive nut has an oval-shaped extension that holds, yet is easily installed. Meets MIL-N-25027.</p>
 <p>Holes in two materials misaligned: Type 7 National floating captive nut will adjust to correct misalignments of as much as .031". Low profile. Simple installation.</p>	 <p>Holes misaligned, vibration present: Type 8 self-locking version of National's floating captive nuts answer both problems, yet offer strong threads in weaker materials. Type 8 combines the features of 6 and 7. Locking feature meets MIL-N-25027.</p>	 <p>No extensions permitted on panel, but threads required: National's captive stud fits flush with parent material. Wide range of standard sizes and threads, with many others available on special order.</p>

Is your application here?

National Radio Company, Inc.

 37 Washington Street, Melrose, Massachusetts 02176 Telephone: 617-665-4800, TWX: 617-665-5032

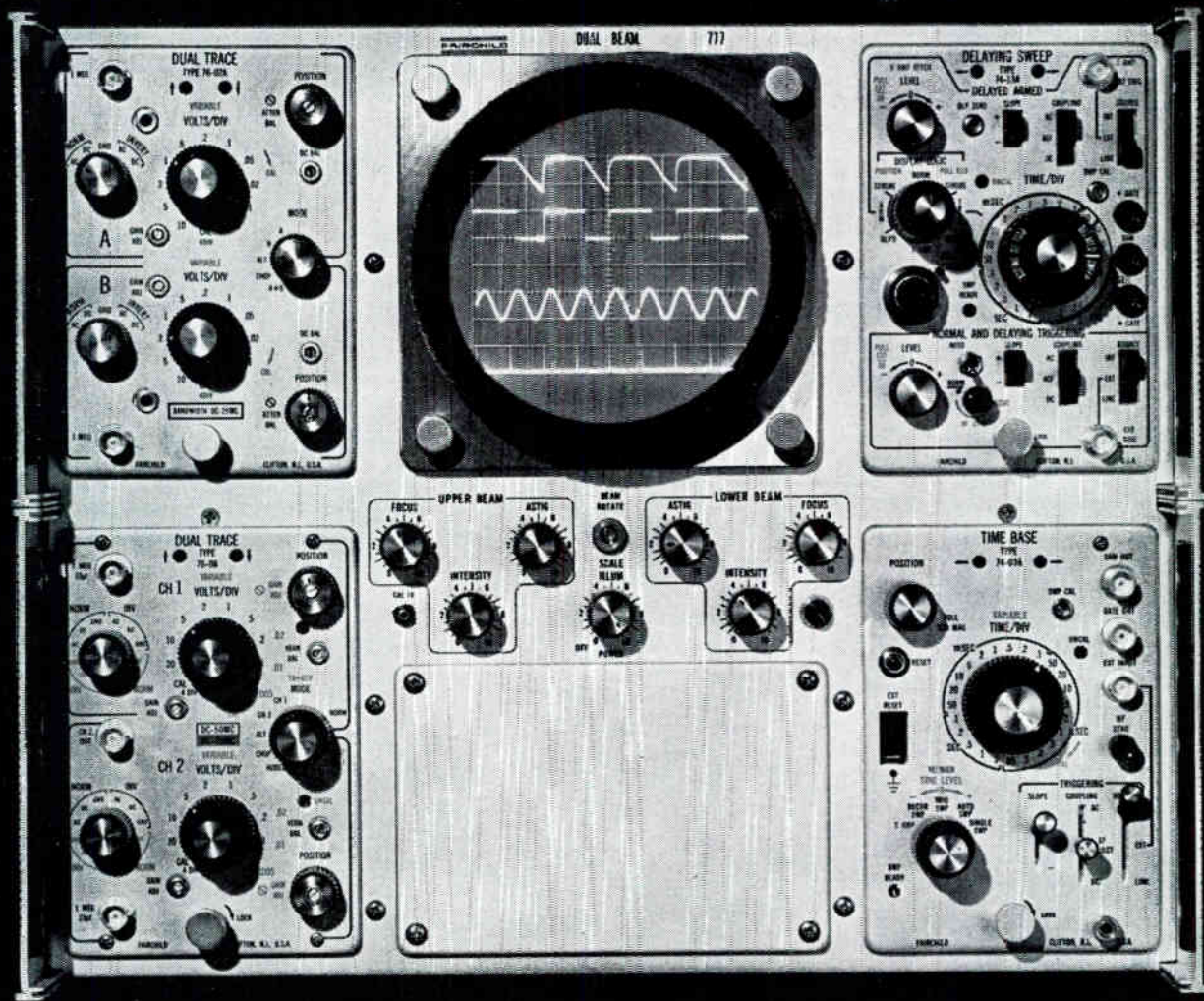

HOW MANY SCOPES CAN THIS ONE REPLACE?

A sizable number, depending upon the range of applications. For this is the Fairchild 777—the most versatile of all industrial scopes. The 777 is a dual beam, dual trace scope in which any four of 22 plug-ins are completely interchangeable in both X and Y cavities. These same plug-ins fit all Fairchild 765H Series scopes. They include DC-100 mc bandwidth, spectrum analyzer and raster display capabilities, sensitivity to 500 $\mu\text{v}/\text{cm}$, risetime to 3.5 ns.

Other features of the 777 include 6 x 10 cm display area for each beam with 5 cm overlap between beams for optimum resolution... unique 13 kv CRT with four independent deflection structures...solid state circuitry (with all deflection circuitry in the plug-ins)...light weight (44 lbs.)...environmentalized for rugged applications. Price (main frame): \$1,600 f.o.b. Clifton, N.J.



The 777 illustrates the Fairchild concept of value through versatility. One scope doing many tasks is only part of it. Future state-of-the-art capability is equally important because it helps you curb the high cost of Technological

*Technological Obsolescence

Obsolescence. And finally, service. Fairchild has more service centers than any other scope manufacturer.

Ask your Fairchild Field Engineer for details on this and other new generation Fairchild scopes. Or write to Fairchild Instrumentation, 750 Bloomfield Ave., Clifton, N.J.

FAIRCHILD

INSTRUMENTATION
A DIVISION OF FAIRCHILD CAMERA
AND INSTRUMENT CORPORATION

FREQUENCY STANDARD

60-cycle standard has bi-metallic tuning fork operating at 960 cps.

This standard has 4 stages of binary division which count down to 60 CPS. The higher freq. tuning fork provides greater stability with changes in temp., attitude, and supply voltage and is more immune to vibration. Output is either an 8v. peak-to-peak square wave, or 3v. RMS sinewave into a 10K load with a 12v. supply. Case is 1½ x 1½ x 2 9/16 in. high with an octal plug connector. Four accuracy ranges are available from 0.2% over a temp. range of -25°C to +85°C (\$69) to 0.015% from +15°C to +35°C (\$114). Sinewave output is \$15 extra. Fork Standards, Inc., 211 Main St., West Chicago, Ill. 60185.

Circle 148 on Inquiry Card

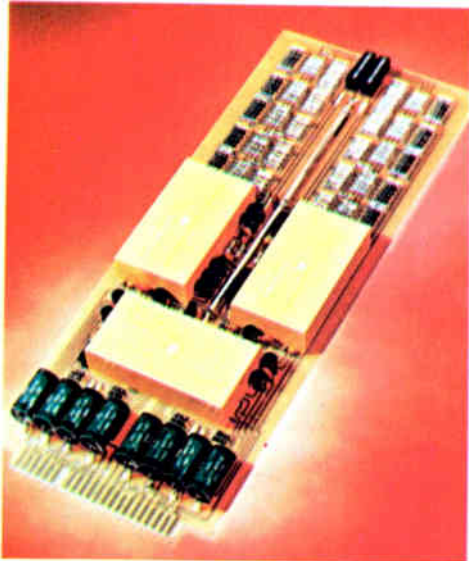

ANALOG MULTIPLIER

Analog multiplying, dividing, squaring, and sq.-root extraction.

Model 502A is a quarter square multiplier. Inputs required are +X and +Y and an inverter on the card gives complementary values. Where the complements are available externally, the inverter need not be used. Max. error is less than 50mv for both inputs within the range of ±100v. The 2 independent squaring networks may be used independently with max. error of 20mv. The multiplier can be externally programmed to function in any of its operating modes without circuit alteration. Zeltex Inc., 2350 Will Pass Rd., Concord, Calif.

Circle 149 on Inquiry Card

VOLTAGE MEASURING SYSTEM

Provides direct reading 11.111110. Accuracy is 5 ppm.

The Model 1045A voltage measuring system provides direct-reading measurement of dc voltage to 11.111110v. full scale on 3 ranges. Seven decade dials provide 1µv resolution on the lowest range. The system combines a direct-reading potentiometer, a direct-reading standard cell comparator, a guarded voltbox and 2 independent null detectors for state-of-the-art accuracy. A simple checking procedure allows the operator to verify the accuracy of the measurements. Electro Scientific Industries, Inc., 13900 N.W. Science Park Dr., Portland, Ore. 97229.

Circle 150 on Inquiry Card

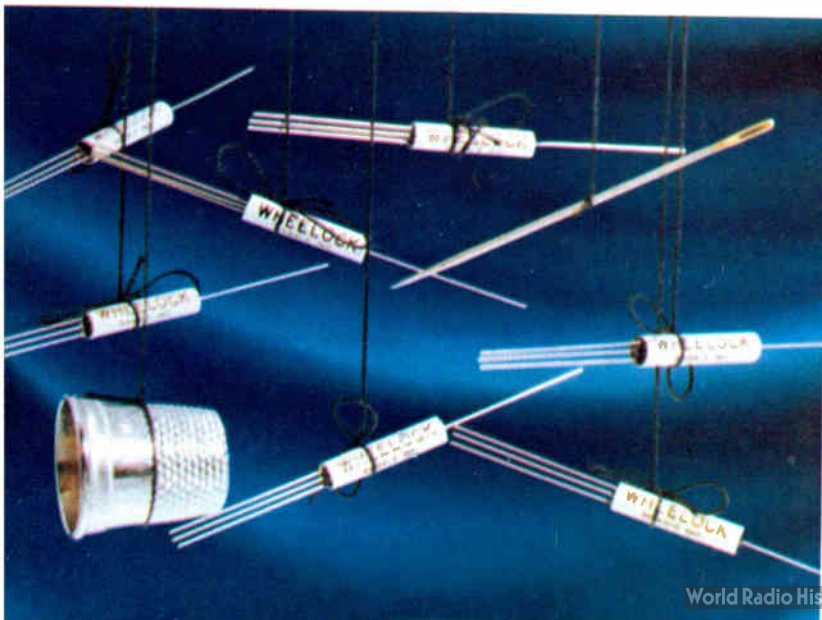

MINIATURE NEEDLE RELAY

Occupies a volume of 0.02 cu. in.; its dia. is 0.19 in.

The series 370 miniature needle relay has nominal coil voltages of 6 and 12v. with nominal rated coil power of 50 or 60mw, respectively. Contacts are rated at 125ma, 4w., and 10 x 10⁶ operations at rated load can be expected. Max. operate time is 0.40msec. The low profile of the relay permits close stacking of PC boards. Application areas include aerospace, integrated circuits and miniaturized instrumentation circuits. Wheelock Signals, Inc., 273 Branchport Ave., Long Branch, N. J. 07740.

Circle 151 on Inquiry Card

SWITCH/DISPLAY MATRIX

For customized keyboards and control panels. Offers flexibility.

Keyboards comprised of bench-assembled switches and indicators can be arranged by units in any pattern of squares, rectangles and rows. A "KB" unit is $\frac{3}{4}$ in. sq.; a $\frac{1}{2}$ unit is $\frac{3}{4} \times \frac{3}{8}$ in.; a $1\frac{1}{2}$ unit is $\frac{3}{4} \times 1\frac{1}{8}$ in.; and a 2-unit is $\frac{3}{4} \times 1\frac{1}{2}$ in. Units may be assembled into a variety of strong, yet light, rows or matrix configurations. The rigidity of mounting hardware eliminates extensive panel reinforcement. Selective external connections are used for direct encoding, which eliminates intricate wiring. Micro Switch, Freeport, Ill.

Circle 152 on Inquiry Card



LOGIC LABORATORY

Helps newcomers learn logic or it can be used as a breadboard.

The Logic Laboratory is a training device and design tool. It contains a power supply, pulse generators, controls, indicators, mounting hardware, and logic modules. All hardware is entirely flexible and expandable. Those learning logic can construct operating logical systems. When used as a breadboard, full scale computer elements or test systems can be built. Digital Equipment Corp., Maynard, Mass.

Circle 153 on Inquiry Card

SLOTTED LINE

Measure impedance of large size coaxial devices in their own dia.

These slotted lines come in 3 different diameters. The $1\frac{5}{8}$ in. slotted line has a freq. range of 300-3000MC. Freq. range of 300-1350MC is reported for the $3\frac{1}{8}$ in. model; and 300-900MC for the $6\frac{1}{8}$ in. slotted line. Characteristic impedance is $50 (\pm 0.15)\Omega$ for the 2 smaller dia. units and $75 (\pm 0.22)\Omega$ for the larger. Residual VSWR is less than 1.010. Lower freqs. and other impedances are also available. Phelps Dodge Electronic Products Corp., 60 Dodge Ave., North Haven, Conn.

Circle 154 on Inquiry Card

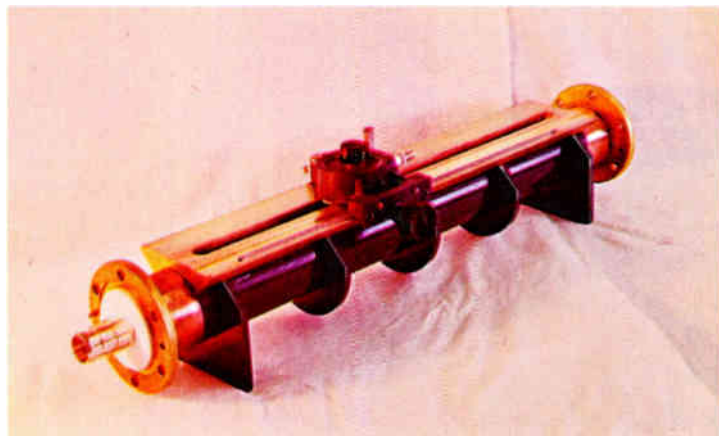

MINIATURE DATA SYSTEM

Gives 50kc data throughput with 12- or 15-bit resolution.

The Multiverter® replaces 3 or more chassis normally needed in the analog front end of data systems. It combines an integrated circuit multiplexer, an advanced sample and hold amplifier, and an analog-to-digital converter. The system provides 12-bit data throughput at 50KC or 15-bit at 30KC. Each multiplexer card accommodates 16 input channels. The sample and hold amplifier has a 100nsec. aperture time and settles in 4nsec. to 0.01% accuracy. Raytheon Computer, Santa Ana, Calif.

Circle 155 on Inquiry Card

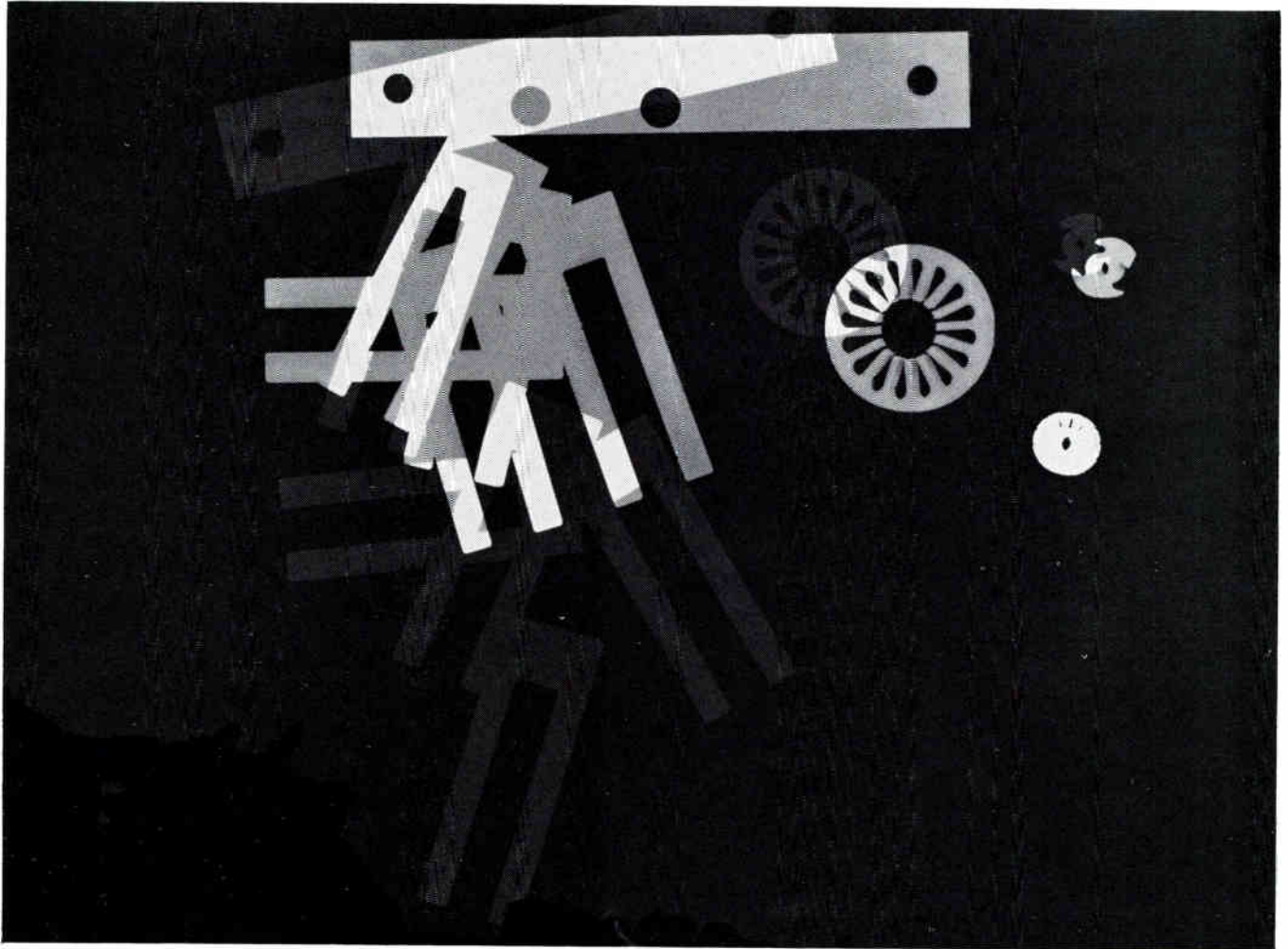

Cut energy loss, core size, and weight with Armco 48 Ni and 48 Ni-R Nickel-Iron Magnetic Alloys



Armco 48 Ni and 48 Ni-R magnetic alloys offer you a wide range of magnetic properties, thicknesses, and costs. They enable you to select core material to achieve the most effective design for high quality audio and instrument transformers, specialty motors and generators, communications, computer, and other high frequency equipment.

Armco 48 Ni is produced in thicknesses of 14, 10, 6, 4 and 2 mils. Precise control of processing assures low hysteresis loss. Armco 48 Ni has

exceptionally high permeability at low and moderate inductions. Its initial permeability is approximately twice that of the oriented silicon steels. Extremely low coercive force enables you to minimize core losses for a wide range of frequencies. In the low and moderate range, H_c for 48 Ni is only 10 to 30% of that for silicon steel.

Armco 48 Ni-R is produced in thicknesses of 14, 10, and 6 mils. Processed to produce small grain size and uniform magnetic properties in all directions, it develops higher per-

meability with a lower temperature anneal than 48 Ni. These special characteristics make it ideal for rotor applications in communications equipment, guidance systems, and sensing devices. Many satisfied customers have reported that Armco 48 Ni-R is superior to any other rotor grade offered in the industry.

For full information on Armco 48 Ni and 48 Ni-R magnetic alloys, call your local Armco Sales Office. Or write Armco Steel Corporation, Dept. E-3395, P. O. Box 600, Middletown, Ohio 45042.

ARMCO STEEL



Photocircuits can solve your **PRINTED CIRCUIT PROBLEMS**

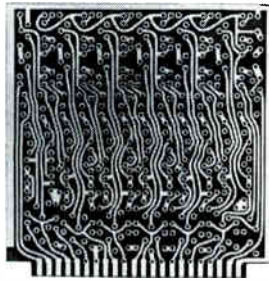

*Here are the solutions
to some typical problems
we have recently received.*

CONCERN OVER MULTILAYER CAPACITY

PROBLEM: A system we are designing requires over 40 multilayer boards. We anticipate a production schedule of five systems per month. Our initial vendor surveys indicate this quantity is too large for the multilayer capacity of local suppliers. Is ours an unusually large multilayer requirement?

SOLUTION: Not for the larger printed circuit manufacturers who have been supplying multilayers for a number of years and have noted the increasing demand for this versatile product. As an example, five years ago Photocircuits was able to fill all customer multilayer requirements with a capability of 50 average size parts per month. Two years ago we had to increase our capacity to 500 parts per month. The newest multilayer facility at our Glen Cove plant is capable of producing over 5000 parts per month. If your boards are typical of those we have made for other systems use, only 5% of our total multilayer capacity would be needed to meet your requirements.

BOARD BREAKAGE

PROBLEM: We are presently using XXXP base material for the printed circuits in our equipment. Production line handling and power driven assembly tools result in cracked and broken boards which have to be scrapped. We can't afford G-10 or epoxy paper. Are there any available low cost materials with high impact strength?

SOLUTION: Photocircuits' new CC-4 additive printed circuit process allows the use of new and unique base materials which are not available as foil-clad laminates. One which seems particularly well suited for your application is a low cost, polyester glass mat material, GL-52R, which was specially developed for use with the CC-4 process. This new material has electrical and mechanical properties superior to XXXP and epoxy paper. Although GL-52R is no more expensive than XXXP, it has an impact strength almost ten times greater. Commercial users have found that breaking, cracking and crazing during assembly and manufacturing are greatly reduced with this material.

*(If you have a problem in printed
circuitry, let us hear from you.)*

SLOW PRICE AND DELIVERY QUOTATIONS

PROBLEM: We often need a quick price and delivery quotation on a number of types of circuit boards for a new application. The time cycle involved in sending out prints to manufacturers and waiting for their reply is often too long for our schedule. How can we get price and delivery information faster?

SOLUTION: Our Standard Circuit Division was set up to help medium quantity users of printed circuits eliminate red tape and delays in quoting and procurement. By only manufacturing boards to a limited number of choices in such areas as base materials, platings and tolerances, the paperwork and communication problems of buying a custom-made component are drastically reduced. The Standard Circuit concept simplifies design and procurement to the point where boards can be ordered from a catalog. The published prices and fixed delivery schedules included in the Standard Circuits catalog should solve your problem. Write us for a copy.

ARTWORK FOR MULTILAYER CIRCUITS

PROBLEM: We've always prepared the master patterns for our printed circuit boards. We have our first application for multilayers and wonder if there are special or unusual requirements for the artwork?

SOLUTION: It would be wise to talk to an Applications Engineer from a reliable printed circuit manufacturer with multilayer experience before beginning the artwork. In addition to requiring much more stringent tolerances and tooling symbols, multilayer artwork almost always requires special attention because of the particular manufacturing process used. Since the artwork for one board may require individual patterns for as many as 15 layers, cost-cutting opportunities should be carefully investigated. Photocircuits' Master Circuit System, for example, uses automatic equipment to produce photographic glasswork for each layer with perfect registration and can save as much as 50% over regular drafting techniques.



Photocircuits

C O R P O R A T I O N

Glen Cove, New York

Anaheim, California

Fig. 1: Diode matrix module (top) and basic memory module (bottom).

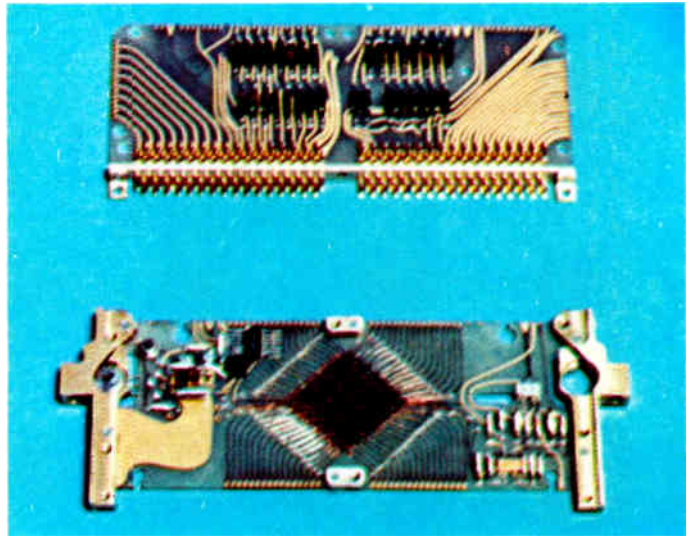

The packaging system described here provides for the compatible use of integrated circuits, thin film circuits, and conventional components in spaceborne digital command and data handling equipments. Design of this system allows for the incorporation of new component types without obsoleting the system.

A Practical Component Packaging

A PRACTICAL PACKAGING SYSTEM for spaceborne electronic equipment must be able to accommodate, in an efficient and compatible fashion, a variety of component types. A packaging system will be described which provides such compatibility. It also provides suitable solutions to other constraints existing in the design of spaceborne digital equipment. This system has been implemented in prototype hardware form and is being applied to a variety of missile and space programs.

Design Procedure

At the outset of the packaging system development, the following criteria were established:

- (1) Maximum use of integrated circuits (IC's).
- (2) Adaptability to the use of thin film microcircuits.
- (3) Compatibility with conventional components.
- (4) A standardized modular system with minimum module types.
- (5) A flexible interconnection system to provide easy adaptation of the module types to a variety of equipments.
- (6) Use of conventional fabrication methods.

To achieve these objectives, a study was made of digital equipment which had been flown on missiles and satellites prior to the start of the study. Also studied were the types of missions and equipment requirements which might be anticipated in the near future. This study indicated that equipment on missile and space vehicles would include PCM telemetry, programmers, data compressors, real time decoders, and eventually general purpose computers. Types of circuits and circuit groups contained in these pieces of equipment were then defined. The degree of commonality at various functional levels was also analyzed. This analysis showed that there were many repetitive circuits and

circuit groups involved, and that the use of standard circuit types was feasible.

The systems study further considered the types of digital functions required and the optimum number of logic functions for a single module. An analysis of information storage needs indicated a strong tendency for grouping into two memory sizes. A study of instrumentation lists yielded the conclusion that analog gates in multiples of 8 would provide the most flexibility.

As a result of the analysis of vehicle equipment functions, a list of 20 module types falling into five general categories was developed. These would fulfill 90% of the circuit needs for the types of spaceborne digital equipment considered. Types of components needed for each function, together with packaging requirements for the modules, and the basic requirements which had been established for interconnection flexibility and modularity then led to the development of the packaging morphology.

Module Types

The module types fall into five families, and within each family several related modules are provided to satisfy various needs. Table 1 lists the module families and types.

By **W. A. KOENIG**,

Manager, Communications & Command,
Dept. 55-42, Bldg. 151,
Lockheed Missiles & Space Co.,
P.O.B. 504,
Sunnyvale, Calif.



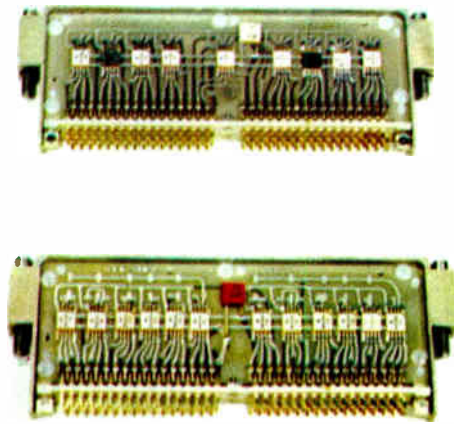
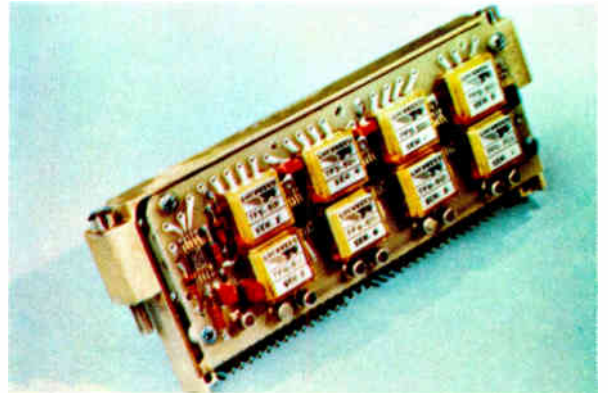

Fig. 2: Two types of logic module (left) make up the logic family. Both types use monolithic silicon integrated circuits of the DTL type.

Fig. 3: Programmer module shown below illustrates how thin film networks are used in conjunction with IC's to generate programming pulses.



System

Clock Modules—An analysis of clock functions indicated that for many uses the stability requirement is low and a rather simple design will suffice. The general purpose oscillator uses a crystal oscillator without temperature control and has a stability of 50 parts/million. For applications such as an orbital programmer, a high stability clock is provided which uses a crystal oscillator with temperature control and has a stability of 1 part/million/24 hrs.

Memory Modules—The basic memory module (M-1) is a 16 x 16 toroidal coil matrix using 50 mil. wide temperature range cores. The associated bit driver and sense amplifier are mounted on the same circuit board with the core matrix, Fig. 1. Memory planes, each containing 256 words 1 bit long, may be stacked in a modular fashion to provide the number of bits needed for a memory system up to a maximum of 32 bits/stack. Fig. 1 also shows the diode matrix module for decoding of the X-Y drive pulses. The M-9 memory module provides strobing and control circuits and also uses voltage failure sensing circuitry to protect against loss of information in the memory in the event of power failure.

Logic Modules—The logic family contains two types of logic modules, Fig. 2. Both types use monolithic silicon IC's of the DTL type. The L-1 logic module contains 12 four-input NAND/NOR gates with all inputs and outputs returned to the external connector for flexibility. The L-2 logic module provides nine binary elements for the implementation of shift registers, ripple counters and similar functions.

Power Supply Modules—Power supply requirements for the universal system are satisfied with three basic dc to dc converter modules which operate from 28 v. dc unregulated. All circuits in the system operate from either ± 28 vdc or ± 6 vdc, so the three types are a

15 w., 6 v. supply; a 15 w., 28 v. supply and a low power 6 v. and 28 v. supply.

Input/Output Modules—The Data Gate Module (I-1) uses a monolithic IC of the FET type. Each module mounts 16 TO-5 cans. These may be used as 32 high level gates (0-5 v.) or as 16 differential low level gates (0-50 mv).

A comparator module (I-2), a programmer module (I-3), and a translator module (I-7) accomplish the A to D conversion. Fig. 3 shows the programmer module. It illustrates how thin film networks are used in conjunction with IC's to generate programming pulses. The thin film circuits shown use titanium resistors and capacitors on an alumina substrate.

The remaining modules in this family include low and high level amplifiers for general purpose use, and a relay driver module. (Continued on page 50)

Fig. 4: Pin side of the wirewrap matrix interconnect board.

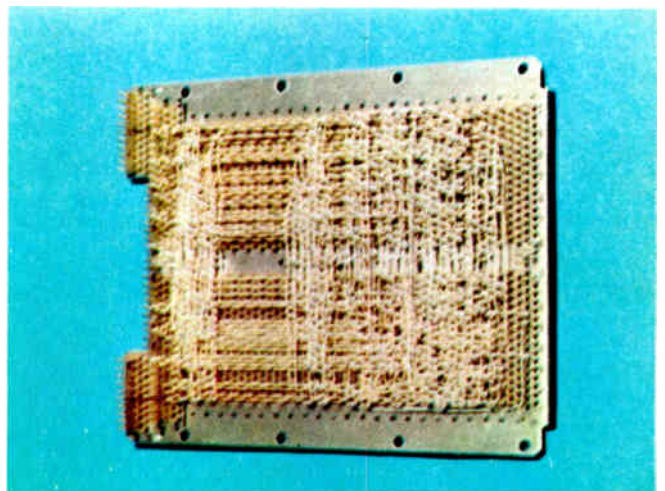



5195



**MIXED ACID
ETCH
3:2:1**

TRANSISTAR®

FOR USE IN MANUFACTURING SEMI-
CONDUCTORS AND OTHER ELECTRONIC
DEVICES AND PRECISION INSTRUMENTS
MALLINCKRODT CHEMICAL WORKS
ST. LOUIS • NEW YORK • MONTREAL

Maximum Limits of Impurities

Acetic Acid (CH ₃ COOH) (w/w) ..	26.9-28.9%
Antimony (Sb)	0.00001%
Arsenic (As)	0.00001%
Chloride (Cl) (w/v)	0.0001 %
Copper (Cu)	0.00001%
Gold (Au)	0.00001%
Hydrofluoric Acid (HF) (w/w) ..	6.6-8.6%
Iron (Fe)	0.0001 %
Lead (Pb)	0.00001%
Nickel (Ni)	0.00001%
Nitric Acid (HNO ₃) (w/w)	38.6-40.6%
Phosphate (PO ₄) (w/v)	0.002 %
Sulfate (SO ₄) (w/v)	0.001 %

This new label puts mix rooms out of business

Mallinckrodt now pre-mixes TransistAR etchants to your proportions on any order of 480 gallons or more. Specify any combination of nitric, acetic and hydrofluoric acids*. You'll get well-known TransistAR high purity (read the label above, for example) and uniformity maintained to within ±1% of your specifications. It's a definite economy. Eliminates mixing errors. Frees your staff for more productive work. Contact us now for full details on new TransistAR mixed etchants.

*Subject to ICC regulations.



ELECTRONIC CHEMICALS
MALLINCKRODT CHEMICAL WORKS
ST. LOUIS • NEW YORK • LOS ANGELES

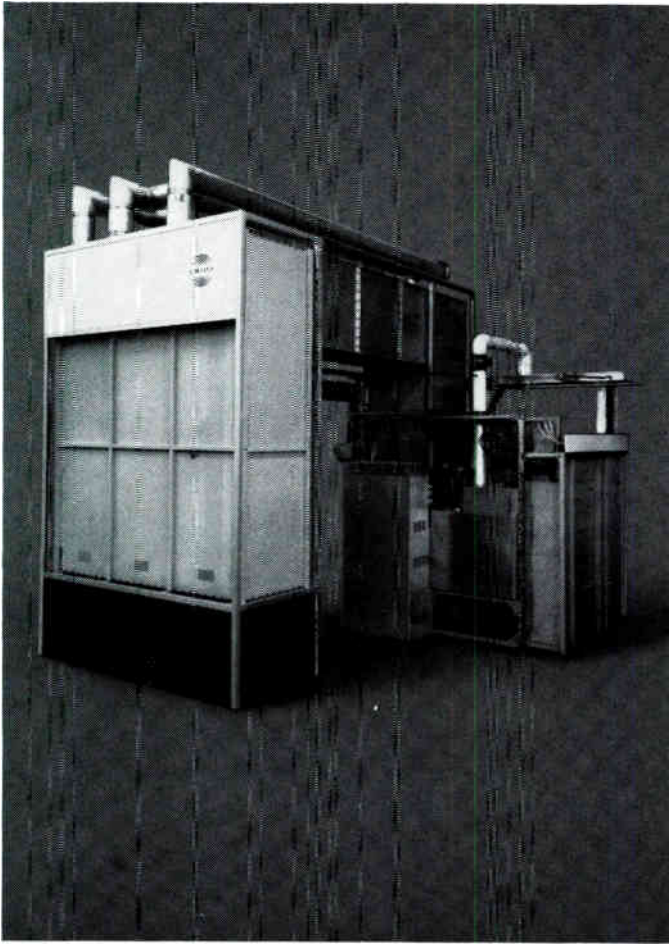

250 KW Transmitter Achieves Extremely High Tank Circuit Efficiency With Jennings Vacuum Capacitors

Two of the most significant features of Collins Radio Company's 821A 250 KW transmitter are the unusually high efficiency of the tank circuits in the final amplifier and the completely automatic tuning techniques. The output network employs large coaxial line sections which are automatically resonated by new internally forced-air cooled Jennings vacuum variable capacitors. It also utilizes the wide capacity range, high frequency response, and high voltage rating of Jennings capacitors to aid in automatic tuning anywhere in the frequency range of 3.95 to 26.5 megacycles.

This permits completely automatic tuning in a maximum of 20 secs and avoids the loss of valuable air time, usually 5 to 15 minutes, consumed by conventional transmitters.

In addition to the low loss dielectric and lowest inductance of any other capacitor Jennings new vacuum capacitors offer (1) highest maximum to minimum capacity change ratios (2) long life (3) high current capability (4) light weight (5) built-in corona rings on many models (6) shock resistant glazed ceramic envelope (7) wide variety to solve most desired combinations of capacitance, voltage, and current.

Whether it's 250 KW or 5 KW, Jennings vacuum capacitors will contribute more to superior transmitter performance than any other capacitor known. A brief examination of our new line of ceramic vacuum capacitors will suggest many new ways in which circuit design can be improved. We will be pleased to send complete details at your request.

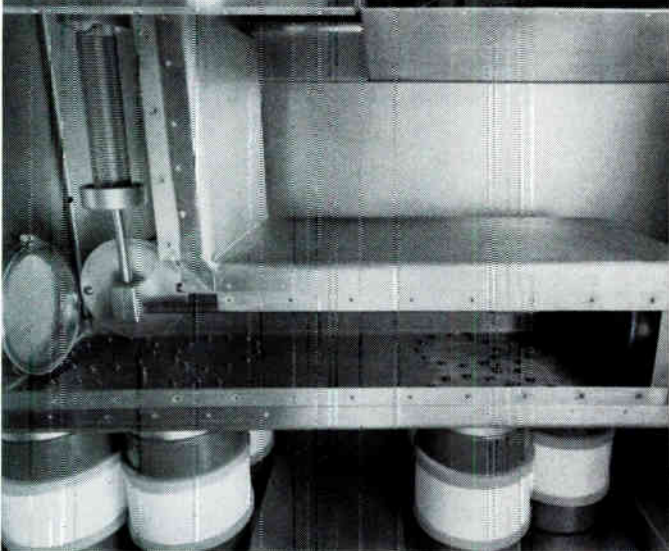

JENNINGS TYPE
CVHP 650

Capacity: 1000 pf
Voltage Rating: 45 kv peak
Current Rating: 215 amps rms



JENNINGS TYPE
CFHP 1000

Capacitance Range: 30-650 pf
Voltage Rating: 45 kv peak
Current Rating: 250 amps rms

RELIABILITY MEANS VACUUM-
VACUUM MEANS

ITT Jennings

JENNINGS RADIO MFG. CORPORATION • Subsidiary
of International Telephone and Telegraph Corporation
970 McLAUGHLIN AVE., SAN JOSE, CALIF. 95108 • PHONE 292-4025

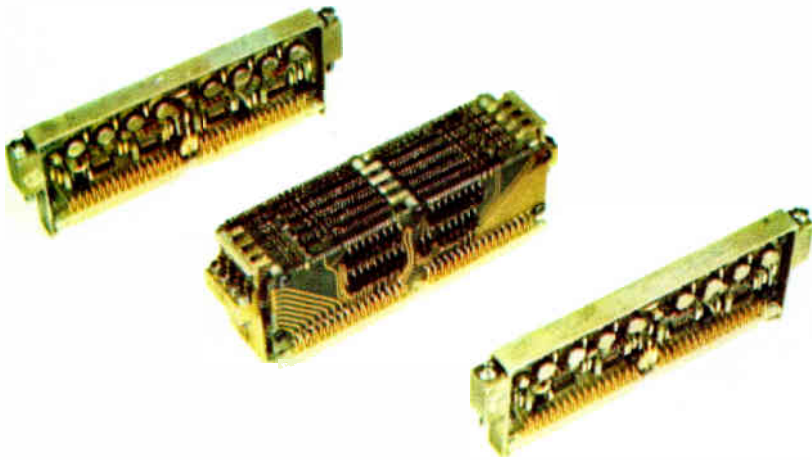

Fig. 5: Special interconnection method used in memory core stacks.

PACKAGING SYSTEM (Continued)

Interconnection Considerations

Interconnections in the packaging system are considered at the component and module levels. The prime consideration in the interconnection of components within the module is compatibility with the various components to be used. IC's may be packaged in either flat pack style or in the multi-lead TO-5 can. The former with thin, flat leads of goldplated Kovar is most suited for a welding or resistance soldering operation using a parallel gap machine. The TO-5 style of package may be either soldered to an etched circuit board or welded in a cordwood type of construction. Conventional components may either be soldered or welded. Consideration of these factors led to the conclusion that

the familiar two-sided etched circuit board, with plated-through holes, provides a near-optimum solution to the problem.

Flat pack IC's are attached to the solder coated copper traces by a resistance soldering operation using a parallel gap welder. Attachment of the thin film circuits, IC's in TO-5 cans, and normal components is done with a wave soldering machine.

Selection of the interconnection media between modules involved consideration of such factors as the required density of point-to-point connections, documentation needs, tooling needs, compactness and flexibility. The methods considered included point-to-point wiring, two-sided etched boards, multilayer etched boards, and wirewrap techniques. Wirewrap was selected because it offers high pin density, is simple to document, comfortably accommodates complex interconnection patterns, and is easily changed.

Fig. 4 shows the pin side of the wirewrap matrix

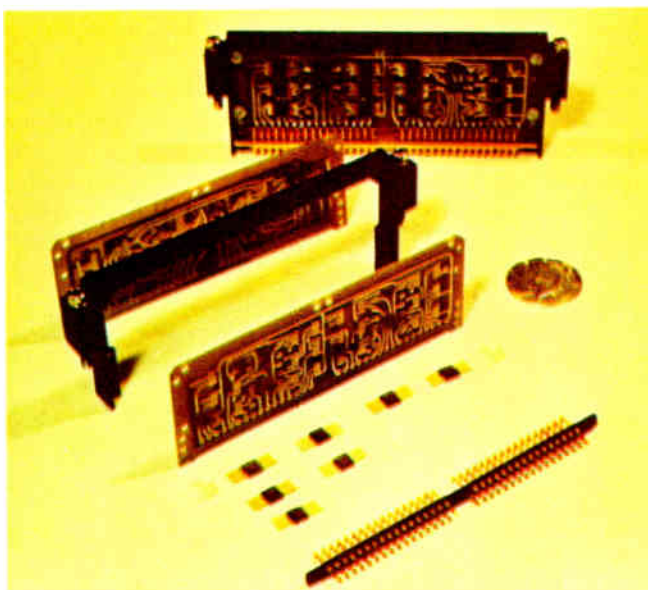
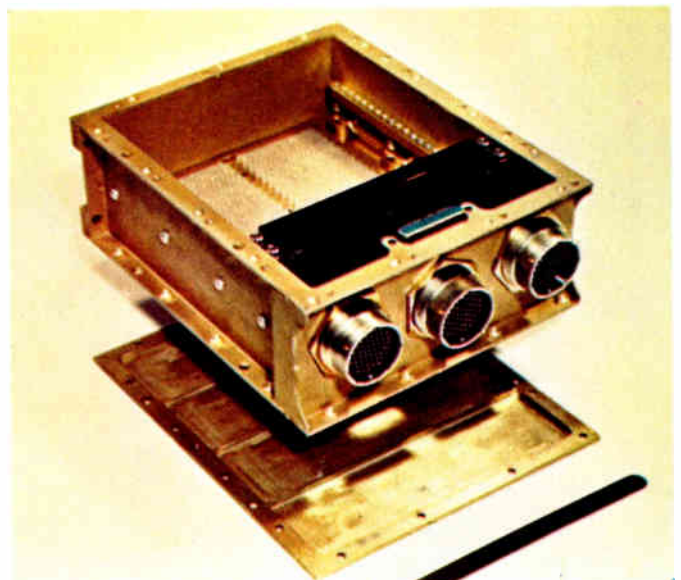

Fig. 6: Basic system module configuration. Two of the boards are attached to a cast aluminum frame to provide for mechanical support and heat transfer.

Fig. 7: Photograph shows how module frames, mounting rails, and wirewrap matrices are mounted in the standard enclosure. Enclosures are designed to be stacked.



motherboard which is used in the packaging system. The main pin field contains 1,524 pins for the interconnection of modules. Wiring shown in the figure is for a small (8 bit, 256 word) memory system with its associated logic and clock functions. It graphically illustrates the degree of wiring complexity encountered in interconnecting logic portions of such a subsystem. Power for all modules is supplied through a series of busses which run down the center of the matrix on the connector side.

A special interconnection method is used in memory core stacks, Fig. 5. The high pulse currents needed in a coincident current memory preclude the use of the wirewrap pins for memory plane interconnections. The photograph shows how buss wires are laid in slots on the edge of the memory boards in a pattern which alternately connects adjacent boards at the top and bottom of the assembly. This method provides for simple assembly and is independent of the number of planes in the stack.

System Packaging

Design objective for the packaging system was that it be modular and that it accommodate a variety of types of components. A module with two dimensions fixed and with the third dimension variable offers a high degree of flexibility consistent with a simple mechanical system. Size of the module boards, as shown in several photographs, is about 2 x 5 in. The basic module consists of the circuit board and connector with its attached components. To provide for mechanical support and for heat transfer, two of the boards are attached to a cast aluminum frame, Fig. 6. Frames are provided in widths of 1/2 in., 3/4 in., and on up in 1/4 in. increments, to accommodate the various types of components used.

Fig. 7 shows how module frames, mounting rails, and wirewrap matrices are mounted in the standard enclosure. External connectors are mounted on the end face of the enclosure and covers are attached top and bottom. The enclosures are designed to be stacked and direct connections can be made between subsystems by means of an auxiliary connector. A half-sized enclosure is also provided. It is the same height and width as the standard enclosure, but is shorter and accommodates half as many frames.

Equipment which is to be operated in the hard vacuum of space must rely solely on conduction for removal of heat dissipated in the circuit components. Frames on which the module circuit boards are mounted provide a direct path for the conduction of heat to the enclosure and, thence eventually, to vehicle surfaces which are capable of radiating energy into space. For circuits where large amounts of heat must be dissipated,

Table 1: MODULE TYPES

Category	Module Number	Module Description
Clock	C-1	General Purpose Crystal Oscillator
	C-2	High Stability Crystal Oscillator
	C-3	Multivibrator
Memory	M-1	16 X 16 Core Plane
	M-2	Current Drivers (4)
	M-3	32 X 32 Core Plane
	M-8	Diode Matrix
	M-9	Strobe & Control
Logic	L-1	Nand/Nor Integrated Circuits (12)
	L-2	Binary (FF) Integrated Circuits (9)
Power Supply	P-1	+ 6 v Supply — High Power
	P-2	± 28 v Supply — High Power
	P-3	± 6 v ± 28 v Supply — Low Power
Input/Output	I-1	Data Gates (32 or 16)
	I-2	Comparator
	I-3	Programmer
	I-4	Relay Drivers (4)
	I-5	Low Level Amplifier
	I-6	High Level Amplifier
	I-7	Translator — Register

several means for transferring heat are used. Two of these methods are apparent in the M-1 memory module shown in Fig. 1. The bit driver circuit must generate large amounts of pulse power when the memory is cycled at its maximum rate and a pattern of "ones" is read into the memory. The transistor in the bit driver is clamped in a hole directly in the module mounting frame, thus maintaining its case temperature close to that of the equipment enclosure. Also, the etched circuit is arranged to provide a broad ribbon of copper from the area under the two heat dissipating resistors directly to the mounting frame.

Conclusions

The universal modular packaging system described provides a high degree of flexibility in the synthesis of digital and related equipment for use in space applications. The module families and the packaging system are currently being applied to a variety of equipment. This equipment includes a PCM telemetry, a memory subsystem, real time decoders, programmers, and timers. Validity of the design concepts have been verified. It has been shown that a variety of component types can be readily accommodated. Since much of the cost and time needed for equipment development is spent in circuit development, this phase has been effectively eliminated. It has been possible to generate a preliminary design, including size, weight, module counts, and approximate cost, in a matter of days after the establishment of performance needs. The use of module and enclosure configuration which have been environmentally qualified provides confidence in the physical integrity of the new equipment at the outset of the design. Physical arrangement of the basic modules and the manner in which they are combined, allow for the incorporation of new component types as they become available, without obsoleting the existing system.

• A REPRINT of ANY ARTICLE in this issue is available from ELECTRONIC INDUSTRIES Reader Service Department.

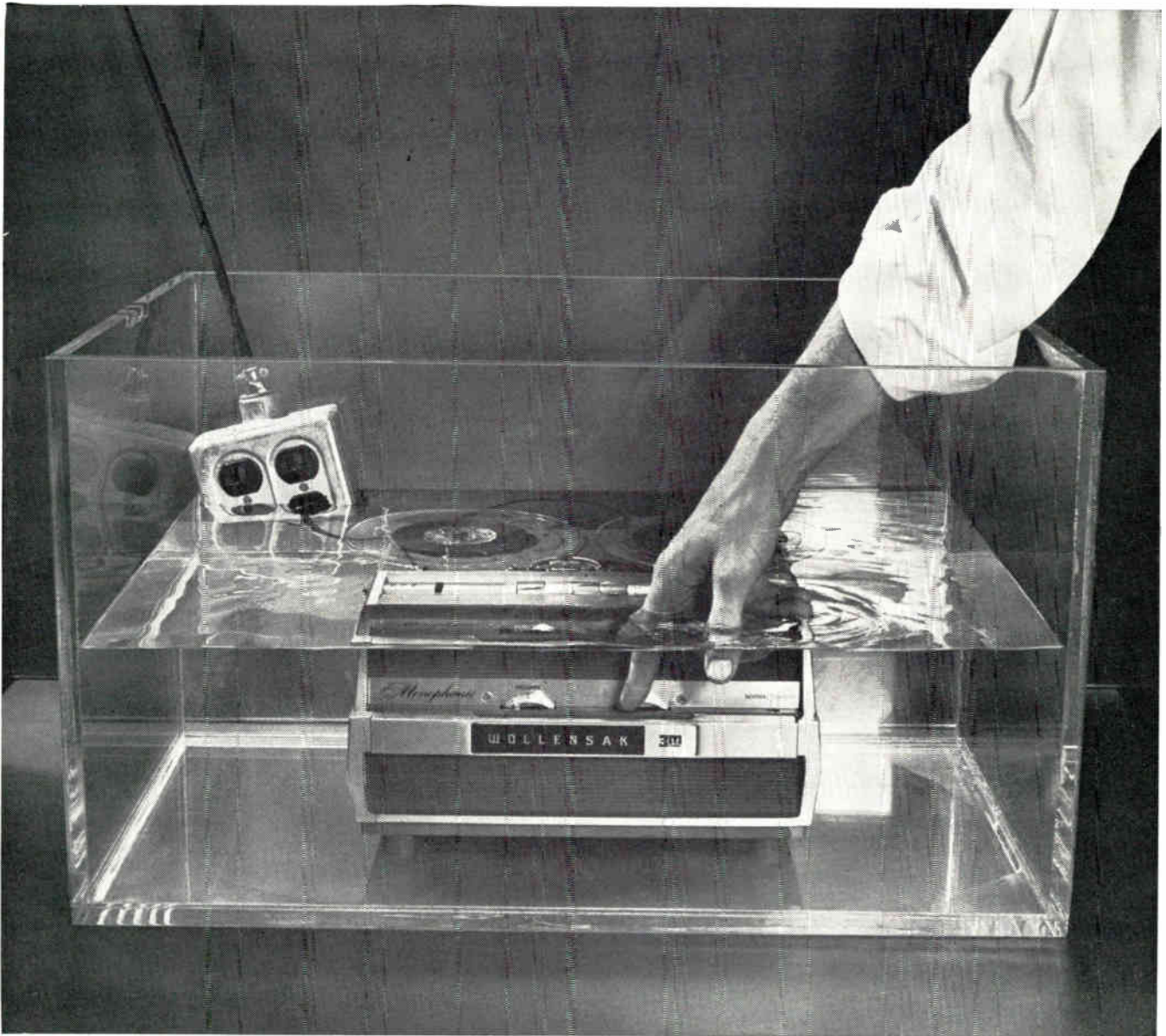

WHAT IS A TAPE RECORDER DOING IN FC-77 COOLANT?

Playing!

This traffic-stopping demonstration of the completely inert dependability of FC-77 coolant has been featured at several national electronic trade shows. An ordinary "right-out-of-stock" tape recorder is lowered into a tankful of FC-77, plugged into an electrical outlet and a hand reaches in and pushes the button to start a practically continuous concert that plays during the show.

All this time, recorder parts of steel, copper, chrome, plastic, rubber, elastomers, glass, nylon, adhesives, as well as recording tapes are directly immersed in FC-77 coolant. Nevertheless the recorder plays on. When at the end of a show, the player is removed from the tank none

of its components are affected. How's that for "inertness"!

All members of 3M's fluorochemical coolant family have this exceptional compatibility with most materials (even at temperatures above the maximum permissible with other dielectric coolants). This "easy-to-get-along-with" coolant, incorporated into your system can bring about better reliability. *Want more?* These coolants have wide liquid ranges, excellent electrical properties, thermal and chemical stability, are non-flammable, non-corrosive, non-toxic. Write and ask about them, particularly our new, economical FC-77. 3M Company, Chemical Division, Dept. KCQ-115, St. Paul, Minn. 55119.

Chemical Division **3M**
COMPANY

WHAT ONE INSTRUMENT...

can be used to accurately test the frequency response of quartz crystals, meeting the rigid requirements of stability, flatness, adjustability and frequency identification necessary for this precise operation?

can measure the dynamic impedance of a power supply at any frequency from 20 Hz to 3000 MHz, or at several frequencies in that range, providing an instantaneous oscilloscope presentation of the supply's impedance characteristics?

can provide complete frequency transmission characteristics of telephone or other transmission lines for equalizing operations, materially reducing testing time, supplying total frequency coverage, and eliminating correlation errors between first and last test readings?

What instrument that does all this can also determine filter passbands, compare input characteristics with phase/amplitude transmission, test relative inputs and outputs of an RF network, and perform many test functions in the lab or in production that by other methods took too much time and supplied incomplete data?

The answer is Telonic's **SM-2000 SWEEP GENERATOR**, a basic control unit that accepts 22 different plug-in oscillator heads covering 20 Hz to 3000 MHz in both wide and narrow frequency segments for a wide variety of applications. It is the most time-saving, versatile instrument you'll find on any test bench.

MORE APPLICATIONS- On request, Telonic will be glad to send you an Application File Folder covering all techniques mentioned here in detail, in addition to many other applications for swept frequency measurements. Your request also places your name automatically on our mailing list to receive further application notes for the file.



Telonic INDUSTRIES INC.
60 North First Avenue, Beech Grove, Indiana
Tel: (317) 787-3231 TWX: 810-341-3202

International Leader in Swept Frequency Instrumentation.

Representatives in all major cities in the U.S. and throughout the world.

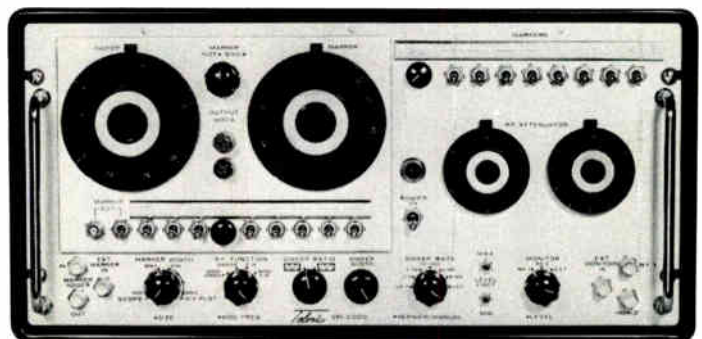
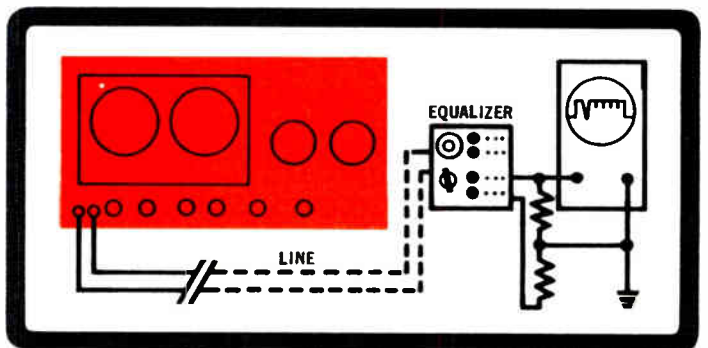
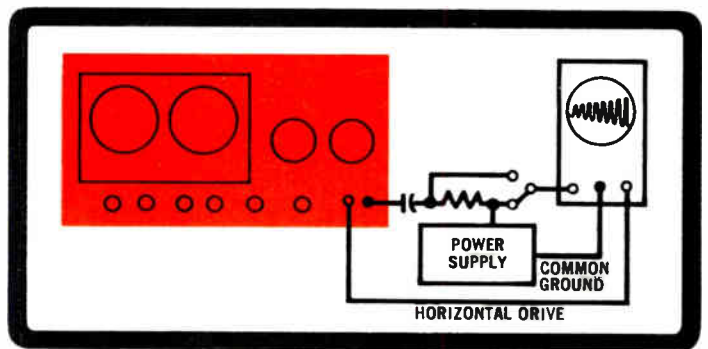
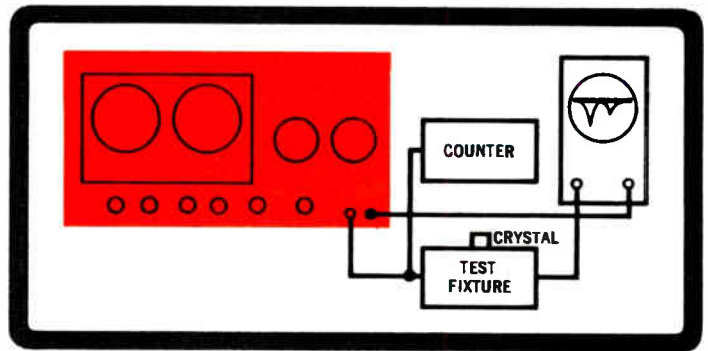

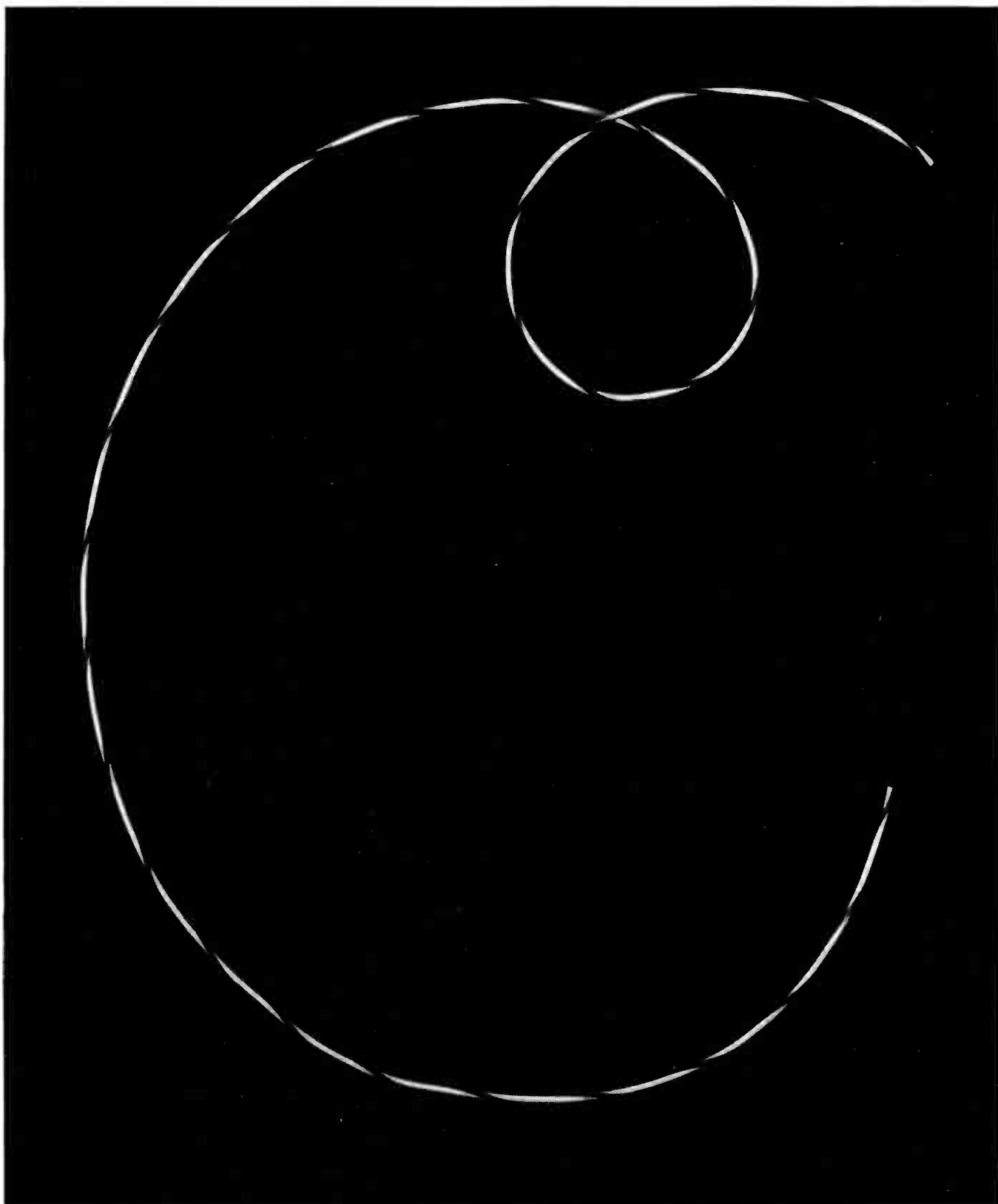

If you ask us for our 3¢ hookup wire, expect a little static.

Before we accept your order, we ask: "What are you using it for? Where? How? When?"

Static? Sure, but we think we know more about wire than any other manufacturer. And we like to pass it on where it'll help.

Based on your answers, maybe we can suggest an equivalent wire that costs less. Or introduce you to a new wire just marketed last week that will work better.

So next time you call Alpha, expect a little static. It'll keep you from getting burned.

Alpha Wire Headquarters: Elizabeth, New Jersey 07207. Write for our new 108-page catalog.
A Division of Loral Corporation

Potentiometer Reliability in Triplicate: All 1/2" Diameter, All 10 Turns, All by Bourns

Bourns gives you a three-way choice in 1/2"-diameter, 10-turn potentiometers: Model 3700 (bushing-mount) and Model 3750 (servo-mount) for MIL and equivalent applications, Model 3707 (bushing-mount) for high-performance, low-price industrial use. The right answer at the right price, whatever the need.

If compactness is a must, you'll appreciate the unique Bourns design that permits a longer resistance element in a shorter package—1" case length for bushing-mount units, 1 1/4" for servo-mount. If humidity threatens, you'll find ready answers in Models 3700 and 3750, which meet requirements of MIL-R-12934 (cycling) and MIL-STD-202, Method 103, respectively.

All three members of this trouble-taming trio incorporate the exclusive Bourns SILVERWELD® termination, and all feature a special rotor and slider block design that insures outstanding wiper stability. In addition, all are subjected to the rigorous

Bourns Reliability Assurance Program. They're available off the shelf. Write for complete technical information.

	Military 10-Turn Model 3700 (bushing-mount) and Model 3750 (servo-mount)	Industrial 10-Turn Model 3707 (bushing-mount)
Std. linearity	±0.25%	±1.0%
Std. resistances	50Ω to 250K	100Ω to 100K
Power rating	1.0W at 70°C	1.0W at 40°C
Max. oper. temp.	125°C	105°C
Resolution	0.11% to 0.012%	0.09% to 0.02%

ONE-HALF ACTUAL SIZE

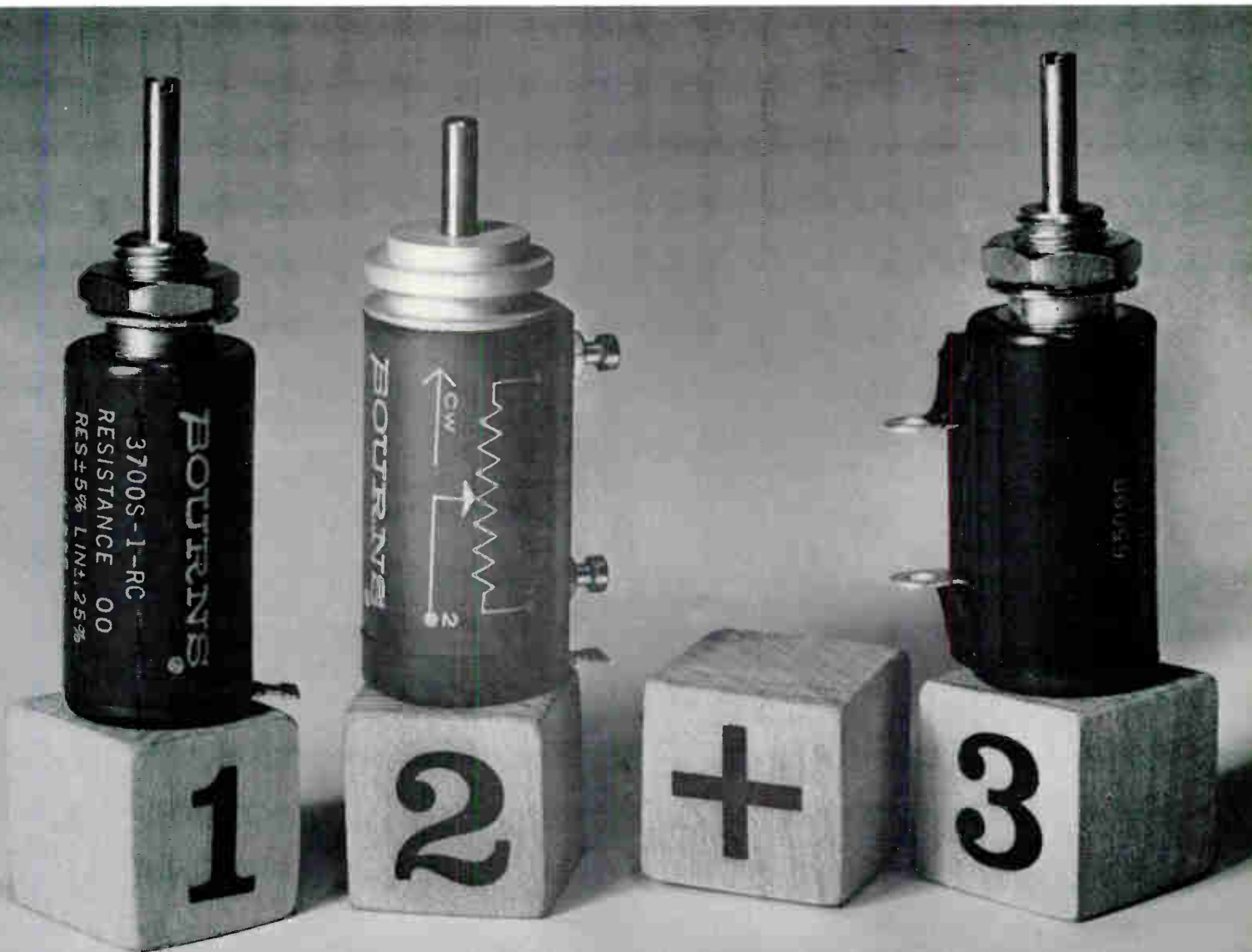

BOURNS

BOURNS, INC., TRIMPOT DIVISION
1200 COLUMBIA AVE., RIVERSIDE, CALIF.
PHONE 684-1700 · TWX: 714-682 9582
CABLE: BOURNSINC.

TRIMPOT® AND PRECISION POTENTIOMETERS—RELAYS—MICROCOMPONENTS—TRANSFORMERS, INDUCTORS, RESISTORS AND CAPACITORS—MICROCIRCUITS

Circle 48 on Inquiry Card
World Radio History

ONLY SPERRY Makes ALL of these PNP – NPN Differential Amplifier Transistors



AND IN ANY OF THESE

FOUR

PACKAGES TOO!

TO-77
(TO-5 Type)



TO-78
(Low Profile To-5)



TO-71
(TO-18 Type)



FLAT PACK

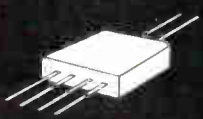

ONE HUNDRED SIXTY-FOUR COMBINATIONS NOW AVAILABLE. Chances are which ever differential amplifier transistor you need, you can get it from Sperry and in the package you want. Get complete information today— Contact SPERRY— SPERRY SEMICONDUCTOR, Norwalk, Connecticut 06852.

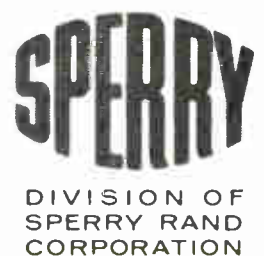

Sperry Europe Continental, 7 Avenue de l'Opera, Paris 1, France

**Progress
Report**
of special interest
for thin film

ALSiBASE®

THIN, SMOOTH
UNGLAZED
Ceramic Substrates

Parts illustrated approximately actual size.

Early in 1965, ALSiBase Substrate Bulletin No. 652 made a brief reference to ALSiMag 772, a 99½% alumina ceramic composition with an "as fired" surface of 10 microinches (CLA) or better.

Where a smoother "as fired" surface is needed on one or both sides, the requirement should be discussed with our technical people. ALSiMag 772 has been improved and is increasingly valuable for use as substrates.

This is of special interest for thin film circuitry. The uniform "as fired" surface is suited for many resistive patterns.

In addition to a smooth surface, ALSiMag 772 has exceptional strength and superior thermal conductivity to help dissipate heat. It is useful at far higher temperatures than any other substrate material with comparable surface characteristics. This surface also has an advantage in its resistance to scratching, abrasion or chemical attack.

The material is uniform and greatly facilitates your production of uniform components. Many applications now requiring glass or glazed substrates may find ALSiMag 772 a superior alternate.

PROTOTYPES AND STOCKED SIZES

Prototypes to your specifications can be supplied promptly at reasonable cost and, almost always, without special tooling. These preferred sizes in ALSiMag 772 are stocked: ½" x ¾", 1" x 1", 1" x 2", 2" x 2"; all in a thickness of .025".

Our experience indicates that you will be well justified in evaluating ALSiBase Ceramic Substrates in ALSiMag 772 with its smooth "as fired" surface.

Let your own practical tests on prototypes or stock items give you the answer.

American Lava Corporation **3M**
A SUBSIDIARY OF COMPANY

PHONE 615/265-3411, CHATTANOOGA, TENNESSEE 37405

For service, contact American Lava representatives in Offices of Minnesota Mining and Manufacturing Co. in these cities (see your local telephone directory): Birmingham, Michigan • Boston: Needham Heights, Mass. • Chicago: Bedford Park, Illinois • Cleveland, Ohio • Laurens, S. C. • Los Angeles, Calif. • Minneapolis, Minn. • Metropolitan New York: Ridgefield, N. J. • Up-State New York: Phelps, N. Y. • Philadelphia, Penn. • Dallas, Texas • Roanoke, Va. • South San Francisco, Calif. All export except Canada: Minnesota Mining and Manufacturing Co., International Division, 700 Grand Ave., Ridgefield, N. J.

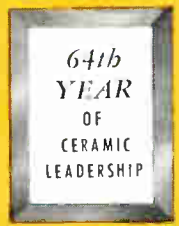

Circle 42 on Inquiry Card

World Radio History

By **J. E. COLE**
 The Marconi Co., Ltd.,
 Chelmsford, Essex, England

Newer design aspects of FM equipment intended for conventional point-to-point work are discussed. Introduced noise, a major problem in microwave design work, is discussed in detail. Methods of calculating and thence overcoming this noise are given. Finally a complete 1800 channel two-way repeater system is described.

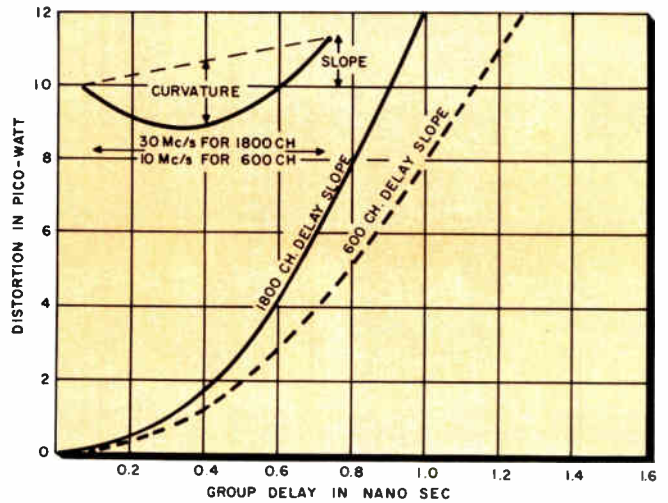

Fig. 1: Noise due to group delay slope.

Design Techniques for Wideband

ELECTRONIC INDUSTRIES
STATE-OF-THE-ART
FEATURE

OVER THE PAST FEW YEARS there has emerged a radical new development in microwave transmission methods—namely, the use of satellite repeater stations. This is a tremendous advance as now a repeater station is not needed every 30 miles along the route.

The role of these satellite systems seems to be in the field of long-range communication whereas, for relatively short-haul needs, the ground-station repeater system will probably continue to be better and cheaper. In any event it will be years before satellite communication emerges from its pilot-scheme basis to provide a world-wide system. Thus, this article will be confined to some newer design aspects of current FM equipment intended for normal point-to-point work.

Overall Performance

Before going on to specific design details, let's first consider overall performance needs of a normal system.

Modern microwave links are designed to transmit wide bands of modulation frequencies up to 10 MC. Information transmitted may be multichannel telephony service of up to 2700 channels, a TV program, or several channels of radar information.

Of these, the most stringent design requirement is for multichannel telephony. It is only by great care in design that 2700 channels can be simultaneously modulated on a single carrier so that they can be retrieved at the end of a 1500 mile link with negligible distortion and an acceptable degree of added noise. Such a link will carry color TV with sound channel, black and white TV with sound channel, or radar information, without any difficulty.

As introduced noise is perhaps the major factor to be taken into account in microwave design work, this aspect will be discussed in some detail.

The C.C.I.R. requirement for a 1500 mile system is that the signal to noise (S/N) ratio in each channel must not be worse than 53 db. In practice it is usual to assess the ratio by specifying the noise power relative to an arbitrary signal level of 1 mw. Thus, in the 1500 mile system the permitted noise power is 53 db below 1 mw, or 5000 pw. This method of computation has the advantage that successive noise contributions can be easily added. It will be the one used here.

Noise in telephone channels comes partly from the thermal noise generated in the receivers proper and partly from intermodulation between channels. The speech channels are spaced uniformly over the entire video band and the overall effect is as though a random noise signal were spread over the band. Any intermodulation between channels causes an apparent increase in the thermal noise in any one channel. For the total noise allocation C.C.I.R. allows 1250 pw for thermal noise in receivers and 3750 pw for intermodulation noise.

Thermal Noise

Remember that we will discuss only the problems affecting normal ground-station microwave systems. In these, reliable propagation is limited to line-of-sight and repeater amplifiers will be needed about every 30 miles along the route. This means that a 1500 mile system will need 50 repeaters. After making allowance for terminal modulating equipment (say 250 pw), permissible noise for each repeater is limited to 20 pw. This figure defines all major equipment features such

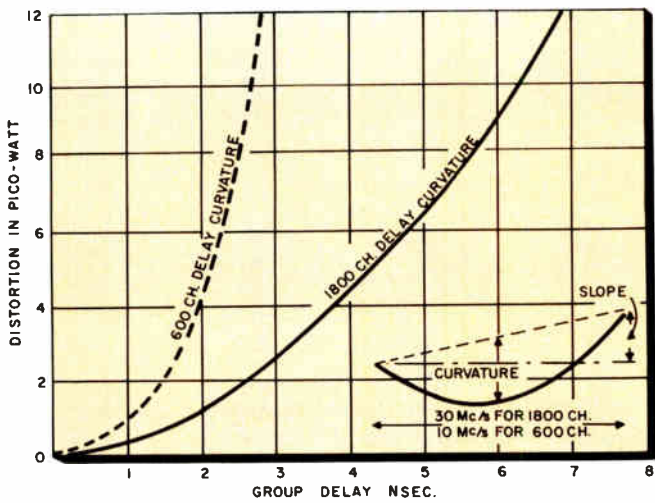
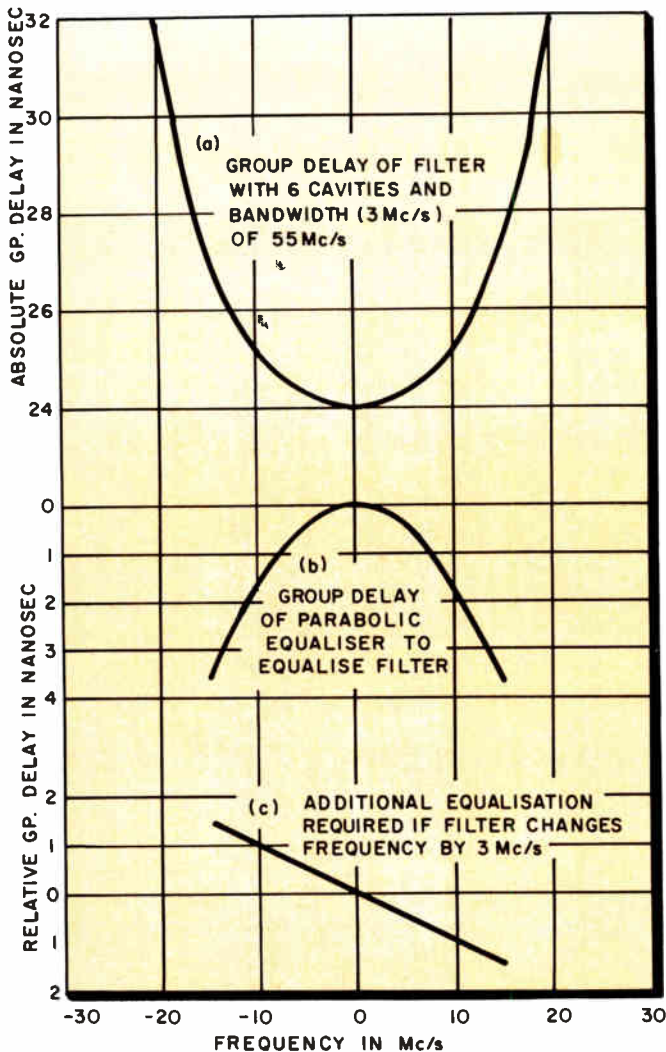

Fig. 2: Noise due to group delay curvature.

Microwave Links

Fig. 3: Group delay of waveguide filter.



as transmitter output power, antenna size, received signal level and noise figure.

Noise introduced by the receiver is $FkTB$ where F = overall receiver noise figure, K = Boltzmann's constant, T = absolute temperature and B = bandwidth in CPS.

Bandwidth of the equipment will be such that the noise around the carrier will be at a substantially uniform level over the bandwidth occupied by the traffic sidebands. Over any bandwidth of 3.1 kc (width of one telephone channel) the noise is $-169 + F$ dbw.

The S/N ratio at the receiver input is

$$S - (-169 + F) \text{ dbw} \quad \text{where}$$

S = the signal level at the receiver input.

Now, although the noise above and below the carrier is uniform, this is an FM system and upon demodulation the noise power assumes a triangular distribution with frequency, rising for the highest frequency channels according to the factor

$$20 \log \frac{\Delta f}{f} \quad \text{where}$$

Δf = the RMS deviation per channel and
 f = the channel frequency.

In FM systems in which a high degree of frequency deviation is used—e.g., in broadcasting work—this effect is used to improve the S/N ratio. But, for microwave radio link uses, a low figure of frequency deviation has to be used, largely on the grounds of bandwidth economy. Under these circumstances there will be an actual deterioration in S/N ratio. A greater power output is designed into the system to overcome this.

Typically, for a 600 channel system, the deviation is 200 kc RMS and the top channel, where the noise is highest, is at 2.5 Mc. In this instance the FM noise degradation is 22 db. For an 1800 channel system the deviation is 140 kc RMS, the top channel is at 8 mc and the FM noise degradation is 35 db.

Noise in the frequency channels decreases pro rata with frequency decrease, whereas ideally there would be an even distribution of noise over all the channels. In practice this is approached by the use of pre-emphasis on the applied input signal. By this means the deviation in the highest channels is increased by 4 db and that in the lowest channels is reduced by 4 db with appropriate gradations in between. The noise in each channel is now a little more uniform. A 2.5 db improvement in S/N ratio is effected by using a weighting network. This net simulates the selectivity against noise which is provided by the human ear and the telephone earpiece.

Because of all these effects the S/N ratio in the highest channel now becomes:

$$\begin{aligned} S - (-169 + F) - 22 + 4 + 2.5 \\ = S - F + 153.5 \text{ db for 600 channels} \end{aligned}$$

$$\begin{aligned} \text{and} \\ S - (-169 + F) - 35 + 4 + 2.5 \\ = S - F + 140.5 \text{ db for 1800 channels} \end{aligned}$$

MICROWAVE LINKS (Continued)

The S/N ratio must now be equated to the target of 20 pw or 77 db. Thus:

$$\text{For 600 channels, } S = F - 76.5 \text{ dbw}$$

$$\text{For 1800 channels, } S = F - 63.5 \text{ dbw}$$

By this means we have now defined the signal level and receiver noise figures needed to meet the 20 pw noise target. We will not discuss here the large variety of combinations of transmitter output power, antenna gain and receiver input stage which will give the needed performance. The choice of these is based mainly on cost factors.

The overall noise figure F used in the design calculations is the noise figure of the complete repeater.

Fig. 4: Formation of an echo.

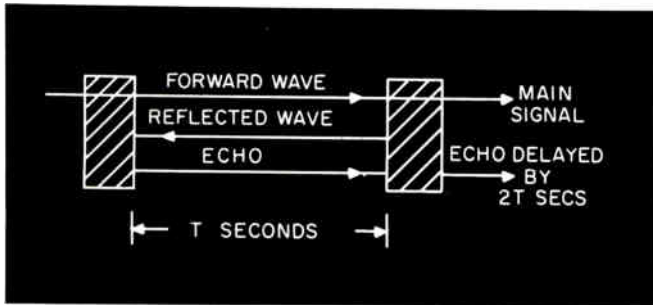
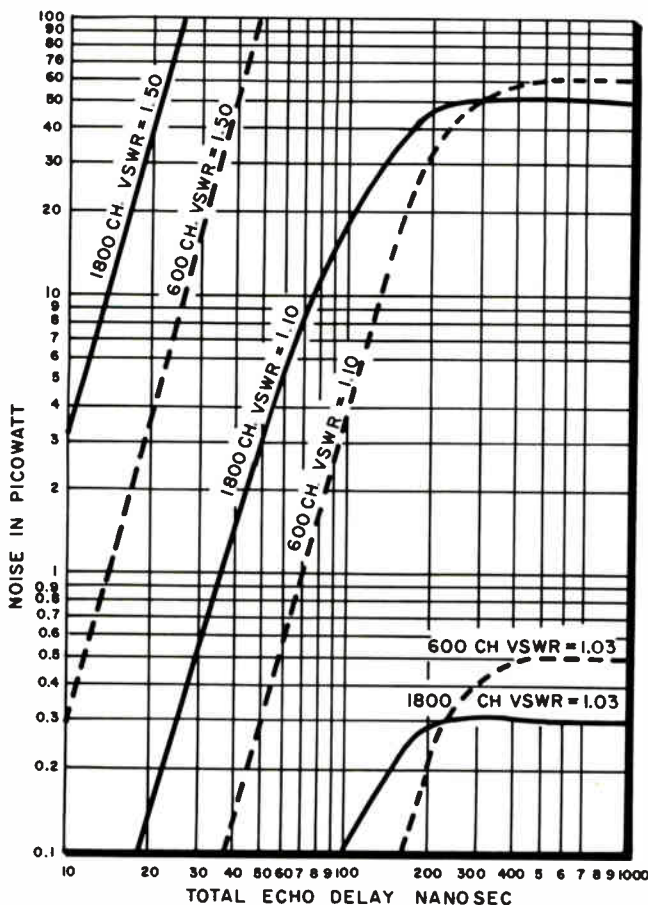

Fig. 5: Noise caused by echoes.



The major contribution to this will always be the first circuit noise, the mixer and the first i-f amplifier stages. But, in high capacity multi-channel work an additional hazard presents itself in the form of noise generated by the travelling wave tube itself. This is because, with a high-capacity system the input signal is high, the amount of protective gain before the TWT is reduced and so the TWT noise figure becomes a significant factor. Thus, in order that the noise contribution of the TWT is not excessive, it may become necessary to drive it with an input signal which is larger than normal. It is worth noting here that a high-gain TWT is a great embarrassment unless it has a correspondingly low noise figure.

TWT's suitable for the output stages of a microwave link now have noise figures of 27 db. The S/N ratio in an 1800 channel system is $S - F + 140.5 = S - 27 + 140.5$ db.

If from the 20 pw (77 db) noise for the complete repeater we can afford to allow 2 pw (87 db) for the TWT, then the S/N ratio which may not be exceeded is 87 db. Thus:

$$87 = S - 27 + 140.5$$

$$S = -26.5 \text{ dbw}$$

This shows that a TWT with a 27 db noise figure should be driven with an input signal of 2 mw.

Intermodulation Noise

The remainder of the noise allocation (3750 pw) is reserved for intermodulation between channels. This distortion in FM links is caused mainly by:

- (1) Non-uniform group delay in the bandwidth occupied by the first and second order FM sidebands.
- (2) Echo distortion caused by successive reflections against mismatched impedances.
- (3) Interference from parallel radio channels.
- (4) Leakage or feedback within a repeater.
- (5) Conversion of amplitude variations to phase variations (AM to PM conversions occurring in TWT's and limiting transistor amplifiers).

These effects exert a major influence on bandwidth and selectivity of the i-f and microwave filters and also on the magnitude of impedance mismatches throughout the equipment. Thus, each demands careful consideration to achieve the desired parameters of the system.

Group Delay Variations—Group delay variations distort the modulation because the relative timing of sidebands and carrier is upset. They may be grouped into two general categories. These are 'group delay slope' which alters the phase of the two sets of sidebands relative to one another, and 'group delay curvature' which alters the phase of the sidebands with respect to the carrier. Of the two, the group delay slope effect produces much the worse distortion.

The noise power is proportional to the square of the group delay variation. So, if successive repeaters have similar group delay variations, the noise will add according to the square of the number of repeaters. Ob-

(Text continued on page 62)

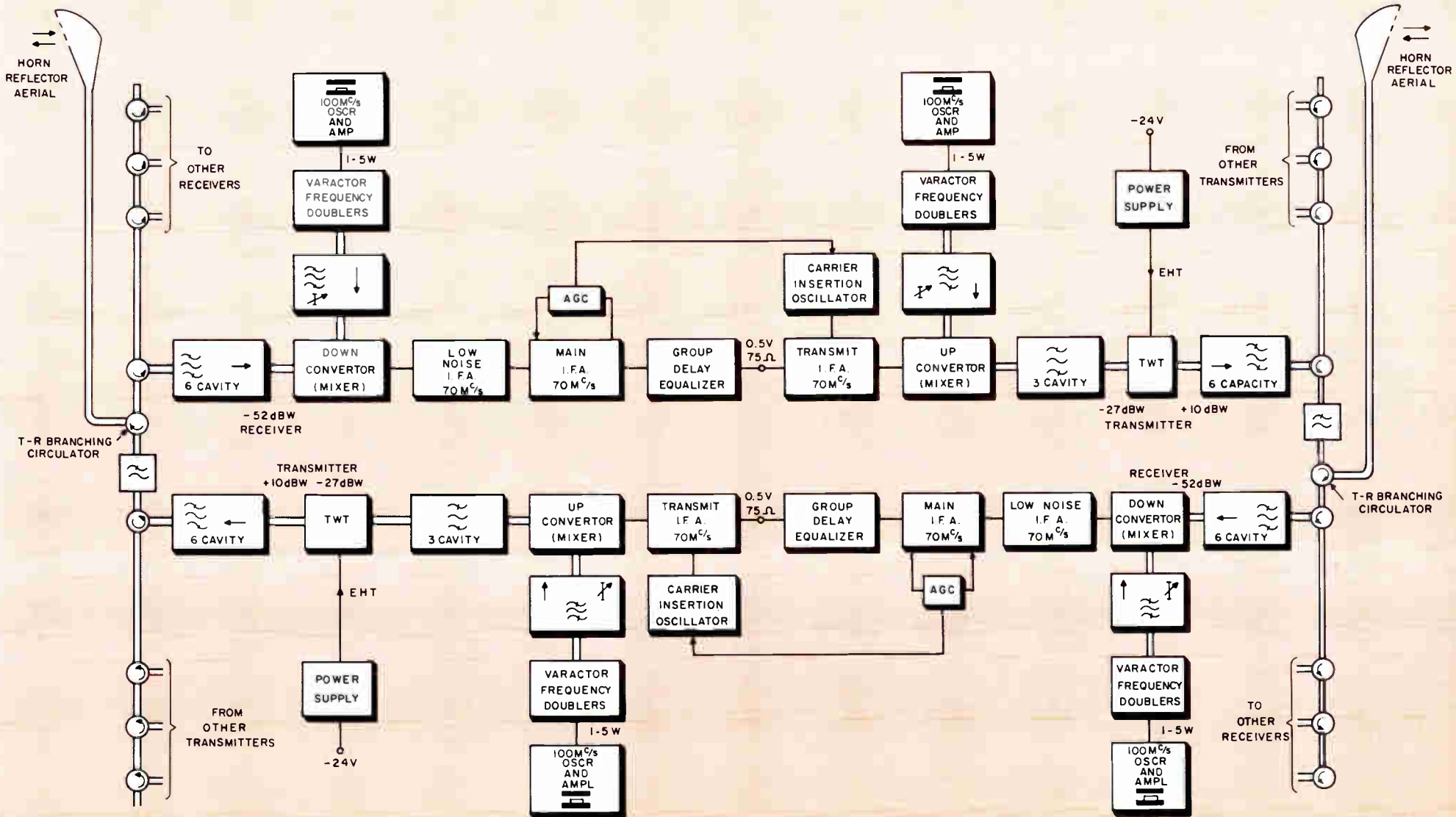
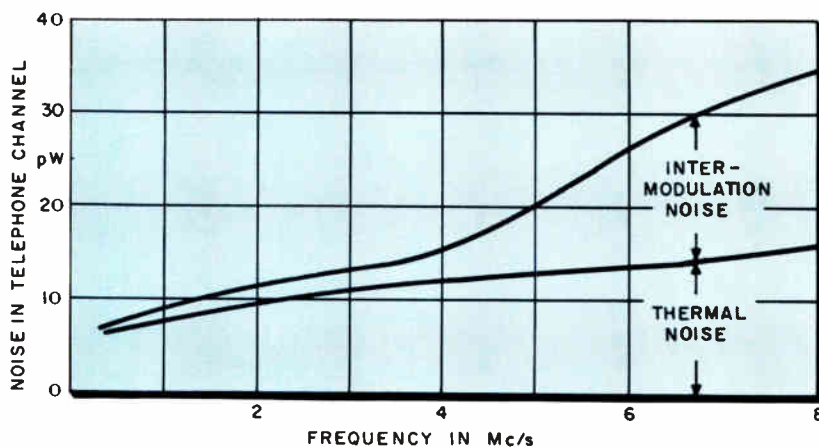

Fig. 6: An 1800 channel two-way repeater.

Fig. 7: Noise in a repeater (less feeders).



MICROWAVE LINKS (Concluded)

viously then, the allocation of 3750 pW would not go far amongst 50 repeaters.

This is overcome by designing the equipment so that the group delay of each repeater is equalized by special networks having inverse group delay characteristics. For complete effectiveness it is wise to aim at equalizing the group delay over the bandwidth occupied by the first and second sidebands of the highest modulation frequency, namely, over ± 5 mc for 600 channels and over ± 16 mc for 1800 channels.

After adjustment of the equalizers, the residual group delay variations should be random enough for them to cease to be directly additive and the distortion noise powers should once again add directly.

The curves of Figs 1 and 2 show the noise due to group delay slope and curvature. These curves enable the noise which is generated by group delay distortion to be calculated.

There is another form of group delay slope distortion which can be introduced by the effect of temperature upon waveguide filters. Normally, these filters are made from brass or copper waveguide, and so when the temperature rises the metal expands, increasing the lengths of the resonant cavities; conversely a drop in temperature produces contraction and a shortening of the cavity lengths.

Because of this, the whole frequency response, including the group delay response, is shifted bodily in frequency, the observed change at 6000 mc being about 1 mc per 10°C temperature change. Whenever the temperatures at all the repeater stations change simultaneously (e.g., at nightfall or at the onset of winter) the increase in noise power is large, as the noise introduced is proportional to the square of the group delay slope.

(A typical filter group delay response is shown in Fig. 3a. Response of an appropriate equalizer is shown in Fig. 3b and group delay slope for a change of 30°C is shown in Fig. 3c. The consequent distortion may be deduced from Fig. 1.)

The most common solution is to use filters made from low expansion steel (invar), but an alternative method is to stabilize the temperature of the equipment rooms.

Echo Distortion—When the reverse wave formed by

reflection against a small mismatch is again reflected against another mismatch, an echo is created, Fig. 4. This echo is a source of distortion, which is aggravated if the echo amplitude is large and if the delay time of the echo is large.

The average distortion noise in the top channel for two equal mismatches (1.03 to 1.50) and various echo delay times, may be deduced from the graphs in Fig. 5.

Echo distortion is best eliminated at the source. The only satisfactory solution lies at the design stage, when every effort should be made to obtain accurate terminations and source impedances at both the microwave and intermediate frequencies.

In the waveguide feeder system connecting the equipment to the antenna, the echo delay time is inevitably large; in normal-sized waveguide it can amount to some 1.5 nsec./ft. Thus, in a feeder 150 ft. long the total delay time for the echo is about 450 nsec. Even with a VSWR of 1.1 at each end of the feeder and neglecting the mismatch of any intermediate bends, the average distortion is 50 pW, though in practice the echo amplitude is somewhat reduced by attenuation of the waveguide.

It follows that great care must be exercised in the installation of waveguide feeders, particularly for the highest capacity systems. Waveguide apertures of successive waveguide sections should, for instance, be accurately aligned with dowel pins. One modern approach to the avoidance of this hazard of echo distortion is to mount the antennas on the ground, pointing upwards to an inclined passive reflecting plate on the mast. Alternatively, the microwave equipment may be mounted at the mast head. In either event elimination of feeder attenuation enhances the S/N ratio.

Similar problems of echo distortion exist at intermediate frequencies. Delay time in polythene filled coaxial cable is 1.7 nsecs./ft. Thus, whenever cable length exceeds 10 ft., special attention must be paid to the accuracy of the terminating and source impedances.

Echo distortion also occurs in waveguide filters, and in high-Q filters the delay time is quite large. For maximally flat filters it can be computed from the equation:

$$\text{Delay (in seconds)} = \frac{K}{\pi B}$$

Where K = 2.0 for a 3 cavity filter
= 2.6 for a 4 cavity filter
= 3.9 for a 6 cavity filter

and B is the bandwidth in mc.

For a typical filter used in an 1800 channel equipment, the delay at the center frequency is 24 nsec., giving a total delay of 48 nsec. To maintain low echo distortion, the impedances next to the filter should have a vswr of less than 1.05.

In practice, where a filter is next to a mixer or TWT of uncertain vswr, a ferrite isolator should be placed next to the filter so that low echo distortion is assured.

Interference from Parallel Radio Channels—To increase the traffic capacity along a given route it is customary to use several radio frequencies along one path. Several sets of equipment may be provided at each terminal and repeater station and the outputs from several transmitters connected in parallel to a common antenna. Inputs to the receivers are likewise derived from a common antenna.

All units of a system which must operate under these circumstances call for very careful design. The following are some of the main issues in this connection:

(1) The branching arrangements must be carefully designed to prevent mutual interference between radio channels.

(2) The i-f amplifier selectivity must be such that interfering signals close to the carrier will not appear at the input to the final demodulator.

(3) The receiver microwave filter must provide selectivity to a degree which ensures that the interfering signals appearing in the image region and other sensitive areas of the receiver are sufficiently attenuated.

(4) The transmitter filter must attenuate all unwanted outputs of the transmitter, (especially those generated in the up-converting mixer), so that the chance of interference in adjacent receivers is minimized.

Leakage or Feedback within a Repeater—Another form of intermodulation noise is brought about by r-f leakage from a transmitter into a receiver. If, for instance, the leakage signal is 70 db down when it enters the receiver, and if it falls within the modulation band of the receiver, then the distortion noise in the affected channels will be 1 pw. The transmitting frequency of a repeater is usually made different from the received frequency; but there is still a chance that the leakage signal will be positioned on a sensitive region of the receiver or that it may cause trouble in adjacent receivers. Leakage directly into a receiver can be especially troublesome if it enters at a point beyond the protective waveguide filter.

Thus, special care must be taken over the tightening of waveguide couplings, the screening of i-f amplifiers, leakage from waveguide tuning screws, leakage from TWT mounts and the decoupling of power

supply leads. In practice, leakage from or into a carefully tightened waveguide coupling is about 80 db and well-designed TWT mounts meet 65-70 db.

The worst situation exists if there is leakage directly between transmitter output and receiver input. The difference in level between these two points is 70 db and the attenuation of the complete leakage path must be at least 140 db if the noise is to be kept below 1 pw.

Conversion of Amplitude Variations to Phase Variations—In some devices, a change in amplitude of the input signal causes a variation in phase shift through the device. This means that amplitude variations or modulation will be converted to phase modulation. This spurious phase modulation creates distortion of the original FM traffic, and shows up as intermodulation noise.

The effect is particularly evident in TWT's, and in this case there are two ways of minimizing the intermodulation noise.

(1) The amplitude variations are reduced by arranging that the up-converter, which is positioned just before the TWT (Fig. 6) should act as a limiter. By driving the up-converter at a high 70 mc level, effective limiting can be obtained.

(2) By operating the TWT at less than peak power output, the AM to PM conversion may be reduced.

Complete Equipment Design

By using design methods outlined here, it is possible to design complete microwave link systems to meet a specified performance.

In Fig. 6 is shown the diagram of an 1800 channel two-way repeater (the Marconi H700 for 4000 or 6000 mc) designed on the principles discussed here.

The equipment uses all the most modern circuit techniques; transistorized 70 mc broad band i-f amplifiers; quartz crystal controlled local oscillator chains consisting of 100 mc transistor oscillator and amplifiers followed by varactor frequency multipliers specially designed for low FM noise; permanent-magnet TWT mounts; ferrite isolators and ferrite three-port circulators, and transistorized extra high voltage supplies for the TWT.

The extensive transistorization has enabled all the thermionic tubes (except the TWT) of previous equipments to be removed. The consequent saving in power supplies has made it possible to build a complete two-way repeater into a single 19 in. wide equipment bay.

Thermal and intermodulation noise figures have been measured and the results are given in Fig. 7. These are very much as were predicted at the design stage of the equipment.

Acknowledgement

The author wishes to acknowledge the help of his colleagues in the preparation of this article and expresses his thanks also to the Director of Engineering & Research, The Marconi Co., Ltd., for permission to publish it.

• A REPRINT of ANY ARTICLE in this issue is available from ELECTRONIC INDUSTRIES Reader Service Department.

Understanding Plasma Diodes and Amplifiers

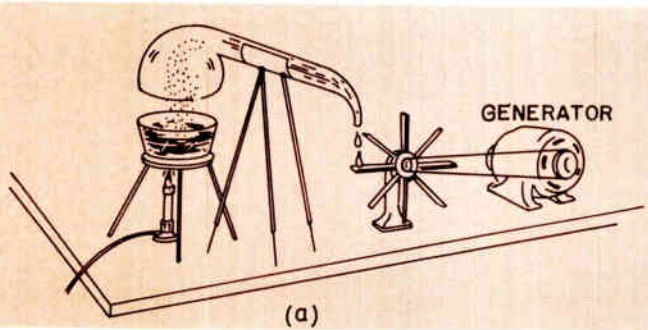

Plasma devices are gaining in popularity as a result of improvements in technology and better understanding of gaseous discharges. Two new devices, representing two diverse uses of gaseous plasmas, are described and the principles of their operation are discussed.

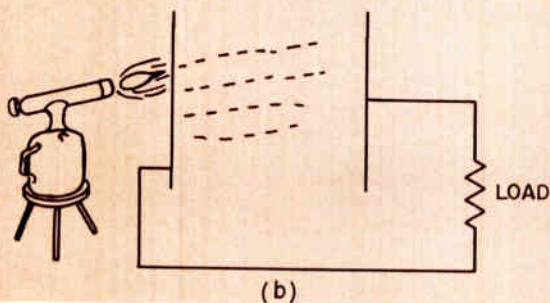

IT WOULD BE DIFFICULT to estimate the fraction of the total power consumption which is used by plasma devices. All one needs to consider is the mercury vapor lamps lighting the streets and highways; neon signs in use; mercury pool rectifiers, power tubes and others in power stations; circuit breakers in distribution stations and many others. There is also another class of plasma devices which appear more "glamorous" whether because of the application, relative paucity, or novelty. To these belong the plasma amplifier, thermionic plasma diode, MHD generator, plasma propulsion engine, and laser.

It is the purpose of this article to discuss two of these—the plasma diode, and plasma amplifier. The reasons for selecting these two are that, first, they are now available; and second, they show the use of two principles.

The plasma diode can be considered a thermodynamic engine with electrons as the working fluid whose potential energy is converted to a useful output. The plasma amplifier, on the other hand, converts the kinetic energy of the plasma electrons to a useful output. In the diode, the plasma provides reduction, or elimination, of the local space charge; in the amplifier, the plasma provides enhancement of the local space charge. The apparently opposite functions of the plasma in these two devices can be reconciled if we realize that the plasma interaction region in the amplifier is several hundred times longer than that in the plasma diode.

The diode is a low voltage, high current device; the amplifier, a high voltage low current device. The amplifier is a low pressure (approx. 20-50 microns), and the diode a relatively high pressure (approx. 1mm = 10^3 microns) device.

Of the other new devices, the MHD generator and plasma propulsion engine are still in the experimental or pilot stage. And the laser has received much publicity already.

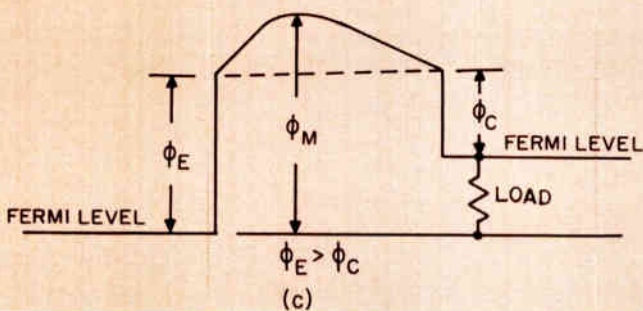

Fig. 1a: The thermionic diode operation is roughly analogous to the device sketched in the top drawing. In (1b) electrons are emitted thermionically, as in a diode, and give up their potential energy to the collector. The bottom drawing (1c) is a potential energy diagram for both of the systems above. Thermal energy is given electrons or water molecules until they have enough energy to overcome the barrier of height. Overcoming the barrier, they reach the collector and give up their energy to the load. Dashed line indicates the barrier.

By **DR. LEON ZELBY**

Associate Professor
Moore School of E. E. and
The Institute of Direct Energy Conversion
University of Pennsylvania
200 So. 33rd Street
Philadelphia, Pa. 19104

Plasma Diode (Thermionic Converter)

The operation of a thermionic diode can be explained on the basis of the mechanical analogue shown in Fig. 1a, somewhat reminiscent of a Rube Goldberg device. Water vapor, heated by the burner, rises and converts the kinetic energy of the water vapor molecules to potential energy of the condensate. On falling down, water droplets drive the paddle wheel which is connected to a load, a drive wheel of a machine, say. In the diode, Fig. 1b, electrons are emitted thermionically from the emitter. On reaching the collector, they give up their potential energy in the load as electric current.

Fig. 1c represents a potential energy diagram for both systems. Thermal energy is given electrons, or water molecules, until they have enough energy to overcome the barrier of height ϕ_M . Once they overcome the barrier, they reach the collector and give up their potential energy in the load. Generally, the height of the barrier is equal to the difference of the work functions of the emitter and collector, i.e., $\phi_E - \phi_C$. The local space charge formation, however, increases the barrier to a height ϕ_M .

Reduction of the distance between the emitter and collector reduces the effects of the barrier height increase. Unfortunately, the spacing must be very small (tens of microns). This creates mechanical problems, particularly when surfaces are heated.

To avoid some of these problems, plasma has been used to overcome the increase in barrier heights by space charge neutralization. This, ideally, results in a barrier of the type indicated by the dashed line in Fig. 1c. A more realistic potential energy diagram of a plasma diode is shown in Fig. 2a, with the corresponding charge density distribution (Fig. 2b), and a pictorial representation (Fig. 2c). The line connecting the two sheaths in Fig. 2a is slanted due to the finite conductivity of the plasma, with V_P representing the voltage drop across the bulk plasma. Comparison of Fig. 1c and Fig. 2a shows very clearly the reduction in the barrier height due to space charge neutralization. The positive sheath at the emitter serves another useful function. The electrons leaving the emitter find themselves in the accelerating field of the sheath so that they enter the bulk plasma with increased velocity and contribute to the degree of ionization by collisions with neutral molecules.

Some typical operating and technical data of the thermionic plasma energy converters are as follows: emitter to collector spacing of about 200 microns; cesium at pressures of about 1 torr; emitter temperatures at about 1800°K; emitter material tungsten, molybdenum; emitter area generally several square centimeters; power output about 20 w/cm² at a voltage of about 0.5-1.0 v; efficiency about 10-15%.

Much work has gone into de-

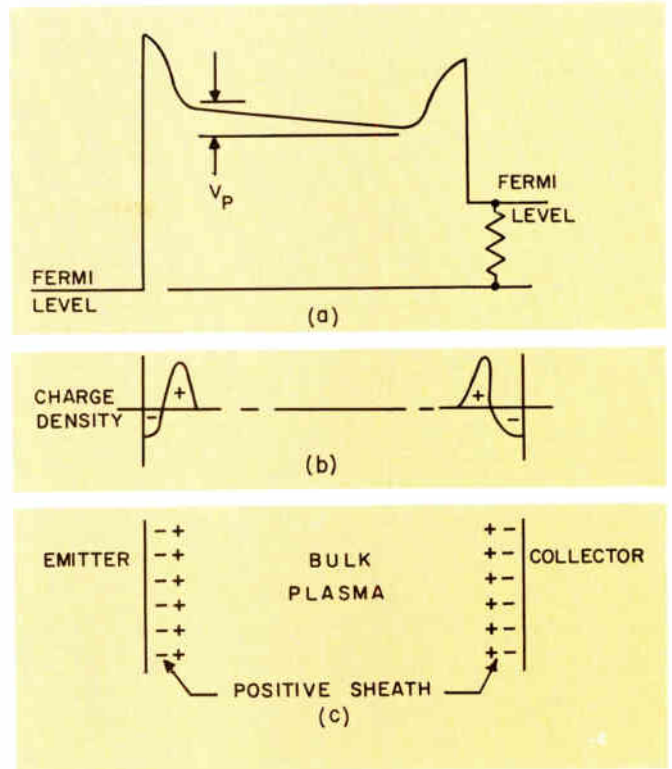

Fig. 2: Here is a more realistic potential energy diagram of a plasma diode (a), with the corresponding charge density distribution (b), and a pictorial representation (c).

velopment of new work function materials for use as collectors. Work function materials of about 1 ev are used in the more efficient converters, since that too contributes to the reduction of barrier.

Plasma Amplifier

Whereas plasma acts only as a "neutralizer" in the plasma diode, it acts as the "active" medium in the plasma amplifier. Its degree of activity is measured in terms of electronic gain, the decibel equivalent of the ratio of the output powers in presence and absence of plasma, other conditions being maintained equal. A schematic of a typical electron beam-plasma amplifier is shown in Fig. 3. The growth constant, in the case of a cold, collisionless plasma is

(Continued on following page)

Fig. 3: This schematic shows a typical electron beam-plasma amplifier.

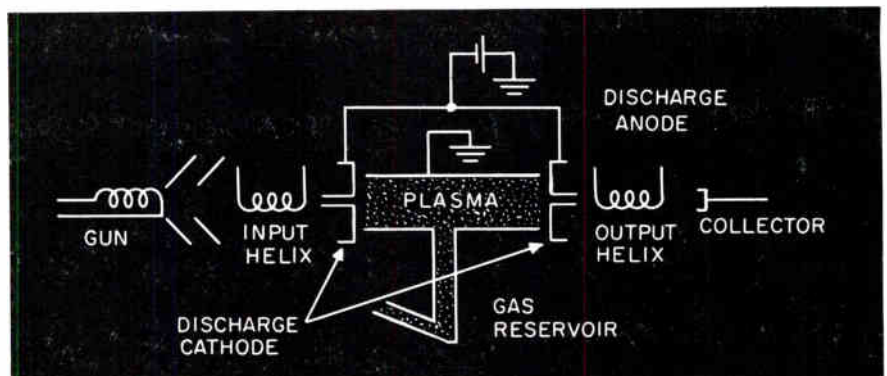
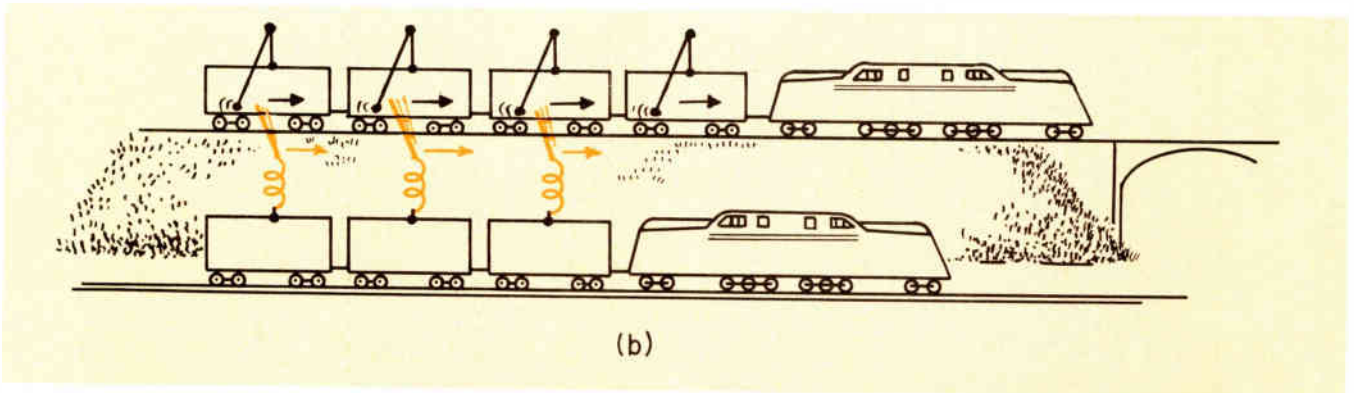
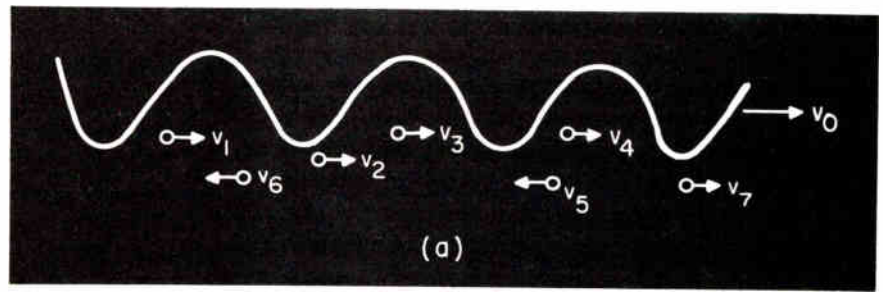

Fig. 4a: Amplification can be discussed in terms of transfer of kinetic energy of plasma electrons to the wave on the beam, sketched here. 4b illustrates the mechanical analogue of an amplifier.



$$\alpha = \frac{\Omega_p}{v_0 \left(\frac{\omega_p^2}{\omega^2} - 1 \right)^{1/2}}$$

where Ω_p and ω_p are related to the electron density of the electron beam and plasma, respectively; v_0 is the average velocity of the electron beam; and ω is the signal frequency. Note that for real α , ω must be smaller than ω_p . To keep the electron beam from scattering, the gas pressure must be rather low (of the order of microns). Yet, to maintain $\omega_p > \omega$, the degree of the ionization of the gas must be high. The relatively low gas pressure is consistent with the assumption of collisionless plasma, so that the extremely simple expression for α represents a fair approximation.

The mechanism of amplification due to interaction of the electromagnetic wave on the electron beam with plasma can be discussed either in terms of interaction of two intermixed streams of different velocities, i.e., plasma ($v = 0$) and electron beam ($v = v_0$). Or it can be discussed in terms of transfer of kinetic energy of plasma electrons to the wave on the beam. Since this latter lends itself more easily to pictorial representation, it will be considered here.

A sketch of the wave on the beam is shown in Fig. 4a. To an observer moving with velocity v_0 the wave appears stationary. From this frame of reference, we see the plasma electrons moving in various directions with velocities v_1, v_2, \dots, v_n . The electric field of the wave will accelerate some of these electrons, decelerate some, and will have no net effect on others. The electrons that

move with velocities slightly greater than v_0 will appear nearly stationary with respect to the wave. If they are in proper phase, they will be decelerated by the electric field of the wave, their kinetic energy will be reduced, and the energy of the wave will be increased. Those electrons whose velocities are substantially different from v_0 will periodically gain and lose energy from and to the wave with a zero average energy transfer. The amplification requires then a suitable velocity distribution of the plasma electrons about the average electron beam velocity v_0 . The requirement of near synchronism between the wave and plasma electrons is the same as that in standard traveling wave tubes between the wave on the electron beam and the wave on the structure.

The mechanical analogue of this amplifier in Fig. 4b shows two trains running on parallel tracks. One train has suspended oscillating pendula; the other oscillating vanes. Energy can be transferred from one to the other provided the train speeds are nearly the same. The device which is on the train that moves slightly faster than the other will lose energy. The energy will be transferred to the device on the other train and will result in increased amplitude of its oscillation.

One of the most important advantages of using plasma for amplification is its power handling capability at high frequencies (millimeter wavelengths). In this, plasma replaces the small structures which, due to extremely small tolerance requirements and small heat dissipation capability, lose their usefulness at such frequencies. Another advantage of use of plasma is the high electronic gain.

Some typical operating characteristics of such amplifiers in X-band are: electron beam voltage near 1 kv; beam current few milliamperes; gas pressure of the
(Continued on page 70)

• A REPRINT of ANY ARTICLE in this issue is available from ELECTRONIC INDUSTRIES Reader Service Department.

The Best in Wirewound & Carbon isn't Good enough anymore...

- 20 Ω –5 Megohms Resistance Range
- Greater Power / Size Ratio
- Greater Stability
- Reduced Cost

Specify from the Broadest Line of Thick Film Controls Available.

Exceed MIL-R-23285 (Navy) metal film; far exceed MIL-R-94B.

TRIMMERS

Series 171
1/2" square
42 \pm 3 turns

Series 170
1/2" square
Side Control

Series 180
1-1/4" x .324 x .295
1 w @ 125°C
Operates to 200°C

Series 172
1/2" square
Wire Leads

Series 180PC
1-1/4" x .325 x .295
For p.c. applications

Series 385
11/32" dia.
Single Turn

Series 630P
1/2" dia.
For p.c. applications

Series 630
1/2" dia.
Single Turn

POTS

Series 400
1-3/64" dia.
3 watts @ 85°C

Series 500
3/4" dia.
1-1/2 watts @ 85°C

Series 550
3/4" dia.
2 watts @ 70°C

Series 600
1/2" dia.
3/4 watt @ 85°C

Series 660
3/8" dia.
1/4 watt @ 125°C

Series 2-500
3/4" dia.
Tandem Series 500

Series 660PC
3/8" dia.
For p.c. applications

IT'S CERMETTM NOW

CTS CERMET Trimmers & Pots offer:

- 1 Environmental Stability & Higher Wattage of Wirewound.
 - 2 PLUS Wide Resistance Range & Infinite Resolution of Carbon.
 - 3 PLUS these other CERMET advantages:
 - Extremely high temperature capabilities.
 - Stability under extreme humidity.
 - No catastrophic failures.
 - Low noise. Long life.
 - 4 PLUS Lower Costs which approach wirewound and carbon prices.
- Accomplished by CTS automated production techniques and the industry's largest output.

Send now for New CERMET Catalog.



Founded 1896

CTS CORPORATION
Elkhart, Indiana

Sales Offices and Representatives conveniently located throughout the world.

Principal Products

Variable Resistors
Selector Switches
Loudspeakers
Trimming Potentiometers
Fixed Resistor Micromodules & Microelectronic Circuitry
Crystals, Filters,
Oscillators & Ovens

Subsidiaries

CTS of Asheville, Inc., Skyland, N.C.
CTS of Berne, Inc., Berne, Indiana
CTS of Paducah, Inc., Paducah, Ky.
Chicago Telephone of California, Inc.,
South Pasadena, Calif.
CTS of Canada, Ltd., Strathville, Ontario
CTS Microelectronics, Inc., Lafayette, Ind.
CTS Research, Inc., Lafayette, Ind.
CTS Knight, Inc., Sandwich, Ill.

Report from

**BELL
LABORATORIES**

New circuits for communications

The success of a modern large-scale communications system depends importantly on the circuits of which it is built. For this reason Bell Telephone Laboratories places great emphasis on exploring new approaches to high-performance, economical circuit design. The circuits illustrated below are but a few examples of recent Bell Laboratories developments that are helping to advance the techniques of communications.

Bell Telephone Laboratories
Research and Development Unit of the Bell System

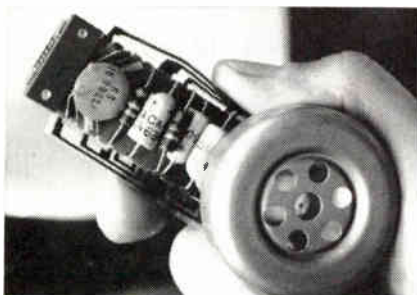

Circuit for mounting inside telephone handset for use by people with impaired hearing. Circuit includes one PNP transistor, provides up to 25 db gain, and has negative feedback for stability and to compensate for variations in component characteristics. Power is derived by taking a small part of direct current supplied to the telephone transmitter. Circuit board is flexible to permit part of conducting path to be bent and entire unit to fit snugly in narrow handset.

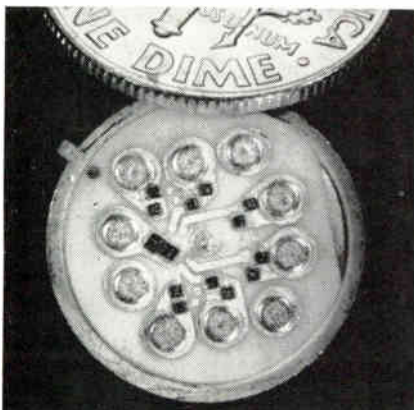

High-speed integrated logic package consists of 3 separate flip-flop circuits assembled together on a single header. On the 11-lead ceramic header, all circuit interconnections are made using gold thermo-compression bond wires. This device contains 6 transistors (2 are required for each flip-flop) and 12 resistors. The individual flip-flops perform their switching functions with typical operating times of approximately 6 nanoseconds.

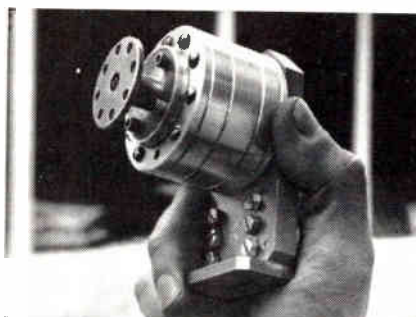

Parametric amplifier used in new microwave radio system will provide low-noise amplification to a radio frequency signal which is frequency-modulated by 1200 telephone conversations. It is a reflection type parametric amplifier operating in the 4-gigacycle range, providing approximately 13 db of gain using a varactor diode pumped at approximately 12 gigacycles. Its very low noise figure, typically 3.5 db, permits increased systems capabilities which are used to increase the number of telephone channels per radio channel.

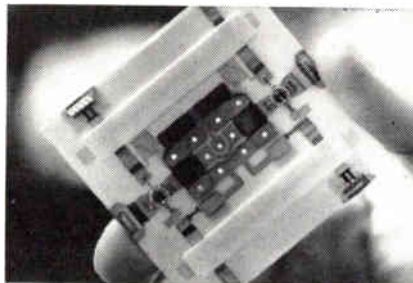

Integrated balanced microwave amplifier makes use of high-frequency germanium transistors for precise wideband applications. Each stage of amplifier (one stage shown) consists of a pair of electrically similar transistors whose inputs and outputs are combined by 3-db couplers. This arrangement eliminates tuning adjustments and provides excellent gain flatness and impedance matching. Multistage amplifiers of this type have been designed to operate with bandwidths of 1000 mc in the 0.5- to 3-gigacycle range, with noise figures of about 6 db.

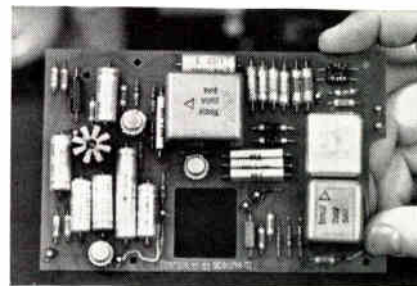

Compressor circuit used in several telephone carrier systems raises volume of soft voice sounds and lowers volume of loud voice sounds. This new circuit effects a 2-to-1 reduction in dynamic range of a telephone signal, which is then transmitted with an improved signal-to-noise ratio. Nearly perfect compression is achieved over greater than the normal voice range, as a result of circuitry that varies the impedance of two precise silicon diodes. A 3-stage feedback transistor amplifier maintains desired stability and provides the required transmission characteristics.

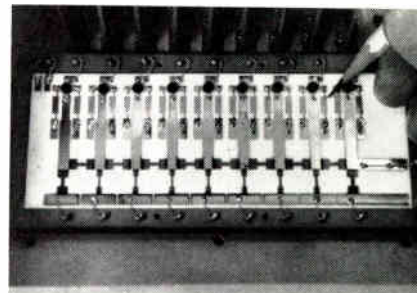

Thin-film decoder for high-speed pulse code modulation systems converts binary pulse sequences into analog signals. Circuit consists of precision resistor network and multiply-encapsulated control diodes. Precision resistors (pointer) generate reference currents that are switched into resistive ladder network (I-shaped elements at bottom of unit). Output voltage is proportional to binary code applied to diodes. Precision sufficient for decoding 9-digit binary codes is obtained, at code rates up to 12 mc (108 mb/s pulse rates).



Gold-plated components
conduct better,
solder easier,
reflect heat,
and resist wear,
corrosion,
oxidation,
galling.

Now let us give you the details.

The details are in our comprehensive reference guide—a voluminous encyclopedia of precious metal electroplating processes. Here you'll find charts, graphs, technical papers, magazine articles. A compendium of today's most advanced knowledge of gold-plating—the facts that have put gold into computers, communications equipment, jet aircraft, missiles, space probes. Write for your copy of "Gold Electroplating Processes."



Sel-Rex Corporation, Dept. Q-11, 75 River Road, Nutley, N. J. 07110.

Smallest available chassis mount resistor offers a new LOW in miniaturization, a new HIGH in reliability.

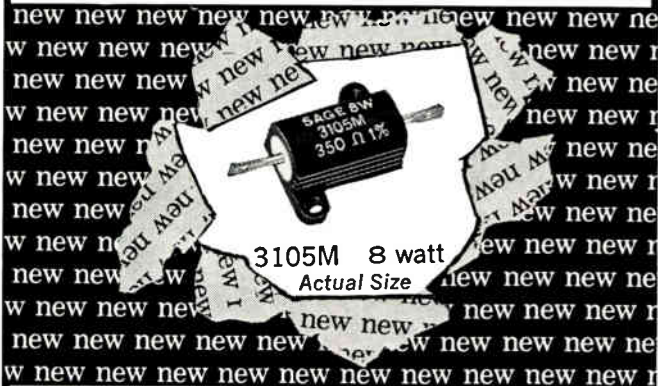

Style 3105M expands the usefulness of Sage's long established line of Type M precision power resistors. Body size is considerably below that of RE65, the smallest MIL-R-18546C style. MIL performance requirements are fully met or exceeded.

PRECISION and STABILITY are synonymous with the Sage trademark. Style 3105M, like all Sage resistors, is typically made to 1% or closer tolerance. TC ± 20 ppm/ $^{\circ}$ C. Standard resistance range .05 Ω to 20,000 Ω .



Units shown actual size, wattage figures for full heat sink mount.

Check these outstanding Sage features:



- Exclusive IMPERVOHM[®] 350 $^{\circ}$ C silicone encapsulation is the only insulating material between winding and housing. It provides superior thermal conductivity as well as unmatched endurance against applied voltage, moisture, temperature shock and prolonged high temperature operation.
- Special high thermal conductivity ceramic cores.
- Welded construction throughout.
- Black anodized aluminum housing is finned for increased heat radiation.

Write for catalog data sheet

SAGE

SAGE ELECTRONICS CORP.
Box 3926 • Rochester, N. Y. 14610

Circle 46 on Inquiry Card

PLASMA DEVICES (Concluded)

order of microns; beam-plasma interaction length a few centimeters; electronic gains about 20 db/cm; net gain of a tube is about 30 db.

The plasma diode, at least now, is primarily a device for use in space vehicles. In land based systems, it can be used with some other generating devices, using their rejected heat. This tends to increase the overall output and efficiency of the system. As a basic generator, however, it is not very useful in land based systems because of the low efficiency. Plasma diodes are available and are produced by RCA, Lancaster, Pa., and The Thermo Electron Engineering Co., Waltham, Mass.

The present day plasma amplifiers are not quite "off-the-shelf" items, with many models still in the experimental stage. They are useful in the range above 1cc for reasons mentioned above. The fact that they are more noisy than other TWT amplifiers makes them somewhat less desirable. Microwave Associates of Burlington, Mass. are quite active in the area of plasma amplifiers.

Selected Bibliography

PLASMA DIODES

1. *Proceedings of Government—Industry Thermionic Roundtable Discussions*, Power Information Center, University of Pennsylvania, June and December 1961.
2. *Symposium on Thermionic Power Conversion, Advanced Energy Conversion*, Vol. 2; July-September, 1962.
3. Report on the Thermionic Conversion Specialist Conference, Gatlingburg, Tenn.; October, 1963.
4. P. J. Brosens, "Solar thermionic generators for space power," *Trans. of the ASME*, Series A, vol. 87, No. 3, pp. 281-289, July, 1965.

PLASMA AMPLIFIERS

1. *Proceedings of the Symposium on Electronic Waveguides*, Brooklyn Polytechnic Inst., Brooklyn, N. Y.; 1958.
2. *Proc. of the Symposium on Millimeter Waves*, Brooklyn Polytechnic Inst., Brooklyn, N. Y.; 1959.
3. *Proc. of the Symposium on Electromagnetics and Fluid Dynamics of Gaseous Plasma*, Brooklyn Polytechnic Inst., Brooklyn, N. Y.; 1961.
4. *Wave Interaction and Dynamic Non-Linear Phenomena in Plasmas*, Penna. State University, University Park; 1963.

DATA RECORDING SYSTEMS will be installed in 42 MATS C-133's by Lockheed Aircraft Services Co. to help pinpoint the cause of aircraft accidents. The \$4.5 million contract was awarded by the Air Force Logistics Command. Recording system retains a 15-hr. continuous record of critical aircraft engine and systems operations. A four-channel voice recorder also retains a 30-min. continuous loop tape record of all cockpit area and pilot to crew conversation. Recorder also contains a beacon to signal aircraft location in case of an accident.

HIGH TEMPERATURE BATTERIES capable of withstanding temperatures of 293 $^{\circ}$ F for 100 hrs. prior to operation in a spacecraft are being designed by Douglas Aircraft for NASA. The batteries could be used for on-board power where extended charge and discharge cycles and the need for sterilization of the spacecraft are needed. Ten silver-zinc multi-plate cells with a capacity of 5 amp hours will be produced. The cells must be able to be recharged as much as 1500 times, be very light weight, operate in any position and withstand shock, acceleration and acoustic stresses.



Look what's new in electronic hardware

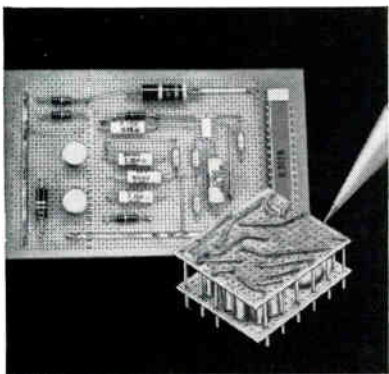

New Micro-Miniature Pre-Punched Insulating Board and Terminals—New Micro-Vectorbord is perfect as a holding matrix for making cordwood modules, and for mounting integrated circuits and discrete components. Dense small hole grid patterns and micro-miniature Push-In terminals, connectors, etc., permit high component densities. Made of epoxy glass in 4 grid patterns: 1/64" to 1/32" thick. Copper cladding if required. Frames for stiffening and mounting in card guides. Plugboards with edge mounted Miniature Elco Varicons available 9-52 contacts spaced .05 centers.

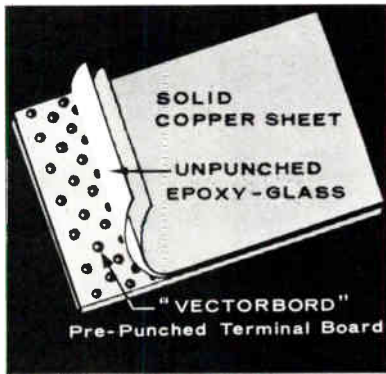

Patented

Copper Covered Sheets of Holes—COPPCO Vectorbord utilizes unpunched sheets of 2 oz. copper bonded to pre-punched insulating board with an adhesive liner of thin unpunched epoxy glass. The result is a sheet of holes with an unperforated copper surface. The inherent utility of pre-punched holes is immediately available for terminals or component leads below the unpunched copper and glass liner layers. Yet holes never interfere with etching conductor paths or areas wherever required. Available off-the-shelf on one or two sides of epoxy glass Vectorbord.

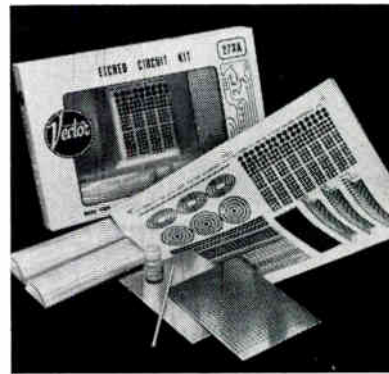

New Do-It-Yourself Resist Patterns for Etching Prototype Circuits in Minutes—New pattern sheets of Vector's Rub-On-Resist have lines from 1/64" to 1/8" and transistor pads for .05" and .1" center-to-center layouts. Easy-to-Use Vectoresist eliminates sticky tapes and photographic techniques for making prototype etched circuit layouts. Junctions do not undercut in etching because application pressure fuses joining pieces. Kit 27XA (\$5.95) has 1 all-purpose Vectoresist sheet and everything else except hot water for making 2 etched circuit boards in minutes.

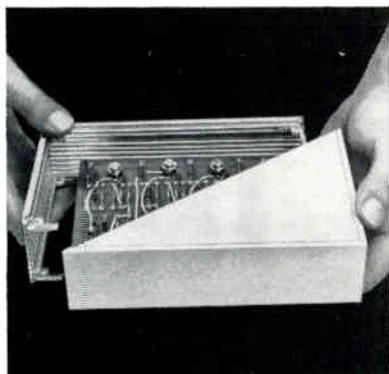

Patent pending

New Expandable Cases—New extruded aluminum Frame-Loc Rails are now available in wide size range to make sleek handsome circuit cases (or chassis) virtually any size or shape. Longitudinal grooves accommodate circuit boards on various center spacings. Circuits on etched cards requiring RFI shielding, or those employing bulkier components can be readily packaged. Complete "RF tight" cases with or without mounted shielded connectors, or case parts only are available with all hardware for plug-in rack, or chassis mounting.

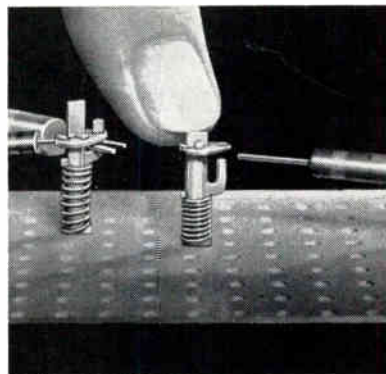

Patent pending

Solderless Side Entry U-Clip Terminal—New Solderless U-CLIPS with less than .002 ohms resistance for instant "Push-In" use in 1/16" or 3/32" holes for testing or breadboarding circuits and components. A unique "side entry" slot for component wires is uncovered by finger pressure on a plunger permitting leads to be conveniently "laid in" rather than threaded through the terminal. Contact reliability is achieved by the possibility to criss-cross leads over a 270° range. Terminals may be used again and again.

Vectorize your breadboarding and profit 3 ways!

SPEED—With Vector hardware experimental circuits are assembled in minutes... without soldering.

DELIVERABILITY—Prototypes made with Vector hardware are handsome enough to deliver for customer approval.

SAVINGS—Experimental circuits made with Vector hardware can be quickly disassembled and the low cost components used over and over without clean-up.



Presented on these pages are statements concerning various aspects of microwave technological developments as viewed by some of the key personages in the industry.

The purpose is primarily to acquaint engineers with advances in technological areas outside their particular specialties.

Trends revealed point the direction to new devices, equipment and systems made possible by advancing state-of-the-art.

Microwaves—Past, Present & Future

A State-Of-The-Art Report By Industry Leaders

“Electronic vs. Mechanical Scanning”

By D. G. Dudley

Group Scientist
Antenna & Microwave Group
Advanced System Technology
Autonetics Division, North American Aviation

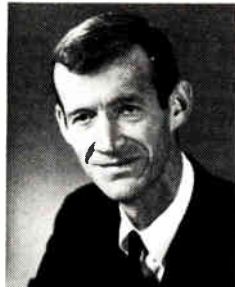

A SHIFT IN EMPHASIS presently in progress in multimode avionics radars is causing a revolution in microwave component and material technology. This shift is from mechanical to electronic scanning.

It has been widely stated that the reason for this shift is the data rate limitations of mechanical scanning; but this view is at best an oversimplification. There are many mechanical scanners which can provide high data rates, but their mechanical inertia limits the antenna to certain fixed scan patterns, and places a serious limit on versatility. For example, the required number of hits on an object varies for different radar operational modes. Optimum information processing consists of time sharing the antenna beam and concentrating the energy in areas of interest. The accelerations, decelerations, and changes in directions involved are not compatible with mechanical fixed scan patterns.

The versatility required for optimum information processing unfortunately tends to be incompatible with lightness of weight, a fact which has caused great pressures on the manufacturers of microwave components. Although electronic scanning is a proven art (such scanning has been used in operational systems since 1957), its use has been limited to ground based and shipboard systems where weight has not been a severe problem. Such is not the case in an avionics package.

Let us consider a typical design. Production at X-band of an antenna array with a 2.5 degree pencil beam and a gain of 34 db requires approximately 2000 radiating ele-

ments. To keep the weight of the antenna system to under a few hundred pounds requires a pro rated weight per radiating element of approximately one ounce. If each element is to be fed by a phase shifter to produce scanning, the weight limitations on the phase shifter components and the accompanying transmission lines have become extreme. These limitations have sent component manufacturers scrambling for new ideas and new methods. The results are just now beginning to show.

Diode phase shifters are a good example of new results. At X-band, for example, diodes have been lightweight for some time but have been expensive, and their holders have been heavy. Decreases in cost per diode from \$100 to approximately \$10 have now been effected and in some cases the holder has been entirely eliminated. When one speaks of 3000 to 4000 diodes per antenna the decrease in total price from hundreds of thousands of dollars to tens of thousands is significant.

Ferrite phase shifters are another example. At X-band, the ferrite phase shifter can presently be purchased for approximately \$100, exclusive of its drivers. Here, however, one of the major limitations has been the weight of the drivers. The development of the digital, latching ferrite phase shifter has simplified this problem because the latching characteristics require less total drive power and thus less weight.

As a final example, let us consider the important subject of transmission line technology. Since each radiating element must be somehow fed, the feeding networks can contribute a major portion of the total antenna weight. Fortunately, methods have already evolved which combine the radiator, phase shifter, and transmission line into one package and it has befallen the materials processing engineers to make the transmission line itself a minor contributor to the overall package weight. This is now being accomplished beautifully by plating techniques in which the transmission line outer walls are plated onto a mandrel, say teflon, and the mandrel then removed. Processes like electroforming are contributing significantly to this type of weight reduction.

"Microwave Devices and Equipment"

By M. E. Hines, V.P.

Director, Special Products Research
Microwave Associates, Inc.

DURING THE PAST FEW YEARS, reliable solid-state microwave devices of many types have achieved wide acceptance. Included are low noise parametric amplifiers, low noise tunnel-diode amplifiers, microwave signal sources using transistors and varactor harmonic generation, high power transmission line switches, high power T-R duplexers, power modulators and frequency converters, and high power phase shifters.

Although tubes are still required for high power microwave generation and amplification, solid-state devices now fill most requirements in new radar and communications equipment. Some types of microwave equipment can now be obtained which use solid-state devices exclusively, such as microwave communications relay for television and telephone multiplex, man-pack radar, beacons and transponders, telemetry transmitters and receivers, and Doppler navigation Radar. Phased-Array antennas, using diode phase shifters, are now being developed for multi-megawatt power levels. Experimental radars have been tested using solid-state duplexers at megawatt power levels.

High power solid-state microwave generation is a goal in active research programs. One of the most promising new principles being studied is the Gunn Effect in which microwave oscillations occur in bulk semiconductor materials.

The newer solid-state microwave devices offer many technical advantages over previous techniques, such as lower noise figure, lower signal losses and precision frequency control of microwave signals. In many cases, efficiency is improved and lower power supply voltages are usually required. Higher reliability is normally obtainable. Size and weight are usually reduced and even greater reductions are now being made possible through integrated circuit development of microwave functional devices.



Microwave Antennas

Dr. Edward A. Wolff,

Keltec Industries Inc.
Chairman, 1965 Int'l Ant. & Prop. Symposium, IEEE

IN THE MICROWAVE ANTENNA FIELD, much attention is being given to antenna arrays. Some facets of array design which are being pursued are mutual coupling for various types of array elements, feed network design and impedance matching, methods of electronic scanning, adaptive arrays, array thinning techniques and non-uniform element spacing, and arrays of large, high gain elements.

The needs of satellite communication systems and radio astronomy research have stimulated the development of large reflector antennas with low noise temperatures. Designers in this area are working on methods of electronically

steering the beam, controlling the illumination of the reflector system for lower noise temperatures, and improving the design of monopulse schemes for tracking.

A relatively new development is the application of optical techniques utilizing the coherent radiation from lasers for the simulation of antennas and the determination of radiation patterns.

Interest is also continuing in broadband log periodic antennas, electromagnetic theory analysis techniques and antenna measurement techniques.

Antenna users are looking for large reflector antennas with higher gain/temperature ratios, large array antennas with better electronic scanning and pattern control, and better techniques for the erection of large antennas in space.

Trends in Solid State Microwave Design

By William P. Stearns,

Antenna and Microwave Group,
Military Electronics Division,
Motorola, Inc.



LOOK FOR AN INCREASINGLY WIDER AVAILABILITY and application of microwave frequency transistors. These will undoubtedly be used in low noise microwave receivers, and in both high and low power oscillators and transmitters. To cite a few examples, a 2.1 gc amplifier has been developed with a 4.1 db noise figure with 7 db gain. Octave-bandwidth amplifiers have been produced with 28 and 60 db gains from 500 to 1000 MHz and from 1.0 to 2.0 GHz, respectively.

These amplifiers can now provide low noise microwave receiver front ends at frequencies through S-band. Frequencies through C- and X-band will be realized within a few years. The noise figures of these amplifiers are comparable with present tunnel diode amplifiers and only about 2 db more than parametric amplifiers.

Second, increased application of microwave semiconductor diodes for microwave signal switching, phase shifting, signal leveling, attenuation and similar microwave signal control functions.

A completely passive—i.e., no external control signals—X_L-band power leveler has been developed using pin diodes and a self-contained diode detection circuit to control power to within a quarter of a db when the input power varies as much as 4 db.

Another example is an S-band (2 GHz) diode switch used in conjunction with an isolator-circulator and filter assembly to switch redundant solid state transmitters. The complete assembly—switch, ferrite isolator, and filter weighs only 5 oz.

Microwave bulk effect devices, such as electro-acoustical amplifiers, oscillators, and delay lines, depend upon the internal resonant and quantum mechanical characteristics of bulk semiconductor materials. Examples of such devices include the Gunn effect oscillator, a device that generates microwave power through the application of a dc voltage, and the cadmium sulfide electro-acoustical amplifier that has provided 34 db gain at 60 MHz. The range of operation from devices such as these is expected to range from 10

(Continued on following page)

MHz to 5 GHz. They can be made very small; e.g., approximately $0.070 \times 0.040 \times 0.015$ in. for a 1 MHz oscillator.

Though certain problems exist presently in developing practical hardware (many of these problems have to do with the high conversion losses encountered in transducers, and the need for materials having high mobility and good heat sink capabilities), their small size potential will spur development activity and, ultimately, these devices will significantly enhance the miniaturization of microwave components and subassemblies.

Trends In Microwave Test Equipment

JOHN L. MINCK,

Marketing Manager, Microwave Division,
Hewlett-Packard Co.

MICROWAVE TEST EQUIPMENT is moving basically in two directions at once. Products are going to higher stability, and thus to higher accuracy on the one hand, and going to broader bandwidths on the other. The race toward wider band coaxial equipment is a good example.

Swept-frequency measuring equipment is increasing in importance. Accuracy levels which previously were attainable only by tedious point-by-point methods now can be achieved in continuously swept displays, thanks to higher directivity in couplers, flatter response in detectors, and new compensation methods, all of which, with the new and more stable sweepers, contribute to really level sweeper output. Continuous display of wideband response, with dynamic range as high as 30 db from square-law devices, is achieved by use of a plug-in for an oscilloscope. This is an example of the trend in new instruments, for it gives more information continuously and at a glance than was previously possible after many minutes with old ratiometer techniques. With effective new leveling techniques it can be provided with output so flat that digitized forward gain or return loss (SWR) measurements can be made.

The state of the instrument art often determines the limits of scientific investigation. As an example, a recently developed spectrum analyzer has opened up new applications. With 2 gc sweep, 60 db dynamic range in a single display, fully calibrated presentations, and a number of other new capabilities, it does jobs that could never be done before, and does others more easily, more rapidly, and more accurately.

Microwave instrumentation has been, for much the most part, useful in developing communication and radar technology. But, there are growing uses elsewhere. For instance, a new microwave spectrometer offers hitherto unavailable capabilities to the research and industrial analytical chemist.

There are still significant gaps in methods of microwave measurement. We have not seen the end of the contributions which can be made by spectrum analysis. In five years, most of the traditional methods of making microwave measurements will, we believe, have been supplanted by faster, more accurate, more convenient methods. The slotted line may



well be obsolete by then. New instrumentation will probably be more costly than traditional microwave instruments, but its value, in saving time and solving previously insoluble problems, will earn its acceptance. This, we think, signifies challenge and opportunity for both the instrument design engineers and for the users of their forthcoming products.



Trends in Broadband Microwave Antennas

By Milton Nussbaum,

Senior V.P.
American Electronic Labs., Inc.

ALTHOUGH THE BROADBAND FREQUENCY independent antenna has been on the scene for only a relatively short time, it has already been incorporated into almost every conceivable application. There are myriad forms of the frequency independent antenna from monstrous LP arrays at the HF end of the spectrum, through inflatable space-borne VHF types, to miniature cavity-backed and conical antennas in X Band.

With increased application of broadband antennas, a considerable effort has been expended to simplify construction and reduce costs. In spite of the impression that the field has matured to the extent that only 'nit-picking' type modifications are required, there are still many unresolved problem areas. These technological deficiencies represent a challenge of sufficient magnitude to maintain an active, dynamic field.

Several general requirements which typify this thesis are:

1. Small, light weight, efficient, high gain antennas for HF and lower frequencies.
2. Airborne antennas with more uniform characteristics that are adaptable to the higher speed aircraft.
3. Improved versions of standard designs to narrow the performance gap between frequency independent and aperture type antennas.

We are making progress towards the ultimate solution to these problem areas but, admittedly, some specific requirements are orders of magnitude beyond the current state-of-the-art.

A few examples of the culmination of some recent development work at AEL are:

1. Development of a truly frequency independent cavity backed spiral antenna for flush mounted airborne use. Bandwidths as high as 12:1 with moderate gain have been achieved.
2. Development of a 20-70 mc planar log periodic antenna of half the conventional size with only a moderate decrease in efficiency.
3. Development of a unique crossed-planar log periodic antenna with very high cross-polarization isolation.
4. Improvement in the conventional pyramidal, log periodic antenna with more uniform characteristics to provide performance up to 13 gc.

These examples are referenced to point out that frequency independent antennas are really in their infancy with respect to many other fields.

(Continued on page 163)

1965 SURVEY OF MICROWAVE SEMICONDUCTORS

ELECTRONIC INDUSTRIES

APPEARING ON THESE PAGES is the first known comprehensive compilation of semiconductors to function at frequencies above 1 GHz. The tabulation is based on replies to a questionnaire mailed to all companies known to make some type of semiconductor.

Because microwave semiconductors are relatively new, the editors sensed some confusion on the part of the company spokesmen as to just what components should be included in the listings. This confusion may have been reflected in the responses to some extent. And, we may appear to have been arbitrary in deciding to omit from the tables semiconductors for use as detectors and mixers. However, the criterion we followed was that all semiconductors included should be functional in some circuit which operates at 1 GHz or above. Thus, the component's cut-off frequency (at which db gain reduces to 0) should be above 1 GHz.

Some of the semiconductors listed are known to be experimental, but all of those shown are understood to be available on order.

It should also be recognized that just to have a microwave tunnel diode, varactor or transistor does not in itself assure operation at microwave frequencies. The circuit in which the device is employed and its physical layout are just as important. Thus, we hope to show by this tabulation the semiconductors that should be useful for microwave applications if suitably designed into circuits. Where supplied by the manufacturers, we have listed the semiconductors by categories based on suggested applications. Also given in the "Applications or Comments" column are manufacturers' suggestions for

correct use and special operating conditions.

A surprising number of semiconductor manufacturers stated in reply to our questionnaire that they make no semiconductors for use at 1.0 GHz or above. We suspect that some of these companies do make semiconductors that, although not specifically designed for microwave frequencies, might work in some types of circuits at 1.0 GHz. We are certain, therefore, that as careful as we were to make this listing complete, there are probably omissions. Such omissions will, if brought to our attention, be corrected in future tabulations.

In the tables, no listing is given for microwave devices such as mixers, r-f power limiters and duplexers, t-r limiters, diode switches and phase shifters. Such devices have different configurations depending upon application and are somewhat difficult to categorize in a meaningful way. Electronic Industries may endeavor to tabulate such devices at a later date if there is sufficient interest on the part of our readers.

Unfortunately, data sheets from Hoffman Semiconductor Div. of Hoffman Electronics Corp. arrived too late to be included in the tables. Hoffman makes germanium tunnel diodes with cut-off frequencies to 3.9 GHz for low-level switching and small signal applications and in TO-18 and DO-17 case styles.

The editors solicit comments from readers and from semiconductor manufacturers as to the usefulness and adequacy of the chart. If well received, the tabulations will be revised and re-issued again in the future.

Below are the complete addresses of companies whose semiconductors are included in the tables:

Microwave Semiconductor Manufacturers*

Alpha Microwave,
Division of Alpha Industries,
381 Elliot St.,
Newton Upper Falls, Mass.

American Electronic Laboratories, Inc.
Richardson Road,
Colmar, Pa.

Amperex Electronic Corp.
Semiconductor-Receiving Tube Div.,
Providence Pike
Slatersville, R.I.

General Electric Co.
Semiconductor Products Dept.,
Electronics Park,
Syracuse, N.Y.

Fairchild Semiconductor,
Division of Fairchild
Camera and Instrument Corp.,
313 Fairchild Drive,
Mountain View, Calif.

KMC Semiconductor Corp.,
Parker Road, R.D. 2,
Long Valley, N.J.

Microwave Associates, Inc.,
Burlington, Mass.

Micro State Electronics Corp.,
Subsidiary of Raytheon Co.,
Murray Hill, N.J.

Motorola Semiconductor Products, Inc.,
50005 East McDowell Road,
Phoenix, Arizona

Philco Corp.,
Solid State Products Operation
Lansdale Division
Lansdale, Pa.

RCA Electronic Components & Devices,
Microwave Tube & Semiconductor Operations,
Harrison, N.J.

Semiconductor Devices, Inc.,
875 West 15th St.,
Newport Beach, Calif.

Siemens America, Inc.,
(Siemens & Halske Aktiengesellschaft)
230 Ferris Ave.,
White Plains, N.Y.

Solid State Electronics Corp.,
15321 Rayen St.,
Sepulveda, Calif.

Sylvania
Electronic Components Group,
Semiconductor Div.,
Subsidiary of General Telephone & Electronics
100 Sylvan Road,
Woburn, Mass.

Texas Instruments, Incorporated,
Semiconductor-Components Div.,
13500 North Central Expressway,
Dallas, Texas.

Transitron Electronic Corp.,
168 Albion St.,
Wakefield, Mass.

*Based on returns from an ELECTRONIC INDUSTRIES questionnaire to all semiconductor manufacturers.

TABLE 1: SNAP-OFF VARACTORS

Snap-off varactors are silicon junction devices designed for single-stage, high-order harmonic generation with efficiency exceeding 1/n. Output frequencies in typical applications are in S-, C-, and X-band. Snap-off varactors can also be used for pulse shaping and pulse amplification.

Company	Type	V _{BR} Breakdown Voltage at 10 μ a (v)	C _{jo} Junction Capacitance Min.-Max. at 0 Bias (pf)	τ Lifetime Min. (ns)	t _f Snap-Off Time Max. (ns)	θ Thermal Resistance Max. °C/W	I _F Forward Current Min. for 1v Forward Potential (ma)	Applications or Comments
Microwave Associates	4748	25	0.3, 0.6	10	.15	150	40	Test conditions: I _f = 10 ma, V _f = 10v, and R ₁ = 50 Ω
	4749	25	0.5, 1.1	10	.10	125	40	
	4750	25	0.5, 1.1	10	.15	125	40	
	4751	25	0.5, 1.1	10	.20	125	40	
	4752	25	1.0, 1.6	10	.15	100	40	
	4753	25	1.5, 2.0	10	.15	75	40	
	4754	20	0.5, 1.5	20	.20	500	40	
	4755	35	1.0, 3.0	30	.30	500	150	
	4756	35	3.0, 10.0	50	.50	500	200	

TABLE 2: VARACTOR TUNING DIODES

Tuning varactors are manufactured by both epitaxial growth and diffusion. Abrupt junction epitaxial types offer greater capacitance swing for the amount of bias applied; diffused types offer higher Q and low leakage current.

Company	Type	C Capacitance at 4v (pf)	Q (Min.) at 4v	V _{BR} Breakdown (v) at 10 μ a	I _R Reverse Current (μ a) at 25V	CR Typical Capacitance Ratio	CR Min./Max. C(2V)/C(30V)	Applications or Comments			
Microwave Associates	4701B	6.8	200	35	0.5	C(2V)/C(100V)	2.5/2.9	Diffused, epitaxial, low voltage, high Q. All values at test temperature 25°C. All values of capacitance are junction plus case. Q is determined at 50 Mc.			
	4701B1	6.8	400	35	0.5		2.5/2.9				
	4701C	8.2	175	35	0.5		2.5/2.9				
	4701C1	8.2	350	35	0.5		2.4/2.7				
	4701D	10	175	35	0.5		2.7/3.1				
	4701D1	10	350	35	0.5		2.7/3.1				
	4701E	12	150	35	0.5		2.7/3.1				
	4701E1	12	300	35	0.5		2.7/3.1				
	4701F	15	150	35	0.5		2.7/3.1				
	4701F1	15	300	35	0.5		2.7/3.1				
	4701G	18	125	35	0.5		2.7/3.1				
	4701G1	18	225	35	0.5		2.7/3.1				
	4701H	22	125	35	0.5		2.7/3.1				
	4701H1	22	225	35	0.5		2.7/3.1				
	4701I	27	75	35	0.5		2.7/3.1				
	4701I1	27	150	35	0.5		2.7/3.1				
	4702A	33	75	35	0.5		2.7/3.1				
	4702A1	33	150	35	0.5		2.7/3.1				
	4702B	39	75	35	0.5		2.7/3.1				
	4702B1	39	125	35	0.5		2.7/3.1				
	4702C	47	75	35	0.5		2.7/3.1				
	4702C1	47	125	35	0.5		2.7/3.1				
	4702D	56	50	35	0.5		2.7/3.1				
	4702D1	56	100	35	0.5		2.7/3.1				
	4702E	68	50	35	0.5		2.7/3.1				
	4702E1	68	100	35	0.5		2.7/3.1				
	4702F	82	40	35	0.5		2.7/3.1				
	4702F1	82	75	35	0.5		2.7/3.1				
	4702G	100	40	35	0.5		2.7/3.1				
	4702G1	100	75	35	0.5		2.7/3.1				
	4273B	6.5	100	110	0.5		4.5		C(2V)/C(60V)	Abrupt junction, epitaxial, high voltage, high Q.	
	4273C	10	100	110	0.5		5.2				
	4273D	15	100	110	0.5		5.2				
	4273E	22	100	110	0.5		5.2				
	4273F	33	100	110	0.5		5.2				
	4273G	47	100	110	0.5		5.2				
	4019B	6.5	100	110	0.5		4.5				
	4019C	10	100	110	0.5		5.2				
	4019D	15	100	110	0.5		5.2				
	4019E	22	100	110	0.5		5.2				
	4019F	33	100	110	0.5		5.2				
	4019G	47	100	110	0.5		5.2				
	4703B	6.5	150	75	0.5		3.5				Abrupt junction, epitaxial, low voltage, high Q.
	4703C	10	150	75	0.5		4.0				
	4703D	15	150	75	0.5		4.0				
4703E	22	150	75	0.5	4.0						

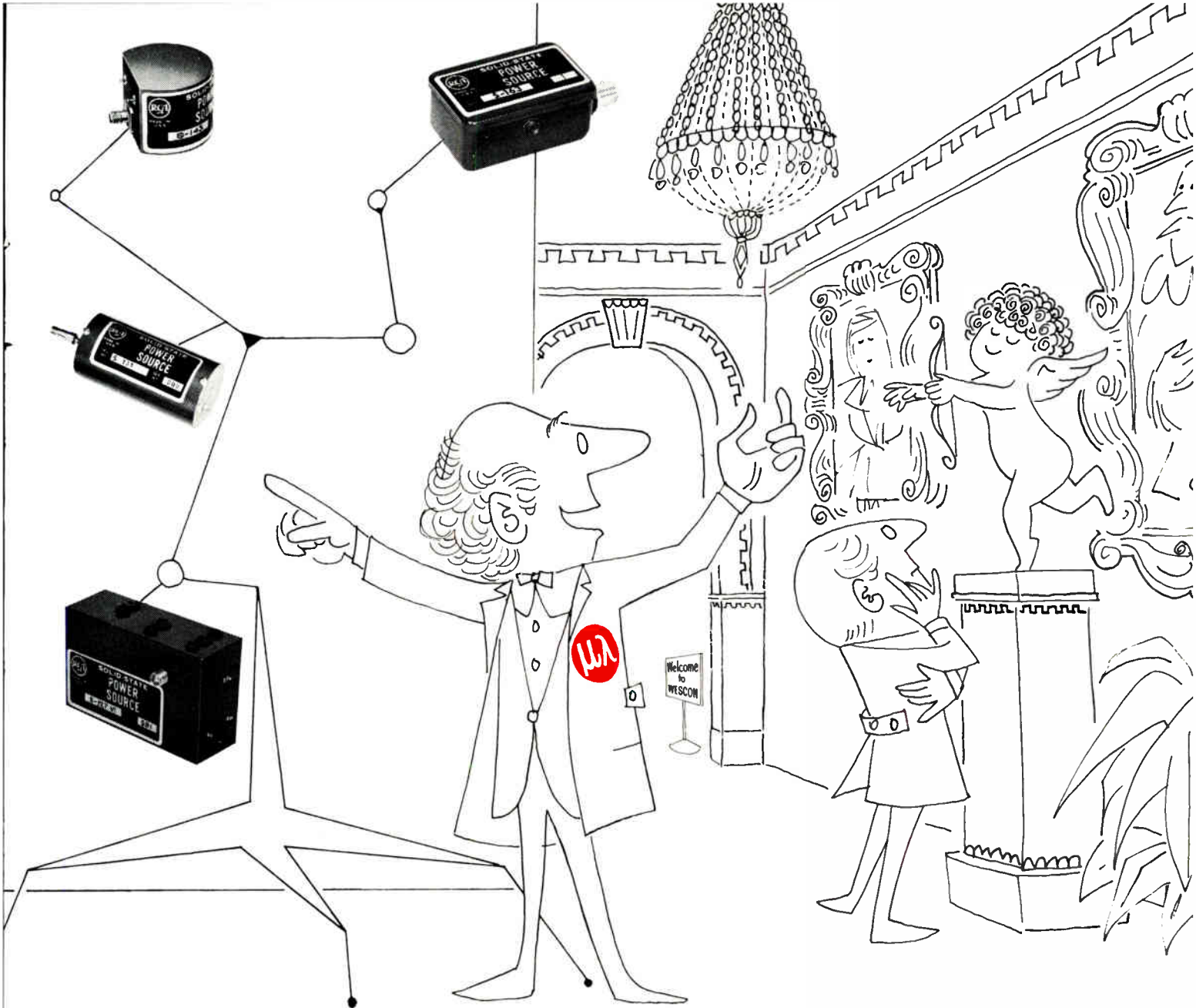

THINKING DESIGN? THINK MODERN! THINK RCA SOLID-STATE MICROWAVE DEVICES

Solid state is "in." It is your answer to low-cost power and reliability for over-all system economy. And you get both in the "years-ahead" capability RCA is assembling into its solid-state Microwave power sources. You can choose from a line of these packaged-circuitry devices whose space-age technology can make present-day systems obsolete.

TOM (Transistor Oscillator Multiplier) and TOVAR (Transistor Oscillator Varactor) devices are readily available over the frequency range of 500 Mc/s to 2250 Mc/s and with power outputs up to 2.0 watts.

Compact and rugged, these RCA devices are designed for low-cost volume production. They're ideal for new telemetry applications as well as low-cost scientific probes in near and outer space experiments in temperature, humidity, and weather-related information.

These power sources can be operated from batteries or solar cells (no DC to DC converter required)! So switch to solid state with RCA. Talk with your RCA Representative. He can tell you more about these designs with power output, efficiency, and frequency that meet your specific requirements. For technical data on specific types, write: RCA Commercial Engineering, Section K50Q, Harrison, N.J.

TYPICAL CHARACTERISTICS OF SIX OF RCA'S SOLID STATE MICROWAVE DEVICES

Type	Nominal Power Output	Freq. Range (Typical) (4)	DC Power (Volts/ma)	Typical Size	Modulation Charact.
S127V2	0.5 to 1.0 w	1.435 to 2.3 Gc/s(1)	30 v/200 ma	1" x 2" x 3"	±300 kc FM
S131	200 mw	1.435 to 1.8 Gc/s(1)	28 v/125 ma	1½" diam. x 3"	±300 kc FM
S163	100 mw	0.5 to 1.0 Gc/s(2)	28 v/150 ma	2¾" x 1½" x 1½"	---- (3)
S170	125-200 mw	1.435 to 2.3 Gc/s(1)	28 v/150 ma	1" diam. x 2"	100% AM (1vPP)
S172	200 mw	0.5 to 1.0 Gc/s(1)	28 v/70 ma	1" diam. x 4½"	---- (3)
S173	2 watts	0.5 to 0.85 Gc/s(1)	30 v/470 ma	2¾" x 1½" x 1½"	---- (3)

(1) Manually tunable ±10 Mc from specified center frequency. (2) Manually tunable ±150 Mc from specified center frequency. (3) Optional features include FM or pulse modulation (ON/OFF); DC Regulation; various connectors. (4) All units are temp. compensated over -50°C to +70°C for nominal stability of ±0.1%.

RCA Electronic Components and Devices



The Most Trusted Name in Electronics

TABLE 2: VARACTOR TUNING DIODES (Continued)

Company	Type	C Capacitance at 4v (pf)	Q (Min.) at 4v	V _{BR} Breakdown (mv)	I _R Reverse Current (μ A)	CR Typical Capacitance Ratio	CR Min./Max.	Applications or Comments
Microwave Associates Cont.	4703F	33	125	75	0.5	4.0	C(2V)/C(40V)	
	4703G	47	100	75	0.5	4.0		
	4704B	6.5	150	50	0.5	3.0		
	4704C	10	150	50	0.5	3.0		
	4704D	15	150	50	0.5	3.0		
	4704E	22	150	50	0.5	3.0		
	4704F	33	125	50	0.5	3.0		
	4704G	47	100	50	0.5	3.0		

TABLE 3: VARACTOR HARMONIC GENERATORS

Company	Type	f In-Out Dynamic Test Frequency (gc)	P _{in} Input Power (w)	E _{ff} Overall Efficiency Min. (%)	C _{jo} Junction Capacitance at 6v Min.-Max. (pf)	V _{BR} Breakdown Voltage Min. (v)	θ Thermol Resistance Max. °C/W	Applications or Comments
Amperex Electronic Corp.	IN4885		25-40	64-55	28 / 39	150		Series Resistance (R _s) - 0.7 max. f _{co} - 80 GC (Typ.) Series Resistance (R _s) - 0.8 max. f _{co} - 55 GC (Typ.)
	IN4886		25	60	28 / 39	120		
Microwave Associates	4764	1, 4	2	45	1/2	40	75	
	4765	4, 12	1	30	0.6 1.2	24	125	
	4086	12, 24	0.15	15	0.2 0.4	8	500	
Micro State Electronics Corp.	Series							Silicon planar epitaxial
	100-106				0.1/0.4	6-120		
	110-116				0.4/1.0	6-120		
	120-126				1.0/2.0	6-120		
	130-136				2.0/4.0	6-120		
	140-146				4.0/8.0	6-120		
	150-156				8.0/15.0	6-120		
160-166				15.0/25.0	6-120			
Semiconductor Devices	Series of devices available with V _{BR} from 6 to 120v and C _{jo} from 0.2 to 50.0+ pf. F _c = 10 gc							
Sylvania Electric Products	D4811C	1-2, 2-4	0.1	50				Frequency doublers
	D4821C	1-2, 2-4	0.2	50				
	D4831C	1-2, 2-4	0.5	50				
	D4841C	1-2, 2-4	1	50				
	D4851C	1-2, 2-4	2	50				
	D4861C	1-2, 2-4	5	50				
	D4871C	1-2, 2-4	10	50				
	D4811F/D4611G	2-4, 4-8	0.1	50				
	D4821F/D4621G	2-4, 4-8	0.2	50				
	D4831F/D4631F	2-4, 4-8	0.5	50				
	D4841F/D4641F	2-4, 4-8	1	50				
	D4851F/D4651F	2-4, 4-8	2	50				
	D4610J/D5147A	4-8, 8-16	0.1	40				
	D4620J/D5246B	4-8, 8-16	0.2	40				
	D4630H/D5246B	4-8, 8-16	0.5	40				
	D4640H	4-8, 8-16	1	40				
	D4651G	4-8, 8-16	2	40				
	D4610K/D5147B	8-10, 16-20	0.1	20				
	D4620J/D5246B	8-10, 16-20	0.2	20				
	D4630J/D5246B	8-10, 16-20	0.5	20				
	D4640J	8-10, 16-20	1	20				
	D4610K/D5147B	10-20, 20-40	0.1	20				
	D4620K/D5246B	10-20, 20-40	0.2	20				
	D5246B	10-20, 20-40	0.5	20				
	D4811F	1-2, 3-6	0.1	40				Frequency triplers
	D4821F	1-2, 3-6	0.2	40				
	D4831F	1-2, 3-6	0.5	40				
	D4841F	1-2, 3-6	1	40				
	D4851E	1-2, 3-6	2	40				
	D4861E	1-2, 3-6	5	40				
	D4811G/D4611G	2-4, 6-12	0.1	30				
	D4821G/D4621G	2-4, 6-12	0.2	30				
	D4831G/D4631G	2-4, 6-12	0.5	30				
D4841G/D4641G	2-4, 6-12	1	30					
D4851G/D4651G	2-4, 6-12	2	30					
D4810J/D4610J/ D5147A	4-8, 12-24	0.1	15					

TABLE 3: VARACTOR HARMONIC GENERATORS (Continued)

Company	Type	f In-Out Dynamic Test Frequency (gc)	P _{in} Input Power (w)	E _{ff} Overall Efficiency Min. (%)	C _{jo} Junction Capacitance at 6v Min.-Max. (pf)	V _{BR} Breakdown Voltage Min. (v)	θ Thermal Resistance Max. °C/W	Applications or Comments
Sylvania Electric Products Cont.	D4820J/D4620J/ D5246B	4-8, 12-24	0.2	15				Frequency triplers (cont.)
	D4830J/D4630J/ D5246B	4-8, 12-24	0.5	15			Typical Harmonic Multipliers	
	D4840J/D4640J	4-8, 12-24	1	15				
	D5147B	8-10, 24-30	0.1	15				
	D5246B	8-10, 24-30	0.2	15				
	D5246B	8-10, 24-30	0.5	15				
	D5147B	10-20, 30-60	0.1	5				
	D5246B	10-20, 30-60	0.2	5				
	D5246B	10-20, 30-60	0.5	5				
	D4863A	0.6, 1.2	7	60				
	D4862C	0.75, 1.5	5	60				
	D4253C/D4853C	1.2, 2.4	4	60				
	D4211D/D4811D	2.0, 4.0	0.3	33				
	D4242F/D4842F	2.4, 4.7	2.5	40				
	D4831H	2.4, 4.8	1.8	49				
	D4261C/D4861C/ D4851C	3.0, 6.0	1.4	47				
	D4222J/D4822G D4221J/D4821J	4.8, 9.6	1	35				
	D4651E	4.8, 9.6	2	35				
	D5047B	4.8, 9.6	1.5	60				
	D4201K/D4801K	8, 16	0.42	29				
	D4244/D4844							
	D4233B/D4833B	0.6, 1.8	0.9	33				
	D4241H/D4841H	8.0, 24	0.2	18				
	D5047C	9.6, 28.6	0.410	55				
	D5047	9.0, 4.5	0.35	1.7				
	D4957	10.0, 50	0.15					
	D4865	0.2, 1.2	2	40				
	D4252B/D4852B	0.26, 1.82	0.200	7.5				

TABLE 4: SILICON VARACTOR DIODES -- GENERAL PURPOSE

Company	Type	C _{jo} Junction Capacitance (pf)	R _s Series Resistance (ohms)	θ Thermal Resistance (°C/W)	V _{BR} Breakdown Voltage (v)	F _{co} Cutoff Frequency (gc)	Applications or Comments
American Electronic Laboratories	Series of devices available with V _{BR} from 6 to 160v. and C _{jo} at -6v. of 0.1 to 16.0 pf. Button, pill and cartridge packages available. Cutoff frequency min. from 5 to 180 gc.						For voltage tuning amplifiers, parametric amplifiers, frequency multipliers, high-speed power limiters and solid state crystal switches.
Microwave Associates	4321AA through 4321G	0.2-0.4 through 25.0-40.0		800 to 250	6		
	4041AA through 4041G1	0.2-0.4 through 25.0-50.0		to 25	6	80	
	4051AA through 4051G1	0.2-0.4 through 25.0-50.0		500 to 40	6	60	
	4322AA through 4322G	0.2-0.5 through 32.0-64.0		800 to 250	12		
	4042AA through 4042G1	0.2-0.5 through 32.0-64.0		to 25	12	80	
	4052AA through 4052G1	0.3-0.5 through 32.0-64.0		500 to 40	12	80	
	4324A through 4324G	0.3-0.6 through 20.0-40.0		400 to 250	24		
	4044AA through 4044G1	0.15-0.3 through 20.0-40.0	- 0.5	to 20	24	75	
	4054AA through 4054G1	0.15-0.3 through 20.0-40.0	- 0.5	300 to 35	24	75	

TABLE 4: SILICON VARACTOR DIODES -- GENERAL PURPOSE (Continued)

Company	Type	C _{jo} Junction Capacitance (pf)	R _s Series Resistance (ohms)	θ Thermal Resistance (°C/W)	V _{BR} Breakdown Voltage (v)	f _{co} Cutoff Frequency (gc)	Applications or Comments		
Microwave Associates Cont.	4325AA through 4325G	0.2-0.4 through 25.0-50.0	21.0 to 0.6	800 to 250	48				
	4045AA through 4045G	0.2-0.4 through 25.0-50.0	— to 1.0	— to 15	48	60			
	4055AA through 4055G	0.2-0.4 through 25.0-50.0	— to 1.0	300 to 30	48	60			
	4326AA through 4326G	0.2-0.5 through 32.0-64.0	21.0 to 0.6	800 to 250	60				
	4046A through 4046G	0.5-1.0 through 32.0-64.0	— to 1.0	— to 15	60	40			
	4056A through 4056G	0.5-1.0 through 32.0-64.0	— to 1.0	125 to 30	60	40			
	4327A through 4327G1	0.25-0.5 through 16.0-32.0	21.0 to 1.0	400 to 250	90				
	4047A through 4047G1	0.25-0.5 through 16.0-32.0	— to 1.0	80 to 15	90	40			
	4057A through 4057G1	0.25-0.5 through 16.0-32.0	— to 1.0	100 to 30	90	40			
	4328A through 4328G	0.3-0.6 through 20.0-40.0	21.0 to 1.3	400 to 250	120				
	4048A through 4048G	0.3-0.6 through 20.0-40.0	— to 1.3	75 to 13	120	30			
	4058A through 4058G	0.3-0.6 through 20.0-40.0	— to 1.3	80 to 30	120	30			
	Philco Corp.	Series L4200 L4300	0.1-6.0 (-6v) 6-40 (-6v) 15-120 (0v typ.)			24-90 90-140	5-100 (-6v) 5-100 (-6v)	DO-23 glass cartridge package Do-4 package	
		L4800 L4900	0.1-20.0 (-6v) 0.1-20.0 (-6v)			24-140 24-120	5-100 (-6v) 5-100 (-6v)	Welded-ceramic cartridge package Pill-PRONG. Welded-ceramic package.	
		Semiconductor Devices	11-9	1.5 (max.)				90	High - Q, low breakdown voltage varactors.
			11-8	1.5 (max.)				80	
	11-7		2.0 (max.)				70		
	11-6		2.0 (max.)				60		
	Sylvania Electric Products	Series D4600 D4800	0.1-30 at 6v 0.4-30 at 6v			6-120 6-120	5-200 5-140	General purpose silicon epitaxial varactors.	
		Texas Instruments	XA706- XA713	0.4-30 C _T		24-120	5-120	Dissipation 0.75-3.5w. For tuning, parametric ampls., harmonic gener- ators.	

TABLE 5: LIMITER VARACTORS

Company	Type	C _{jo} Junction Capacitance at 0v Min.-Max. (pf)	R _s Series Resistance Max. at 500 mc (ohms)*	θ Thermal Resistance Max. (°C/W)	V _{BR} Breakdown Voltage Min. (v)	f _{co} Cutoff Frequency at 0v Bias (gc)	Applications or Comments
Microwave Associates	4684	1.8, 2.8	0.8	75	8	35	*Measure with 100-mA current.
	4685	0.4, 0.8	1.2	150	8	70	
	4686	0.3, 0.6	1.4	250	8	90	
	4687	0.2, 0.4	1.8	500	8	100	
	4688	0.1, 0.2	2.5	1000	8	100	

TABLE 6: HIGH POWER VARACTORS

Company	Type	C _{jo} Junction Capacitance at 0 v (pf)	R _s Series Resistance Max. at 500 mc (ohms)	θ Thermal Resistance Max. (°C/W)	V _{BR} Breakdown Voltage at 10 μa (v)	F _o Operating Frequency (gc)	Applications or Comments
Microwave Associates	4760AA	80/160	1.2	6	90	3	Max. Junction Temperature 150°C
	4760A	40/80	1.5	6	90	3	
	4760B	20/40	2.0	9	90	3	
	4760C	10/20	2.5	12	90	3	
	4760D	5/10	3.5	15	90	3	
	4761AA	80/160	1.2	6	120	3	
	4761A	40/80	1.5	6	120	3	
	4761B	20/40	2.0	9	120	3	
	4761C	10/20	2.5	12	120	3	
	4761D	5/10	3.5	15	120	3	
	4763	50/100	1.0	5	250	3	
Motorola Semiconductor Products	IN4388	C _T 10 (pf) (typ.)	2.0 at 50 mc		150 (typ. at 10 μadc)	to 1 (gc)	Harmonic generator silicon-dif- fused junction type.
	MV1808	C _T 5.8 (typ.)	0.5 (typ.)	19 (typ.)	80 (typ.)	to 3 (gc)	

TABLE 7: GALLIUM ARSENIDE VARACTORS

Company	Type	C _{jo} Junction Capacitance at 6v Min.-Max. (pf)	f _c Min. Cutoff Freq. 2v/6v (gc)	V _{BR} Min. Breakdown Voltage (v)	θ Max. Thermal Resistance °C/W	Applications or Comments		
Microwave Associates	4644A	0.15, 0.30	240, 300	6	800	High voltage, high cut- off diffused junction mesa structure. For mi- crowave switch, har- monic generator, modu- lator, limiter and du- plexer applications. Power dissipation 300 mw to 1.5 w.		
	4644B	0.15, 0.30	190, 250	6	800			
	4644C	0.15, 0.30	160, 200	6	800			
	4644D	0.15, 0.30	120, 150	6	800			
	4644E	0.15, 0.30	80, 100	6	800			
	4645B	0.3, 0.6	190, 250	6	400			
	4645C	0.3, 0.6	160, 200	6	400			
	4645D	0.3, 0.6	120, 150	6	400			
	4645E	0.3, 0.6	80, 100	6	400			
	4646C	0.60, 1.2	160, 200	6	200			
	4646D	0.6, 1.2	120, 150	6	200			
	4646E	0.6, 1.2	80, 100	6	200			
	Micro State Electronics Corp.	Series						High voltage, high cut- off diffused junction mesa structure. For mi- crowave switch, har- monic generator, modu- lator, limiter and du- plexer applications. Power dissipation 300 mw to 1.5 w.
		4150-4156, 3250-3256	0.2/1.1	10-120	18			
4200-4206, 3130-3136		0.2/1.1	10-120	30				
4250-4256, 3160-3166		0.2/1.1	10-120	45				
4300-4305, 3200-3205		0.2/1.1	10-100	60				
4160-4166, 3260-3266		1.1/3	10-120	18				
4210-4215, 3150-3155		1.1/3	10-100	30				
4260-4265, 3170-3175		1.1/3	10-100	45				
4310-4314, 3210-3214		1.1/3	10-80	60				
4170-4174, 3270-3274		3/6	10-80	18				
4220-4223, 3140-3143		3/6	10-60	30				
4270-4273, 3180-3183		3/6	10-60	45				
4320-4322, 3220-3223		3/6	10-40	60				
4180-4182, 3280-3282		6/10	10-40	18				
4230-4232, 3145-3147	6/10	10-40	30					
4280-4282, 3190-3192	6/10	10-40	45					
4330-4331, 3230-3231	6/10	10-20	60					
Sylvania Electric Products	Series D5047	0.4-1.0	200-350 at -6v Bias	-6		For both parametric am- plifiers and high fre- quency harmonic multi- pliers		
	D5200	0.3-2.4	150-350 at -6v Bias	6-40				
Texas Instruments	XV05	0.3/0.7 C _T	500	6 Min.		For use in parametric amplifier NF (db) - 3 at 16.5 gc High voltage types for use in tuning, harmonic generators, etc.		
	XV06	0.3/0.6 C _T	400	6 Min.				
	XV07	0.3/0.6 C _T	300	6 Min.				
	XV01	0.35/1.0 C _T	300	6 Min.				
	XV02	0.35/0.70 C _T	200	6 Min.				
	XV03	0.35/0.60 C _T	150	6 Min.				
	XV04	0.35/0.60 C _T	100	6 Min.				
	XA900	0.4/1.4 C _T	50 (min.) V _R = 6v	30 (I _R = 1 μa)				
	XA901	0.4/1.4 C _T	100 (min.) V _R = 6v	30 (I _R = 1 μa)				
	XA902	0.4/1.4 C _T	200 (min.) V _R = 6v	30 (I _R = 1 μa)				

TABLE 7: GALLIUM ARSENIDE VARACTORS (Continued)

Company	Type	C _{jo} Junction Capacitance at 6v Min.-Max. (pf)	f _c Min. Cutoff Freq. 2v/6v (gc)	V _{BR} Min. Breakdown Voltage (v)	θ Max. Thermal Resistance °C/W	Applications or Comments
Texas Instruments	XA903	0.4/1.4 CT	300 (min.)	V _R = 6v	30 (I _R = 1 μA)	High voltage types for use in tuning, harmonic generators, etc. Parametric Ampls., switches, phase switches.
	XA905	0.4/1.4 CT	50 (min.)	V _R = 6v	50 (I _R = 1 μA)	
	XA906	0.4/1.4 CT	100 (min.)	V _R = 6v	50 (I _R = 1 μA)	
	XA907	0.4/1.4 CT	200 (min.)	V _R = 6v	50 (I _R = 1 μA)	
	XA908	0.4/1.4 CT	300 (min.)	V _R = 6v	50 (I _R = 1 μA)	
	A600-A602	0.45/1.0 CT	90-150		8	
	A610-A612	0.45/1.0 CT	90-150		8	

TABLE 8: PARAMETRIC AMPLIFIER VARACTORS

Company	Type	C _{jo} Junction Capacitance at 0v Min.-Max. (pf)	f _c Min. Cutoff Freq. (gc)	β Min. Beta	I _R Max. Leakage Current at 3v μA	V _{BR} Breakdown Voltage (v)	Applications or Comments
Alpha Microwave Div. Alpha Ind.	Series						
	101	0.2-0.39	50-300	5.0-3.5			Max. Pwr. Diss. — 150 mw (Si)
	102	0.40-0.79	50-300	5.0-3.5			
	103	0.80-1.59	50-225	5.0-3.5			
	201	0.2-0.39	50-300				Max. Pwr. Diss. — 150 mw (GaAs)
	202	0.4-0.79	50-300				
	203	0.80-1.59	50-225				
Micro State Electronics Corp.	6100, 6200, 6300	0.1/0.2	100 (6v)	3.5			Silicon
	6101, 6201, 6301	0.1/0.2	150 (6v)	3.5			
	6102, 6202, 6302	0.1/0.2	200 (6v)	4.0			
	6103, 6203, 6303	0.1/0.2	250 (6v)	4.5			Gallium arsenide
	6104, 6204, 6304	0.2/0.3	100 (6v)	3.5			
	6105, 6205, 6305	0.2/0.3	150 (6v)	3.5			
	6106, 6206, 6306	0.2/0.3	200 (6v)	4.0			
	6107, 6207, 6307	0.3/0.5	100 (6v)	4.0			
	262, 4101	0.2/1.0	80 (-6v)				
	263, 4102	0.2/1.0	105 (-6v)				
	264, 4103, 4403	0.2/1.0	130 (-6v)				
	265, 4104, 4404	0.2/0.8	160 (-6v)				
	266, 4105, 4405	0.2/0.7	200 (-6v)				
	20006, 4106, 4406	0.1/0.6	250 (-6v)				
	4107, 4407	0.1/0.5	320 (-6v)				
4108, 4408	0.1/0.4	360 (-6v)					
Microwave Associates	4534	0.8, 1.2	50	5	1		
	4034	0.8, 1.2	50	5	1		
	4535	0.6, 0.9	60	5	1		
	4035	0.6, 0.9	60	5	1		
	4536	0.4, 0.65	70	5	1		
	4036	0.4, 0.65	70	5	1		
	4537	0.4, 0.6	80	5	1		
	4037	0.4, 0.6	80	5	1		
	4538	0.4, 0.6	100	3.5	1		
	4038	0.4, 0.6	100	3.5	1		
	4539	0.3, 0.5	120	3.5	1		
4039	0.3, 0.5	120	3.5	1			
Sylvania Electric Products	D5046	0.3-0.8	or -3v Bias			5.5 at 10 μA	Silicon varactors for parametric am- plifier applications
	D5046A	0.3-0.7	150	3.0		5.5 at 10 μA	
	D5046B	0.3-0.6	200	3.0		5.5 at 10 μA	
	D5146	0.3-0.6	250	3.0		5.5 at 10 μA	
	D5146A	0.3-0.6	75	8.0		5.5 at 10 μA	
	D5146B	0.3-0.6	100	8.0		5.5 at 10 μA	
		125	8.0		5.5 at 10 μA		

TABLE 9: AMPLIFIER & OSCILLATING TRANSISTORS

Company	Type	V _{CB0} (v)	I _{CB0} (mA)	h _{FE} Min.-Max.	f _T (gc)	r _b , C _c (psec)	NF (db)	Applications or Comments
Amperex Electronic Corp.	A490	30	10	25-125	1.0	4-15	5	
Transitron Electronic Corp.	2N2784 2N3633	15 15		40/120 50/150	1.0 1.3			Switching or Amplifying
KMC Semiconductor Corp.	2N3880 K2501 K2502 K2503			6.5 db*	1.5		6	*At 1 gc Osc. Pwr. Out = 70 mw at 1 gc Osc. Pwr. Out = 85 mw at 1 gc Osc. Pwr. Out = 30 mw at 2 gc
Fairchild Semiconductor	MT1038 MT1039	30 30	500 500	20/80 20/80	1.0 1.0			Osc. Pwr. Out = 1.0 w at 1 gc Osc. Pwr. Out = 0.8 w at 1 gc
Motorolo Semiconductor Products	2N3279, 2N3280 2N3281, 2N3282 2N3544 2N3783, 2N3784 2N3785	30 (max.) 30 (max.) 25 (max.) 30 (max.) 15 (max.)	1000 50 K (max.) 10 5 K 5 K	10/70 10/100 25/ 20/200 15/200	0.5 (typ.) 0.4 0.8/1.6 0.7/1.6	5 (typ.) 5 (typ.) 10 (max.) 1/6 1/10	2.9 (typ.) 4.0 (typ.) 6.5 (max.)/7.0 (typ.) 2.9 (max.)	Germanium pnp epitaxial mesa dif-fused base. For use as high-gain, low-noise amplifiers, oscillators, mixers and frequency multipliers. Oscillation f _{max.} = 2000 mc (typ.) VHF/UHF silicon npn epitaxial passivated transistor. P out at 1000 mc = 16 mw (typ.) Germanium pnp epitaxial mesa for high-gain, low-noise amplifiers, oscillators, and frequency multipliers.
Siemens & Holske	AFY34	-40		>10	3.5			Universal applications to 1.5 gc. Germanium pnp mesa.
Solid State Electronics Corp.	SST610	60	0.3 ma (typ.)	>5 K				nnp silicon diffused mesa. Highly stable.
Texas Instruments	X3024A 2N3570 X3016A XS09 XS10 XS12 XS13	-15 min. -15 min. 30 min. 30 min. 30 min.	-6.0 max. -6.0 max. 1 max.	25/250 25/250 20/200 20/200 20/200	 1.4	2.0 2.0 5	5 at 1 gc 7 at 1 gc silicon 6 at 1 gc silicon	Germanium, UHF and L-Band amplifier L-C Band oscillator. Silicon P _{omin} 30 mw at 2 gc P _o 30 mw at 1 gc P _o 250 mw at 1.5 gc P _o 250 mw at 1.5 gc

TABLE 10: SWITCHING DIODES

Company	Type	Frequency (gc)	Insertion Loss, db (Forward Bias)		Isolation, db (Reverse Bias)		Power Level (w)	Applications or Comments
			Typ.	Mox.	Min.	Typ.		
Philco Corp.	L4702	4.5	1.0	1.5	25	30	5.0	C through K-Band silicon epitaxial switching diodes
	L4703	5.0	1.0	1.5	25	30	5.0	
	L4704	5.5	1.0	1.5	20	25	2.5	
	L4705	6.0	1.0	1.5	25	30	5.0	
	L4706	6.5	1.0	1.5	25	30	5.0	
	L4707	7.0	1.0	1.5	25	30	4.0	
	L4708	7.5	1.0	1.5	25	30	3.0	
	L4709	8.0	1.0	1.5	20	25	2.5	
	L4710	7.5	1.0	1.5	25	30	5.0	
	L4711	8.0	1.0	1.5	25	30	5.0	
	L4712	8.5	1.0	1.5	25	30	4.0	
	L4713	9.0	1.0	1.5	25	30	3.0	
	L4714	9.5	1.0	1.5	25	30	2.5	
	L4715	8.5	0.5	0.75	20	25	5.0	
	L4716	9.0	0.5	0.75	20	25	5.0	
	L4717	9.5	0.5	0.75	20	25	5.0	
	L4718	10.0	0.5	0.75	20	25	5.0	
	L4719	10.5	0.5	0.75	20	25	4.0	
	L4720	11.0	0.5	0.75	20	25	3.0	
	L4721	11.5	0.5	0.75	20	25	2.5	
	L4722	12.0	0.5	0.75	20	25	2.5	
	L4750	13.0	0.4	0.75	20	25	5.0	
	L4751	13.3	0.4	0.75	20	25	5.0	
	L4752	14.0	0.4	0.75	20	25	5.0	
L4753	14.5	0.4	0.75	20	25	4.0		

TABLE 10: SWITCHING DIODES (Continued)

Company	Type	Frequency (gc)	Insertion Loss, db (Forward Bias)		Isolation, db (Reverse Bias)		Power Level (w)	Applications or Comments
			Typ.	Max.	Min.	Typ.		
Philco Corp. Cont.	L4754	15.0	0.4	0.75	20	25	4.0	C through X-Band germanium switching diodes
	L4755	15.5	0.4	0.75	20	25	3.0	
	L4756	16.0	0.4	0.75	20	25	2.5	
	L4757	16.5	0.4	0.75	20	25	2.5	
	L4758	17.0	0.5	0.75	20	25	2.5	
	L4759	17.5	0.5	1.0	20	25	2.5	
	L4765	20.5	0.4	0.75	10	15	2.0	
	L4766	21.0	0.4	0.75	10	15	2.0	
	L4767	21.5	0.4	0.75	10	15	2.0	
	L4768	22.0	0.25	0.5	10	15	2.0	
	L4769	22.5	0.25	0.5	10	15	2.0	
	L4770	23.0	0.25	0.5	10	15	2.0	
	L4771	23.5	0.25	0.5	10	15	2.0	
	L4772	24.0	0.25	0.5	10	15	2.0	
	L4773	24.5	0.25	0.5	8	12	2.0	
	L4774	25.0	0.25	0.5	8	12	2.0	
	L4775	25.5	0.25	0.5	8	12	2.0	
	L4776	26.0	0.25	0.5	8	12	2.0	
	L4130	4.5	0.75	1.2	25	28	1.0	
	L4131	5.0	0.75	1.2	25	28	1.0	
	L4132	5.5	0.75	1.2	25	28	1.0	
	L4133	6.0	0.75	1.2	25	28	1.0	
	L4134	6.5	0.75	1.2	25	28	1.0	
	L4135	7.0	0.75	1.2	25	28	1.0	
	L4138	7.5	0.75	1.2	25	28	1.0	
	L4139	8.0	0.75	1.2	25	28	1.0	
	L4140	7.5	0.75	1.2	25	28	1.0	
	L4141	8.0	0.75	1.2	25	28	1.0	
	L4142	8.5	0.75	1.2	25	28	1.0	
	L4143	9.0	0.75	1.2	25	28	1.0	
	L4144	9.5	0.75	1.2	25	28	1.0	
	L4145	8.5	0.75	1.2	25	28	1.0	
1N3482	9.0	0.75	1.2	25	28	1.0		
L4146	9.5	0.75	1.2	25	28	1.0		
L4120	10.0	0.75	1.2	25	28	1.0		
L4147	10.5	0.75	1.2	25	28	1.0		
L4136	11.0	0.75	1.2	25	28	1.0		
L4122	11.5	0.75	1.2	25	28	1.0		
Texas Instruments	Type	V _{BR} (v)	I _R (μo)	V _F (v)	C _T (pf)	τ _{rr} (psec)	F _{co} (gc)	Metal silicon barrier diode Sampling and switching diode Parametric ampl. and switches
	XD27	20 min.	0.05 max.	1 max. at 50 ma		100 max.		
	XD28	15 min.	0.1 max.	0.85 max. at 50 ma		100 max.		
	A670	10 min.	.001 max.	1.4 max. at 5 ma		300 max.		
	A671	10 min.	.001 max.	1.4 max. at 5 ma		300 max.		
	XD500	6 min.					144	
	XD501	6 min.					108	

TABLE 11: PIN DIODES

Company	Type	V _{BR} Breakdown (v) min. at 10 μo	C _j Junction Capacitance max. (pf)	C _j Junction Capacitance typ. (pf)	C _T (cp + cj) max. at V _R = 50v f = 1 mc (pf)	R _s Series Resistance max. (ohms)	Applications or Comments
Micro State Electronics Corp.	6000, 6010	200			0.5, 0.4	1.5	Low C for broadband use. Suitable for waveguide coax strip line to X-band. Silicon.
	6001, 6011	400			0.5, 0.4	1.5	
	6002, 6012	600			0.5, 0.4	1.5	
	6006, 6016	1,000			0.5, 0.4	1.5	
	6007, 6017	1,400			0.5, 0.4	2.0	
	6003, 6013	200			0.9, 0.8	1.0	
	6004, 6014	400			0.9, 0.8	1.0	
	6005, 6015	600			0.9, 0.8	1.0	
	6008, 6018	1,000			0.9, 0.8	1.2	
	6009, 6019	1,400			0.9, 0.8	1.7	
Philco Corp.	L8313A, L8413A	200	.2	2.0		3.0	For high power microwave switching, limiting and duplexing.
	L8313B, L8413B	200	.2	2.0		1.5	
	L8314A, L8414A	200	.4	4.0		2.5	
	L8314B, L8414B	200	.4	4.0		1.2	
	L8315A, L8415A	200	.6	6.0		2.0	
	L8315B, L8415B	200	.6	6.0		1.0	
	L8316A, L8416A	200	.9	9.0		1.5	
	L8316B, L8416B	200	.9	9.0		0.8	
	L8317A, L8417A	200	1.5	15.0		1.5	

TABLE 11: PIN DIODES (Continued)

Company	Type	VBR Breakdown (v) min.	C _j Junction Capacitance max. (pf)	C _j Junction Capacitance typ. (pf)	C _T (c _p + c _j) max. at V _R = 50v f = 1 mc (pf)	R _s Series Resistance max. (ohms)	Applications or Comments
Philco Corp. Cont.	L8317B, L8417B	200	1.5	15.0		0.7	For high power microwave switching, limiting and duplexing.
	L8323A, L8423A	300	.2	2.0		3.0	
	L8323B, L8423B	300	.2	2.0		1.5	
	L8324A, L8424A	300	.4	4.0		2.5	
	L8324B, L8424B	300	.4	4.0		1.2	
	L8325A, L8425A	300	.6	6.0		2.0	
	L8325B, L8425B	300	.6	6.0		1.0	
	L8326A, L8426A	300	.9	9.0		1.5	
	L8326B, L8426B	300	.9	9.0		0.8	
	L8327A, L8427A	300	1.5	15.0		1.5	
	L8327B, L8427B	300	1.5	15.0		0.7	
	L8333A, L8433A	400	.2	2.0		3.0	
	L8333B, L8433B	400	.2	2.0		1.5	
	L8334A, L8434A	400	.4	4.0		2.5	
	L8334B, L8434B	400	.4	4.0		1.2	
	L8335A, L8435A	400	.6	6.0		2.0	
	L8335B, L8435B	400	.6	6.0		1.0	
	L8336A, L8436A	400	.9	9.0		1.5	
	L8336B, L8436B	400	.9	9.0		0.8	
	L8337A, L8437A	400	1.5	15.0		1.5	
	L8337B, L8437B	400	1.5	15.0		0.7	
	L8343A, L8443A	500	.2	2.0		3.0	
	L8343B, L8443B	500	.2	2.0		1.5	
	L8344A, L8444A	500	.4	4.0		2.5	
	L8344B, L8444B	500	.4	4.0		1.2	
	L8345A, L8445A	500	.6	6.0		2.0	
	L8345B, L8445B	500	.6	6.0		1.0	
	L8346A, L8446A	500	.9	9.0		1.5	
	L8346B, L8446B	500	.9	9.0		0.8	
	L8347A, L8447A	500	1.5	15.0		1.5	
L8347B, L8447B	500	1.5	15.0		0.7		

NOW AVAILABLE!



exclusive 1965 Marketing Map

showing

A Distribution of Electronic Plants in the United States on a County Basis

- PLUS -

- Detailed breakdown of 8 major metropolitan areas
- Distribution of plant locations & electronic engineers in major states

This map is 52 x 33 inches and is suitable for framing and wall mounting

PRICE: \$3.50 each

Please make checks payable to ELECTRONIC INDUSTRIES and mail to Marketing Department, ELECTRONIC INDUSTRIES, Chestnut & 56th Streets, Philadelphia, Pennsylvania 19139

TABLE 12: GALLIUM ARSENIDE TUNNEL DIODES

Company	Type	R _N Negative Resistance Min.-Max. (ohms)	I _p Typical Peak Current (ma)	R _s Series Resistance Max. (ohms)	C _j Junction Capacitance Min.-Max. (pf)	F _r Minimum Resistive Cut-off Freq. (gc)	F _{xo} Minimum Self- Resonant Freq. (gc)	V _p Typical Peak Voltage (mv)	I _p /I _v Peak to Valley Ratio Min.	P Calculated Oscillator Power Available (mw)	F _{ro} (Min.) (gc)	Applications or Comments
KMC Semiconductor Corp.											15	High Freq. Osc.
Microwave Associates	4651A 4651B 4651C 4652A 4652B 4652C 4653A 4653B 4653C 4654A1 4654A 4654B 4654C 4655	35, 55 35, 55 35, 55 15, 25 15, 25 15, 25 8, 12 8, 12 8, 12 3, 5 3, 5 3, 5 3, 5 -, 13	5 5 5 10 10 10 20 20 20 50 50 50 50 20	4 3 2 3 2 2 2.0 1.5 1.5 2.0 1.5 1.2 1.2 3.0	0.8, 1.5 1.5, 2.5 2.5, 5.0 1.5, 2.5 2.5, 5.0 5.0, 10.0 2.0, 4.0 4.0, 8.0 8.0, 20.0 -, 4.0 5.0, 10.0 10.0, 15.0 15.0, 30.0 -, 1.2	10.0 8.0 5.0 9.0 6.0 4.0 8.0 6.0 4.0 15.0 6.0 4.0 3.0 25	10.0 7.5 6.0 9.0 7.0 5.0 7.0 5.0 4.0 8.0 6.0 5.0 4.0 20	150 150 150 150 150 150 180 180 180 180 180 180 180 180 150	15 15 15 15 15 15 15 15 15 10 10 10 10 10	0.25 0.25 0.25 0.50 0.50 0.50 1.0 1.0 1.0 2.5 2.5 2.5 2.5 2.5		At 900 Mc.
Micro State Electronics Corp.	1540 1541 1542 1530A 1531A 1532A 1533A 1534A 1535A 1536A		5 10 20 5 10 20 50 100 250 500	3 (typ.) 2 (typ.) 1.5 (typ.) 1.0 (typ.) 0.8 (typ.) 0.6 (typ.) 0.4 (typ.) 0.3 (typ.) 0.25 (typ.) 0.17 (typ.)	0.75 (typ.) 1.5 (typ.) 3.0 (typ.) 3.0 (typ.) 6.0 (typ.) 12.0 (typ.) 30 (typ.) 60 (typ.) 150 (typ.) 300 (typ.)	10 9 8 6 4 3.5 3.0 2.0 1.0 0.7	17 (typ.) 11 (typ.) 7 (typ.)	160 (max.) 165 (max.) 170 (max.) 125 125 125 135 140 150 160				Microwave oscillator diodes.
R. C. A.	40076 40058 40059 40060 40061 40062 40063 40064 40065	1.1 (typ.) 4.4 (typ.) 4.4 (typ.) 11 (typ.) 11 (typ.) 22 (typ.) 22 (typ.) 44 (typ.) 44 (typ.)	200 50 50 20 20 10 10 5 5	0.8 3.0 3.0 8.0 8.0 9.0 9.0 12.0 12.0	16 (typ.)	5 2.0 1.0 1.0 0.50 0.70 0.25 0.45 0.18		240 180 180 180 180 180 180 170 170	15/1 12 10 11 9 10 9 10 8	12 mw @ Land S bands		For microwave oscillator. For pulse generators, transistor drivers, microwave frequency converters and oscillators.

TABLE 13: GALLIUM ANTIMONIDE TUNNEL DIODES

Company	Type	R _N Negative Resistance Min.-Max. (ohms)	I _p Typical Peak Current (ma)	R _s Series Resistance Typical (ohms)	C _j Junction Capacitance Typical (pf)	F _r Minimum Resistive Cut-off Freq. (gc)	F _{xo} Minimum Self- Resonant Freq. (gc)	V _p Typical Peak Voltage (mv)	I _p /I _v Peak to Valley Ratio Min.	P Calculated Oscillator Power Available (mw)	NF Noise Constant Max.	K Max.	Applications or Comments
KMC Semiconductor Corp.						25						0.95	High Freq. Low Noise Amp.

TABLE 13: GALLIUM ANTIMONIDE TUNNEL DIODES (Continued)

Company	Type	R _N Negative Resistance Min.-Max. (ohms)	I _p Typical Peak Current (ma)	R _s Series Resistance Typical (ohms)	C _j Junction Capacitance Typical (pf)	F _r Minimum Resistive Cut-off Freq. (gc)	F _{xo} Minimum Self- Resonant Freq. (gc)	V _p Typical Peak Voltage (mv)	I _p /I _v Peak to Valley Ratio Min.	P Calculated Oscillator Power Available (mw)	NF Noise Constant Max.	K Max.	Applications or Comments
Micro State Electronics Corp.	233A	85/120	1.0	3	3.0	3					0.85		Amplifier, converter, mixer types for phased arrays, microwave relay links, telemetry, radar.
	1504A/1560A	85/120	1.0	4	1.5	6					0.85		
	1505A/1561A	85/120	1.0	5	1.0	8					0.90		
	1507A/1562A	85/120	1.0	6	0.6	12					0.90		
	1508A/1563A	85/120	1.0	7	0.4	15					0.95		
	1512A/1564A	85/120	1.0	7	0.3	20					0.95		
	1520A	60/85	1.5	3	3.0	3					0.85		
	1521A/1581A	60/85	1.5	4	1.5	6					0.85		
	1522A/1582A	60/85	1.5	5	1.1	8					0.85		
	1523A/1583A	60/85	1.5	6	0.7	12					0.90		
	1524A/1584A	60/85	1.5	7	0.6	15					0.90		
	1525A/1585A	60/85	1.5	7	0.4	20					0.95		
	1526A/1586A	60/85	1.5	8	0.3	25					0.95		
	1509A/1570A	40/60	2.0	5	1.5	8					0.85		
	1506A/1571A	40/60	2.0	5	0.75	12					0.90		
	1510A/1572A	40/60	2.0	6	0.6	15					0.90		
	1511A/1573A	40/60	2.0	6	0.4	20					0.95		
	1513A/1574A	40/60	2.0	7	0.3	25					0.95		
	1575A	40/60	2.0	7	0.25	30					0.95		

TABLE 14: GERMANIUM TUNNEL DIODES

Company	Type	R _N Negative Resistance Min.-Max. (ohms)	I _p Typical Peak Current (ma)	R _s Series Resistance Max. (ohms)	C _j Junction Capacitance Min.-Max. (pf)	F _r Minimum Resistive Cut-off Freq. (gc)	F _{xo} Minimum Self- Resonant Freq. (gc)	V _p Typical Peak Voltage (mv)	I _p /I _v Peak to Valley Ratio	I _o /R _N Noise Voltage Max. (mv)	-G Neg. Cond. (mhos x 10 ⁻³)	Applications or Comments
General Electric Co.	IN2939		1.0	4.0	15 Max.	2.2 (Typ.)		65	7.15		6.6	Gen. Purpose Switching, Osc., Amp., and Converter Ckts.
	IN2939A		1.0	4.0	10 "	2.6 "		60	7.15		6.6	
	IN2940		1.0	4.0	10 "	2.2 "		65	4.55		6.6	
	IN2940A		1.0	4.0	7 "	2.6 "		65	4.55		6.6	
	IN2941		4.7	2.0	50 "	2.6 "		65	4.52		30	
	IN2941A		4.7	2.0	30 "	3.9 "		65	4.52		30	
	IN2969		2.2	3.0	25 "	2.5 "		65	4.58		16	
	IN2969A		2.2	3.0	15 "	3.3 "		65	4.58		16	
	IN3149		10.0	1.5	90 "	2.6 "		65	4.55		60	
	IN3149A		10.0	1.5	50 "	3.1 "		65	4.55		60	
	IN3150		22.0	1.0	150 "	2.2 "		65	4.58		100	
	IN3712(TD-1)		1.0	4.0	10 "	2.3 "		65	5.56		8.0	
	IN3713(TD-1A)		1.0	4.0	5 "	3.2 "		65	7.15		8.5	
	IN3714(TD-2)		2.2	3.0	25 "	2.2 "		65	4.58		18	
	IN3715(TD-2A)		2.2	3.0	10 "	3.0 "		65	7.09		19	
	IN3716(TD-3)		4.7	2.0	50 "	1.8 "		65	4.52		40	
	IN3717(TD-3A)		4.7	2.0	25 "	3.4 "		65	7.83		41	
	IN3718(TD-4)		10.0	1.5	90 "	1.6 "		65	4.55		80	
	IN3719(TD-4A)		10.0	1.5	50 "	2.8 "		65	7.15		85	
	IN3720(TD-5)		22.0	1.0	150 "	1.6 "		65	4.58		180	
	IN3721(TD-5A)		22.0	1.0	100 "	2.6 "		65	7.09		190	
	TD-9		0.5	6.0	5 "	1.3 "		60	5.0		4.0	
	TD-401		60/80	1.85	3.0	3.5 "	5.0 "					

88 TABLE 14: GERMANIUM TUNNEL DIODES (Continued)

Company	Type	R _N Negative Resistance Min.-Max. (ohms)	I _p Typical Peak Current (ma)	R _s Series Resistance Max. (ohms)	C _j Junction Capacitance Min.-Max. (pf)	F _r Minimum Resistive Cut-off Freq. (gc)	F _{xo} Minimum Self- Resonant Freq. (gc)	V _p Typical Peak Voltage (mv)	I _p /I _v Peak to Valley Ratio	I _o /R _N Noise Voltage Max. (mv)	-G Neg. Cond. (mhos x 10 ⁻³)	Applications or Comments
General Electric Co. (Cont.)	TD-402	60/80	1.85	4.0	1.8 Max.	10 (Typ.)						Gen. Purpose Switching, Osc., Amp., and Converter Ckts.
	TD-403	60/80	1.85	5.0	1.0 "	15 "						
	TD-404	60/80	1.85	5.0	0.75 "	20 "						
	TD-405	60/80	1.85	6.0	0.60 "	25 "						
	TD-406	60/80	1.85	6.0	0.48 "	30 "						
	TD-407	60/80	1.85	6.0	0.37 "	35 "						
	TD-408	60/80	1.85	6.0	0.30 "	40 "						
Company	Type	R _N Negative Resistance Min.-Max. (ohms)	I _p Typical Peak Current (ma)	R _s Series Resistance Max. (ohms)	C _j Junction Capacitance Min.-Max. (pf)	F _r Minimum Resistive Cut-off Freq. (gc)	F _{xo} Minimum Self- Resonant Freq. (gc)	V _p Typical Peak Voltage (mv)	I _p /I _v Peak to Valley Ratio	I _o /R _N Noise Voltage Max. (mv)	K _d Noise Constant Ratio (Max.)	Applications or Comments
KMC Semiconductor Corp.						25					1.45	High-Freq., Low Noise Amplifiers
Micro State Electronics Corp.	224A	85/120	1.5 (typ)	2 (typ)	2.5 (typ)	3					1.35	Amplifier, converter, mixer types for phased arrays, microwave relay links, telemetry, radar.
	1005A/1201A	85/120	1.5 "	3 "	1.0 "	6					1.40	
	1007A/1202A	85/120	1.5 "	4 "	0.6 "	10					1.45	
	1020A/1204A	85/120	1.5 "	4 "	0.5 "	15					1.45	
	1021A/1205A	85/120	1.5 "	5 "	0.45 "	20					1.45	
	1022A/1206A	85/120	1.5 "	5 "	0.4 "	25					1.45	
	1023A/1207A	85/120	1.5 "	6 "	0.35 "	30					1.45	
	1208A	85/120	1.5 "	7 "	0.25 "	40					1.50	
	1140A	60/85	2.5 "	2 "	3.5 "	3					1.35	
	1141A/1241A	60/85	2.5 "	3 "	1.5 "	6					1.40	
	1142A/1242A	60/85	2.5 "	3 "	1.0 "	10					1.45	
	1143A/1243A	60/85	2.5 "	4 "	0.6 "	15					1.45	
	1144A/1244A	60/85	2.5 "	4 "	0.5 "	20					1.45	
	1145A/1245A	60/85	2.5 "	5 "	0.4 "	25					1.45	
	1146A/1246A	60/85	2.5 "	6 "	0.4 "	30					1.50	
	1247A	60/85	2.5 "	7 "	0.3 "	40					1.50	
	225A	40/60	3.5 "	2 "	2.0 "	6					1.30 (typ)	
	1100A/1220A	40/60	3.5 "	2.5 "	1.4 "	10					1.30 "	
1101A/1221A	40/60	3.5 "	3 "	0.8 "	15					1.35 "		
1102A/1222A	40/60	3.5 "	4 "	0.6 "	20					1.35 "		
1103A/1223A	40/60	3.5 "	5 "	0.4 "	30					1.40 "		
1224A	40/60	3.5 "	6 "	0.3 "	40					1.40 "		
Microwave Associates	4604A	60, 80	1.5	8	---, 0.8	15	17	55	5	60		At 900 Mc.
	4604A1	60, 80	1.5	8	---, 0.5	25	22	55	5	60		
	4604B	60, 80	1.5	6	0.8, 1.5	10	12	55	5	65		
	4604C	60, 80	1.5	6	1.5, 3.2	3	6	55	5	85		
	4605A	40, 60	2.0	8	---, 0.9	15	15	55	6	60		
	4605B	40, 60	2.0	6	0.9, 2.0	10	11	55	6	65		
	4605C	40, 60	2.0	5	2.0, 4.0	3	6	55	6	85		
	4606A	25, 35	4.0	4	---, 1.2	15	13	55	6			
4606A1	25, 35	4.0	4	---, 0.8	22	18	55	6				

TABLE 14: GERMANIUM TUNNEL DIODES (Continued)

Company	Type	R _N Negative Resistance Min.-Max. (ohms)	I _p Typical Peak Current (ma)	R _s Series Resistance Max. (ohms)	C _j Junction Capacitance Min.-Max. (pf)	F _r Minimum Resistive Cut-off Freq. (gc)	F _{xo} Minimum Self- Resonant Freq. (gc)	V _p Typical Peak Voltage (mv)	I _p /I _v Peak to Valley Ratio	I _a /R _N Noise Voltage Max. (mv)	K _d Noise Constant Ratio (Max.)	Applications or Comments
Microwave Associates (Cont.)	4606A2	25, 35	4.0	4	---, 0.6	30	21	55	6			At 900 Mc.
	4606B	25, 35	4.0	4	1.2, 2.5	10	10	55	6			
	4606C	25, 35	4.0	4	2.5, 4.0	3	5	55	6			
	4607A	8, 12	10.0	3	---, 2.0	15	9	60	6			
	4607A1	8, 12	10.0	3	---, 1.2	22	16	60	6			
	4607A2	8, 12	10.0	3	---, 1.0	30	18	60	6			
	4607B	8, 12	10.0	3	2.0, 4.0	8	6	60	6			
	4607C	8, 12	10.0	3	4.0, 8.0	3	4	60	6			
	4608A	3.5, 4.5	30.0	2	---, 6.0	10	6	80	6			
	4608B	3.5, 4.5	30.0	2	6.0, 12.0	5	4	80	6			
	4608C	3.5, 4.5	30.0	2	12.0, 25.0	3	2	80	6			
	4609A	1.6, 2.4	60.0	1	---, 15.0	8	5	80	6			
	4609B	1.6, 2.4	60.0	1	15.0, 30.0	4	3	80	6			
4609C	1.6, 2.4	60.0	1	30.0, 60.0	2	2	80	6				
Philco Corp.	L4650/L4660	75 (typ-min)	1.5	5 (typ)	1.1 (typ)	6.0			5.0		1.50	Amplifier, Converter and Mixer
	L4650A/L4660A	75 "	1.5	5 "	1.1 "	6.0			5.0		1.35	
	L4651/L4661	75 "	1.5	5 "	0.7 "	10			5.0		1.55	
	L4651A/L4661A	75 "	1.5	5 "	0.7 "	10			5.0		1.45	
	L4652/L4662	75 "	1.5	5 "	0.6 "	12			5.0		1.55	
	L4652A/L4662A	75 "	1.5	5 "	0.6 "	12			5.0		1.45	
	L4653/L4663	75 "	1.5	5 "	0.5 "	15			5.0		1.55	
	L4653A/L4663A	75 "	1.5	5 "	0.5 "	15			5.0		1.45	
	L4654/L4664	75 "	1.5	5 "	0.4 "	20			5.0		1.55	
	L4654A/L4664A	75 "	1.5	5 "	0.4 "	20			5.0		1.45	
	L4655/L4665	75 "	1.5	5 "	0.3 "	25			5.0		1.55	
	L4655A/L4665A	75 "	1.5	5 "	0.3 "	25			5.0		1.45	
	L4656/L4666	75 "	1.5	5 "	0.25 "	30			5.0		1.55	
L4656A/L4666A	75 "	1.5	5 "	0.25 "	30			5.0		1.45		
RCA	40077	110 (typ-min)	1.0	6	1.3 (typ)	6	7 (typ)	65	10/1 (typ)	55 (typ)		Small signal
Sylvania Electric Products	D5360/D5560/D5570		1.2	8	1.5 (max)	5.0						R _j (ohms) 100 (typ)
	D5360A/D5560A/D5570A		1.2	4	0.45 "	25						100
	D5560B/D5570B		1.2	6	0.50 "	20						100
	D5361/D5561/D5571		1.8	7	2.0 "	5.0						67
	D5361A/D5561A/D5571A		1.8	3	0.60 "	25						67
	D5561B/D5571B		1.8	6	0.70 "	15						67
	D5362/D5562/D5572		2.7	6	3.0 "	5.0						44
	D5362A/D5562A/D5572A		2.7	2.5	0.75 "	25						44
	D5562B/D5572B		2.7	6	1.10 "	12						44
	D5363/D5563/D5573		3.9	6	5.0 "	5.0						31
	D5363A/D5563A/D5573A		3.9	2	1.00 "	25						31
	D5563B/D5573B		3.9	6	1.60 "	10						31
	D5364/D5564/D5574		5.6	6	7.0 "	5.0						22
	D5364A/D5564A/D5574A		5.6	1.5	1.40 "	25						22
	D5564B/D5574B		5.6	6	2.30 "	7.5						22
	D5365/D5565/D5575		8.2	6	10.0 "	5.0						15
	D5365A/D5565A/D5575A		8.2	1	2.00 "	25						15
	D5565B/D5575B		8.2	6	3.30 "	5.5						15

Part 2

1965 Survey

Special Purpose Potentiometers

POTENTIOMETER SPECIFYING GUIDE (Part 2) covers variable resistors used as transducers, attenuators, rheostats and potentiometers for DC and AC voltage and current control applications. Transducer potentiometers listed in the charts are the light sensitive and pressure sensitive types as well as the rectilinear pots for transforming linear motion and position into corresponding electrical quantities.

Attenuators include rotary and slide audio types used in broadcasting, recording and sound motion picture installations, plus some video and RF types for TV and test equipment use. Rheostats are the variable resistors and slidewires, usually with one fixed and one movable terminal, and commonly used for generator field and motor speed control, lamp dimming and other

Linear motion potentiometers (Precision Line, Inc.)

RP49 series linear position potentiometer (Humphrey, Inc.)

Below: PR-1 series rectilinear potentiometer (MEKTRON Div., California General, Inc.)

Bottom: Vermistat® AC potentiometer (Perkin-Elmer Corp.)

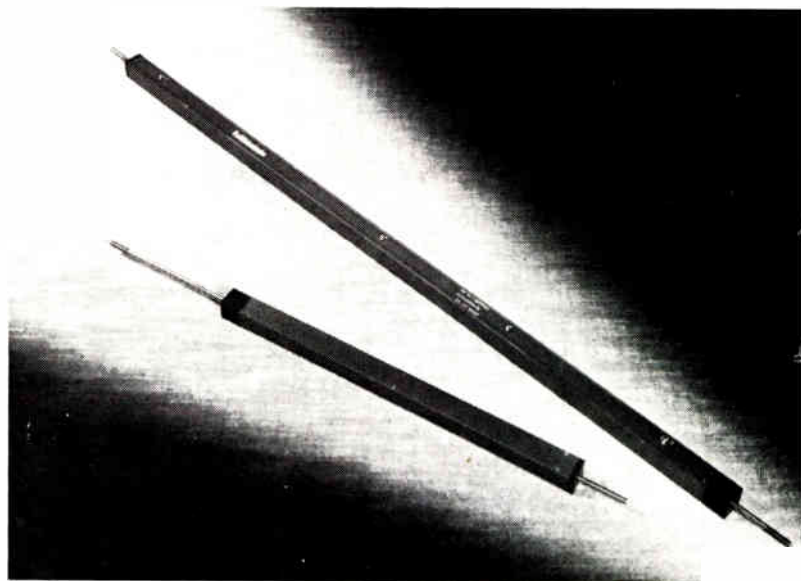

Second in a series of special reports identifying suppliers and listing available Mil Spec precision potentiometers and their characteristics, as compiled by EI editors.

Of Potentiometer Specifications

applications involving variation of voltage and current.

Not covered in this Guide, however, are the special laboratory potentiometers for precision measuring of current and resistance.

Rectilinear Potentiometers

Rectilinear, or translatory potentiometers are circular, rectangular or tubular devices containing one or more resistance elements and wipers actuated by a shaft extending from the side or end of the enclosure. They are designed to present an electrical resistance that is proportional to the longitudinal travel of the shaft.

Rectilinear pots are used for precision position indication and control in automatic machinery, process equipment and computers. Linear and non-linear outputs are available as are shaft stroke lengths up to 30 or more inches. Wire, carbon, conductive plastic and films are used for resistance elements.

Attenuators

Control and mixing of audio in broadcasting, recording and motion picture projection is a primary application of attenuators. Attenuators permit the control of a number of loads or channels over wide limits and permit the setting of levels in one channel with minimum effect on the loading and response of other channels.

There are two general classifications for audio attenuators: (1) attenuators for unbalanced circuits (one side of line at zero potential); and (2) attenuators designed for balanced circuits (both sides of line above ground). Under each, attenuators are further grouped by circuit, such as "ladder" or "T" and "H." The Ladder control features simplicity and consists of consecutive π resistor sections combined to supply the required terminal impedances and reduction in volume. T and H networks have zero insertion loss for 1:1 impedance ratios and constant impedance, in and out, on all steps of control.

These networks may be inserted in a transmission line system without introducing reflection losses. In selecting an attenuator, the output level and impedance of the signal source should be considered. Circuit noise must be far below the signal voltage. For a high quality system (50-15,000 cy), at least 40-60 db pro-

gram peaks above background noise is desirable. The wider the band, the higher the background noise. Therefore, it is not possible to set a hard and fast rule and say that "T" networks should be used for low level mixing (i.e., between source and preamplifier) and ladder networks for high level mixing (between preamplifier and main amplifier).

However, when the output of the source, volume range, frequency band, number of channels to be mixed and output desired are known, the best type control can be selected with ease. Rotary and slide types are available. Slide attenuators are frequently used in program mixing when the operator has to control multiple units with one hand (Daven).

Rheostats

Physically, a rheostat and a potentiometer may be identical, the difference being in how the device is wired into the circuit. The rheostat is usually connected as a series variable resistor, while the potentiometer is connected as a voltage divider.

When a potentiometer is used as a rheostat, it is recommended that a jumper be wired between the high resistance terminal and the rotor terminal. This shunt will provide added protection and longer life to the rheostat by minimizing arcing which may occur if the brush rides over dust or dirt that may accumulate on the track.

In selecting a rheostat (or potentiometer) use the following procedure:

1. Determine maximum current, and for tapers, also minimum current.

2. Compute required maximum resistance.

(Continued on page 92)

POTENTIOMETER SURVEY

Part 1 appeared in the
October EI Issue.

Future Potentiometer Survey Parts will appear in these issues:

Part 3: Trimmer Potentiometers
(EI January, 1966)

Part 4: General Purpose Potentiometers
(EI March, 1966)

SWR Slidewire Resistor (Superior Electric Co.)

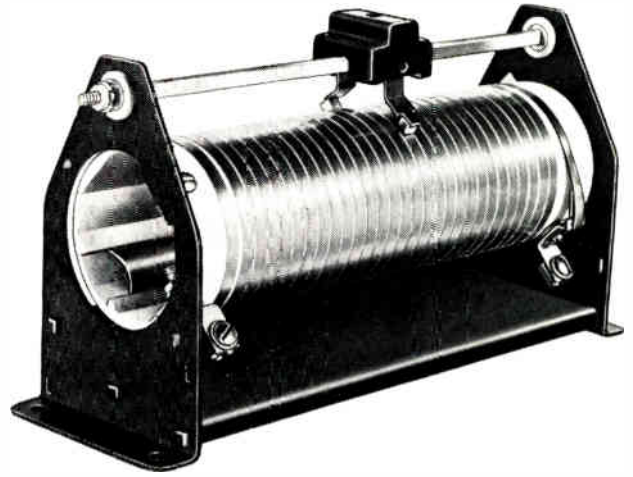

POTENTIOMETERS (Concluded)

3. Find power required.
4. Determine physical size required by mounting conditions, temperature rise, voltage, wattage and application.
5. Determine mechanical requirements such as bushing and shaft length, type, non-turn location, other features, temperature coefficient.
6. Select rheostat that provides desired characteristics (Memcor).

AC Potentiometers

The AC potentiometer is a continuous rotation, multi-turn unit which employs the principles of an auto trans-

former in relating voltage to shaft position. Used in military type servos and in computers, the AC potentiometer features high accuracy (typically $\pm .01\%$ absolute linearity), low phase shift, low output impedance (20 ohms) and essentially infinite resolution.

High linearity is achieved by the use of precisely located auto transformer taps that accurately define the output function. A toroidal resistance element interpolates between the taps. To remotely relate shaft position, a servo is positioned in accordance with an error signal transmitted by a null transformer in the AC potentiometer circuit (Perkin-Elmer).

(Continued on page 94)

ATTENUATOR CIRCUITS

(Daven Division, Thomas A. Edison Industries)

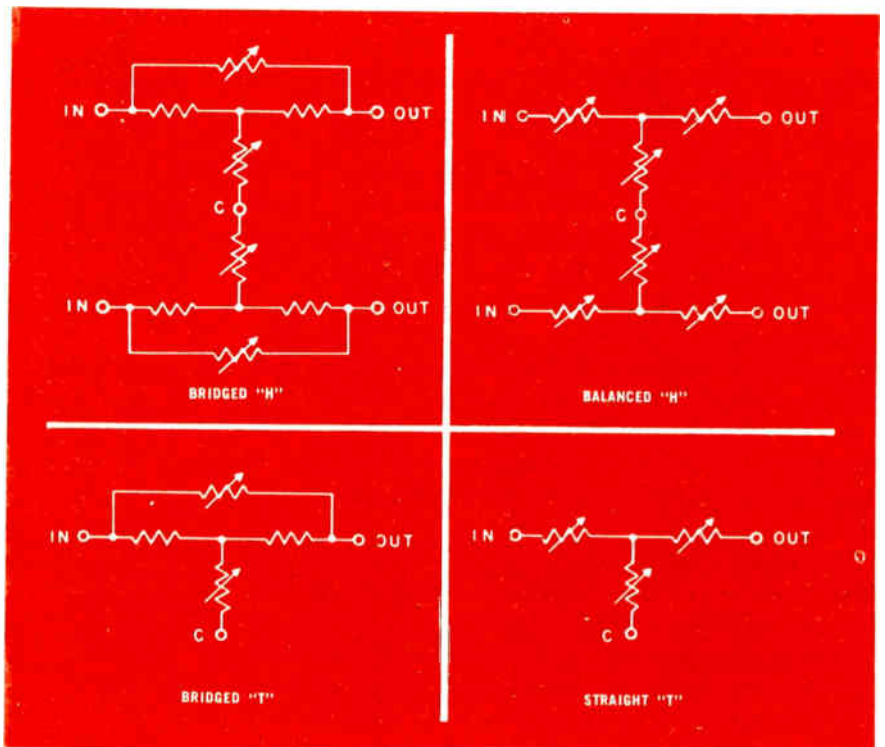
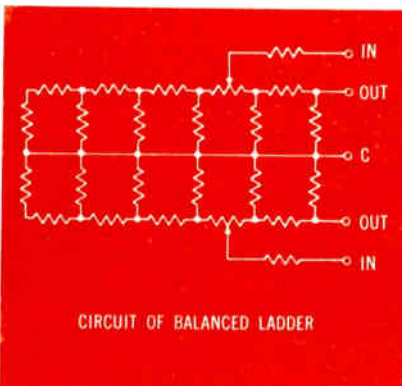
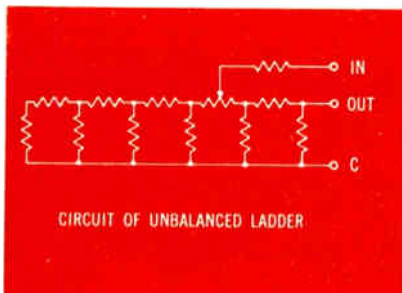

Revolution in Resolution: 0.032% in a TRIMPOT® Potentiometer Package!

Seven inches of wirewound resistance element in a package just 5/16" square and one inch long—that's our new Model 3070! With resolution seven to ten times better than you normally get from wirewound units this small, Model 3070 TRIMPOT potentiometer gives you premium adjustability at no premium in space, weight, or temperature coefficient. Settings you make with this unit stay set, too; the exclusive rotor/wiper design, based on that of our precision potentiometers, is outstandingly stable under shock and vibration.

Model 3070 also offers slip-clutch action, the indestructible SILVERWELD® termination, and resistance wire with twice the normal cross-section area. Units are available immediately in a broad choice of terminal types and mounting styles, including two panel-mount versions.

Write today for free technical data.

Resolution:	0.032% to 0.15%
Standard resistances:	75Ω to 50K
Power rating at 70°C:	1.5W
Max. operating temp.:	175°C
Temp. Coeff. (entire unit):	70ppm/°C
Humidity:	Meets MIL-STD-202B, Method 106 (Cycling)
Size:	5/16" x 5/16" x 1 1/16"

If it's TRIMPOT®, it's BOURNS

TRIMPOT is a registered trademark of Bourns, Inc.

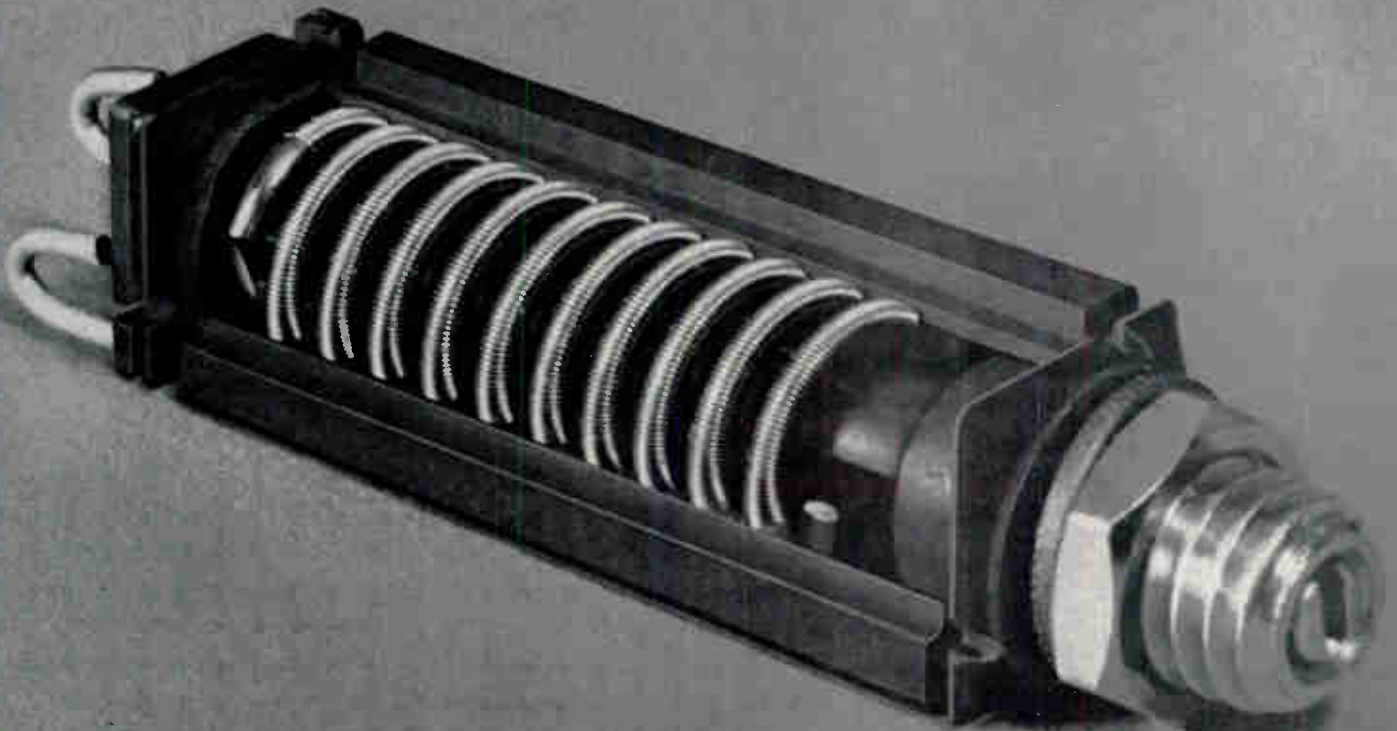
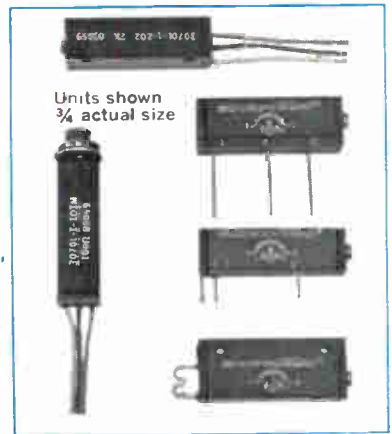

BOURNS, INC., TRIMPOT DIVISION
1203 COLUMBIA AVE., RIVERSIDE, CALIF.
PHONE (841) 7-0-74, TX. 714-952-8882
CABLE: BOURNSINC

MANUFACTURER: TRIMPOT® & PRECISION POTENTIOMETERS, RELAYS; TRANSDUCERS FOR PRESSURE, POSITION, ACCELERATION. PLANTS: RIVERSIDE, CALIFORNIA; AMES, IOWA; TORONTO, CANADA

Circle 50 on Inquiry Card

World Radio History

POTENTIOMETERS (Special Purpose)

Special Purpose Potentiometers and Rheostats	Type No. or Series	Potentiometer	Rheostat	Attenuator	Position Transducer	Photoconductive Transducer	Pressure Sensitive Transducer	Linear Motion Differential	Carbon (C); Cermet (CT); Comp. (CO)	Met. Film (F); Cond. Plastic (CP); Wire (W)	Resistance Max. (Kilohms)	Resistance Tolerance (±%)	Resolution (±%); Infinite (N)	Oper. Temp. (°C) Max.	Power Rating (W)	Linearity (±%)	Enclosed	Sealed	Servo Mtg. (S); Bush. Mtg. (B); Screw (SC)	Wire Leads (L); Pins (P); Terms. (T)	Miniature (M); Subminiature (S)	Height (In.)	Width (In.)	Length (In.)	Dia. (In.)	Weight (Oz.)		
Aerovox Corp. Hi-Q Div. 1100 Chestnut St. Burbank, Calif.	1210/30/50	X	X	(20 steps)					C		to .6	5				X		B	T	M			1.3	1.1				
	2210/30/50	X	X	(10, 20 steps)					C		to 1K	5				X		B	T	M			1.3	1.1				
	—			(20 steps)					C	W	to .6	5				X		B	T				2.2	1.7				
	—			(30 steps)					C	W	to .6	5				X		B	T				2.2	2.1				
	—			(32 steps)					C	W	to .6	5				X		B	T				2.2	2.1				
				(45 steps)					C	W	to .6	5				X		B	T				2.2	2.5				
*Ladder, Bridged "T" and Bridged "H" Types																												
Bolton Electronics Corp. 246 Park Ave. Garden City, L.I., N.Y.	—	X		(pendulum actuated)							.265					.5	X		T				1.5		14			
	—	X		(pendulum actuated)							1					.5	X		T				1.1		14			
Burns, Inc. Trimpot Div. Riverside, Calif. 92507	3600	X		(10-turn clockface)							to 250	5		1.5					T				1		.75			
	3640	X		(10-turn clockface)							to 500	5		2.5					T				1.5		1.2			
California General, Inc. Mektron Div. 798 F St. Chula Vista, Calif.	PR1	X			X				W							.5				L					.6			
	00776	X		(.6" stroke)	X						.001		N			1				L					1			
	PR3	X		(6" stroke)	X						5					.5				L			8		.6			
	PR2	X		(4.6" stroke)	X						5		.001	2		.5				L			6.4		.5			
Carter Mfg. Co. 23 Washington St. Hudson, Mass.	118GJ	X						X	W		25	5	150	3			X	B							.8			
	118B	X							W		10		.13	150	1											.8		
Carter Precision Electric Co. 3401 W. Madison St. Skokie, Ill.	W300	X		T/L					W					5				B	T						2.7			
	V7	X		L (dual)					W					4		X		B	T						1.4			
	W201	X		L					W					15				B	T						1.4			
	V2	X		L					W					2		X		B	T						1.4			
Central Scientific Co. 237 Sheffield St. Mountainside, N.J.	PG3610		X	(slidewire)					W		to 5.7			425					T				12.5					
Clarostat Mfg. Co., Inc. Dover, N. H.	—		X								to 5			25				B	T									
	—		X								to 10			50				B	T									
	—		X		(Mil type)						to .2			25/50				B	T				1.5	1.8				
	51	X		(4 KV type)				CO			to 50K			1				B	T				1	2				
Computer Instruments Corp. 92 Madison Ave. Hempstead, L. I. N. Y.	1000	X			X						to 10	10	N	85	.2	.5				T				1.4	1.1	2		
	4000	X			X						to 10	10	N	85	.25	.3				T			2	2	2.1	12		
	4500	X			X						to 10	10	N	85	.4	.3				T			2	2	3.2	14		
	7000	X		(altitude transd.)							to 10	10	N		.2					T			2.6	2.6	2.6	8		
	7100	X		(airspeed transd.)							to 10	10	N		.2					T			2.6	2.6	2.6	8		
Daven Div. Thomas A. Edison Industries Livingston, N. J.	—			1 (20 steps)							to 600	5		.6		X		SC					2		2.2			
	—			1 (30 steps)							to 600	5		.6		X		SC					2		2.2			
	—			2 (20 steps)							to 600	5		.6		X		B					1.9		1.7			
	—			2 (30 steps)							to 600	5		.6		X		B					1.9		1.7			
	—			3 (20 steps)							to 600	5		.6		X		SC					3.8		2.7			
	—			3 (30 steps)							to 600	5		.6		X		SC					3.8		2.7			
	—			"T" (45 steps)							to 600	5		.6		X		SC					2		2.7			
	—			(20 steps)							to 1K	5		.6		X		SC/B					1.9		1.7			
	—			(30 steps)							to 1K	to 2		.6		X		SC					2		2.2			
	2500	X									to 200	1		.5		X		SC					2		2.2			
	V250		X	"T" (to 45 steps) (video to 10 mc)							75	2.5				X		SC					2		2.2			
	1790		X	(video)							to 600					X												
	1080/90		X	(20/30 steps)												X												
	1. "T" and balanced ladder 2. Unbalanced ladder 3. Balanced "H" (printed circuit slide attenuator)																											
	Edcliff Instruments 1711 S. Mountain Ave. Monrovia, Calif.	3-120	X		(to 6" X stroke)	X				W		to 300	5		4		X				M			7.6		.5		
3-131		X		(to 4" X stroke)	X				W		to 300	5		3		X				M			5.7		.37			
3-143		X		(to 6" X stroke)	X				W		to 300	5		4		X										.75		
3-150		X			X				W																	.53		
Electro Scientific Industries 13900 N.W. Science Park Dr. Portland, Ore. 97229	DP1211	D							W		to 100		.003			X		SC	T				5.9	3				
	DP1311	D							W		to 100		.0003			X		SC	T				6.9	3				

Our Elmenco capacitors get burned. So you won't.

Arco uses special burn-in tests to find defects that are functions of time and environment.

We connect the Elmenco mica capacitors to lines and bake them up to 72 hours at temperatures up to 150°C.

These tests discover potential failures not caught by static testing. And guarantee every Elmenco capacitor that's burned in is five times more reliable than those that aren't.

Elmenco capacitors meet the requirements of missile and computer manufacturers. Yet they're priced for television sets. Are they hard to get? Not at Arco. We carry more than anybody else. (Virtually an infinite number of specific values between .000001 mfd and 1.0 mfd). And we ship within 24 hours.

All of which are good reasons you won't get burned when you buy from Arco (and Arco's authorized industrial distributors).



Arco Electronics

A DIVISION OF LORAL CORPORATION

COMMUNITY DRIVE, GREAT NECK, N.Y./DALLAS, TEXAS/PASADENA, CALIFORNIA. WRITE FOR OUR FREE CATALOG

POTENTIOMETERS (Special Purpose)

Special Purpose	Type No. or Series	Potentiometer	Rheostat	Attenuator	Position Transducer	Photoconductive Transducer	Pressure Sensitive Transducer	Linear Motion	Differential	Carbon (C); Cermet (CT); Comp. (CO)	Mer. Film (F); Cond. Plastic (CP); Wire (W)	Resistance Max. (Kilohms)	Resistance Tolerance (±%)	Resolution (±%); Infinite (N)	Oper. Temp. (°C) Max.	Power Rating (W)	Linearity (±%)	Enclosed	Sealed	Servo Mfg. (S); Bush. Mfg. (B); Screw (SC)	Wire Leads (L); Pins (P); Term. (T)	Miniature (M); Subminiature (S)	Height (In.)	Width (In.)	Length (In.)	Dia. (In.)	Weight (Oz.)
Potentiometers and Rheostats																											
Electro-Techniques 11301 Ocean Ave. La Habra, Calif.	200	X	(1" stroke)					X		W	to 50	5			.5	1									2		
Fairchild Controls 225 Park Ave. Hicksville, L.I. N. Y.	— 999	X X	(to 6" X .5" stroke)					X X		W	to 600 1	3			to 5		X					.3	.4	1.3			
John Fluke Mfg. Co. P.O. Box 7428 Seattle, Wash. 98133	40A 50A 60A 45A 55A 56A 65A 66A	D D D D D D D D								W W W W W W W W	to 10 to 100 to 100 to 12 to 120 to 120 to 120 to 120	.5 .05 .05	.02 .002		3 5 5	.05 .005 .002	X X X X X X X				T T T T T T T T					2.7 4.5 6 2.7 3.2 3.2 4.1 4.1	2 3 3 2 2 3 3 3
Giannini Controls Corp. 1600 S. Mountain Ave. Duarte, Calif.	8644/46 8620 86125 84135 * Ohms/in.	X X X X	(1/2" to 6" strokes)		X						to 50 to 135*	5		N .002		.5 .5											
Gotham Audio Corp. 2 W. 46th St. New York, 36, N. Y.	PREH	X		X				X		C	5K	10/20			.4		X				P						
Humphrey, Inc. 2805 Canon St. San Diego, Calif. 92106	CP34 RP33 RP35 RP48 RP49 RP67 RP82	X X X X X X X						X X X X X X		W W W W W W W	10 10 10 5 1 .14 20	10 5 3 10 5	.2	300 300 300 120 150 175 275	4 .5 1 1 1.3 1		X X X X X X X			S SC SC B SC B	L L				1 38 2.6 3.5 .6 1 .75 6	1 4 20 2 6 1.5	
Markite Corp. 155 Waverly Place New York, N. Y. 10014	— — 2064 — — 9748 8761	X X X X X X X	(1" to 3" stroke) (1" to 10" stroke) (1.29 stroke) (1.89" stroke) (2.85" stroke) (1.34 stroke) (1.24 stroke)		X X X X X X					CP	to 150 to 400 to 65 to 100 to 150 to 20 to 20	10 10 10 10 10 10 10	N N N N N N N		to 2 to 7 .9 1 1 1 1	.5 .5 1 1 1 1 1				L L T T L L L					.5 .75 1.3 1.7 1.8 2.8 2.5 3		
Maury Instrument Corp. 4555 W. 60th St. Chicago, Ill. 60629	1310	X						X			100			135	to 3		X X		SC	T					to 6	1.2	12
Milwaukee Resistor Co. 700 W. Virginia St. Milwaukee 4, Wisc.	— — —		(1 1/2" stroke) (2 1/2" stroke) (3" stroke)		X X X					W W W	5 15 25			100 200 300		X X X			B B B						2.5 3.5 4	2.5 3 3.5	
MRC Electronics Corp. 5300 21st Ave. Brooklyn, N. Y. 11204	A B C			X X X						W W W	5 10 10			25 50 100											1.4 1.5 1.7	1.6 2.2 3.1	
New England Instrument Co. Natick, Mass.	LMP	X	(5 1/4" stroke)					X		CP	500	10		125	.7	1					L				5.2		8
Ohmite Mfg. Co. 3660 Howard St. Skokie, Ill. 60076	C E G H K J L R P T N U 3000	X X X X X X X X X X X X X								W W W W W W W W W W W W	5 15 10 25 10 50 10 2.5 2.5 2.5 2.5 2.5	10 10		340 340	7.5 12 75 25 100 50 150 500 225 750 300 1K to 50		X X		B B B B B B B B B B B B	T T T T T T T T T T T T T	S				.5 .8 2.7 1.5 3 2 4 8 5 10 6 12	.3 .8 2.7 1.5 3 2 4 8 5 10 6 12	



Red 110-2	alpha ferric oxide	cubical	0.3-1.2	5.4	.33	.67	99.1	.05	.25	.10	.02	.10	.002	.002	.08	
							99.4	.10	.35	.15	.03	.04	.15	.005	.004	.15

THIS COLOR REPRESENTS A MASS TONE OF MAPICO RED 110-2.

Columbian Carbon focuses on the reduction of fluctuating characteristics in magnetic tape and ferrite components

It's a safe bet that product uniformity is a critical problem in your plant. Starting with extremely uniform raw materials goes a long way toward making your quality control problems considerably less difficult.

State of the art in ferrites advances at an extremely rapid rate. So do the requirements for iron oxides with pre-selected and controllable characteristics.

Columbian Carbon's Mapico® pure synthetic iron oxides are produced by a variety of carefully controlled methods,

each designed to give a different shape, size and set of electronic characteristics. Uniformity from shipment to shipment is strictly held within pre-set narrow limits. Sixteen basic iron oxides are available in quantity.

Write for detailed specs. Or tell us about your particular application and special requirements. Columbian Carbon Company, Mapico Iron Oxides Unit, 380 Madison Avenue, New York, New York 10017. Branch offices and agents in principal cities.



COLUMBIAN CARBON COMPANY

POTENTIOMETERS (Special Purpose)

Special Purpose	Type No. or Series	Potentiometer	Rheostat	Attenuator	Position Transducer	Photoconductive Transducer	Pressure Sensitive Transducer	Linear Motion	Differential	Carbon (C); Cermet (CT); Comp. (CO)	Met. Film(F); Cond. Plastic(CP); Wire(W)	Resistance Max. (Kilohms)	Resistance Tolerance (±%)	Resolution (±%); Infinite (N)	Oper. Temp. (°C) Max.	Power Rating (W)	Linearity (±%)	Enclosed	Sealed	Servo Mtg. (S); Bush. Mtg. (B); Screw (SC)	Wire Leads (L); Pins (P); Terms. (T)	Miniature (M); Subminiature (S)	Height (In.)	Width (In.)	Length (In.)	Dia. (In.)	Weight (Oz.)	
Perkin-Elmer Corp. Norwalk, Conn. 06852	2	X*	(10-turn)									200 ¹					.02								2.7	1.7	8.3	
	3	X*	(30-turn)									50 ¹					.01								2.7	1.7	9	
	4	X*	(10-turn)									30 ¹					.05			S	T	M			1.6	1	2	
	5	X*	(10-turn)									60 ¹		.01			.05			S	T	M			1.8	.7	2	
	7	X*	(20-turn)									100 ¹		.004			.1											
	20	X*	(10-turn)											.13			.1											
	1. Input impedance																											
	Note: Terminal Linearities shown																											
	* AC Potentiometer																											
Precision Line, Inc. 63 Main St. Maynard, Mass.	—	X	(to 3" stroke)					X				2					.5				T				1			
	—	X	(3" to 5" stroke)					X				2					.25				T				1			
	—	X	(5" to 20" stroke)					X				2					.1				T				1			
Rex Rheostat Co. 149 Babylon Tpk. Roosevelt, L. I.	—	X	(slidewire)								(to 50 kc)	(2.8 amp.)																
Samaris, Inc. 300 Seymour Ave. Derby, Conn.	260	X								W	to 500				6				SC	T					1.4	3	5	
	275	X								W	to 500				11				SC	T					2.6	3	7	
	245	X								W	to 50				25				B	T					1.2	1.7		
	241	X								W	to 50				50				B	T					1.5	2.4		
Servanic Instruments, Inc. Costa Mesa, Calif.	G-1/2"	X	(6" stroke)				X					1-10		.005			.5	X		L					.5			
	G-3/4"	X	(24" stroke)				X					1-50		.005			.5	X		L					.75			
	2091	X				X					to 10	5		.3		.5	X							1.5	1	3.5		
	2101	X				X					to 10	5		.3		1	X			S				1.5	.75	2		
	2121	X				X					to 10	5					X							1.5	1.5			
	2131	X					X				to 10	5		.15			X							2.1	1.2			
	2151	X					X				to 10	5		.1			X							2.1	1.2			
	3031	X				X					to 10	5		.25		.85	X			S				3	1.5	1.8		
	3051	X					X				to 10	5					X											
	3061	X					X				to 10	3		.25		.5	X								1.8	1		
	3071	X					X				to 10	5					X								1.1	1.5		
	3121	X					X				to 10	5					X			S					1.2	1.2	4	
Subminiature Instruments Corp. Riverside, Calif.	—	X					X				2		.76			1.5				S								
	—	X					X	X			.056		.13			.26*				S								
	—	X					X	X			2		.4			.8*				S								
	* Terminal																											
Sparton Corp. 2400 E. Ganson St. Jackson, Mich.	831	X					X			W	to 10	5	.25				1.5	X							1.5	1.6		
	411	X					X			W	to 10	5	1	71			X							2.5	2.5	3.5		
	402	X					X	X		W	to 20	10	.25				1	X										
	224	X	(1/2" stroke)				X	X		W	to 2.5	10	.0015	71			.5											
	226	X	(10" stroke)				X			W	to 30	10					.5											
	401	X					X													S								
Herman H. Sticht Co. 27 Park Place New York, N. Y. 10007	—	X	(slidewire)								to 20K					to 1K		X							to 20	2.5		
Superior Electric Co. Bristol, Conn. 06012	SWR	X	(slidewire)								to 1					to 500			SC	T			6.1	4	12			
Tru-Ohm Prods. Memcor Div. Huntington, Ind.	R12 1/2	X								W	to 5	10				12			B	T				.7	.8			
	R25	X								W	to 5	10				25			B	T				1.3	1.6			
	R50	X								W	to 10	10				50			B	T				1.4	2.3			
	R75	X								W	to 10	10				75			B	T				1.7	2.7			
	R100	X								W	to 10	10				100			B	T				1.7	3.1			
	R150	X								W	to 10	10				150			B	T				2	4			
	R300	X								W	to 2.5	10				300			B	T				2.2	6			
	RE25	X								W	to .5	10				25			B	T				1	1.6			
Ward Leonard Electric Co. Mount Vernon, N. Y. 10550	68	X			X	(1/2" stroke)				W	10							X	X									
	25R	X								W	5					25					T				1.6			
	50R	X								W	10					50					T				2.3			
	100R	X								W	10					100					T				3			
	150R	X								W	10					150					T				4			
	300R	X								W	2.5					300					T				4			
	N152	X	(Mil Spec.)								W	20	10				50					T				6		

down with “specials”!!



who needs 'em with Ohmite's big variety of *stock* GPR relays

MOUNTING AND CONNECTING VERSATILITY

Solder to Terminals Use Quick-Connectors Plug into P.C. Board Socket Mount

VERSATILE ENCLOSURES

Terminals Through-Chassis Terminals Above Chassis Octal Style Plug Socket for Std. Terminals

EXCLUSIVES AND OTHER VARIETIES

Exclusive Enclosed 4-Pole Unenclosed 4-Pole Exclusive Enclosed Latching Unenclosed Latching

■ All these and other physical variations are stocked for a variety of general purpose and specialized electrical functions such as plate circuit, thyatron, and indicator-light types. Both unenclosed and enclosed relays fit the same SOGPR socket. And don't forget, dual-purpose terminals (for soldering and quick-connectors) are standard on all unenclosed and most enclosed relays. Many models UL and CSA listed.

Contact Combinations—Up to 4PDT.

Contact Ratings—Two ratings: fine-silver contacts, gold-flashed, 5 amps resistive at 115 VAC or 32 VDC; silver-cadmium, 10 amps.

Coil Operating Voltage Range—Up to 230 VAC 60 cycles, or 110 VDC.

Coil Wattage—1.4 Watts DC; 1.6 watts (2.0 volt-amps) AC, except 2.4 watts (3.7 volt-amps) for 4-pole AC relays.

Insulation—Tested at 1500 VAC between terminals and ground.



Yours for the asking...
Catalog 700 showing all
Ohmite relay lines.

RHEOSTATS • POWER RESISTORS • PRECISION RESISTORS • VARIABLE TRANSFORMERS • RELAYS
TAP SWITCHES • TANTALUM CAPACITORS • SEMICONDUCTOR DIODES • R.F. CHOKES

OHMITE

MANUFACTURING COMPANY
3662 Howard Street • Skokie, Illinois 60076
Phone: (312) ORchard 5-2600



"... STATE-OF-THE-ART information on Components and Equipment."

Microwave Slide Rule

"RF Filter Slide Chart" is a 3-section "slide-rule" type chart providing spec. data for microwave filters. Designed for circuit designers and specifiers, the chart has 3 sections: "Chibishev Response," section No. 1, gives degree of attenuation at various freqs. for 2- to 19-pole filters. "Reflection - Transmission Relationships," section No. 2, gives voltage and power reflection/transmission characteristics and loss in db for various vswr's. The "Band-pass," section No. 3, shows attenuation and bandwidth characteristics for 2- and 6-section filters, plus bandwidth and insertion loss for various types of filters. Telonic Engineering Co., 480 Mermaid St., Laguna Beach, Calif.

Circle 156 on Inquiry Card

Measurement Handbook

This pocket-size handbook explains the streamlined metric system adopted at the 11th General Conference of Weights and Measures. The publication also includes the latest revisions made in the system. Copies of the SI handbook are available from Brown Engineering Co., Inc., 300 Sparkman Dr. N.W., Huntsville, Ala.

Circle 157 on Inquiry Card

Microwave Tube Papers

Three technical papers, which deal with design advancements that have improved the performance of klystrons and TWTs and aided equipment manufacturers in solving system problems, are available. Entitled, "Negative Grid Control for Microwave Tubes"; "Noise Performance of Traveling Wave Tubes"; and "The Life of a Microwave Tube," they contain performance data and applications. Sperry Electronic Tube Div., Gainesville, Fla.

Circle 158 on Inquiry Card

Semiconductor Guide

Milgray's Guide to RCA Semiconductor Products, 20 pages, is illustrated and includes: an Index of RCA semiconductor devices; application guide to RCA transistors, from audio-freq. uses through r-f, power-switching and computer applications, etc. Milgray Electronics, Inc., 160 Varick St., New York, N. Y. 10013.

Circle 159 on Inquiry Card

Oscilloscope Cameras

A 12-page booklet on oscilloscope cameras and accessories is available. It describes standard camera systems and also contains detailed specs. on available components and accessories which can be used to simplify custom designing a camera to meet individual specific needs. In addition, the booklet features a series of waveform photographs illustrating many typical uses with various lens/object-to-image ratio combinations. Tektronix, Inc., P. O. Box 500, Beaverton, Ore. 97005.

Circle 160 on Inquiry Card

Connector Chart

This product news bulletin features a complete device/application chart. The special chart makes it simple for the user to determine the most suitable connector for a given application problem. The chart covers 150 types of caged jacks and combinations. Description includes actual size outline drawings, dimension drawings, cross sectional views and recommended applications. Cambridge Thermionic, 445 Concord Ave., Cambridge, Mass.

Circle 161 on Inquiry Card

Meter Catalog

"Quick Reference" Catalog (M865) illustrates a cross-section of a complete line of custom-built meters. It illustrates and describes various types of meters such as taut-band, ruggedized, aircraft, subminiatures, wattmeters, freq. meters, etc. All are built to an individual customer's order; therefore, nearly every range and type of indicating instrument can be provided. The Hickok Electrical Instrument Co., 10514 Dupont Ave., Cleveland, Ohio

Circle 162 on Inquiry Card

Microwave Catalog

A completely revised 84-page catalog of precision microwave components and instruments is available from Microlab/FXR, 10 Microlab Rd., Livingston, N. J.

Circle 163 on Inquiry Card

Design a Switch

This catalog allows microwave engineers to order custom-made microwave switches. The catalog enables the user to call out standard microwave modules from the accompanying charts and receive a finished microwave switch which meets his specific need. When ordering a custom-made (for specific) microwave switch, the user merely chooses the model number which fulfills his needs from Chart A, adds the appropriate EIA waveguide size designation from Chart B, and fills in any additional alternate specs. from Chart C. Guide Industries Inc., 11855 Wicks St., Sun Valley, Calif.

Circle 164 on Inquiry Card

Design Aid Brochure

A design aid brochure entitled, "R-F and Microwave Dielectric Heating System Design Parameters," contains basic design data concerning means of generating r-f power at microwave and lower freq.; means of coupling r-f fields to material to be processed; and detailed data on various parameters of material, such as dielectric constants, loss constants, etc. The publication examines various factors governing the choice of processing frequencies. Useful equations and tables of parameters of various dielectric materials are included. Industrial Applications Laboratory, Eitel-McCullough, Inc., 301 Industrial Way, San Carlos, Calif.

Circle 165 on Inquiry Card

Diode Catalog

Bulletin 3138-7, "Corotrons — High Voltage Regulating and Reference Diodes" is a 40-page catalog and technical data manual. Printed in 2 colors, it includes definitions, specs. and ratings on 43 basic models. Each basic model is treated separately, and performance and data are given for the various tubes within the voltage range for the basic model. Performance curves, dimensional drawings, photographs and schematics complement the descriptive data. The Victoreen Instrument Co., 10101 Woodland Ave., Cleveland, Ohio.

Circle 166 on Inquiry Card

Diode Wall Chart

This 17 x 11 guide lists the most popular of more than 4000 different zener and reference diodes. The guide includes zener diodes with nominal voltages from 2.4 to 200v. in $\pm 5\%$, 10% and 20% tolerances. Dissipation ratings are from $\frac{1}{4}$ w to 50w. Numerous Mil types are shown and case dimensions are detailed for the designer. Motorola Semiconductor Products, Inc., Dept. TIC, Box 955, Phoenix, Ariz. 85001.

Circle 167 on Inquiry Card

Microwave Processing

A brochure, "Microwave Processing Systems for Industry," describes the basic principles of microwave heating, the advantages of microwave processing, and typical industrial microwave processing systems. It also describes a microwave processing application laboratory where customers can obtain assistance in evaluating the use of microwave heating to meet their particular processing needs. Raytheon Co., Microwave & Power Tube Div., Waltham, Mass. 02154.

Circle 168 on Inquiry Card

Microwave Diodes

Data Sheet No. 4100A describes sub-miniature glass microwave diodes for use in mixing, video detection, etc. Both axial lead and ribbon lead construction are offered in this standard 1N830 series. These small diodes are ideally suited for stripline applications. Micro Oprics div. of Alpha Industries, Inc., 381 Elliot St., Newton Upper Falls, Mass.

Circle 169 on Inquiry Card

Silicon Transistors

A 2-color technical bulletin entitled "Silicon Transistors in Power Supply Design" compares germanium and silicon power transistors. Illustrated with diagrams and curves, it covers power, leakage current, voltage considerations, and changes in V_{BE} vs. temp. Other significant electrical and thermal characteristics are compared, such as: gain and saturation voltage, transient response, a new design approach and economic considerations. Silicon Transistor Corp., East Gate Blvd., Garden City, N. Y. 11532.

Circle 170 on Inquiry Card

Inside story of the new look in series regulators

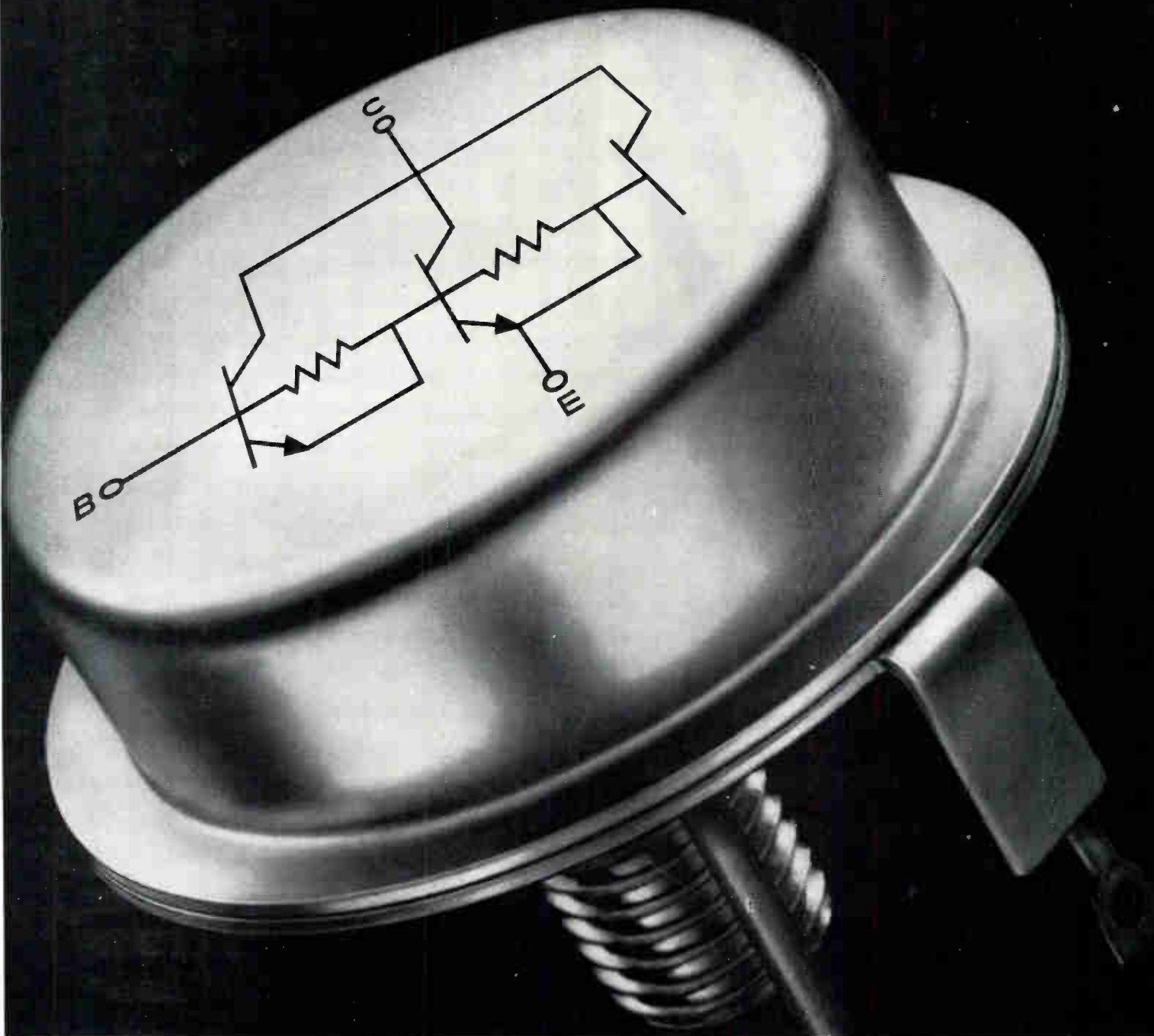

Westinghouse power integrated amplifiers eliminate a complete driver stage.

Save space, improve reliability, cut costs with Westinghouse power integrated amplifiers. Types 2N2233 and 2N3477 provide exceptionally high gain at high power levels— $h_{FE} = 400$ at 10 amps I_C , $V_{CE} = 200$ volts and $P_D = 150$ watts. Single and double ended packages provide complete design flexibility. Check these exclusive features:

- Hard soldered junctions eliminate thermal fatigue.
- Large emitter-base area puts an end to secondary breakdown.
- True monolithic construction stops runaway leakage.

SINGLE ENDED	DOUBLE ENDED	V_{CE}	h_{FE}
2N2226	2N3470	50	100
2N2227	2N3471	100	@
2N2228	2N3472	150	10A
2N2229	2N3473	200	
2N2230	2N3474	50	400
2N2231	2N3475	100	@
2N2232	2N3476	150	10A
2N2233	2N3477	200	

You can be sure if it's Westinghouse



Circle 54 on Inquiry Card

World Radio History

And, of course, reliability is assured by the exclusive Westinghouse Lifetime Semiconductor Guarantee.* For full information call your Westinghouse salesman or distributor, or write to the Westinghouse Semiconductor Division, Youngwood, Pennsylvania.

*Westinghouse warrants to the original purchaser that it will correct any defect or defects in workmanship, by repair or replacement f.o.b. factory, for any JEDEC-type silicon power semiconductor during the life of the equipment in which it is originally installed, provided said device is used within manufacturer's published ratings and applied in accordance with good engineering practice. This warranty is applicable to devices of the stated types shipped after March 9, 1964, until further notice. This warranty shall constitute a fulfillment of all Westinghouse liabilities in respect to said products. This warranty is in lieu of all other warranties expressed or implied. Westinghouse shall not be liable for any consequential damages. SC-205C

BUSS QUALITY

small
dimension
fuses



For protection of all types of electronic and electric devices

The complete line of BUSS and "TRON Family" fuses includes quick-acting, slow-blowing, signal or visual indicating fuses in sizes from 1/500 amperes up.

All standard items are easily obtained through your BUSS distributor, but if you don't find what you want get in touch with us.

Insist On
BUSS

QUALITY
Fuses

BUSSMANN MFG. DIVISION, McGraw-Edison Co., St. Louis, Mo. 63107

Write for
BUSS
Bulletin SFB

Insist On
BUSS

QUALITY
Fuseholders

BUSSMANN MFG. DIVISION, McGraw-Edison Co., St. Louis, Mo. 63107

Write for
BUSS
Bulletin SFH-10

BUSS: The Complete Line of Fuses and . . .

NEW TECH DATA

Design Monograph

"Elastomer Terminology" is a design monograph that should clarify the terminology relating to rubber and rubber products. Working definitions for such commonly misunderstood terms as modulus, damping, elongation, drift, tensile and elasticity are provided. Many of these terms are already a part of the technical language of the engineer, but they may have different meanings and thus cause misunderstanding when applied to rubber. Technical Information Dept., Lord Mfg. Co., div. of Lord Corp., Erie, Pa. 16512.

Circle 274 on Inquiry Card

Designer Data Book

A comprehensive Piezoelectric data book has been developed for electronic device, circuit and system designers. The 45-page technical book is entitled, "Piezoelectric Technology — Data for Designers." The book progresses from general descriptions of characteristics and principal uses of piezoelectric materials and elements to coverage of piezoelectric constants and specific properties of ceramics. There also is a discussion of equivalent circuits and their application. Piezoelectric Technology is illustrated with 40 different figures and 7 tables. Conversion charts are included. Clevite Corp., Piezoelectric Div., 232 Forbes Rd., Bedford, Ohio.

Circle 275 on Inquiry Card

Circuit-Breaker Chart

A 5-step method for selecting circuit breakers for a wide variety of uses is available in an easy-to-use chart. This chart, entitled "Select a Circuit Breaker," is presented for 1, 2, and 3 pole circuit breakers with ratings from 1/4 to 100a. and trip time ratings from 6msec. to 30 sec. at 200% of rated load. Wood Electric Corp., 244 Broad St., Lynn, Mass.

Circle 276 on Inquiry Card

Switch Catalog

Precision switches are illustrated in new catalog that has engineering drawings, specs., operating characteristics and ordering data on a complete line of standard snap action switches. Overtravel in electrical ratings are 2 to 25a. Cherry Electrical Products Corp., P. O. Box C439, Highland Park, Ill. 60036.

Circle 277 on Inquiry Card

Reference Chart

A reference chart of standard formulas and tables for use with laboratory test equipment is available. The reference chart features typical test set-ups for determining return loss and response, amplitude response, return loss measurement, and testing UHF converter performance. In addition, the reference booklet contains a dbmv microvolt chart, a return loss vswr chart and transformation formulas. Blonder-Tongue Laboratories, Inc., 9 Alling St., Newark, N. J. 07102.

Circle 278 on Inquiry Card

Waveguide Isolators

Series 200 isolators offer up to 30db isolation and cover freqs. from 2.6 to 14.0gc in bands up to 1/2 octave. vswr's are 1.15 typical, 1.20 max. The loss in broadband models is 0.8db typical, 0.9 max. In medium and narrow band units the loss is typically 0.3db to 0.8db. Complete details available from Microwave Technology Div. of Alpha Industries, Inc., 381 Elliott St., Newton Upper Falls, Mass. 02184.

Circle 279 on Inquiry Card

Relay Catalog

This catalog lists 327 different relay models. Included are mercury-wetted contact and dry-reed relays, coaxial, time-delay, telephone-sealed and dust-covered relays. Magnecraft Electric Co., 5577 N. Lynch, Chicago, Ill. 60630.

Circle 280 on Inquiry Card

Microcircuit Hardware

This catalog describes microcircuit mounting hardware. It includes a new packaging concept for mounting circuit chips on mother boards, card mounting seats, card files, horizontal and vertical equipment drawers. The circuit chip mounting hardware makes possible easy, rapid handling of microcircuits through reliable pressure contact of circuit leads with mating leads on the mounting board. Scanbe Mfg. Corp., 1161 Monterey Pass Rd., Monterey Park, Calif.

Circle 281 on Inquiry Card

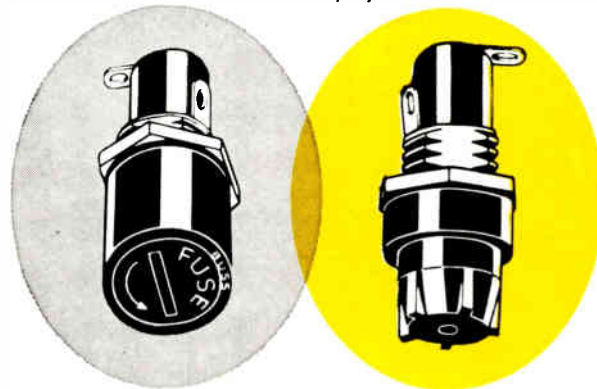

Screw type slotted knob that is recessed in holder body and requires use of screwdriver to remove or insert it.

Screw type knob designed for easy gripping, even with gloves. Has a "break-away" test prod hole in knob.

BUSS Space Saver Panel Mounted Fuseholders

Fuseholder only 1 1/8 inches long, extends just 3/32 inch behind front of panel. Takes 1/4 x 1/4 inch fuses. Holder rated at 15 ampere for any voltage up to 250.

Military type available to meet all requirements of MIL-F-19207A.

NEW TECH DATA

Coils Catalog

Over 300 precision-wound electronic components are described in a well-illustrated, 16-page, 2-color catalog. Included are complete lines of variable inductors, adjustable r-f chokes, subminiature r-f chokes, r-f transformers, iron-core chokes and ceramic coil forms. Listed in the catalog are inductances, Q min., test freqs., res. ohms and other data. Delta Coils, Inc., 1128 Madison Ave., Paterson, N. J. 07503.

Circle 282 on Inquiry Card

Resistance Element

A combined data sheet and designer's order form and self-mailer for a hot molded carbon resistance element is available. The data describes the availability of custom resistance elements for recording instruments, attenuators, servo followers, controllers, indicating instrumentation and calibration devices. It lists all the specs. and includes a temp. coefficient curve. The self-mailer permits the designer to sketch the mechanical design of the custom resistance element he would like to order and then fill in the electrical specs. Clarostat Mfg. Co., Inc., Dover, N. H.

Circle 283 on Inquiry Card

Potentiometer Catalog

A 2-color, short-form potentiometer catalog is available which contains the latest data on trimming, precision, and non-linear potentiometers and miniature switches and turns-counting dials. It is designed for quick, easy reader reference and includes design details, photos, cut-away drawings and prices. Spectrol Electronics Corp., 1704 S. Del Mar Ave., San Gabriel, Calif. 91776.

Circle 284 on Inquiry Card

Product Catalog

This sectionalized product catalog pictures and describes industrial controllers, recorders, indicators, control systems, precision measuring instruments, thermocouples, and accessories. Catalog should be of great value to specifying engineers and buyers. West Instruments Corp., Schiller Park, Ill.

Circle 285 on Inquiry Card

OR/NOR Gate

SW301 is a 5-input OR/NOR gate. It has a fanout of 26 and a propagation delay of 6nsec. Operating temp. is -55 to $+125^{\circ}\text{C}$ and storage temp. is -65 to $+200^{\circ}\text{C}$. Available in TO5 or flat packs. Complete data and schematic available from Stewart-Warner Microcircuits Inc., 730 E. Evelyn Ave., Sunnyvale, Calif. 94086.

Circle 286 on Inquiry Card

Components Catalog

"Erie Electronic Components" catalog, 28 pages, covers monobloc ceramic capacitors, tubular and discs, transcaps, button mica capacitors, feed thru and stand offs, trimmers, film capacitors and by-pass capacitor systems for transmitting tubes. Also broad band RFI filters, bushing and eyelet filters, multi section filters, silicon diffused rectifiers, diodes and integrated networks. Erie Technological Products, Erie, Pa.

Circle 287 on Inquiry Card

Synchro Handbook

This 42-page catalog not only lists a complete line of synchros, but also contains design data and circuits. Further, a definition of synchro terms is included. The Bendix Corp., Montrose Div., So. Montrose, Pa.

Circle 288 on Inquiry Card

Power Supply Catalog

Catalog B-657 gives complete specs. for a line of voltage and current regulated power supplies, and contains data of interest to all power supply buyers and users. New application notes, including some which are particularly useful for constant current operation, an up-dated glossary of power supply terms, and expanded explanations of regulated power supply capabilities are given. Kepco, Inc., 131-38 Sanford Ave., Flushing, N. Y. 11352.

Circle 289 on Inquiry Card

.. Fuseholders of Unquestioned High Quality

BUSS SHIELDED FUSEHOLDERS

PREVENT RADIO FREQUENCY INTERFERENCE

For use where fuse and fuseholder could pick up radio frequency radiation which interferes with circuit containing fuseholder—or other nearby circuits.

Fuseholder accomplishes both shielding and grounding.

Available to take two sizes of fuses— $\frac{1}{4} \times 1\frac{1}{4}$ " and $\frac{1}{4} \times 1$ " fuses.

Meet all requirements of both MIL-I-6181D and MIL-F-19207A.

VISUAL INDICATING FUSES

FUSE ONLY .270 x .250 INCHES

GMW FUSE and HWA FUSEHOLDER

BUSS SUB-MINIATURE FUSEHOLDER COMBINATION

For space-tight applications. Fuse has window for inspection of element. Fuse may be used with or without holder.

Fuse held tight in holder by beryllium copper contacts assuring low resistance.

Holder can be used with or without knob. Knob makes holder water-proof from front of panel.

Military type fuse FM01 meets all requirements of MIL-F-23419. Military type holder FHN42W meets all military requirements of MIL-F-19207A.

Insist On BUSS QUALITY Fuseholders

For complete information write for BUSS Bulletin SFH-12

BUSSMANN MFG. DIVISION, McGraw-Edison Co., St. Louis, Mo. 63107
Circle 55 on Inquiry Card

Insist On BUSS QUALITY Fuses and Fuseholders

Write for BUSS Bulletin SFB

BUSSMANN MFG. DIVISION, McGraw-Edison Co., St. Louis, Mo. 63107
Circle 55 on Inquiry Card

great jumping
butterballs!

EMC has put
greater
capacitance
in a smaller
package!



**NEW METAMORPHIC® CERAMIC CAPACITOR
SERIES WITH INCREDIBLE CHARACTERISTICS**

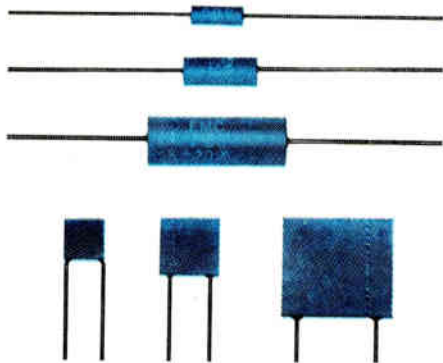

(PATENT PENDING)

**Tubular (axial lead)
and rectangular
(radial lead)
capacitors**

- Capacitance range from 10pf to 10 μ f
- Temperature coefficient $\pm 10\%$ over a temperature range of -55°C to 125°C
- Dissipation factor less than 1.5% at 25°C measured at 1KC (.5 VRMS)

WRITE FOR CAPACITOR

SELECTOR SLIDE RULE

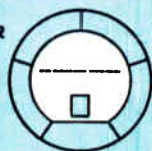

ELECTRO MATERIALS CORPORATION

11620 SORRENTO VALLEY ROAD • SAN DIEGO, CALIF. 92121
(AREA CODE 714) 459-4355 • TWX: 714, 277-3195

NEW TECH DATA

VSWR Nomograph

This nomograph simplifies the calculation of vswr and reflection coefficient from minimum slotted-line width. It can also be used to convert freq. to wavelength and vswr to reflection coefficient. Direct-reading freq. range of the chart is 0.3 to 10gc. General Radio Co., West Concord, Mass.

Circle 191 on Inquiry Card

Microwave Report

Report R11-457, "Microwave Components for Communications Systems," describes components for line-of-sight, troposcatter, and space communications systems. Included in the 28 pages are typical specs. for waveguide, isolators, circulators, filters, loads, switches, feed horns, and other systems. General system data and diagrams are also included. Airtron Div., Litton Industries, 200 E. Hanover Ave., Morris Plains, N. J.

Circle 192 on Inquiry Card

Microwave Catalog

This short-form microwave components catalog contains photos and brief specs. on flexible waveguide, rigid waveguide components, airborne and special-purpose antennas and feeds, stripline switches and power dividers, Beacotron TWT limiter tubes, noise sources, and TR tubes. Copies are available from Electronic Specialty Co., 4561 Colorado Blvd., Los Angeles, Calif. 90039.

Circle 193 on Inquiry Card

Telemetry Checkout

Data Sheet No. 348 gives full description and specification data on the Model 621 single-channel PCM decommutator, which provides economical check-out of PCM telemetry systems and sub-systems. The unit is designed for bench check-out work, accepts serial PCM data from telemetry commutator systems, r-f receivers, tape recorders, or PCM simulators. Telemetrics, Inc., 2830 S. Fairview Street, Santa Ana, Calif.

Circle 194 on Inquiry Card

Klystron Amplifier

Data is available on a high gain, wide bandwidth klystron amplifier. The VA-877A delivers 10kw over a tunable frequency of 4.4 to 5.0gc. The tube is ideal for tropospheric forward-scatter uses. It may be operated synchronously tuned, or with the second and third cavities detuned for maximum bandwidth. Varian Associates, Tube Division, 611 Hansen Way, Palo Alto, Calif.

Circle 195 on Inquiry Card

IC Selection Guide

A complete guide to the selection of HLTTL Monolithic Integrated Circuits is available. The brochure combines circuit listings, schematics and logic diagrams with cross-references, specs. and circuit characteristics. The guide also outlines series circuits and specs. and gives Quality Assurance and reliability data. Write on company letterhead to Transistron Electronic Corp., Wakefield, Mass.

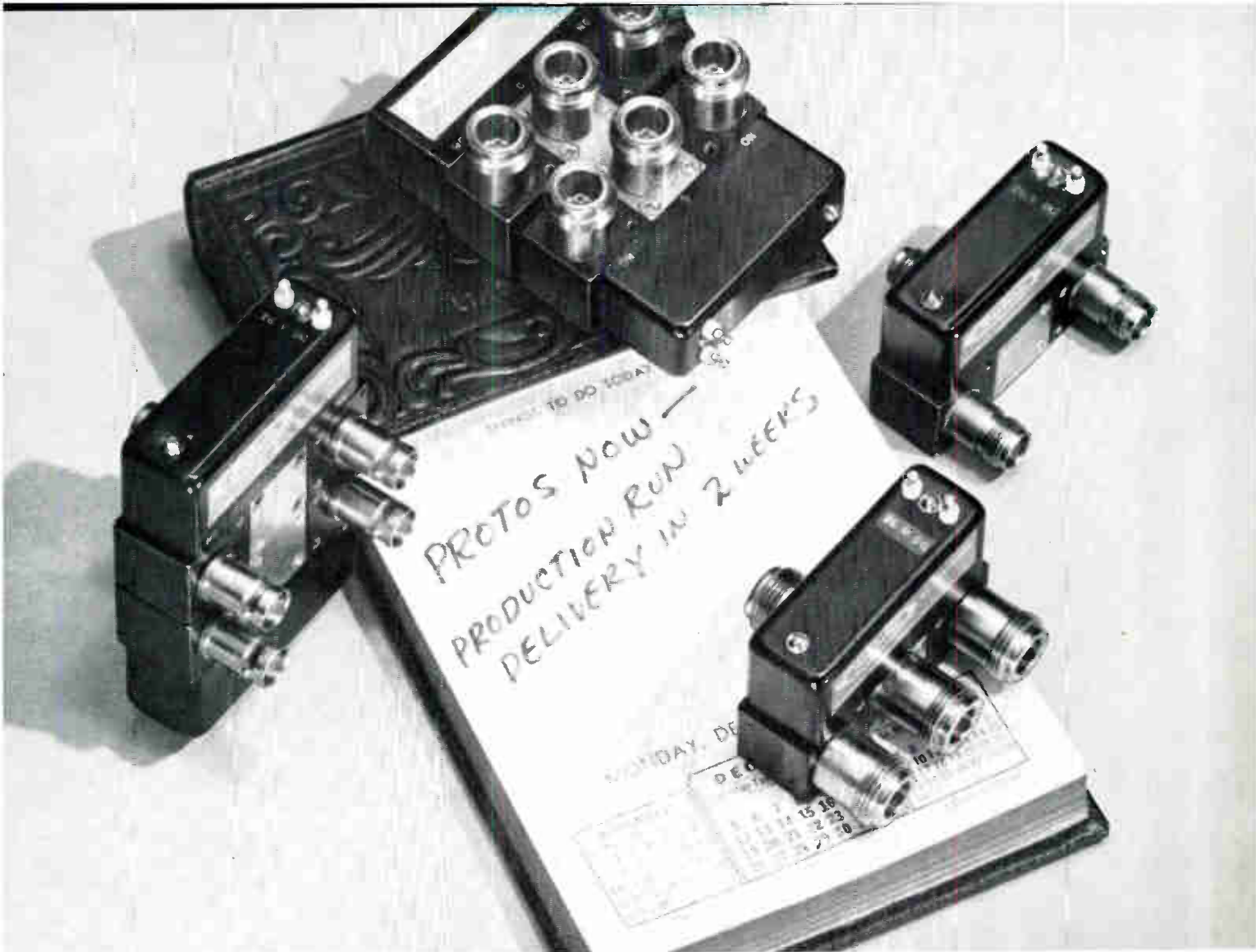

New Amphenol design cuts RF switch delivery to 14 days

Modular construction of Dynaform* switches puts prototypes or production quantities in your hands as quickly as they can be assembled and shipped.

OVER 300 VARIATIONS. Amphenol Dynaform switches are built from 23 standard modules. From these come over 300 switch variations: SPDT, DPDT, and Transfer. Shorting, non-shorting or resistor terminations can be provided. A variety of coil voltages are available.

Connectors are BNC, TNC or

type N positioned for through-panel or above-chassis mounting.

LIGHTER WEIGHT. New aluminum construction cuts weight to less than one-half that of comparable RF switches.

Completely enclosed design makes Amphenol Dynaform switches dust-proof, too.

FREQUENCY RANGE EXTENDED. Electrical performance of the new Dynaform switch is better than any other blade-type RF switch. Usable frequency range

has been extended to 6 Gc. Cross-talk remains consistently low in all frequency ranges.

Designed and tested to exceed the requirements of classes B2b and B3b coaxial switches per Military Specification MIL-S-3928B.

DELIVERY IN 2 WEEKS. Order today and be prepared to install your custom design Dynaform in 14 days. Call your Amphenol Sales Engineer. Or write Amphenol RF Division, 33 E. Franklin St., Danbury, Connecticut.

*Dynaform is a trademark of Amphenol Corporation.



RF DIVISION

amphenol corporation

Specify Amphenol... the leading name in cable, connectors, assemblies, RF switches, potentiometers, microelectronics

Circle 57 on Inquiry Card

Your most advanced circuits

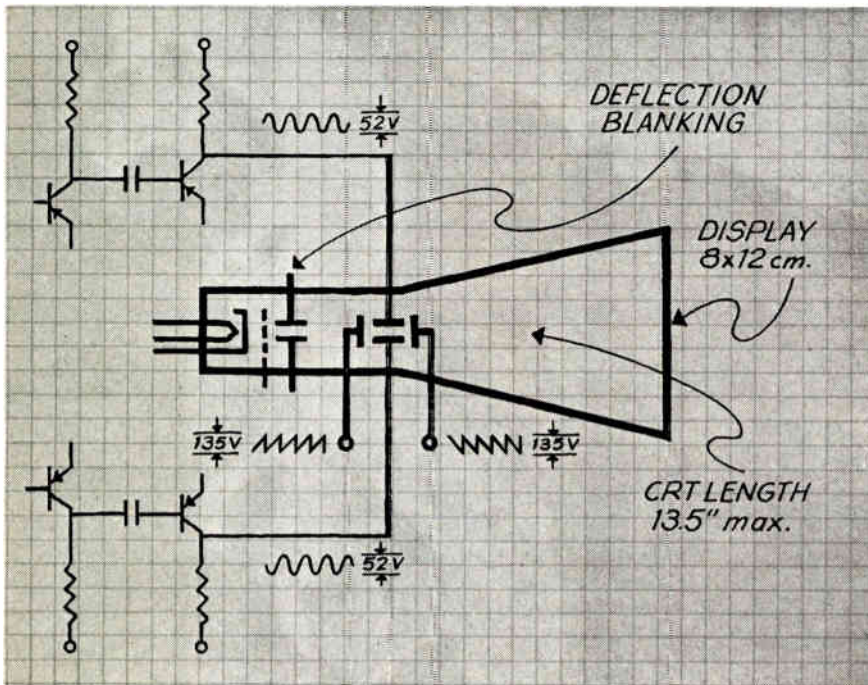

deserve the most advanced CRT, the Amperex D 13-27

Check this unique combination of features:

- Short Length, 13.5 in.
- Vertical Sensitivity, 13 V/cm
- Horizontal Sensitivity, 27 V/cm
 - Scan, 8 x 12 cm
 - Spot Size, 0.012 in.
 - Face, 5" flat
- Utilizes Deflection Blanking Electrodes

(this allows blanking circuitry to be referenced to ground)

For complete specifications and applications assistance on the D 13-27 and other new Amperex Cathode Ray Tubes, write: Amperex Electronic Corporation, Tube Division, Hicksville, L. I., New York 11802.

Amperex®

Circle 58 on Inquiry Card

NEW TECH DATA

Thyratron Theory

A 15-page brochure, "Hydrogen Thyatron Theory and Application," describes the scope, principle of operation, construction, applications, characteristics and ratings of hydrogen thyatrons, and offers a guide for selection. Applications covered are the charge or discharge line-type pulsing circuits, as clipper tubes or hold-off triodes, and in Blumlein or clamper circuits. General Electric Co., Schenectady, N. Y.

Circle 196 on Inquiry Card

Switch Catalog

Forty-four pages of engineering ideas are contained in a new rotary, slide and lever switch catalog. Twelve rotary types from 1 to 2 13/16 in. dia., 2 types of lever switches and 5 sizes of slide switches are completely described. Engineering section shows why to choose a particular insulation material. The special considerations in life testing switches that make such tests more precise are described in detail. More than 100 complete engineering drawings are included. Centralab div. of Globe-Union Inc., P. O. Box 591, Milwaukee, Wis. 53201.

Circle 197 on Inquiry Card

IC Design Aid

In this application brochure, integrated circuit use is approached from the system designer's viewpoint, and development stages of a digital system are discussed. Problems encountered in designing ICs are enumerated and modular solutions are described. The brochure also includes logic transformation rules, hardware, and packaging designs, and system checkout and maintenance procedures. Whittaker Corp., Abacus Div., 12838 Saticoy St., N. Hollywood, Calif.

Circle 198 on Inquiry Card

Microwave Catalog

This revised and expanded catalog on microwave test equipment contains data on over 1200 standard waveguide and coaxial instruments and components. Freq. range covered are 2.0 to 40.0gc. This catalog contains complete information on waveguide and coaxial devices. All of these catalog items are available in the standard military waveguide sizes, as well as the EIA standard waveguide sizes. Complete technical data, descriptive test illustrations, and price lists are given. Waveline Inc., Caldwell, N. J.

Circle 199 on Inquiry Card

Miniature Trimmer

This bulletin describes miniature trimmer potentiometer Model MS37. The 0.375 in. dia. unit is wirewound and available in standard resistance ranges from 20 to 25KΩ. The bulletin contains details on all military specs. applied to production, packaging, and test procedures where applicable. The bulletin also includes electrical, mechanical, and environmental specs., and drawings. Minelco, 600 South St., Holbrook, Mass.

Circle 200 on Inquiry Card



New flexible lighting you can twist, coil, weave...

it's protected
by **ACLAR**[®]

Panelescent[®] Tape-Lite—developed by Sylvania—makes lighting available in a continuous flexible ribbon only $\frac{1}{32}$ " thick. The electroluminescent light source consists of a thin strip of aluminum foil, a layer of phosphors and a transparent conductive coating—all sealed between protective layers of Allied Chemical Aclar fluorohalo-carbon film.

Why did Sylvania choose Aclar? Because it protects better than any other transparent film! Aclar absorbs no

water at all and transmits virtually no moisture vapor. It has excellent dielectric strength... withstands severe shock and pressure... resists tearing and pinholing, and is chemically inert to harshest chemicals. The film is fully transparent—all the brightness of Tape-Lite comes through!

Shielded by Aclar, Tape-Lite flexible lighting has many display and safety applications, as in decorative wall lighting, highway marking, and instrument panel illumination. What

clear, strong, moisture-proof Aclar has done for lighting... it may be able to do for *your* product. To explore the possibilities, write to:

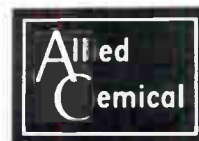

GENERAL CHEMICAL DIVISION
P.O. Box 353, Morristown, N.J.



EXTENDS
solid state power
source capability to

60 Gc

with development of

10-20 Gc DOUBLER and **20-60 Gc TRIPLER**

These outstanding developments coupled with AEL's highly efficient X-Band Power Source make the following possible . . .

12 WATTS AT 28 VOLTS gives you:

- (a) 200 mw at 10 Gc
- (b) 80 mw at 20 Gc
- (c) 2 mw at 60 Gc

If you have a custom or standard requirement for frequency multipliers and solid state sources — ask AEL for the best solution. Call or write to . . .



American Electronic Laboratories, Inc.
P. O. BOX 552, LANSDALE, PENNSYLVANIA 19446 • (215) 822-2929

NEW TECH DATA

Pellet Resistors

Data is available on a new series of stripline pellet resistors used as terminations or wherever a resistor is needed in a flat package. Called Filmstrip, the flat pill configuration is simple to incorporate into almost any circuit. Optional leads are provided for possible use on PC boards or with coaxial components. Although the pellet resistors can be used from dc to 11Gc with a max. vswr of 1.3 at the high freq. end, the optimum usage occurs from dc to 4.0Gc with a vswr of less than 1.1. Filohm Corp., 48 W. 25 St., New York, N. Y. 10010.

Circle 206 on Inquiry Card

Application Notes

Application notes on the use of logarithmic amplifiers are available. The notes cover subjects such as photo-multiplier logarithmic amplification, logarithmic rate counting, and logarithmic video amplification using the output directly from a vidicon target. The use of logarithmic amplifiers in conjunction with sweep generators are also described. Optical Electronics Inc., Box 11140, Tucson, Ariz. 85706.

Circle 207 on Inquiry Card

Expansion System

Product bulletin PI 65011-1 describes the DES-30 Digital Expansion System. This unit adds hybrid capabilities to small analog computer facilities and, in addition, may be linked to a general purpose analog or digital computer or used as an aid in digital instruction or design. It is especially useful in advanced problem solving including simulation of discrete systems, statistical calculations, Fourier analysis, transport delay simulation, and incremental and iterative computations. Electronic Associates, Inc., W. Long Branch, N. J.

Circle 208 on Inquiry Card

Tapes

Detailed specs. and application data for the full line of electrical insulating, protective, and color-coding tapes are contained in a new 16-page catalog. Included are electrical characteristics, physical characteristics, dimensions, and packaging data. Plymouth Rubber Co., Inc., Tape Div., 104 Revere St., Canton, Mass. 02021.

Circle 209 on Inquiry Card

Adhesive Guide

This 3-color, 8½ x 11 in. fold-out selection guide (Z-TPCR551) lists a complete line of tube packaged adhesives and sealants for bonding and sealing any common type of material. The guide lists 8 adhesives and 17 common types of materials, and designates the proper adhesive for a specific material bonding application. A chart lists 4 sealants that will meet almost any type of sealing requirement. Adhesives, Coatings and Sealers Div., 3M Co., 2501 Hudson Rd., St. Paul, Minn.

Circle 210 on Inquiry Card

Con Avionics' new silicon power supply has an M.T.B.F. of 100,000 hours and a 5 year guarantee. It costs \$65.

These dc regulated power supplies are available in nearly 200 different voltage-current combinations. Silicon transistors are used throughout and the units operate in ambients as high as 75°C, with a small external heat sink.

The Mean Time Between Failure of the modules is 100,000 hours, calculated according to Mil Handbook 217. They are certified to meet the environmental tests of Mil-E-5272, and most of the requirements of three other mil specs. In addition, they meet the RFI requirements of Mil-I-6181.

Prices start at \$65. Every time you specify one of these supplies, instead of a comparable germanium unit, you save considerable money. If you're using commercial supplies, typical savings-per-unit are about \$40. For military supplies it's much more.

The fastest way to get complete technical information and prices is to write, call, TWX or wire Gerry Albers at Con Avionics.

	SPECIFICATIONS		
	STANDARD MODEL	"A" MODEL	
Total Regulation (Line and Load)	±0.5%	±0.05% or 2 mv.	ALL MODELS 105-125 v ac, 47 to 440 cps
Ripple (rms. max.)	10 mv	1 mv or .003%	Temperature 75°C ambient max. 95°C base plate max.
Temperature Coefficient	0.07%/°C	0.015%/°C	Response Time 10 microseconds
			Military Specifications Certified to meet the environmental requirements of MIL-E-5272 and the RFI requirements of MIL-I-6181



CONSOLIDATED AVIONICS

800 Shames Drive • Westbury, L. I., New York • (516) ED 4-8400

A DIVISION OF



CORPORATION



LOW NOISE Transistors

THE 2N3880

3.5 db max. System Noise Figure at 450 mc. Selected versions available down to 2.5 db max. System Noise Figure at 450 mc. (5.5 db max. at 1000 mc.) All available in TO-50 packages.

THE K1201 MOS FET

4.5 db max. System Noise Figure at 450 mc, 45 db AGC range, 400 mv Dynamic Range giving 1% cross-modulation. Selected G_m 's to 3000 umhos minimum.



2 Gc OSCILLATOR Transistors

K 2503 : 30 mw @ 2 Gc.

$f_t = 1700$ @ $V_{cb} = 10$ volts, $I_c = 30$ ma.

K 2502 : 85 mw @ 1 Gc in TO-46

K 2501 : 70 mw @ 1 Gc in TO-18



TUNNEL DIODES

Back diodes — — — down to 25 microamps.

Low-noise microwave diodes in Ge, GaSb and GaAs to 50 Gc.

1.0 K — factor max. @ $f_{ro} = 50$ Gc.

KMC MANUFACTURES SEMICONDUCTOR DEVICES ONLY, AND IS NOT YOUR "BLACK-BOX" COMPETITOR.

FOR CATALOGS AND SPECIFICATIONS — — — WRITE OR PHONE



semiconductor corporation

PARKER ROAD, LONG VALLEY, NEW JERSEY (201) 876-3811

NEW TECH DATA

Drum Memory System

The VRC Type 1116 Drum System stores up to 524,000 18-bit words. The system costs less than 10¢/word, complete, in large capacity size. It is word addressable with 8.5msec. average access time, and sequential words are available at a 17µsec. rate. The memory is adaptable to any computer with direct memory access. Vermont Research Corp., Precision Park, North Springfield, Vt. 05150.

Circle 211 on Inquiry Card

Readout Catalog

The DiGi line of incandescent numeric readouts are described in a new catalog. The 2-color brochure features complete product specs., actual-size photographs and detailed outline drawings. Microphysics Inc., 68 Urban Ave., Westbury, L. I., N. Y. 11590.

Circle 212 on Inquiry Card

Laser Welding

Laser Welding Research Report (F-51-851), 12 pages, highlights circuit board welding methods which give excellent fusion welds on conventional types of claddings without substrate damage. Also described are solder reflow techniques employing the laser as a heat source to join integrated circuits and other devices to boards where melting and fusion of board cladding is not required. Examples of unique laser welder uses are included. Union Carbide Corp., Linde Div., 270 Park Ave., New York, N. Y. 10017.

Circle 213 on Inquiry Card

Telemetry System

A block diagram of the Model 8420 Telemetry System, specs., and system description are contained in Bulletin 8420. The system can handle PCM, PAM, PDM, FM and range time code signals. Digital processing performed on data channels includes: editing, merging of multiple inputs, smoothing, data compression, limit check, scaling, linearizing, time editing, and converting to display codes. Beckman Instruments, Inc., Systems Technical Information Service, 2500 Harbor Blvd., Fullerton, Calif. 92634.

Circle 214 on Inquiry Card

Strip Conductor

A new brochure describing edge-conditioned aluminum strip conductor is available. The edge-conditioned conductor has rounded edges—free of burrs, ridges and other irregularities which may cause concentrated high voltage stresses in coils, transformers and other electrical uses. The brochure contains technical data to aid in the design of components using aluminum strip conductor. Frequently used formulas and a chart which plots electrical resistivity against conductor size are included. A section is devoted to data on typical interleaving materials and methods of joining strip conductor. Reynolds Metals Co., PRD-100, Richmond, Va. 23218.

Circle 215 on Inquiry Card

ANOTHER FIRST FROM U.S. COMPONENTS!

NEW REMOVABLE CRIMP-CONTACT

REPC* CONNECTORS THAT MEET

TRI-SERVICE SPECS MIL-C-23353/9

AND MIL-C-23353/10—AVAILABLE NOW!

REPC* A NEW ESTABLISHED RELIABILITY CONCEPT FROM U.S.C.

*REMOVABLE RE-ENTRANCY PRINTED CIRCUIT

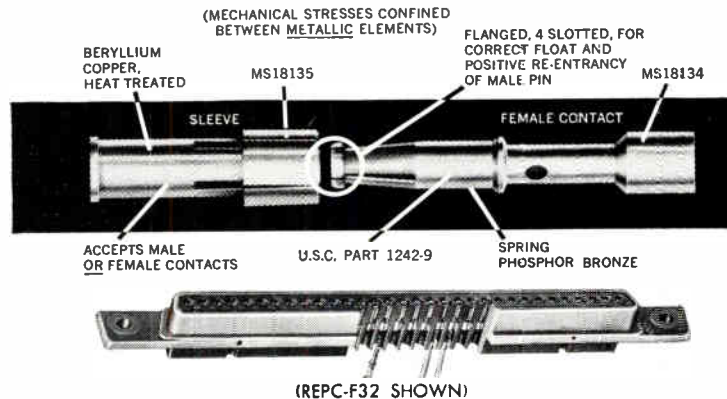

The new U. S. C. REPC concept utilizes the unique REMI design that confines mechanical stresses between *metallic* elements only. Five years of use in millions of REMI connectors is *proof* of its established reliability! This outstanding U. S. C. patented ** contact sleeve design, is now specified as MS18135 (per MIL-C-23216) along with U. S. C. Part No. 1242-9 (female crimp-barrel socket contact MS18134 per MIL-C-23216), on both new military specification sheets.

Why settle for less than the best removable crimp-contact connector for *your* equipment? Write for the new REPC brochure or phone today for prompt assistance regarding your standard or special connector needs.

**U. S. Pat. 2,979,689 & FIVE INTERNATIONAL PATENTS.

REPC-F () SERIES MEETS MIL-C-23353/9

CONTACT CENTER-TO-CENTER .156 INCH.

CONTACTS: Part 1242-9 meet MS18134 per latest MIL-C-23216 and are ordered separately. Type is crimp, removable, closed-entry.

NO. OF CONTACTS: 7, 11, 15, 19, 23 (in Military Spec.) and 32 Contact.

TEST VOLTAGE: 1800 V.R.M.S. at Sea Level.

CURRENT RATING: 7.5 Amps.

MATING CONNECTORS: Any numerical counterpart in UPCC-M () A, B, or C Series.

CONNECTORS WITH 7 THRU 23 CONTACTS MEET APPLICABLE PROVISIONS OF NAS713 AND NAS714. VARIOUS POLARIZATIONS OPTIONAL.

FULL LINE OF CRIMPING TOOLS AVAILABLE — MIL-T-22520A CLASS I, MS3191 (ALL) and CLASS II TOOLS. REMOVAL TOOL RT1256 MEETS MS18137 PER LATEST MIL-C-23216.

© U. S. COMPONENTS, Inc. 1965.

REPC-SGF () SERIES MEETS MIL-C-23353/10

CONTACT CENTER-TO-CENTER .100 INCH.

CONTACTS: Part 1242-9 meets MS18134 per latest MIL-C-23216 and are ordered separately. Type is crimp, removable, closed-entry.

NO. OF CONTACTS: 11, 17, 23, 29, 35.

TEST VOLTAGE: 1800 V.R.M.S. at Sea Level.

CURRENT RATING: 7.5 Amps.

MATING CONNECTORS: Any numerical counterpart in UPCC-SGM () A, B, or C Series.

THESE CONNECTORS MEET ALL APPLICABLE PROVISIONS OF NAS713. VARIOUS POLARIZATIONS OPTIONAL.



U. S. COMPONENTS, INC.

1320 ZEREGA AVENUE, BRONX, N. Y. 10462

TEL. 212 TA 4-1600

Cable Address: COMPONENTS NYK.

TELEX: 01-2411TWX—212-824-6990

**A date for you to remember
from February 3 to 8, 1966
in Paris (at Porte de Versailles)**

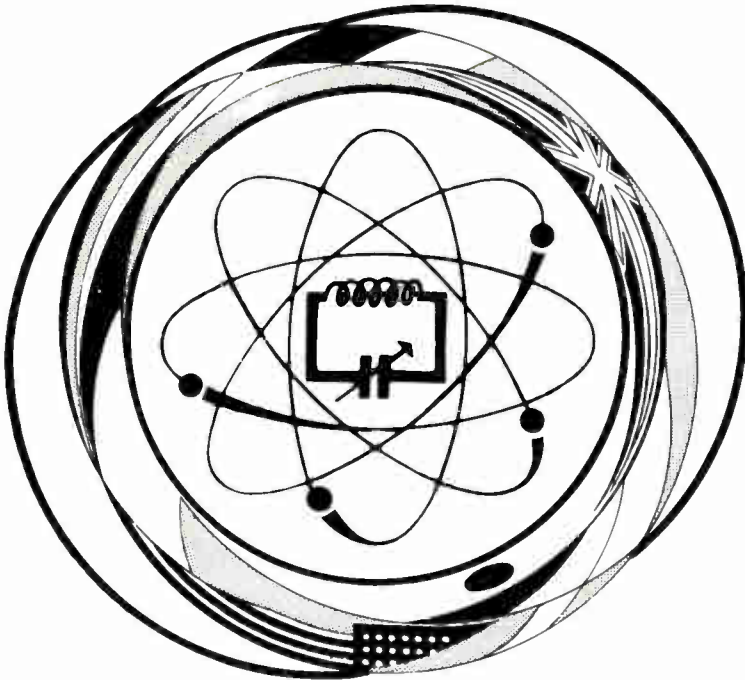

International Exhibition of

ELECTRONIC COMPONENTS



the latest discoveries in the field of electronics:
all components, tubes and semi-conductors, measuring and control appliances, audio equipment . . .

For information and literature write to:
S.D.S.A. 16 RUE DE PRESLES, PARIS 15e., FRANCE

Official carrier: Air France,
Overseas Trade Show Department,
683 Fifth Avenue, New York, N. Y. 10022

PUBLISERVIS
PARIS



Please fill in this application for admission card, cut it out (as per top and bottom dotted lines) and mail it to:

S.D.S.A. Relations Exteriéures
16 Rue de Presles - Paris 15e.

NAME:

FIRM:

ADDRESS:

INTERNATIONAL EXHIBITION OF ELECTRONIC COMPONENTS

INTERNATIONAL NEWS

London—International Instruments, Electronics and Automation Exhibition at Olympia, May 1966, will be used as a spring-board for major sales drives by the electronics industries of countries which are directly in competition with the United Kingdom.

London—After ten years of continuous operation on some of the most advanced statistical research programs, the Elliott Brothers 401, first Elliott computer sold commercially, is being retired to a science museum.

Hull—Ideal-Standard Ltd., a leading British manufacturer of plumbing equipment, will soon join U.K.'s growing ranks of automated firms by installing an NCR 315.

Shepperton, Middlesex — Dynamco Systems Ltd., incorporated Winston Electronics, has signaled its first month under the new name by booking about \$15 million in new orders for data logging systems.

Cambridge—A new Grating Infrared Spectrophotometer that provides resolution needed in the 3000cm⁻¹ region has been exhibited by Unicam Instruments Ltd. The range 650 to 4000 cm⁻¹ is covered with two gratings back to back.

Glasgow—A Sperry Rand Univac 1108 computing system has been ordered by Great Britain's National Engineering Laboratory at East Kilbride, Scotland, to be used to prepare machine tool control tapes.

Munich—"SIERRA," a system of two 3003 SIEMENS data processors that books seats and sleeping berths, prints seat reservations and tickets, computes prices, performs accounting, and prints passenger lists, is to be supplied to the Spanish railways.

Berlin—Sperry Gyroscope has sold two SGN-10 Inertial Navigation Systems to be evaluated as part of an all-weather landing program by Deutsche Lufthansa A.G. in Boeing 707 aircraft.

Amsterdam — A 960-conversation microwave network installed by General Telephone & Electronics International Inc. will serve the four largest cities in The Netherlands, including Rotterdam, Utrecht and The Hague.

Copenhagen — Raytheon will distribute Engelhard Industries' "Capac" cathodic protection for ships in continental Europe, equipment and spare parts will be stocked in Copenhagen.

Erlangen — Siemens-Schuckertwerke has opened its new research center in Bavaria. At a cost of 100 million DM, it is Europe's largest private enterprise research establishment.

Montpellier — Seven months after ground breaking, IBM France's new plant has started assembly of IBM System/360 computers, which will be shipped to customers in Europe.

Paris—A new ground-based secondary radar system, SECAR, developed by Marconi and Compagnie Francaise Thomson Houston (CFTH) can interrogate on all civil and military modes.

Basel—More than 600 manufacturers were represented at the second International Exhibition of Industrial Electronics (INEL 65) held September 7 through 11 in the Swiss Industries Fair.

Zurich—Balzers Inc., of Liechtenstein, which supplies a large amount of high-vacuum equipment to the world, has acquired Trub-Tauber Scientific Division, Zurich, maker of research instruments.

Taranto—Italy's newest and most modern steel plant, Italsider Steel Corp., is using a Westinghouse automatic mill control to regulate ingot buggy travel between soaking pits and slab-mill conveyors.

Madrid—Burrroughs Corp. announced a new subsidiary in Spain, Burrroughs S.A., with headquarters in Madrid. The company also will have offices in Barcelona, Bilbao, Seville and Valencia.

New Delhi—The government of India, through its wholly owned company, Bharat Electronics Ltd., has awarded RCA a \$5 million contract for military electronic equipment.

Tokyo—Hitachi Ltd. has given RCA a contract for more than \$7 million to supply airborne digital data link equipment for Japan's F-104J Self Defense Forces aircraft.

Hong Kong—A new company, Transelectronics Ltd., with a production capacity of one million radio chassis per year will soon be established in Hong Kong, according to Far East and Pacific, ITT Corp.



Beckman solves space age problems in DeKalb-Atlanta

Where can a company get a good deal on warehouse space—close to the booming space age projects of the Southeast? Beckman Instruments, a leader in the field of producing instruments for industry, science and biochemical research, found the industrial site and technical talent it needed in DeKalb-Atlanta's Peachtree Industrial Blvd. District. From DeKalb, Beckman markets direct—developing an increasingly productive relationship with Southeast customers. If you have a space—or space age—problem, DeKalb-Atlanta may be your launching site, too. Write today for more details.

Reid Williamson, Jr., Manager, Industrial Committee of 100, or B. H. Manning, Jr., Chairman, DeKalb County Commission, P.O. Drawer 15059, Atlanta, Georgia 30333

NAME _____
TITLE _____
COMPANY _____
ADDRESS _____
CITY & STATE _____



from
A to Y
**TRANSCO
SWITCHES**

... building blocks in
microwave systems
for over 20 years

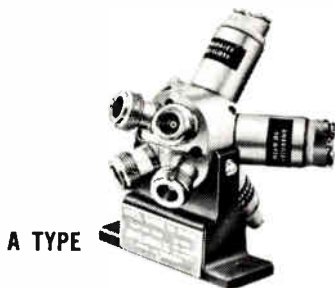

A TYPE

Frequency — to 11 Gc with N connectors.
Typical at 7 Gc — VSWR 1.2:1 — Insertion
Loss 0.2 db — Crosstalk 35 db down —
Weight 12 oz. SP4T.

Transco may not cover the alphabet but
we do cover the microwave switching
spectrum. We offer the most complete
line of switches in the industry.
Find out about switch types A to Y.
Also waveguide and solid state.
Write for your catalog today.

*Patented

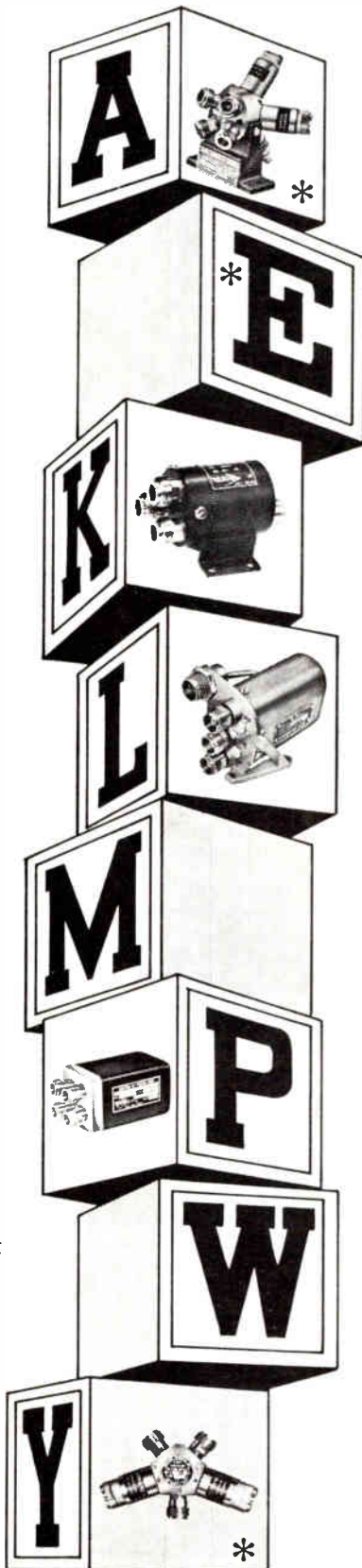

**MICROELECTRONIC
DEVELOPMENTS . . .**

In a major expansion of microelec-
tronic product lines, General Instru-
ment Corp. has introduced a whole
"family" of standard off-the-shelf MOS
integrated circuits, designed for low
cost computers, calculators, data proc-
essing, communications and other elec-
tronic systems.

A line of ceramic resistive pastes for
silk screen printing for microelectro-
nics has been announced by Electro-Sci-
ence Laboratories, Inc. New resistive
glaze compositions feature "superior
heat stability, greater resistance to se-
vere moisture exposure and improved
electrical load stability." They may
also be used for making discrete resis-
tors or as part of a thick film hybrid
circuit. Standard sheet resistivities in
decade ranges from 10 to 20K ohms
per square are offered.

Precision artwork stepping machine,
"designed to be more accurate than
any available until now," has been in-
troduced by The Jade Corp., Beth-
ayres, Pa., for micro mask manufac-
turing. The machine, Jade 4M, offers
precise image placement with a re-
peatability of ± 10 microinches
(0.00010) for monolithic circuits. The
Jade 4M can generate any stepped
field with an area of 3 x 3 in. Maxi-
mum image size at 10X is 0.05 x 0.05
in. with a resolution of 200 lines/mm
(0.001 in. lines).

"In response to demands for seminar
service," an integrated circuit seminar
will be held in Philadelphia, Pa., De-
cember 6-10, by the Integrated Circuit
Engineering Corp., Phoenix, Ariz. Free
brochure describing the seminar and
rates is available from I.C.E.'s Eastern
Office, P.O. Box 4388, Philadelphia,
Pa. 19118.

Fast-pump vacuum system which
produces pressures of below 10^{-8} Torr
in less than 5 min. with ultimate vac-
uum of 10^{-7} Torr has been developed
by Denton Vacuum, Inc. Designated
Model DV-503-FP, the system pumps
at about twice the speed of conven-
tional systems. Some typical applica-
tions include evaporation and deposi-
tion of thin films for optics, semicon-
ductors, microelectronics and printed
circuit production and carbon evapo-
ration.

TRANSCO 

TRANSCO PRODUCTS INC.
4241 Glencoe Ave., Venice, California
213/391-7291 - TWX 213/871-5282
Cable Address - (Transco Venice,) Calif.

An equal opportunity employer - We invite resumes from qualified engineers

Our 24th year of serving the Aerospace Industry

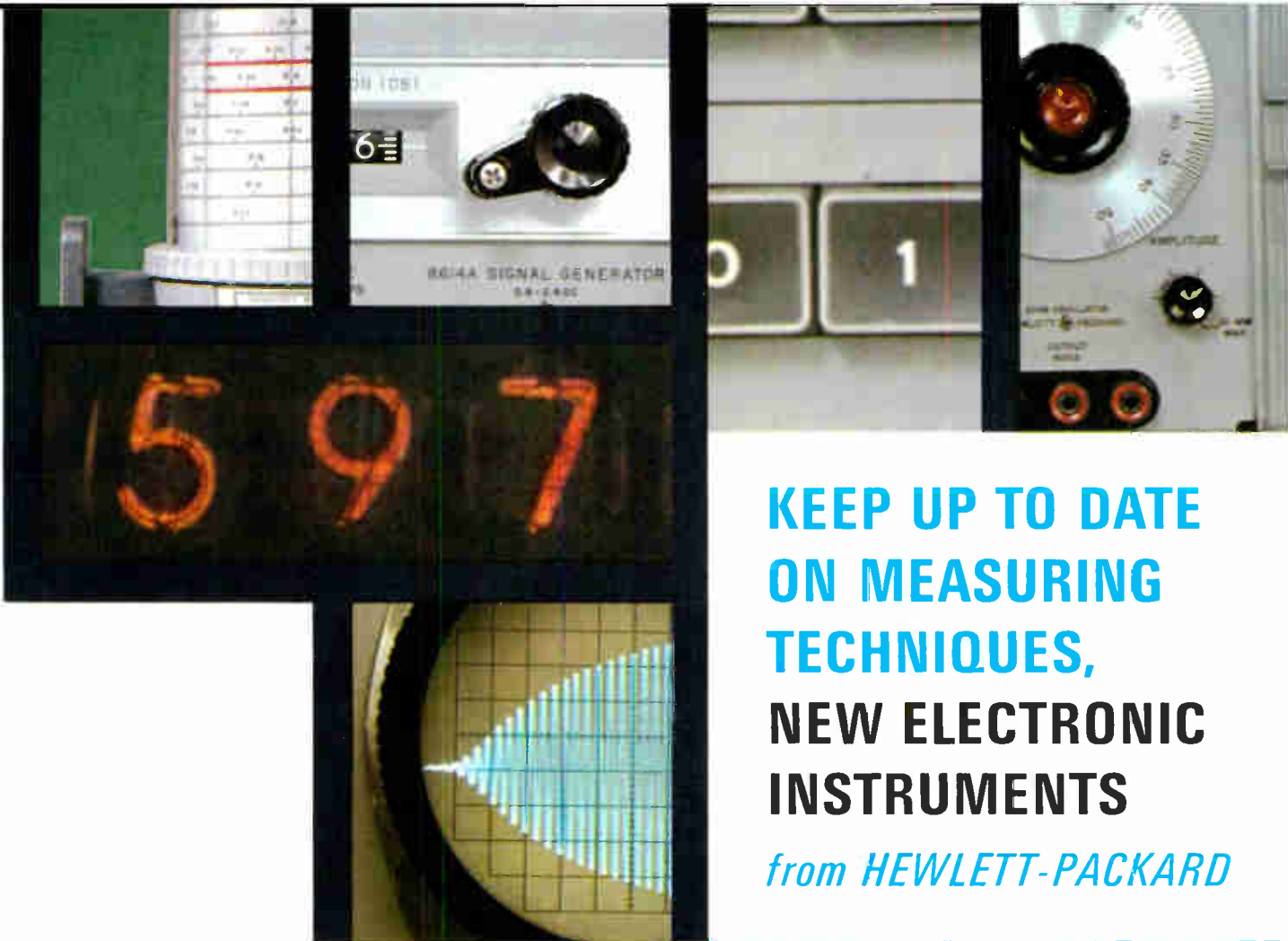

**KEEP UP TO DATE
ON MEASURING
TECHNIQUES,
NEW ELECTRONIC
INSTRUMENTS**
from HEWLETT-PACKARD

*JOIN the thousands of engineers and scientists
regularly receiving the latest information on state-of-
the-art electronic measurement from Hewlett-Packard*

JUST USE THE HANDY
POSTCARD TO BE A REGULAR
RECIPIENT OF

hp Journal

Here's a monthly technical publication from the Hewlett-Packard R&D laboratories. The hp Journal, yours just by having your name put on the mailing list, describes new measuring techniques and advances in state-of-the-art measuring instruments.

Typical subjects covered in the Journal include a high resolution quartz thermometer, new techniques for spectrum analysis, a new simplified instrumentation-class magnetic tape transport, microwave harmonic generation and nanosecond pulse generation with the step-recovery diode, intercontinental time correlation with flying clocks, frequency synthesizers, broadband solid-state amplifiers, rms voltmeter with high crest factor rating.

**Measurement
News**

Your local hp field office sends you this bi-monthly publication, announcing new instruments and the availability of new application data, and presenting articles of local interest. Every issue will be sent you when you have your name put on the mailing list.

**FILL IN AND MAIL
THIS POSTCARD**

*to have your name put on the mailing
list for hp Journal and Measurement
News—as well as to request other
technical data.*

MEASUREMENT NEWS

HEWLETT
PACKARD NEELY
WALSH SYSTEM

DECEMBER / JANUARY

hp HEWLETT-PACKARD JOURNAL
TECHNICAL INFORMATION FROM THE HEWLETT-PACKARD LABORATORIES

**New Coaxial Couplers for Reflectometers,
Detection, and Monitoring**

Coaxial couplers with flattened response and high directivity facilitate vector type measurements of several kinds.

As a result of the development of a new type of coaxial coupler, the HP 8940 series of couplers is now available. This series of couplers is designed for use in reflectometers, detection, and monitoring applications. The couplers are available in two models, one for use in reflectometers and one for use in detection and monitoring applications. The couplers are available in two models, one for use in reflectometers and one for use in detection and monitoring applications.



WE ALSO

World Radio History

BUSINESS REPLY MAIL
No Postage Necessary if Mailed in the United States

POSTAGE WILL BE PAID BY—
HEWLETT-PACKARD
1501 Page Mill Road
Palo Alto, California 94304
Department EI

First Class Permit
No. 201
Palo Alto, Calif.

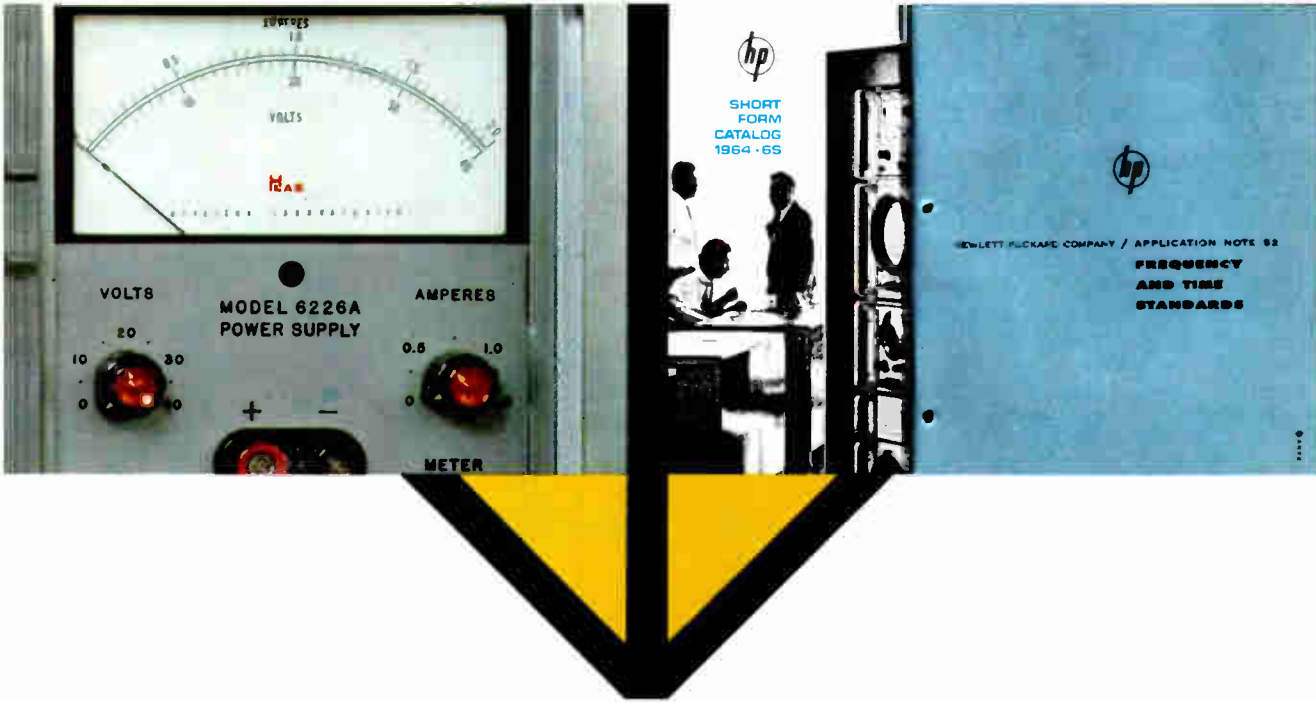

Technical Data, Application Information...

yours for the asking!

Gentlemen:

- Please put my name on the mailing list for the hp Journal and Measurement News
- Please send the complete index of hp Application Notes
- Please send the hp Shortform Catalog
- Please send data sheets on

_____ (instrument type)

_____ (frequency range or model type)

Please *print* or *type* your name and complete address, giving mail station or other delivery code.

name _____ title _____

dept., building, mail station—etc. _____

company _____

post office box or street number _____

city _____ state _____ zip _____

This is my company address home

SHORTFORM CATALOG

For a complete index listing with brief specs of all Hewlett-Packard measuring instruments, use the postcard to request your copy of the hp shortform catalog.

DATA SHEETS

Or request complete details on instruments that will help you solve your measuring problem. Just ask for a data sheet on specific instrument model numbers, or describe the basic function, frequency range, etc. of the instrument you need.

APPLICATION NOTES

Use the postcard to obtain a complete index of more than 50 application notes available from Hewlett-Packard and its divisions. Typical subjects include time domain reflectometry, spectrum analysis, loop gain measurements, ac volt-meter selection, crystal control of signal sources 1 to 40 gc, strain gage recording.

GENERAL CATALOG

Information and specifications on the more than 900 instruments in the Hewlett-Packard product line are presented in the 400-page Hewlett-Packard General Catalog #25, available without charge from your local Hewlett-Packard field office.



ALL CHANNEL RECEIVER

Model 1320 All-Channel VLF Phase Tracking Receiver tunes from 5 through 80kHz (751 channels). Designed by RMS Engineering, Inc., Atlanta, Ga., it calibrates frequency standards by comparing them with stabilized Government VLF transmissions.

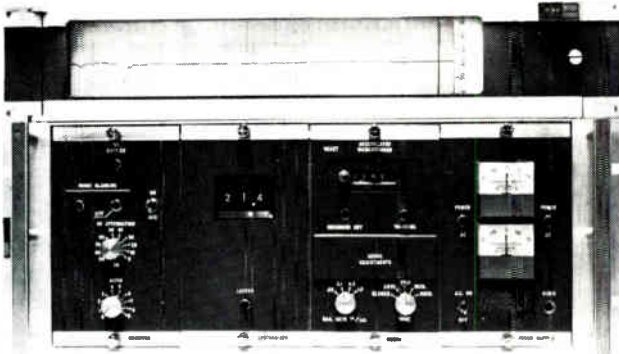

Parts 26 and 27 of the 1965 Book of ASTM Standards, recently published by the American Society for Testing and Materials, 1916 Race St., Philadelphia, Pa., contain all the ASTM standards for plastics. In the two parts there are 448 standards of which approximately 21% are new, revised, or changed in status. These parts replace and supersede all previous editions. Part 26, 548 pages (224 standard), costs \$10.00 (ASTM members: \$7.00). Part 27, 822 pages (224 standards), is priced at \$15.00; (ASTM members: \$10.50).

Program charts can be prepared by relatively inexperienced personnel using a curve-following instrument made by Corning Instrument and Controls, Penndel, Pa. It automatically adjusts process set points to a pre-determined time schedule or program. Accuracy is $\pm 0.15\%$.

Failure rates for off-the-shelf silicon-monolithic integrated circuits have been established by Battelle researchers on the basis of about 68 million part-test hrs. of data. No failures have been reported for operating-life tests at 25°C, so it can be determined only that the failure rate is less than an upped 60% confidence limit of 0.067%/1000 hrs. This report, Order 614 103N, "Reliability of Integrated Circuits Used in Missile Systems," can be had from Clearinghouse, U.S. Dept of Commerce, Springfield, Va. 22151. Price, \$3.00

A Waveform Analysis Center to meet the need for spectrum signature data has been established at Weston-Boonshaft and Fuchs Div. of Weston Instruments, Hatboro, Pa. Capabilities include low-cost investigation of transient and random signals in dynamic environments for determining signal content, power spectra, and transfer functions.

A low-cost automatic 11 point program panel for use with pressure calibration systems is available from Gilmore Industries, Inc., Cleveland, Ohio. According to the manufacturer, the Model 349 Programmer can complete an 11 point calibration run unattended, saving both test time and personnel. All preset pressures can be scanned up-scale, and when the highest set point is reached, the system reverses and returns through the same set points of scanning down-scale.

Basic research laboratories working with chemical kinetics, election exchange rates, molecular structures, odd electron wave functions and other phenomena will be interested in a spectrometer made by Varian Associates, Palo Alto, Calif. Model E-3 is a 9.5Gc instrument with a built-in X-Y recorder that allows spectral data to be presented in terms of field measurement.

An instrument that provides dc output voltage directly proportional to the logarithm of the input frequency has been developed by Omnigraphic Corp., Houston, Tex. Called the HLFC-120 Log Frequency Converter, it should find uses in acoustical and vibration system, for filter and amplifier testing, and for nuclear counting. The instrument allows frequency response curves to be automatically plotted without mechanical linkages between the sweep oscillator and recorder.

Rapid, accurate Go/NoGo limit testing and analog measurements is provided by tape-programmed Model 9400. The basic system consists of a digital voltmeter or multimeter, an input scanner, tape reader, and a data-control unit. Perforated tape provides the program data. A front panel keyboard allows manual data insertion. The limit testing or measurement output data is available in the form of isolated contact closures for alarm and/or recording, or it is visually displayed. The tester is a product of Auto Data Inc., Kearny Mesa Rd., San Diego, Calif.

A convenient method for calibrating radiation pyrometers is offered by the Acutemp, a precision temp. calibrator. Made by Pyrotel Corp., Mamaroneck, N.Y. it gives direct temp. dial readout in various ranges from 0° F to 1000° F.

NASA GETS FACTs

NASA is using a special version of an automatic circuit tester to simulate voltage outputs and validate wiring between its Houston Center and units under test. The basic tester, called FACT (Flexible Automatic Circuit Tester), was developed by Hughes Aircraft, Culver City, Calif., to checkout hardware ranging from cabling to complex airframe or missile wiring.

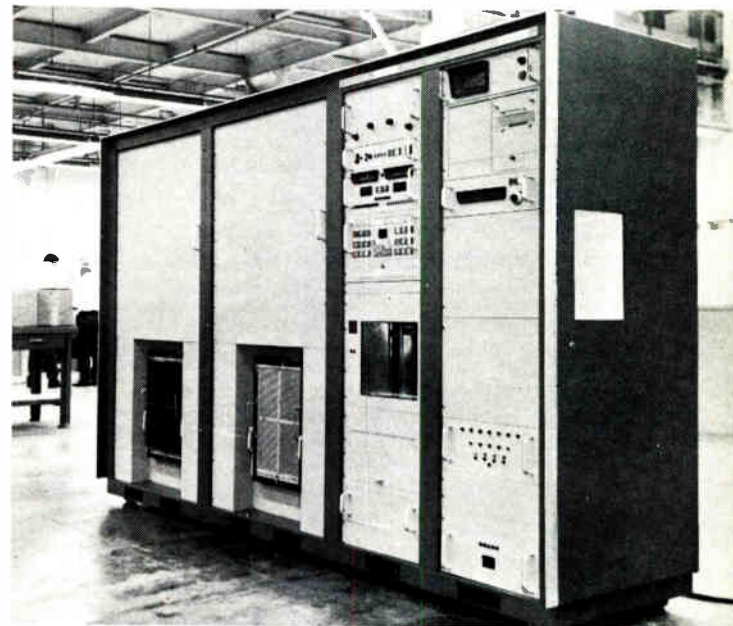

Small changes in temperature, often encountered in electronic equipment can be measured using currently available fast detectors. New Cryogenic cooling methods make this method practical.

Photoconductive Detectors For Infrared



The "Cryomite" closed cycle cooler by Malaker. The mercury-doped germanium infrared detector is mounted behind the window at left.

THE APPLICATION OF LONG-WAVELENGTH, photoconductive detectors to infrared (IR) scanning, plotting or mapping of electronic devices offers advantages over other types. But, cryogenic cooling of such detectors is needed. Some of the available detectors, together with their operating mechanisms, are shown in Table 1. There are four general categories of detectors: thermal, photoconductive, photovoltaic, and photoelectromagnetic. A discussion of each type follows.

Thermal Detectors

Thermal detectors include such devices as thermistor bolometers, thermocouples, thermopiles, and the Golay Cell. These detectors are generally wideband; that is, with appropriate windows they cover the complete IR spectrum. But, they are not very fast, because thermal conduction through a solid or a gas takes time. The faster ones have time constants of about 1 msec.

Photoconductive Detectors

When radiation impinges on a photoconductive detector, a change of conductivity takes place that is separate from any heating effect. Because the mechanism is a basic quantum electronic effect, the response time is very fast. Depending on the lifetime of the charge carriers in the particular photoconductor used, response times shorter than $1\mu\text{sec}$ have been observed. The

spectral range covered by a particular photoconductor is much narrower than the spectral range of thermal detectors; but in general the photoconductor is more sensitive in this narrower range. Fortunately, many different photoconductive detector materials have been developed; and the spectral ranges overlap. Thus, photoconductive detectors can be selected for almost any portion of the IR spectrum.

Photovoltaic Detectors

Radiation applied to the junction of a photovoltaic detector causes a potential difference across the detector. Such detectors are very fast but cover a narrower spectral range than do thermal detectors.

Photoelectromagnetic Detectors

Radiation on a PEM detector causes a potential difference across the detector. The response is very fast over a narrow spectral range. Apart from the relatively low-level signals produced by the photovoltaic and photoelectromagnetic detectors, the main disadvantage to their use for the application to be discussed is the lack of enough detectors to cover a significant part of the IR spectrum.

Detector Applications

One use is to detect the IR radiation from electronic components and equipment that vary little in temperature from normal room ambient. The detector to be used must match the spectral range of radiation emitted from the components. As shown in Fig. 1, the spectral power (W_λ) from a 25°C black body is plotted as calculated from the Stefan-Boltzmann equation. Also plotted are the spectral detectivity curves of two photoconductive detectors—cadmium doped germanium (Ge: Cd) and mercury doped germanium (Ge:Hg). Peak detectivity of these detectors corresponds closely to the peak radiation emitted from objects at 25°C , and it was for this reason that they were selected. Fast time response and high detectivity of these detectors allows them to be used for rapid scan display on an intensity modulated long persistence oscilloscope. They would have been used more than they have if it had not been for the need of cryogenic cooling, heretofore quite difficult.

TABLE 1: PHOTOCONDUCTIVE DETECTORS

TYPE	PRIMARY OPERATING PRINCIPLE	EXAMPLE
THERMAL	Thermal change in resistance	Thermistor Bolometer
	Heat transport accompanied by charge transport	Thermocouple
	Thermal expansion of a gas	Golay Cell
PHOTO-CONDUCTIVE (PC)	Photoionization produces current carriers thereby changing electrical conductivity	PbS
		PbSe PbTe InSb P-type Ge(Au) Ge-Si(Zn,Sb) Ge(Cu) Ge(Zn)
PHOTO-VOLTAIC (PV)	Photoionization produces electron-hole pairs separated by internal electric field at junction, thus establishing potential difference	InSb InAs
PHOTO-ELECTRO-MAGNETIC (PEM)	As hole-electron pairs produced by Photoionization diffuse into material, they are separated by external magnetic field, thus establishing potential difference	InSb

By **GEORGE F. GIGGEY**

Raytheon Co., Infrared and Optical Research Laboratory, Burlington, Mass.

Measurements

Detector cooling reduces thermal noise in the detector for weak signal observation. Ge, for instance, has many allowable energy levels due to impurities in the crystal lattice. By controlling the type and amount of a particular impurity, one can almost "tune" the material to be sensitive to certain IR spectral regions. Impurity levels in Ge are shown in Fig 2. The shallow acceptor levels of Cd, Hg and Cu are selected for reasons that will be discussed with the aid of Table 2. The discrete impurity energy levels of these three elements in Ge were chosen because of the relation of available energy level to spectral response. The photon energy (E_i) in electron volts of the radiation to be detected is given as $h\nu = hc/\lambda$ where h is Planck's constant, and ν is the frequency which can also be expressed as c/λ (the speed of light divided by the wavelength of the radiation). If this photon energy is greater than the impurity level in the Ge, the impurity atoms will be ionized into charge carriers by the radiation, and photoconductivity takes place. If the photon has less energy than the impurity energy level, there is no effect on the material. From this relationship, it is seen necessary to have smaller impurity levels to obtain photoconductivity at longer wavelengths. A useful form of this relationship between maximum wavelength response or cutoff wavelength (λ_{max}), and the available energy level, is given at the bottom of Table 2. Using this relationship, the cutoff wavelengths for the materials considered in this table are: Ge:Hg, 13 microns; Ge:Cd, 21 microns; and Ge:Cu, 31 microns.

For photoconductivity to take place, the lattice energy (which is given as a function of kT , where k is Boltzmann's constant and T is the absolute temperature in °K) must be less than the impurity energy level in the crystal. If this condition is not maintained, the impurity atoms will be ionized by the lattice energy and the effect of the incoming radiation can not be observed.

For a typical impurity level in Ge, the number of charge carriers per cc (ionized impurity atoms) versus detector temperature is shown in Fig. 3. This plot is without incoming signal radiation and is shown for two different background levels. Detector temperature increases to the left, and the total number of charge carriers is the sum of the thermally excited carriers,

TABLE 2: IMPURITY ENERGY LEVELS vs SPECTRAL RESPONSE IN GERMANIUM.

DISCRETE ENERGY LEVELS IN GERMANIUM	
Hg	0.09 ev
Cd	0.06 ev
Cu	0.04 ev

$E_i = h\nu = \frac{hc}{\lambda}$	\geq	$f(kT)$
Photon Energy		Lattice Energy
$\lambda_{max} = \frac{1.24}{E_i}$		

Fig. 1: Detectivity of cadmium and mercury-doped germanium infrared detectors. Spectral power curve of 25°C black body is shown for comparison.

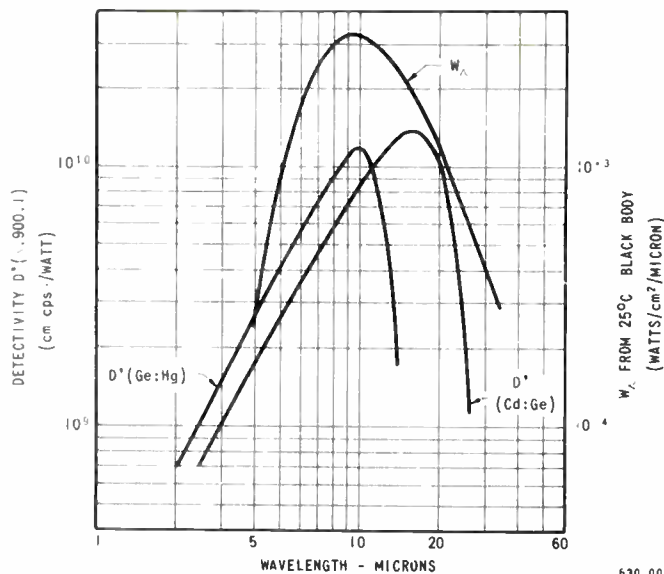

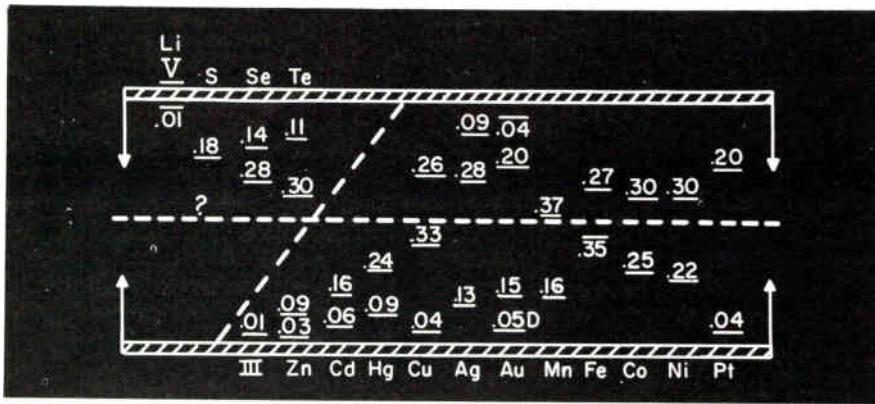

Fig. 2: Energy levels of impurity atoms in germanium.

PHOTOCONDUCTIVE DETECTORS (Continued)

N_T , and the background carriers, N_B . The number of background carriers is determined by the flux density of background radiation incident on the detector.

The effect of detector temperature on detectivity is shown for cadmium doped germanium in Fig. 4. As shown, the detectivity drops off with detector temperature above 25°K. Similar figures can be drawn for other impurities in Ge with requirements of 30°K or lower for Ge:Hg and 17°K for Ge:Cu. Generalizing then, for photoconductive detectors with increasingly longer wavelength cutoff, lower detector temperatures are needed.

Detector Cooling Methods

Heretofore, the most practical method of cooling detectors has been to make use of the normal boiling point of various liquefied gases. Below 30°K there are only three liquefied gases available—neon, hydrogen and helium. A metal liquid helium dewar suitable for IR detector cooling to 4.2°K is shown in Fig. 5. This dewar has a side-looking window near the bottom and is shielded with liquid nitrogen to reduce the helium evaporation rate. Dewars of this type can operate on

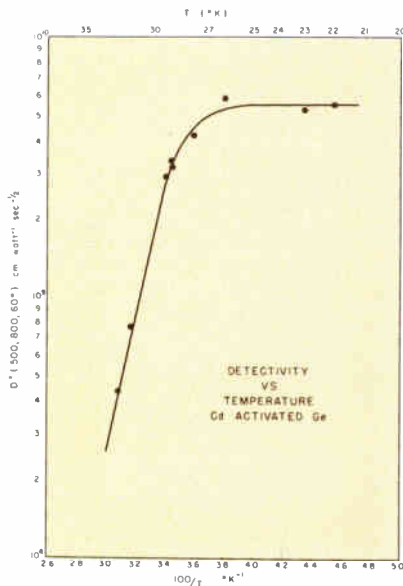

Fig. 3: Variation of free charges with temperature for a typical impurity level in germanium.

VARIATION OF NUMBER OF FREE CHARGES WITH TEMPERATURE

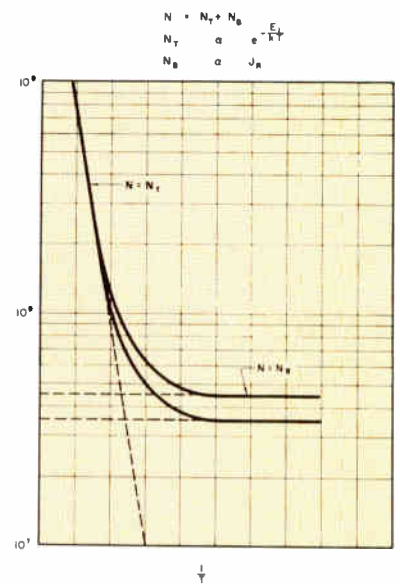

Fig. 4: Detectivity vs temperature for cadmium-doped germanium.

one filling for 6-8 hrs. The filling operation and the accessory equipment needed to operate this dewar are shown in Fig. 6. A liquid helium storage tank is shown with a vacuum insulated transfer tube which is used to transfer the liquid helium to the detector dewar.

The increased availability of liquid helium at lower cost has made it more practical for detector cooling. It now is shipped by air freight and truck anywhere in the country. This availability and low cost make it practical to fill a detector dewar in the morning and operate it all day for about a dollar an hour.

A newer method for cooling detectors requiring temperatures of 30°K or less is by using one of the many cryogenic refrigerators designed for IR cooling. There are several closed cycle coolers using Joule-Thompson expansion valves or expansion engines to reach temperatures of 30°K or below. But, one development of the past two years that has done much to make detector refrigeration more practical is the availability of coolers based on the Stirling cycle. These are available from several manufacturers. One production model from Cryogenerators, Inc., called the Cryogen, is shown in Fig. 7. Another is the "cryomite" made by Malaker (photo page 118). These are closed cycle coolers; thus, no liquefied gases or make-up gases are needed for operation. In addition, Stirling cycle

Fig. 5: Liquid helium dewar for infrared detector cooling to 4.2°K.

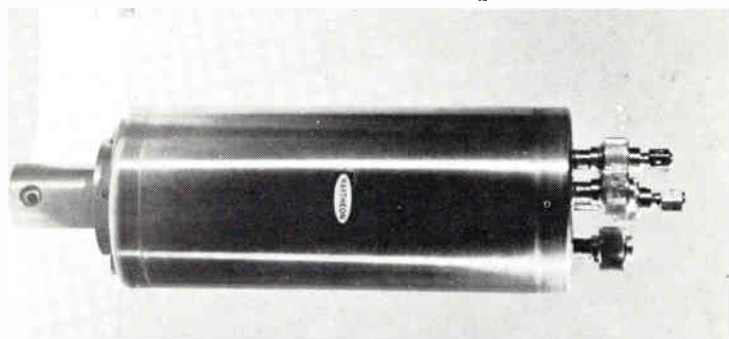

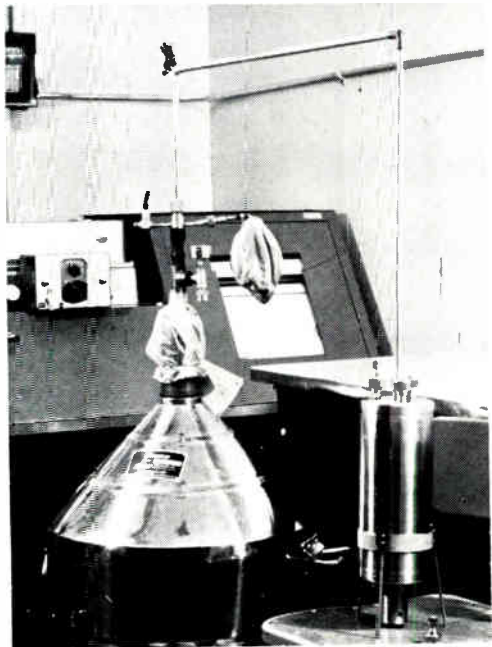
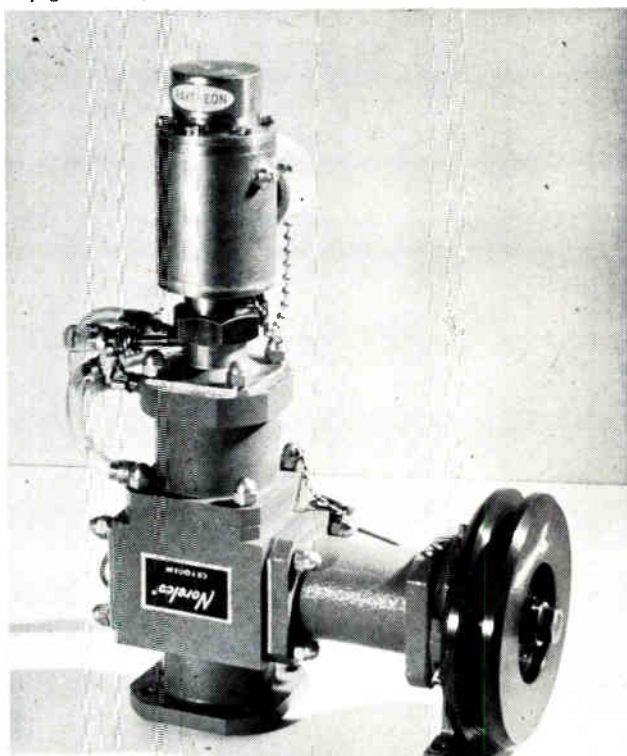

Fig. 6: (left) Filling and operating setup for liquid helium dewar.

coolers are very compact (12 in. in length and 15 lb in weight) and will operate in any attitude. They are particularly useful with mercury doped germanium detector material. The encapsulated detector is mounted on the cold head just behind the window in the vacuum jacket. The electrical connections to the detector are made by vacuum tight connectors on the side of the vacuum jacket. The cooler is driven by a fractional horsepower motor. Ambient temperature cooling is required either by water or air circulation to remove the heat of compression. These coolers can then be operated anywhere with only an electrical power source and the availability of ambient temperature heat rejection.

Fig. 7: A "Stirling cycle" cooler—the Cryogem, made by Cryogenerators, Inc.



from NYTRONICS

**HIGH
RELIABILITY
CERAMIC
CAPACITORS**
Over 300,000 in Stock!

- ★ 24 Hour delivery.
- ★ 93 standard values from 5.6 pf. to 2.5 mfd.
- ★ Meets MIL-C-11015 requirements.
- ★ Subminiature components.
- ★ Rugged, epoxy-encapsulated.
- ★ Highest reliability and performance.

MIL-CAP in CK05 and CK06 case styles are 0.200" and 0.300" square by 0.100" thickness; capacitance range — CK05, 47 pf to 1,000 pf; CK06, 1,200 pf to 10,000 pf — both $\pm 10\%$ and $\pm 20\%$ capacitance tolerance; capacitance change $\pm 15\%$ maximum over temperature range of -55°C to $+150^{\circ}\text{C}$. Working voltage 200 VDC, insulation resistance 100,000 megohms at 25°C , 1,000 megohms at 150°C . Dissipation factor $2\frac{1}{2}\%$ maximum at 1 kc.

HY-CAP offers capacitance range 0.01 mfd. to 2.5 mfd. with maximum capacitance change of $\pm 12\%$ over temperature range of -55°C to $+125^{\circ}\text{C}$. Case size range from 0.225" to 0.800" width, 0.175" to 0.550" height and 0.110" to 0.375" thickness; working voltage 100 VDC; dissipation factor $2\frac{1}{2}\%$ maximum at 25°C .

DECI-CAP has greatest capacitance range available in cordwood envelope. Molded 0.100" diameter by 0.250" long; capacitance range 5.6 pf to 27,000 pf; capacitance tolerances $\pm 10\%$; capacitance change $\pm 7\frac{1}{2}\%$ from 5.6 pf to 470 pf and 15% maximum from 560 pf to 27,000 pf over temperature range of -55°C to $+125^{\circ}\text{C}$; working voltages 200 VDC from 5.6 pf to 470 pf and 100 VDC from 560 pf to 27,000 pf; insulation resistance 20,000 megohms minimum and dissipation factor $2\frac{1}{2}\%$ maximum at 25°C .

For Complete Engineering Data Write Dept. EI, or Phone (201) 464-9300

NYTRONICS

550 Springfield Ave., Berkeley Heights, N. J.

Design Leaders — STANDARD Components to Meet CUSTOM Requirements

Circle 69 on Inquiry Card

121

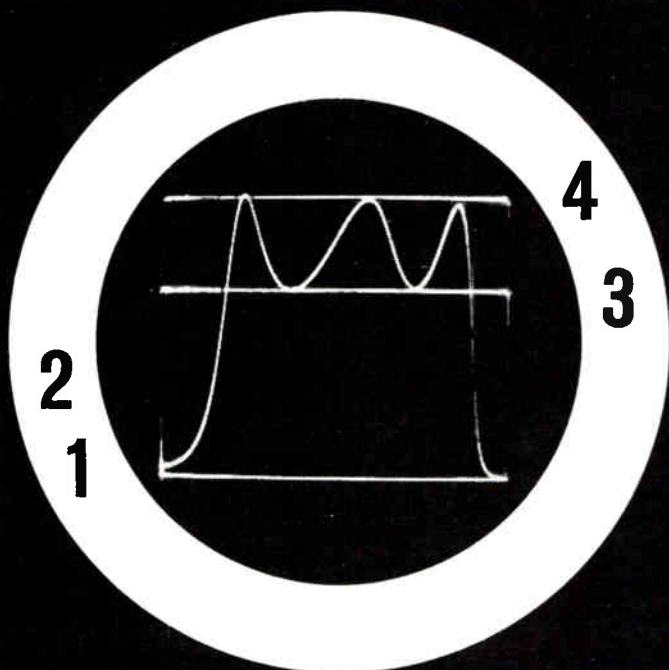

See **4** response traces on your scope

Fast,
accurate
measurements
by
comparison
up to
1,200 mc



New Jerrold 3-Position Coaxial Switcher Model TC-3

\$295⁰⁰

The new Jerrold Solid-State 3-position coaxial switcher turns any single-trace oscilloscope into a 4-trace scope, letting you insert two reference traces automatically in addition to the test trace and baseline. These reference traces have the distinct advantage of permanent relative accuracy over hand-scribed or painted reference lines.

Results are repeatable, and as accurate as the reference attenuators. Generator and scope drift do not affect the accuracy of the measurements. The wide frequency range from dc to 1,200 mc extends the usefulness of the comparison technique well into the UHF band. At only \$295, the TC-3 Coaxial Switcher can save you thousands of dollars in speed and accuracy of laboratory and production rf measurements.

Jerrold also offers the sweep generators, attenuators, and other equipment needed for fast, accurate measurement of loss, gain, and VSWR. Write for literature.



Industrial Products Division, Philadelphia, Pa. 19132
In Canada: Jerrold Electronics, 60 Wingold Ave., Toronto 19, Ont.
Export: Rocke International, 13 E. 40th St., New York, N. Y. 10016

SWEEPGENERATORS • PRECISION ATTENUATORS • AMPLIFIERS • COMPARATORS

Circle 70 on Inquiry Card

EIA CONSOLIDATES IN NEW WASHINGTON BUILDING

Electronic Industries Association has moved into its new nine-story building at 2001 "I" St., N.W., Washington, D.C. The Engineering Department, once based in New York, and the Newark (N.J.) Type Registration Office have joined the other departments in D.C.

Staff operations for the seven product division and five service departments of the 42-year-old trade association for electronics manufacturers are housed in one location for the first time since the late 1930's. The West Coast representative will remain in Hollywood.

EIA's new mailing address is 2001 Eye St., N.W., Washington, D.C. 20006; new switchboard number, area code 202, 659-2200.

SATURN I-B WILL USE SOLID-STATE TELEMETRY

The initial flight of the Saturn I-B early next year will mark the "first vehicle on which all telemetry transmitters are solid state devices," reports Electronic Communications, Inc.

The Douglas S-IVB second stage will be equipped with ECI Model 503 VHF, FM solid state transmitters now in quantity production. The units were designed with a special FM modulator to assure that the stability requirement of 0.005% is met. The system has a modulation frequency response from dc to 200 kc.

The transmitter operates directly from the craft's 28-volt source, eliminating need for an external supply and a dc-dc converter. The units accommodate SS/FM, PAM/FM/PCM/FM and FM/FM inputs and deliver 3 watts of r-f power on any fixed frequency in the 216 to 260 mc range.

AUDIO-VISORY NURSE CALL FOR PATIENT EMERGENCY

A transistorized "Audio-Visory" Nurse Call system, designed for "effective and instant communications for hospitals at low cost," was disclosed by Motorola. Patient stations are solid state, no relays are used and equipment is expected to be almost maintenance free, reports Motorola.

Another highlight of the system is the attractively styled nurse master station, which not only provides instant visual indication of the calling room, but also classifies the call according to urgency.

SHIPBOARD RADAR SIMULATOR SOLID-STATE, COMPACT

A marine radar simulator for training on board ship has been developed by Solaratron's Military Systems and Simulation Division. The equipment is small, fully transistorized, and suitable for bulkhead mounting on merchant or navy vessels.

It will provide training in anti-collision problems and ship, helicopter or aircraft direction, according to the firm, of Farnborough, England. The simulator can be fitted without the need to modify the ship's radar equipment, and can be completely isolated from live radar.

The equipment can feed any ship's live radar displays with up to four simulated radar echoes, each of which is controllable with respect to course and speed.

HIGH RADIATION SOURCE FOR LASER PUMPING

A high-intensity radiation device has been developed by Union Carbide Corporation's Linde Division. Designated the vortex-stabilized arc radiation source, the device is reported usable and important in continuous laser pumping, solar simulation, high-speed melting of exotic materials, and hyper-velocity re-entry simulation.

Tests of the arc device have shown it to be a more intense continuous radiation source than carbon-, mercury-, or xenon-arc lamps. The device has produced a radiance of 7200 watts/cm² steradian, using argon.

As a heat source, the vortex-stabilized arc also has shown good performance. A radiation flux at the surface of the arc column of 22,000 watts/cm² has been achieved.

THREE-COLOR CRT DISPLAY FOR NUCLEAR REACTOR

A three-color cathode-ray tube alphanumeric display for a data processing and control system for a computer-controlled nuclear reactor will be supplied by the Industrial Products Div. of IT&T.

The division is producing the high-speed three-color display system for Astrodata, Inc., Anaheim, Calif., prime contractor to the Atomic Energy Commission for the computer-controlled system.

The display equipment includes an alphanumeric character generator and a model KM-906, 19-inch high-speed three-color Computer-Scope.

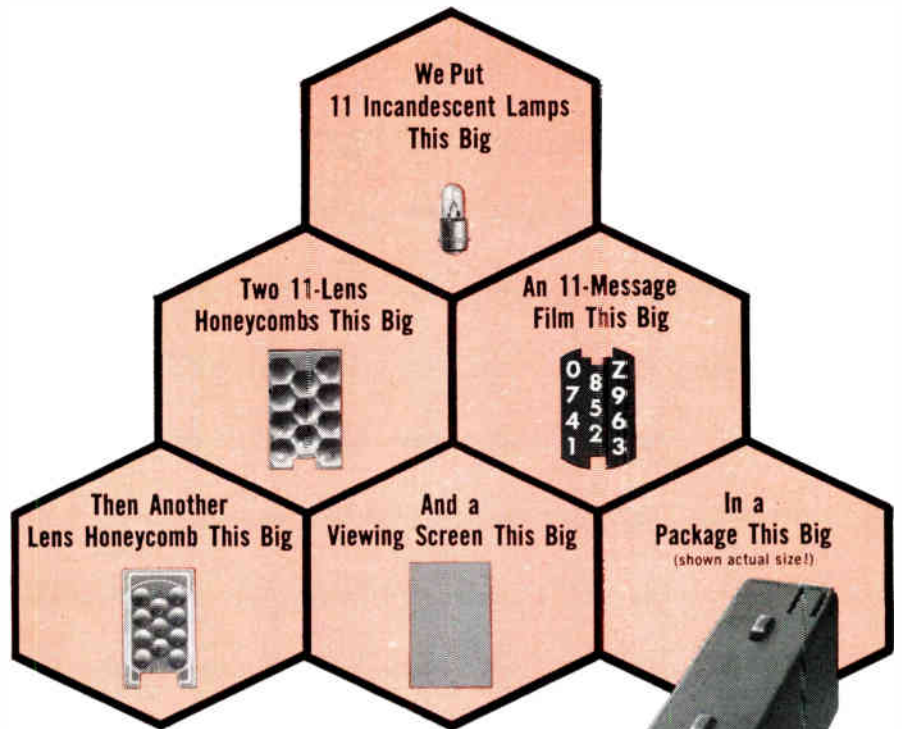

Now, You Have the Smallest Rear-Projection Readout in the World!

It Displays Characters This Big.

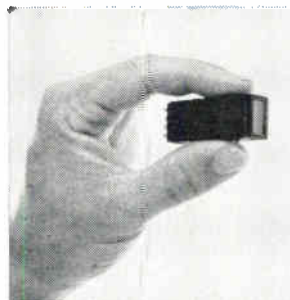

All the versatility, readability, and reliability of our patented rear-projection readouts are now available in the world's tiniest theatre: the $\frac{3}{4}$ " H x $\frac{1}{2}$ " W IEE Series 340. We've managed to fit everything but a projectionist in there to give you a choice and clarity of message that no other type of readout can match—regardless of size!

The tiny 340 uses film to project any message: numbers, letters, words, symbols, colors. *Anything* you can put on film! You're not limited to crudely formed characters that look strange to the eye. Choose type styles that human-factors tests prove to be most readable!

Your message appears clearly and sharply on a single-plane screen. There's no visual hash or camouflage-netting effect from unlit filaments. The 340 may be tiny, but your message appears *big*, up to an easily read $\frac{3}{8}$ " in height!



HERE'S HOW IT WORKS:

All IEE readouts are passive, nonmechanical devices built for long life. An input signal through the proper contact illuminates the desired lamp, projecting only the selected message through the lenses onto a non-glare viewing screen. This one-lamp-per-message concept eliminates character misreadings caused by partial failures.

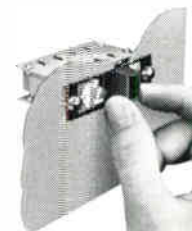

**CLICK, IT'S IN
CLICK, IT'S OUT!**

For quick, easy lamp replacement or change of message, just press the front of the 340, pull the whole unit out! Permanently wired base remains in assembly!



SEND TODAY FOR COMPLETE INFORMATION

INDUSTRIAL ELECTRONICS ENGINEERS, INC.

7720 LEMONA AVE. • VAN NUYS, CALIFORNIA • PHONE: (213) 787-0311 • TWX (213) 781-8115
REPRESENTATIVES IN PRINCIPAL CITIES

EDITOR'S NOTEBOOK

TWO DEVICES—a computer and an optical reader—are assuring personnel of Roberts Dairy Company, Omaha, Neb., prompt and accurate handling of dairy orders. Daily, retail and wholesale salesmen inscribe orders on prepared forms with lead pencil. An IBM 1231 optical reading device scans the forms and transfers data from 1,200 sheets per hour directly into an IBM computer for processing.

AUTO ANTENNA that “performs efficiently at broadcast frequencies as well as 27 MC on CB” has been developed by Webster Manufacturing, South San Francisco, Calif. The antenna has an encapsulated top-loading coil to achieve one-quarter wavelength resonance for operation of a CB transceiver. Webster says there is no degradation when it is used for the entertainment radio.

AUTOMATION will certainly not retire “The Coldstream Guards” or even join Her Majesty’s household regiments as a regular unit, the guardsmen would have it known. It’s just that a closed-circuit TV system by EMI Electronics Ltd. (Hayes, Middlesex) was used to keep watch over priceless objects during 150th anniversary of the Battle of Waterloo, at London’s Wellington Barracks. It was a bit of a help while the sergeant-major stepped down for a pint, you know?

ELECTRONIC SIRENS have a new champion in Motorola. A combination siren and public address vehicle warning system offers all the advantages of mechanical operation without age-old mechanical problems, according to Motorola. The transistorized audio amplifier is capable of producing a variety of warning sounds and public address functions. The system boasts 100 w of siren output power and 45 w of public address output power when used with two speakers.

LEAK DETECTOR—A portable mass spectrometer-type unit developed by Mikros Division of Varian Assoc., detects one part of helium in 10 million parts of air, can be attached to any basic vacuum system for spot leak detection. The assembly is comprised of a gun-electrometer optics module in stainless steel housing and a portable solid state electronics module containing the power supply and all controls.

EDP SYSTEM will eventually help eliminate the “out of stock” phrase at Harry S. Manchester Inc., Madison, Wis., department store. Company officers said that with its shiny new IBM System/360 Model 20 the “company will be a pioneer in the use of computers by department stores of this size. We expect our operation to be a model for other stores in our class.”

ZOOM LENSES, which allow photographers to shift easily from telephoto views to wide angle photos, will be designed automatically for Bell & Howell Cameras by an SDS 930, Scientific

Data Systems announced. The computer will be used to solve complex math formulas needed in design of both zoom and fixed focal length lenses.

DIGITAL PLOTTER is being used to proof-read material in minutes that still requires man 20 hours to complete, California Computer Products Inc. reports. The system is currently being used to check accuracy of control tapes for automated machine tools in experiments at IIT Research Institute in Chicago. An error in the tape shows up as a bulge on otherwise smooth lines. The tape holds 240 pages of numbers.



BOOKS

Microwave Tube Characteristics Tabulation, 14th Ed.

Published 1965 by D.A.T.A. Inc., Box 46, Orange, N. J. 07050. Price \$18.50 in the U. S. and Canada or \$20.50 elsewhere.

Tabulation covers technical characteristics of the commercial microwave tube lines of 48 U.S. and overseas manufacturers. Types covered include Backward Wave Tubes, Helitrons, Klystrons, Magnetrons, Platinotrons, and Traveling Wave Tubes.

Semiconductor Junctions and Devices

W. B. Burford III and H. G. Verner. Published 1965 by McGraw-Hill Book Co., 330 West 42nd St., New York, N.Y. 10036. Price \$12.00. 328 pages.

Book provides a simplified, self-study approach to important aspects of transistor operation, the Fermi energy and black box concepts and use of Esaki and other single junction diodes.

The engineer will gain practical pointers on how to form a planar junction . . . what relationship equilibrium currents have to p-n junction . . . whether a device is reliable . . . and how junctions behave under external bias. References and indexes enable ready access to answers for these and other important questions.

Microwave Tube Characteristics Networks and Telephone Traffic

V. E. Benes. Published 1965 by Academic Press Inc., 111 Fifth Ave., New York, N.Y. 10003. Price \$12.00. 319 pages.

Book is a systematic study of the combinatorial nature of communications networks, and of the traffic in them. Three kinds of traffic theory problems are considered: combinatorial problems of network design, probabilistic problems of traffic analysis (encompassing statistical problems of traffic measurement and analytical problems of calculation of the grade of service), and variational problems of routing traffic in networks. Emphasis is on basic concepts rather than engineering formulas, but practical problems always motivate the choices of topics.

ASTM Standards, Part 29: Electrical Insulating Materials

By ASTM. Published 1965 by the American Society for Testing and Materials, 1916 Race St., Phila., Pa. 19103. Price \$19.00; to members \$13.30. 1104 pages.

This book is one part of the 1965 Book of ASTM Standards which is comprised of 32 parts. It is issued annually. It contains all current formally approved ASTM standard and tentative specifications, methods of test, recommended practices, and definitions, as well as certain other related materials, such as proposed methods. Each part contains all actions accepted at the Annual Meeting preceding the issue date. All other actions accepted by the Society at least six months before the issue date are also included.

Modern Science and Technology

Edited by Robert Colborn. Published 1965 by D. Van Nostrand Co., Inc., 120 Alexander St., Princeton, N.J. Price \$22.50. 750 pages.

Scope of this book ranges from such articles as the abstract, theoretical "Dynamics of Space-Time" and "Gravity Experiments" to accounts of industrial practice such as "Non-traditional Machining" which reports on current advances in metalworking. Book contains material on such wide ranging topics as lasers, atomic absorption, traffic control, nuclear power, food processing by nuclear radiation; the chemistry of silicon and fluorine; rockets and boosters; international communication by satellite; learning machines and computers; reliability and quality control; and oceanographic studies.

Books Received

Photometry, 3rd Ed.

By John W. T. Walsh. Published 1965 by Dover Publications, Inc., 180 Varick St., New York, N.Y. 10014. Price \$3.00. 544 pages, paperback.

This Dover edition is an unabridged and unaltered republication of the third edition published by Constable and Company in 1958.

2-Way Mobile Radio Handbook, Revised Edition

By Jack Helmi. Published 1964 by Howard W. Sams & Co., Inc., 4300 West 62nd St., Indianapolis 6, Ind. Price \$3.95. 223 pages, paperback.

Compatible insulations that fit together for highest reliability

You can be confident of complete system dependability when you choose compatible 3M insulating products. For these products were developed from identical or related chemistry to work with and complement each other when combined in a single system. They help you realize the full potential from your electrical equipment by reducing the risk of failure due to use of incompatible materials. Whatever your need—tape, tubings, slot-linings, or resins—3M's compatible insulations assure maximum dependability. For more information, see your 3M "IQ" Man*.

 "IQ" means Insulation Qualified. Your 3M Man is trained and qualified to advise and assist with insulation problems. Call him or write: 3M Co., St. Paul, Minn. 55119

Electrical Products Division 

TAPES • RESINS • TUBINGS • VARNISHES • COATED FABRICS • LAMINATES • MICA PRODUCTS

Circle 72 on Inquiry Card

ELECTRONIC INDUSTRIES • November 1965

Profit By America's Broadest Stock of Standard Magnetic Lamination Dies

LET **HOWCOR**
TOOLING SAVE YOU
TIME AND MONEY

Whatever the application, the chances are you will find in HOWCOR-owned dies a size and type exactly suited to your needs. Reduces your lamination costs, speeds delivery of quality-controlled HOWCOR laminations. For proof, consult our new catalog, mailed on receipt of the coupon below.

Please send us the catalogs checked:

- HOWCOR Motor Lamination Catalog
- HOWCOR Transformer Lamination Catalog



NAME _____

ADDRESS _____

CITY _____ STATE _____ ZIP _____

HOWCOR
LAMINATIONS
A Division of Howard Industries, Inc.
3912 McLean Ave., Chicago, Illinois 60647

Circle 73 on Inquiry Card

PHONE CIRCUITRY



Components and circuit board of new "Trim-line" telephone receiver, designed by Henry Dreyfuss, and being made by Western Electric for the Bell System. Dial, recall button, receiver and transmitter are in the handset, doing away with need to reach for standard base to dial. Printed circuitry and miniaturization permit handset to weigh only 12 oz. Set will be available at some extra charge by 1967.

NARROW BAND SYSTEM CUTS COST IN TV SENDING

A new technique for television developed by a New York engineer permits pictures to be transmitted over ordinary telephone lines instead of coaxial cable.

The engineer, George J. Doundoulakis, reports that his method can be a source of great savings in television. He estimates the reduction in closed-circuit line charges at 95%. According to the inventor, the system, which he calls Sonic Vee, economizes on microwave frequencies by velocity scanning. The engineer says his narrow bandwidth method can transmit a picture with high definition using 30kc rather than the usual 4.5mc. A telephone line uses 3,500 cycles, so nine telephone lines would be enough.

Mr. Doundoulakis asserts that Sonic Vee also has FM uses. FM stations may be able to send TV pictures over part of the extra radio channel that they now use, apart from their regular broadcasts, to provide music for restaurants and other clients.

The inventor, and his associate, Ira Kamen, also say that the narrow bandwidth will reduce costs of home recording and playback equipment. They predict inexpensive libraries of plays on tape.

WATER-COOLED LASER

A new water-cooled laser unit (6-868) that delivers up to 125 joules, more than 50 joules four times a minute, has been introduced by Maser Optics, Inc. Laser head uses a split, hinged, quick-opening, dual-elliptical, highly-polished, silver-plated cavity.

DESIGNER NEEDS SOLVED...

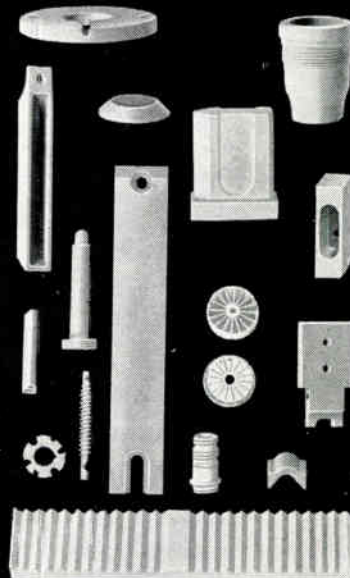

DIAMONITE® HIGH ALUMINA CERAMICS

Diamonite—extremely versatile. Forms a myriad of shapes requiring ■ electrical insulation ■ low dielectric loss ■ high heat resistance ■ thermal conductivity ■ hardness ■ wear resistance ■ chemical inertness or ■ high mechanical strength. ■ It readily metalizes for brazed assemblies or vacuum seals.

DIAMONITE CAN BE YOUR SOLUTION

Send for "Ceramics in Product Design" Brochure Today



DIAMONITE
PRODUCTS MFG. CO. SHREVE, OHIO 44676
Div. of U.S. Ceramic Tile Co.

Circle 68 on Inquiry Card

ELECTRONIC INDUSTRIES • November 1965

LASERS FOR THE MASSES



Lasers are moving into the science classroom, low-budget industrial and biological research, and even the home workshop. An inexpensive, less precision ruby rod has been developed by United Electronics Laboratories, Louisville, Ky. UEL claims the rods are of the same Cr concentration and crystallographic orientation as those now used in large research laboratories. They are offered in two sizes and with instructions for assembling equipment.

WORLD-WIDE CONTROLS SEEN FOR CHEMICAL PROCESSING

Petroleum and chemical companies with plants throughout the world are expected to develop world-wide systems using satellites to control refineries and continuous process units.

This projection is the result of a recent study on "Developments in Advanced Process Control Systems" by The Diebold Group, Inc. The study was made for a group of petroleum and chemical companies.

Projected findings show that petroleum and chemical industries are within ten years of seeing computer-based systems automatically adjust valve positions and start or stop pumps throughout the world. The decision or plan would be produced at one central location.

EDP TO ALERT DOCTORS ON PATIENTS' CONDITIONS

A computer-based electronic "early warning system" to alert physicians in surgery on swift and subtle physiological changes in a patient's condition is being developed for Presbyterian Medical Center in San Francisco.

The Institute of Medical Sciences, research affiliate of the center, and IBM Corp., in the joint study, report that the major engineering problem is to select reliable sensing systems which will produce maximal physiological data with little or no interference to the patient's comfort.

Dr. Herbert D. Steinbeck, IBM's life science team manager, said that the patient monitoring system will use a standard IBM 1800 computer which is to be installed at the medical center.

SCIENTISTS FIND TECHNIQUE FOR NEW MAGNETIC ALLOYS

Scientists of IBM Corp. have developed fabrication techniques which may be used to create entirely new magnetic alloys which would otherwise be impossible to mix, according to IBM spokesmen.

Using a special vapor-deposition technique, Drs. Arthur S. Nowick and Siegfried R. Mader have produced magnetic films of cobalt-gold alloys with compositions from 25% to 60% gold. Normally, gold and cobalt mix only slightly.

Scientists say the deposition technique can be used to extend the known range of magnetic alloys. Magnetic films produced by the process can be either amorphous or metastable crystalline. All films produced to date are stable, even above room temperature.

The cobalt-gold alloy is ferromagnetic even when amorphous. Amorphous alloys have a low coercive force, and it may be possible to create amorphous films with less coercive force than that of crystalline alloys.

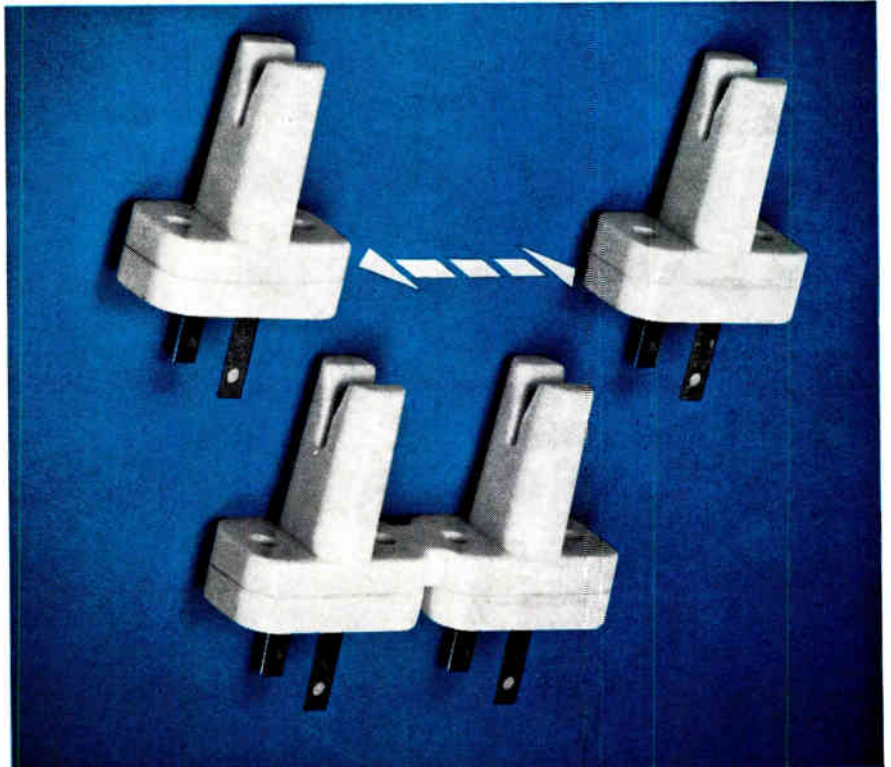

NEW! FROM TEXTOOL... SOCKETS FOR ALL AXIAL LEAD COMPONENTS!

- Fixed or variable contact center distance.
- Low profile, Kelvin contact.
- Greater component density.
- Accommodates leads up to .030 diameter.
- Spring configuration locks lead in position.
- Gold plated, heat treated beryllium-copper contacts.

SOCKET SPECIFICATIONS

SOCKET NO.	MATERIAL	CONTACT CENTER DISTANCE	TEMP.	COLOR
22-000-080M	Delrin	From .730	100°C	White
22-000-080M	Polypropylene	From .730	125°C	Green
22-000-081M	Delrin	.800(FIXED)	100°C	White
22-000-081M	Polypropylene	.800(FIXED)	125°C	Green

For complete data and prices for our entire socket line contact:

TEXTOOL PRODUCTS INC.

1410 Pioneer Drive
Irving, Texas

Dallas:
ME 1-5585

Irving:
BL 3-9296



**SPRAY
COATER
ORGANICALLY
FINISHES
ELECTRONIC
and
ELECTRICAL
COMPONENTS**
having axial leads (such
as capacitors, fuses and
resistors), at rates of up to
**12,000
PER HOUR**

The completely automatic, remote masking C/M Model HD-3 applies a solvent and abrasion-resistant clear coating that protects color coding and labeling, or a light-tight seal for silicon diodes. Coating is confined to desired area while racks, loaded with diodes move continuously through spray station. The diodes, while in the racks, are spun so as to assure an even coating and remain in the racks for both spraying and baking operations.

Also inquire about the C/M Model PR-1 automatic powdered resin coating machine, the C/M Model TL-1 automatic tray loading machine, and the C/M Model ML-1 magazine loader.

SEND FOR LITERATURE

Conforming Matrix
CORPORATION

839 NEW YORK AVENUE
TOLEDO 11, OHIO



Circle 75 on Inquiry Card

READY, AIM, TALK!



Space talk by light beam will be tested early in 1966 between Gemini 7 and ground stations. Gail Wedgwood sights through optical telescope of RCA laser transmitter, similar to one to be tried on Gemini 7. NASA has scheduled the laser talk experiment during a proposed 14-day orbit.

**RR REVIVAL IS
POSSIBLE WITH EDP**

Combined computer-based communications network and advances in information technology will permit railroads to retrieve, in the 1970's the freight business which they have lost to trucks, waterways, air and pipelines. This is based on a conclusion by The Diebold Research Program.

The Diebold Research Program study postulates a new concept for the control of rail freight operations which currently depend upon bill of lading and waybill data. If this proposed data system were installed in the 1970's, car use could be improved from 20% to 50%; improvement would increase revenue from \$10 to \$20 million annually for every 10,000 freight cars owned, Diebold reports.

System-wide freight operations will be controlled at a central headquarters by 1975. The network will depend upon recent developments in data input devices. By providing centralized car inventory and distribution, shippers can expect at least a 25% improvement in speed of receiving an empty car.

15" COLOR TUBE LOOMS

The Radio Corporation of America announced plans to produce early next year 15 in. rectangular color CRTs for lightweight portable receivers. The 15-inch tube will provide an ideal combination of weight and size that can be carried around but still have a large enough screen for comfortable group viewing.

FREE! NEW!

**NEWARK
1966 INDUSTRIAL
ELECTRONICS
CATALOG
LISTING**

over 1000

TEXAS INSTRUMENTS



Semiconductors

including the new

"SILECT"® TRANSISTORS



These economically-priced silicon transistors are designed for consumer and industrial applications.

They are packaged in silicone plastic that will not burn or deform at soldering temperatures and is naturally opaque. Sample lots have been tested to the moisture resistance requirements of MIL-STD-202B, method 106A, with no failures.

"SILECT" Transistor series currently available include high frequency (NPN), medium-power (NPN), low-noise, low-level (NPN), unijunctions and PNP transistors.

- Immediate Delivery from Stock
- Factory OEM Prices

NEWARK CATALOG 85

- Industry's Most Complete Catalog
- 660 Pages • Over 70,000 items
- Over 600 Standard Brand Lines
- Seven Stocking Warehouses
- Over \$6,000,000 Industrial Electronics Inventory

NEWARK ELECTRONICS CORPORATION

Main office and warehouse • Dept. EI
223 West Madison • Chicago, Ill. 60606

Authorized Texas Instruments
Warehouses in:

CHICAGO, ILL.
(312) ST 2-2944

CINCINNATI, OHIO
(513) 421-5282

DENVER, COLORADO
(303) 757-3351

DETROIT, MICHIGAN
(313) 548-0250

GRAND RAPIDS, MICHIGAN
(616) 452-1411

LOS ANGELES AREA
(213) OR 8-0441

Other Newark Warehouses in:

NEW YORK CITY
(212) 255-4600

Circle 76 on Inquiry Card

GERMANIUM TUNNEL DIODES MASS PRODUCED

The microwave germanium tunnel diode, long known for its delicate nature, is now being mass produced by Sylvania. The batched-produced units are so rugged they can be assembled directly into hybrid thin-film integrated circuits.

A new manufacturing technique, which allows up to 3000 passivated devices on one wafer, is the key to the device's ruggedness. In manufacture, an oxide protection is applied to cover all of the diodes on the surface of each slice. The contacts then are placed over the oxide. No external supports are needed. This is due to a thin-film technology which allows the fabrication of passive components on the units while in slice form. The diodes are completely ruggedized and provide long-term stability of characteristics. Due to the new manufacturing process, they have lower series resistances than standard tunnel diodes. Resistive cutoff frequencies greater than 50Gc have been obtained.

The new series, designated D-5360, D-5560, and D-5570, withstand repeated temperature cycles from cryogenic to +100°C. They exceed MIL-STD 750 mechanical stress testing of 1500 G shock, 20 G vibration, 20,000 G centrifuge.

NEW PHONE PUTS DIAL IN PALM OF HAND

It used to be that a circuit was designed and components were chosen to fit the circuit. Then, the package was designed to contain the circuit. And, now? Turnabout.

Henry Dreyfuss, noted designer, came up with his small "Trimline" receiver for Bell Telephone. Object was an exterior package that would appeal to the user. All circuitry, except the bell, is in the handpiece, including the dial.

And now the engineers' problem: design a curved palm-sized circuit package to fit the "Trimline" receiver (which can be dialed either seated or reclining). The need was for flexible printed circuits and miniaturization. Tiny components were designed to fit the space.

There are no integrated circuits for this device as yet, but its only a matter of time. The next version of this receiver will be the push-button model to replace the dial in the future.

Now — the most adaptable, reliable

DATALITE[®]

SYSTEM OF INDICATION

For computers, data processing,
and other readout applications

39-6-1471 (a)

7538 W/39-6-1471 (b)

257-7558-1631 (c)

250-7538-1471 (d)

249-7840-931 (e)

Build your light indicators with a system—the DATALITE system. Here's how: Choose a "Datalamp" Cartridge (a) and combine it with a "Datalamp Holder" (b); or use a screw-on "Data Cap" with a rotatable readout lens (c, d)...For multi-indications, "Datalamp" Cartridges may be mounted on a "Data Strip" or "Data Matrix" in any required configuration.

"Datalamp" Holders accommodate DIALCO's own plug-in ultra-miniature Neon or Incandescent "Datalamp" Cartridges. Complete assembly mounts in 3/8" clearance hole. Also available with permanent (not replaceable) Neon lamps (e). Legends may be hot-stamped on cylindrical lenses. Styles shown here are only typical components in the extensive DATALITE system of light indication.

SAMPLES ON REQUEST—AT ONCE—NO CHARGE.
For complete data, request current Catalog.
(Illus. approx. actual size)

Foremost Manufacturer of Indicator Lights

DIALIGHT CORPORATION

60 STEWART AVENUE, BROOKLYN, N.Y. 11237 212 HYACINTH 7-7600

Circle 77 on Inquiry Card

COMPLETE LINE OF SOLID-STATE COUNTERS... AS LOW AS \$395!!!!

There is no need for an instrument, which functions as a counter, to cost thousands of dollars. Anadex manufactures a pre-set counter for \$395. If your interest is counting and you're tired of paying for unnecessary functions, Anadex has the instrument for you... You can count on it! Send for counter Catalog 4563.

... THE NAME YOU CAN COUNT ON

7833 HASKELL AVENUE, VAN NUYS, CALIFORNIA ■ PHONE 213-873-6620. TWX 213-781-6811

Circle 78 on Inquiry Card

These P&B relays are immediately available at factory prices from your electronic parts distributor



CD-38

SOLID STATE TIME DELAY—You get excellent timing characteristics in these knob-adjustable solid state relays. Timing range: 0.6 to 60 seconds. AC or DC models. Internal DPDT relay rated at 10 amperes, 115V AC resistive. For continuous duty over temperature range of -40°C to $+55^{\circ}\text{C}$.



KHP

COMPACT FOUR-POLE RELAY—Small, rugged 4PDT relay designed to meet exacting requirements of data processing, computer and process control applications. Rated at 3 amperes at 30V DC or 115V AC resistive. Solder terminals. Special sockets have printed circuit or solder lug terminals. Also available hermetically sealed.

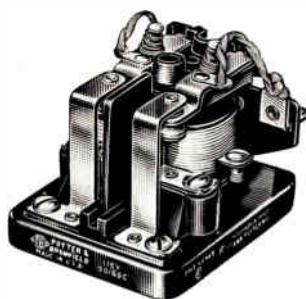

PR

POPULAR 25 AMPERE POWER RELAY—Compact, heavy-duty power relay listed by U/L and CSA. Screw terminals and rugged construction suitable for industrial application requiring reliability and long life. AC or DC models.



GM

VERSATILE IMPULSE/SEQUENCING RELAY—Unusual single-coil relay can be used to latch, step, count and switch in sequence. Switching occurs during drop-out for greater reliability. AC or DC models. Contacts rated for 3 amperes. Can also be furnished with uni-directional printed circuit boards having 10 or 12 switch positions.



KR3-H

SMALL RELAY SWITCHES 20 AMPERES—Three KR3-H relays will fit in space required for most other 20-ampere relays. Mechanical life exceeds one million operations and twin contacts are rated at 20 amperes at 115V AC, 60 cycles resistive or 28V DC, 1 HP 115/230V 60 cycles. Contact terminals will accept $\frac{1}{4}$ " quick-connects or solder connections. Contact arrangement: SPST-NO-DB.

...and there are 60 other types to choose from!

Chances are, you'll save both time and money when you order standard P&B relays from an authorized distributor. You'll get speedy service at factory prices. Your P&B distributor has available more than

60 basic relay types totalling 627 coil voltages and contact arrangements. All are shown in our new Stock Catalog 100 . . . free from your electronic parts distributor. Ask for a personal copy today.



POTTER & BRUMFIELD

Division of American Machine & Foundry Company, Princeton, Indiana
Export: AMF International, 261 Madison Avenue, New York, N.Y.

Reporting late developments affecting the employment picture in the Electronic Industries

ACADEMY OF SCIENCE SPAWNS ACADEMY OF ENGINEERING

To cope with increasing engineering problems faced by the U. S. Government, a National Academy of Engineering (NAE) was established in 1965, thereby strengthening the role of the engineer in our society.

The National Academy of Sciences, founded during the Civil War, has been major advisor to Government on scientific matters. During World War I, the National Research Council was set up to carry out major government research projects. After World War II, it came to light that more than half of the projects administered by the NRC were actually engineering in nature. The Congressional charter for the NAS covers the NAE as well.

Membership in the Academy of Engineering will be based largely on pioneering accomplishments in a new field of technology or contributions to engineering theory and practice, with processes or finished products as important as publications.

Currently, membership includes the 25 members of the founding committee plus about 20 recently admitted. The roster is expected to swell to 300 or more within several years.

N. J. R&D COUNCIL SEEKS TO UP-GRADE TECHNICIANS

Following a successful conference on curricula for and training of technicians, the New Jersey Council for Research and Development will soon release a report laying the groundwork for education-industry programs to enhance the supply of technicians in the state.

New Jersey, which reportedly accounts for 10% of the nation's R & D dollars, faces a growing shortage of scientists, engineers, and technicians, according to a Council survey.

The report will emphasize the need for technicians ready to go to work at the end of two years college-level training, curricula recommended by conferees, and the need for industry to "upgrade the image" of technicians so parents and students alike will view such a career as desirable.

INDUSTRIAL CHEMISTS SEE BLACKBOARD 250 MILES AWAY

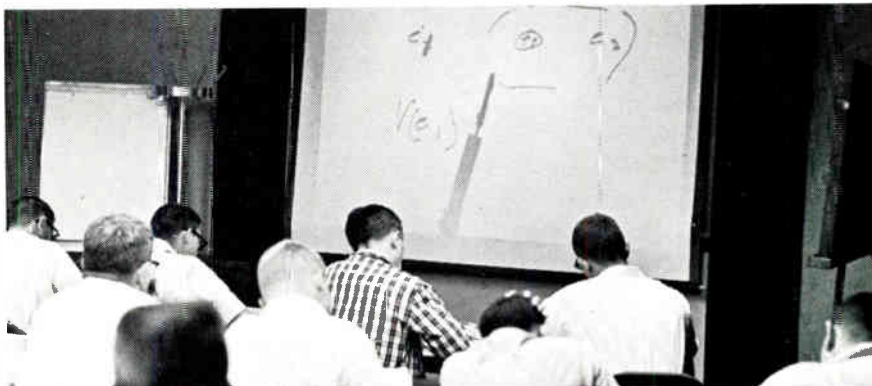

Texas A&M University is now conducting graduate-level chemistry courses by telephone for industrial chemists at Corpus Christi and Freeport over a GT&E communications system which transmits written data through conventional telephone circuits for visual display.

DEMAND FOR TECHNICAL HELP SEEN RISING THROUGH 1970

A climate of continuing demand for engineers, scientists and other professional technical people may possibly extend through 1970, predicts Deutsch & Shea, Inc.

The prediction is based in part upon an analysis of demand for technical help during the past five years, as measured by the Engineer/Scientists Demand Index maintained by the New York firm that specializes in the technical manpower field.

During the past five years demand for technical persons has fluctuated widely. The Index, based on 1961 as 100.0, has ranged from a low of 65.2 to a high of 153.7. These extremes, however, cancelled themselves out in the long run and the 60-month average for the Index has been 101.2.

This indicates that, although the extent of the demand for technical people varied during the past five years, there has been a considerable market for their services during that period.

The past 12 months have seen a new pattern of demand emerging; a slow, steady upswing in recruiting activities. This contrasts with past years when upturns have been abrupt and quickly

followed by downtrends in demand. This suggests a growing market for the services of engineers and scientists in the immediate future.

For long-range, vast national investments in R&D during the past few years should result in the growth of new technologies, and the start of many planned activities. All of these activities will result in increased demands for technical manpower from now through 1970.

DATA CLEARINGHOUSE BEGINS INTERNSHIP PROGRAM

Recent science and engineering graduates, documentalists, and science librarians are acquiring first-hand knowledge and work experience in operating the Commerce Department's Clearinghouse for Federal Scientific and Technical Information.

Many graduates are now in a one-year internship to learn modern methods used by the Clearinghouse in handling large volumes of scientific and technical data. According to Bernard M. Fry, Clearinghouse director, the program is designed to offer a unique and challenging experience for young documentalists of high potential.

The program will train the intern, reports Mr. Fry, by giving him a broad-based work experience upon which he may build a career in science documentation and information handling if he wishes.

FOR MORE INFORMATION . . . on opportunities described in this section fill out the convenient resume form, page 134.

Microwave installation serving Alaskan RR System (Motorola).



Market for Microwave Components

SHIFTING MICROWAVE MARKETS have been undergoing several stages. Defense slashbacks began in 1963. Consolidation of markets and companies that started in 1963-64 is still continuing. At the same time, defense-aerospace-industrial markets keep improving.

Microwave markets were created—and depressed—by defense operations. The market that had grown like topsy for years—suddenly fell flat. When the bottom fell out of the estimated \$1.5 to \$2 billion government microwave market, the \$200 to \$250 million industrial markets obviously could not take up the slack.

In retrospect, the setback suffered by certain defense microwave companies in 1963-64 only *seemed* greater when contrasted with the sharp growth of defense microwave markets and companies up to the end of 1962. But not all component, equipment or systems contractors were hurt. Though microwave test equipment makers suffered, Hewlett-Packard Co., for example, “significantly increased government sales.”

Microwave companies recently experienced a game of musical chairs. Some were marking time, merging, being acquired, or going bankrupt. Technologies were explored, while defense weapon system programs were stalled, phased-out, or cancelled. Older programs and systems were maintained, retrofitted or refined. In sum, the military turned from being the biggest builder to being the biggest user of microwave systems.

But that corner has been turned. And Wall Street brokers already turned over higher stock prices in anticipation of improved business for firms including: Collins Radio, Raytheon, Microwave Associates, Sanders Associates, Sperry Rand and Varian Associates, among others.

Here are glimpses of microwave markets:

THE DEFENSE MARKET holds the lion's share, with radar constituting 55% to 60% of military microwaves. Phased-array radar is the big white hope. Its main capability is simultaneously tracking ballistic missiles and directing defensive fire. Mechanically-directed antennas are too slow. The phased-array antenna's narrow beam is computer-programmed and electrically-steered for faster operation.

Phased-arrays will be used in the proposed Nike X missile site radar system to help protect wide areas of continental U. S. The Army recently awarded a \$12,405,408 contract to Western Electric (WE), for Nike X *preproduction* engineering and planning. This award enables long range work for a program that might swell into more than \$6 billions!

MP-7 portable microwave equipment can be placed into operation within minutes after being placed at a battle scene (Motorola).



By **SIDNEY FELDMAN**

Associate Editor
ELECTRONIC INDUSTRIES

Microwave market mix continues to shift in emphasis. Events of recent years reduce firms through shake-out, merger or acquisition. Survivors expect bigger market portions because there will be fewer competitors. Biggest market area is still defense radar.

Turns Upward

But such financing depends upon costs of the Vietnam war, the nuclear threat of Communist China, plans for the Department of Defense (DOD) Fiscal Year 1967 budget. Certain scientists claim Nike X may prove unfeasible. Yet tiers of contractors expect work from these WE major subcontractors: Ampex, Douglas Aircraft, General Electric, Martin, Raytheon, and Sperry Rand.

Microwave Associates also points to "increasing use of analogous technology applicable in systems ranging from all-solid-state Air Force radars to satellite antennae." Phased-array components may find growth markets in allied fields, particularly in microwave switches.

Defense markets developing along with radars and

Ralph Bondley, GE Microwave Tubes, observes new high emission cathode that can reach emission densities beyond 10a per sq.cm.

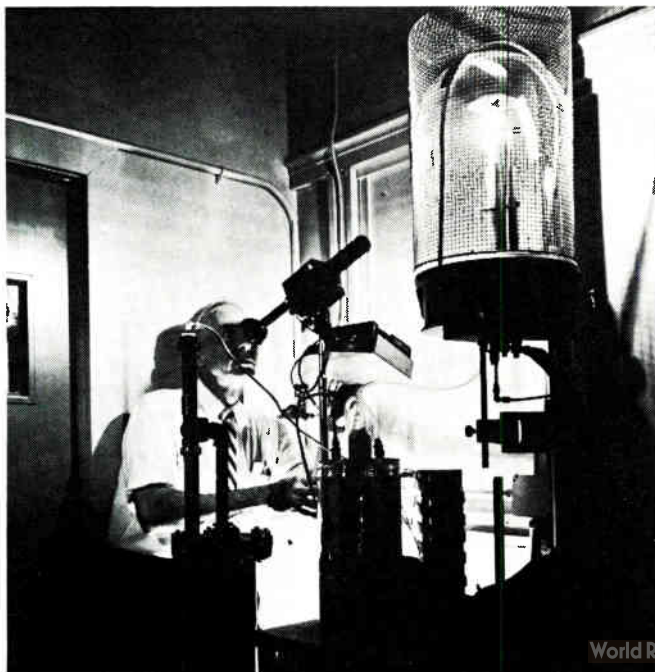

Antenna system, 30-ft. diameter, for Apollo Unified S-Band tracking/communication system built by Collins Radio for Nasa-Goddard.

associated systems for manned fighter aircraft include the F-111, the RF4C reconnaissance aircraft, the new A-7A VAL naval and marine attack plane, the YF-12A reconnaissance bomber. Other aircraft radar markets may be beefed-up with defense operations, ranging from anti-submarine warfare to war in Vietnam.

There will be fewer production items, such as Polaris submarines and Minuteman missiles. Slackened production is expected for ground-to-air and ground-to-ground missiles, depending upon Vietnam. Other missile activities continue for DOD and the North Atlantic Treaty Organization (NATO).

THE AEROSPACE MARKET utilizes microwaves for telemetry, tracking, navigation, communications relay, and radioastronomy ears to detect radio energy sources from outer space. This still relatively small market of several million dollars at times generates more publicity than profits. It also enables microwave companies to help advance themselves, along with the state-of-the-art.

Noteworthy areas include:

- National Aeronautic and Space Administration (NASA) has a new, unified S-band microwave system that should enhance aerospace communications and tracking. It was built and installed by Collins Radio for NASA-Goddard. NASA is building a microwave laboratory at its Electronics Research Center, Cambridge, Mass.

- Communications Satellite Corp. (COMSAT) space system utilizes microwaves to compete sharply with foreign government communications monopolies and the American Telephone & Telegraph Co. (AT&T).

- American Broadcasting Co. would decrease dependence upon AT&T and also challenges COMSAT's right as sole operator of U. S. communications satel-

ELECTRONIC INDUSTRIES

Please type or print

Professional Profile

The ELECTRONIC INDUSTRIES Job Resume Form for Electronic Engineers

Name _____ Tel. No. _____
 Street _____
 Address _____ Zone _____
 City _____ State _____

Single Married Citizen Non-Citizen Date of Birth _____
 Will Relocate Yes No. If Yes Another City Another State
 Salary Desired to Change Jobs in present area _____
 Salary Desired to Change Jobs and relocate in another area _____
 Professional Memberships _____

College or University	Major	Degree	Dates

RECENT WORK EXPERIENCE

Company	Div. or Dept.	Title	Dates

SIGNIFICANT EXPERIENCE AND OBJECTIVES

STATE ANY FACTS ABOUT YOURSELF THAT WILL HELP A PROSPECTIVE EMPLOYER EVALUATE YOUR EXPERIENCE AND JOB INTERESTS. INCLUDE SIGNIFICANT ACHIEVEMENTS, PUBLISHED PAPERS, AND CAREER GOALS.

Mail to: ELECTRONIC INDUSTRIES—Professional Profile—56th & Chestnut Sts.—Philadelphia, Pa. 19139. This resume is confidential. A copy will be sent only to those Companies advertising for engineering personnel in this issue, whose number you circle below.

800 801 802 803 804 805 806 807 808 809 810

MICROWAVE INDUSTRY SUMMARY FOR SELECTED PRODUCTS*

PRODUCTS	Dollar Value—Year 1964		
	1st Half	2nd Half	1964 Year
1. Components (Includes (1) ferrite, (2) semiconductor, (3) non-ferrite, non-semiconductor assemblies, and (4) solid state duplexer assemblies)	\$41,427,967	\$45,844,684	\$87,272,651
2. Tubes (Magnetrons, Klystrons, Traveling Wave, Gas Duplexer, and High Vacuum Microwave Tubes)	\$72,164,660	\$63,441,507	\$135,606,167
3. Semiconductor Diodes**	\$5,166,293	\$6,009,087	\$11,175,380
4. GRAND TOTAL	\$118,758,920	\$115,295,278	\$234,054,198
SYSTEMS			
Point-to-Point Systems***	1st Half	2nd Half	1964 Year
Line of Sight Relay above 470 mc; Beyond the Horizon Systems—Scatter, Video Relay above 1,000 MC	\$32,379,318	\$25,597,518	\$57,976,836

* Derived from data obtained from regular manufacturers' reports to the EIA Marketing Services Department on Microwave Components, Microwave Systems, Microwave Tubes, and Microwave Diodes. Data on Microwave Components represents total industry sales; tubes, Diodes and Systems data represents actual company inputs to EIA, with no estimation for non-participating manufacturers.

** Includes mixer diodes, video detectors, varactors, microwave tunnel diodes, and switching diodes (excluding crystal mount) operating above the 1 KMC frequency level.

*** This figure is orders received and therefore will be somewhat different from actual sales for any given time period. It includes Line of Sight Relay Systems above 470 MC, Beyond the Horizon (Scatter) Systems and Video Relay Systems above 1,000 MC sales for the industrial, common carrier, Government, and export markets. "Non-electronic" items (towers, poles, electrical power facilities, switchboards, etc.) are not included.

MICROWAVE MARKET (Continued)

lites. ABC seeks Federal Communications Commission (FCC) authority to build a \$21.5 million synchronous-orbit satellite system.

THE COMMUNICATIONS MARKET also involves educational television and ultra-high-frequency (UHF) television. Solid-state microwave TV transmitters and receivers have been developed as TV relays for broadcasting special events. Microwaves help link TV communications networks in many parts of the world. Overseas, International Telephone and Telegraph Corp. (ITT) created transistorized microwave equipment for prime new links between London and Northern France.

Hard times in defense microwave business were eased by the continuing build-up of domestic telecommunications links. Both AT&T and Western Union (WU) expanded their microwave facilities, aided by defense suppliers. WU inaugurated its coast-to-coast microwave beam relay network (over which this editor spoke briefly).

AT&T broadened its microwave radio relay system which now represents about 50% of the Bell System's total telecommunications switching network. Installations comprise about 1,700 microwave towers that bounce signals along 43,000,000 circuit miles of AT&T's Long Lines Dept. message network. Associated Bell companies use other microwave facilities.

THE INDUSTRIAL MARKET, unlike government markets, requires greater capital investment by microwave equipment makers to stimulate demand. Motorola, long in government and industrial microwave markets, may launch a campaign to broaden sales among public utilities, common carriers, and other industrial customers. Litigation also continues over AT&T's special services and rates that compete with private industrial microwave systems.

Varied promising markets also include air and surface ground control systems; small craft marine radar; civilian aircraft weather radar and altimeters. Quasi-exotic applications include use of microwave power tubes for: cooking and industrial heating; thermionic energy conversion; chemical and food processing; plasma and magnetohydrodynamics power generation, and microwave power transmission.

THE INTERNATIONAL MARKET can be double-edged, since foreign countries offer markets and foreign companies offer competition. Microwave capabilities are available chiefly in England, France, West Germany, Italy, Norway, and Japan.

English and French microwave companies are developing joint radar systems, among other applications. English firms do well in Commonwealth countries. The Japanese and West Germans keep making strides in microwave operations. Yet ITT will install Ground Control Approach Radar Systems for the Royal Nether-

Digital equipment for Apollo Unified S-Band tracking /communications (Collins). Background left is antenna control center.



MICROWAVE MARKET (Concluded)

lands Air Force. And General Telephone & Electronics International built the first microwave system to link two South American countries: Argentina and Uruguay.

Biggest dollar growth comes from Europe, because of its rapidly improving technology in communications and defense electronics.

Successful microwave companies are making advances in technology, as well as in marketing and management. In the technical area there are many frontiers of activity, including:

- Expansion of microwave industry operations is hampered by inadequate measurement capability. Activities here are being conducted by the Microwave Circuit Standards Section of the National Bureau of Standards.

- Electromagnetic compatibility (EMC) is of great import in the design and sales of microwave and other electronic systems. DOD alone may represent about a \$15 million annual market for EMC instruments.

A buyer's market had developed as a result of DOD's tighter grip on its dollars, tighter control on systems and replacement parts, and tightening-up of procurement practices which, in turn, caused companies to tighten-up their operations.

As a result, there has been a series of mergers,

consolidations and some bankruptcies. Eitel-McCullough was merged into Varian Associates. The Micro-line products of Sperry Rand's Microwave Electronics Division were acquired by Narda Microwave. And in some cases both electron tube and solid state electronic components marketing operations were combined. And the end of these consolidations is not in sight. For this, DOD may be both blamed and credited.

Currently, microwave markets are easing-up with expanding operations such as the Nike X. Yet the pressure is on for microwave companies to operate as well in the business office as in the laboratory and on the production floor. One enterprising sales approach is Microwave Associates' integrated marketing program.

A computer monitors about 200 to 250 microwave programs in the development stage, and about 50 programs in the "bid stage," without contract awards. Microwave Associates believes this gathering and analysis of military and industrial information may give it six-to-nine months' lead-time over competitors.

Microwave marketers are being confronted by double jeopardy in the marketplace: government buyers are tough because they're sophisticated, and industrial buyers can be tougher because they are sophisticated about their own needs, but unsophisticated about electronic applications. In the long run, surviving microwave firms expect bigger cuts of the market pie partly because there will be fewer hungry competitors to feed.

TOPS IN KNOBS

EXCLUSIVE
DESIGNS
FROM
STOCK MOLDS



AVAILABLE
ONLY
FROM
ROGAN







Choose from wide variety of knobs that meet requirements of modern industrial development...match progress of military - electronic advancement.



Save tooling costs... get faster deliveries... get details on complete line of Rogan stock molded knobs. Write on business letterhead for new catalog.

ROGAN BROTHERS, INC. 8025 N. Monticello Ave.
Skokie, Illinois 60076

Specializing In Stock Molded Knobs Since 1939

Circle 104 on Inquiry Card

Precise engineering and construction result in

UNIFORM HEAT

throughout the work space

- High velocity recirculating blowers
- Greater heat input
- Adjustable louvres for balanced airflow
- Superior heat seals

All combine to provide excellent temperature uniformity in these rugged cabinet ovens.

30 Standard Models

- Work space from 4.6 to 72.3 cubic feet
- Temperature ranges from 100 to 1250° F.
- Electronic combustion devices insure safety for gas fired models
- Indicating control instrument
- Factory tested

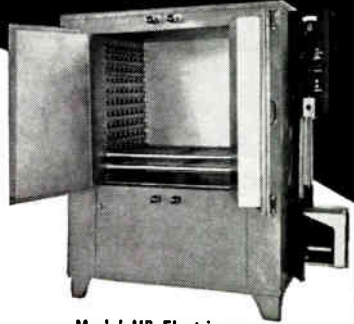

Model HB Electric or Gas Cabinet Oven

Other ovens from \$132.50 up, including a complete line of laboratory, bench, cabinet, walk-in, and custom-built units.

Write for literature to help you select the right oven for your application

Specialists in Heat Process Equipment



GRIEVE-HENDRY CO.

1335 North Elston Avenue, Chicago, Illinois 60622

Circle 110 on Inquiry Card
ELECTRONIC INDUSTRIES • November 1965

ENGINEERS NEED, DESIRE MORE STUDY, SURVEY FINDS

Engineers are finding it tough to keep pace with the swiftly-moving current of knowledge flowing from universities, government and industry.

Some 2000 Pennsylvania engineers, in answer to a survey on continuing education, claim that engineers, need further and continuing study in the basic sciences and mathematics, in new techniques and the use of new tools, in the updating of communication skills, and in management.

The study has been summarized in an 80-page report by Drs. Samuel S. Dubin, a psychologist, and H. LeRoy Marlow, a management educator, of Pennsylvania State University.

Only working engineers who obtained a B.S. degree in engineering prior to 1959 were surveyed.

Engineers do not necessarily want college credit courses, the Penn State professors found. What they really want are informational courses and seminars, meetings and communications. They believe these will help them improve their professional skills.

The study outlined special recommendations for universities, companies, professional societies, government and the individual engineers to help in the updating process.

ENGINEER-TEACHER WAGES RISING, REPORT SHOWS

The average teacher of engineering now earns \$10,725 through regular teaching plus another \$2,775 for other activities such as consulting or writing.

Total professional income of \$13,500 represents an increase of 11.7% since the last study in 1962, according to a survey of 7,000 engineering teachers by the Engineering Manpower Commission of Engineers Joint Council. Increase for the previous 2-year period was 9.7%.

The study shows progressively increasing income for (1) instructors (\$7,675), (2) assistant professors (\$10,700), (3) associate professors (\$13,275), and (4) professors (\$17,850). Department heads earn higher basic salaries and their total income (\$18,050) has also overtaken that of professors. The previous survey showed lower outside professional earnings for department heads. Engineering deans were highest in the group with \$20,300.

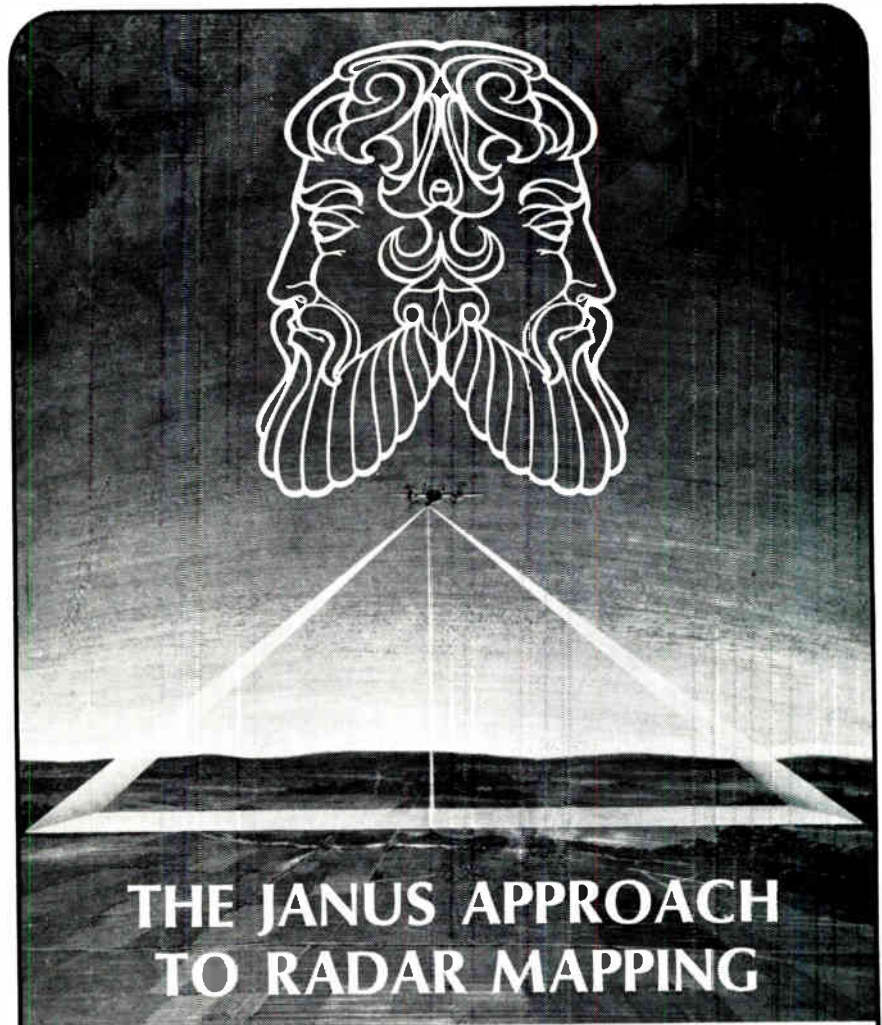

THE JANUS APPROACH TO RADAR MAPPING

Like the mythological Roman guardian of portals, the U.S. Army's new AN/UPD-2 airborne electronic sensor has the ability to look in opposite directions simultaneously. Produced by Motorola's Western Center, this sidelooking radar system (SLAR) transmits a high-energy pulse at a 90° angle to the line of flight — from horizon-to-horizon. A narrow fan-shaped beam, less than 1° in thickness, penetrates fog and darkness and the intensity of the return echo from outlying terrain is recorded as a synchronous "range vs. time" video signal. This signal is displayed on a cathode ray tube as intensity modulation, and photographed synchronously with the illumination of successive strips of terrain by the radar antenna. The AN/UPD-2 compensates for drift angle distortion by rotating the intensity-modulated line scan on the cathode ray tube a proportionate amount. This SLAR has **outstanding stability** and **field-proven reliability**.

Motorola's leadership offers challenging opportunities to engineers and scientists. Specific program areas are:

Antennas & Propagation
Solid State R.F.
Microwave Techniques
Missile & Space Instrumentation
Operational Support
Integrated Circuitry

Equipment Reliability Analysis
Parts Reliability
Data Acquisition, Processing
& Display
CW Transponders
Radar & Radar Transponders
Fuzes

Guidance & Navigation
Command & Control
Space Communications
Signal Processing
ECM, CCM & Surveillance
Tracking & Telemetry

Contact Phil Nienstedt, Manager of Recruitment, Department 6911

MOTOROLA



in PHOENIX

Military Electronics Division • Western Center • P.O. Box 1417, Scottsdale, Arizona
MOTOROLA ALSO OFFERS OPPORTUNITIES AT CHICAGO, ILLINOIS — AN EQUAL OPPORTUNITY EMPLOYER

THE KEY TO YOUR MAGNETIC SHIELDING Problems...



*Seamless tubing
construction*



Hydrogen annealing for maximum permeability



Customized fabrication to your exact engineering specifications



Fabrication in all types of MU metal materials including...

- Magnaloy
- Westinghouse Hypernik
- Hypernom
- Carpenter 49
- HY-MU 80
- Mu Metal



Ultimate in attenuation -60/-80 db

We have perfected the art of seamless-tube construction in magnetic shielding components at a price comparable to or lower than the "old-fashioned" overlapped welded seam designs

QUOTATIONS submitted on request per your blue print specifications for...

- ENGINEERING SAMPLES
- PROTOTYPES
- PRODUCTION RUNS

SEND FOR ILLUSTRATED BROCHURE

Magnetic **RADIATION
LABORATORIES, INC.**
7325 W. North Ave. - River Forest, Ill.
PHONE (Area Code 312) 771-7172

Circle 80 on Inquiry Card

WHAT'S NEW

CLOSE SUPPORT FOR TROOPS

THE AIR FORCE IS EVALUATING an aerial photographic reconnaissance system they hope will aid close support for ground troops. Called Project See Fast, the photo scanning and reconstruction system was developed by Philco Corporation's Aeronutronic Div., Blue Bell, Pa. The purpose of the system is to scan sensing imagery and reconstruct it at a remote receiver station. This will provide field commanders with a real-time view of action in a forward position.

The system uses an airborne single-line, flying-spot scanner to transform data from 70mm photographic film to video form for transmission via data link to a relay aircraft. From here it is retransmitted to a ground-station van. There, a cathode-ray tube film recorder converts the video data to a photographic image on 5 in. film. Rapid film processing and viewing provisions permit near real-time analysis of the data.

The unit can scan 50 ft. of aerial photographs on 70mm film at a rate of 1 inch/sec. and reproduce them at two times the size on 5 in. film at a rate of 2 inch/sec. The overall resolution is 20 optical lines/mm with 10 shades of gray ranging from neutral density 0.2 neutral density 2.0.

A line trace formed by a 1.2 mil (half brightness) spot on the scanner's 5 in. CRT light source is imaged 1 to 0.5 on the continuously moving 70mm photographic images. The intensity of the spot is modulated by the density of the emulsion in the photograph, and its light is collected by a photomultiplier which yields the video signal for transmission. The system operates in the near ultra-violet spectral region. The light-collecting system of the video photomultiplier produces a 100:1 range of densities, and eliminates ambient light which could cause signal-to-noise degradation. It also

STANPAT

REPETITIVE SYMBOLS & DRAWING DETAILS

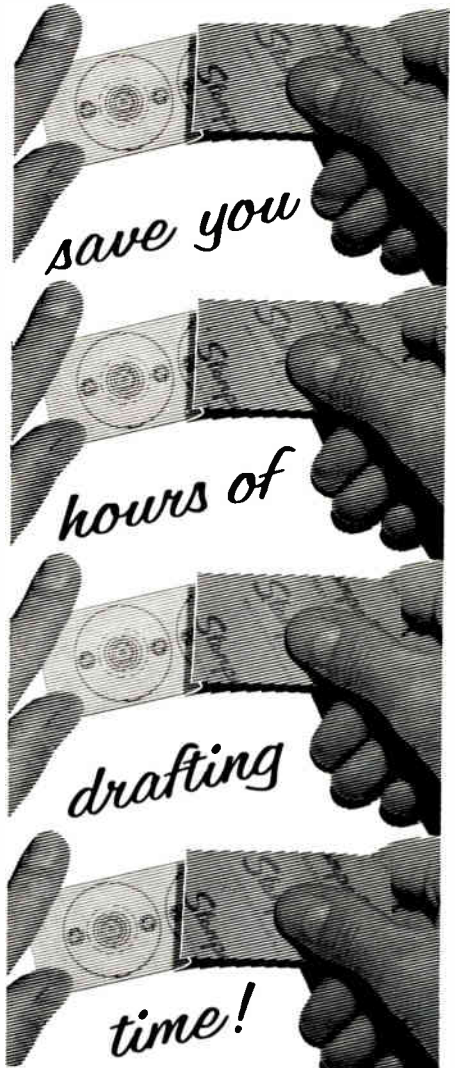

If your engineering designs require four or more repetitive drawings, STANPAT triacetate sheets, preprinted with your own symbols, can be applied in seconds rather than drawn in hours.

The STANPAT formula gives permanent adhesion without ghosting. Your own drawing details reproduce crisp and clean everytime on all types of tracing media. Excellent for microfilm reproduction... non-reflective surface receptive to both pencil and ink.

Write today and find out how STANPAT can save you hours of routine drafting time. Literature and samples on request, or enclose your symbols for quote.

*faithfully serving the engineer
for over two decades*



STANPAT
PRODUCTS INC.
Whitestone 57, N.Y., Dept. C11
telephone: 212-359-1693

Circle 81 on Inquiry Card

ELECTRONIC INDUSTRIES • November 1965



A photoscanning and reconstruction system is being tested to provide military field commanders with aerial photographic reconnaissance data in near real time. Photo at left is the original sensor imagery; at right is the reconstructed photo.

distributes the light of the scanning spot over an area of the photocathode, preventing noise from being introduced into the video by variations in gain across the photosensitive surface. Another photomultiplier, called a grain canceller, collects the light directly from the CRT. Since this light is not modulated by data on the film, it contains only the noise variations of the

CRT phosphor. The outputs of each photomultiplier are logged and subtracted, yielding a noise-free video which is combined with a synchronizing signal for transmission.

A ground or airborne terminal recorder accepts the signal from the data link receiver, performs the signal processing necessary to extract the synchronizing signal, and exposes the 5 in. film.

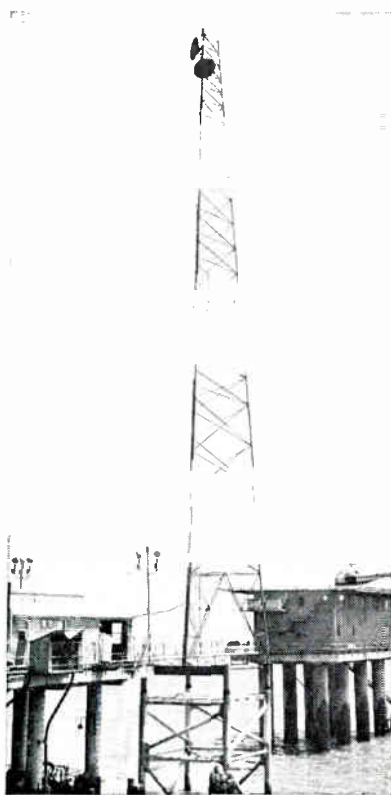

ROHN TOWERS "STAND UP" to Hurricane Hilda!

A series of ROHN micro-wave towers, used on Shell Oil Company offshore platforms near the Louisiana coast, took on the full fury of "Hurricane Hilda" and withstood the test!

Designed for 50 pound windload per square foot, these towers stood up to winds known to have been well in excess of this.

For towers proved in design, engineering and construction, specify ROHN. Complete tower, lighting kit, microwave reflector, and tower accessory catalogs and specifications available on request. Representatives world-wide.

Write — Phone — Wire for Prompt Service

ROHN Manufacturing Co.

Box 2000, Peoria, Illinois

Phone 309-637-8416 — TWX 309-697-1488

"World's Largest EXCLUSIVE Manufacturer of Towers; designers, engineers and installers of complete communication tower systems."

Circle 82 on Inquiry Card

**ONLY
TRYGON
HR-B Series
POWER
SUPPLIES**
give you all
these features

- All silicon —60°C operation
- Constant voltage/constant current
- .01% regulation; 0.5 mv ripple
- Up to 300 watts—voltages to 160V.
- Remote sensing—remote programming
- TRYLINK® precision current mode
- Automatic overvoltage protection option
- Half Rack Size—Bench or rack mount



Looking for a challenging engineering opportunity with growth potential? Contact D. Hauptman at Trygon. An equal opportunity employer.

TRYGON
ELECTRONICS, INC.
Roosevelt, N.Y. 11575

Please rush me your new 52-page Power Supply Handbook—FREE

Name _____

Title _____

Company _____

Address _____

City _____ State _____ Zip _____

Circle 122 on Inquiry Card

AMPERITE

Thermostatic DELAY RELAYS

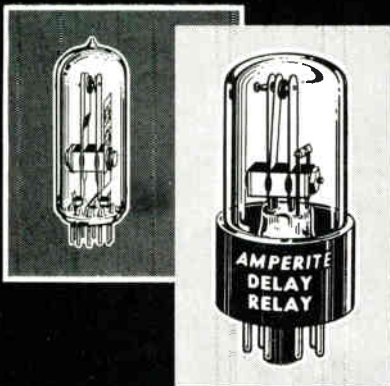

**Only a glass seal
offers true hermetic sealing**
... assuring maximum stability and life!

Delays: 2 to 180 seconds ... Actuated by a heater, they operate on A.C., D.C., or Pulsating Current ... Being hermetically sealed, they are not affected by altitude, moisture, or climate changes ... SPST only—normally open or normally closed ... Compensated for ambient temperature changes from -55° to $+80^{\circ}$ C ... Heaters consume approximately 2 W. and may be operated continuously ... The units are rugged, explosion-proof, long-lived, and—inexpensive!

TYPES: Standard Radio Octal, and 9-Pin Miniature.
List Price, \$4.00

PROBLEM? Send for Bulletin No. TR-81

AMPERITE

BALLAST REGULATORS

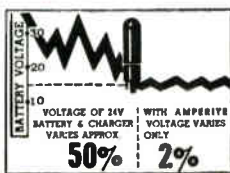

Hermetically sealed, they are not affected by changes in altitude, ambient temperature (-50° to $+70^{\circ}$ C.), or humidity ... Rugged, light, compact, most inexpensive ... List Price, \$3.00.

Write for 4-page Technical Bulletin No. AB-51

AMPERITE

600 PALISADE AVE., UNION CITY, N.J.

Telephone: 201 UNION 4-9503

In Canada: Atlas Radio Corp., Ltd.,
50 Wingold Ave., Toronto 10

Circle 83 on Inquiry Card

NEW PRODUCTS

THERMOELECTRIC MODULES

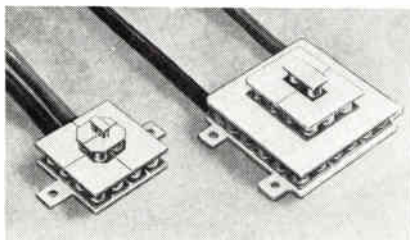

Cooling units provide up to 115° C reduction from room temp.

These units are useful where either a small quantity of heat must be removed or precise temp. control is necessary. Hot side electrical isolation is provided so components can be readily mounted to cold side, and hot side fastened to convenient heat sink. Three-stage units, the TC-821 and TC-1851, providing up to 115° C temp. reduction, handle heat loads up to 1w. Two-stage units, the TC-44 and TC-185, provide up to 90° C temp. reduction, and can handle as much as 8w. of heat removal with appreciable temp. reduction. Ohio Semitronics Inc., 1205 Chesapeake Ave., Columbus, Ohio 43212.

Circle 266 on Inquiry Card

ENVIRONMENTAL SYSTEM

Multiple test bay temp. chambers for continuous checkout of components.

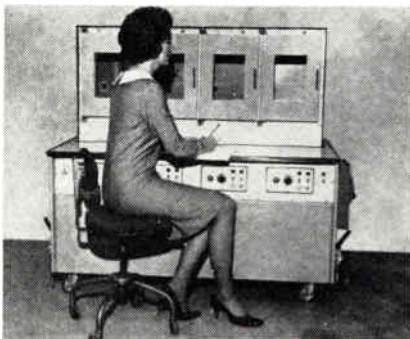

The individually controlled chambers of this unit have a range of 0 to $+50^{\circ}$ C and can be controlled within $\pm 1/8^{\circ}$ C. Temp. setting of 1 chamber has no effect upon the other chambers. Each may be individually programmed. In an initial application, the system operates at temps. at-or-near amb. for sorting of products whose characteristics vary widely with a few degrees change in temp. Difficulties of keeping accurate temp. control in a chamber near amb. are overcome through use of constant mechanical refrigeration bucked by heat in the individual chambers. Delta Design, Inc., 8000 Fletcher Pkwy, La Mesa, Calif.

Circle 267 on Inquiry Card

DOUBLE-SHIELDED BWO



Features magnetic and RFI shielding. Meets Mil-I-26600 and Mil-I-6181.

This line of BWOs offers double shielding (unsaturated magnetic shielding and RFI shielding) and filtering. The WJ-2005 covers C-band (4.0-8.0gc), with 20mw minimum power output and helix voltage of 300-1800v. The WJ-2005 covers X-band (8.0-12.4gc), with 50mw minimum power output and helix voltage of 450-1500v. The WJ-2007 covers $K\mu$ -band (12.4-18.0gc), with 40mw minimum power output and helix voltage of 550-2000v. Cathode current for all 3 is 10ma max. and the units measure 3 x 3 x 8 in. Watkins-Johnson Co., 3333 Hillview Ave., Palo Alto, Calif.

Circle 268 on Inquiry Card

MEMORY UNIT

Stores tape-programmed numerical control system instructions.

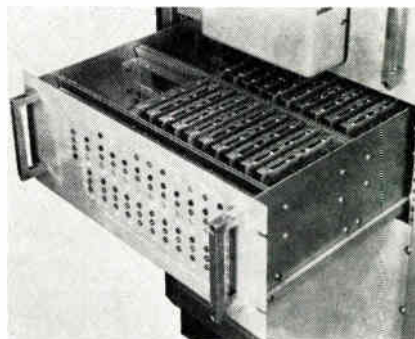

The model 201 numerical control system memory modular performs the same function, when used with a single-line reader, that previously required a block reader. The unit's advantages are derived from its flexibility. Inputs can be slow-speed mechanical or high-speed photocell signals, and the unit can be closed by either logic signal level or contacts. The solid-state, expandable memory stores binary-coded decimal, decimal, or any standard code. Control logic speed is said to be fast enough to use with the highest speed reader presently available. Westinghouse Products Support Equipment Dept., Box 153, Baltimore, Md.

Circle 269 on Inquiry Card

IC CORE MEMORY

Operating speed of 1 μ sec. full cycle
and access time is less than 500nsec.

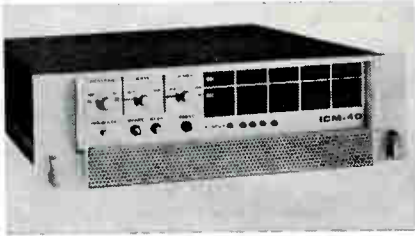

The ICM-40 is an integrated-circuit, coincident-current, random-access core memory. The 5 $\frac{1}{4}$ in. high unit, designed for mounting in a standard relay rack with pull-out front-of-rack access, permits word capacities to 16,384. Standard operating modes include clear/write, read/restore, and read/modify/write cycles. Output signals include memory busy, information available, and end-of-cycle. Hold address control input also is available which interfaces with both discrete component and integrated circuit systems. Computer Control Co., Inc., Old Connecticut Path, Framingham, Mass.

Circle 270 on Inquiry Card

COIL WINDER

For high production runs of
suppressor chokes and resistors.

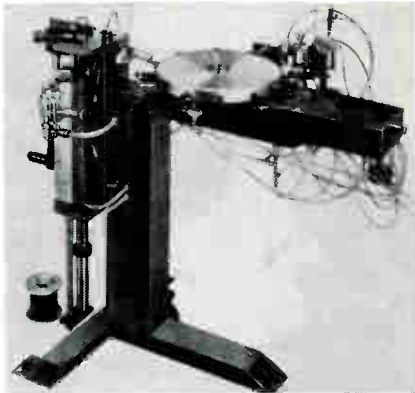

The Rotawinder™ is an entirely air-operated coil winding and finishing machine which produces close or space-wound coils at the rate of 600/hr. or better. It has a pneumatically operated transfer turret with multiple stations. Although loading is done manually, an automatic clamp-and-pull action severs the surplus wire tail at the axial lead, so that no further trimming is needed. Unclamping and ejection after the final operation is automatic. Automated wire welding to the axial leads is available as an option. Associated American Winding Machinery, Inc., 750 St. Ann's Ave., Bronx, N. Y.

Circle 271 on Inquiry Card



IBR®
SILICON AVALANCHE
INTEGRATED BRIDGE RECTIFIERS

FULL WAVE BRIDGES
**FULL WAVE CENTER
TAP RECTIFIERS**
**HALF WAVE THREE
PHASE RECTIFIERS**

Each in one
small package

You can reduce rectifier cost, size requirements, and installation time with the Varo IBR® series of silicon avalanche integrated rectifiers. All IBR® devices feature 2000 V min. circuit-to-case insulation and SAR® (silicon avalanche rectifier) characteristics to control transient overvoltages and permit decreased PRV safety factors in design consideration.

For full-wave bridge applications: the 1N4436 (250 V min. BV_R), 1N4437 (450 V min. BV_R), and 1N4438 (650 V min. BV_R). Output current is 10 amps at 100° C (T_C).

The full-wave center tap and 3-phase half and full wave rectifiers are designed for 140 V and 280 V RMS operation with 250 V and 450 V min. avalanche voltages. They have 5 amp/leg DC I_O at 100° C (T_C) and 100 amp, one-cycle current surge. IBR® voltage doublers for 70 V and 140 V RMS operation are also available.

IBR® devices are available in three mounting configurations: press-fit, TO-3, and single stud. Flag terminals also available.

Write today for complete information and new low prices.

45524 - 3 ϕ FULL WAVE



VARO INC

SPECIAL PRODUCTS DIVISION
2201 WALNUT ST., GARLAND, TEXAS 75041 (AREA CODE 214) 276-6141 TWX 214-276-8577



NEW PRODUCTS

when you
need a
spot of color



SILIKROME® COLOR CAPS

slip easily over miniature lamps to add color or change color. Made of silicone rubber, they are unbreakable, reuseable, and lightweight. Eliminate inventories of colored lamps; use clear lamps plus colored SILIKROME filters. Consistent uniformity and stability of color even at high temperatures. Impervious to con-

taminents. No special mounting fittings required.

Be a color expert, send for Catalog SK-1
APM-HEXSEAL CORP.



41 Honeck St., Englewood, New Jersey
(201) LO 9-5700

WE ALSO MANUFACTURE A COMPLETE LINE OF SEALING HARDWARE

Circle 86 on Inquiry Card

LOW-COST POTENTIOMETER

Resistance range, 10Ω to 20K (±10%).
Power rating 0.25w. @ 25°C.

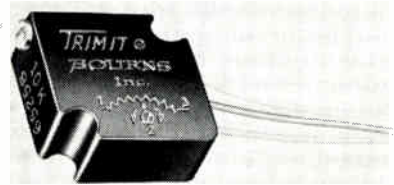

The 1/2 in. sq. wirewound Model 3257 Trimit® potentiometer is priced at \$2.36 in 100 piece quantities. It features an idling mechanism which prevents damage from forced adjustment at the end of wiper travel; a temp. range from -65 to +105°C; fused Silverweld® termination, which eliminates the chief cause of potentiometer failure; and shock and vibration capabilities of 20G and 10G. Bourns, Inc., 1200 Columbia Ave., Riverside, Calif.

Circle 272 on Inquiry Card

COAX WAVEMETER

Coaxial microwave freq. meter covers 3.7 to 12.4 GHz with no spurious responses.

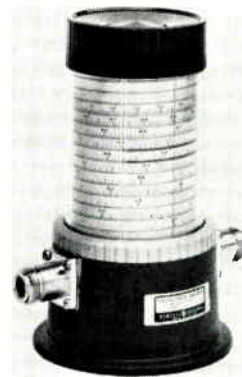

Model 537A has a spurious-free response across nearly 2 octaves. This is accomplished by a tuned cavity for the quarter-wave mode, with concurrent damping of three-quarter wave modes. It has a 75 in. direct-reading scale, with scale calibrations accurate to ±0.1%, in increments of 10 MHz. Worst-case overall accuracy is ±0.17%, allowing for scale errors, humidity variations from 0 to 100%, temps. ranging from 12 to 33°C, and for backlash. The instrument provides at least 1db response dip at resonance, and has Q in excess of 1000. Hewlett Packard, 1501 Page Mill Rd., Palo Alto, Calif. 94304.

Circle 273 on Inquiry Card

NEW
LOWER
PRICE

Schauer Heavy Duty 1/2 Watt Zeners

— are the highest quality,
lowest priced in the industry!

Check the data below and compare Schauer Zeners with the units you are now using for quality and price. These 10-watt silicon junctions in a 1/2-watt package feature very low dynamic impedance and very high surge capacity — 25-watt-ms surge from 1.0 to 10 ms.

TYPICAL CHARACTERISTICS

Vz @ 25°C.	Iz @ 20 ma	Iz @ 100 ma	TC %/°C.	1-99 price 10% Tol.
2.4 V.	14 ohms	3.2 ohms	-0.54	NOW ONLY 50¢ EACH
3.0	17	3.9	-0.55	
3.6	18	4.1	-0.50	
4.3	17	3.9	-0.37	
5.1	10	2.3	-0.19	
6.2	2.0	0.5	+0.18	
7.5	1.5	0.4	+0.44	
9.1	4.0	0.9	+0.53	

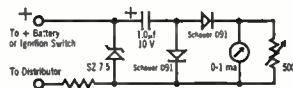

Tachometer Circuit

In addition to the communications industry, a wide range of products incorporate Schauer semiconductors in their circuitry. Shown above is the circuit for an inexpensive automobile tachometer.

Contact your local distributor or write direct for prices and Catalog No. 621.

Semiconductor Division
SCHAUER MANUFACTURING CORP.
4518 Alpine Ave., Cincinnati, Ohio 45242

Circle 87 on Inquiry Card

the all new ALPHA SOLDER and FLUX R & D KIT

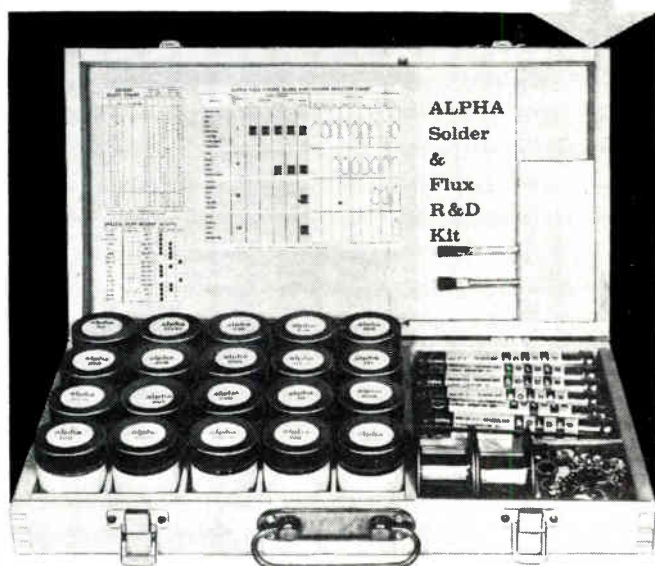

- HELPS SOLVE SOLDERING PROBLEMS!
- SPEEDS RESEARCH & DEVELOPMENT!
- MINIMIZES EXPERIMENTAL WORK!
- SAVES TIME, ENERGY, MONEY!

Alpha's compact Solder & Flux Kit contains 19 soldering chemicals — fluxes, flux cleaners, protective coatings; 14 kinds of solders — including paste solder, solders meeting Fed. Spec. QQS-571 d, and unusual solder alloys for high and low soldering temperature applications; spools of solder foils; and a box of assorted preforms. Use it to do all experimental pre-production soldering jobs . . . select compatible materials for a new design, process or assembly . . . correct and solve pre-and post-soldering production problems.

Built into this all-in-one R & D Kit are Alpha's Flux Finder Guide and Solder Selector Chart. Special Soft Solder Alloy Diagrams, Solder Alloy Chart and other valuable data on solder alloys, fluxes and chemicals.

Complete Kit price: \$24.00, including shipping. Price slightly higher outside the Continental U.S.A. Start saving time, energy, money . . . **get your Kit now!**

For more information write for Bulletin A105.

Solders, fluxes, preforms, special alloys, lead and tin products, ultra-high purity metals for semi-conductor devices.

alpha **ALPHA METALS, INC.**
56 WATER ST., JERSEY CITY, N. J. 07304 201-434-6778
Los Angeles, Calif. • Alphasoy Corp. (Div.), Chicago, Ill.
Alpha Metals, Inc. (U.K.) Ltd., London, England

J4992



Circle 88 on Inquiry Card
ELECTRONIC INDUSTRIES • November 1965

Grayhill[®]

PUSH POST[™]

UNIQUE FAST-CONNECT

SPRING TENSION
BINDING POST

- Depress, insert wire, release—for firm, positive connections
- Nickel plated brass
- Thermoplastic Button caps
- Stainless steel spring
- Insulating washers available
- Gold finish available on request

Write for Current Engineering Catalog

Grayhill
INC.

543 Hillgrove Avenue
La Grange, Illinois 60526
Area Code 312, Phone 354-1040

"PIONEERS IN MINIATURIZATION"

Circle 89 on Inquiry Card

For Permanent
Temporary Connections

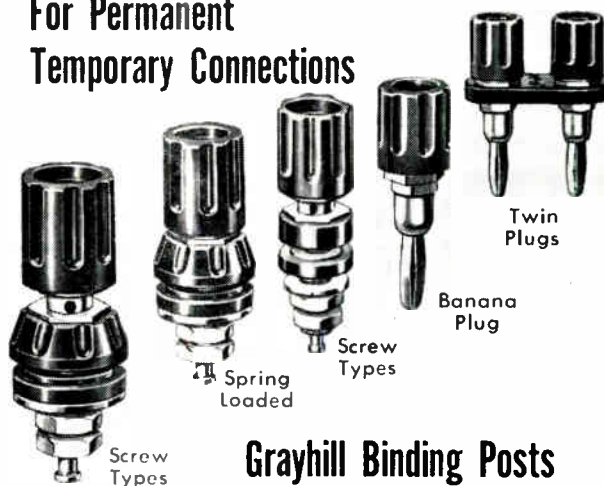

Grayhill Binding Posts
— offer you dependable contact

GENERAL SPECIFICATIONS

- Non-cut flush cross hole
- Non-turn "D" style insulating washers
- Molded plastic per MIL-M-14
- Carry 30 Amps.
- Voltage breakdown 3000 VAC
- Gold finish available on request

Ask for Current Engineering Catalog

Grayhill
INC.

543 Hillgrove Avenue
La Grange, Illinois 60526
Area Code 312, Phone 354-1040

"PIONEERS IN MINIATURIZATION"

Circle 89 on Inquiry Card

"... advancing the STATE-OF-THE-ART in Components & Equipment.

POWER TUBES

Delivers top performance at B⁺ voltages of 240-270v, while running cool.

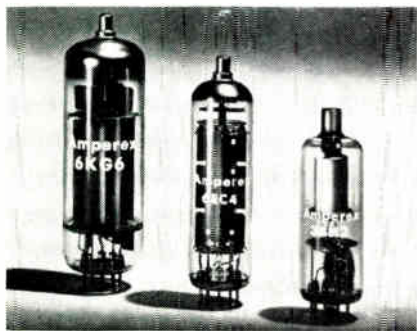

Tubes currently available in this line are the 6KG6 horizontal output pentode; 6EC4 damper diode; and 3BH2 high-voltage rectifier diode. The 6KG6 runs 50°C cooler than comparable tubes at max. operating conditions. It offers 34w. max. plate dissipation and 1.4a. peak anode current. The 6EC4 is rated for 5600v. PIV and 450ma average cathode current. The 3BH2 features an anti-corona shield. Amperex Electronic Corp., Semiconductor and Receiving Tube Div., Slatersville, R. I. 02876.

Circle 216 on Inquiry Card

PREAMPLIFIER CONVERTER

Receiver noise figures are reduced to 2.5db, greatly improving radar sensitivity.

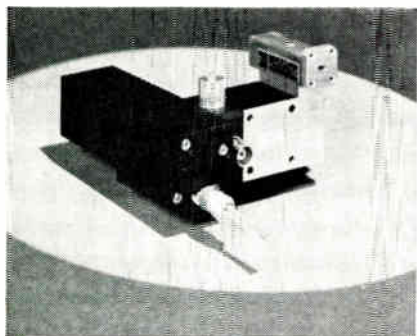

This low-noise K_a-band preamplifier-converter is suitable for airborne uses. The package includes a low-noise 2.3db nondegenerate parametric amplifier, a miniature mixer with 6db SSB noise figure, and an all solid-state local oscillator. The preamplifier-converter can be electronically tuned over a 600mc band anywhere in K_a band, with an r-f gain of 20db at a typical 3db bandwidth of 60mc. Package weight is 18 oz. and overall dimensions are 2.7 x 4.5 x 4 in. Texas Instruments Incorporated, P. O. Box 6015, Dallas, Tex.

Circle 217 on Inquiry Card

PRE-AMPLIFIER

Provides a 1 million to 1 voltage gain over a freq. of 0.1 cps to 100kc.



The low-freq. seismic amplifier provides high gain and low noise with min. size and weight in a rugged package. Uses range from the laboratory to seismic field exploration. Other military and commercial uses exist in such areas as l-f sonar systems and vlf communications. The amplifier extracts low-level signals. Each stage provides a 30db gain with an input impedance of 100K. Noise equivalent is less than 0.2μv. General Electric Co., Military Communications Dept. (1-55), P. O. Box 129, Oklahoma City, Okla.

Circle 218 on Inquiry Card

FREQ.-TO-DC CONVERTER

Provides 10 selectable overlapping freq. ranges continuously adjustable.

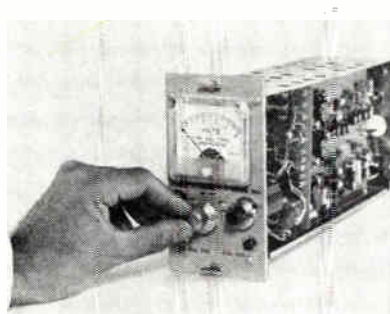

The frequency-to-dc converter Model PI-408 provides 10 selectable overlapping freq. ranges. These are continuously adjustable from 50 cps to 50kc full scale, with automatically selected crystal-controlled calibrate freq. for each range. Additional features include transformer coupled input with 60db common-mode rejection, low output impedance — less than 0.5Ω, improved linearity and stability, and scaled sq. wave output with marker pulses for every 10 and 100 input pulses. Anadex Instruments Inc., 7833 Haskell Ave., Van Nuys, Calif.

Circle 219 on Inquiry Card

ELECTROSTATIC AMPLIFIER

Simplifies operation and calibration of piezoelectric systems.

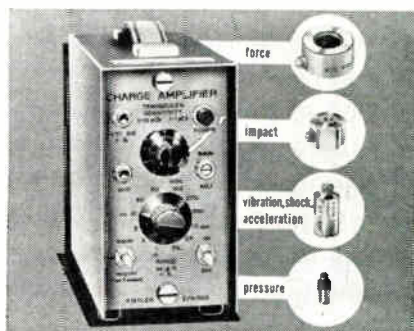

Model 503 incorporates 12 full-scale ranges from 1 to 50K psi, pounds or G's full-scale to match the extensive range of a quartz transducer. It accommodates any transducer sensitivity. Freq. response is from near dc to more than 100kc. The non-saturating electronics, with a MOS insulated gate input transistor, recovers instantaneously from extreme overloads of either polarity. Max. linear output signal exceeds ±10v. and ±10ma. Kistler Instrument Corp., 8989 Sheridan Dr., Clarence, N. Y. 14031.

Circle 220 on Inquiry Card

TRANSISTORIZED DISPLAY

Provides operator with instant and continuously visible digital information.

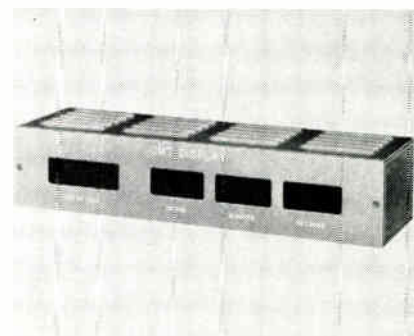

TNA-100 Series are used in systems where low-level signals are present. This package displays day of year, hrs., min. and sec. Signal input is low-level binary coded decimal, 1 wire/bit. An integral power supply provides the high voltage required by the display tubes. Input signals and 115vac enter the unit through connectors in the rugged metal case. The digital display assembly is also ideal for computer and guidance system readouts, digital clocks, etc. Transistor Electronics Corp., P. O. Box 6191, Minneapolis, Minn. 55424.

Circle 221 on Inquiry Card

3 new instruments to measure antenna and microwave components and systems

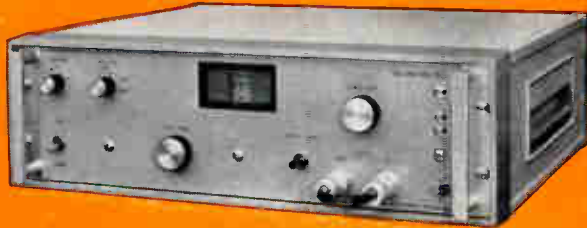

SIGNAL SOURCE, SERIES 2160
One watt minimum output.
2 Gc to 4 Gc continuous coverage.
 Completely **self-contained**.
 25 ppm/°C frequency stability.
 High tuning resolution.
 \$2300.

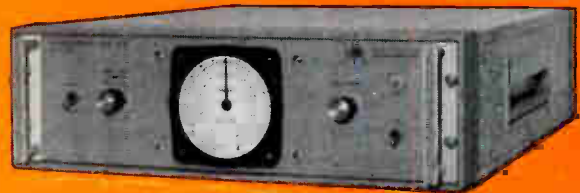

RECORDER-SWEEPER DRIVE, SERIES 1570
Simultaneous control of frequency and recorder chart drive.
Variable speed, bi-directional drive.
 Times-ten chart expansion.
 Frequency indicator.
 Automatic limit stops.
 \$975.—(less case).



RECTANGULAR RECORDER, SERIES 1520
 Recording **accuracy of ± 0.15 db** over **40-db dynamic range**.
 Selective logarithmic, linear or square-root recording functions.
 Ultra high-speed pen response.
 Accurate single- or dual-speed chart drive.
 Crystal or bolometer input/bolometer bias supply.
 From \$4300.

AS A SYSTEM:
ACCURACY to ± 0.15 db. . . .
40-db. DYNAMIC RANGE
FULL OCTAVE BANDWIDTH
 and **AUTOMATIC**.

Improve your accuracy and efficiency with these outstanding units!
 Each unit is unique in itself; and when combined, these off-the-shelf components constitute a new measuring tool for wide-range- frequency sensitive applications.
 Circle the Reader Service Card or write today for complete information.

SCIENTIFIC-ATLANTA, INC.

BOX 13654, ATLANTA, GA. 30324 • TEL. 404 - 938-2930 • TWX 810-766-4912 • WUX: PSO • CABLE: SCIATLA



INFRASONIC VOLTMETER

This peak to peak vtm has been designed to make accurate measurements from 30 kHz down to 0.05 Hz, or even to 0.01 Hz with corrections. Square waves may be measured with the stated accuracy to 0.5 Hz. Accuracy is better than 3 percent of reading regardless of voltage or frequency. Provision is made for speeding up measurements that might be delayed by severe overload or by a dc component on the input signal, or by a reduction of the voltage being measured. This instrument may be used for measurements of peak to peak voltages in such applications as automatic control systems involving low frequency servomechanisms, and in fields where infrasonic frequencies down to 0.01 Hz are encountered, or in measuring voltages at very low frequencies at the output of signal generators. Flutter down to 0.05 Hz is virtually eliminated, and is very small at 0.01 Hz. Power line transients have negligible effect.

Price \$365.

0.01 Hz to 30 kHz

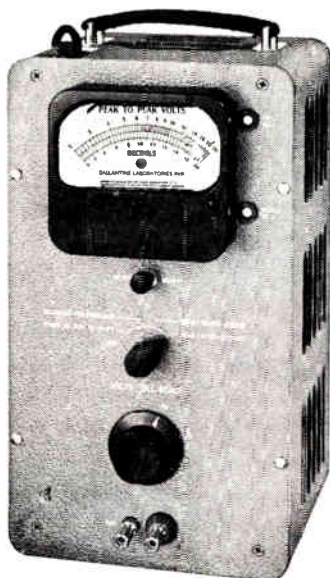

model 316

SPECIFICATIONS

Voltage Range 20 mV-200 V peak-to-peak
 Frequency Range 0.05 Hz-30 kHz
 (Down to .01 Hz with correction)
 Accuracy 3% ENTIRE RANGE
 AT ANY POINT ON SCALE
 Input Impedance 10 MΩ shunted by
 17 pF or 40 pF



— Since 1932 —

BALLANTINE LABORATORIES INC.

Boonton, New Jersey

Circle 90 on Inquiry Card

NEW PRODUCTS

DC POWER MODULE

Highly regulated in the range of $\pm 0.25\%$. Ripple and noise less than 1mv.

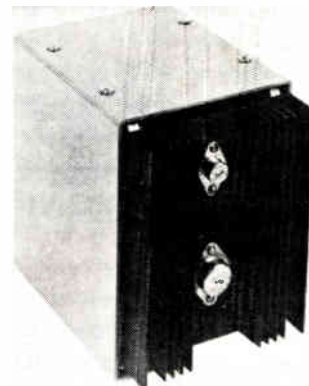

The MS series silicon regulated dc power module has a response time of 50msec and dynamic impedance of 0.0005 ohms. This device is self-cooled and requires no additional heat dissipating devices, enabling it to operate up to 81°C. Protection devices include automatic electronic current limiting, short-circuit protection and automatic overload protection. It is currently available in voltage ranges from 3-100v, and currents from 100ma to 12a. Perkin Electronics Corp., 345 Kansas Street, El Segundo, Calif.

Circle 222 on Inquiry Card

MICROWAVE SWITCH

TR crystal switch provides 140db isolation between transmitter and receiver.

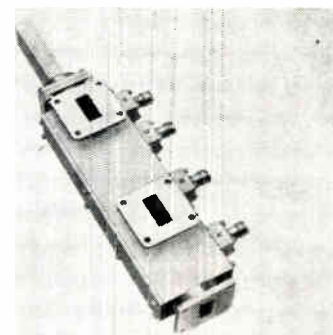

This crystal switch can be used as both a TR and a pulse-forming device. It has a switching speed of less than 10nsec. and provides an isolation of 140db. The switch is a DPDT configuration. In a typical application it allows the transmitter to be transferred to internal dummy load when in the receive mode. R-F leakage is maintained 90db below the input signal in order to minimize the coupling between stages. The average power handling capability over all operating modes can be as high as 1w CW. Max. vswr is 1.5:1, and instantaneous bandwidth is 200 mc at X-band. American Electronic Laboratories, Inc., P. O. Box 552, Lansdale, Pa.

Circle 223 on Inquiry Card

High Quality Coil Forms For All Electrical Applications

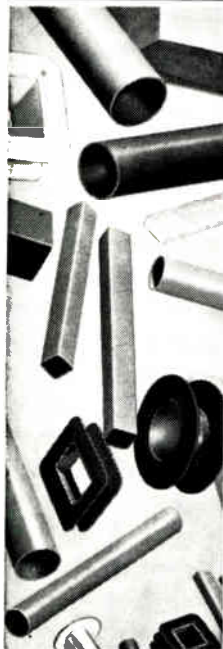

SQUARE AND RECTANGULAR TUBES—Choice of any dielectric material or combinations. Any length, shape or size. Especially recommended for Class A, B and H temperature ranges.

ROUND TUBES—Any decimal size up to 8". Fabricated from dielectric kraft, fish paper, acetate, DuPont Mylar, Johns-Monville Quinterra, fibre glass, other materials or combinations.

RESINITE PHENOLIC IMPREGNATED—Feature the highest resistivity of any resinated product. Furnished in any shape or size—plain, embossed or internally threaded, also in fly-back transformer forms.

BOBBINS—Molded or fabricated—to specification in all sizes, shapes and dielectrical materials for all electrical and corrosion requirements, Class A, B and H temperature ranges.

Request catalog and prices. Ask about Precision's complete coil form service.

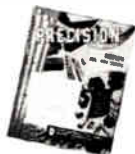

PRECISION PAPER TUBE COMPANY

1049 S. Noel Ave., Wheeling, Ill. 60090 (Chicago Suburb)

TELEPHONE 312...537-4250 TWX 312...537-5202

Circle 91 on Inquiry Card

Tung-Sol Read-Out Lamp Saves Customer Two Operations, Cuts Shrinkage

Our customer's problem stemmed from handling. The bulbs he bought went first to a wiring company to have lead wires attached. (Shrinkage here due to lead wire damage). After the leads were attached the bulbs went to a molder to have bases added. (More shrinkage due to bulb damage and lead wire breakage). Shrinkage in both operations ran as high as 15 per cent.

Now Tung-Sol does the whole job and the customer has benefitted 4 ways: (1) two processing steps eliminated. (2) valuable production time saved. (3) inventory reduced. (4) gets 1000 usable lamps for every 1000 purchased.

Tung-Sol can harness to any specifications and mold to any configuration. Describe your application to us for free suggestions about how Tung-Sol can solve your problem at a saving.



If your application requires only bulbs, ask for a quotation from Tung-Sol. The Tung-Sol line of miniature and subminiature lamps is extensive. Quality is the best that more than half a century of know-how can produce.

TUNG-SOL INSTRUMENT LAMPS

Tung-Sol Electric Inc., Newark, N. J. 07104

ACTUAL
SIZE



ONE ENVIRONMENTAL CHAMBER WE DON'T MAKE

We're specialists in controlling temperature and humidity to faithfully reproduce just about any test condition you can name. To mention a few of our units: Full Range Constant Temperature/Humidity Cabinets that automatically perform Step 7-A ($-10^{\circ}\text{C}.$) of MIL-202C, Method 106B—without changing program cams! CO_2 or LN_2 chambers with ranges from $-200^{\circ}\text{C}.$ to $+316^{\circ}\text{C}.$ Low-High chambers with a range from $-73^{\circ}\text{C}.$ to $+649^{\circ}\text{C}.$ Dual Thermal Shock Test Cabinets that automatically transfer specimens from temperatures as low as $-73^{\circ}\text{C}.$ to as high as $+260^{\circ}\text{C}.$ And there are many others—all built to unmatched standards of reliability—most featuring the exclusive POWER-O-MATIC 60[®] Saturable Reactor Proportioning Control System. Plus a wealth of design/engineering experience to tailor standard units to meet special needs or to custom-engineer equipment to your specifications.

If this capability fits into your plans, write for details on all our environmental cabinets. You'll probably find just the unit you're looking for. Ask, too, for data on Blue M furnaces, ovens and baths. There's no obligation.



BLUE M

Corporate headquarters:
Blue Island, Illinois 60406

BLUE M *Electric Company*
BLUE M *Engineering Company*
BLUE M *International*

DIVISIONS

Circle 92 on Inquiry Card

Circle 44 on Inquiry Card

color coded nutdrivers

now in new, handy kits

FOR BENCH, WALL OR TOOL BOX

Sturdy, new pebble-grain plastic cases provide handy means for keeping nutdrivers in good order on the workbench or in tool box for service calls. Lids snap shut, lock tight to protect tools. No. 77 case has hole in lid lock for wall hanging . . . molded compartments keep tools from tumbling out.



No. 77
SOLID SHAFT
NUTDRIVER KIT

7 Hex Openings: 3/16", 7/32", 1/4", 9/32", 5/16", 11/32", 3/8"



No. HS6-18
HOLLOW
SHAFT
NUTDRIVER KIT

10 Hex Openings: 3/16", 7/32", 1/4", 9/32", 5/16", 11/32", 3/8", 7/16", 1/2", 9/16"

PROFESSIONAL QUALITY

Precision fit, case-hardened sockets; polished and plated steel shafts; shockproof, breakproof, color coded plastic (UL) handles.

WRITE FOR CATALOG 162

XCELITE®

XCELITE, INC., 28 BANK ST., ORCHARD PARK, N. Y.
Canada: Charles W. Pointon, Ltd., Toronto, Ont.

Circle 93 on Inquiry Card

NEW PRODUCTS

TELEMETRY ANTENNA

It has a VSWR of 1.5:1 over any 1.0Mc band. Polarization is linear.

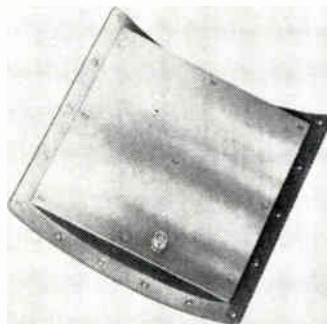

The DM AK18 is a shallow cavity telemetry antenna for use on missiles and rockets which are approx. 15 in. in dia. Designed for conformance to missile surface and configuration, with a minimum of penetration into the vehicle, the DM AK18 provides max. radiated power in a vertical plane. The stainless steel unit is flush mounted and weighs 2 lbs. Efficiency is 90%. Dorne and Margolin, Inc., Westbury, N. Y.

Circle 224 on Inquiry Card

WIDE-BAND AMPLIFIER

Gain settings from 10 to 1000. Delivers an output of 100ma at $\pm 20v$.

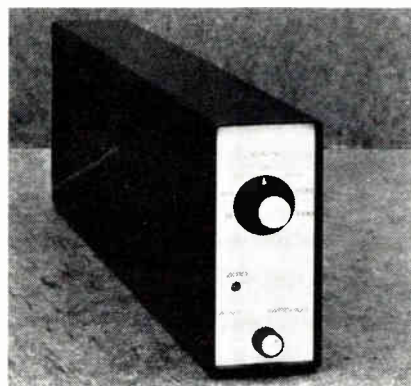

The ADV-1 amplifies small signals from low-impedance sources, such as thermocouples and strain gauges. It is well suited to many instrumentation system applications, for data acquisition, and general laboratory use. It has a self-contained power supply. Active components are silicon devices which achieve low-drift, low-noise and fast recovery from overloads. Other principal features are high gain accuracy and high common-mode rejection. Eight ADV-1 amplifiers, assembled in a rack adapter, can be mounted in a standard 19 in. rack using 5 1/4 in. vertical panel space. Fairchild Instrumentation-West, 844 Charleston Rd., Palo Alto, Calif.

Circle 225 on Inquiry Card

the next best thing
to a primary standard

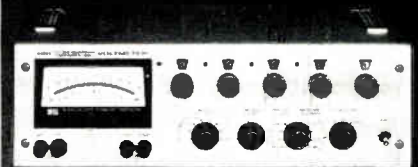

NEW AC/DC DIFFERENTIAL VOLTMETER

0.01% DC - 0.05% AC

Compare the high long-term range of accuracies offered by the Keithley 661! Weigh its full year guarantee on limits of error! Examine the outstanding features that make this combination ac/dc instrument the low cost answer to your secondary standard needs. See how its front panel polarity switch, large meter and in-line readout make it functionally easy-to-use. The 661 is ideal for virtually all calibration, stability and regulation checks. For proof, scan these advantages:

AC	DC
0.05% limit of error	0.01% limit of error
4x voltage ranges, 0.5 to 500v	4x voltage ranges, 0.5 to 500v
6x null ranges, 1 mv fs to 100v	7x null ranges, 100 μ v fs to 100v
10 cps to 80 kc bandwidth	Input resistance, infinite at null, 0-500v
1 meg, 45 pf input impedance	guarded null detector
10 μ v resolution	2 μ v resolution
5 dial readout	5 dial readout

ONLY \$1275

FREE

engineering-
application
note giving
all details



OTHER KEITHLEY
DIFFERENTIAL VOLTMETERS

Model 660A—0.02% dc accuracy \$650
Model 662—0.01% dc accuracy \$995

K

KEITHLEY INSTRUMENTS

12415 Euclid Ave. • Cleveland, Ohio 44106

Circle 119 on Inquiry Card

FIRST CLASS
PERMIT NO. 36
PHILA., PA.

BUSINESS REPLY MAIL
No Postage Stamp Necessary If Mailed in U.S.A.

POSTAGE WILL BE PAID BY

ELECTRONIC INDUSTRIES

P. O. Box 9801

Philadelphia, Pa. 19140

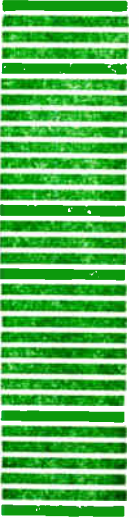

FIRST CLASS
PERMIT NO. 36
PHILA., PA.

BUSINESS REPLY MAIL
NO POSTAGE STAMP NECESSARY IF MAILED IN UNITED STATES

POSTAGE WILL BE PAID BY

ELECTRONIC INDUSTRIES

Chilton Company

Chestnut & 56th Sts.

Philadelphia, Pa. 19139



Att: Circulation Dept.

FREE!

Catalogs, Literature
New Products and
New Tech Data
Another Reader Service of the

ELECTRONIC INDUSTRIES

STATE
OF THE
ART
MAGAZINE

NAME
COMPANY
ADDRESS
CITY, STATE
TELEPHONE NO. (area code)

TITLE
DEPT.
MAIL STOP
Zip Code
EXT.

Please send me the items I have circled.

	1-B										EI-229										NOVEMBER 1965																																																																																																																																																																																																																																																																																																																																																																																											
1	11	10	9	8	7	6	5	4	3	2	1	12	13	14	15	16	17	18	19	20	21	22	23	24	25	26	27	28	29	30	31	32	33	34	35	36	37	38	39	40	41	42	43	44	45	46	47	48	49	50	51	52	53	54	55	56	57	58	59	60	61	62	63	64	65	66	67	68	69	70	71	72	73	74	75	76	77	78	79	80	81	82	83	84	85	86	87	88	89	90	91	92	93	94	95	96	97	98	99	100	101	102	103	104	105	106	107	108	109	110	111	112	113	114	115	116	117	118	119	120	121	122	123	124	125	126	127	128	129	130	131	132	133	134	135	136	137	138	139	140	141	142	143	144	145	146	147	148	149	150	151	152	153	154	155	156	157	158	159	160	161	162	163	164	165	166	167	168	169	170	171	172	173	174	175	176	177	178	179	180	181	182	183	184	185	186	187	188	189	190	191	192	193	194	195	196	197	198	199	200	201	202	203	204	205	206	207	208	209	210	211	212	213	214	215	216	217	218	219	220	221	222	223	224	225	226	227	228	229	230	231	232	233	234	235	236	237	238	239	240	241	242	243	244	245	246	247	248	249	250	251	252	253	254	255	256	257	258	259	260	261	262	263	264	265	266	267	268	269	270	271	272	273	274	275	276	277	278	279	280	281	282	283	284	285	286	287	288	289	290	291	292	293	294	295	296	297	298	299	300	301	302	303	304	305	306	307	308	309	310	311	312	313	314	315	316	317	318	319	320	321	322	323	324	325	326	327	328	329	330	331	332	333	334	335	336	337	338	339	340	341	342	343	344	345	346	347	348	349	350	351	352	353	354	355	356	357	358	359	360	361	362	363	364	365	366	367	368	369	370	371	372	373	374	375	376	377	378	379	380	381	382	383	384	385	386	387	388	389	390	391	392	393	394	395	396	397	398	399	400

SPECIAL PRIORITY REQUEST

Postcard valid 8 weeks only

For immediate need or a call by a sales representative, write number (s) in box (do not circle above)

Item No.	Item No.	Item No.	Item No.	Item No.	Item No.
----------	----------	----------	----------	----------	----------

World Radiobroadcast address shown is your home, where is your company located? City _____ State _____

NEW *Change of Address*

Company _____
Mail Stop/or
Dept., Div. _____

Street _____

City _____ State _____ Zip _____

OLD
PASTE WRAPPER IMPRINT OR WRITE COMPLETE OLD ADDRESS



Source Date	
Co. Code	
File No.	
Function Industry	-
Title Unit	-

1. Do you wish to continue receiving ELECTRONIC INDUSTRIES? Yes _____ No _____

Signature _____ Title _____

2. Check ONE box for your PRIME FUNCTION DATE _____

Corporate Management	Engineering Management	Manufacturing Management	DESIGN ENGINEERING				Research & Development Engineering	Application	Evaluation	Mechanical	Quality Control	Production	Reliability	Standard	Test	Value	Purchasing	Sales	Co. Copies & Libraries	All Others
			Circuits	Components	Equipment	Systems														
A	B	C	D	E	F	G	H	J	K	M	N	P	R	S	T	V	W	X	Y	Z

3. Check ONE box for your plant's PRIME nature of business

- MANUFACTURING INDUSTRIES**
- (01) Computers, Data Processing & Peripheral Equipment Mfr.
 - (02) Communication Systems & Equipment Mfr.
 - (03) Consumer Electronic Equipment Mfr.
 - (04) Industrial Control Systems & Equipment Mfr.
 - (05) Navigation & Guidance System Mfr.
 - (06) Test Measurement & Instrumentation Mfr.
 - (07) Aircraft, Ground Support, Missile, Space Vehicle & Undersea Access & Equipment Mfr. not covered in other product classifications
 - (08) Component Mfr.
 - (09) Sub-System Assembly Mfr. (Modules, Assembled Circuits)
- NON MANUFACTURING INDUSTRIES**
- (10) Materials & Hardware Mfr.
 - (11) Industrial Co. Using or Incorporating Any Electronic Equipment in Their Manufacturing, Research or Development Activities. (Other than Electronic Co.)
 - (12) Commercial Users of Electronic Equipment
 - (13) Independent Research, Test & Design Laboratories & Consultants (Not Part of a Manufacturing Company)
 - (14) Government Agencies & Military Agencies
 - (15) Distributors, Mfr. Representatives
 - (16) Education & Libraries
 - Other (explain) _____

4. This Address is (check most applicable)

- Mfg. Plant (*)
- Mfr's R&D Lab. (&)
- Other (explain) _____

FIRST CLASS
PERMIT NO. 36
PHILA., PA.

BUSINESS REPLY MAIL
No Postage Stamp Necessary If Mailed in U.S.A.

POSTAGE WILL BE PAID BY

ELECTRONIC INDUSTRIES

P. O. Box 9801

Philadelphia, Pa. 19140



FIRST CLASS
PERMIT NO. 36
PHILA., PA.

BUSINESS REPLY MAIL
NO POSTAGE STAMP NECESSARY IF MAILED IN UNITED STATES

POSTAGE WILL BE PAID BY

ELECTRONIC INDUSTRIES

Chilton Company

Chestnut & 56th Sts.

Philadelphia, Pa. 19139



Att: Circulation Dept.

NEW PRODUCTS

SEALED SWITCH

Both panel and switching elements separately sealed against environments.



Series PS are sealed tab-type thumb-wheel switches with panel and switching elements separately sealed against all hostile environments. Complete sealing not only protects the switch against dust, salt spray, corrosion and other contamination, but prevents any contamination from getting through to relays and other components. Especially recommended for RFI applications. Switch life exceeds 100,000 operations. Chicago Dynamic Industries, Inc., Precision Products Div., 1725 Diversy Blvd., Chicago, Ill. 60614.

Circle 226 on Inquiry Card

RING MODULATOR

The 5 to 100mc unit uses no filters. Gives high isolation.

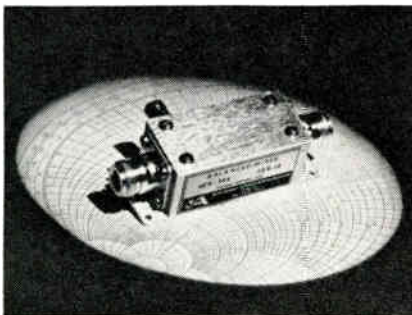

Model HFX-306 is a double-balanced mixer. It uses no filtering or tuned circuits to achieve isolation of greater than 20db between any 2 ports. Freq. range is 5mc to 100mc for all ports. The unit may be used as a mixer or modulator with input and output freqs. anywhere within the 5-100mc band. Replaceable hot carrier diodes obtain low noise figure (8db max.) and min. intermodulation distortion. External bias provides for optimum operation at drive levels from 0.5 to 50mw. It can be used as an up and down converter mixer to give double sideband output with carrier suppressed 20db or more. Anzac Electronics, Inc., Moody's Lane, Norwalk, Conn.

Circle 227 on Inquiry Card

steatite, alumina, ceramic & lava insulators

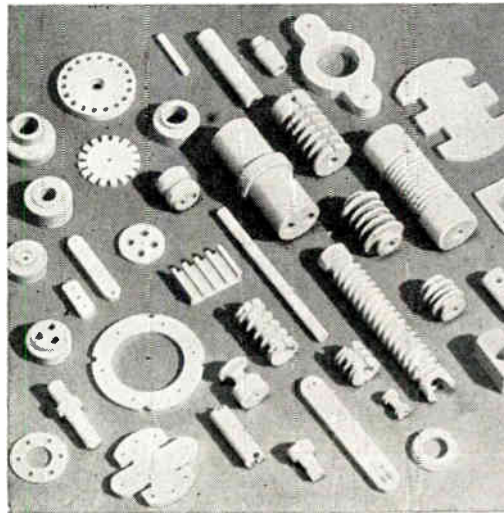

for
electrical
and
electronic
applications

Custom-molded, extruded or machined to close tolerances to meet your exact specifications. Prompt delivery at low cost on large or small orders. Over half a century of service is your guarantee of complete satisfaction.

FIND OUT TODAY. Illustrated bulletin with complete technical data will be sent on request.

SUPERIOR STEATITE & CERAMIC CORP.

87 West Forest Avenue, Englewood, N. J. • 'phone: (201) 568-4555

West Coast Representative:

Yarbrough Sales Co., 1608 Orange Street, Alhambra, California • 'phone: (213) 283-0668

Circle 94 on Inquiry Card

MIDGET IN SIZE

GIANT

IN POWER

NOW!

New and Smaller Sizes TYPE LK Rectangular High Voltage CAPACITORS

"The little one" with the tremendous power!
4 times the life of MIL-C-25A in case sizes reduced up to 80%! And you also get: superior resistance, better power factor, withstands greater overloads, may be operated to 125° and voltage ratings from 600 to 500,000 volts.

Write today for Bulletin LK
Also ask for FREE pocket size
"Comparator" and "Conversion" chart

Plastic Capacitors, INC.

2620 N. Clybourn • Chicago 14, Illinois
DI 8-3735



Custom  Engineering at
Production Prices

*IF you need a
"thing-a-mabob"
to do the job...
it's as easy as*

ONE...

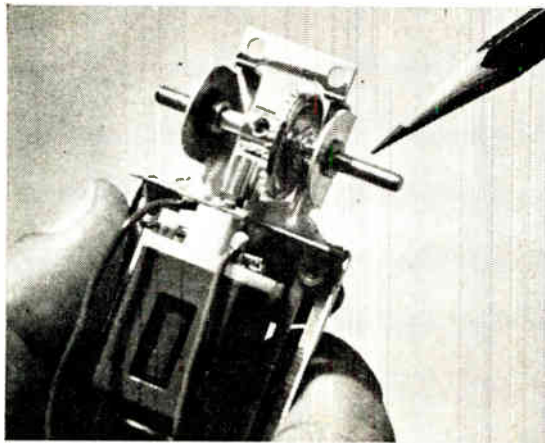

TWO...



FREE!

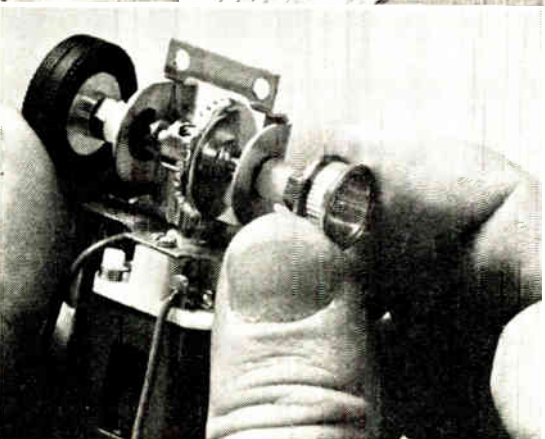

*...with the design-it-yourself Fischer
"Uncommon Parts" Idea Kit*

With the aid of this kit you simply figure the size and shape of the special part you require... sketch it with its mating parts on a self-mailing drawing/specification sheet and return it to Fischer for production. If you need additional assistance, Fischer's factory engineers are at your service.

*Send for your
free copy today*



B2535-FS

Fischer

SPECIAL MANUFACTURING CO.
492 Morgan Street
Cincinnati, Ohio 45206
Phone: 513-961-1280

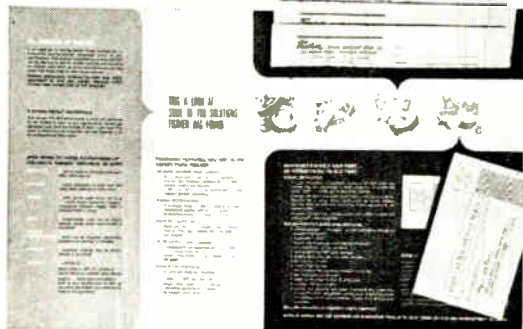

Circle 95 on Inquiry Card

MICRO-MINIATURE RESISTORS

They are 0.102 in. long and 0.035 in. dia. and are rated at 30mW.

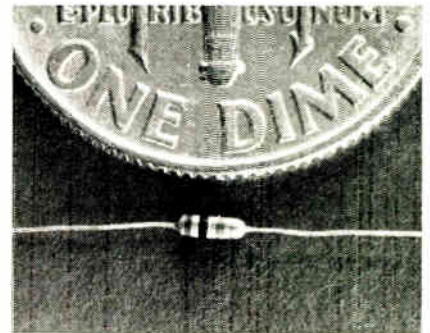

RKL 2 resistors are designed for hybrid or cordwood circuits. Resistance values are 47Ω to $100K\Omega$ ($\pm 20\%$ or $\pm 10\%$). The carbon deposit is extended to cover cavities at the ends of the rod. The leads are soldered to nickel plating overlaying the carbon in these cavities. This assures stable electrical contact, a strong mechanical bond and provides a long resistance path. Quantity prices are as low as 18¢ each. British Radio Electronics Ltd., 1742 Wisconsin Ave., N.W., Washington, D. C.

Circle 228 on Inquiry Card

WIRING SYSTEM

Instructs production wiremen in point-to-point wiring.

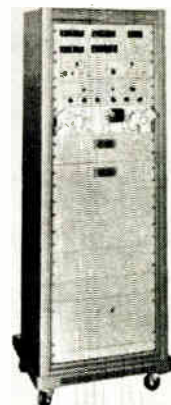

This zero defect wiring system instructs production wiremen in point-to-point wiring with numeric, alphanumeric or other illuminated displays. It verifies that punched tape instructions were correctly carried out before providing new instructions. Automatic testing for continuity or shorts is also provided. The system prevents errors from being built into products; eliminates wiring debugging, repair and reinspection; and provides automatic mode for continuous in process quality assurance. Micro Metrics, Inc., 176 Pennsylvania Ave., Paterson, N. J.

Circle 229 on Inquiry Card

new generation

TALYSURF
surface measuring machine

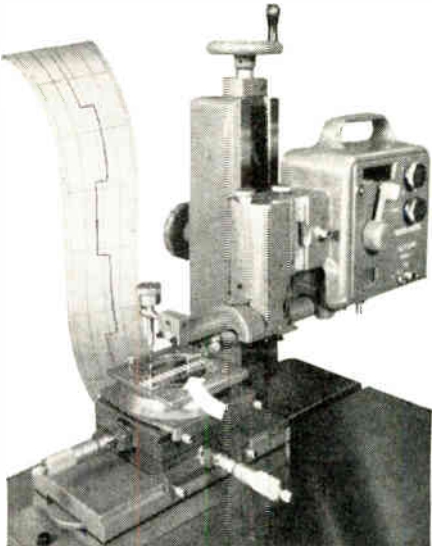

Determines Thickness and Analyzes Surface of Microcircuit Thin Films

The Talysurf Model 4 measures and records variation in surface finish of substrates and deposits; and thickness of deposits. At 100,000X each chart division equals 250 A with estimation to 50 A. Eight magnification values range from 500X to 100,000X. Accuracy of the calibration is within 2% of the calibration master.

With one traverse, the practically weightless fine stylus electronically traces an actual surface profile. The Talysurf record is a true inkless straight line graph of every irregularity—the final, acknowledged authority for precision. It is your guarantee, whatever the surface finish specification, for thin film or any parts requiring unquestioned accuracy—whether of hard or soft material, flat or curved shape.

For complete information concerning Talysurf and Interferometric Methods, write Dept. TE-115.



ENGINEERING INSTRUMENTS DIVISION

ENGIS EQUIPMENT COMPANY
8035 AUSTIN AVE. MORTON GROVE, ILL.
TELEPHONE 312 • 966-5600

Circle 96 on Inquiry Card

NEW PRODUCTS

MINIATURE CONNECTOR

Said to give zero defect performance after numerous quick disconnects.

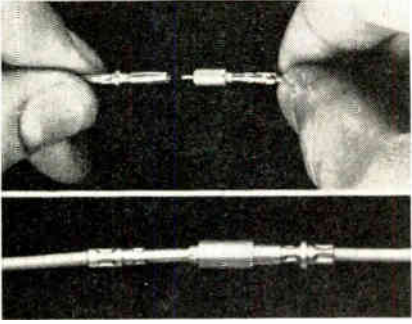

The ConeX series are miniature wire-to-wire interconnecting devices. Overlapping segments of the 2 wires, hand-inserted into the devices, are forged into 1 section with electrical conductivity better than that of an equivalent length of wire. ConeX may be connected and disconnected any number of times and at any point within a circuit with a hand swaging tool. Its simple construction, plus wire-to-wire contact, protects it against hostile amb. environments, shock and vibration. Solatron Enterprises, 5658 Bankfield Ave., Culver City, Calif. 90230.
Circle 232 on Inquiry Card

FIXED RESISTORS

The 1/8w. hot molded fixed resistors are ideal for miniaturized equipment.

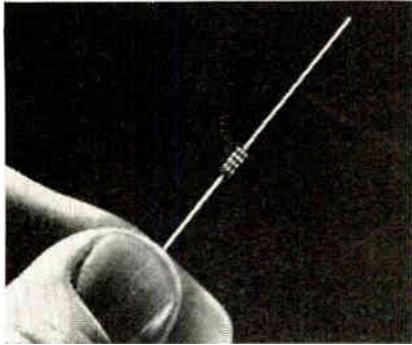

Type BB hot molded resistor is rated 1/8w. at 70°C amb. It offers a theoretical packaging density approaching 730K units/cu. ft. The resistor, with full length leads, weighs 0.074 grams. They may be used with encapsulating casting resins. The leads are adaptable to substantial weld scheduled latitude, and they are solder-coated to make them readily solderable even after long periods of storage. The resistors meet the requirements of Mil-R-11, Style RC05 and are available in resistances from 2.7Ω to 100 megohms. Allen-Bradley Co., 136 W. Greenfield Ave., Milwaukee, Wisc. 53204.
Circle 233 on Inquiry Card

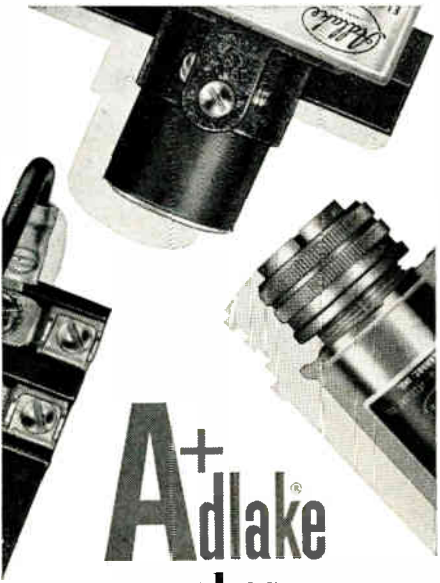

A+ Adlake

makes more kinds of mercury relays than anybody



Send for a free catalog.

A recent addition to the Adlake line: the polarized bistable mercury wetted contact relay, pictured above, which delivers speeds up to 100 operations per second. Others include: time delay; load (contacts open or closed); wetted contact (including epoxy encapsulated and sensitive non-bridging).



THE ADAMS & WESTLAKE COMPANY
Elkhart, Indiana

Dept. R-8811 Relay Division
Dial Area 219 CONgress 4-1141

Circle 106 on Inquiry Card

ONE HEAD REPLACES TWO!

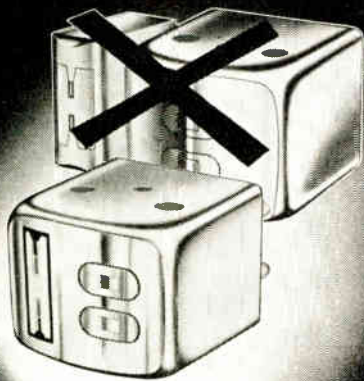

**THREE FUNCTIONS...
DOZENS OF REASONS
TO SPECIFY IT!**

*new combination
head series provides
erase-record-play
in 1 compact case!*

Save space and money in recording equipment with Nortronics Combination Erase-R/P heads! Mount only one head instead of two—Also can be used to give three head performance with only two heads.

NOW, Nortronics offers, "Combo" heads in 4-track stereo—4-track mono—2-track stereo—2-track mono—All featuring Nortronics laminated low loss core structures for the ultimate in high frequency performance!

Each style and version is available in a wide range of standard impedances for all types of circuitry. Each has the following standard Nortronics features: Deposited quartz gaps; Highly polished all-metal faces; Superb shielding; and they're available now!

**Write for Form No. 7177A
for Complete Information**

Nortronics
8149-H 10th Ave. N., Minneapolis, Minn. 55427

Circle 97 on Inquiry Card

NEW PRODUCTS

MILLIVOLT SYSTEM

Reads the output of any load cell, pressure transducer or low level signal.



Model H reads true force in the "curve" mode with a standard load cell. The accuracy is $\pm 0.025\%$ of reading. It reads mv/v. on the plus or minus mode of any device with an accuracy of $\pm 0.015\%$ of reading. The system has automatic balance, requires no stabilization, is completely portable and can be set up with a 10 min. warm up time. Operation is extremely simple. Correction or multiplication factors are not necessary; the only requirement is load and read. Gilmore Industries, Inc., 3355 Richmond Rd., Cleveland, Ohio. 44122.

Circle 240 on Inquiry Card

ANALOG MULTIPLIER

Output is proportional to instantaneous product of 2 input voltages.

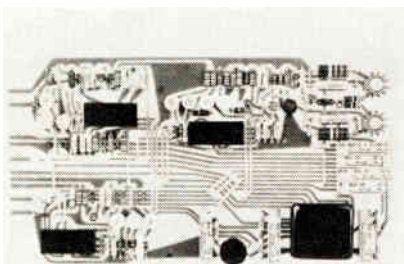

Halleflex® Model 1700-153 analog multiplier is a self-contained solid-state device. This unit consists of 2 input amplifiers, a multiplier using 2 thin-film Hall-effect voltage generators and an output amplifier. True algebraic products are obtained through 4-quadrant multiplication, and the resultant output voltage has a true mathematical sign. Power requirements are ± 20 vdc. Output voltage is 0.1 times the 2 inputs within the range of -10 to $+10$ vdc at 1ma. Static accuracy is $\pm 0.5\%$ of full scale. Helipot Div. of Beckman Instruments, Inc., 2500 Harbor Blvd., Fullerton, Calif. 92634.

Circle 241 on Inquiry Card

BATTERY CHECK-OUT

Provides complete and automatic electrical check-out of exotic batteries.



This battery analyzer, discharger, and charger tests silver zinc, silver cadmium, nickel cadmium, conventional lead acid batteries, and individual cells of any battery type. Manual operation allows selection of closely-held constant current charge or constant current discharge at all battery or cell voltages, or constant potential charge with current-limit crossover. An ampere hr. read-out in both charge and discharge modes provides indication of battery capacity and acceptability. Test circuits analyze the battery. Macarr Inc., 4360 Bullard Ave., New York, N. Y.

Circle 242 on Inquiry Card

DC POWER SUPPLIES

Compact, well regulated dc supply with 20 watts output.



STB Series Models 6102A and 6106A use as their reference element a temp.-compensated zener diode having a temp. coefficient of less than 20 ppm/°C. A high gain feedback amplifier with a matched silicon differential amplifier package monitors and controls the output voltage. The input voltage is 105-125/210-250vac, single phase 48-63 cps. The output of the 6102A is 0-40v. at 0-500ma, and the output of the 6106A is 0-100v. at 0-200ma. Ripple and noise is less than 40 μ v RMS and less than 100 μ v peak to peak. Hewlett-Packard/Harrison Div., 100 Locust Ave., Berkeley Heights, N. J.

Circle 243 on Inquiry Card

FLUORESCENT COATING

For printed circuit boards.
Simplifies production control.



Eccocoat T 264 F is a 2-part, thixotropic epoxy coating designed for PC boards. In daylight it is transparent and water white, while under ultraviolet light it fluoresces a bright yellow green. Inspection under UV highlights surfaces that have not been coated, thus providing a simple and rapid means for quality control. It is a solventless system, so that any porosity in the laid-down film is eliminated. Its adhesion to plastics, ceramics, glass, metals and wood is excellent. Emerson & Cuming, Inc., Canton, Mass.

Circle 244 on Inquiry Card

IMAGE ORTHICON

Allows stations to shoot good quality color in black and white lighting.



The Z7866 low-light level image orthicon can be used for low-light level conditions in the studio, as well as for such remote pickup as night time sports and news events. Peak-to-peak signal vs. RMS noise is 40:1 to 45:1. The new I.O. has a long-life target which lasts about 4000 hrs. Low noise is achieved with a unique construction feature. The high sensitivity and high resolution enable the tube to produce good-quality color pictures with 50-100 ft.-candle illumination, and black and white pictures in 25-50 ft.-candles. General Electric Co., Electronics Park, Syracuse, N. Y.

Circle 245 on Inquiry Card

NEW FROM KNIGHTS

new low price

proportional
control ovens
for precise
control of
temperature
environment
for crystals
and components.



Four new proportional control ovens — 952 thru 955 Series — eliminates usual noise problems associated with thermostat controlled ovens. Temperature remains constant without deviations due to thermostat on-off cycling found in other devices. Models 952 and 953 are designed primarily for crystals and small components. The larger Models 954 and 955 are for large components, oscillators, etc. and can be supplied with 4, 7, or 9 pin internal sockets. Standard operating temperatures are 65°, 75° and 85°C ± 5°C. Other temperatures and closer tolerances are available. At constant ambient temperature oven stability is ± .025°C max.

Standard input voltage is 28VDC. Other voltages available on special order.

For detailed information request Bulletin 952-5 from your CTS Knights representative or from the main office.



CTS Knights, Inc.

of Sandwich, Illinois
(formerly The James Knights Co.)
a subsidiary of CTS Corporation, Elkhart, Indiana



NEW PRODUCTS

We say our varactors are the most reliable

...who doesn't?

So far as we know, nobody is in the business of deliberately making "unreliable" varactors.

Given the standard production, packaging and QC techniques, the manufacturers of these useful devices do a pretty good job. Unfortunately for reliability engineers, what is generally considered as a satisfactory failure rate for varactors would be considered disastrous in, say, transistors.

When we at Philco decided to offer varactor diodes, we felt — frankly — that

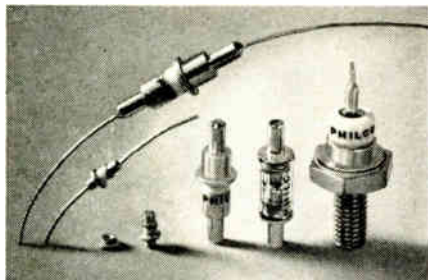

this reliability problem was the soft underbelly of the varactor business. And that our ultimate justification would have to be in offering a wide range of demonstrably more reliable devices.

Today, our expanded line of epitaxial silicon varactors features units fabricated by planar processes. The inherent reliability of this technology is obvious. So much for the first step. It soon became evident, however, that planar technology alone will not assure low failure rates. Special care is necessary in both preseal and postseal processing. We take it.

Thermally bonded junction contacts, welded-ceramic packaging, planar technology, all make for excellent *a priori* evidence of reliability. We didn't stop there. We measured. High-temperature storage. Stress dissipation. Post-storage mechanical and thermal tests. Bond strength.

We came up with a failure rate of 0.001 per cent/per 1,000 hours. On adequately large samples. For an MTBF comparable to transistors throughout the entire line.

Don't take our word for it. Send for your copy of the complete test documents.

It remains only to say that all required varactor types in all necessary packages are available. And that, astonishingly enough, this validated superior performance costs no more. Same price.

For prompt technical help call, write or wire Russ Wright, or at least circle the bingo card! (Phone 215-855-4681.)

SOLID-STATE PRODUCTS OPERATION



Circle 100 on Inquiry Card

MAGNETIC DRUM HEAD

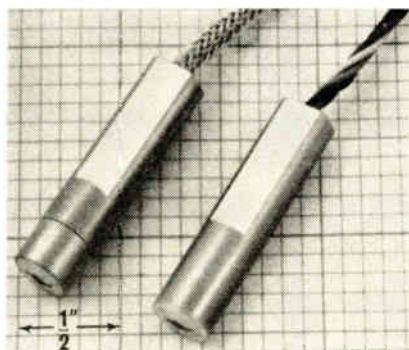

For use with non-contacting magnetic memory or storage drums.

The 4047D can be used alone or in multiples in a variety of operating mounts. Heads are individually adjustable for head-to-drum spacing. Max. mechanical stability is achieved by using a metallic structure throughout. It integrates into both solid-state and vacuum-tube circuits and withstands continuous 120ma dc without damage. Standard inductance is 67μh for each leg at 100kc with a gap of 0.001 in. Industrial Div., Pickering & Co., Inc., Sunnyside Blvd., Plainview, L. I., N. Y.

Circle 234 on Inquiry Card

TELEMETRY RECEIVER

Provides high-quality reception under severe electromagnetic interference.



The Model 4004 DTR (Diversity Telemetry Receiver) rejects co-channel and adjacent-channel interference and gives optimum RFI isolation. It operates through the S-band. Two receivers and a predetection combiner on one chassis give improved performance and simplified maintenance. The 4004 DTR is completely modular. Radio-freq. tuning units to cover 130 to 2300mc plug in from the front panel. The internal plug-in modules can be changed without system realignment. A switch on the tuner provides continuous tuning across the band, or selects 1 of 2 crystal-controlled freqs. for fixed signal reception. ITT Federal Laboratories div. of ITT Corp., San Fernando, Calif.

Circle 235 on Inquiry Card

When You Think of a Wire Source for "Specials"

... Think of **Columbia Wire and Supply Co.**

Columbia Wire can assure the finest service for special wire requirements. We are constantly producing products for the production lines of consumer and military oriented manufacturers. This includes braiding and shielding • harnesses • marked and numbered leads • extension cords and cables • cut leads with terminals • assemblies • automatic terminal attaching • wire stripping • power cord sets.

For fast delivery on stock items, Columbia stocks millions of feet of many products — including: air conditioner cable ■ automotive cable ■ coaxial cable ■ hi-temp wire ■ hi-voltage wire ■ hook-up wire ■ inter-com wire ■ juke box speaker cable ■ microphone cable ■ shielded cable ■ shielding-braided copper ■ shielded multi-conductor cable ■ speaker cable ■ television wire and cable ■ test lead wire ■ tinned copper-solid ■ U/L service cord ■ Teflon ■ mil-spec hook-up ■ mil-spec cables ■ heater cord breather tube cable.

For your next wire need, standard or special, ask Columbia... your order will be given prompt and careful attention.

Write for Catalog 111



Columbia
WIRE & SUPPLY CO.
2850 IRVING PARK ROAD
CHICAGO 18, ILLINOIS

Circle 101 on Inquiry Card

NEW PRODUCTS

HIGH POWER TERMINATIONS

Highly efficient dummy loads cover freq. range from 3.95 to 40gc.

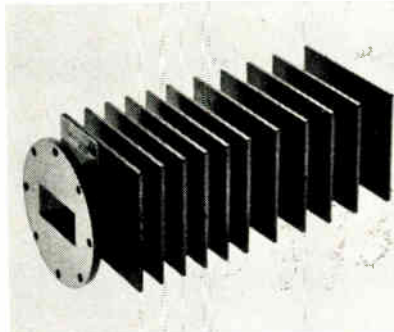

A series of 7 standard terminations are available for terminating high-power waveguide transmission systems. A new dissipative material eliminates common problems such as deterioration at high temp., moisture absorption, and damage due to shock and vibration. All units have external cooling fins and are equipped with standard waveguide flanges. They provide high power absorption combined with min. vswr characteristics in a small physical configuration. No auxiliary external cooling is required. Waveline Inc., Caldwell, N. J.

Circle 236 on Inquiry Card

WIRE UN-WRAP TOOL

Removes and replaces wire connections on solderless type terminals.



This hand tool removes and replaces coiled wire connections on wire wrap type terminals. It does the job without the usual procedure of destroying the connection by uncoiling, cutting off the wire, stripping insulation, and then gum wrapping a new connection. The un-wrap end of the tool slightly loosens the wire coil so that it may be removed intact from the terminal. When located on another terminal the re-wrap tool retightens the wire coil. Time used is sec. and no damage to the coil results. McCallus Industries Inc., 6324 Vesper Ave., P. O. Box 88, Van Nuys, Calif. 91408.

Circle 237 on Inquiry Card

ELECTRONIC INDUSTRIES • November 1965

MINIATURE LAMPS

Bulb diameters as small as 0.094 in.; length is 0.145 in.



These microminiature lamps are available in voltages from 5 to 28 and in 3 styles: sub-midget flanged base, unbased with wire terminals, and with axial lead wire terminals. "Tipless" style bulbs permit undistorted end viewing. Lamp life is 100,000 hrs. The axial-lead style was developed for imbedding in thin wall panels. It provides a broad source of light, dissipates heat over a wide area, allowing a wider selection of panel materials, and eliminates the tendency to terminal lead short circuits. Hudson Lamp Co., Kearny, N. J. 07032.

Circle 238 on Inquiry Card

BWO POWER SUPPLY

Built for severe Mil-E-5400 Class 2 environmental requirements.



With the Model PM 1346, high-voltage, lightweight, programmable dc-to-dc BWO power supply, dc power is taken from 28vdc source and converted to 3 well regulated dc outputs. Output #1 is programmable from 300v. to 1350v. at 8ma. Ripple is less than 100mv. Output #2 gives 90 to 150vdc at 1ma and a ripple of under 100mv. Output #3 provides 6.3vdc at 1a. for the BWO filament. The output varies less than 1% under all possible combinations of line variation, load change, long term drift, and amb. temp. change. Pioneer Magnetics, Inc., 1745 Berkeley St., Santa Monica, Calif. 90404.

Circle 239 on Inquiry Card



PORTABLE VIBRATION METER

CEC's new I-157 Vibration Meter offers, along with portability, many significant advantages over previous models.

Its solid-state electronics are equally at home with a battery pack or a-c power, thus making the I-157 an ideal portable instrument for field use, or for rack mounting in the lab or on the production line. General accuracy has been improved even further, including a more accurate internal calibration for transducers. In addition, the new vibration meter provides six selectable inputs and a means of checking continuity of pickup circuits.

Applications—Wherever you find vibration... from diesel compressors, tugboat engines and gear boxes to automobile motors, gas turbines and engine test cells.

Basic specifications—*Frequency:* 5 to 2,000 cps (displacement); 5 to 20,000 cps (velocity). *Displacement:* 0.0005 to 0.500 inch peak-to-peak full scale. *Velocity:* 0.05 to 50 ips average full scale. *Sensitivity adjustment:* ±1%. *Linearity:* ±2%. *Frequency response:* ±2%. *Input impedance:* 10 K ohms at ±5%. *Input voltage:* 90-140/180-260 v rms at 50-400 cps or two 9 v batteries in series when using optional power supply. Provisions for three plug-in filters as well as connections for CEC Type 1-159 Variable Filter.

For complete information, call or write CEC for Bulletin 1157-X3.

CEC

Transducer Division

CONSOLIDATED ELECTRODYNAMICS
A SUBSIDIARY OF BELL & HOWELL/PASADENA, CALIF. 91109
INTERNATIONAL SUBSIDIARIES: WOKING, SURREY, ENGLAND
AND FRIEDBERG (HESSLEN), W. GERMANY

Circle 102 on Inquiry Card

NEW PRODUCTS

REFERENCE DIODES

Temp. coefficients of 0.001%/°C over a current range (0.5 to 7.5ma.).

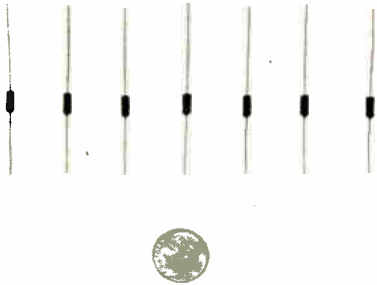

Series 1N4916 through 1N4932A are 19.2v., low-noise, temp. compensated reference diodes. The diodes have a max. steady power dissipation at or below +50°C of 400mw and operating temp. range of -65°C to 175°C. They offer low noise and are ideal for use in audio, or small signal circuits where noise interference is to be held to a min. Typical noise is approx. 0.2μv/sq. ft. cycle. Dickson Electronics Corp., 310 Wells Fargo Ave., Scottsdale, Ariz.

Circle 250 on Inquiry Card

CABLE CLAMP

Holds cable in place without screws or other mechanical fasteners.

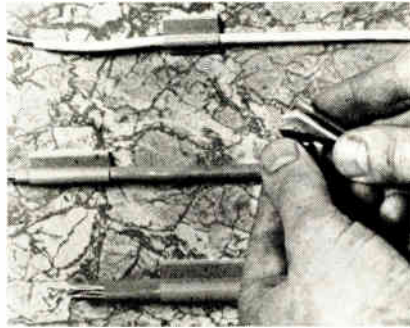

The Scotchflex brand adhesive cable clips are constructed of polyvinylchloride with a foam adhesive backing. They are available in 4 sizes to handle bundles or jacketed cable from 1/8 to 1/2 in. in dia. The new, foam adhesive backing allows the clamp to be quickly and firmly mounted to any clean, dry surface, including such areas as electronic equipment chassis, walls, desks, etc. They hold JKT or coaxial cables. Dept. D5-700, 3M Co., 2501 Hudson Rd., St. Paul, Minn. 55119.

Circle 251 on Inquiry Card

TRACKING RECEIVER

Freq. range is 225 to 260mc. RF input: 3 channels from monopulse feed.

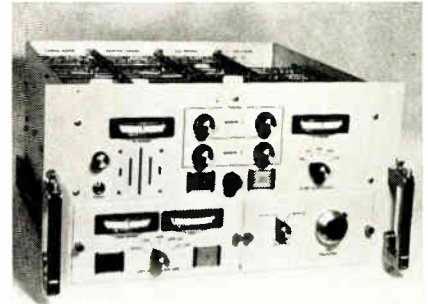

Model 103 Monopulse Tracking Receiver, supplied with a 3-channel pedestal-mounted preamplifier-converter unit, covers the 225 to 260mc band. One sum channel plus 2 identical error channels derive azimuth and elevation error signals for control of large ground antennas. Noise figure is better than 4.5db across band. Gain is 30db (±1db) across band to 50Ω loads. UED Aerospace Div., Teledyne Systems Co., 12930 Panama St., Los Angeles, Calif. 90066.

Circle 252 on Inquiry Card

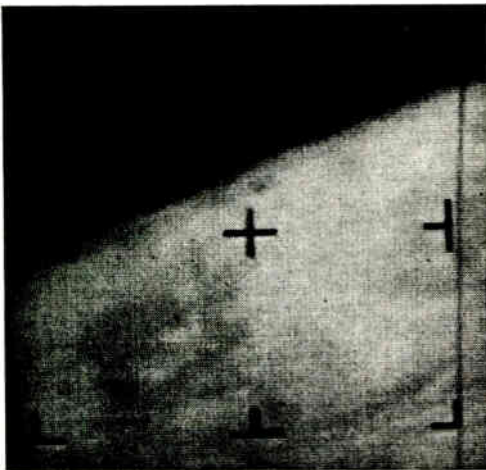

First close-ups of Mars sent across 134,000,000 miles of space

The amplifier: Hughes TWT Model 216H

NEW PRODUCTS

GATED FLIP-FLOPS

Contains 4 flip-flops which are useful for control functions.

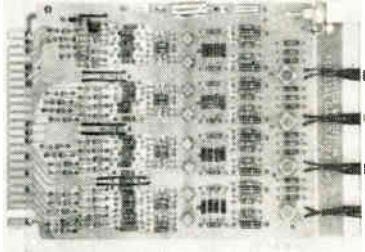

Model 03 module is a complete new line of 1MC system logic functions available in both germanium and silicon versions. The flip-flops, which can be used either individually or together, are alerted by a "O" level at one input and triggered by a positive-going transition at another point. Since the triggering transition is typically the trailing edge of a pulse, all required conditions can be set up without encountering race condition or critical timing problems. Navigation Computer Corp., Valley Forge Industrial Park, Norristown, Pa.

Circle 253 on Inquiry Card

HIGH VOLTAGE SUPPLY

Furnishes 300 to 5000vdc; accuracy to 0.1%. Output is 15ma.

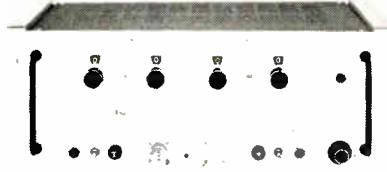

The Model 243 provides potentials for photomultiplier tubes and other detectors. Other applications include calibration tests, voltage gradients studies and leakage resistance measurements. Four in-line calibrated dials permit the output voltage to be set in 1v. steps from 300 to 5000vdc. Accuracy is within ± 0.1 of dial setting. A trimming potentiometer permits interpolation between steps with 15mv resolution. Max. current load is 15ma dc. Output polarity can be positive or negative. Keithley Instruments, 12415 Euclid Ave., Cleveland 6, Ohio.

Circle 254 on Inquiry Card

MULTIPLEXERS

High-speed units handle as few as 8 channels and as many as 128 channels.

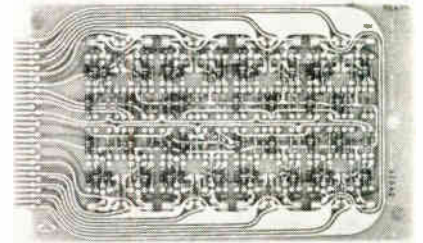

Series 970 multiplexers can handle from 8 to 128 channels. The units accept single-ended inputs or differential 3-wire inputs consisting of a differential input and guard shield. Gain is adjustable from 1 to 20, so that input signals as low as ± 500 mv full scale are amplified to ± 10 v. With an internal impedance less than 1Ω the amplifier delivers 10ma to the multiplexer load. For differential inputs, an input resistance of 100 megohms is maintained and amplification is available externally. Astrodata, Inc., P. O. Box 3003, 240 E. Palais Rd., Anaheim, Calif.

Circle 255 on Inquiry Card



Just one of Hughes Traveling Wave Tubes in space, the Model 216H aboard Mariner 4 is dramatic proof of what you, too, can expect. Their long life is indicated by over 630,000 failure free hours accumulated by 40 tubes (including 30,000 hours in space). Reliability? MTTF 274,000 hours at 90% confidence.

Hughes TWTs aboard Mariner, the Early Bird and Syncom II and III satellites have logged over 30,000 failure-free hours of operation. Other programs scheduled to use them include: Apollo, Surveyor, Pioneer, the Lunar Orbiter, Applications Technology Satellite and Saturn Telemetry. Shouldn't you consider Hughes when

it's time to choose? For information, please contact your nearest Hughes Microwave Tube Division office: Los Angeles, 11105 S. La Cienega, SP 6-1515, Ex. 6661; Lexington, Mass., 862-6800; Red Bank, New Jersey, 741-1259; Washington, D.C., 234-9300.



Singer Co. Metrics Div. makes it easier for you to specify

Refer to
their 54-page catalog
in the 1965

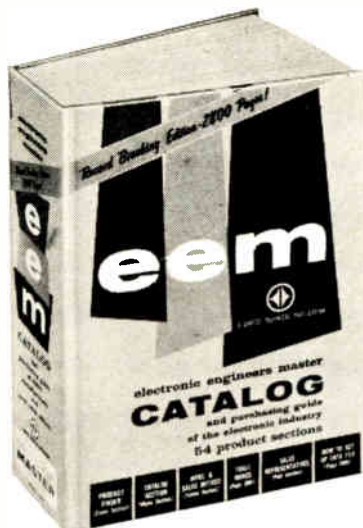

eem — Electronic Engineers Master
645 Stewart Ave. • Garden City, N. Y. 11533

Circle 120 on Inquiry Card

NEW PRODUCTS

COMPACT THYRATRON

*Designed specifically for radar uses.
Mean anode current is 600 ma.*

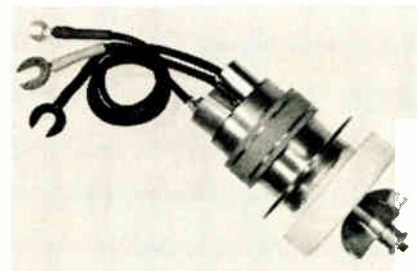

E2830 is a metal-bodied deuterium-filled pulse modulator thyratron. Tube measures $4\frac{1}{2} \times 2\frac{1}{4}$ in. dia. and has a peak anode voltage of 20kv., forward and reverse, peak anode current is 500a. It can also be used as a grid-controlled rectifier with ratings of 20kv., forward and reverse, and 1a. mean current. The metal body facilitates grid cooling and enables the gas density of the tube to be kept constant. This contributes to compactness and well controlled triggering characteristics at high power. The M-O Valve Co. Ltd., Brook Green Works, London W.W. 6, England.

Circle 256 on Inquiry Card



Big, 16-page, illustrated catalog lists over 7000 stock Brady Wire Markers . . . Tech Data, Industrial and Mil specs, types, sizes, prices . . . plus time-saving automatic application methods. Over 200 individual self-sticking automatic markers included for testing. Get acquainted with Brady's efficient, low-cost wire marking system. Order your *free kit* now.

148-B

W. H. **BRADY** CO., 75c W. Glendale Ave., Milwaukee, Wis. 53209
EST. 1914

Manufacturers of Quality Pressure-Sensitive Industrial Tape Products, Self-Bonding Nameplates, Automatic Machines for Dispensing Labels, Nameplates, Masks and Tape

Circle 105 on Inquiry Card

MEGOHMMETER

Available for measuring resistances to 10 million megohms.

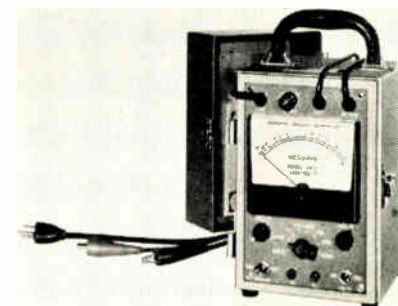

Model 2851 Vibrotest portable megohmmeter measures resistances as great as 10 million megohms at 500 vdc, or 2 million at 100v. Its 100v. test potential complies with the new EIA standard for measurement of composition, film and wirewound resistors having resistances over 100K Ω . The range may be multiplied by 1, 10, 10², 10³, 10⁴, and 10⁵ by means of a rotary selector switch. Six megohm ranges are available at either 500vdc ($\pm 5v.$) or at 100vdc ($\pm 5v.$). Accuracy of $\pm 2\%$ is achieved over the greater portion of the scale range when used at 500v.; at 100v., accuracy is within $\pm 5\%$ over most of scale. Associated Research, Inc., 3777 W. Belmont Ave., Chicago, Ill. 60618.

Circle 257 on Inquiry Card

"Microwave Energy Sources"

By T. Moreno
V.P., Tube Div.
Varian Associates



MODERN RADAR SYSTEMS that utilize sophisticated pulsing techniques have forced the development of high-power, wide band amplifiers with good phase linearity. Modern crossed-field amplifiers and hybrid klystron-TWT amplifiers deliver high peak and average powers over greater than 10% bandwidths. Further technological progress in this area can be anticipated.

Requirements of forward scatter and satellite communications systems have led to notable progress in sophisticated, high-power, continuous wave microwave transmitters. A new generation of sophisticated, high-power klystrons has been evolved for these requirements. The satellite systems have also led to the development of ultra-reliable traveling-wave tubes that are carried in the satellites themselves.

There is currently much government-sponsored development activity in the area of sophisticated broadband TWT's for electronic countermeasures. It is evident that a great need is felt for higher-performance systems in this area, and as a result, much government funding has been concentrated in advancing the state-of-the-art.

In the low-power area, significant inroads have been made by solid-state sources into an area once monopolized by vacuum tubes. Microwave transistors have begun to appear, coupled with multipliers using varactors and step-recovery diodes, they provide energy for a variety of new applications. In the future, bulk effect semiconductor devices, such as Gunn-effect oscillators and Reed diodes, can be expected to receive much attention, and great improvements in performance will almost certainly be achieved.



Microwave Semiconductor Devices

By Dr. Arthur Uhlir, Jr.
V.P., Manager, Semiconductor Div.
Microwave Associates, Inc.

HIGHER-POWER HIGH-FREQUENCY TRANSISTORS serve as attractive sources in their own right up to 2 GHz and have moved the fundamental oscillator (or power amplifier) for many transistor-varactor sources to the 500-1000 MHz range. One watt of cw power at 12GHz will become reproducible and relatively economical. Packaging of plural varactor elements for convenient use will be a significant advance. Series and parallel connections will merely in-

crease power capability, while push-pull and bridge circuits will also improve electrical stability and bandwidth.

Increasing reliability in packaged PIN diodes for microwave switching will be paralleled by availability of reliable PIN chips for hybrid micro-electronic circuits.

No new receiving mixer designs up to 5 GHz should be undertaken without consideration of Schottky-barrier mixer diodes which will have reproducibility far improved over earlier experimental types. For X- to K-band, point-contact devices made with fused-glass pin beads and epitaxial silicon represent the first point contact diodes to be made in a package with good thermal expansion match.

Looking more than one year ahead, one can be sure that basic circuits such as balanced mixers will be integrated. Also, new methods of microwave generation may find practical application. Avalanche oscillators are already available for experimental evaluation, largely because of the reproducibility inherent in silicon devices at the present time. On a laboratory basis, however, gallium arsenide Gunn effect devices are capable of more efficiency: 5% versus 0.1%.

"Microwave Tubes"

By: Thomas D. Sege
General Manager
EIMAC, A Division of Varian Associates



THE STATE-OF-THE-ART IN MICROWAVE ELECTRON TUBES was for a long period the limiting factor in weapons system design. Today, systems may include a mixture of tubes and semiconductor devices, or may even include no electron tubes.

Faced with prospects of diminished business from the military, the industry responded with a surge of manufacturing economies and increased product reliability. These resulted from the rapid maturation of techniques throughout the industry's technologies: dry pumping with its singularly beneficial effect on tube life is one example.

Startling new products, such as the traveling wave tube are now unlikely. Rather, one can expect a strengthening of the trend toward refinement and control which has already brought some tube processes to the point where computerized design programs can be used with confidence.

The industry is entering other sectors of the economy. After serving almost entirely within that most elegant of electronic regimes—communications—microwave is moving out of the parlor into the kitchen to cook and bake, and into the industrial plant for the controlled and efficient heating and drying of a vast range of materials.

The microwave techniques of the youngest element of the tube industry are being absorbed by the eldest. Planar gridded triodes operating at ever increasing frequency and power levels have characterized this trend to date.

Generally within the industry, design problems are no longer approached with an air of mixed excitement and apprehension but rather with confidence in anticipation of accomplishment.

"Solid State At Microwave Frequencies"

By H. K. Jenny

Manager, Advanced Development Engineering
Microwave and Power Devices,
Electronic Components and Devices,
Radio Corporation of America



RAPID ADVANCES IN THE MICROWAVE SOLID-STATE art are heralding unprecedented progress for the users of microwave frequencies. The key words are simplicity, reliability, and economy, since microwave applications have to date been very much limited by the high cost per operating hour.

Solid-state devices are rapidly moving into power-oscillator and amplifier applications. Today, cw powers exceeding 100 watts at UHF, 5 watts at S band, and 1 watt at X band have been demonstrated in integral subsystems. With-

in the next two years, these levels will increase by more than an order of magnitude.

Integrated solid-state microwave circuits which combine to perform two or more functions such as oscillation, conversion, amplification, detection, switching, limiting, and phase shifting are starting to evolve as the building blocks of tomorrow's sky-rocketing utilization of the huge microwave frequency spectrum.

A sobering thought should, however, be added. Paradoxically, technology is advancing at such a rapid pace that designs never fully realize their production potential. The circle is completed by some equipment designers who, all too often, ask for the exotic rather than for proven production hardware. This circle tends to keep the volume of a given device down and its cost up. On the other hand, many agree that a system can be more effective in terms of cost and performance if it is planned around available hardware rather than the exotic.



"Military Radar"

By Leonard Swern

Sperry Gyroscope Company,
Division of Sperry Rand Corporation,
Great Neck, N. Y.

ONE OF THE MOST SIGNIFICANT DEVELOPMENTS for radar designers is the portable, electronically scanned radar. While radar systems which scan with no moving parts are not new, those that were built in the past were very large, heavy and narrow band. Now, with the advent of the compact, low-loss, digital microwave phase shifter, it is possible to design completely passive antennas containing no power sources; and these antennas are therefore lightweight, stowable, and relatively inexpensive. Such an antenna (Fig. 1) is space fed with microwave energy from a single source. The only electrical contacts to it are the drive wires for activating the phase shifters. It may easily be hinged for air transport, and can be quickly erected at any spot. The phase shifters are short sections of waveguide or strip transmission line containing either square-loop microwave ferrites, or semiconductor variable-capacitance diodes.

... The continuing advances in solid state components—in microelectronics in general—enable the system designer to greatly increase radar reliability. Airborne and spaceborne radars can now be designed which contain no

vacuum tubes, except the CRT display. Even the source of microwave energy is a semiconductor device which has, essentially, an indefinite lifetime. The conventional low frequency portions of the radar consist of monolithic microcircuits; and the small number of interconnections between these integrated circuits is probably the major remaining source of potential failures in the system. More and more circuit functions are being integrated in a single wafer of semiconductor, and the attendant reductions in size and weight are a bonus to the increased reliability just discussed. It is important to note that the compactness which solid state techniques permit in these air and spaceborne radars allows much more sophisticated characteristics to be built into systems. We now have multi-function airborne systems containing the kind of elaborate signal processing capabilities that were formerly possible only in large ground installations. Although the advances in airborne systems are most dramatic, ground and ship-based radars have also benefited, of course, from the reliability and compactness of solid state and microcircuit technology.

Signal processing in present day radars has given them many of the characteristics of modern communication systems. Because of space limitations, we cannot give an adequate description of pulse coded systems containing adaptive features which fit them optimally both to the environment and to the threat. It is important to note though, that a very sophisticated radar technology has been built up in recent years which draws heavily on information theory and digital logic. The results of all this ferment are becoming visible now on radar sites all over the earth, and in space as well.

Phase shifter antenna design is lightweight, stowable and relatively inexpensive.

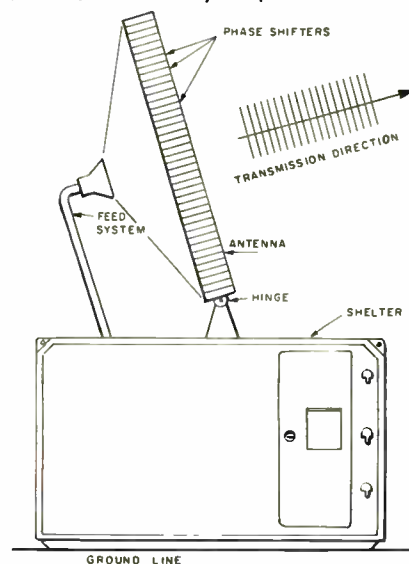



That's all the operator does with the new Ideal Precision Wire Stripper. Insert the wire, pull it out, and it's automatically precision stripped without nicking, or scraping.

The secret is a unique stripping blade design, a carbide blade mounted on a leaf spring and installed on a rotating head. The blade partially cuts insulation, then rotational force twists the slug, severing the remaining web of insulation. Since the blade never touches the conductor, stripping is nick-free. Blade adjusts in increments of .0004".

For single-conductor wire, either solid or stranded, in sizes AWG #16 to #26 with single-layer insulation including Teflon and PVC. Write for specifications.

IDEAL MAKES NICK-FREE STRIPPING AT PRODUCTION RATES AS EASY AS PUSH-PULL



IDEAL INDUSTRIES, INC.
5127-K Becker Place, Sycamore, Illinois
IN CANADA: IDI Electric (Canada) Ltd., Ajax, Ontario

Circle 109 on Inquiry Card

The tools we don't make will save you money on the ones we do

We *don't* make the slower-moving specialty hand tools . . . but we *do* make those items that meet 90% of all user demand. Because of this specialization, you benefit from the economies we enjoy in production and marketing. ■ On this basis, S-K Wayne is able to offer premium quality . . . at prices *below* those of comparable industrial lines. ■ Take the wrench you see at right. It looks better and feels better . . . because that's the way it's made. Yet it's priced to give you the finest value in combination wrenches available today. ■ The same is true of other S-K Wayne tools . . . including sockets and ratchets, industrial pliers, utility pliers, etc. Check your industrial distributor today . . . or write for Free pocket catalog.



S-K WAYNE TOOLS

S-K Wayne Tools • Chicago, Ill. 60632 • Defiance, Ohio
Subsidiary of Symington Wayne Corporation

Circle 107 on Inquiry Card

ELECTRONIC INDUSTRIES • November 1965

COAXIAL RELAYS

Our Specialty

OVER 15 YEARS
... THE NO. 1 SOURCE!

- ★ **DESIGN:** To your specifications or our proposal for your application.
- ★ **PRODUCTION:** Complete production facilities for every requirement.
- ★ **TYPES:** All types from dry circuit to 1 kw rating. DC - 4800 mc - Land based or airborne.

TO Meet MILITARY OR INDUSTRIAL REQUIREMENTS!

Many types now tooled for production!
Use our Design and Engineering facilities. . . We may have it ready for you now!

DOW-KEY CO., Inc.

Thief River Falls, Minnesota • Box 1870



DK78 Series

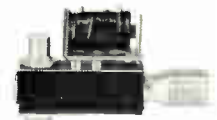

DK77 Series



DK67 Series



DK61 Series

Circle 108 on Inquiry Card

165

Specifically Engineered for
RF COMPONENTS

Q-max

A-27 Superfine
EXTREMELY LOW-LOSS
RF LACQUER



Q-MAX impregnating and coating composition penetrates deeply, seals out moisture, provides a surface finish. Q-MAX imparts rigidity and promotes stability of the electrical constants of high frequency circuits. Effect on the "Q" of RF windings is negligible.

Write for catalog today.

Q-max Corporation
MARLBORO, NEW JERSEY
Telephone: 462-3636 (Area Code 201)
Circle 121 on Inquiry Card

AUTEC ELECTRONIC SYSTEMS NOW BEING INSTALLED

Implementation of electronic systems is in process for the weapons range facility of the U. S. Navy's Atlantic Undersea Test and Evaluation Center (AUTEC), according to ITT Corp. ITT Federal Laboratories, domestic research and manufacturing division, is prime contractor for the AUTEC weapons range facility in the British Bahamas.

AUTEC, the world's most advanced undersea antisubmarine warfare (ASW) weapons testing facility, will have underwater tracking instrumentation located 10 miles off the east coast of Andros Island, about 130 miles southeast of Miami.

The sea is more than a mile deep at that point, due to a valley-like underwater depression. This ravine is about 100 miles long and 20 miles wide. The site was selected because it is one of the few deep-water locations that provides a relatively quiet, controlled sea environment that is close to land.

The weapons range will be 35 miles long and 5 miles wide, with an impact area 6,000 yards in diameter at its southern end. Underwater instrumentation will enable the Navy to accu-

rately evaluate the performance of advanced weapons whose trajectories pass through both air and water, as well as advanced torpedoes.

An underwater communications system will be installed to permit voice contact between submarines and shore facilities during test operations.

Underwater hydrophone arrays in the weapons testing area will permit tracking of submerged weapons with an accuracy greater than that obtainable by radar tracking of airborne targets.

P-C BOARD PRESS

A 30-ton laminating press, recently featured at NEP/CON '65, has all features needed for semi-automatic production of multilayer printed circuit boards, according to Pasadena Hydraulics, Inc. Platens have a total usable working area of 163 square inches. Press will develop maximum material pressure of 370 P.S.I. and will control accurately down to 12 P.S.I. Pressure control accuracy is ± 1.2 P.S.I. over the working area during heating and cooling cycle.

HART SERIES T CRYSTAL CAN RELAY

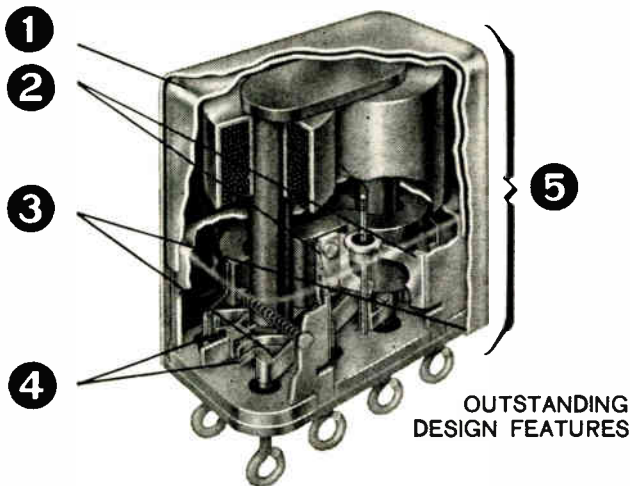

OUTSTANDING
DESIGN FEATURES

- ① **Hermetically Sealed Coil** prevents contact contamination; seals organic coil material from switch section.
- ② **Unique Hinge Design**—no pivot or bearing problems; free from wear particles.
- ③ **Welded Construction** increases reliability of joints; further reduces contamination.
- ④ **Bifurcated Contacts** increase low level switching reliability.
- ⑤ **Improved Sensitivity**—100 MW or less at pull-in.

Specify Hart Series T for sensitive, highly reliable dry circuit switching. Write for literature.

 **HART MANUFACTURING CO.**
306 BARTHOLOMEW AVE., HARTFORD 1, CONNECTICUT
Tel. 203-525-3491
a subsidiary of OAK ELECTRO/NETICS INC.

Circle 111 on Inquiry Card

**NEW
FOR 1966**

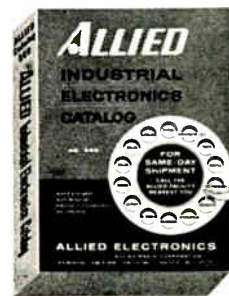

FREE INDUSTRIAL ELECTRONICS CATALOG

Here's the standard of the industry from Allied, the world's largest stocking distributor of electronic components and equipment. 552 pages. 64,000 items, 6,000 new products. Factory OEM prices. Same-day shipment. Get your personal copy now.

P&B **WIDEST SELECTION • SAME-DAY SHIPMENT**
See your Allied Catalog for Potter & Brumfield Relays: General Purpose, Special Purpose, Power, High Performance, Mercury Wetted Contact, Telephone types — available from stock.

For FREE catalog, check reader service card or write direct to:

ALLIED ELECTRONICS

subsidiary of ALLIED RADIO CORPORATION
100 N. Western Ave., Dept. 218, Chicago, Illinois 60680

Circle 112 on Inquiry Card
ELECTRONIC INDUSTRIES • November 1965

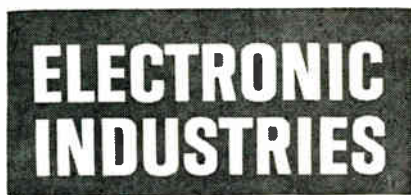

Advertisers — November 1965

This index is published as a convenience.
No liability is assumed for errors or omissions.

A	
The Adams & Westlake Co.	155
Allen-Bradley Insert Fol. p. 32	
Allied Chemical	
General Chemical Division	107
Allied Electronics	166
Alpha Metals, Inc.	143
Alpha Wire	54
American Electronic Laboratories, Inc.	108
American Machine & Foundry	
Potter & Brumfield Division	130
Ammon Instruments, Inc.	168
Amperex Electronic Corporation	106
Amperite	140
Amphenol Corporation	
RF Division	105
AMP Incorporated	17
Anadex Instruments Inc.	129
APM-Hexseal Corporation	142
Arco Electronics	95
Armco Steel Corporation	44
Astrodata	14
Automatic Electric Company	13
B	
Ballantine Laboratories, Inc.	146
Beckman Instruments	
Helipot Division	29
Belden Manufacturing Company	21
Bell Telephone Laboratories	68
Blue M Electric Company	147
Bourns, Inc.	
Trimpot Division	55, 93
W. H. Brady Company	162
Bussman Mfg. Division	
McGraw-Edison Co.	102, 103
C	
C. P. Clare & Co.	24, 25
Columbian Carbon Company	97
CMC-Computer Measurements Company	32
Conforming Matrix Corporation	128
Consolidated Avionics	109
Consolidated Electrodynamics	
Data Recorders Division	7
Transducer Division	159
Columbia Wire & Supply Co.	158
CTS Corporation	67
CTS Knights, Inc.	157
D	
Dale Electronics, Inc. Inside Back Cover	
Daven Division	
McGraw-Edison	16
DeKalb County Commission	113
Delco Radio	
Division of General Motors	36, 37
Dialight Corporation	129
Diamondite Products Mfg. Co.	126
Dow-Key Co., Inc.	165
E	
EEM-Electronic Engineers Master	162
Electro Materials Corporation	104
Engis Equipment Company	155
F	
Fairchild Instrumentation	
A Div. of Fairchild Camera & Instrument	41
Fischer Special Manufacturing Co.	154
Formica Corporation	15
G	
Genisco Technology Corp.	
Eidema Corp. Division	168
Grayhill Inc.	143
Grieve-Hendry Co.	136
H	
Hart Manufacturing Co.	166
Hewlett-Packard Insert Fol. p. 114	
Howcor Laminations	
A Div. of Howard Industries, Inc.	126

Hughes Aircraft Company	
Microwave Tube Division	160, 161
I	
Ideal Industries, Inc.	165
Industrial Electronics Engineers, Inc.	123
International Exhibition	112
Interstate Electronics Corporation	30
ITT	
Jennings Radio Mfg. Corporation	49
Wire and Cable Division	27
J	
Jerrold Electronics	122
K	
Keithley Instruments	148
Kent Corporation	6
Mathias Klein & Sons	10
KMC Semiconductor Corporation	110
M	
Mac Panel Company	28
Magnetic Radiation Laboratories, Inc.	138
Magnetics, Inc.	20
Mallinckrodt Chemical Works	48
McLean Engineering Laboratories	168
Method Electronics, Inc.	31
Minnesota Mining & Manufacturing Co.	
American Lava Corporation	57
Chemical Division	52
Electrical Products Division	124, 125
Motorola	
Military Electronics Division	137
N	
National Radio Company, Inc.	40
Newark Electronics Corporation	128
Nortronics	156
Nytronics	121
O	
Ohmite Manufacturing Co.	99
P	
Philco Corporation	158
Photocircuits Corporation	45
Plastic Capacitors, Inc.	153
Polarad Electronics Corporation	19
Potter & Brumfield	
Div. of American Machine & Foundry Co.	130
Precision Paper Tube Company	146
Q	
Q-Max Corporation	166
R	
RCA	
Semiconductor Division	Back Cover
Microwave Campaign	77
Rogan Brothers, Inc.	136
Rohn Manufacturing Co.	139
Rowe Industries, Inc.	168
S	
Sage Electronics Corp.	70
Schauer Manufacturing Corp.	142
Scientific-Atlanta, Inc.	145
Sei-Rex Corporation	69
S-K Wayne Tools	165
Sperry Semiconductor	
Div. of Sperry Rand Corporation	56
Sprague Electric Company	2, 5
Stanpat Products, Inc.	138
Superior Steatite & Ceramic Corp.	153
T	
Tektronix, Inc.	12
Telonic Industries Inc.	53
Textool Products Inc.	127
Transco Products Inc.	114
Triplet Electrical Instrument Co.	11
Trygon Electronics, Inc.	139
Tung-Sol Electric Inc.	147

U	
U. S. Components, Inc.	111
United Transformer Corp. Inside Front Cover	
V	
Varo Incorporated	141
Vector Electronic Co., Inc.	71
W	
Westinghouse Corporation	
Semiconductor Division	101
X	
Xcelite, Inc.	148



REGIONAL SALES MANAGERS

Philadelphia 19139—56th & Chestnut Sts.
(Area Code 215) SHerwood 8-2000
JOSEPH DRUCKER

New York 10017—100 East 42nd St.
(Area Code 212) OXford 7-3400
GERRY PELISSIER

Boston, Mass. 02110—10 High St.
(Area Code 617) LIBerty 2-4460
ROBERT G. SMITH

Chicago 60621—540 N. Michigan Ave.
(Area Code 312) 467-9660
JOHN W. BERNHARDT
PHILIP T. CLARK

Cleveland 44114—601 Rockwell Ave.
(Area Code 216) SUperior 1-2860
GREG JOHNSON

Hollywood, Fla. 33021
4831 Tyler St., Hollywood Hills
FRANK A. SMITH

Los Angeles 90057—
1543 W. Olympic Blvd.
(Area Code 213) DUnkirk 7-1271
GEORGE F. KELLEY
BURT UNDERWOOD

San Francisco 94103—1355 Market St.
(Area Code 415) 861-7107
DON MAY

Atlanta 30309—1776 Peachtree St. N.W.
(Area Code 404) 875-1255
JOHN W. SANGSTON

Dallas 75206—Meadows Bldg.
Expressway at Milton
(Area Code 214) EMerson 3-6426
HAROLD E. MOTT

EUROPEAN SALES OFFICES

London, S. W. (1)—67/68 Jermyn St.
St. James
MAX F. HOLSINGER

United International Industrial Press
Eitelstrasse 32
4 Dusseldorf—Rath, Germany
MAX F. HOLSINGER

FAR EAST SALES OFFICE

Tokio Marunouchi, Japan
C. P. O. Box #1572, Room 814
Tel.: 211—3506-3509
TogIn Bldg.
CLARENCE T. SAKAGUCHI

Eldema... First in Indicators

FLANGE BASE LAMP HOLDERS

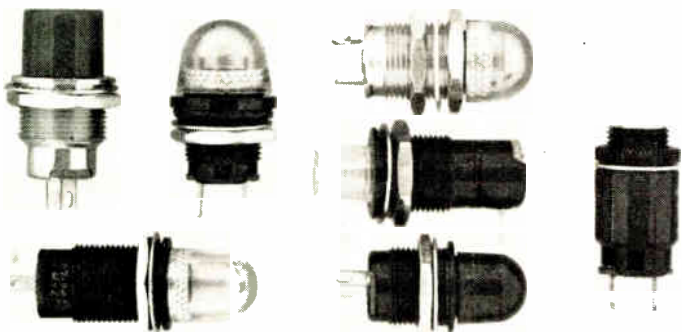

Here are some of Eldema's many styles of lamp holders—all for use with replaceable flange based long-life neon or incandescent T1-3/4 lamps. These panel indicators are available in a variety of lens colors and shapes, body sizes and finishes...with or without built-in resistors. A number of types carry Mil Spec numbers. There is an Eldema lamp holder for every application.

Write today for our catalog!

ELDEMA CORPORATION
a subsidiary of
Genisco | TECHNOLOGY |  | CORPORATION
 18435 Susana Rd./Compton, Calif./Tel. (213) 774-1850/TWX 213-639-3380

Circle 113 on Inquiry Card

FULLY AUTOMATED TELEMETRY GROUND STATION FOR NASA

A computer controlled telemetry ground station is being designed for NASA Marshall Space Flight Center by Defense Electronics, Inc. All telemetry parameters will be selected and controlled by a general-purpose digital computer.

A group of six subsystems will be designed and developed to receive and demodulate all types of Saturn telemetry data. All operational functions will be controlled by one master computer.

One feature of the system is a VHF/UHF Receiver Subsystem, consisting of eight DEI Model CR-101 Computer-Controlled Receivers. The computer can turn the equipment on or off and select any of 16 crystal-controlled carriers in VHF or UHF.

CLASSIFIED

The Proprietor of British Patent No. 830,736 for "An improved Magnetic Recording and Reproducing method and an apparatus for Carrying out such method," is desirous of entering into negotiations for the sale of the Patent, or for the grant of a license thereunder. Communications should be addressed to Page, White & Farrer, 27, Chancery Lane, London, W.C.2.

More torque, Less weight

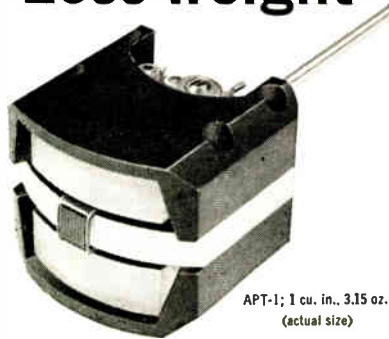

APT-1; 1 cu. in., 3.15 oz.
(actual size)

in moving coil mechanism

Stable, linear, accurate mechanism for indicating, control or recording systems. 1% linearity over 18-0-18° and greater accuracy assured by coil design with over 75% of winding "working" in high energy, uniform field air gap. Coil system weighs 0.85 gm, develops 26.4 mmg of torque; 31:1 T/W. Vibration resonance negligible; acceleration errors sharply attenuated. Standard pivots and jewels—custom damping—wide range of sensitivities.

AMMON

AMMON INSTRUMENTS, INC.
 345 Kelley Street, Manchester, N. H. 03105

Circle 114 on Inquiry Card



McLEAN VENTURI FAN

Low Cost • High Velocity • Fast Delivery

This 420 CFM, 2-way, push or pull type fan can be quickly and easily mounted anywhere. No parts to assemble—just bolt the package to an opening and you have instant cooling or exhausting at a low price. The motor is built by McLean to precision tolerances for thousands of hours of guaranteed service-free life. It's a 4-pole shock-mounted, 115 volt, 50/60 CPS single phase, shaded pole type. Prices start at \$31.50 each, but major discounts apply for volume. McLean Engineering Laboratories, P. O. Box 228, Princeton, N. J. Phone 609-799-0100, TWX 609-799-0245, TELEX 083-4345.

Send for 1965 Catalog

Circle 115 on Inquiry Card

When you're
in need of
**Corona-Free
High-Voltage
Connectors**

Contact
ROWE

Industries, Inc.

CABLE DIVISION

1702 Airport Highway

Toledo 43609

TWX 419-379-0186

PHONE 419-382-5666

Circle 118 on Inquiry Card

ELECTRONIC INDUSTRIES • November 1965

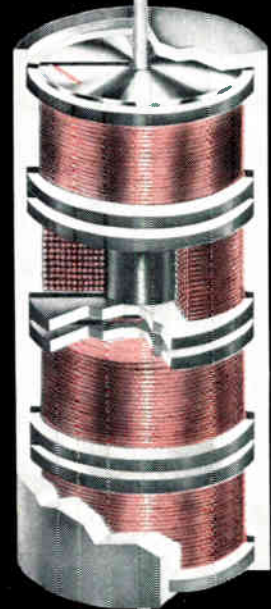
DALE**RELIABILITY**TOTAL CAPABILITY IN
PRECISION RESISTANCE

DALE can do a better job of making the BOBBIN you need

Here are four solid reasons for putting Dale to work on your bobbin requirements:

- 1. BETTER BASIC CONSTRUCTION.**
Termination and winding patented due to strength and stability advantages. MWA & WWA now use high-rel methods from Dale Minuteman Program. Both meet applicable requirements of Mil-R-93C and new Mil-R-39005.
- 2. BETTER WIRE QUALITY.**
Exclusive vendor reliability improvement program yields wire with maximum spool-to-spool homogeneity.
- 3. BETTER ALL-MOLDED COATINGS.**
New Dale-developed molding compounds give denser package; pass salt-water immersion test. All precision bobbins now molded.
- 4. BETTER "SPECIAL" CAPABILITY**
for supplying bobbins with special windings, special housings, special screening and acceptance testing.

WRITE FOR CATALOG A

MWA & WWA SERIES BOBBIN SPECIFICATIONS

DALE TYPE	MIL-R-93 TYPE	POWER RATING (WATTS)	RESISTANCE RANGE (1% TOLERANCE)	DIMENSIONS (L. x D.)
MWA-8	-	.1	1 ohm - 100K ohms	.250 x .078
MWA-10	-	.125	1 ohm - 125K ohms	.312 x .078
WWA-13	-	.125	1 ohm - 300K ohms	.375 x .125
WWA-22	-	.15	.1 ohm - 350K ohms	.250 x .250
WWA-23	RB-56	.15	.1 ohm - 600K ohms	.375 x .250
WWA-24	RB-55	.20	.1 ohm - 800K ohms	.500 x .250
WWA-26	RB-54	.25	.1 ohm - 1 Megohm	.750 x .250
WWA-36	RB-53	.33	.1 ohm - 3 Megohms	.750 x .375
WWA-38	RB-52	.50	.1 ohm - 4 Megohms	1.000 x .375

Standard Tolerances: 1%, .5%, .25%, .10%, .05%

Load Life: .5% Max. ΔR in 1500 hours at MIL-R-93 conditions. Power ratings may be doubled for commercial applications.

Operating Temperature: -55° C to -145° C

Special Modifications Available: Tolerances to .005%; Matched Resistor Tolerances to .001%; Special TC's to ± 2 PPM/°C; Special Matched TC's to an accuracy of 1 PPM/°C.



DALE ELECTRONICS, INC.

1304 28th Avenue, Columbus, Nebraska

Also Sold by Dale Electronics Canada, Ltd., Ontario, Canada



Circle 98 on Inquiry Card

2.5 Watts Output with 4 dB Gain at 1 Gc/s as a Tripler



RCA-2N4012 "overlay" Transistor

FREQUENCY MULTIPLICATION WITH POWER GAIN

at UHF and Microwave Frequencies

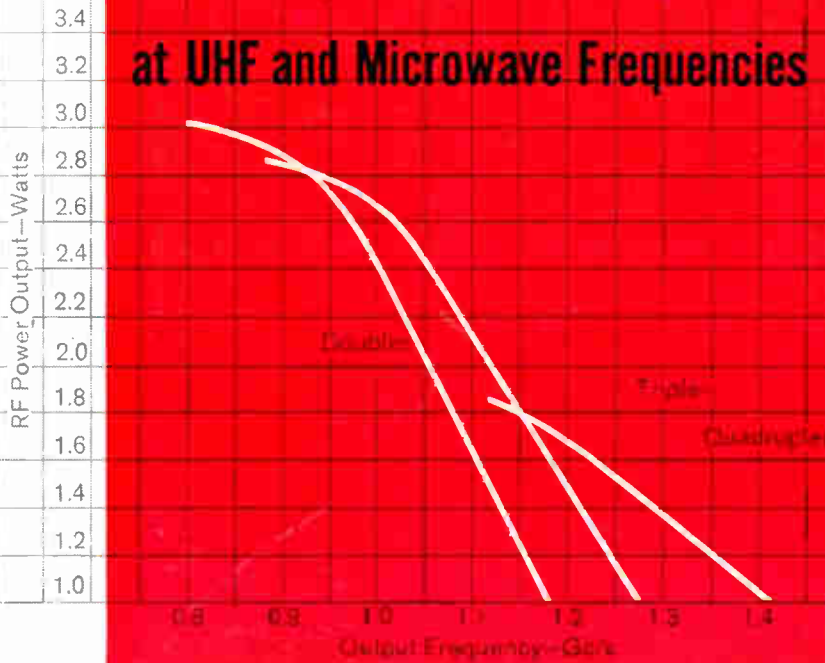

Input Power = 1 Watt
 $V_C = 28$ Volts
 Case Temp. (T_C) = 25°C

Now for the first time, you can achieve frequency multiplication with power gain at microwave frequencies with a single solid-state device, the new RCA-2N4012 silicon transistor. With this new RCA "overlay" unit, you can greatly simplify circuit design as well as reduce costs. At 1 Gc/s, one single 2N4012 can replace both the transistor power amplifier and varactor diode stages previously required.

Offering frequency multiplication with power gain in the 1 Gc/s region, the RCA-2N4012 as a doubler, tripler, and even as a quadrupler, extends transistor performance into the microwave region with watts of power! When used in a common-emitter configuration, this transistor provides stable operation—power output varies smoothly with changes in power input.

Talk to your RCA representative about how the RCA-2N4012 can help you cut design costs in your space, military, and commercial applications. For technical data, write: RCA Commercial Engineering, Section 1-J-11, Harrison, N.J.

	2N4012 DOUBLER	2N4012 TRIPLER
Output Power	3 (typ)	2.5 (min) Watts
Output Frequency	800	1002 Mc/s
Input Frequency	400	334 Mc/s
Conversion Gain	4.8 (typ)	4 (min) dB
MAXIMUM RATINGS	V_{CBO} 65 Volts V_{CEO} 40 Volts V_{CEV} 65 Volts V_{EB0} 4 Volts I_C 1.5 Amperes	

ALSO AVAILABLE THROUGH YOUR RCA DISTRIBUTOR

RCA Electronic Components and Devices



The Most Trusted Name in Electronics

Circle 117 on Inquiry Card