

ELECTRONIC INDUSTRIES

THE STATE-OF-THE-ART MAGAZINE

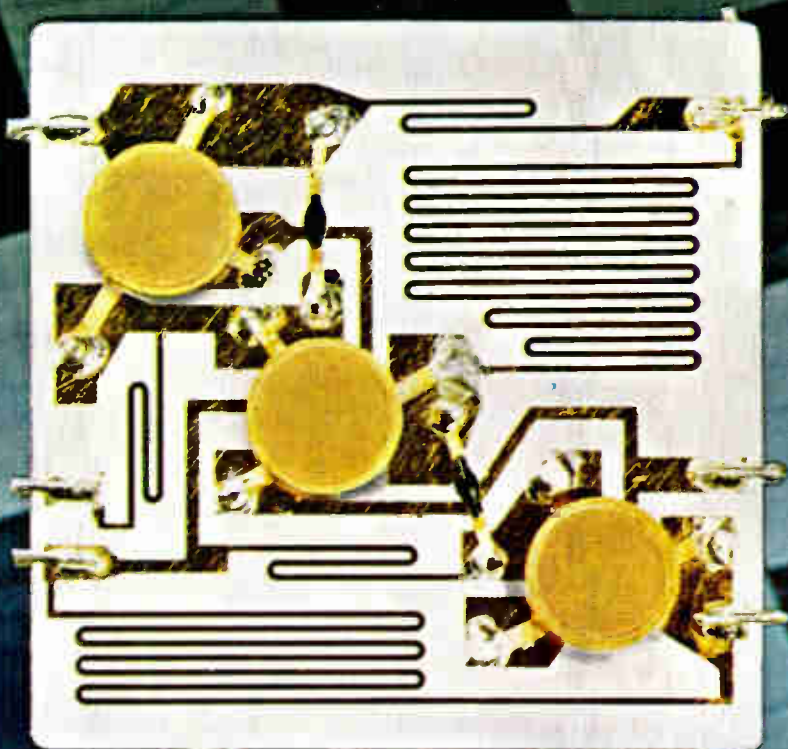

*The Flexibility
of Hybrid Circuits*

B
B
B

F. W. Preziosi, Grp. H.
2921 Soutter Ave SE
Cedar Rapids, Iowa
126500 Collins Radio

**REFERENCE ISSUE —
Monolithic & Thin-Film Circuits
Measurement & Test Section
JUNE 1965**  **Chilton Company**

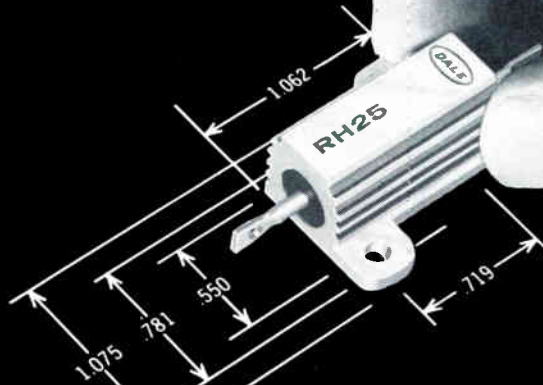
DALE**RELIABILITY**TOTAL CAPABILITY
IN PRECISION RESISTANCE

25 watt POWER in
15 watt Mil Size equals
10 watt DALE BONUS!

All new Dale RH Housed Wirewound design dissipates 25 watts from 15 watt Mil Size

This superior heat dissipation is typical of Dale's all-new RH line. It means extra design flexibility plus unprecedented stability when operated at MIL-R-18546C levels. It stems from: (1) New, specially conductive extruded aluminum housings; (2) A new Dale-developed molding compound which binds resistance unit and housing together in a homogeneous void-free mass with exceptional heat transfer ability.

COMPLETE HOUSED RESISTOR CAPABILITY

In addition to RH resistors, Dale produces PH Housed wirewounds for through-chassis mounting in 10, 25 and 100 watt sizes. Both RH and PH lines are available in non-inductive styles and with special mounting methods, terminals and other variations to suit your application.

RH RESISTOR SPECIFICATIONS

DALE TYPE	EQUIV. MIL. TYPE	DALE RATING*	MIL. RATING	RESISTANCE RANGE (OHMS)	STANDARD HEAT SINK
RH-5	—	7.5	—	.1 — 24K	4x6x2x.040 AL CHASSIS
RH-10	RE-65	12.5	10	.1 — 47K	5x7x2x.040 AL CHASSIS
RH-25	RE-70	25	15	.1 — 95K	12x12x.125 AL PANEL
RH-50	RE-75	40	20	.1 — 273K	
RH-100	—	100	—	.1 — 50K	
RH-250	RE-80	250	120	.1 — 75K	

ELECTRICAL & ENVIRONMENTAL SPECIFICATIONS

Tolerance: 3%, 1%, .5%, .25%, .10%, .05%

Load Life: 1% max. ΔR (RH-5-50) 3% max. ΔR (RH-100-250) in 1000-hour load life

Operating Temp: -55 C to -275 C

Overload: \pm .5% max. ΔR per MIL-R-18546C

*Power Rating based on 275 C max. internal hotspot temperature with resistor mounted on proper heat sink as specified by Mil. Spec.

WRITE FOR RESISTOR CATALOG A



DALE ELECTRONICS, INC.

1304 28th Avenue, Columbus, Nebraska

Also Sold by Dale Electronics Canada, Ltd., Toronto, Ontario, Canada

Circle 98 on Inquiry Card



ELECTRONIC INDUSTRIES

The State-of-the-Art Magazine

WHO'S ON FIRST?

Dear Reader:

Do you know where you are on your company's Organization Chart?

You should. Otherwise, you don't know where you are going, nor how you will get there.

Why not take a few moments and diagram the chain-of-command in your company as you see it. Then take a little more time to verify it. It should be worth-while.

For one, you will learn the interdependence of management, design engineering, research, engineering and quality control.

After you have made your own study and have analyzed your position within your company, give a thought to the changes that have taken place during the past six months. Have they affected your relative position? Are you moving ahead, or standing still?

If you do undertake this project, perhaps you would also do us a favor and send us a chart of your engineering department or group as you see it. We will not identify you or your company, but we would like your comments on what you think of your own company's organization. Later this year we'll publish composite engineering organization charts of typical companies which you should find interesting for comparison purposes.

*Sincerely,
The Editors*

1965-1966 EDITORIAL FEATURES

- JULY**
- RFI—State-of-the-Art
 - Plug & Jack Connectors Specification Chart
 - Solid State Photoconductors
 - Automatic Testing of Microcircuits
-
- AUGUST**
- WESCON Show
 - Power Relays Specification Chart
 - Characteristics of Photovoltaic Diodes
-
- SEPTEMBER**
- State-of-the-Art in Solid State Devices
 - Potentiometers, part 1, Specification Chart
 - Phototransistors & Silicon PNP Light-Activated Devices
-
- OCTOBER**
- Special Purpose Relays
-
- NOVEMBER**
- Microwave, 13th Annual Issue
 - Potentiometers, part 2, Specification Chart
-
- DECEMBER**
- Switches, part 1, Specification Chart
 - Computers, State-of-the-Art
-
- JANUARY**
- 1966 Review & Forecast for the Electronic Industries
-
- MARCH**
- 1966 IEEE Show Coverage
-

Electronic Sciences Spur Graphic Arts

AS ONE APPROACH TO EXPANDING job opportunities for engineers, we have urged electronic companies to serve and sell to other industries. One industry that is quite receptive to electronic equipment is printing and publishing.

The marriage of the electronic sciences and the printing arts is noteworthy for corporate as well as technical reasons. Let us consider companies that recently announced developments in "electronic printing."

RCA, one of the oldest and broadest-based electronic companies, recently formed a Graphic Systems Division. Its mission is "to develop, manufacture and market new electronic equipment and systems for handling all types of printed information." President Elmer W. Engstrom said this Division expressed the "conviction that the graphic arts field, particularly the printing industry, offers a major opportunity for new electronic technology and business."

This unified venture into graphics also represents a kind of "fallout" of defense/aerospace technology and personnel. Dr. Nathaniel I. Korman, Graphics chief engineer is an example. He was formerly chief systems engineer of Missile & Surface Radar Engineering and more recently, director of advanced military systems.

At the same time, the Harris-Intertype Corp. (whose subsidiaries include Gates Radio Co. and PRD Electronics) demonstrated two highly automated typesetting systems which depend heavily upon electronic devices. A "Today" exhibit showed a computer that converts rough copy on a tape into a coded tape to print justified (even) lines. This tape then guides fast machines to produce conventional hot metal type slugs, paper, or film "phototype" composition.

A "Tomorrow" exhibit incorporated a Farrington optical scanner into a computerized system to produce type for use with standard printing equipment. This optical machine "read" 30 lines of typewritten copy in a second. It produced, in the form of "photographic copy," either lines of text or advertising layout ma-

terial. Neither product was handled by an operator after the typewritten matter was put into the optical scanner.

Mergenthaler Linotype Co., cooperating with CBS Laboratories Division of Columbia Broadcasting System, is developing a \$4 million photocomposing system for the U. S. Air Force. This Lexical-Graphical Composer-Printer System will produce fully printed and illustrated books. About 10 standard-size pages will be printed each minute on a 500-foot output roll. Here, text material will be carried on a magnetic tape generated by electronic data processing equipment. Illustrative material will be stored on video-tape.

Several other companies have many years of experience in automated printing equipment. These include Fairchild Graphic Equipment, a division of Fairchild Camera and Instrument Corp., which makes electronic machines for facsimile, engravings, and high-speed wire transmission of signals to operate remote typesetting machines. Log Electronics makes electronic enlargers. And Crosfield Electronics Inc. specializes in electronic devices for test, measurement and control of ink, paper and printing presses.

Our point that electronic companies should serve other industries was amply demonstrated nearly 100 years ago. Back in 1886 in Baltimore a *watchmaker* named Ottmar Mergenthaler served the printing industry by perfecting the world's first mechanized typesetting machine called the "Linotype."

Printing and publishing are most receptive to the use of electronic technology because they are related to the broad fields of information and communications. This market comprises \$8.4 billion for commercial printing, \$2.3 billion for periodical publishing, and \$2 billion for book publishing—an estimated total of \$12.7 billion for 1965.

We see the printing and publishing industry as a major growth market for electronic equipment and services.

Bernard F. Obatala

New from Sprague!

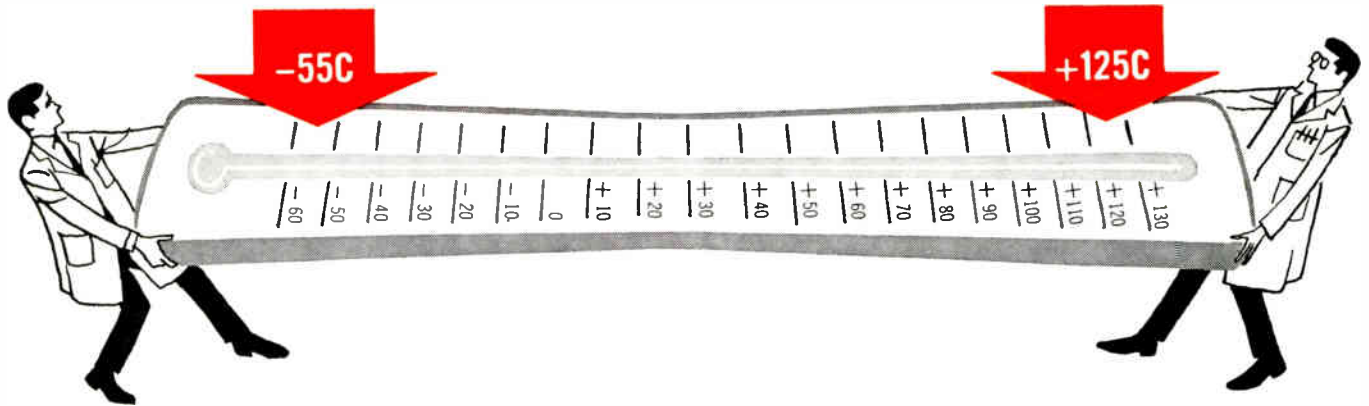

E-X-T-E-N-D-E-D T-E-M-P-E-R-A-T-U-R-E R-A-N-G-E



TYPE 600D **EXTRALYTIC**[®] ALUMINUM ELECTROLYTIC CAPACITORS

VOLTAGE RATINGS TO 150 VDC, unlike other so-called "wide temperature range" aluminum electrolytics with compromise voltage ratings only to 60 volts.

CAPACITANCE STABILITY over entire temperature range. Even at -55 C , capacitance drop is very small.

OPERATING AND SHELF LIFE comparable to or better than that of foil tantalum capacitors.

LESS EXPENSIVE than foil tantalum capacitors, yet meet electrical requirements of proposed military specification MIL-C-39018.

SMALLER AND LIGHTER than tantalum capacitors in equivalent capacitance values and voltage ratings.



For complete technical data, write for Engineering Bulletin 3455 to Technical Literature Service, Sprague Electric Company, 233 Marshall Street, North Adams, Massachusetts.

SPRAGUE COMPONENTS

CAPACITORS
TRANSISTORS
RESISTORS
INTEGRATED CIRCUITS
THIN-FILM MICROCIRCUITS

PULSE TRANSFORMERS
INTERFERENCE FILTERS
PULSE-FORMING NETWORKS
TOROIDAL INDUCTORS
ELECTRIC WAVE FILTERS

CERAMIC-BASE PRINTED NETWORKS
PACKAGED COMPONENT ASSEMBLIES
BOBBIN and TAPE WOUND MAGNETIC CORES
SILICON RECTIFIER GATE CONTROLS
FUNCTIONAL DIGITAL CIRCUITS



'Sprague' and '®' are registered trademarks of the Sprague Electric Co.

48C-165-03A3

EDITORIAL: Electronic Sciences Spur Graphic Arts 1

STATE-OF-THE-ART FEATURES

The Status of Monolithic and Thin-Film Circuits J. Lathrop 34
Thin-Film Hybrid Approach to Integrated Circuits R. Saunders 38

MEASUREMENT & TEST SECTION

- **A Close Look At Measurement Standards** E. T. Ebersol 88
- **Low Level High-Frequency R-F Voltage Standards** W. F. White 96
- **Measuring Frequency Deviation** R. F. Zimmerman 100
- **Selecting the Right Meter** R. F. Estoppey 102
- **Improved Circuits for Testing SCR's** H. R. Camenzind 93
- **Oscilloscope Sampling Techniques** G. J. Frye 108

DESIGN/DEVELOPMENT

Laminates for Multi-Layer P-C Boards N. Skow 54
Late Developments in Capacitor Design R. Graf 70
Design for a Simple Voltage Regulator A. Perlin 162
Engineers Notebook: Rise-Time Calculations M. Applebaum 164
Color Photomicrographs of Electronic Devices S. Slenker 47

PROFESSIONAL GUIDELINES

How EIA Faces the Challenge of Change H. North 138

WHAT'S NEW

Twenty Flat Packs In 1.4 in.³ 79	Network Testing Systems 80
Checkout for Apollo Instruments 79	Pads Hold Wire Clippings 80
Multi-Use Console Welder 80	Interference Measurements 151

DEPARTMENTS

Highlights 4	New Tech Data 121
Radarscope 8	Editor's Notebook 130
Coming Events 14	Books 134
Washington Trends 20	Measurement & Test Books 113
Electronic Snapshots 43	Professional Guidelines 137
Marketing 26	International News 132
Letters 32	New Products (Meas. & Test) 116
Circuit-Wise 152	New Products 179

COVER: Despite the dramatic advances in monolithic circuits, hybrids continue to provide significant advantages. Shown here is a 1-in. square "photo amplifier" designed and manufactured by Burroughs. Chips in the background are the same unit, in various stages of manufacture. The transistors on the chip are by Texas Instruments Incorporated. See articles on pages 34 and 38.

*STATE-OF-THE-ART: up-to-the-moment capability in each area of electronic technology



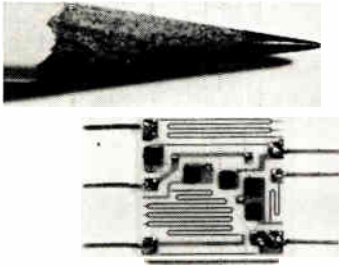

Hybrid Circuits

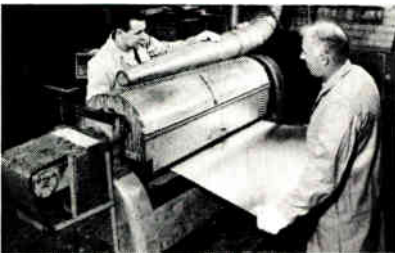

Laminates For P-C Boards

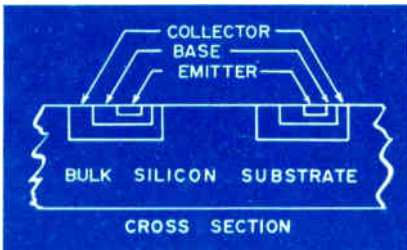

Monolithic & Thin Film Circuits

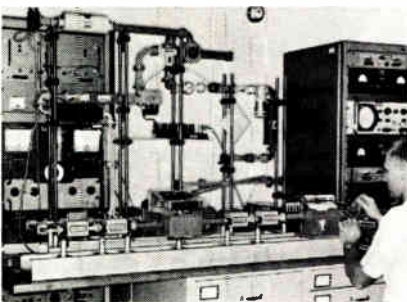

Measurement Standards

Capacitors

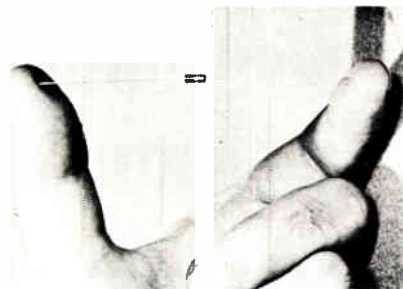

THIN-FILM HYBRID APPROACH TO INTEGRATED CIRCUITS 34

The form of integrated circuitry known as the thin-film hybrid can be a very practical, economical and time-saving approach to miniaturization of electronic circuits. This is particularly true for circuit development and feasibility studies, and for prototype models.

STATUS OF MONOLITHIC & THIN FILM CIRCUITS 38

The approaches of thin film and monolithic circuits are not competitive but complementary. Certain advantages keep oscillating back and forth between the two as new fabrication methods develop. The final outcome will probably be a combination of the two methods.

HOW TO TAKE COLOR PHOTOMICROGRAPHS 47

Engineers have been taking photographs for years, particularly scope traces. With microelectronics they now have a need for photomicrographs—in color—to show proper detail. This method does the job very well.

LAMINATES FOR MULTI-LAYER PRINTED CIRCUIT BOARDS 54

Copper-clad laminates of normal thickness are easy to produce, test and use, whereas the thin laminates present some problems in both producer and user. These problems, as well as the properties of thin laminates, are discussed.

LATE DEVELOPMENTS IN CAPACITOR DESIGN 70

Energy storage, ceramic and mica capacitors are discussed in this updated companion article to "Capacitors: Today and Tomorrow," which was published in the June 1964 issue of ELECTRONIC INDUSTRIES.

A CLOSE LOOK AT MEASUREMENT STANDARDS 88

Consistency in electronic measurement procedures and reporting is paramount. Meaningful precision measurements in this country must be based on common standards at NBS. To aid in assessing the achievable accuracy of certain measurements, state-of-the-art precision of the NBS standards is discussed, together with techniques of instrument calibration.

LOW-LEVEL R-F VOLTAGE STANDARDS 96

Micropotentiometers can be used for the calibration of high-frequency voltmeters. Sources of possible error and what can be done about them are described in this informative article.

SELECTING THE RIGHT METER 102

Useful tutorial information is given on the characteristics of basic meter mechanisms of all types—for both dc and ac applications.

HOW EIA FACES THE CHALLENGE 138

In trying to provide a maximum of service to its membership a unified industry association today encounters many complex problems. New technology begets new manufacturing specialties and brings ever changing demand. Here's how the Electronic Industries Association, now in its 42nd consecutive year has organized to meet this fluid situation.

• A REPRINT of ANY ARTICLE in this issue is available from ELECTRONIC INDUSTRIES Reader Service Department, 56th & Chestnut Streets, Philadelphia, Pa. 19139

In Volume Production!

The NAND/NOR Gate shown here is one of a series of CERACIRCUIT DTL Logic Modules.



a compatible line of DTL Logic

CERACIRCUIT[®] THIN-FILM MICROCIRCUITS

5 Mc DTL LOGIC CIRCUITS

The basic member of the Sprague series of DTL Logic Modules is the UC-1001B NAND/NOR Gate (see schematic), with typical propagation time delay of 10 nsec per stage over a temperature range of -55°C to $+125^{\circ}\text{C}$. Other DTL Logic Ceracircuits include UC-1002B SCT Flip-Flop, UC-1003B Buffer-Driver, UC-1004B Exclusive OR/Half-Adder, UC-1005B 8-Diode Gate, and UC-1006B 5-Diode Gate.

To facilitate contact packaging and assembly

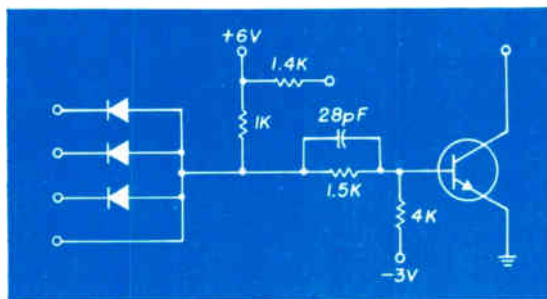

Circuit schematic, UC-1001B NAND/NOR Gate.

on printed wiring boards, all 5 Mc DTL Ceracircuit Modules are encapsulated in one standard case, 1.0" wide x 0.4" high x 0.2" thick.

CUSTOM-TAILORED CERACIRCUITS

Ceracircuit Ceramic-base Microcircuits provide the circuit designer with highly desirable features—component familiarity, design versatility, increased reliability, circuit economy. Thin-film hybrid ceramic technology permits wide ranges of resistance and capacitance values, holding close tolerances without the usual high-cost penalties. Each passive component is deposited on a single ceramic substrate, keeping its identity and allowing conventional design procedures.

WRITE FOR COMPLETE DATA

For information on Ceracircuit DTL Logic Modules, or custom Ceracircuits to satisfy your specific requirements, write to Technical Literature Service, Sprague Electric Co., 233 Marshall Street, North Adams, Massachusetts 01248

SPRAGUE COMPONENTS

THIN-FILM MICROCIRCUITS
INTEGRATED CIRCUITS
TRANSISTORS
CAPACITORS
RESISTORS
48M-4187 R1

PULSE TRANSFORMERS
INTERFERENCE FILTERS
PULSE-FORMING NETWORKS
TOROIDAL INDUCTORS
ELECTRIC WAVE FILTERS

CERAMIC-BASE PRINTED NETWORKS
PACKAGED COMPONENT ASSEMBLIES
BOBBIN and TAPE WOUND MAGNETIC CORES
SILICON RECTIFIER GATE CONTROLS
FUNCTIONAL DIGITAL CIRCUITS



[®]'Sprague' and [®]'@' are registered trademarks of the Sprague Electric Co.

first
vibrating reed
electrometer
for everyday
tests and
measurements

VICTOREEN PICOMETER

▽ Instrument makers agree, instrument users concur — dynamic capacitor electrometers are vastly performance-superior to high-sensitivity vacuum tube electrometers. This means the new Victoreen Picometer — *priced competitively with obsolescent tube types* — puts a new workaday instrument within reach of virtually every scientist or engineer.

▽ The vibrating reed Victoreen Picometer has a sensitivity, stability and simplicity unmatched by conventional electrometers. It provides extremely stable indication for currents in the 10^{-14} ampere range, and for voltages from 10 millivolts. Solid-state printed circuitry is used extensively throughout for maximum reliability. Optional battery operation. Full line of accessories. Model 474 is shown below. Model 474R for rack mounting also available. Request full details.

BE PRECISE . . . SPECIFY VICTOREEN.

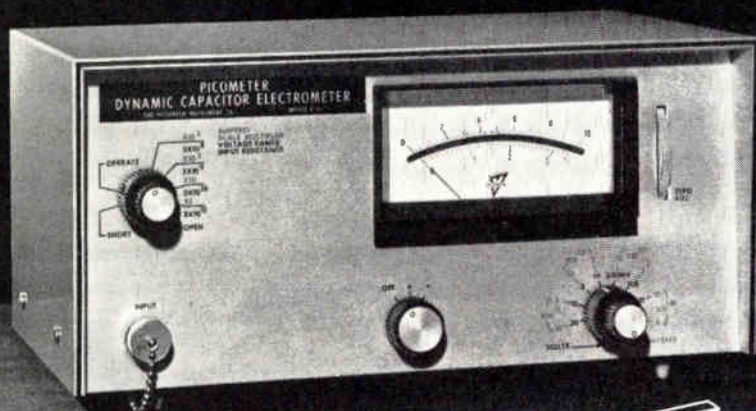

WORLD'S FIRST NUCLEAR COMPANY

VICTOREEN



THE VICTOREEN INSTRUMENT COMPANY
10101 Woodland Ave. • Cleveland, Ohio 44104 U.S.A.

4741 A

**ELECTRONIC
INDUSTRIES**



SHELBY A. McMILLION,
Publisher

BERNARD F. OSBAHR,
Editor

CREIGHTON M. MARCOTT
Executive Editor

JOHN E. HICKEY, Jr.
Managing Editor

SMEDLEY B. RUTH
SIDNEY FELDMAN
Associate Editors

JOHN J. HUNTER
ROBERT J. BRAMLETT
Assistant Editors

DR. ALBERT F. MURRAY
Consulting Editor

ELMER KETTERER, Art Director
ANNE AXE, Editorial Assistant
ANN LAVENDER, Research Assistant
MAE MOYER, Reader Service
IDA GOOD, Editorial Secy.

EDITORS-AT-LARGE

Eastern Region

ELMER T. EBERSOL,
100 East 42nd St.
New York 17, N. Y.
(Area Code 212) OXford 7-3400

Western Region

J. PHILIP GEDDES,
198 S. Alvarado St.
Los Angeles 57, Calif.
(Area Code 213) DUNkirk 7-1271

Defense/Space

CHARLES R. WILHIDE,
4400 Brookside Drive
Alexandria, Va.

WASHINGTON NEWS BUREAU

1093 National Press Bldg.
(Area Code 202) 393-3474
TWX—202 965—0675

GEORGE BAKER, Mgr.
NEIL R. REGEIMBAL

BUSINESS DEPARTMENT

ELMER DALTON
Advertising Promotion
& Circulation Manager

EDWARD G. SHAUD, Jr.
Marketing Manager

ARA H. ELOIAN
Production Manager

See Advertisers Index on page 203 for
Regional Sales Managers.

Chilton Company—G. C. BUZBY, Chairman of the Board; R. E. McKENNA, President. Executive Vice President: G. T. Hook. Vice Presidents: P. M. Fahrendorf, L. V. Rowlands, M. E. Cox, E. B. Terhune, Jr., R. W. Case, Jr., J. H. Kofron. Treasurer: Stanley Appleby. Secretary: J. A. Montgomery. Other Directors: C. A. S. Heinle, G. E. Cameron, T. C. Campbell, H. W. Barclay, W. A. Phair; Assistant Treasurer: J. Miades; Assistant Secretary: I. C. Holloway.

JOHN H. KOFRON
Chilton Research Director

ELECTRONIC INDUSTRIES, June, 1965. Vol. 24, No. 6. A monthly publication of Chilton Company. Executive, Editorial & Advertising offices at Chestnut & 56th Sts., Phila., Pa. 19139. (Area Code 215) Sherwood 8-2000. Controlled circulation postage paid at Philadelphia, Pa. \$1 a copy; Reference issue (June), \$5.00 a copy. Subscription rates U. S. and U. S. Possessions: 1 yr. \$10.00; 2 yrs. \$18.00. Canada 1 year, \$12.00; 2 yrs. \$20.00. All other countries 1 yr. \$18.00; 2 yrs. \$30.00. Copyright 1965 by Chilton Company. Title Reg. U. S. Pat. Off. Reproduction or reprinting prohibited except by written authorization.

Sierra's 351A

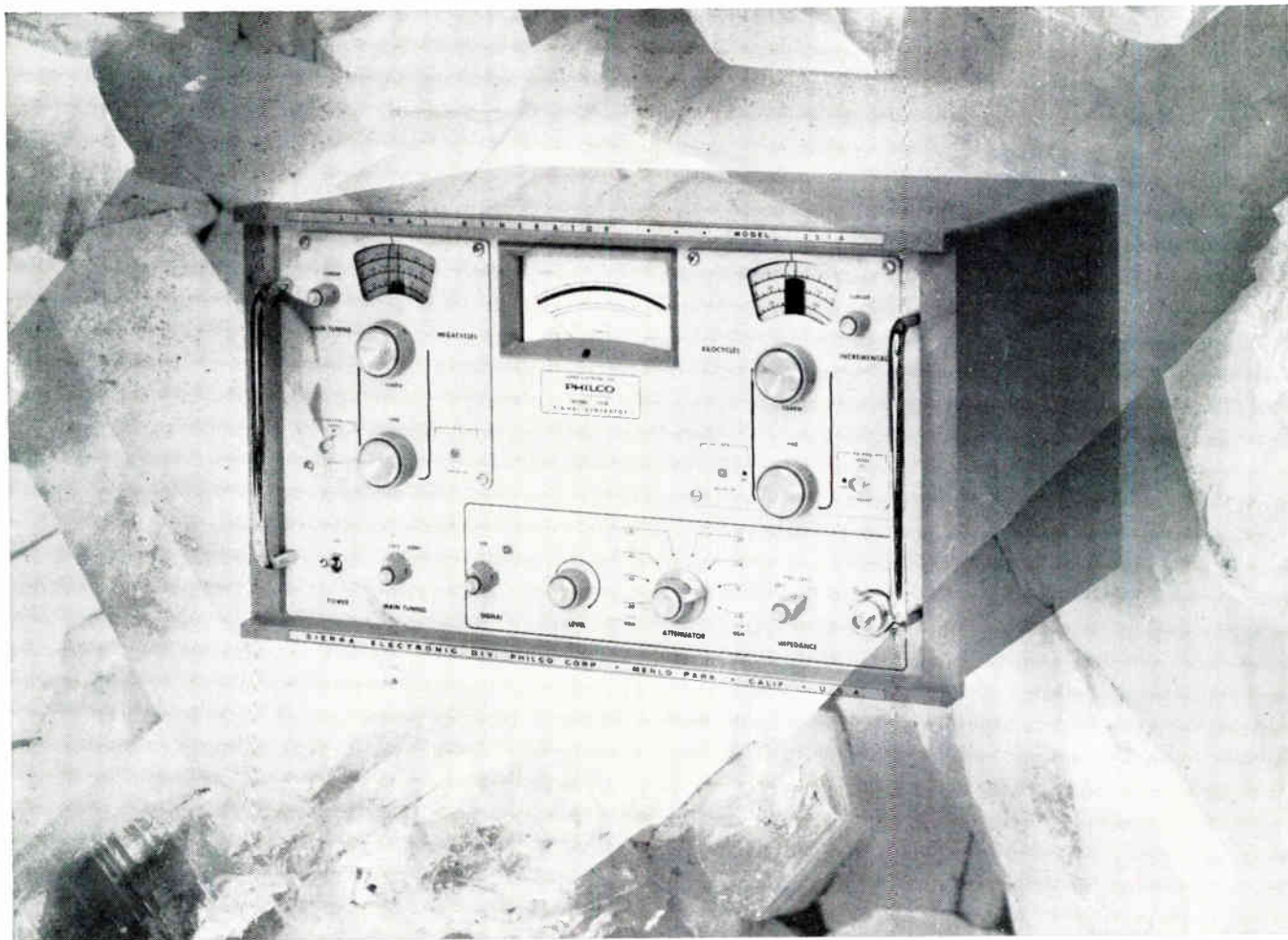

Crystal-Controlled Accuracy

Sierra's 351A Signal Generator provides you with crystal-controlled accuracy and single-range tuning from 10 kc to 15 Mc. Use it in conjunction with the 128A voltmeter and you have the capability of synchronous tuning over the whole range.

This all-solid-state signal generator gives you frequency accuracy of ± 10 ppm ± 300 cps. Output level is from 0 to -90 dbm referred to a 600Ω system. Ultra-stability is accomplished by a unique automatic level controlling circuit. Frequency response is ± 0.3 db to 10 Mc and

± 0.5 db above 10 Mc. You can read 500-cycle increments directly from the front panel, even at 15 Mc.

For high quality and versatility, the Sierra 351A Signal Generator is your best buy. Price \$2,950.00.

Contact Sierra today!

**Voltmeters/Wave Analyzers/Signal Generators/
Transistor Testers/Fault Locators/Power
Monitors/Power Sources/Calorimeters/Loads/
Couplers/Power Amplifiers**

SIERRA ELECTRONIC DIV.

OF

PHILCO

A SUBSIDIARY OF *Ford Motor Company*

3885 Bohannon Drive, Menlo Park, California

Developments and trends affecting the State-of-the-Art of technologies throughout the electronic industries

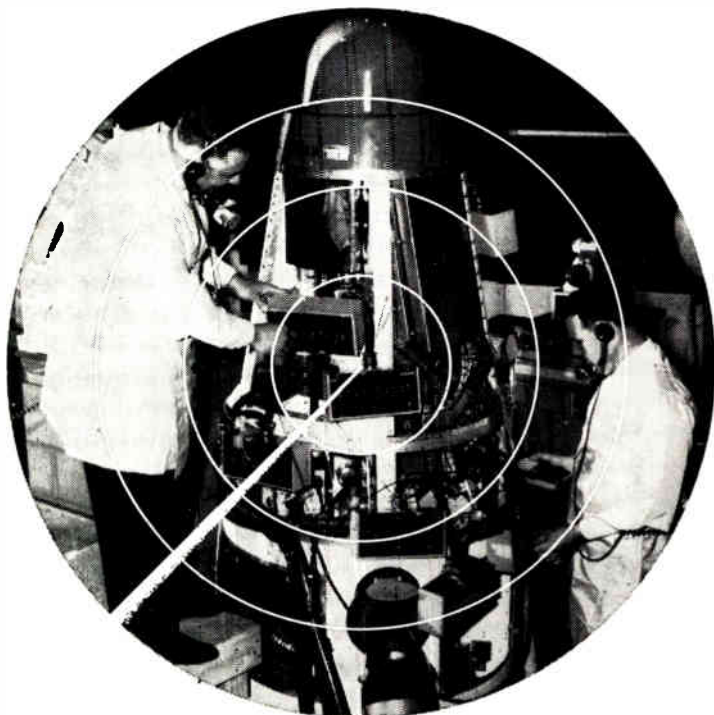

STELLAR INERTIAL GUIDANCE SYSTEM

Stellar inertial guidance equipment is checked prior to a recent flight test conducted by the Air Force and Lockheed. Object of the test was to demonstrate feasibility of the system in a ballistic missile environment during the boost phase and in flight. System was developed by General Precision's Aerospace Systems Div.

BLIND SPOTS can be detected in a person's vision automatically. The automatic instrument uses three basic parts. First is light flashes programmed for selected locations and frequencies. The second is a computer which receives signals from the patient's brain in reaction to these flashes. These signals are picked up by electrodes placed on the scalp. The third device plots the points of light detection. From the plot the blind spots can be located. The Syber Div. of Technical Measurement Corp. is making the instruments.

METAL-FORMING PROCESS recently reported by IBM enables sheet metal to be stretched and molded around complex shapes. The process, which is still in the early stages of investigation, is based on the phenomenon of "superplasticity." This is the ability of certain metals to be stretched many times their original length. It has already been demonstrated that an alloy of 78% zinc and 22% aluminum can be formed around intricate shapes through use of the vacuum-forming process.

DIGITAL DATA received from space vehicles launched at Cape Kennedy will shortly be monitored by scientists in Huntsville, Ala. using TV consoles. The scientists will save travel time to the Cape by remaining at Huntsville and viewing TV pictures and graphic displays of digital data concerning a launch. Data from pre-launch and launch operations will be sent via telephone lines to a Burroughs B-5000 computer and from there to equipment which will present the data to video displays. This digital-to-video equipment was developed by Stromberg-Carlson Corp.

LABORATORY TESTS as GE's Schenectady plant have demonstrated the feasibility of increasing power levels of today's voltage tunable magnetrons (VTM's) by a factor of two to five times. VTM's rated at 75 w minimum power output produced 200 to 250 w output across an increased bandwidth of 700 MC (2700-3400 MC) in an electromagnet at higher fields and voltages than normally used. Only a small increase in back heating was observed. Another VTM was operated at even higher magnetic fields and voltages. The tests indicated the possibility of eventually reaching kw power levels.

H-F RESISTANCE WELDING processes which produce continuous longitudinal and spiral joints at high speeds can now be interrupted or "pulsed" electronically for "spot" welding. Ferrous, non-ferrous and dissimilar metals can be joined by the process recently announced by AMF-Thermatool, Inc., New Rochelle, N. Y. Intermittent welds can be made at hundreds of feet per minute, between lapping or butting members. It uses r-f current, introduced through small sliding contacts into the metal, to heat it to forge-welding temperatures in μ secs.

OPTICAL GUIDANCE system for rendezvous and docking spacecraft is being developed by ITT for NASA. The system will furnish propulsion and attitude control systems with angle, range, and range rate information to bring two spacecraft together. Pulsed gallium arsenide lasers on both craft provide acquisition at around 120 kilometers. After acquisition one vehicle remains passive, while the other maneuvers. Laser pulses from the maneuvering craft are returned from the passive craft by corner reflectors to provide needed data. The changing data is fed into an on-board computer. When the vehicles are less than 3 kilometers apart, an incoherent GaAs source is used to give more precise measurements. This source is continuously modulated at 5MC with an accuracy better than 4 inches.

SYNTHETIC EMERALDS of gem quality have been made in about two minutes by scientists at the Naval Ordnance Laboratory, White Oak, Md. The crystals are attracting attention because of the maser characteristics of emerald. The high-temperature, high-pressure method produces clear single crystals of emerald directly from beryl powder. Crystal color can be controlled easily by various amounts of metallic oxides.

TV THROUGH LEAD is a development of the Rauland Corp. and Argonne National Laboratory. The system permits scientists to look through a lead wall and detect a stream of water flowing on the other side. The method uses neutron radiography developed by Argonne. Rauland developed a special tube that converts the stream of neutrons into light and intensifies the image. The image is picked up and transmitted by closed-circuit TV.

A MAGNETIC DATA STORE made of ferrite in a waffle-iron setup has been developed in ITT's Standard Telecommunication Laboratories in London. It has a closed flux path that combines the advantages of normal thin-film and ferrite-core stores. An experimental unit has been built with a store of 196 words of 30 bits each. It has a 0.5 μ sec. read-and-write cycle. Typical operating values are a word write current of 300 ma., digit current of ± 125 ma., read current of 500 ma., and disturbed output pulse of 30 mv for 30 nsec.

FUEL CELLS

These two fuel cells are among seven modules being offered for demonstration and experimentation purposes by Allis-Chalmers Mfg. Co. Shown here is a 28v, 1800w model (right) and a 12v, 800w model (left) complete with instrumentation panel. The company reports that this is the first public offering of such systems.

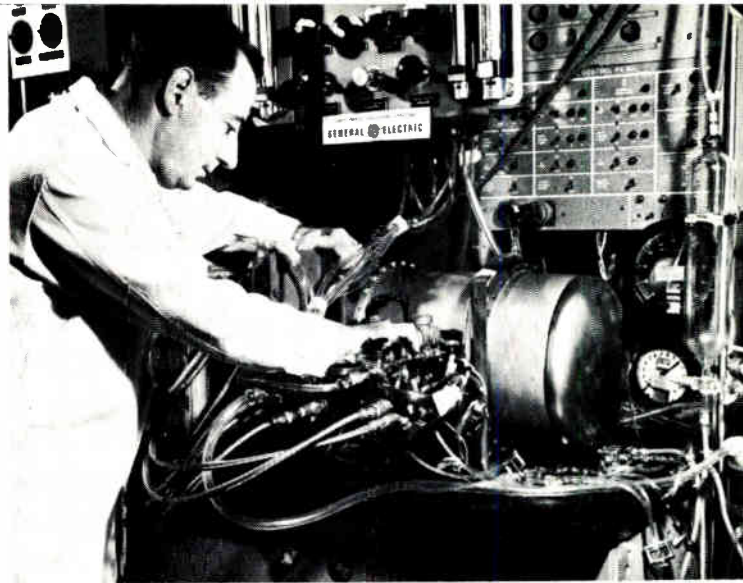
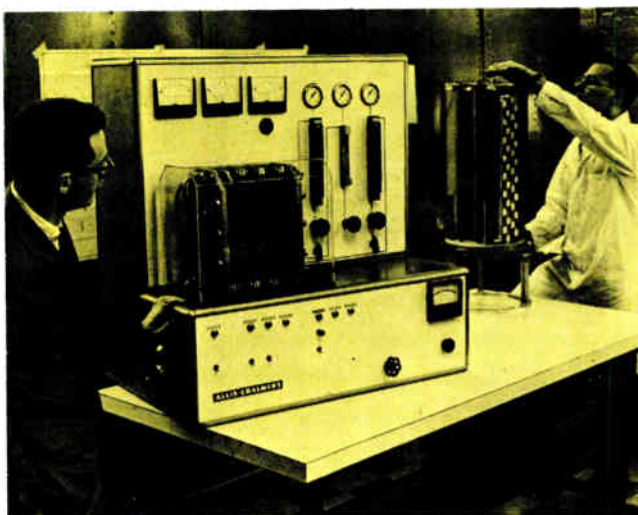

FUEL CELL POWER

Test engineer examines General Electric Co. fuel cell battery scheduled for use on the two-man Gemini spacecraft. It is one of two production fuel cell batteries expected to furnish power for the spacecraft. The batteries, which operate by combining hydrogen and oxygen, are now undergoing final qualification tests.

INTEGRATED CIRCUIT packaging and new manufacturing techniques have permitted Fairchild Semiconductor to drastically cut prices. An epoxy package has been developed to replace the standard TO-5 can. The epoxy package is similar to their metal can industrial series. The circuit wafers are taken from regular production lines in California and sent to their Hong Kong plant. Here they are assembled in ceramic-base, epoxy-coated packages.

THERMOELECTRIC POWER SUPPLY being developed by Westinghouse (for the Navy) for use on a sea research buoy has an over-all efficiency of over 5½%. The 100-w self-contained generation device will provide power for data collection, storage and transmission equipment on a 40-foot-diameter buoy. Propane gas will be burned to produce heat for the thermoelectric junctions. Cooling to provide a temperature differential will be done by rejecting heat to seawater.

INTEGRATED CIRCUIT which performs the functions of six transistors and 16 resistors is being used in a new hearing aid announced recently by Zenith. Called Solitaire, the in-the-ear aid features a circuit small enough to be passed through the eye of a needle. It weighs less than 6.2 grams including the battery.

PRECIOUS METAL POWDERS are available as true spheres. Particle size can be controlled within 50 mesh increments in a range from -50 to -400 mesh. The technique for doing this was developed by Metz Refining Co. The spherical particles can be used for filters, flame plating, fuel cell and battery electrodes, slip castings, and brazing alloy powders.

This is Siemens

making transformers, switchgear, telephones and electronic components in this fine factory in Brazil. In India, we make cables, in Spain generators, in Finland telephone material – and so on through 28 countries and virtually the whole gamut of electrical engineering. We erect, service and repair our installations in almost every country in the world: of the 240,000 in the Siemens family, quite 40,000 are employed abroad.

Everywhere, they provide imaginative planning, high-quality equipment, skilled and rapid installation and reliable service.

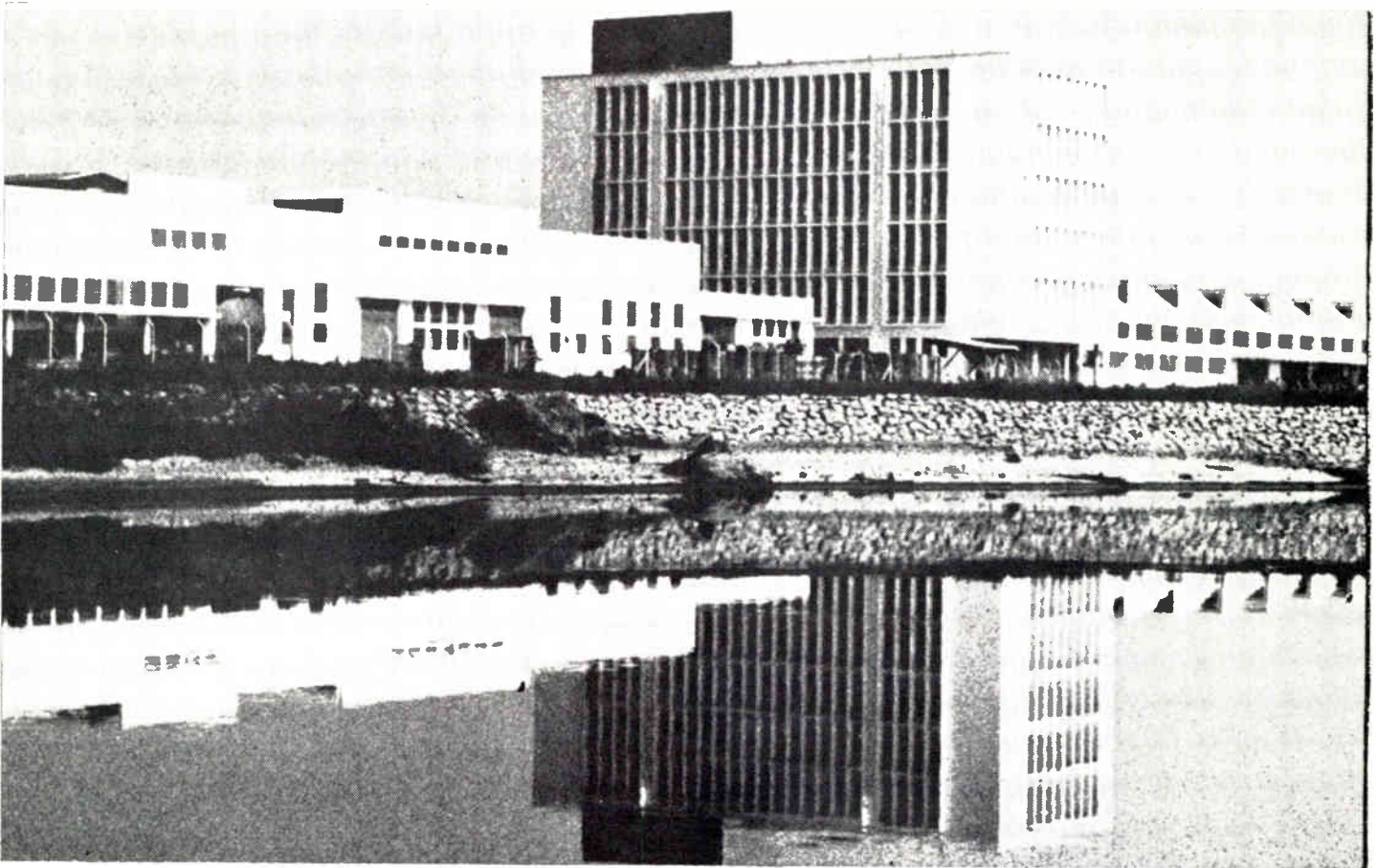

Siemens Tubes

Special Quality Tubes

with special interface-free cathode,
high mutual conductance to anode current ratio,
especially designed for use in critical industry and military
applications where reliability and long life are of primary
importance.

Description		E 88 CC 6922 Twin Triode	E 188 CC 7308 Twin Triode	E 288 CC 8223 Twin Triode	EC 8010 8556 UHF Triode	E 280 F 7722 Pentode	
Characteristics	Anode supply voltage	100	100	100	200	190	V
	Anode current	15	15	30	25	20	mA
	Mutual conductance	12.5	12.5	20	28	26	mA/V
Maximum Ratings	Anode voltage	220	250	250	200	220	V
	Anode dissipation	1.5	1.65	3.0	4.5	4.0	W
	Cathode current	20	22	40	35	30	mA

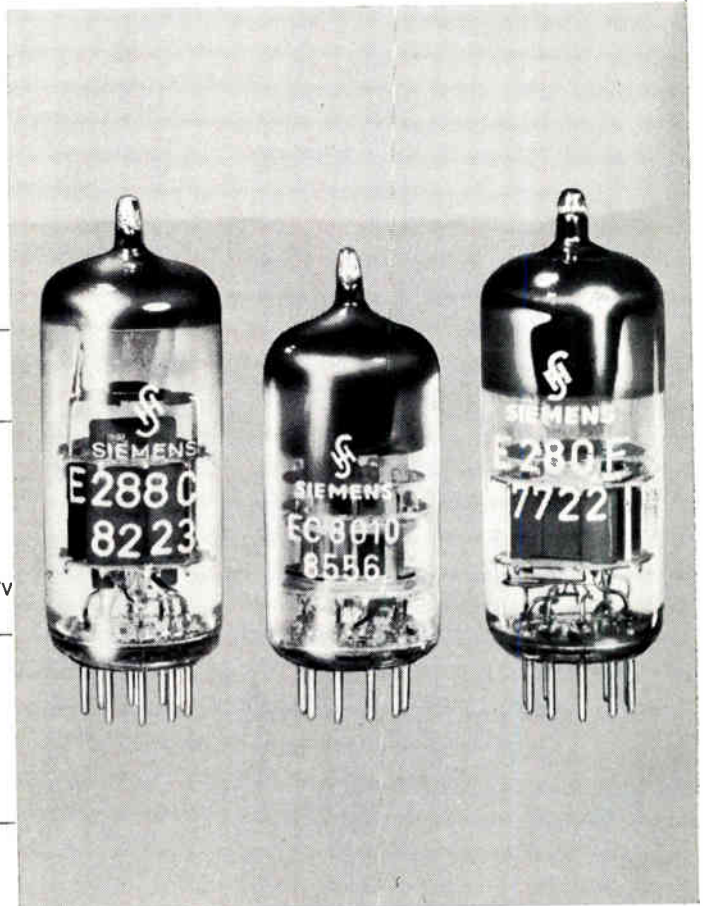

SIEMENS AMERICA INCORPORATED
Components Division
230 Ferris Avenue, White Plains, N. Y.

In Canada:
SIEMENS HALSKE SIEMENS SCHUCKERT (CANADA) LTD.
407 McGill Street, Montreal 1, P.Q.

We found 8 ways to improve on success

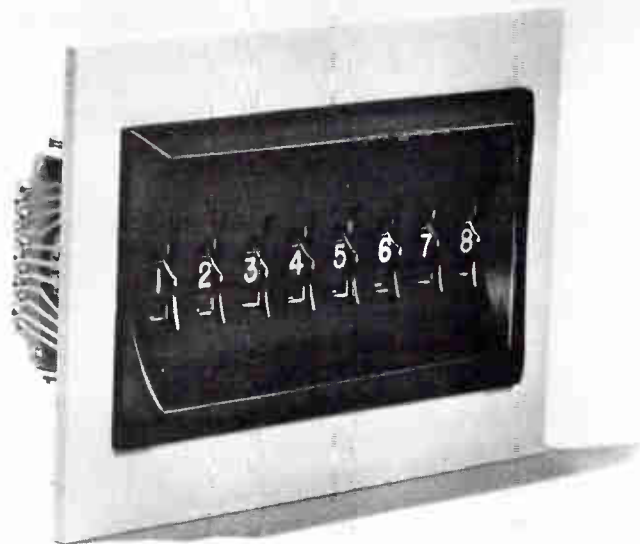

This is why more CDI thumbwheel switches are specified



One-piece all-aluminum instrument type bezel and one-piece all-aluminum frame. Both are available for 1 to 20, or more switches. Provides maximum switching versatility and dependability in the least possible space.



Unusual flexibility available. (A) Multiple decks with single thumbwheel operation. (B) Locks which prevent switch manipulation. (C) Instant re-set to zero. (D) Switch/counter combinations. (E) Variable switch spacing above 1/2".



Engraved and filled thumbwheels with custom legends provide easy legibility long wear and error-proof, in-line read-out. Tab type thumbwheels are easy to operate and are bi-directional.



Thumbwheel legends can be color filled or color coded. Thumbwheels can also be color coded to meet special requirements. Bezels can be easily color matched to customer's panel.



Leaf blades with rare metal contact points. Standard CDI switches are supplied with fine silver contacts mounted on silver plated beryllium-copper or phosphor bronze contact arms. Optional gold alloy or palladium contacts may be ordered.



CDI offers unlimited code combinations. Truth tables, available upon request, show relationship of switch positions, output terminals, and physical arrangements of terminals. Complement outputs are indicated by primes.



Removable modules from front of panel for simple replacement and servicing. Series TD-R, TB-R, TTD-R and TTB-R switches plug into receptacles which are mounted on the frame. For standard bezels only.



Internal lighting available in one of two lamp assemblies. One clear lamp is standard. Green or Aviation Red lamps may be ordered. Lamps are replaceable in the field.

Competent CDI Sales Engineers, backed by CDI's laboratory and engineering departments are always available for assistance and recommendations.



CHICAGO DYNAMIC INDUSTRIES, INC.

PRECISION PRODUCTS DIVISION 1725 Diversey Blvd., Chicago, Illinois 60614 Phone: WE 11ington 5-4600

THE BUSINESS PRINCIPLES OF AN AEROSPACE INDUSTRY

These statements of policy were presented at an Engineering Forum by Vice President of Engineering at McDonnell, Mr. Kendall Perkins. If you, as an engineer are encouraged to follow these principles in your work, you will gain. If you are successful in the pursuit of these goals, the Nation will gain.

"... Organizations, like people, have personality and character. The things which make an organization distinctive are the ways in which it differs from other organizations. These generally stem from subtle differences in the principles which guide it and the practices it has learned to follow. What then are the guiding principles at McDonnell?

"We believe it is a good business principle, for example, to give high priority to anticipating and doing our best to meet the needs of the customer—those needs which are really sound and will not change tomorrow. This often means passing up the easy-to-get contract, or the quick and easy solution to a problem, or even the approbation of a customer representative who may have become oversold on a particular project or a particular solution to a problem. Anticipating real and lasting customer needs often means creating something the customer hasn't yet asked for and doesn't yet want to buy—and then developing it and presenting it in such a way that the need becomes sufficiently apparent and pressing to open the door to a contract.

"We're not always right in what we believe the customer should have but we've found that timely and energetic effort to find what he needs, and to find an optimum solution, pays off handsomely in the long run. It was this principle which led us to start work on a manned orbiting spacecraft more than a year before the NASA asked for bids on Mercury. The same principle led us to undertake the design of an unusually versatile, high performance fighter for the Navy more than a year before our first Navy contract for Phantom II's. Thus it might be said that our largest current contracts have stemmed from the practice of anticipating customer needs. We still look forward to sizable production contracts for products conceived several years ago and actively developed since.

"We believe it is a good business principle to give high priority to meeting the needs of the individuals who make up our organization. This means many things in addition to a fair salary. It means treating people as they should want to be treated—with fairness and understanding. It means

defining responsibilities and necessary constraints, but not blocking initiative. It means opportunities for personal development by training, and freedom to transfer to other kinds of work. It means opportunities to contribute to attainment of worthy objectives. It means opportunities to advance to positions of responsibility and recognition, depending primarily on such contributions. It means the fairest and most thoughtful attention to adjustments in position and salary.

"We're not always right in our treatment of people but it's not for lack of trying at all levels. Our record has been outstanding in that we have close to the highest morale and close to the lowest percentage of terminations in the aerospace industry.

"We believe it is a good business principle to effectively foster cooperation between people. It may sound corny to talk about team action as much as we do. But nowhere in industry is there so great a need for cooperation—internal and external—as in the aerospace industry. Few other industrial products are as complex or as dependent upon such advanced engineering as a manned spacecraft or high performance aircraft. Few require so many kinds of engineering talent interacting toward the solution of so many kinds of problems. Few products require reconciling so many requirements expressed by so many people in so many documents. In short, there is a demand for effective coordination in the thinking of great numbers of people unmatched in any other industry.

"There is no such thing as an expert in all phases of an airplane, a missile, or a spacecraft. Successful systems of this complexity are developed only by employing the combined efforts of a team of people engaged in a wide variety of engineering and other activities. Technical areas are as far apart as chemistry and UHF radiation, hypersonic aerodynamics and gyroscope design, exotic high temperature materials and computer technology. No single brain can firmly grasp all these areas. Hence there is no substitute for an effective team—one whose members have learned to work together in harmony and mutual respect. The man who would lead

such teams must be capable of grasping what is told by others and appreciating the implication, but he must be modest enough to depend on the abilities and judgment of others and delegate responsibility whenever he safely can. Advanced systems development cannot be successfully run in a high-handed manner.

"I feel we have been successful at McDonnell in creating a harmonious atmosphere and minimizing non-constructive controversy. I believe we have built a team where there is a real sense of pride in group accomplishment and, at the same time, recognition of individual accomplishment. There is acceptance of necessary constraints without undue loss of individual spontaneity. We in management do our level best to provide a climate where these things can happen.

"The process of fully considering inputs from, and working in close harmony with so many other people calls for a type of organization and a set of skills and habits not ordinarily taught in school. It calls for keeping our viewpoints as broad as we can. It calls for changing our minds when the logic of the situation demands. It calls for keeping the best interest of the customer and the company ahead of our own immediate desire. It calls for recognizing that the other fellow's opinion can validly differ from our own without signifying either poor judgment or questionable motives on his part. It calls for keeping our heads when those about us are losing theirs and blaming it on us. It calls for these and many other practices in good human relations.

"We believe it is a good principle to make important decisions with the most meticulous care. In comparing our company with others it strikes me that we are more careful than most about reaching our decisions. We have learned the importance of examining all alternatives, digging up all the pertinent facts, fully analyzing results, and being objective and thorough in our judgments. This has tended to become a habit, exasperating at times, but well worth it on balance. It began when the company was formed and, in my opinion, has had more to do with our success than any other single practice."

Engineers, Scientists, Physicists and Mathematicians with energy, enthusiasm, and great creativity are needed for projects in the national interest underway at McDonnell. If you would like to work where the business principles outlined above are corporate policy and where the pursuit of excellence is a permanent corporate goal, we urge you to complete and mail the brief resume form below.

MCDONNELL An Equal Opportunity Employer.

Mail This Form To: W. R. Wardle, McDonnell Employment, Dept. AZ-6, Box 516, St. Louis, Mo., 63166

Name _____ Home Address _____
 City & State _____ Phone _____ Age _____
 Education: BS _____ MS _____ Ph D _____ Major Field: _____
 Date _____ Date _____ Date _____
 Primary Experience Area: _____ Present Position: _____
 _____ Number of Years _____ I would like to receive application form



LONCO

the complete chemical program

*for better, lower cost
printed circuits!*

Having production problems with your printed circuits? You can lick them with the LONCO Complete Chemical Program or any one part. Here it is.

REMOVE RESISTS....

LONCO RESIST REMOVERS will remove solder resists from your printed circuits swiftly without harm or degradation to laminates or metals. Applied by brush, immersion or spray, they permit easy rinsing after only 30-60 seconds leaving clean surfaces for further processing.

SOLDERABLE SURFACES....

LONCO COPPERBRITE is an oxide remover that does not etch away your copper! Instead, it completely cleans away surface oxides, hydrates, and metallo-organic contaminants. COPPERBRITE lasts indefinitely, increases adhesion of plating and produces surfaces of maximum solderability on copper, gold and tin-nickel. Applied automatically by dip or brush methods.

PROTECT....

After COPPERBRITE cleans your copper surfaces LONCO SEALBRITE NO. 230-10 keeps them that way! It protects surfaces from oxides and dirt and improves solderability with its unique solder assist coating. Use on copper, solder, gold plated, tin immersion and tin nickel surfaces. Applied by roller coating, dip or spray methods.

MASK....

Mask out solder "take" with LONCO PC NO. 33-R SOLDER RESISTS—a hard tough film that performs excellently with SEALBRITE NO. 230-10. Minimizes bridging, improves soldering of uncoated areas, greatly enhances appearance of the finished board. Outstanding electrical characteristics.

GET ALL THE FACTS! WRITE FOR THE LONCO COMPLETE CHEMICAL PROGRAM FOR PRINTED CIRCUITS! Visit us at Space 657-659, NEP/CON.

LONDON CHEMICAL COMPANY, INC.

1533 No. 31st Avenue, MELROSE PARK, ILL. 60160



Resist partially removed by LONCO Resist Remover #49.

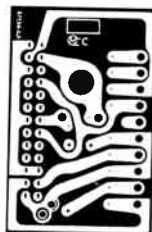

Copperbrite cleaned surfaces readily accept solder.



Flexible circuit protected by Sealbrite.



Note clean edges, efficient use of solder.



COMING EVENTS

June

- June 7-9: 1st Annual IEEE Communication Conv. (Globecom VII), IEEE; Univ. of Colo. & NBS Labs., Boulder, Colo.
- June 7-9: Symp. on Automatic Support Sys. for Adv. Maintainability, IEEE; Chase Park Plaza Hotel, St. Louis, Mo.
- June 14-15: 1965 Midwest Symp. on Circuit Theory, IEEE & Colo. State Univ.; Colo State Univ., Ft. Collins, Colo.
- June 21-24: Aerospace Tech. Conf., IEEE; Shamrock-Hilton Hotel, Houston, Tex.
- June 23-25: Joint Automatic Control Conf., IEEE, ASME AIChE, ISA; Rensselaer Polytech Inst., Troy, N. Y.
- June 27-July 2: Summer Power Mtg., IEEE; Detroit, Mich.
- June 28-30: 7th Nat'l Symp. on Electromagnetic Compatibility, IEEE; Waldorf-Astoria Hotel, New York, N. Y.

July

- July 6-8: San Diego Symp. for Biomedical Eng., IEEE & U. S. Naval Hosp.; San Diego, Calif.
- July 12-15: Conf. on Nuclear & Space Radiation Effects, IEEE; Univ. of Mich., Ann Arbor, Mich.

'65-'66 Highlights

- WESCON, Western Electronic Show & Conv., Aug. 24-27, IEEE, WEMA; Cow Palace, San Francisco, Calif.
- Nat'l Electronics Conf., Oct. 25-27; McCormick Place, Chicago, Ill.
- NEREM, Northeast Research & Eng. Mtg., Nov. 3-5, IEEE; Boston, Mass.
- IEEE Int'l Conv., Mar. 21-24, 1966; Coliseum, New York Hilton, New York, N. Y.
- July 13-15: Aerospace Vehicle Flight Control Conf., SAE, NASA; International Hotel, Los Angeles, Calif.
- July 26-29: 2nd Annual AIAA Mtg. & Tech. Demonstration, AIAA; San Francisco Civic Ctr., San Francisco, Calif.

August

- Aug. 23-27: 6th Int'l Conf. on Medical Elect. & Biological Eng'g, IFMEBE; Tokyo, Japan.
- Aug. 24-27: Western Electronics Show & Conv., IEEE, WEMA; Cow Palace, San Francisco, Calif.
- Aug. 30-Sept. 1: Antennas & Propagation Int'l Symp., IEEE; Sheraton Park Hotel, Washington, D. C.

September

- Sept. 8-10: 13th Annual Indus. Elect. & Control Inst. Conf., IEEE; Sheraton Hotel, Phila., Pa.
- Sept. 13-15: 12th Annual Petroleum Industry Conf., IEEE; Sheraton-Lincoln Hotel, Houston, Tex.
- Sept. 13-17: 6th Int'l Elec'l Insulation Conf., IEEE; New York Hilton Hotel at Rockefeller Ctr., New York, N. Y.

For the best possible color-TV picture...

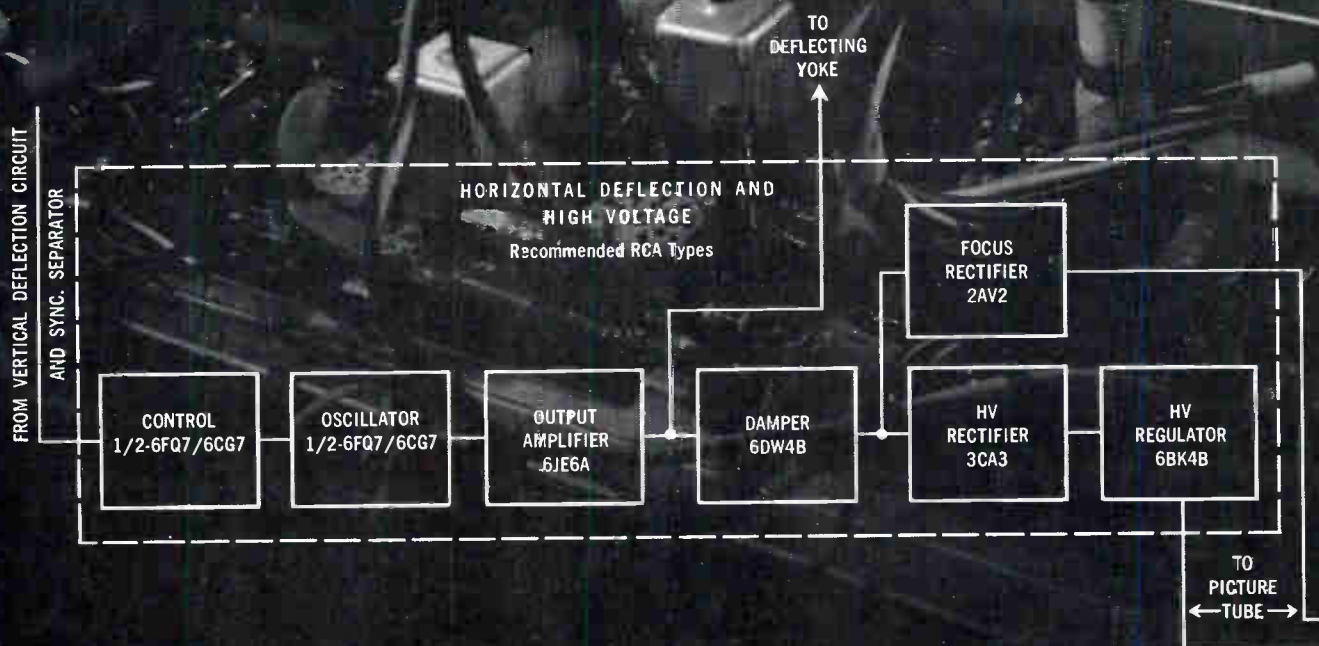

these horizontal-deflection and high-voltage circuits need color-TV receiving tubes by RCA

Here's where you really can benefit from the knowledge and experience that RCA accumulated during the developmental stage of color TV. This background enables RCA to design and select tubes that offer the color-set manufacturer the best combination of price, performance and reliability on the market today.

Take these tubes for example:

- RCA-6JE6A NOVAR Beam Power Tube for the Horizontal-Deflection-Amplifier socket of color-TV receivers using "B" supply voltages from as low as 270 volts to as high as 400 or more volts. No "snivet" problems with this tube—a new special plate construction eliminates "knee" discontinuities in the zero-bias Eb-Ib characteristic. Other benefits of the 6JE6A are: maximum plate dissipation rating of 30 watts; maximum grid no. 2 input of 5 watts and a high plate-current to screen-current ratio.

- RCA-6BK4B Beam Triode for the High-Voltage Regulator socket. New materials technology has permitted an increase in the maximum plate dissipation rating to 40 watts with no danger of glass electrolysis failure at the plate seal. Dark Heater provides cooler tube operation—important for long tube life and reliability.
- RCA-6DW4B NOVAR Half-Wave Vacuum Rectifier for the Damper circuit. Recently modified to lower overall height by bottom exhaust construction, the 6DW4B features low voltage-gradients and high permeance. RCA's Dark Heater and

Bonded Cathode contribute to long, dependable performance.

As part of our persistent effort for perfection, each of these tube types is subjected to extensive tests, in actual color-TV receivers, in our Tube Reliability Laboratory. This testing is standard procedure for all of RCA's COLOR-TV RECEIVING TUBES and each sample lot must meet rigid QUALITY standards before its associated production lot is released to the warehouses.

For more information on RCA's COLOR-TV RECEIVING TUBES, call your nearest RCA District Office or write to RCA Commercial Engineering, Harrison, N. J. 07029.

RCA Electronic Components and Devices, Harrison, N. J.



The Most Trusted Name in Electronics

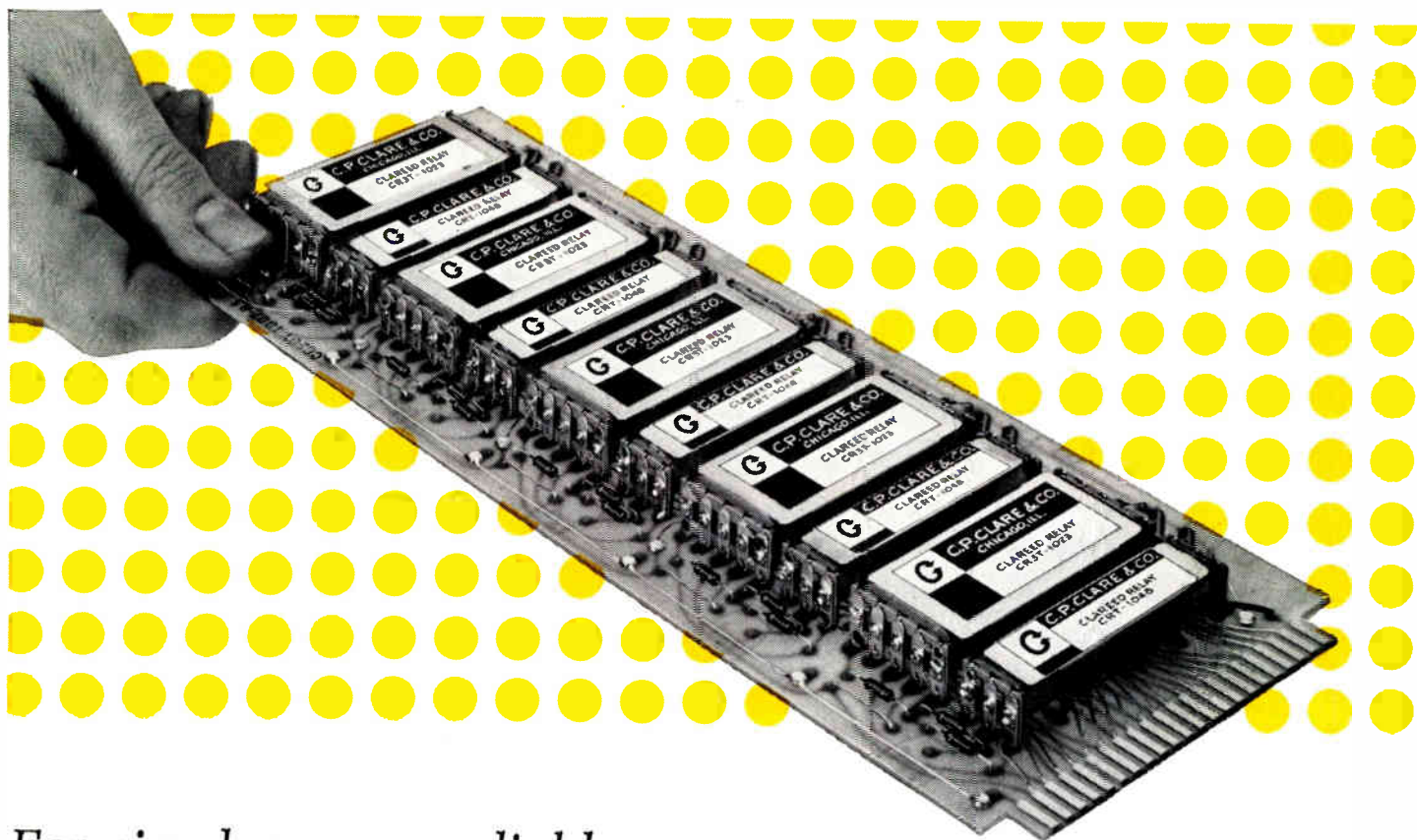

For simpler, more reliable

digital control circuits...

CLAREED®

CONTROL MODULES

pre-packaged counting, selection and logic devices

■ Counting, selection and logic switching problems are readily solved with Clareed Control Modules. Pre-packaged (or custom-designed if your problem is a new one), these modules combine speed, simplicity, and reliability ...at lower cost than comparable solid state circuitry, and without unnecessary design delay.

Counting. Pre-packaged printed circuit board modules in wide variety, for assembly to perform as decimal ring counters, radix (n) counters, bi-directional counters, shift registers, etc. Typical applications include scanning systems, digital clocks, data tracking and data transmission systems.

Selection. Pre-packaged printed circuit board modules in wide variety, for interconnection to perform as selection matrices. Typical applications include more versatile equivalents of traditional cross-bars, selection matrices capable of individual memory, and check-out matrices which can be operated with all contacts either normally open or normally closed. (Combining these Selection Modules with Clareed Counting Modules, the designer can readily provide a wide variety of scanners.)

Logic. Pre-packaged units for printed circuit board assembly in custom-designed logic modules, which efficiently perform such logic functions as AND, inclusive OR, NAND, NOR, exclusive NOR, etc. These standard Clareed units, in Clare-customized systems, provide master control circuitry which greatly reduces complexity and cost of digital control systems.

Take a look at these Clareed advantages! You'll see how this versatile switching concept can fit into your plans for industrial or commercial systems.

- multiple input and output capabilities, making possible logic at both input and output
- switching capabilities from low level up to 15 va, ac or dc, automatically available at all points without additional output circuitry
- complete isolation between input and output. The output is the contact closure
- immunity to transient and external noise
- data handling speeds up to 120 bits per second, 250 bits as special
- modular printed circuit board construction compatible with modern electronic assembly techniques...meets the requirements of almost any application

TYPICAL CLAREED CONTROL SYSTEM APPLICATIONS

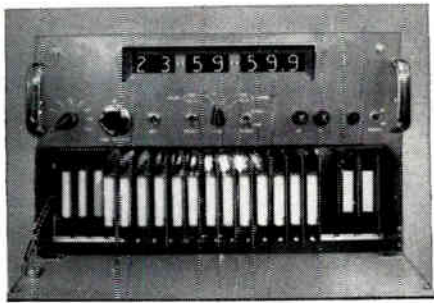

Digital Clocks using Clareded Control Modules as ring and binary counters, illustrate a variety of solutions for basic counting circuits in application for timed events, testing and systems control. Counting is performed by flux operated flip-flop elements; switching in the high-rate counter is done by Clare mercury-wetted contacts. This design provides:

- Greenwich time output
- elapsed time output
- local and/or remote visual readout
- local and/or remote control
- 7 digit capability

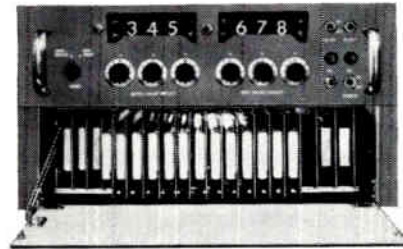

Industrial Preset Counters demonstrate production counting and control applications which provide a wide range of switching functions. Clareded flip-flop Modules are the basic switching elements used to provide this more versatile control. This design provides:

- low-cost anti-coincidence circuit for multi-channel operation
- preset 3 digit or 6 digit capability
- multi-channel input
- batch mode operation
- preset unit and batch operation
- special packages available to meet NEMA general purpose, explosion-proof, gas-tight, and water-tight enclosure requirements

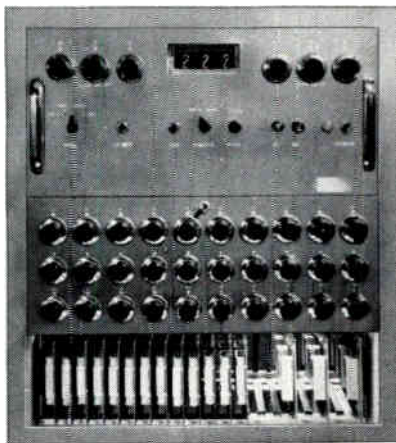

Scanners exemplify flexible sub-systems for instrumentation sampling, data logging and control systems requiring multiplexing. In the example shown, the driver is a three-decade counter composed of Clareded flip-flops; the control section uses flux and contact logic to control the driver and provide strobe drive to the matrix. A broad range of scanning options is possible:

- scan rate up to 100 crosspoints per second
- any number of crosspoints
- any number of poles per crosspoint
- special crosspoints for low level scanning
- contact forms A, B, C, or D at any crosspoints
- sequential scan with stop and recycle modes
- random scan of any 10 points in any sequence

Clareded Control Modules can be applied to the switching requirements of most systems. Proven Clareded solutions span many completely different application areas, including:

- machine tool numerical control
- telephone peripheral equipment
- engine test cell scanning systems
- psychological testing equipment
- process counting and recording
- missile checkout systems
- supervisory control and alarm annunciator systems

What's more important is how can Clareded Control help with your switching problems? Take another look at the Clareded advantages. Then, ask your Clare engineer how these plus features apply to your system. Write for Manual 400, Clareded Control Modules, or ask for specific data on Clare Industrial Preset Counters, Digital Clocks and Scanners. C. P. CLARE & CO., Group 06D4, 3101 Pratt Boulevard, Chicago, Illinois 60645.



relays and related control components

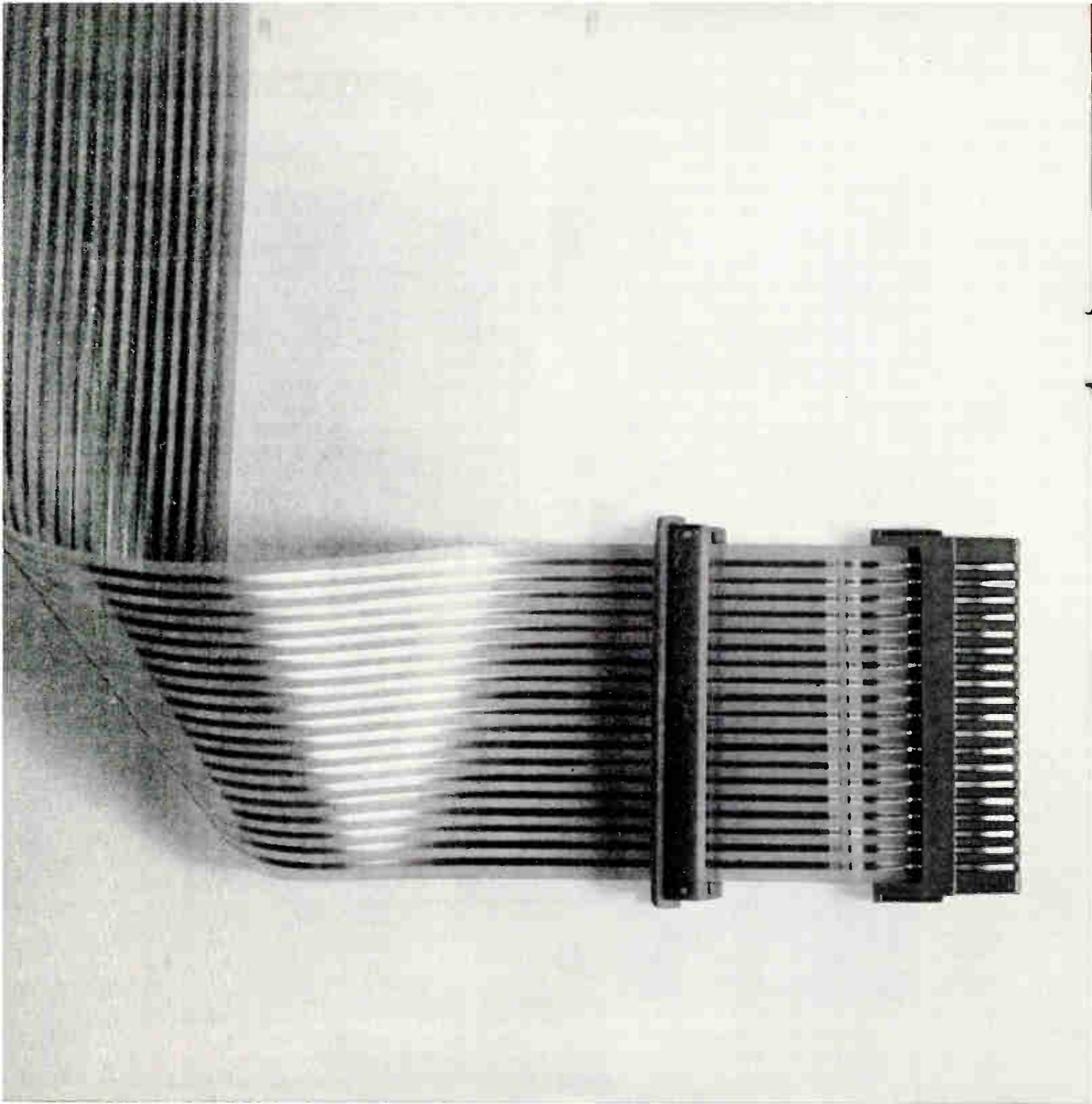

***Now for the first time . . .
quick, rugged, low-cost
terminations for flat cable***

If you use or plan to use flat, flexible cable, here's a completely new, more reliable termination method. This Amphenol Flex-1 connector has ribbon contacts that weld through the insulation directly to *unstripped* flat cable. As you can see in the picture, the insulation hugs the welded, solid-metal terminations. Each termination is a *gas-tight* bond that won't deterio-



rate with age or prolonged use.

Yet this entire 19-contact connector was welded in less than 30 seconds!

How's it done? Amphenol's new flat-cable connector introduces a welding process that melts insulation at the piercing point. There's no stripping. Conductors aren't exposed or damaged during termination.

Now as never before, you get a

connector that matches the reliability and economy of flat, flexible cable. (Flat cable bends, twists, runs serpentine style, or stacks like layer cake . . . in less space and with less weight than ordinary round cable, and with no performance sacrifice.) Three years of research and testing proved the reliability of the Flex-1 termination. Connectors can with-

stand a *minimum* of 500 mating cycles without mechanical degradation.

With all this reliability, a 19-contact Flex-1 connector still measures only 1/2" thick and weighs less than 2 oz. Have your Amphenol Sales Engineer show you the Flex-1; and write for our catalog. Amphenol Connector Division, 1830 South 54th Avenue, Chicago, Illinois 60650.



CONNECTOR DIVISION

amphenol corporation

Specify Amphenol . . . the leading name in cable, connectors, assemblies, RF switches, potentiometers, microelectronics

Circle 78 on Inquiry Card

World Radio History

FCC AND CATV CONTROL — Under heavy pressure from broadcasters, networks, and Congress, FCC assumed jurisdiction over Community Antenna TV Broadcasting (CATV). The agency issued rules requiring CATV systems that bring in distant stations by microwave to carry all local TV programs and to stop duplicating network programs on any local station within 15 days. The FCC move is expected to be protested by CATV operators.

CUTBACK IN R&D FUNDS—Congress is resisting an Administration bid to boost R&D spending in the next fiscal year. House Armed Services Committee chopped \$504.6 million from a Pentagon request, deciding to keep such programs at current levels. The Committee also pared \$150 million from weapons and equipment, and inserted a provision for congressional approval before the Pentagon's \$150 million emergency R&D fund can be appropriated. The committee's action, in effect, will place a ceiling on congressional money appropriations.

FOOLPROOF COMMUNICATIONS — Early Bird success has space experts forecasting worldwide, foolproof data distribution in this decade. Communications Satellite Corp. (COMSAT) asserts that future satellites will offer communications for any country with a ground station. Early Bird is limited to transmissions between Europe and North America. Development of the satellite network needed for a worldwide system will be costly. COMSAT paid NASA \$3.3 million to launch Early Bird. It paid Hughes Aircraft another \$3 million to build it.

COMET-ASTEROID PROBE VEHICLE

Artist's rendering shows spacecraft proposed by Philco WDL Div. for unmanned exploration of comets and close-approach asteroids. Results of a study conducted by WDL for the Jet Propulsion Laboratory show that such missions are feasible using a modified Mariner.

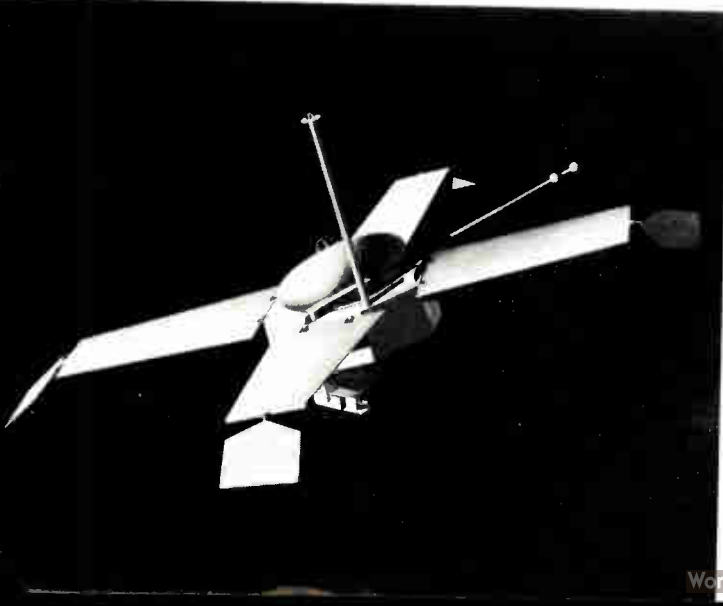

NEW SLANT ON PATENTS—Contention that patents are becoming less important to industry is rebutted by a congressional review of the system. Most manufacturers in a survey by Sen. John L. McClellan's (D.-Ark.) subcommittee on patents flatly rejected the contention. Nearly all agreed that patents are of greater importance to smaller and newer firms. The subcommittee and industry agree, too, on the need for cross-fertilization of ideas—that is, encouraging publication of inventions, rather than suppression as trade secrets.

FCC TIGHTENS SATELLITE RULE — Main effect of an FCC decision in rejecting an application for an experimental station for satellite communication is to tighten ground rules under which this type of communication will be government controlled. The application was from ITT Cable & Radio, Inc., which wanted to build a ground station in Puerto Rico.

FEDERAL CONTROL OF EDP FACILITIES—Industry doesn't like the idea that the government should own and manage data equipment used by contractors. Aerospace Industries Association, commenting on proposed legislation (H.R. 4845) to that end, protests that the law would negate government policy to place maximum responsibility on contractors. It would, AIA protested, undermine contractors' competitive position and flexibility, threaten serious delays in contract fulfillment, inhibit technological advances, and might increase overall costs.

INDUSTRY CONVERSION STUDIED — Congress is concerned over what electronic firms can do to offset defense spending shifts. Hearings have begun on proposed National Economic Conversion and Diversification Act. The bill—S.30—would establish a commission to set policies and programs to aid such conversion. It is designed to encourage industry to look into ways of meeting new public needs and wants as federal procurement demands change—or diminish.

ANTENNA FARMS PUSHED—U. S. aviation officials are promoting antenna farms as an answer to flying hazards from tall radio-TV towers. FCC has been urged to adopt rules for locating tall towers in clusters designated by FCC and FAA. FAA administrator N. E. Halaby told congress that a proposed bill to limit towers to 2,000 feet is not the answer. He said aviation's problem is with towers even far short of that height because of location. Antenna farms would make the limit bill unnecessary, he said. He also suggested that the TV industry consider alternatives to raising antenna height, possibly satellites.

DESIGN ENGINEERS:

NOW . . . Capacitance-to-volume ratio to 20 mf/cu. in.
in Subminiature, Highly Reliable Ceramic Capacitors

SUBMINIATURE MONOBLOC* CAPACITORS



Featuring HIGH CAPACITANCE . . . HIGH RELIABILITY

Erie's new Monobloc ceramic film Capacitors represent the most significant design advance in more than a decade. Now, Erie's exclusive Monobloc Process, in which very thin films of ceramic can be bonded into solid structures, permits virtually unlimited range of capacitance values, characteristics and sizes to suit exacting design requirements. Monobloc Capacitors provide volumetric efficiencies from 10 to 100 times the capacitance (to 20 mf/cu. in.) attainable in conventional components of the same size . . . and still meet Established Reliability specifications for Aerospace, Military and Commercial applications.

These proven subminiature Monobloc Capacitors are encapsulated to suit the design engineers' need; hermetically sealed, glass encased . . . precision molded . . . and phenolic coated as illustrated at right. No other manufacturer produces a true hermetically sealed, glass encased capacitor . . . and in capacitance values to 10,000 pf.

Write TODAY, for literature and samples to: Monobloc Dept., Erie Technological Products, Inc., Erie, Pa.

Design Advantages . . .

- Volumetric efficiency to 20 mf/cu. in.
- Capacitance values 5 pf. to .5 mfd . . . higher values upon request.
- IR at room temperature . . . 100 K megohms.
- Working Voltage . . . 50 V, 100 V and 200 V.
- Inherent stability due to monolithic construction.
- Conservatively rated for long, trouble-free life.
- Available to Established Reliability or to your custom specification.

*Trade name for Erie Technological Products, Inc.

Another series of components in Erie's Project "ACTIVE" . . .
Advanced Components Through Increased Volumetric Efficiency.

ERIE MONOBLOC CAPACITORS . . .

- Hermetically Sealed Glass Encased Types



- Precision Molded Types

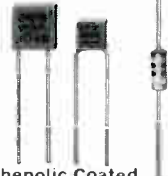

- Phenolic Coated Types Weecons



ERIE

TECHNOLOGICAL

PRODUCTS, INC.



Formerly
Erie Resistor
Corporation

644 West 12th Street
Erie, Pennsylvania

SILICON TRANSISTOR CORPORATION



INDUSTRIAL SILICON NPN AND PNP POWER TRANSISTORS



These power transistors were designed specifically for use in regulated power supplies, transistorized auto ignition systems, converters, inverters, switching regulators and power amplifiers. In addition, they are excellent general purpose transistors for industrial power applications. They are rugged enough to prevent second breakdown with peak switched power ratings of approximately 20 times the DC rating.

NPN TYPES

Type	Case Type	Collector Dissipation Watts		Collector Voltage			Current Gain hFE Min.—Max.	Test Conditions Ic VCE		Sat. Res. rce (sat.) Ohms. Max.	Test Conditions Ic Ib		ISO @		
		25°C Case	100°C Case	Vce Volts	Vce Volts	Max. Ic Amp.		Ic Amp.	Vce Volts		Ic Amp.	Ib Amp.	Veb Volts	Max. Ma	
2N3232	Ind TO-3	117	67	80	60	7.5	18 — 55	3.0	10	0.833	3.0	0.20	6	1	
2N3233	Ind TO-3	117	67	110	100	7.5	18 — 55	3.0	10	0.833	3.0	0.20	6	1	
2N3234	Ind TO-3	117	67	160	160	7.5	18 — 55	3.0	10	0.833	3.0	0.20	6	1	
2N3055/ 2N3235	Ind TO-3	117	67	90	55	15	20 — 70	4.0	4.0	0.275	4.0	0.40	7	5	
2N3236	Ind TO-3	150	85	90	90	15	17 — 60	5.0	4.0	0.220	5.0	0.50	7	5	
2N3237	Ind TO-3	200	100	90	75	20	12 — 36	10.0	4.0	0.200	10.0	1.35	7	5	
2N3238	Ind TO-3	150	85	80	80	15	8.5— 25	10.0	10	0.300	10.0	1.33	8	5	
2N3239	Ind TO-3	150	85	80	80	15	8.5— 25	10.0	10	0.100	10.0	1.33	8	5	
2N3240	Ind TO-3	150	85	160	160	15	8.5— 25	10.0	10	0.100	10.0	1.33	8	5	
2N3442	Hi TO-3	117	67	160	140	10	20 — 70	3.0	4.0	0.33	3.0	0.3	7	1000	
STC4245	Hi TO-3	117	67	50	40	15	15 — 60	8.0	4.0	.188	8.0	0.8	5	10	
STC1861	Hi TO-3			160	140	3.0	20 — 80	0.5	4.0	2.0	0.5	.05	7	1	
2N3441	TO-66			160	140	3.0	20 — 80	0.5	4.0	2.0	0.5	.05	7	1	
STC1862	Hi TO-3			50	40	3.0	25 —100	1.5	4.0	1.0	1.5	.15	5	5	
STC4401	TO-66			50	40	3.0	25 —100	1.5	4.0	1.0	1.5	.15	5	5	
2N3054	TO-66			90	55	3.0	25 —100	0.5	4.0	2.0	0.5	.05	7	1	
STC1860	Hi TO-3			90	55	3.0	25 —100	0.5	4.0	2.0	0.5	.05	7	1	
STC3722	TO-63	200	75	55	40	20	15	5.0	4.0	0.22	5.0	0.5	10	25	
STC3723	TO-63	200	75	65	50	20	15	5.0	4.0	0.22	5.0	0.5	10	25	
STC3724	TO-63	200	75	60	75	20	15	5.0	4.0	0.22	5.0	0.5	10	25	
STC3725	TO-63	200	75	85	70	20	15	5.0	4.0	0.22	5.0	0.5	10	25	
STC3726	TO-63	200	75	45	80	20	15	5.0	4.0	0.22	5.0	0.5	10	25	
STC3727	TO-63	200	75	105	90	20	15	5.0	4.0	0.22	5.0	0.5	10	25	
STC3728	TO-63	200	75	115	100	20	15	5.0	4.0	0.22	5.0	0.5	10	25	
STC3729	TO-63	200	75	135	120	20	15	5.0	4.0	0.22	5.0	0.5	10	25	
STC3730	TO-63	200	75	155	140	20	15	5.0	4.0	0.22	5.0	0.5	10	25	
STC3731	TO-63	200	75	175	160	20	15	5.0	4.0	0.22	5.0	0.5	10	25	
STC3732	TO-63	200	75	195	180	20	15	5.0	4.0	0.22	5.0	0.5	10	25	
STC3733	TO-63	200	75	215	200	20	15	5.0	4.0	0.22	5.0	0.5	10	25	
STC3734	TO-63	200	75	55	40	20	25	5.0	4.0	0.20	5.0	0.5	10	25	
STC3735	TO-63	200	75	65	50	20	25	5.0	4.0	0.20	5.0	0.5	10	25	
STC3736	TO-63	200	75	75	60	20	25	5.0	4.0	0.20	5.0	0.5	10	25	
STC3737	TO-63	200	75	85	70	20	25	5.0	4.0	0.20	5.0	0.5	10	25	
STC3738	TO-63	200	75	95	80	20	25	5.0	4.0	0.20	5.0	0.5	10	25	
STC3739	TO-63	200	75	105	90	20	25	5.0	4.0	0.20	5.0	0.5	10	25	
STC3740	TO-63	200	75	115	100	20	25	5.0	4.0	0.20	5.0	0.5	10	25	
STC3741	TO-63	200	75	135	120	20	25	5.0	4.0	0.20	5.0	0.5	10	25	
STC3742	TO-63	200	75	155	140	20	25	5.0	4.0	0.20	5.0	0.5	10	25	
STC3743	TO-63	200	75	175	160	20	25	5.0	4.0	0.20	5.0	0.5	10	25	
STC3744	TO-63	200	75	195	180	20	25	5.0	4.0	0.20	5.0	0.5	10	25	
STC3745	TO-63	200	75	215	200	20	25	5.0	4.0	0.20	5.0	0.5	10	25	
PNP TYPES															
2N3778	TO-5	8.75	5.0	40	40	1.0	10 —100	0.2	2.5	1.0	0.2	.03	8	1	
2N3779	TO-5	8.75	5.0	60	60	1.0	10 —100	0.2	2.5	1.0	0.2	.03	8	1	
2N3780	TO-5	8.75	5.0	80	80	1.0	10 —100	0.2	2.5	1.0	0.2	.03	8	1	
2N3781	TO-5	8.75	5.0	100	100	1.0	10 —100	0.2	2.5	1.0	0.2	.03	8	1	
2N3782	TO-5	8.75	5.0	40	40	3.0	10 —100	1.0	2.5	0.75	1.0	.15	8	1	

SILICON TRANSISTOR CORP. East Gate Boulevard, Garden City, New York 11532 516 Pioneer 2-4100 TWX 510-222-8258

Astrodata's New Astrolock*TM-loop FM Subcarrier Discriminator



Stability

Within $\pm 0.01\%$ of center frequency for 24-hours after a 5-minute warm-up.

Linearity

Better than $\pm 0.02\%$ of full bandwidth, best straight line.

The Astrodata Model 402-201, all solid-state FM subcarrier discriminator utilizes the new Astrolock phase-frequency detector, crystal-referenced, FET chopper-stabilized VCO, and current mode loop filter, which are proprietary developments of Astrodata, Inc.

This completely new and different type of locked-loop discriminator gives performance exceeding that of both conventional phase-locked-loop and pulse-averaging types of discriminators.

The new crystal-referenced, FET chopper-stabilized VCO provides state-of-the-art performance in stability and linearity, without a temperature controlled oven.

The Astrolock detector, with its composite phase-frequency characteristic, assures positive lock-in at any signal

level within the 66 db dynamic range. True locked-loop performance is provided for deviations up to $\pm 40\%$, with specified linearity. A quadrature detector mode of operation, selected by a switch on the front panel, provides correlation detection for extremely low S/N signals.

The Model 402-201 introduces a new method of tape-speed compensation in which the reference frequency is processed in the frequency domain. As a result, tape speed compensation is perfect at any fixed frequency from lower bandedge to upper bandedge, and is better than 30 db for intelligence frequencies up to a modulation index of 4. Deviations of more than $\pm 3\%$ anywhere in the band can be accommodated. No adjustments are necessary.

With this new Astrodata Tape Speed Compensation system, the over-all

stability for a given data channel is that of the data discriminator alone, whereas in a conventional system the over-all stability is the sum of the stabilities of both the data discriminator and the reference discriminator.

A complete line of accessories is available for use with the Model 402-201. Channel Selectors and Low Pass Filters are provided for all standard IRIG and Constant Bandwidth center frequencies up to 300 kc. Six discriminators and one common power supply mount in a rack adapter which occupies a panel space of 7-in. x 19-in.

For complete technical information on Astrodata's unique Astrolock - loop FM Subcarrier discriminator and full line of telemetry components, call your local Astrodata engineering sales representative or write to us directly.



ASTRODATA INC.

P. O. Box 3003 • 240 E. Palais Road • Anaheim, California 92803

*Trademark TEL. (714) 772-1000 • TWX 714-776-3760 • FAX • TELEX 06-78828 • CABLE ADDRESS • ASTRODATA, Anaheim

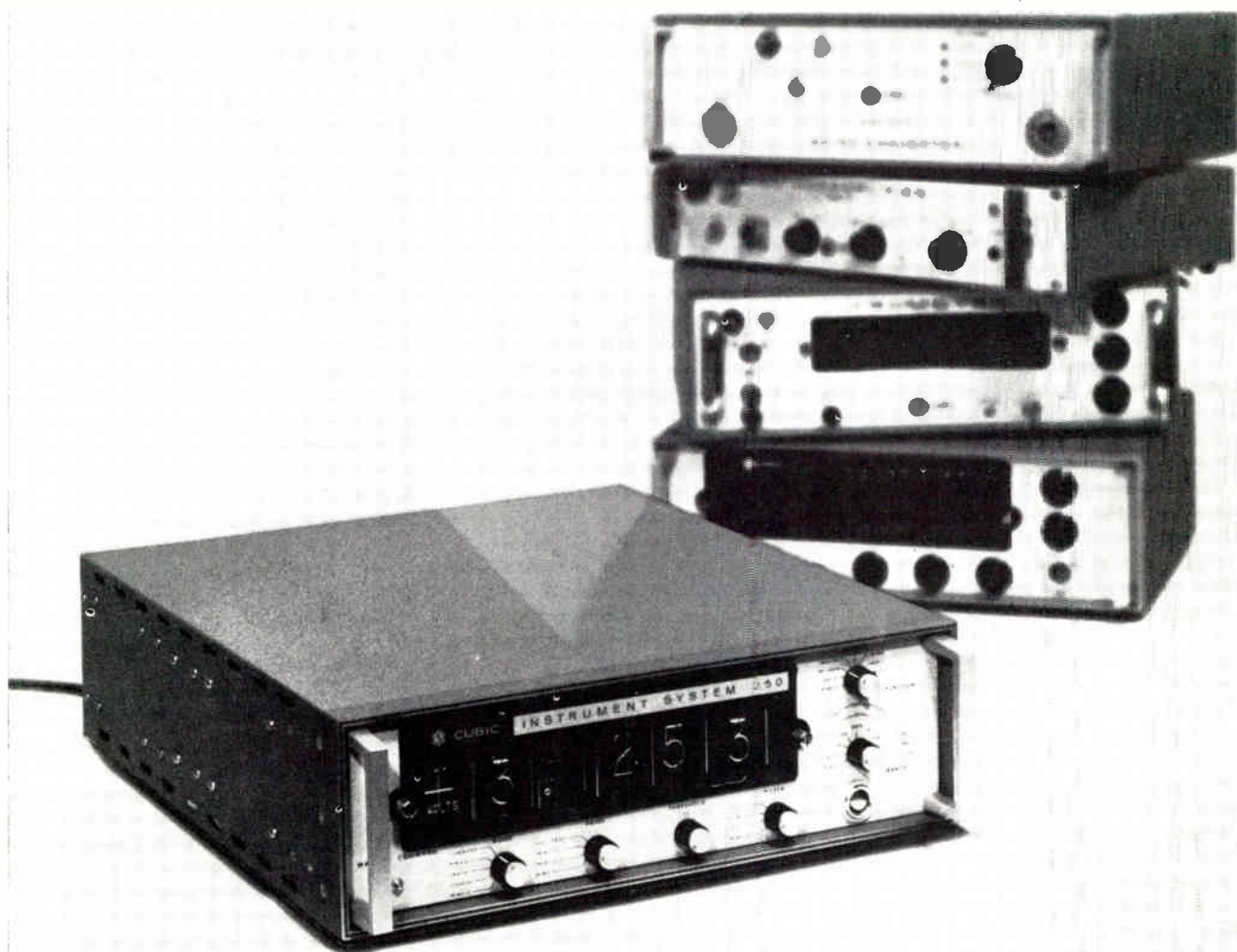

One Cubic Instrument System performs the function of four separate instruments!

The industry-leading approach to digital instrumentation is offered by Cubic Corporation's Instrument Systems. Each employs plug-in modules to perform five different measurements. These include DC volts, bipolar DC ratio, AC volts, ohms, and low-level DC to 1 micro-volt. Function Selector Knob on the instrument face changes function... without changing plug-in modules. A Cubic Instrument System eliminates the need for other instruments to make basic measurements.

Designed for easy expansion

Each Instrument System is based on a flexible design. Adding basic input and output devices or separate peripheral equipment quickly

alters capabilities. Accessory connector modifications or field programming of accessory plugs also changes an Instrument System to meet new requirements. Front panel functions are programmable, for adaptation to varied systems.

Four models available

Instrument System 150—Low-cost industrial 5-digit DVM unit.

Instrument System 250—Current-summing, reed relay DVM for reliability.

Instrument System 350—5-digit DVM features solid state switching for speed.

Instrument System 240—Cubic's rugged 4-digit, reed relay DVM.

Accessories

Input Modules: Preamplifiers, AC-DC Converters, Ohms-to-volt Converters, Scanners.

Output Modules: Data Translators and Buffers.

Peripheral Accessories #640 Scanner, #800 Data Translator, #811 Printer, Typewriters, Tape Punches. For information about Instrument Systems, write: Cubic Corporation, Dept. D-159, 9330 Balboa Ave., San Diego, Calif. 92123.



CUBIC
CORPORATION
SAN DIEGO, CALIFORNIA 92123
INDUSTRIAL DIV.

SWEPT FREQUENCY MEASUREMENT, 5Mc TO 12.4Gc

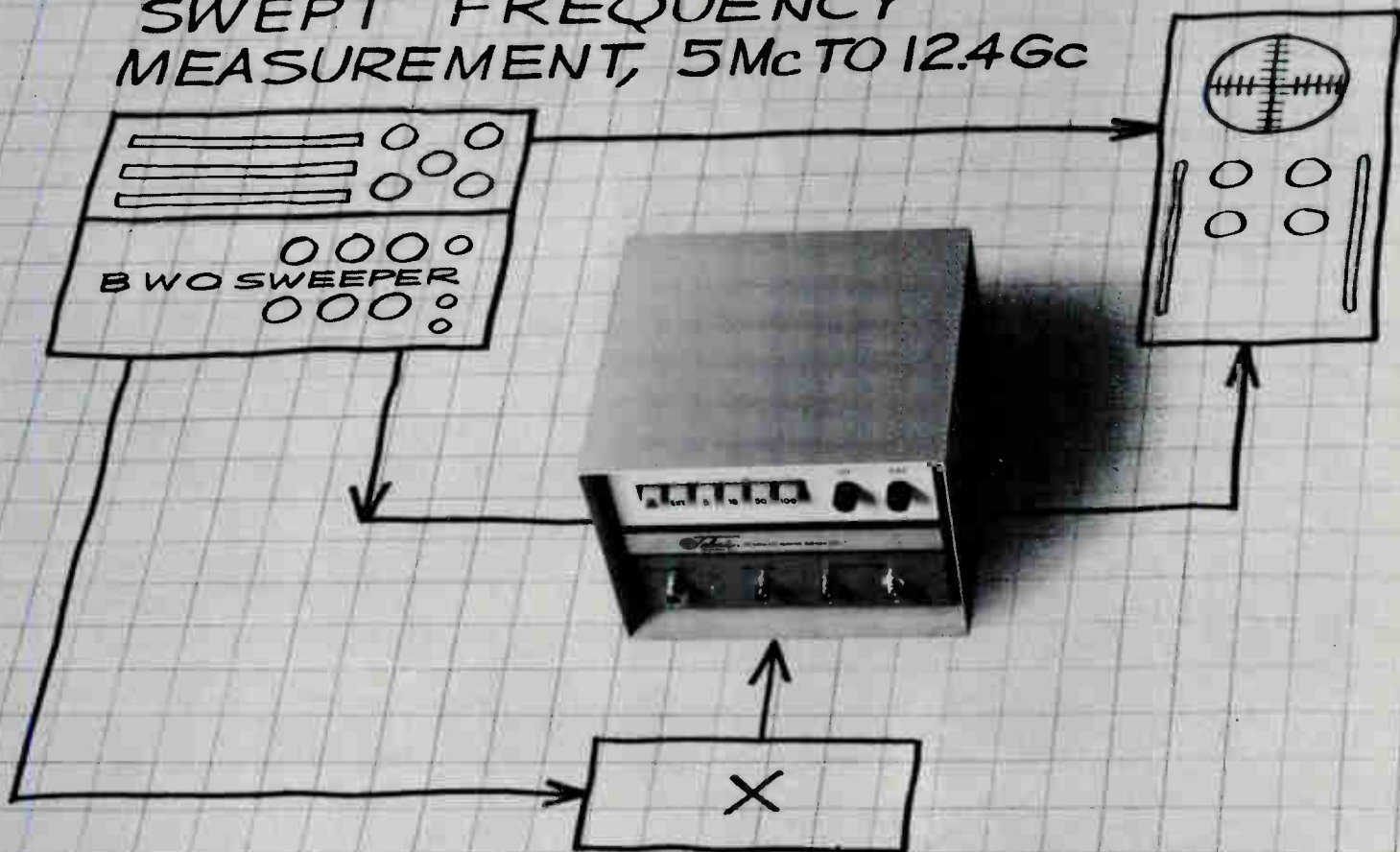

ACCURACY, (.001%) STARTS WITH A SINGLE TMS-1

Telonic's new TMS-1 Microwave Marker Generator makes a .001% system out of any BWO Sweep Generator. That's an improvement in accuracy of about 100X for a frequency range extending from 5 Mc to 12.4 Gc. Test results can be obtained much more quickly and reliably, with a low investment in instrumentation.

Now, you can determine swept frequencies with accuracies approaching that of a frequency counter but at a fraction of the price. What's more, only one TMS-1 Generator is needed to cover this entire band rather than a costly series of .1% wave meters.

The TMS-1 provides sharply defined Birdy-type markers on the scope trace (even on steep slopes) every 5, 10, 50, or 100 Mc, selected by convenient push-buttons. Provision is also made for connecting an external oscillator for any frequency from 2 Mc to 200 Mc if other intervals are desired. An extra push button and an RF connector are available for this purpose.

If you would like to see the new TMS-1 in action contact your local Telonic representative for a demonstration, or write direct for complete details and specifications.

GENERAL SPECIFICATIONS

FREQUENCY RANGE	5 Mc to 12.4 Gc
STANDARD MARKER INTERVALS	5, 10, 50, 100 Mc
ACCURACY001%
POWER REQUIREMENTS	115V, 60 cycle
CONNECTIONS	Sample In, External Oscillator, Marker Adder In, Marker Adder Out
DIMENSIONS	6" high x 8" wide x 10½" deep
WEIGHT	15 lbs.

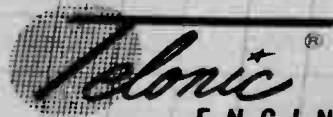

ENGINEERING CO.

DIVISION OF TELONIC INDUSTRIES, INC.
480 Mermaid Street, Laguna Beach, California
Phone (714) 494-7581, TWX 714-673-1120
Representatives in all principal cities

COMPONENT SALES LEVELED, RISE NOT DUE TILL 1966

The current plateau in electronic component sales, most authorities agree, can be blamed mostly on the changing face of defense spending and tenacious cost-cutting by many U. S. agencies.

As a result, component sales are not expected to touch the four-billion dollar level before 1966. Sales have levelled at about \$3.8 billion for 1964 and the same is forecast for 1965. The growing trend in price cutting of many components is also helping to keep dollar volume down.

Market men in general believe that rising profits in the component market will depend largely on how the industry puts aerospace/defense "spin-off" components to use in industrial and consumer products, where practically all diversifying activity is now.

Profit margin is expected to hold around 2% and may not rise until 1966 or after. A recent report by Stanford Research Institute indicates that out of the total money spent for electronic products, the components share will be around 22%. In 1962 the share was 26%. According to the report, the decrease is caused by lower prices coupled with growing importance of systems contribution to the value of electronic equipment.

The biggest dollar grower and maker in semiconductors in 1965 will probably be integrated circuits. The market totaled \$50 million in 1964. Estimates for 1965 range from \$65 million to \$130 million.

COMMERCE OFFICIAL SEES 1965 EXPORT AT \$1 BILLION

The electronic industries are in the forefront of the nation's drive to increase U. S. sales abroad, with 1964 exports at a record high and the prospect of a 5% rise this year, reports the Commerce Department's deputy assistant secretary for international commerce.

Eugene M. Braderman said exports of electronic products last year accounted for \$950 million of the \$25.6 billion national total. "Informed guessers" at the Commerce Department look toward an increase to \$1 billion (about 5% more) this year, he said.

TEST EQUIPMENT REPORT

The Electronic Industries Association's Marketing Services Department will soon begin collecting marketing data on "Factory Dollar Sales of Electronic Testing and Measuring Equipment." Industry summaries will be issued each quarter.

SHOWCASE OF THE SKY



Flying showroom. General Electric uses specially equipped DC-7 to tour major cities and show products. William Longstreet (above) briefs GE salesmen in a product area.

WESTERN SALES RISING AFTER 1964 SLOW-DOWN

Sales curve of western electronic industries is turning up again after the 1964 slow-down. Most firms are forecasting higher sales in 1965 and a total output at about \$3.840 billion, according to Western Electronic Manufacturers Association (WEMA).

Factory sales in the 13 western states dropped last year to \$3.735 billion from \$3.875 billion in 1963. WEMA President William H. Heflin noted that percentage increase of western sales will be parallel to the whole industry's national growth of 2.5% to 3%. The association predicts total U. S. sales for 1965 will rise to \$16.4 billion, from

last year's \$16 billion.

Although WEMA did not attempt to forecast employment trends, Mr. Heflin said that "many companies are stepping up their hiring activity again to handle increasing production and research."

Los Angeles metropolitan area holds the largest concentration of electronic manufacture, with 1964 sales of \$2.150 billion and employment of 143,000. The San Francisco Bay area accounted for \$800 million last year, with employment of 45,000.

Arizona continues to be the fastest-growing electronic complex. Sales for 1964 reached \$265 million, up 13.2%. Year-end employment stood at 17,100. Figures for other areas of the West last year included \$175 million for San Diego; \$165 million for Pacific Northwest; and \$180 million in the balance of the West.

SCIENTIST CAUTIONS FIRMS ENTERING CIVILIAN MARKETS

Defense contractors seeking to enter civilian markets must move cautiously, according to Dr. Leonard S. Sheingold of Sylvania Electric Products Inc.

He warned that vast differences exist between military and civilian markets, and they must be understood and assessed before any move is made toward diversification.

Dr. Sheingold, Vice President-Advanced Technology for Sylvania Electronic Systems, cited five primary differences: (1) how requirements are determined for equipment supplied (2) general product characteristics (3) marketing approaches and methods (4) timeliness and cost, and (5) how research and development projects are financed.

"In the civilian area," continued Dr. Sheingold, former Air Force Chief Scientist, "marketing techniques vary according to the structure of the product market. New commercial products require substantially more customer education than products of a similar sales volume to the military."

R&D EXPENDITURES RISE, BUT GROWTH RATE SLOWS

Total 1965 expenditures for R&D in the U. S. should reach a record \$22 billion, but the percentage increase may be the lowest in more than ten years, according to economists at Battelle Memorial Institute.

Estimated 1965 expenditures will mark the fourth consecutive year that annual increases in R&D funds have been greater than \$1.5 billion. Final figures for 1964 will be about \$20.5 billion. The 22-billion-dollar total forecast for 1965 represents only a 7% to 8% increase over 1964. The increase from 1963 to 1964 was 11%.

Breaking down the total for 1965, the government may spend about \$15.8 billion for all R&D; industry may spend \$5.8 billion; academic and non-profit groups may spend \$.5 billion.

Perhaps you didn't realize that CTS is a major supplier of trimmers

Look at the versatility of the CTS Trimmer Line

- Broadest line of CERMET™ trimmers in the world
- Wide range of most popular styles of wirewound and carbon trimmers
- Unexcelled resistance materials technology
- Broad choice of resistance elements best suited to your applications
- Unsurpassed tooling and high volume production capability
- Complete capability for military, industrial and entertainment applications
- From 10¢ production quantity types to highly sophisticated types

Immediate availability from distributor stocks

Note the wide range of types and sizes. However, if you don't see what you need, we can design one to your exact specification.



Founded 1896

CTS CORPORATION
Elkhart, Indiana

Sales Offices and Representatives conveniently located throughout the world.

Principal Products

Variable Resistors
Selector Switches
Loudspeakers
Trimming Potentiometers
Microminiature Components & Circuit Packages
Crystals, Filters,
Oscillators & Ovens

Subsidiaries

CTS of Asheville, Inc., Skyland, N. C.
CTS of Berne, Inc., Berne, Indiana
CTS of Paducah, Inc., Paducah, Kentucky
Chicago Telephone of California, Inc.,
South Pasadena, Calif.
CTS of Canada Ltd., Streetsville, Ontario
CTS Microelectronics, Inc., Ridgefield, Conn.
CTS Research, Inc., Lafayette, Ind.
CTS Knights, Inc., Sandwich, Ill.

CERMET Trimmers

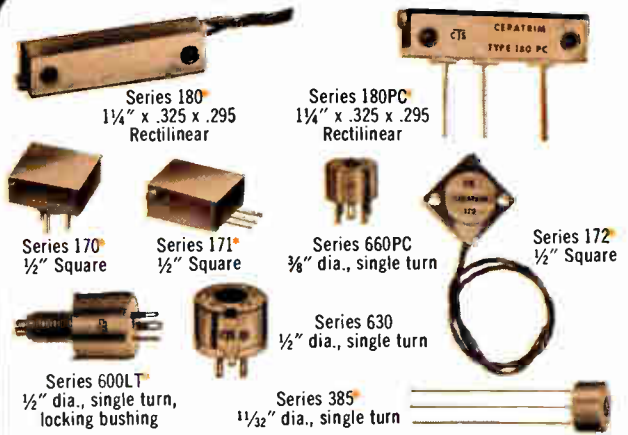

Wirewound Trimmers



Carbon Trimmers

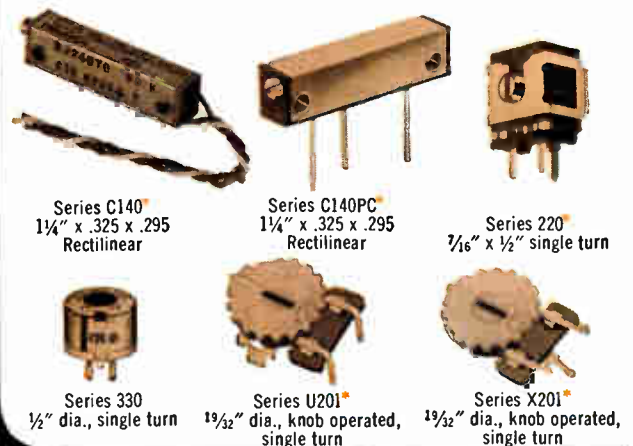



THE ONLY COMPLETE SOURCE FOR YOUR ELECTRONIC CONNECTORS U. S. COMPONENTS

AVIONICS • AUTOMATION • COMMUNICATION • CONTROLS • INSTRUMENTATION
MISSILES • PORTABLE EQUIPMENT • PRINTED CIRCUITS • TEST APPARATUS

A CONNECTOR MAKES IT WORK!

U. S. Components makes connectors for every conceivable purpose. Write for details and information on these new series.



MIC-15M MIC-30FDTP



XMI-50M2HRSL-P

XMI-50F2SLX



901-25M



UPCC-6M29



901-25F



UPCC-6F29



REPC-32F



RPCR-52



UPCR SERIES

Single Row Printed Card Receptacle
Number of contacts—(Beryllium Copper) 6, 10, 15, 18, 22
Solder wire hole size $1/16" \times 3/32"$
Voltage breakdown between contacts—sea level 2500 V. A.C. RMS.
Current rating 5 amps.
Polarizing pins and contacts—snap-in or out design permitting easy interchangeability.
Pat. #2,853,689.

UPCR-D. Double Row Printed Card Receptacle. Solder Type Terminals

Card range thickness accommodation
UPCR-D052—.072 (nom. $1/16"$)
UPCR-93D080—.104 (nom. $3/32"$)
Number of contacts (Beryllium Copper) 6, 10, 15, 18, 22 per row, (2) rows
Solder wire hole size $3/64" \times 3/32"$
Voltage breakdown between contacts—sea level 2500 V. A.C. RMS.
Current rating 5 amps.



Pat. #2,909,755

MPC SERIES—Micro Miniature Printed Circuit Connectors

Number of contacts 15, 23, 33, 37, 49
Maximum wire size26 AWG Wire
Voltage breakdown between contacts—sea level 3100 V. A.C., RMS.
Current rating 3 amps.



UPCC-SLH SERIES. Hooded Screw Lock

UPCC-M2SL Male Chassis Screw Lock
UPCC-F2HSL Female Hooded Mating Unit
Available 7, 11, 15, 19, 23, 32 contacts
Voltage Breakdown between contacts—sea level 2500 V. A.C. RMS.
Male — available solder dip, wire solder turret, taper tab terminals
Female — available wire solder, turret tab terminals
Pat. #2,953,767

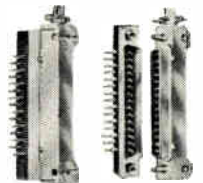

UPCC SERIES. Printed Circuit Connector
Card range thickness accommodation—
Male Dip Solder
UPCC-M () A $1/16"$
UPCC-M () B $1/8"$
UPCC-M () C $1/4"$
UPCC-F () female #20 AWG wire
UPCC-FDN () Solder dip terminals
UPCC-FDL () Solder dip terminals
Maximum wire size—female #20 AWG wire
Number of contacts 7, 11, 15, 19, 23, 32
Voltage Breakdown between contacts—sea level 2500 V. A.C. RMS.
Current rating 7.5 amps.

UPCC-SL SERIES. Printed Circuit Screw Lock

Card range thickness accommodation—
Male Dip Solder
UPCC MSL () A $1/16"$
UPCC MSL () B $1/8"$
UPCC MSL () C $1/4"$
UPCC-FSL () female #20 AWG wire
UPCC-FD-SL () Solder dip terminals
Number of contacts 7, 11, 15, 19, 23, 32
Voltage Breakdown between contacts—sea level 2500 V. A.C. RMS.
Current rating 7.5 amps.



Pat. #2,953,767

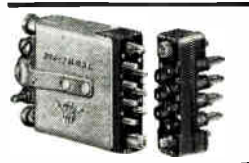

990-SL SERIES. Power Screw Lock
Number of contacts 7, 10, 15, 18
Maximum wire size #16 AWG, wire
Voltage breakdown between contacts—sea level 5300 V. A.C. RMS.
Current rating 13 amps.
990-SL-SDL (solderless) uses #53 taper pin
Patent #2,761,108. Double lead threads. "Twice the speed with double lead."

MH SERIES. Miniature Hex

Number of contacts 4, 5, 7, 9
Maximum wire size #20 AWG wire
Voltage breakdown between contacts—sea level 1215 V. A.C. RMS.
Current rating 7.5 amps.
MH-SDL (solderless) uses #37 taper receptacle
Also available MHM Hermetic Seal. Plug Series.
Pat. #2,848,702



Pat. #2,848,702



SMI SERIES. Subminiature
Number of contacts 5, 7, 11, 14, 20, 26, 29, 34, 42, 50, 75
Maximum wire size #20 AWG wire
Voltage Breakdown between contacts—sea level 1950 V. A.C. RMS.
Current rating 7.5 amps.
SMI-SDL (solderless) uses #37 taper receptacle
Other configurations upon request.

SMI-SL SERIES. Subminiature Screw Lock

Number of contacts 5, 7, 11, 14, 20, 26, 29, 34, 42, 50, 75
Maximum wire size #20 AWG wire
Voltage Breakdown between contacts—sea level 1950 V. A.C. RMS.
Current rating 7.5 amps.
SMI-SL-SDL (solderless) uses #37 taper receptacle
Other configurations upon request.
Pat. #2,761,108

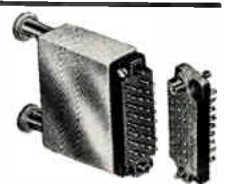

GENERAL NOTE
All Sub-miniature (SMI), Miniature (MI), 980, 990 series Connectors, available with Solder Type, Solderless Type (SDL) and Turret Type (TU) Terminals

Connectors are available with molded bodies made of asbestos-filled me'amine, glass-filled alkyd, asbestos or glass-filled diallyl phthalate, or mica-filled bakelite. All connectors meet or surpass all applicable sections of MIL-Q-9858, MIL-C-8384B, MS MIL-C-21097A, MIL-C-25955 and NAS specifications. Rigid quality control is applied on a 100% basis for inspection and testing. All solder cups can be provided with 60-40 solder or projecting terminals can be solder dipped.



U. S. COMPONENTS, INC.

NEW YORK, N. Y. • Cable Address: COMPONENTS NYK



THE ONLY COMPLETE SOURCE FOR YOUR ELECTRONIC CONNECTORS U. S. COMPONENTS

AVIONICS • AUTOMATION • COMMUNICATION • CONTROLS • INSTRUMENTATION
MISSILES • PORTABLE EQUIPMENT • PRINTED CIRCUITS • TEST APPARATUS

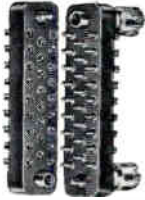

SMI-K SERIES
Subminiature Hoodless Knob Type Screw Lock
Number of contacts 5, 7, 11, 14, 20, 26, 29, 34, 42, 50, 75
Maximum wire size #20 AWG wire
Voltage Breakdown between contacts—sea level 1950 V. A.C. RMS.
Current rating 7.5 amps.
SMI-K-SDL (solderless) uses #37 taper receptacle
Pat. 2,761,108. Other configurations on request.

SMI-KC SERIES
Subminiature Hoodless Knob Type Screw Lock
Reentrancy female contact Anti-Rotation Brackets
Number of contacts 5, 7, 11, 14, 20, 26, 29, 34, 42, 50, 75
Maximum wire size #20 AWG wire
Voltage Breakdown between contacts—sea level 1950 V. A.C. RMS.
Current rating 7.5 amps.
SMI-K-SDL (solderless) uses #37 taper receptacle
Pat. 2,761,108. Other configurations on request.

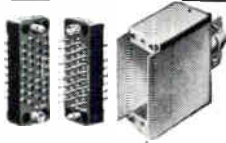

MI-SERIES. Miniature
Number of contacts 7, 12 (8-4), 14, 18, 20, 21, 26, 34, 41, 50, 75
Maximum wire size #20 AWG wire
Voltage breakdown between contacts—sea level 2800 V A.C. RMS.
Current rating 7.5 amps.
MI-SL (solderless) uses #37 taper receptacle
MI-F Series #18 wire — MI-W Series #16 wire

HMI SERIES. Hermetic Seal Miniature
Number of contacts 7, 12 (8-4), 14, 18, 20, 21, 26, 34, 41, 50, 75
Maximum wire size #20 AWG wire
Voltage breakdown between contacts—sea level 2200 V A.C. RMS.
Current rating 7.5 amps.
Mates with corresponding MI-F (female) series connectors.



MI-SL SERIES. Miniature Screw Lock
Number of contacts 7, 12 (8-4), 14, 18, 20, 21, 26, 34, 41, 50, 75
Maximum wire size #20 AWG wire
Voltage breakdown between contacts—sea level 2800 V A.C. RMS.
Current rating 7.5 amps.
MI-SL-SDL (solderless) uses #37 taper receptacle
Pat. #2,761,108
ALSO AVAILABLE FOR #18 AWG WIRE
6-32—Double or single lead threads can be furnished.

Pat. #2,761,108

HMI-SL SERIES
Hermetic Seal Miniature Screw Lock
Number of contacts 7, 12 (8-4), 14, 18, 20, 21, 26, 34, 41, 50
Maximum wire size #20 AWG wire
Voltage breakdown between contacts—sea level 2200 V A.C. RMS.
Current rating 7.5 amps.
Mates with corresponding MI-FSL (female screw lock) series connectors.
6-32—Double or single lead threads can be furnished.



MI-KSL SERIES
Miniature Hoodless Knob Type Screw Lock
Number of contacts 7, 12 (8-4), 14, 18, 20, 21, 26, 34, 41, 50, 75
Maximum wire size #20 AWG wire
Voltage breakdown between contacts—sea level 2800 V A.C. RMS.
Current rating 7.5 amps.
MI-K-SDL (solderless) uses #37 taper receptacle
ALSO AVAILABLE FOR #18 AWG WIRE

Pat. #2,761,108

MI-BSL "FBI" SERIES
Miniature Bracket Screw Lock
Number of contacts 34, 41, 50, 75
Maximum wire size #20 AWG wire
Voltage breakdown between contacts—sea level 2800 V A.C. RMS.
Current rating 7.5 amps.
Hoods aluminum anodized
Brackets die-cast aluminum
MI-BSL-SDL (solderless) uses #37 taper receptacle
Pat. #2,761,108; #2,845,603; #2,845,604



Pat. #2,761,108; #2,845,603; #2,845,604



MI-MBSL SERIES
Miniature Bracket Modular Screw Lock
Number of contacts 123, 150, 225
Maximum wire size #20 AWG wire
Voltage Breakdown between contacts—sea level 2800 V. A.C. RMS.
Current rating 7.5 amps.
Hoods aluminum anodized
Brackets die-cast aluminum
MI-MBSL-SDL (solderless) uses #37 taper receptacle
ALSO AVAILABLE FOR #18 AWG WIRE
Pat. #2,761,108; #2,845,603; #2,933,713;
#2,845,604; Additional Patents Pending.
Other configurations upon request.

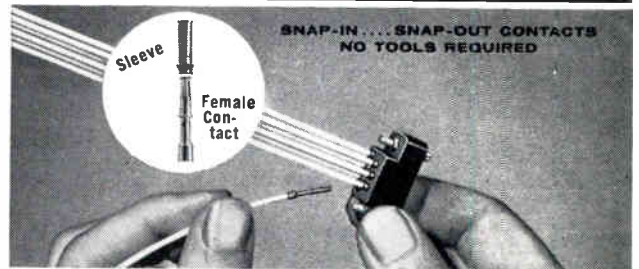

MRO-MRA. Miniature Round
Number of contacts 7, 9
Maximum wire size #20 AWG wire
Voltage breakdown between contacts—sea level 1215 V A.C. RMS.
Current rating 7.5 amps.
MRO-SDL—MRA-SDL (solderless) uses #37 taper receptacle

ALSO AVAILABLE FOR #18 AWG WIRE

REMI SERIES—Standard and Screwlock
Number of contacts 7, 12 (8-4), 14, 18, 20, 21, 26, 34, 41, 50, 75, 104
Type of contact crimp style, removable with "snap-n, snap-out" feature
Wire sizes accommodated 18, 20, 22, 24, 26, 30
Pat. 2,979,689

REMI counterparts of our MI, MI-SL, MI-KSL, MI-BSL and MI-MBSL SERIES can be provided.



UMI SERIES—Ultra Miniature Series
Number of Contacts 5, 7, 9, 11, 14, 20, 26, 29, 34, 44, 50
Max. Wire Size #22 AWG Wire
Voltage breakdown between contacts—sea level 1330 V. A.C., RMS.
Current rating 3 amps.
ALSO AVAILABLE IN UMI-SL SCREWLOCK SERIES

980 SERIES. Power-Guide Pin Spring Release
Number of contacts 12, 18, 24, 34
Maximum wire size #16 AWG wire
Voltage breakdown between contacts—sea level 4000 V A.C. RMS.
Current rating 13 amps.
980-SDL (solderless) uses #53 taper pin
Patent #2,658,182

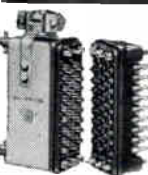

980-SL SERIES. Power Screw Lock
Number of contacts 12, 18, 24, 34
Maximum wire size #16 AWG wire
Voltage breakdown between contacts—sea level 4000 V A.C. RMS.
Current rating 13 amps.
980-SDL (solderless) uses #53 taper pin
Patents #2,658,182; #2,761,108

990 and 990S (Short Contacts) SERIES.

Power
Number of contacts 7, 10, 15, 18
Maximum wire size #16 AWG wire
Voltage breakdown between contacts—sea level 5300 V A.C. RMS.
Current rating 13 amps.
990-SDL (solderless) uses #53 taper pin



U. S. COMPONENTS, INC.
NEW YORK, N. Y. • Cable Address: COMPONENTS NYK

This is the most revolutionary solenoid catalog ever written!

If you specify high performance DC solenoids, it will be well worth your while to write for it immediately. For the first time, a solenoid catalog allows you to pinpoint the unit that matches your design

requirements...by utilizing a master selector and a system of multiplier factors. Fast, easy, accurate. Write for yours today.



ELECTROID Corporation, 56 Progress St., Union, N. J., (201) MU 6-8290.

ELECTROID
CORPORATION

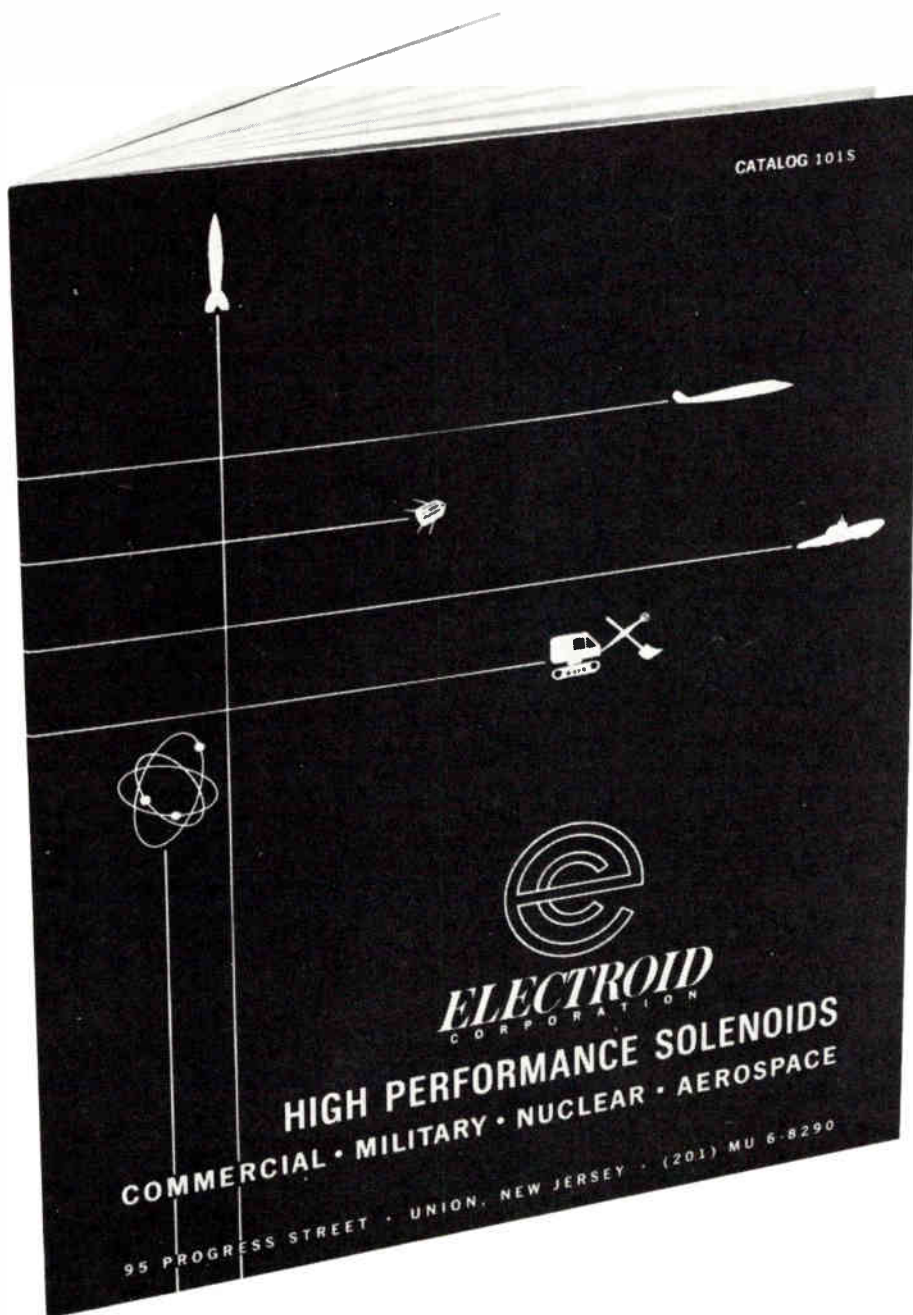

Looking for METAL "X"?

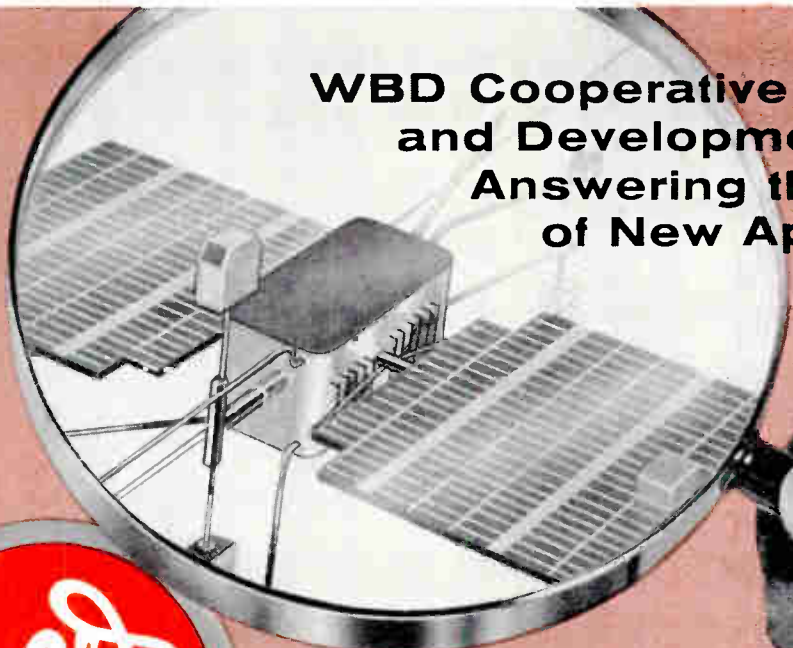

WBD Cooperative Research and Development is Answering the Challenge of New Applications!



CUSTOM ALLOYS – New applications in ever broadening ranges of environmental conditions require improved alloys and in many cases, entirely new alloys. WBD maintains fully-integrated research, development and production facilities to help in solving your custom alloy requirements.

STANDARD ALLOYS – The Wilbur B. Driver Company manufactures wire and strip in electrical resistance, electronic, chemical, mechanical and glass sealing alloys. There is a WBD Precision Alloy to meet practically any requirement. Ultra-fine gauges in both wire and strip are produced on specially designed equipment.



Life Test Panel in Engineering Laboratory at Wilbur B. Driver

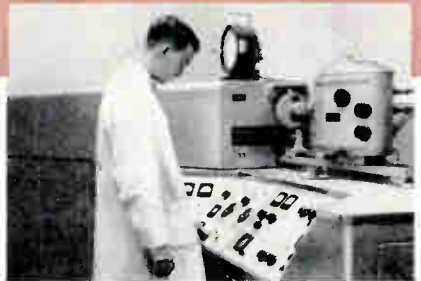

The Wilbur B. Driver Spectrographic Laboratory Showing Control Panel



Experimental Vacuum Melting Furnace in Research Laboratory

PRECISION ALLOYS FOR ALL INDUSTRIES—WIRE, ROD, RIBBON, STRIP, FOIL

Resistance Alloys:

- ALCHROME®
- TOPHET® A, C, D, 30
- EVANOHM®
- Nos. 30, 60, 90, 180 ALLOYS
- BALCO®
- BALLAST® NICKEL
- CUPRON®
- MANGANIN

Ceramic Sealing Alloy:

- CERAMVAR

Glass Sealing Alloys:

- RODAR
- NIRON® 52
- NIROMET® 46
- NIROMET® 42

Vacuum Tube Alloys:

- ANODE MATERIALS
- CARBONIZED NICKEL
- CARBONIZED NICKEL-CLAD STEEL
- ALUMINUM-CLAD STEEL
- COPPER CORE ALCLAD
- CATHODE MATERIALS
- NIPIRE
- NITUNG

FILAMENT AND GRID MATERIALS

- COBANIC®
- MAGNOCARB®
- MANGRID®
- PERMOCARB®
- PERMAGRID®
- MODIFIED HILO®

Thermocouple Alloys:

- TOPHEL®-NIAL® (Type K)

Corrosion Resisting and Mechanical Alloys:

- BERALOY®
- NILSTAIN®
- MONEL®
- INCONEL®

*Trade Mark International Nickel Co.

MANUFACTURING PLANTS:

1875 McCARTER HIGHWAY
NEWARK, NEW JERSEY 07104
50 RONSON DRIVE
REXDALE (TORONTO, CANADA)

BRANCH OFFICES:

CHICAGO*, PHILADELPHIA,
LOS ANGELES*, CLEVELAND*,
HARTFORD

*Indicates Warehouse



WILBUR B. DRIVER COMPANY

NEWARK, NEW JERSEY 07104 – Telephone: (Area Code 201) 482-5550

Circle 76 on Inquiry Card

World Radio History

Who needs a dual-output, dual-range power supply?

You might—if you want to step up to the most versatile, sophisticated laboratory power supply available today! Consider the advantages.

The new DL40-700 Silicon Dual-Lab supply gives you TWO independent outputs from one half-rack chassis—simultaneously!

Flexibility? Each of these outputs has TWO independently selectable ranges—40V at 350ma, or 20V at 700ma.

Convenience? Each output is controlled by a concentric vernier voltage control and has its own switchable volt/ammeter.

Versatility? Series or parallel the two outputs at will! Consider, too—at only \$249, the DL40-700 costs only slightly more than a single output power supply with comparable features. Who needs it?

If you want a power supply with real versatility and flexibility, two power supplies in one for your dual voltage laboratory needs...

you do!

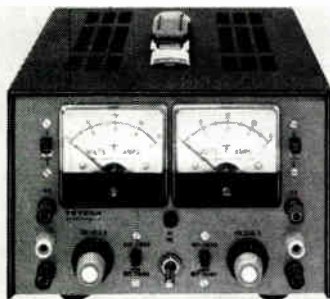

For all the exciting features, write

TRYGON
POWER SUPPLIES
Roosevelt, New York
TEL (516) 378-2800 • TWX (516) 868-7508

Circle 87 on Inquiry Card

LETTERS

to the Editor

Shades of Color . . .

Editor, ELECTRONIC INDUSTRIES:

The announcement that you are proceeding into full-color production is a welcome one, and the change should improve your product and its acceptance greatly. Congratulations. However, your requirement that transparencies exceed 4 x 5 in. is archaic. Virtually every news-magazine, working to split-second deadlines, can handle 35 mm color as can most general circulation magazines. If you draw your contributors from the ranks of the engineering profession, they will have considerable difficulty meeting your size requirements, not to mention the increased cost to them.

Alvin F. Rymsha

Equipment Div.
Raytheon Co.
Boston Post Rd.
Wayland, Mass.

More on Color

Editor, ELECTRONIC INDUSTRIES:

Congratulations on your announcement of full color printing for ELECTRONIC INDUSTRIES in the future. This will certainly add a great deal to the clarity and the interest of your articles.

However, I must point out that some of the best color magazine work in the country is done from 35 mm originals. Certainly, you do not desire or expect to surpass the excellent color reproduction found in *Life*, the *National Geographical*, *Arizona Highways*, etc., etc., the majority of which comes from 35 mm transparencies.

I feel quite safe in saying that particularly regarding original laboratory photographs or equipment and experiments, you will almost always find 35 mm color being used. About the only place where 4 x 5 and larger color is used is in commercial advertising photography where the distortion correcting swings and tilts of the view camera are desirable.

What you will find then if you insist on 4 x 5 transparencies is that people will have 4 x 5 duplicate trans-

parencies made from 35 mm originals, and this is certainly far less likely to produce good results in the final illustration than having the original 35 mm transparencies submitted.

E. G. Dyett, Jr.
Manager/Instrument Div.

H. H. Scott, Inc.
111 Powder Mill Rd.
Maynard, Mass. 01754

Ed. Note: We can take color art in practically any form—photographs, transparencies (including 35 mm) and original drawings.

We Make Relays

Editor, ELECTRONIC INDUSTRIES:

Your interesting article on Reed Relays and Sensitive Relays in your March 1965 edition listed only American made devices. For completeness, your readers may be interested to know that we are the only Canadian manufacturer of a Contactless Contact Meter Relay, producing a modification of the original optical meter relay developed many years ago by P. Gossen & Co., of West Germany.

This rugged and reliable contactless contact relay has been accepted by the U. S. Army as well as some American industries.

R. Spencer Soanes,
Director

Canadian Research Institute
85 Curlew Drive
Don Mills, Ontario

Terminology Error

Editor, ELECTRONIC INDUSTRIES:

On page 62 of the April issue you have committed an error whose seriousness is not lessened by its widespread commission. The word "micro-photograph" is used where "photomicrograph" is obviously intended. A "microphotograph" is a very minute photograph of an object, whereas a "photomicrograph" is a photograph of a very minute object. This difference is certainly not trivial.

Roger E. Schell

442 Griscom Dr.
Woodbury, N. J. 08096

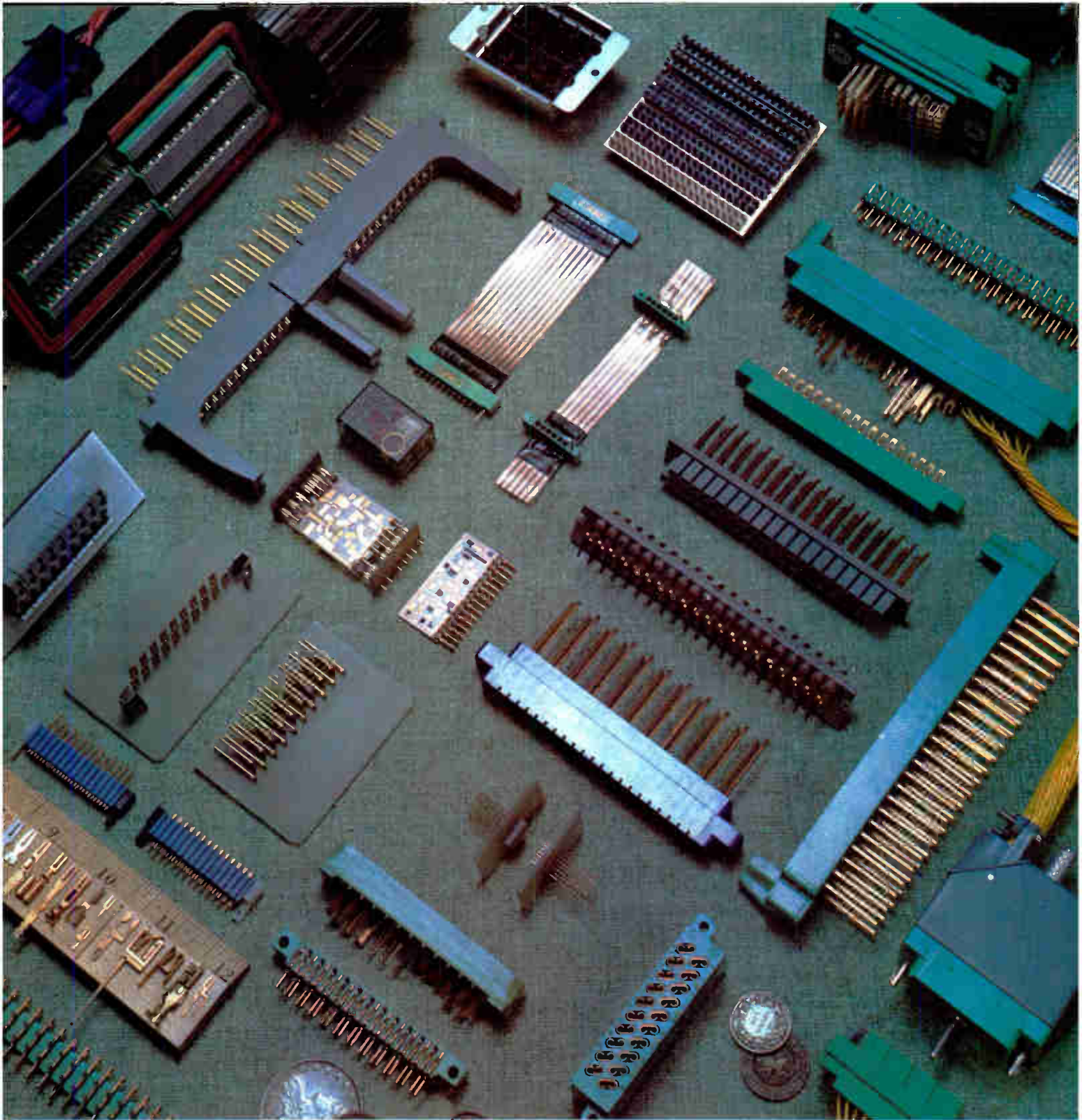

Connector Collector.

*TRADE-MARK
†PAT. PENDING

Some men collect ELCO VARICON® Connectors. One sample of each model they've specified and used over the years. To keep for their own personal standard of comparison. For reliability. Versatility. Adaptability. Production economy. One sample of each size. Standard. Miniature. Sub-miniature. Micro-miniature. For rack-and-panel applications. Printed circuitry. Modules. Plates. Packaging. Substrates. Interconnections for integrated circuitry. With contact tails for every conceivable terminating technique. Including our VARILOK® crimp-and-insert, and TERMIWELD*† for flat flexible cables. Each with the world's most reliability-proven fork-design ELCO VARICON® contact. Or other equally hi-rel ELCO VARICON® nose designs.

Send us \$29,650 for a hand-made sample of each of our models. Or a 4¢ postal requesting our Product Digest. Or Technical Bulletins covering the exact models you have in mind. That's the thrifty way of starting your own personal ELCO VARICON® Connector collection. At a saving of \$29,649.96. Write today while this offer is still in effect.

if it's new...if it's news...it's from



ELCO CORPORATION: Main Plant and Offices, Willow Grove, Pa. 19090; 215-659-7000; TWX 510-665-5573. ELCO Pacific: W. Los Angeles, Cal. 90064. ELCO Midwest, Chicago, Ill. 60645. Representatives, Subsidiaries and Licensees Throughout the World.

By RALPH SAUNDERS,

Senior Engineer,
Burroughs Corp.,
Defense and Space Group,
Great Valley Laboratory,
Paoli, Pa.

The form of integrated circuitry known as the thin-film hybrid can be a very practical, economical and time-saving approach to miniaturization of electronic circuits.

This is particularly true for circuit development and feasibility studies, and for prototype models.

Thin-Film Hybrid

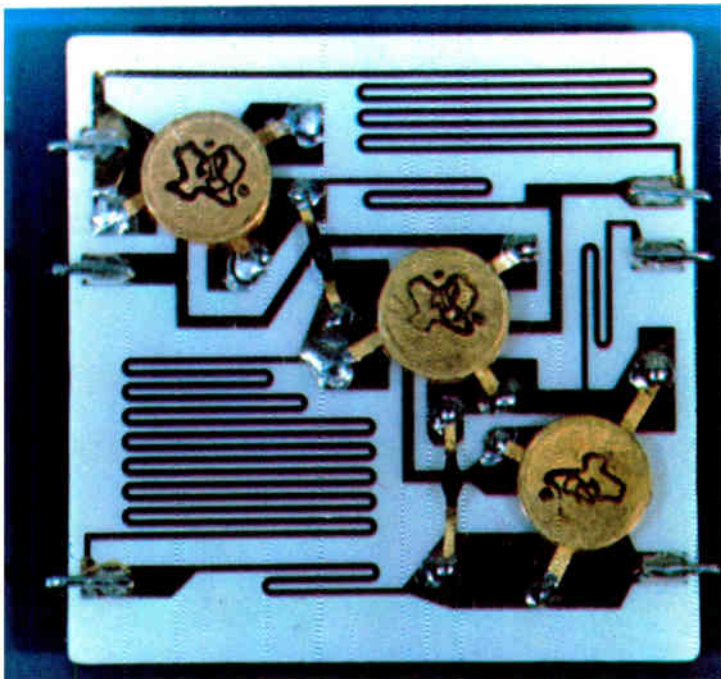

Photoamplifier circuit (above) built on a 1 in. substrate uses TO-50 transistors and microdiodes. It is also shown on the cover.

Inhibit driver (right) for a memory system.

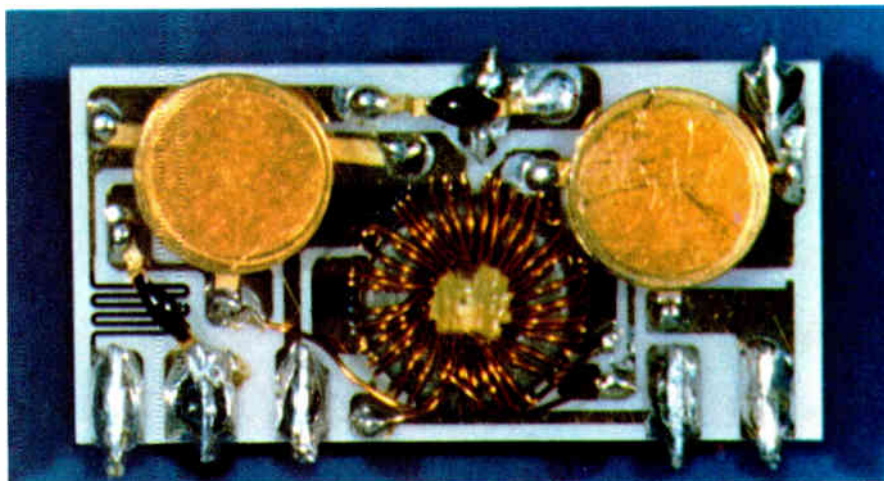

An artist's drawing (below left) of a thin-film flip flop. Artist's drawing (below right) of the same thin-film flip flop using chip transistors instead of the TO-50 type. Both drawings were made from actual circuits.

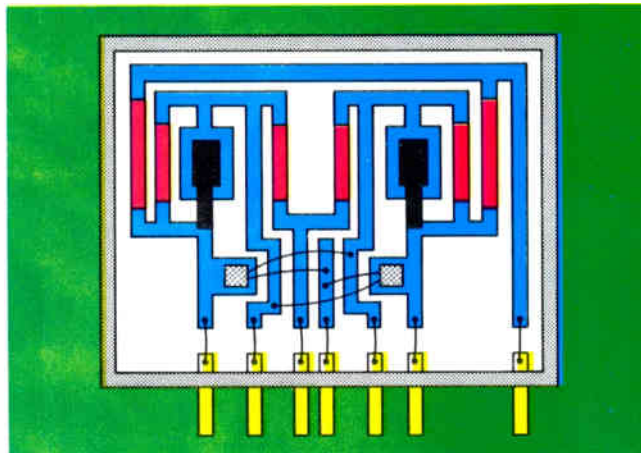
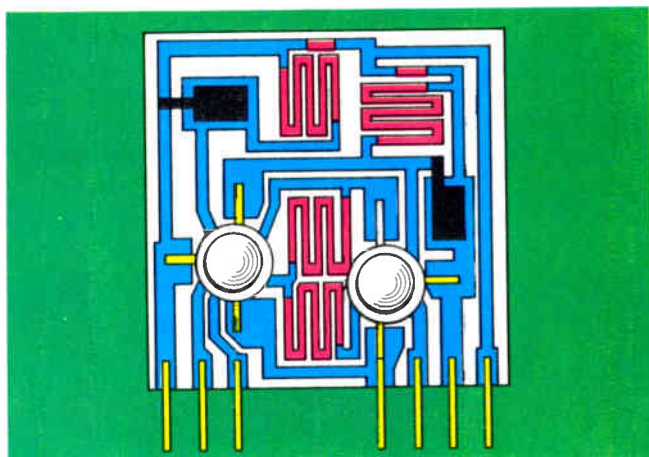

IN THE PAST DECADE, THE ELECTRONICS INDUSTRY has been much concerned with circuit miniaturization. The result has been an art termed microelectronics, or more commonly, integrated circuitry.

From all indications, integrated circuits (IC's) appear to be capable of replacing much existing circuitry. Presently available IC's have this capability within defined limits of power, noise, frequency, etc. Present limitations preclude their replacing all circuits in existing devices. But, the present pace of the state-of-the-art indicates that many of these limitations will be overcome.

Molecular Circuits

Much of industry's effort has been in the development of what has been referred to as the true molecular circuit—a functional electronic block in which physical phenomena are combined to perform a required circuit function within an active substrate. Quite a variety of "standard" molecular circuits are now available "off-the-shelf" for IC uses. Cost and availability are at-

try wanted. The pattern is scribed through a thin layer of opaque material on a stable mylar base. After scribing, the unwanted opaque material is peeled off, leaving the desired circuit pattern.

For a resistor/conductor network, only three master patterns are needed. They are: (1) an overall basic resistor/conductor pattern; (2) a pattern defining resistor areas; and (3) another pattern blocking out resistor areas, but dimensionally adjusted to provide for photo-resist insulation of the resistor/conductor junctions during later anodizing of the resistors.

Materials and Processing

The base substrate for the hybrids must be smooth and highly polished because the deposited metallic materials are measured in angstroms. Certain glasses and glazed ceramics are satisfactory. They can be used either in small individual pieces or in larger sheets containing many circuits that are later cut apart.

A variety of resistive and conductive materials can be used to produce resistor/conductor networks in

Approach to Integrated Circuits

tractive for many of these standard circuits; but, if circuits or functions other than those readily available are needed—which is normal if the state-of-the-art is to advance—then cost and time become significant factors. This is true because of the relatively complex tooling and processing involved.

Hybrid Circuits

Thin-film hybrids are made of thin metallic films deposited on a suitable substrate. The films are used to form passive components and conductors. Discrete active components are attached to form complete circuit functions, or modular parts of larger circuits.

Resistor values are obtained by the length/width ratio of the resistive areas, based on the ohms/square of the resistive material. Capacitance values are largely dependent on film area. This normally limits two-dimensional capacitors to the low picofarad range. To use a wide range of capacitance values, it has been found economically expedient to use normal multi-layer, ceramic wafer capacitors. These are attached to the basic substrate conductor pattern.

In this article the basic substrate will be considered, for clarity, to contain only resistor/conductor networks.

Circuit Geometry

Tooling of a thin-film hybrid circuit consists mainly of the preparation of master art work patterns suitable for photo-reduction. These patterns are based on the circuit schematic and correspond to the thin-film geome-

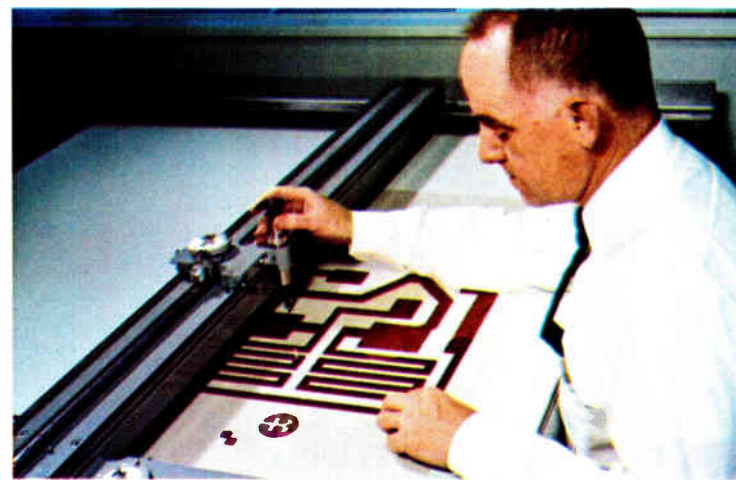

Author Ralph Saunders uses a coordinatograph to make scribed resistor/conductor pattern. Coordinatograph is a combination drafting/scribing machine which has extreme dimensional accuracy.

thin-film form. The ones used here in describing the fabrication process are tantalum for the resistive elements, and gold for the conductor and terminal areas. A seed layer of nickel between the tantalum and gold is used to provide good adhesion between the two. Since the process to be used is that of selective photoetching, the selected materials are deposited sequentially over the entire area of the substrate by cathodic sputtering in a partial argon atmosphere. Basic depositions can be done by batch processing and the prepared sub-

THIN-FILM HYBRIDS (Continued)

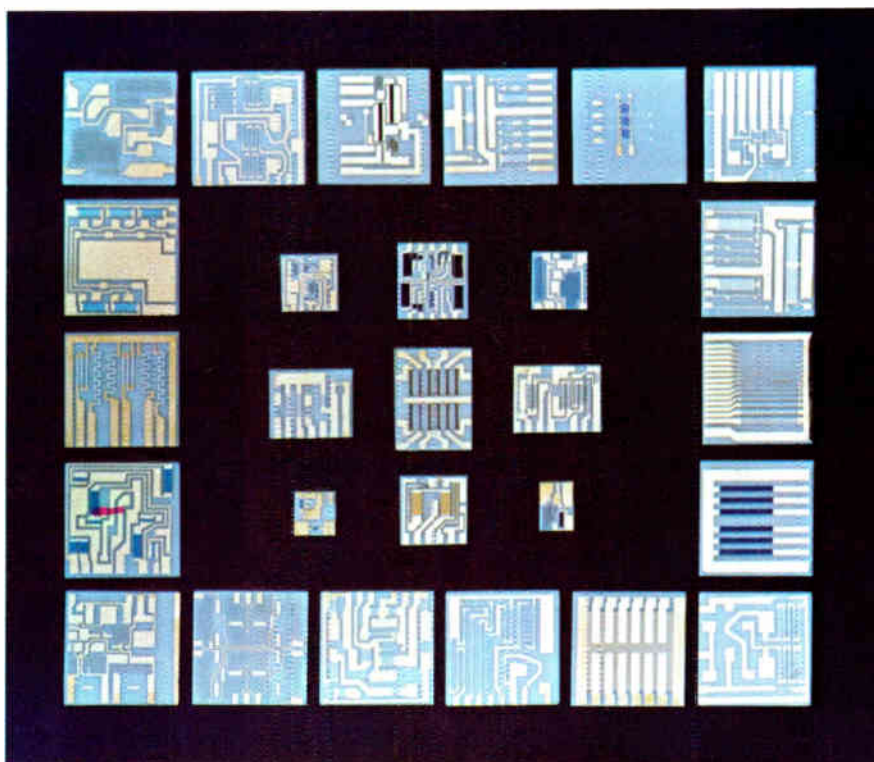

Examples of photoetched thin-film circuits before discrete semiconductors are attached.

strates stockpiled for future off-the-shelf use. Thus, the elapsed time needed to produce finished circuits for a specific use is greatly reduced.

Processing the prepared substrate into the needed resistor/conductor network consists of several sequential operations. These are: applying photo-resist to the substrate, exposing through the proper film mask, developing, and selective etching of the gold conductor/resistor pattern and of the nickel/gold overlay from the resistor areas. Later chemical anodizing of the exposed tantalum resistor areas brings the resistors into value and passivates them at the same time.

At this point in the process, the resistor/conductor network can be checked before the discrete components are affixed. If rejects occur, they can be discarded with no loss of transistors, diodes, or capacitor elements.

Discrete Elements

The transistors used for these hybrids are available in three forms: (1) a hermetically sealed unit, such as the TO-50 package; (2) passivated chips which are mounted on a Kovar base and provided with gold wire leads; and (3) passivated chips with the three terminal areas on one flat side, so that they can be fastened down flat on the substrate terminal areas provided.

Diodes are available in the standard DO-18 microdiode package, and in both passivated chip forms described above.

Wafer-type capacitors have been described previously.

The discrete elements, as well as terminal wires or pins, are attached to the processed substrate by normal soft-soldering methods.

The circuit is now ready for final testing and encapsulation. The encapsulation provides for mechani-

cal and some environmental protection. If required, the circuits can be mounted within hermetically sealable headers.

Case Example

A photoamplifier for use in an optical tape reader provides an interesting example of the evolution of a hybrid circuit, as developed from a normal PC.

The original schematic for the circuit contained 5 resistors, 3 transistors, and 2 diodes. Using available TO-50 transistors and microdiodes, the circuit was made on a 1 in.² ceramic substrate as a thin-film hybrid. It was checked in the actual use as a replacement for the original printed circuitry, and performed well. A second version was built using chip transistors and diodes, on a 1/2 in.² substrate—with equally satisfactory results.

Because of the low noise level achieved using these hybrids, it was possible to modify the original circuit, eliminating 2 resistors, 2 diodes and a transistor.

This modified circuit was again built using TO-50 transistors, and then, for further reduction in size, with chip transistors. A tendency of the circuit to oscillate in the chip version was corrected by adding a small wafer capacitor across the input terminals on the substrate. This was done with only minor adjustment to the artwork master.

Finally, because of the small size of the final hybrid, it was possible to build eight such circuits, stacked on

• A REPRINT of ANY ARTICLE in this issue is available from ELECTRONIC INDUSTRIES Reader Service Department.

0.1 in. centers, so that they could be mounted directly under the punched tape adjacent to the photocells. This eliminated the need for shielded wire between the photocells and the amplifiers.

Advantages of Thin-Film Hybrids

A basic advantage of the thin-film hybrid form of circuitry is the fact that the master artwork (tooling) is relatively simple to lay out initially. And, it is comparatively easy to alter to accommodate circuit or component changes—an important feature in development work.

Another important feature is the fact that materials and discrete elements can be chosen that do not need compromise either of process or resultant component characteristics. Also, it appears that the operating frequency of thin-film hybrids is sufficiently greater than molecular circuits to make them attractive for liner device uses above 10 mc. It also appears that an order-of-magnitude improvement in gain is possible at the higher frequencies with thin-film circuitry primarily because parasitic capacity is reduced.

There is another advantage of this hybrid form of circuit over molecular circuits. It is that the orders-of-magnitude larger substrates used allow for much more total power dissipation than is possible with the almost microscopic molecular circuit substrates.

Photographs below show evolution of a photoamplifier. Top photo shows the original unit using TO-50 transistors and microdiodes (left) and a second version using chip transistors and diodes. Bottom photo shows the modified version after two resistors, two diodes and a transistor were eliminated. Unit on the left uses TO-50 transistors and the one on the right uses chip transistors.

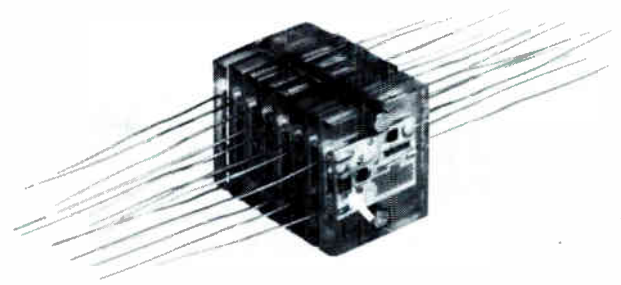
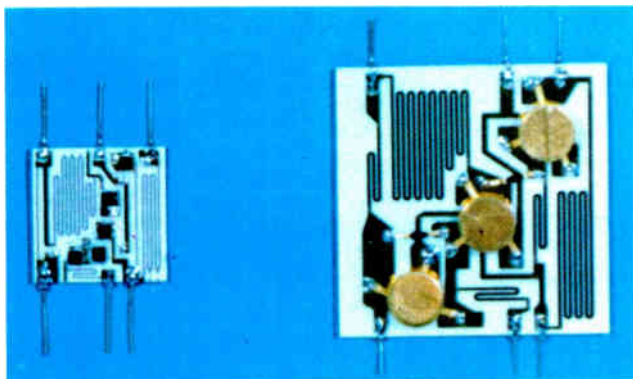
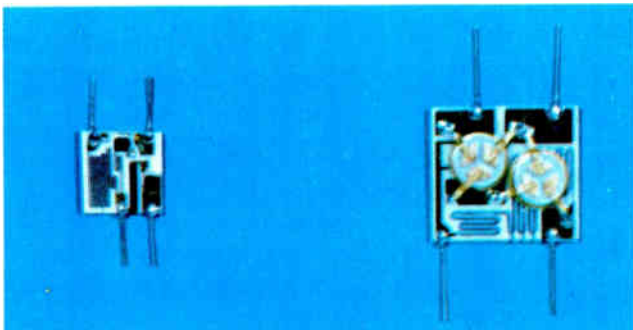

Assembly of eight photoamplifiers (above). Arrow points to capacitor added to prevent oscillation. Typical thin-film hybrid circuits using TO-50 transistors and microdiodes are shown in photo below.

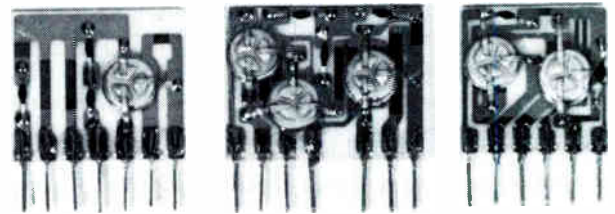

Conclusions

An in-house capability for building of thin-film hybrids can be an effective tool when exploited by designers in the application of integrated circuitry to electronic equipment. Also, for prototype work and limited production, such a capability can be of great value in terms of cost savings and elapsed time.

Because of the comparatively simple tooling needed, and the few process steps involved, working circuits can be produced singly, or in small production quantities, right along with circuit development work. Thus, results can be evaluated and designs firmed up, or modified, as the occasion demands. An elapsed time of only a week from schematic to finished working circuit, with a first-piece cost well below \$300, excluding semiconductor elements, is very realistic for these circuits. The comparative simplicity of the entire process is reflected in high yield and, as indicated by evaluation work in progress, in a high degree of reliability.

Acknowledgement

The author wishes to thank Elmer C. Duckinfield and Mark A. Foley, of these laboratories, for processing and preparing the circuits shown.

Bibliography

- (1) Sprague, J. J., "Integrated Circuits," *International Science and Technology*, April 1964, pp. 43-52.
- (2) Kirby, P. L., "A Practical Approach to Thin Film Circuits," *British Communications and Electronics*, April 1964, pp. 242-246.
- (3) Keonjian, E., *Micro-Electronics*, McGraw-Hill Book Co., 1963.
- (4) Brauer, J. B. and O'Connell, E. P., "Microelectronics—Where, Why and When?" *Electronic Industries*, Sept. 1964, pp. 32-36.
- (5) Meehan, A., "Where Thin Films are Today," *Electronic Industries*, Sept. 1964, pp. 64-67.

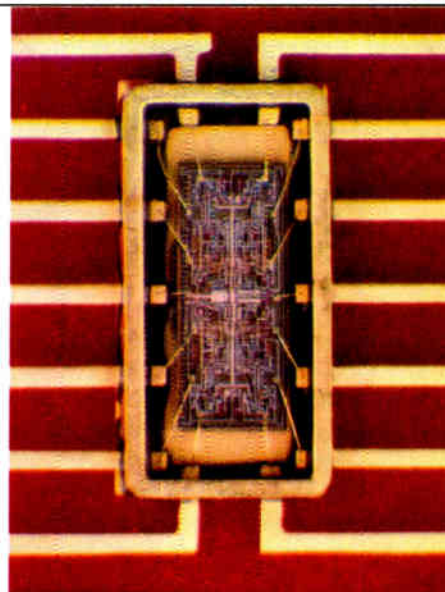
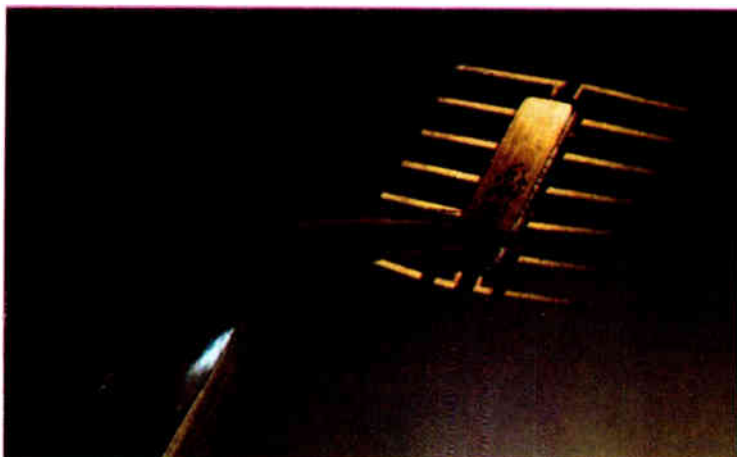

The approaches of thin film and monolithic circuits are not competitive but complementary. Certain advantages keep oscillating back and forth between the two as new fabrication methods develop. The final outcome will probably be a combination of the two methods.

The Status of Monolithic and

**ELECTRONIC
INDUSTRIES**

STATE-OF-THE-ART

FEATURE

A "CHIP" TRANSISTOR was incorporated into a circuit containing passive silk screened components by Diamond Ordnance Fuze Laboratory personnel and reported at the Electron Devices Meeting in Washington in 1957.³ This

feat while not particularly practical, did show the great potential of miniaturization.

Integrated Circuits

Texas Instruments announced in 1959 that it had made an integrated circuit entirely out of silicon with no externally formed passive elements.⁴ This unit was a multivibrator.

The transistors were mesa devices, the resistors portions of the bulk semiconducting material, and isolation of the components was achieved by etching away unwanted material. This device, crude as it appears by today's standards, was revolutionary when announced. How could any circuit be smaller than the chip of silicon itself? People began to think in terms of integrated rather than miniaturized, and functional performance in place of component specifications. The objectives began to be reduced cost and higher reliability, rather than reduced size and weight.

The advent of high-volume silicon device processing made the fabrication of integrated monolithic circuits

simple and almost universal.⁵ Leads could be formed at will interconnecting stable, low leakage devices which had all been formed simultaneously. A new factor was introduced now, and that was the circuit application. Where the devices had previously been minute curiosities, they were now being looked at in the reality of performance—and found to be wanting in many cases.

It appeared that the best general approach to total performance was the thin film circuit, an early example is shown in Fig. 1. An inert substrate, such as glass or ceramic, has deposited on it resistive, dielectric, and conductive layers. These are selectively etched to form the resistors, capacitors, and interconnections. Transistors and diodes are then attached and the completed circuit potted. Scientists at the Royal Radar Establishment (RRE) in England had been examining the use of thin films for a number of years.⁷

The thin film circuit allowed the designer to select the best semiconductor devices for his use from a catalog. Resistor and capacitor performance can be optimized through the use of various metals, insulators, and dielectrics which were perhaps better suited for the purpose than silicon. In the case of tantalum, both the resistive paths and dielectrics could be formed from the same material by anodization. The Bell Telephone Labs. did much of the early investigation of this material.^{8,9}

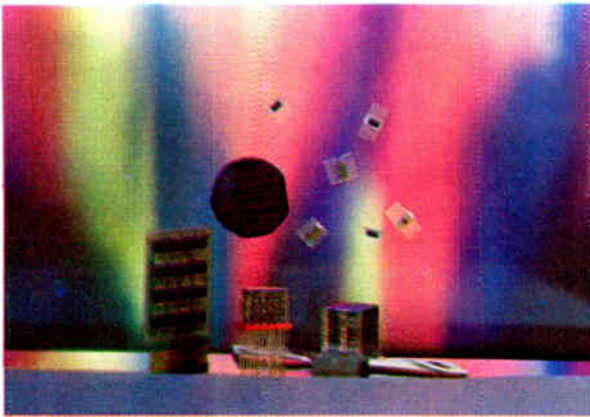

Left: Some individual integrated circuits and the advanced equipments using them. Right: An integrated circuit in its flat pack.

Fig. 1 (below): A thin film tantalum circuit.

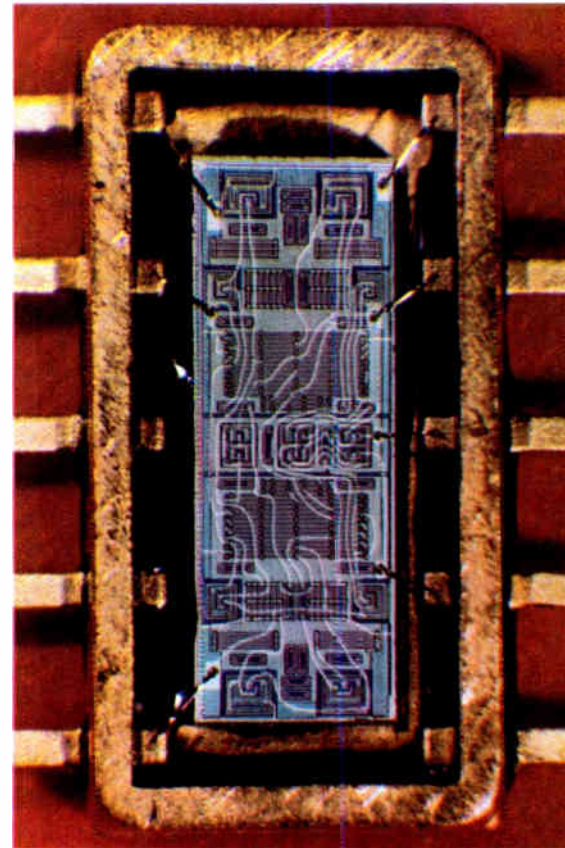
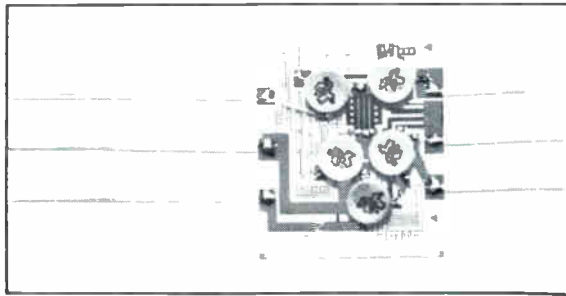

Thin Film Circuits

By J. W. LATHROP, Mgr. of Technology Programs,
Texas Instruments Incorporated, Dallas, Texas

Early Difficulties

Computer applications serve to show the difficulties the monolithic structures encountered. Computer-logic building blocks could be made simply in discrete form which took advantage of transistor improvements. These circuits, however, could not be made with the same degree of performance in monolithic form, mainly because of parasitic capacitance associated with the circuit elements, and because accurate resistor control was also needed.

On the other hand, adequate performance could be obtained with thin film circuits. To avoid overpackaging, glass surface coatings and chip attachment methods were developed. This allowed "uncanned" semiconductor devices to be attached to a substrate containing the passive elements.¹⁰ Individually adjusted silk screened resistors were used very much, as in the early DOFL approach. The tantalum resistors and capacitors also could be used since they can be made with the required tolerance.

Isolation

That was the situation at the start of 1964. Components had reached a high degree of perfection. On the other hand, the monolithic block, with its inherent advantages of simultaneous processing and minimum interconnections, could not make full use of this com-

ponent performance. It appeared that for ultimate performance the user would require the isolation and control methods of thin film circuits. All of this changed with the improved isolation methods in monolithic structures. A major portion of this article will be devoted to a discussion of isolation methods.

The normal isolation between components in a monolithic structure is from reverse biased p-n junctions, as shown in Fig. 2. Actually, of course, the p-n junction has capacitance and normal junction leakage associated with it. This results in incomplete isolation. The use of epitaxial material gave added performance for the active devices, but still has the basic disadvantages associated with a p-n junction.

Some fabrication methods for isolating epitaxial structures are shown in Fig. 3. In the top diagram, a heavy p-type diffusion is made before each epitaxial layer is deposited, as well as after the final deposition. This method is applicable where thick, high-resistivity layers need to be isolated. Where the layers are fairly thin, it is possible to isolate in a single diffusion as shown in the middle. The bottom sketch represents a single isolation diffusion also, but it only has to penetrate a single film because the high resistivity layer was previously formed by diffusion.

A thin film circuit with a separately attached semiconductor device has excellent isolation, but at the price of separate processing and a larger physical size.

MONOLITHIC & THIN FILM CIRCUITS (Continued)

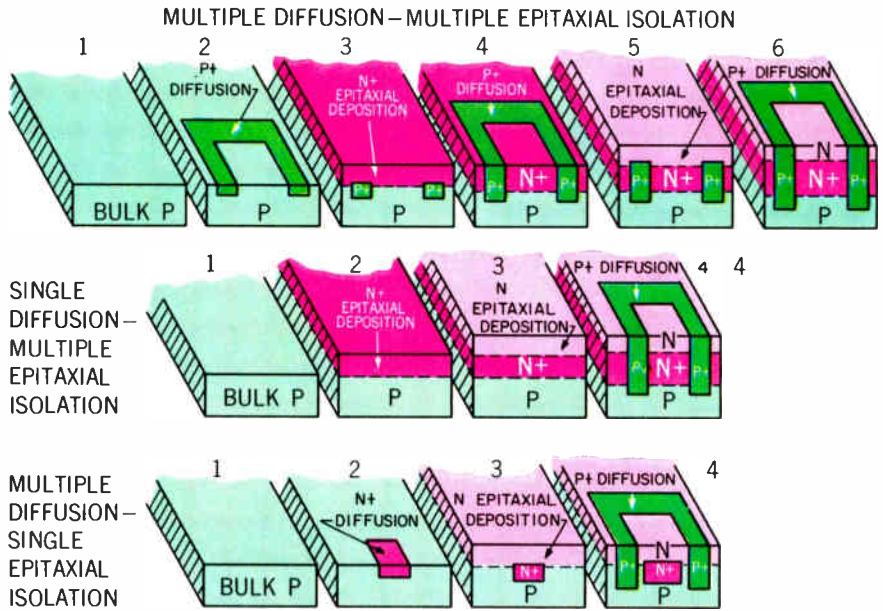

Fig. 3 (right): A sequence of steps and methods to achieve device isolation.

Fig. 2 (below): Cross section of two active devices. The interaction problems are discussed in the text.

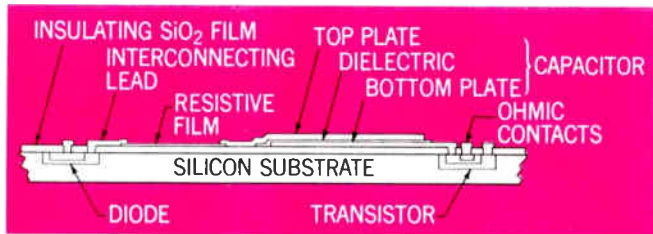
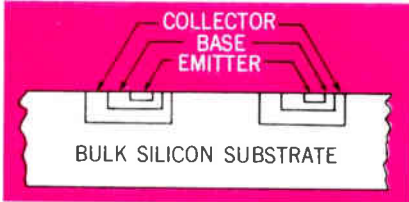

Fig. 4: Sketch shows a thin film/monolithic structure. Much effort has been expended in the past few years to develop this method.

The advantages of small size will become increasingly important as circuits have to operate at higher and higher speed. In 1 nsec. an electrical signal will propagate only one foot, and unless circuit elements are placed close together, the advantages of recent high-speed devices can be lost.

A method of isolating the passive components from the active elements is to deposit the passive elements in thin film form over oxide coated silicon, which has been processed previously to yield the active devices.¹¹ The resulting form is shown in Fig. 4. The disadvantage, of course, is the incomplete isolation of the active elements and the additional processing operation of thin film deposition. The degree of isolation afforded by this method is significant, and much effort has been expended in the past few years in developing this method.

The thin film circuit component fabrication methods are not directly usable in this case, because of the need for compatibility with semiconductor processing, and the semiconductor engineer's preference for a dry process. Evaporated nichrome films have formed satisfactory resistors.¹² Contact system developed for this material are compatible with semiconductors.

Tantalum, which has long been the favorite of thin film circuit fabricators because of the dielectric properties of its oxide and the ease with which it can be

anodized, is also being examined for use over oxidized silicon.¹³ The objection of wet processing for anodization can be overcome by reactively sputtering the metal, i.e., sputtering in the presence of oxygen. The resistivity of the film varies with the partial pressure of oxygen.¹⁴ More oxygen will result in more of the higher resistivity oxide being formed. On the other hand, if a sheet resistivity of 200 ohm/sq is desired, sputtering in nitrogen should be considered, since TaN₂

Fig. 5: The simplest form of dielectric isolation method is shown.

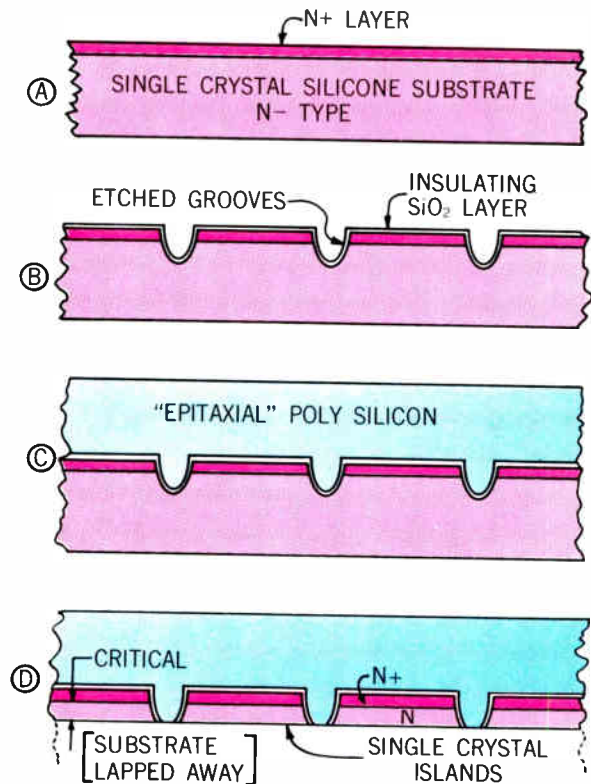

is formed with the reaction going to completion at about 5×10^{-5} torr.

More Ideal Methods

Early in 1964 it became evident that a more ideal method of semiconductor isolation was possible which still retained the common processing of the completely monolithic structure. In its simplest form¹⁵ this dielectric isolation method is shown in Fig. 5. Starting with a single crystalline substrate having a heavily doped epitaxial layer, as shown in A, grooves are etched several mils deep outlining various regions of the slice. An oxide is either grown or deposited over the entire slice as shown in B and polycrystalline silicon epitaxially deposited as in C. Finally, the original substrate is lapped away, as shown in D, to define islands of single crystal silicon isolated from each other by an insulating layer of oxide. Impurities can now be diffused into these islands to form the components of the circuit.

For the first time, here was a method which allowed the isolation of all devices as completely as if they had been separately attached onto polycrystalline oxide-covered silicon. The major disadvantage with the method, as shown in Fig. 5, is the degree of control required on the lapping operation. The critical distance from the n-n+ junction to the surface (and consequently to the subsequently formed p-n base-collector junction) can determine a number of transistor characteristics. Presently, the tolerance on this operation is about ± 0.1 mil. For control over the device characteristics ± 0.05 or better is needed.

A number of methods have been proposed which minimize this difficulty.¹⁴ One is shown in Fig. 6. In this method a highly doped uniform single crystal substrate as shown in A is processed in exactly the same fashion as in Fig. 5 to yield isolated islands of low-resistivity material B. By using a SiO₂ film for selective masking, regions within these islands can be vapor etched C, and lower resistivity silicon redeposited as in D. The critical distance is now controlled by the etch and deposit processes of epitaxial deposition, which are superior to mechanical lapping.

Another method¹⁶ is shown in Fig. 7. The critical distance is controlled during the initial step of epitaxially depositing an n-film on an n± substrate shown in A. Next an insulating SiO₂ layer is deposited over the n- layer and polycrystalline material over this. The only purpose of this polycrystalline layer is to serve as a "handle" during operations and allows the substrate to be thinned to a few mils as shown in B without breakage. Grooves are then etched in this thinned single crystal material creating mesas over which an oxide may be grown as in C. Finally an epitaxial polycrystalline "substrate" is deposited over thin oxide and the "handle" material removed to leave isolated regions having a common flat surface as shown in D.

The processes of Figs. 6 and 7 minimize the lapping control for dielectric isolation, but at the expense of additional processing. The p-type, as well as n-type material may be processed and both types of islands may be formed on the same slice.

The result of these methods is isolated islands of semiconductor material into which impurities may be

Fig. 6: This is the polycrystalline handle method of isolation.

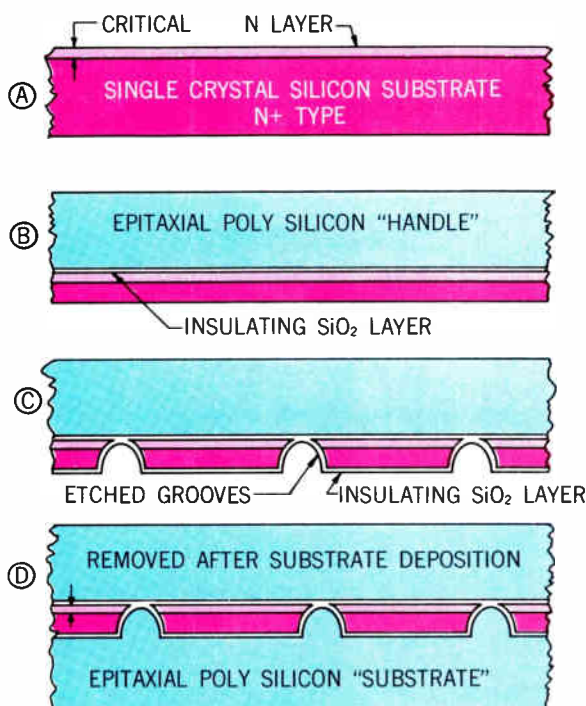
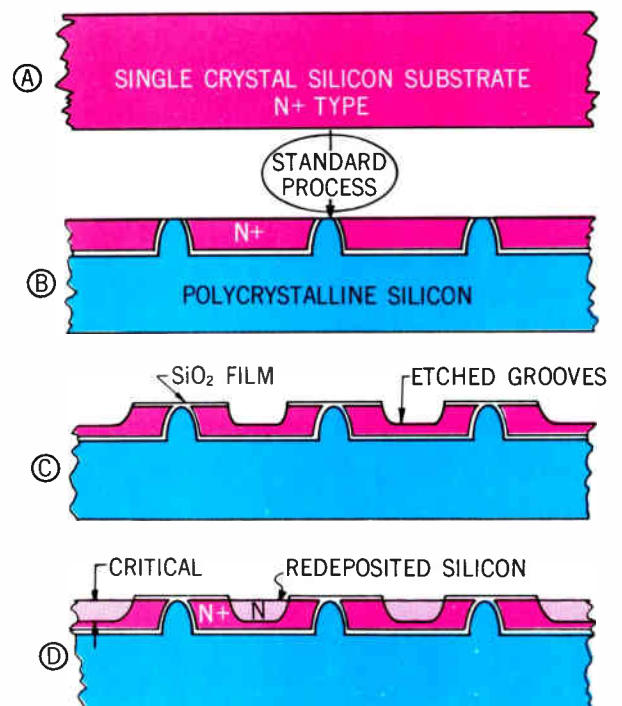

Fig. 7: Etch and redeposit method of dielectric isolation.



MONOLITHIC & THIN FILM CIRCUITS (Concluded)

diffused to form active and passive components. Another method of isolation which physically separates the semiconductor elements after processing, rather than before, is the "beam lead" method developed by BTL.^{17, 18} When this method is used to separate discrete elements, as shown in Fig. 8, the result is a chip which is more compatible with passive substrates, such as those of anodized tantalum which BTL developed.

Modifications of this method can be used to isolate the individual components of a monolithic structure. One of these methods, now in development, is where silicon is processed similarly to p-n junction isolation, except that no isolation diffusion is made. The "finished" slice is then brought together with an insulating substrate, such as glass. The exact adhesion method still represents a tough problem. The silicon is then thinned in a noncritical lapping or etching operation and finally, a photo etch step is performed to isolate various parts of the circuit.

Because for every mil etched down there is about a mil of sideways etching or undercut, air isolated islands are separated from each other by several mils. It is approximately as if the region filled with polycrystalline material in the dielectric isolation method were void in the beam lead approach.

Conclusion

The technological status of thin film and monolithic circuits is, therefore, still one of change with advantages

oscillating back and forth between the two approaches as new methods develop. Interestingly enough, because of these new methods the thin film approach, which appeared to be the only way of meeting ultra-high-speed needs, may instead be inferior to the monolithic structure, unless its size can be further reduced. Small physical size, at first the major influence behind the integrated circuit, and then neglected in favor of low cost, may be returning as the only way to fully use the potential of today's high speed devices.

Combinations of the two approaches through methods such as the "dry" deposition of thin films on silicon or the beam lead attachment of silicon to passive substrates will eventually bring both methods together.

The present emphasis on isolation methods as the guiding technology behind thin film or monolithic structures is of more than technological significance. It is an important factor in satisfying the need to closely couple the integrated circuit designer to the fabrication process. Without a more direct form of isolation than the p-n junction, it is difficult to predict the performance of a design from a discrete element breadboard. By providing more complete isolation, a circuit designer can once again specify performance from a circuit breadboard.

It has long been a dream to establish a "library" of components, made from semiconductors, thin films, etc., by known and controlled processes from which the circuit designer could select his elements. Computer programs can be developed to aid in this process and even produce a final layout with all processing instructions, provided the elements do not interact with each other in some unknown way.

Fig. 8: Beam lead method physically separates the elements.

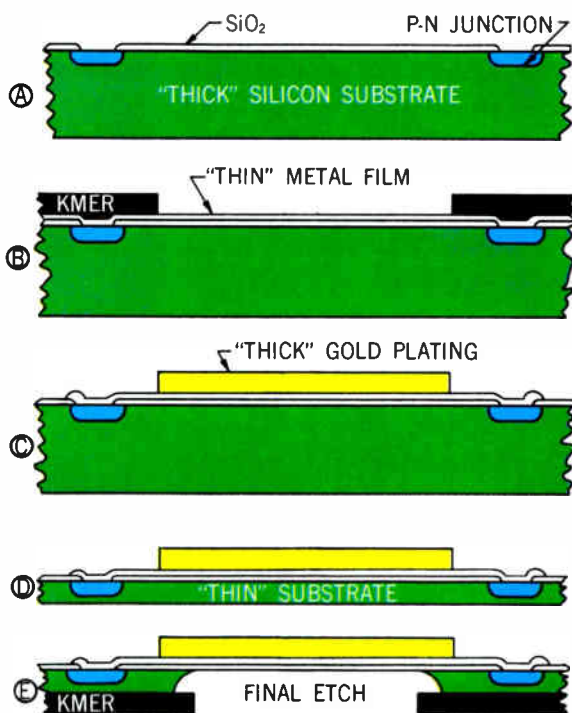

References

1. W. S. Hinman, Jr., and C. Brunetti, National Bureau of Standards Journal of Research, 37, July 1946.
2. G. W. A. Dummer, "Electronic Components in Great Britain," Proc. Components Symposium, Washington, D. C. p. 19, May 1962.
3. J. R. Nall and J. W. Lathrop, "Photolithographic Fabrication Techniques for Transistors which are an Integral Part of an Integrated Circuit," Electron Devices Meeting, Washington, D. C., October 1957.
4. J. S. Kilby and E. Keonjian, "Design of a Semiconductor-Solid Circuit—Adder," Electron Devices Meeting, October 1959.
5. J. S. Kilby, U. S. Patent No. 3,138,743, June 23, 1964.
6. J. W. Lathrop, R. E. Lee, and C. H. Phipps, "Semiconductor Networks for Microelectronics," Electronics, May 13, 1960.
7. G. W. A. Dummer, "Components for use with Transistor Techniques," Brit. Communications and Electronics, 6, 422, (1957).
8. D. A. McLean, IRE WESCON Convention Record, Vol. III, 87, (1959).
9. D. A. McLean, "Tantalum Film Circuits," Seminar on Integrated Circuits, New York Chapter IEEE, Basic Sciences Division, pp. 39-44, January 15, 1964.
10. E. M. Davis, W. E. Harding and R. S. Schwartz, "An Approach to Low-Cost High-Performance Microelectronics," WESCON, August 1963.
11. R. S. Clark, Jr., and D. Brooks, "Thin Film/Monolithic Circuits—How and When to Use Them," Electronic Design, 12 (1964).
12. O. J. Wied and M. Tierman, "Planar Microminiaturized Nickel-Chromium Resistors," Microelectronics Symposium, St. Louis, Mo., April 1964.
13. M. J. Walker, "A Compatible Technique for the Formation of Tantalum Thin-Film Resistors on Silicon Integrated Circuits," Electron Devices Meeting, Washington, D. C., October 1964.
14. N. Schwartz, "Reactive Sputtering," Tenth National Vacuum Symposium, American Vacuum Society, p. 325 (1963) Macmillan, New York.
15. D. McWilliams, C. Fa, G. Larchian, and O. Maxwell, Jr., "A New Dielectric Isolation Technique for High Quality Silicon Integrated Circuits," J. Electrochemical Society III, 153C, July 1964.
16. G. L. Schnable and A. F. McKelvey, "A Technique for Preparing Oxide-Isolated Silicon Wafers for Microcircuits," Electron Devices Meeting, Washington, D. C., October 1964.
17. M. P. Lepselter and R. W. MacDonald, "Beam-Lead Devices," Electron Devices Meeting, Washington, D. C., October 1964.
18. M. P. Lepselter, H. A. Waggener, and R. E. Davis, "Beam-Leaded and Intraconnected Integrated Circuits," Electron Devices Meeting, Washington, D. C., October 1964.

SATELLITE CHECK ▶

Unusual view of NASA Syncom III active repeater satellite, before launch, being mated to 3rd stage of Delta launch vehicle.

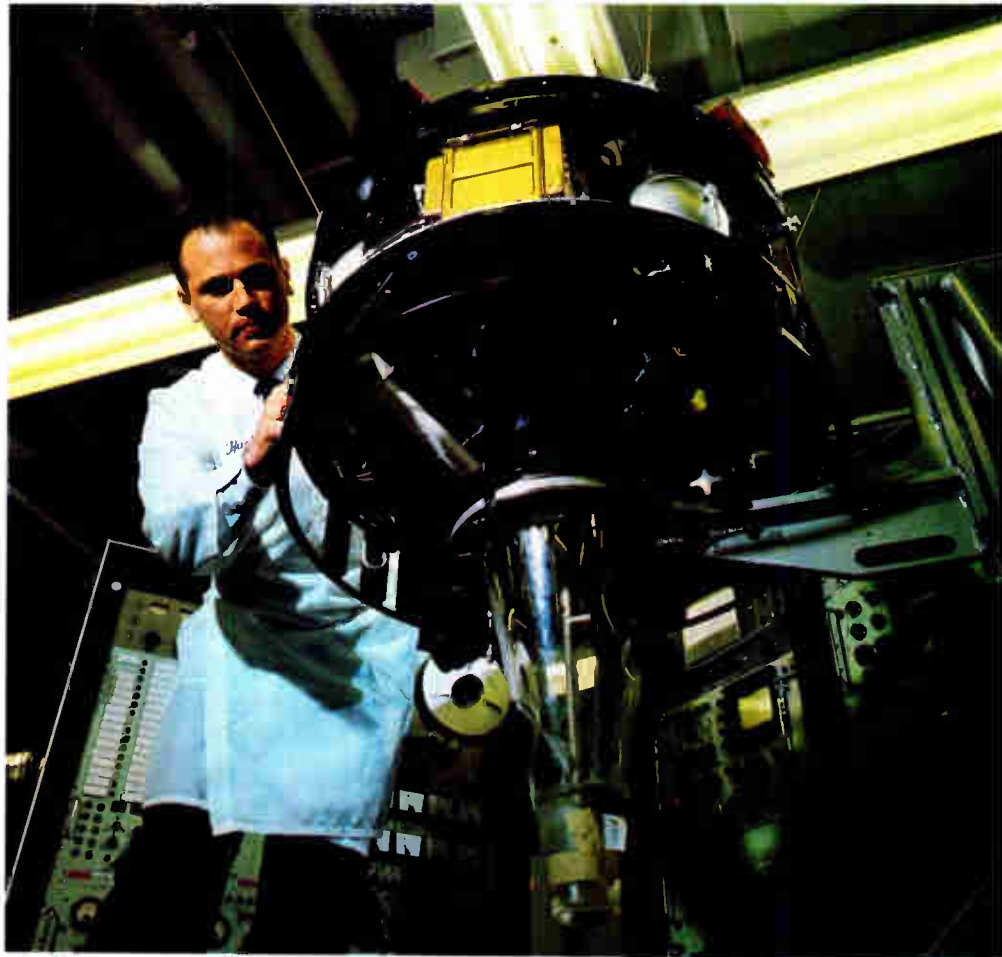

▼ DISTORTION GONE

FAA says it has eliminated radio signal distortion from several airway navigation sites with Koppers Co. plastic radome antenna shelters.



ELECTRONIC SNAPSHOTS

The Changing
STATE-OF-THE-ART
in the electronic industries

OH, BUOY ▶

Long range oceanographic telemetering buoy, designed and built by Convair (General Dynamics) for the Office of Naval Research, being towed on-station off Hollywood Beach, Fla.



▲ DIVING SAUCER

Submersible vehicle for 1000-foot depth is forerunner of Westinghouse Deepstar family which may descend to 20,000 feet. Electronic equipment includes sonar, readout instruments, indicators, sensors, recorders.

Si INGOTS ▶

Silicon crystal ingots waiting for the rotary diamond slicer—the second stage of semiconductor making at Fairchild Semiconductor.



CERAMIC DISK ▶

Showing how pre-oxidized metal "goes into solution" with CERAMICITE on bonding, making chemical and compression bond. Ceramic modified glasses by Consolidated Electroynamics used in headers, terminals.



ELECTRONIC SNAPSHOTS (Continued)

▼ COLOR PHOSPHOR

Dr. Albert K. Levine with container of GT&E's new red vanadate phosphor for color picture tubes. Sylvania is now using the "truer and brighter" phosphor in picture tubes.

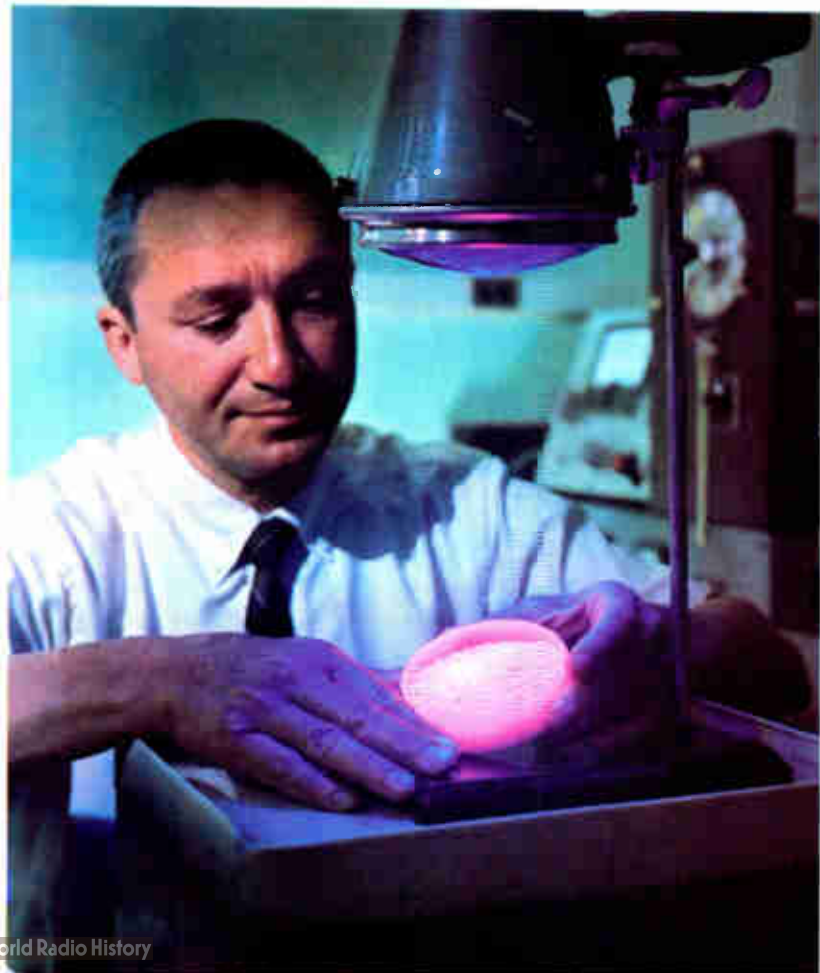

▲ BATTERIES

Diana Holmes, Hoffman Electronics Corp., makes final check of new sun-powered batteries using solar cells.

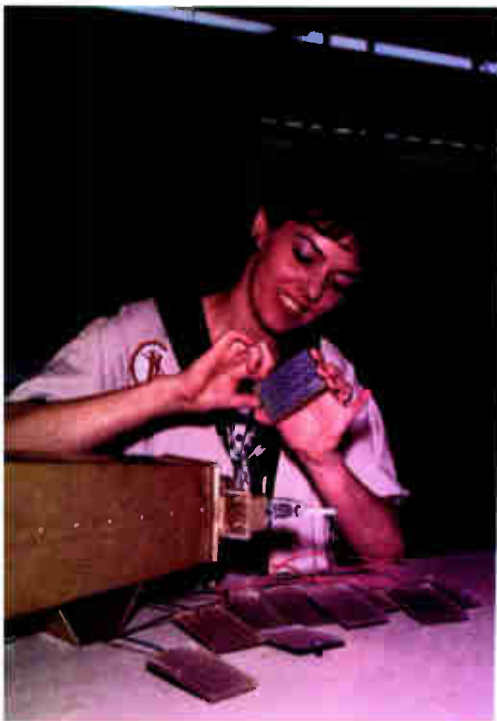

▼ FLAT PACK

Integrated circuit package with gold-plated Kovar leads; made with Corning Code 7052 "hard" glass and low expansion sealing glass. Firm reports seal yield greater than 97%.

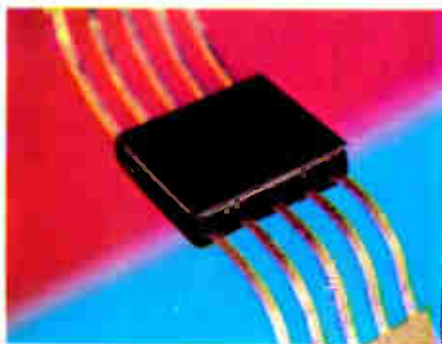

SEARCH FOR FLAWS ►

Inspector examines microcircuit in visual display test, one of many checks on microcircuits now produced in quantity at Philco, Lansdale, Pa.



▲ CHECKING THE DOTS

An inspector at RCA Tube Division uses an elaborate device to check the position of phosphor dots on the face of a 25-inch rectangular color television tube.

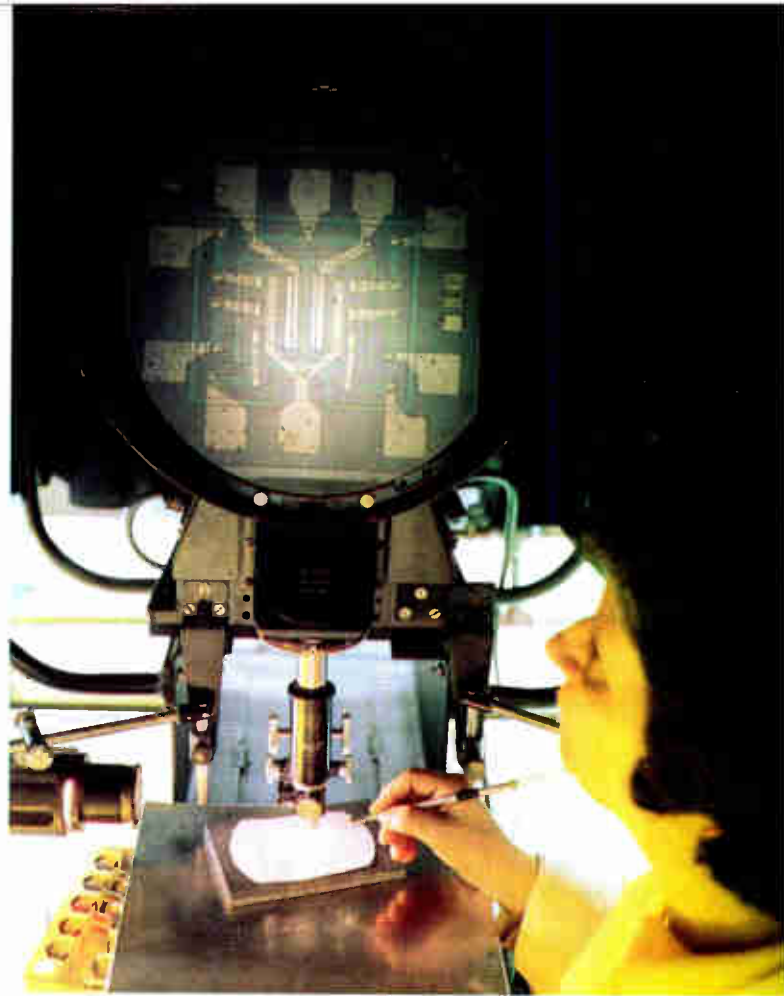

▲ SILVER PANELS

For "Mariner C" Mars vehicle under fabrication at Electro-Optical Systems, Inc. Single panels are 3' x 6' and contain 7,056 silicon solar cells. Panels are released by squibs after booster separation.



▲ AUTO SCRIBER

Type-writer sized scribing machine, controlled electronically, can dice any rectangular pattern semiconductor wafer. Device developed by Tempress Research Co.

MIGHTY MITE ►

Tweezer holds Sperry Rand's half-inch-long rod of Yttrium iron garnet which may replace bulky gear in background and make radar simpler, more efficient, less costly.



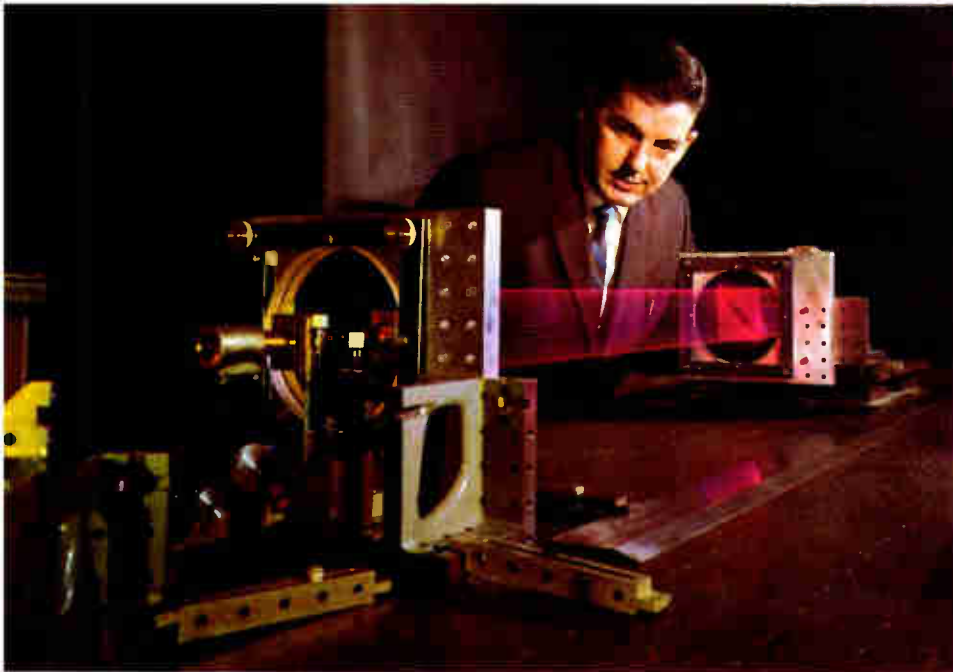

◀ FOLDED LASER BEAM

Two-mile laser beam folded into a 10-foot space, in experiment at Bell Labs by Donald Herriott, may result in optical delay lines for high-speed sequential computer memories.

▼ PLASMA RESEARCH

Basic research in plasmas is part of Honeywell's work in gaseous electronics. Gerald Rork uses quadrupole mass spectrometer to analyze ion collision.



ELECTRONIC SNAPSHOTS (Concluded)



◀ PROCESSOR CHECKOUT

Technician inspects and tests processor for new IBM System/360, which employs micro-electronic circuits to operate in low nano-second range.

▼ TO SHOOT A LIGHT FANTASTIC

Pencil-slim beam from end of gas laser tube (below) through mirror comes through in more than 120 additional colors at Hughes Aircraft Co. Laser emits blue, green, violet, red and yellow beams.



▲ U. S. STANDARDS

Extremely accurate, sealed double-wall 1-ohm resistors at National Bureau of Standards, Boulder, Colo. Thermostat-regulated oil bath keeps resistors and Wenner bridge at fixed temperature.

By **STEPHEN SLENKER**

President
Piconics, Inc.
North Billerica, Mass.

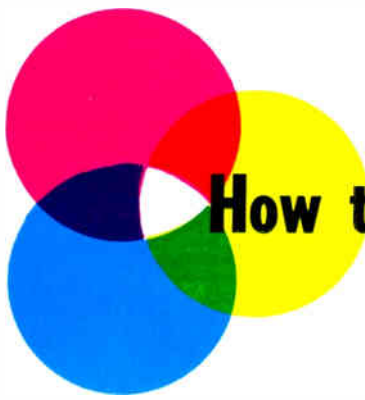

How to Take Color Photomicrographs of Electronic Devices

Engineers have been taking photographs for years, particularly scope traces. With microelectronics they now have a need for photomicrographs—in color—to show proper detail. This method does the job very well.

AN ELABORATE OPTICAL SYSTEM is not necessary for good microphotography. The optical system consists of a microscope with interchangeable eyepieces and nose-pieces, and any camera. Altering the optical system by changing magnification will require refocusing. The microscope focusing problem can be partially solved by using either a binocular, bi-ocular, or stereo microscope, where the camera will be attached to one eyepiece and the operator will be able to focus by looking through the other.

Any camera may be used, but it must be attached to the microscope in some fashion. If the camera lens is the same diameter as the microscope eyepiece, plastic electrical tape can be used for attachment. If the eyepiece can be brought level, so that the camera will rest on it without falling, attachment may not be needed. If the camera is unusually heavy, it may be necessary to make a tube to accommodate the camera on one end and the microscope eyepiece on the other end.

Professionals focus cameras by observing the image on a ground glass plate. This method can be used on any camera. A ground glass is made by cutting a piece of slide cover glass to the width of 35 mm film with a glass cutter and then spraying lightly with a glass frosting bomb. (Hardware stores will do this for a few cents.) This "ground glass" is then taped into the camera, ground side down, with the back of the camera removed. With the camera in position on the microscope, the optical system is then ready to be calibrated.

The Equipment

Your microscope has a diopter adjustment to compensate for variation between the eyes. This adjustment can be used to compensate for variation in focusing between the camera and the other eyepiece. The microscope used by me was an Olympus, Elgeet, model VA-II, selling for \$99.95. The camera was a Mansfield Starlite, purchased used for \$5.00. The camera must have a shutter that can be held open for taking time exposures, and must accept a cable release.

The camera was fastened to the eyepiece which is

not adjustable, and the lens was set to maximum opening, infinity range, and at time exposure.

The microscope was then focused, while looking at the ground glass. A 20 power auxiliary magnifying glass was used to get perfect focus on the ground glass. After the microscope has been focused, the diopter adjustment can be made on the other eyepiece by focusing for a clear image. Care must be taken if sharp pictures are to be obtained.

The object selected should be such that it requires the utmost resolving power of the optical system. Such an object is a hairline scratch on a coin. Both lenses should be synchronized on the same scratch. A mark was placed on a tape on the eyepiece diopter scale for the correct focusing position for each eyepiece. Then the entire focusing procedure was repeated to see if

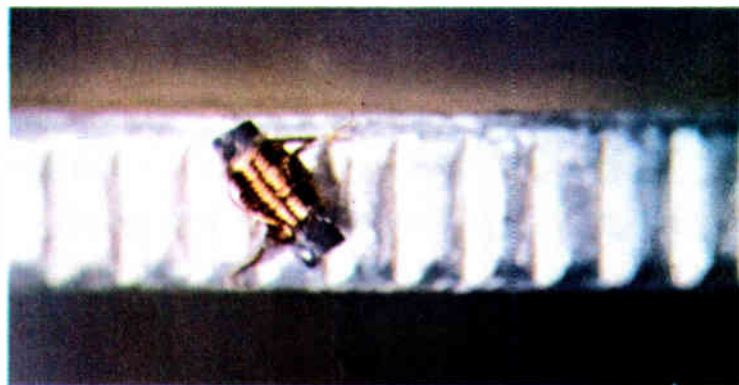

Tunable transformer on the edge of a dime. Small depth of field made it necessary to focus on the inductor.

the marks on the eyepiece diopter scale were still accurate. The first few trails indicated that great care was needed in going through the procedure. After many refocusing procedures, a statistical average mark was obtained which would give perfect focusing. When focusing, it is essential to rock the adjustments out of focus and then estimate the mechanical center of the two out-of-focus positions that are barely detectable.

If different eyepieces are to be used, then it is a good idea to work at the highest power eyepiece first.

MICROPHOTOGRAPHY (Continued)

Mark the diopter adjustment on the diopter scale for this power. Then change the camera eyepiece but *not* the other eyepiece, re-focus the camera, and record the new diopter adjustment for this eyepiece. The highest power eyepiece will give the shortest depth of field and will permit more accurate focusing. A complete set of recorded diopter adjustments should permit accurate focusing for all eyepieces. Since the nosepieces change both optical systems in an identical manner, no additional focusing procedures are needed for using various nosepieces.

Proper Exposure

The light intensity should be measured in the plane of the film emulsion. By reading the light here, all changes in the optical system will be taken into account. Since the camera has been equipped with a



Toroid, on the date of a dime. Extreme contrast should be avoided. A darker background should have been used for this.



A toroid, slug, and transformer on a penny. Background is dark and aids in showing subtle color differences of the units.

An adjustable inductor is compared to the head of a match.



Tuneable transformer on a .01 inch per division rule. The background for the object tends to distract from the subject.

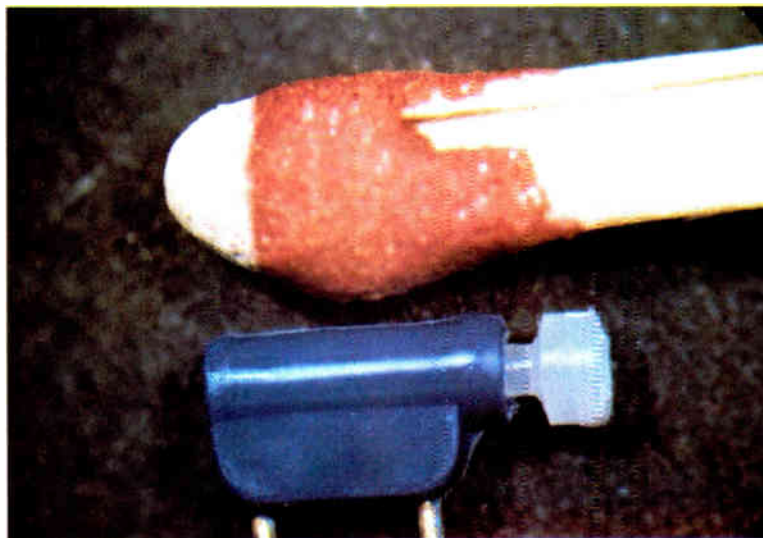

ground glass, it is only necessary to take readings from this surface in a darkened room.

When a conventional "light" meter is used, we find that more sensitivity is needed than is available. A super-sensitive exposure meter is simple to build. An inexpensive cadmium sulphide cell can be used for the light sensor. It should have a low internal resistance, small aperture, and spectral peak in the center of the color spectrum. Such a device was purchased for \$1.50 from Lafayette Radio, (catalog #19G4701). The photocell was attached to a standard VOM, with the meter set to the R x 10K scale.

Calibration of Exposure Meter

The cell must be calibrated. If the photocell light-meter is to be used for measuring light on a ground glass surface, then we must maintain light within the room at a low level so that most of the light detected by the light cell is from the ground glass image, and not from the room. To determine if the room is dark enough, open and close the camera shutter, while observing the meter reading. If a large variation is noted, then an accurate reading can be obtained. It is important to make this test before each measurement.

The cell-VOM can be used with any optical system. This feature permits the cell-VOM to be used on the camera when it is set up without a microscope. Therefore, calibration can be done by calibrating the cell-VOM with a conventional light meter. Once it is calibrated, it can be used with a microscope, telescope, or any other optical system.

To calibrate the cell-VOM, focus a small light on a table in a darkened room. Take a reading with a conventional light meter at 8 in. from the table and record the value. Place the camera with ground glass and cell in exactly the same location as the light meter, being careful to prevent the light from back illuminating the ground glass. Open and close the shutter and observe the change in reading on the VOM. The readings should be at least 30% different if the ground glass is not being directly illuminated appreciably. Record the reading obtained on the VOM with the shutter opened. Repeat the procedure for several distances to provide a good spread of values in conventional light meter readings. A graph may be plotted as shown in Fig. 1.

Microphotography uses less light than conventional photography. It will be necessary to calibrate the cell-VOM at low light levels. A very simple technique was used to do this. A graph was made which compares illumination vs half-illumination. Since half of the illumination would require two times the exposure time,* it is possible to keep doubling the exposure time and halving the illumination reading until a useable exposure time is obtained.

This procedure requires, as extra equipment, two lights with switches. In a darkened room, the lights are positioned so that turning on either light produces the same reading on the cell-VOM. This reading is recorded. Then both lights are turned on and the

meter reading is recorded. The two recorded readings are one point on the curve of intensity vs half-intensity. Both lights can be moved and the procedure repeated, to provide another point. When enough points are obtained, a curve can be plotted as shown in Fig. 2.

Exposure Meter at Eyepiece

The cell-VOM meter may be used at the eyepiece of the microscope with the advantage that the camera need never be opened after calibration is done, and the greater light intensity available permits readings in a brightly lighted room. A graph of eyepiece readings vs ground glass readings must be made. These readings are taken in a darkened room. The cell is moved from the eyepiece to the ground glass surface for each measurement. A white paper is placed under the microscope to provide a uniform background for calibration. A reading from the eyepiece was recorded. Then a reading from the ground glass was recorded. Then the microscope light was moved so that a different intensity was obtained, and another pair of readings was taken. A graph can be plotted as shown in Fig. 3.

If light measurements are to be always taken at the eyepiece, it is necessary to learn the effects of chang-

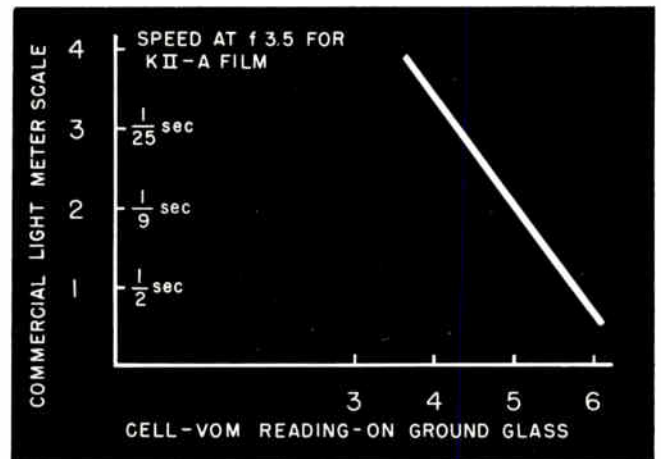

Fig. 1: Calibration of cell-VOM with a normal light meter.

ing the optical system. Changing eyepieces does affect the intensity of reading. If the eyepiece power is doubled, then the area viewed is divided by 4 or the light intensity is divided by 4. This means that the time would need to be multiplied by four. If the cell-VOM has been calibrated with the highest power eyepiece available, then a simple time multiplying factor can be used for determining the exposure of the camera with any other eyepiece. The cell should always be used with the same eyepiece, irrespective of the eyepiece used with the camera.

$$(\text{HIGH POWER}/\text{LOWER POWER})^2 = \text{time multiplying factor}$$

(Continued on following page)

*There are certain corrections that need to be made at long exposures that will be discussed later.

1. These lights are available from Tensor Co. or from Lafayette Radio, 1965 Catalog #13G0108. Two of these lights were used by the author.

MICROPHOTOGRAPHY (Concluded)

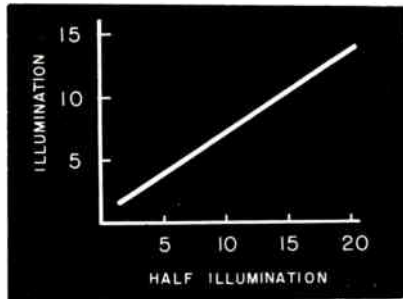

Fig. 2: Illumination vs. half illumination.

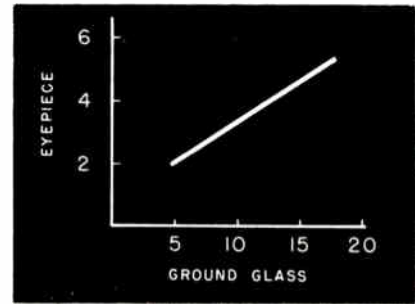

Fig. 3: 20x eyepiece reading is plotted.

This equation was verified using 3 sets of eyepieces. An interesting observation is that changing objectives has no effect on the light readings.

Color Balancing

A proper color balance between the film, the lighting and the exposure time is needed. You must have the object illuminated with the same color spectrum for which the film was designed, if true color is desired.

There are 3 basic approaches. One is to use specially filtered light. Sylvania manufactures a special sealed beam photoflood that has a balanced daylight output. This light can be used with daylight film.

Another approach is to use compensating filters on the camera. Kodak manufactures color balancing filters that permit the use of almost any type of film with any type of light.

The least expensive approach is to use the proper light source and select a film designed for the light source. Kodak professional type A film is balanced for photoflood lights. These lights are inexpensive. It is probable, that standard microscope lights will give a good color balance, if they are designed for short bulb life. Some of the new high intensity 12 volt reading lamps have a good color spectrum on the highest setting.¹

Another problem in obtaining accurate color reproduction under a microscope, is the change in spectral response of the film with exposure time. The film does not have constant characteristics with respect to the length of time of the exposure. When exposures are of a long duration, the color film produces a washed-out look with an off-color hue. It is possible to use color compensating filters to correct this.

It is generally possible to avoid the use of these

filters by relocating the illumination so that it is more intense or by using more lights.

Another important effect in obtaining color balance is the direction of light and reflectivity of the articles to be photographed. Objects in close proximity to the object to be photographed, may absorb certain colors and reflect others. The reflected light being cast upon the desired subject may change the color drastically. If low light angles are used, the color change will be enhanced. So, maintain the light at near right angles to the surface being photographed, if this effect is to be minimized.

The effect may be used to advantage on long exposures, by using a colored shiny paper as a light reflector. Obtaining color balance in this fashion is quite tricky.

In some cases, subjects may contain extreme variations in light. If silver and black appear in the same picture, one or the other will not be properly exposed. There is only a certain range of dynamic lighting intensity that yields an acceptable light tolerance for the film, and exceeding this range gives poor results. The best situation is to have objects with about the same light reflectivity in one photograph.

Depth of Field

The depth of field, or vertical distance that appears in focus, is extremely small in microphotography. The depth of field depends upon magnification. Higher magnification reduces the depth of field. Increasing the lens opening also reduces the depth of field. If the subject is not planar, you must use extreme care between magnification, focus, lens opening, and depth of field, to achieve a clear picture.

In photographs where objects are used for size comparison, have the subject of principal interest in focus rather than the object that is being used for size comparison. Generally, a point halfway between the top and bottom surfaces of the principal subject provides the best focusing point.

The actual camera and microscope optical system used was the cheapest obtainable, thereby proving that it is technique, rather than quality of optics that generally produces good microphotographs.

1. These lights are available from Tensor Co. or from Lafayette Radio, 1965 Catalog #13G0108. Two of these lights were used by the author.

Table 1

This table can be made from the data to quickly determine the proper exposure from the eyepiece reading.

VOM reading—10K Ω	2.5	3	4	5.5	7.5	10.5	15	22
20x eyepiece—TIME	1/4	1/2	1	2	4	8	16	32
15x eyepiece—TIME	1/8	1/4	1/2	1	2	4	8	16
10x eyepiece—TIME	1/16	1/8	1/4	1/2	1	2	4	8

Open a savings account here!

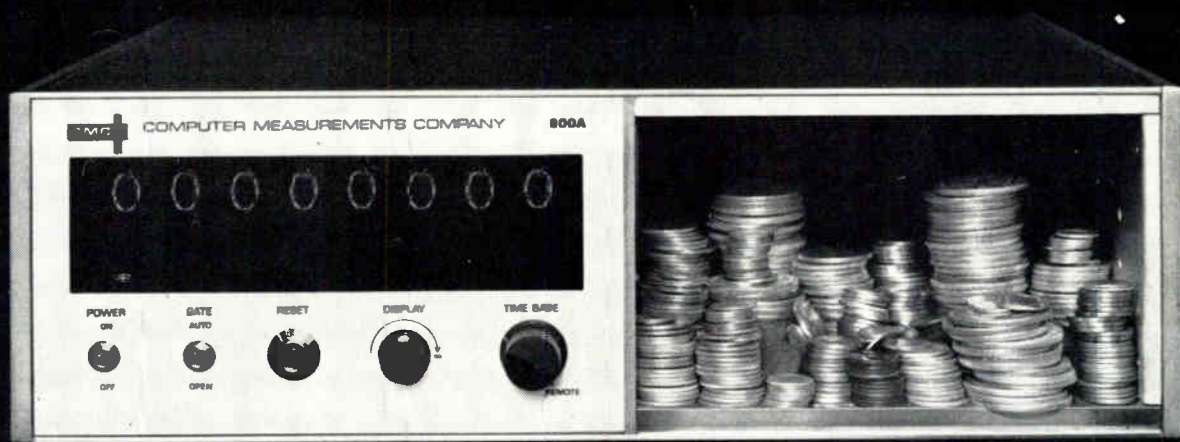

Just like a piggybank, our Digi-Twin 800-Series solid state counter really is a great place to save money. The reason is that big space where the plug-ins go. The two other big names in counters (Hewlett-Packard and Beckman) offer function plug-ins only. So you're stuck. That didn't seem fair to us, so our Digi-Twin is the only counter offering **three frequency range plug-ins**: 25 Mc, 50 Mc, and 110 Mc. So if you now need only 25 Mc, why pay for 50 Mc? Then if your next project requires a different frequency range you can buy a whole new counter from them... or just an inexpensive 50 Mc or 110 Mc plug-in for ours. ■ Maybe it's our attitude in giving you the best instrument, without charging you all the traffic will bear, that has earned us our solid third place in counter sales. If so, maybe you'll be interested in our ripening plans to offer you more and better instruments. And not just counters, either! ■ Say, have you earned your Crusading Engineers medal yet? It's the newest status symbol given to honor engineers like you who have the guts to compare the performance specs of **all three major brands of counters**. After that it's up to you to decide which counter actually fits your needs best. Earn your medal by writing now for our technical catalog. **It's free**. Incidentally, this counter is delivered without the cash inside.



12976 Bradley • San Fernando, California • Phone (213) 367-2161 • TWX 213-764-5993

FUNCTION MODULES: Counter-Timer Function Module • Frequency-Period (2 modules available) • 600 Mc Heterodyne Converter • Integrating Digital Voltmeter • 100 Mc Direct Counting Adapter • Digital Phase Meter • More Functions Due Soon

COMPUTER MEASUREMENTS COMPANY IS A LEADING DESIGNER AND MANUFACTURER OF ELECTRONIC INSTRUMENTATION TO COUNT, MEASURE, AND CONTROL.

SEQUENTIAL SWITCHING— Compact, Efficient, Low Cost with **CLARE STEPPING SWITCHES**

Counting • Totalizing • Sequence Control • Monitoring

■ Where circuit requirements call for selecting, interrupting, or changing connections in response to momentary impulses of current, CLARE's full line of rotary stepping switches provides exactly the device you need.

Compact and ruggedly built, CLARE Stepping Switches have many new, improved features which contribute to longer service life, greater capacity and unusual freedom from maintenance. Contacts are bifurcated for maximum operating reliability. They may be gold plated for low-level switching, with consistently low contact resistance. Your choice of terminals: taper tabs, solder, or plug-in. Special units available to meet airborne shock and vibration requirements.

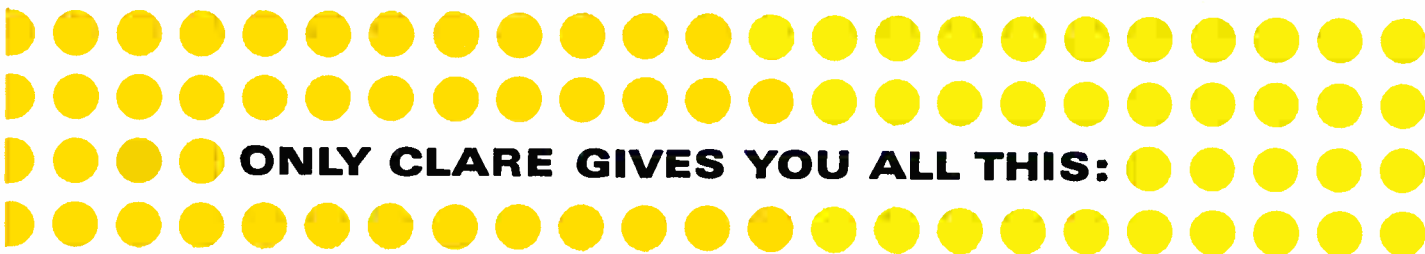

ONLY CLARE GIVES YOU ALL THIS:

1 Special Purpose Shorting Switches...for Test and Encoding Circuits

2 High Voltage Sequential Control Capacity

CLARE will provide special stepping switches to stand off voltages up to 2500 volts. Number of switch levels available depends upon voltage.

3 Special Enclosures for Adverse Environments

CLARE Stepping Switches are available in dust covers or hermetically-sealed in nitrogen or fluid to minimize undesirable effects of tampering, shock, or vibration, as well as salt air, humidity, fungus, corrosive atmosphere, sand and dust.

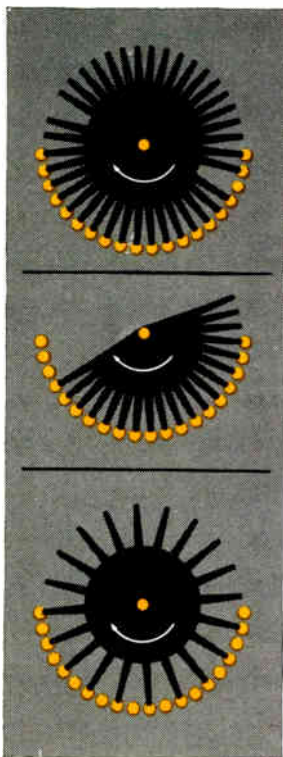

"All but one"

Ideal for the classic "multi-conductor cable" test for leaks, shorts, continuity, etc. Shorts all circuits except one together, making possible sequential testing of each circuit individually.

"Progressive"

Useful for location of trouble sources in test circuits. Provides incremental increases and decreases in power as required by some control systems. With self-interruption, can effectively provide bi-directional control.

"Alternate"

An excellent code conversion device, generating a wide variety of coded control outputs. Useful in transmitting special coding in sequential repetition. Readily adaptable to binary coded decimal encoding.

Type 26: Up to 624 contact points

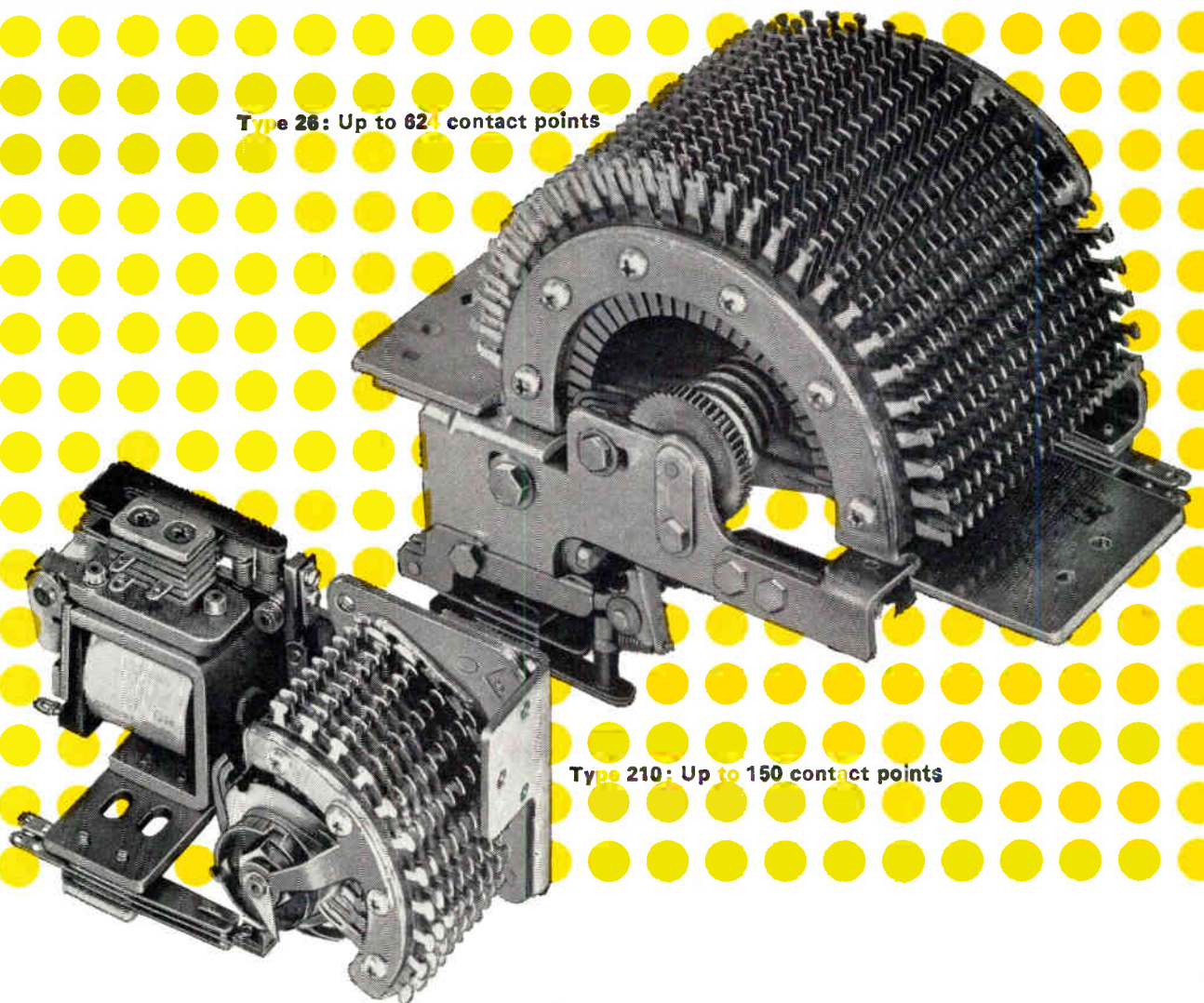

Type 210: Up to 150 contact points

4 Custom-Designed Functional Sequence Control Units...

CLARE engineering can provide functional assemblies incorporating such features as variable time delay pulse generators. Combining stepping switches with solid state (for time delay and pulse generation) and relays (for switch-over between stepper levels), these assemblies expand the capabilities of Clare Stepping Switches.

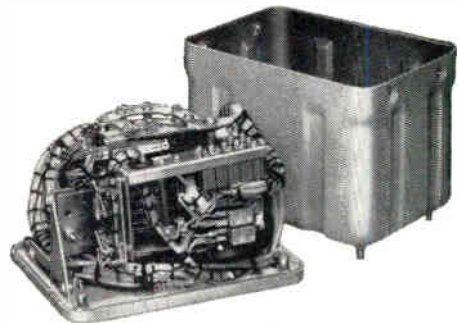

Typical Clare-designed sequential switching unit: 104 point sequence scanner. Solid State pulse generator, driving 10-level, 52-point stepping switch, provides predetermined time interval at each position—and pulse repetition rate from 6 per second to 6 per minute.

5 Easy Installation with New Plug-in Connector for Type 211 Stepping Switches

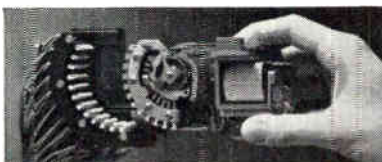

Faster, easier assembly and replacement. Connector contacts, crimped to lead wires, snap into connector frame. Plated contact areas (tin or gold over nickel) for contact reliability.

For information write:
C. P. CLARE & CO.
Group O6D6,
3101 Pratt Boulevard,
Chicago, Illinois
60645





By **DR. NORMAN A. SKOW,**

Director of Research,
Synthane Corp.,
Oaks, Pa.

Laminates for Multi-Layer Printed Circuit Boards

Copper-clad laminates of normal thickness are easy to produce, test and use, whereas the thin laminates present some problems to both producer and user. These problems as well as the properties of thin laminates are discussed.

INDUSTRIAL THERMOSETTING LAMINATED SHEETS consist of fibrous sheet materials. These materials are impregnated with a thermosetting resin and consolidated under heat and pressure into hard, solid products. They possess high mechanical strength and good electrical properties. The sheets are generally either a paper made from cellulose or asbestos, or a fabric made from cotton, asbestos, nylon or glass.

The principal resins used are phenolic. Others are melamine, silicon, polyester and epoxy. These are dissolved in a solvent to form resin solutions with which the fibrous sheet materials may be impregnated.

After impregnation and drying, the material is cut into sheets. These are stacked together between metal platens. They are then pressed at temperatures of from 285° to 335°F and at pressures of from 500 to 2000 psi for one to two hours. During this operation, the resin passes from a fusible soluble stage into one which is almost infusible and insoluble.

About 30 types of industrial thermosetting laminates are made.

Copper

Copper in sheet form is available either as a rolled or electrolytically deposited copper. Either one may be bonded to any one of the 30 laminates. Electrolytically deposited copper is generally used because the rough solution side makes it possible to produce a higher bond strength between the copper and laminate.

For the past 12 years, copper-clad laminates have been widely used for printed circuit (PC) boards. For these boards, the copper has been generally limited to electrolytically deposited copper and the laminates to any one of eight types. The fibrous material in the laminate is either paper or glass fabric and the resin either phenolic or epoxy. The copper is 0.0014 or 0.0028 in. in thickness, and the laminate varies from 1/32 to 1/8 in.

Laminates for Multi-Layer Boards

For this use the number of copper-clad laminates has been reduced to two; namely G-10 (normal epoxy-bonded glass fabric) and FR-4 (flame-retardant epoxy-bonded glass fabric). Production problems encountered in making these materials are compounded because:

(a) The mechanical difficulties of pressing thin sheets in large hydraulic presses are greater than for sheets of normal thickness.

(b) The nature of multi-layer circuits, using narrower copper lines closer to each other and separated by thinner laminates, demands the use of more uniform and more perfect laminates and copper.

(c) Present test procedures for laminates, in some cases, are not suited for these thin materials and must be revised.

Manufacture

Laminates are pressed in sheets

Dr. N. A. Skow



with a minimum of 38 x 38 in. Laminates needed for multi-layer boards vary in thickness from 0.003 in. to 0.031 in. Thickness tolerances vary from ± 0.001 for the thinner sheets to ± 0.003 for the thicker sheets. There are six factors which can contribute to variations in thickness over this large an area. They are uniformity of: thickness of glass fabric, resin impregnation, resin flow, parallelism of press platens, thickness of copper, and uniformity in thickness of press plates. With the possibility of at least six variables contributing to non-uniformity of thickness, the difficulty of maintaining a thickness tolerance of ± 0.001 in. is obvious.

Besides uniformity of thickness, the resin flow must be uniform over the entire surface of the sheet with no voids or resin-starved areas. Because of the thickness of the laminate there is little room for flow. Or, stated in another manner, because of the limited amount of material available to flow, little flow can take place.

The copper foil must be uniform in thickness and free of scratches, dents, pits and foreign inclusions. To insure this, the highest quality copper foil is used and all manufacturing operations done in a dust-free atmosphere. After pressing, the laminates are removed from the press, cut to size, tested, inspected and packaged. Much care is taken to avoid damage to these delicate sheets.

Properties

Length and width of the copper-clad panel must not change during any of the operations performed in making the PC. This is important because when drilling through a multi-layer board the exact location of the copper lines inside the board must be known. Thus the laminate must be resistant to heat and to certain cleaning solvents and etching chemicals.

It is important that the thin laminate have good dielectric strength, dielectric constant and surface resistance. The material must be strong and well-bonded

to the copper. The bond must not be weakened by trichlorethylene vapors, etching solutions, soldering operations or shearing, sawing, drilling or punching. It must be uniform from area to area because no wire must lift from the board during any of the fabrication operations. Any void must be eliminated because the solder used to fill plated-through holes must not be allowed to short any two internal wires.

To meet all of these needs it has been necessary to limit the thin copper-clad laminates for multi-layer PC boards to the two types previously mentioned. In those cases where improved flame-retardance is needed, FR-4 is used instead of G-10. But, in general, G-10 is more trouble-free than FR-4 as any chemical additives used to improve flame-retardance usually detract from the overall properties of the laminate. If FR-4 were equal to G-10 in every respect, in addition to being more flame-retardant, there would be no reason for using G-10.

Quality Control and Specification

The more specification restrictions placed on any product the more complicated the production of that product. While acceptable pieces will be produced, percentage yield will be reduced, testing time will be increased and delivery time delayed. With film-thin laminates for multi-layer PC's, it is especially important to write specs for only those characteristics which must be controlled to give satisfactory fabrication. These operations generally include printing, baking, etching, rinsing, degreasing, bonding to other layers of copper-clad, punching or drilling, fluxing and soldering.

Besides using quality materials and uniformity in production, this means that the laminate must not: blister when baked; or be affected by the etchant, or the washing or degreasing operations. It must be free from lubricants that would harm the printing and the bonding with prepreg, and it must not be affected by the fluxing operation. *(Continued on page 62)*

Assembly of laminates (below left) used in multilayer PC boards. Layers A and B are thin laminates with copper on one or both sides which has been etched to the desired design. C is a layer of prepreg which bonds layers A and B together. The composite then becomes

one sheet as in D. Special equipment for polishing the exposed surface of the metal foil is shown below right. The polished finish is free from waxes and greases, and is ready for printing and etching.

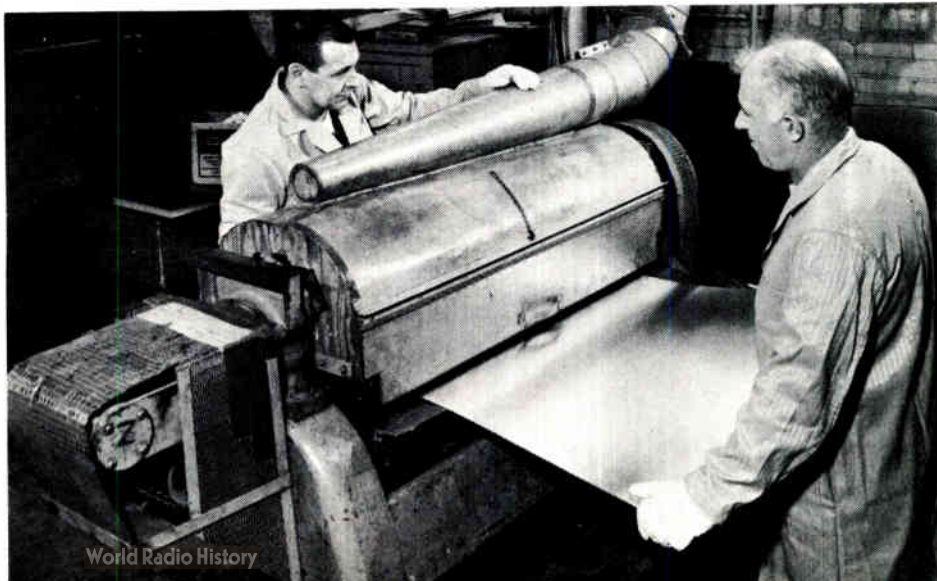
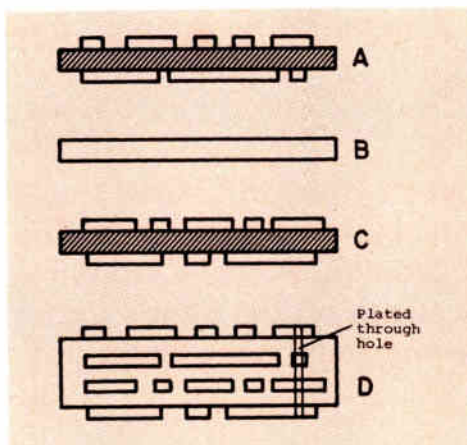

Better meter

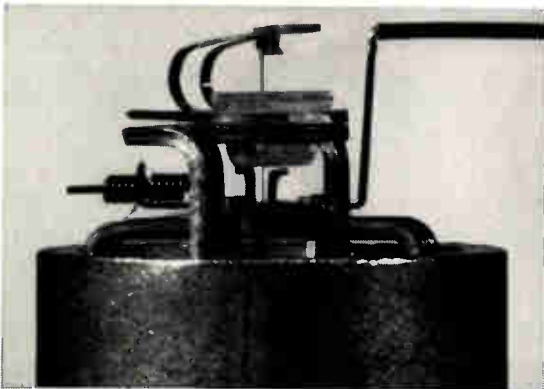

Using advanced manufacturing techniques, Honeywell has perfected a meter mechanism which brings new reliability to low-priced panel meters.

It's the astonishing new **AUTO-TORQUE** mechanism.

As you can see from the photograph, **AUTO-TORQUE**'s design is remarkably clean and uncluttered. Parts have been reduced 50%.

There are no pivots and jewels. No hairsprings. No screws. No nuts. And the mechanism is self-shielded, too — a feature which makes special calibration unnecessary.

Honeywell's **AUTO-TORQUE** mechanism is almost completely machine-made. Parts are made to tighter tolerances to permit automated assembly. Any chance for slip-ups in manufacture is virtually nil.

FRICION-FREE, PROTECTED FROM SHOCKS

In more conventional meters you get friction and wear. However, meters with Honeywell's new **AUTO-TORQUE** design operate completely friction-free. The moving system is suspended on metal bands under tension. Positive stops restrict travel of the moving system to prevent undue stress on the bands under extreme operating conditions. Result: repeatability and toughness never possible before with conventional meters.

Better buy

You might expect to pay considerably more for Honeywell meters with the AUTO-TORQUE mechanism. Actually you pay less in OEM quantities. For large-volume buyers, savings will be particularly impressive. And remember — meters with the new AUTO-TORQUE mechanism meet the highest standards — and are backed by Honeywell, a leader in quality meters of all types.



Honeywell's MM and MS meters are the first to feature the new mechanism. On the outside, crisp-looking case, easy-to-read face. On the inside, the more reliable, tougher yet less expensive AUTO-TORQUE mechanism.

Better check Honeywell

Honeywell, Precision Meter Division,
Manchester, New Hampshire 03105.

Please send me more information on this
important advance in meter design.

Name _____ Title _____

Company _____

Address _____

City _____ State _____ Zip _____

**TOO SMALL
TO BE A
LIFESAVER?***



**NOT
IF YOU'RE DESIGNING
ELECTRICAL CIRCUITS**

In the race toward smaller circuits and higher density packaging, some electrical design engineers are sinking in a sea of overlarge components. Those in the know are being buoyed up by Magnetics' miniature powder core line—moly-permalloy cores as small as 0.110" I.D.

Designers involved with highly critical inductor stability factors are welcoming another Magnetics innovation—guaranteed temperature stabilization in miniature powder cores. The "D" type limits the change in inductance to $\pm 0.1\%$ from 0 to +55 degrees C. The "W" type limits the change from $\pm 0.25\%$ from -55 to

+85 degrees C. Our new "M" type limits the change to $\pm 0.25\%$ from -65 to +125 degrees C. A wide selection of core sizes and permeabilities broadens the engineer's design scope even more. And all of these sizes are designed so they can be wound on present miniature toroidal winding equipment.

If you are faced with a problem of compacting a circuit design, it will pay you to investigate the condensing potential of Magnetics' miniature powder cores line. For the complete story, write Dept. EI-30, Magnetics Inc., Butler, Pa.

**Actual size of Magnetics' 0.110" I.D. powder core*

MAGNETICS inc.
®

For Capacitors with **GREATER RELIABILITY . . .**

Choose
EL-Menco

*The Capacitors You
Find Wherever
There's Electronics!*

EL-MENCO DUR-MICA CAPACITORS

Only 1 Failure Per 43,000,000 Unit-Hours!

- It has been computed that "debugged" DM30, 10,000 MMF units, when subjected to 257,000 hours of life at 85°C with 100% of the rated DC voltage applied, will yield only 1 FAILURE PER 43,000,000 UNIT-HOURS!
- DM15, DM16, DM19, DM20 . . . perfect for miniaturization and for new designs using printed wiring circuits. Also available in DM30, DM42 and DM43.
- New "hairpin" parallel leads insure easy application. Exceed all electrical requirements of military specification MIL-C-5A.



EL-MENCO TRIMMERS & PADDERS

Design Versatility!

- Available in 350 VDC and 500 VDC as well as other test voltages.
- All bases are of low-loss steatite.
- Special lugs are obtainable for printed circuitry.
- Miniature units are available.
- Solder Lugs can be bent in any position without affecting the capacity setting due to the rigid construction.
- Various types of mounting brackets are available for all trimmers.
- Units can be constructed for special applications.

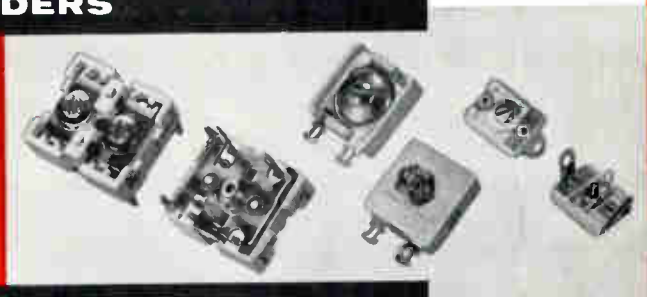

EL-MENCO *MYLAR-PAPER DIPPED CAPACITORS

Only 1 Failure in 14,336,000 Unit-Hours!

- Life tests at 105°C with rated voltage applied have yielded only 1 FAILURE PER 14,336,000 UNIT-HOURS for 1 MFD. Since the number of unit-hours for these capacitors is inversely proportional to the capacitance, 0.1 MFD Mylar-Paper Dipped capacitors will yield only 1 FAILURE PER 14,336,000 UNIT-HOURS!
- Working volts DC: 200, 400, 600, 1000 and 1600.
- Durez phenolic resin impregnated.
- Tolerances: $\pm 10\%$ and $\pm 20\%$ (closer tolerances available).
- Dielectric strength: 2 or 2½ times rated voltage, depending upon working voltage.
- Exceed all electrical requirements of E.I.A. specification RS-164 and military specifications MIL-C-91A and MIL-C-25A.

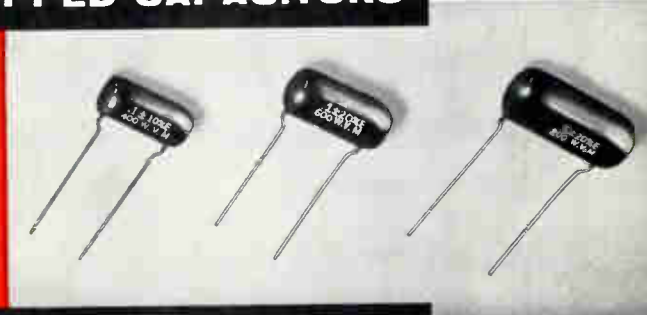

*Registered Trademark of DuPont Co.

EL-MENCO MOLDED MICA CAPACITORS

Superior Performance!

- Unmatched for excellent stability, dielectric strength, high insulation resistance, extremely high "Q" and correspondingly low power factor.
- Units can be subjected to a short "debugging" life test at elevated voltage and temperature for removal of early life failures and for improved reliability.

*Write for Free Samples and Booklets
on Any of The Above Capacitors*

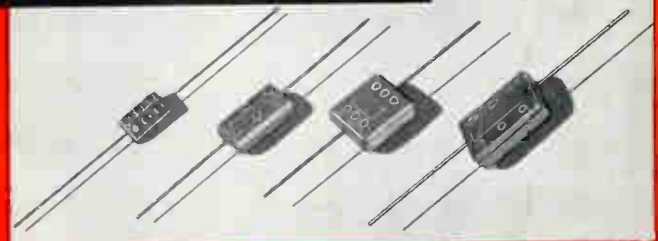

EL-MENCO OFFERS A COMPLETE LINE OF CAPACITORS . . . STANDS READY TO SERVE ALL YOUR CAPACITOR NEEDS.

THE ELECTRO MOTIVE MFG. CO., INC.

WILLIMANTIC, CONNECTICUT

*Dipped Mica • Molded Mica • Silvered Mica Films • Mica Trimmers & Padders
Mylar-Paper Dipped • Paper Dipped • Mylar Dipped • Tubular Paper*

MANUFACTURERS OF
EL-Menco
Capacitors

ELCO ELECTRONICS, INC., Company Sales,
2500 West 21st, New York
Exclusive Distributor in Britain and Dominions
by the E. C. and Canada

West Coast Manufacturing Center
COLLINS & HYDE CO., INC. Corporate Way
Palo Alto, California
2100 National Boulevard, Los Angeles, California

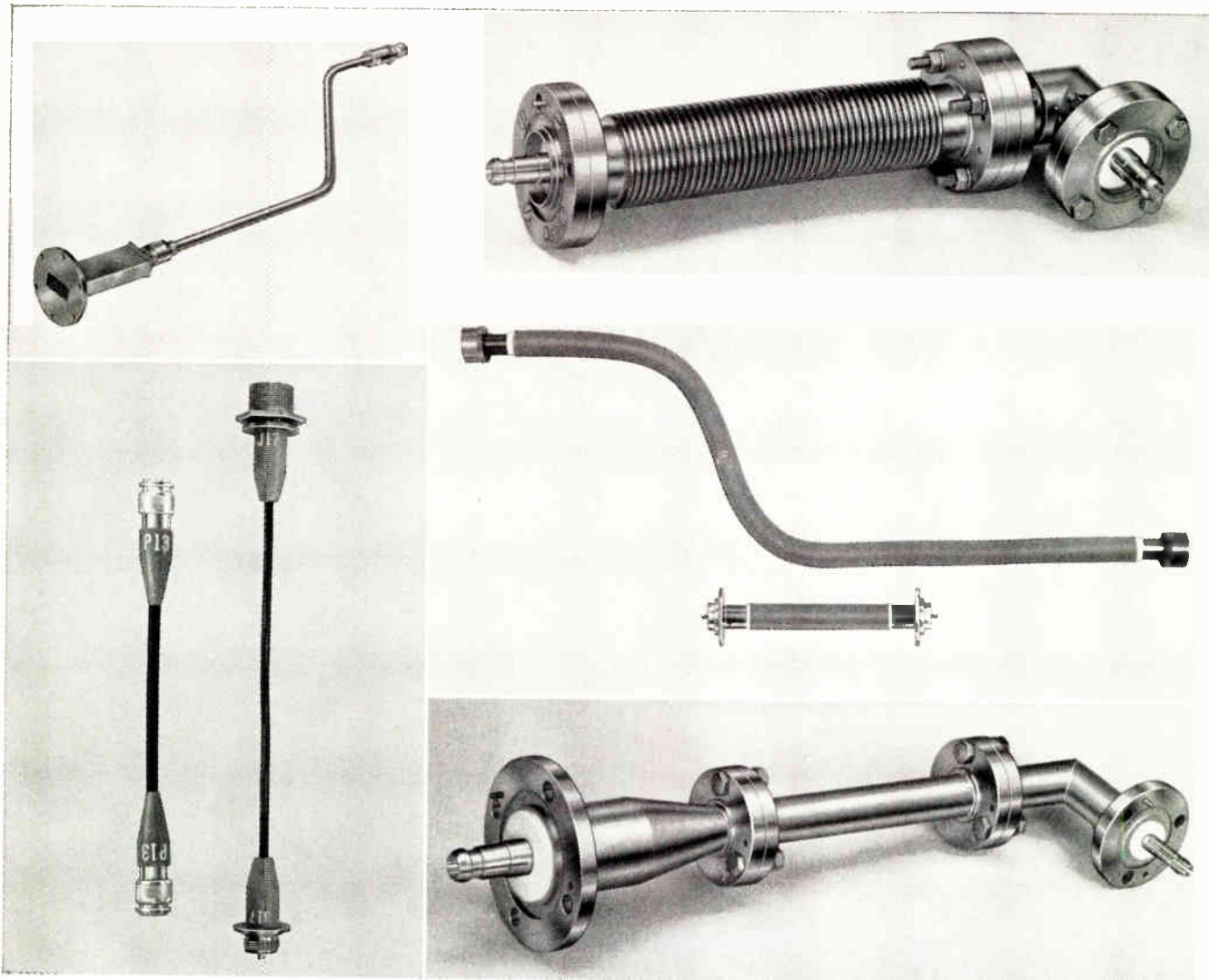

Coaxial cable assemblies. Ingenious solutions to very special installation and transmission problems.

Phelps Dodge Electronic's coaxial cables are available by the mile or by the foot. They are also available in unique, one-of-a-kind shapes and configurations which greatly extend application parameters. For instance, in transmitter installations, a cable assembly can eliminate the need for elbows and other high cost RF plumbing. In tight physical confines, or under difficult environmental conditions, a special cable assembly might well be the answer.

We have made hundreds. And, they are all different. Tracking antenna harnesses, as an ex-

ample, sections of cable which accurately place each antenna element in phase with other elements. Special local oscillator and receiver lines, each a section of Styroflex® coaxial cable cut to very tight electrical length for transition to waveguide. An airborne vibration isolator, an extremely flexible corrugated assembly connecting rigid line to shock mounted gear. Or, in equalizing and balancing networks. Matching sections.

We would like to hear about your needs. Write for Bulletin CC-1.

PHELPS DODGE ELECTRONIC PRODUCTS
NORTH HAVEN, CONNECTICUT



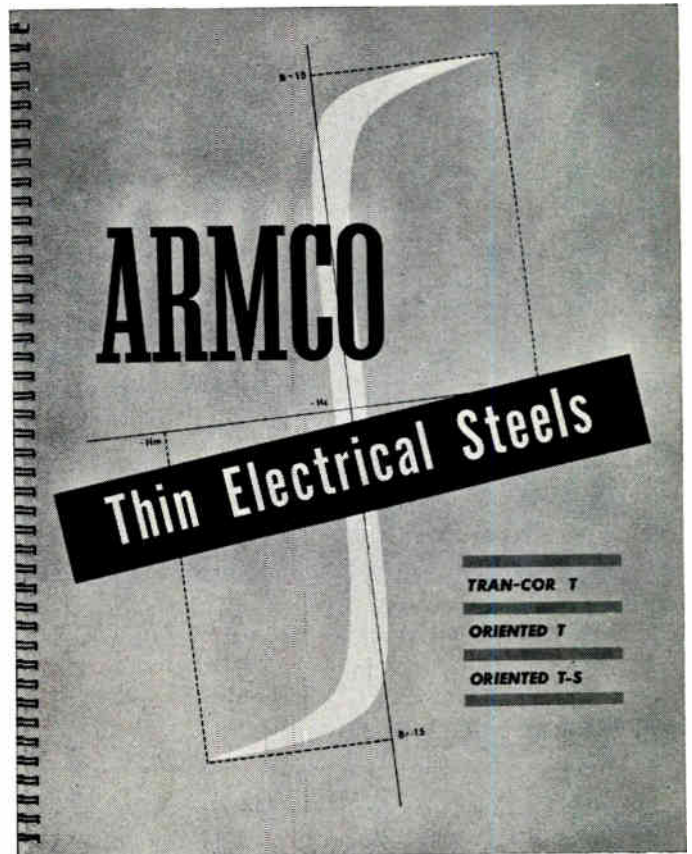
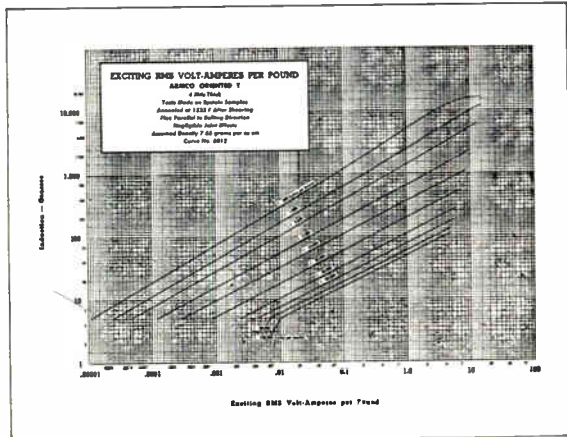

Reduce size and weight of cores for 400 cps and higher frequency units with Armco Thin Electrical Steels

Design manual provides useful data on Armco Thin Electrical Steels, including 46 pages of design curves on pertinent magnetic properties

Armco TRAN-COR® T (7 and 5 mils), Oriented T (6, 5, 4, 2, 1 mil), and Oriented T-S (4 mil) enable you to design high frequency equipment with lower core losses—smaller and lighter cores—and savings in copper. That's because these Armco Thin Electrical Steels provide combinations of high permeability, low hysteresis loss, low eddy current loss, high lamination factor, and minimum interlaminar loss.

The latest edition of "Armco Thin Electrical Steels" helps you design to make more effective use of the multiple advantages of these special electrical steels. Selection of the grade and gage for the most efficient balance of performance and cost is simplified with this helpful, easy-to-use manual. The facts you need for designing maximum-performance aircraft, television, radio, and other high frequency equipment are at your fingertips. In addition, Armco engineers and metallurgists are available to assist you in both design and production. Write for complete information on Armco Thin Electrical Steels and for your free copy of the design manual. Armco Steel Corporation, Steel Division, Dept. E-2335, P. O. Box 600, Middletown, Ohio 45042.

ARMCO STEEL



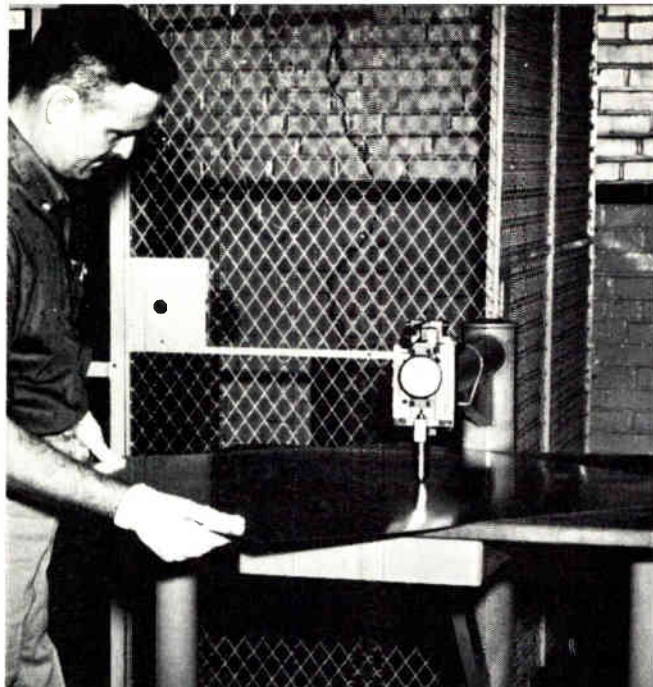

Thickness measuring of copper-clad sheets is done on this special measuring table. Thickness of the entire sheet is tested.



Heat and high pressure, applied to the piles, weld the laminations into a solid sheet and bond the metal foil to the base laminate.

COPPER-CLAD LAMINATES (Continued)

It means that the copper-to-laminate bond must not be affected by the thermal shock of soldering; that the multi-layer board must withstand sawing, drilling and soldering; that the internal wires must not have changed location and, finally, that the composite must possess good electrical and mechanical features and, in some cases, be flame-retardant.

All of these qualities can be assured by the following specs and quality control tests:

Water Absorption—The water absorption test indicates whether or not the laminate is properly cured. Reproducibility of test values is poor because of the small weight-surface area ratio. But, until a better test for

degree of cure is developed it will be necessary to test for water absorption. The method of test is ASTM Designation D-570-59aT. Test values are shown in Table 1.

Solvent Resistance—The laminate, after the copper has been removed by etching, shall not soften, delaminate or blister when suspended for two minutes in trichloroethylene vapor over the liquid boiling at atmospheric pressure. This is an additional check on the degree of cure.

Oven Test—The copper-clad panel (8 x 8 in.) is measured for length and width. It is then etched to remove the copper, rinsed in water, oven dried at 250°F, cooled to room temperature and remeasured. The change in dimensions must be less than ± 0.0008 in./in. This is to insure minimum change of wire position.

Printability—No lubricants should be used on the unclad surfaces of panels with copper on one side. This is to insure printability and to permit bonding of the prepreg in the preparation of the multi-layer board. Several printability tests have been devised and one of the most common is the tape adhesion test. A piece of pressure sensitive tape is pressed over a printed area. The tape is removed in one abrupt motion and the tested area examined. No major damage to the printing should be noticeable.

Copper Bond Test—For laminates 0.015 in. in thickness and greater, the test described in NEMA Publication LI 1-1965, Part LI 1-10.12 is satisfactory. For thickness less than 0.015 in., it is desirable to pull the copper at a 180° angle in a tensile testing machine. In either case the minimum test value should be 5 lbs/in. of width. This applies to both 1 and 2 oz. copper.

Dielectric Strength—The material when tested in

(Continued on page 68)

Table 1.

Property Values for Grade G-10 and FR-4

Property to be Tested	Conditioning Procedure	Thickness, inches		
		under 0.010 in.	over 0.010 in. to 0.015 in.	over 0.015 in. to 0.031 in.
Water absorption, Max. %	D - 24/23	2.0	1.5	1.0
Dielectric Strength, Parallel to laminations, KV, Min.	D - 48/50	30	30	30
Dielectric Constant at 1 MC, Max.	D - 24/23	5.4	5.4	5.4
Surface Resistance, Megohms, Min.	C - 96/35/90	500	500	500
Peel Strength, lbs/in. width 1 oz. and 2 oz.	A	5	5	5
Flammability, secs., Max. Grade FR-4 only	A	25	25	25

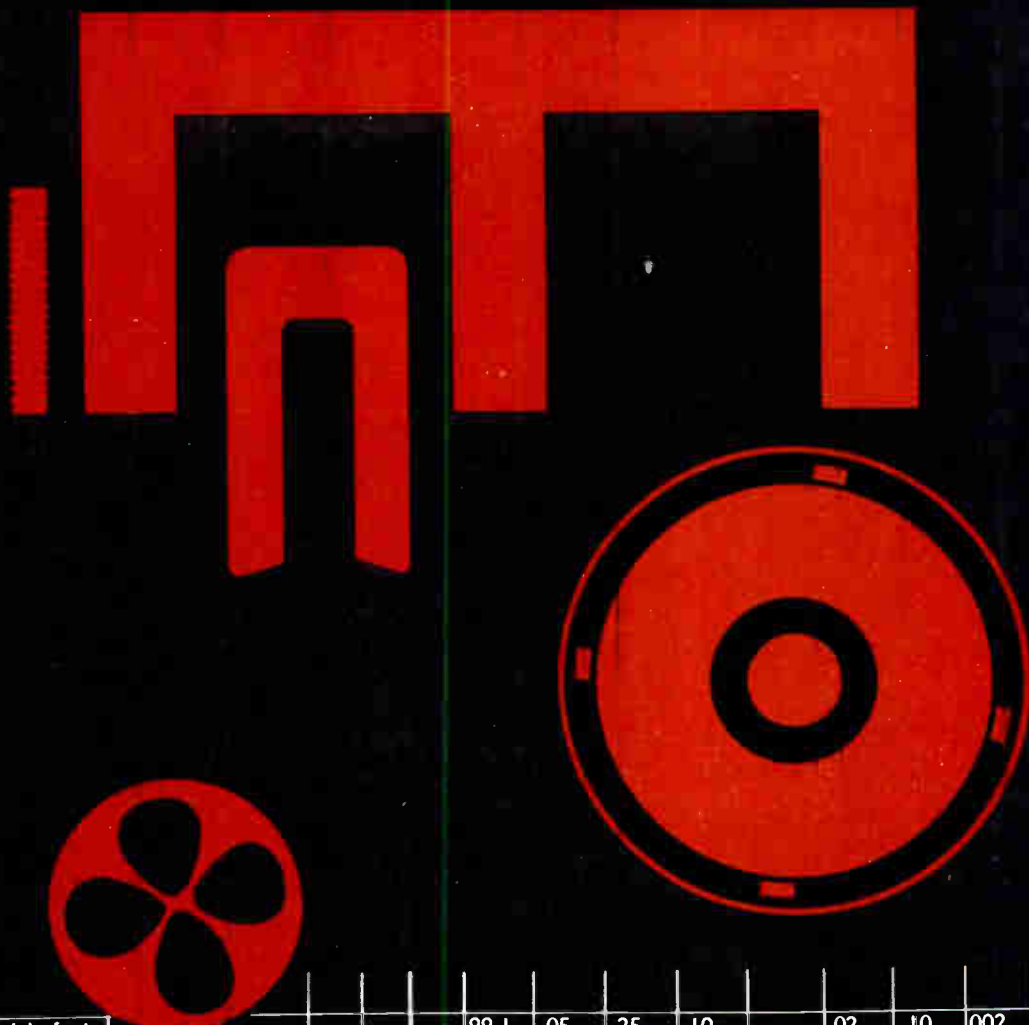

Red 110-2

alpha ferric
oxide

cubical

0.3-1.2

5.4

.33

.67

99.1

.05

.25

.10

.15

.03

.02

.10

.002

.002

.08

.005

.004

.15

THIS COLOR REPRESENTS A MASS TONE OF MAPICO RED 110-2.

Columbian Carbon focuses on the reduction of fluctuating characteristics in magnetic tape and ferrite components

It's a safe bet that product uniformity is a critical problem in your plant. Starting with extremely uniform raw materials goes a long way toward making your quality control problems considerably less difficult.

State of the art in ferrites advances at an extremely rapid rate. So do the requirements for iron oxides with pre-selected and controllable characteristics.

Columbian Carbon's Mapico® pure synthetic iron oxides are produced by a variety of carefully controlled methods,

each designed to give a different shape, size and set of electronic characteristics. Uniformity from shipment to shipment is strictly held within pre-set narrow limits. Sixteen basic iron oxides are available in quantity.

Write for detailed specs. Or tell us about your particular application and special requirements. Columbian Carbon Company, Mapico Iron Oxides Unit, 380 Madison Avenue, New York, New York 10017. Branch offices and agents in principal cities.



COLUMBIAN CARBON COMPANY

Circle 95 on Inquiry Card

World Radio History

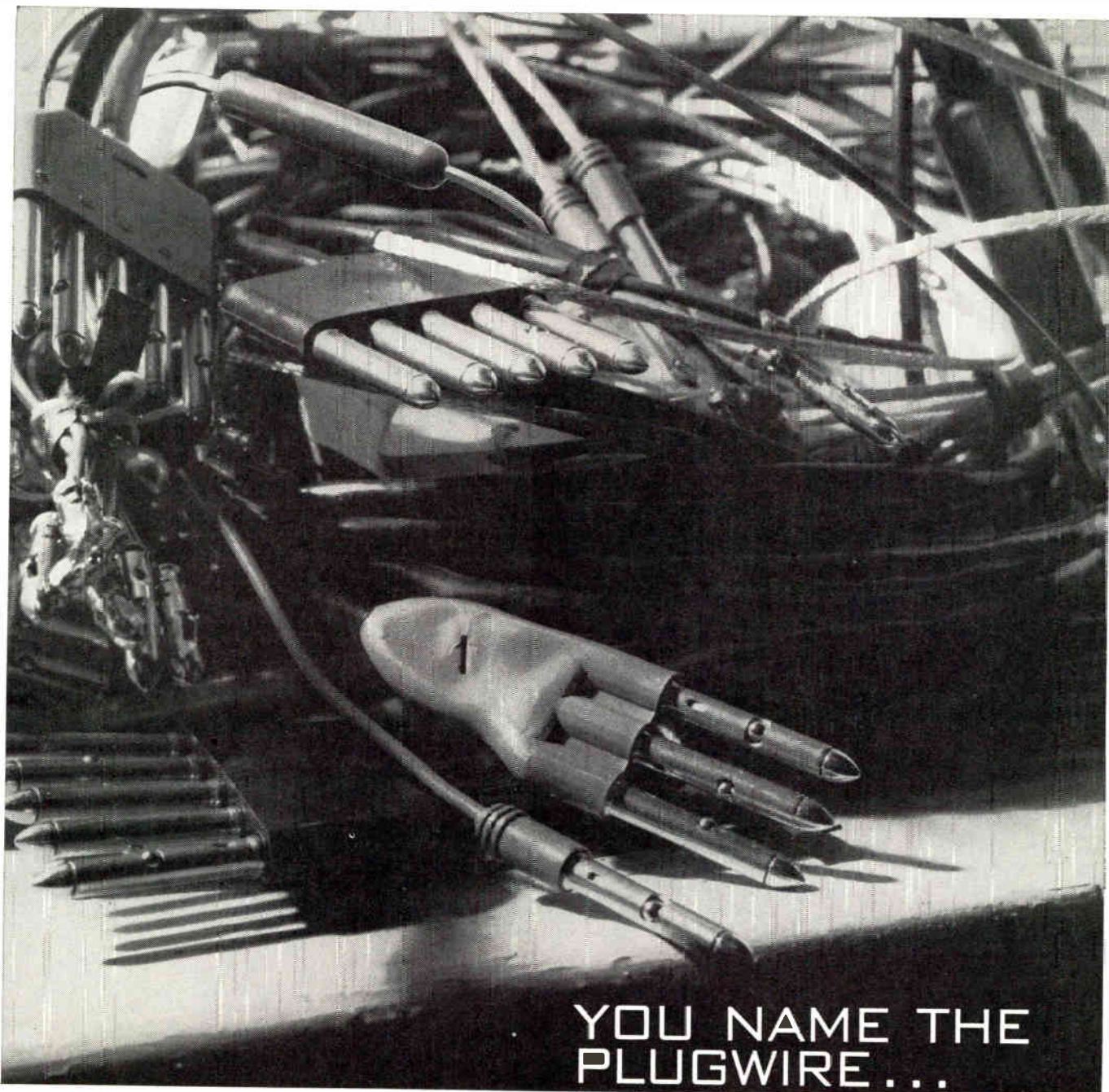

YOU NAME THE PLUGWIRE... MAC PANEL MAKES IT!

Even for uncommon, one-of-a-kind applications

MAC Panel can supply any type of plugwires needed for your OEM requirements — from single conductor to seven conductor shielded plugwires with polarized tip moldings, from single conductor coaxial to diode wires.

And, most likely, MAC Panel can supply them from stock on hand. Except, of course, the ones MAC Panel designs and makes especially for you.

All plugwires are available as manual or fixed

types in a wide selection of color coded lengths and with voltage ratings that will meet or exceed your specifications.

All plugwires are guaranteed to meet exacting standards, too. So if your plans call for precision plugwires . . . or for that matter plugboards or complete plugboard programming systems . . . call your MAC Panel representative or write MAC Panel for all the technical data.

O.E.M. DIVISION

MAC PANEL COMPANY **MAC** High Point, North Carolina
PANEL

Representatives Throughout the World

If you're awfully busy and you have anything to do with production soldering... here's quick free access to all that's new in resistance soldering and thermal wirestripping —from

WASSCO

GLO-MELT

pioneers in resistance soldering and thermal wirestripping

Save your company time and money . . . use this coupon

QUICK, FREE HELP—Fill in your name and address, check one or all of the squares and mail. We will send you the information you want *immediately*.



Complete temperature-and-time controlled power units for resistance soldering, thermal wirestripping, basic building blocks for automated soldering. Once proper temperature and time have been set, same job can be repeated over and over again . . . accurately.



New tweezer-type thermal wirestripper. Squeeze and pull; no twisting. Adjustable strip-length stop. Nickel-chrome elements. Soft-touch finger grips. Strips thermoplastics, including Teflon. Also, information on other thermal wirestripping handpieces.



Most comprehensive source of information on resistance soldering and thermal wirestripping. Acquaints you with basic system, equipment and steps of operation. Asks and answers many important questions about the method.



New tweezer handpiece for perfect contact-control on micro-miniature setups. Holds part while it solders. Electrodes can be formed or bent. Also, information on many different handpieces for resistance soldering.



New infinitely-variable heat source. One source for all types of miniature soldering and wirestripping jobs. Dial exact temperature needed. Repeat job again and again, using dial readings as exact guide.



New Wassco Glo-Melt catalog. All that's new in resistance soldering and thermal wirestripping equipment. The tools for high-speed production, perfect connections, simplified jobs, safety, comfort and lower material and power costs.

Name _____ Title _____ Company _____

Street _____ City _____ State _____

ADDRESS TO—WASSCO GLO-MELT DIVISION, AMERICAN ELECTRICAL HEATER COMPANY
6110 CASS AVENUE, DETROIT, MICHIGAN 48202



type 422

portability



awkward situations



easy carrying



tight squeezes



small spaces

The Type 422 is dimensionally proportioned for comfortable portability and on-the-job convenience.

Small Size — with maximum overall dimensions of 6 $\frac{3}{4}$ " high x 10" wide x 17 $\frac{1}{2}$ " deep, including panel cover and handle, making it easy to carry anywhere, even through a revolving door.

Light Weight — ~21 pounds, with panel cover and included accessories.

Low Power Requirements—for AC model, ~40 watts; for AC-DC model, ~28 watts AC, ~22 watts DC; power drain on external DC is constant for 11.5v—35 v range.

Rugged Construction — designed and tested to meet Tektronix environmental requirements:

Storage (without batteries) —55°C to +75°C, to 50,000 ft.

Operating (without batteries) —15°C to +55°C, to 15,000 ft.

Storage (with batteries) —40°C to +60°C

Operating (with batteries) —15°C to +40°C, to 15,000 ft.

No fan used. Runs cool and stays clean.

Versatile Performance—with bandwidth of dc-to-15 Mc, sensitivity to 10 mv/div, sweep speed of 0.5 μ sec/div to 0.5 sec/div, and dual-trace operation in a compact instrument. Ch 2 X10 to 1 mv div (AC only).

Sharp, Bright Displays—even under high ambient light conditions. Rectangular 4" CRT provides 7.9 square inches of usable graticule area. (For comparison, 6 cm x 10 cm = 9.3 square inches.)

Quality — same \pm 3% calibration accuracy, value engineering, careful manufacture, strict quality control, and international engineering support as other Tektronix laboratory oscilloscopes.

Type 422 Oscilloscope (AC only) \$1325

Type 422 Oscilloscope (AC-DC) \$1750

(Includes set of 20 NiCd cells)

U.S. Sales Prices f.o.b. Beaverton, Oregon

For a demonstration—call your Tektronix Field Engineer

Tektronix, Inc.

Type 422

Designed to handle the shocks, vibrations, temperatures, and other adverse conditions encountered in industrial environments. Proportioned to fit the job for ease in viewing and operation. Carrying handle adjusts for various tilt positions and is a sturdy support stand; front cover serves as accessory and storage case.

Circle 96 on Inquiry Card

World Radio History

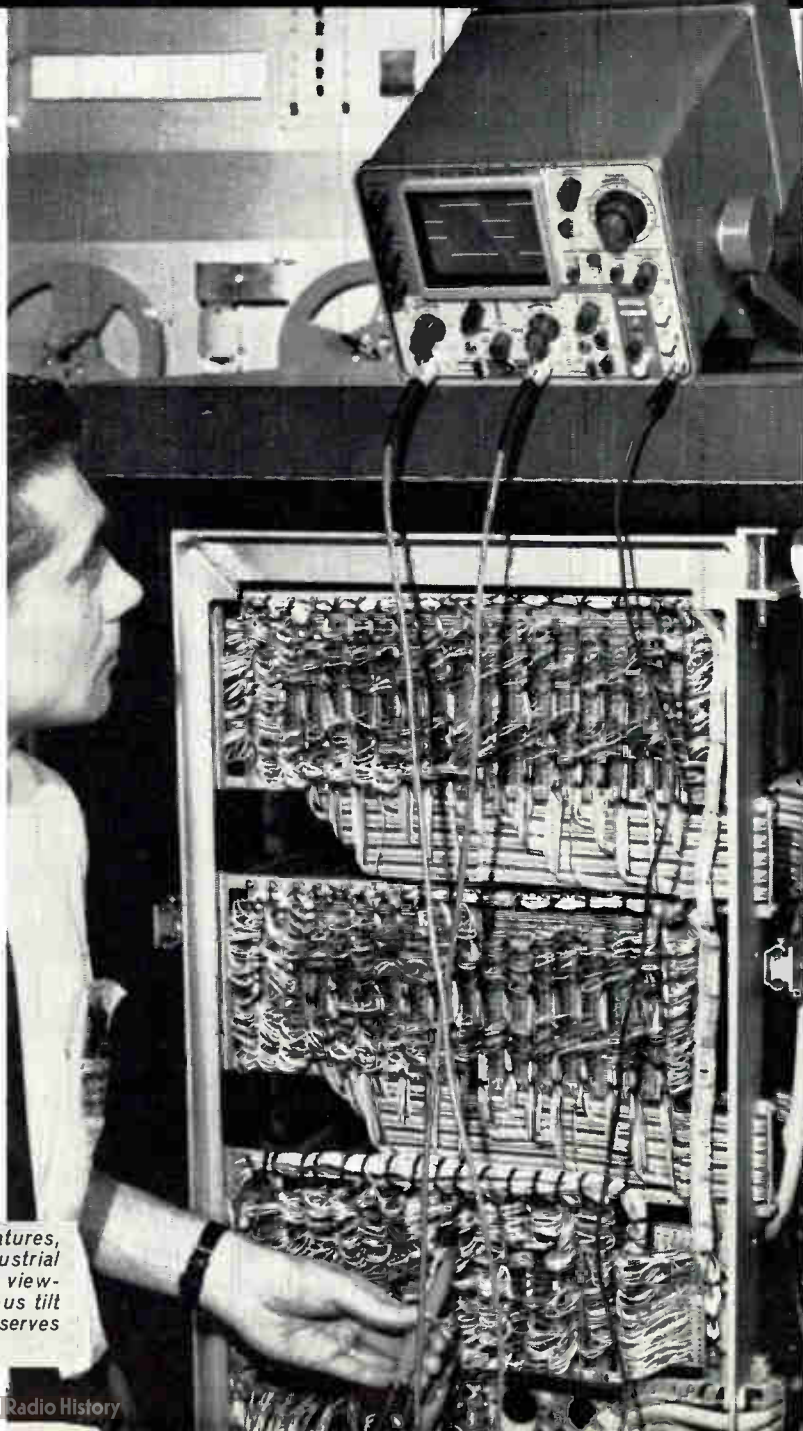



TERMINALS FIT
0.062-INCH
GRID HOLES

0.200-INCH
CENTERS

Made for each other...

AE's new
dry-reed switches
and standard
printed-circuit boards

That's because PC CORREEDS* are specifically designed for direct insertion into standardized grids. Terminals are located on multiples of 0.200-inch centers. And all terminals are designed to fit standard 0.062-inch holes; permit the use of small wiring pads. Standardized terminal size and spacing also allow for greater packaging density.

In addition to this feature, PC Correeds have separate terminals to eliminate strain on the glass capsule.

These terminals are "ribbed" for added strength and rigidity, and are welded . . . not soldered . . . to the capsule leads. Individual capsules can be removed without having to remove the entire package. The bobbins are made of glass-filled plastic for greater strength and to eliminate breakdown due to moisture absorption.

For the full facts on how these new AE Printed-

Circuit Correeds meet the requirements of modern electronic circuitry, write to the Director, Electronic Control Equipment Sales, Automatic Electric, Northlake, Illinois 60164.

2-capsule
(Forms 2A,
1B, or 1A
Mag. Latch)

3-capsule
(Forms 3A,
2B, or
1A-1B)

5-capsule
(Forms 5A
or 2A-2B)



*Patent applied for.

AUTOMATIC ELECTRIC
SUBSIDIARY OF
GENERAL TELEPHONE & ELECTRONICS **GTE**

Tung-Sol Read-Out Lamp Saves Customer Two Operations, Cuts Shrinkage

Our customer's problem stemmed from handling. The bulbs he bought went first to a wiring company to have lead wires attached. (Shrinkage here due to lead wire damage). After the leads were attached the bulbs went to a molder to have bases added. (More shrinkage due to bulb damage and lead wire breakage). Shrinkage in both operations ran as high as 15 per cent.

Now Tung-Sol does the whole job and the customer has benefitted 4 ways: (1) two processing steps eliminated. (2) valuable production time saved. (3) inventory reduced. (4) gets 1000 usable lamps for every 1000 purchased.

Tung-Sol can harness to any specifications and mold to any configuration. Describe your application to us for free suggestions about how Tung-Sol can solve your problem at a saving.



If your application requires only bulbs, ask for a quotation from Tung-Sol. The Tung-Sol line of miniature and subminiature lamps is extensive. Quality is the best that more than half a century of know-how can produce.

TUNG-SOL

INSTRUMENT LAMPS

Tung-Sol Electric Inc., Newark, N. J. 07104

ACTUAL
SIZE



COPPER-CLAD LAMINATES (Concluded)

... from page 62

accordance with ASTM-D229 Section 24C shall exhibit a dielectric strength of 30,000v minimum under condition D-48/50.

Dielectric Constant—The material when tested in accordance with ASTM-D150 shall exhibit a dielectric constant not greater than 5.4 under condition D-24/23.

Surface Resistance—The material when tested in accordance with ASTM-D257 shall exhibit a surface resistance not less than 500 megohms under condition C-96/35/90.

All three of the above tests, because of the thinness of the material, are difficult to perform. For example, in measurement of dielectric constant the specimen's capacitance may be so large that measurement with normal instruments may not be possible.

Materials satisfying the above three electrical requirements are being used successfully in multi-layer boards.

Copper Foil Surfaces—The surfaces shall be copper foil having a minimum purity of 99.50%* (silver considered as copper), in nominal thicknesses of 0.0014 in. (about 2 oz./ft.²).

Thickness tolerances for copper foil shall be as follows:

Nominal Thickness, in.	Tolerance, inches	
	Plus	Minus
0.0014	0.0004	0.0002
0.0028	0.0007	0.0003

Copper surfaces shall be free from defects which may affect serviceability, such as blisters, wrinkles, cracks, holes, dents and scratches.

The number of pin holes exceeding an average diameter greater than 0.005 in. shall not exceed one in a ft.² There shall be no pin holes with an average diameter greater than 0.015 in.

Flammability—When tested in accordance with ASTM-D568 the flame shall extinguish within 25 secs. This test, or modifications thereof, has been found suitable for distinguishing between flame retardant and non-flame retardant grades.

Bonding of Thin Layers Into Multi-Layer Board—After making the thin laminates they must be bonded together to produce the multi-layer board. This is done by use of Type G-10 prepreg which is specifically coated for this use. The resin content must be high (46 to 50%) and the flow must be adequate (12 to 16%) because the assembly is made at a hydraulic pressure of from 200 to 500 psi and a temperature of 290° to 320°F. The G-10 prepreg is used for FR-4 laminates as well as for G-10 laminates due to its superior adhesive properties.

*Analysis for determining the minimum purity of the copper shall be made in accordance with the ASTM method for Chemical Analysis of Copper (Electrolytic Determination of Copper), E-53-48, copies of which are available from the American Society for Testing Materials, 1916 Race St., Phila. 3, Pa.

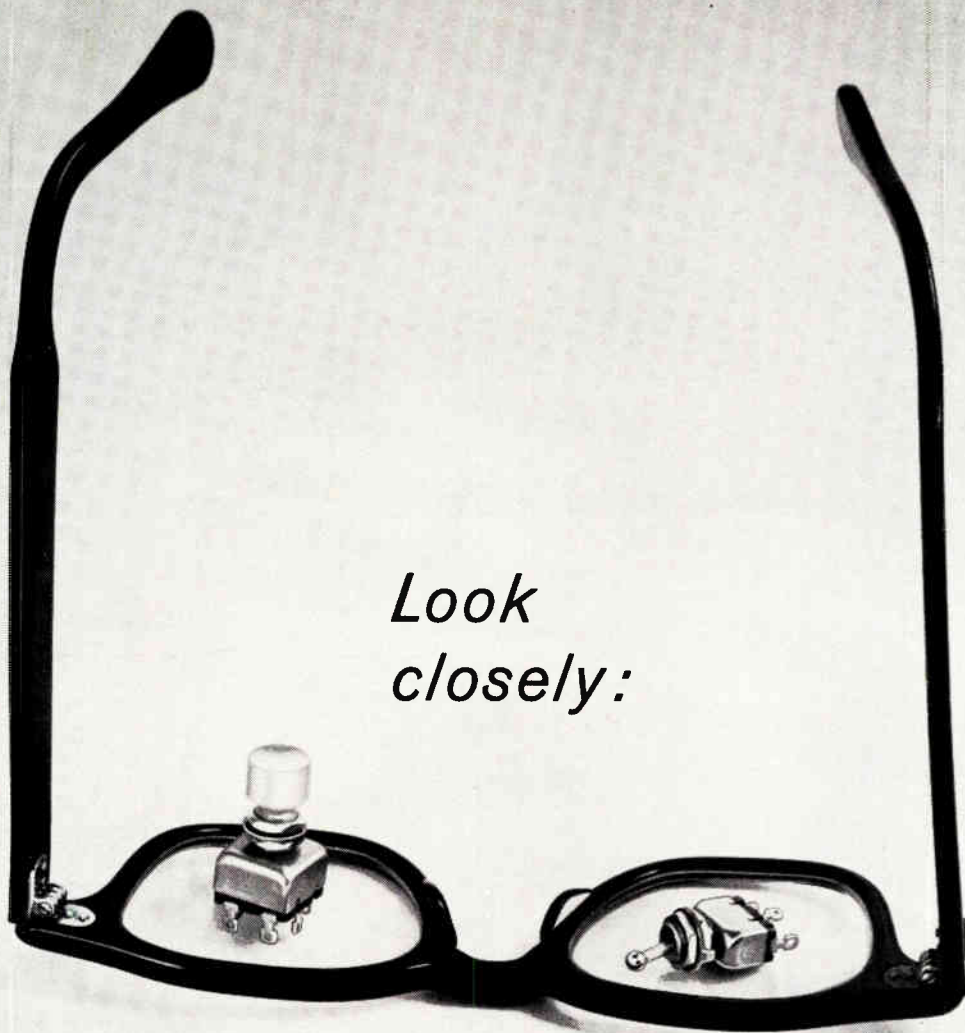

*Look
closely:*

*These are true subminiature switches
from a family of 274 different types.
That's a lot of switches.*

And that's a lot more than most subminiature switch producers can say. **Reason:** Most subminiature switches are just scaled-down big switches. Arrow-Hart subminiature switches are different. They're **true** subminiatures from the drawing board up. For one thing, they use subminiature-rated components. For another, they're much more versatile, more thrifty with space.

Best of all, there are 274 different pushbutton and toggle types. All varieties of contact arrangements. All designed to deliver maximum performance, dependability, and ruggedness — in minimum envelope and weight.

If you need a special subminiature switch, Arrow-Hart's Innovators in Switch Design can create it for you . . . and produce it quickly, efficiently, and economically.

This broad line of subminiature switches and the specialists who can innovate creatively for you and your products . . . are two of many reasons why you **buy better electrically** at Arrow-Hart. Write today for free folder. The Arrow-Hart & Hegeman Electric Co., 103 Hawthorn Street, Hartford, Conn.



QUALITY SINCE 1890

ARROW-HART

The Arrow-Hart & Hegeman Electric Company, Hartford, Connecticut 06106

*Our 75th
Anniversary Year*

LY • BUY BETTER ELECTRICALLY • BUY BETTER ELECTRICALLY • BUY BETTER ELECTRICALLY • BUY BETTER ELECTRICALLY • BUY

By RUDOLF F. GRAF,

Sprague Electric Co., North Adams, Mass.

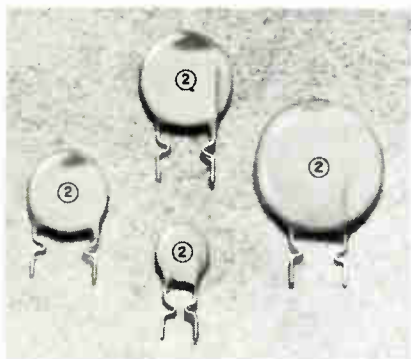

Hooked-lead Cera-mite® ceramic disc types.

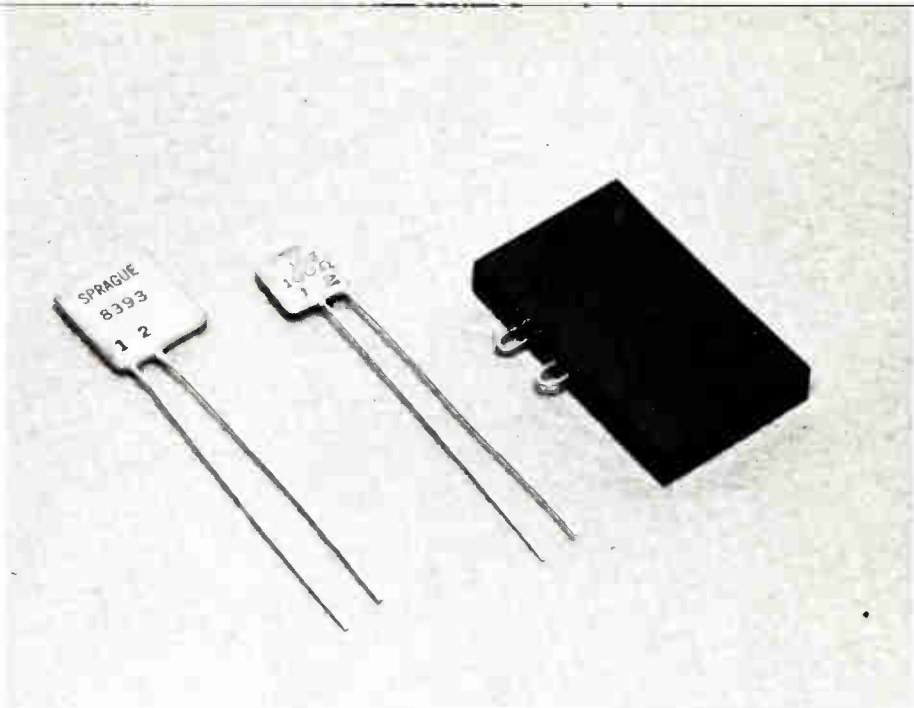

Printed ceramic-base arc-suppression networks.

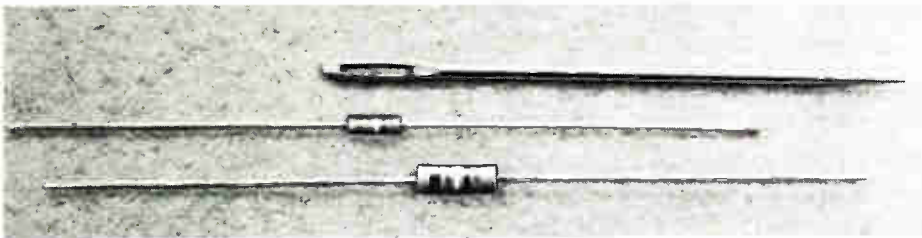

Cerod® Monolythic® capacitors are ideally suited for "cordwood" modules.

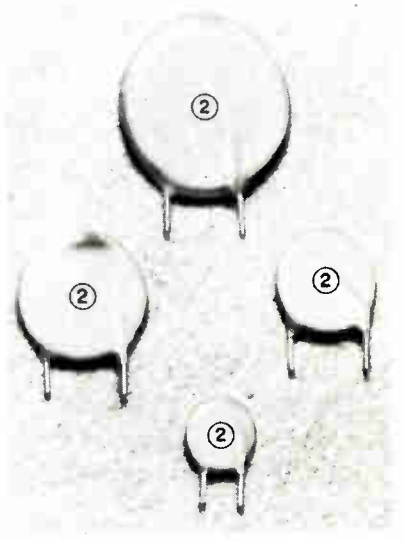

Pin-terminal Cera-mite® ceramic disc types.

Late Developments In Capacitor Design

ENERGY STORAGE CAPACITORS are used in applications where energy must be stored and released upon sudden demand. Some uses are with welders, lasers, exploding wires, metal forming, plasma generators, thermonuclear research, ion propulsion systems, photographic and pulse discharges, and lighting. These capacitors are used because the peak power needs in such circuits exceed the maximum output available from power supplies. Thus, the capacitor serves as a reservoir which can be emptied, essentially instantaneously, when its stored energy is needed.

Wide variations in required voltage (from a few hundred volts to many kv), capacitance (from fractions of a μf to farads), discharge rate (from a few msec. to fractions of a $\mu\text{sec.}$), rep. rates (from a single shot to a few hundred/sec.) and energy requirements (from a few watt-sec. to many megawatt-secs.) and limitations in size, cost and weight have brought about the development of three basic types of capaci-

tors (plus others for specialized uses) to cover most energy storage capacitor needs. To aid in the selection of suitable energy storage capacitors, these types are grouped based on their optimum operating voltage range in Table 1.

Electrolytic Types

For years only paper-oil capacitors were used for energy storage applications; but, with needs for higher capacitance units, the excellent volume efficiency of electrolytic capacitors, as well as their increased stability and reliability, have made them a good choice for energy storage uses within their voltage range.

At 4watt-sec./in.³ they yield the highest available

Energy storage, ceramic and mica capacitors are discussed in this updated companion article to "Capacitors: Today and Tomorrow," which was published in the June 1964 issue of ELECTRONIC INDUSTRIES.

energy density at the lowest cost as well as the lowest weight/watt-sec. Shortcomings are the temperature limitations imposed by the increase in ESR (equivalent series resistance) at low temperature where the capacitor is not useable because too much energy is lost within it. Second, is their high leakage current. Also, each individual section is limited to a maximum of 450 v.

Electrolytic capacitors are used in many areas. One use is in photoflash units where the most popular largest value is a 525 μ f, 450vdc unit in a can 2 in. in diameter by 4 in. long.

Another use is in the signal or flasher area which involves the discharge of the capacitor into a tube filled with gas at a low pressure. This energy is converted into light.

A satisfactory and successful application of aluminum electrolytics in energy storage uses is in the world's first all-geodetic satellite, Anna. This satellite flashes sequential strobe signals to ranging stations.

A factor to consider in the use of energy storage capacitors is that of the discharge current on the capacitor itself. This current through any energy storage capacitor is in the reverse direction to that of the charging current. This promotes oxide formation on the cathode of an electrolytic capacitor and reduces the capacitance. Thus, the cathode of energy storage types is generally etched to provide increasing capacitance stability during the life of the capacitor. It also assures low contact resistance between foil and electrolyte. Cathodes are also extended and swaged to reduce the inductance and ESR to get as much energy as possible out of the capacitor.

Metallized Types

Electrolytic capacitors can be series connected to

increase their operating voltage range, but at about 2500 v. they are generally not useable. On the other hand, the paper foil capacitor has poorer volumetric efficiency at 2500 v. than at, say, 5000 v. Thus, the metallized energy storage capacitor using a composite dielectric of metallized paper and plastic film, has been designed to fill the gap. Energy densities as high as 3.0 watt-secs./in.³ can be achieved.

This metallized Difilm™ energy storage capacitor (such as Sprague type 282P) makes possible a reduction in size of about 1/2 and a 1/3 weight reduction over normal paper capacitors.

The thermal conductivity of metallized capacitors is not as good as that of paper foil types; thus, they must be operated at slower discharge rates. But, special manufacturing methods can improve the thermal conductivity so that the discharge rate may be increased for a special use.

Capacitor Features

In energy storage uses the time needed to discharge the capacitor is very important. This is true because high discharge currents are needed and the flow of charge/unit time, which is the amount of current, is determined not only by the magnitude of the resistance and the inductance of the circuit, but also by their ratio to each other.

Two important parameters of all energy storage capacitors are their inductance and series resistance. Both of these properties depend largely on the geometry and internal construction of the capacitor. Design work in the energy storage area is slanted toward the reduction of the inherent inductance of the capacitor and increased current carrying capacity to yield faster discharges at higher discharge currents.

(Continued on following page)

Table 1

PHOTO-FLASH-ENERGY STORAGE CAPACITORS

	ALUMINUM ELECTROLYTIC	METALLIZED PAPER PLUS FILM	PAPER-OIL PHOTO-FLASH AND LASER	PAPER-OIL HIGH SPEED LARGE VOLT. REVERSAL
Optimum Voltage	450v	2500v	5000v	5000v
Efficient Voltage Range	300v - 900v	1000v - 5000v	2000v & up	2000v & up
Best Volume Efficiency $\left(\frac{\text{watt-sec}}{\text{in.}^3}\right)$	4	2.5	1.5	1.0
Inductance (μ h)	0.01 to 0.1	0.02 to 0.2	0.02 to 0.2	as low as 0.0025
Internal Series Resistance (ohms)	0.1 to 0.5	0.02 to 0.2	0.01 to 0.1	0.01 to 0.1
Max. Discharge Rate	1/sec	5/sec	10/sec	30/sec
Operating Temp. (Normal)	0 to +65°C	-55 to +85°C	0 to +50°C	0 to +50°C

CAPACITORS (Continued)

Typical buttonhead ceramic capacitors.

Table 2

Life test data on 380 μ f 475 vdc energy storage capacitor

Flashes	Cap. (μ f)	ESR (Ω)
33,530	411.5	0.54
78,100	421.1	0.62
183,300	429.8	0.66
288,475	438.6	0.64
348,338	434.7	0.66
496,556	428.6	0.69
602,168	444.7	0.68
702,803	440.0	0.73
859,726	442.8	0.71
1,011,687	446.3	0.70

Final Change: Capacitance: 7.5% increase
ESR: 23% increase

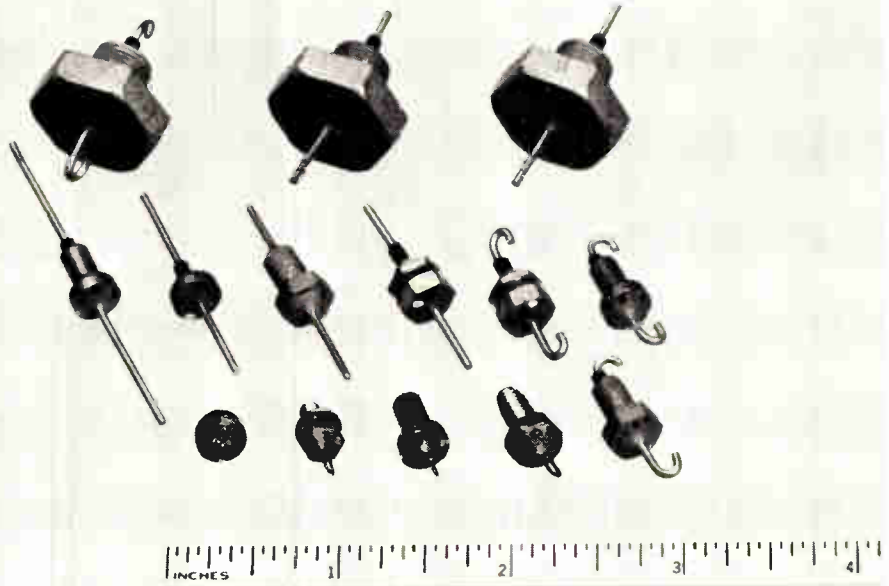

Ten years ago the best units had an inductance of about 0.2 μ h. Now designs are available with inductance as low as 0.00015 μ h.

Castor oil is used as an impregnant for capacitors which are used for energy storage in circuits where high reversals occur as a result of oscillatory discharges, e.g., those found in plasma research and magnetic forming uses. This gives a substantial improvement in life over capacitors impregnated with chlorinated diphenyl. For photoflash and other non-oscillatory energy discharge uses, castor oil, (proven reliable over the past 20 years) is still in use. However, castor oil units cannot always be used if the application requires a non-flammable impregnant.

CERAMIC CAPACITORS

Fixed ceramic capacitors are available in a variety of sizes, shapes and ratings. The most common is the disc ceramic capacitor.

Ceramic capacitors are broadly classified into two groups. Those in the first group have a dielectric constant from about 5 to 500 at room temperature. They are used for temperature compensation in tuned circuits or for high frequency bypassing or coupling where a high Q capacitor is needed. They are gen-

erally made with titanium dioxide and a mixture of clay to achieve the desired temperature coefficient. Temperature-compensating ceramic capacitors are available with controlled temperature coefficients ranging from +100 to -5600 parts/million/ $^{\circ}$ C. This TC is predictable and repeatable within their operating limits. Tolerances as close as $\pm 1\%$ are practical.

The other group of capacitors is made with materials whose dielectric constant is anywhere from 200 to about 10,000 and over. These are used for non-critical bypass and coupling applications where high capacitance is needed, and nonlinear capacitance-temperature features as well as power factors of 1 to 2% can be tolerated. It is characteristic of the higher dielectric constant materials to expect that the TC will not be reproducible from one measurement to the next. Also, the amount of dc and ac present in the measuring circuit will affect the final capacitance reading obtained at any given temperature. Capacitance tolerance varies from $\pm 20\%$ to GMV (Guaranteed Minimum Value).

Ceramic capacitors exhibit ferroelectric properties. But, in most uses where their TC is not of prime importance (there is no tuned circuit), the voltages encountered are so low that variations in the dielectric

Monolithic capacitor derating as a function of temperature.

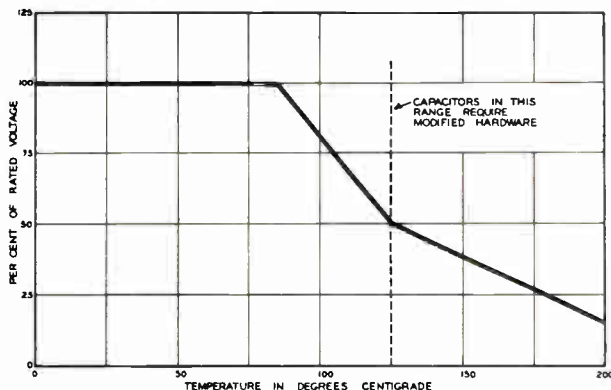

Impedance as a function of frequency for high K Monolithics®.

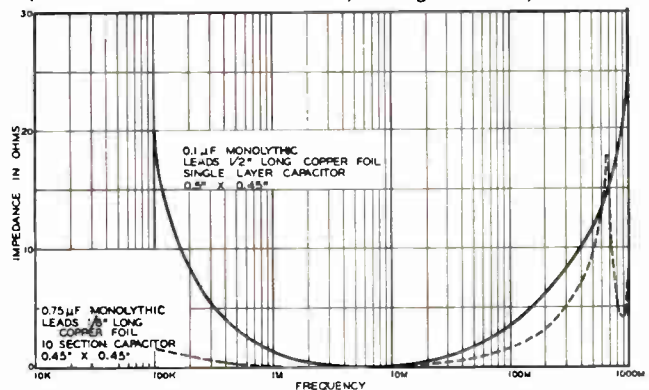

constant (and thus the capacitance) are not large enough to be of any concern.

When more capacitance is desired in a given diameter disc than can be obtained in a single unit, two discs can be stacked and connected in parallel.

Barium Titanate Capacitors

Reduced barium titanate capacitors called Hypercon™ capacitors are available in ratings up to 25vdc. These capacitors are essentially barium titanate pellets reduced by heat in a controlled atmosphere and re-oxidized on discrete areas of the surface during the silvering process. Rated voltage of these units should not be exceeded, because the application of over-voltage causes excessively high leakage currents, which may result in quick and sudden failure. A 3v., 0.02μf capacitor can be made in about 1/8 in. diameter, and values up to 0.1μf are available at 25v. Hypercons™ are now made with a rating of about 12μf-v./in.².

Capacitors for PC Boards

Printed wiring board uses in many cases require that a ceramic capacitor have a low-seated height on the board. This is required because they may be subject to vibration in the end use of the equipment. Also, low lead inductance may be an important consideration in order to assure maximum bypass efficiency. Their low silhouette provides both minimum lead inductance and good vibration resistance. Hooked-lead ceramic capacitors are used to assure positive clearance on printed wiring boards. Sufficient length of leads allows peening in any direction for positive contact to the conducting surface.

Monolithic Capacitors

An extensive development effort during the 50's resulted in a new family of capacitors using monolithic construction. This construction has produced capacitors with a bulk factor (ratio of capacitance to value) as high as 0.58μf/in.³ for high stability dielectric materials, and 85μf/in.³ for high dielectric constant material. These monolithic capacitors are, in effect, supported thin film capacitors. They consist of many layers of a thin ceramic dielectric (about 0.0025 in./

(Continued on Page 148)

Capacitance change with temperature for high K material type.

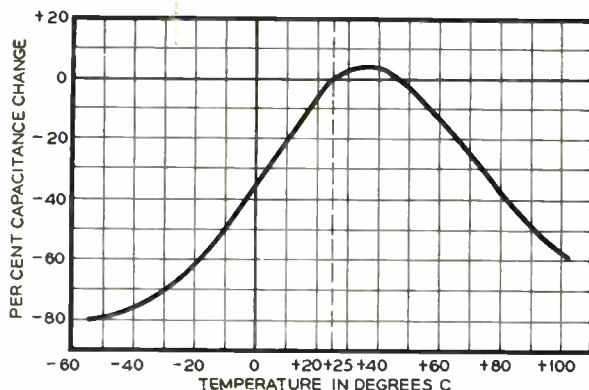

\$175⁰⁰ new reduced price!



AEL Model 245

SEMICONDUCTOR TESTER

- ✓ Tests low and high power semiconductors either in or out of circuit.
- ✓ Measures Beta with as low as 50 ohms emitter-base shunt.

OTHER IMPORTANT FEATURES

- Measures beta in two ranges covering 1 to 1000.
- No critical nulling adjustments required.
- Measures diodes and rectifiers for opens or shorts, in-circuit with 20 ohms across device terminals.
- Completely safe for semiconductors — resistance measurements are independent of semiconductor loading. Power output limited to 0.25 microwatts.
- Simple to operate — only three controls . . . can be used by semi-skilled personnel.
- Operates on type "C" flashlight batteries.
- Easy to read — measurements are indicated on a 6½" taut-band meter.
- Portable — easy to carry — weighs less than 10 pounds.
- Ruggedly built — has high impact plastic case.

WRITE NOW for detailed technical bulletin on the amazing AEL Model 245 Semiconductor Tester.



American Electronic Laboratories, Inc.
P. O. BOX 552R, LANSDALE, PENNA. 19446 • (215) 822-2929
suburban Philadelphia



Start here for higher silicon device yields

Czochralski crystals from Mallinckrodt

Mallinckrodt single crystal silicon is custom grown to your specifications. It is used in devices requiring the highest order of electronic performance.

Excellent crystal perfection. Mallinckrodt crystals average under 1,000 dislocations per cm^2 , measured to within 1.5 mm of the edge. The structures are free from lineage and slip.

Greatest accuracy. Lapped slices, for example, are held within 100 microinches of parallel. Even "as cut" slices have excellent finishes, free of cut marks.

Mallinckrodt will meet your toughest specifications consistently, year after year. We've done it for many of the industry's most critical buyers. Call us for more details. Also get the latest data on Mallinckrodt TransistAR[®] dopants, etchants and solvents.

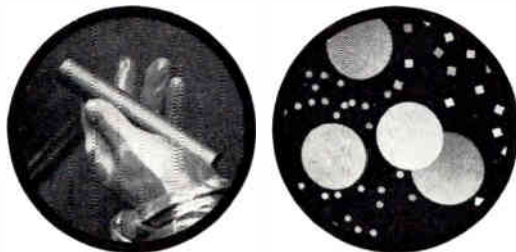

Available from Mallinckrodt. Czochralski crystals up to 1 $\frac{3}{8}$ " diameter grown on the 1:1:1, 1:1:0, or 1:0:0 axis. Your specifications for: resistivity, dopant, lifetime and dislocation density. Slices as-cut, lapped or polished. Dice of various shapes.

MALLINCKRODT CHEMICAL WORKS

Mallinckrodt
Electronic Products[®]

Second & Mallinckrodt Streets • St. Louis, Mo. 63160



Honeywell now has EIA registered 5-amp planars with collector isolated from case. They'll give you greater design latitude with freedom from insulation worries. Order today from your nearest Honeywell distributor. **Honeywell**

SEMICONDUCTOR PRODUCTS 1177 Blue Heron Boulevard, Riviera Beach, Florida
 HONEYWELL INTERNATIONAL: sales offices in all principal cities of the world.

Type Number	Hex Dim.	DESIGN LIMITS						PERFORMANCE SPECIFICATIONS					
		T_J	θ	P_T	BV_{CBO}	BV_{CEO}	BV_{EBO}	h_{FE}	$V_{BE(sat)}$	$V_{CE(sat)}$	I_{CBO}	f_T	
		$^{\circ}C$	$^{\circ}C/W$	Watts	Volts	Volts	Volts		Volts	Volts	μA		
		Max.	Max.	Max.	Min.	Min.	Min.	@ $I_C = 1 A$	@ $I_C = 1 A$	@ $I_C = 1 A$	@ $V_{CB} = 60V$	mc	
2N3744	7/16	200	3.33	30	60	40	7.0	20	60	1.2	0.25	0.1	30
2N3745	7/16	200	3.33	30	80	60	8.0	20	60	1.2	0.25	0.1	30
2N3746	7/16	200	3.33	30	100	80	8.0	20	60	1.2	0.25	0.1	30
2N3747	7/16	200	3.33	30	60	40	7.0	40	120	1.2	0.25	0.1	40
2N3748	7/16	200	3.33	30	80	60	8.0	40	120	1.2	0.25	0.1	40
2N3749	7/16	200	3.33	30	100	80	8.0	40	120	1.2	0.25	0.1	40
2N3750	7/16	200	3.33	30	60	40	7.0	100	300	1.2	0.25	0.1	50
2N3751	7/16	200	3.33	30	80	60	8.0	100	300	1.2	0.25	0.1	50
2N3752	7/16	200	3.33	30	100	80	8.0	100	300	1.2	0.25	0.1	50

YOKE SPECIALISTS

COMPLETE LINE for every Military and Special Purpose in PRODUCTION QUANTITIES or CUSTOM DESIGNED to your specific requirement.

- Yokes for all $\frac{7}{8}$ " $1\frac{1}{8}$ ", $1\frac{1}{2}$ " and $2\frac{1}{8}$ " neck dia. CRT's—only a few representative types are illustrated.
- Core materials to suit your requirements.
- Special test instruments can establish your yoke deflection parameters to an accuracy of $\pm 0.1\%$.
- Special designs for color displays
- Yokes available with series aiding field design or with parallel (bucking) field design.



Types V21 & V22

VIDICON YOKES & FOCUS COILS for 1" Vidicons IN VOLUME PRODUCTION NOW. For both commercial and military applications. Engineering Service available. Special designs for all types of 1" vidicons including electrostatic focus magnetic deflection types. For full technical details request catalog page.



Type P7



Type P8

ANTI-PINCUSHION DEVICES, both PM and EM types

Eliminates CRT geometrical picture distortion. Type P7 permanent magnet anti-pincushion assembly requires no current... occupies small space... easily adjustable... mounts directly on standard yokes... available in wide choice of magnet strengths with tight tolerances. Type P8 electromagnetic coil anti-pincushion assembly has very high precision construction... allows convenient front panel adjustment. For full technical details request catalog page.



Type Y69

TWEETER YOKE for $1\frac{1}{2}$ " neck dia. CRT's.

For generating characters in alpha numeric displays. Matches solid state circuitry. Eliminates electrostatic diddle plates. Frequency response up to 10 mc with a Q of 15. For full technical details request catalog page.



Type Y58 Series
Up to 40°, 52°, 70° and 90° deflection angles.

STATOR YOKES for $1\frac{1}{2}$ " neck dia. CRT's. For time shared sweep displays and other stator yoke applications. Available with high efficiency push-pull windings.



Type Y65
Up to 70° deflection angle

MINIATURE PRECISION ENCAPSULATED PUSH-PULL YOKE for $\frac{7}{8}$ " neck dia. CRT's.

Available in wide range of impedances and windings for both transistor drivers and vacuum tube circuits. Features electrically balanced windings with equal deflection sensitivities. Close angular tolerances of the display are achieved by precise construction. Epoxy encapsulated to withstand extreme environments. For full technical details request catalog page.



Type Y25-R Series
Up to 52° and 70° deflection angles

COMPACT ROTATING COIL YOKES for $1\frac{1}{2}$ " neck dia. CRT's.

For Radar Plan Position Indicator and all other rotating coil applications. Versions available with dc off-centering coils. Complete in aluminum housing containing deflection coil, slip rings and brush assembly, drive gear and bearing for easy installation into any equipment design. Only $3\frac{3}{4}$ " OD x $2\frac{1}{4}$ " long. For technical details request catalog page.



Type Y15 Series
Up to 52°, 70° or 90° deflection angles

PUSH-PULL OR SINGLE ENDED YOKES for $1\frac{1}{2}$ " neck dia. CRT's.

For military and oscilloscope applications requiring maximum resolution, low geometric distortion and high efficiency. Square core design with parallel opposed magnetic field. Available with extremely sensitive windings. For full technical details request catalog page.



Type Y16-6
Up to 60° deflection angle

HIGH SPEED PUSH-PULL YOKES for $1\frac{1}{2}$ " neck dia. CRT's.

Ideal for high speed data presentation and oscilloscope applications using push-pull circuits requiring exceptionally high deflection rates, low distortion and high efficiency. Available with medium to very low impedance coils. Low stray capacity. Series magnetic field design. For full technical details request catalog page.



Type Y66
Up to 60° deflection angle

LARGE I.D. YOKES for $2\frac{1}{8}$ " neck dia. CRT's.

Designed especially for characteron CRT's to give minimum twisting or distortion of characters. Suitable also for precision displays with other types of $2\frac{1}{8}$ " neck dia. CRT's.



Type F10

PRECISION ELECTROMAGNETIC FOCUS COILS for $\frac{7}{8}$ ", $1\frac{1}{2}$ ", $2\frac{1}{8}$ " and other neck dia. CRT's.

All designed for ultimate focus. Negligible effect on spot size when properly aligned to beam. Static types (all sizes)—low power or high power. Dynamic-static combinations ($1\frac{1}{2}$ " neck dia.)... compact single gap design... or double gap design to simplify circuitry by eliminating coupling between static and dynamic coils. Wide range of coil resistances available. For full technical details, request catalog pages. Please specify your CRT and beam accelerating voltage.

For engineering assistance in solving your display problems, please contact our nearest representative:

- Boston-New England 762-3164
- Metropolitan N.Y.: 695-3727
- Upstate N.Y.: 315, 652-7911
- Philadelphia Area: 789-2320
- Washington-Baltimore Area: 277-1023
- Florida Area: 813, 527-5861
- Los Angeles: 283-1201

syntronic INSTRUMENTS, INC.

100 Industrial Road, Addison, Ill. (20 miles west of Chicago), Phone (Area 312) 543-6444

Specialists in Components and Equipment used with Cathode Ray Tubes

New IBM miniature dry reed switches give you low contact resistance —less than 100 milliohms throughout life

But that's not all.

These new reed switches are now double plated, rhodium over gold, to give you low noise as well.

And long life too—up to 125 million error-free operations (mean time to first error).

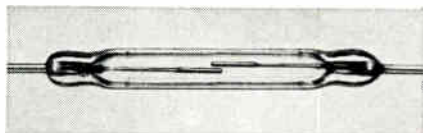

We dynamically set the air gap for each switch (shown here 2X actual size).

Whether you use IBM miniature dry reed switches in relays or magnet actuated applications you get highly consistent performance throughout life. Here's why.

First, we *dynamically* set the air gap between the reeds. This means a stable sensitivity of $\pm 7 \text{ NI}$ (maximum) in every reed switch. No need to select or grade them.

Then we check contact resistance of each switch (including leads) under low level conditions. Result: a mean of 50 milliohms.

To verify long switching life we conduct life tests on a regular basis. Here we monitor every switching operation to identify every error—all the way up to end of life.

Finally we test our reed switches to meet rigid standards of quality in 34 important areas, such as alignment,

leakage and voltage breakdown.

But perhaps the best proof of their life/performance is our own testimonial: We use them in practically all of our own computers, including the new System/360.

Why not put IBM miniature dry reed switches to the test in one of your applications. For complete specifications, life ratings and test criteria write to the IBM Industrial Products Division, 1000 Westchester Avenue, White Plains, New York 10604.

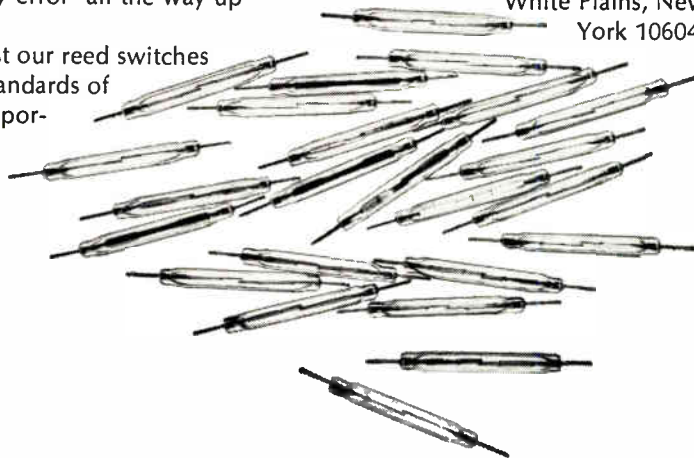

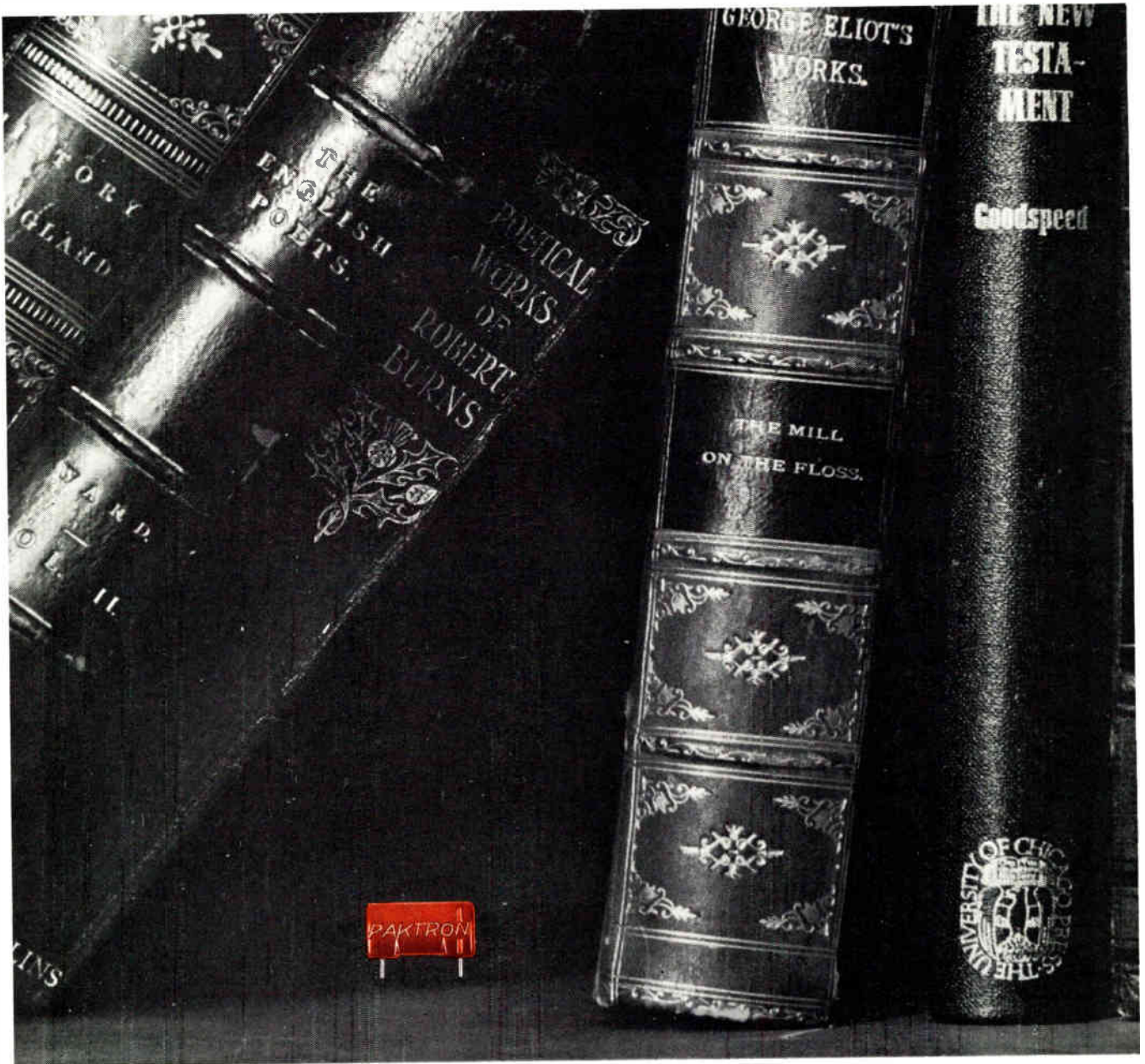

ONE THING ABOUT CLASSICS . . . THEY NEVER CHANGE

PAKTRON® molded Classic™ capacitors stand the test of time. Hot or cold, it doesn't make much difference to a PAKTRON Classic™ capacitor. With the inherent stability of polycarbonate, PAKTRON Classic™ polycarbonate film/foil capacitors satisfy applications where minimum capacitance change with respect to temperature excursions is a design criterion. They are highly resistant to moisture, shock, vibration and contamination, and have passed many of the toughest electrical-environmental requirements. Dimensions are precise. All parts are certified and fully tested by PAKTRON. All this leads to the most important PAKTRON Classic™ capacitor feature . . . over the entire temperature range, PAKTRON Classic™ capacitors never change. Ask for samples.



PAKTRON® Classic™ molded polycarbonate film capacitors

- Working Voltage: 50 WVDC
- Tolerances: $\pm 1\%$, $\pm 2\%$, $\pm 5\%$, $\pm 10\%$
- Operating Temperature Range: -65°C to $+105^{\circ}\text{C}$

PCR-700
.700 inches long. Capacitance values to 0.1 mfd.

PCR-330
.330 inches long. Capacitance values to 0.010 mfd.

PCA-375
.375 inches long, .200 inches dia. Capacitance values to .015 mfd.

"Remember, you're never more than a few feet away from a product of ITW"



PAKTRON

DIVISION ILLINOIS TOOL WORKS INC.
1321 LESLIE AVENUE • ALEXANDRIA, VIRGINIA 22301

WHAT'S NEW

TWENTY FLAT PACKS IN 1.4 CUBIC INCHES

THE BI/CON® INTERCONNECTING CARRIER SYSTEM PROVIDES a unique method of packaging and interconnecting integrated circuits. It eliminates the cramming of circuits on printed-circuit cards and conventional surface wiring.

The carrier system, a product of Elco Corp., Willow Grove, Pa., is an off-the-shelf unit. With it an endless variety of both analog and digital sub-systems can be constructed in a short time. The complete unit consists of 5 basic parts: The Carrier—a thermoset-plastic molded housing which acts as the carrier for the integrated circuits, the interconnecting media, and the external contact assembly. The Omni-Comb®—a kovar or copper universal interconnecting layer. The External Contact Insulator—a molded 0.050 in. center-to-center connector body capable of holding 40 contacts. The Bi/Con Contact—a BcCu contact rated at 3 amps. The Retaining Clip—a molded semi-rigid plastic pressure device. When assembled, these basic parts form a completely interconnected subsystem

- (4) Insert the Omni-Comb into the carrier.
 - (5) Fold the leads of the IC using the folding tool and position the IC in the desired location of the package. Hold the package in place with a retaining clip.
 - (6) Again using the graphic aid format, determine the position and number of desired external connections. Assemble the contacts and insulators to agree with the graphic aid format.
 - (7) Insert the assembled contact insulators into the carrier.
 - (8) Now, terminate the package by hand soldering, welding, or dip soldering.
- The finished package can be mounted on standard printed-circuit boards.

CHECKOUT FOR APOLLO INSTRUMENTS

GENERAL-PURPOSE TEST UNITS, that will calibrate, checkout, and maintain instrumentation systems and components in the Apollo command modules and Lunar Excursion Module, are being delivered by North American Aviation's Autonetics Div. to NASA. Called Spacecraft Instrumentation Test Equipment (SITE) it consists of a four-bay control console and a 14-bay equipment rack. It can be operated by one man.

SITE's control console contains a punched tape programmer, digital printer, and control and readout devices. Within the equipment rack is a wide range of stimuli generation, measurement equipment,reed relay switching matrices, and control logic to provide the capability to checkout instrumentation systems in Apollo and the spacecraft.

In an average test, SITE can perform 600-700 individual checks in approx. 30 min. Where fault isolation in a system or component is required, it can complete testing with 800-900 checks in about 45 min.

With SITE, 1 man can perform up to 900 checks in less than 1 hr.

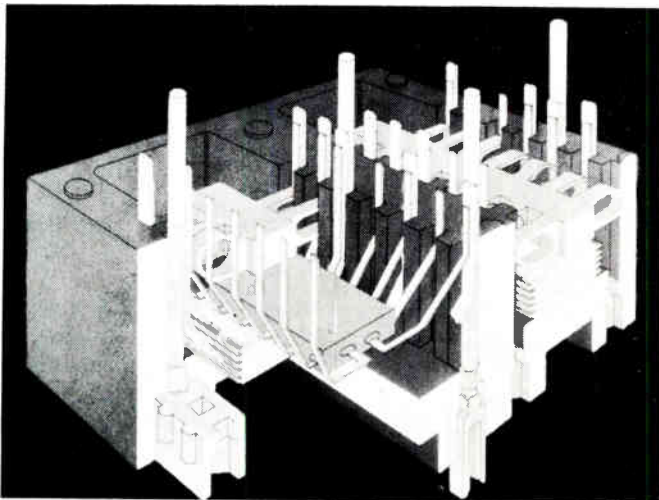

Packaging system allows flat packs to be stocked in layers.

which contains a maximum of twenty 14-lead flat packs.

Here is how a typical logic function is assembled:

- (1) Using an Omni-Comb graphic-aid format, mark the numerical lead designation in the corresponding position of the integrated circuit (IC) outline. Now designate the type of IC within the body of the outline. Fill in the corresponding tooth/lead position which complete the desired interconnection. (A 1-to-1 relation exists between the Comb outline and IC outline.)
- (2) Combine all layers wherever possible.
- (3) Remove the unwanted interconnecting teeth from the Omni-Comb layer. This is done by a programmed or hand punch. Then fold the teeth of the layer using a folding jig.

WHAT'S NEW

MULTI-USE CONSOLE WELDER

MICROSOLDERING, MICROWELDING, AND DIFFUSION BONDING are easily performed by the Model 700 Polytronic Welder. The system, a product of the Weltek Division of Wells Electronics, Inc., South Bend, Ind., consists of a miniature ac power supply, an all pur-

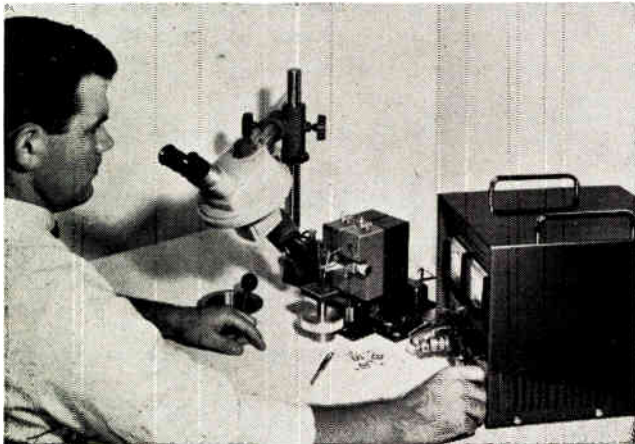

Versatile unit performs 5 different kinds of miniature welding.

pose weld head, a micro-positioner, binocular swing away Stereozoom optics, light source, and accessories.

The power supply may be cycled continuously and at very fast rates since it does not depend on capacitors or batteries. Energy pulses are controllable down to 1 msec and up to 800 msec. Both constant current and constant voltage sources are available, along with automatic resistance feedback controls.

AUTOMATIC NETWORK TESTING SYSTEM

TESTING WIRING NETWORKS IN MULTI-LAYER BOARDS, back panels, electronic assemblies and cables can now be done automatically with the IBM TE 602 Programmed Network Testing System. It tests wiring networks at speeds compatible with high-volume test-

The TE 602 automatically checks up 20,736 terminal points.

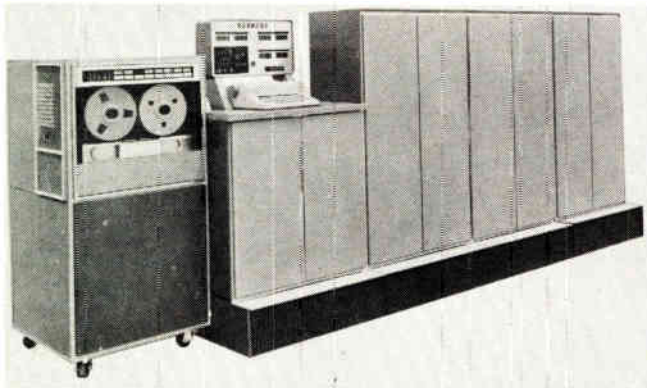

The all purpose weld head can be set up to do 5 different kinds of miniature welding plus micro-soldering and diffusion bonding. The force range is 3 oz. to 20 lbs. The micro-positioner is accurate to ± 0.0005 , and the optics permit a magnification of 7X to 30X.

PADS KEEP WIRE CLIPPINGS FROM FLYING

DO-IT-YOURSELF RUBBER PADS FOR WIRE CUTTERS, which keep loose wire ends from flying, can be ready-made from a silicone rubber sealant applied from a tube. The procedure, perfected by General Electric Co., Silicon Products Dept., Waterford, N. Y., is simple and solves a serious problem. The cutter jaws are first cleaned and then bound shut with tape or rubber bands. Next the silicone rubber sealant (General Electric RTV-102) is applied into the jaw depression and left to cure for 24 hrs. After the rubber cures the jaws are cut open with a razor blade. Wire cutters are then ready to go.

Sealant prevents wire clippings from popping out of pliers.

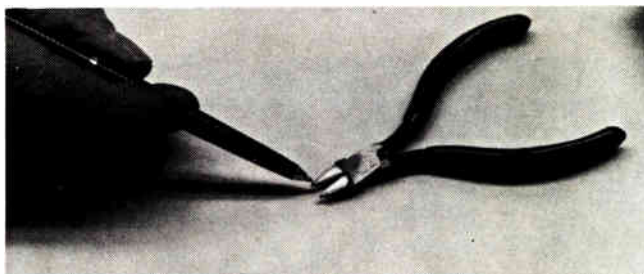

ing required in many commercial and military electronic manufacturing operations. Testing such networks prior to assembly enables the TE 602 to closely monitor reliability and quality control levels before networks are placed into electronic assemblies.

The system, developed by IBM's Industrial Products Div., White Plains, N. Y., operates under the control of either a computer or a magnetic tape reader. It can apply shorts and continuity checks to wiring networks in circuits and assemblies ranging from 864 to 20,736 terminal points. Various tests are performed to determine that: Continuity exists in defined networks; any two points of a network will carry a specified amount of high current; a high-voltage pulse does not cause a short between networks; and no extra wires or circuit paths exist. All tests can be performed without modification to the basic system.

A printed copy of wiring errors found is provided by an IBM Selectric®. This printout makes available a permanent record of errors and their locations which can be the basis for rework of networks. An interface easily adapted to a wide variety of holding fixtures is also included with the system.

TERMINALS AND SPLICES

The industry's widest range of products in these categories, available in every size and shape, AMP's terminals and splices meet or exceed most military and commercial specifications. Both insulated and uninsulated types are available in various base materials with a choice of platings. They offer the advantages of the matched tool and terminal technique developed by AMP for uniform connections with high resistance to corrosion, shock and vibration, and superior conductivity. Environmental splices withstand high temperatures, effects of corona, moisture and vibration, and they exceed applicable requirements for tensile strength, millivolt drop, and dielectric strength. AMP terminals or splices are available for all wire sizes from 26 AWG through 1125 MCM.

INSULATED

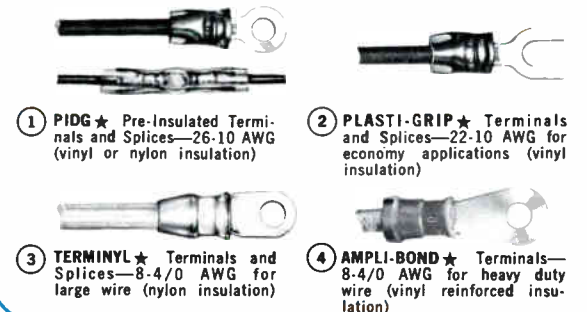

① **PIDG** ★ Pre-Insulated Terminals and Splices—26-10 AWG (vinyl or nylon insulation)

② **PLASTI-GRIP** ★ Terminals and Splices—22-10 AWG for economy applications (vinyl insulation)

③ **TERMINYL** ★ Terminals and Splices—8-4/0 AWG for large wire (nylon insulation)

④ **AMPLI-BOND** ★ Terminals—8-4/0 AWG for heavy duty wire (vinyl reinforced insulation)

UNINSULATED

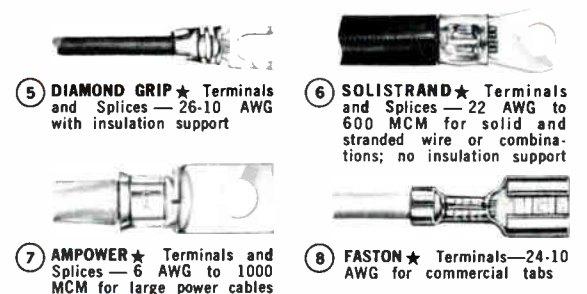

⑤ **DIAMOND GRIP** ★ Terminals and Splices—26-10 AWG with insulation support

⑥ **SOLISTRAND** ★ Terminals and Splices—22 AWG to 600 MCM for solid and stranded wire or combinations; no insulation support

⑦ **AMPOWER** ★ Terminals and Splices—6 AWG to 1000 MCM for large power cables

⑧ **FASTON** ★ Terminals—24-10 AWG for commercial tabs

ENVIRONMENTAL

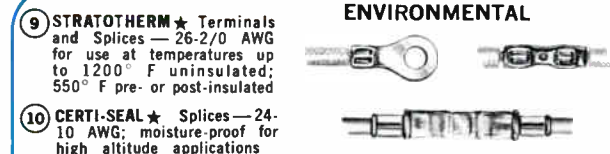

⑨ **STRATOTHERM** ★ Terminals and Splices—26-2/0 AWG for use at temperatures up to 1200° F uninsulated; 550° F pre- or post-insulated

⑩ **CERTI-SEAL** ★ Splices—24-10 AWG; moisture-proof for high altitude applications

PIN & SOCKET CONNECTORS

AMP offers a full range of connectors using crimped, snap-in contacts. These connectors are available in all standard sizes and combinations (including pin and socket coaxial mix), and subminiature connectors, to meet requirements of military and commercial applications. Includes a complete line of hardware, contact sizes, contact positions and materials; in rack and panel, bulkhead, or free hanging versions. Thoroughly tested and manufactured with quality control from raw material to finished product.

RECTANGULAR

AMP-INCERT ★ Connectors for rack and panel or bulkhead mounting with contact sizes from 10 to 20 . . .

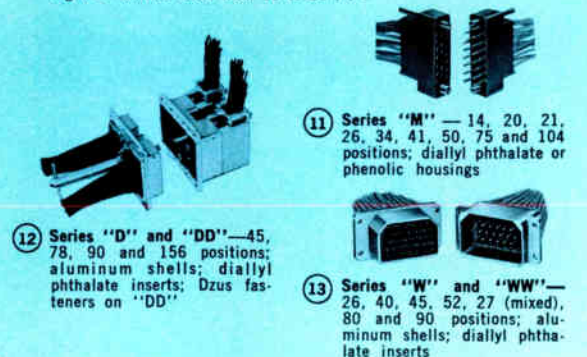

⑪ Series "M"—14, 20, 21, 26, 34, 41, 50, 75 and 104 positions; diallyl phthalate or phenolic housings

⑫ Series "D" and "DD"—45, 78, 90 and 156 positions; aluminum shells; diallyl phthalate inserts; Dzus fasteners on "DD"

⑬ Series "W" and "WW"—26, 40, 45, 52, 27 (mixed), 80 and 90 positions; aluminum shells; diallyl phthalate inserts

PRECISION ENGINEERED PRODUCTS

Over 20,000 different product items backed by more than 5400 U. S. and foreign patents issued or pending . . . A solution to nearly every connection problem in the electronic/electrical industries . . . Dependable product performance and long-lasting reliability assured by quality control procedures from receipt of raw materials through to the finished product . . . Research and testing facilities second to none in the industry . . . Constant and continuing efforts to improve existing products and to develop new products for future needs.

To help you evaluate which of AMP's broad product lines is best suited to your particular application, this folder describes briefly the general features of the following AMP★ products:

- Terminals and Splices
- Multiple Wire Connectors
- Printed Circuit Connectors
- Taper Technique Products
- Coaxial and Shielded Wire Products
- Interconnection and Packaging Systems
- Programming Devices
- Capacitors, Power Supplies and Pulse Packages
- Application Tooling

For specific information on any of AMP's products in this folder, circle the appropriate number from 1 to 67 on the Reader Service Card.

CIRCULAR AND SUBMINIATURE



14 **CIRCULAR**—Stainless steel housed subminiature connectors; 16, 28, 37, 58 and 85 size #22 contacts; contacts removable without tools; locking seal; conforms to MIL-C-26500

15 **SUBMINIATURE**—Cadmium plated brass shell; polyurethane housing; 50 size #28 Type VII contacts; panel or bulkhead mounting

ENVIRONMENTAL



16 Series "A"—100 positions; aluminum shells; diallyl phthalate inserts; silicone rubber or neoprene seals

17 Series "DDE"—126 and 144 positions; aluminum shells; polyurethane inserts; polychloroprene seals

SPECIAL



18 **ACTIVE PIN CONNECTORS**—Subminiature; 20 split pins on .100" centers; polyurethane in polycarbonate block; 1-3 oz. insertion/withdrawal force; measures .1" x .6" x 2" mated.

19 **PIN AND SOCKET/COAXIAL MIXED**—Combines pin-and-socket contacts and subminiature coaxial contacts in any configuration in a rectangular connector with up to 156 positions.

20 **DUAL LATCH STAR CONNECTORS**—High-density with hermaphroditic contacts in polycarbonate housings of 40, 60, 132, 396 positions, plus modular miniature and 200-position cable connectors; crimp, snap-in design, or weld, solder or wrap post versions.

PRINTED CIRCUIT CONNECTORS

Board edge connectors are available in one and two-piece types in a wide variety of sizes and configurations. Contact densities down to .050" are available; special egg-crate design provides dielectric barrier between contacts; housings are of diallyl phthalate or phenolic material. All printed circuit connectors feature unique wiring methods ranging from manual to completely programmed termination.

TWO-PIECE CONNECTORS

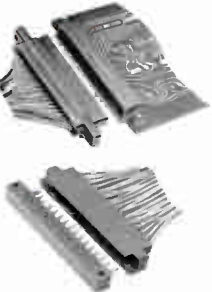

21 **RIGHT-ANGLE TYPE**—19 positions, sealed or unsealed; uses pin and socket contacts #20.

22 **AMP-BLADE STAR Connectors**—crimp snap-in contacts; 17, 23, 29, 35, 41 and 47 positions. High density, triple-point contact pressure; controlled insertion/extraction forces; conform to MIL-C-21097A specifications.

23 **Two-piece connectors** also available with weld, solder, wrap or post contacts which accept **TERMI POINT STAR** clips.

ONE-PIECE CONNECTORS



24 **AMP-LEAF STAR Connectors**—8, 15, 18, 22, 30 and 32 positions; for one or two-sided boards.

25 **One-piece connectors** available with weld, solder, wrap or post contacts which accept **TERMI POINT** clips.

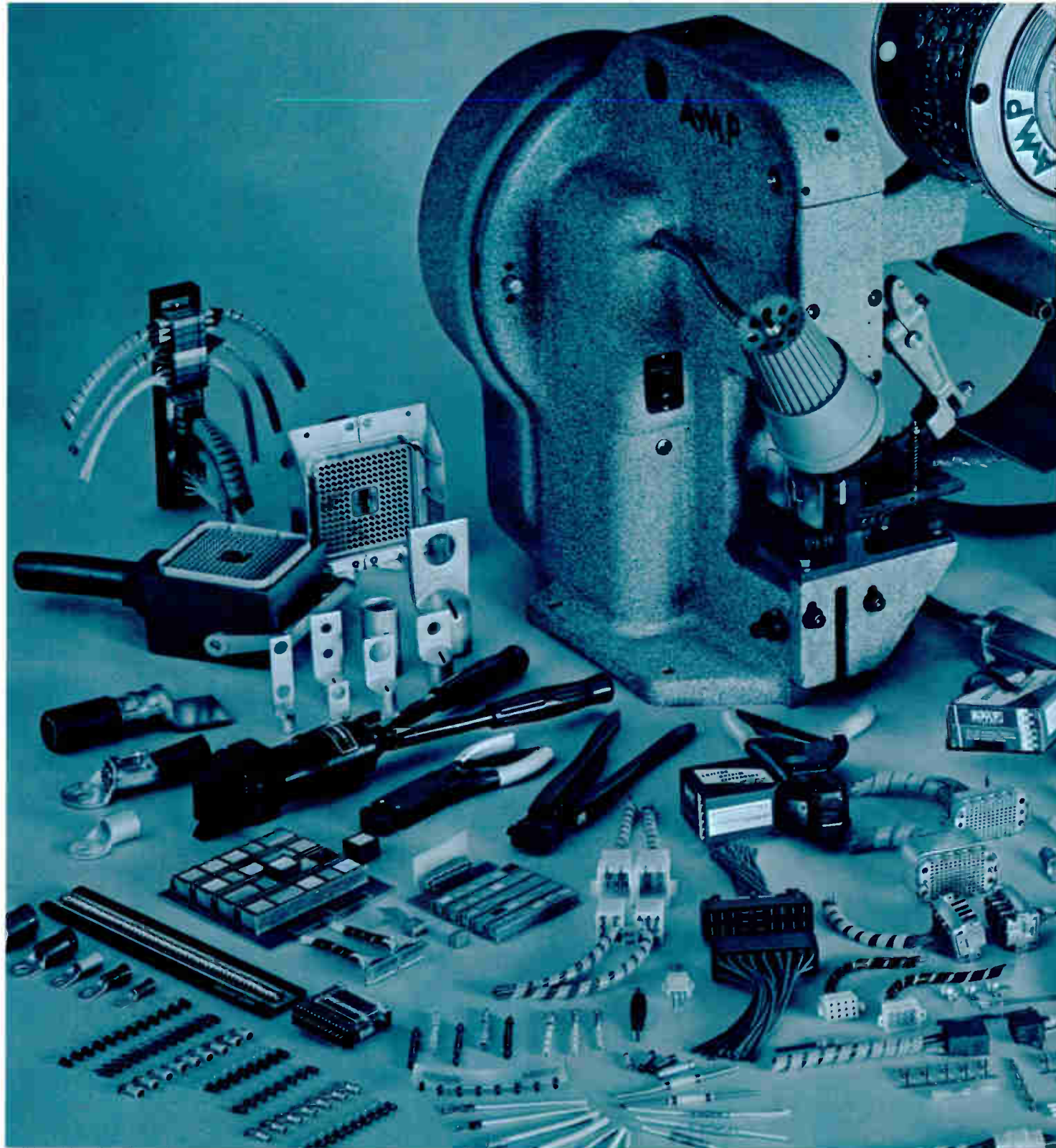

26 **AMP-TAB STAR Connectors**—10, 15, 18, 22, 30, 31, 41 and 43 positions; accepts either two or four terminals per position. Terminals can be inserted or extracted while connector is engaged.

27 **TERMI-TWIST STAR Connectors**—compatible with automatic **TERMI POINT** wiring machine for high-density and fast assembly. Conforms to MIL-C-21097 dimensions and performance specifications at lowest applied cost.



28 **DUO-TYNE STAR Flag Connectors**—crimp snap-in right-angle contacts with color-coded housings in 3, 5, 6, 9, 12, 14, 15, 18 and 22 positions.

PRINTED CIRCUIT COMPONENTS & INTERCONNECTION SYSTEMS

Special components for printed circuit boards complement AMP's broad connector line.

29 **AMP MODU STAR INTERCONNECTION SYSTEM**—flexible, low-cost modularization. Consists of post contact and box-shaped female member having dual cantilever springs. Mounts vertically or horizontally; on boards up to 3/32" thick.



30 **TEST PROBE RECEPTACLES**—various sizes of nylon housed receptacles for mounting on boards up to 1/4" thick; probe insertion at either end.



PORTABLE POWER CRIMPING TOOLS



35 AMP pneumatic and hydraulic tools set new standards of speed, economy and convenience for hand application.



TAPE-FED TOOLS



36 Semi-automatic hand and pneumatic AMP-TAPEMATIC★ crimping tools use magazine-loaded, tape-mounted terminals, contacts or splices. Tape tool eliminates loose piece selection and automatically locates part in crimping position ready for application.

AUTOMATIC CRIMPING MACHINES

37

AMP-O-LECTRIC★ Machine crimps up to 4,000 uniform connections per hour; foot pedal or switch control.



38

AMP-O-MATIC★ Machine is electro-pneumatically powered and produces up to 3,000 finished terminations per hour.



39

AMPOMATOR★ Automachine is the epitome of AMP's Automated Machines. Produces up to 5,700 finished leads or 11,400 terminations per hour depending on lead length, completely automatically. Electrically operated, it feeds the wire, strips one or both ends to the desired length, and attaches terminals in one machine cycle.



40

AMP-TAPETRONIC★ Electronic Machine crimps tape-mounted terminals. Operates by automatic sensing device or foot control; allows quick die changes; terminals are fed from 1,000-unit magazine or from 5,000-unit reels.



TOOLING

31

HELICAL SPRING CONTACT — "pluggability" for high-density modules or printed circuit boards; pin and tab contacts mate with spring receptacles.



32

CIRCUITIP★ TAPERED TERMINAL TIPS — crimped to leads hold components firmly to printed circuit boards for solder dipping; automatic crimping of 7200 per hour.



33

MINIATURE SPRING SOCKETS — facilitates soldering and eliminates need for heat sinks when mounting transistors, diodes and wire leads; mount on .050" centers.



Even with the finest terminal and the best wire, a precision-crimping tool is the only assurance of uniform, high-quality circuit connections time after time. The AMP concept of matching tool and terminal has resulted in a precision crimp with maximum tensile strength and electrical conductivity. From hand tools for prototype work or small quantity production to high-speed automatic crimping machines capable of making 11,400 terminations per hour, the AMP crimping method is identical, precise and dependable.

34

CERTI-CRIMP★ Hand Tools — Designed for hard-to-reach application and limited quantity production. Color coded for quick tool/terminal check; ratchet assures complete bottoming of dies before terminal is released to prevent over-crimp or under-crimp.



GENERAL PURPOSE CONNECTORS

Economical assembly, easy maintenance and crimped, snap-in contacts. For most commercial applications, FASTIN-FASTON★, AMPEEZ★ or AMP-LOK★ Connectors are ideal—they have minimum insertion and withdrawal forces, maximum amperage ratings, strong resistance to vibration, corrosion and environmental contamination.

(continued over flap)

GENERAL PURPOSE CONNECTORS (cont.)

Other connectors with special applications for industrial or commercial products include MATE-N-LOK[®], AMP-UNYT[®], and TERMI-BLOK[®] connectors. Contacts are available in strip form for application with a wide range of A-MP Automachine tooling.



④② **AMPEEZ Connectors** — 7, 14 or 20 circuits; 25 amperes; panel mount or free hanging; no hardware required.



④③ **FASTIN-FASTON "187" Modular Connectors** — 3-circuits; can be stacked to provide versatility, reduce inventory.



④⑤ **TERMI-BLOK Connectors** — high-density interconnections for power-control wiring without tools; modular construction; accepts wire sizes #22-10 AWG.



④④ **MATE-N-LOK Connectors** — Panel mount, motor mount, free-hanging; 1 to 15 circuits. No hardware required.

TAPER TECHNIQUE PRODUCTS

AMP offers the most extensive line of taper pins available — insulated or uninsulated — in either stamped and formed or solid types. Taper pins mate with inserts in nylon or diallyl phthalate stackable single or two-piece blocks in a variety of shapes and sizes up to 101 cavities.

Precision engineered, self-cleaning, self-locking taper pins provide optimum electrical and mechanical performance.



⑤② **TAPER PINS** — available in wire range #26-12 AWG, insulated, uninsulated and with insulation support.



⑤③ **TAPER TAB RECEPTACLES** — mate with flat taper tabs .016" to .023" thick; accommodate wire range #24-18 AWG.



⑤④ **TAPER PIN RECEPTACLES** — mate with .037" diameter taper pins, accommodate wire range #26-20 AWG. Variety of types available.



⑤⑤ **TAPER PIN BLOCKS** — a complete line is available with any combination of single and commoned taper pin receptacles.

TERMI-POINT TERMINALS AND TOOLS

These new products feature a new point-to-point wiring technique which makes uniform, gas-tight, reliable connections with great speed in dense wiring applications. TERMI-POINT clips are highly serviceable, resistant to shock, vibration, and corrosion. Wire types which may be used with TERMI-POINT clips include stranded, enameled, tinsel, printed and solid — all with the same degree of reliability. Stripping, clipping, and terminating is accomplished in one operation with the lightweight "pistol-design" TERMI-POINT tool, or at high speed with AMP's automated wiring machine, which can be programmed to wire panels with various densities. AMP's TERMI-POINT products make possible unique serviceability and levels of reliability and density not available with other point-to-point wiring products.



⑤⑥ **Panel wired by numerically controlled TERMI-POINT machine can be easily serviced and rewired without damage.**



Gas-tight, efficient connections which use tinsel, enameled, stranded, solid or printed wire.

AMP-MECA[®] INTERCONNECTION SYSTEMS

A new concept in the interconnection of electronic circuit functions and devices. AMP-MECA assemblies provide "building block" simplicity for the most intricate circuit designs. Easily serviced, pluggable sub-module circuit cells can be made larger or smaller, stacked, spread, or aligned in unlimited combinations to accommodate design needs.

The use of a specially developed interconnection layout chart makes possible conversion from the schematic to the physical in less time than conventional methods.



⑤⑦ **AMP-MECA Modules or cells are available in incremental sizes to accommodate and interconnect components in various sizes and quantities.**



TYPICAL AMP-MECA ASSEMBLY

For specific information on all A-MP products, write to:

AMP INCORPORATED • HARRISBURG, PENNSYLVANIA

AMP-MAD[®] MULTI-APERTURE MAGNETIC DEVICES

These digital devices are built using multi-aperture ferrite cores and copper wire in the switching, storage, and transfer networks, thus providing the ultimate in space-saving reliability. No "standby" or non-operating power is needed and very low power is required during operation. Miniaturization is achieved without the usual cost penalty; assembly and servicing are simplified.



⑤⑧ **MODEL 506 Pinboard Programmer** — Solid-state, variable frequency source of programmed information, with 6 channels of 50 steps.



⑤⑨ **BINARY SEQUENCE DETECTOR** — Solid state ferrite cores; requires no standby power; decodes 16-bit word with wired-in accuracy; starts anywhere; rejects simultaneous application of '1' and '0'.

CAPITRON[®] PRODUCTS

The CAPITRON Division offers more than 2,500 different designs of capacitors, transformers, power supplies and pulse networks. Available as off-the-shelf items or custom designed, CAPITRON Products find both commercial and military applications where weight and space reduction is important. Two unique A-MP dielectrics are used throughout.



⑥① **AMPLIMICA[®] CAPACITORS** — Un-cased, laminated construction for operation up to 200° C. Capacities from .010 to 1.0 μfd.



⑥② **POWER SUPPLIES** — Environmentally conditioned encapsulated, canned, or open frame units with output currents from 1.0 μa to 5 amps and voltages to 40,000 V DC.



⑥③ **STATIC INVERTERS AND FREQUENCY CHANGERS** — Solid state units with 5% or less harmonic distortion and high efficiencies.



⑥④ **LGH[®] LEAOS AND TERMINALS** — High voltage, high altitude lead assemblies; feed-through terminals and splices for up to 40,000 V at 5 amps.

PROGRAMMING DEVICES

AMP is a one-source supplier for a complete line of programming devices. They range from single fixed panels, through rack and panel mount systems with removable front patchboards, to integrated card programming systems. Gold over nickel plated contacts and double-wiping action on contact surfaces assure outstanding performance throughout this product line. AMP's Shielded and Coaxial Patchcord Systems are the first of their kind. They provide rapid re-programming of high frequency circuits with low cross talk and minimum interference.



⑥⑤ **AMP'S Universal Patchcord Systems offer rapid interchange of circuits with complete reliability.**

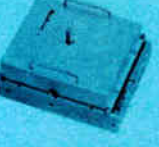

⑥⑥ **Special Anti-Vibration and Airborne Systems are constructed for maximum resistance to extreme environmental conditions.**

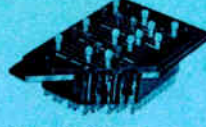

⑥⑦ **Simplicity, flexibility, and economy are virtues of AMP's Matrix and Universal Pinboards.**



⑥⑧ **Rack mount and desk type Card Programming Systems feature semi-automatic card ejection and safety interlocks.**

COAXIAL CABLE & SHIELDED WIRE PRODUCTS

COAXICON[®] CONNECTORS — A complete line of multiple and single-in-line connectors for coaxial cable in a range of RG/U sizes from RG-196/U to RG-62/U . . . featuring solderless connections made with AMP's one-stroke crimping technique for terminating inner conductor, outer braid and cable support simultaneously. All feature low VSWR, AMP's standard gold over nickel plating, mechanical strength, and complete intermatibility.

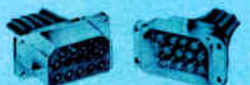

④⑥ **MINIATURE** — (Type IV contacts) 7, 14 and 20 positions; also 25-position "T" connector for RG/U, twisted pair, shielded wire, or other cable types.



④⑦ **STANDARD** — 10, 18, 26 and 34 positions and standard "Y" connector, or "T" connector with 10 positions.



④⑧ **BNC & TNC TYPE** — Quick connect/disconnect for coaxial cables; bayonet or threaded; single-crimp; meets requirements of MIL-C-3608A, MIL-C-39012 and MIL-C-23329A.



④⑨ **SUBMINIATURE** — Single and multiple connectors for RG-178/U and similar cable.

TERMASHIELD[®] SPLICES & FERRULES

Complete selection of ferrules for the fastest, most reliable method on the market for attaching one or more ground taps to shielded wire. Insulated and uninsulated splices available for single or multiple conductor shielded wire. Unique crimping process assures maximum conductivity.



⑤① **FERRULES** — Pre-insulated, post-insulated, and uninsulated; post-insulated type resistant to temperature of 550°F; uninsulated type resistant to temperature of 650°F. One stroke of crimping tool attaches ferrule. Pre-insulated ferrules available for printed circuits.



⑤② **SPLICES** — Pre-insulated, post-insulated, and uninsulated; single or multiple conductor TERMASHIELD splices. Only two crimps needed to splice shielded wire and coaxial cable; positive connection; no soldering; for wire sizes from 24 AWG to 14 AWG. Multiple splices resistant to temperature of 550°F.

ELECTRONIC INDUSTRIES

Measurement and Test Section

STATE-OF-THE-ART FEATURE

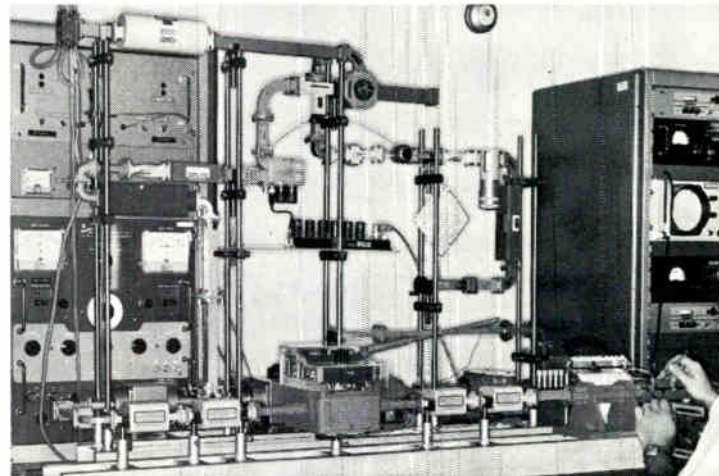
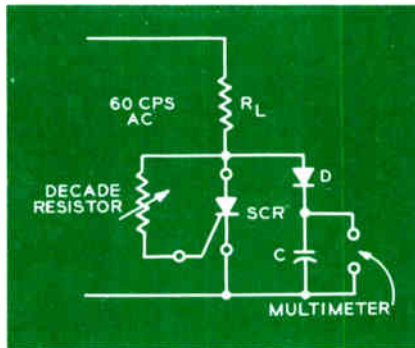
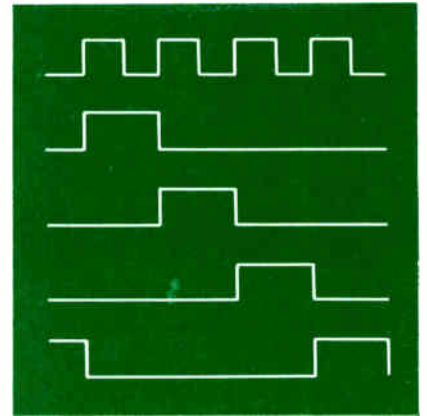

CONTENTS:

A Look At Measurement Standards	88
Testing SCR's	93
Low-Level R-F Voltage Standards	96
Measuring Frequency Deviation	100
Selecting The Right Meter	102
Oscilloscope Sampling Techniques	108
Survey of Measurement Textbooks	113
New Products—Measurement & Test	116
New Literature on Measurement & Test	118

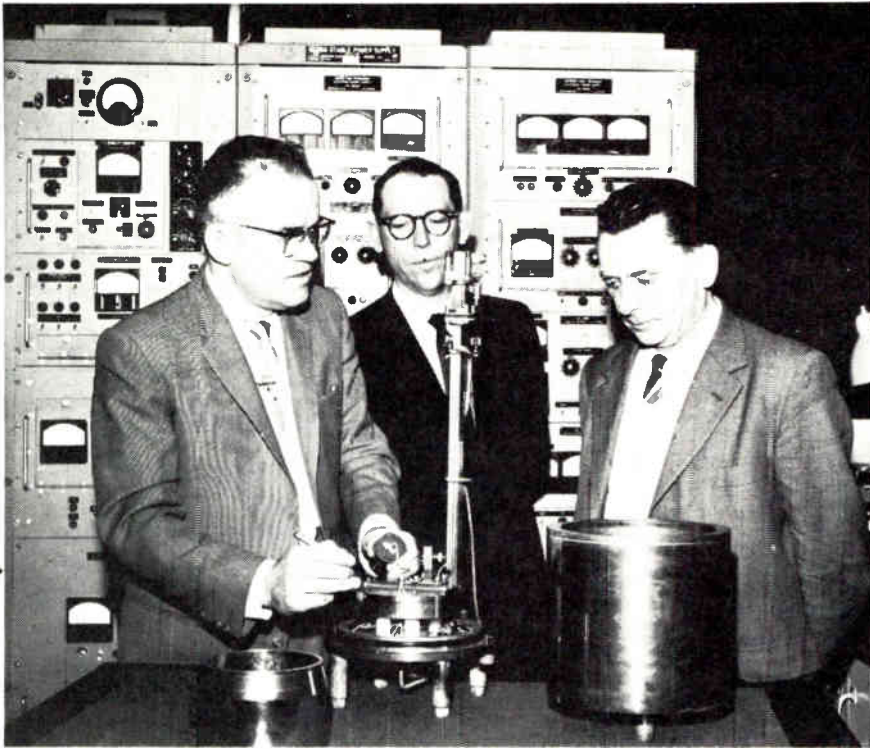

Members of the staff at NBS explain construction details of the NBS microcalorimeter—the U. S. standard of microwave power—to Dr. Wolfdietrich H. Schaffeld (right), Head of the Microwave Physics Laboratory, Physikalisch Technische Bundesanstalt, Braunschweig, Germany.

By **ELMER T. EBERSOL**

Editor-at-Large
Electronic Industries

A Close Look At Measurement Standards

**MEASUREMENT
and TEST**

FEATURE

AS ELECTRONIC equipment and systems become increasingly complex; as demands of our defense

and space programs become greater in terms of precision and reliability guarantees for electronic hardware, standards of measurement become urgent. Probably no single factor has delayed technological progress more than lack of consistency in measurement procedures and reporting.

In the United States, the center for standards around which all precise measurements are performed, is the National Bureau of Standards. Because of the increasing demands on the Bureau, it was reorganized in 1964 to better serve our national interests. In January, 1964, the program of NBS was grouped into four institutes. These are: 1. The Institute for Basic Standards; 2. The Institute for Materials Research; 3. The Institute for Applied Tech-

nology; and 4. The Central Radio Propagation Laboratory.

The Institute for Basic Standards (IBS) provides the basis within the United States for a complete and consistent system of physical measurement. It attempts to promote accuracy at all levels of measurement—by providing accurate calibrations at the highest level; by developing and publishing methods of precision measurement for general use; by offering general consultation; by cooperation with technical societies; by arranging specialized conferences; and by sponsorship of the National Conference of Standards Laboratories.

While it has no legal power to require industry to use its services, IBS cooperates closely with industry and other Government agencies through advisory and consultative committees, to determine developing needs for increased accuracy and measurement services. IBS coordinates its measurement systems with the measurement systems of other

nations. Principal activities of the Institute include the development and maintenance of the national standards for physical measurement, determination of fundamental physical constants, acquisition of reference data on the properties of matter and administration of a National Standard Reference Data System, research and development on measurement techniques and instrumentation, and the calibration of master standards in terms of the national standards.

The Institute for Basic Standards

There are thirteen separate divisions in IBS. Those of most interest to electronic engineers warrant listing. In Washington are the divisions on Electricity, Metrology, Mechanics, Heat, Atomic Physics, and Radiation Physics. In Boulder, Colorado, are the Radio Standards Laboratory, and the divisions on Radio Standards Physics and Radio Standards Engineering. The calibration services come under the Radio Standards Engineering division.

The coordinator of these services is Mr. W. F. Snyder.

The Bureau's budget has been severely limited, making it impossible to provide the calibration services to industry that have been requested. Cooperation by industry in establishing high quality standards laboratories throughout the country, whose standards are periodically checked by the Bureau, has helped NBS keep reasonably current with important calibration demands. Companies too small to have precision calibration facilities of their own can and should use the services available in larger companies and independent calibration laboratories before making demands directly on NBS.

Unfortunately, initiation of new measurement research projects was curtailed at IBS in 1964 because of budgetary limitations. However, work begun in previous years resulted in the offering of a number of new services. These included: extension of power calibration in WR62 waveguides (12.4 to 18 gc) to include determination of the calibration factors of bolometer units and bolometer-coupler units; measurement of the magnitude (range: 0.025 to 1.0) of the reflection coefficient of waveguide reflectors (mismatches) in WR62 waveguides; calibration of three-terminal capacitors at 110 kc and 1 mc; determination of frequency stability of signal sources in the range from 0 to 500 mc; and extension of field-strength calibration services for horizontally polarized dipole antennas from 300 to 1000 mc.

A facility was established for the calibration of germanium resistance thermometers over the range 2 to 5°K. This facility is useful in low-temperature studies of solid-state devices for space-borne computers and in the phenomenon of superconductivity. The range is expected to be extended from 2 to 20°K in 1965.

The NBS atomic scales were improved in 1964 by adding two additional clocks to the three-clock system previously used for interpolating on these scales between cali-

CALIBRATION SERVICES AVAILABLE AT NBS BOULDER IN THE LOW FREQUENCY REGION

ITEM	NOMINAL VALUES	ACCURACY RATING	CALIBRATION UNCERTAINTY	NOTES
Standard Resistors: (1) Thomas-type (2) Other precision types, including sealed wirewound resistors	1 ohm 0.0001 ohm to 10 ⁶ ohms	0.001% 0.01%	0.0001% 0.0003 to 0.002%	25.0°C 25.0°C 20°C to 35°C on request
Resistance Apparatus: Bridges, Wheatstone and Kelvin Potentiometers Resistance boxes Megohm resistors	0.01 ohm to 10 ⁷ ohms 10 ⁷ to 10 ¹² ohms	0.02% or better 0.02% or better 0.02% or better 0.5% or better	0.002 to 0.01% 0.0003 to 0.02% 0.002 to 0.01% 0.01 to 0.5%	
Standard resistors for current measurements (shunts)	0.00001 ohm to 20 ohms	0.04% or better	0.005 to 0.02%	0 to 1000 amperes 20% and 100% rated current
Voltage: Standard cells unsaturated	1.0183 to 1.0198 volts	0.01%	0.005%	Calibration discontinued See Federal Register 28, No. 145 (July 28, 1963) Calibration in thermally regulated air bath or thermally regulated oil bath dc
saturated	1.0178 v at 35°C 1.0182 v at 28°C		0.0001%	
Dc and ac high voltage voltmeters	1 to 50 kv	1% or better	0.5%	60 and 400 mc dc
High voltage resistive dividers	1 to 50 kv	0.5% or better	0.01 to 0.1%	
Ac-dc transfer standards	Up to 30 amperes and 750 volts	0.1% or better	0.01 to 0.05%	Ac-dc difference 20 cps to 50 kc
Fixed capacitance standards	100 pf or 1000 pf	0.005% or better	0.002%	Hermetically sealed (air dielectric) 1000 cps Air dielectric 1000 cps Mica dielectric 65, 100, 400, 1000, 10,000 cps 100,000 cps
	0.01 to 1000 pf	0.1% or better	0.01 to 0.06%	
	0.001 to 1 μf	0.05% or better	0.02 to 0.2%	
	0.001 to 0.01 μf	0.05% or better	0.04 to 0.2%	
Fixed inductance standards	50 μh to 10 h 50 μh to 100 mh	0.1% or better 0.1% or better	0.02 to 0.2% 0.05 to 0.2%	100, 400, 1000 cps 10,000 cps
Dc Ratio Direct reading ratio sets		0.0005% or better	0.00005 to 0.0002%	Low voltage
Resistive voltage dividers	10 ⁻⁶ to 1	Linearity 0.002% or better	0.0001 to 0.001% of input	Low voltage
Universal ratio sets Volt boxes	3 to 1500 volts input and 0.15 or 1.5 volts output	0.002% or better 0.04% or better	0.0001 to 0.0003% 0.005% for conventional type (0.001%) for master standard similar to design described in NBS (RP 1419)	Low voltage 20% and 100% rated voltage
Ac Ratio Current transformers	0.5 to 400/5 amperes	ASA 0.3 accuracy class	0.05% ratio, 2 min. phase angle at 60 cps	60 and 400 cps
Voltage transformers	Up to 13,200/115 volts	ASA 0.3 accuracy class	0.05% ratio, 5 min. phase angle at 400 cps	60 and 400 cps
Inductive voltage dividers	ratio 10 ⁻⁶ to 1	Linearity 0.0001%	0.2 × 10 ⁻⁶ of input	100 volts at 1000 or 400 cps. Calibration of three highest decades only.

brations with the U. S. Frequency Standard. Daily precision was improved from $\pm 1 \times 10^{-11}$ to $\pm 3 \times 10^{-12}$.

Standards Engineering

The NBS program in radio standards engineering includes basic research on physical principles and fundamental engineering techniques having applications in the field of precision electromagnetic measure-

ments. What are the calibration standards in the various areas?

Low-Frequency Calibration

A new voltage calibration method, which uses inductive voltage dividers to establish audio frequency voltage ratios, is now the basis for calibrations on inductive voltage dividers at 400 and 1000 cps. Multisection dividers are used, for which relative errors are calculated at each tap and

absolute measurements made at certain non-zero-error taps. This information is combined to obtain accurate values on in-phase voltage ratio and phase angle at all taps.

A service was begun at IBS in 1964 for the calibration of multi-megohm resistors to 10^{10} ohms with an uncertainty of $\pm 1\%$. The system depends upon a Wheatstone bridge using high-quality wire-bound resistors in wye-delta ratio circuit.

High-Frequency Standards

Recently completed is a prototype noise power comparator which compares power at 3 mc from noise generators having effective noise temperatures between 75 and 30,000°K with an uncertainty of less than 0.5%. This prototype will serve as the pattern for comparators for calibrating noise factor instruments over a wide range of frequencies.

Electromagnetic Measurements

A special bolometer and resistance element combination has been developed to eliminate dual bolometer error in radio frequency voltage measurement and has promise of yielding accuracies within 0.1% up to 500 mc.

Electric-field standards were developed for the frequency range of

300 to 1000 mc. NBS now has electric-field standards covering the range of 30 to 1000 mc with an uncertainty of about 0.8 db.

A thermal noise generator, cooled by liquid nitrogen, was constructed for use at 30 mc. Its electrical and thermal characteristics are being evaluated in preparation for its use as a working standard of noise power. Other noise generators for operation at various temperatures are being constructed with adjustable output impedances which essentially eliminate mismatch errors.

A special correlation detector was developed for use in 30 mc attenuation-measuring systems, permitting simultaneous phase and amplitude nulling in the measurement of complex insertion ratios. This precise detector achieves a sensitivity of 36 picovolts with a 30 sec integration time, only 17% greater than the theoretical limit.

A new calorimetric reference standard for R. F. power measurements in the frequency range 30 kc to 1000 mc has been put to use. The accuracy of the standard is within 0.25%, and the power range is 5 to 100 w. This equipment augments other reference standards, which extend downward in power to 10 mw.

International comparisons of R. F. power standards have been completed with Great Britain and Japan and are in process with Canadian transfer standards.

Two systems have been developed for the standardization and measurement of the peak voltage amplitude of short-duration, fast-rise, dc, or unidirectional pulses. The accuracies achieved are within 0.2% from 1 to 100 v peak. These systems are expected to form the basis of reference standards up to several thousand volts.

A dual twin-T bridge circuit was developed to make resistance measurements directly in terms of capacitance and frequency up to a few hundred megacycles. Operating at 1.5 mc, this bridge is useful not only in the determination of resistance and reflection coefficient standards, but also in determining the R. F.-dc difference of thermoelements used in standards and for precise measurements of Q and loss.

A high-frequency ratio transformer bridge is under development and has demonstrated capabilities of a few parts per million at 1 mc. It is for use with new high-frequency inductance standards and to increase the accuracy of high-frequency capacitance measurements by three-terminal techniques. An all-coaxial reflectometer was put into operation in the frequency range from 0.1 to 1 gc. Measurement uncertainty is reduced to 0.1%.

Well under way is the construction of an electrodynamic ammeter for measurement of current in terms of mechanical properties and time. Operating at frequencies from about 0.1 to 1 gc and to an estimated accuracy of 0.1%, this instrument will be used as an accurate absolute standard of R. F. current, and also as a basis for establishing R. F.-dc corrections for thermoelement standards used in determining other quan-

Relationships between the cesium beam frequency standard and the U. S. Working Frequency Standard at NBS Boulder, and the standard frequency and time broadcasts from WWVL, WWVB, WWVH and WWV.

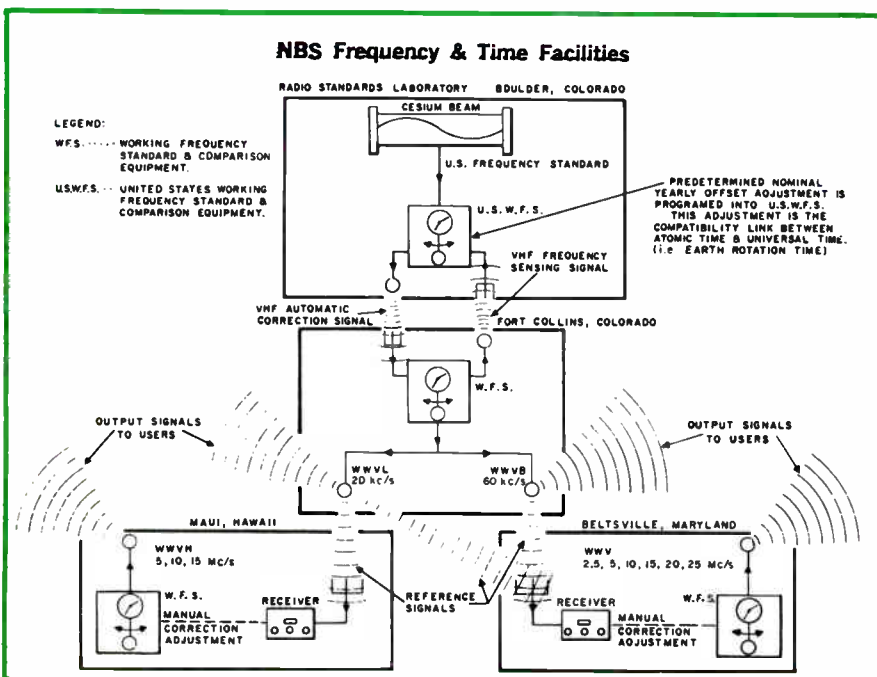

Radiometer used to compare two microwave noise sources. A working standard, consisting of a special gas-discharge tube housed in a waveguide, is compared with the NBS reference standard; or an interlaboratory standard is compared with a working standard. This comparison of noise sources is made on the comparison arm (foreground) with the calibrated attenuator measuring the difference between noise power levels. Signals from the sources being compared and from the level-set source (middle) are modulated by motor-driven rotary-vane attenuators. The resulting signal is beat against a local oscillator (upper left). A superheterodyne synchronous receiver gives a null reading on an oscilloscope and indicates a balance between the noise source (for comparison) and the level-set source. A recorder gives a continuous reading of this balance. Charles K. S. Miller of NBS is connecting a working standard to the comparison arm of the radiometer.

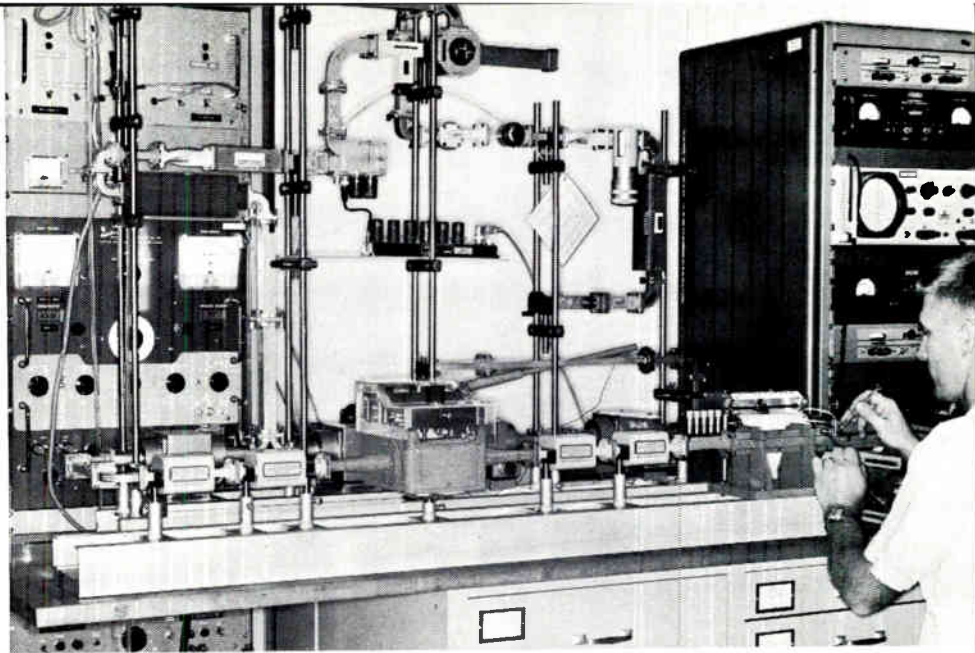

tities such as voltage, power, and field strength, supplementing the impedance correction system currently in use.

High-Frequency Calibration

NBS facilities now make possible field-strength calibration services for horizontally polarized dipole antennas up to 1000 mc. Dipole antennas can now be calibrated at any frequency from 30 to 1000 mc. The present calibration uncertainty for this service is approximately 12%.

Improved standards for the Calibration of Q-meters from 50 kc to 45 mc has been established by a statistical procedure for adjusting the values of the NBS standards.

A cw power calibration service is now offered at power levels from 1 mw to 100 w at 500 mc for coaxial R. F. calorimeters having Type N connectors. Calibration uncertainty is ± 1 to 2 percent depending upon the stability and standing-wave of the calorimeter being calibrated.

R. F. voltage measurements at 500 mc can be made to an accuracy of 5 percent over a range from 0.2 to 7 v.

The Lag In Standardization

NBS people found that in the Soviet Union, Russian metrologists take the position that the development of standards and measurement techniques must precede the development of technology in any particular field. Therefore, somewhat contrary to NBS experience, Russian pro-

grams on standards and measurement techniques are extensively financed. The Bureau feels, however, that measurement standards and techniques develop naturally along with other phases of science and technology. A slight lag is both necessary and desirable, but not too much of a lag as exists at present in the U. S.

According to H. W. Lance, Asst. Chief of the Radio Standards Laboratory, "a philosophy of allowing standards to develop completely naturally, with no emphasis on co-ordinated standards programs, would certainly bring grief in a large industrial economy like our own, in which similar types of measuring equipments are made by different manufacturers and subsystems for complex devices are manufactured in different locations. It is when one attempts to apply these various types of measurement equipment and to make these complicated systems work that he realizes most agonizingly the extent to which standards and measurement techniques do indeed lag behind the development of technology."

Some of the consequences of inadequate measurement ability are: 1. Excessive time to complete research and development programs with possible erroneous published information on research data; 2. inability to produce in practice what is possible in principle, thereby denying the nation equipment or systems

which would enhance its prestige and the national defense; 3. failure of production output to satisfy customers, with consequent rejection, rework, and slippage of program schedules (because, different standards and measurement techniques—possibly both erroneous—are used by producer and customer); 4. necessity for overdesign to assure acceptance; 5. necessity of repeated calibrations and tests to secure some semblance of agreement, resulting in duplication of effort; 6. acceptance of equipment outside the tolerance limits or rejection of equipment inside the tolerance limits; 7. inability to maintain equipment to required performance specifications; 8. operational failure of equipment, including extremely complex and expensive systems; and 9. unnecessary exposure of personnel to dangers and hazards.

Specific Problems and Needs

In discussing the problem of standards with NBS people, we came up with the following list of considerations of interest to readers:

Microwave Standards lag behind microwave technology to an extent such that only possibly 10 to 30 percent of the standards job that ought to be done has been done.

Future Measurement Needs, evaluated from many sources including industry, governmental agencies and scientific groups, are largely uncoordinated and are often difficult to evaluate as to relative urgency. Ef-

forts to date point to the microwave field as one where there is serious lag in development of standards and measurements techniques.

Noise measurement is a problem with the increasing use of long range detection and communications systems for satellites and space probes. No national standards exist on which to base uniform measurements of low noise temperatures.

Power is increasing for long range systems, both cw and pulser. Only a bare beginning has been made on suitable standards and measurement techniques.

Phase Shift measurement accuracy must be increased with the advent of phased array radar systems and other applications of critically phased circuits.

Millimeter Waves standards are becoming urgent with more and more work in this region of the spectrum.

Extension of Ranges of existing standards is necessary. In general, there are demands for the extension of frequency ranges, the extension of dynamic ranges, a general increase in accuracy, and the development of standards for other than coaxial line and rectangular waveguides.

Soviet Metrology

U. S. Metrology people have visited the Soviet Union to see what they are doing in the important area of precision measurements. It is reported that in many areas they are near or equal to our capability. If they continue their present relative emphasis on metrology, they could soon surpass the U. S. in some areas.

Nothing new or novel, representing any major measurement breakthrough, has been seen in the Soviet Union. However, the organization of Soviet metrology differs considerably from ours. Whereas NBS develops and maintains the national standards and carries on a broad program of research in measurement of physical quantities in the U. S., it has no regulatory functions. In

the Soviet, six Institutes operate under the State Committee on Standards, Measures and Measuring Instruments. These are major national measurement research and development facilities located in various centers. The main Institute is the Mendeleev Institute at Leningrad, which performs much of the basic research, maintains the fundamental standards, and provides a higher level of accuracy in many fields than the other five Institutes. Associated with each Institute is a Verification Laboratory, which provides calibration services for a number of State Control Calibration Laboratories which in turn are responsible for low echelon laboratories. In all, there are more than 150 calibration centers located throughout the country to provide rapid calibration services for laboratories and factories. The Mendeleev Institute is the principal authority in the measurement chain.

While the Soviets can meet their scientific manpower needs in the calibration field through a quota system, enough students are said to apply or specialize in precision measurement to assure an adequate staff to support a growth rate of 15 to 20 percent per year. This is in sharp contrast to this country, where the selection and training of measurement personnel is a serious problem.

Understanding the Measurement Problem

Most engineers, if they are honest with themselves, will have to admit to being laymen when it comes to being experts on making electronic measurements. Why is this so? Principally because the theory of measurement was not taught in college. What measurement knowledge was obtained was through use of specific test instruments in connection with laboratory experiments. This proved to be mostly knowledge of "knob twisting" rather than testing technique.

As a result of such poor training, measurements made on the job are

often poorly made, using the wrong equipment, with misinterpretation of results being obtained.

In spite of the availability of about 20 publications on instrumentation, reviewed elsewhere in this special section, there is a real need for good information on basic principles of measurement. One of our larger and better schools of electrical engineering is only now setting up a course in electronic measurements and has found it difficult to obtain a suitable text for student use.

The reader is referred to a two-part article on "Making Meaningful Measurements" which appeared in *ELECTRONIC INDUSTRIES* in February, 1965, p. 90, and March, 1965, p. 124. This article has some of the elements needed by engineers who must make measurements with meaningful results. More such material is needed.

Publications

The National Bureau of Standards publishes periodically its Technical Highlights of the National Bureau of Standards. The most recent of these, a 1964 edition, was announced early this year. It can be obtained for \$1.00 from the Superintendent of Documents, U. S. Government Printing Office, Washington, D. C. 20402. Ask for publication 264.

Another publication, announced in late 1964, is NBS Monograph 83, entitled: Project FIST (Fault Isolation by Semi-automatic Techniques). Described is a method of fault isolation for checking module performance for purposes of maintaining electronic equipment. The publication is especially useful to electronic engineers engaged in the design of industrial electronic equipment as well as those who are engaged in the development of electronic equipment for the military. A copy of this publication, co-authored by Messrs. Shapiro, Laug, Rogers and Fulcomer, Jr. of NBS, can be obtained from the Superintendent of Documents for 55 cents.

Improved Circuits For Testing SCR's

Direct meter indication of gate trigger voltage and holding current is obtained using a sinewave 60 cycle test voltage.

MEASUREMENT and TEST

FEATURE

THE SILICON CONTROLLED RECTIFIER, now used widely in power control, voltage conversion and switching applications, is a three-leaded device with characteristics similar to that of the gas-thyratron. A current between anode and cathode of this device can be controlled with the third electrode, the gate. The amount of current and voltage necessary between gate and cathode to trigger the SCR into conduction and the minimum anode current to hold it in conduction are very temperature sensitive and depend to a large extent on biasing conditions.

The accurate measurement of these parameters is therefore of importance not only to the manufacturer of these devices but also to the circuit designer. So far, manually adjustable dc voltages have been used to determine these parameters. This procedure is rather time consuming and inaccurate because noise and hum tend to make the readings lower than the true values.

In this article, simple circuits are described which use 60 cps ac voltage to measure these parameters. The positive slope of a half-sine wave is used to determine gate trigger current and trigger voltage and the negative slope to measure holding current. These parameters are indicated directly on a meter.

Basic Test Circuit

The basic circuit is shown in Fig. 1. An ac voltage is applied between anode and cathode of the SCR under test through a load resistor, R_L . A decade box is connected between anode and gate. As the ac voltage increases in the positive direction, the current flowing

By H. R. CAMENZIND

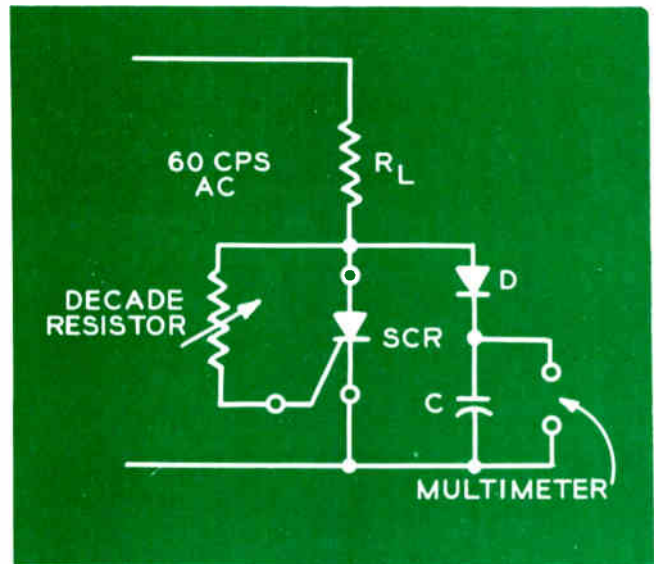

Fig. 1: Basic test circuit for Silicon Controlled Rectifiers.

into the gate increases. As soon as the trigger current is reached, the SCR turns on and the anode voltage drops. The voltage at the anode just prior to triggering is measured with a peak reading voltmeter consisting of diode^d, capacitor^c, and the multimeter. The gate current to trigger is the peak voltage divided by the resistance of the decade box. Because this resistance can be made very large, very small currents can be measured. An error is introduced by the forward voltage drop of the gate-to-cathode diode. It is partially compensated by the diode used in the peak reading voltmeter. Although the voltage drops of these two diodes are never precisely equal, the error this introduces is made small by choosing a large full-scale voltage for the peak reading voltmeter.

Although this circuit is capable of measuring gate current to trigger with an accuracy of better than $\pm 3\%$ without a regulated supply voltage, it has two drawbacks. In the first place, most SCR data-sheets specify a fixed, low anode voltage for the measurement of the gate trigger characteristics. In the second place, short

H. R. Camenzind is a graduate of the Institute of Technology in Zurich, Switzerland. He is a staff member at the P. R. Mallory Laboratory for Physical Science in Burlington, Mass., where he is engaged in circuit design for integrated circuits and semiconductors.



MEASUREMENT & TEST

Testing SCR's (Continued)

pulses to measure these parameters would be preferable, since large anode currents might heat up the device under test.

Practical Test Circuit

A circuit which takes care of these shortcomings is shown in Fig. 2. The waveform diagram, Fig. 3, will help explain the testing phenomenon. The positive half of a 60-cps voltage is applied to the gate of the SCR under test through a transistor, Q_1 , and one of the precision resistors, R_5 to R_{17} . The anode of the SCR is connected to 6v dc through resistor R_{18} and transistor Q_3 . When the anode current of the SCR reaches 1 a. (i.e., when the SCR has turned on) the voltage drop across R_{18} is sufficient to turn on Q_6 and SCR is connected to 6v dc through resistor R_{18} and the collector voltage of Q_4 drops to ground potential and the transistors Q_1 , Q_2 , Q_3 and Q_5 , which were all conducting, are now turned off. The peak voltage just prior to firing is measured by the peak reading voltmeter D_4 , C_1 , R_4 and M . For this instrument, a full scale voltage of 20 v was chosen. The full scale read-

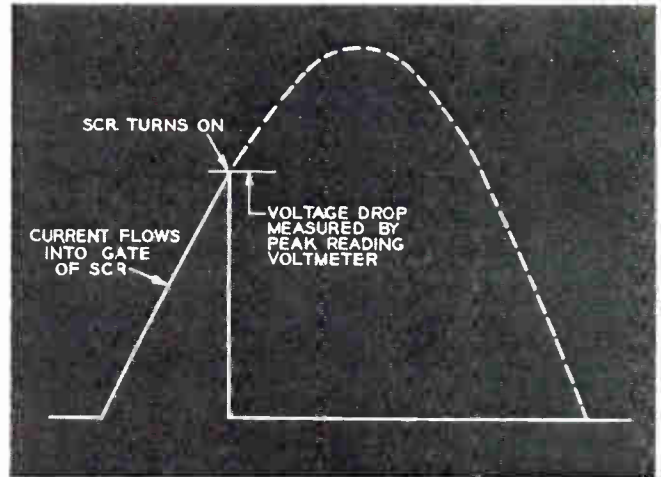

Fig. 3: As current flows into the gate of the SCR, the voltage drop is measured by the peak reading voltmeter, as shown.

ing is given by 20v divided by the connected resistor, R_5 through R_{17} .

To measure gate voltage to trigger, auto-transformer T_2 is connected into the circuit. This transformer divides the voltage down, so that the same peak reading voltmeter can be used. It must be capable of carrying 1 a. half wave.

For the 6v power supply, rechargeable batteries were chosen. These batteries are constantly charged with

Fig. 2: Recommended test circuit for Silicon Controlled Rectifiers.

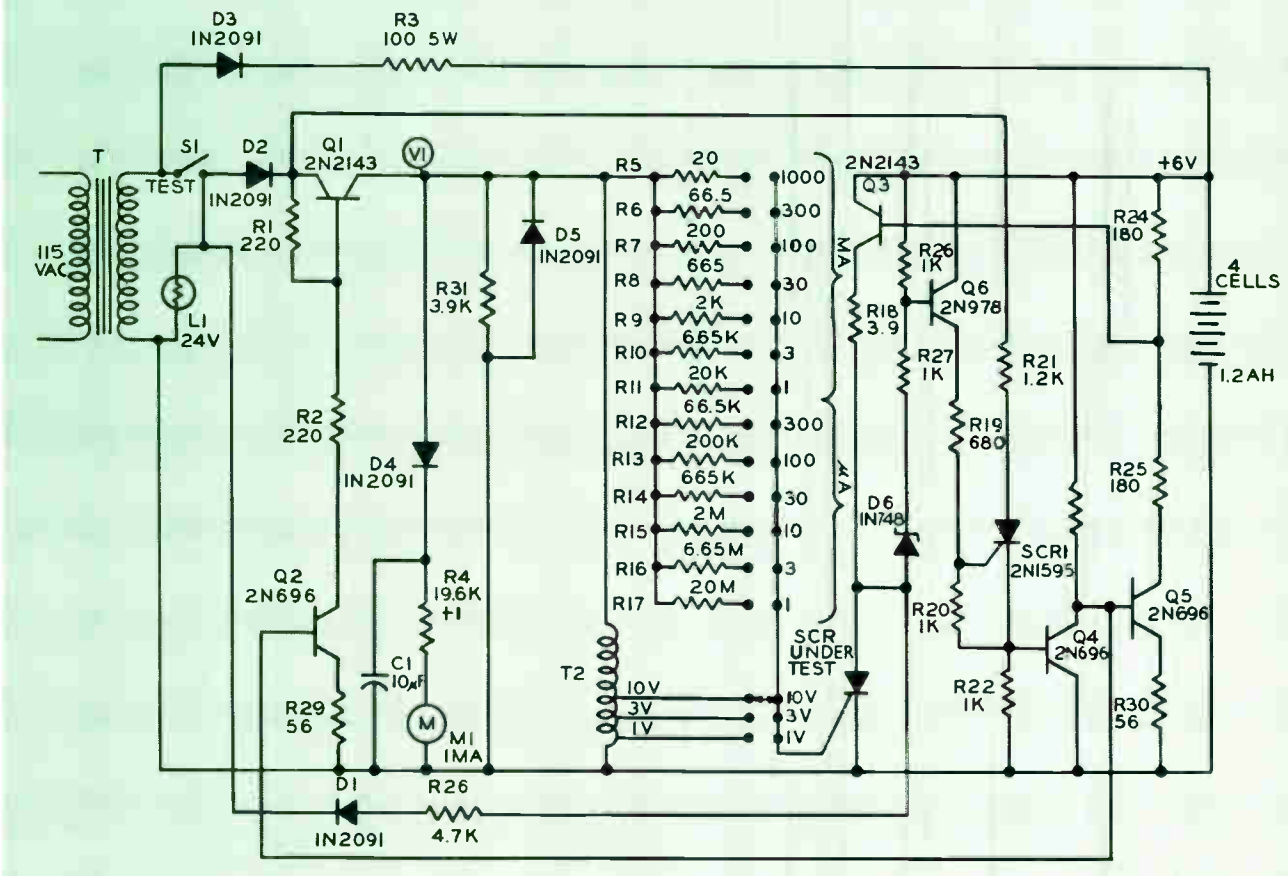

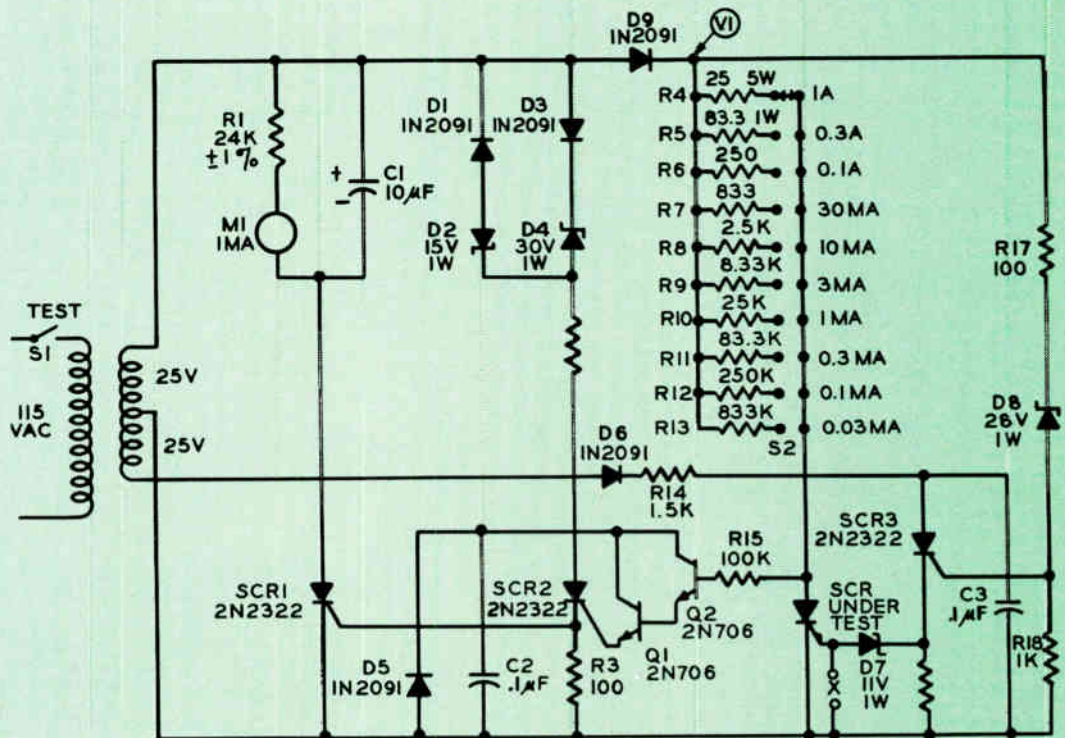

Fig. 4: Test circuit for measuring holding current of SCRs.

about 80 mA. Thus, large capacitors and rectifiers are eliminated.

This meter is being used to evaluate controlled rectifiers of all sizes. By using 1% resistors (R_4 through R_{17}), an overall accuracy of better than $\pm 3\%$ is achieved. The meter has a range from $1 \mu\text{a}$ to 1 a and 1 v to 10 v.

Measuring Holding Current

The same principle is used in a different meter circuit, Fig. 4, to measure holding current (See Fig. 5). In this circuit, the negative slope of a half wave ac voltage is used to decrease the "on" current of the SCR under test, and the current at which it switches off is measured.

Capacitor C_3 is first charged with a positive voltage. During the positive slope SCR_3 is turned on and delivers a pulse to the gate of the SCR under test. The anode current of the SCR under test is then flowing through one of the precision resistors, R_4 to R_{13} . When the holding current is reached, the anode voltage in-

creases rapidly. This voltage spike is used to trigger SCR_2 through a Darlington pair, Q_1 and Q_2 , to provide high impedance. SCR_2 in turn triggers SCR_1 , which acts as a gated diode for the peak reading voltmeter consisting of R_1 , C_1 and M .

Both meters allow the application of bias current or resistance between gate and cathode of the SCR under test to measure these parameters under actual circuit conditions.

Fig. 5: Conditions for operation of the holding current test circuit of Fig. 4.

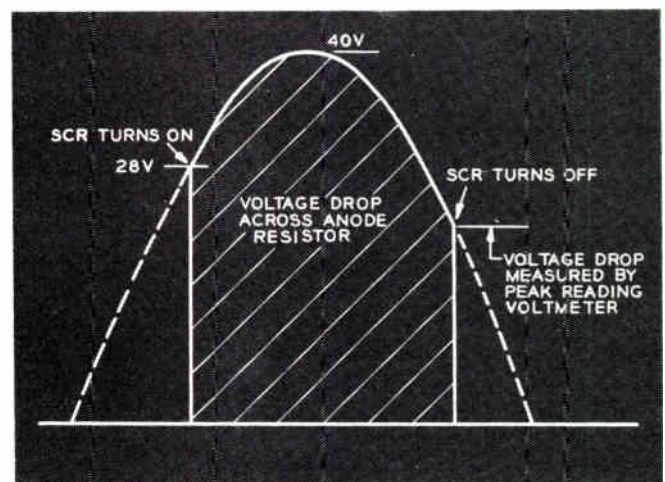

• A REPRINT of ANY ARTICLE in this issue is available from ELECTRONIC INDUSTRIES Reader Service Department.

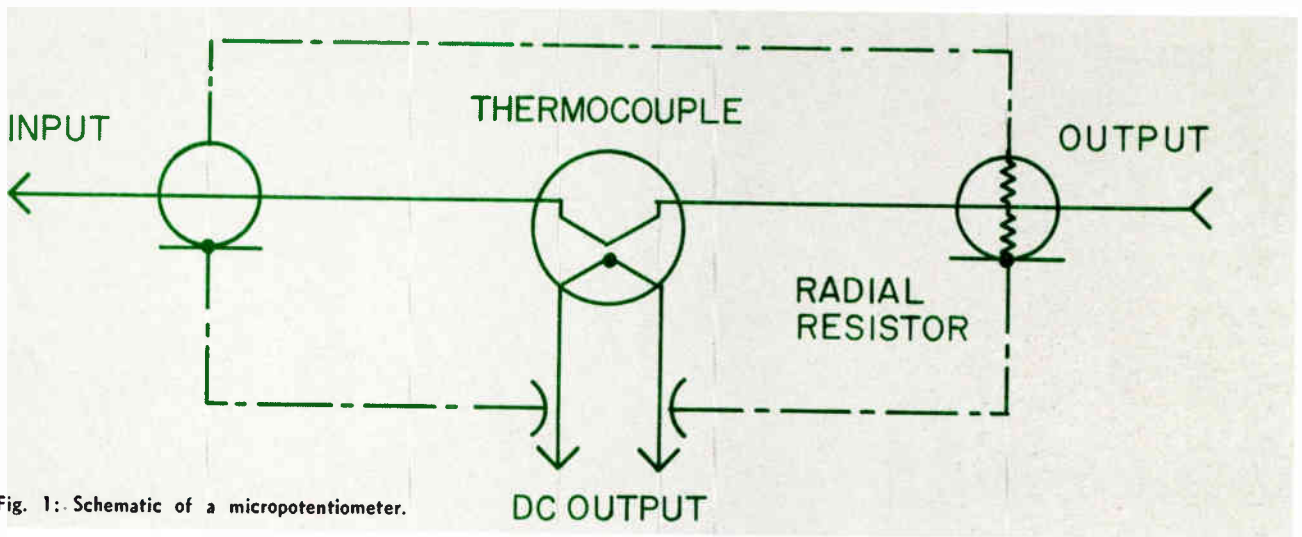

Fig. 1: Schematic of a micropotentiometer.

Low-Level High-Frequency R-F

MEASUREMENT and TEST

FEATURE

VOLTAGE MEASUREMENTS ABOVE 10 MC have been limited until recently to signals of approximately 1 v or higher. Lower voltages required ac amplification before rectification and, although sensitivities into the microvolt region were achieved, bandwidths beyond a few megacycles were rare. Now, improved components and design techniques allow flat and stable microvolt amplification—detection to the 30 to 50 mc region. Semiconductor diodes with sensitive dc amplifiers have further extended millivolt measurements to 1 gc and beyond.

With the availability of sensitive, high frequency voltmeters has come the twin problems of standardization and application. Because of the newness of the field new standards had to be designed. Sources and magnitudes of a number of measurement errors, peculiar to low level, high frequency applications had to be investigated.

The Micropotentiometer

In 1953 Mr. Myron Selby, of the NBS Boulder Laboratories, announced a new low-level voltage standard, the micropotentiometer. Designed to serve as a known voltage source for the standardization of signal generators and sensitive voltmeters, it consisted of only two essential components—a vacuum thermocouple and a specially constructed radial resistor. Fig. 1 shows the configuration of a micropotentiometer. In application, Fig. 2, a convenient dc or low-frequency ac source is connected to the input of the micropotentiometer, as shown in Fig. 3a.

In application, the level of the source is adjusted until the product of the resulting current and the resistance of the radial resistor produce the desired volt-

age drop. This voltage can be measured with a suitable potentiometer or voltmeter. The dc output from the thermocouple, which is proportional to the rms value of the current, is also accurately measured.

Now, an R.F. generator, covering the desired frequency range, is connected to the input of the micropotentiometer as shown in Fig. 3b. Its amplitude is adjusted until the dc output from the thermocouple is the same as it was previously. This means that the same current is flowing in the circuit as previously. If the effective impedance of the radial resistor is unchanged from dc or low-frequency ac conditions, the resulting R.F. voltage drop is identical to the previously measured value. The voltage drop across the radial resistor is now known at any frequency and can be used as a calibrating voltage source or standard.

The range of output voltages available from a given micropotentiometer is limited by the allowable current range of the thermocouple. This is usually from one-third rated heater current to one and one-third, producing an output voltage range of four to one. This range can be extended by changing the value of the radial resistor, the current rating of the thermocouple, or both.

Micropotentiometers are available from several manufacturers. A typical package is shown in Fig. 4. Output voltages from 1 μ v to several tenths of a volt can be produced with thermocouples of 5, 10 or 15 ma ratings. These micropotentiometers can be calibrated by the manufacturer or directly by NBS. Typical units will show no frequency response errors from dc to at least 100 mc. That is, by maintaining a constant dc thermocouple output, a constant output voltage can be achieved over this frequency range. At higher frequencies, the micropotentiometer response tends to rise to a usual calibration at 900 mc of 10 to 15%. Although usable



By WALLACE F. WHITE

The application of micropotentiometers in the calibration of high frequency voltmeters. Sources of possible error and what can be done about them.

Voltage Standards

above this frequency limit, calibration facilities are not presently available.

Calibration of a Voltmeter

The test setup required to calibrate a high frequency voltmeter using a micropotentiometer as a standard is extremely simple. A suitable generator, the micropotentiometer, and a stable dc thermocouple monitor voltmeter are all that are required. Fig. 2 shows a typical arrangement. The simplicity of the equipment required, however, is in contrast to the number of error sources that can spoil a low level, high frequency voltage calibration. What are some of these error sources? (Although this discussion applies to the application of micropotentiometers in the calibration of high frequency voltmeters, we should also realize that most of the topics considered apply as well when the voltmeter is later used in an actual voltage measurement. In this case, the role of the micropotentiometer is taken by the voltage being measured, but all other conditions remain unchanged.)

Error Sources

Basically, the error sources can be divided into three groups—those that alter the output of the micropotentiometer (or voltage being measured) from its expected value, those that modify the micropotentiometer output before it arrives at the voltmeter terminals, and those that affect the response of the voltmeter itself. Fig. 5 will be used to illustrate these effects.

Micropotentiometer Errors

Considering the first error source—micropotentiometer errors. One effect has already been discussed. This is the rise in micropotentiometer output at high



Fig. 2: Test setup for calibrating a high-frequency voltmeter.

frequencies. This rise is due primarily to the fact that the radial resistor does not act as a pure resistance at high frequencies. Some residual reactance exists that alters the total impedance, and therefore the output voltage rises at high frequencies. This error can be compensated for by calibrating the micropotentiometer against known standards and applying the resulting correction to the micropotentiometer output.

An additional micropotentiometer error that is more difficult to control is the loading effect of the external circuitry on the impedance of the radial resistor. This can be resistive loading, capacitive loading, or a combination of both. Resistive loading at low frequencies is simply handled by Ohm's law. At higher frequencies, the difficulty is usually in knowing what the resistive or capacitive loading is. This is because the source of the loading—the voltmeter under calibration—often has an unknown input impedance at high frequencies which must be measured. And the magnitude of this impedance is transferred by the transmission system that connects the voltmeter to the micropotentiometer output. The actual loading effect must be calculated by transmission line equations or graphically determined by means of a Smith chart.

Transmission Errors

The second general source of calibration errors—those that alter the micropotentiometer output that arrives at the voltmeter terminals—can be classified as transmission errors. Transmission errors include voltage drops in connecting leads and transmission effects caused by an unmatched transmission system. Normally, voltage drops in connecting leads can be disregarded when working with high impedance voltmeters. However, as the calibration frequency is raised, the effect from this

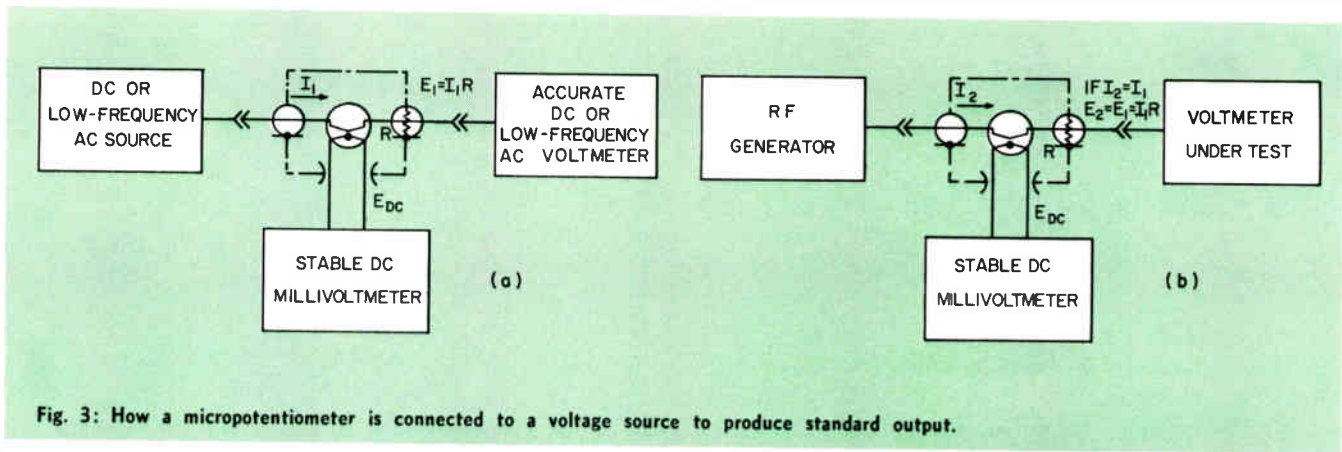

Fig. 3: How a micropotentiometer is connected to a voltage source to produce standard output.

VOLTAGE STANDARDS (Continued)

source can become important. Particularly to be considered is the inductance associated with the usual ground lead of ac voltage probes. Such ground leads are essentially useless above 100 mc. In their place, short coaxial connectors must be substituted.

Even the use of coaxial connectors, however, is not enough to eliminate transmission errors. Any transmission system used to connect the micropotentiometer to the voltmeter being calibrated, however short, will at high frequencies have an appreciable electrical length. If the system is not perfectly terminated in its characteristic impedance, there will be standing waves. The magnitude of the voltage impressed on the voltmeter terminals will therefore not only be a function of the micropotentiometer output but also the parameters of the transmission system (its characteristic impedance and electrical length), the input impedance of the voltmeter which initiates the mismatched condition, and the output impedance of the micropotentiometer which causes multiple reflections on the system. Corrections for these errors can be computed, using standard transmission line formulas, provided that the electrical parameters are known or can be measured.

Referring to Fig. 5, and recalling the equations that describe voltages and currents on a lossless transmission line as:

$$E_o = E_T \cos l^\circ + j I_T Z_o \sin l^\circ \quad (1)$$

$$I_o = I_T \cos l^\circ + j \frac{E_T}{Z_o} \sin l^\circ \quad (2)$$

where the electrical length, l° , is related to the actual length, l , in centimeters, and frequency, f , in cycles by

$$l^\circ = 1.2 \times 10^{-8} f l \quad (3)$$

The output voltage, E_T , can be solved in terms of the input voltage, E_o , as follows:

Substitute for I_T in equation (1) the relationship

$$I_T = \frac{E_T}{Z_T} \text{ and rearrange terms.}$$

$$E_o = E_T \left(\cos l^\circ + j \frac{Z_o}{Z_T} \sin l^\circ \right).$$

$$\text{Then, } \frac{E_T}{E_o} = \frac{1}{\cos l^\circ + j \frac{Z_o}{Z_T} \sin l^\circ} \quad (4)$$

Eq. (4) is a general expression that describes the effect of a mismatched transmission line on the voltage output from that line. For most voltmeter applications at high frequencies, the terminating impedance, Z_T , is capacitive. If one makes this assumption and introduces the term:

$$\alpha = \omega C Z_o, \quad (5)$$

eq. (4) simplifies to

$$\frac{E_T}{E_o} = \frac{1}{\cos l^\circ - \alpha \sin l^\circ} \quad (6)$$

Eq. (6) now is a general expression for the transmission line effect on a capacitively terminated line.

Loading Errors

Loading errors can be introduced by considering the effect on micropotentiometer output of the input impedance, Z_s , of the transmission line.

$$Z_s = \frac{E_o}{I_o} = \frac{E_T \cos l^\circ + j I_T Z_o \sin l^\circ}{I_T \cos l^\circ + j \frac{E_T}{Z_o} \sin l^\circ}$$

Multiplying numerator and denominator by $\frac{Z_o}{I_T \cos l^\circ}$ and simplifying, gives

$$Z_s = Z_o \frac{Z_T + j Z_o \tan l^\circ}{Z_o + j Z_T \tan l^\circ}; \quad (7)$$

and, if one again considers a capacitive termination, then

$$Z_s = -j Z_o \frac{1 - \alpha \tan l^\circ}{\alpha + \tan l^\circ} \quad (8)$$

The unloaded micropotentiometer output is given by the product IR . But when the transmission line is connected, the micropotentiometer output will be determined by the product of I and the parallel combination of R and Z_s , as follows.

$$E_o = I \frac{R Z_s}{R + Z_s} \quad (9)$$

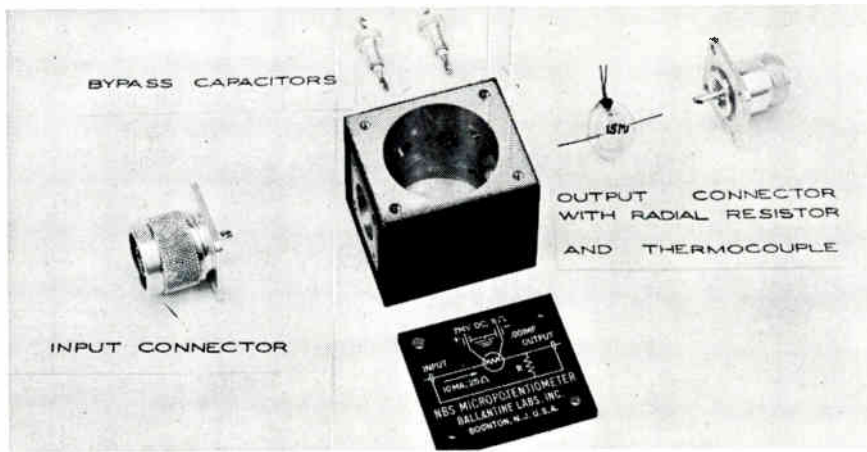

Fig. 4: Typical micropotentiometer unit.

One can now rewrite eq. (6) as:

$$\frac{E_T}{E_o} = \frac{E_T}{I \frac{RZ_o}{R + Z_o}} = \frac{1}{\cos l^\circ - \alpha \sin l^\circ}$$

$$\text{or} \quad \frac{E_T}{IR} = \frac{\frac{Z_o}{R + Z_o}}{\cos l^\circ - \alpha \sin l^\circ} \quad (10)$$

Substituting for Z_o , eq. (8) and simplifying, the final result is:

$$\frac{E_T}{IR} = \frac{1}{1 + j \frac{R}{Z_o} \left(\frac{\alpha + \tan l^\circ}{1 - \alpha \tan l^\circ} \right)} \times \frac{1}{\cos l^\circ - \alpha \sin l^\circ}$$

$$= (\text{loading effect}) \times (\text{transmission effect}) \quad (11)$$

Eq. (11) now completely describes the voltage, E_T , actually applied to the input of a voltmeter as compared to the unloaded calibration voltage, IR , when the voltmeter is connected to the source by a length of capacitively terminated transmission line.

Notice that the loading effect disappears, as would be expected if $R=0$. And, if the electrical length of the transmission line is negligible, the loading term degenerates to the familiar $\frac{1}{1 + j \omega RC}$. The transmission term disappears for zero electrical length and increases as the length, frequency, capacitance, or characteristic impedance are increased.

Example:

A numerical example will be helpful in demonstrating the magnitudes possible from these effects. Assume calibration of a voltmeter having an input capacitance of 5 pf, with a micropotentiometer consisting of a thermocouple and a 3.2 ohm radial resistor operated at 700 mc. Further assume that the voltmeter is connected to the micropotentiometer by a 50 ohm connector whose length is 1 in. It is found that by applying eq. (11) that:

$$\frac{E_T}{IR} = \frac{1}{1 + j \frac{R}{Z_o} \left(\frac{\alpha + \tan l^\circ}{1 - \alpha \tan l^\circ} \right)} \times \frac{1}{\cos l^\circ - \alpha \sin l^\circ}$$

$$= 0.987 \times 1.88 = 1.85.$$

That is, for a total transmission length of 1 in., the voltage delivered to the voltmeter will be 85% greater than the unloaded calibration source. If the length is increased to 1½ in., the results are:

$$\frac{E_T}{IR} = 0.943 \times 3.77 = 3.56.$$

For the same conditions except for changing the radial resistor, R , to 22 ohms:

$$\frac{E_T}{IR} = 0.658 \times 1.88 = 1.24 \text{ for } l = 1 \text{ in.}$$

$$= 0.380 \times 3.77 = 1.43 \text{ for } l = 1\frac{1}{2} \text{ in.}$$

In this case, the loading effect is helping to compensate for the transmission effect.

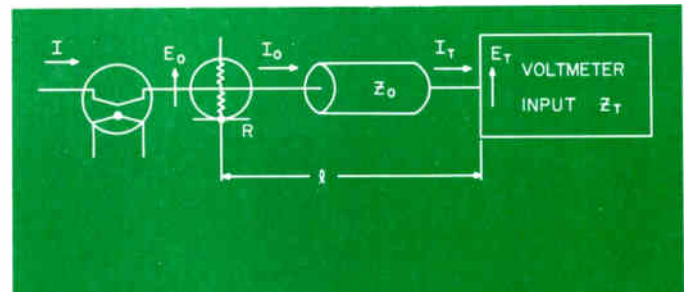

Fig. 5: Diagram to illustrate the error sources and their effects.

Error Compensation

This example should serve to indicate the large errors that can be caused at high frequencies when operating with an unmatched transmission system. These errors can be materially reduced, however, even for unmatched loads, if we connect the voltmeter to the micropotentiometer over a lossless transmission line set to an integral number of half-wavelengths in electrical length. This effectively puts the voltmeter input exactly at the micropotentiometer output and makes l° in the above equations equal to zero. With this technique, it is necessary to change the length of the line as the frequency is changed.

Most high-frequency voltmeters have as an accessory a T-adaptor designed to match the voltmeter probe to

(Continued on Page 107)

Circuit described employs digital techniques to compare the frequency of an unknown signal to a standard reference. Output is in multiples of one count of error. Sophisticated counting devices are unnecessary.

Measuring Frequency Deviation

By R. H. ZIMMERMAN

**MEASUREMENT
and TEST
FEATURE**

ENGINEERS FREQUENTLY ENCOUNTER devices whose outputs are scaled to provide precise frequencies, repetition rates, or events per unit of time. The groupings of such devices range from power inverters and oscillators to rotational servo components and often calls for specialized testing, adjusting or qualifying procedures. The generally accepted method for checking precision frequencies is either to count events for an accurate predetermined length of time or to measure the length of time (period) between an integral number of events and average the result.

Fig. 1: Block Diagram Basic Frequency Deviation Circuit.

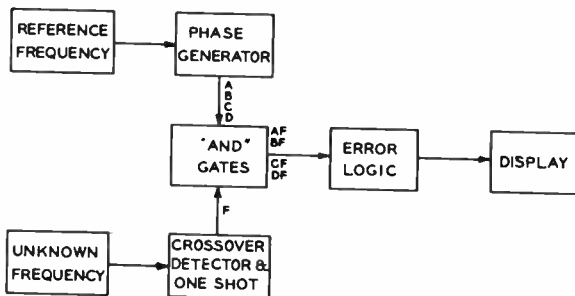
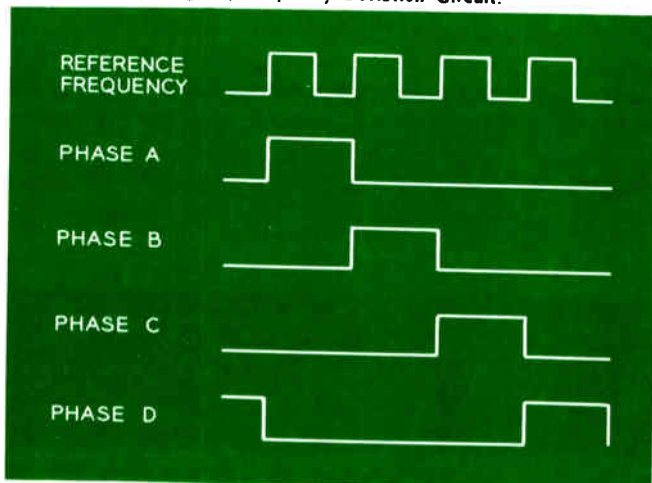

Fig. 2: Timing Diagram, Frequency Deviation Circuit.



A careful analysis of the parameters to be tested, before a unit is deemed acceptable, will often show that test devices employing the above-mentioned techniques are far from satisfactory. Such devices may not be capable of easily determining both the long-term and short-term stabilities, separating out errors caused by occasional missing counts or events, or excluding errors introduced by test leads or surrounding equipment in the form of noise modulation, transients or jitter.

While an engineer, performing a laboratory evaluation of some precision device, may sometimes be able to avoid the above problems, the methods used might not be readily adaptable for rapid repetitive measurements or production testing. For such applications, a circuit which could perform the required tests while retaining characteristics of speed and simplicity of operation would be desirable. Described here is such a circuit.

Method Advantages

The approach outlined has the following advantages: (1) accurate comparison of an unknown frequency to a standard; (2) display of results directly in terms of error; (3) savings in cost, package size, and testing time as compared to commercial counters; (4) easily modified for unique testing requirements; and (5) a minimum of operator skills required.

Test Principles

If two frequencies are superimposed on an oscilloscope screen, the relation between them can be determined by counting the number of times they move in and out of synchronism. This procedure is tantamount to determining a beat frequency, which in this case represents the deviation of one from the second, if the latter is a precision reference. An attempt to realize such a beat using analog techniques would be quite cumbersome, particularly at lower frequencies and small errors. For example, an error of 0.01% at 400 cps would produce a beat of one twenty-fifth of a cycle per second. Errors of this order of repetition become simple to handle with digital circuitry as here described.

Circuit Description

A block diagram for the frequency deviation circuit is shown in Fig. 1. The precision reference frequency

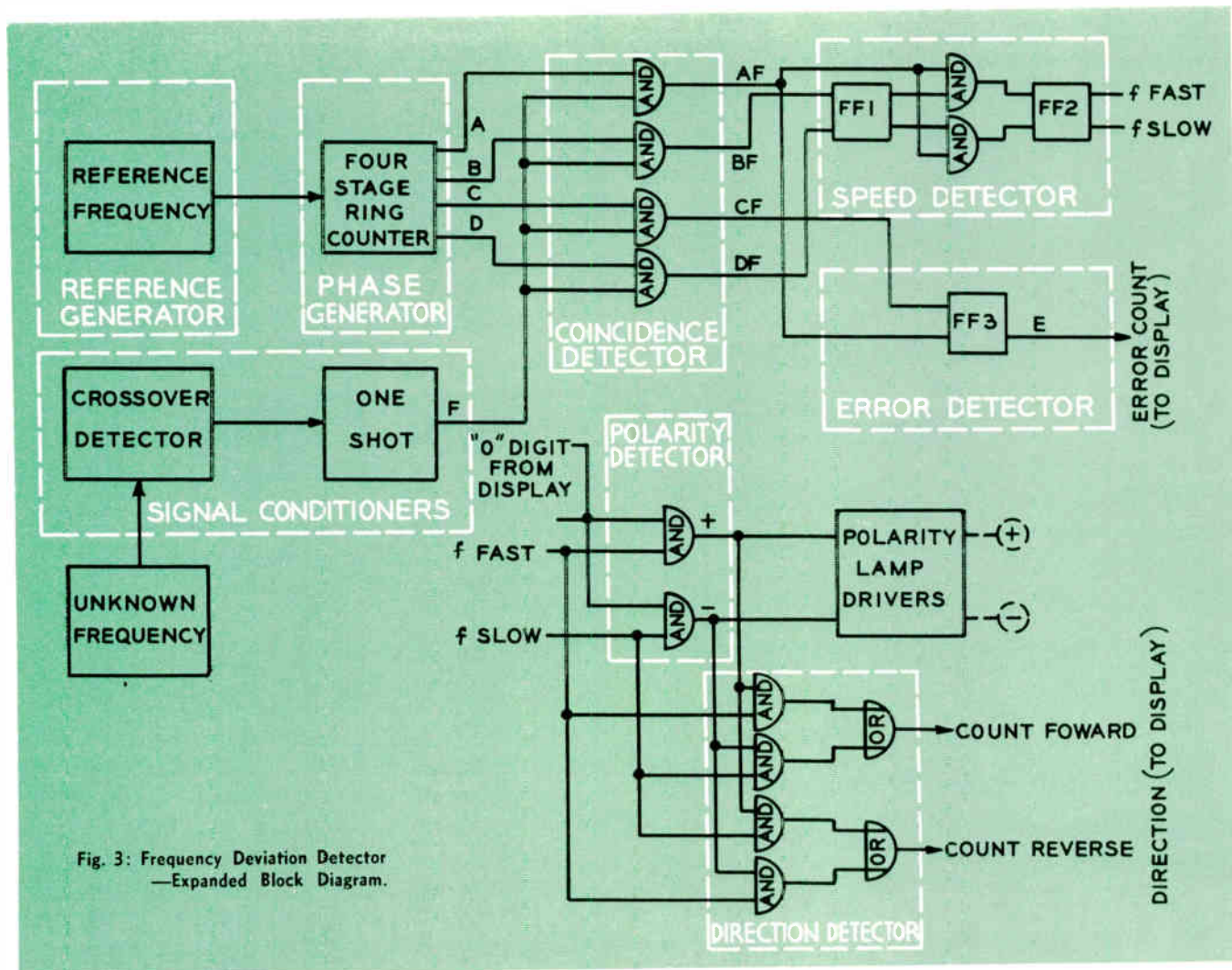

Fig. 3: Frequency Deviation Detector
—Expanded Block Diagram.

is fed to a phase generator to provide identifiable intervals as shown in Fig. 2. Four such segments (A through D) are provided to allow for the determination of the polarity of the errors counted. A cross-over detector and one-shot are used to generate a pulse in synchronization with the unknown frequency. This pulse (F) is ANDed separately with each phase of the reference in the AND gates of the coincidence detector, and the outputs (AF, BF, CF, and DF) are developed to provide the basis for remaining logic. The error count generator is an R-S flip-flop which produces a "1" output whenever the unknown has cycled from coincidence with reference phase C to phase A. The recording of a count of an error is made only when the output changes from "0" to the "1" state, and repeated pulses on the set input will produce no further counts of error.

Practical System

A more complete system is illustrated in the block diagram of Fig. 3. The logic developed is intended for a bidirectional counter such as an EECO type N-904, but may be altered for desired display devices.

The speed detector consists of two R-S flip-flops and two dual input AND gates. The outputs are dependent on whether the unknown pulse occurred dur-

ing B or D phase prior to coincidence with A phase.

The polarity detector employs two dual input AND gates and an R-S flip-flop to establish the polarity of the error while the counter is initially in the zero state or passes through the zero state while a test is run.

The direction detector senses whether the counter should display increasing or decreasing digits of error. Four dual input AND gates and two dual input OR gates are sufficient to perform the function.

Operation

In typical operation, the operator would push the reset button, clearing the counter and resetting the error flip-flop. He would then observe the counter to determine the counts of error representative of the extent the unknown frequency deviates from the standard. He may also note whether the count jumps back
(Continued on Page 107)

Mr. Zimmerman is Senior Engineer in the Litton Data Systems Division of Litton Systems, Inc., Van Nuys, Calif. A graduate of U.C.L.A. in 1962, Mr. Zimmerman was group engineer for two years in Module Test Equipment Design at Lockheed Missiles and Space Co. before joining Litton.

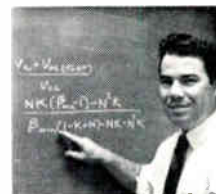

By R. F. ESTOPPEY

Selecting The Right Meter

Tutorial information on the characteristics of basic meter mechanisms of all types—for both dc and ac applications.

MEASUREMENT and TEST

FEATURE

ELECTRICAL MEASUREMENT of voltage or current involves a great deal more than just connecting instruments into the circuit. There are a great many instruments to choose from. Before selecting a meter, one

must first determine what is to be measured, whether a voltage or current, whether dc, or average or effective ac, etc. It is helpful to know the mechanism of the various meters available in order to understand their capabilities and their limitations.

Direct Current Mechanisms

The measurement of direct current presents no problem, since the average and effective values are equal. The most common instrument to use for measuring direct current is the permanent-magnet moving-coil mechanism type of instrument. This measures the average value of current.

External-Magnet Type

One type of dc mechanism is shown in Fig. 1. It is called the "external-magnet moving-coil" mechanism. The magnet material is usually Alnico V and is in the form of a U. Across the open portion of the U are soft iron pole pieces with a large circular air gap into which is placed the circular core. The core is also made of soft iron, and a uniform flux is present in the air gap between the core and the pole piece. In the air gap is a movable coil which is suspended by pivots, top and bottom, which are constrained by two sapphire jewels mounted in top and bottom bridges. Pivots and jewels are constructed to provide very little friction to the movement of the movable coil. Pancake type of spiral springs are attached to the moving coil and to

each bridge to serve as restoring torque and also to conduct current to the many turns of fine wire which makes up the moving coil. This wire is usually wound on aluminum frames, although in some cases no frame is used. One end of a pointer is mounted to the moving coil and the other end moves over a graduated scale which is calibrated in terms of the quantity to be measured.

Core Magnet Type

In Fig. 2 is shown the core magnet moving coil dc mechanism which is also in common use today. In this type of mechanism the core is an Alnico V magnet surrounded by a soft iron yoke. The remainder of the construction is similar to the external magnet type of mechanism.

The advantage of this type is that it is shielded from the effects of external magnetic fields, since the solid soft iron yoke prevents the external field from entering the air gap where it would increase or decrease the air gap flux and produce an incorrect indication. Due to the fact that the amount of magnetic material mounted inside the core is limited in the area, the core magnet mechanism cannot have as much magnetic material for a given moving coil as the external magnet type mechanism. Because of this, the external magnet mechanism can produce a larger flux across

Roy F. Estoppey is Director of Engineering at Weston-Newark Div. of Weston Instruments, Inc., Newark, N. J. Mr. Estoppey received his B. S. degree in electrical engineering from Rutgers University, joining Weston in 1936. He is a member of IEEE, ISA, ASA and Tau Beta Pi. He is chairman of the subcommittee of ASA on ac ratio devices for the sectional committee on electrical reference instruments and devices.



the air gap. This means the external magnetic mechanism can be made more sensitive and require less current to produce full scale deflection. Thus, the external magnet mechanism is used where the greatest sensitivity is required; and the core magnet mechanism is used where shielding is important and sensitivity is of secondary importance.

As current is applied to the moving coil, the moving element rotates and assumes a position where the electrical torque produced is exactly equal to the mechanical torque produced by the spiral spring. The torque is proportional to the first power of the current in the moving coil, and thus the mechanism measures the average value of the current. Spring torque and moving coil turns are chosen to provide the range desired, consistent with good ballistic characteristics and sufficient torque to prevent friction between pivots and jewels from causing a readable error.

Taut Band Mechanism

Some permanent magnet moving coil type dc instruments are presently using a taut band in place of pivots and jewels. This type of mechanism is shown in Fig. 3. This suspension consists of two rectangular ribbons of special alloy fastened to the top and bottom of the moving coil. They are held taut by top and bottom springs so that the moving coil will not sag and strike the core or pole pieces when the instrument is used in different positions. The taut band serves three purposes: 1. To provide a frictionless suspension for the moving coil; 2. To carry current to the moving coil; 3. To provide the mechanical restoring torque supplied by spiral springs in pivot and jewel type construction. Due to the lack of friction, it is possible to use less torque in instruments with taut band suspension, and they do not require as much power in the moving coil as mechanisms supplied with pivots and jewels. This means greater sensitivity can be supplied, and the resistance of the moving coil will be less than that of the pivot and jewel construction. This advantage is greater resistance in voltmeters and less resistance in milliammeters and microammeters, thus reducing the effect the instrument will have upon the circuit when measurements are being made.

The actual power taken by the permanent magnet moving coil type instrument can vary from approximately $0.1 \mu w$ to approximately $400 \mu w$ in the moving coil. This depends upon the model and type of instrument as well as the range. In instruments where the coil is brought directly out to the binding posts, they can be used as single range microammeters and low range milliammeters. Multirange instruments as well as high range milliammeters and ammeters are provided with shunts across the moving coil. This increases the power taken by the instrument due to the added power lost in the shunt. Practical ranges vary from $5 \mu a$ to 50 a. self-contained. Higher ranges to thousands of amperes can be provided by means of the simple expedient of external shunts.

Voltmeters are obtained by adding resistance in series with the moving coils. The lower range instruments will require several times the power taken by the moving coil due to the additional power taken in the series resistance. Higher-range instruments will require still greater power than the moving coil, and this factor may have to be considered when making measurements. Practical ranges vary from 1 mv to 750 v self-contained. Ranges to several thousand volts can be supplied by means of external resistance.

Alternating Current Mechanisms

A number of instruments measure the effective value of the ac current or voltage, which is the usual requirement.

Moving Iron Type

The most common type contains the moving iron mechanism shown in Fig. 4. It consists of two thin rectangular strips of high grade magnetic iron surrounded by a coil known as the field coil. One strip

Fig. 1: External magnet moving coil meter mechanism for measuring direct current.

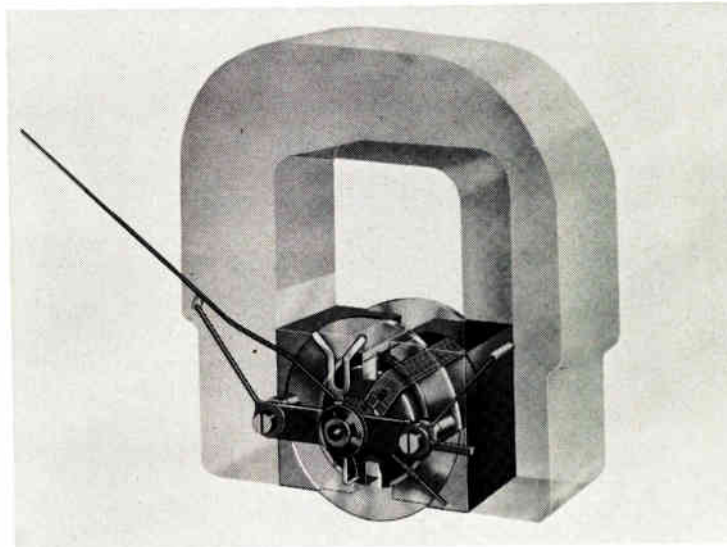

of iron or vane as it is known, is fixed in location and the other vane is attached to a staff which is mounted in pivots and jewels and is free to rotate. To the staff is also fastened a pointer and a restoring torque spring. Current is passed through the field coil, and it produces a flux which magnetizes the two vanes. There will be a repelling force between the two vanes since the ends are magnetized with the same polarity. The torque produced by the vanes is opposed by the mechanical torque of the spring, and the moving element will come to a position of rest depending upon the current in the field coil. The pointer rides over a scale which can then be calibrated in terms of field coil current. The torque produced is dependent upon the magnetic energy in the field coil which is proportional

to the current squared. Thus the indication is a function of the square of the current, and the instrument indicates rms or effective value of the current.

Damping means must be provided in this instrument, and both air damping and magnetic damping are in common use today. Air damping is provided for the mechanism shown in Fig. 4 by means of a damping vane mounted to the staff. This vane is mounted in a closed chamber called the Damping Chamber. A minimum of clearance is provided between the air damping vane and the damping chamber, thus restricting the movement of the vane by the air in the chamber. This makes it possible to bring the pointer to a stop in a short period of time; however, the damping is usually not as effective as that of the permanent magnet moving coil type of instrument. Greater moving element weight and inertia are also contributing factors to a poorer damping found in iron vane mechanisms.

As a Current Meter—

This mechanism is basically a current measuring instrument, and various ranges are provided by changing the turns on the field coil to suit the range required. Low-range milliammeters have a great number of turns and high resistance, while high-range ammeters have only a few turns and low resistance. Shunts are not practical for this instrument, and multiranges are sometimes provided by using more than one field coil winding or by the use of internal or external current transformers. The power taken by the field coil may vary from approximately 0.25 w up to 3 w. It should be noted that this power is much higher than that required by the moving coil in the permanent magnet moving coil instrument. This is one of the reasons why these instruments are usually not designed for use in direct current circuits.

Fig. 2: Core magnet moving coil dc mechanism.

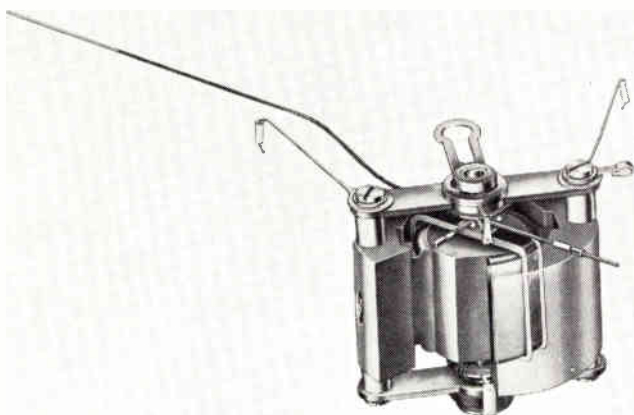

As a Voltmeter—

The instrument becomes a voltmeter by adding resistance in series with the field coil. In this case, the field coil has a large number of turns for high-range voltmeters and a low number of turns for low-range voltmeters. This is necessary to provide sufficient resistance in series with the field coil to overcome the effects of the field coil resistance which is all copper. Since the deflection responds to the current through the field coil, the resistance of the instrument must remain constant for a given voltage range. The resistance of the field coil changes approximately 0.40% per degree centigrade with temperature and will thus have a high temperature error due to its own internal heating as well as changes in ambient temperature. It is, therefore, necessary to make the series resistance many times the copper resistance and of a material which does not change with temperature.

The inductance of the field coil is also an important consideration since the impedance of the voltmeter circuit will increase as the frequency increases. This will cause the current in the field coil to decrease and cause a lower reading at a higher frequency. There are means of compensating for this inductance to some degree by connecting a capacitor across the series resistance. This increases the frequency range of an instrument; however, it is still necessary to keep the inductance-to-resistance ratio low in order to keep frequency error to a practical value.

The lowest practical range is approximately 10 ma, and the highest self-contained range is usually 50 a. Voltmeter ranges run from approximately 1 v to 750 v self-contained. High ranges can use the 10 or 15 ma coil of the milliammeters; however, low ranges such as 1 v full scale may require a field coil current of 0.5 a. Also, the low ranges have the poorest temperature and

Fig. 3: The taut band mechanism.

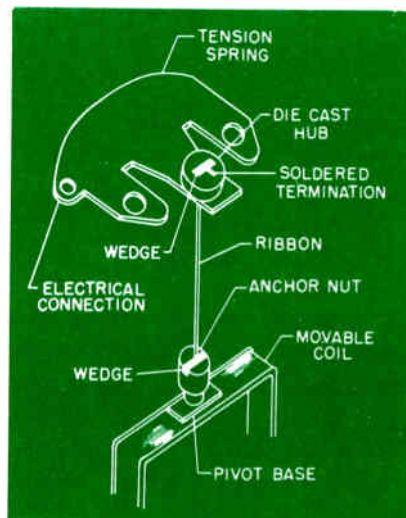

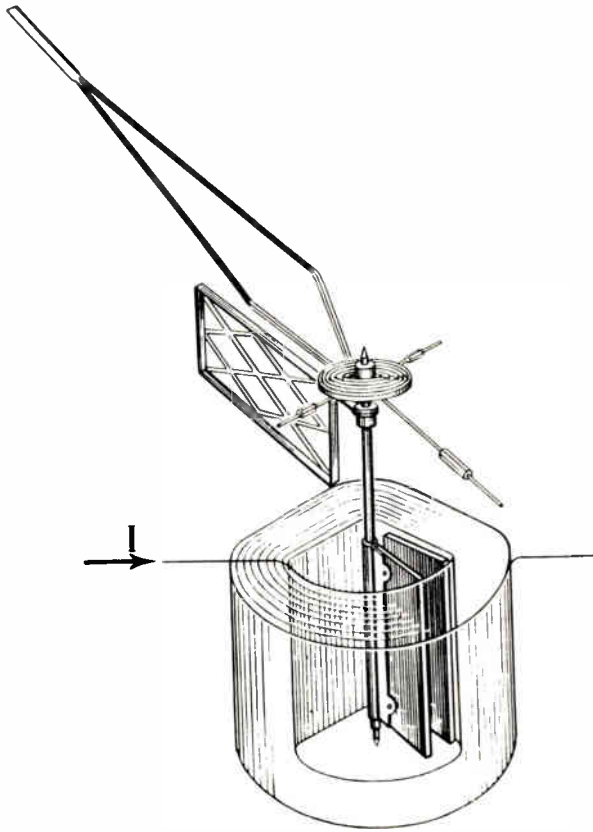

Fig. 4: Moving iron type mechanism for ac measurements.

frequency ratings, since they are a compromise between current and these errors. Current and potential transformers are usually recommended to extend the ranges of the ammeters and voltmeters. This is the most practical way, since high ranges would require excessive power which is often not practical.

Frequency Ratings—

The frequency rating of ammeters and milliammeters is usually 25 to 500 cps. Voltmeters are usually rated for 25 to 125 cps. Beyond this range, internal compensation for frequency is supplied. With compensation, the frequency rating is usually 25 to 2500 cps. at slightly reduced accuracy.

AC Instruments On DC

The moving iron instrument can also be used on direct current; however, most instruments used in this way have a rather large error due to hysteresis effect in the iron vanes. This error can be reduced by taking the average of direct and reversed readings; however, the accuracy of a permanent magnet coil type of instrument is usually not obtained unless the iron vane instrument is designed with special vane material having very little hysteresis effects. This is usually not done since it is more practical to use the permanent magnet moving coil instrument for dc measurements because it requires a fraction of the power.

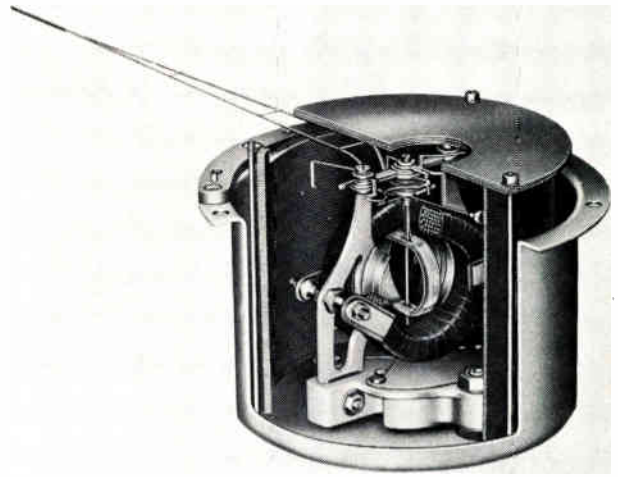

Fig. 5: The electro-dynamic ac mechanism.

Electrodynamic Type

The electrodynamic mechanism shown in Fig. 5 is used a great deal for the measurement of alternating current and voltages as well as power. It is also known as the electrodynamicometer or dynamometer type of instrument.

The electrodynamic mechanism consists of a pair of field coils fastened to a supporting structure. Inside the field coil is a moving coil attached to a staff which is mounted in pivots and jewels and free to rotate. A pointer and two torque springs and damping vane are also mounted to the staff. Currents in the moving coil and field coil will produce a torque proportional to the instantaneous product of the two currents. Thus, if the moving coils and field coils are connected in series, the same current will pass through both and the deflection is proportional to the square of the current. The instrument is then a milliammeter and measures the effective or rms value of the current. Adding series resistance converts the instrument to a voltmeter, and the instrument measures the effective value of the voltage. The instrument is used as a wattmeter to measure power by passing load current through the field coils and by connecting the moving coils to suitable series resistance across the load to measure the voltage. Indication is proportional to the product of the voltage and current times the cosine of the angle between them.

Many of the comments made about the moving iron instrument apply to the electrodynamic type of instrument. The coils are copper and when used as a voltmeter must have many times the coil resistance in series in order to swamp out the change in resistance of the moving coil and field coils, with change in temperature. The coils also have inductance, and therefore the instrument must be limited in frequency range. The frequency ranges are about the same as for the moving iron instrument. The power required for full scale deflection is approximately 0.5 w to 1 w in the mechanism's coils. Additional resistance in the voltmeters make the instrument power required some 3 or 4 w for the lowest range of a multirange instrument, and high-range instruments require proportionally more.

There is one important difference between the moving iron instrument and the electrodynamic instruments. This is ability of the electrodynamic instruments to measure accurately dc and ac voltages, currents and power. For this reason, the electrodynamic instruments

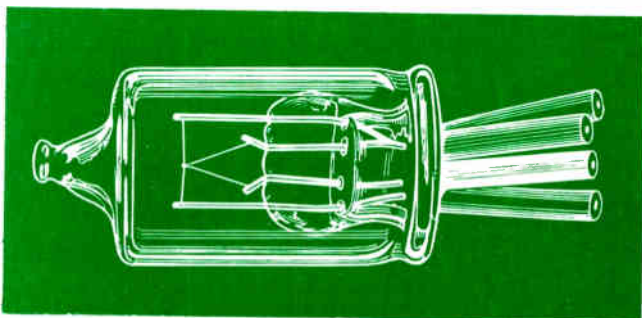

Fig. 6: A thermal element—heart of a thermal voltmeter or ammeter.

are known as transfer standards since they can be calibrated on direct current and used on alternating current. This also makes it desirable to produce electrodynamic instruments of high accuracy, and an accuracy of 0.1% of full scale value can be obtained.

Thermal Type

Another important instrument, which measures the effective value of the voltage or current, is the thermal voltmeter and ammeter. This instrument uses the thermal element to convert the alternating current into direct current which is then read on a permanent-magnet moving-coil type instrument. The heart of the thermal instrument is the thermal element shown in Fig. 6. This consists of a glass enclosure containing the straight heater wire connected to two supports. The thermocouple, in the form of a V, is connected to the center of the heater by a small bead which provides electrical insulation between the heater wire and the

thermocouple and at the same time conducts heat to the thermocouple from the heater wire. Air is evacuated from the glass enclosure to reduce the convection losses between the thermocouple and the surrounding medium.

The thermocouple consists of two dissimilar metals which when heated will produce a voltage. The heating of the thermocouple is accomplished by passing a current through the heater wire, raising its temperature. Since heat is proportional to I^2R , the millivolts developed are proportional to the square of the current, and the thermal element measures the effective value of the current. This type of thermal element can be provided with ranges of approximately 1.5 ma to 500 ma. Voltmeters are made by adding resistance in series with the low range thermal elements. The power taken by the thermal element is in the order of 2.25 mw, which is a great deal less than the moving iron or electrodynamic type of instrument. Voltmeter sensitivities may run from 2 to 10 ma, and ranges from 1 v to 750 v are practical. Ammeters in ranges from 1 to 50 a. are usually supplied by using external thermal elements. These elements use a tubular type of heater in order to reduce the skin effect at high frequency. They are also supplied with a special type of construction to compensate for the effects of temperature effects inherent in thermocouples.

In addition to their low power consumption, thermal instruments are noted for their ability to be used over a wide frequency range. The thermal element itself can be used on direct current and from approximately 5 cps to 2 mc. This is a nominal rating for single range milliammeters. Multi-range milliammeters using shunts, and voltmeters, are limited in frequency to approximately 15 kc. This limitation is caused primarily by limitations in the shunts or series resistances.

Thermal instruments have two drawbacks in their use. One is the inability to withstand overloads. As a result, it is very easy to burn out the heater in the thermal element. Burn-out can occur from 2 to 3 times full scale deflection; and, in many cases an overload may change the accuracy of the instrument even though it has not burned out the heater. Another disadvantage is the effect of external temperature upon the instrument indication. Since the millivolts developed by the thermocouple are very low, it is necessary to provide a dc instrument with marginal temperature compensation. In addition to this, an instrument measures the difference in millivolts developed between the hot end of the thermocouple which is at the heater and the cold end which is at the instrument. The instrument is recommended for use at 25°C (77°F) which is the temperature at which it is calibrated. It can be used at derated accuracy from 20 to 30°C or to within rated accuracy by applying suitable correction factors.

(. . . From page 99)

a 50 ohm transmission line. Such adapters have a specified maximum VSWR for a given frequency. The uncertainty caused by this VSWR is usually rather large. The magnitude of uncertainty can be considerably reduced by introducing an adjustable air line between the micropotentiometer and T-adapter/voltmeter. The line is adjusted in length to produce a minimum and a maximum indication on the voltmeter. The mean of these two readings is a close approximation to the voltage that would exist on the transmission line if there were no standing waves present.

The third general source of calibration errors are those that affect the response of the voltmeter itself. Included among these are ground current errors and response and waveform errors.

Ground Current Errors

Currents can flow along the ground system of interconnected equipment. These currents may be of power line frequency—caused by voltage drops on the power distribution system—or they may be of signal frequency—caused by leakage from generators into the ground system. Either type can cause voltage calibration errors if they flow across finite impedances in the voltmeter input. Any voltage drop there can add to the signal.

Ground currents can be minimized by operating at the highest possible signal level, by limiting the frequency range, by applying careful grounding, by the use of isolation transformers in either the signal or power system, and by the use of coaxial connectors and battery-operated equipment.

Response and waveform errors can be particularly troublesome at high frequencies. Most calibrations

sources, including micropotentiometers, are rms responding. When they are used to calibrate voltmeters that are not also rms responding—for example, rf diode voltmeters which are peak responding, or sensitive amplifier-rectifier voltmeters that are often average responding—there can be calibration errors depending on the percentage, order and phase of the harmonics present. As the frequency is increased, these errors become harder to determine and control. Most high frequency generators have higher harmonic distortion than low-frequency generators, the means to measure rf distortion are limited, and the amount of distortion varies along a mismatched transmission line. If, for example, we connect a 250 mc source having 1% third harmonic distortion, to a 10 pf load over a 1 in. transmission line, the amount of 3rd harmonic distortion delivered to the load will be close to 5%, instead of 1%.

Another source of error often occurs because the response of high frequency voltmeters is often highly peaked beyond the specified operating range. If harmonics exist in this region, their effect on voltmeter response will be in excess of that normally expected.

To minimize waveform and distortion errors, the calibration source and voltmeter should both ideally be rms responding. Interconnections should be coaxial and as short as possible. A matched transmission system is preferred, and the frequency of measurement should be no higher than necessary.

Wallace F. White is Manager, Research and Development, at Ballantine Laboratories, Inc., Boonton, N. J. He received a B.S. from Rutgers in 1949 and an M.S. from M.I.T. in 1950. He taught for a year at Polytechnic Institute of Brooklyn before joining Ballantine.

FREQUENCY DEVIATION (Concluded)

(. . . From page 101)

and forth, indicating noise or modulation. Since a bidirectional counter is used, the unit under test may be adjusted continuously during a run (instead of having to adjust only between test runs).

The entire circuit requires four R-S flip-flops, 12 dual input AND gates, two dual input OR gates, a level detector, a one-shot, and a four-stage ring counter or equivalent. Additional circuitry could be added for determination (for instance) of the missing counts, but since additional display would probably be desired for this type of parameter, it is not included here.

Special Considerations

The frequency standard used may be crystal controlled, tuning fork derived, or may be any of several commercial devices for precision uses. For the circuit of Fig. 3, the frequency reference should be four times

that of the unknown so that the intervals generated by the ring counter will present quarter periods and the error read will be in cycles. A time base could be added to provide error directly in cycles per second. If the reference were made forty times the unknown, the error would be in tenths of cycles, etc.

Accuracy

The accuracy of the system is the accuracy of the reference plus or minus one count. The percentage contribution of the latter may be reduced through the use of higher reference frequencies (i.e., ten times that required). This procedure is limited by the frequency of the unknown and the frequency modulation (by noise) to be tolerated.

The unit described will not be affected by modulation up to a period of the reference (one phase). Correspondingly, the useful frequency range is limited by the desired accuracy and the capabilities of the circuit modules used.

By **GEORGE J. FRYE**

A tutorial article outlining a number of facets of the sampling technique that are not universally known or understood.



Oscilloscope Sampling Techniques

**MEASUREMENT
and TEST**

FEATURE

THE BASIC PRINCIPLES of sampling oscilloscope operation are not complicated but many facets escape the casual observer. A number of important considerations are presented to point up this facility for the practicing engineer.

When using a sampling oscilloscope, signal information is viewed or sampled only during an extremely short interval of time which is synchronized with the signal being viewed. This short sample gives the instantaneous level of the signal at a fixed point in time relative to the start of the signal event. By slowly changing the relative time between the start of the signal event and the sampling interval, it is possible to slowly scan the signal. This process of the slow scan of a fast signal event is known as "equivalent-time" sampling. A sampling oscilloscope operating in equivalent-time has a relatively slow real-time horizontal sweep rate, but gives a display which can represent an extremely fast sweep rate. Equivalent-time sweep rates much in excess of the speed of light are easily accomplished; ten picoseconds per centimeter, or 3.3 times the speed of light, is easily reached.

The usefulness of the very high sweep rates is limited by the equivalent-time risetime of the sampling oscilloscope; this risetime can be no shorter than the sampling time interval. The risetime of a typical sampling oscilloscope is 0.35 nsec, which represents a 3 db bandwidth of 1 gc.

The equivalent-time mode of operation is not the only one possible for a sampling oscilloscope, however; operation in a real-time mode, like a conventional oscillo-

scope, is also possible. In this mode, the sampling of the signal is done non-synchronously at a high repetition rate, and the sweep is set at a rate which will allow many samples per scan to appear on the screen.

The main purpose of this article is to elaborate on this real-time technique and to expose some of the advantages and disadvantages attendant to it.

Dot Transient Response

Before discussion of real-time sampling, it is worthwhile to consider characteristics of the sampling vertical amplifier system used in the newer sampling oscilloscopes.

A block diagram of a typical sampling vertical amplifier is shown in Fig. 1. Its operation is as follows: With the signal applied to the input of the normally non-conducting first gate, the strobe generator is fired, momentarily causing the gate to conduct. If a potential difference exists across the gate, current flows into or out of capacitor C_1 , causing it to charge toward the value of signal voltage present at that moment in time. If the gate were held in a conducting state long enough, C_1 would charge completely, resulting in a system with 100 percent sampling efficiency. Sampling efficiencies of up to 25 percent are obtained in practice. The ac amplifier responds to this change in voltage across C_1 and delivers a pulse to the second gate. The second gate conducts, being driven from the strobe source, allowing the memory capacitor to absorb the charge delivered by the ac amplifier, then is returned to the non-conducting state so that a new dc output level is seen. This output change is proportional to the difference in voltage across the first gate when the gate was made to conduct. Now, if an attenuator, B, were inserted so as to feed back this dc output voltage to capacitor C_1 , so that it charges up to a value of voltage exactly equal to the signal voltage at that sampled instant in time, then the vertical system is said to be adjusted for unity dot transient response.

This type of vertical system is a form of chopper-stabilized, null-seeking servo system with all of its

George J. Frye has been associated with Tektronix, Inc., Portland, Oregon since 1962, working on sampling oscillography. He holds an MSEE from the Univ. of Kansas, where he also served as an instructor in Electrical Engineering and headed the Electronic Circuits Group of Project JAYHAWK. Mr. Frye is a member of Sigma Xi and of IEEE.

Author Frye (left) demonstrates the sampling principle.

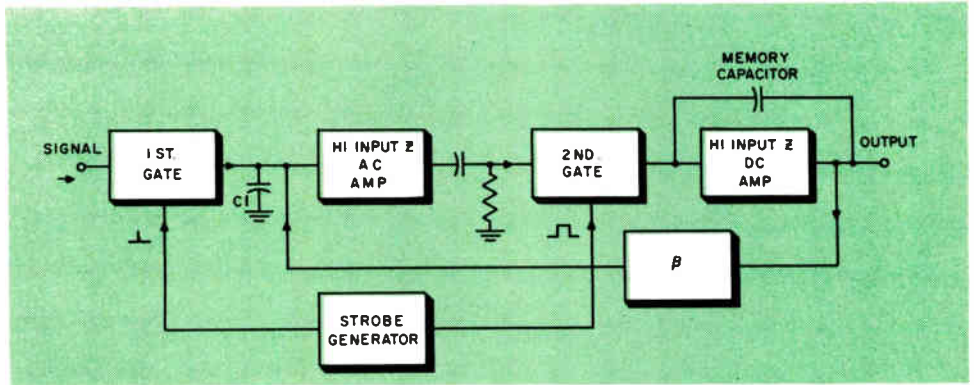

Fig. 1 (right): typical sampling vertical amplifier.

attendant response characteristics. If the sampling system is asked to jump from a reference voltage position to a new value in one sample, displays such as are shown in Fig. 2 will be observed. In Fig. 2A, response is correct, or unity. In Fig. 2B, dot transient response is such that the true risetime is not seen; rather, the display risetime is limited by the fact that the internal servo loop takes several samples to obtain a null. The true risetime is only seen if the system is operated so that the signal risetime is spread out over a large number of samples. Dot patterns at Figs. 2C and 2D are typical of what is observed with too much servo loop gain.

Real-Time Sampling

A conventional sampling oscilloscope may be converted to real-time operation by slaving it with an ordinary dc-coupled real-time oscilloscope such as is found in most laboratories. By taking advantage of the vertical signal output jacks on the sampling oscilloscope, the vertical channel of the real-time oscilloscope can be connected into the sampling system. By free-running the trigger circuit in the sampler, and using the sweep and internal trigger circuits in the real-time oscilloscope, real-time sampling displays are easily produced. The connection is shown in Fig. 3.

The requirements that the real-time oscilloscope must meet are not severe. Since for most sampling oscilloscopes, the maximum sampling repetition rate is 100 kc, a real-time oscilloscope with a bandwidth of 300 kc is adequate (1 μ sec risetime). The horizontal accuracy of the system is dependent upon the built-in accuracies in the real-time oscilloscope; vertical calibration accuracy is dependent on the calibration of both the real-time and the sampling oscilloscopes.

In real-time sampling, the vertical sampling servo must be adjusted for unity dot transient response. The necessity for this adjustment is easily seen in Figs. 4A and 4B. Both figures represent the same square wave and were taken at a sweep rate of 0.2 msec/cm with a vertical deflection factor of 50 mv/cm. Tektronix Type 661 sampling oscilloscope and Type 535A real-time oscilloscope were used here. In Fig. 4A is shown the response of the sampler with the dot transient response set close to unity. In Fig. 4B is shown the risetime limited by a dot transient response of about 25 percent.

Another form of transient response limitation is shown in Figs. 5A and 5B. The signal sweep rate and deflection factor are the same as in Fig. 4. Once again, Fig. 5A shows good dot transient response, and Fig. 5B shows exponentially limited response. In this latter case, the limiting is in the form of a 0.005 μ f capacitor loading the input of the real-time oscilloscope. This capacitor forms an integrating time constant with the 10,000 ohm source impedance of the sampling oscilloscope vertical channel.

The deliberate introduction of such a time constant can be used for random noise reduction. The sampling vertical unit, because of its extremely wide bandwidth, has a noise level of around 1 mv peak-to-peak per gigacycle of bandwidth. This noise can be reduced by introducing an integrating time constant to the sampler vertical output, or loading this output with a capacitor. The real-time bandwidth is thus greatly reduced, but the sampler may now be used as a highly stable chopper-stabilized dc voltmeter and low-frequency oscilloscope.

(Continued on Page 110)

Fig. 2: Displays showing various response to a dot transient (one sample). See text for explanation.

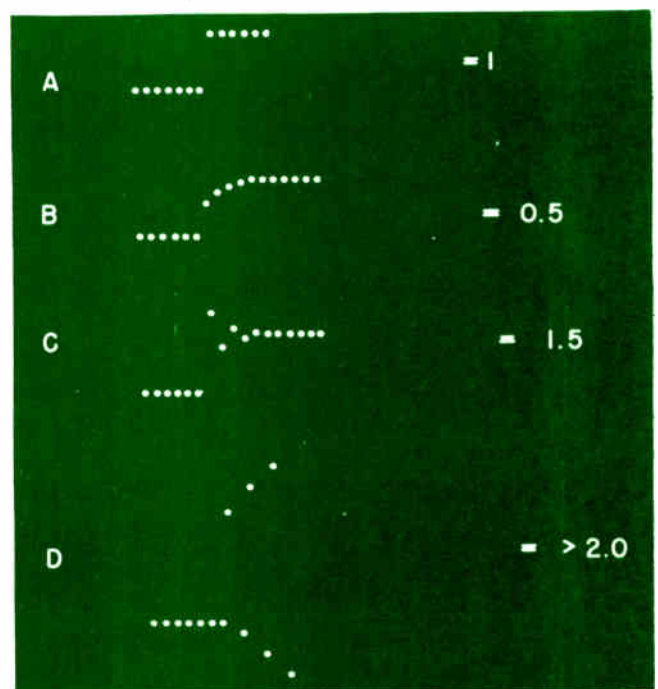

Long term stability of 20 mv per day with short term dc stability of 200 μ v is not unusual.

Input Considerations—Probes

The input impedance of the sampling unit is also an important consideration, especially in low frequency applications. In a typical sampling oscilloscope, four basic input systems are now available as follows:

1. 50 ohm coaxial input.
2. Passive probes operating into 50 ohm coaxial input.
 - a. 10X Probe: 500 ohm Input R
 - b. 100X Probe: 5,000 ohm Input R
3. Cathode follower probe operating into 50 ohm system: 10 megohm input R shunted with 1.5 pf to 3.6 pf for 1000X or 10X attenuator heads, respectively.
4. Active sampling probe: 100X input R, shunted by 2 pf.

The 50 ohm system demands the most power from the measured circuit, but is the most stable. Its disadvantages diminish as the bandwidth increases because of RC considerations. The passive probes help the circuit loading problems somewhat, but also demand a significant amount of driving power. The two active probes, the cathode follower type and the active sampling

provided to prevent any motion of the cable during the measurement.

The dynamic range of the two active probes is also rather limited as compared to conventional real-time oscilloscope passive probes. The cathode follower probe is limited to ± 1.5 v or ± 150 v maximum signal swing when used with 10X or 1000X attenuator heads, respectively. The direct sampling probes are limited to ± 2 v or ± 20 v maximum signal when used unattenuated or with a 10X attenuator, respectively.

The use of the real-time sampling hookup does present advantages over standard low-frequency oscilloscopes. While retaining the internally triggered option of the conventional real-time oscilloscope, it gives the user a chopper-stabilized dc amplifier with a potential bandwidth of up to 5 or 6 gc.

Applications

One potential application is shown in Fig. 6. This picture shows the modulation envelope of a 400 mv peak to peak, 1.93 gc carrier wave at a real-time sweep rate of 20 msec/cm. Modulation percentages are easily observed on carriers with this real-time technique.

Internal triggering of the real-time oscilloscope on the modulation envelopes presents a problem in the timing of the trigger holdoff circuit. The real-time oscilloscope is constructed so that it is recovered to accept triggers only after the sweep circuitry has been fully reset at the end of the previous sweep. Triggering on the modulation envelope is accomplished by setting the real-time oscilloscope for dc triggering and adjusting the triggering level so that a sweep is made when the envelope crosses through this level. If, however, the real-time oscilloscope trigger circuit is recovered so that it is allowed to accept triggers during the peak of a modulation cycle, then the circuit will fire immediately, giving an unsynchronized display. This recovery problem can be overcome by adjusting the sweep rate or the modulation frequency so that the trigger circuit recovers in a modulation valley; another way out of the problem is by external triggering from the low-frequency modulation source.

Another application is demonstrated in Fig. 7. Fig. 7A shows a picture of a real-time sampling display; the horizontal sweep rate is 0.2 msec/cm, and the vertical deflection factor is 50 mv/cm. This display shows the envelope of a gated 400 mc tunnel diode oscillator, including the dc components. Fig. 7B shows an equivalent time display of the wave; deflection factor is the same, but the horizontal equivalent sweep rate is 1 nsec/cm. Both of these displays were taken from the 535A slave oscilloscope; the equivalent-time hookup is shown in Fig. 8. Here, the sawtooth output from the real-time oscilloscope is attenuated with a 100k potentiometer and patched into the external horizontal scan input of the sampling unit. The potentiometer is set so that the

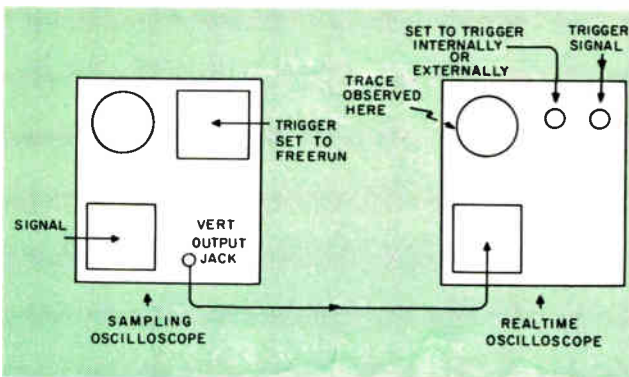

Fig. 3: Connection for using a sampling oscilloscope for real-time sampling operation. Trigger circuit in sampler is made free-running.

probe, give the lightest circuit loading but still present limitations.

The cathode-follower probe introduces its own dc drift characteristic into the picture; the probe is outside of the chopper stabilized loop and is therefore uncompensated for drift. This factor becomes important when millivolt-per-centimeter sensitivities are being used.

The active sampling probe, which contains an internal sampling gate, suffers from a cable problem. Flexing of the probe cable changes the dc balance of the sampling system; a typical change is ± 5 mv. If these probes are used for high stability dc level checks, means must be

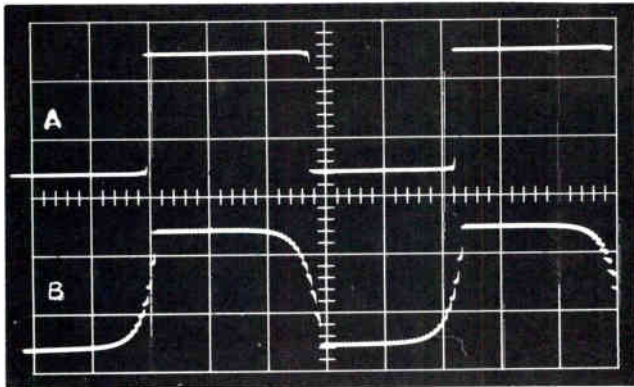

Fig. 4: Sampler response curves. At A, the dot transient response is close to unity. At B, the dot response is about 25%.

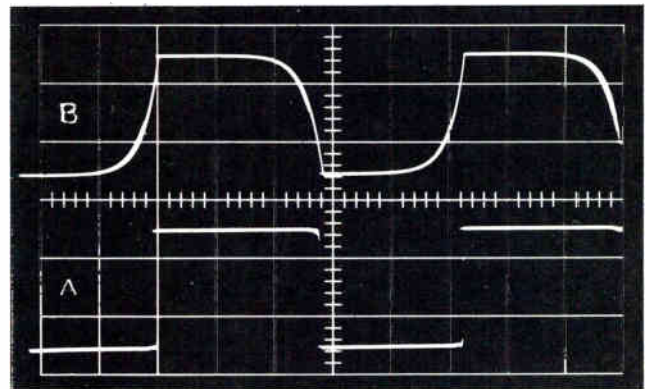

Fig. 5: Good transient response at A is limited at B by input loading on the real-time oscilloscope of a 0.005 μ f capacitor.

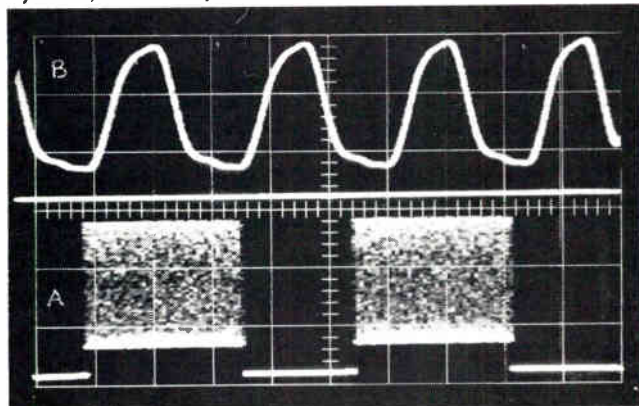

Fig. 6: Application of real-time sampling. Modulation envelope of a 400 mv p-p, 1.93 gc carrier wave at a real-time sweep rate of 20 msec/cm. Modulation percentage is easily observed.

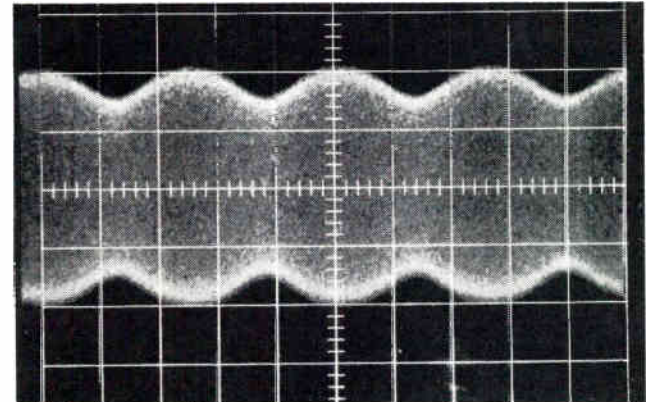

Fig. 7: Display of output from 400 mc tunnel diode oscillator. At A is the R.F. envelope. At B is the equivalent-time display of the wave.

sweep displayed on the real-time oscilloscope matches that on the sampler. The triggering used is that present in the sampler, while the real-time trigger is set to free run.

Another significant problem, known as false display, is found in sampling. Because the sampling display is composed of lots of small samples with a great deal of time in between, large signal excursions are possible between each sample. If a 100 kc sine wave is observed with a sampler that is running either a real or equivalent-time per sample of 10 μ sec, then the display on the screen is that of a straight line. If a 101 kc wave were viewed, a 1 kc sine wave would be observed on the screen. False displays may be checked by changing the time per dot calibration of the instrument. Sampling oscilloscopes provide a dots/cm control for equivalent-time false display check, and a recovery time control on the trigger circuits for real-time checks.

Equivalent-Time Mode Noise Reduction With Real-Time Integration

If, in an equivalent-time system, one were to reduce the real-time sweep rate to zero and to sit at one point in time relative to the signal event, a large number of samples would be accumulated, each one of which would represent the value of voltage equal to the sum of signal plus noise for that particular sample. If the noise components present are random with respect to the signal, the average value of noise voltage for a

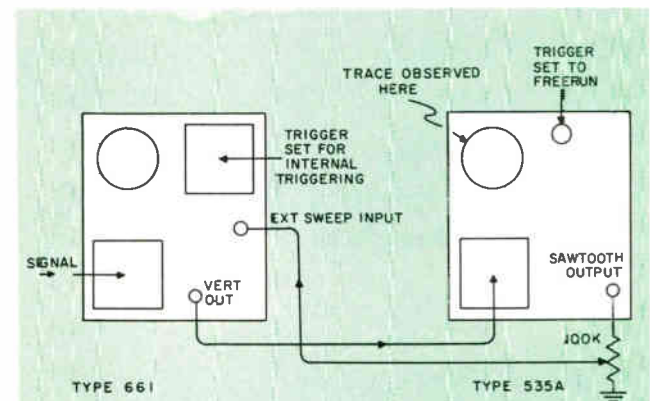
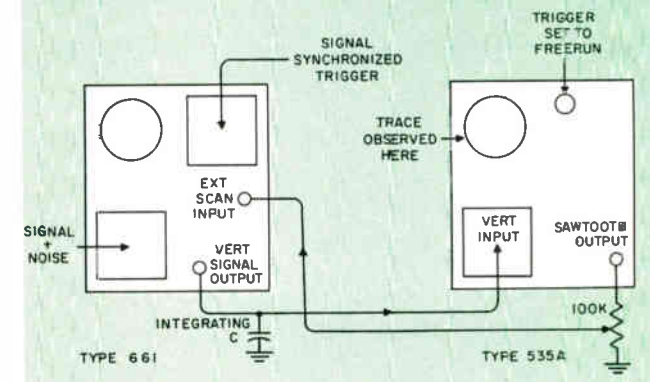

Fig. 8: Equivalent-time hookup. See text.

Fig. 9: Hook-up to take advantage of averaging effect of several thousand samples, to get rid of random noise effect. See text.



OSCILLOSCOPE SAMPLING (Concluded)

particular point in relative time is zero. If, therefore, one observes this relative point in time for several thousand samples, and passes these individual samples into an integrating network, then the net output of the network will be the value of signal voltage for that point in relative time.

To make this averaging effect usable, such an arrangement as shown in Fig. 9 can be employed. The 10 k source impedance of the sampling system, together with the integrating C, form the integrating, noise-reducing time constant; this noise reduction principle is much the same as that used in the real-time mode just discussed. This time constant should be chosen so that the lowest frequency noise component is effectively integrated to zero. The sweep rate of the real-time oscilloscope should then be adjusted so that the risetime of the fastest equivalent time step is not limited by the integrating time constant. The use of an external trigger source is almost a necessity in order to eliminate jitter from the display.

A typical waveform display using this system is given in Fig. 10. Both top and bottom photos represent the same signal, which is a 100 kc trapezoid about 7 mv high. The dotted display is made up of the 7 mv trapezoid plus an assorted number of pulses and differentiated square waves. The dotted display was made with a vertical deflection factor of 20 mv/cm, a real-

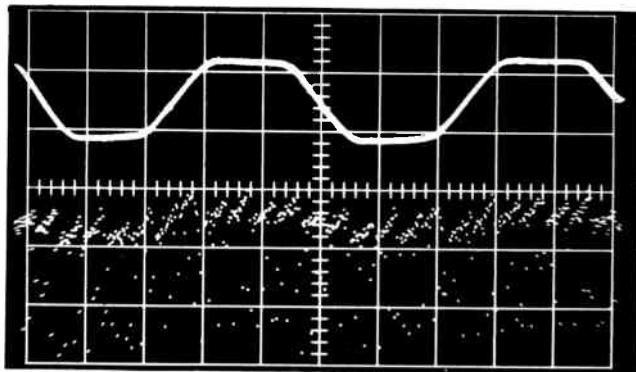

Fig. 10: Waveforms observed using hook-up shown in Fig. 9. Signal is a 100 kc trapezoid 7 mv high. Dotted display is combination of trapezoid plus assorted pulses and differentiated square waves. Clean display shows what this particular connection can accomplish.

time sweep rate of 20 msec/cm, and an equivalent-time sweep rate of $2 \mu\text{sec/cm}$.

The clean display uses a 1.0 sec integrating time constant and a real-time sweep rate of about 10 sec/cm. The deflection factor is 5 mv/cm and the equivalent time sweep rate is again $2 \mu\text{sec/cm}$.

The full versatility of the sampling technique has not yet been exploited. The ability to process signal information in both real and equivalent time allows the engineer a greater freedom of choice in measurement than he has enjoyed up to now. What the engineer can do with the sampling technique is at present limited by knowledge of application. The full exploitation lies in the hands of the competent, resourceful engineer.

NOW AVAILABLE!

**ELECTRONIC
INDUSTRIES**

exclusive 1965 Marketing Map

showing

A Distribution of Electronic Plants in the United States on a County Basis

— PLUS —

- Detailed breakdown of 8 major metropolitan areas
- Distribution of plant locations & electronic engineers in major states

This map is 52 x 33 inches and is suitable for framing and wall mounting

PRICE: \$3.50 each

Please make checks payable to **ELECTRONIC INDUSTRIES** and mail to Marketing Department,
ELECTRONIC INDUSTRIES, Chestnut & 56th Streets, Philadelphia, Pennsylvania 19139

MEASUREMENT & TEST BOOKS

The Editors present here a comprehensive list of books currently available from publishers, covering all aspects of electronic measurement. These are not all "new" books. The compilation is intended specifically as a reference source for engineers.

Industrial Electronics Measurement

Edited by Alexander Schure. Published 1964 by John F. Rider Publisher, Inc., New York, N. Y. Price \$3.75. 128 pages.

This is an elementary reference text. Basic meter movements and fundamental circuits for measuring quantities such as voltage, current and resistance are described. Despite its title, this book does not present electronic instruments designed for specific industries.

Chapters discuss meters to measure voltage, current, and power, and impedance bridges and potentiometer circuits. Other chapters cover transducer circuits for measuring non-electrical quantities, such as pressure and temperature. Frequency and phase measurements are also covered.

Review questions are presented at the end of each chapter. An electronic symbol chart also is included.

Basic Electronic Test Instruments

By Rufus P. Turner. Revised 1964 edition, published by Holt, Rinehart and Winston, Inc., 383 Madison Ave., New York City 10017. Price \$6.25. 297 pages.

Here is a book that lives up to its title by listing and describing 17 groups of meters basic to electronic measurements. Highly specialized or unique custom instruments are not included.

The author discusses the theory, construction and operation principles of these instrument types: simple meters for current and voltage; ohmmeters and volt-ohm-milliammeters; electronic voltmeters; power meters; impedance checkers; capacitance checkers; inductance checkers; special-purpose bridges and accessories; oscilloscopes and applications; R-F test oscillators and signal generators; audio test oscillators; frequency-measuring devices for radio frequencies; frequency-measuring devices for audio frequencies; audio-amplifier testing devices; R-F signal tracers; tube and semiconductor testers, and miscellaneous instruments including Q meters, field strength meters and the modulation monitor.

This book is the revised version of a definitive text first published in 1953. Among changes, the broader use of solid state circuits and devices is reflected in new instruments described here. A handy section lists abbreviations. Many circuits are shown, along with photographs of certain instruments.

Electronic Instrumentation

By Sol D. Prensky. Published 1963 by Prentice-Hall, Inc., Englewood Cliffs, N. J. 07632. Price \$15.65. 534 pages.

The author goes beyond operating instructions and general principles of operation to present instrument functions. He aims to clarify significant factors, such as equipment tolerances and precise calibration procedures, related to effective performance of electronic instruments.

This book chiefly discusses laboratory-type instruments. Consideration of service-type instruments is limited mainly to testing principles. Three points generally are made about each major instrument type: (1) Fundamental principles of why it works; (2) Explanation of how it works by examining specific functions of a representative example; and, (3) Illustration of where it works best by reviewing practical applications.

There is an introductory discussion of electric and electronic measurement fundamentals. Topics include the basic meter in dc and ac measurements, comparison measurement methods, and ac bridge and impedance measurement methods. The primary group of general purpose instruments considered includes electronic voltmeters, oscilloscopes, signal generators, and recorders with their accompanying transducers. Tube and transistor testers also are described.

Other equipment discussed are nuclear radiation-detection, counting, and digital-display instruments, and analog computers. Audio-frequency and radio-frequency test methods are analyzed. A chapter is devoted to specialized instrument applications, such as chemical analysis, gas chromatography, and biological-medical instruments.

Understanding of standard and highly developed instruments is aided by illustrations of instruments and simplified functional circuits. Four useful appendices comprise a bibliography, lists of manufacturers and buyers' guides, instrument glossary, and a statement of Thevenin's Circuit Theorem relating to instrumentation.

Electronics and Instrumentation

By Robert T. Ramey. Published 1963 by Wadsworth Publishing Co., Inc., Belmont, Calif. Price \$13.35. 321 pages.

This book introduces readers to general electronic matters as well as electronic instruments. Its dual approach thus suits newcomers to electronic fields, as well as serving as a refresher to advanced electronic workers. The book also serves the growing numbers of researchers using instruments in fields such as biology, medicine and psychology.

The chapter on electronic instruments discusses noise, instrument amplifiers, vacuum tube voltmeters, oscilloscopes, electrometers, the gaussmeter, time and frequency measurements, and the calorimetric power meter. Transducers also are reviewed because of their basic importance in converting signals to be processed by instruments. Displacement, velocity and acceleration, pressure, thermal and optical transducers are described.

The author examines passive measurement systems. These comprise the ohmmeter, RC measurements, the electrical bridge, a noncontact bridge, and T-network measurements. He also discusses vacuum tube, transistor and feedback amplifiers.

Basic, review-type material covered here includes chapters on physical electronics, conduction in the solid state, and electronic circuit analysis.

Practical Oscilloscope Handbook

By Rufus P. Turner. Published 1964 by John F. Rider Publisher, Inc., New York, N. Y. Price \$2.95 each for paperbound Volume 1 (124 pages) and Volume 2 (101 pages) or \$6.95 for a single cloth-bound book.

Contrasted with most books which broadly cover various laboratory and service instruments, this book concentrates on oscilloscopes. Yet this approach makes good sense because the oscilloscope is one of the most versatile and universal of electronic instruments.

No space is spent on general or measurements theory, except where required to understand an application. The author also has minimized technical jargon. Instead of complex detailed circuits, he prefers using skeleton circuits and block diagrams.

Volume 1 discusses basic tests and measurements. The author covers first principles of oscilloscope operation, controls and adjustments, accessories and

general operating procedure. He also discusses voltage and current measurements, frequency and phase measurements and comparisons. He further discusses a-f amplifier tests and measurements, and receiver and transmitter tests and adjustments.

Volume 2 discusses industrial and laboratory tests and measurements. The author describes features of professional oscilloscopes and how to record from the oscilloscope. He reviews checking physical qualities, checking components, and checking performance of electric, electronic and even some non-electric circuits.

Microwave Measurements Manual

By Robert Kellejian and Clifford L. Jones. Published 1965 by McGraw-Hill, Inc., 330 West 42nd Street, New York, N. Y. 10036. Price \$4.50. 152 pages.

As microwave frequencies are being used more extensively for radio communications, detection, and control, there is a more critical need for persons trained to work in the field of microwave technology.

The authors therefore have prepared this guide for training microwave technicians in schools, in industry, and in laboratories. Practical and commercial aspects of microwave operations are briefly considered. The authors then discuss application of circuitry measurements to ensure the proper performance of microwave equipment.

The bulk of this manual contains 16 experiments, each stating objectives, equipment used, procedure, problems and questions. Topics covered include the reflex klystron, coupling and directivity of directional couplers, the absorption wavemeter, and swept-frequency techniques. Other experiments concern standing-wave ratio, reflectometer techniques, detector characteristics, a *veguide* impedance matching, and propagation patterns. Also included are experiments on measurements of VSWR, power, attenuation, impedance, and precise frequency.

Appendixes contain symbols, abbreviations and formulas, a glossary, standard waveguide characteristics, and a list of test equipment required to perform stated measurements.

Electronic Precision Measurement Techniques and Experiments

By members of the Staff of Philco Technological Center. Published 1964 by Prentice-Hall, Inc., Englewood Cliffs, N. J. 07632. Price \$13.00. 336 pages.

During the past decade electronic equipment and systems have become increasingly complex, and electronic measuring equipment to test and calibrate this gear similarly had to be complex and precise. However, while many books cover measurement technology and equipment, this

book helps fill the growing need for technical literature on precision measurement techniques.

This manual broadly presents information on precision measurement techniques, chiefly on electrical and electronic equipment. Much of this source book is concerned with special techniques and laboratory exercises for using and calibrating typical precision measuring instruments. Answers are given to these laboratory problems.

Measurement and calibration techniques are discussed for use with mechanical, as well as basic electrical and magnetic test equipment. Also covered are voltage, current, and impedance measuring equipment; also test equipment and calibration techniques associated with waveforms.

There are separate chapters on calibration and measurement techniques of microwave and radac equipment; also on radar equipment and systems. Introductory chapters discuss standardized calibration, mathematical evaluation of errors, systems and units of measurement, and basic standards and measurements.

Appendixes contain useful conversion and correction data, physical properties of materials and systems, and mathematical techniques including use of the Smith Chart in solving various microwave problems. A bibliography also is included.

Principles of Electronic Instrumentation

By William A. Lynch and John G. Truxal. Published 1962 by McGraw-Hill Book Co., 330 West 42nd St., New York, N. Y. 10036. Price \$7.95. 828 pages.

The growing importance of an interdisciplinary approach to electronic instrumentation is reflected in positions held by the authors. They are heads of the mechanical engineering and electrical engineering departments respectively, of Polytechnic Institute of Brooklyn (N. Y.).

These authors seek to serve various specialists in electrical engineering who must be familiar with the nature of instrumentation in varied applications. Yet they also are reaching out to mechanical, chemical, aeronautical and civil engineers who need to know the views, language and techniques of electronic instrumentation.

The authors first present basic analytical concepts which underlie modern instrumentation engineering. They discuss electrical signals, circuits, the transfer-function model, block and signal-flow diagrams, and analog simulations. Next, the authors present basic elements and structure of instrument systems. These comprise electronic amplifiers and feedback systems.

In final chapters the authors consider how instruments are assembled into sys-

tems which meet broad performance specifications. They focus on instrumentation systems and communication, electro-mechanical transduction systems and systems for automatic navigation. Most chapters include problems for discussion and solution.

Electronic Measuring Instruments

By Harold E. Soisson. Published 1961 by McGraw-Hill Book Co., 330 West 42nd St., New York, N. Y. 10036. Price \$7.50. 352 pages.

The author gradually builds up the reader's background and acquaintance with electronic measuring instruments. He first accents the function and use of basic components used to make measurements. Then he uses the systems approach to show logical use of detectors, transfer units and end devices in measuring or control systems.

Subjects handled in early chapters include detectors, amplifiers, power supplies, semiconductors. Next, the author considers basic meter and recorder movements. He then discusses instruments for measuring current, voltage, power, impedance, inductance and capacitance.

Other chapters cover oscilloscopes, oscillators, tube and transistor checkers, and calibration units. Also analyzed are counting and optical-electronic measuring instruments. Here, the author advances into a review of electronic computers and simulators, and future uses of electronic instrumentation for measurement and control.

Problems and a bibliography appear at the end of nearly all chapters. An appendix lists mathematical expansions on total work, instantaneous current, and self-inductance, along with abbreviations and symbols.

Principles of Electronic Instruments

By Gordon R. Partridge. Published 1960 (third printing) by Prentice-Hall, Inc., Englewood Cliffs, N. J. 07632. Price \$12.50. 393 pages.

Many authors in this field have contented themselves with describing circuitry, operations and use of electronic instruments. Such authors have concentrated on discussing *standard* laboratory or service instruments. They either avoid or briefly mention custom instruments.

Dr. Partridge discusses how electronic instruments work, why they are desirable—and how to design certain special-purpose instruments. He first developed this approach to help his students in a graduate program at Purdue make specialized research instruments which were not available off-the-shelf.

This book explains how circuits make typical instruments operate. Yet it seldom discusses how to make measurements. About half of the book discusses instruments to measure electrical quantities by electronic methods. Discussions here con-

cern voltage measurements, dc vacuum tube and ac electronic voltmeters, electrometer tubes and circuits, electronic wattmeters and phasometers, and digital display. There are chapters on instruments for measuring frequencies and for testing components.

The other half of this book treats non-electrical quantities. Here transducers convert quantities into a measurable electronic signal. Areas discussed include measurement of time and velocity, sound, light, pressure and temperature, and radioactivity.

Emphasis is put on circuits designed to operate at relatively low frequencies: direct current to a few hundred kilocycles per second. Discussion of instruments in radio frequency and microwave regions are left to other specialized books on those subjects.

Modern Oscilloscopes and Their Uses

By Jacob H. Ruiters, Jr. Published in revised edition 1955 by Holt, Rinehart and Winston, Inc., Technical Div., 383 Madison Ave., New York, N. Y., 10017. Price \$7.00. 346 pages.

This was one of the earliest good references on cathode-ray oscilloscopes. It was first issued in 1949 and revised in 1955. The background, basic circuits, operations and applications of oscilloscopes are covered.

This book predated transistors and diodes of the type used in modern electronic test equipment. Thus, there are no references to semiconductors or some of the more sophisticated oscilloscope trigger and gating circuits, amplifiers and power supplies. Such material, it is assumed, will be included in any future revision of this book.

Electronic Measurements

By Frederick Emmons Terman, and Joseph Mayo Pettit. Published 1935, revised 1952, by McGraw-Hill Book Co., 330 West 42nd St., New York, N. Y., 10036. Price \$13.50. 707 pages.

Originally this book was published in 1935 for radio engineers, then revised in 1949 for electronic engineers. It now covers television, radar and other pulsed systems, microwaves, and various other techniques for engineers using electronic instrumentation.

Though this book is now more than a decade old, it is useful as a textbook and a reference book of fundamental principles. Material covered includes voltage and current, power, circuit constants of lumped circuits and in systems involving distributed constants. Other chapters discuss measurement of frequency; waveform, phase and time-interval measurements, amplifier and receiver measurements. Characteristics of triodes, pentodes and similar tubes are reviewed, but there is no mention of semiconductors.

Concluding chapters cover radio waves, laboratory oscillators, special waveform generators, reactance and resistance standards and devices, and attenuators and signal generators.

Electronic Time Measurements

Edited by Britton Chance, Robert I. Hulsizer, Edward F. MacNichol, Jr., and Frederick C. Williams. Published 1949 by McGraw-Hill Book Co., 330 West 42nd St., New York, N. Y. 10036. Price \$11.00. 538 pages.

It is nearly two decades since this book of technical material was released with security clearance after World War II. It is one of the Massachusetts Institute of Technology Radiation Laboratory Series of 27 books.

Although this volume is out-dated because it was published in 1949, it is one of the few books that concentrates on electronic time measurements. It covers radio distance and speed measurements, and techniques of pulse time measurements. Individual chapters discuss the generation of fixed indices, and generation of movable indices-circuits.

Also covered are manual measurements, techniques of automatic time measurements, and systems for automatic time and position measurement. There also are chapters on special data-transmission systems, relay radar systems and delay and cancellation of recurrent wave trains.

Electronic Instruments

Edited by Ivan A. Greenwood, Jr., J. Vance Holdam, Jr., and Duncan Macrae, Jr. Published 1948 by McGraw-Hill Book Co., 330 West 42nd St., New York, N. Y. 10036. Price \$13.50. 721 pages.

Back in 1948 this book was rushed into print to present material researched during World War II and cleared by security. The Radiation Laboratory of Massachusetts Institute of Technology, supervised by the National Defense Research Committee, prepared this book as one of 27 volumes. But much research has since been conducted, and still continues to be spurred by our current interests, ranging from "limited war" to outer space.

We have come a long way in solid state technology, for example, of which there is not even a hint in this book. However, this volume contains material that is basic and comprehensive. It discusses electronic "analogue" computers, instrument servomechanisms, voltage and current regulators, pulse test equipment, and the design and construction of electronic apparatus.

Electronic Tests and Measurements

By Robert G. Middleton. Published 1963 by Howard W. Sams & Co. Inc., The Bobbs-Merrill Co. Inc., Indianapolis and New York City. Price \$6.95. 288 pages.

Two prime areas covered by the author are basic design and operating principles of measuring instruments, and theory of circuits being measured. Subject matter comprises electrical and electronic units, nonlinear devices, basic principles of transients, bridge measurements, amplifiers, negative feedback, and high-frequency tests and measurements.

Electronic Test Instrument Handbook

By Joseph A. Risse. Published 1962, by Howard W. Sams & Co. Inc., The Bobbs-Merrill Co. Inc., Indianapolis and New York City. Price \$4.95. 288 pages.

The author analyzes practical aspects of using electronic instruments. He discusses operating principles, functions, and applications. Broad categories of instruments reviewed include the volt-ohm-milliammeter, the vacuum tube voltmeter, battery testers-eliminators and tube testers, diode and transistor testers, and signal generators.

Chapters review capacitance, inductance, and impedance tests; Q meters; the oscilloscope; frequency and modulation measurements. Other instruments discussed are used for special tests, precision and laboratory tests, audio tests, and industrial test and measuring.

Test Equipment Maintenance Handbook

By Robert G. Middleton. Published 1963 by Howard W. Sams & Co. Inc., The Bobbs-Merrill Co. Inc., Indianapolis and New York City. Price \$2.95. 160 pages.

Book seeks to match the broad use of electronic test instruments with equally useful maintenance information. The author concentrates on procedures for calibrating, modifying, troubleshooting and repairing standard service instruments generally used today.

Instruments discussed are volt-ohm-milliammeters, vacuum tube voltmeters, audio oscillators, square-wave generators, RF generators, color generators, oscilloscopes, and tube, transistor, and CRT testers.

Automotive Electronics Test Equipment

By Allen Lytel. Published 1962 by Howard W. Sams & Co. Inc., The Bobbs-Merrill Co. Inc., Indianapolis and New York City. Price \$2.50. 112 pages.

Here is one of the few books that relates the use of electronic test equipment to a specific industrial application. It discusses specialized electronic tests instruments used to maintain automobile and truck internal combustion engines.

The author surveys automotive testers and analyzers. These include testers of coils and condensers generators and voltage regulators, alternators, distributors, and tachometers. Also covered are combustion, and ignition system analyzers.

ABC's of Electronic Test Equipment

By Donald A. Smith. Published 1963 by Howard W. Sams & Co. Inc., The Bobbs-Merrill Co. Inc., Indianapolis and New York City. Price \$1.95. 96 pages.

Construction, operation and applications of basic electronic test instruments are analyzed. Units described are the basic meter; volt-ohm-milliammeter; vacuum tube voltmeter; battery, diode, and transistor testers; tube testers; the signal tracer; the oscilloscope; battery eliminator, and signal generator.

NEW PRODUCTS

COUNTER/TIMER

Measures freqs. from 0 to 1.2MC and time intervals from 1 μ sec. to 10⁶ sec.



Model SA-535 portable counter/timer measures higher freqs. directly, while those at the lower end of the range can be counted by period measurement facilities. Time intervals are counted in steps of 1 μ sec.; for time interval measurement, the instrument may be gated externally by positive pulses or manually by pushbuttons. Measurement accuracy is ± 1 count \pm internal crystal stability. The instrument can also serve as a gated totalizer for regular or random event counting. Racal Communications, Inc., 8440 Second Ave., Silver Spring, Md.

Circle 225 on Inquiry Card

WAFER TESTER

Tests and classifies up to 75K transistors a day in wafer form.

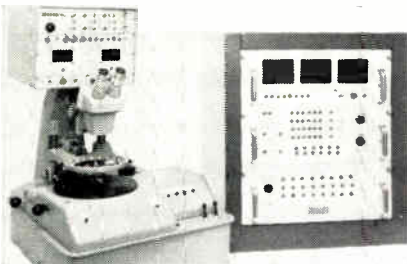

The 920A Automatic Wafer Die Sort teams with the 1990-TT Automatic Go/No-Go Transistor Tester to eliminate wasted production time. Once the 920 probe points are positioned, the probe steps across, down, reverses its path and indexes until the wafer is completed. Each probing point is independently adjustable in X, Y and Z axes; and has a usable range of 0.3 in. in each plane. X and Y axes are independently programmable. Ring assembly accommodates any combination of probing heads and/or inking arms up to a combined total of 18. The transistor tester tests up to 24 electrical parameters in any sequence. Electroglas, Inc., 150 Constitution Dr., Menlo Park, Calif.

Circle 226 on Inquiry Card

INSERTION LOSS MEASURER

Measures with ± 0.005 db absolute accuracy and ± 0.001 db relative accuracy.

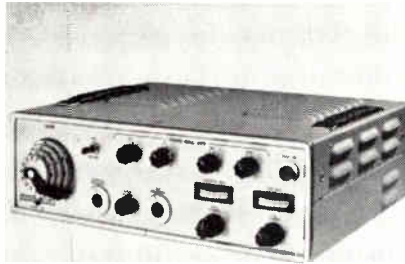

Model DB-3000 Precision Insertion Loss Measurement Set operates at any freq. from 100cps to 90cc. The unit is completely portable. The audio input signals into the system are derived from the demodulated r-f signal fed into the network under test. The dynamic range is more than 25db for single step measurements; the range may be extended by using 2 or more steps with standard calibrated attenuators. Noise level is better than -70db. DeMornay-Bonardi, div. of Datapulse, Inc., 780 So. Arroyo Pkwy., Pasadena, Calif.

Circle 227 on Inquiry Card

SYNC GENERATOR

For the high-resolution systems of fine-detail closed TV scan rate.

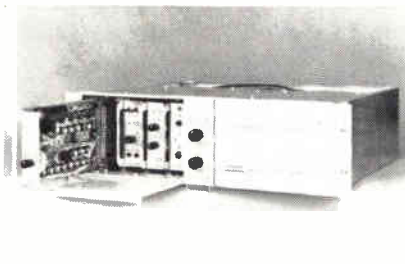

The 2490 series includes a standard-rackmounting dual-compartment enclosure containing either 1 or 2 separate complements of plug-in circuit assemblies. The sync plug-in is available for closed circuit TV (873- and 945-line) and for color or monochrome televising at the EIA standard 525-line broadcast scan rate. Optional 525-line genlock (bi-directional) and dot/bar generator (525- or 945-line) are contained in separate plug-ins, as is the individual power supply for each compartment. All plug-ins of the 2490 series use microcircuit modules integrating several multicomponent functions in 1 standard TO-5 semiconductor case. Colu Electronics, Inc., Kin Tel Div., San Diego, Calif.

Circle 228 on Inquiry Card

FREQUENCY COUNTER

Sensitivity better than 0.5v. RMS with an input impedance in excess of 150K.



With the TCF-1, no sensitivity adjustment is required in the input range of 0.5v. to 250v. RMS. A double-shielded case and a floating input provide direct current isolation in excess of 500v. Both line and internal clocks are provided for a measuring accuracy in excess of 0.01%. A resolution of 0.1 cps is provided over the full 7 cps to 120kc measuring range. A register overload indicator provides unambiguous 6 digit resolution over 10kc. Power consumption is less than 8w. W. H. Clark Inc., 2830 - 46th Ave., N., St. Petersburg, Fla.

Circle 229 on Inquiry Card

BULBLESS INDICATOR

Functions like an illuminated button, but requires no bulb or power.

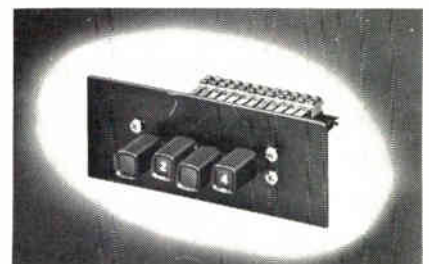

The Glo-Button X Series combines the economy of non-illuminated switching with the advantages and efficiency of the illuminated type. The button has a translucent front screen upon which a desired legend is marked in an opaque color. The opaque color provides the background for the legend, while the legend itself remains clear. An internal fluorescent illuminator is carried on a pusher which has 2 legs extending out from the rear. When the station is actuated, the rear legs of the pusher bring the orange-red fluorescent illuminator flush with the screen. The legend then magically lights up due to reflected amb. light and projects the legend or symbol. Switchcraft Inc., 5555 N. Elston Ave., Chicago, Ill.

Circle 230 on Inquiry Card

Now... a complete line of precision
FREQUENCY SYSTEMS

FOR NAVIGATION • COMMUNICATIONS • TRACKING • CALIBRATION

Here is the industry's most complete line of all solid state precision frequency standards. Their advanced performance with **guaranteed specifications**, meets the most exacting time and frequency requirements of electronic systems such as: • Navigation and Guidance Systems • Communications and Computer Equipment • Tracking Systems • Calibration and Standards Labs. Typical Frequency Standard Systems for these applications requiring measurements to parts in 10^9 , 10^{10} or 10^{11} with direct digital readout, are shown in the block diagrams (left). Call, or write for a demonstration. Dept. AEI-524.

• **Stability of PARTS IN 10^9**

S1076AR Frequency Standard	1
Digital Counter	6

• **Measurement of PARTS IN 10^9**

*S1055A VLF Frequency Standard	2
S1061BR Frequency Error Expander	5
Digital Counter	6

• **Measurement of PARTS IN 10^{10}**

S1055C VLF Phase Comparator	2
S1069AR Frequency Standard	3
S1061BR Frequency Error Expander	5

Digital Counter	6
Strip Chart Recorder	7

• **Measurement of PARTS IN 10^{11}**

S1055C VLF Phase Comparator	2
S1065AR Frequency Standard	4
S1061BR Frequency Error Expander	5

Digital Counter	6
Strip Chart Recorder	7

*Automatically Calibrated Frequency Standard



Motorola S1076AR Frequency Standard—Parts in 10^{10} Setability • Less than 2×10^{-9} Aging Per Day • 10 Second short term stability $\pm 5 \times 10^{-10}$ • 100 kc and 1 mc outputs • Proportional controlled oven • Motorola precision 3 mc crystal • Zener regulation • All silicon circuitry • Coarse and fine frequency adjust • Small size— $3\frac{1}{2}$ " high • Model S1076AR \$585.

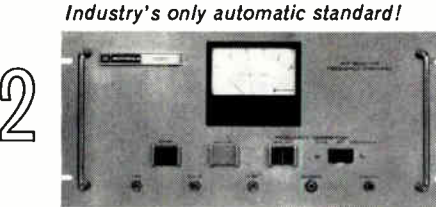

Motorola VLF Receiver Frequency Standard—This unique frequency standard automatically corrects its 1×10^{-9} /day or 5×10^{-10} /day internal oscillator to VLF signals. Also available as a servo driven Phase Comparator to phase plot S1069AR or S1065AR Standard • VLF Frequency Standard Model S1055A \$5,850 • VLF Phase Comparator Model S1055C \$4,250.



Motorola S1069AR Frequency Standard— 1×10^{-10} Setability • Less than 5×10^{-10} Aging Per Day • 1 Second short term stability $\pm 1 \times 10^{-10}$ • Proportional controlled double oven • Motorola precision 3 mc crystal • Zener regulation • All silicon circuitry • Digital reading linear fine frequency adjust • New smaller size— $3\frac{1}{2}$ " high • Model S1069AR \$1,950 • Model S1069BR (single oven) \$1,795 • 10/24 hr. internal battery \$285.00 • Spectrally Pure 5 mc Output \$250.00.

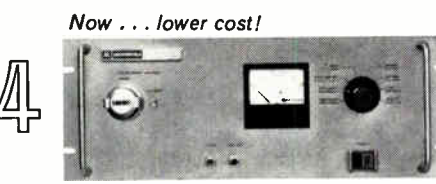

Motorola S1065AR Frequency Standard— 1×10^{-11} Setability • Less than 5×10^{-11} Aging Per Day and 1 Second Short Term Stability • Proportional double oven construction • Pre-aged 2.5 mc 5th overtone crystals • Digital reading linear fine frequency adjust • Solid State silicon design • Model S1065AR \$3,450 including power supply, rack mounting and 15 hour battery • Spectrally pure 5 mc output \$250.00.



Motorola S1061BR Frequency Error Expander—This frequency comparator allows high resolution, accurate frequency comparisons to be made quickly on a digital counter directly in parts in 10^9 in 1 second, parts in 10^{10} in 10 seconds, parts in 10^{11} in 100 seconds. Accepts 100, 250, 500 kc and 1, 2, 3, 4, 5 mc Test inputs. Model S1061BR \$1,495.



Motorola Communications & Electronics • 4501 Augusta Blvd., Chicago, Ill. 60651, Phone 312-772-6500 • A Subsidiary of Motorola Inc.

... advancing the STATE-OF-THE-ART in Components & Equipment.

Engineering Standards

Catalog H-65, 84 pages, gives specs. and engineering drawings on a line of insulated terminals, terminal headers, weldable terminals, connectors, printed circuit terminals, terminal boards, and instrument panel hardware. Units meet applicable Mil Specs. Litton Industries, USECO Div., 13536 Saticoy St., Van Nuys, Calif.

Circle 349 on Inquiry Card

Infrared Microplotter

This brochure contains photos and operating spec. on the Model 700A Infrared Thermal Microplotter. The unit is an infrared radiometer which analyzes the temp. distribution on small structures such as microcircuits. It has a spatial resolution of 1.4 to 0.3 mil and a sensitivity of $\frac{1}{2}^{\circ}\text{C}$ at 30°C . Sierra Electronic Div., of Philco, 3885 Bohannon Dr., Menlo Park, Calif.

Circle 350 on Inquiry Card

Insulation Tester

Data is available on a non-destructive insulation tester which accurately measures insulation resistance and leakage values in a variety of components. Cut-off circuits, which anticipate breakdown, cut-off high voltages to the test leads, providing max. safety to the operator and preventing damage to the component under test. Various voltage and current ranges are available. Complete specs. available from Telemet Co., 185 Dixon Ave., Amityville, N. Y.

Circle 351 on Inquiry Card

Frequency Detectors

Bulletin F-25R describes detectors which allow freq. measurement with an accuracy better than 0.25%. These solid-state detectors are capable of highly linear measurement over freq. ranges from 0-50 cps up to 0 to 100kc. Shape or amplitude of the signal input does not derate performance. Specs., recommended drive circuit connections, and outline dimensions are given. Airpax Electronics Inc., Seminole Div., Ft. Lauderdale, Fla.

Circle 352 on Inquiry Card

Digital Voltmeter

Model 4000 is an integrating type DVM. It features automatic ranging and polarity, constant high impedance, accuracy of $\pm 0.01\%$ and bi-polar noise rejection. High inherent stability is provided by a frequency-to-voltage comparator which corrects for any degree of non-linearity and for both short and long-term drift. Full details available from Hughes Instruments, 2020 Oceanside Blvd., Oceanside, Calif.

Circle 353 on Inquiry Card

Meters Catalog

This 16-page catalog describes a new line of panel meters and pyrometers. The laboratory series feature wrap-around window, cushion jewel mounts, solid-state compensation, mirrored scales, ceramic pointer stops, helical coil balance weights, together with 1-piece aluminum alloy movement frame. Accuracy 1%. Mastercraft Instrument Co., 1598 McPoland Ave., Dubuque, Iowa.

Circle 354 on Inquiry Card

Vibration Testing

Booklet 168, 12 pages, describes equipment and procedures for sweep random vibration testing. The new techniques described point out that random testing is now practical for even the smallest environmental laboratories. MB Electronics, div. of Textron Electronics, Inc., 781 Whalley Ave., New Haven, Conn.

Circle 355 on Inquiry Card

Test Equipment Catalog

This 8-page, 2-color catalog presents specs., descriptions, prices and photographs of test and measurement systems. The catalog includes details on test sets for the automatic measurement of phase, amplitude, and impedance. Wiltron Co., 717 Loma Verde Ave., Palo Alto, Calif.

Circle 356 on Inquiry Card

Digital Voltmeter

Catalog 423 describes the Model 5600 DVM, which has a 22msec. reading time and a 0.005% of reading accuracy. It filters superimposed noise in 0.2 sec. and has a high CMR even when tied to grounded output. Dana Laboratories Inc., Irvine, Calif.

Circle 357 on Inquiry Card

Vibrations Analysis

Technical Review 3-64, a 40-page illustrated booklet, discusses the subject of nonlinear random vibrations. This thorough examination starts with the basic differential equation governing nonlinear, single degree-of-freedom systems. The booklet shows the instrumentation setup used in the studies. It includes an extensive bibliography. B&K Instruments, Inc., 3044 W. 106th St., Cleveland 11, Ohio.

Circle 358 on Inquiry Card

Counting Systems

Radioactivity counting systems are described and illustrated in 24-page Bulletin 7056. The new brochure describes the LOWBETA II and the new WIDEBETA II Planchet Counting Systems. It also covers the technique of low level counting, comparison of counting systems, and applications of low level counting. Technical Information Section, Beckman Scientific and Process Instruments Div., 2500 Harbor Blvd., Fullerton, Calif.

Circle 359 on Inquiry Card

DC Current Meters

This bulletin gives performance data for over 400 different dc current meters along with price information, photographs of the meters and dimensions. Portable and panel mounted meters are available to permit measurements from $1\mu\text{a}$ to 10a. full scale. As many as 23 ranges can be provided in a single instrument, all featuring accuracy better than 0.25% full scale. Greibach Instruments Corp., New Rochelle, N. Y.

Circle 360 on Inquiry Card

Facilities Brochure

This 12-page capabilities and facilities brochure describes military systems and equipment research and engineering. It outlines current research on phased arrays and control, processing, analysis, display and communication of data. Maxson Electronics Div., Great River, L. I., N. Y.

Circle 361 on Inquiry Card

Clock Movement

These digital readout clock movements can be installed in any equipment, or products, rack, console, clock case, cabinet and panel. They are designed for front or back mounting. Available in 120vac, 50 or 60 cps, 115vac, 400 cps. More data available from Pennwood Numechron Co., Tymeter Electronics, 7249 Frankstown Ave., Pittsburgh, Pa.

Circle 362 on Inquiry Card

Phase Bridge

Application Note No. 7 describes an insertion loss insensitive microwave phase bridge. Detailing the operation of this bridge, which is capable of better than 1° accuracy, the note also gives data on suggested accessory instrumentation. Weinschel Engineering, Gaithersburg, Md.

Circle 363 on Inquiry Card

Vibration Calibration

Bulletin 218114 contains complete description and specs. on the Model 892K vibration calibrator. The system calibrates accelerometers over an amplitude of 1 to 1000Gs and freq. of 1 to 10kc. Accuracy over most of this range is better than 1% with linearity and repeatability errors less than 0.1%. Kistler Instrument Corp., 8989 Sheridan Dr., Clarence, N. Y.

Circle 364 on Inquiry Card

Modules & Instruments

"Building Blocks for Analog" is an 11-page catalog which fully covers a line of analog modules and instruments. Included are descriptions and specs. of solid-state dc operational amplifiers, logarithmic modules and instruments, and power supplies; typical applications and base connections. Nexus Research Laboratory, Inc., 480 Neponset St., Canton, Mass.

Circle 365 on Inquiry Card

Allen-Bradley hot molded resistors reliably did the job entrusted to them on the historic Ranger 7, Ranger 8, and Ranger 9 missions to the moon

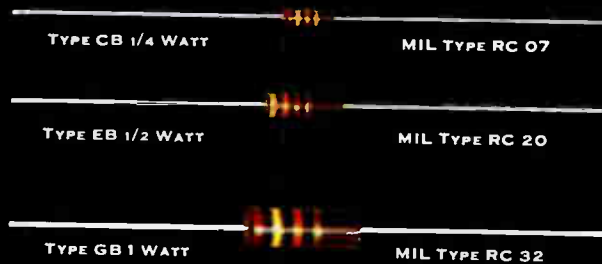

A-B HOT MOLDED FIXED RESISTORS available in all standard EIA and MIL-R-11 resistance values and tolerances, plus values above and below standard limits. Shown actual size are the resistor ratings used on the Ranger spacecrafts. Additional ratings available from A-B include the Type BB, 1/8-watt and the Type HB, 2-watt resistors.

■ The highly successful journeys of Ranger 7, Ranger 8, and Ranger 9 to the moon, which produced thousands of photographs of the lunar surface, were brilliant scientific accomplishments. The "quality" of Allen-Bradley hot molded resistors warranted their selection for this tremendously important space probe. Certainly, the faith of the Ranger engineers in the reliability of these components was justified.

Due to the exclusive hot molding process, Allen-Bradley resistors are so uniform from one resistor to the next—billion after billion—that long term performance is accurately predictable. Also, the resulting stable characteristics and the conservative ratings are your constant

guarantee of the ultimate in reliability and performance in the most critical service.

The consistent quality built into all Allen-Bradley resistors is well worth the cost of these components. When a lower price determines the purchase, you get no more than you pay for—a lower quality. At such slight savings per "device," can you afford the gamble you take with the reputation of your product?

Complete details on Allen-Bradley resistors are contained in Publication 6024—please write Allen-Bradley Co., 222 W. Greenfield Ave., Milwaukee, Wis. 53204. In Canada: Allen-Bradley Canada Ltd., Galt, Ont. Export Office: 630 Third Ave., New York, N. Y., U.S.A. 10017.



ALLEN-BRADLEY
QUALITY ELECTRONIC COMPONENTS

trying to work with two grades of resistors
is a headache—and not cheap



■ Such two grades of resistors are bound to get mixed up in production—and correcting such a mistake is expensive. It can't be expected of the assembler that he tell one grade from the other by merely looking at the resistor!

The Allen-Bradley hot molded resistors whose all-around quality has not been equaled to date—may cost a bit more, but when, for instance, RCA wired us: "The resistors furnished by you were part of the highly successful Ranger 7 mission to the moon"—doesn't this tell its own story? To satisfy top quality requirements, Allen-Bradley hot molded resistors were made available and are found in use all over the world. Now these resistors—presumably in A-1 condition—are available on the moon.

The secret of the superiority of Allen-Bradley resistors lies in craftsmanship, manufacturing know-how, and the specially designed, fully automatic production machinery. This combination produces such complete uniformity from one resistor to the next that their long term performance is accurately predictable. This has been true during the last 30 years—and will remain true for the next 30 years. Furthermore, the conservative ratings and stable characteristics of all Allen-Bradley hot molded resistors guarantee superior and reliable performance even in the most critical circuits.

For over three decades Allen-Bradley has been supplying hot molded resistors—not by the millions but by the billions

—and there has never been one instance of catastrophic failure. You should not expect to obtain such standard of performance and dependability from resistors whose only "advantage" consists of a lower price. Remember, you get what you pay for!

Protect both the "name" and the "quality" of your product by standardizing on Allen-Bradley hot molded resistors. For complete specifications, please write for Technical Bulletin 5050: Allen-Bradley Co., 222 W. Greenfield Ave., Milwaukee, Wis. 53204. In Canada: Allen-Bradley Canada Ltd., Galt, Ontario.



HOT MOLDED FIXED RESISTORS available in all standard EIA and MIL-R-11 resistance values and tolerances, plus values above and below standard limits.



ALLEN-BRADLEY
QUALITY ELECTRONIC COMPONENTS

NEW TECH DATA

Spectrum Analyzer

This brochure describes a Real Time Multiple-Filter Spectrum Analyzer. It has solid state commutation, uniform freq. response and Gaussian or Chebyshev crystal filters. Plug-in modules permit changes in bandwidth, freq. range, selectivity and dynamic range. A freq.-sharing principle permits optimum use of filters for max. economy. Damon Engineering, Inc., 240 Highland Ave., Needham Heights, Mass.

Circle 366 on Inquiry Card

Tape Equipment

Bulletin 702A describes a complete line of instrumentation-type magnetic tape recording equipment for space, oceanographic, and other scientific fields. Described are general purpose, extreme environment, special purpose and data logging type units which handle from 125 to 4750 ft. of magnetic tape. Kinelogic Corp., 29 So. Pasadena Ave., Pasadena, Calif.

Circle 367 on Inquiry Card

Wave Analyzer

Audio Wave Analyzer Model EWA-88 is fully described in this 2-page data sheet. The unit incorporates built-in electronic scan over its freq. range of 20 cps to 50kc, and provides front-end protection from off-freq. signals. Metrics Corp., 88 Church St., Amsterdam, N. Y.

Circle 368 on Inquiry Card

Readout Tube

This data sheet describes a side viewing, neon glow, numerical display tube. The NL-7037 is intended for use in large wall displays, or displays where long distance readability is important. The character can be read from 100 ft. National Electronics, Inc., Geneva, Ill.

Circle 369 on Inquiry Card

Semiconductor Catalog

This 20-page condensed catalog describes a line of transistors, FETs, microcircuits, and special products. It contains tables showing operating characteristics. Amelco Semiconductor, 1300 Terra Bella Ave., Mountain View, Calif.

Circle 370 on Inquiry Card

Design Handbook

Precision Mechanical Differentials is the subject of a design handbook and catalog. The handbook features 30 removable A-size drawings and actual test data, as well as specs., tables, and design criteria. The contents include separate sections on backlash, torque (breakaway, starting and running), load, and environmental conditions. Dynamic Gear Co., Inc., 175 Dixon Ave., Amityville, N. Y.

Circle 371 on Inquiry Card

Assembly Equipment

This 28-page catalog should be of interest to all who have anything to do with the problems of small parts assembly. Complete application data on automatic screwdrivers, nut runners, stud drivers, parts positioners, feeders, etc. are included. Dixon Automatic Tool, Inc., 2326 23rd Ave., Rockford, Ill.

Circle 372 on Inquiry Card

Laser Formulas

This comprehensive chart contains useful laser formulas, data, constants, conversion factors, and hints. Some of the data includes output wavelength and fluorescent lifetime of various solid-state systems; energy bank formulas; linear/angular conversion table; laser radar range formulas; optical formulas; table of indexes of refraction; beam shaping formulas; etc. Maser Optics, Inc., 89 Brighton Ave., Boston, Mass.

Circle 373 on Inquiry Card

Ceramic Chart

Property Chart No. 651 contains mechanical and electrical characteristics of AlSiMag technical ceramic compositions. It is a valuable working tool for anyone whose work involves design, production or purchasing of precision technical ceramics. American Lava Corp., Manufacturers Rd., Chattanooga, Tenn.

Circle 374 on Inquiry Card

Frequencies Chart

This wallet-size card lists microwave freqs. from P- to V-band and letter-freq. combinations from VLF to EHF. The 2-color card also contains a chart with the joint Army-Navy (AN) method of designating systems and equipment. Electronic Specialty Co., 4561 Colorado Blvd., Los Angeles, Calif.

Circle 375 on Inquiry Card

Lamp Socket

The 22-200 Bi-Pin Lamp Socket plugs directly into printed circuit boards. Designed for T 1¼ and T 1½ lamp outlines, this socket is ideal for computers, business machines, and other uses. More data available from Grayhill, Inc., 561 Hillgrove Ave., La Grange, Ill.

Circle 376 on Inquiry Card

Test Equipment

This 16-page catalog includes photos, descriptions, and specs. of a line of microwave test equipment and components. Sweep oscillators, sweep signal generators, microwave amplifiers, variable attenuators, levelers, sampler attenuators, crystal detectors, etc. are described. Alfred Electronics, 3176 Porter Dr., Palo Alto, Calif.

Circle 377 on Inquiry Card

Thermal Expansion Chart

A chart showing the linear thermal expansion of beryllium oxide, alumina and various metals at temps. to 1200°C is available. Six commonly used solders and brazing alloys are included in the chart. Using this chart, it can quickly be determined what metals and brazing alloys to use with beryllium oxide or alumina to achieve the optimum ceramic-to-metal seal. National Beryllia Corp., First & Haskell Aves., Haskell, N.J.

Circle 378 on Inquiry Card

IC Screen Printer

Bulletin 100 describes the Presco Model 100 Screen Printer. With its patterns of molybdenum, silver, gold-platinum, resistor compositions, glazes, colored inks, etc. can be applied to flat ceramic substrates, discs, wafers, and modules. Direct lineal micrometer adjustment between the screen and work holder provides accurate X-Y-Z and angular orientation for ease of initial alignment of pattern. Precision Systems Co., Inc., P. O. Box 148, Somerville, N. J.

Circle 379 on Inquiry Card

Precision Resistors

Type RX-15 Megamite Resistors have resistance values to 10¹²Ω. Max. working voltage is 500v., and max. amb. 100°C. Tolerance ranges are 2, 5, 10%. Specified resistance rating is given at 20v. (±1v.) and at 25°C as standard procedure. In most applications noise level is negligible. Complete details available from Victoreen Instrument Co., 10101 Woodland Ave., Cleveland, Ohio.

Circle 380 on Inquiry Card

Pin Rectifiers

The Series MM microminiature PIN rectifiers exhibit sharp breakdown characteristics, fast recovery time, high efficiency, and low capacitance. Output current varies from 500ma for 50 PIV units to 125 ma for the 2800 PIV units. Leakage current is 0.1µa at rated PIV. Complete details available from Solitron Devices, Inc., 256 Oak Tree Rd., Tappan, N.Y.

Circle 381 on Inquiry Card

Application Guide

A 20-page booklet entitled, "Application Guide for Superconducting Magnets" is available. It covers the definition of a superconducting magnet; the basic components of such a system; and the various magnet and dewar types. Operating procedures and economic advantages of the magnets are described. Typical applications are shown in tabulated chart form. In addition to the charts, numerous photographs and diagrams illustrate the booklet. Westinghouse Cryogenic Systems Dept., P. O. Box 8606, Pittsburgh, Pa.

Circle 382 on Inquiry Card

This P&B relay switches 20 amperes, costs only \$3.90* each, is available from leading parts distributors...

and it's this small



Here is a real space-saving power relay—ideal for applications where limited space is a factor. *Three* KR3 relays will fit in the space required for *one* 20-ampere relay of most other makes. The KR3 occupies only little more than one and a half cubic inches.

Installation is simple, too. Standard KR3 relays have a convenient stud and mounting tab—and the contact terminals will accept $\frac{1}{4}$ " quick-connects or solder connections.

Field-proved for more than a year, the KR3 is available for immediate

shipment from authorized P&B distributors. Tests show mechanical life will exceed one million operations . . . and the twin contacts are rated at 20 amperes at 115V AC, 60 cycles resistive or 28V DC, 1 HP 115/230V 60 cycles.

Relays ordered from the factory can be supplied in clear, high-impact polycarbonate case with octal plug.

For complete information, call your nearest P&B sales representative or write direct. Remember . . . you can buy cheaper relays but you cannot buy P&B quality for less.



ENGINEERING SPECIFICATIONS

GENERAL:

Insulation Resistance: 1000 megohms.
 Expected Life: 1 million mechanical operations, min.
 Breakdown Voltage: 500V rms 60 cycles bet. all elements.
 Temperature Range | AC and DC: -45°C min.
 Open Relay | AC: +70°C max.
 DC: +85°C max.

CONTACTS:

Arrangements: SPST-NO-DB (1 Form X) only.
 Rating: 20 amps @ 115V AC, 60 cycles resistive, or 28V DC; 1 HP 115/230V 60 cycles.

COILS:

Voltage: DC: to 110V
 AC: to 230V
 Power: DC: 1.2 watts min.
 AC: 2.0 volt-amps.
 Resistance: 16,500 ohms maximum.
 Duty: Continuous.

MOUNTING:

Open: One 6-32 stud and $\frac{1}{4}$ " locating tab on $\frac{7}{16}$ " centers.
 Enclosed: Octal socket.

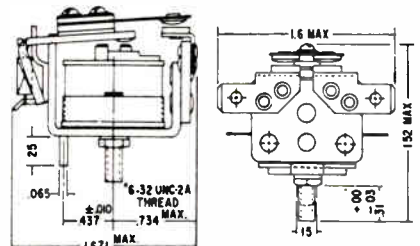

*Unit price for 6 to 115V AC models.
 Quantity discounts available.

RIDE THE AMF MONORAIL AT THE NEW YORK WORLD'S FAIR



POTTER & BRUMFIELD

Division of American Machine & Foundry Company, Princeton, Indiana
 In Canada: Potter & Brumfield, Division of AMF Canada Ltd., Guelph, Ont.
 Export: AMF International, 261 Madison Avenue, New York, N.Y.

NEW TECH DATA

Connector Catalog

"Capsule Catalog" No. LPX-64 contains data on the LPT—a low-cost, bayonet-locking tri-cam connector. The series is available in shell sizes 8 through 24, in 23 insert configurations, in either pin or socket arrangements. This new series meets the requirements of Mil-C-26482. The Deutsch Co., Electronic Components Div., Municipal Airport, Banning, Calif.

Circle 383 on Inquiry Card

Solenoid Guide

Catalog 101S, 24 pages, provides a general working knowledge of the factors influencing the design and operating characteristics of solenoids. Included is a master selector chart for push or pull solenoids, which enables every solenoid user to translate sets of design requirements into a unit giving the desired quality and dependability at the lowest possible cost. Electroid Corp., 95 Progress St., Union, N.J.

Circle 384 on Inquiry Card

Photocell

The Cadmium Sulfide photocells described in this data have heavy 0.083 in. bases, as compared to the industry norm of 0.010 to 0.020 in. These new, rugged bases give photocells long life performance. They are structurally strong packages that will not flex under atmospheric changes. The Pioneer Electric & Research Corp., div. of Penn Controls, Inc., 743 Circle Ave., Forest Park, Ill.

Circle 385 on Inquiry Card

Bus Assemblies

This brochure describes the Laminar Bus Assembly—comprised of flat conductive bars interleaved with ground planes and insulation. The bus assembly can be engineered for low inductance, low characteristic impedance, and high capacitance. Thus it will dampen stray noise, eliminate cross-talk, improve low level signal transmission, and minimize voltage drop. Rogers Corp., Rogers, Conn.

Circle 386 on Inquiry Card

Production Machines

A new 16-page fully illustrated catalog describing Tweezer-Weld automatic small parts production machines is available. The catalog describes 16 machines, ranging from a semi-automatic cathode tabbing machine to an automated bi-reed switch production facility. Sequences of operation of each machine illustrated, and a page of detailed sketches describing the forming and assembly operations used to produce a typical small part are included. Federal Tool Engineering Co., 1386 Pompton Ave., Cedar Grove, N. J.

Circle 387 on Inquiry Card

Semiconductor Catalog

This 28-page microwave semiconductor catalog contains complete electrical and mechanical specs. for mixer and detector diodes, power varactors, PN switching diodes, tunnel diodes and harmonic generator circuit characterized varactors. Photographs and outline drawings are included as well as complete instructions for ordering and specifying microwave semiconductors. Microwave Associates, Inc., Northwest Industrial Park, Burlington, Mass.

Circle 388 on Inquiry Card

Battery Manual

Bulletin 6770 entitled, "The Nickel-Iron Industrial Storage Battery" explains the fundamental principles, operation and care of this type of battery. The manual's 27 pages of text, charts, graphs and other illustrations offer a detailed review of operating characteristics, and provide a comprehensive digest of basic data of interest to all users of this type of energy source. The Electric Storage Battery Co., Rising Sun & Adams Aves., Phila., Pa.

Circle 389 on Inquiry Card

Connector Catalog

Catalog MC-1, 48 pages, covers a complete line of miniature connectors for military and commercial uses. It includes photos and dimension drawings of connectors meeting Mil-C-26500, Mil-C-26518 and Mil-C-38300 along with a listing of the performance characteristics of each. Amphenol Connector, 1830 S. 54th Ave., Chicago, Ill.

Circle 390 on Inquiry Card

Integrated Circuits

Data is available on a new family of passivated, monolithic, epitaxial, silicon-integrated DTL circuits. The SW 930 Dual NAND Gate consists of a 2-input plus expander NAND Gate and a 3-input NAND Gate. These gates operate at 10mc with typical propagation delays of 20nsec. into a 15 pf load. The SW 931 RS/JK Clocked Flip-Flop features low output impedance in both high and low states. Stewart-Warner Corp., 1826 Diversey Pkwy., Chicago, Ill.

Circle 391 on Inquiry Card

Oscillator

This data describes an all solid-state, high-level differential voltage-controlled oscillator. It has an input impedance greater than 10 megohms on both inputs. The Model 501-100 uses a new type crystal referenced circuit which provides state-of-the-art performance in stability and linearity. Center freq. and deviation sensitivity are determined by standard plug-ins that are available for all standard IRIG and constant bandwidth freqs. Astrodata Inc., 240 E. Palais Rd., Anaheim, Calif.

Circle 392 on Inquiry Card

Ferrite Isolators

Data is available on ferrite isolators which cover the freq. bands 5925—6425mc, 5925—6175mc and 6175—6425mc. The CIC4 has a max. forward loss of 0.35db, and a min. reverse loss of 35db. The vswr is 1.02:1. The CIC5 and CIC6 are resonance isolators with forward and reverse loss of 0.5db min. and 25db max. respectively. Both have a vswr of 1.06:1. Complete details available from The M-O Valve Co. Ltd., Brook Green Works, London W.6, Riverside 3431.

Circle 393 on Inquiry Card

Operational Amplifier

Data is available on the H-6000 operational amplifier. It has an input impedance of 10 megohms differential and 100 megohms common mode. Input offset is less than 500 μ v and 10na with temp. drifts less than 10 μ v/ $^{\circ}$ C and 1na/ $^{\circ}$ C. Response to supply voltage variation is 10 μ v/% and 0.1na/%. Union Carbide Electronics, 365 Middlefield Rd., Mountain View, Calif.

Circle 394 on Inquiry Card

Tool Catalog

A 32-page catalog containing a comprehensive line of specialized tools for microelectronics production and research is available. Catalog 435 was designed, illustrated, and written to fill the needs of all those doing microelectronic work. Hammel, Riglander & Co., Inc., P. O. Box 222, Village Station, New York, N. Y.

Circle 395 on Inquiry Card

Solvent Brochure

This brochure describes Genesolv-D, Electronic Grade, a special solvent used for precision cleaning. It is used for cleaning electronic components, missile hydraulic systems, scientific instruments, motors, liquid oxygen equipment and other special equipment requiring chemically inert solvents. Charts on the solvent's physical properties, threshold limit values, surface tension, etc., are contained in the booklet. General Chemical Div., Allied Chemical Corp., P. O. Box 353, Morristown, N. J.

Circle 396 on Inquiry Card

Current Regulators

Data is available on compact 2 terminal current regulators which use module techniques. The units operate from 10 to 50vdc, while maintaining output current to within 1% of the preset value. Standard current values are 3-30ma for Model CR3 and 20-50ma for Model CR5. Temp. coefficient of current is held to 0.03%/ $^{\circ}$ C throughout an operating temp. range of -55 to +125 $^{\circ}$ C. Vibration, shock, acceleration and humidity are in accordance with Mil-E-5272A. Crescent Engineering & Research Co., 5440 N. Peck Rd., El Monte, Calif.

Circle 397 on Inquiry Card

Limitron Fuses

...for the Protection of Semi-Conductor Rectifiers



LIMITRON fuses provide extremely fast opening on overload and fault currents, with a high degree of restriction of the let-thru current.

If each SCR and individual diode is protected by a proper size Limitron fuse, the fuse will open to protect the unit when the current drawn exceeds the rating of the unit. Thus the SCR or individual diode is taken out of the circuit before damage can be done to other diodes in the rectifier.

For full information and opening time charts ask for BUSS Bulletin HLS.

MORE **BUSS QUALITY** FUSES

BUSSMANN MFG. DIVISION
McGraw-Edison Co., St. Louis, Mo. 63107

For Protection of

NEW TECH DATA

Coil Form Tubing

Data is available on coil form tubing that meets the requirements of miniaturized magnetic windings. Wall thickness is 0.005 in. and cross sections is 1/4 in. sq. or less. Fiberglass cloth 0.001 in. thick and Class F epoxy resin are the ingredients. Stevens Tubing Corp., 128 N. Park St., E. Orange, N. J.

Circle 331 on Inquiry Card

Rotating Devices

This 50-page catalog describes a line of synchros, resolvers, dc motors, counters, tachometers, and angle indicators. Photos and operating curves are included. Clifton Precision Products, Clifton Heights, Pa.

Circle 332 on Inquiry Card

Mechanical Plastics

The 6 most commonly used mechanical thermoplastics—TFE fluorocarbon, nylon, acetal, polycarbonate, phenolic, acrylic, and the new Delrin AF bearing stock—are analyzed in an 8-page brochure. It discusses the advantages and limitations of each plastic, typical uses, and methods of fabrication. Cadillac Plastic & Chemical Co., 15111 Second Ave., Detroit, Mich.

Circle 333 on Inquiry Card

Vibration Isolators

Bulletin 2.23 describes in detail the advantages and characteristics of the new series E21 isolators. It includes photographs, specs., dimensioned drawings, load range chart, and curves showing load vs. deflection and load vs. natural freq. characteristics. Barry Controls, 700 Pleasant St., Watertown, Mass.

Circle 334 on Inquiry Card

Power Rectifiers

"Guide to Industrial Rectifiers," 64 pages, illustrates and provides specs. on 30 examples of stock and custom-made dc power supply rectifiers. Units for uses such as: electrolytic gas production; general purpose 250v. industrial power; synchronous motor excitation; battery charging; and capacitor manufacturing are described. Request on company letterhead from The Meaker Co., subs. of Sel-Rex Corp., Nutley, N. J.

Circle 334 on Inquiry Card

Integrated Circuits

SU-Series Utologic integrated circuits, especially suited to military GSE and severe environment industrial applications, is described in a 22-page brochure. Data on the 7 circuit family of ANDs, NORs, and a J-K binary element includes typical characteristics and subsystem uses. Operating range is -20 to +85°C. Signetics Corp., 811 E. Arques Ave., Sunnyvale, Calif.

Circle 336 on Inquiry Card

Module Rack

The 5 1/4 x 11 in. module rack can be used with any combination of 1, 2, 4, or 8 in. modules, and will also accept PC cards in combination modules. The rack makes it possible to package a power supply and circuit boards or a memory unit and logic boards into 1 compact unit. For complete details and price information contact Vero Electronics Inc., 48 Allen Blvd., Farmingdale, N. Y.

Circle 337 on Inquiry Card

Zener Regulators

Data Sheet 503-B describes the Series HW-6.8 thru HW-91 microminiature lw. zener regulators. They replace conventional metal cased zeners without circuitry changes. The data sheet contains specs., diagrams, a nomograph, and curve. Hoffman Electronics, Semiconductor Div., El Monte, Calif.

Circle 338 on Inquiry Card

Optics & Systems

This 8-page brochure details Perkin-Elmer's capabilities in optical components, devices, systems, consultation, design and engineering. The booklet, "Optics Plus," describes facilities for large and small components and devices for use from the vacuum ultraviolet to the far infrared. Computer design facilities for optics and systems are described as are manufacturing and testing equipment. Optical Operations, Perkin-Elmer Corp., Main Ave., Norwalk, Conn.

Circle 339 on Inquiry Card

NEW TECH DATA

Voltage Stabilizers

GEA-7358B, 8 pages, describes the the Stabiltron line of ac voltage stabilizers. Models are now available in ratings of 0.5, 1, 2, 5 and 10 kva. They maintain extremely precise voltage output in spite of wide fluctuations of line voltage, load, load power factor, freq. and amb. temp. General Electric Co., Schenectady 5, N.Y.
Circle 340 on Inquiry Card

Anhydride Hardeners

Data on anhydride hardeners for epoxy resins is presented in a 42-page brochure. It contains tables never before published. The revised booklet presents a large bibliography as well as new data on applications for filament winding. Twenty-six tables and 7 graphs are included. Allied Chemical Corp., 40 Rector St., New York, N. Y.
Circle 341 on Inquiry Card

Programming Systems

This catalog describes a complete line of patchboard and programming systems. It gives complete electrical and mechanical specs. on systems ranging from 240 to 5120 contacts. A broad line of manual and semi-permanent patchcords in lengths from 3 to 45 in. is also described. CAM Corp., Box 10325, Greensboro, N.C.
Circle 342 on Inquiry Card

Heat Sink

Model 2910 uses a "T" design to provide optimum heat dissipation performance for low and medium power transistors. The fin arrangement gives 15.5 sq. in. of effective surface area in a $1\frac{1}{4} \times 1\frac{1}{4} \times \frac{3}{4}$ in. size. It achieves an efficient heat transfer coefficient in free convection or forced convection flow. Astro Dynamics, Inc., Second Ave., N.W. Industrial Park, Burlington, Mass.
Circle 343 on Inquiry Card

Article Abstracts

Abstracts of articles on topics from aerospace and computer technology are contained in "Mesa Mentions." This monthly publication is provided as a time-saving service to those interested in computer engineering, data of processing and related subjects. Mesa Scientific Corp., 1833 E. 17th St., Santa Ana, Calif.
Circle 344 on Inquiry Card

Variable Blowers

Airflow flexibility in heat removal is offered in this line of packaged cooling equipment. Any of 4 basic air discharge directions may be specified to provide a higher level of cooling efficiency for specific conditions. Air may be discharged diagonally upward, vertically upward, from top rear of blower etc. McLean Engineering Laboratories, P. O. Box 228, Princeton, N. J.
Circle 345 on Inquiry Card

Switch-Lite Assembly

A Switch-Lite assembly, incorporating a subminiature micro switch and illuminated plunger with independent lamp circuit, is described in this product bulletin. The compact device is ideal for designs requiring a SPDT switch with an integral pilot light. It permits separate or simultaneous operation of the switch and light. Minimum life is 25,000 cycles. The Ucinite Co., div. of United-Carr Inc., Newtonville, Mass.
Circle 346 on Inquiry Card

Oxide Substrates

Data is available on beryllium oxide substrates for thin film uses. The standard size is 1 in. sq. x 0.025 in. thick, with one surface lapped to a finish of 10 rms. The substrates are also available in other sizes and specs. National Beryllia Corp., First & Haskell Aves., Haskell, N. J.
Circle 347 on Inquiry Card

Inductive Devices

"Inductive Devices" is a 20-page, 3-color catalog. It covers the following product areas: encapsulated r-f chokes, encapsulated variable inductors, encapsulated subminiature and miniature variable inductors, encapsulated subminiature and miniature toroidal inductors, etc. The work provides descriptions, application notes, and general features of each product line. Vanguard Electronics Co., 930 W. Hyde Park Blvd., Inglewood, Calif.
Circle 348 on Inquiry Card

Semi-Conductor Rectifiers

Limitron Fuses

... for the Protection
of Semi-Conductor Rectifiers

LIMITRON fuses are available in ampere sizes up to 800 and voltages up to 600.

They come in various types and sizes to fit various types of application.

Should you have a special problem, our staff of fuse engineers are ready to assist you at any time.

For full information on LIMITRON fuses for the Protection of Semi-Conductor Rectifiers ask for BUSS Bulletin HLS.

MORE **BUSS QUALITY** FUSES

BUSSMANN MFG. DIVISION
McGraw-Edison Co., St. Louis, Mo. 63107

Circle 112 on Inquiry Card

World Radio History

This is Siemens

Never before has electrical engineering covered such a wide field as today. This extends from the thin magnetic films of high-speed memories to the mammoth dimensions of modern turbine generators. Electrical systems operate with subminiature waves only a thousandth of a millimeter in length as well as low-frequency waves up to several kilometers in length. Research has penetrated into a subtemperature region only a few degrees above absolute zero. For its plasma investigations it generates temperatures approaching that of the sun. Reactor technology harnesses the inmost forces of the atomic nucleus. Communications satellites circle the earth.

These extreme achievements give an idea of the broad range of our activities, which extend all the way from the study of first principles to the ultimate development of new products. That is why the Siemens Group keeps 15,000 of its employees assigned to R&D projects alone. The results of their efforts are of concrete benefit to all of our customers: every system that leaves our factories and every system we install reflects the sum total of the experience acquired and evaluated daily at our R&D laboratories.



Components Plant, Munich

Siemens Polystyrene "Styroflex" Capacitors

"Mica" properties at "paper" prices

Unique properties of Polystyrene and the method of manufacture developed by Siemens (The polystyrene is stretched and stabilized in the stretched condition before winding. After winding, special heat treatment shrinks the film, forming a hard, stable body.) results in low cost STYROFLEX capacitors which offer:

Reliability: 1) against voltage breakdown (assured by tests on each unit at 3.3 times rated voltage). 2) in the microvolt range (assured by positive welded contacts between foil and leads).

Stability against change in capacitance over long periods of time is one result of the solidity and hardness of the capacitors... produced by the special film shrinking manufacturing process.

Low Self-Inductance: values as low as for extended-foil construction.

Low Dissipation Factor: usually even lower than for mica capacitors, making them especially suitable for filter circuits.

High Resistance to Humidity: polystyrene has the lowest water absorption coefficient of all capacitor dielectric materials.

Highest Insulation Resistance: higher than for any other kind of dielectric.

Immediate Shipment: substantial stocks are held in White Plains, N.Y.

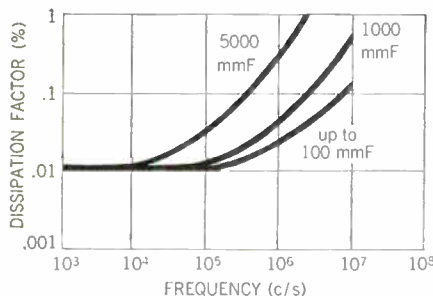
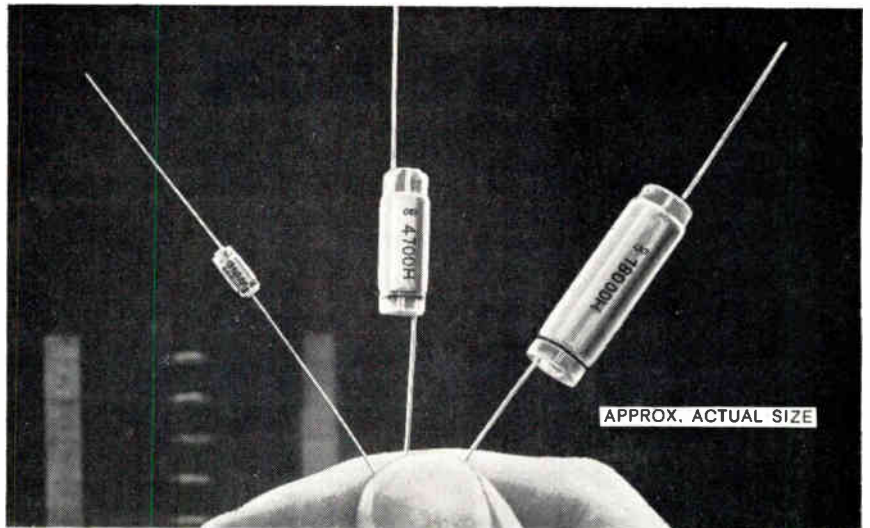

Low dissipation factor (usually even lower than for mica capacitors) is provided by Styroflex capacitors... making them specially suitable for filter circuits.

SIEMENS AMERICA INCORPORATED
Components Division
230 Ferris Avenue, White Plains, N. Y.

In Canada:
SIEMENS HALSKE SIEMENS SCHUCKERT (CANADA) LTD.
407 McGill Street, Montreal 1, P.Q.

NEW TECH DATA

Air Capacitors

This 12-page catalog lists 88 types of standard variable air capacitors. It also gives designers of OEM equipment a glimpse of a few special capacitors developed for space-age exotic uses. Hammarlund Mfg. Co., 73-88 Hammarlund Dr., Mars Hill, N. C.

Circle 311 on Inquiry Card

Zener Chip Diodes

Data is available on hermetic zener chip diodes which feature low-temp. glass passivation and alloy junction in an area 0.050 sq. and 0.30 in. deep. Electrical characteristics meet or exceed equivalent 400mw glass diodes. Alloy junctions permit production of zeners in the 3.3v. to 12v. range. Diffused zeners in chip form cover the 7.5v. to 100v. range. U. S. Semiconductor, 3540 W. Osborn Rd., Phoenix, Ariz.

Circle 312 on Inquiry Card

Crystal Sockets

Data Sheet 31A contains dimensional drawings, descriptive technical data and illustration of a new line of miniature and subminiature printed circuit and conventional solder lug crystal sockets. They may be used for crystals with 0.486, 0.273 and 0.192 pin centers and with 0.050 or 0.040 pin dia. Connector Corp., 6025 No. Keystone Ave., Chicago, Ill.

Circle 313 on Inquiry Card

Solving Problems

How major corporations handle hard-to-crack scientific/technical problems without adding lab equipment, research personnel, or administrative overhead is described in a new brochure, "The Scientific Side of Industry." Examples of specific problems solved in recent years are given. How to command the resources of many specialists so as to handle these problems is also described in this 12-page brochure. Bjorksten Research Laboratories, Inc., P. O. Box 265, Madison, Wisc.

Circle 314 on Inquiry Card

Insulating Varnish

Data is available on an aerosol spray insulating varnish that gives visual check on the thickness of the coating applied. Thickness is determined by matching the color of the applied spray with a color gauge chart on the can. The spray is used to insulate armature and stator windings, coils, to protect leads, restore dielectric properties, etc. Crown Industrial Products Co., 145 State Line Rd., Hebron, Ill.

Circle 315 on Inquiry Card

Storage Unit Manual

This 25-page document covers all details of the 5025 DISCHILE® storage unit. Included are application data, major design features, access and capacity data and interfacing considerations. The 5025 can be easily integrated into custom digital data handling equipment. DISCHILE Div., Data Products Corp., Culver City, Calif.

Circle 316 on Inquiry Card

Replacement Guide

This 24-page guide simplifies replacement of almost all transistors, diodes, and rectifiers found in entertainment products. Each ET unit is classified by circuit function. Tung-Sol Electric Inc., Newark 4, N. J.

Circle 317 on Inquiry Card

Zener Wall Chart

This wall chart lists in detail military and commercial zener diodes, voltage references, multi-current references, certified and industrial references. The chart further describes ranges and representative specs. for each. Transitron Electronic Corp., 168 Albion St., Wakefield, Mass.

Circle 318 on Inquiry Card

Motor Catalog

A complete line of induction motors and blowers is described in this catalog. Complete specs. are included, together with graphs and tables of performance. Fasco Industries, Inc., Augusta at North Union, Rochester, N. Y.

Circle 319 on Inquiry Card

Semiconductor Wall Chart

This wall chart is a replacement and interchangeability guide for transistors (EIA types, manufacturers replacements, and foreign substitutes) and germanium diodes (EIA types, foreign and misc.). Recommended use and base diagrams are included. Semitronics Corp., 265 Canal St., New York, N. Y.

Circle 320 on Inquiry Card

INSULATIONS? THINK 3M!

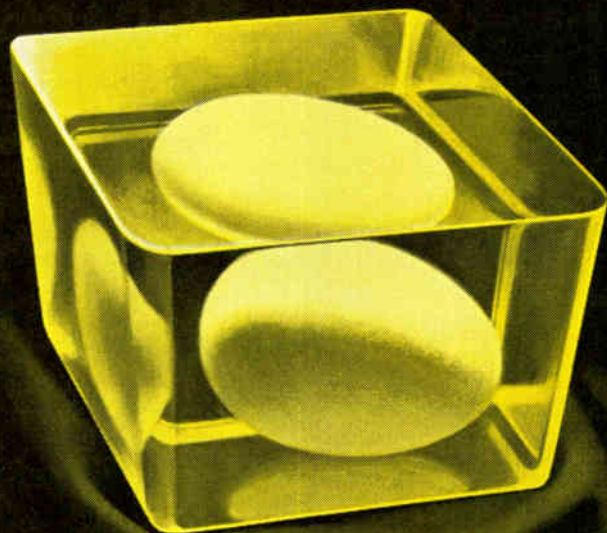

Attenuators Catalog

Catalog A-15, 32 pages, describes a complete line of attenuators. The catalog features tables, schematics, and photographs. Daven, Livingston, N. J.

Circle 321 on Inquiry Card

Preamplifiers

This application bulletin will assist the design engineer and user in the application of the SP series of solid-state preamps. The bulletin defines the capabilities and limitations of the preamps and system-preamp interface. The data contains typical curves, noise figure, input and output vswr, etc. Applied Technology Inc., 3410 Hillview Ave., Stanford Industrial Park, Palo Alto, Calif.

Circle 322 on Inquiry Card

Silicone Elastomer

Data is available on a silicone elastomer which protects semiconductor surfaces. It operates from -40° to $+250^{\circ}\text{C}$; has a voltage capability of 1kv; and protects against flash and contamination. Transene Corp., 121 Conant St., Danvers, Mass.

Circle 323 on Inquiry Card

Voltage Reference

Bulletin 96401 describes the Model VRS-611 Portable Voltage Reference Source. Theory of operation, applications, and various options are discussed. Data contains specs. and block diagrams. Epsco Inc., Data System Products Div., 411 Providence Hwy., Westwood, Mass.

Circle 324 on Inquiry Card

NEW TECH DATA

Rectifiers Catalog

A new line of miniature flangeless silicon rectifiers, designated Series A, is covered in Bulletin 112. Said to offer equal or better ratings than larger top-hat package types, the new silicon rectifiers offer flexible axial leads and flangeless construction. The sheet includes a dimensional drawing and complete electrical rating data and specs. Edal Industries, Inc., 4 Short Beach Rd., East Haven, Conn.

Circle 325 on Inquiry Card

Power Supply News

A technical bulletin concerned with the many aspects and uses of electronic power supplies is available. It is intended as an aid to anyone concerned with understanding the capabilities of power supplies. The current issue, Vol. 5, #146-1089, contains 6 pages, 4 of which are devoted to an engineering presentation. Kepco Inc., 131-38 Sanford Ave., Flushing, N. Y.

Circle 326 on Inquiry Card

Wire Catalog

Catalog Section C contains data on switchboard and rheostat wire and cable for industrial and military use. Included are wires and cables for use in swinging panels, switchboards and other types of control apparatus, and for open wiring of rheostats, switchboards, control panels and ovens where oil, grease, corrosive vapors and/or moisture is present along with elevated temps. Continental Wire Corp., 322 N. Cherry St., Wallingford, Conn.

Circle 327 on Inquiry Card

Lamp Catalog

Virtually every microminiature lamp now available in the industry is described in this new catalog. These microminiature lamps come in lengths as short as 5/32 in. and dia. as small as 3/32 in. Life is approx. 100K hrs. Both based and unbased styles are described, including the newly designed axial lead types. Request Form 103 from Hudson Lamp Co., Kearny, N. J.

Circle 328 on Inquiry Card

Magnetic Shields

Data Sheet 177 illustrates and describes various photomultiplier magnetic shields. The units can be shorter in length and yet give better protection from magnetic fields than shields previously available. Magnetic Shield Div., Perfection Mica Co., 1322 No. Elston Ave., Chicago, Ill.

Circle 329 on Inquiry Card

Variable Inductors

Bulletin 145 describes the 15-series variable inductors which operate in the 20kc to 100mc range. The series find use in high-Q tuned circuits, such as filters and tank circuits. They are designed and built to meet Mil-C-15305. Aladdin Electronics, 703 Murfreesboro Rd., Nashville, Tenn.

Circle 330 on Inquiry Card

New Scotchcast[®] Poly U Resin protects like silicone, costs less

New "Scotchcast" Brand Poly U is an easy handling, room or oven-curing, flexible polyurethane resin system. Ideal for encapsulating or coating delicate electrical or electronic devices. Equal or better than silicones in most important properties, at far less cost. Low-viscosity, penetrates easily into fine windings . . . cures into a void-free insulation shield. Extremely flexible . . . prevents squeeze or vibration shock on critical components . . . can even protect a fragile egg. Completely transparent for quick visual inspection of parts. Easy to use "Scotchcast" Poly U is highly resistant to heat, cold, moisture and abrasion. Far less toxic than other polyurethanes. Two-part mixing ratio, long pot life and low exotherm assure safe, easy handling. For facts on this and other new polyurethanes see your 3M "IQ" Man*.



"IQ" means Insulation Qualified. Your 3M Man is trained and qualified to advise and assist with insulation problems. Call him or write: 3M Co., St. Paul, Minn. 55119

Electrical Products Division 

TAPES • RESINS • TUBING • VARNISHES • COATED FABRICS • LAMINATES • MICA PRODUCTS

Circle 114 on Inquiry Card

ELECTRONIC INDUSTRIES • June 1965



Free fact-filled bulletin on Sola voltage regulators!

Get this practical, useful information on how, when and where to use Sola Constant Voltage transformers. Get top performance and full service life from electrical and electronic circuits which are sensitive to ever-present voltage fluctuations; write today for

the bulletin that has the answers to these costly problems.



Sola Products Cataloged in VSMF and Thomas' Micro-Catalog

Please send me your free, fact-filled bulletin on Sola voltage regulators.

Name

Title

Company

Address

City State Zip

EDITOR'S NOTEBOOK

IGNITION NOISE may now be eliminated, permitting long range two-way radio communications noise-free, reports Estes Engineering Co., Gardena, Calif. The firm's new product, Electro-Shield Kits, eliminates noise by shielding and filtering noise at its sources, such as spark plugs, ignition coil, etc.

DIAL 'M' FOR METALLURGY might be a librarian's reply to a scholar or scientist numbed by the vast and complex catalog methods used to retrieve science data. Current USAF-supported research at Lehigh University is concentrated on developing an automated telephone-like dial and code system for retrieving data. Research also includes classifying style-level or readability of data, and ways to express language in mathematical or logical forms for computer analysis.

ATOMIC ENERGY is being used by American Broadcasting Company to spot trouble in TV transmitting antennas—even on the Empire State Building 1400 feet above street level. Picker X-ray Corp. engineers use isotopes to take "see-through" pictures of coaxial lines to pinpoint hidden breaks in the lines without shutting down the transmitting system. The alternative is to dismantle some 400 feet of cable for visual examination.

SMOKE SNIFFER and fire detector, electronic, that "smells" smoke and other combustion gases, almost before there is any, is now being marketed by BRK Electronics, Skokie, Ill. The device, according to BRK, can be hooked to any alarm system approved by U.L., and is able to give advance warning when fire is about to occur! A smoldering short circuit may be detected hours or days before any other device would suspect danger.

COMPUTER SIMULATION is not only teaching sailors and officers how to man an attack center of a nuclear submarine but is apparently doing it so well that trainees emerge after several hours of nerve-jangling reality almost believing they have been through a major undersea battle. Three attack centers at the U.S. Naval Submarine School, New London, Conn., are controlled by a huge Honeywell 800 digital computer. Equipment, dials, levers, knobs are operational, or are painstakingly accurate facsimile.

COLOR TELEVISION will have shown more than 2.6 million visitors to themselves at the RCA Pavilion by the time the New York World's Fair ends later in 1965. Visitors actually see themselves twice, once live as they stand and gape, strike a Barrymore pose, or make funny faces, and again moments later on another color set through videotape.

DO-IT-YOURSELF computer service centers have opened in eight major cities across the nation. Data-Mat, originated by Statistical Tabulating Corp., Chicago, allows customers to drive up and process data on a choice of systems, including a high-speed Honeywell 200, much as a housewife drops in at the local laundromat. There is free parking, too!

PROCESSED BOOKKEEPING is helping accountant John Hayes, Richardson, Tex., to keep many clients happy. Clients turn over entire accounting problems and routines, and each client and transaction is assigned a numeric code. Once a month Mr. Hayes takes punched client tapes to nearby GE Data Processing Center. Client gets monthly ledger sheet and year-to-date statement.

ELECTRONIC PACKAGE, designed to evaluate new uses of molecular components in aerospace equipment, may also be valuable to the foot soldier. The one-pound, five-inch long device, built by Westinghouse, called a command control receiver, could provide combat infantry with silent attack signals that defy enemy detection. The device has eight tiny lights which could be code signalled to light in various combinations.

TELEPHONE AMPLIFIER, useful for noisy ticket offices, now being produced in London by Magnetic Broadcasting Co. Ltd. No cords, suction pads or connections needed, says the firm. The head, Magnifone Mark VII, is about the size of a telephone earpiece. It contains an induction pickup, four-transistor amplifier and directional loudspeaker. Telephone receiver is hung behind instrument head which activates automatically.

COMPUTER SYSTEM that will "help out in the kitchen" and assist the clinical laboratory—in addition to doing routine accounting duties—will soon be in operation in North Memorial Hospital, Minneapolis. The system, NCR 315, will printout individual patient menus, plus patient data for all other hospital routines. This jack-of-all-trades will furnish doctors with daily lab reports.

WE'LL DESIGN YOUR MAGNETIC SHIELDS



About 80% of all magnetic shield designs now in use originated here.

Maybe it's because our designs work. Maybe our designs work because we've had the most experience. All are good reasons to contact us.

Netic and Co-Netic magnetic shields are the recognized standard all over the world for military, laboratory, industrial and commercial applications. They are insensitive to ordinary shock, do not require periodic annealing, and have minimal retentivity. A few typical applications are illustrated. Our design department is yours.

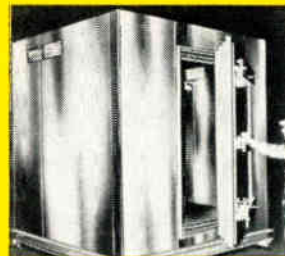

Magnetically Shielded Room



CRT Shield Complex



Scan Converter Shield

Sectionalized P.M. Shield



Nesting Cans

MAGNETIC SHIELD DIVISION

Perfection Mica Company

1322 N. ELSTON AVENUE, CHICAGO, ILLINOIS 60622

ORIGINATORS OF PERMANENTLY EFFECTIVE NETIC CO-NETIC MAGNETIC SHIELDING

Circle 116 on Inquiry Card

DIGI EC

NEW

LOW-COST MODULE DIGITAL READ-OUT

.1% Accuracy - .02% Resolution

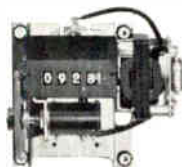

Digital Read-Out \$115.00
Base Price

- Single or Multi-Range
- Linear or Special Function Reference such as Log, Inverse Log, etc.
- 1000, 2000 or 4000 Digits Full Scale Display

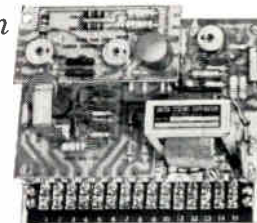

Amplifier \$125.00
Base Price

- All Solid State with silicon transistors
- 50 db AC rejection @ 60 CPS
- Floating or grounded input
- Full scale input 100 MV to 1000 V-DC
- Operates from 115 V-AC-28 watts

Mount & interconnect—2 compact and reliable modules to provide fast and accurate digital read-out for voltage or transduced parameter input.

UNITED SYSTEMS CORPORATION

918 Woodley Road, Dayton 3, Ohio (513) 254-3567

Stocking Representatives throughout the World.

TRANSFER
AC Accuracy



within $\pm 0.01\%$
Calibration traceable to NBS

RFL Model 400 AC/DC Voltage Transfer Standard

For standardizing AC voltages from 0.25 to 1000 volts, at frequencies from 15 c/s to 50 kc/s over eleven full-scale ranges. Potentials at frequencies up to 500 kc/s can be measured at reduced accuracies. RFL Model 60 High Frequency Thermal Converters for standardizing AC potentials up to 75 volts at frequencies up to 30 megacycles can also be used.

Completely self-contained, this thermal voltage converter contains many features, including an audio frequency voltage multiplier, thermocouple, galvanometer, galvanometer sensitivity keys, balancing controls, a 3-function monitoring meter and batteries for the galvanometer lamp and thermocouple balancing supply.

The main function selector has four positions: AC Meter, DC Meter, Thermocouple AC, and Thermocouple DC. The AC Meter position allows the self-contained 6-inch monitoring meter to measure the AC emf applied to the instrument. The DC Meter position monitors the applied DC reference voltage. The AC and DC Thermocouple positions apply the appropriate emf to the thermocouple for precise balance adjustment. A feature of these TC functions is the use of the monitor meter to indicate the thermocouple output emf while balance is being attained. A reversed DC position is provided to enable a check of the DC reversal characteristics of the thermocouple without reversing the DC reference external connections.

The equipment case is vinyl covered aluminum and includes a cover (not shown). For complete information contact Radio Frequency Laboratories, Boonton, N.J.

PRICE \$775.



Circle 118 on Inquiry Card

INTERNATIONAL NEWS

London—STC Components Group is offering a choice of infra-red filters for the wavelength range from 5,000 to 1,400. STC reports the rugged filters will function in crude optical systems.

London—Plans are now working for an international conference on thermionic electronical power generation under the aegis of O.E.C.D. European Nuclear Energy Agency, I.E.E., set for Savoy Place, London, September 20-24, 1965.

Wolverhampton—H. M. Hobson aircraft control system manufacturer, has expanded analog computing facilities with six more EMIac II computer modules (for a total of 10) installed by EMI Electronics Ltd.

Sidcup, Kent—STC has introduced into UK their Swiss associate's range of professional quality aluminum electrolytic capacitors that "have an established reliability acceptance in Europe."

Paris—A complete sell-out to more than 350 engineers from 128 firms and 15 nations was registered by the one-week course on design of integrated circuits offered by Motorola on April 5 to 9.

Brussels—A scientific liaison office to maintain closer contact with leading European centers of science and technology in major fields has been opened in Brussels by Xerox Corp.

Ghent—Vynckier-Freres & Cie, S.A., and Rogers Corp., Rogers, Conn., agreed on a 20-year pact for Rogers patent and trademark rights to Mektron molded circuits for all of Western Europe and Finland, Greece, Spain and Turkey.

Munich—The Electronica exhibition committee has decided that chances for the Second Electronica (October 1966: electronic 66) are excellent considering the success of the first Electronica (October 1964).

Stuttgart—Some 120 firms in the German radio and TV industry will display their wares in a 10-acre exhibition area on the Killesberg at the 1965 German Radio and Television Exhibition, August 27 to September 5. Other exhibits will include phonographs, sound equipment, broadcasting, postal systems and antennas.

Acts fast at set point

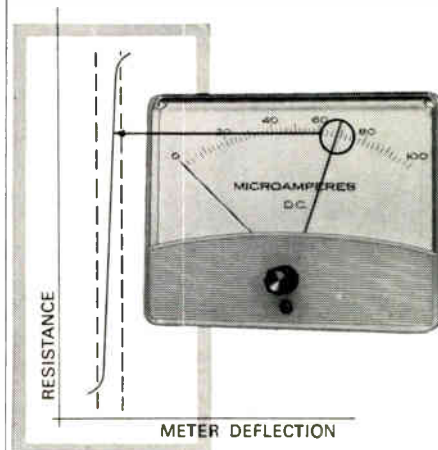

Almost instantaneous—that's the response at set point of API's contactless (optical) meter-relay.

Highly efficient use of internal light results in a "slope" of at least 100 to 1 between the extremes of resistance of a photoconductor. This ratio insures fast response (see curve above).

Above all, API's contactless meter-relay is simple and direct in operation—and therefore reliable and easy to apply. It's sophisticated but not complicated.

It's also inherently fail-safe and unaffected by ambient light—and it continuously indicates, either side of set point, an unamplified signal from any variable.

The COMPACT Trim new package



Here's the latest in convenience—a contactless meter-relay with all control components in an attached barrel. Simply hook up line power, signal and load—and it's ready to operate. Details in Bulletin 44.

API's contactless meter relay comes in all popular current and voltage ranges, including AC. Many in stock for quick delivery. Ask for literature with prices and circuits.

api
INSTRUMENTS CO.

Formerly Assembly Products, Inc.
CHESTERLAND OHIO • PHONE: 216-423-3131

Circle 119 on Inquiry Card

ELECTRONIC INDUSTRIES • June 1965

Oslo—A compact Univac 1004 system in Brussels transmitted a tough problem to a high-capacity 1107 system in Oslo, which answered the Brussels unit, the first operation of its kind in Belgium or Norway. It may be the forerunner of an international data pool.

Lisbon—in the process of modernizing communications facilities, Companhia Portuguesa Radio Marconi (C.P.R.M.) has ordered \$210,000 worth of Marconi self-tuning transmitting equipment, including four 7.5kw transmitters.

Baghdad—Republic of Iraq has ordered RCA TV equipment for three new stations as part of a 5-year expansion program. Stations, to cost about \$1.5 million, will be in Basra, Mosul and Kirkuk.

Tehran—Nippon Electric Co. of Tokyo has won a contract with Ministry of Iranian Posts, Telegraphs and Telephones for three 100kw and eight 10kw medium wave broadcasting transmitters, plus antennas, power and installation.

Vancouver, B.C.—A 600-mile microwave system will be installed by Collins Radio Company of Canada Ltd. for British Columbia Hydro and Power Authority. Cost: \$5.3 million for complete "turn key" project.

Auckland, N.Z.—New Zealand's international airline TEAL has ordered the latest Marconi transistorized doppler navigation equipment (AD560) for a new fleet of DC8 jet airliners.

Wellington, N.Z.—As part of plans to expand TV service, New Zealand Broadcasting Corp. has ordered fixed microwave link and tower equipment from EMI Electronics Ltd. for the Christchurch and Wellington regions. Cost: about \$112,000.

Melbourne—Bond's Industries Ltd., major Australian producer of textile products, is developing a completely integrated management control system based on its recently installed Honeywell 200 computer.

Sao Paulo—Vidros Corning Brasil, S.A., Corning subsidiary, will build a 128,000-sq. ft. plant at Suzano, near Sao Paulo, to make TV tubes. The 400-employee plant will be in operation by mid-1966.

Slash YOUR production costs! with **KÄHLE** **AUTOMATIC EQUIPMENT**

**-FOR PRODUCTION, ASSEMBLY,
CONTROL, INSPECTION, TESTING**

Typical KAHLE cost-saver designed and built for a leading miniature lamp manufacturer. Automatically assembles stem and bulb, then seal-molds, exhausts and tips-off the lamp...

**CAPACITY
OVER 2,000
UNITS
PER
HOUR!**

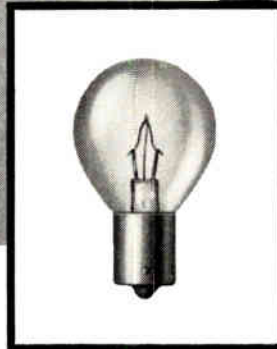
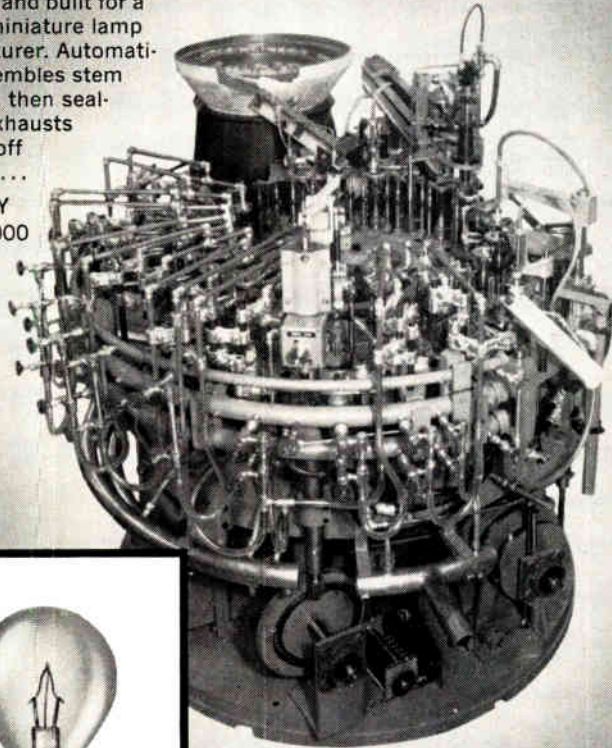

- KAHLE did it here!

KAHLE Servos and Feedbacks detect rejects prior to completion of assembly

Instrumentation feedbacks and servos can be supplied that will reject faulty parts prior to assembly and product finishing... saving materials and time in production.

KAHLE Machines are Customer-approved under actual operating conditions

Your equipment is run in our factory, using your materials in the presence of your engineers; the machine is not shipped to you unless you approve it!

CONSULT KAHLE—Save time and money by letting professionals build your specialty production equipment for automation!

KÄHLE

Designers and Builders
of Automatic Equipment
for High Speed Production
for Over 30 Years

Kahle Engineering Company

3318 HUDSON AVE., UNION CITY, N. J.

Telephone: UNION 7-6500 (Area Code 201)

from
BURR-BROWN
a new
operational
amplifier
with low drift
and high
input impedance



The latest addition to the popular Burr-Brown operational amplifier family is model 1508. It's an all-silicon solid-state differential input unit which approaches FET and chopper-stabilized performance without the attendant cost. You will find it particularly useful in high impedance circuits and integrators requiring extremely low current drift. It is also excellent for voltage reference applications drawing from standard cells. And, it is small... a modular 1.8" x 1.2" x 0.6.

TYPICAL PERFORMANCE @ 25°C

Input Impedance differential	1.0 Mohms
common mode	500 Mohms
Current Drift	± .05 na/°C
Voltage Drift	± 10 μv/°C
D.C. Gain	96 db
Unity Gain Bandwidth	1.0 Mcps
Rated Output	± 10 V (min) @ 20 ma

The Burr-Brown 1508 is immediately available at \$110 in unit quantity... \$99 in quantities of ten. Connectors and accessories are also in stock.

FOR COMPLETE TECHNICAL INFORMATION on the 1508... or, for prompt assistance with your operational amplifier application, wire, write or phone Burr-Brown today.

BURR-BROWN

RESEARCH CORPORATION
INTERNATIONAL AIRPORT INDUSTRIAL PARK
BOX 11400, TUCSON, ARIZONA 85706
PHONE: 602-294-1431 • TWX: 910-952-1111

Circle 121 on Inquiry Card

BOOKS

Integrated Circuits: Design Principles and Fabrication

Prepared by the Engineering Staff, Motorola, Inc., Semiconductor Products Division. Published 1965 by McGraw-Hill Book Co., 330 West 42nd St., New York, N. Y. 10036. Price \$12.50. 374 pages.

This book brings together theoretical and practical aspects of integrated-circuits manufacture and demonstrates their application to IC design. Compiled by Motorola's Semiconductor Products Division, it reflects the accumulated experience of hundreds of engineers, scientists, technicians, statisticians, and other technical people. The material in the book covers the design of semiconductor and thin-film integrated microcircuits, including theory and processing from initial material processing, through device packaging and reliability testing.

Processes such as compatible methods (thin-film passive elements on semiconductor substrates containing active elements), and the parasitic-less monolithic process are among the subjects covered.

Other topics include: junction theory and properties; impurity diffusion and diffused junction properties; field-effect devices for integrated circuits; crystal growing and the epitaxial process; wafer processing; and IC packaging.

American Microelectronics Data Annual—1964-65

Edited by G. W. A. Dummer and J. Mackenzie Robertson. Published 1965 by Pergamon Press Ltd., and distributed by the Macmillan Co., 60 Fifth Ave., New York 11, N.Y. Price \$22.50. 941 pages.

Book presents comprehensive, fully-illustrated information on major thin film, semiconductor integrated and hybrid circuit assemblies now available from sources in the U. S. Applications information is given for all the techniques described, and a special index enabling location of assemblies by circuit function or design category is provided in addition to the main index.

Books Received

An Exploratory Study of the Structure and Dynamics of the R&D Industry

By Albert Shapero, Richard P. Howell and James R. Tombaugh. Published 1964 by Stanford Research Institute (Publications Dept.), Menlo Park, Calif. 94025. Price \$5.50 (plus 4% sales tax in Calif.). 144 pages, paperback.

1963 Digest of Literature on Dielectrics, Vol. 27

Published 1964 (Publication 1230) by the National Academy of Sciences—National Research Council, 2101 Constitution Ave., N.W., Washington, D.C. 20418. Price \$15.00. 255 pages, paperback.

The Transistor—Basic Theory and Application

By Joachim Dosse. Published 1965 by D. Van Nostrand Co., Inc., 120 Alexander St., Princeton, N. J. Price \$8.75. 283 pages.

Available at these Distributors

EAST

- Binghamton, N. Y.**—Federal Electronics
P. O. Box 208/PI 8-8211
Philadelphia 23, Penn.
Almo Industrial Electronics, Inc.
412 North 6th Street/WA 2-5918
Pittsburgh 6, Penn.—Radio Parts Company, Inc.
6401 Penn Avenue/361-4600
Newton 58, Mass.—Greene-Shaw Company
341 Watertown Street/WO 9-8900
Clifton, N. J.—Eastern Radio Corporation
312 Clifton Avenue/471-6600
New York 36, N. Y.—Harvey Radio Company, Inc.
103 West 43rd Street/JU 2-1500
Baltimore 1, Md.—Radio Electric Service Company
5 North Howard Street/LE 9-3835

SOUTH

- Birmingham 5, Ala.**—Forbes Distributing Company, Inc.
2610 Third Avenue, South/AL 1-4104
West Palm Beach, Fla.—Goddard, Inc.
1309 North Dixie/TE 3-5701
Richmond 20, Va.—Meridian Electronics, Inc.
1001 West Broad Street/353-6648

MIDWEST

- Detroit 3, Mich.**—Glendale Electronic Supply Company
12530 Hamilton Avenue/TU 3-1500
Battle Creek, Mich.—Electronic Supply Corporation
94 Hamlin Ave./P.O. Box 430
Phone: 965-1245
Minneapolis 16, Minn.—Admiral Distributors, Inc.
5305 Cedar Lake Road, St. Louis Park/545-0223
Indianapolis 25, Ind.—Graham Electronics Supply, Inc.
122 South Senate Avenue/ME 4-8486
Cleveland 1, Ohio—The W. M. Pattison Supply Co.
Industrial Electronics Division
777 Rockwell Avenue/621-7320
Chicago 30, Ill.—Merquip Electronics, Inc.
4939 North Elston Avenue/AV 2-5400
Cincinnati 10, Ohio—United Radio, Inc.
1308 Vine Street/241-6530
Kansas City 11, Mo.—Walters Radio Supply, Inc.
3635 Main Street/IE 1-7015
St. Louis 17, Mo.—Electronic Components for Industry Co.
2605 South Hanley Road/MI 7-5505

WEST

- Dallas 1, Texas**—Adleta Company
1907 McKinney Ave./RI 1-3151
Houston 1, Texas—Harrison Equipment Company, Inc.
1422 San Jacinto Street/CA 4-9131
San Diego 1, Cal.—Electronic Components of San Diego
2060 India Street, Box 2710/232-8951
Los Angeles 15, Cal.—Radio Products Sales, Inc.
1501 South Hill Street/RI 8-1271
Los Angeles, Cal. 90022—Kierulff Electronics
2585 Commerce Way/OV 5-5511
Mountain View, Cal.—Kierulff Electronics
2484 Middlefield Road/968-6292
Denver, Colo.—L. B. Walker Radio Company
300 Bryant Street/WE 5-2401
Seattle 1, Wash.—C & G Electronics Company
2221 3rd Avenue/Main 4-4355
Phoenix, Ariz.—Midland Specialty Co., Inc.
1930 North 22nd Ave./258-4531
Albuquerque, N.M.—Midland Specialty Co., Inc.
1712 Lomas Blvd., N.E./247-2486
Tucson, Ariz.—Midland Specialty Co., Inc.
951 South Park Ave./MA 4-2315

Ask for a complete catalog

DELCO RADIO 

DIVISION OF GENERAL MOTORS, KOKOMO, INDIANA

400V 2.0A 3.5A SILICON TRANSISTORS

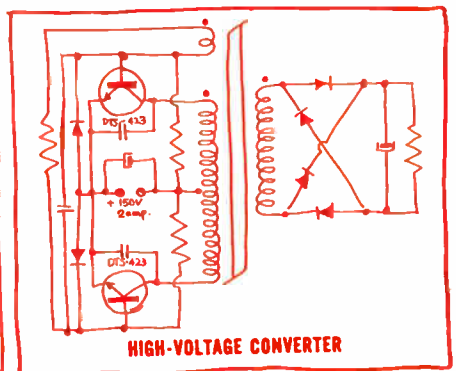
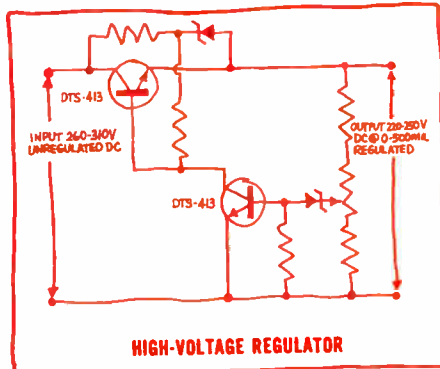
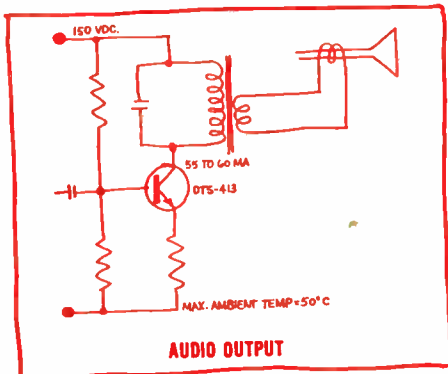
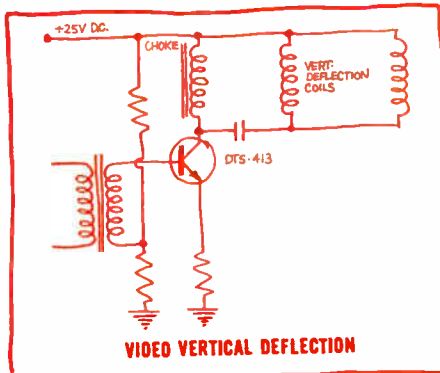
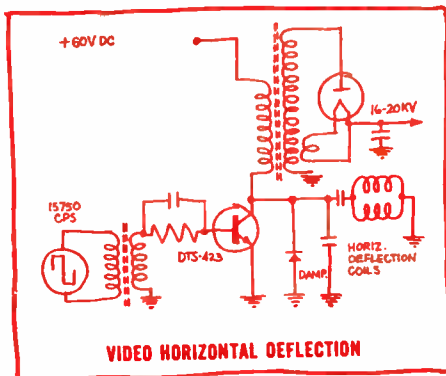

INEXPENSIVE

From Delco Radio, come two new silicon power transistors that transcend the known limits of semiconductor cost and capability. ■ **V_{CEO} 400V at less than three cents a volt—even in sample quantities!** ■ The DTS-413 and DTS-423 open the door to a host of new ideas, new circuits, new products and product improvements. ■ As an example, practical—and immediate—applications are both vertical and horizontal TV outputs. Large-screen all-transistor TV is, for the first time, technically and economically practical. ■ Delco's achievement also permits a reduction in current, reduction in size of other components, and a hike in efficiency in circuits where high energy output is needed. ■ High punch-through voltage, high frequency response, and low saturation resistance are provided by the silicon element itself, which is fabricated by our unique triple sequential diffusion process. ■ Complete freedom from "purple plague" and exceptional resistance to thermal and mechanical shock are a result of ultrasonic bonding of aluminum to aluminum base and emitter contacts. ■ Contact us right now for data sheets and prices. Be one of the first to take advantage of these Delco Radio high-voltage silicon power transistors.

RATINGS	DTS 413	DTS 423
VOLTAGE		
V _{CEO}	400 V (Max)	400 V (Max)
V _{CEO} (S _{us})	325 V (Min)	325 V (Min)
V _{CE} (Sat)	0.8 (Max)	0.8 (Max)
	0.3 (Typ)	0.3 (Typ)
CURRENT		
I _c (Cont)	2.0A (Max)	3.5A (Max)
I _c (Peak)	5.0A (Max.)	10.0A (Max)
I _b (Cont)	1.0A (Max)	2.0A (Max)
POWER		
	75 W (Max)	100 W (Max)
FREQUENCY RESPONSE		
f _t	6 MC (Typ)	5 MC (Typ)

FIELD SALES OFFICES

UNION, NEW JERSEY*
Box 1018 Chestnut Station
(201) 687-3770

SANTA MONICA, CALIFORNIA*
726 Santa Monica Blvd.
(213) 870-8807

DETROIT, MICHIGAN
57 Harper Avenue
(313) 873-6560

SYRACUSE, NEW YORK
1054 James Street
(315) 472-2668

PALO ALTO, CALIFORNIA
201 Town & Country Village
(415) 326-0365

CHICAGO, ILLINOIS*
5151 N. Harlem Avenue
(312) 775-5411

*Office includes field lab and resident engineer for applications assistance.

DELCO RADIO
DIVISION OF GENERAL MOTORS, KOKOMO, INDIANA

Here is the D52

It is the best scope you can buy

\$495.

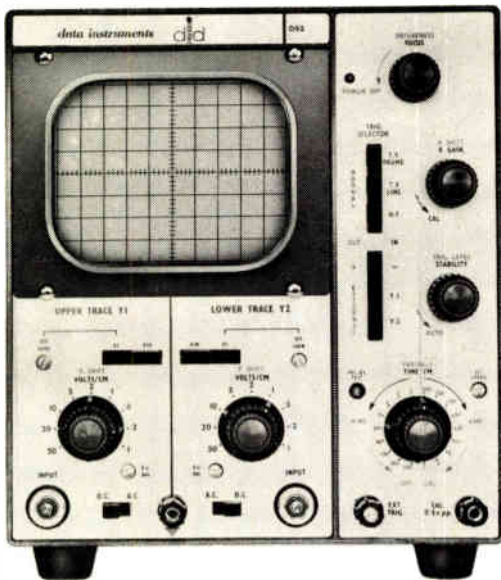

We have to qualify that statement, of course. But not very much. Within its range of application no dual beam scope will perform better or more reliably than Data Instruments D52. Consider the features: A five inch precision flat face CRT with an illuminated graticule. Built-in critically damped amplifiers for accurate response. Frequency compensated attenuators and an extremely linear time base with trigger level and stability controls. A full year warranty and complete field and factory service. Look at the specs:

data instruments



VERTICAL AMPLIFIER				
BANDWIDTH	SENSITIVITY/cm	RISETIME	IMPEDANCE	ACCURACY
(1) DC-6mc	100mv to 50V	.06 μ sec	1M Ω + 30pf	\pm 5%
(2) DC-300kc	10mv to 5V			
TIME BASE		CRT		PHYSICAL
SPEED/cm	TRIGGER & HOR. AMP	DIA.	PHOSPHOR	VOLTS
1 μ s to 0.5 sec. \pm 5%	Exp. x 10 10cps-400kc	5"	P1-P7 dual beam	3.6kv
				DIM. & WT. 15"x9 $\frac{1}{4}$ "x8 $\frac{1}{2}$ " 24 lbs.
The S52, with matched X and Y Amplifiers is also available at \$575				

Better still, use it. Drop us a note and we'll arrange a demonstration in your plant. You'll agree, that within its range the D52 is the best scope you can buy. And at \$495 you can buy it.

Data Instruments Div. • 7300 Crescent Blvd. • Pennsauken, N.J.

Reporting late developments affecting the employment picture in the Electronic Industries

SURVEY REPORT PREDICTS STARTING SALARY RISES

Average starting salary of June engineering graduates with bachelor's degrees will rise to \$630 per month, according to a survey among selected industrial firms, reported by Frank S. Endicott, Director of Placement, Northwestern University.

"Trends in Employment of College and University Graduates in Business and Industry," the 1965 Endicott Report, reveals that returns from 200 companies shows a 25% increase in demand for 1965 engineering graduates. This is a factor which could further inflate starting salaries. Last year's graduates averaged \$613 per month, against pre-season estimates of \$610.

Master's degree holders in engineering are expected to receive an average starting salary of about \$750, compared with the expected salaries of \$730 for masters in physics and \$700 for chemistry.

COMPANY SCHOLARSHIPS, LOAN PLANS STUDIED

During the 1961-62 college year, 181 firms maintained 7,750 scholarships at a cost of \$7,878,309, including grants to colleges involved. These facts on company scholarships and student loan plans are revealed in a recent study by the National Industrial Conference Board.

Almost all of 232 plans were set up for one or more specific company goals. In most cases the goals included improved employee relations, developing skills, and public relations.

Children of employees are eligible for scholarships in 134 of the 232 plans; employees can qualify in 35 plans. Other groups eligible include students already in college (37 plans), community high school graduates (32 plans), and graduates of any high school (31 plans). In 128 plans, students may select their own college. Company scholars are permitted in 137 plans to take any course toward a bachelor degree.

RESEARCH TOOL FOR COMPUTER ASSISTED INSTRUCTION



A pre-school pupil studies a reading comprehension assignment projected on a built-in viewing screen on one of six IBM experimental display terminals at Stanford for computer assisted instruction research at the University's Mathematical Studies Institute.

1965 MAY BE A BOOM YEAR FOR ENGINEER EMPLOYMENT

This appears to be developing into a boom year in employment for engineers and scientists, in a startling reversal of conditions in 1964.

Because of large-scale cut backs in defense spending, many technical persons found themselves without jobs and with few openings available. Now the picture has changed; the search for technical talent has picked up, with more recruiting activity underway today than in the past two years.

A measure of the zeal with which

COMPUTER SCIENCE STUDY

The need for more persons trained in computer applications has led to a graduate program in computer science at Iowa State University, Ames, Iowa. The new program will go into operation this fall quarter. Offering masters' and Ph.D. degrees, the program is being organized under the departments of mathematics, statistics and electrical engineering.

FOR MORE INFORMATION . . . on opportunities described in this section fill out the convenient resume form, page 143.

employers are now seeking qualified technical people is the March level of the Engineer/Scientist Demand Index maintained by Deutsch & Shea, Inc. The Index rose to 119.0 in March, the highest point since January 1963. The first quarter average for 1965 shows a healthy 111.4, more than a third above the 74.6 average for the first quarter of 1964.

The prediction is that the current level of demand will be maintained through the Spring months, and perhaps into early Summer. Part of the increase is seasonal. But recruiting activity is up all around the country.

MEDICAL ENGINEERING SPURS NEW CENTER AT IITRI

A Medical Engineering Center is being established at IIT Research Institute in Chicago, it was disclosed by Dr. E. H. Schulz, Institute Director. The Center, reports Dr. Schulz, will coordinate skills in the physical sciences and engineering to help medical researchers devise instrumentation.

The center will have representatives from all IITRI research divisions covering the full range of physical sciences and technologies.

In trying to provide a maximum of service to its membership, a unified industry association today encounters many complex problems. New technology begets new manufacturing specialties and brings ever changing demand. Here's how the Electronic Industries Association, now in its 42nd consecutive year has organized to meet this fluid situation.

How EIA Faces The Challenge

SINCE BECOMING PRESIDENT of the Electronic Industries Association just a year ago I have given much thought to the question "Why should an electronic manufacturer be a member of EIA?" And I believe I have found some of the answers.

Basically, companies join EIA for five principal reasons:

1. To enjoy the benefits of a forum in which joint action can be planned in the interest of the individual manufacturers and the industry as a whole.
2. To acquire a spokesman who can express opinions of member-companies to contracting offices, regulatory agencies, or Congressional committees in instances that might embarrass companies if they spoke for themselves.

3. To obtain services which depend upon the cooperation of many or all members such as the collection of marketing statistics or the development of technical standards.

4. To receive Association publications which provide information on Government actions and industry practices and thus serve as aids in decision making.

5. To participate in industry conferences, seminars, and workshops from which members can acquire valuable knowledge in conducting their business.

Made in America

Trade associations are basically an American institution and a product of our free enterprise system.

Examples of literature and reports EIA publishes for its member companies and for the electronic industries in general.

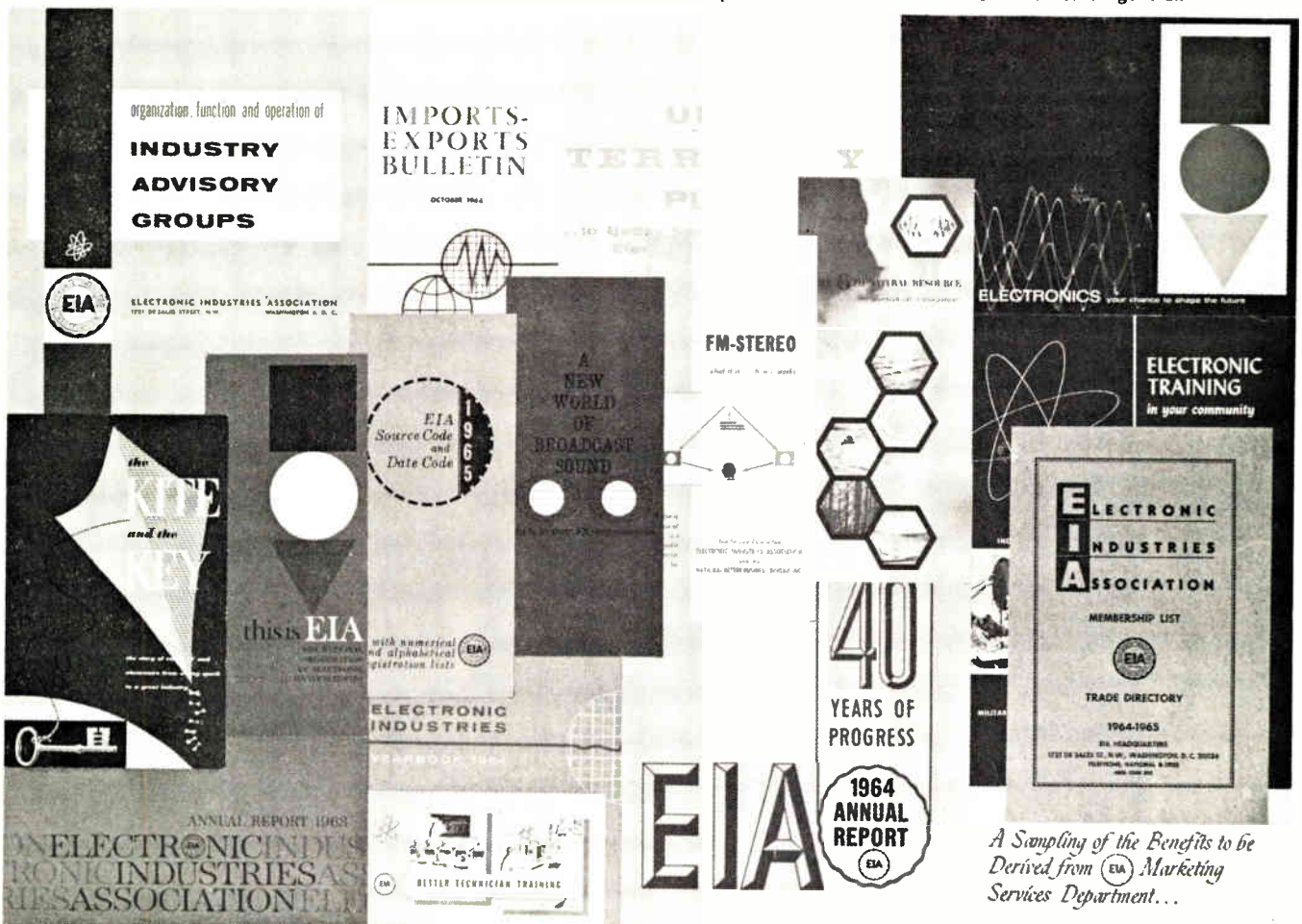

A Sampling of the Benefits to be Derived from EIA Marketing Services Department...

By **DR. HARPER Q. NORTH**

President, Electronic Industries Association
Vice President, R&D,
Thompson Ramo Wooldridge, Inc.

Of Change



Dr. Harper North

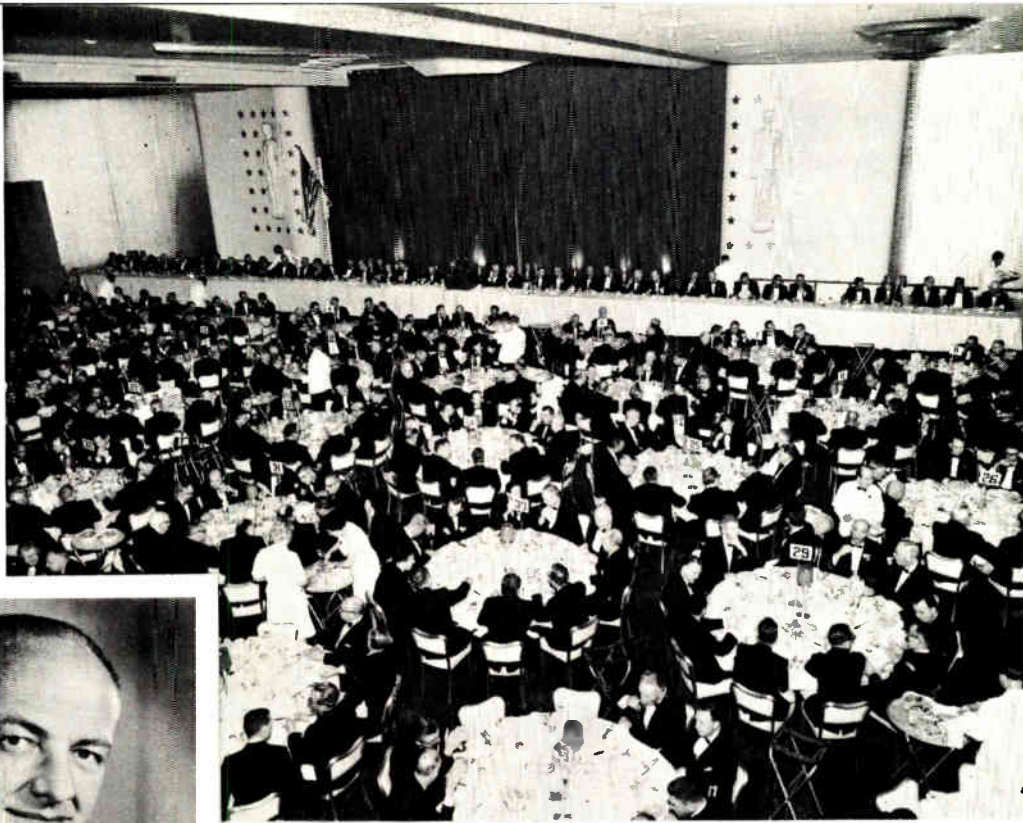

Government-Industry Dinner at 1965 National Electronics Marketing Symposium held in Washington early this spring, sponsored by EIA.

Europe had trade guilds as far back as four centuries ago and has cartels today. But their objectives have been to suppress, rather than encourage, competition. Often a businessman has had to join these organizations to survive. Membership in an American trade association, on the other hand, is entirely voluntary. However, the fact that about 12,000 national, regional, state and local associations are now operating within the United States would seem to prove that business men have found them useful.

An electronic manufacturer who recognizes that trade associations perform a worthwhile service may ask why should he belong to EIA rather than to an organization whose members represent a great variety of industries and business men.

Members of the National Association of Manufacturers and the U. S. Chamber of Commerce, for instance, cut across many product lines. Their views on national issues consequently are important. Other organizations specialize in management-labor relations or some other problem common to all industries. They perform a useful function. However, neither type of association can adequately represent or serve the special interests of any one industry.

The electronic industries are relatively new in the U. S. economy. They are still growing and developing new markets and new products. While it does have some problems which are common to all manufacturers, it also has many problems and needs which are distinctive and require handling by an organization of electronic manufacturers. Moreover, occasionally the

interests of the electronic industries are in conflict with those of other industries.

Standards Speeded Growth

It was for this reason that the Radio Manufacturers Association (RMA) was formed in 1924 and that EIA has grown to its present size. One of the primary needs of early radio manufacturers was for technical standards which would permit interchangeability of standard components. Thus the RMA Engineering Department was born. It is not an exaggeration to say that the rapid growth of the electronic industries would not have been possible without the standards developed by industry engineers through our Engineering Department.

In the early radio days many states and some cities sought to exercise control over this new medium both for reasons of public safety and as probable sources of tax revenue. RMA organized an industry drive against laws banning auto radios and joined in court tests which subsequently established the interstate character of broadcasting.

Industry statistics and marketing analyses were scarce at that time. But RMA inaugurated a confidential reporting and tabulating system. I might add that this was done in spite of the doubts of many members that a trade association could or would keep company figures secret from their competitors. As new electronic markets developed in the 1950's, EIA's Marketing Services Department expanded from four to about 15 persons as of today. The reason for the expansion was an increasing membership demand for new marketing reports. The department now issues a total

EIA FACES CHALLENGE (Continued)

of 101 statistical reports periodically during the year. In addition, the Requirements Committee staff releases scores of studies of budgets, appropriations, defense and space programs, and other information on defense and space spending.

These two services—standards and statistics—are so essential to the electronic industries, it can be said without qualification that if EIA did not provide them some other organization would have to be formed to do so.

These are not the only EIA services, however, which have a clear cut value to electronic manufacturers. Members receive regular publications which are not obtainable elsewhere and which condense the endless flow of government data of vital interest to our industry. Among these are the Weekly Report, International News, Industrial Relations Digest, Electronic Trends, Export-Import Bulletin, Yearbook, and periodic reports on procurement awards and opportunities, patents, and engineering standards and registration.

It is often unrecognized that work done by industry specialists as members of association committees usually is of value to non-participants as well. For instance, our Traffic Committee has a long and creditable record of obtaining reduced rates for electronic products or forestalling proposed rate increases. Last year our International Department helped bring about a cut in ocean freight rates which saved one member \$100,000 in three months.

The value of the time and talent contributed by hundreds of engineers working on standards and specifications is incalculable. Our Engineering Department held more than 500 committee meetings last year. Marketing specialists, contractual experts, lawyers, and credit managers among others work through EIA for the good of all members.

Why EIA is in Washington

RMA moved its headquarters from Chicago to Washington in 1933 at a time when the New Deal was placing all industries under the Blue Eagle. No doubt the move was considered temporary. Yet today, more than 30 years later, EIA could not move from Washington and serve the industry adequately unless it maintained a Washington office. In fact, this fall EIA will move into its new Washington building indicating the permanency of its headquarters location. In addition to providing more attractive and efficient headquarters for the EIA staff, this building will enable us to consolidate all Association operations, except a small West Coast branch office, under one roof.

Not only does the Federal Government account for 60% of our industry business, but a number of Government agencies exercise some form of control over electronic manufacturing beyond the role of a major

customer. A recent example is the Federal Communications Commission which under an act of Congress requires all television receivers to include UHF tuners. The Federal Trade Commission establishes rules governing the sale and advertising of electronic products. The Labor Department fixes minimum wages under the Walsh-Healey Act. There are many other examples, and Congress frequently acts on legislation which has a direct effect on the electronics industry.

EIA, representing a major group of electronic manufacturers, is able to act promptly and speak authoritatively for the electronics industry because it is headquartered in Washington. It has been there so long and has proved to Government that Congressional committees and Government departments and agencies instinctively turn to EIA for information and advice on the industry.

The Defense Department is perhaps the principal Government agency with which EIA maintains effective liaison on behalf of the electronic industries, but there are many others including the Department of Labor, the Commerce Department, the Federal Trade Commission, the Federal Communications Commission, the Tariff Commission, the Federal Aviation Authority, the National Aeronautics and Space Administration, the Office of Education, and several Congressional committees.

By reason of this day-to-day relationship several of these departments and agencies volunteer their services in support of legislation in which our industry is interested or present the electronic industries point of view in international negotiations. An example of the latter was the recent EIA effort to persuade the Conference of the International Radio Consultative Committee (CCIR) to adopt the color television standards developed by the National Standards Television Commission under EIA's sponsorship. The Department of Commerce and the FCC backed the NTSC standards in the CCIR. The Labor Department recently revised its proposed health standards under the Walsh-Healey minimum wage act on our recommendations. Three U. S. agencies supported EIA's appeal for repeal of the 10% excise tax on radio-TV-phono equipment and parts.

While Government offices, of course, are open to all citizens, both the Government and industry often find it more effective, as well as more convenient and less embarrassing, to work through a trade association. Washington alone has more than 200 such associations either headquartered there or with branch offices having the responsibility for government-industry relations.

On several occasions EIA has been called on by a Government agency to develop information for governmental publications, such as the Language Laboratory Manual published by the U.S. Office of Education. Several Government departments look to EIA for industry statistics as well as for comments and recommendations on proposed regulations. The FCC adopted transmission standards for monochrome and color tele-

(Continued on page 142)

ELECTRONIC INDUSTRIES ASSOCIATION

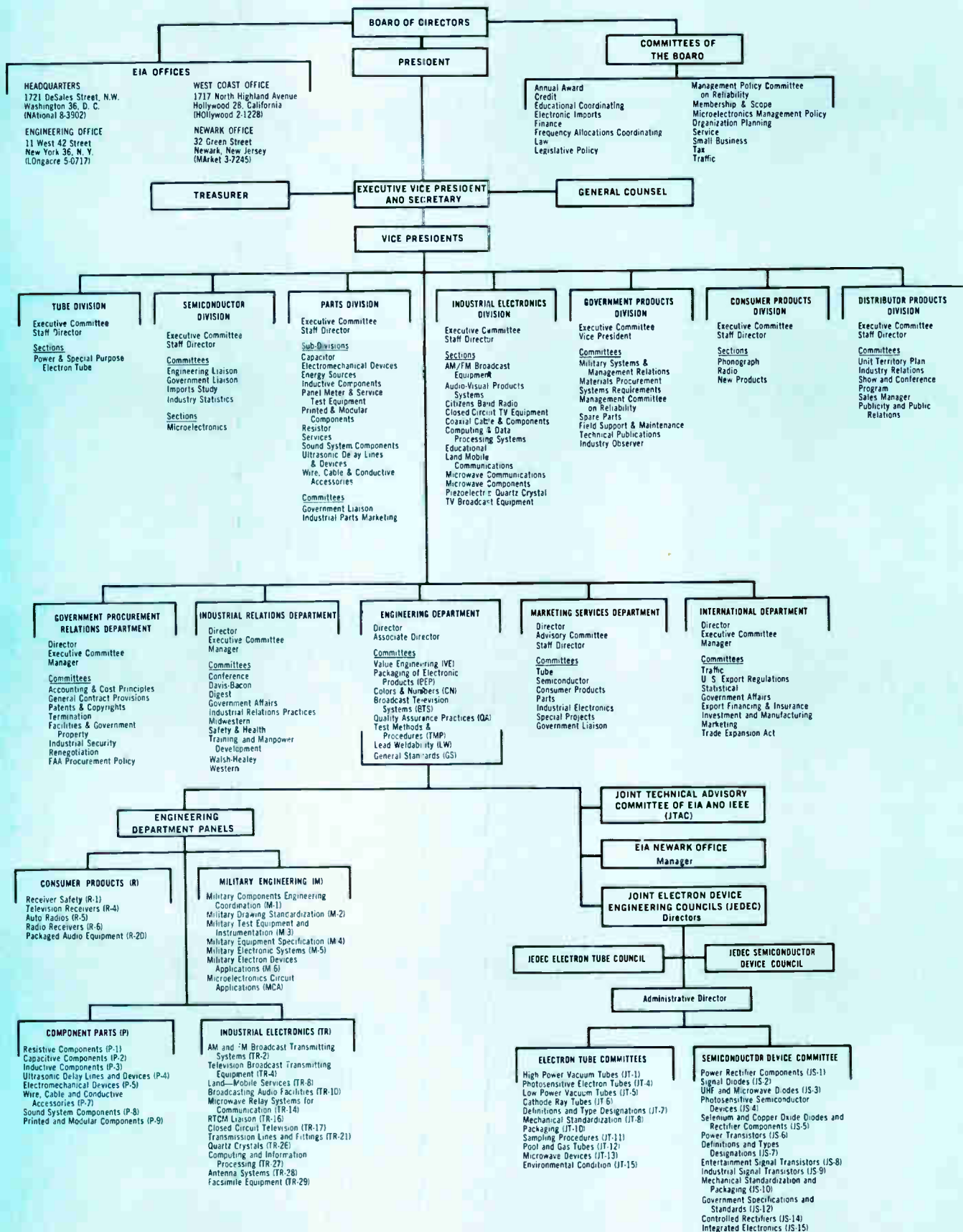



Architect's drawing of new EIA building, which will consolidate nearly all operations except regional offices, will be occupied early this fall.

EIA FACES CHALLENGE (Continued)

(. . . From Page 140)

vision and for FM stereo which were recommended by industry committees formed by EIA.

One EIA department—Government Procurement Relations—is occupied entirely with maintaining industry liaison with the Defense Department, NASA, and FAA.

EIA's other two service departments—Industrial Relations and International—not only maintain constant communications with appropriate Government agencies but sponsor conferences and seminars devoted to problems peculiar to electronic manufacturers.

Divisions are Autonomous

All active members of EIA belong to one or more of its seven product divisions. These divisions are, in many respects, trade associations within a trade association or a closely knit federation. The Consumer Products Division, for instance, functions as an association of radio-TV-phonograph manufacturers. The Government Products Division operates as an organization of defense and space contractors. The Industrial Electronics Division provides a home for a variety of manufacturers of electronic industrial products.

Component manufacturers, whose products are probably more varied than those of equipment and system producers, are formed into four groups, each of which functions autonomously under the EIA umbrella. They are the Parts, Tube, Semiconductor, and Distributor Products Division. A new Microelectronics Subdivision

has been formed recently and may later become a division.

EIA's membership meetings are arranged in the nation's major electronic manufacturing centers. A Spring Conference in Washington deals largely with government-industry relations. A summer convention in Chicago ties in with the industry's principal exhibition of consumer products at the Music Show. A third meeting in late fall is held in either Los Angeles or San Francisco in recognition of the importance of the West Coast electronic industries.

All seven product divisions meet separately during these three-day conferences but join each other at receptions and luncheons. Their elected directors also exchange views and act jointly at the Board of Directors meeting which includes the conference. Thus EIA members benefit from the opportunity to see both their competitors and their customers and suppliers.

I would be less than candid if I did not concede that these divisions occasionally have conflicting interests and points of view. EIA's attitude toward imports from low-wage countries, such as Japan, is a case in point. Component manufacturers are understandably concerned over foreign competition because of their higher labor costs. Receiver manufacturers at the same time must compete with imported TV and radio sets. They consequently try to hold down their production costs by importing some standard components.

This basic conflict in interests might well tear apart a weaker trade association than EIA. Yet we have not only survived this conflict but have worked out a general accord in our proposals to the Government in preparation for the current GATT conferences in Geneva. In brief, we asked that consumer products be reserved from further tariff cutting but that negotiations be conducted on other electronic products on a truly reciprocal basis. There was not a dissenting vote when this policy was adopted by our Board of Directors.

Role of Regional Associations

It is not surprising that the electronic industries, with their broad diversity of products and scattered centers of production, should have several regional trade associations. These organizations perform an important function for their members and also enable them to meet more often and more conveniently than is practical for a national trade association.

An electronic manufacturer may well ask why, if he belongs to a local or regional electronic association, should he join EIA as well. The same question might apply to single product or "splinter" associations.

I certainly do not wish to underestimate the value of these associations. They are necessary to deal with local or regional problems and to hold local forums, but they do lack the strength and breadth of a national association, particularly in dealing with Federal agencies. Moreover, they cannot provide the range of

(Continued on Page 144)

ELECTRONIC INDUSTRIES

Please type or print

Professional Profile

The ELECTRONIC INDUSTRIES Job Resume Form for Electronic Engineers

Name _____ Tel. No. _____
 Street _____ Zone _____
 Address _____
 City _____ State _____

Single Married Citizen Non-Citizen Date of Birth _____
 Will Relocate Yes No. If Yes Another City Another State
 Salary Desired to Change Jobs in present area _____
 Salary Desired to Change Jobs and relocate in another area _____
 Professional Memberships _____

College or University	Major	Degree	Dates

RECENT WORK EXPERIENCE

Company	Div. or Dept.	Title	Dates

SIGNIFICANT EXPERIENCE AND OBJECTIVES

STATE ANY FACTS ABOUT YOURSELF THAT WILL HELP A PROSPECTIVE EMPLOYER EVALUATE YOUR EXPERIENCE AND JOB INTERESTS. INCLUDE SIGNIFICANT ACHIEVEMENTS, PUBLISHED PAPERS, AND CAREER GOALS.

Mail to: ELECTRONIC INDUSTRIES—Professional Profile—56th & Chestnut Sts.—Philadelphia, Pa. 19139. This resume is confidential. A copy will be sent only to those Companies advertising for engineering personnel in this issue, whose number you circle below.

- 800 801 802 803 804 805 806 807 808 809 810

EIA FACES CHALLENGE (Continued)

(. . . From page 142)

services and the information available in a national association based in Washington.

A national trade association also provides a better opportunity for industry cooperation whether in the collecting of marketing data, standardization of products, or market promotion. It enables different product groups—including suppliers and customers—to discuss and resolve their mutual problems more easily.

Yet many EIA actions are taken in behalf of a small segment of the industry despite its broad representation. For instance, our staff moved promptly to offset the impact of a recent Internal Revenue Service ruling affecting only speaker and amplifier manufacturers by persuading IRS to postpone the effective date to coincide with expected repeal or reduction of the tax. It has often come to the aid of component producers on problems with Government procurement agencies, such as the Department of Defense, and has represented small manufacturers in dealings with the Small Business Administration and other U.S. agencies.

Whether we like it or not, the Federal Government is today reaching into all the states and municipalities and, directly or indirectly, affecting the economic life of these communities. Therefore, while local and regional organizations are important, only a national association having established contacts with Government departments and agencies in Washington is equipped to act promptly and effectively in behalf of the industry it represents.

Growth Threatens Future

If one were to look only at our industry statistics, including EIA data and many corporate annual reports, he might well think that such a growing and productive industry has no serious problems. And that the same might be said of EIA. Unfortunately, this is not true.

Oddly enough, the electronic industries as an entity and EIA as its national trade association are encountering problems brought on by the industry's rapid growth and the diversity of its markets.

There is a danger that electronic manufacturing will prove so essential to so many industries that it will lose its identity as a major manufacturing group—the fifth largest in the United States. It could become primarily a supplier of the vital ingredients of systems and equipment which may not be identified as electronic. Since the early 1950's electronics has been publicly recognized as a glamour industry. Heavy investments—not always sound—resulted and these in turn have spurred further growth.

Should the electronic industries lose identity as one of the major industrial groups contributing to the nation's economic growth, it might also surrender the direction of its research, its marketing, as well as its attraction to the investor.

It is here, I believe, that EIA performs an important function in serving as a public relations spokesman for the electronic industries. Throughout its forty-one years EIA has had a large share in creating a favorable public image of the electronic industries as dynamic, creative, progressive, and of unlimited horizons.

A Time for Decision

Electronic manufacturers must decide whether they wish to retain an identity as an industry or will be satisfied to serve many other industries which depend on electronic technology. Of course, radio and television are not in danger of such submersion, but many electronic products and systems for industrial and governmental markets are. I believe any manufacturer who is seriously concerned with his future, as well as this year's profits, will want to see electronics continue to grow as a major industry or industrial group. He also will realize that an effective national trade association can best preserve this identity.

While a consolidation of all manufacturer organizations in the electronic industries might simplify the solution of our problems, it may neither be desirable nor practical to bring this about in the immediate future. Yet I believe that industrial unity is vital to our joint survival and that a high degree of cooperation between all electronic associations is essential now.

We have recently entered into an arrangement with the National Electrical Manufacturers Association for an exchange of information and services, and I believe this cooperation will be broadened gradually. Technologically, electric and electronic products are becoming more similar than different so that one day the two industries—which have a common origin—may well merge.

The Magnetic Recording Industries Association is at this writing in the process of merging with EIA as the plan has been approved by both Boards of Directors. Its members will have a home plus all the advantages and services of a larger association through their affiliation with EIA.

EIA, through our Government Products Division, helped form the Council of Defense and Space Industry Associations during the past year. I believe the cooperation that has resulted between several associations concerned with government business will be of benefit to the Government as well as to the member-companies involved.

Because of its strategic location in the Nation's Capital and by reason of its special membership services, EIA could provide regional and limited product electronic associations with much information they cannot collect directly and also could represent them in governmental and legislative hearings where our interests coincide. The result would be a stronger industry voice in Washington.

Coordination, if not consolidation, is also needed in the various electronic industry exhibitions. RMA spon-

(Continued on page 146)

Announcing an unexpected development in electron tube conduction cooling

To give you maximum design flexibility while simultaneously reducing equipment size and cost, Amperex has developed an entirely new conduction cooling technique for electron tubes.

The key to the new technique is a beryllia heat-conduction block that is not integral to the power tube it serves. Indeed, its only connection to the tube is through an efficient thermal compound. Thus, for your design purposes, the size of the heat block will be in direct proportion to the power requirements you plan to place upon the tube—the lower the plate dissipation, the smaller

the beryllia block and its heat sink. The position of tube and block in the chassis will be largely a function of your design-layout-requirements (rather than determining them as was the case heretofore).

In the event of tube failure, the new Amperex cooling method means that the tube is all you replace, the customary inconvenience and additional expense of replacing the block being eliminated.

In addition, the Amperex technique, like other conduction cooling methods, eliminates the cost, space and downtime normally associated with most other approaches to cooling.

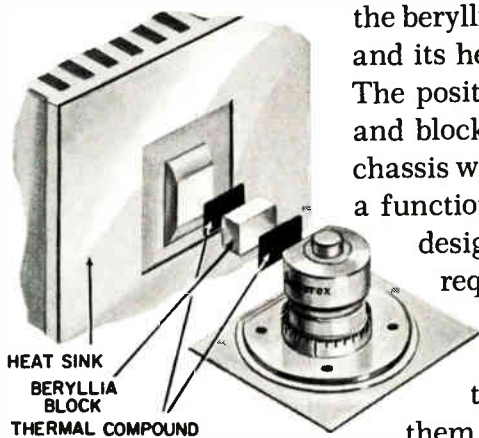
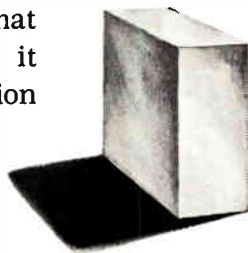

To implement its new technique, Amperex has developed a new power tetrode, the type 8560.

This rugged, compact, new ceramic and metal tetrode derives from the "4X" tube series, it therefore can be counted on for exceptional efficiency and reliability not only for the popular 50, 150 and 470Mc commercial communications bands, but for SSB and point-to-point AM and FM applications as well.

The 8560 is designed for use as a high-efficiency RF power amplifier at frequencies up to 500Mc.

As a Class C amplifier under CCS conditions it can produce 270 watts output at 175Mc from 4 watts drive. The maximum allowable plate dissipation of the 8560 is solely a function of the effectiveness of the conduction cooling system and approaches 500 watts under the most ideal conditions.

Amperex is ready to put its new cooling technique and its unique new power tetrode to work for you. Applications assistance as well as complete data is available. (Data includes all formulas necessary for designing a conduction cooling system to fit your particular applications.)



Wire or write: Amperex Electronic Corporation, Tube Division, Hicksville, Long Island, New York, N. Y. 11802.

Amperex®

IN CANADA: PHILIPS ELECTRONIC DEVICES, LTD., TORONTO 17, ONT.

EIA FACES CHALLENGE (Concluded)

sored the first radio shows but later withdrew from the field. Today radio-TV-phono manufacturers are showing renewed interest in an annual national exhibit for dealers, and EIA's Consumer Products Division this year has taken steps to make the National Music Show a better exhibition for this purpose. This trend probably will be accentuated in the years ahead.

Industry-wide promotion programs, such as the highly successful "Radio-in-Every-Room" campaign sponsored by RMA at the end of World War II, also seem to be returning to popularity. While such promotions have been limited chiefly to consumer goods in the past, they might well be applied to some of the newer industrial markets.

Establishment of an Electronic Capabilities Center has been suggested and deserves careful study. EIA has been sponsoring an increasing number of marketing symposiums. Combined marketing studies if conducted through EIA would save manufacturers considerable money and probably be more comprehensive than those made for single companies. Competitive advantages of such studies when conducted exclusively for a single manufacturer are temporary at best.

The impact of foreign competition on many electronic products necessitates more long range industry planning. While EIA cannot effectively carry on laboratory research for the industry, it can provide a forum for developing industry-wide programs and activities which will convert this research into new markets. It can and does help extend foreign markets for U.S. electronic products by working with our Government to remove trade barriers abroad.

The electronic industries, like any healthy youth, are having growing pains. EIA, through a critical self-examination, is constantly trying to improve its services and readjust its organizational structure to meet changing membership requirements and to attract new product groups. The recent formation of a microelectronics subdivision is an example.

While EIA is now entering its 42nd year, it is far from settling down to the apathy of middle age. Through continual review and frequent changes, it not only strives to serve its members well today but also to anticipate their needs of tomorrow.

• A REPRINT of ANY ARTICLE in this issue is available from ELECTRONIC INDUSTRIES Reader Service Department.

INTERFERENCE PROBLEM—Sen. Warren B. Magnuson (D.-Wash.) proposes authorizing FCC to regulate manufacture, import, sale and shipment of any device that might cause radio interference. FCC now has authority to ban use of such devices, but has no power to set minimum design standards before marketing. Interfering devices currently include: garage door openers, electronic heaters, and toys radiating r-f energy far beyond what they need.

alpha PRODUCT PACKAGE number one source for 9

STEPS TO ECONOMICAL RELIABLE SOLDERING

The Alpha Product Package consists of a complete range of compatible fluxes, soldering chemicals and quality solders designed for maximum efficiency and reproducibility.

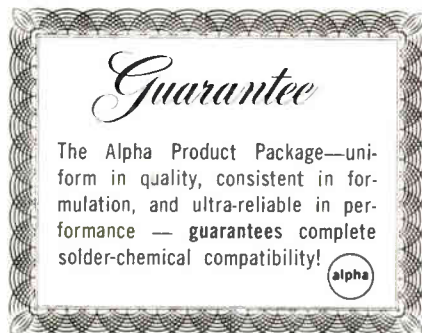

● For complete information on the Alpha Product Package call or write for Bulletin A-104.

Alpha is also the number one source for solder preforms, special alloys, lead and tin products, and ultra-high purity metals for semi-conductor devices.

- PRECLEANERS
- PROTECTIVE COATINGS
- SOLDER RESISTS
- FLUXES
- FLUX THINNERS and REMOVERS
- SOLDERS
- POST-SOLDERING CLEANER
- SOLDER BLANKET
- RESOLDERING or TOUCH-UP

alpha **ALPHA METALS, INC.**
56 WATER ST., JERSEY CITY, N. J. 07304 201-434-6778
Los Angeles, Calif. • Alphasoy Corp. (Div.), Chicago, Ill.
Alpha Metals, Inc. (U.K.) Ltd., London, England

J-5230

SEE US AT THE NEP/CON SHOW • BOOTH 311

MICROELECTRONIC DEVELOPMENTS . . .

Vacuum evaporated thin films, in conjunction with multichip transistor flat packs, have been incorporated in two off-the-shelf logic elements, resulting in a flip flop with low power (0.1mw @ 100kc) as well as high speed (up to 10mc @ 2mw), according to Alpha Microelectronics Co., Inc., Beltsville, Md.

Sperry Rand Corp. has made arrangements with Fairchild Semiconductor division of Fairchild Camera and Instrument Corp. to buy nearly a half-million monolithic microcircuits, an amount equal to 20% of the entire semiconductor microcircuit output last year. Cost is \$2 million.

A microcircuit conductor kit—for laboratory use by designers or resistor and/or capacitor networks and hybrid cermet circuits—has been introduced by Electro-Science Laboratories, Inc., Philadelphia, Pa. The kit provides sample containers of ceramic dielectric coating, three ceramic conductive coatings and a slow-drying thinner, as well as brushes and stainless steel spatula.

Raytheon's Semiconductor Operation will expand its integrated circuit manufacturing facilities at Mountain View, Calif., and increase its production capacity. The firm will add 20 Diode-Transistor-Logic (DTL) devices to its present line of Direct-Coupled-Transistor-Logic (DCTL) integrated circuits.

A new microelectronics laboratory has been set up by Electronic Communications, Inc., St., Petersburg, Fla. The facility is expected to broaden the firm's technical ability and expand its capability in microminaturization. At first, the laboratory will concentrate on research in thin film techniques and hybrid circuitry for both digital and analog applications.

The Microelectronics Operation of Philco Corporation's Lansdale (Pa.) Division has started a program to triple its production of microcircuits by the middle of 1965. Additional equipment is being installed in the photoengraving and assembly operations. Philco now makes seven microcircuit families: four of its own, and the other three by license agreement with Fairchild Semiconductor.

TRACKING IN REVERSE

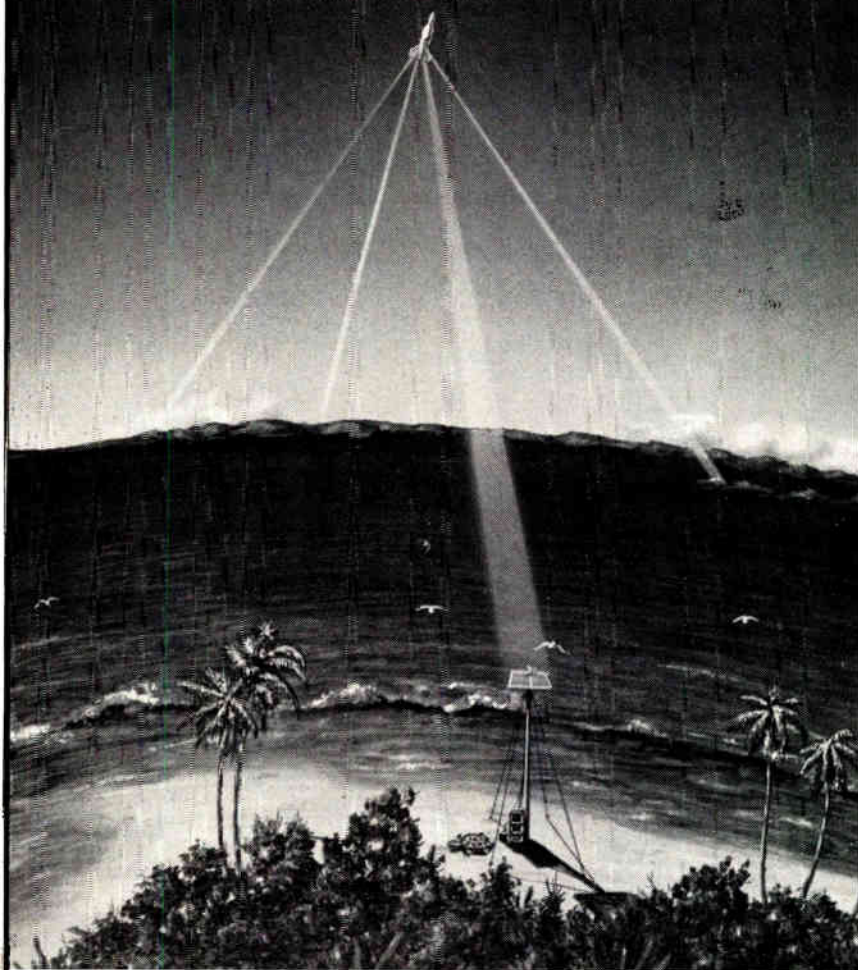

The NASA Marshall Space Flight Center at Huntsville, Alabama, has awarded a new R & D contract to Motorola's *Military Electronics Division Western Center*. It calls for systems engineering and developing equipment for a new concept in high-accuracy measurement of spacecraft position and velocity. Using integrated circuitry the tracking equipment is being miniaturized into a small, lightweight package that can be installed in manned or unmanned spacecraft instead of being ground based in large manned complexes. Thus, navigational data will be provided directly to on-board control equipment. Ground stations will consist only of small highly mobile electronic equipment to return signals to the spacecraft from remote, unmanned sites if desired. This AROD (Airborne Ranging Orbital Determination) System is typical of the exciting aerospace programs which offer outstanding opportunities to qualified engineers and scientists at Motorola.

Specific opportunities are:

Antennas & Propagation	Equipment Reliability Analysis	Guidance & Navigation
Solid State R.F.	Parts Reliability	Command & Control
Microwave Techniques	Data Acquisition, Processing	Space Communications
Missile & Space Instrumentation	& Display	Signal Processing
Operational Support	CW Transponders	ECM, CCM & Surveillance
Integrated Circuitry	Radar & Radar Transponders	Tracking & Telemetry
	Fuzes	

Contact Phil Nienstedt, Manager of Recruitment, Department 696



Military Electronics Division • Western Center • P.O. Box 1417, Scottsdale, Arizona
MOTOROLA ALSO OFFERS OPPORTUNITIES AT CHICAGO, ILLINOIS — AN EQUAL OPPORTUNITY EMPLOYER

KIT OR ASSEMBLED!

Either Way, These HEATH Instruments Are Your Best Buy!



A Heathkit IM-21 Laboratory AC VTVM.
 • 10 voltage ranges—0.01 to 300 volts RMS full scale • 10 megohm input Z
 Kit IM-21, 5 lbs. **\$33.95**
 Assembled IMW-21..... **\$52.95**

B Heathkit IM-11 VTVM... Versatile!
 • 7 AC, 7 DC, 7 Ohms ranges • Frequency response ± 1 db, 25 cps to 1 mc.
 Kit IM-11, 5 lbs. **\$24.95**
 Assembled IMW-11..... **\$39.95**

C Heathkit Wide-Band Oscilloscope
 • 5 mc bandwidth • Sweep 10 cps to 500 kc • 5" screen with graticule
 Kit IO-12, 24 lbs. **\$76.95**
 Assembled IOW-12..... **\$126.95**

D Heathkit IM-13 "Service Bench" VTVM • 7 AC, 7 DC, 7 Ohms ranges • Extra-large 6" meter • Gimbal mounting
 Kit IM-13, 7 lbs. **\$32.95**
 Assembled IMW-13..... **\$49.95**

E Heathkit Variable-Voltage Regulated Power Supply • Furnishes B+, Bias, & Filament voltages • Fully metered
 Kit IP-32, 16 lbs. **\$56.95**
 Assembled IPW-32..... **\$84.95**

F Heathkit Audio Generator • Switch-selected output—10 cps to 100 kc • Near-perfect sine wave
 Kit IG-72, 8 lbs. **\$41.95**
 Assembled IGW-72..... **\$64.95**

G Heathkit "Solid-State" Regulated DC Power Supply • 0.5 to 50 v. • Up to 1.5 amp. • Less than 150 uv ripple
 Kit IP-20, 13 lbs. **\$72.95**
 Assembled IPW-20..... **\$114.95**

H Heathkit Battery Eliminator • Switch select 6 or 12 v. DC power • AC ripple less than .3%
 Kit IP-12, 20 lbs. **\$47.50**
 Assembled IPW-12..... **\$59.95**



FREE CATALOG
 Fully describes these at over 200 other different and exciting Heathkits and savings of 50% or more! Fill out the coupon below and send for your FREE copy today!
 Available through NDEA—see your State Education office.

HEATH COMPANY, Dept. 53-6
 Benton Harbor, Mich. 49023

Please send my free 1965 Heathkit Catalog.
 Enclosed is \$ _____, plus postage.
 Please send model(s) _____

Name _____
 (Please Print)

Address _____

City _____ State _____ Zip _____

Prices & Specifications subject to change without notice. TE-134

CAPACITORS (Continued)

layer) with alternate electrodes. After successive layers of dielectric and electrodes are prepared, the chip is fired as a single piece, lead wires are attached, and a protective coating is applied. This construction is ideal for h-f bypass and decoupling uses. Lead configuration can be modified to provide good feedthrough characteristics.

Monolithic™ capacitors can also be made in multiple sections with the necessary number of leads all in one single resin coated unit. Resistors may also be screened on the substrates to permit greater freedom in the design of R-C networks.



High-voltage metallized energy storage capacitor.

Arc suppression networks consisting of a Monolithic™ capacitor in series with a low value resistor are used with relays and switches for the suppression of contact arcing. This will not only prolong contact life, but will also eliminate much electromagnetic interference.

Buttonhead Capacitors

Buttonhead ceramic capacitors are used for coupling, bypass and feed-thru applications in UHF TV receivers and other electronic equipment. They consist of one or more ceramic-dielectric discoidal capacitor elements within the "head" of a capacitor case. This case has either a threaded or a straight shank depending on whether the capacitor is to be screwed to a chassis, inserted into a mounting hole, or soldered to a chassis. This design permits the current to fan out into a 360° pattern from the center terminal. This minimizes the parallel resonance effect normally associated with tubular ceramic capacitor design. Buttonhead stand-off capacitors minimize ground inductance and hold it at a fixed value while providing a short, uniform bypass to ground. They also provide effective shielding of the capacitor element by the outer metal shell.

Small sized, uniformly dimensioned, cylindrical fully-molded units are a relatively recent introduction. They are for use mainly in semiconductor circuitry.

Two "cordwood" sizes (0.090 x 0.250 and 0.138 x 0.390) comparable to $\frac{1}{4}$ and $\frac{1}{2}$ w. composite resistors are available. These capacitors are made in a variety of temperature-stable and temperature-compensating ceramic forms for operations up to 125°C. Maximum capacitance at this time is 0.01 μ f in the smaller body size and up to 0.033 μ f in the larger. Both are rated at 100vdc and are available with a tolerance as close as $\pm 10\%$.

Dielectric Materials

Many ceramic dielectric materials with dielectric constants varying from 10 to about 15,000 have been developed. They include various blends of titania and titanates of rare earths. There are about 500 different body formulations available today for the production of ceramic capacitors. New formulations are continually being added and improvements in performance are constantly taking place. There is now underway a trend to uncased ceramic pellets for some uses in specialized forms of circuit packaging. But, definite and standard parametric and physical parameters have not yet been formed.

Hermetically Sealed Types

Hermetically sealed precision ceramic capacitors with tightly controlled TC's and close tolerance are used in capacitance-type gasoline gauges in aircraft and missiles. They are also used as the capacitor element in an L-C tuned circuit in a transmitter or frequency generator. Another use is as secondary capacitance standards.

Ceramic capacitors lend themselves readily to encapsulated assemblies consisting of many discs or plates. These can thus be contained in a small volume. With the addition of external diodes, ladder-type voltage multiplier networks can be built which yield output voltages of many kv at low-current levels.

MICA CAPACITORS

Mica capacitors have good capacitance stability, a
(Continued on following page)

Miniature molded ceramic capacitor for "cordwood" modules.

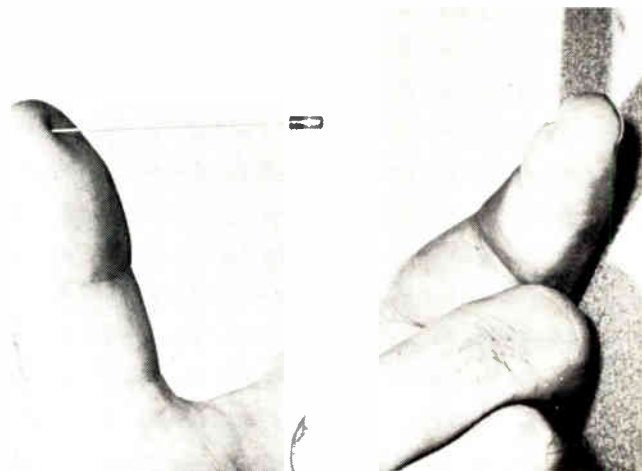

**PROVEN RELIABILITY—
SOLID-STATE POWER INVERTERS,
over 260,000 logged operational hours—
voltage-regulated, frequency-controlled,
for missile, telemeter, ground support,
135°C all-silicon units available now—**

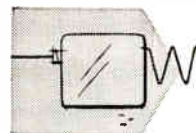
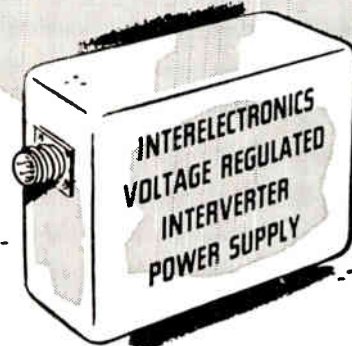

Interelectronics all-silicon thyatron-like gating elements and cubic-grain toroidal magnetic components convert DC to any desired number of AC or DC outputs from 1 to 10,000 watts.

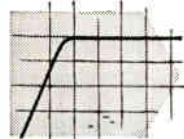

Ultra-reliable in operation (over 260,000 logged hours), no moving parts, unharmed by shorting output or reversing input polarity. High conversion efficiency (to 92%, including voltage regulation by Interelectronics patented reflex high-efficiency magnetic amplifier circuitry.)

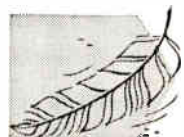

Light weight (to 6 watts/oz.), compact (to 8 watts/cu. in.), low ripple (to 0.01 mv. p-p), excellent voltage regulation (to 0.1%), precise frequency control (to 0.2% with Interelectronics extreme environment magnetostrictive standards or to 0.0001% with fork or piezoelectric standards.)

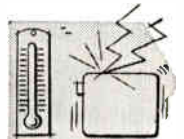

Complies with MIL specs. for shock (100G 11 mlsc.), acceleration (100G 15 min.), vibration (100G 5 to 5,000 cps.), temperature (to 150 degrees C), RF noise (1-26600).

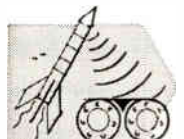

AC single and polyphase units supply sine waveform output (to 2% harmonics), will deliver up to ten times rated line current into a short circuit or actuate MIL type magnetic circuit breakers or fuses, will start gyros and motors with starting current surges up to ten times normal operating line current.



Now in use in major missiles, powering telemeter transmitters, radar beacons, electronic equipment. Single and polyphase units now power airborne and marine missile gyros, synchros, servos, magnetic amplifiers.

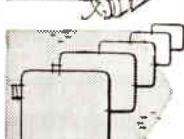

Interelectronics—first and most experienced in the solid-state power supply field produces its own all-silicon solid-state gating elements, all high flux density magnetic components, high temperature ultra-reliable film capacitors and components, has complete facilities and know how—has designed and delivered more working KVA than any other firm!

For complete engineering data, write Interelectronics today, or call 914 ELMwood 8-8000 in New York.

INTERELECTRONICS CORP.
600 U. S. Route 303, Congers, N. Y.

CAPACITORS (Concluded)

low and controllable positive or negative TC and good h-f characteristics. They can be manufactured to tolerances as close as 0.25%.

Colorless and transparent India Ruby Muscovite mica possesses the best characteristics for use in capacitors. It is thus the most commonly used type. Mica has a dielectric strength of between 3000 and 6000v/mil, a dielectric constant between 6.5 and 8.5 (about twice that of paper) and a dissipation factor as low as 0.0001.

Types and Construction

The most commonly used "postage stamp" or dipped-mica capacitors are made by interweaving alternating layers of mica splittings with a conductive material, which may be a thin slip of metal foil. Many such layers are built with the foil alternately extended beyond the edge of the mica. Then all of these extended foils are connected on each side, and they become the capacitor terminals.

Silvered mica capacitors are made without the conductive foil. In this construction the plates of the capacitors consist of a thin layer of silver which is screened on the mica surface and then fired to remove the volatile elements from the silver paste. The capacitor element can be molded in phenolic resin or vacuum

dipped and coated to produce a dipped mica capacitor.

Fabmika™ capacitors became available in the late 50's for use in jet engine systems, missile controls, atomic reactors, airborne high voltage dc power supplies, induction heating equipment, transmitters, electrostatic precipitators and pulse forming networks.

The dielectric material used in Fabmika™ capacitors is made from high quality mica which is exfoliated at high temperatures. It is then subjected to chemical treatments and neutralization. Then it is drawn out in a continuous strip on a modified paper making machine. The end result is again a homogeneous mica sheet which can now be uniformly cut and stacked or rolled. Stacked-foil Fabmika™ capacitors are available for operation up to 310°C on special design.

Radiation resistance is one of the outstanding characteristics of mica capacitors.

About three years ago cylindrical and rectangular cast mica capacitors became available. These can be operated, without derating, up to 125°, even though they are about 30% smaller and 30 to 40% lighter than their ceramic-cased counterparts. They can be easily stacked, with or without the use of endplates. The capacitor element is cast in a solid epoxy block without any impregnant.

• A REPRINT of ANY ARTICLE in this issue is available from ELECTRONIC INDUSTRIES Reader Service Department.

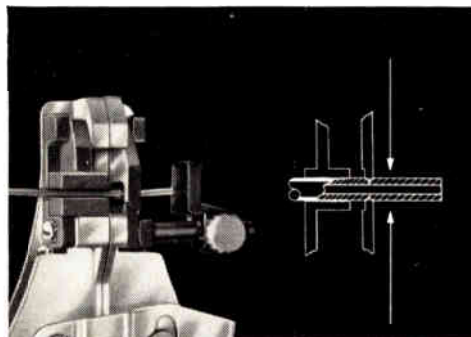
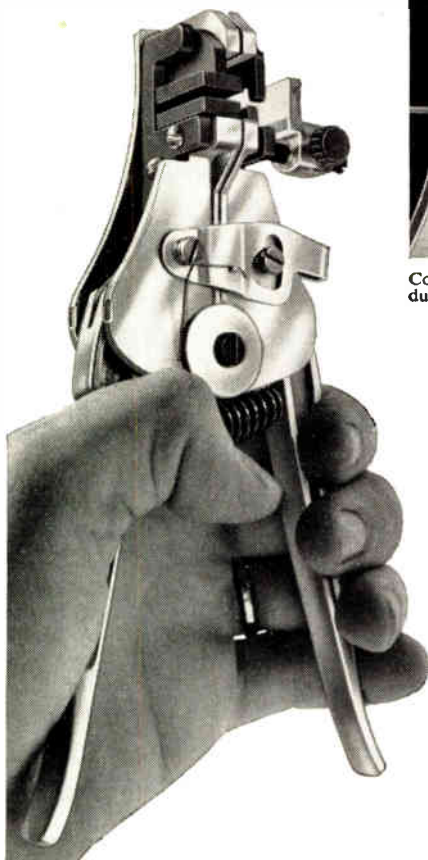

Collet clamping action compensates for off-center conductor, irregular insulation.

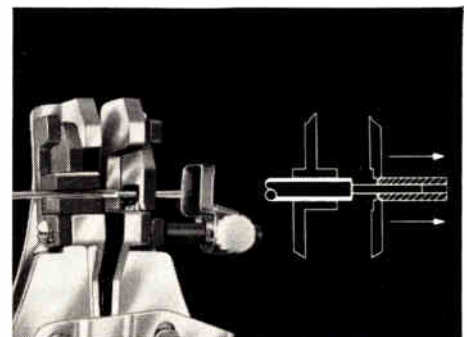

Die severs insulation and strips slug. Never touches conductor, can't nick or scrape.

NO-NICK, NO-SCRAPE WIRE STRIPPING

With Ideal's Custom Stripmaster® you can production strip both stranded and solid conductor wires to aerospace precision specifications. Even under 40-power magnification wires show no nicks, scrapes, or scratches. That's because insulation is removed with dies rather than knife blades. These dies sever insulation with a colletting action that automatically compensates for off-center conductors and insulation irregularities. Special grippers hold the wire without crushing or marking insulation as dies strip the slug without touching the conductor. Each pair of matched dies is individually machined on watchmaker's equipment to precision tolerances.

There are standard Custom Stripmaster models for Type E Teflon, Type EE Teflon, and for general-purpose insulation in wire sizes 10 to 14, 16 to 26, and 26 to 30. Custom Stripmasters with special dies are available for unusual stripping problems.

If you are precision stripping any kind of wire on a production basis, you ought to know about the Ideal Custom Stripmaster. Write today for details.



IDEAL INDUSTRIES, INC.
5127 - F Becker Place, Sycamore, Illinois
IN CANADA:
IDI Electric (Canada) Ltd., Ajax, Ontario

WHAT'S NEW

AUTOMATIC INTERFERENCE AND ATTENUATION MEASUREMENTS

A COMPLETELY AUTOMATIC RECEIVER SCANNING and plotting system that permits rapid RFI, filter and shielded enclosure attenuation, and attenuation site survey measurements has been developed by White Electromagnetics Inc., Rockville, Md. The Model 120 Auto Spectrum Plotter (ASP) scans 20 cps to 1gc in 25 continuous octaves, and plots out the signal amplitude versus frequency in 15-band X-Y plotter graph paper in three minutes.

The manner in which the ASP presents its data is of great significance, especially when it is used to measure r-f interference inside shielded enclosures. Here the test specimen is set up in the usual manner and the ASP

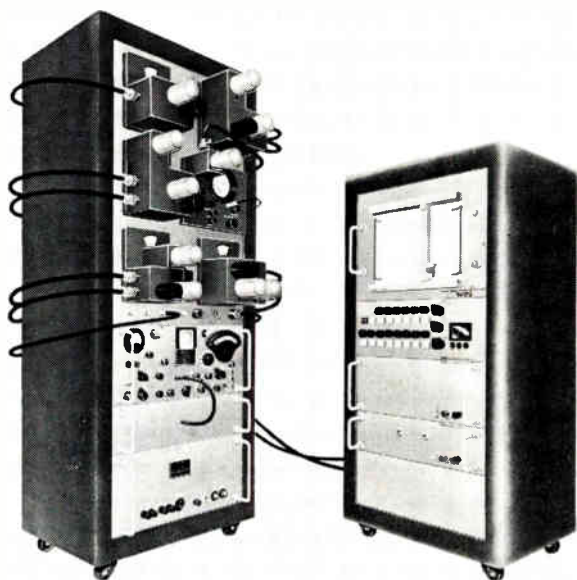

The fully automatic measuring system reduces time needed to perform and measure interference and attenuation experiments.

is set to automatic mode. The equipment scans each receiver band sequentially, switching in and out the proper antenna, receiver, receiver band, and output patching as the peak interference is plotted on the multi-band paper. The old methods required the performance of a series of comparable measurements, data reduction, and plotting of results.

For electromagnetic ambient site survey measurements, the multi-band scan and plotting time can be preset anywhere between 3 minutes and 8 hours with band-scan repeat capability. In this way, a band can be scanned and plotted out many times to develop statistical data.

NOW! 6 POLES OF SWITCHING IN 1/2 SQUARE INCH!



SWITCHCRAFT SERIES 35000

littel

"MULTI-SWITCH"

MULTIPLE STATION PUSH BUTTON SWITCHES

COMPACT — CONSERVES SPACE — An astounding 6PST switching in 1/2 square inch panel space, 6 PDT in .6 square inch! In addition, narrow rectangular silhouette permits stacking in tight parallel rows from 3/4" centers, row-to-row, and up—control panels can be compressed a significant 20 to 50% in size. Only 2 5/8" depth behind panel.

VIRTUALLY UNLIMITED VARIETY — Positive interlock with fool-proof, fail-safe lock-out; or non-lock momentary action; or all-lock (accumulative lock); or push-to-lock, push-to-release . . . or any combination of above on a single frame! Two to eighteen stations per row. Ganged and coupled matrixes, electrical lock-up and release, solenoid release . . . all available. Surprisingly low-cost, too.

ENGINEERING BONUSES GALORE — Complete stack module for any station removes from rear of panel with one screw—without removing entire switch! Dry film lubricant means no grease or dirt pick up. Simple, reliable displacement principle for smooth action throughout life of switch. Cross-bar welded palladium contacts (3 amps, 300 watts max., A.C. non-inductive load). Up to 6 "TINI-STACKS" per station—provides minimum of SPST to 6PDT. Modern square buttons in choice of Red, Black, White, Brown or specials.

**FOR EXPERT
FACTORY-TRAINED
ASSISTANCE**

Switchcraft has a unique network of local, factory-trained distributors to give you expert assistance in determining applications, recommending procedures, writing specifications, and supplying Multi-Switches from stock at factory prices. Write for the name of your Switchcraft Factory Trained Multi-Switch Distributor.

SWITCHCRAFT

5599 Elston Ave., Chicago, Ill.
Canada: Atlas Radio Corp., Ltd.
50 Wingold Ave., Toronto, Ont.

Circuit Features Zero-Level Clipping

OFTEN, CLIPPING ACTION must start as the input voltage crosses the waveform zero axis (positive-to-negative or negative-to-positive transition point). Conventional transistor and diode circuits designed for this function often fail to maintain the start of clipping at the zero point.

A tunnel-diode circuit provides clipping action as the voltage crosses the zero axis. Separate outputs are provided for positive and negative clipping.

At time T_0 the input voltage is negative, diode 1 is in the low-voltage/high-current state and diode 2 is in the high-voltage/low-current state. Both diodes are biased at their peak-point voltages. As the negative-input voltage moves towards positive, the current through diode 1 increases until at T_1 the peak-current value is reached and diode 1 switches to the high-voltage state. The rapid decrease in current through diode 1 causes a back emf to appear across the inductor.

The negative pulse appearing at point A, due to the voltage developed across the inductor, causes diode 2 to switch to its low-voltage/high-current state and the output voltage at point C falls to the zero level. As the positive voltage (peak at T_2) decreases, the current through diode 2 will increase until, at T_3 which is at exactly input voltage zero, the peak current value of diode 2 is reached and it switches to the high-voltage/low-current state. At this time, T_3 , the inductive voltage at A is positive and diode 1 switches to the low-voltage/

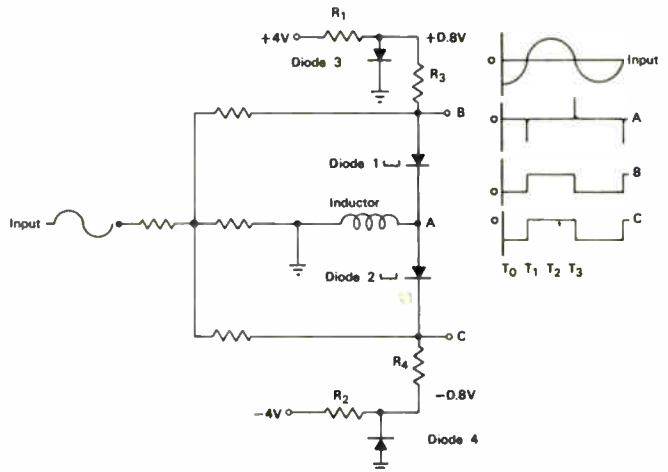

high-current state. In this manner, diodes 1 and 2 will switch to the opposite voltage/current state at every zero crossing (times T_1 and T_3) of the input voltage. Switching time is in nanoseconds.

The positive square waves which appear at B and the negative square waves which appear at C will rise and fall exactly co-incident with the respective zero crossing of the input voltages regardless of the frequency, amplitude, or shape of the input signal, within the limits of circuit operation.

Resistors R_1 and R_2 and diodes 3 and 4 provide the biasing and compensating circuits for the tunnel diodes. Resistors R_3 and R_4 are the load resistors for outputs B and C respectively.

For further information contact: Technology Utilization Officer, Goddard Space Flight Ctr., Greenbelt, Md., 20771. Ref. B65-10002.

MICRO-GEAR IS WORKING ROUND THE CLOCK

to meet the growing demand for gears that meet the most exacting specifications. Bulletin M-100, yours on request, explains why.

MICRO GEAR, Inc.
DIVISION OF HOWARD INDUSTRIES, INC.
PROPHETSTOWN, ILLINOIS

GEAR TYPES: Spur, Helical, Worms, Worm Wheels, Internal, Segment, Sprocket, Ratchet, Straight Coniflex Bevel

LOW COST Printed Circuit Connector

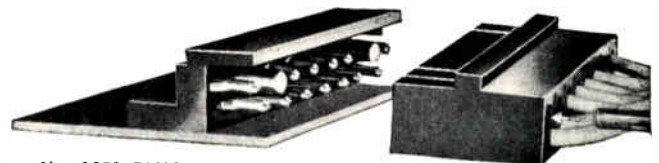

No. 1453 PLUG

CONNECTOR

- COMPACT RELIABILITY
- FROM 9 TO 33 CIRCUITS
- STANDARD .156" CENTERS
- GREATER CONTACT AREA — GREATER CONTACT PRESSURE
- SIMPLIFIED TERMINAL ASSEMBLY

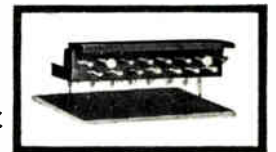

Molded of UL approved Phenolic, in tiers on standard centers. The #1453 Series offers unmatched performance for minimized circuit deterioration, elimination of exotic plating or materials, and offers greatest contact surface and pressures, positive polarity. Four choices of rigid mounting methods and hand or automatically crimped terminals . . . all are plus factors of this unique multiple circuit connector.

Millivolt drop as low as $\frac{1}{2}$ mv. Resistance as low as 7 milliohms. Current ratings to 15 amps per circuit. Voltages to 1500V. Worth looking into, isn't it?

(312) 969-4550

molex **MOLEX PRODUCTS CO.**
5233 Katrine Ave., Downers Grove, Ill.

**FIRST CLASS
PERMIT NO. 36
PHILA., PA.**

BUSINESS REPLY MAIL
No Postage Stamp Necessary If Mailed in U.S.A.

POSTAGE WILL BE PAID BY

ELECTRONIC INDUSTRIES

P. O. Box 9801

Philadelphia, Pa. 19140



**FIRST CLASS
PERMIT NO. 36
PHILA., PA.**

BUSINESS REPLY MAIL
NO POSTAGE STAMP NECESSARY IF MAILED IN UNITED STATES

POSTAGE WILL BE PAID BY

ELECTRONIC INDUSTRIES

Chilton Company

Chestnut & 56th Sts.

Philadelphia, Pa. 19139



Att: Circulation Dept.

FREE!

Catalogs, Literature
New Products and
New Tech Data
Another Reader Service of the

ELECTRONIC INDUSTRIES

STATE
OF THE
ART
MAGAZINE

NAME TITLE
 COMPANY DEPT.
 ADDRESS MAIL STOP
 CITY, STATE Zip Code

Please send me the items I have circled.

	1	2	3	4	5	6	7	8	9	10	11	12	13	14	15	16	17	18	19	20
	21	22	23	24	25	26	27	28	29	30	31	32	33	34	35	36	37	38	39	40
	41	42	43	44	45	46	47	48	49	50	51	52	53	54	55	56	57	58	59	60
	61	62	63	64	65	66	67	68	69	70	71	72	73	74	75	76	77	78	79	80
	81	82	83	84	85	86	87	88	89	90	91	92	93	94	95	96	97	98	99	100
	101	102	103	104	105	106	107	108	109	110	111	112	113	114	115	116	117	118	119	120
	121	122	123	124	125	126	127	128	129	130	131	132	133	134	135	136	137	138	139	140
	141	142	143	144	145	146	147	148	149	150	151	152	153	154	155	156	157	158	159	160
	161	162	163	164	165	166	167	168	169	170	171	172	173	174	175	176	177	178	179	180
	181	182	183	184	185	186	187	188	189	190	191	192	193	194	195	196	197	198	199	200
	201	202	203	204	205	206	207	208	209	210	211	212	213	214	215	216	217	218	219	220
	221	222	223	224	225	226	227	228	229	230	231	232	233	234	235	236	237	238	239	240
	241	242	243	244	245	246	247	248	249	250	251	252	253	254	255	256	257	258	259	260
	261	262	263	264	265	266	267	268	269	270	271	272	273	274	275	276	277	278	279	280
	281	282	283	284	285	286	287	288	289	290	291	292	293	294	295	296	297	298	299	300
	301	302	303	304	305	306	307	308	309	310	311	312	313	314	315	316	317	318	319	320
	321	322	323	324	325	326	327	328	329	330	331	332	333	334	335	336	337	338	339	340
	341	342	343	344	345	346	347	348	349	350	351	352	353	354	355	356	357	358	359	360
	361	362	363	364	365	366	367	368	369	370	371	372	373	374	375	376	377	378	379	380
	381	382	383	384	385	386	387	388	389	390	391	392	393	394	395	396	397	398	399	400

SPECIAL PRIORITY REQUEST

Postcard valid 8 weeks only

For immediate need or a call by a sales representative, write number (e) in box (do not circle above)

Item No. _____ Item No. _____ Item No. _____ Item No. _____
 Item No. _____ Item No. _____ Item No. _____ Item No. _____

NEW

Change of Address

Company _____
 Mail Stop/or _____
 Dept., Div. _____

Street _____

City _____ State _____ Zip _____

OLD

PASTE WRAPPER IMPRINT OR WRITE COMPLETE OLD ADDRESS

[Blank box for old address]



Source Date _____
 Co. Code _____
 File No. _____
 Function Industry _____
 Title Unit _____

1. Do you wish to continue receiving ELECTRONIC INDUSTRIES? Yes _____ No _____
 Signature _____ Title _____

2. Check ONE box for your PRIME FUNCTION

Corporate Management	Engineering Management	Manufacturing Management	DESIGN ENGINEERING				Research & Development Engineering	Application	Evaluation	Mechanical	Quality Control	Production	Reliability	Standard	Test	Value	Purchasing	Sales	Co. Copies & Libraries	All Others
			Circuits	Components	Equipment	Systems														
A	B	C	D	E	F	G	H	J	K	M	N	P	R	S	T	V	W	X	Y	Z

3. Check ONE box for your plant's PRIME nature of business

MANUFACTURING INDUSTRIES

- (01) Computers, Data Processing & Peripheral Equipment Mfr.
- (02) Communication Systems & Equipment Mfr.
- (03) Consumer Electronic Equipment Mfr.
- (04) Industrial Control Systems & Equipment Mfr.
- (05) Navigation & Guidance System Mfr.
- (06) Test Measurement & Instrumentation Mfr.
- (07) Aircraft, Ground Support, Missile, Space Vehicle & Undersea Access & Equipment Mfr. not covered in other product classifications
- (08) Component Mfr.
- (09) Sub-System Assembly Mfr. (Modules, Assembled Circuits)

- (10) Materials & Hardware Mfr.
- (11) Industrial Co. Using or Incorporating Any Electronic Equipment In Their Manufacturing, Research or Development Activities. (Other than Electronic Co.)

NON MANUFACTURING INDUSTRIES

- (12) Commercial Users of Electronic Equipment
- (13) Independent Research, Test & Design Laboratories & Consultants (Not Part of a Manufacturing Company)
- (14) Government Agencies & Military Agencies
- (15) Distributors, Mfr. Representatives
- (16) Education & Libraries
- Other (explain) _____

4. This Address is (check most applicable)

Mfg. Plant (*) Mfr's R&D Lab. (&) Other (explain) _____

If address shown is your home, where is your company located? City _____ State _____

FREE!

Catalogs, Literature
New Products and
New Tech Data

Another Reader Service of the

ELECTRONIC INDUSTRIES

STATE
OF THE
ART
MAGAZINE

NAME TITLE

COMPANY DEPT.
MAIL STOP

ADDRESS

CITY, STATE Zip Code

Please send me the items I have circled.

													1-B	EI-229	JUNE 1965				
1	2	3	4	5	6	7	8	9	10	11	12	13	14	15	16	17	18	19	20
21	22	23	24	25	26	27	28	29	30	31	32	33	34	35	36	37	38	39	40
41	42	43	44	45	46	47	48	49	50	51	52	53	54	55	56	57	58	59	60
61	62	63	64	65	66	67	68	69	70	71	72	73	74	75	76	77	78	79	80
81	82	83	84	85	86	87	88	89	90	91	92	93	94	95	96	97	98	99	100
101	102	103	104	105	106	107	108	109	110	111	112	113	114	115	116	117	118	119	120
121	122	123	124	125	126	127	128	129	130	131	132	133	134	135	136	137	138	139	140
141	142	143	144	145	146	147	148	149	150	151	152	153	154	155	156	157	158	159	160
161	162	163	164	165	166	167	168	169	170	171	172	173	174	175	176	177	178	179	180
181	182	183	184	185	186	187	188	189	190	191	192	193	194	195	196	197	198	199	200
201	202	203	204	205	206	207	208	209	210	211	212	213	214	215	216	217	218	219	220
221	222	223	224	225	226	227	228	229	230	231	232	233	234	235	236	237	238	239	240
241	242	243	244	245	246	247	248	249	250	251	252	253	254	255	256	257	258	259	260
261	262	263	264	265	266	267	268	269	270	271	272	273	274	275	276	277	278	279	280
281	282	283	284	285	286	287	288	289	290	291	292	293	294	295	296	297	298	299	300
301	302	303	304	305	306	307	308	309	310	311	312	313	314	315	316	317	318	319	320
321	322	323	324	325	326	327	328	329	330	331	332	333	334	335	336	337	338	339	340
341	342	343	344	345	346	347	348	349	350	351	352	353	354	355	356	357	358	359	360
361	362	363	364	365	366	367	368	369	370	371	372	373	374	375	376	377	378	379	380
381	382	383	384	385	386	387	388	389	390	391	392	393	394	395	396	397	398	399	400

SPECIAL PRIORITY REQUEST

For immediate need or a call by a sales representative, write number (s) in box (do not circle above)

Item No. Item No. Item No. Item No. Item No.

Postcard valid 8 weeks only

ELECTRONIC INDUSTRIES

Source Date	
Co. Code	
File No.	
Function Industry	
Title Unit	

Company _____

Mail Stop/or Dept., Div. _____

Name _____

Company Address _____

City _____ State _____ Zip _____

1. I wish to receive ELECTRONIC INDUSTRIES

Signature _____ Title _____

2. Check—ONE—box for your PRIME FUNCTION

Corporate Management	Engineering Management	Manufacturing Management	Systems	Research & Development	Application	Evaluation	Mechanical	Quality Control	Production	Reliability	Standard	Test	Value	Purchasing	Sales	Co. Copies & Libraries	All Others								
A	B	C	D	E	F	G	H	I	J	K	L	M	N	O	P	Q	R	S	T	U	V	W	X	Y	Z

3. Check—ONE—box for your plant's PRIME nature of business

MANUFACTURING INDUSTRIES

(01) Computers, Data Processing & Peripheral Equipment Mfr.

(02) Communication Systems & Equipment Mfr.

(03) Consumer Electronic Equipment Mfr.

(04) Industrial Control Systems & Equipment Mfr.

(05) Navigation & Guidance System Mfr.

(06) Test Measurement & Instrumentation Mfr.

(07) Aircraft, Ground Support, Missile, Space Vehicle & Undersea Access & Equipment Mfr. not covered in other product classifications

(08) Component Mfr.

(09) Sub-System Assembly Mfr. (Modules, Assembled Circuits)

NON MANUFACTURING INDUSTRIES

(10) Materials & Hardware Mfr.

(11) Industrial Co. Using or Incorporating Any Electronic Equipment in Their Manufacturing, Research or Development Activities. (Other than Electronic Co.)

(12) Commercial Users of Electronic Equipment

(13) Independent Research, Test & Design Laboratories & Consultants (Not Part of a Manufacturing Company)

(14) Government Agencies & Military Agencies

(15) Distributors, Mfr. Representatives

(16) Education & Libraries

Other (explain) _____

4. This address is (check most applicable)

Mfg. Plant (*) Mfr's R&D Lab. (&) Other (explain) _____

If address shown is your home, where is your company located? City _____ State _____

**FIRST CLASS
PERMIT NO. 36
PHILA., PA.**

BUSINESS REPLY MAIL
No Postage Stamp Necessary If Mailed in U.S.A.

POSTAGE WILL BE PAID BY
ELECTRONIC INDUSTRIES

**P. O. Box 9801
Philadelphia, Pa. 19140**



**FIRST CLASS
PERMIT NO. 36
PHILA., PA.**

BUSINESS REPLY MAIL
NO POSTAGE STAMP NECESSARY IF MAILED IN UNITED STATES

POSTAGE WILL BE PAID BY
ELECTRONIC INDUSTRIES

**Chilton Company
Chestnut & 56th Sts.
Philadelphia, Pa. 19139**



Att: Circulation Dept.

DATA SYSTEM DEVELOPED FOR AUTOMATIC MAINTENANCE

An automatic system that helps keep large electronic systems in operation and in good repair has been developed by Westinghouse Defense and Space Center, Surface Division.

The system—Automatic Diagnostic Maintenance Information Retrieval (ADMIRE)—reduces personnel training, and reduces the need for training simulators and automatic test equipment on complex systems, according to Westinghouse.

Through the systems approach where operation and maintenance are thought of as part of the over-all system, ADMIRE was designed to make optimum use of man and machine.

Some applications include: radar control centers, ship and shore control stations, and military and space command and control centers. Other suggested uses are in large automated industrial plants, electrical power distribution and control stations, and communication centers.

LTV PULSE MODULATOR HITS 65 MEGW. WITHOUT GAS TUBE

An all solid-state pulse modulator with a 65 megawatt peak output has been designed by Ling Division, LTV Ling Altec, subsidiary of Ling-Temco-Vought, Inc. LTV engineers described the device as the first line-type pulse modulator above the kilowatts range that does not use a gas switch tube.

James A. Ross, vice-president engineering, said that although the unit has a 65 megawatt output, extension of the modulator design concept proves the ability to go to unlimited super power levels far beyond conventional gas tube modulators.

With an average output of 75kw, Mr. Ross said, the design will have applications in radar, linear accelerator installations and X-ray generating electron accelerators.

FACSIMILE SYSTEM

The first operational wideband facsimile transmission system in interstate service has been installed at the Burns Harbor (Ind.) plant of Bethlehem Steel Corp., it was announced by General Telephone & Electronics Corp. The high-speed LDX (Long Distance Xerography) system sends written, printed, or sketched material over conventional telephone circuits to the Bethlehem Steel headquarters in Bethlehem, Pa.

AIR LAB TO HELP SOLVE LOW-LEVEL FLIGHT PROBLEMS

A flying laboratory to find answers to low altitude flight problems soon will be available to military agencies and industry.

North American Aviation's Avionics Division is outfitting a Sabre-liner jet with current avionics equipment and test instruments. Equipment will include low-light-level television, infrared scanner, LASER rangefinder and stabilized optics, all for visual designation and ranging. A scan converter will be used for display freeze

while a head-up display and helmet-mounted display are included.

A multimode radar will be used for precision automatic terrain following, ground mapping and ranging. A microelectronic inertial and precision navigator, and a microelectronic digital computer for system tie-in and checkout also will be installed. Other equipment will include video tape recorders plus standard instrumentation.

The flight test program is expected to be in operation by Sept. 1, 1965.

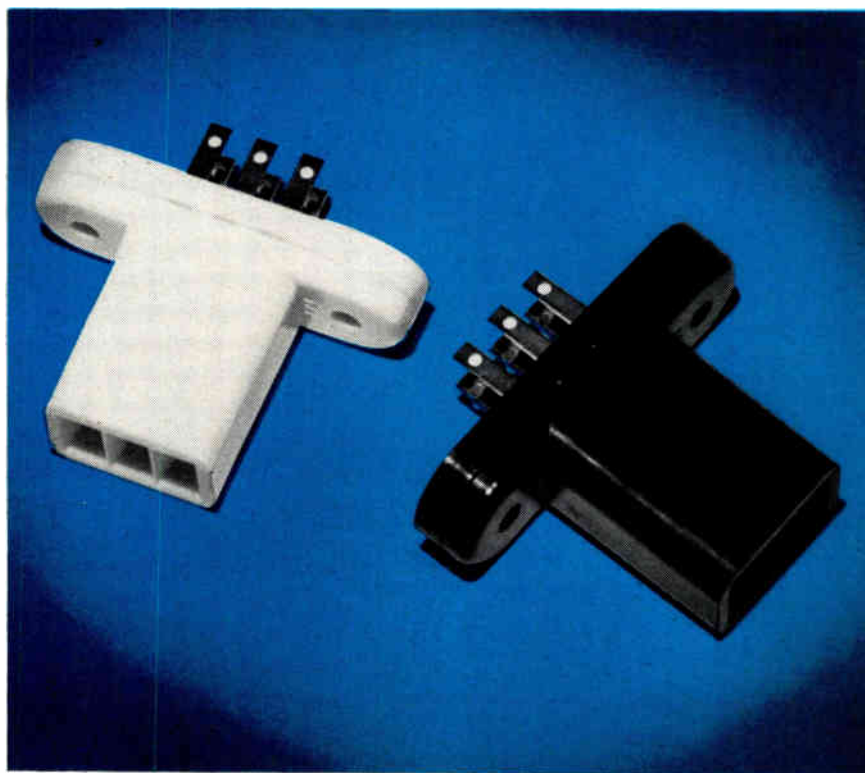

NOW! FROM TEXTOOL... PROVEN SOCKETS WITH GREATER RELIABILITY!

Only Textool brings you in-line sockets with such a proven record of reliability for use over longer periods of time. Made to accommodate TO-5 and TO-18 configurations, these easy-loading sockets offer double contacts (Kelvin) for each lead and are available in heat-treated beryllium-copper, unplated or plated contacts.

SOCKET SPECIFICATIONS

SOCKET NO.	MATERIAL	TEMPERATURE
23-012-048M	Delrin	To 100°C
	Silicone	To 200°C

For complete data and prices for our entire socket line contact:

TEXTOOL PRODUCTS INC.

1410 Pioneer Drive
Irving, Texas

Dallas:
ME 1-5585

Irving:
BL 3-9296



"Serving the diminishing dimensions technology."

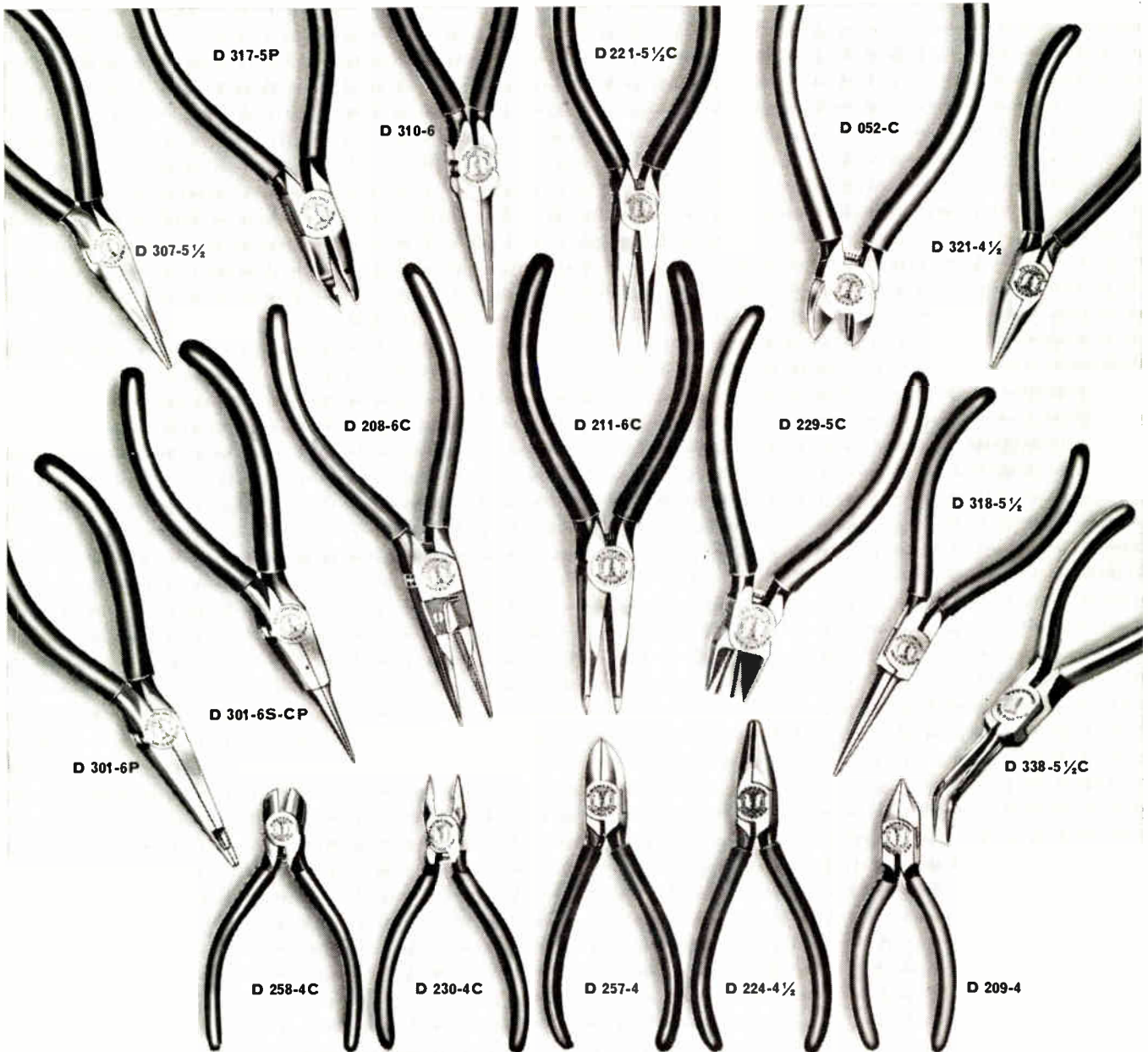

Midgets and specials for electronic assemblies

A cutter that cuts clean and holds the crimped end . . .
 One that cuts and crimps wiring on a printed circuit for efficient dip soldering . . .
 A trimming plier, flush cutting . . .
 A needle nose plier that reaches deep into miniature assemblies . . .
 These and dozens of other pliers are available from stock in the complete Klein line. In fact, here you will find pliers exactly designed for any electronic system where clean cutting accuracy, crimping and bending are necessary in extremely confined space.

The Klein line of specially designed electronic pliers offers a plier exactly designed for each specific job—saving time, speeding assemblies, assuring a better product. For complete information write for the Klein catalog on electronic pliers.

See Your Distributor • Foreign Distributor: ITT Export Corporation, New York



Mathias KLEIN & Sons
 Established 1857 Chicago, Ill., U.S.A.
 INCORPORATED
 7200 McCORMICK ROAD, CHICAGO 45, ILL.

10 ohms dynamic "on" resistance and 50 μV offset

The Amperex silicon planar/epitaxial choppers, type 2N2569 now offers not only the lowest offset voltage in the industry, but the lowest dynamic "on" resistance as well. Every factory-matched pair of 2N2569's is guaranteed not to exceed 50 μV_{off} and 10 ohms r_{ec} max. The offset voltage will remain stable over extremely wide temperature ranges.

Behind this unprecedented combination of lows for production quantity matched pairs is the 2N2569 itself with its offset voltage of only 250 μV (180 μV typ.)—and its r_{ec} of 10 Ω max., the lowest ever offered in a commercially available transistor.

A second chopper, the 2N2570 (identical to the 2N2569 but with offset voltage of 500 μV max.) is also available.

These two low level choppers offer exceptional performance at exceptional prices, singly or in pairs. They are ideally suited for low level voltage measurements, DC amplifier stabilization, analog-to-digital conversion, telemetering and wherever ultra-precise switching is the requirement.

For complete data and applications information, write: Amperex Electronic Corporation, Semiconductor and Receiving Tube Division, Dept. 371, Slatersville, Rhode Island 02876.

2N2569 and 2N2570

V_{off} : 2N2569...180 μV typ.; 250 μV max... $I_{\text{B}} = 150 \mu\text{A}$, $I_{\text{E}} = 0$

V_{off} : 2N2570...350 μV typ.; 500 μV max... $I_{\text{B}} = 150 \mu\text{A}$, $I_{\text{E}} = 0$

ΔV_{off} : Matched Pr...50 μV max... $I_{\text{B}} = 150 \mu\text{A}$, $I_{\text{E}} = 0$

BOTH TYPES (Single)

r_{ec} ...10 Ω max... $I_{\text{B}} = 1 \text{ mA}$; $I_{\text{E}} = 100 \mu\text{A}$; $f = 1 \text{ KC}$

I_{ECS} ...2 nA max... $V_{\text{ECS}} = 5 \text{ V}$; $T = + 25^\circ\text{C}$

h_{FE} ...50 min.; 100 typ... $V_{\text{CE}} = 10 \text{ V}$; $I_{\text{c}} = 100 \mu\text{A}$

$C_{1\text{b}}$...10 pf max... $V_{\text{CB}} = 0 \text{ V}$; $f = 1 \text{ Mc}$

f_{t} ...100 Mc. min... $V_{\text{CE}} = 10 \text{ V}$; $I_{\text{c}} = \text{mA}$

Envelope: TO-18

Amperex®

IN CANADA: PHILIPS ELECTRON DEVICES, LTD., TORONTO 17, ONTARIO



Yes, we've hit a new low in transistor choppers!

Try These Two New Additions To Your

<p>INTRODUCTION TO EDP</p> <p>TEACH YOURSELF...</p> <ul style="list-style-type: none"> • The role of computers in business organizations. • The computer as a problem-solving tool. • Elements in computer programming. • Symbolic and machine language concepts. • The computer's central processor. • System flowcharts—input and output format. • Hardware and software concepts. 	<p>READING & EVALUATING FINANCIAL REPORTS</p> <p>LEARN HOW TO...</p> <ul style="list-style-type: none"> • Read and understand income statements and balance sheets • Identify critical items and trends • Evaluate the strength of your company • Compare stocks for investment. • Conduct professional ratio-analyses.
---	--

TEST YOUR SKILLS IN THESE ELECTRONICS GROWTH AREAS

Engineers and technicians at General Electric, North American Aviation, ITT, General Dynamics, Raytheon, Philco, Douglas Aircraft, Continental Device, Automatic Electric, and other leading companies have selected 7 initial subjects in these areas for their own personal development.

Test **your** knowledge of these fundamental subjects. Here are some sample questions from comprehensive examinations being used in the electronics industry to measure performance in these areas. Try them yourself.

PERT

```

    graph LR
      1((1)) -- 1.2 --> 2((2))
      1 -- 7.5 --> 3((3))
      2 -- 3.1 --> 4((4))
      3 -- 5.4 --> 6((6))
      4 -- 14.3 --> 7((7))
      5 -- 9.2 --> 8((8))
      6 -- 10.2 --> 9((9))
      7 -- 3.8 --> 10((10))
      8 -- 10.3 --> 10
      9 -- 5.6 --> 11((11))
      10 -- 2.9 --> 11
      4 -- 1.5 --> 5((5))
      5 -- 1.5 --> 6
  
```

12. Examine the network you have just constructed.

- Identify the critical path by giving the sequence of events along the path: _____.
- Give the T_E which you calculated for the ending event of the network _____ weeks
- It is now reported that activity 6-9 cannot be completed in less than 11.8 weeks. Will it still be possible to meet T_L ? yes no
- If the changes mentioned in (c) above would make it impossible to plan completion of the project by the time the allotted span has run out, what can he do to replan so that he does meet the schedule?

INTRODUCTION TO TRANSISTORS

29.

- The NPN transistor circuit illustrated above operates as a(n) _____.
- With reference to the circuit shown above, MATCH the items below on the left with those on the right by placing one letter in each blank:

A. base-collector junction	1. _____ high impedance
B. emitter-base junction	2. _____ input impedance
	3. _____ low impedance
	4. _____ output impedance

BASIC TRANSISTOR CIRCUITS

27.

- The schematic diagram above shows an emitter-coupled one-shot _____.
- In the stable state Q_1 is on off and Q_2 is on off.
- The positive pulse turns on Q_1 , which in turn: cuts off Q_2 turns on Q_2 .
- When C_1 discharges, Q_2 is: cut off turned on.
- When Q_2 conducts, drawing current through R_2 , Q_1 becomes _____ biased.

"Engineer's Job Mobility" Series!

**CAN YOU REALLY AFFORD
THE TIME TO UPGRADE YOUR
KNOWLEDGE IN THESE
ELECTRONICS GROWTH
AREAS ?**

**PROGRAMMED INSTRUCTION
COULD BE THE ANSWER FOR
YOU—TAKE A LOOK AT THE
PERFORMANCE DATA:**

Most people can't take the time to search the literature, return to school, or take lengthy correspondence courses. So thousands of engineers and technicians are turning to PROGRAMMED INSTRUCTION, a new teaching technique based upon the findings of behavioral psychologists.

You are led through a carefully designed and tested self-instructional program in which the subject matter is carefully structured and presented in increasingly complex steps which assure that you will attain maximum learning in minimum time. This is why Programmed Instruction is "an ideal way to train engineers in technical subjects — they learn 10% to 25% more in half the time," according to Russell S. Pease, Engineering Consultant at Du Pont.

With the 5 subjects now available as the initial courses in a new programmed instruction series, you can master an entire subject in a day—and score 90% or better on a comprehensive final exam.

For example, when engineering members of the American Materials Handling Society took the PERT program at home in their spare time, they averaged 12.2 hours to complete the program and scored 90.1% on the final exam. Here is their individual performance data:

Job Title	Fore-man	Ops. Mgr.	Proj. Eng.	Supervisor		Pers. Mgr.	Chief Eng.	Traffic Mgr.
Education	H.S.	B.S.	M.S.	H.S.	H.S.	B.A.	B.S.	B.S.
Time (hrs.)	11.3	10.5	9.4	13.3	19.0	13.8	11.3	9.5
Age (yrs.)	36	22	44	48	52	47	47	50
Score (%)	94	97	97	94	92	87	80	79

**FOLLOW THESE
THREE SIMPLE STEPS:**

To rate your own performance and skill needs in these subjects:

- 1) Send for your 10-day review copies of the self-instructional programs.
- 2) Try the final examination included with each program.
- 3) If you are convinced that the skills imparted by the program are valuable, honor the enclosed invoice. Otherwise, return the programs and completed exams and pay nothing.

Name _____
 Title _____
 Address _____
 City _____ State _____
 Company _____

- My check or company purchase order is enclosed.
 Bill me or my company directly.

Clip and send this coupon to:

Please send me the programs designated below. At the end of 10 days, I'll either send the indicated price, plus a few cents for packing and postage, or return the program and my completed final examination and owe nothing.

TITLE	PRICE	
Introduction to Electronic Data Processing	\$9.50	<input type="checkbox"/>
Reading and Evaluating Financial Reports	6.75	<input type="checkbox"/>
PERT	12.50	<input type="checkbox"/>
Introduction to Transistors	9.50	<input type="checkbox"/>
Basic Transistor Circuits	9.50	<input type="checkbox"/>
Counting Systems and Binary Arithmetic	7.50	<input type="checkbox"/>
Applied Electricity	12.50	<input type="checkbox"/>

BASIC SYSTEMS INCORPORATED 880 THIRD AVENUE/NEW YORK, N.Y.

Design for a Simple Voltage Regulator

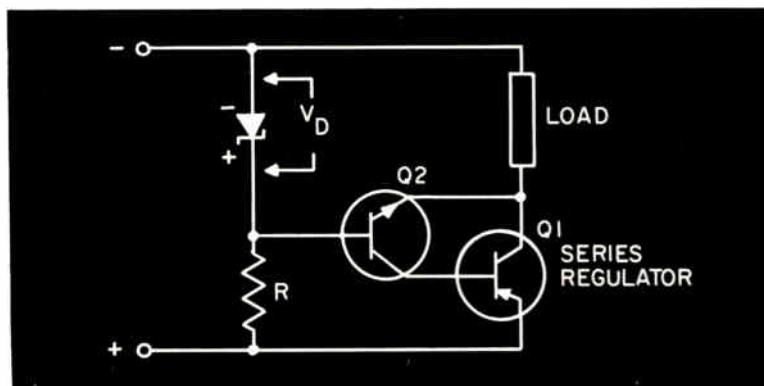

Fig. 1: The voltage regulator circuit.

This useful voltage regulator circuit requires only one discrete component and three semiconductor devices. It offers several advantages over most other voltage control circuits

A VOLTAGE REGULATOR circuit to be presented here offers several advantages over most of the more conventional voltage control circuits. It uses only one discrete component and three semiconductors. Regulation depends upon the semiconductor element characteristics rather than the value of any resistive component. Also, the output voltage differs from the regulating diode only by the base-to-emitter drop of the control transistor (Q2). The control current which must be provided by the zener diode is small, so a low power unit may be used.

* * *

Circuit operation may be seen through examination of Fig. 1. The load forms the collector load for series regulator transistor Q1. This transistor will adjust its own V_{ce} to maintain constant potential drop across the load. Next to this network is a zener diode and associated dropping resistor. The zener is selected to provide a regulated voltage of:

$$V_D = V_z + V_{BE2}$$

where: V_D is the rated potential for the zener diode.

V_z is the desired load voltage.

V_{BE2} is the base-to-emitter drop in Q2.

Interconnecting these two networks is Q2. The base of Q2 is kept at the voltage determined by the zener diode. The collector of Q2 drives the series regulator base and the emitter is connected to the positive side of the load. At turn-on, Q1 and Q2 are initially non-

conducting. But, as the base of Q2 is raised to a positive level by the rising zener voltage, Q2 conducts since its emitter is returned to a negative level. Collector current for Q2 must flow through the base-to-emitter junction of Q1, causing it to conduct. Soon, both Q1 and Q2 will be in conduction, and load current will be shared between them. Q2 will accept $1/\beta_1$ of the total current through Q1 (where β_1 is the dc gain of Q1) and the load will draw a current of

$$I_L = I_{C1} + \frac{I_{C1}}{\beta_1} = I_{C1} \left(1 + \frac{1}{\beta_1} \right)$$

Regulation

Normal transistor action of Q2 will maintain a potential at its emitter which differs from the established base voltage by V_{BE2} . It will draw more or less current, as needed to maintain this condition. It controls the base current of Q1 in the process. Q1, in turn, will correspondingly increase or decrease its impedance to maintain the needed potential at its collector. The voltage across the load will thus be regulated at

$$V_2 = V_D - V_{BE2}$$

Regulation in this circuit is primarily dependent upon the characteristics of the zener diode. This is because the Q1-Q2 pair will maintain a potential at the collector of Q1 which differs from that at the base of Q2 by only the V_{BE2} drop. Resistor R must thus be small enough to provide sufficient current to the zener diode

By **ALLAN PERLIN,**

Sr. Design Engineer,
Aircraft Armaments, Inc.,
Cockeysville, Md.

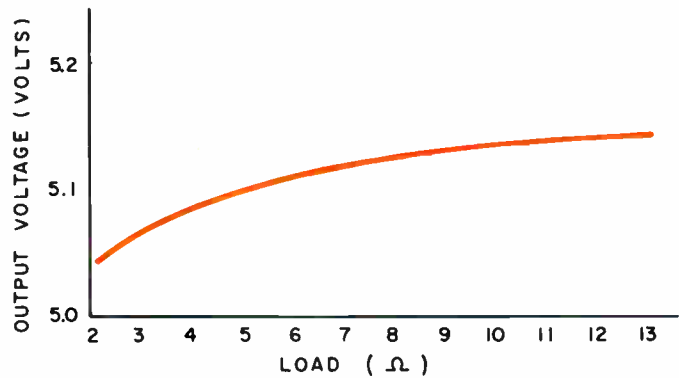

Fig. 2: Regulation with varying load.

under all operating conditions. At the same time it must deliver a current to Q2 which is equal to at least

$$I_{BE2} = \frac{I_L}{\beta_1 \beta_2}$$

where: I_{BE2} is the base current taken by Q2.

I_L is the maximum load current.

β_1 and β_2 are the minimum beta values for Q1 and Q2 respectively.

Temperature Compensation

Temperature compensation may be needed if the circuit is to be operated over a wide temperature range. If the temperature coefficients of the base-emitter junction of Q2 and the zener diode are considered, the expression for load voltage becomes:

$$V_L = V_D (1 + \Delta_D) - V_{BE} (1 + \Delta_B)$$

where Δ_D and Δ_B are the temperature coefficients of the diode and emitter-base junctions, respectively.

For high voltage (over 5 v) zener diodes, Δ_D is generally positive, and for most transistors, Δ_B is negative. For low voltage alloy zener units, Δ_D also may be negative. In the latter instance, the reduction in V_D will be matched by a reduction in V_{BE} , so that the net V_L will remain nearly constant over a wide temperature range (°C to +70°C).

For zener diodes having a positive temperature coefficient, there will be a net increase in output voltage as temperature is increased. But, the effect is self-mollifying since only a small increase occurs. And, this is true only when a higher voltage is being regulated, thus reducing the percentage error. For example, a typical V_{BE} might vary from 0.5 v to 0.3 v over the range from 0° to 70°C, while a zener diode might undergo a variation of about 5% to 6% of its nominal value over the same range. For a typical all-transistor system, with a regulated level of about 20 v, this represents a change of 1.2 v. And, the V_{BE} change, although offering no

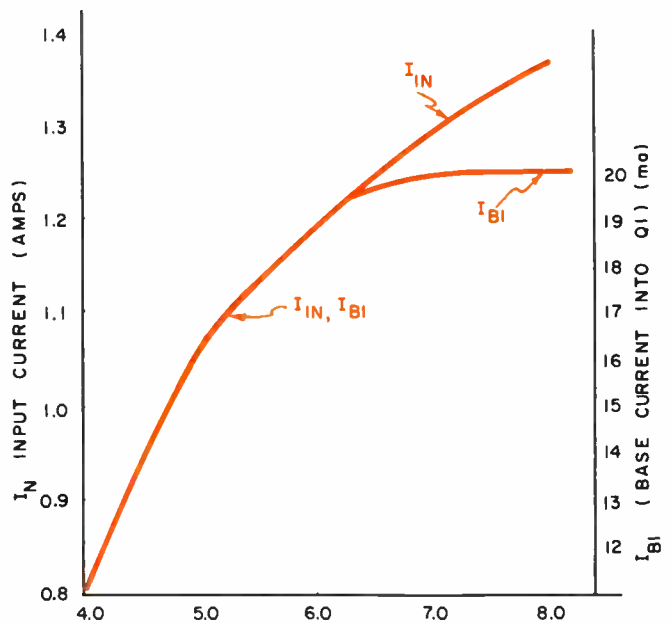
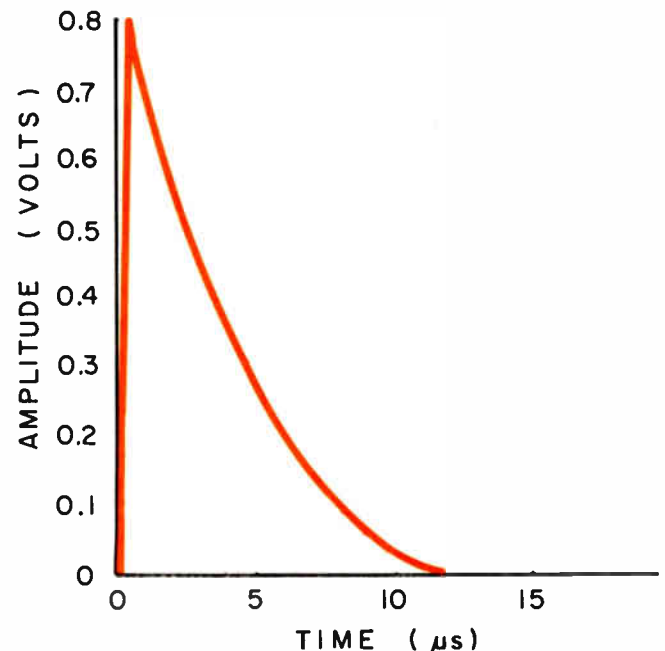

Fig. 3: Input and base currents as a function of input voltage.

Fig. 4: The unbypassed transient characteristic.



VOLTAGE REGULATOR (Concluded)

compensation, does not materially contribute to the error. At higher voltages, of course, the V_{BE} effect is further reduced.

It may thus be concluded that this regulator offers good regulation and temperature compensation at low regulated potentials. At higher levels, the only material temperature effect is that introduced by the zener drift.

Typical Unit

In a typical unit built for evaluation, Q1 was a 2N1358, Q2 was a 2N2102 and the zener diode was a 1N2032 having a nominal value of 5.8 v. R was 15 ohms and V_{BE} was about 0.7 v thus providing a regulated output of 5.1 v.

Regulation with varying load is shown in Fig. 2 (system designed for use in the 3 to 5 ohm load region). Over the range plotted, the regulation from no load (13 ohms or more) to full load (3 ohms) is ± 0.035 v. or $\pm 1.4\%$. Below the 3 ohm load level, a sharp drop in output was observed. This resulted from the fact that the load impedance was approaching the output impedance of the regulator. The output at 2 ohms was 5.05 v.

Operation of Q1 is essentially confined to a constant-base-current characteristic, once the zener has started to regulate. This may be observed by reference to Fig. 3. This figure shows the input current and Q1 base current as a function of input voltage. Note that prior to the start of regulation, I_{B1} shares a fixed proportion of the total current to the load. In the regulated region, I_{B1} (which is I_{CE2}) is constant and all current variations occur through Q1.

Transient Characteristic

The unbypassed transient characteristic is shown in Fig. 4. To obtain this waveform, the regulator was loaded with 3 ohms and a parallel load of 12 ohms was intermittently added to and removed from the output. This represents a direct load transient of 0.6 ohms, or 20% of the nominal value. The transient shown was reduced to only 5 mv by addition of a 150 μ f, 15 v capacitor in parallel with the load. Transient shape was only slightly modified.

The same test was run with a 5% load change, and spikes of 10 mv amplitude and 5 μ sec width were observed. These were considered too small to cause system problems and were virtually eliminated when capacitive filtering was added.

• A REPRINT of ANY ARTICLE in this issue is available from ELECTRONIC INDUSTRIES Reader Service Department.

ENGINEER'S NOTEBOOK

#78 Time Constant and Rise Time Calculations

By MAX H. APPLEBAUM, Head, T.V. Lab,
Warwick Electronics, Inc.,
8345 Hayvenhurst, Sepulveda, Calif.

TIME CONSTANT AND RISE TIME are rapidly calculated for both RC and LR circuits with this nomograph. Only one step is needed.

In an RC circuit the time constant T is defined as the time it takes to charge the capacitor to 63.2% of the maximum voltage. In the LR circuit it is defined as the time it takes for the current to reach 63.2% of its maximum value. Rise time T_R is the time it takes for the charge to rise from 10% to 90% of its maximum value.

T and T_R can be found simultaneously by drawing a straight line from R_L to L at their respective values for the LR circuit and from R_C to C at their respective values for the RC circuit. T and T_R for each case is found where the line crosses the center scale.

Other values of L, R and C can be substituted in the nomograph by multiplying any value shown by 10^n where n may be positive or negative. When L, C, or R_C are multiplied by 10^n then T and T_R are also multiplied by 10^n . When R_L is multiplied by 10^n then T and T_R are multiplied by 10^{-n} .

Example No. 1: Find T and T_R of an LR circuit when R_L is 300,000 ohms and L is 0.65 henries.

Solution: Draw a straight line from 30 on the R_L scale to 0.65 on the L scale. The line crosses the T scale at 0.022 and the T_R scale at 0.05. Since R_L was multiplied by 10 the T and T_R values are multiplied by 10^{-1} . The answers are then 2.2 μ sec for T and 5 μ sec for T_R .

Example No. 2: Find T and T_R for an RC circuit where R_C is 250,000 ohms and C is 0.15 μ f.

Solution: Draw a straight line from 25 on the R_C scale to 0.15 on the C scale. The line crosses the T scale at 0.37 and the T_R scale at 0.82. Since R_C was multiplied by 10 and C was multiplied by 10 then T and T_R are multiplied by 10^2 . The answers are then T=37 msec and T_R =82 msec.

TIME CONSTANT AND RISE TIME NOMOGRAPH

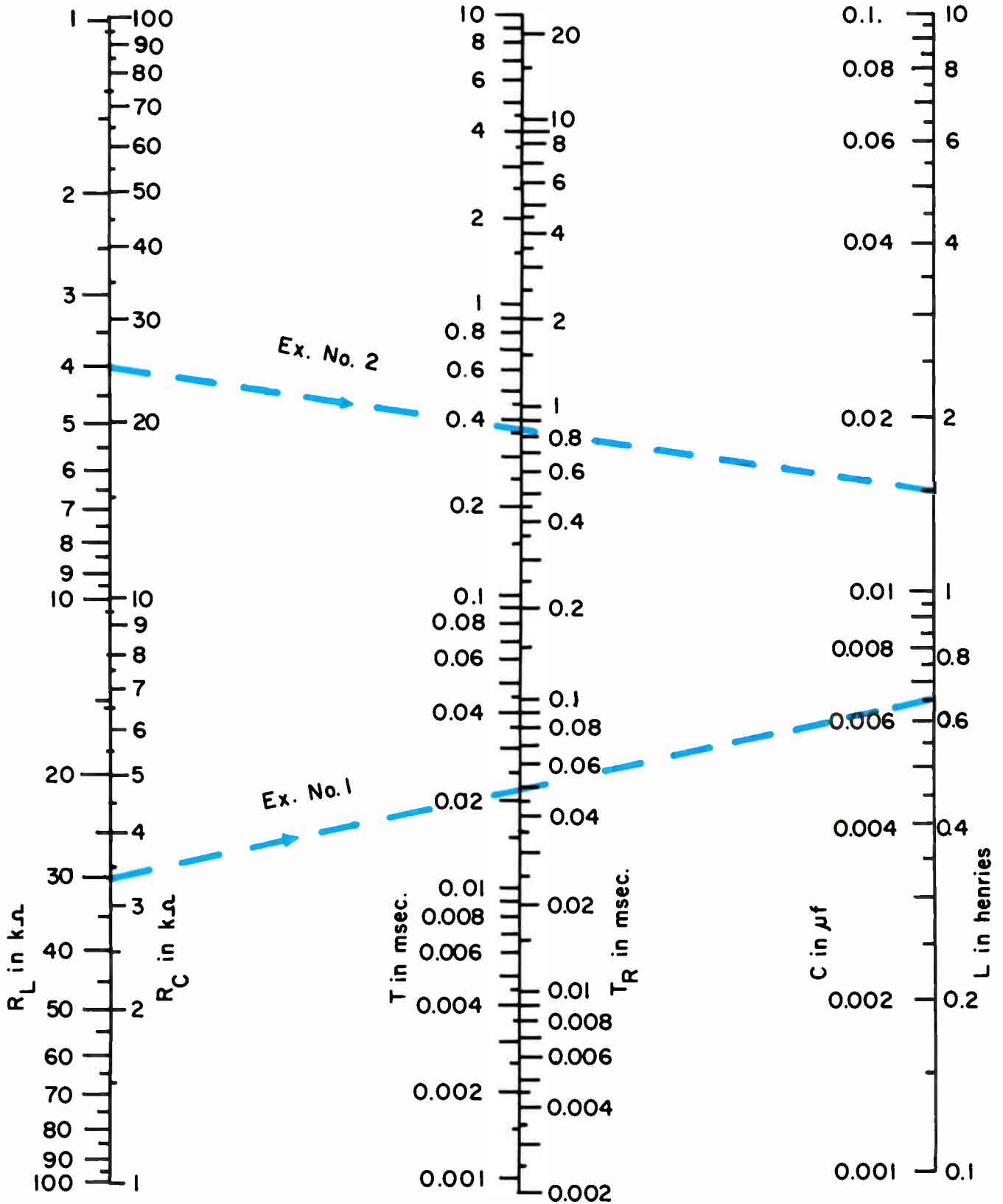

IBR[®]

SILICON AVALANCHE
INTEGRATED BRIDGE RECTIFIERS

ADVANCED DESIGN FOR 3-PHASE RECTIFICATION

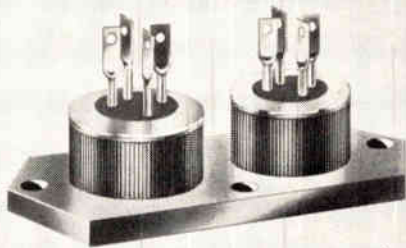

Increased versatility and a broader range of IBR[®] applications are now available with the addition of the 45524 to the Varo IBR[®] line. This advanced-design 45524 offers 3-phase, full-wave rectification in a new small-sized package with SAR[®] (Silicon Avalanche Rectifier) characteristics to control avalanche voltages.

The Varo 45524 features circuit-to-case insulation of 2000 V min., with a thermal resistance, θ junction to case of 4°C/watt. Operating temperature range is -65°C to +165°C. It has 450 V BV_R min., 5 amps/leg DC I_o at 100°C (T_c), 100 amp one-cycle current surge, and is designed for 280 V RMS operation. Also available for 140 V RMS operation.

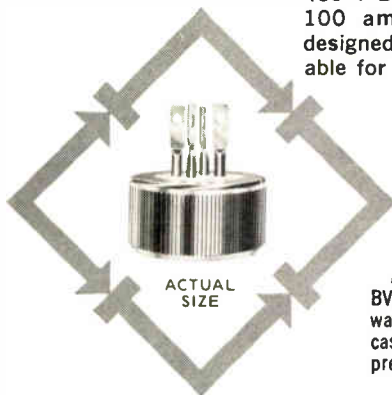

45524
3-PHASE
RECTIFIER

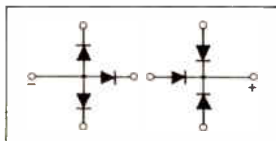

Also available: The Varo IBR[®] IN4436 (250 V BV_R min.) and IN4437 (450 V BV_R min.) full-wave bridge rectifiers with 2000 V min. circuit-to-case insulation in 3 versatile mounting techniques: press-fit, TO-3, and single-stud mounts.

Write today for complete information and a better solution to all your rectification problems.



VARO INC

SPECIAL PRODUCTS DIVISION

2201 WALNUT ST., GARLAND, TEXAS 75041, (AREA CODE 214) 276-6141

BURROUGHS INTRODUCES NEW COMPUTER-ACCOUNTER

A new electronic computing-accounting machine has been introduced by Burroughs Corp. Engineers report that the machine is a versatile, high-performance system which uses solid-state circuitry for split-second multiplication.

Called E1100, the computer-accounter includes diode-transistor logic devices; in all, there are some 1,200 diodes and 250 transistors in the equipment, which takes up the space of an ordinary office desk plus typewriter and two-drawer filing cabinet.

The E1100's multiplier consists of 12 magnetic core decimal decade counters, called incremental flux stepping counters. In each decade two silicon transistors and two permalloy tape wound cores operate on the "ladle and bucket" principle. Individual decades are addressed to allow the generation of a 20-digit product using only the 12 decades.

Many operational conveniences and innovations are included as a part of the package including faster answers, greater workload capacity, warning lights, safety locks, and a selector knob for operational changes.

The machine has a memory for storing constant factors such as tax rates, interest and discount rates.

AUTOLOG PROGRAM

A program called Autolog that measures the performance of data processing equipment has been developed for Series 200 computers by Honeywell. It provides reports on machine performance, productive time of various components of the system, and a simplified method for compiling and analyzing operational statistics, by application, on usage of time and equipment. The program was written for use with Series 200 systems with a minimum of 4,096 characters of memory, three half-inch tape units, a card reader and a printer.

IMPROVED COLOR TUBE

General Electric announced it has begun pilot production of an improved type of color TV picture tube. Fred J. Borch, GE's president and chief executive officer, described the tube as "an improved version of the shadow-mask type, which is standard in the industry." He said it is of a "simpler design which can lead to less costly tube installation and service."

There are now **8 basic versions of Autronex®** for electronic applications

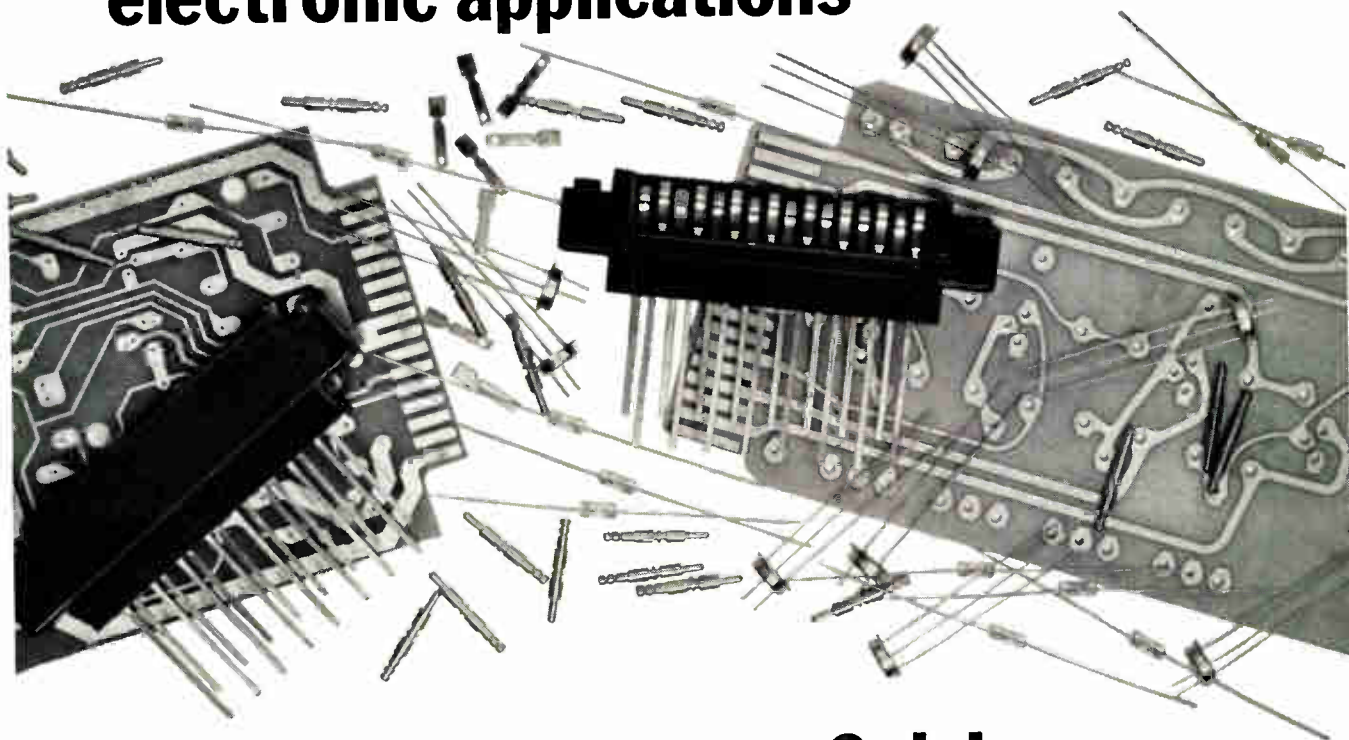

Solving your gold plating problem might make it **9.**

In electronic components, a minute variation in requirements can create the need for a new gold plating process. That's why we have 8 distinct formulations of Autronex®. Originally each was a response to a particular plating problem. Today, these same 8 basic formulations are meeting hundreds of requirements. That's a major advantage of working with Sel-Rex. Our scientific approach allows us to

change existing processes and create new ones as needed. Our ability to meet these needs has made Autronex the most widely used process in electronics.

Autronex is an acid bath, extremely stable and easy to operate. Each formulation produces an electroplate with purity, hardness and ductility characteristics to meet specific application requirements. All deposits

are mirror bright, exhibit constant electrical resistivity, good solderability characteristics, and have excellent resistance to corrosion, oxidation and galling.

If you're looking for a means of improving your precious metal plating let us know the details of your application requirements.

Write: Sel-Rex Corporation, Dept. EI-6, Nutley, New Jersey 07110



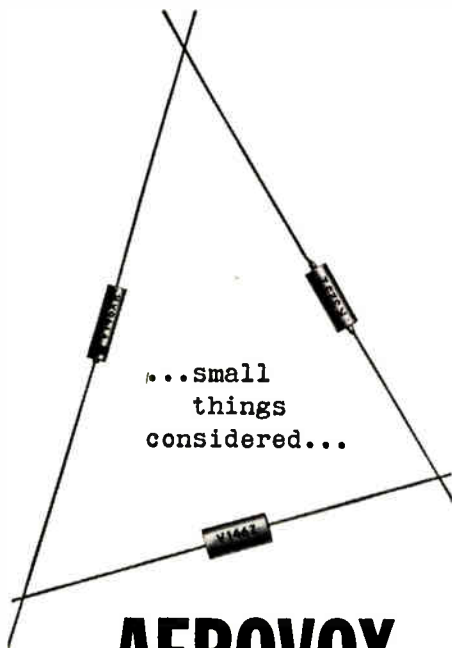

...AEROVOX MINIATURIZED FILM AND METALLIZED FILM CAPACITORS NEW!

Types V146Z, V146XR, K323Z

The miniature requirements of transistorized circuits for military, industrial and commercial applications can best be met by reliable, guaranteed-quality Aerovox capacitors. New designs, and continuing improvement of existing products assure "state-of-the-art" technical excellence.

V146Z Metallized Mylar® Flat Wrap and Fill

Capacitance Range: 0.01 to 5.0 Mfd.
Voltage Range: 200 VDC to 600 VDC
Temperature (max.): 125°C

V146XR Mylar Round Wrap and Fill

Capacitance Range: 0.001 to 2.0 Mfd.
Voltage Range: 150 VDC to 600 VDC
Temperature (max.): 125°C

K323Z Metallized Polycarbonate

Capacitance Range: 0.01 to 5.0 Mfd.
Voltage Range: 200 VDC to 600 VDC
Temperature (max.): 125°C

Aerovox Miniature Film and Metallized Film Capacitors are instantly available from your local Aerovox Distributor. Call him for fast, efficient service.

© DuPont Registered



**AEROVOX
CORPORATION**

DISTRIBUTOR DIVISION, NEW BEDFORD, MASS.

Technical Leadership—Manufacturing Excellence

Circle 138 on Inquiry Card

CONVERSATION PIECE



Inventor Alec H. Reeves holds a conversation chopper that has solved the problem of congested telephone circuits. Known as a "pulse code modulator" that chops speech into "bits," it was invented by Mr. Reeves 25 years ago, but has undergone continued development and refinement, and is now used in England and U. S.

GE CAPACITOR DIVISION EXPANDS TO MEET MARKETS

In what the firm calls a demonstration of confidence in the volatile electronic business, General Electric reports it will invest more than a million dollars in 1965 on new production equipment and laboratory facilities. These expenditures will be for GE's Electronic Specialty Capacitor section at Irmo, S. C.

Prime targets of the increased production are the rapidly increasing color TV market, computer, and other industrial electronic equipment markets.

BAR TRANSDUCER

A new Electrosonic BAR transducer has been presented by Linden Laboratories, Inc., State College, Pa. The device is for ultrasonic cleaners that operate in extreme environments and demand high reliability.

The transducer, according to Linden engineers, performed continuously in tests for more than 3,000 hours. It can be operated in rapid temperature cycling. It can start at 0°F., and can be changed instantly to 212°F., or the reverse.

SUBSIDIARY PACT

An agreement has been completed between Datamec Corporation and Hewlett-Packard Company whereby Datamec will become a wholly-owned subsidiary of H-P through a stock exchange. Effective date of the proposed combine is June 30, 1965, according to David Packard, H-P board chairman.

NEW HIGH DENSITY RELAYS DELIVER 200 OPNS. PER SECOND



These contact form C relays follow signals up to 200 operations per second without variation in timing. Are available in single-side-stable, bi-stable and chopper forms. Adlake MWSA 16000 relays like the one on the left are the only ones you'll find anywhere molded in epoxy. Though less expensive, they stay cooler. Contain no wax to overheat and run. Parts are rigidly secured—no movement to cause circuit noise. Epoxy is proof against all caustics and solvents except acetic acid. The metal encased version on the right can be grounded to assure magnetic shielding. Use it where magnetic interference is a special problem. For more information, call Adlake. And remember, *Adlake makes more kinds of mercury relays than anybody.*

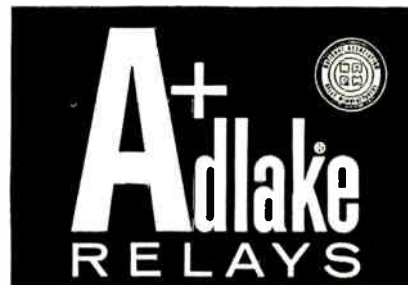

The Adams & Westlake Company
Dept. R-8806, Elkhart, Indiana
Phone Area 219, COngress 4-1141

Circle 139 on Inquiry Card

ZENITH SEEKING FCC NOD FOR NATION-WIDE PAY TV

Zenith Radio Corp. has asked the FCC to authorize subscription TV on an "extended nation-wide basis" and to make it available to operating and proposed stations as a supplemental service.

Supporting the petition, filed jointly with Teco, Inc., was an analysis of the Hartford, Conn., subscription test. Now in its third year, the test is being conducted over WHCT. Hartford, by RKO General. The operation uses the Phonevision subscription TV system and equipment developed and made by Zenith.

In a proposed rule for FCC approval, the Zenith-Teco petition recommended that the Commission set general standards for subscription TV systems, allowing all systems that meet FCC requirements to compete in the market.

The Zenith-Teco presentation asserted that the Hartford test results show that subscription TV is of the greatest importance to families who can least afford higher prices at theater box offices. It also asserted that the system adds to TV program choices available, can increase numbers of services available, and attracts a level of audience support that can make it a sound business venture.

Beginning with 188 subscribers in June, 1962, the Hartford test was serving some 4,775 homes at the end of its second year. Subscription programming came from more than 50 different sources. Projections, which Zenith called "conservative," indicate that over-the-air subscription TV can begin to operate profitably with 20,000 subscribers. With only 10% of TV homes signed up, the service can become sound business in at least the 100 top TV markets in the country, according to the petition.

PERFECT COLOR TV

Color television of perfect quality could be relayed from space directly to homes and schools in any part of the world within two or three years, reports Dr. Harold A. Rosen, assistant manager of Hughes Aircraft Co. Space Systems Division. He said that technology exists for launching a 1,550-lb. stationary satellite into synchronous orbit to relay color and monochrome broadcasts to receivers anywhere, including areas where TV reception is not possible now.

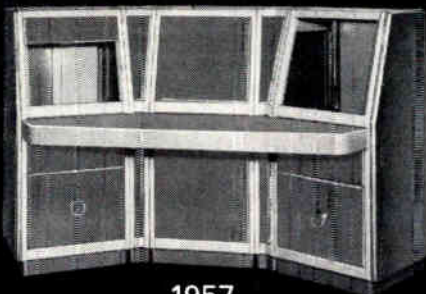

1957

What is the difference* between these enclosures?

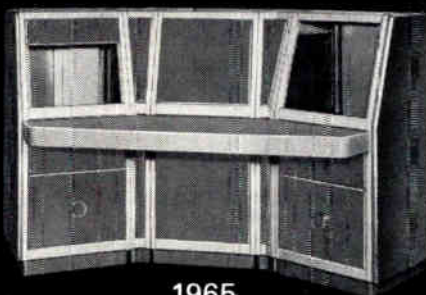

1965

*1965 EMCOR CONSOLE COSTS \$199.70 LESS

EMCOR I MODULAR ENCLOSURES ARE ENGINEERED TO BE THE BEST BUY!

On October 15, 1957, the EMCOR I Console shown above cost \$1094.65.** On April 15, 1965, the same EMCOR Console cost \$894.95—a difference of \$199.70 less.** As a result of Ingersoll Products' enclosure engineering and manufacturing "know-how," today's EMCOR customers realize handsome savings. As the original modular enclosure system, EMCOR I units established Ingersoll Products' coveted reputation for enclosure quality many years ago. EMCOR features of rugged construction, high load carrying capacities, variety of configurations, long-lasting beauty, etc., haven't changed. EMCOR Enclosures literally defy obsolescence. For EMCOR I Depth of Line selection at mass production prices, call your nearest EMCOR Sales Engineering Representative or write for full details—no obligation!

Albany: 436-9649; Albuquerque: 265-7766; Binghamton: 723-9661; Boston: 944-3930; Bridgeport: 368-4582; Buffalo: 632-2727; Chicago: 676-1100; Cleveland: 422-8080; Dallas: 631-7450; Dayton: 298-7573; Del Mar, Calif.: 454-2191; Denver: 934-5505; Detroit: 357-3700; Ft. Lauderdale: 564-8000; Houston: 526-2959; Huntsville: 536-8393; Indianapolis: 356-4249; Kansas City: 444-9494; Los Angeles: 938-2073; Minneapolis: 545-4481; New Orleans: 242-5575; New York City: 695-0082; Orlando: 425-5505; Palo-Alto: 968-8304; Philadelphia: 242-0150; Phoenix: 273-1673; Pittsburgh: 884-5515; Seattle: 722-7800; St. Louis: 647-4350; Syracuse-Utica: 732-3775; Tulsa: 742-4657; Fort Lee, N. J.: 944-1600; Valley Forge, Pa.: 265-5800; Washington, D. C.: 836-1800; Winston-Salem: 725-5384.

**Prices listed are subject to EMCOR Discount Schedule.

Ingersoll Products 1000 W. 120th St., Dept. 1245, Chicago, Ill. 60643 DIVISION OF BORG-WARNER CORPORATION

electronic
equipment

BORG **WARNER** T.M.

VISIT US IN BOOTH 302-304 AT NEPCON

Circle 140 on Inquiry Card

DATAFLASH or DATARITE®?



It depends. Within this complete CEC family are five types of papers and two developer solutions that cover the entire range of oscillography.

DATAFLASH 56. A high writing speed product which produces superb traces, timing, and grid lines where Xenon lamps are used.

DATAFLASH 55. The extreme sensitivity of this paper now makes it possible to obtain *perfect* oscillograph records at writing speeds in excess of 75,000 ips.

DATAFLASH 54. Direct-print Dataflash 54 is supremely effective at writing speeds up to 50,000 ips.

DATARITE 33. DATARITE refers to CEC's Datarite Magazine in which oscillograms are automatically developed and dried as quickly as data is recorded. DATARITE 33 is ideal for high writing speed applications.

DATARITE 22. Type 22 has less sensitive emulsion than Type 33. At low writing speeds, it will give excellent oscillograms.

Type 49943-4 Datarite Developer Solution is an ammonia-type formula which combines high writing speeds with reduced paper staining in high humidity environments.

Type 49943-3 Datarite Developer Solution is a non-ammonia, general purpose formula which provides exceptionally high trace contrast and high writing speed capability.

For all the facts about CEC oscillograph papers and chemicals, call or write for CEC Bulletin Kit #7062-X4.

CEC
CONSOLIDATED
ELECTRODYNAMICS

A SUBSIDIARY OF BELL & HOWELL/PASADENA, CALIF. 91109
INTERNATIONAL SUBSIDIARIES: WOKING, SURREY, ENGLAND
AND FRIEDBERG (HESSEN), W. GERMANY

Circle 141 on Inquiry Card

170

TWO-WAY CB RADIO



New Ray-Tel TWR-5 CB two-way radio introduced by Ford Motor Co., may be used in new communications network advocated by Automobile Manufacturers Association. All-transistor unit operates at 5w. input, maximum FCC allowable power input for CB equipment.

NASA WILL RECEIVE ELECTRONIC ITEMS FROM DSA

The Defense Supply Agency (DSA) will furnish an estimated one-and-a-half-million dollars worth of electronic items yearly on a reimbursable basis to NASA as a result of an interagency agreement.

Some 12,000 centrally managed items at DSA's Defense Electronics Supply Center (DESC), Dayton, Ohio, are covered in the agreement. Fourteen NASA depots will receive support from DESC beginning July 1, 1965.

Among major NASA projects receiving such support will be the Gemini and Apollo programs, and all unmanned investigations employing sounding rockets, orbiting spacecraft, and interplanetary probes.

Also receiving support will be meteorological and communications satellite systems and their development, and advanced research and technological development to support U. S. aeronautical and space programs.

SOLID-STATE MOBILE RADIOS

RCA has introduced two mobile radios, both all solid-state; one operates in the 450mc band at 15w. output. The other operates at 150mc at 30w. output. Transmitter and receiver frequency stability of both is $\pm 0.0005\%$. RCA engineers said the radios can operate continuously because of 100% solid-state construction and improved heat dissipation.

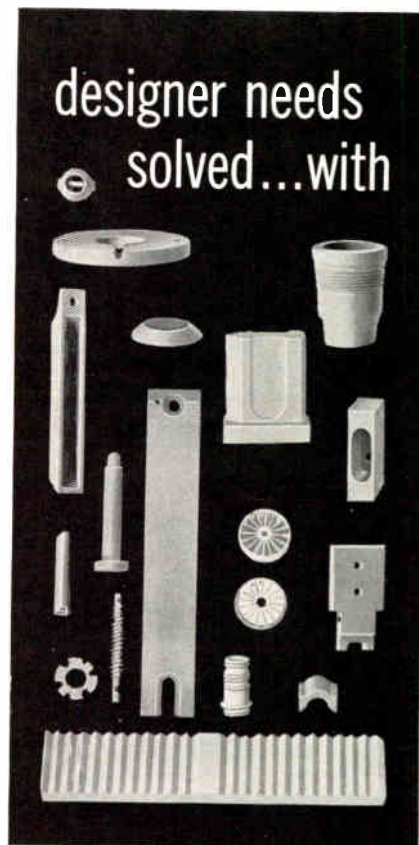

DIAMONITE® HIGH ALUMINA CERAMIC

EXTRAORDINARY VERSATILITY

Diamonite . . . superb for components requiring high heat resistance, thermal conductivity, hardness, wear resistance, chemical inertness, high mechanical strength, low dielectric loss or electrical insulation.

FORMS MYRIADS OF SHAPES

Diamonite components are formed to almost any shape for specific needs. Readily metalized for brazed assemblies or vacuum seals.

DIAMONITE CAN BE YOUR SOLUTION

Our engineers will work with you, analyze your design, assist with prototypes and gear-up to meet your production requirements.

3620-A

Write for "Ceramics in
Product Design" brochure.



PRODUCTS MFG. CO. SHREVE, OHIO 44676

DIV. OF U. S. CERAMIC TILE CO.

Circle 142 on Inquiry Card

ELECTRONIC INDUSTRIES • June 1965

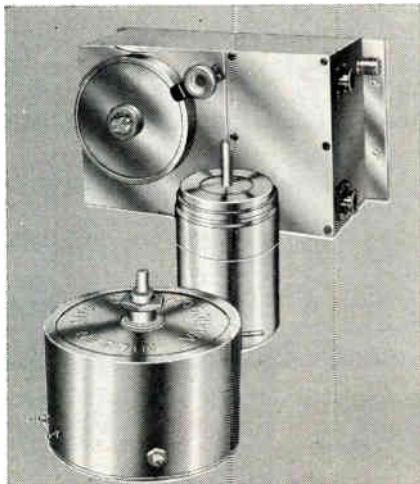

PHASE SHIFTERS

1 KCS TO 200 MCS



CONTINUOUS
0° thru 360°

NILSEN MFG. CO.

Box 127, Haines City, Fla. 33844
(Area Code 813) ■ 422-1197

Circle 143 on Inquiry Card

More torque, Less weight



APT-1; 1 cu. in., 3.15 oz.
(actual size)

in moving coil mechanism

Stable, linear, accurate mechanism for indicating, control or recording systems. 1% linearity over 18-0-18° and greater accuracy assured by coil design with over 75% of winding "working" in high energy, uniform field air gap. Coil system weighs 0.85 gm, develops 26.4 mmg of torque; 31:1 T/W. Vibration resonance negligible; acceleration errors sharply attenuated. Standard pivots and jewels—custom damping—wide range of sensitivities.

AMMON

AMMON INSTRUMENTS, INC.
345 Kelley Street, Manchester, N. H. 03105

Circle 144 on Inquiry Card

DOUGLAS OFFERS 'SPIN-OFF' FOR LICENSE NEGOTIATIONS

Research and Development in aerospace industry often leads to new products with commercial applications. Douglas Aircraft Co. discloses some of its recent developments which the firm is now offering to other firms interested in negotiating licensing agreements.

Among electronic developments are a self-contained pin engagement indicator for connectors, and an electric motor rotation sensing device.

The monitoring method for pin engagement in electrical connectors requires inclusion of one or more special pins in existing connectors. Although these pins are made from or are coated with a material of predetermined resistive value, they can perform like regular pins in the circuit. With engagement indicating pins, it is possible to determine degree of engagement in one or a series of connectors on a common line. Technique is applicable to most connector types including printed circuit, circular, rack-and-panel, and rectangular.

To prevent a motor from rotating in the wrong direction, a sensing device stops the motor immediately. The device is incorporated in the motor. If the stator flux is in the wrong direction the device energizes the brake to stop rotation. The time lag is so short that little, if any, rotation in the wrong direction occurs. The device also may be used to engage or disengage a clutch, or to activate an indicator showing direction of rotation.

ENGINEER AWARDS

As part of Engineer's Week, the Los Angeles Engineers' Week Committee presented eight engineers with achievement awards. Among them was Rebecca H. Sparling, materials specialist at General Dynamics/Pomona, who was cited for "her outstanding contributions to engineering and her leadership in encouraging women to become engineers." She is a member of the Society of Women Engineers.

500,000 PICTURES

Weather satellites put into orbit by NASA have returned almost a half-million cloud cover pictures of Earth, 90% of them usable, since the first TIROS (Television Infrared Observation Satellite) was launched five years ago (April 1, 1960).

ABOUT TIME!



A fluid temperature chamber with phenomenally low gradients... at a sensible price!

Here's stability that only a fluid temperature chamber can provide—combined with Delta Design exclusive Type III Control for programming with ease and unmatched flexibility. All this at prices starting at \$2910—less than half what you might expect to pay for a mechanically refrigerated chamber. Result: new Series 5500 Fluid Chambers are the best buys in environmental test equipment.

Temperature gradients of 5500 Chambers average less than 0.05°C throughout the entire 14" cube of working volume. Rely on resettable of ±0.25°C for inspecting critical electronic components... for calibrating transducers and sensors... for any application where such tight control as ±0.01°C is a must. Standard 5500 models provide temperatures from -30 to +175°C; to -73°C in one model. Special models are available for running "shock treatment" tests at high, low and ambient temperatures at the same time, in the same chamber.

Get all the facts on Delta Design fluid chambers... or tell us your requirements. Contact us directly or the Delta/Non-Linear Systems office nearest you—on any environmental control problem. It's our specialty.



The Environmental Control People

8000 Fletcher Parkway • La Mesa, Calif.
Phone: (714) 465-4141

Overseas Representative: Microwave International Corp., 420 Lexington Ave., New York, N.Y., U.S.A.
Cable: Microken—N.Y.

Circle 145 on Inquiry Card

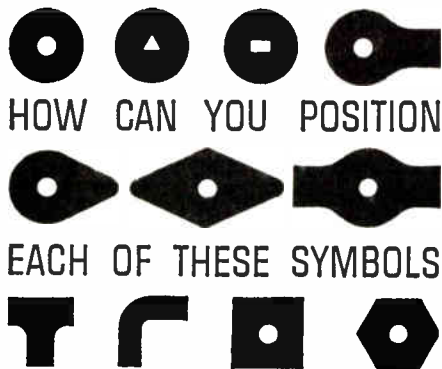

 HOW CAN YOU POSITION

 EACH OF THESE SYMBOLS

 IN JUST 3 SECONDS?

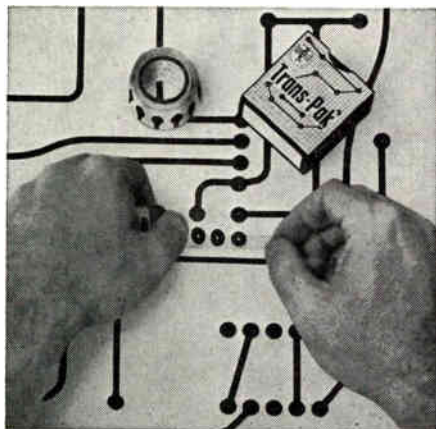

WITH

Trans-Pak

DIE-CUT SYMBOLS

IN ROLL FORM!

Simply position, press and peel your way to faster, more accurate, distortion-free printed circuit masters. With Trans-Pak every terminal pad, elbow, connector, teardrop, or any other symbol is "predrawn" for you. No inking! No cutting! No stripping! Trans-Pak pressure-sensitive die-cut symbols are available in black crepe and red translucent material. Any symbols can be made up in die-cut roll form conveniently packaged 250 symbols to a roll . . . without a die-charge. Send for Trans-Pak catalog of printed circuit symbols and Free sample strip of Trans-Pak. Introduce yourself to the best method of making printed circuit masters. Look in the Yellow Pages for your Chart-Pak dealer's name.



1960-1965

15

 TH

 ANNIVERSARY

Chart-Pak, Inc.

 931 River Road

 Leeds, Massachusetts.

Please send a Trans-Pak sample strip, Trans-Pak Printed Circuit catalog, and the 1965 Chart-Pak general catalog.

Name..... Title.....

Company.....

Address.....

City..... State..... Zip.....

CHART-PAK, INC.

 Dealers in principal cities throughout the world.

 Circle 146 on Inquiry Card

ELECTRONIC NULL



Electronic null detector (center) speeds production line selection of precision resistors. Instrument is an Alnico Model ND-2 Null Detector made by MB Electronics, Div. of Tectron Electronics Inc. The device is self-contained and self-powered. Operators say jarring does not disturb the indicator.

PLUMBICON COLOR TV CAMERA

IS SMALLER AND LIGHTER

A new smaller and lighter-weight color TV camera has been introduced by North American Philips Company, Inc. Called the Norelco PC-60 Plumbicon Camera, the device is greatly reduced in size and weight owing to solid-state circuits and small Plumbicon pickup tubes, according to Norelco engineers.

The camera with 10-to-1 servo controlled zoom lens is about the same size as current models of black and white cameras, according to Norelco. Basis of the small color camera is a "vastly improved photo conductive pickup tube in which image lag is greatly reduced." The 8" x 1" tube has "good sensitivity and a low 'dark current' eliminating shading problems."

RADIATION SURVEY

A 1964 survey shows more understanding in solar radiation simulation since the previous 1963 survey. Results of the survey, conducted by the Institute of Environmental Sciences Solar Radiation Simulation Committee, are in five sections: General, Thermal Testing, Materials Testing, Radiation Sources and Instrumentation.

The survey is available from Institute of Environmental Sciences National Office, 34 S. Main Street, Mt. Prospect, Ill.; members—\$3.00, non-members—\$5.00.

VISUAL

MAGNETIC

CONTROL

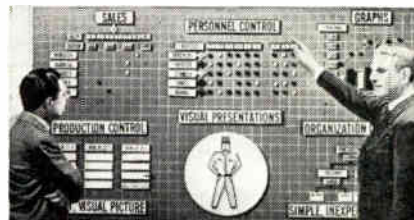

MAGNETS MOVE FASTEST—AND EASIEST—OF ALL

SIMPLEST VISUAL CONTROL FOR

Sales • Production • Personnel

 Maintenance • Machine Loading • Scheduling

 Charts • Visual Presentations • Graphs

COLORFUL MAGNETIC ELEMENTS

ORGANIZE FOR ACTION

 SHOW FACTS INSTANTLY

 ELIMINATE MISTAKES

 GET THE JOB DONE

Priced From

\$3800

Including Magnetic Elements

Price List & Brochure E16

FREE

On Request

Methods Research Corp.

105W-Willow Ave., Staten Island, N.Y. 10305

Circle 147 on Inquiry Card

VISION and SITE

ARE ONE

AND THE SAME

 in the

DAYTONA BEACH

FLORIDA

Industrial area

Vision . . . describes Daytona Beach planning when it established an Industrial Park providing an efficient location and economical facilities for your new plant site. Add the convenience of full Metropolitan Area Services, plus proximity to the N.A.S.A. Missile and Aerospace Complex at Merritt Island, Cape Kennedy and the growing Florida consumer market . . . You'll discover why the Daytona Beach Industrial Area offers the best of sites to companies with vision!

Write to: Robert H. Miles, Industrial Manager

DAYTONA BEACH Area Committee of 100

 (Ormond Beach, Daytona Beach, Daytona Beach Shores, South Daytona, Holly Hill, Port Orange), P.O. Box 1309, Dept. 1-59

 Daytona Beach, Florida

Circle 155 on Inquiry Card

CIRCUIT-WISE

Zener Diode Function Generator

FOR MANY APPLICATIONS, an electronic differential analyzer requires a function generator that can produce functions discontinuous in slope, as well as smooth monotonic and polytonic continuous functions. Diode function generators previously used alone or with smooth oscillators needed external voltage references. They are subject to reference voltage drift, as well as to temperature variations in the diodes.

A function generator using zener diodes is reasonably stable with temperature variations. It requires no external reference voltage. The generator provides a wide variety of breakpoints and features repeatable operation with a minimum of recalibration.

The general layout of the zener diode function generator is shown in Fig. 1. An input signal is fed into R_1 which is connected in parallel with an impedance network and a zener diode. In series with these circuit elements is another parallel network consisting of a zener diode, a second impedance network, a high-gain dc amplifier, and a resistance R_2 .

The function generated appears at the output of this parallel network in the form of a voltage varying in

time. The nature of this function depends on the two impedance networks.

The network may consist of one or more basic cells shown in Fig. 2, connected in parallel. The cell has a reversing switch for an interchange of the external connections.

The diode is selected for its zener voltage which determines the point in the generated function at which there is an abrupt change in the slope. This voltage is the point at which the resistance in the back direction is very low. Diodes are available covering a wide range of zener voltages so that a great variety of functions may be generated.

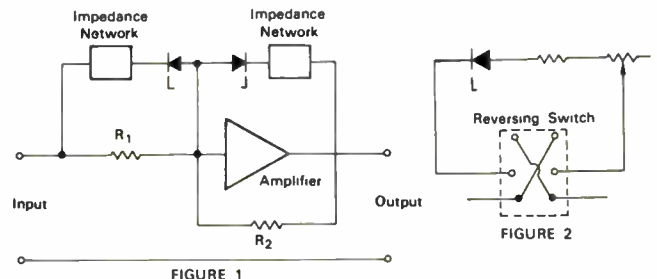

FIGURE 1
For further information contact: Technology Utilization Officer, Jet Propulsion Laboratory, 4800 Oak Grove Dr., Pasadena, Calif. 91103. Ref.: B65-10013.

**PLEASE USE YOUR
ZIP CODE**



When entering or renewing a subscription to this publication or writing us for any purpose, please be sure your Post Office Zip Code appears with your address.

This will facilitate prompt handling by the Post Office and help us to give you better service.

**ELECTRONIC
INDUSTRIES**

56th & Chestnut Streets,
Philadelphia, Pa. 19139

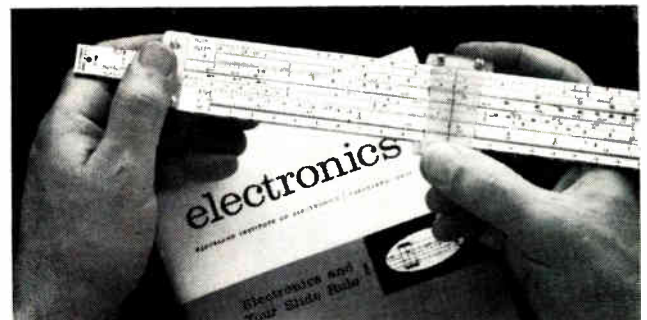

NEW ELECTRONICS SLIDE RULE WITH PROGRAMMED INSTRUCTION COURSE

Professional, all-metal 10" slide rule . . . designed specifically for engineers and technicians. Comes with four lesson AUTO-PROGRAMMED Instruction Course. Carries special scales to speed solution of reactance and resonance frequency problems. Has handy decimal point locator plus widely used formulas and conversion factors not found on any other rule. Can be used for conventional computation, too. Made to our rigid specs by Pickett, Inc. Rule, AUTO-PROGRAMMED Instruction Course and top grain leather case . . . a \$50 value for less than \$20! Send coupon for FREE booklet. Cleveland Institute of Electronics, 1776 E. 17th St., Dept. ER-101, Cleveland, Ohio 44114.

SEND COUPON FOR FREE BOOKLET!

Cleveland Institute of Electronics

1776 E. 17th St., Dept. ER-101, Cleve., Ohio 44114

Please send FREE Electronics Slide Rule Booklet.

SPECIAL BONUS: Mail coupon promptly . . . get FREE Pocket Electronics Data Guide too!



NAME _____ (Please Print)
ADDRESS _____ COUNTY _____
CITY _____ STATE _____ ZIP _____

A leader in Electronics Training . . . since 1934.

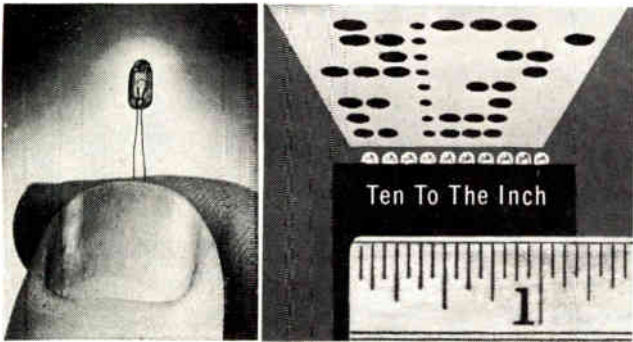

THIS TINY DEVICE CAN TRIGGER A MIGHTY RESPONSE!

It is built like an ultra-miniature incandescent lamp, but the visible light it produces is merely incidental. The energy emitted is mainly in the infra-red range between 0.7 and 3.0 microns—wave lengths to which most photocells are highly sensitive.

Moreover, this "energy emitter" is so compact it can be mounted *ten-to-the-inch*—matching the perforation spacing on standard punched tape.

Extremely shock resistant and with a life expectancy of years before replacement is required, this Chicago Miniature Energy Emitter presents interesting new possibilities in the design of equipment incorporating photosensitive units.

Write for complete information.



CHICAGO MINIATURE LAMP WORKS

4437 Ravenswood Ave., Chicago, Illinois 60640

Circle 149 on Inquiry Card

Material: High Thermal Nomex*
Process: Spiral Winding

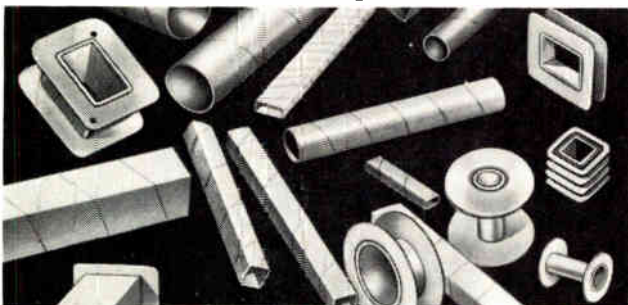

Result: Great New Line Of Tubing And Bobbins

Yes, these tubes and bobbins are spirally wound from Nomex to provide heat-resistant and insulation qualities equal to considerably more costly materials and fabrication methods. Here are a few quick facts:

- Rated for operation above Class "H."
- Temperature Characteristics: self extinguishing, will not melt but chars at 400°C. (750°F.).
- Outstanding overload and flash protection.
- Diameters from .125" to 2.000"
- Wall thicknesses from .004" to .040", dependent on dia.
- All shapes—round, square, rectangular.
- Combinations of Nomex with other materials for added economy or individual requirements.

Write or phone for full information.

*DuPont Trademark



PRECISION PAPER TUBE CO.

RESINITE DIVISION

1049R S. Noel Ave., Wheeling, Ill. 60090 (Chicago Suburb)

TELEPHONE 312... 537-4250 TWX 312... 537-5202

Circle 150 on Inquiry Card

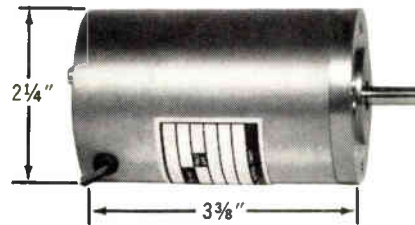

1/10 HP D.C. MOTOR

a new permanent magnet motor

New Globe permanent magnet GRP d.c. motor drastically cuts space requirements for a powerful reliable MIL spec unit. While the PM type offers utmost efficiency, we can also furnish wound field designs in this frame for series, split series, shunt, split shunt, or universal operation. SPECS: 0.1 hp in the 4,000 to 10,000 rpm range, 2 1/4" dia., weight 40 ounces. We'll supply special gearing for any speed-torque combination. Voltages to 115 v.d.c. Governors, brakes, radio noise filters available. Request Bulletin GRP. Check our stock list for 24-hour prototypes. Globe Industries, Inc., Dayton, Ohio 45404.

GLOBE

GLOBE INDUSTRIES, INC.



Circle 151 on Inquiry Card

a source for that special resistor??
of course!...

resistors, inc.

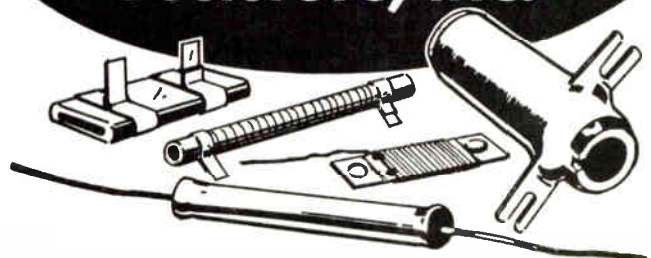

At Resistors, Inc., your power resistance applications are our *only* concern—not a sideline. Industrially perfect wire wound resistors are all we make—and we've been making them for more than 25 years: all sizes, all shapes, all resistance values. Some of our customers, for example, require axial lead resistors with resistances as low as .033 ohms with a tolerance of 1%. Critical? Yes, but definitely available at Resistors, Inc., where special jobs are standard. Of course, we have a complete line of conventional wire wound resistors suited to meet almost all your needs. But see for yourself. Send today for our complete new catalog.



resistors, inc.

5226 W. 26TH STREET • CHICAGO, ILLINOIS 60650
(312) OLYMPIC 2-7555

Circle 152 on Inquiry Card

CIRCUIT-WISE

Transistor Voltage Comparator

DETECTION OF THE HIGHEST VOLTAGE input among a group of varying voltage inputs was desired. The sensing circuit must function without the aid of external circuits. A transistorized circuit that can be directly coupled to a binary encoder for readout was a solution.

The voltage comparison circuit uses one transistor for each input line being monitored. The base-emitter junctions of the transistors are connected as in a standard diode comparator circuit. The collector circuits of the transistors perform the sensing function.

The emitters of all the transistors are tied to one common resistor R_1 . Each transistor has a load resistor in its collector circuit. With the maximum input voltage on the base of Q_1 , the base-emitter junction of Q_1 will be the only one forward biased. Transistor Q_1 will be conducting and the voltage at the emitters of all transistors will be equal to the voltage on the base of Q_1 minus the voltage drop across the base-emitter junction of Q_1 .

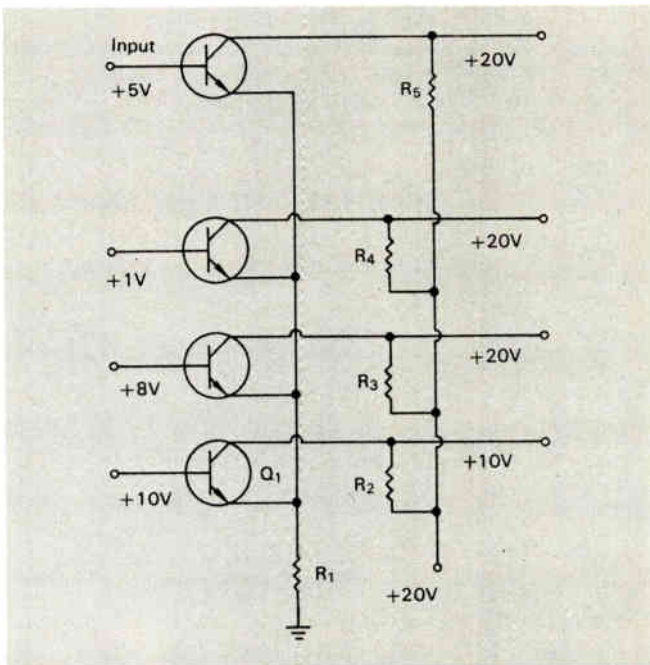

tion of Q_1 . Voltages on the emitters of all transistors, except Q_1 , will be more positive than the voltages on their respective bases and they will be cutoff. The output voltages of these transistors will be very high compared to that of Q_1 .

Although npn transistors are shown, pnp may be used with reversed polarities. This circuit could be used to advantage wherever diode comparator gates are presently in use. Input voltage levels will be governed by the transistors used. The individual values of R_2 , R_3 , R_4 , and R_5 are much greater than R_1 .

For further information contact: Technology Utilization Officer, Goddard Space Flight Ctr., Greenbelt, Md., 20771. Ref. B65-10028.

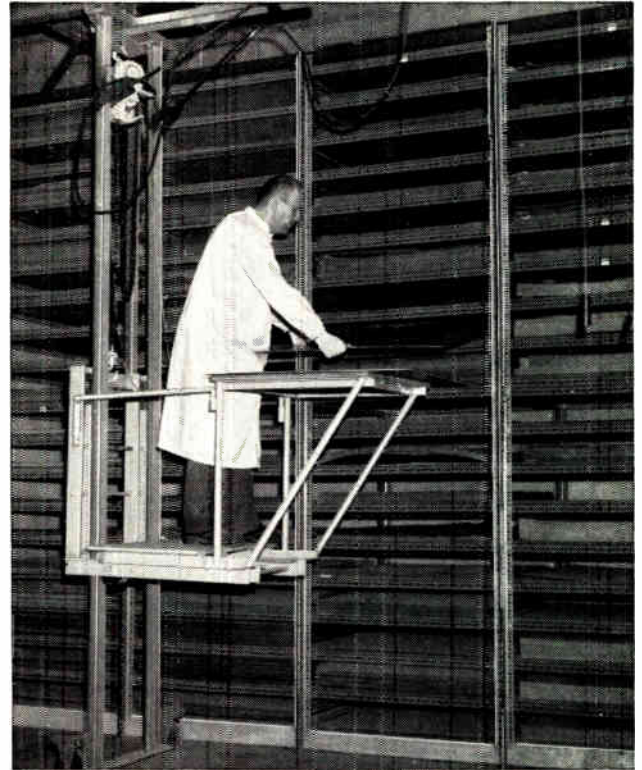

20,000 pounds of COPPER-CLAD Laminates NOW in STOCK

We have systematically increased our stock of Synthane copper-clad laminated plastics. We now have 20,000 lbs. of copper-clad sheets, made under clean room conditions, ready to ship or fabricate immediately.

Our stock includes both paper phenolic and glass epoxy grades in a wide variety of laminate and foil thicknesses.

Standard sheet sizes stocked are 36" x 36", 36" x 42" and 36" x 48". Panels cut to your size are available.

Write for complete information about Synthane metal-clad laminates, using the coupon below.

SYNTHANE

CORPORATION **S** OAKS, PENNA.

666-5011 (Area Code 215) TWX 215-666-0589

Synthane-Pacific, 518 W. Garfield Ave., Glendale 4, Calif TWX 213-240-2104U

Synthane Corporation, 27 River Rd., Oaks, Pa.

Gentlemen:

Please send me information about Synthane metal-clad laminates.

Name _____

Address _____

City _____ Zone _____ State _____

NEW PRODUCTS

GRAPHIC LEVEL RECORDER

Measures and records ac signals throughout freq. range of from 2 to 200kc.



The Model 2305 detects and records the true RMS, average, or peak values of ac signals vs. time or freq. With chopper input, it detects and records dc signals. Accuracy is ± 1 db for sine, complex, or random signals. Recording can be presented in either linear or logarithmic terms. Dynamic ranges of from 1:3 to 1:5000 are selected by changing range potentiometers. Writing speeds from 2 to 2000 mm/sec. (in 14 steps) provide averaging times from 0.01 to 2 sec. B&K Instruments, Inc., 3044 W. 106th St., Cleveland 11, Ohio.

Circle 261 on Inquiry Card

DETENT WAFER SWITCHES

Rated $\frac{1}{2}$ a. @ 125v.; max. voltage is 400vdc. Max. current $3\frac{1}{2}$ a. @ 6v.

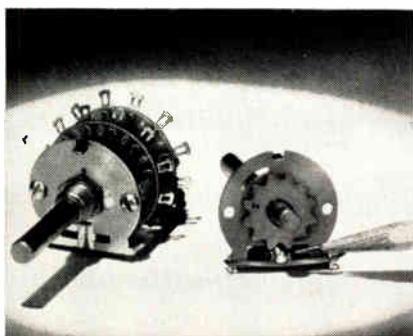

The SK series rotary wafer switches feature a ball detent action to control and accurately maintain detent torque. This greatly increases switch life, and assures positive indexing. The switch spans life cycling from 50,000 to above $\frac{1}{2}$ million. Models are available in 2 position—180° throw; 3 position—120° throw; 4 position—90° throw; 8 position—45° throw; 10 position—36° throw; and 12 position—30° throw. All models use strut screw and spacer construction, permitting any number of wafers/switch. All models are available with ac on-off switches rated @ 3 or 5a., 125vac. Standard Grigsby, Inc., 920 Rathbone Ave., Aurora, Ill.

Circle 262 on Inquiry Card

MOUNTING BASE

For use in clamping wire bundles and harnesses of small dia.

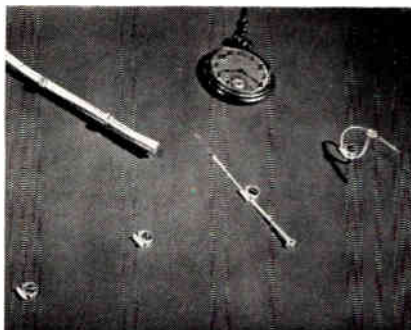

The TC-104 is $\frac{5}{16}$ in. wide and $\frac{13}{32}$ in. long. It is fabricated of nylon and, when installed with a #5 screw, exhibits a min. tensile holding strength of 18 lbs. The mounting base is premounted in position before the harness is installed. When the harness is ready for mounting, a Ty-Rap tie is slipped under the slot in the mount, brought around the wire bundle, threaded through the eye in the Ty-Rap head and secured. This combines the clamping function with the tying function at this spot. The Thomas & Betts Co., 36 Butler St., Elizabeth, N. J.

Circle 263 on Inquiry Card

TV CAMERA

Features ultra-high resolution and minimum size and weight. Uses ICs.

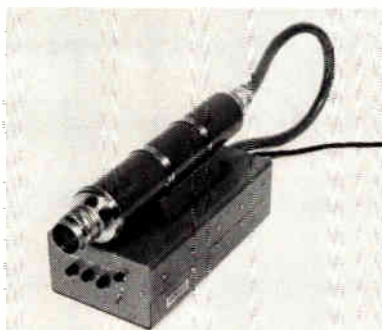

The TCS-950 solid-state Vidicon camera uses silicon Micrologic® integrated circuits. It produces in excess of 1000 line center horizontal resolution at all scan rates and vertical resolution of 700 lines using a 1029 line/frame format. Typical scan rate formats available are 525, 625, 875, 945, and 1029 lines/frame. The system uses a 25 mc bandpass to achieve corner-to-corner optical quality displays. Typical signal-to-noise performance is 36db @ 1.0fc faceplate illumination and 30db @ 0.5fc faceplate illumination using a fully transistorized preamplifier. Fairchild Dumont Laboratories, 750 Bloomfield Ave., Clifton, N. J.

Circle 264 on Inquiry Card

TRIMMER CAPACITOR

Length behind panel is $\frac{5}{16}$ in. Capacitance is 1.0mmf to 10.0mmf.



The GS 11184 piston trimmer capacitor features sealed end which has been closed by mechanical means without solder. This permits repeated soldering and re-soldering to turret cap without unit damage. The capacitor has a dia. $\frac{5}{16}$ in.; Q @ 1mc is 1000min. Temp. coefficient is ± 50 ppm/°C; insulation resistance is 10^6 megohm. Dielectric strength is 1000vdc at 50% relative humidity at max. rated capacitance. DC working voltage is 500. Roanwell Corp., Roanwell Bldg., 180 Varick St., New York, N. Y.

Circle 265 on Inquiry Card

PORTABLE RFI SYSTEM

Covers freq. spectrum from 10kc in low freq. range to 10gc in upper limits.



The LF-SHT-2R is a hand-portable, precision RFI system. It performs essentially the same instrument functions as systems occupying 6 or more drawers of a standard rack and weighing hundreds of lbs. It is 17 x 17 x 11 in. and weighs 55 lbs. The system has provision for 4 tuner units: 10 to 160kc; 150kc to 32mc; 31mc to 1gc; and 950mc to 10gc. The unit has 2 functional modes—average signal measurement, and peak measurement. To facilitate calibration and permit substitution measurements, an impulse generator is an integral part of the instrument. Stoddard Electro Systems, 2045 Rosecrans Ave., Gardena, Calif.

Circle 266 on Inquiry Card

RCA

announces a

new high-speed

miniature core-driver... **RCA-40283**...

especially designed for ultra-compact computers

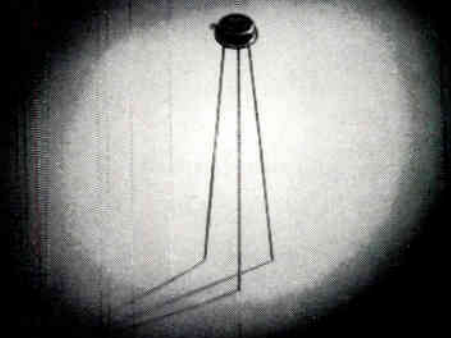

ACTUAL SIZE

Now—commercially available, this tiny new RCA-40283 N-P-N silicon core-and-line driver packs substantially all the performance of TO-5 core drivers into a tiny TO-46 case.

✓ Check these features:

HIGH POWER-HANDLING

CAPABILITY: 2 watts max at $T_c = 25^\circ\text{C}$

HIGH OUTPUT VOLTAGE:

$V_{ce0} = 30$ volts max.

HIGH GAIN-BANDWIDTH

PRODUCT: $f_T = 375$ Mc (typical)

FAST SWITCHING:

Turn-on time: 16 nsec typ at $I_c = 150$ ma, $I_{B1} = I_{B2} = 15$ ma

Turn-off time: 27 nsec typ at $I_c = 150$ ma, $I_{B1} = I_{B2} = 15$ ma

Storage time: 17 nsec typ at $I_c = 150$ ma, $I_{B1} = 15$ ma

WIDE TEMPERATURE RANGE:

-65° to $+200^\circ\text{C}$, storage and operation

EXCELLENT HEAT DISSIPATION:

At case temperatures up to 25°C : 2 watts max.

At free-air temperatures up to 25°C : 0.4 watt max.

VERY LOW COLLECTOR SATURATION VOLTAGES:

$V_{ce}(\text{sat}) = 0.28$ v. at $I_c = 150$ ma, $I_B = 7.5$ ma

$V_{ce}(\text{sat}) = 0.45$ v. at $I_c = 500$ ma, $I_B = 50$ ma

These units are in stock—available for immediate delivery. For complete information call your RCA Field Representative today, or for technical data write—RCA Commercial Engineering, Sec. CJ6, Harrison, N.J.

AVAILABLE THROUGH YOUR RCA DISTRIBUTOR

RCA ELECTRONIC COMPONENTS AND DEVICES



The Most Trusted Name in Electronics

Circle 154 on Inquiry Card

World Radio History

BY-BUK

PRINTED CIRCUIT DRAFTING AIDS

Time Saving Shapes and Narrow Tape for Making Printed Circuit Master Drawings

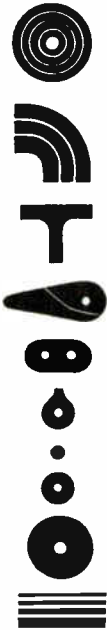

"KWIKY-DOT" overlapping Donuts and solid Discs for quick and easy application.

Pressure-sensitive Teardrops, Twin Pads, T's, and Corners.

Black non-stain, non-smudge narrow tape in 15 or 60 yd. rolls from 1/32" wide. Also red translucent and black on white.



WRITE FOR HANDY CROSS REFERENCE CHART, PRICE LIST AND FREE SAMPLES.

BY-BUK COMPANY

4314 W. Pico Blvd. • Los Angeles 19, Calif.

Telephone 937-3511 • Long Distance Area Code 213

Same Day Shipment is Our Usual Service

Circle 158 on Inquiry Card

SELF-CALIBRATING ±0.03° ACCURACY

(minimum)

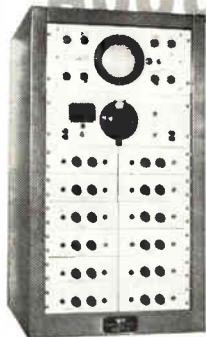

PRECISION PHASE STANDARD 70N0



DELAY



PHASE CALIBRATION



MEASUREMENT

Capability of up to 12 plug-in frequencies • Crystal controlled frequency selection, 30cps to 50kc; others available • Includes Oscilloscope, Precision Phase Shifter, Lissajous Pattern Generator, each of which can also be used independently • IDEALLY SUITED FOR STANDARDS DEPARTMENTS, INSTRUMENT CALIBRATION.

COMPLETE **ACTON** DATA ON REQUEST

Laboratories, Inc.

533 Main Street • Acton, Massachusetts

A Subsidiary of Bowmar Instrument Corporation

Circle 159 on Inquiry Card

Trade Fair

and Congress

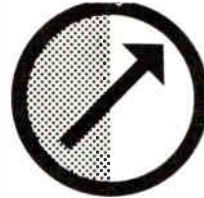

INTERKAMA

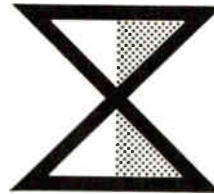

presents for all branches of industry and research an international range of instrumentation and automation equipment, with particular emphasis on electronics, pneumatics and hydraulics.

DÜSSELDORF Oct. 13-19, 1965

For information: German American Chamber of Commerce, Inc., New York: 666 Fifth Avenue; Chicago: 77 E. Monroe Street.

Circle 160 on Inquiry Card

Send today for complete information on the only readout that works like a rear-projector, uses film to display anything (even colors!), gives you 12 message positions all in a single plane, and plugs in and out from the front for quick lamp replacement. All that and it's only 1½" x 1-1/16"! Just think what its bigger brothers can do...

INDUSTRIAL ELECTRONIC ENGINEERS, INC.
7720 Lemona Avenue • Van Nuys, California
Phone: (213) 787-0311 • TWX (213) 781-8115
Representatives in Principal Cities

©1965 IEE

Circle 161 on Inquiry Card

ELECTRONIC INDUSTRIES • June 1965

"... advancing the STATE-OF-THE-ART in Components & Equipment."

SELECT DIODE ARRAYS

Variety of circuit functions in extremely small packages.

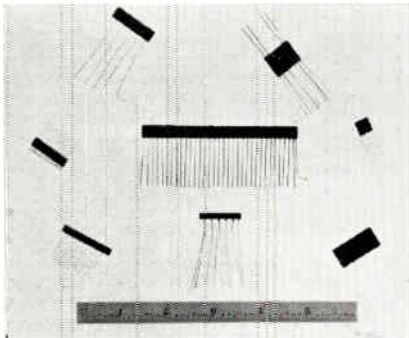

The MSC123 series of "Memory Select Diode Arrays" are fabricated on a simple, low-cost assembly process. This eliminates tooling or set-up charges for custom or high volume requirements. Circuit functions offered include logic address and other digital bit select functions. Versatility of circuit arrangements allows for broad flexibility in the same basic package outline. Units range to 28-diode arrays. MicroSemiconductor Corp., 11250 Playa Court, Culver City, Calif.

Circle 231 on Inquiry Card

PC CONNECTOR

For double-sided PC Boards; designed for automatic assembly.

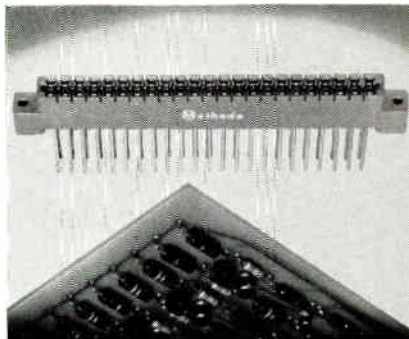

Model XFD-946W(M) is a 46-contact PC board connector designed for automatic assembly of lead wires. It accepts 1/16 in. thick double-sided PC boards. The connector has contacts and wire-wrap terminals on 0.200 in. centers, making it applicable to mass production assembly such as programmed wire wrapping. It has bifurcated contacts, and insulation is of high-dielectric glass-filled diallyl phthalate. The connector accepts a 1/16 in. thick board, up to 4½ in. across contact area, with up to 23 contacts on each side of board. Methode Electronics, Inc., 7447 W. Wilson Ave., Chicago, Ill.

Circle 232 on Inquiry Card

LOW-PASS FILTERS

Min. attenuation is 75db from 100 to 2KMc over temp. range of -55° to 125°C.

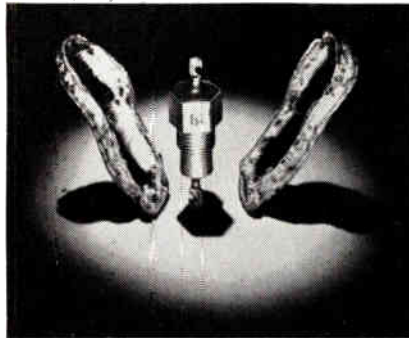

Series MF-320 subminiature h-f low-pass filters exhibits high attenuation that is stable and independent of direct or low-freq. current bias up to 35 amps or low-freq. current. Working voltage is 100vdc. At 50Mc the attenuation is more than 50db. The filters greatly attenuate the reverse passage of h-f energy to the outside, while allowing the passage of direct and low-freq. alternating currents into circuit compartments. Gulton Industries, 212 Durham Ave., Metuchen, N. J.

Circle 233 on Inquiry Card

HIGH-POWER CIRCULATOR

For mobile communications. Device operates between -4°F and +140°F.



Type 31900 high power vhf circulator is for 450-470Mc mobile communications service. It is a 3-port junction circulator with high-level isolation over an exceptionally wide temp. range. This development offers a min. of 20db isolation between -4°F and +140°F and 27db in the range of 60°F to 90°F. It handles transmitter power up to 250w. The device cannot be damaged through operation with any port open or shorted under full power. For use as an isolator, one of the ports may be terminated with a 50Ω, high power load. Andrew Corp., P. O. Box 807, Chicago, Ill.

Circle 234 on Inquiry Card

DISPLAY MODULE

Allows signal polarity to be read at long distances and wide angles.

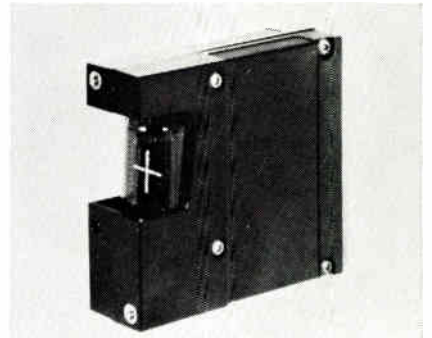

The Model B-100-24 is an all-silicon polarity-indicating module. The "+" or "-" glows depending on the relative levels of the input signals, which may be a differential of 6v. or more. Since the circuit uses a common rather than a ground, the drive signal may have an arbitrary reference level. Designed as a building block module for timing systems and computers, it measures 3 x 3 x 1 in. Janus Control Corp., Hunt St., Newton 58, Mass.

Circle 235 on Inquiry Card

PRECISION RESISTOR

Precision wirewound resistors have a power rating of ½w. @ 70°C.

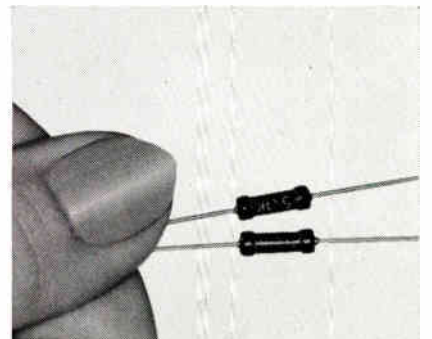

Model WS127-2 is ¾ in. long x ¼ in. dia. It has all-welded connections for long-term reliability. Developed for use as calibration resistor, standard items are available with a resistance range of 10Ω to 5K, (±1%). Resistance range of 0.1Ω to 10K, at 0.1% tolerance, available on spec. order. Specs. include: operation @ 100% of rated wattage from 0°C to +70°C, derating to 0 @ +150°C; load life of 1000 hrs. at rated power, with 0.5% max. resistance shift; overload 10 times rated power for 5 sec. with 0.2% max. shift. Caddock Electronics, 6151 Columbus Ave., Riverside, Calif.

Circle 236 on Inquiry Card

NEW PRODUCTS

SERIAL SHIFT REGISTER

Has 612 MOS FET devices on a single chip. Power dissipation is 200mw.

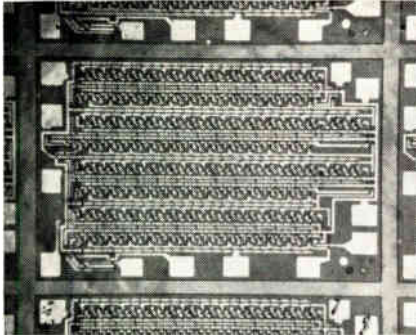

The GME 100-Bit Serial Shift Register has 5 inputs and 2 outputs. Single registers may have more than 1 input and 2 outputs. If the register length must be adapted to an existing design, pairs of registers on a single device with a capacity up to 50 bits/register may be obtained. This means there can be 2 distinct registers on a single chip with up to 50 bits each, varying in length from 1 to 50 bits. Freq. range of the shift register is 5Kc to 1Mc. General Micro-electronics, Inc., Santa Clara, Calif.

Circle 237 on Inquiry Card

SCR TESTER

Evaluates all significant parameters of semiconductor to 100a.

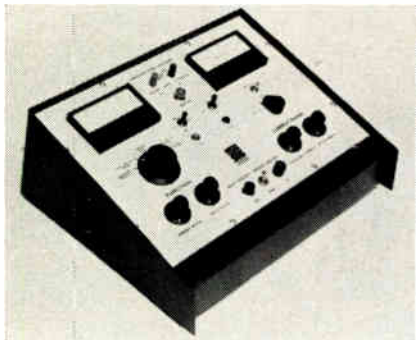

The model MP-122 SCR Tester will evaluate all significant parameters of SCRs and switches, gate turn-off SCRs, photo switching devices, unijunction transistors, and conventional rectifiers and diodes. Parameters that can be tested include: forward and reverse blocking voltages to 1kv; leakage current with sensitivity to 1 μ a; gate firing current and voltage to 100ma and 5v.; forward saturation voltages to 1adc and 100a. pulse; holding current to 1a.; gate turn-off current to 300ma; dv/dt to 500v./ μ sec; and unijunction standoff ratio and valley voltage. Sensory Systems, Inc., Box 2071, Costa Mesa, Calif.

Circle 238 on Inquiry Card

HIGH VOLTAGE CARTRIDGES

For applications requiring minimum size and max. power.

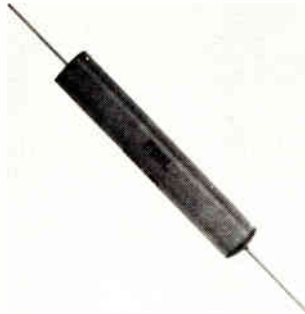

The half-wave configuration of the L-series packages consist of matched, pre-tested, pre-selected double diffused avalanche rectifiers offering self-protection against voltage transients. Axial leads facilitate point-to-point circuit soldering by eliminating the soldering of many diodes to get equivalent circuitry and faster assembly. Half-wave circuits are available in voltage ratings from 1500 to 30Kv PIV, and currents from 20ma to 1a. Edal Industries, Inc., 4 Short Beach Rd., E. Haven 12, Conn.

Circle 239 on Inquiry Card

THERMAL STANDARD

Measures $\pm 0.01\%$ RMS ac transfer without calibration curves or tables.



With the Model 540B ac/dc Thermal Transfer Standard, thermocouple burnout is eliminated. In addition, a search circuit provides visual indication of the % of rated input. DC input to the thermocouple is reversed via front panel switch to check its reversal characteristic, which is guaranteed to be less than 0.01% of input. Sensitivity to test control causes galvanometer deflection exactly equivalent to an input level change of 0.1% or 0.01%. This feature is useful in checking either the internal thermocouple dc reversal characteristic or the freq. response of a device under test. John Fluke Mfg. Co., Inc., Seattle, Wash.

Circle 240 on Inquiry Card

TRANSISTORIZED MOTOR

Reliable operation under high humidity and saline atmospheric conditions.



The Model 318 transistorized dc motor is for use in remote controls, timing apparatus, recorders, displays, etc. It consists of a synchronous hysteresis motor and a transistor network designed for operation from 6, 12 or 24vdc. It operates with high loads over extended speed ranges. The self-contained transistorized inverter system is molded into the housing. Speed ranges: 1/20 RPM to 1400 RPM. Torque @ 1 RPM: start 16 oz. in.; run 60 oz. in. Bristol Motors, Old Saybrook, Conn.

Circle 241 on Inquiry Card

STORAGE TUBE

Dual gun tube uses a solid dielectric film as the storage medium.

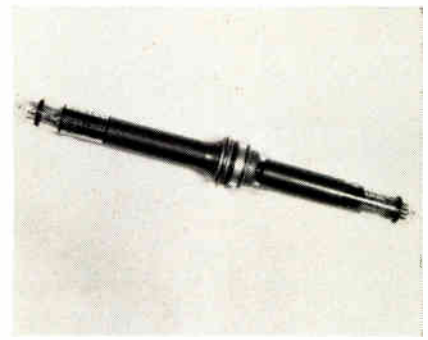

The RW-5 can receive an electrical input in one scanning mode, write this data on the storage surface by the EBIC principle (electron-bombardment-induced-conductivity), and then read out this stored data as a signal with a scanning mode which is independent of the input. The tube is especially attractive for airborne and space uses, and requires no dynamic focusing or crosstalk cancellation. Overall size is 13-3/16 in. long x 1-47/64 in. max. dia. Resolution is 840 TV lines/target dia. It operates over a wide range of storage and erase conditions. Warnecke Electron Tubes, Inc., 175 W. Oakton St., Des Plaines, Ill.

Circle 242 on Inquiry Card

Why does Arco ship connectors sooner than we have to?

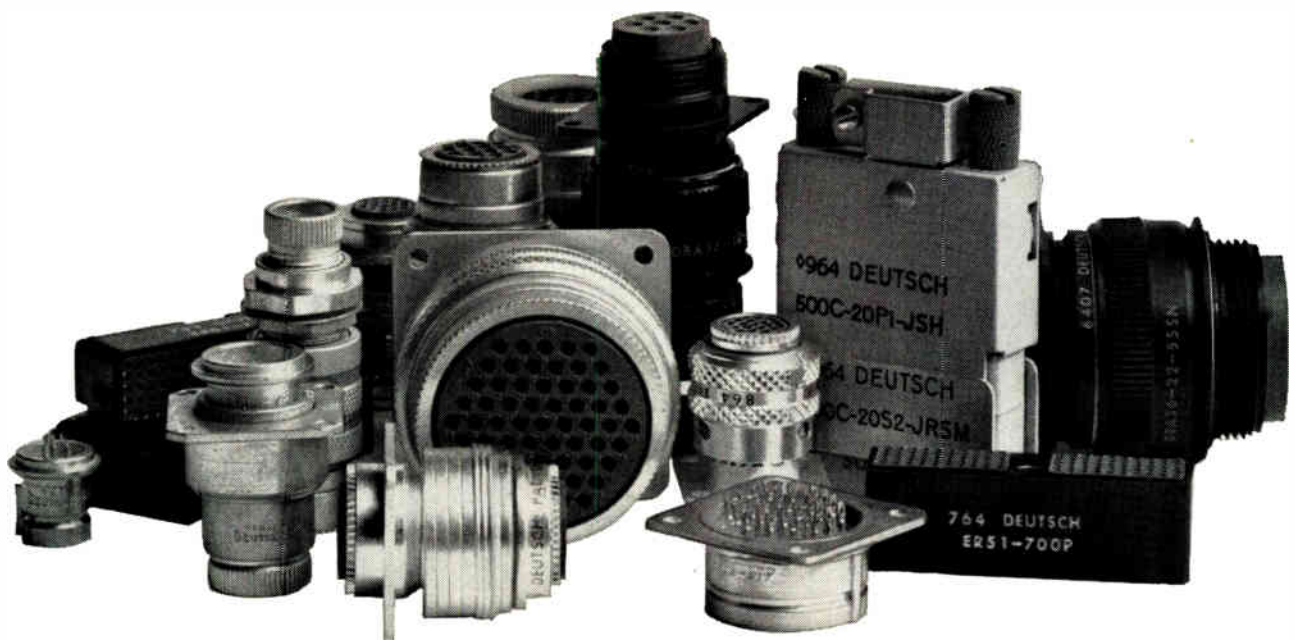

When you're a distributor who's also a manufacturer, that's the way you do things.

Buy connectors from most people and they ship in a few days. Buy them from Arco and we ship within 24 hours — days sooner than we have to, to keep up with the competition.

Because Arco's a distributor, we know how fast you need the connectors you order. So we've set ourselves up to ship them out as fast as if we'd done the ordering.

Because Arco's a manufacturer, we've set ourselves up to ship them out as well built as if Deutsch had done the assembling. We have the components, the blueprints, the

tools and the people to assemble Deutsch connectors with the same care and precision that Deutsch does. We have the test equipment to make sure they're assembled with the same accuracy and reliability. When you order Deutsch connectors from Arco, you get the most reliable connectors you can buy. And you get shipment within 24 hours.

That's why it pays to do business with a distributor who's also a manufacturer. If we don't have what you want already built, we can build it for you in a hurry.



Arco Electronics
A DIVISION OF LORAL CORPORATION

Community Drive, Great Neck, N. Y. / Dallas, Tex. / Pasadena, Calif. / Write for our free Deutsch catalog.

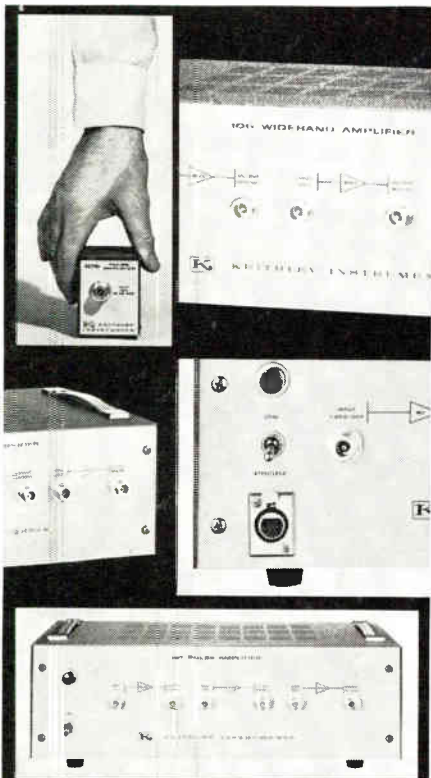

AMPLIFYING WIDEBAND SIGNALS?

Here are six dependable ways from 15 cps to 180 mc

Wideband or pulse tuned Keithley amplifiers give you frequency response spanning 15 cps to 180 mc; midband flatness of 0.5 db; rise time under 3 nanoseconds and; overload recovery within 50 nanoseconds.

Use the Keithley 104 or 105 for their choice of input impedances (1 megohm at 10 pf or 50 ohms); choose high voltage gain and low noise (35 μ v with respect to the input) offered by the 106 or 107 models; select the bantam-sized 108 or 109 for carry-around convenience in general lab work.

Amplifying wideband signals? Choose the amplifier engineered to do your job:

Sine Wave Tuned	Gain	Price
Model 104	1, 10, 100	\$675
Model 106	10, 100, 1,000	\$675
Model 108	10	\$185
Pulse Tuned	Gain	Price
Model 105	1, 10, 100	\$675
Model 107	10, 100, 1,000	\$675
Model 109	10	\$185

Model 1081 Power Supply for Models 108 and 109... \$135

Send for Engineering Note giving complete specifications



KEITHLEY INSTRUMENTS

12415 Euclid Avenue • Cleveland 6, Ohio

Circle 163 on Inquiry Card

NEW PRODUCTS

CRYSTAL OSCILLATORS

Generates fixed freq. from 1 cps to 200mc.
Has 1 pp 10⁷ stability with no oven.

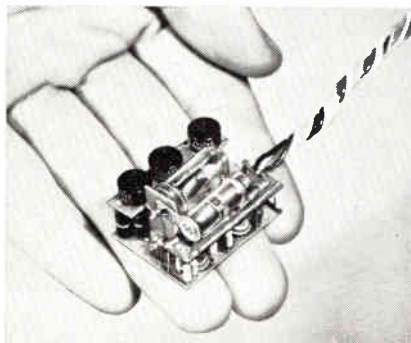

This line of temp. compensated crystal oscillators measure 1 cu. in. Four standard models are available with ± 12 vdc ($\pm 5\%$) input voltage and 1mw power output into 50 Ω with 50mw power drain. Sinewave, pulse and sawtooth outputs are offered. Freq. adjustment range is 6 ppm min. Aging rate is less than 1 ppm/year. Warm-up time is zero. Models can be designed to accept any input voltage from ± 10 to ± 50 vdc. Electronic Systems Div., Arvin Industries, Inc., 13th St., Columbus, Ind.

Circle 243 on Inquiry Card

CIRCUIT CARD DRAWER

Horizontal drawer unit can hold up to 75 circuit cards.

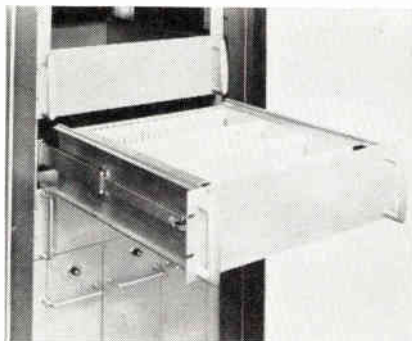

These units are available in 3 models, 2 of which are hinged to allow complete access to circuit cards, connectors and wiring during servicing. One hinged model has interchangeable extruded flanges framing the front panel, allowing the option of either rack-mounted or desktop approach to instrument design. All "Tilt-File" drawers lock open or closed. All models use molded Nylon circuit card support hardware, and provide up to 3 full-depth card files, each holding 25 cards. Space is provided behind the front and rear panels for mounting other assemblies. Scanbe Mfg. Corp., 1161 Monterey Pass Rd., Monterey Park, Calif.

Circle 244 on Inquiry Card



Best long distance visual display now competitively priced

\$19.00 EACH IN QUANTITY
2" HIGH NUMERALS

Bright, long-life National Readout Tube* displays provide best readability over longer viewing distances. National Readout Tubes can be designed into lightweight, compact displays. More for your money too. National's standards for high quality are retained, while quantity prices save you big money over all other visual displays on the market. Request full technical data and prices today!

*Manufactured under license from Burroughs Corporation.



NL 7037

NATIONAL

ELECTRONICS, INC.
A SUBSIDIARY OF EITEL-McCULLOUGH, INC.
PHONE: (312) 232-4300 • GENEVA, ILLINOIS, U.S.A.

Circle 164 on Inquiry Card

ELECTRONIC INDUSTRIES • June 1965

NEW PRODUCTS

ROTARY SWITCH

Rotary power selector switch can switch 5a. It has 0.82 in. dia.

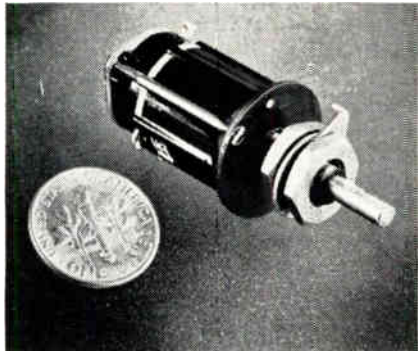

The series 52300 selector switch is available with 1, 3, or 5 decks, each with up to 8 positions. High current switching capacity is aided by a roller action. This switch action provides large mass contacts, eliminates current carrying springs and wiping action, and contributes to longer switch life. Contacts are made of coin silver and gold alloy for low level switching. It meets the environmental requirements of Mil-E-5272C and performance of Mil-S-6807B. Staco, Inc., 1139 Baker St., Costa Mesa, Calif.

Circle 247 on Inquiry Card

ADMITTANCE BRIDGE

Measures low values of capacitance with resolution of 0.002pf.



The Model 33A S7 r-f Admittance Bridge provides direct reading h-f capacitance measurements with a resolution of 0.002pf. Basic accuracy is 1% over a range from 0 to 15pf with low test signal levels. It also measures conductance with a resolution of 0.5 micromho and a basic accuracy of 2% over a range from 0 to 25K micromhos. In addition, it is useful for determining shunt inductance, shunt or series resistance, dissipation factor, and Q. Internally supplied crystal controlled test freqs. of 1, 5, 10, 20, 30, 50, and 100mc are continuously adjustable in level from at least 100mv down to 1mv. Boonton Electronics Corp., Parsippany, N. J.

Circle 248 on Inquiry Card

Measures 0 — ±1,100 V dc; 0 — 350 V ac (20 Hz to 1000 MHz); 0 — 5,000 MΩ

Ballantine DC/AC Voltmeter/Ohmmeter

Ballantine's Model 345 DC/AC Voltmeter/Ohmmeter is a multi-purpose instrument for use in the laboratory and on the production line.

It features a single, 5-inch, mirror-backed logarithmic scale and decade switching for both ac/dc volts and ohms measurements . . . and assures you of unrivaled ease, speed, accuracy and resolution in making these measurements. Its logarithmic scale, for example, permits an accuracy specification of 1% of indication for dc; 2% of indication for ac; and 3% of indication for ohms.

Since there are no wrong scales to read, errors in reading are reduced greatly. Because of the instrument's decade switching, you can make more measurements without the need for range switching.

The Model 345's accuracy is maintained for power line voltage changes of ±20%, so necessary for use on the production line. Because its built-in ac and dc reference standards enable you to check its accuracy in a few seconds, there's no need of removing it from service.

Write for full details

Model 345 Price: \$350



— Since 1932 —
BALLANTINE LABORATORIES INC.

Boonton, New Jersey

Circle 165 on Inquiry Card



You get what you see with a
FAIRCHILD SCOPE CAMERA

The highest precision and clarity in oscilloscope photography are insured by a long list of Fairchild design features. Pinpoint focusing at any object-to-image ratio within lens range is one. Heavy duty synchro shutters with jam-proof activation are others. With Polaroid Land Back, 6 x 10 cm field can be recorded 0.9 actual size. Option of f/1.9 or f/2.8 lens. Prices start at \$350. For specifications or a demonstration, contact your local Fairchild Field Engineer, or write to Fairchild Scientific Instruments, 750 Bloomfield Avenue, Clifton, N. J.

FAIRCHILD
DU MONT LABORATORIES
SCIENTIFIC INSTRUMENT DEPARTMENT

UNITRON INCORPORATED

60 CPS to 400 CPS FREQUENCY CONVERTERS SINE WAVE

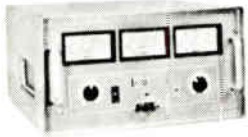

PS 62-64
1 KVA 1 ϕ



PS 65-202
2 KVA 1 ϕ

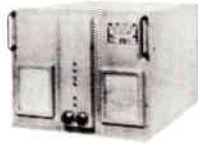

PS 65-203
2.5 KVA 3 ϕ

Unitron can now provide reliable 400 cps sine wave 1 ϕ and 3 ϕ power from a standard 60 cps source. These units find excellent application in shipboard, G.S.E. and laboratory systems where checkout of 400 cps airborne and missile equipment is required. In addition these units feature • proven reliability • short circuit and overload protection • RFI protection • voltage regulation • low distortion • stable frequency • light weight. All units are designed to meet applicable military specifications for G.S.E. and laboratory equipment.



CAIN & CO.
15840 Ventura Blvd.
Encino, California
(213) 783-4700

UNITRON, INC.
1624 N. First St.
Garland, Texas
(214) 276-8591

Circle 167 on Inquiry Card

DEPENDABILITY...



Informative
fact sheet is
immediately available
by writing to:

Plastic Capacitors, inc.

2620 N. Clybourn • Chicago 14, Ill.
DI 8-3735

Additional Reliability
In the Redesigned

PLASTIC DIELECTRIC CAPACITORS TYPE "OF" GLASS CAP

Designed for continuous operation for 10,000 hours at an ambient temperature of 85° C. Hermetically sealed glass tubular construction with metal end ferrules. Ideal for DC filter applications. Available 2KV to 60 KV; capacitance range .5 mfd. to .0001 mfd.

Custom  Engineering at
Production Prices

Circle 168 on Inquiry Card

NEW PRODUCTS

REFERENCE SOURCE

High-voltage reference source has accuracy of 0.01%. May be rack mounted.



Model VS-1000-NR is a 1000v. all solid-state precision high voltage reference source. The unit has output as well as measuring capability; requires no balancing; has a 6-decade direct reading device with full scale of ± 1111.11 vdc, in 1mv steps; and is absolutely short-circuit proof and overload proof. Electronic Development Corp., 423 W. Broadway, Boston, Mass.

Circle 249 on Inquiry Card

SEMICONDUCTOR TESTER

Provides safe operation for in or out of circuit testing of PC boards.

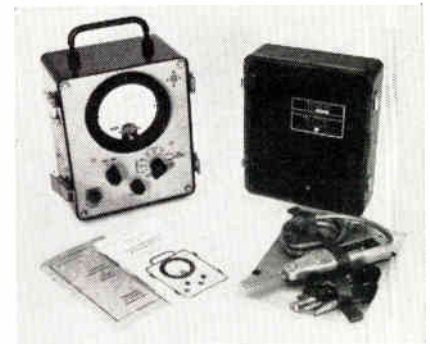

Module 245-MA is a portable, militarized in-circuit semiconductor tester for quantitative trouble-shooting and repair of semiconductor circuits on PC boards. This device is completely safe and fool-proof for all semiconductors. No damage can occur from applying incorrect polarity or leads to the semiconductor under test. It measures a variety of functions: transistor beta; resistance appearing at the electrodes of a transistor or diode; reverse leakage of a transistor or diode; a shorted or open condition of a diode; and condition of the internal batteries to indicate replacement when required. Power output of the tester is limited to 0.25 μ w. American Electronic Laboratories, Inc., P. O. Box 552, Lansdale, Pa.

Circle 250 on Inquiry Card

Photocircuits can solve your **PRINTED CIRCUIT PROBLEMS**

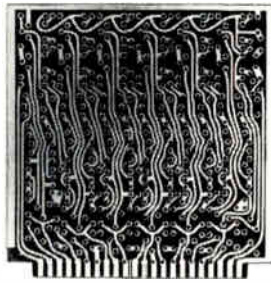

*Here are the solutions
to some typical problems
we have recently received.*

SMALL-QUANTITY CUSTOM WORK

PROBLEM: Our power supplies and amplifiers are made to customer specifications. Last-minute changes often make it necessary for us to have redesigned circuit boards in 48 hours. Since the quantities involved are very small, we're having trouble finding a supplier who will shorten his normal delivery cycle for us. We'd like to have the quality of Photocircuits' products, but we feel sure a large firm such as Photocircuits can't give us the special service we have to have. Can you recommend anyone?

SOLUTION: Our PROTOcircuits Division, almost ten years old, was set up specifically to solve this problem for prototype and small-quantity customers. PROTOcircuits is a small internal facility, working independently of our regular operation. Paperwork is cut to the minimum — most quotes, delivery promises and other information are often handled by phone. Like an express checkout at the supermarket, our PROTOcircuits group won't even look at you if you need more than a handful of parts!

NO LOCAL SUPPLIERS

PROBLEM: Our R&D Laboratory is not located near any large manufacturing areas. When purchasing components such as transistors, resistors and capacitors, our engineers select from manufacturers' or distributors' catalogs and order by mail or telephone. Since printed circuits are not available "off the shelf", we have trouble getting the parts we need when we need them. Have you done anything to help those of us far from the metropolitan mainstream?

SOLUTION: More than half the customers of our Standard Circuit Division had the same problem you do. They found they could order printed circuits by mail and telephone as easily as other components because of the unique Standard Circuit concept. By using only a limited number of standardized design, manufacturing and procurement techniques, all completely described in a 70-page catalog, the paperwork and communication problems of buying a custom-made component are drastically reduced. Additional benefits of the Standard Circuit concept in-

clude fast deliveries, low prices and the elimination of tool and set-up charges.

INTEGRATED CIRCUITS

PROBLEM: Our product-engineering group is designing equipment utilizing integrated circuits. The increased packaging density offered by interconnecting them with multilayer printed circuits is not absolutely necessary. Are there any other advantages to consider?

SOLUTION: Many multilayer customers consider two other factors as equally important. First, heat removal from small, flat-pack integrated circuits can often be a problem. With multilayers, all interconnecting circuitry can be placed on internal layers. Wide strips of copper are then plated on the surface of the board under the area where the flat packs will be mounted. By running these strips to the edge of the board to connecting hardware, excellent heat sinks are created for the integrated circuits. Second, another troublesome area is "cross-talk" between critical circuits on the board, or isolating circuits from external interference. This problem is easily solved with multilayer printed circuits, by incorporating copper shielding planes, where necessary, on internal layers.

MAKE OR BUY PRINTED CIRCUITS

PROBLEM: At a rather large capital expense, we're considering updating our internal facility for making printed circuits. In announcing your new "CC-4 Process", you stated that it allows substantial cost reductions in printed-circuit manufacturing. Are these reductions large enough to influence our decision?

SOLUTION: If you consider savings in the cost of printed circuit assemblies of 10-20% important — Yes. Large volume printed circuit users with internal facilities have compared the cost of completed assemblies using their own etched foil product against the same assemblies incorporating CC-4 boards made by Photocircuits. The low cost of these boards combined with the production economies resulting from the superior solderability of CC-4 copper revealed that "making" was more expensive than "buying".

(If you have a problem in printed circuitry, let us hear from you.)

 **Photocircuits**
CORPORATION
Glen Cove, New York • Anaheim, California

NEW PRODUCTS

MICROMINIATURE DELAY LINES

Associated read-write amplifier circuits are in microelectronic form.

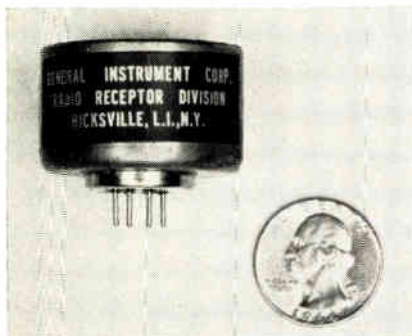

The MMDL series magnetostrictive delay lines are 2 in. in dia., 1/2 in. high, including 7-pin connector, and weigh less than 1 1/2 oz. They are available in delay ranges of 10 to 500μsec., and are longitudinal in type. They use a method of "soft encapsulation" of the entire media package which provides high shock and vibration performance. They operate dynamically at shocks of over 100Gs and in vibration as high as 20Gs in each of 3 planes. Temps. coefficients of delay are 20 ppm/°C. Radio Receptor Div., General Instrument Corp., 174 Andrews Rd., Hicksville, N. Y.

Circle 255 on Inquiry Card

DELAY LINE

For calibration of oscilloscopes, altimeters, and radar systems.

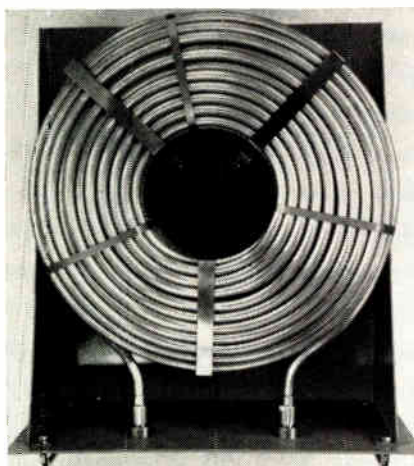

This coaxial-cable delay line is fabricated from 1/2 in., 50Ω Foamflex. Type NF panel-mount connectors are provided on this standard unit. It offers a standard delay of 500nsec. (±0.25nsec.). Attenuation ranges from 17.5 to 30db over a freq. range from 2.0 to 4.0gc. Under the same parameters, max. vswr is approx. 1.15. Phelps Dodge Electronic Products Corp., 60 Dodge Ave., North Haven, Conn.

Circle 256 on Inquiry Card

VARIABLE DELAY LINES

Delay time from 0-60nsec. at impedances of 300 to 600Ω.

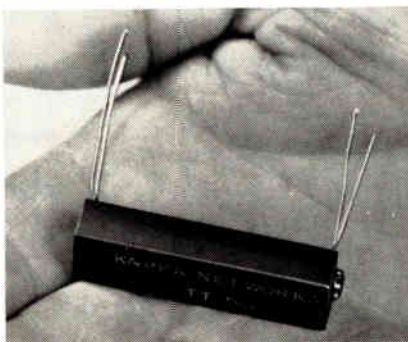

The rise time from this subminiature unit is approx. 5 to 15nsec., and dielectric strength is 30v. Resolution is better than 0.5nsec.; attenuation is below 0.5db. Kappa Networks, Inc., 165 Roosevelt Ave., Carteret, N. J.

Circle 257 on Inquiry Card

VARIABLE DELAY LINE

Consists of 6 individual delay lines. Delays range from 0.5 to 31.5μsec.



Model 500-31.5 is a variable time delay unit consisting of 6 individual delay lines. The time delays of these individual lines are so arranged that by switching in 1 or more lines, 63 different delays can be obtained. These delay times range from 0.5 to 31.5μsec. in 0.5μsec. steps. Since the delayed output pulse is always the addition of individual lines, it is free of distortions caused by reflections from tapped lines. At total delay, the unit has a time delay-to-rise-time ratio of greater than 48 to 1. Accuracy of time delay: 1% at full delay. Rise time: 0.65 max. for max. delay. Impedance: 500Ω. Allen Avionics, Inc., 255 E. 2nd St., Mineola, N. Y.

Circle 258 on Inquiry Card

VARIABLE DELAY LINE

Fig. of Merit $Q = 50$ to 1 ; impedance = $2K\Omega (\pm 10\%)$; attenuation = 3db.

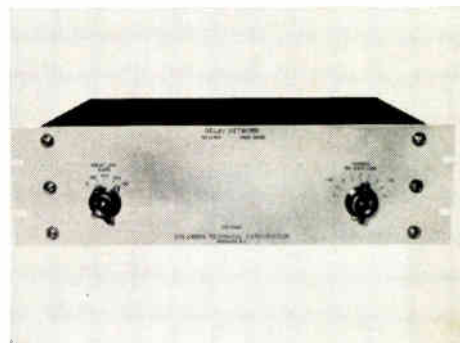

The CTC-2694 consists of 4 separate delay lines within a single case. It has 10 switches on the front panel, and 10 corresponding input and 10 output terminals on the rear panel. Each of the first 3 lines have 10 taps individually spaced at 1/10 of the delay time of the respective line. The 4th line also has 10 taps, but each is variable ±4μsec. from center, providing a vernier adjustment and, thereby, making a great variety of delay times available. Overall time delay is 544μsec. (±0.5%). Columbia Technical Corp., Woodside, N. Y.

Circle 259 on Inquiry Card

DELAY LINE PACKAGE

Thirteen taps range from 0.500μsec. to 6.5μsec. in 0.500μsec. steps.

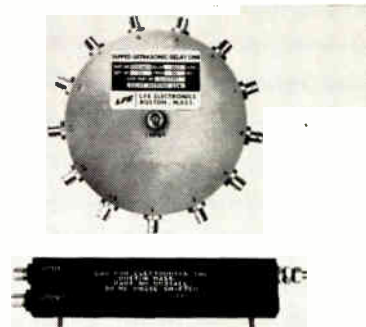

This ultrasonic delay-line multi-package has an attenuation of 45db (±1db) into 75Ω. Delay tolerance is ±10nsec. Spurious signals, triple travel and feed thru are 35db min. below the main signal. Nominal center freq. is 30mc. Operation in a digital system with no r-f carrier is possible. The variable phase shifters provide up to 360° of additional phase shift, and permit setting of delays to within a fraction of a nsec. to compensate for circuit and cable delays. Laboratory for Electronics, Inc., 1079 Commonwealth Ave., Boston, Mass.

Circle 260 on Inquiry Card



this designers catalog

*is just
a start*

STANDARD AND CUSTOM-DESIGNED DELAY LINES

Described in ESC's latest Electromagnetic Delay Line Catalog is one of the most extensive selections of stock delay lines in the industry. But, this is just a start! Since many delay lines must be custom-designed for computer line, geophysical, sonar, ATC transponder and beacon decoding networks, and other specific applications, ESC has at your service the largest staff of design specialists in the field.

- Millisecond delay networks
- Lumped constant delay lines
- Distributed constant delay lines
- Decade delay lines
- Pushbutton decade delay lines
- Continuously variable delay lines
- Variable lumped constant delay lines
- Nanosecond delay lines
- Miniature variable networks
- Miniature trimmer delay lines



The World's Leading Producer of Delay Lines

ESC

ELECTRONICS CORP.

534 BERGEN BOULEVARD • PALISADES PARK, N. J.
201-947-0400

NOW! MAGNETS TAKE THE HEADACHES OUT OF LATCHING RELAYS!

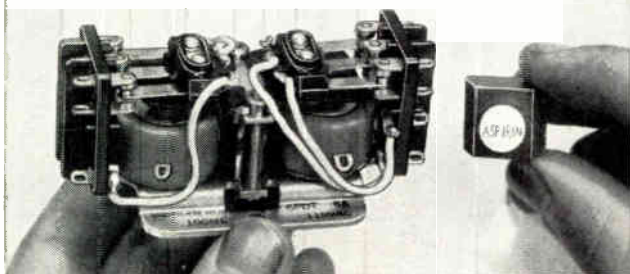

NO Mechanical Interlock Relay Can Match the 10 Million + Mechanical Operations of These Magnetic Relays!!

New Milwaukee general purpose latching relays use trouble-free magnets instead of troublesome interlocking metal levers. Results: Longer life; greater reliability and sensitivity in AC and DC versions; better shock and vibration characteristics — won't trip when jarred; securely mounted — far less chance of misalignment during installation and servicing.

AVAILABLE IN ALL THESE VARIATIONS

- Electrical or mechanical operation — or both
- Polarized — at less than half the cost of competitive relays
- Center off — up to 6 PDT 10 amps contacts
- Push-to-reset — can replace circuit breaker
- Dust cover, plug-in — easy to install and maintain

NEW 120 magnetic power latcher — up to DPDT 15 amp or DPST NO DM 35 amps. Write us or wire for details.



Milwaukee Relays

606 Pioneer Road, Cedarburg, Wis. 53012
Telephone (414) 377-4010

Circle 156 on Inquiry Card

SILVER PLATING



on the job

EASILY APPLIED

Cool-Amp can be applied on the job. The only equipment needed is a clean rag, a wire brush and some water. Cool-Amp contains no cyanide and can be used in underground vaults, substations and hard to get at places by several persons at the same time.

REDUCES RESISTANCE

Cool-Amp Powder deposits a genuine coat of silver that will not peel off. It prevents oxidation, minimizes overheating, thereby reducing maintenance. Provides cool maximum conductivity for all copper, brass or bronze current-carrying connections.

FREE SAMPLE—Write today for informative folder and free sample of Cool-Amp. One pound will silver plate approximately 6,000 square inches. \$13.50 per pound—Shipped F.O.B. Portland.

The **COOL-AMP** Co.

8625 S. W. 17th Avenue, Portland 19, Oregon

Circle 171 on Inquiry Card

FOR A COMPLETE LINE OF FLEXIBLE SLEEVING...

Specify

Varflex



Send for Free Folder of Actual Test Samples



Get acquainted with the broad range* of Varflex-manufactured flexible insulating sleeveings. Write for your free folder containing test-length samples of **Silicone**, **Varglas**, **Varfil**, and **Varflo** products.

Fast service, too: deliveries may be made promptly off-the-shelf or produced on order within one week.

*Types 1 through 6 in all NEMA grades conforming to military and ASTM specifications. Sizes from .010" to 3" ID.

Varflex
CORPORATION
Rome, New York

Circle 157 on Inquiry Card

TOPS IN KNOBS

EXCLUSIVE DESIGNS FROM STOCK MOLDS



AVAILABLE ONLY FROM ROGAN



Choose from wide variety of knobs that meet requirements of modern industrial development... match progress of military - electronic advancement.



Save tooling costs... get faster deliveries... get details on complete line of Rogan stock molded knobs. Write on business letterhead for new catalog.

ROGAN BROTHERS, INC. 8025 N. Monticello Ave. Skokie, Illinois 60076
Specializing In Stock Molded Knobs Since 1939

Circle 197 on Inquiry Card
ELECTRONIC INDUSTRIES

• June 1965

NEW PRODUCTS

LAMINATE MATERIAL

Design versatility for flexible, stacked and continuous etched circuits.

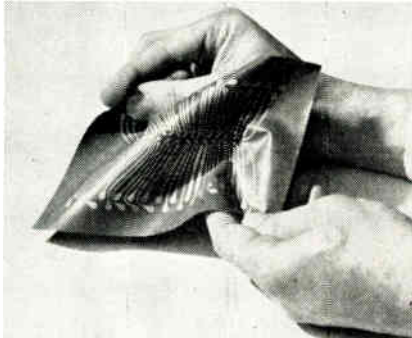

The MX6500 flexible epoxy "CuClad" is a flexible, copper-clad, fiber reinforced epoxy dielectric system capable of withstanding Class B (130°C) operation. The laminate can be plated, etched, soldered and otherwise processed in accordance with standard PC processing techniques. The base material is a cured epoxy which bonds directly to the copper without helper adhesives. Bond strength is 18 lbs./in. The low modulus of the epoxy allows it to accommodate stresses usually applied to copper. 3M Co., 2501 Hudson Rd., St. Paul, Minn.

Circle 267 on Inquiry Card

BALANCED MIXERS

Uses hot-carrier diodes. Delivers an i-f output to 250mc into 50Ω.

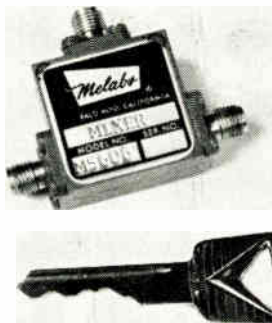

Model M-5606 broadband mixers use Schottky-barrier hot-carrier diodes. The unit offers low noise figure, low i-f impedance, unusually wide dynamic range, and high pulse signal inputs without danger of burnout. It accommodates signal inputs from 1.8gc to 3.6gc. Input impedance is 50Ω with a max. vswr of 1.5. Local-oscillator input power from +5 to +20dbm permits wide dynamic range; lower input levels can be used when an external bias is provided. The noise figure is 7db max., including 1.5db i-f and image freq. contribution. Melabs, 3300 Hillview Ave., Stanford Industrial Park, Palo Alto, Calif.

Circle 268 on Inquiry Card

MODULAR SOLID STATE DATA RECORDERS



SS 822
\$1295⁰⁰

2 CHANNEL
Two Channel Performance



SS 844
\$1985⁰⁰

4 CHANNEL
Features: ¼" tape, 10½" reels, two inputs per channel, Electro Dynamic Braking.

WRITE ...

for complete catalogue and specifications



IPS	RESPONSE	WOW	S/N
15	± 2db 30-30,000 cps	0.06%	57
7½	± 2db 30-20,000 cps	0.09%	56
3¾	± 3db 30-10,000 cps	0.18%	50 db

CROWN INTERNATIONAL, Box 1000, Elkhart, Ind., U.S.A.

Circle 172 on Inquiry Card

NEW MINIATURE HIGH VOLTAGE CONVERTERS

A reliable, stable high voltage source for use with:

- Photo Multipliers
- Ionization Chambers
- Neutron Detectors
- Fission Chambers
- Particle Counters
- Image Intensifiers
- Channel Amplifiers

Thousands of hours of research by MIL engineers have produced a series of highly accurate and reliable miniature high voltage converters. These rugged, compact converters measure only three cubic inches, weigh less than four ounces. Features include .005% regulation against line, .1% against load, floating output, silicon semi-conductors, fully tested and aged components, 3,000-hour life. Over 200 variables of standard unit immediately available.



ACTUAL SIZE

For full details, write for free Product Data Bulletin No. 1



MIL ASSOCIATES, INC.

Dept. EI-1, Box 187, Hudson, N. H. 03051

Circle 173 on Inquiry Card

steatite, ceramic & lava insulators

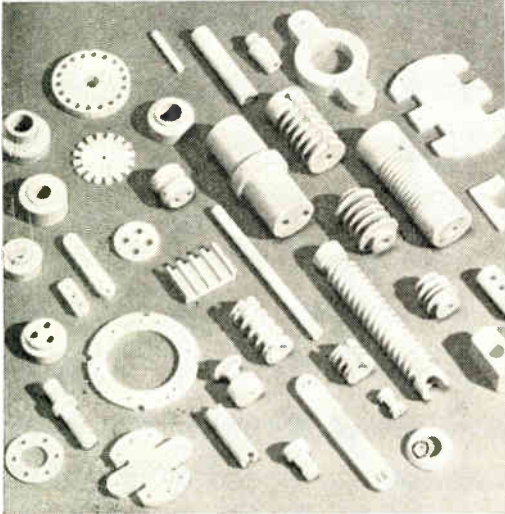

**for
electrical
and
electronic
applications**

Custom-molded, extruded or machined to close tolerances to meet your exact specifications. Prompt delivery at low cost on large or small orders. Over half a century of service is your guarantee of complete satisfaction.

FIND OUT TODAY. Illustrated bulletin with complete technical data will be sent on request.

SUPERIOR STEATITE & CERAMIC CORP.

87 West Forest Avenue, Englewood, N. J. • 'phone: (201) 568-4555

West Coast Representative:
Yarborough Sales Co., 1608 Orange Street, Alhambra, California • 'phone (213) 283-0668

Circle 174 on Inquiry Card

SWITCH to the Best

MODEL 78 SWITCH

- 2000 volt peak flashover at 60 cps
- 20 ampere current carrying capacity
- Low loss silicone impregnated steatite stators and rotors
- Current carrying members heavily silver plated
- Stainless steel detent assembly
- Coin silver contact shoes
- 18 positions maximum
- Sleeve bearing

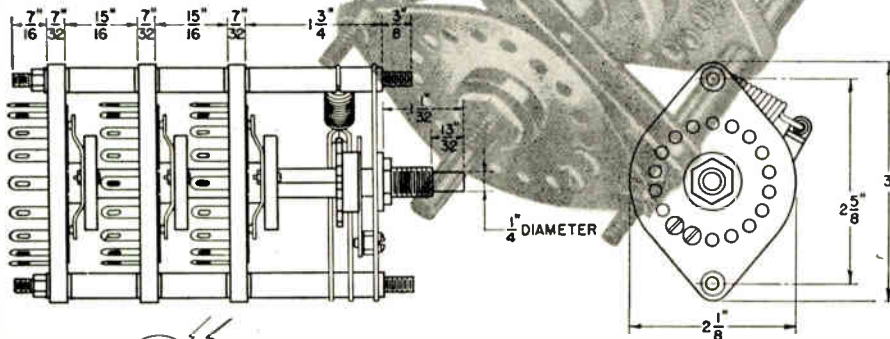

RADIO SWITCH CORPORATION
MARLBORO, NEW JERSEY - Tel. 462-6100 (Area Code 201)

NEW PRODUCTS

LOSS TEST SET

Full scale resolution is 0.0001db with an accuracy of $\pm 0.1\%$ + ($\pm 0.001db$).

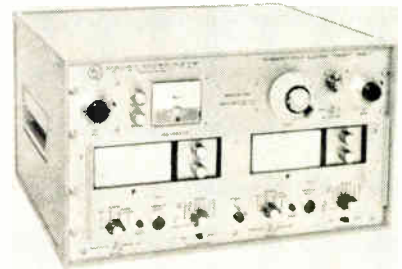

The MT-100A is a dual-channel dc comparator insertion loss test set for extremely accurate measurements. It measures low values of insertion loss from 10mc to 40cc. Range is 0 to 10db. This instrument can be used for accurate power measurements from 1µw to 10mw. It is suitable for laboratory or field use, and is available with an optional rechargeable battery pack. Maury Microwave Corp., 10373 Mills Ave., Montclair, Calif.

Circle 269 on Inquiry Card

CONNECTOR CONTACTS

Accepts 1 wire into 1 terminal which in turn feeds several contact legs.

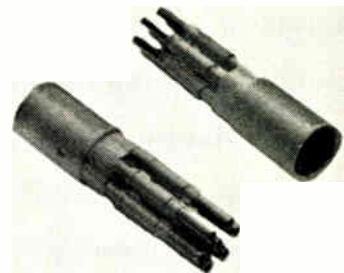

The Bussed Contacts design provides many additional layouts within the same connector series and even within the same connector. It is composed of a number of contact legs of common size bussed or jointed to a common termination pot. The contacts satisfy electrical and physical requirements of conventional contacts while preserving flexibility. Using a common layout, connectors can be used as distribution devices, eliminating terminal strips or buss bars. A redundancy of conducting paths assures electrical reliability; redundancy of retention devices assures mechanical reliability. ITT Cannon Electric, 3208 Humboldt St., Los Angeles, Calif.

Circle 270 on Inquiry Card

NEW PRODUCTS

TEST SOCKET

Accepts flat packs. Positive wipe action contacts are self-cleaning.

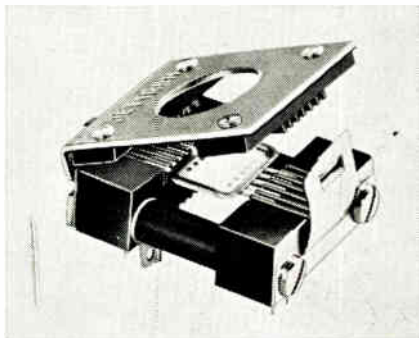

Series 71-062 is a 150°C life test cycling socket rated at 5000 hrs. It accepts flat package networks up to 14 leads. The socket is easy to load for fast testing, and separate lead grooves prevent shorting. The contacts are beryllium copper, nickel and then gold plated. A cover hole provides access to the package to facilitate further testing and ensure adequate cooling. Jettron Products, Inc., 56 Route 10, Hanover, N. J.

Circle 271 on Inquiry Card

MULTIMETER

Could fill the gap between conventional analog multimeters and digitals

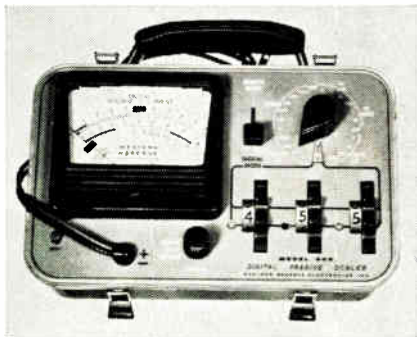

The Model 300 Digital Passive Scaler applies program techniques to manual measurements. It virtually eliminates misinterpretation in a passive measurement system having inherent accuracies expressed as % of indicated value. The unit measures dc and ac voltage, dc current and resistance. In addition to digital, this new equipment provides conventional analog display as a search mode. The instrument features a fail-safe protection system which guards against accidental over-load; controlled power ohmmeter which is safe for semiconductor circuit measurements; and a Wheatstone bridge. Western Reserve Electronics, Inc., 12430 Euclid Ave., Cleveland, Ohio.

Circle 272 on Inquiry Card

MICROWAVE DIODES

Increase range of radar and other communications equipment by approx. 5%.



These epitaxial microwave diodes are for use in the S- and X-bands and have noise figures of 5.5 and 6.5db. Due to the greatly improved noise figure, the new diodes, in some cases, may eliminate parametric and tunnel diode amplifiers. The S-band diodes are the D5621G and D5621GR while the X-band units are specified as D5623G and D5623GR. Sylvania Electric Products Inc., 730 Third Ave., New York, N. Y.

Circle 273 on Inquiry Card

VOLTAGE REFERENCE

Zero impedance voltage reference features 0.005% accuracy from 1μv to 10v.

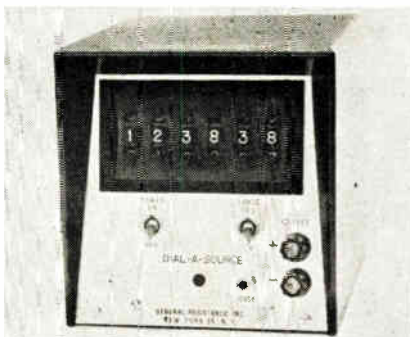

Dial-A-Source is a dialable voltage reference providing state-of-the-art accuracy with solid-state power supply versatility. It combines a Dial-A-Volt reference with a chopper-stabilized operational amplifier. This reference is unaffected by a 25ma load and line variations of 105 to 125v. Remote sensing provides the calibrated voltages across the actual load even at points distant from the output terminals. IR drops in interconnecting harnesses are automatically compensated, insuring specified performance at the load. This feature eliminates the primary source of interface errors in calibration consoles and systems. General Resistance, Inc., 430 Southern Blvd., New York, N. Y.

Circle 274 on Inquiry Card

HALLMARK STANDARDS Inc. Introduces...

A New "Taut Band" Electrostatic Voltmeter



Model KVE

with major improvements in accuracy, stability and ruggedness

Model KVE instruments are newly designed DC-RF electrostatic voltmeters for making true rms or peak measurements up to 100 kv. Insulation resistance 3×10^{15} ohms min. Multirange switch controlled instruments available. Indication is independent of frequency or wave form.

Model LVE is bench type portable with ranges down to 100v fs.

Hallmark's Unusual Design Features

- "Taut Band" ruggedizes moving element!
- No pivot friction!
- Eddy current damping provides two second response time!
- Newly designed insulator minimizes DC calibration drift from polarization!
- Linearized scale! Resolution is the same over the entire measuring range!
- Hysteresis and zero set less than $\pm 0.1\%$ after eight hours continuous duty!

Accuracy $\pm 0.5\%$ for most ranges. Unconditional two-year warranty. All scales individually calibrated and hand drawn. Calibrations traceable to NBS.

Write for literature.

HALLMARK STANDARDS Inc.

1995 Palmer Ave.
Larchmont, N. Y. 10538



Symbol of Quality
in Electrical Standards

Circle 176 on Inquiry Card

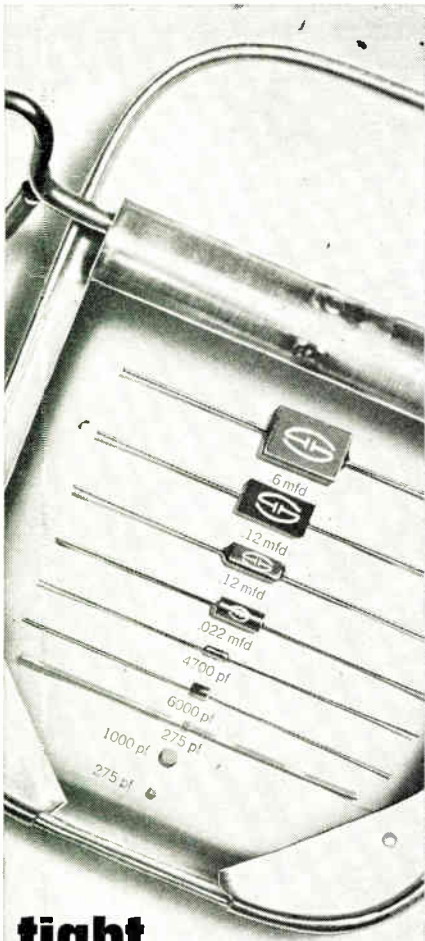

tight squeeze packaging problems?

Fit more capacitance into a smaller volume. Spaceborne amplifier . . . desk top computer . . . biomedical transmitter . . . or spy olive floating in a martini glass, when smallest size and highest reliability are essential, specify Scionics microminature ceramic capacitors. Standard values, from 47 pf to 1 mfd, 50 volts and 200 volts are in stock for immediate delivery.

West Coast Distributor: P.D.Q. Electronics Corp. • 2288 Westwood Blvd., L.A. 64, Calif. • (213) 879-0870

East Coast Distributor: Advanced Component Corp. • 119 Luther Ave., Liverpool, New York 13088 / (315) 472-7886

CAPACITOR DIVISION
8900 Winnetka Avenue, Northridge, California
213-341-5500 / TWX 213-341-7559
THE SCIONICS CORPORATION

SCIONICS

SCIENCE AND ELECTRONICS FOR INDUSTRY

Circle 177 on Inquiry Card

NEW PRODUCTS

STEP-SERVO MOTOR

The system provides a full 90° step angle at pulse rates up to 100/sec.

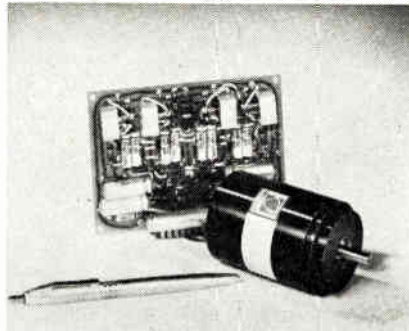

The TORMAX 90 is a size 20 step-servo motor and controller system. Response is to 10msec. and life expectancy is 1 billion cycles. The system consists of a heavy duty permanent magnet, 4 phase step-servo motor and a matched 4 phase SCR PC controller. Applications include computers, X-Y plotters with high torque requirements, and digital flight simulators. IMC Magnetics Corp., Western Div., 6058 Walker Ave., Maywood, Calif.

Circle 275 on Inquiry Card

POTENTIOMETERS

Two new zero-based linearity precision potentiometers eliminate phase-in.

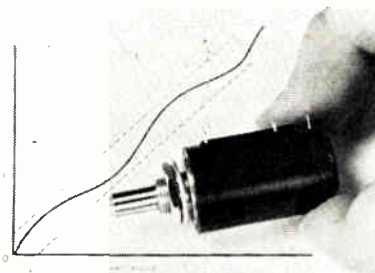

ZERO-BASED LINEARITY

The series 2170 and 2180 have a zero-based linearity with $\pm 0.15\%$ linearity tolerance. The pots eliminate "zero-error" signal that occurs when an ordinary pot is in the zero-stop position. The 2170 offers a $\frac{1}{4}$ in. shaft dia., while the 2180 offers a $\frac{1}{8}$ in. dia. Both have $\frac{7}{8}$ in. outer dia. They are guaranteed to operate after 2 million shaft revolutions, and offer a spring-loaded wiper drive mechanism with zero-backlash for precise, repeat settings. These new pots can be ganged or tapped even with rear-shaft extensions. Both withstand 50 G's shock and 20 G's vibration. Resistances from 25 to 125k are available. Amphenol Controls Div., 120 S. Main St., Janesville, Wis.

Circle 276 on Inquiry Card

HIGH CURRENT RELAY

The 1.14 x 1.125 x 1.03 in. relay switches 10a.

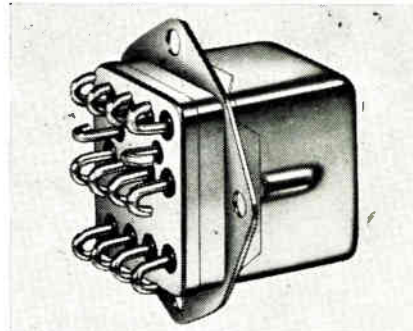

The series 4005 DPDT relay weighs $2\frac{1}{2}$ oz. and handles 3-phase 10a. inductive or resistive loads, a 5a. motor, or a 3a. lamp load. It is rated 28vdc or 115v. or 115/200v. 400 cycles ac with case grounded. It also has full 1500v. RMS dielectric insulation and meets or exceeds Mil-R-6106-D with no restrictions on overload or rupture tests. Guardian Electric Mfg. Co., 1550 W. Carroll Ave., Chicago 7, Ill.

Circle 277 on Inquiry Card

THERMOSETTING SILICONE

Quadruples the power dissipation of zener diodes without increasing size.

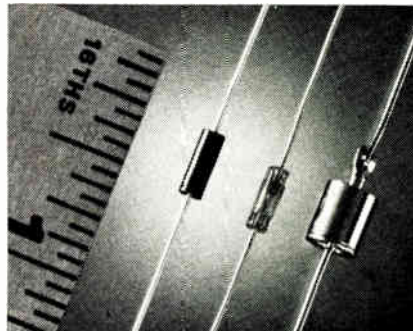

Dow Corning 304 molding compound is made for diode uses. It withstands both vibration, thermal, and mechanical shock better than glass. In addition, much lower molding temps. than those needed for sealing glass packages (about 325°F as compared to about 850°F) permits leads to be soldered to the junction. The package eliminates cracking caused by the differential thermal contraction between metal and glass during cooling—a problem with glass packages. It is flame, acid and solvent resistant and can be cleaned in the same manner as glass. Dielectric strength and moisture absorption rates are equivalent to those of glass. Dow Corning, Midland, Mich.

Circle 278 on Inquiry Card

VARIABLE CAPACITORS

Units are 0.208 x 0.208 x 0.120 in. Have wide delta-C ranges.

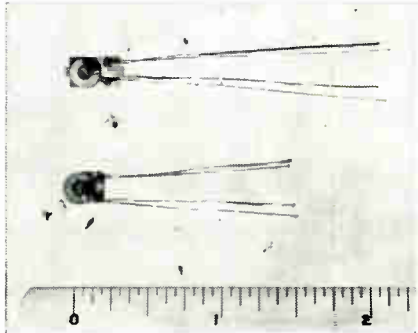

MT 200 Modutrim series have delta-C ranges of: 1.6-9.0; 3.0-12.0; 3.5-20.0; 4.0-15.0; 5.0-30.0; 6.5-40.0; and 8.5-50.0pf. Working voltages are 50vdc except for the 1.6-9.0pf unit, which is 500wvdc. Capacitance change closely approximates a straight-line function for the 180° rotation. Adjustment torque is within 1-5 in.oz. Components Div., JFD Electronics Corp., 15th Ave. & 62nd St., Brooklyn, N. Y.

Circle 279 on Inquiry Card

RESISTOR-CAPACITOR UNIT

Has advantages of Cermet resistors-capacitors with heat dissipation of alumina.

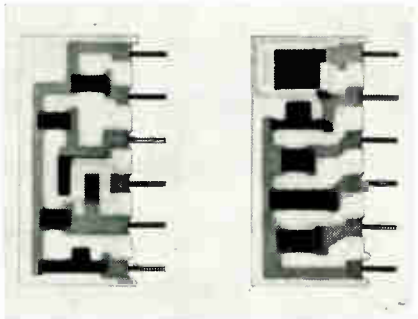

The Series 750 is a compact passive circuit network module. It combines the stability and reliability of Cermet resistors and capacitors with the excellent heat dissipation of a thick alumina substrate. It is available as a single resistor or capacitor, networks of each or combinations of both. Tinned copper pins are swaged into alumina substrate and connected to circuit by solder and Cermet conductors. The entire module is insulated and sealed by a cover coat. Applications include computers and other industrial and military electronic equipment using large numbers of repetitive passive circuits. CTS Corp., Elkhart, Ind.

Circle 280 on Inquiry Card

telephone quality components

There is no higher standard for switching components. Specify famous Stromberg-Carlson... known to telephony since 1894.

RELAYS: Types A, B, BB, C and E. All standard spring combinations are available. Send for Bulletin T-5000R3.

KEYS: Broad selection of push-button, cam and twist types. Send for Bulletin T-5002R2.

HANDSETS: High-efficiency instruments; standard or with switch assemblies. Send for Bulletin T-5017R.

Full-line data on request.

**STROMBERG-CARLSON
CORPORATION**

115 Carlson Road • Rochester, N.Y. 14603



Circle 178 on Inquiry Card

Look to the Leader

PERMACOR®

For Every Electronic Powdered IRON CORE Need!...

As the world's largest producer of iron cores, Permacor has the capability and facilities to supply any requirement or meet any specification you may have.

Write for Complete Information

PERMACOR®

A Division of Radio Cores, Inc.

9540 Tulley Ave., Oak Lawn, Ill.
Phone: 312-GARDen 2-3353



See 4 response traces on your scope

**Fast,
accurate
measurements
by
comparison
up to
1,200 mc**



New Jerrold 3-Position Coaxial Switcher Model TC-3

\$295⁰⁰

The new Jerrold Solid-State 3-position coaxial switcher turns any single-trace oscilloscope into a 4-trace scope, letting you insert two reference traces automatically in addition to the test trace and baseline. These reference traces have the distinct advantage of permanent relative accuracy over hand-scribed or painted reference lines.

Results are repeatable, and as accurate as the reference attenuators. Generator and scope drift do not affect the accuracy of the measurements. The wide frequency range from dc to 1,200 mc extends the usefulness of the comparison technique well into the UHF band. At only \$295, the TC-3 Coaxial Switcher can save you thousands of dollars in speed and accuracy of laboratory and production rf measurements.

Jerrold also offers the sweep generators, attenuators, and other equipment needed for fast, accurate measurement of loss, gain, and VSWR. Write for literature.



Industrial Products Division, Philadelphia, Pa. 19132
In Canada: Jerrold Electronics, 66 Wingold Ave., Toronto 19, Ont.
Export: Rocke International, 13 E. 40th St., New York, N. Y. 10016

SWEEP GENERATORS • PRECISION ATTENUATORS • AMPLIFIERS • COMPARATORS

NEW PRODUCTS

AXIAL LEAD RECTIFIERS

The 0.145 in. dia. diodes are rated at 6a. with fan cooling.

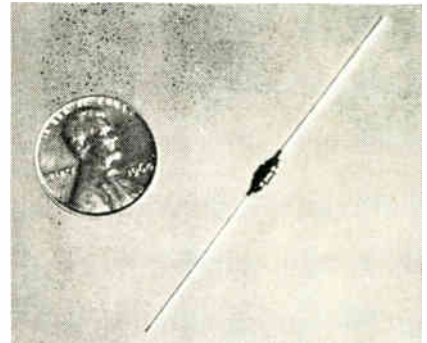

These rectifiers are available at PIVs from 50 to 800v. Since they are controlled avalanche diodes, they are suited for ultra-reliable assemblies. They tolerate surges to 100a., and leakage @ 25°C is typically 0.5µa. They have a glass-fused junction and low thermal resistance. Uni-trode Corp., 580 Pleasant St., Watertown, Mass.

Circle 281 on Inquiry Card

DIGITAL LOGIC SYSTEM

Adds hybrid capabilities to analog computers. May be computer linked.

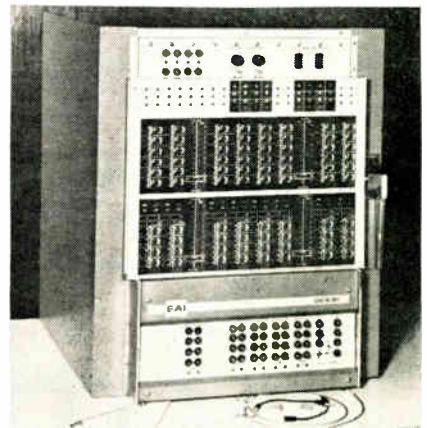

With the DES-30, digital operations are done by modular building blocks. These blocks relieve the programmer of details of timing, loading, and other circuit considerations. All facilities provide the necessary interface or features to enhance hybrid problem set-up with a minimum of programming and debugging effort. All outputs are buffered to provide max. noise immunity and fan out. Inputs and outputs to the components, as well as control signals, are terminated at a plug-in patch-bay. This permits the interconnecting of digital circuits with patch cords and plugs much like that of an analog computer. Electronic Associates, Inc., W. Long Branch, N. J.

Circle 282 on Inquiry Card

NEW PRODUCTS

DIODE MULTIPLIER

Input freq.: 100mc to 2gc; output freq.: 12.4 to 18.0gc. Power is 400mw.

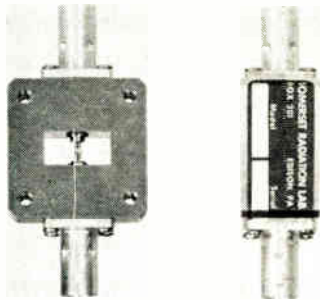

The Model P802 Ku-band Step-Recovery Diode Multiplier permits single-stage jumps from VHF or UHF excitation freq. to SHF Ku-band freqs. Input power in the 100mc to 2gc range produces output power in the 12.4 to 18.0gc band with a conversion efficiency approaching 1/n with optimum impedance matching and bias. It is ideal for high-stability, all-solid-state local-oscillator and low-power transmitter service, and precision freq. measurements. Somerset Radiation Laboratory, Inc., P. O. Box 201, Edison, Pa.

Circle 283 on Inquiry Card

NULL DETECTOR

Has 16 ranges from 30nv full scale to 100mv in 1x and 3x steps.

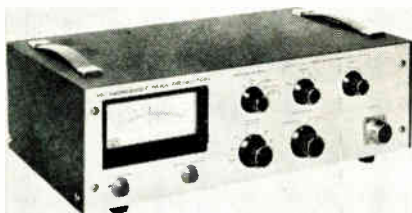

Model 147 DC Electronic Null Detector features resolution of better than 3nv with 10Ω source resistance, and 10nv resolution with 300Ω source resistance. It features: zero shift less than 15nv for source resistance changes from 0 to 300Ω; line freq. rejection of better than 5000:1 on the most sensitive range; line and self-contained rechargeable battery operation; recovery in less than 20 sec. from an overload of 60 million times on the most sensitive range; and internal zero suppression up to 100μv. Keithley Instruments, Inc., 12415 Euclid Ave., Cleveland 6, Ohio.

Circle 284 on Inquiry Card

LASER DETECTOR

Measures rise time, peak power and light-pulse waveforms of Q-switched lasers.

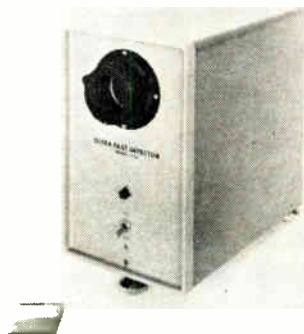

The Model 620 consists of a biplanar vacuum photodiode with an intrinsic rise time of 0.3nsec. The diode has a photocathode selected to optimize response at the ruby laser wavelength of 6943 Å. The diode is mounted in a waveguide assembly terminated in a standard 125Ω coax connector. Output signal may be displayed or photographed on a TWT oscilloscope. The unit may also be used to detect modulation and beating CW lasers and light sources. Optics Technology, Inc., Palo Alto, Calif.

Circle 285 on Inquiry Card

SWEEP/MARKER GENERATOR

Voltage control of freq. over a 1300mc range. Controls 500mc at one setting.

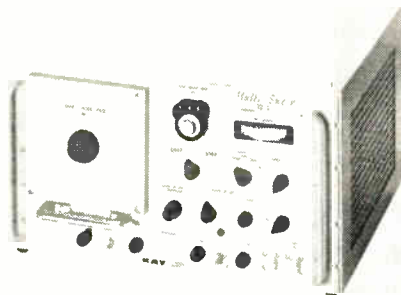

The Model 121-C Video-UHF Sweep and Marker Generator provides octave wide sweeps from 100 to 1Kmc. Other features include: external input of dc to 20kc; extended narrow sweep operation over the full freq. range; ruggedized layout with standard plug-in simplicity; optional added 0-10db, 1db step attenuator. It delivers 0.5v. RMS into load with excellent flatness and waveshape; linear freq. output; and a freq. marker system. Harmonic marks at 1, 10 and 100mc and circuits for an external variable marker are provided. Kay Electric Co., Pine Brook, Morris County, N. J.

Circle 286 on Inquiry Card

not tomorrow...

not the next day...



**but
the day
after that!**

Acopian guarantees that any of their 62,000 different single or dual output plug-in power supplies will be shipped in three days! Request detailed 12-page catalog and price list from Acopian Corp., 927 Spruce Street, Easton, Pennsylvania, or call collect (215) 258-6149.

Circle 181 on Inquiry Card

Eisler

a name to remember
in machinery
for electronics



At left:
Largest assortment
of wet and dry type
Glass Cutters.

Below:
An Eisler
precision
vertical
Spot Welder
designed
exclusively
for welding
electronic
components.
Sizes from
1/2 to 7 1/2 KVA



Write us today for full particulars!

EISLER ENGINEERING COMPANY

Dr. Charles Eisler, M.E., President
770 South 13th Street, Newark, N. J., U.S.A. 07103

Circle 182 on Inquiry Card

Mail this...

fairmount CHEMICAL CO., INC.

136 Liberty St., New York, N. Y. 10006



- High wetting properties for good bite
- Non-corrosive connections
- Residues removed by heating or water rinse
- No change on aging

Please send samples of your
hydrazine-activated

flux core solder

Name _____

Title _____

Company _____

Address _____

City _____

State _____ Zip _____

for samples, technical data on hydrazine- activated flux* or core solder.

*U.S. Patent No. 2,612,459
and others.

Circle 183 on Inquiry Card

NEW PRODUCTS

SHAFT ENCODER

Feature a life of 5 million revolutions
min. at a running speed of 500 RPM.

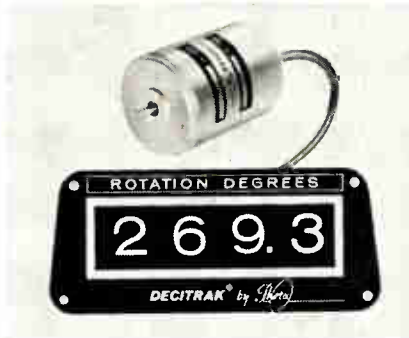

The Decittrak series of decimal shaft encoders are characterized by a direct decimal output and do not require any translation circuitry. It drives lamp-banks, printers, and other displays with its power output of 24vdc, 120ma. Used as a remote position indicator, the Decittrak finds uses in antenna systems, servos, film readers, and tracking pedestals. Theta Instrument Corp., Saddle Brook, N. J.

Circle 287 on Inquiry Card

EXPONENTIAL RESISTOR

Used to obtain a large class of precision, nonlinear mathematical functions.

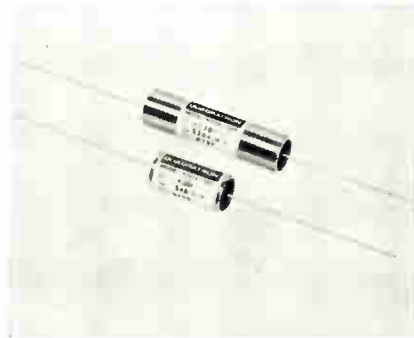

The Quadratron® is used as an input or feedback element with high-gain operational dc amplifiers. The sq. law resistance of its semiconductive element makes it suitable for generating a multitude of functions, including square, sq. root, multiplication, division, sine, cosine, etc. The resistor is available in 2 types: Model 4100A-1-010, a 10v. unit; and Model 4100A-1-100, a 100v. unit. Bourns, Inc., 1200 Columbia Ave., Riverside, Calif.

Circle 289 on Inquiry Card

POLYCARBONATE CAPACITORS

Metallized units are relatively
insensitive to temp. changes.

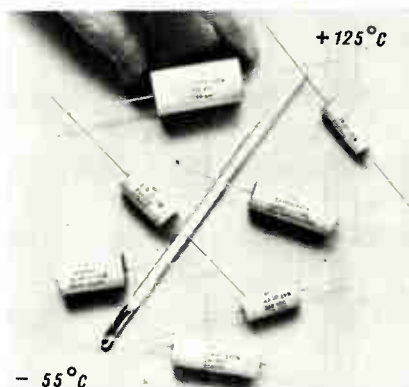

Capacitance of these metal-cased units varies only slightly with temp., the change being typically less than 55 ppm/°C from 25° to 85°C. Dissipation factor is typically less than 0.45% to 10kc from -55° to 125°C, and it is typically less than 0.1% at 1kc over the range from 25° to 125°C. Typical insulation resistance values are 100K megohms x µf @ 25°C; 10K megohms x µf @ 85°C; and 1K megohms x µf @ 125°C. Capacitances range from 0.01µf to 10µf. Dc voltage ratings are: 200, 300, and 400v. General Electric Co., Schenectady, N. Y.

Circle 288 on Inquiry Card

SPECTRUM ANALYZER

Operates in real time and simultaneously covers the 1 to 200 cps range.

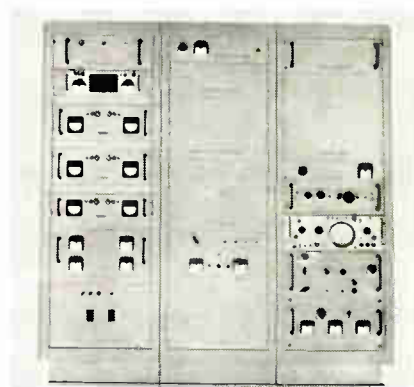

The Model 4A-T uses no contiguous filters. Special freq.-conversion circuits permits the 200 cps freq. coverage to be positioned anywhere in the audio freq. range. The selectivity characteristic is independent of freq. and the resolution is variable from 1 cps to 10 cps. A complete freq. analysis of the input signal is displayed on a 5 in. CRT each sec. for 1 cps resolution or every 1/10 sec. for 10 cps resolution. Real-time, hard-copy recordings of the analyzer output can be provided. Federal Scientific Corp., 615 W. 131st St., New York, N. Y.

Circle 290 on Inquiry Card

THIN-FILM FLIP FLOP

Dissipates less than 1mW and is capable of speeds up to 1Mc.

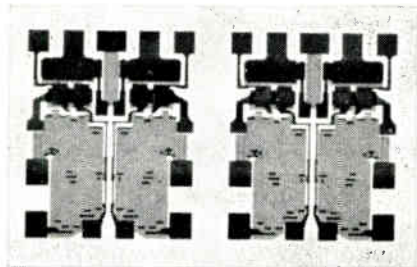

This complementary pulse counter has no inserted passive components. The resulting package, including transistors in TO-18 cans, is 0.45 x 0.65 x 0.1 in. and weighs less than 5 grams. It has Kovar leads. With a ± 6 vdc supply, the flip flop is insensitive to noise below 1v., and is capable of accepting information from 4 different scalars. It drives a load approx. 4 times its own basic power consumption. Alpha MicroElectronics Co., Inc., 10501 Rhode Island Ave., Beltsville, Md.

Circle 291 on Inquiry Card

REAR-PROJECTION READOUTS

Available with replaceable film for exchanging message displays in the field.

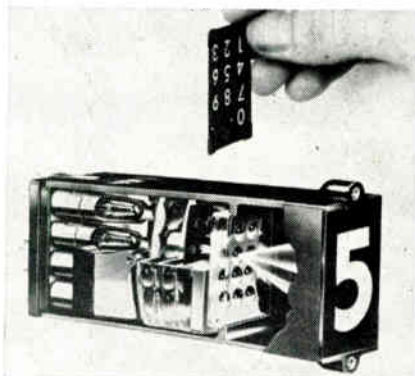

All IEE rear-projection readout devices are supplied with film already in them and set-up to meet customer display requirements. Now it is possible to change this film in the field. Each piece of the replaceable film contains up to 12 different message displays, which may be anything that is photographically reproducible. Each of the 12 messages on the film may be projected onto the viewing screen at the front of the unit by lighting the corresponding miniature incandescent lamp at the back of the unit. Each unit may be quickly disassembled and the film replaced in a matter of minutes. Industrial Electronic Engineers, Inc., 7720 Lemona Ave., Van Nuys, Calif.

Circle 292 on Inquiry Card

Increased relay values with new products, new methods, and improved technical support—that is the 1965 Price Electric story! This pioneer relay house has implemented a comprehensive program to revolutionize the concept of value in the relay field, introducing value in four dimensions.

GO

PRICE

for VALUE⁴

- 1 PRODUCT VALUE**—The Price relay reliability record has been raised to a new level through overall product line standardization and aggressive quality control.
- 2 COST VALUE** — Systematic product standardization plus new methods of manufacture equal the best news buyers ever had: a price structure reflecting true market value. Technically devised methods for order processing and servicing eliminate the hidden cost in buying relays.
- 3 SERVICE VALUE** — Service value is an expression of the total relationship between two particular companies. Everything in our organization is structured to insure that Price relays meet indicated performance and quality levels, and our name is on the line for on-time deliveries.
- 4 TECHNICAL SUPPORT VALUE** — This is the extra from Price, the fourth dimension, the new parameter to be included in your list of fundamental value measurements. We have correlated test and application data to produce uniform descriptions of performance limits of standard devices. Your time and cost in selection and verification for specific applications are cut drastically.

HALF-SIZE CRYSTAL CAN

STYLE 5A. DPDT, 2 amps, DC operated.* Lightweight micro-miniature relay particularly adaptable to high density packaging. Contacts rated low-level to 2 amps, 28 VDC. Solder and plug-in terminals available on popular 0.2" grid spacing. Sensitivity 225 milliwatts, meets 50G shock, 20G vibration through 2,000 cps, and requirements of proposed drawing MIL-R-5757/9A of spec. MIL-R-5757.

CRYSTAL CAN

STYLES 6, 6A & 6B. DPDT, 2 amps, DC operated.* Lightweight, crystal can type relay is simple, reliable and versatile. Ideal for miniaturized assemblies. Termination can be provided to meet most requirements. STYLE 6, sensitivity 170 milliwatts, is available to meet requirements of MIL-R-5757D, Type RY4NA3B3L01. (Supersedes MS24250-6.) STYLE 6A, sensitivity 170 milliwatts, is designed specifically for use in printed circuitry. Installed height is approximately 0.44". STYLE 6B has sensitivity of 40 milliwatts.

OVERSIZED CRYSTAL CAN

STYLE 7. DPDT, 10 amps, DC operated.* Solder or plug-in terminals. Contact rating 10 amps, 28 VDC. Sensitivity 500 milliwatts. 50G shock. 20G vibration through 2,000 cps. Made to requirements of MS27245 and MIL-R-5757D.

* Suitable for AC operations with rectifiers.

Delivery of many types from stock.
Get our quotation first!

PRICE RELAYS

PRICE ELECTRIC CORP.
323 Church St.
Frederick, Md.
Phone: 301/663-5141
TWX 301/553-0462

GO PRICE...FOR VALUE⁴

NEW PRODUCTS

HIGH TEMP. THERMISTOR

Provides strong electrical signals in amb. up to 1600°F.

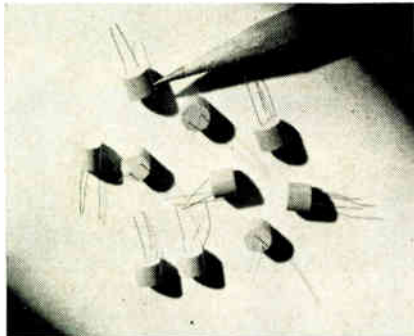

The 1100-PLUS is expected to find wide usage by manufacturers of thermal controls. Based on a metal oxide system, the thermistor is $\frac{3}{8}$ in. dia. by $\frac{3}{8}$ in. thick with $\frac{1}{2}$ in. platinum lead wires. The response time and stability of the device are compatible with existing sensors now used. Ratings can be varied by changing the physical size of the element or type of encapsulation. The Carborundum Co., Niagara Falls, N. Y.

Circle 293 on Inquiry Card

MINIATURE RELAY

Gold flashed fine silver contacts are rated @ 3a., non-inductive.

The JA series relay is well suited to computers, logic systems, and data processing equipment. It is a general purpose relay available in 4 PDT standard contact arrangements for ac or dc operation. Standard configuration features solder terminals and 3-48, 23/64 in. mounting stud. The unit can be used with a 94-79 and 92-80 plug-in socket. Line Electric Co., 249 River St., Orange, N. J.

Circle 294 on Inquiry Card

VOLTAGE REFERENCE

For calibrating instruments. Contains a true 500v. source.

The Model 600 solid-state all-silicon precision voltage reference supply has 0.002% accuracy. A divider network with resistors matched to better than 0.001% accuracy and encased in an oil bath allows for 8 voltage reference taps off the source, ranging from 0.05v. to 500v. Research Corp., 2309 Pontius Ave., Los Angeles, Calif.

Circle 295 on Inquiry Card

CODE CONVERTER

Accepts parallel 8-bit argument; produces parallel 8-bit function output.

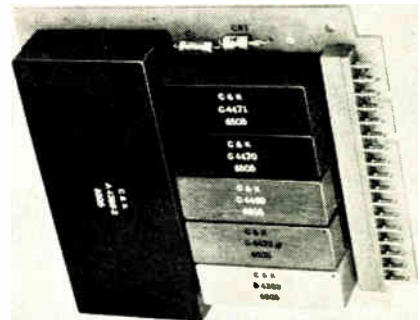

The Model 4043 Magnetic Code Converter uses magnetic tape-wound cores and silicon circuits to give readouts of arbitrary binary functions. The 256 binary function numbers are arbitrary; they are specified by the user and permanently wired into the 32-bit core matrix. The unit features low power consumption, small size, and lightweight. C & K Components Inc., 101 Morse St., Newton, Mass.

Circle 296 on Inquiry Card

Now...a "Flat-Pack" Welder for less than \$1500!



Available now—a 100% repeatable "flat-pack" welder, with feedback control, for just \$1425. How? We added a constant voltage accessory (Model VC-2) to our regular module welder! The VC-2 automatically compensates for changes in lead size, plating, and material consistency. Send for details...today!

Free Sampling Service!

Send us sample materials for experimental bonding or welding. No obligation.

Weltek Precision Welders
by WELLS ELECTRONICS, INC.
1701 S. Main Street, South Bend, Indiana, U. S. A.

Circle 185 on Inquiry Card

NOW 2 VIBROTEST MEGOHMMETERS



Model 2850
dual test voltage
500 vdc and 50 vdc
Only \$250
fob Chicago

Model 2851
dual test voltage
500 vdc and 100 vdc
Only \$305
fob Chicago

Measure resistance to 10 million megohms

versatile • accurate • reliable

advanced features

24" total scale length... 1 to 10,000,000 megohms in 6 decades

measures resistance on printed circuits, transistor and miniaturized circuit components, cables, motors, etc.

measures leakage resistance of capacitors

measures grounded and ungrounded sections of three-terminal resistors

2-357

Get all facts... write for Bulletin 2-1.4

- constant test voltage over full range
- no overload damage
- positive line voltage control
- maximum guarding flexibility
- latest tube-miniaturization techniques

AR ASSOCIATED RESEARCH, INC.
3787 W. BELMONT AVE., CHICAGO, ILLINOIS 60618

Circle 186 on Inquiry Card

ELECTRONIC INDUSTRIES • June 1965

NEW PRODUCTS

DC POWER SUPPLIES

Weight and size reduced 33%; ripple dropped to 0.1% of output.

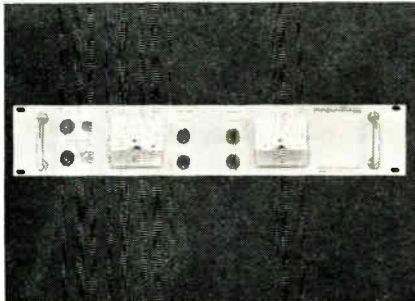

The SCR-1P line of dc power supplies uses SCRs and all silicon circuits. They feature: constant voltage/constant current operation with automatic cross-over; output continuously variable to zero in either voltage or current mode; remote programming in both constant voltage and constant current operation; and remote error sensing. Efficiency is 75% at full output. Harrison Laboratories, 100 Locust Ave., Berkeley Heights, N. J.

Circle 297 on Inquiry Card

LOW NOISE CABLE

Uses a unique manufacturing method to achieve low noise levels.

In Mini-Noise X-5, carbon thread is added over the dielectric, producing a conductive layer between dielectric and shield. This results in a consistently low noise level. The Mini-Noise X-5 allows easy termination to connectors and is low priced. Microdot Inc., 220 Pasadena Ave., So. Pasadena, Calif.

Circle 298 on Inquiry Card

BREADBOARD

Reduces time needed to prove out integrated circuit designs.

This integrated-circuit demonstration breadboard contains a full selection of DTL circuits. The breadboard houses a signal generator panel, an etched circuit board with room for interconnecting 24 circuits, a circuit storage box, a power supply, and interconnecting leads. Siliconix Inc., 1140 W. Evelyn Ave., Sunnyvale, Calif.

Circle 299 on Inquiry Card

PLUG-IN OSCILLATOR

Temp. stability $\pm 1 \times 10^{-10}/C^{\circ}$; short-term stability $1 \times 10^{-10}/sec.$



Model S1077A all solid-state oscillator uses a precision glass-enclosed crystal that operates in a thermally-balanced, proportionally-controlled oven. The oscillator is reverse-voltage protected and accepts either negative or positive input power. Freq. output is 1Mc, 1v. RMS into 1k load. Freq. can be adjusted with an internal coarse or fine adjustment to 1×10^{-10} . Motorola Precision Instrument Products, 4501 Augusta Blvd., Chicago, Ill.

Circle 300 on Inquiry Card

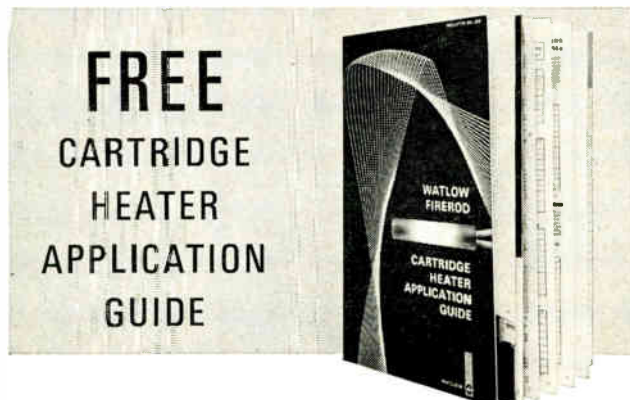

...most comprehensive ever printed

- Determining Wattage Requirements
- Allowable Watt Densities in Solids, Liquids, and Gases
- How to Select Heater Size
- Installation Recommendations
- Surface Heat Loss Charts
- Solving a Typical Problem
- Various FIREROD® Configurations
- Catalog of Stock FIRE-RODS

SEND FOR YOUR FREE COPY TODAY!

WATLOW ELECTRIC HEAT

WATLOW ELECTRIC MANUFACTURING COMPANY
12001 Lackland Rd., St. Louis, Mo. 63141, Phone: (314) HE. 2-4600

Circle 187 on Inquiry Card

ELECTRONIC INDUSTRIES • June 1965

Cut Calibration Costs



Calibrate by Actual Hours of Use

- Provide consistent, use-related calibration periods
- Up to 50% reduction in calibration costs
- Consistent with MIL-C-45662A
- A standard calibration program with leading companies.

Curtis Plug-in Elapsed Time Meters have been especially designed for the requirements of a Calibration by Use, cost reducing program. See how you can cut your calibration costs. Write for the free Curtis Calibration by Use brochure.

Curtis Instruments, Inc.

351 Lexington Avenue
Mt. Kisco, N. Y.

Circle 188 on Inquiry Card

NEW PRODUCTS

DC-DC CONVERTER

Converts 28vdc to any output from 5 to 3650vdc @ 100w.

A family of Hi Temp dc to dc converters is capable of sustained full load operation at 100°C. They use modular design, and measure 3 x 5½ x 3¼ in. Units have complete isolation of inputs and outputs, and an adjustment range of 12% from the nominal output voltage. Abbott Transistor Laboratories Inc., 3055 Buckingham Rd., Los Angeles, Calif.

Circle 301 on Inquiry Card

COOLING CELLS

Provides attenuation on the order of 100db up to ½ cut-off freq.

This honeycomb panel is removable for ventilating and shielding electronic equipment. The removable feature affords a low-cost, quick replacement for the honeycomb panel should it be damaged. For ⅛ in. cell size, the cut-off freq. is 48gc. For ¼ in., the cut-off freq. is 24gc. Due to a free space of 95%, the pressure drop through the cooling cells is low. Metex Electronics, Div. of Ferrodynamics Corp., Walnut Ave., Clark, N. J.

Circle 302 on Inquiry Card

SLIDE SWITCH

Can be mounted and wired in 1 dip soldering operation, greatly reducing labor.

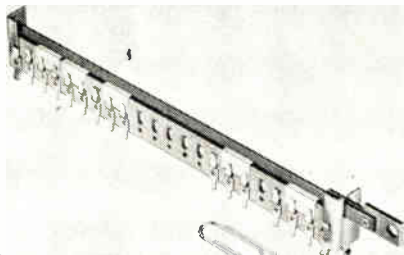

This vertical mounting slide switch offers an 80% reduction in PC board area required for mounting and connections. With up to 20 switch contacts in a variety of configurations, the switch is easily adapted to most circuit requirements. Current rating for make and break is 0.450a. @ 115vac or 2.6a. @ 28vdc. Current carrying capacity is as high as 12a. Average initial contact resistance is 2.0 to 3.5 milliohms. The switch may be furnished either with or without spring return from position "two" to position "one." Centralab, the Electronics Div. of Globe-Union Inc., P. O. Box 591, Milwaukee, Wisc.

Circle 303 on Inquiry Card

FLIP-FLOP MICROCIRCUIT

Completely eliminates skewing problems and increases min. propagation delay.

The Micrologic 926 J-K Flip-Flop is a silicon planar epitaxial device. The circuit contains 17 transistors, 26 resistors, and 2 diodes on a chip 47½ miles sq. The 926 has a fan-out of 5, good noise immunity, and pre-set and pre-clear inputs. It also has an unlimited ability to toggle and steer into high capacitive loads, with a typical toggle rate of 20mc. Available in TO-5 and flat packages. Fairchild Semiconductor, 545 Whisman Rd., Mountain View, Calif.

Circle 304 on Inquiry Card

TAPE TRANSPORT

Tape speeds of 75 and 112.5 ips at 800 bpi with no program restrictions.

Model SC-1060 is 7- or 9-channel compatible and can be adapted to all major computer formats. A new tape drive design uses a single capstan to pass the tape through a low friction tape path. The bidirectional unit has start time of 3msec. and stop time of 3msec. Potter Instrument Co., Inc., 151 Sunnyside Blvd., Plainview, N. Y.

Circle 305 on Inquiry Card

CRATEX® RUBBERIZED ABRASIVES

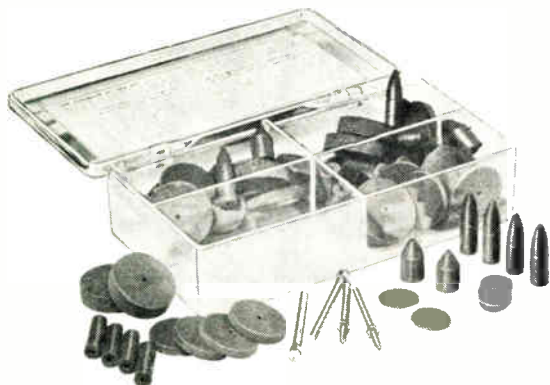

Order this try-it-yourself kit for light deburring, smoothing, polishing

Ideal for countless finishing applications after dimensional grinding or shaping. 80 wheels and points equally assorted in four grit textures—Coarse, Medium, Fine and Extra Fine. Plus four mandrels—⅛" shank. Neatly packed in four compartment plastic box for easy selection. Order from your distributor or from us for delivery by the Cratex distributor nearest you.

\$750 KIT #777 COMPLETE

SEND FOR FREE CATALOG Illustrated—8 pages. Details applications, sizes and shapes, safe speeds, operating rules and methods.

CRATEX® MANUFACTURING CO., INC.

1600 ROLLINS ROAD • BURLINGAME, CALIFORNIA
Cratex is sold through leading industrial distributors.

Circle 189 on Inquiry Card

TO YOUR SPECS

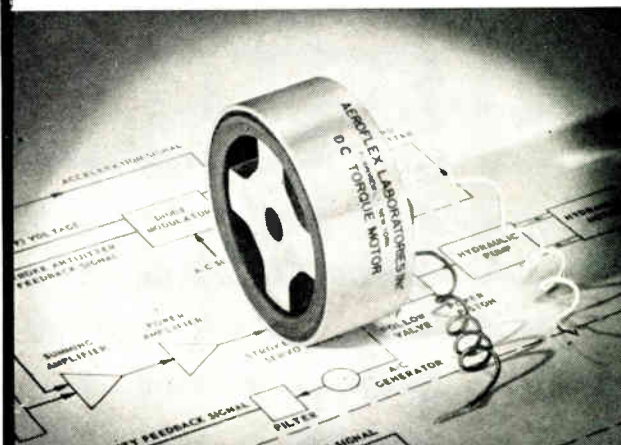

BRUSHLESS Complete DC Torquer Servo Systems

... in many different sizes and shapes ■ ranging from the Jet Vane Actuator used on the Ranger and Mariner spacecraft ■ to Synchro Drive Oscillators and Signal Data Converters for the F-111 ■ and Automatic Throttle Controls for diesel locomotives.

This capability ranges in experience from 1 oz. in. torquers and associated servo control components to giant 10,000 lb. torque motors complete with drive systems for radio telescope and tracking control.

For detailed information on how this capability can help you save money and time, write to Dept. RZ-100



AEROFLEX LABORATORIES INCORPORATED
SOUTH SERVICE ROAD • PLAINVIEW • LONG ISLAND • NEW YORK 11803

Circle 190 on Inquiry Card

ELECTRONIC INDUSTRIES • June 1965

NEW PRODUCTS

STORED-CHARGE METER

Measures zener diode stored charge. May be operated by untrained personnel.

The Model QS-3 stored charge meter measures the stored charge of a zener diode. Readings can be made on diodes too fast to measure on conventional sampling scopes. The unit features current ranges of 0.1, 1, and 10ma.; automatic zero adjustment; automatic polarity indication. It has stored charge ranges of 10, 30, 100, 300, and 1000 picoulombs. B-Line Electronics Corp., Waltham, Mass.

Circle 306 on Inquiry Card

SINGLE DECADE PRINTER

Escape mechanism permits the counter to be zeroed with one 400msec. pulse.

Model WR-25 is available for 24 or 60vdc operation. It may be obtained as loose decades to be built into customer's systems, or combined with a power supply, paper and ribbon feed to form complete digital recorders. Features include speeds up to 25 cps and electrical digital transfer to cascade into the following decade between 9 and 0. Hengstler Numerics, Inc., 318-320 Bergen Blvd., Palisades Park, N. J.

Circle 307 on Inquiry Card

NETWORK CONNECTOR

Microelectronic unit can be soldered into production or prototype systems.

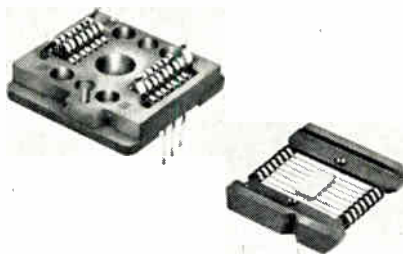

The Mech Pack Connector is recommended for hand- or wave-soldering to PC cards for production packaging. It can also be used with prototype systems to plug in and operate semiconductor networks, and with test equipment for rapid and easy network inspection. Over-all height of the connector with a $\frac{1}{4} \times \frac{1}{8}$ in. 14-lead flat pack engaged is less than 0.400 in. This permits the direct replacement of discrete component cards in systems which have card spacings down to 0.500 in. Metals & Controls Inc., div. of Texas Instruments Incorporated, 34 Forest St., Attleboro, Mass.

Circle 308 on Inquiry Card

DATA MEASURING SYSTEM

Makes and records a wide range of electrical and physical data.

Model 12941 data system records 25 to 100 channels of ac and dc voltage, μv , resistance, freq. and time. Using transducers, it will also measure many physical parameters. It tests semiconductors or monitors physical parameters such as temps., stress, light intensity, torque, etc. It has a basic range of $1\mu\text{v}$ to 1kvdc . Non-linear Systems, Inc., Del Mar Airport, Del Mar, Calif.

Circle 309 on Inquiry Card

INDICATORS

Transistor controlled. Operate from output signals of ICs.

The Tec-Lite M Series Indicators allow calculation of fan-out and fan-in. These transistor-controlled indicators solve the high current and voltage problems typical of incandescent and neon lamps. The indicators offer memory as well as self-contained momentary contact switches isolated from lamp circuitry. Transistor Electronics Corp., Box 6191, Minneapolis, Minn.

Circle 310 on Inquiry Card

We crate and deliver our promises

Special Ovens

Our experienced heat processing engineers will work closely with you to develop highly specialized electric, gas, oil or steam ovens for your most unusual application.

Whatever your requirement might be—from the simplest to the most complex; small or large—consult Grieve-Hendry for a prompt, practical and economical solution.

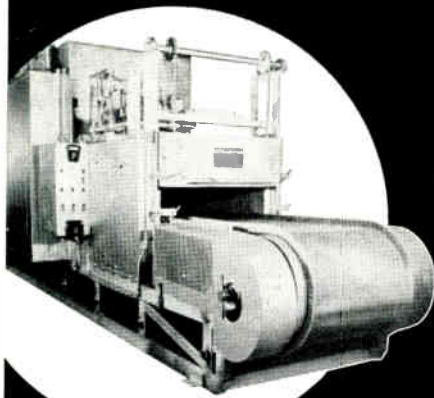

Temp. ranges to 1250° F.

- Comprehensive design and manufacturing experience
- Practical money-saving ideas
- Superior trouble-free performance
- Extensive field representation
- We stand behind our products

WRITE FOR FURTHER INFORMATION

Specialists in Heat Process Equipment

GRIEVE-Hendry Co., Inc.

1335 N. ELSTON AVE. • CHICAGO, ILL. 60622

Circle 191 on Inquiry Card

ELECTRONIC INDUSTRIES • June 1965

New 20 pg. Catalog makes it Easy to Select

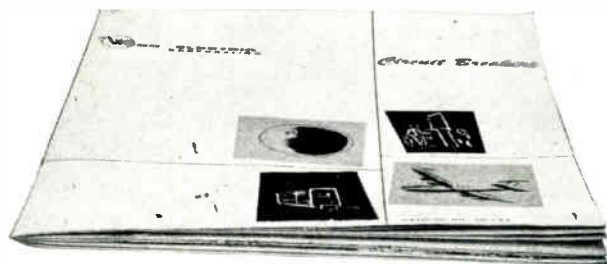

the right Thermal or Magnetic Circuit Breakers

Write for your FREE COPY



WOOD ELECTRIC CORPORATION

244 Broad Street, Lynn, Mass. (617) LY8-5313

Circle 192 on Inquiry Card

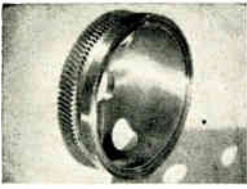

Bonding Phenolic gear blank to rotor housing



Assembling spindle tension cap for textile machine



Connecting components of klystron leakage shield

For difficult bonding problems like these...

ARMSTRONG EPOXY RESIN ADHESIVES

The tough bonding jobs... those calling for exceptional physical properties such as high strength, heat and chemical resistance, good dielectrics, etc... call for Armstrong Epoxy Resin Adhesives. They work equally well when bonding such materials as metals, wood, glass, ceramics, hard rubber and thermosetting plastics to themselves or to each other. You get strong, permanent bonds... tensile shear strengths up to 4000 psi. Will not dry out or deteriorate with age. 100% solids, no volatiles. Only contact pressure required. Cure at room or elevated temperatures.

Armstrong Epoxy Adhesives now available in convenient pre-mixed frozen packaging. Write for free technical data...

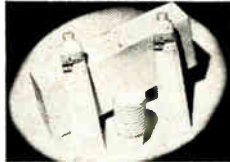

Send for Trial Test Kit Today!

Send \$2.00 and specify the materials you wish to bond. You'll get complete Test Kit of proper adhesive for your application. General-purpose A-12 sent where materials not specified. Sent postpaid in U. S. if check accompanies order.



ARMSTRONG PRODUCTS CO., INC.
Epoxy Resin Adhesives • Coatings • Tooling Compounds
356 ARGONNE RD. • WARSAW, INDIANA
Circle 193 on Inquiry Card

INSTANT

Instant drafting with symbols and drawing details preprinted on tri-acetate sheets ready for use. Your own engineering details can be applied in seconds, rather than drawn in hours.

The STANPAT formula gives permanent adhesion without ghosting. Crisp, clean reproduction everytime on all types of tracing media. Excellent for microfilm reproduction.

Write today and find out how STANPAT can save you hours of routine drafting time. Literature and samples on request, or enclose your symbols for quote.



faithfully serving the engineer for over two decades

STANPAT PRODUCTS, INC.
Whitestone 57, N.Y., Dept. E6
Telephone: 212-359-1693

Circle 194 on Inquiry Card

CORE MEMORY recently installed at the Manned Spacecraft Center (MSC) in Houston is the largest capacity computer memory ever built and delivered by anyone according to its maker—the IBM Corp. The memory—an IBM 2361 Core Storage unit—will process information used by MSC-based flight controllers for Gemini and Apollo missions. Each 2361 has almost 20 million ferrite cores. Design of the unit provides for storage of 524,000 36-bit words and a total cycle time of 8 μ secs in each memory.

FIBER OPTIC light transmission system is being used by IBM to read punched cards. A bundle of fibers is butted against a single light source. The other end of the bundle is split into strands and connected to openings which correspond to the data card hole pattern. Photo cells are placed above the openings. A card is placed between the two devices. The light passes through only where the card has holes, thus "reading" the card. This system can be applied to punched tape also.

WORLD-WIDE WEATHER prediction system is undergoing a feasibility study by General Electric Company's Missile & Space Div., headquartered at Valley Forge, Pa. A possible system would be comprised of buoys located in the oceans of the world. These buoys would gather both weather and oceanographic data. The data would be transmitted to three earth orbiting satellites, and then to a central computer for processing.

WORLD'S FIRST
MINIATURE
PUSH TO MAKE — PUSH TO BREAK
PUSH BUTTON
FOR "REVERSE" APPLICATIONS



Controls 2 circuits — PUSH to make contacts and PUSH again to reverse action. Fast make and break snap-action to handle a high current of 5 amps @ 115VAC. Solid silver contacts and terminals. Compact 1/2" size.

PUSH FOR CONTACT	PUSH FOR CONTACT
ON	ON
(1) — (2)	(2) — (3)
(4) — (5)	(5) — (6)



ALCOSWITCH
Lawrence, Mass. Dept. R-57

THE WORLD'S FINEST
MINIATURE
ALCOSWITCH
Available from these stocking distributors:

Alco Elec., Lawrence, Mass.
Allied Radio, Chicago, Ill.
Almo, Philadelphia, Pa.
Arrow, Farmingdale, N. Y.
B & B Distr., Berkeley, Cal.
Colorvision, Reseda, Cal.
D & H Distr., Baltimore, Md.
Electric Switches, L. A., Cal.
Electronic Components of San Diego, Cal.
Fortune Elec., San Francisco
Goddard, W. Palm Beach, Fla.

Harrison Radio, N. Y., N. Y.
Harvey Radio, N. Y., N. Y.
Indusribution, Oak Park, Ill.
Interstate Elec., Wichita, Kan.
Peninsula Elec. Supply, San Jose, Cal.
Radio Products, L. A., Cal.
Reliance Merchandising, Philadelphia, Pa.
Ed Warburg Co., L. A., Cal.
Wehle Elec., Buffalo, N. Y.
Woffard Elec., Houston, Tex.

Circle 195 on Inquiry Card
ELECTRONIC INDUSTRIES • June 1965

This index is published as a convenience.

No liability is assumed for errors or omissions.

A	
Acopian Corporation	195
Acton Laboratories, Inc.	178
Adams & Westlake Company, The	168
Aeroflex Laboratories Inc.	200
Aerovox Corporation	
Distributor Division	168
Alcoswitch	202
Allen-Bradley Company	Insert fol. p.
Alpha Metals, Inc.	146
American Electrical Heater Company	65
American Electronic Laboratories, Inc.	73
American Machine & Foundry Company	
Potter & Brumfield Division	122
Ammon Instruments, Inc.	171
AMP Incorporated	Insert fol. p.
Ampere Electronic Corporation	145, 159
Amphenol Corporation	
Connector Division	18, 19
API Instruments Company	132
Arco Electronics	181
Armo Steel Corporation	
Steel Division	61
Armstrong Products Co., Inc.	202
Arrow-Hart & Hegeman Electric Company, The	69
Associated Research, Inc.	198
Astrodata Inc.	23
Automatic Electric	67
B	
Ballantine Laboratories Inc.	183
Basic Systems Incorporated	160, 161
Borg-Warner Corporation	
Ingersoll Products Division	169
Burr-Brown Research Corporation	134
By-Buk Company	178
C	
Chart-Pak, Inc.	172
Chicago Dynamic Industries, Inc.	
Precision Products Division	12
Chicago Miniature Lamp Works	174
Clare & Company, C. P.	16, 17, 52, 53
Cleveland Institute of Electronics	173
Clevite Corporation	
Brush Instruments Division	Inside Back Cover
Columbian Carbon Company	63
CMC-Computer Measurements Company	51
Consolidated Electrodynamics	170
Cool-Amp Company, The	188
Cratex Manufacturing Co., Inc.	200
Crown International	189
CTS Corporation	27
Cubic Corporation	
Industrial Division	24
Curtis Instruments, Inc.	199
D	
Dale Electronics, Inc.	Inside Front Cover
Data Instruments Division	136
Daytona Beach Industrial Area	172
Delta Design	171
Diamonite Products Mfg. Co.	170
Driver Company, Wilbur B.	31
E	
Eisler Engineering Company	196
Echo Corporation	33
Electroid Corporation	30
Electro Motive Mfg. Co., Inc.	59
Erie Technological Products, Inc.	21
ESC Electronics Corp.	187
F	
Fairchild Scientific Instruments	183
Fairmount Chemical Co., Inc.	196
G	
General Motors	
Delco Radio Division	134, 135
Globe Industries, Inc.	174
Grieve-Hendry Co., Inc.	201
H	
Hallmark Standards Inc.	191
Heath Company	148
Honeywell	
Precision Meter Division	56, 57
Semiconductor Products Division	75
Howard Industries, Inc.	
Micro Gear, Inc., Division	152
I	
IBM Corporation	
Industrial Products Division	77
Ideal Industries, Inc.	150

Illinois Tool Works Inc.	
Paktron Division	78
Industrial Electronic Engineers, Inc.	178
Interkama	178
Interelectronics Corp.	149
J	
Jerrold Electronics	
Industrial Products Division	194
K	
Kahle Engineering Company	133
Keithley Instruments	182
Klein & Sons Incorporated, Mathias	158
L	
London Chemical Company, Inc.	14
M	
Mac Panel Company	
O.E.M. Division	64
Magnetics Inc.	58
Mallinckrodt Chemical Works	
Electronic Products Division	74
McDonnell	13
McGraw-Edison Company	
Bussmann Mfg. Division	124, 125
Methods Research Corp.	172
Mil Associates Inc.	189
Milwaukee Relays	188
Minnesota Mining & Mfg. Co.	
Electrical Products Division	128, 129
Molex Products Co.	152
Motorola Inc.	
Communications & Electronics Division	117
Military Electronics Division	147
N	
National Electronics, Inc.	182
Nilsen Mfg. Co.	171
P	
Perfection Mica Company	
Magnetic Shield Division	131
Phelps Dodge Electronic Products	60
Photocircuits Corporation	185
Plastic Capacitors, Inc.	184
Potter & Brumfield	
Division of American Machine & Foundry Company	122
Precision Paper Tube Company	
Resinite Division	174
Price Electric Corp.	197
R	
Radio Cores, Inc.	193
Radio Corporation of America	
Designers' Entertainment Receiving Tubes	15
Semiconductor-Computer Campaign	177
Semiconductor Industrial	Back Cover
Radio Frequency Laboratories	132
Radio Switch Corporation	190
Resistors, Inc.	174
Rogan Brothers, Inc.	188
S	
Scionics Corporation, The	
Capacitor Division	192
Sel-Rex Corporation	167
Siemens America Incorporated	
Components Division	10, 11, 126, 127
Sierra Electronic Division of Philco	7
Silicon Transistor Corporation	22
Sola Electric Company	130
Sprague Electric Company	
Capacitor Division	2
Microcircuit Division	5
Stanpat Products, Inc.	202
Stromberg-Carlson Corporation	193
Superior Seatite & Ceramic Corp.	190
Switchcraft, Inc.	151
Synthane Corporation	175
Syntronic Instruments, Inc.	76
T	
Tektronix, Inc.	66
Telonix Industries, Inc.	
Telonic Engineering Co. Division	25
Textool Products Inc.	157
Trygon Power Supplies	32
Tung-Sol Electric Inc.	68
U	
United Shoe Machinery Corporation	
USM Eyelets Fastener Division	204
United Systems Corporation	131
Unitron, Inc.	184
U.S. Components, Inc.	28, 29

V	
Variflex Corporation	188
Varo Inc.	
Special Products Division	166
Victoreen Instrument Company, The	6
W	
Watlow Electric Manufacturing Company	199
Wells Electronics, Inc.	198
Wood Electric Corporation	201

ELECTRONIC INDUSTRIES

REGIONAL SALES MANAGERS

Philadelphia 19139—56th & Chestnut Sts.
(Area Code 215) SHERWOOD 8-2000
JOSEPH ORUCKER

New York 10017—100 East 42nd St.
(Area Code 212) OXFORD 7-3400
GERRY PELLISSIER

Boston, Mass. 02110—10 High St.
(Area Code 617) LIBERTY 2-4460
ROBERT G. SMITH

Chicago 60621—540 N. Michigan Ave.
(Area Code 312) 467-9660
JOHN W. BERNHART
PHILIP T. CLARK

Cleveland 44114—601 Rockwell Ave.
(Area Code 216) SUPERIOR 1-2860
GREG JOHNSON

Los Angeles 90057—198 S. Alvarado St.
(Area Code 213) OUNKIRK 7-1271
GEORGE F. KELLEY
BURT UNDERWOOD

San Francisco 94103—1355 Market St.
(Area Code 415) 861-7107
OON MAY

Atlanta 30309—1776 Peachtree St. N.W.
(Area Code 404) 875-1255
JOHN W. SANGSTON

Dallas 75206—Meadows Bldg.
Expressway at Milton
(Area Code 214) EMERSON 3-6426
HAROLD E. MOTT

EUROPEAN SALES OFFICES

London, S. W. (1)—67/68 Jermyn St.
St. James
MAX F. HOLSINGER

United International Industrial Press
Eitelstrasse 32
4 Dusseldorf—Rath, Germany
MAX F. HOLSINGER

FAR EAST SALES OFFICE

Tokio Marunouchi, Japan
C. P. O. Box #1572, Room 814
Tel.: 211-3506-3509
Togin Bldg.
CLARENCE T. SAKAGUCHI

RESEARCH MEN URGED TO CUT DISCOVERY-USE TIME LAG

The commander of the Air Force Office of Aerospace Research referred to "coupling" as the process of reducing the time lag between scientific discovery and its impact on technology. He urged scientists, engineers, and R&D managers to emphasize that process.

"Military preparedness," said Major General Don R. Ostrander, "means keeping up with all technical advances and scientific discoveries. It means putting to use this cascade of knowledge as fast as possible in developing

the most sophisticated defense posture in history."

General Ostrander said that important changes in the R&D posture in recent years are the result of more stringent requirements that must be met. Such changes have placed more emphasis on research and exploratory development.

Coupling is the proposed "solution for accomplishing this tremendous task. The problem of coupling is the problem of time."

SOLID STATE IN APPLIANCES MAY CUT SERVICE PROBLEMS

The prospect of greatly reduced service problems on major appliances was raised as manufacturers considered the use of solid state devices to replace or to work along with standard functional controls.

The new and growing "semiconductor family" for appliance use was presented at the Annual Meeting of the Consumer Products Division of the National Electrical Manufacturers Association at Hollywood, Fla.

J. E. Mungenast, manager-market development, GE Semiconductor Dept., said that the semiconductors of most interest were "super-switches" (which he identified as transistors, silicon-controlled rectifiers, and ac semiconductor switches). These, he said, function as sensitive relays. They are "hermetically sealed, noiseless, vibration-proof and have no wear-out mechanism."

Through their use, he added, we may detect humidity, temperature, variations of light, weight and strain with inexpensive sensors.

Mr. Mungenast pointed out to NEMA members that solid state appliance sensing and control devices—thermistor, cadmium sulfide photocell, humidity sensor, and silicon strain gage—plus the appropriate amplifier, now offer appliance design engineers a flexibility not found within electro-mechanical parts.

Services of engineers in NEMA Power Semiconductor Components Section were offered to appliance firms in exploring greater use of solid state devices in electric consumer products.

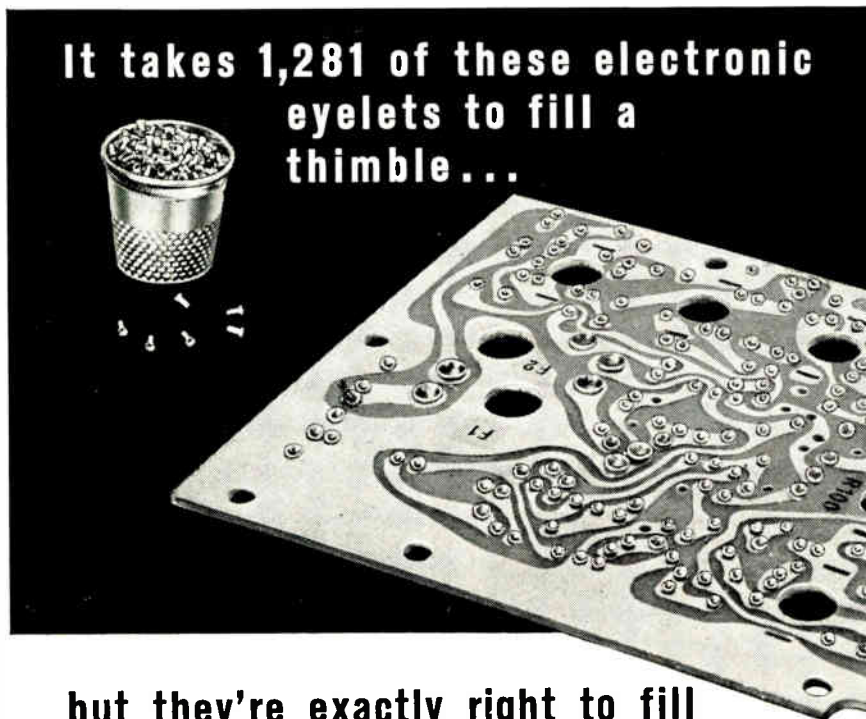

but they're exactly right to fill today's subminiature PW Board needs

The USM System of Standard Electronic Eyelets (only 21 sizes to meet most of your eyeleting needs) includes the very small .059 and .047 diameters required for today's much smaller PW boards. USM also offers other larger and smaller sizes. Normal sizes or subminiatures, USM Electronic Eyelets, and Eyeletting Machines, are the best and most efficient means of meeting *all* your PW board needs. Order this USM Electronic Eyelet Selection Kit and see for yourself — or ask one of our representatives to call and discuss your requirements in detail.



USM Eyelets

FASTENER DIVISION

United Shoe Machinery Corporation

1653 River Road, Shelton, Connecticut



Branches: Atlanta, Ga. • Boston, Mass. • Chicago, Ill. • Cincinnati, Cleveland, Ohio • Dallas, Texas • Sun Valley (Los Angeles), Calif. • Lynchburg, Va. • Milwaukee, Wisc. • Nashville, Tenn. • New York, N.Y. • St. Louis, Mo.

AIR LINES START USING RCA ALL-WEATHER RADAR SYSTEM

Commercial air lines have begun using a modernized, all-weather radar system that "provides twice the usual range and can see the weather behind the weather," RCA disclosed.

The new AVQ-10 was designed for high performance jet transports; its advanced features can be retrofitted into the 2,500 "first generation" AVQ-10 systems currently in use by some 50 air lines around the world. The number of tubes in the system has been cut from 54 to only six.

Doubling of the radar's range has been done through a new tunnel diode amplifier, specially designed by RCA for the AVQ-10.

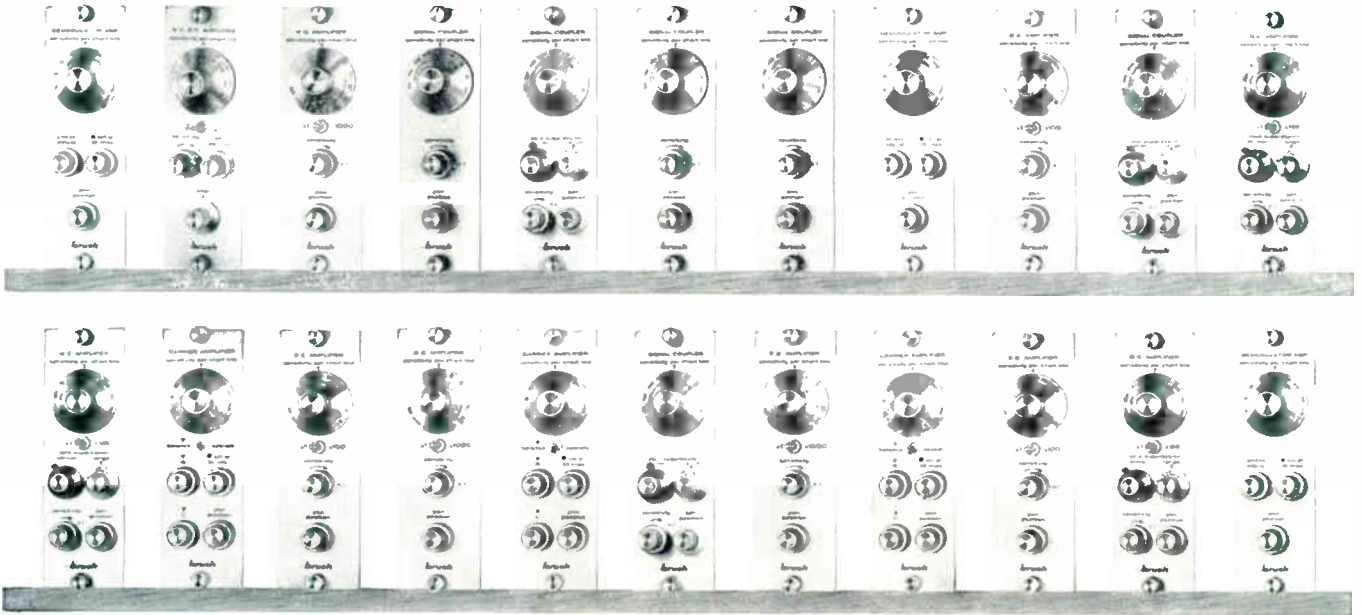

Brush has an "off-the-shelf" preamplifier for almost any recording requirement that comes to mind.

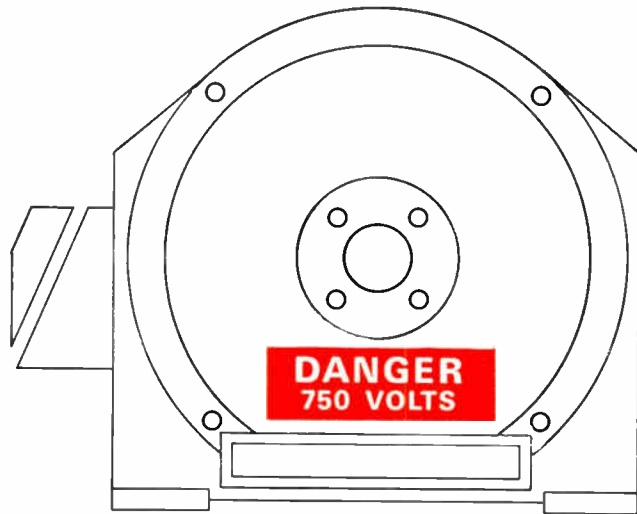

Take high voltage motors for instance.

Recording *their* electrical performance is especially tough. But thanks to a new free-floating, high gain Brush preamplifier, (second from left, top row) it's just another job. This newest addition to the Brush line of 22 different preamplifiers accepts signals up to 1000 volts DC OFF-GROUND, potential differences to 1000 volts DC; plugs into any advanced model Brush Direct Writing Recorder; eliminates possibility of damaged equipment, disruptive downtime and



danger to personnel. Surprised that Brush stocks such a highly specialized preamplifier? Don't be. And don't be surprised either, when the folks at Brush promise to meet *your* direct-writing recording requirements with an optimum-performance system of "off-the-shelf" modular sub-systems. They can . . . better and faster than anyone else in the business. See for yourself. Write: Brush Instruments Division, Clevite Corporation, 37th & Perkins, Cleveland, Ohio 44114.



brush

CLEVITE

INSTRUMENTS DIVISION

Circle 198 on Inquiry Card

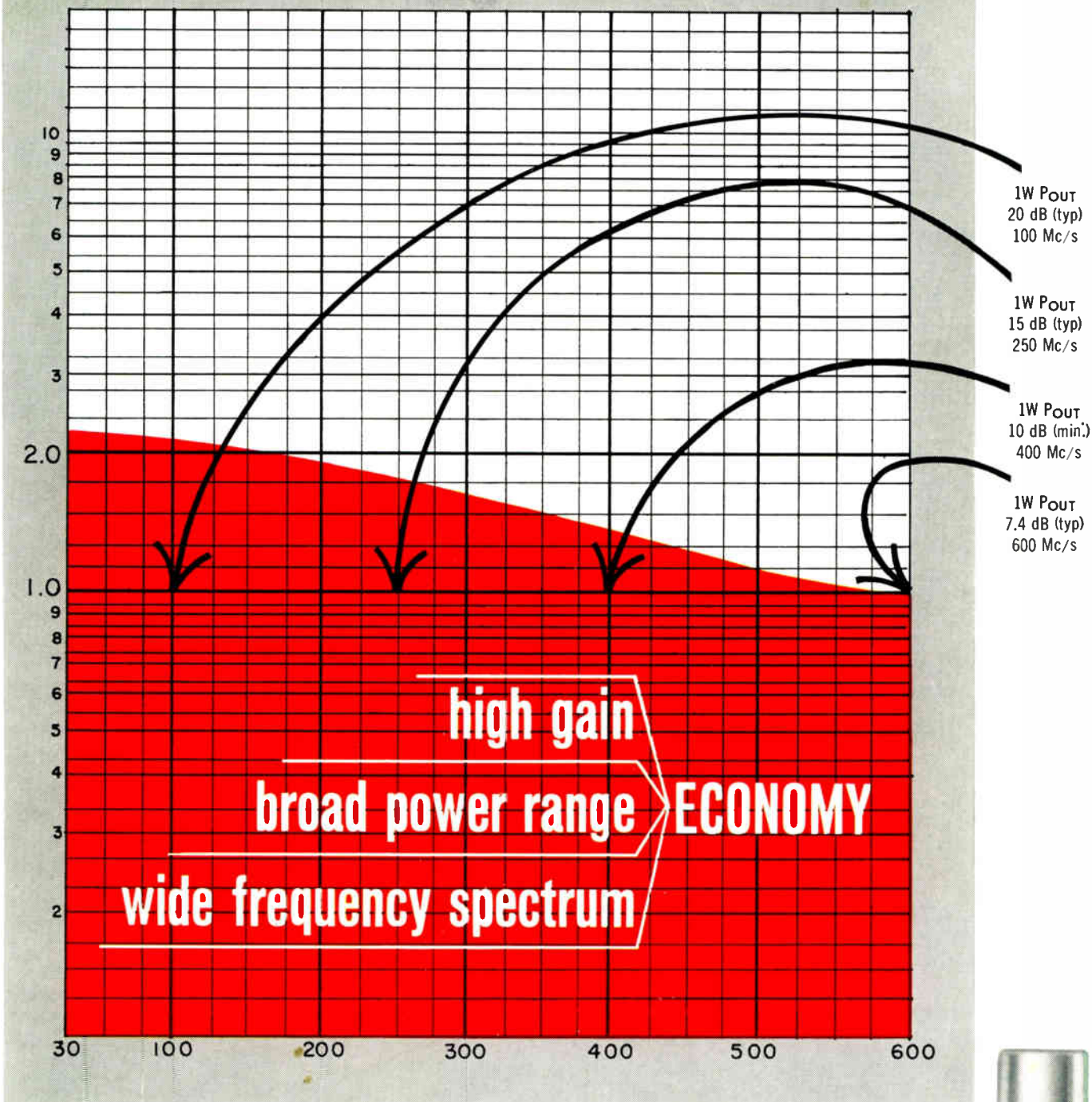

Another overlay breakthrough:
2N3866 now in mass production

for CB to UHF
 $f_T = 800$ Mc/s (typ)

Another RCA breakthrough in "overlay" technology now brings you a new generation of transistors for 1 and 1.8 watts output across a broad band of frequencies from 27 Mc/s to above 400 Mc/s. RCA-2N3866—first of the new high-gain, high-frequency "overlay" family—offers a guaranteed minimum of 1 watt power output at 400 Mc/s (10dB gain) from a 28-volt supply.

Geared for pre-driver, driver and output applications from Citizen's Band to UHF, 2N3866—for operation from 8 to 28-volts—can bring a new combination of economy and "overlay" performance to all these applications:

- Citizen's Band • Community Antenna TV • Sonobuoy • Military Tactical Communications • Rescue Beacons • Instrumentation
- Portable Equipment • Mobile Units • Aircraft Communications
- Microwave Power Sources.

Discuss the new RCA-2N3866 and other RCA "overlay" transistors with your RCA Representative or your RCA Distributor. For technical bulletins, write: RCA Electronic Components and Devices, Commercial Engineering, Section 1J6, Harrison, New Jersey.

Also Available Through Your RCA Distributor



CHARACTERISTICS
INCLUDE:

$I_C = 400$ mA (max)

$V_{CER} = 55$ V (max)

$C_{ob} = 3$ pF (max) at 30V

$P_T = 5$ W (max) at $T_C = 25^\circ$ C



The Most Trusted Name in Electronics

Circle 199 on Inquiry Card

World Radio History