

ELECTRONIC INDUSTRIES

& TELE-TECH



New!

3-D OSCILLOSCOPE

Audio Transformer Short Cuts • "Immittance" Charts
White Noise in Vacuum Tubes

February • 1957

Chilton Publication

SHARE THIS COPY
Please Reel to

Research for Leadership

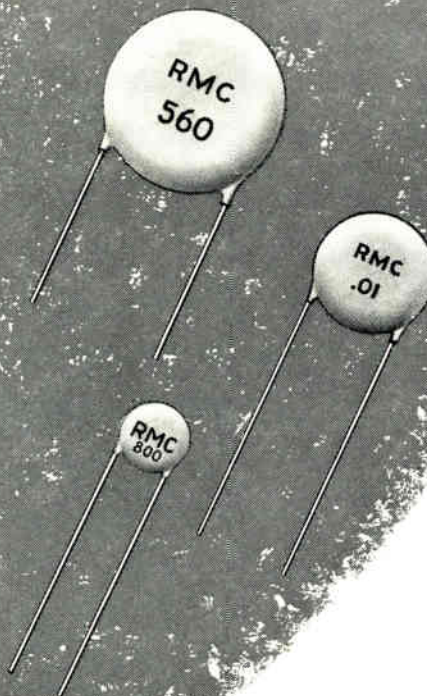

**Specify RMC DISCAPS for
the finest in ceramic capacitors**

RMC has steadily increased its leadership in the ceramic capacitor industry as a direct result of a continuing research program. Our modern research laboratory has contributed many innovations in the field and is always at work improving the characteristics of standard DISCAPS. Write on your company letterhead for information on DISCAPS for standard or special applications.

DISCAP
CERAMIC
CAPACITORS

RMC

RADIO MATERIALS CORPORATION
GENERAL OFFICE: 3325 N. California Ave., Chicago 18, Ill.
Two RMC Plants Devoted Exclusively to Ceramic Capacitors
FACTORIES AT CHICAGO, ILL. AND ATTICA, IND.

ELECTRONIC INDUSTRIES

& TELE-TECH

Vol. 16, No. 2

February, 1957

FRONT COVER: This is one of the exciting possibilities for the new electroflor display materials developed by Shannon Luminous Materials Co. Stacked, transparent matrices add the Z axis to ordinary X-Y displays. One immediate possibility is use of the 3-D matrix as a plan-position-altitude indicator for air traffic control. Further details can be found on page 50.

MONTHLY NEWS ROUND-UP

Radarscope: <i>What's Ahead for the Electronic Industries</i>	2
As We Go To Press.....	5
TOTALS: <i>Late Marketing Statistics</i>	11
Coming Events.....	16
Electronic Industries' News Briefs.....	24
Washington News Letter.....	76
New Tech Data for Engineers.....	85

Editorial: Growing Reliability; Electronic-Communication "Czar" 49

"Crystal Ball" Plots 3-D Curves in Color..... J. R. Alburger 50

"Immittance"—New Tool for Network Analysis.... H. M. Wasson 54

New Hub Solves Linearity Problem... J. W. Weidenman & D. S. Rathje 56

Electronic Probes Check Turbines..... 58

Electronic Eyes Inspect Drinks..... 59

Electronic Light — Luminous Capacitors..... 59

Audio Transformer Design Short Cuts..... R. T. Henszey 60

Scream of a Jet — In a Six-Inch Test Cell..... R. H. Jacobson 63

Applying the Doppler Effect to Direction Finder Design (Part 2) J. A. Fantoni & R. C. Benoit 66

Standardized White Noise Tests..... J. Robbins 68

International Electronic Sources..... 101

NEW ELECTRONIC EQUIPMENT

New Products . . . For the Design Engineer.....	70
New Products . . . For the Electronic Industries.....	74

DEPARTMENTS

Books.....	22	Tele-Tips.....	34
Industry News.....	26	Personals.....	46
News of Reps.....	126		



3-D Display in Color! 50



New "Electroflor" materials fluoresce or show visible colors at low voltages. Layers of the material, with transparent electrodes, form a solid, clear 3-D display device.

"Immittance"—A New Tool 54

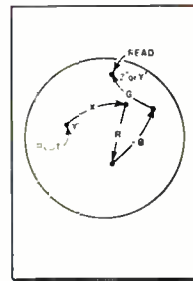

Two Smith Charts, reversed 180°, indicate "immittance"—the combination of impedance and admittance—at a single point, simplifying network analysis.

Design For Linear Pots 56

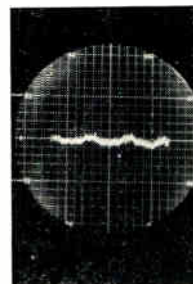

This different approach to potentiometer design achieves high stability through use of a machined aluminum hub and an unusual winding technique.

Transformer Design 60

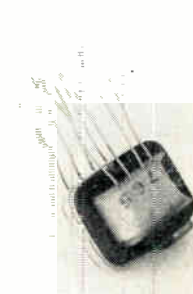

Here is a simple step-by-step procedure for designing a audio transformers. The finished developmental units can be wound on bobbins, ready for use, in a matter of hours.

ELECTRONIC INDUSTRIES & Tele-Tech, Feb., 1957, Vol. 16, No. 2. A monthly publication of the Chilton Co. Executive, Editorial & Advertising offices at Chestnut & 56th Sts., Phila., Pa. Accepted as controlled circulation publication at Phila., Pa. Additional acceptance at N. Y., N. Y. 75¢ a copy. Subscription rates U. S. and U. S. Possessions: 1 yr. \$5.00; 2 yrs. \$8.00; 3 yrs. \$10.00. Canada 1 yr. \$7.00; 2 yrs. \$11.00; 3 yrs. \$14.00. All other countries 1 yr. \$10.00; 2 yrs. \$16.00. Copyright 1957 by ELECTRONIC INDUSTRIES & Tele-Tech, solely owned by The Chilton Co., Inc. Title Reg. U. S. Pat. Off. Reproductions or reprinting prohibited except by written authorization.

RADARSCOPE



OVEN-TESTING RADAR

Radar coupler being placed in the oven at Westinghouse's Air Arm Div., Baltimore, Md., is designed for operation at 400°F. to eliminate need for cooling system. It couples the fire control system to the automatic pilot to zero plane in on target.

ANTI-COLLISION RADARS announced by Collins for airline use last August will be delayed. Collins regrettably announced that developmental work was proving disappointing, and released its customers from contracts totaling \$10 million. Most major U. S. airlines had signed up for the Collins devices.

ELECTRONIC FUEL INJECTION will mean the end of mechanical linkage for accelerator control (no carburetor), and the substitution of a potentiometer.

AIRCRAFT INDUSTRY is concerned over reports that the government may consider permitting facilities of the domestic watch industry to wither away. The watchmakers have developed miniaturization to a very high degree, and their techniques have been found extremely valuable in the design of compact airborne equipment.

FUSE INDUSTRY has appointed a task group to survey its capacity to meet emergency needs of full-scale mobilization. The group will study capacity, output and metals consumption by manufacturers of fuses.

DEVELOPMENT COMPANIES are now working on a hydraulic drive for radar antennas. The Air Force

had this problem: In remote locations, stations supply their own power from motor generator sets. When the antenna turned into the wind, the driving motors required so much power that they took the radar off the air. The new hydraulic system uses an accumulator which can store power. By calling upon this power when the antenna turns into the wind, the peak power requirement is reduced by 75%. The accumulator also recovers power when the antenna is turning with the wind. This reduces the normal power requirement by 15%.

HIGH SPEED PRINTER-PLOTTER that translates the output of an electronic computer into printed records as fast as the computer will calculate has been developed for Army Ordnance by Burroughs Corp. Reportedly the first read-out device to match the speed of a computer the unit is known as BEPOC (Burroughs Electrographic Printer-Plotter for Ordnance Computing).

NEW DUTCH RADIO is powered by a kerosene lamp. The transistorized loudspeaker set operates on 40 ma. at 1.9 v. Power is obtained from a hollow spiral of 192 Chromel-constantan thermocouples placed over the chimney of a kerosene lamp. Overall amplification is 125 db, giving satisfactory operation in most civilized areas. Maximum potential of the thermopile is 2.2 v, and maximum power is 242 mw. at 1.1 v.

ELECTROLUMINESCENCE

Dr. Erwin F. Lowry, manager of fluorescent engineering for Sylvania's Lighting Division, demonstrates a glowing 4-in.-sq. lamp of porcelainized steel and ceramic coating, latest high intensity developmental model of Sylvania's Panelescent lamp.



Analyzing current developments and trends throughout the electronic

industries that will shape tomorrow's research, manufacturing and operation

NOVEL PHOTOCCELL developed by RCA senses with a high degree of accuracy both direction and intensity of a light source. Approximately the size of a pencil eraser it reportedly performs many functions which have been handled previously only with as many as four separate conventional photocells. Among the applications foreseen for the new cell: guiding missiles by sunlight, spotting flashes of artillery and enabling blind telephone operators to find plug-in positions on a switchboard.

TRANSISTOR PRICES continue to fall. Latest is the announcement by Texas Instruments of a 50% cut in the price of the VHF transistor which they introduced 10 months ago. The transistor has an oscillating frequency more than 250 MC, opening the door to transistorized TV receivers.

GOVERNMENT OFFICIALS list their main problems as: 1. reliability of equipment 2. standardization of parts needed 3. equipment incompletely engineered when it reaches the field 4. problems of heat in the equipment in high speed missiles and aircraft and 5. reluctance of electronics producers to adopt standardized parts and automation techniques; according to DATA, government research and development digest.

ENGINEERING OUTLOOK

LOOK FOR more engineering firms to move South, particularly to Florida. Firms that have already made the move report that recruiting engineers is no problem when the attraction of year-round outdoor living is included. Among the firms that have already set up Florida plants are RCA, General Electric, Sperry Rand, Minneapolis-Honeywell and a number of the top aircraft companies. As wage differentials between various sections of the country decrease, climate should become an increasingly potent recruiting weapon.

MANAGEMENT CIRCLES are concerned over the lack of top quality engineering administrators, and the extreme difficulty in training such men. The same drive toward specialization that is responsible for the great progress made in the past decade is turning out engineers with such narrow interests that they are poor administrative timber. One industry spokesman last month flatly predicted that the lack of such trained personnel will be the chief obstacle to the industry's progress within a few years.

ALL SIGNS POINT to a drastic change in the methods of classifying engineers. Where duties out-

side the conventional engineering assignments are involved, appropriate titles are being coined such as "Publications engineers" or "Engineering Writers" or "Administrative engineer." A rumor reaching us says that one large employer of engineers last month started a program of re-classifying all engineers not actually working in the lab or plant to "assistant engineer."

A TIGHTER REIN on government contractor's advertising for engineering personnel was urged last month by Chairman Davis of the House Civil Service Comm. He pointed out that defense cost-plus contractors working on research and development are pirating engineers and scientists from other companies and charging up the expense to the government. Davis called for action "to stop use of tax money for excess advertising and other recruiting practices leading to pirating."

TESTING NEW INSULATION

Sample lengths of 5 kv power cable with lead sheath and insulated with Irrathene, GE's new irradiated polyethylene tape, are shown being given a dielectric power loss test at GE's Wire and Cable High Voltage Lab, Bridgeport, Conn. The tape protects against corona.

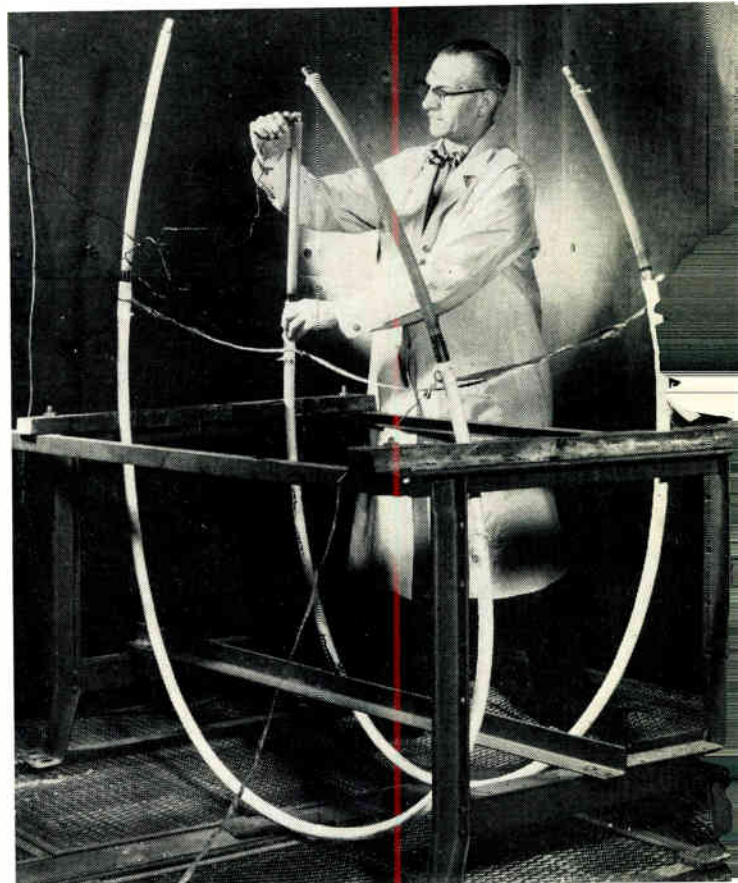

H+ THERE IS ONLY ONE MAGNET WIRE WITH AN EXTREMELY HIGH SPACE FACTOR CAPABLE OF SUCCESSFUL, CONTINUOUS OPERATION AT **250°C**

IT IS SPRAGUE'S...

Cerroc

CERAMIC INSULATED MAGNET WIRE



CEROC is an extremely thin and flexible ceramic insulation deposited on copper wire. This ceramic base insulation is unaffected by extremely high temperatures. Thus, in combination with silicone or Teflon overlays, Cerroc insulations permit much higher continuous operating temperatures than are possible with ordinary insulations.

There are three standard Cerroc Wires: Ceramic Single-Teflon and Ceramic Heavy-Teflon for operation at 250°C feature unique characteristics of flexibility, dielectric strength and resistance to moisture. They have been used successfully to 300°C in short time military applications. Ceramic Single-Silicone, for 200°C application, pairs the ceramic with a silicone reinforcement to facilitate winding.

All three Cerroc Wires have far superior cross-over characteristics to all-plastic insulated wire—all provide an extraordinarily high space factor that facilitates miniaturization with high-reliability standards.

ENLARGED CROSS-SECTIONS OF CERROC® COPPER MAGNET WIRE

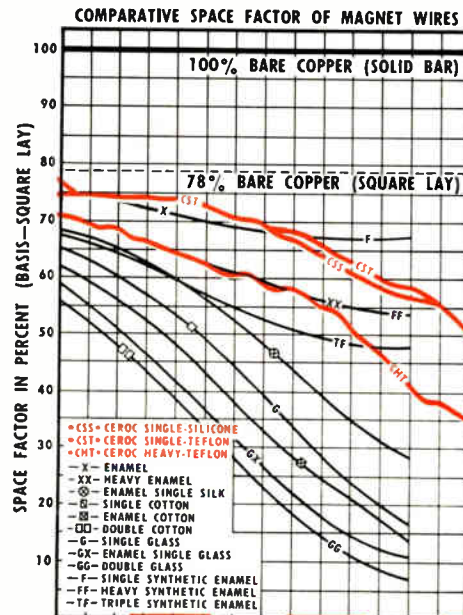
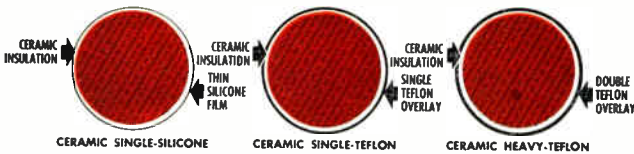

COMPARATIVE SPACE FACTOR OF MAGNET WIRES

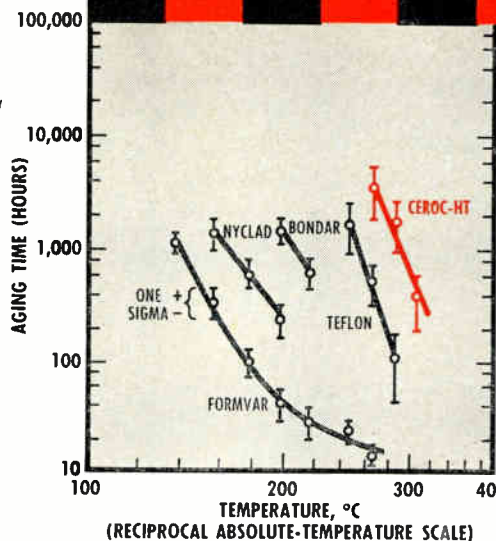

AGING CHARACTERISTICS OF MAGNET WIRE INSULATIONS

FROM AIEE 55-48
By Permission



ELECTRIC COMPANY
233 MARSHALL ST. NORTH ADAMS, MASS.

As We Go To Press...

RCA Bares \$6.9 Million Loss in Color for '56

Brig. Gen. David Sarnoff, board chairman of RCA, revealed in a year-end statement that RCA's net loss on color in 1956 came to approximately \$6.9 million. However he forecast "modest" profits on color sets and color tube during the second half of 1957 and "substantial" profits in all branches of color TV after that.

As of the end of 1956 RCA had sold and delivered 102,000 21-in. color sets, the model introduced in the Fall of 1955. The total factory billing price for these receivers, and color picture tubes, color components and equipment was approximately \$58 million.

Describing RCA's plans for the future, Sarnoff said, "RCA's goal for color television in 1957 is to produce and sell 250,000 color sets, to double the number of color programs on the air, to attract sponsors to the new and productive medium, and to encourage others in the industry to enter the field.

"Barring unforeseen circumstances we expect on this volume to earn, during the second half of 1957, a modest profit on the color sets and color tubes we sell. Thereafter, profits from operations in all branches of color TV should be substantial."

USAF Unveils New Falcon Missile

A new version of the Hughes Falcon, the GAR-1D, has been announced. The air-to-air guided missile can climb at supersonic speed higher than any other existing armament of its kind, and is designed to be carried in quantity by all-weather jet interceptors like the Northrop F-89H Scorpion and the supersonic delta-wing Convair F-102A.

Approximately six feet long and six inches in diameter, the new Falcon weighs less than a man, has a range of several miles.

Development was in the Hughes Culver City labs, and manufacture is in the Tucson, Ariz., plant.

ELECTRONIC SATELLITE

Employee at U. S. Naval Research Lab. in Washington inserts electronic circuit package into earth satellite which will be launched during the International Geophysical Year — 1957-58. Satellite will travel around earth at 19,000 mph after launching from a three-stage rocket.



Glass Color TV Tubes

The RCA color TV picture tube will soon be produced with an all-glass, as well as metal envelope. The price will be the same.

The new tube will use the same design of internal assemblies, including the aperture mask and the 3-gun mount. Production of the all-glass version was made possible by a unique glass flux which melts at a relatively low temperature.

JET AGE TESTING



Air Force personnel use the new "Period Analyzer" developed by American Machine and Foundry Corp. for faster, more accurate analysis of men who have to stand the stresses of the jet age. Unit analyzes brain waves to assess alertness level in pilots.

ARDC to Get New "Lock-On" Radar Range

Contracts have been awarded to build a new radar range in the Mojave desert for use in developing and testing new "X" aircraft. The new installation will be used by Air Research and Development Command's Air Force Flight Test Center and National Advisory Committee for Aeronautics' High Speed Flight Station.

Three permanent and one mobile units will form a highly accurate range extending for over 400 miles from Edwards Air Force Base.

Reeves Instrument Corp., a subsidiary of Dynamics Corp. of America, will build the instrumentation radars.

Wescon Officers Named for 1957

'57 Wescon chairman is GE's Donald B. Harris, manager of electron tube research in Palo Alto. Vice-chairman for exhibits is Norman H. Moore, of Litton Industries; vice-chairman for convention activities is Hewlett-Packard's B. M. Oliver.

BURROUGHS RESEARCH CENTER NEEDS Good ENGINEERS

THAT CERTAIN MAN

Although he's not a stereotyped individual, he does have certain characteristics that are common to many GOOD engineers.

He's ambitious, he's inquisitive, and if he's still a young man he's been out of college only a few years, has a wife and possibly one or two children. He likes his job and the company he works for . . . but he's a little restless. He knows he is a good engineer but wants a chance to prove it. In many cases, he's bogged down with too much paper work, — not enough responsibility. Or, perhaps doing the job of a trained technician. He needs a change of pace. He needs creative work to still his restlessness and prove his ability. He wants recognition, and a chance to advance.

If YOU are that "certain man", tell us about yourself and your aspirations. There are many challenging openings in our four research facilities.

Inquiries are invited from those qualified as:

- ELECTRICAL ENGINEERS
- ELECTROMECHANICAL ENGINEERS
- MECHANICAL DESIGN ENGINEERS
- MECHANICAL ENGINEERS
- MATHEMATICIANS
- PHYSICISTS



Write or Telephone

M. E. JENKINS, PLACEMENT MANAGER • PAOLI 4700

For Interview at Your Convenience

BURROUGHS CORPORATION

Research Center

PAOLI, PA. • On Philadelphia's Main Line Near Historic Valley Forge

ELECTRONIC INDUSTRIES

& Tele-Tech

One of the Publications
Owned and Published by
CHILTON COMPANY

Address all mail to
Chestnut & 56th Sts., Phila. 39, Pa.
SHerwood 8-2000

BERNARD F. OSBAHR, Editor
MAURICE CLEMENTS, Publisher
ORESTES H. CALDWELL
Editorial Consultant

CREIGHTON M. MARCOTT
Managing Editor

ARNOLD LOOK
RICHARD G. STRANIX
JOHN E. HICKEY, JR.
Assistant Editors

DR. A. F. MURRAY
STANLEY GERSTIN
Contributing Editors
ROLAND C. DAVIES
Washington News
B. V. SPINETTA
Directory Editor
ELMER KETTERER
Art Editor
ELMER DALTON
Circulation Manager
BARBARA CROWERS
Editorial Secretary

BUSINESS STAFF

Philadelphia Office—

BLAIR McCLENACHAN
Sales Manager

GORDON HERNDON
Production Manager

WILLIAM D. McCARNEY
Sales Promotion Manager

New York Office—100 East 42nd St.
Phone OXFord 7-3400

JOSEPH DRUCKER
GERALD B. PELISSIER
MENARD DOSWELL III
District Managers

Chicago Office—360 N. Michigan Ave.
RAnDolph 6-2166

GEORGE FELT
District Manager

Cleveland Office—930 Keith Bldg.
SUperior 1-2860

SHELBY A. McMILLION
District Manager

Los Angeles Office—

198 S. Alvarado St.
DUnkirk 7-4337

B. WESLEY OLSON
District Manager

San Francisco Office—1355 Market St.
Underhill 1-9737

DON MAY
District Manager

Tulsa—Petroleum Building
420 S. Boulder St.

OFFICERS and DIRECTORS

JOS. S. HILDRETH Board Chairman
G. C. BUZBY, President

Vice Presidents: P. M. Fahrendorf,
Harry V. Duffy, Treasurer, William H.
Vallar; Secretary, John Blair Moffett;
George T. Hook, Maurice E. Cox,
Frank P. Tighe, Leonard V. Rowlands,
Robert E. McKenna, Irving E. Hand,
Everit B. Terhune, Jr., Russell W. Case,
Jr., John C. Hildreth, Jr.

HOW TO TEST CORES

You can get your core program off the ground now with the Burroughs BCT-301. This complete and flexible system for accurately measuring the operating characteristics of tape wound cores is the result of six years of core research at Burroughs. And with it, you get the benefit of advanced techniques and procedures which are now in everyday use at Burroughs, and are accepted practice among major core manufacturers.

Designed expressly for the individual testing of square loop cores, the BCT-301 allows precise control over frequency, pattern, amplitude, and rise time of the core driving signal. Thus, you can get extremely accurate measurements of the switching time of the core as well as the amplitude of the output pulse. And the unitized sections of the BCT-301 can be expanded and modified to meet new testing requirements as they arise.

Write for additional details on the BCT-301, or request a demonstration of how this new tool can get your core program off the ground now.

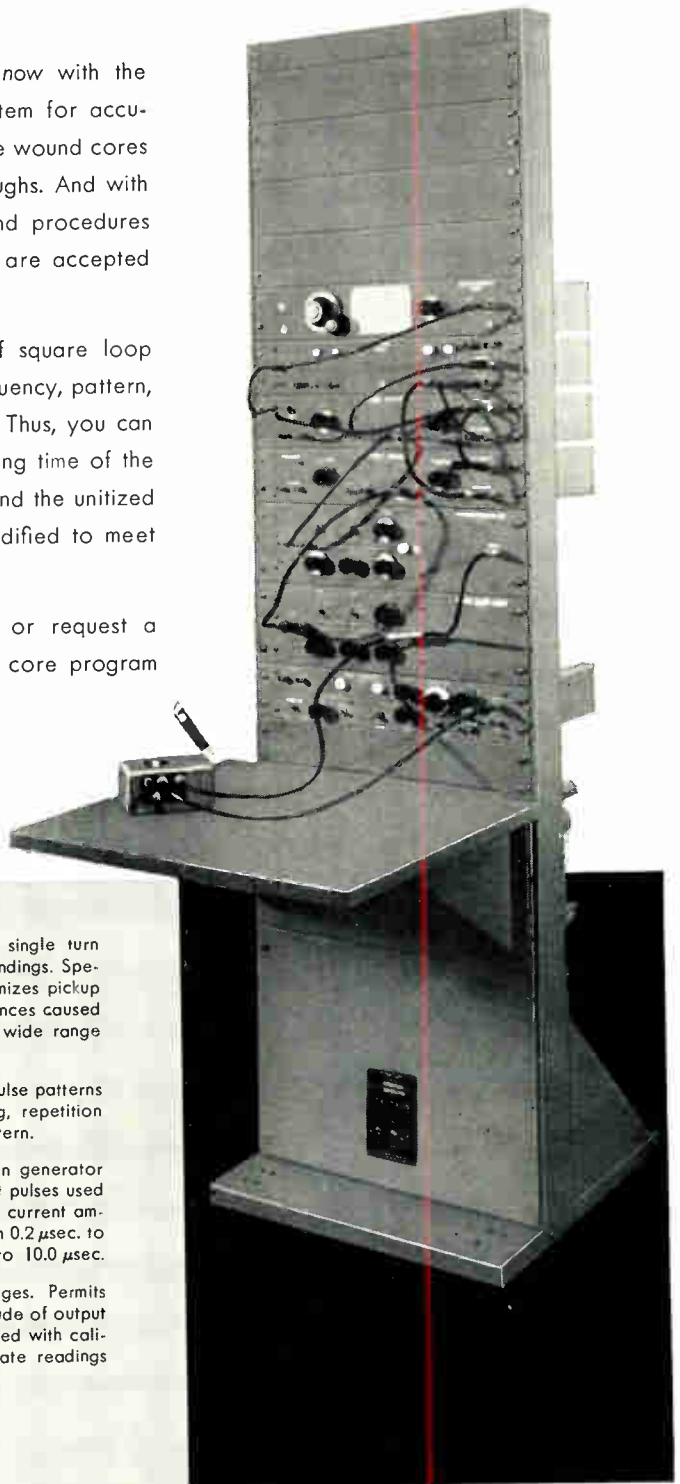

specifications

tools for engineers

- | | |
|---------------------------|--|
| core mounting jig: | Low-noise test mounting jig applies tight single turn loops around core for input and output windings. Special electrical and mechanical design minimizes pickup by the secondary as well as other disturbances caused by air flux. Adjustable pins accommodate wide range of bobbin sizes with equal precision. |
| pattern generator: | Provides extreme flexibility in generating pulse patterns applied to core, controlling pulse spacing, repetition rate of cycle, and number of pulses in pattern. |
| current drivers: | Two drivers convert voltages from pattern generator into positive and negative constant current pulses used for driving core. Front panel controls vary current amplitude from 0 to 1.0 ampere; rise time from 0.2 μ sec. to 1.0 μ sec.; pulse duration from 1.0 μ sec. to 10.0 μ sec. |
| calibrator: | Accurately measures currents and voltages. Permits measurement of driving current and amplitude of output voltage with an error of less than 1%. Used with calibrated oscilloscope, permits highly accurate readings of switching time. |
| power supply: | Provides seven regulated d-c voltages. |



Burroughs Corporation • ELECTRONIC INSTRUMENTS DIVISION, DEPT. D, 1209 VINE STREET, PHILADELPHIA 7, PA.

ELECTRONIC INDUSTRIES & Tele-Tech • February 1957

Circle 4 on Inquiry Card, Page 97



They're made from standard materials—

WHY DO IRC[®] RESISTORS OFFER HIGHEST REPRODUCIBILITY

Carbon, glass, coating resins, molding powder, copper wire, and a metal alloy—they're the only materials you'd need to make a resistor such as IRC's famous Type BT fixed composition resistor. But the real problem, you'd soon discover, is to make every resistor just like the ones before it and just like those following it. That's where IRC's exclusive processes pay off. They give you resistors that "test out" more alike in mechanical and electrical characteristics than any other resistors of their type. That's why only IRC

resistors make possible unvarying performance of your own equipment.

The outstanding thing about IRC production processes is that they provide this uniformity at economical mass-production rates. For example, over 5 miles of carbon filament are drawn every day for film type resistors. And for maximum efficiency and uniformity, this filament is measured and cut while it's being produced. It's this kind of know-how that makes every type of IRC resistor your best buy. Send the coupon today for more facts.

How **IRC** provides unique reproducibility

FILM RESISTORS



Type BT Fixed Composition Resistors



Type DC Deposited and Type BO Boron Carbon Resistors



Molded Type MD Deposited and Type MB Boron Carbon Resistors



Type HFR High Frequency Resistors



Type MV High Voltage Resistors



Resistance Strips and Discs

IRC film resistors exceed military specifications but the really outstanding thing is that they do it with unusual lot-to-lot uniformity in characteristics. What's the reason for this reproducibility? IRC's secret production processes!

You'll find this kind of production know-how in the making of Type DC Deposited Carbon Resistors, for example. The carbon used and the way the carbon film is formed both assure complete dispersion for better resistor performance. In IRC Boron Carbon Resistors, too, the unique method used to combine gases results in greater uniformity at low cost.

WIRE WOUND RESISTORS

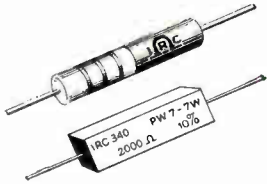

Types BW and PW Low Power Wire Wound Resistors



Types PWW and FRW Power Wire Wound Resistors



Type WWJ Precision Wire Wound Resistors



"PH" Series Encapsulated Precision Resistors



Type CL Insulated Wire Wound Chokes



Type MW Bracket Mounted Resistors

IRC wire wound resistors are exceptionally uniform in their accuracy of adjustment and in characteristics making for long-term stability. The main reason is that they are all automatically machine wound under uniform tension and constant temperature and humidity conditions.

You can see the result of this superior winding skill in the element of the Type CL Insulated Choke, for example. Extremely fine wire is wound so expertly that the element appears to be one smooth, uninterrupted surface! This same winding skill also makes the element of all other IRC wire wound resistors a study in perfection—free from shorted turns or winding strains.

Insulated Composition Resistors • Deposited and Boron Carbon Resistors • Power Resistors • Voltmeter Multipliers • Ultra HF and Hi-Voltage Resistors.

Wherever the Circuit Says

Low Wattage Wire Wounds • Resistance Strips and Discs • Selenium Rectifiers and Diodes • Hermetic Sealing Terminals • Insulated Chokes • Precision Wire Wounds.



HYCOR, Division of International Resistance Co., Sylmar, Los Angeles County, California
Subsidiaries: Circuit Instruments Inc., St. Petersburg, Florida
Hycor Company, Inc., Vega Bojo, Puerto Rico

INTERNATIONAL RESISTANCE COMPANY

Dept. 234, 401 N. Broad St., Philadelphia 8, Pa.

In Canada: International Resistance Co., Ltd., Toronto, Licensee

Please send technical bulletins describing Fixed Compositions Deposited and Boron Carbons High Frequency Types High Voltage Types Low Power Wire Wounds Power Wire Wounds Precision Wire Wounds Insulated Chokes Resistance Strips and Discs.

NAME _____

COMPANY _____

ADDRESS _____

CITY _____ STATE _____

Experience has shown that connector problems fall into three main classes—(1) Selection of the most suitable connector from those cataloged—(2) Modification of an existing type or the use of a non-cataloged "special"—or, (3) Design and use of a new type or series.

MINIATURES AND SUB-MINIATURES



THREE POPULAR MINIATURES

connector problems?

The first problem may best be met by the use of Cannon Electric Condensed Catalogs (ICC and RJC) plus the Plug Guide (CPG) and the small 8-page Guide which are keys to the various engineering bulletins on such types as AN (MIL Specification), Miniature, Rack/Panel/Chassis, Audio, etc. If modifications are required, consult your local Cannon Representative who in conjunction with factory sales engineers, constantly is making adaptations to fit special needs. New designs are always being considered, designed, and developed by Cannon Electric. For those whose requirements are "off-trail," a "Connector Requirements Sheet," fully filled in, will save time and effort in arriving at a suitable design. We will gladly send this sheet upon request, plus the new Miniature Bulletin, or the other bulletins.

Please Refer to Dept. 201

CANNON PLUGS

CANNON ELECTRIC CO., 3208 HUMBOLDT ST., LOS ANGELES 31, CALIFORNIA

WORLD'S LARGEST EXCLUSIVE MANUFACTURER OF ELECTRIC CONNECTORS FOR INDUSTRY

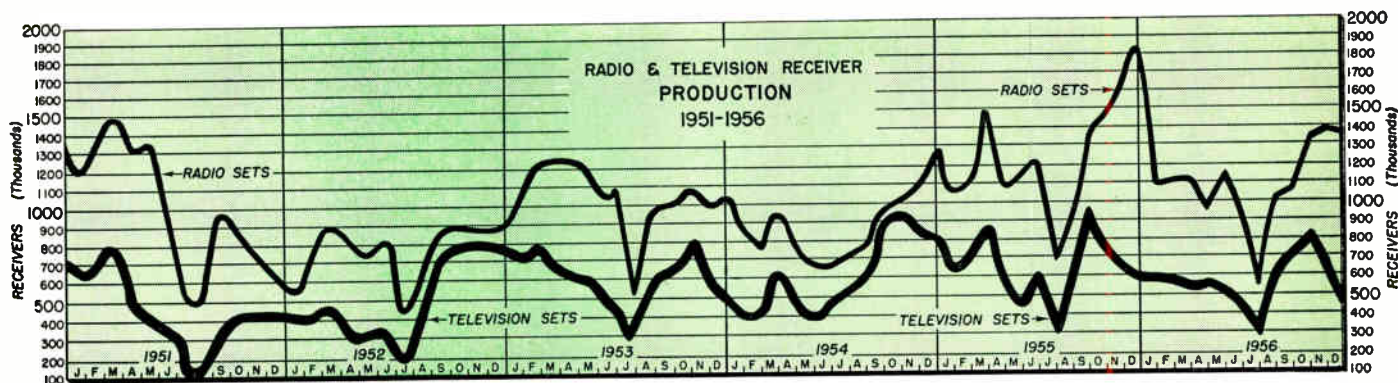

ELECTRICAL MANUFACTURING INDUSTRY

ELECTRICAL PRODUCTS	1954	1955	1956	1957 Est.
Appliances	\$ 4,145.1	\$ 4,675.8	\$ 4,800.0	\$ 5,150.0
Illuminating Equip.	670.7	737.8	830.0	913.0
Signal & Communication Equip.	1,053.7	1,260.0	1,260.0	1,450.0
Industrial Apparatus	2,120.5	2,432.6	2,919.0	3,210.0
Building Equip. & Supplies	491.7	590.1	680.0	730.0
Insulating Materials	267.4	334.2	401.0	440.0
Insulated Wire & Cable	1,140.7	1,483.0	1,925.0	2,020.0
Generation, Transmission and Distribution Equip.	1,768.3	1,630.0	1,800.0	2,070.0
Other Electrical Products	4,037.0	4,441.0	5,000.0	5,500.0
Total Electrical Manufacturing Industry	\$15,695.1	\$17,584.5	\$19,615.0	\$21,483.0

(Data in Millions of Dollars. Includes Exports and Interplant Transfers.)

—NEMA Statistical Department

ELECTRONICS for 1957

Receiving tube volume should be about \$400 million. Approximately \$100 million will be in military and industrial types and \$300 million for commercial receiving tubes. A 10% increase in power tubes is expected.

TV picture tube production is anticipated to reach 14 million with 6.8 million being for replacement.

Semiconductor sales should more than double the 1956 volume, soaring to between \$65 and \$70 million in 1957.

—L. B. Davis, Gen. Mgr., General Electric Co.

STATION NOTES

60,000 stations aid water transportation.
52,000 stations utilized by air transportation.
30,000 stations for land transportation.
32,000 stations serve industry.

21,000 stations required for public protection.

2,500 stations used by common carriers.

154,000 stations operated by amateurs.

4,500 stations for broadcast.

386,000 transmitters used for public safety.

275,000 transmitters utilized by industry.

251,000 transmitters are operated by land transportation services.

—G. C. McConaughy, Chairman, FCC

GOVERNMENT ELECTRONIC CONTRACT AWARDS

This list classifies and gives the value of electronic equipment selected from contracts awarded by government procurement agencies in Dec., 1956.

Amplifiers	8,340,746	Fire Control Equip.	920,473	Relays	79,527
Amplifiers, Audio	363,201	Generators, Signal	303,066	Relays, Solenoid	39,411
Amplifiers, R. F.	277,711	Indicators	62,073	Resistors	27,923
Amplifiers, Servo	40,673	Insulators	63,667	Sonar Equipment	808,800
Analyzers	30,939	Kits, Modification	68,880	Spare Parts	511,287
Antennas & Components	114,615	Kits, Radar Modification	59,330	Switches	229,219
Antenna Towers	672,021	Magnetron Repairs	33,300	Telephone Terminals	2,741,230
Attenuators	25,509	Meters	66,663	Teletype Equipment	70,236
Batteries, Dry	148,782	Meters, Frequency	1,508,182	Testers	1,038,198
Batteries, Storage	648,029	Meters, Watt	66,331	Test Equipment Repairs	300,000
Cable Assemblies	124,431	Oscillographs	27,342	Test Sets	279,505
Capacitors	25,301	Oscilloscopes & Accessories	2,132,288	Test Sets, Radar	769,840
Coils	49,964	Power Supplies	253,864	Test Sets, Radio	132,650
Communications Equip., Scatter	279,866	Radar Equipment	1,396,953	Testers, Tube	1,212,510
Computers & Accessories	189,789	Radio Receivers	58,548	Tubes, Electron	2,742,818
Converters, Frequency	111,447	Radio Receiver-Transmitters	16,190,450	Wire & Cable	704,972
Electronic Equip., Misc.	4,966,332	Recorders & Accessories	147,019	Wiresonde Sets	304,796
Filters	109,459	Rectifiers, Metallic	81,648	X-ray Machines	105,450

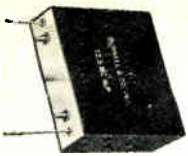

SUBMINIATURE FILTERS

- for I.F. amplifiers, printed circuit use
- temperature compensated to .15% from -55°C to $+85^{\circ}\text{C}$
- for operations above 1 mc
- dimensions: $13/16'' \times 2-1/2'' \times 2''$ high



ENCAPSULATED TOROIDS

- hermetically sealed
- high Q
- center-mounting permits stacking
- complete range of sizes and types
- dimensions: $21/32'' \times 3/8''$



TOM THUMB TELEMETERING FILTERS

- miniaturized for guided missiles
- high temperature stability
- designed to withstand shock and vibration
- hermetically sealed —wt. 1.5 oz.
- dimensions: $45/64'' \times 45/64'' \times 2''$ high



SUBMINIATURE ADJUSTORODS

- precise continuous adjustment of inductance over a 10% range
- no external control current needed
- hermetically sealed
- low cost—wt. .83 oz.
- dimensions: $45/64'' \times 45/64'' \times 3/4''$ high



you're all set to roll...

...with a toroid, filter or related network by Burnell.

For Burnell *specializes* in these components; in manufacturing them *and* in delivering them on schedule — at competitive prices.

Today Burnell makes toroids, and the filters of which they are the basic components, small enough to meet a multitude of new purposes . . . in aircraft and guided missiles . . . in receivers, carrier and telemetering systems.

Very likely we already have the answer to your network needs among our extensive files. If not, we can swiftly find that answer for you. Try us and see.

Burnell & Co., Inc.



EI-27

first in toroids, filters and related networks

45 WARBURTON AVENUE, YONKERS 2, N. Y. TELEPHONE: YONkers 5-6800

PACIFIC DIVISION: 720 MISSION STREET, SOUTH PASADENA, CALIFORNIA TELETYPE: PASADENA 7578

John L. Burns New President of RCA

John L. Burns, 48-year-old management consultant, has been named to succeed Frank M. Folsom as president of R.C.A. Mr. Folsom, who is scheduled to retire in two years, becomes chairman of the executive committee of RCA.

Mr. Burns has a varied background. His education includes master's and doctor's degrees in metallurgy from Harvard University. After a number of years with Republic Steel he joined the firm of Booz, Allen and Hamilton, one of the country's top management consulting firms. In his fifteen years in the management consulting field he set up management policies for hundreds of private corporations, including the Radio Corp. of America.

General Sarnoff, in announcing the election of Mr. Burns, said: "Mr. Burns is no newcomer to R.C.A. He has been associated with our activities for ten years. He has worked closely with us in our periodic review of the company's objectives, policies, organization planning and our business programs and operations. All our executives are enthusiastic about working with him."

Control Engineering Neglected in U. S.

Comments by a group of Russian instrumentation specialists at an informal meeting in Germany indicate that the U. S. is falling far behind the USSR in the instrumentation control field.

David M. Boyd, Jr., of Universal Oil Products Co., Des Plaines, Ill., reports that Russian educators told him that the USSR is graduating 5,000 control engineers annually—about 10 times the number trained in U. S. colleges.

"The difference here in the U. S. is that there are no degree-carrying courses in instrumentation," Boyd points out. "In fact, when we are trying to hire an instrument man, we look for a chemical engineer whose hobby, for instance, is operating a ham radio station."

More News on Page 16

ELECTRONIC SHORTS

▶ The increasing demand of government agencies for reliable tubes under extremes of shock, vibration, and temperature is effectively reducing the overall capacity of electron tube manufacturers to meet emergency mobilization needs. More stringent requirements require greater manufacturing care, more extensive testing. The Receiving Tube Industry Advisory Committee has suggested greater uniformity in specifications used by government agencies as a partial cure. The committee also asks for a constant check on availability of essential materials such as nickel, tantalum, tungsten, and ceramics.

▶ The new four-wire switching system developed by Automatic Electric for long distance telephone circuits shows improved stability and freedom from echo in comparison with two-wire switching. In addition, it eliminates the need for hybrid circuits in local connecting trunks. First installation of the new system was in the 21,000 phone New Westminster exchange of British Columbia Telephone Co.

▶ Boeing will equip 860 military airborne cargo-carriers and aerial tankers with \$914,000 worth of Consolidated Electrodynamics aircraft engine vibration-monitoring systems. The vibration pickup unit, mounted on the engine, is insensitive to air turbulence and shocks normally encountered during takeoff and landing, but senses any unusual engine vibration.

▶ 22.4% of all TV sets were built before 1953, and nearly 13% (5,295,000 sets) were built before 1950. Owners of these sets are seen as excellent prospects for new sets in 1957. A strong shift to portable TV, similar to the swing away from console radios 20 years ago, will probably have similar results, with larger sales volume more than compensating for lower price and profit margin.

▶ A new atomic frontier has been opened by the neutron diffraction technique announced by Westinghouse Radiation and Nucleonics Lab. The new technique photographs crystal diffraction patterns of metals and organic crystals not suitable for X-ray diffraction techniques.

▶ Automation of both military and commercial production is being jeopardized by duplication of scientific effort and breakdown of technical communications, according to an analysis of Daystrom president Thomas Roy Jones. Mr. Jones has proposed to Rep. Wright Patman's automation subcommittee that a joint military-civilian organization be established to disseminate accumulated scientific knowledge in instrumentation and automation.

▶ The largest backlog of government orders in the history of Raytheon Manufacturing Co. is reported for the end of 1956. The total exceeds \$245 million—more than 2½ times the backlog at the end of 1955.

▶ The Bell Labs plan to construct a new reactor at their Whippany, N. J. laboratories. The new reactor will facilitate the increasing use of neutrons for solid state studies and the use of radioactive isotopes in other research. One important series of studies will seek better understanding of transistors by investigating the effects of neutron bombardment on transistors.

▶ GE is making a strong bid for the trucking communications market. A new field force, specially trained in motor carrier applications has been established. GE's mobile communications sales manager James D. Helm sees tremendous growth potential in the motor carrier field due to the increased operational efficiency possible with proper communications.

▶ A new airborne ATC transponder beacon, the RCA AVQ-60 will provide automatic identification of air traffic for ground air traffic control centers. The 25-pound unit has a receiving and transmitting range of over 200 miles. Unique features include a beam switching tube for coding operations; sub-assembled r-f, i-f and video amp., decoder, coder, and modulator power supply; and extensive use of printed wiring and silicon diodes.

another example of exciting work at los alamos...

PREPARATION OF RaLa SOURCES

Since 1944 the Los Alamos Scientific Laboratory has pioneered in the study of the effects of intense radiation on chemical, biological and radiographic systems. Among energy sources for such experimentation are extremely small, high-intensity gamma ray emitters containing radioactive lanthanum-140. Known as RaLa, these sources range up to 10,000 curies (370 million million disintegrations per second, equivalent to several times the known amount of the world's extracted radium).

Obviously, preparation of RaLa sources is done entirely with remote-handling equipment largely controlled with pushbuttons and actuated through servo-mechanisms. Design and much of the fabrication of the handling apparatus are also Los Alamos accomplishments and the Laboratory facility is one of the most highly developed in the United States.

Scientists and engineers interested in these or other projects at Los Alamos Scientific Laboratory are invited to write to:

*Director of Scientific Personnel
Division 1705*

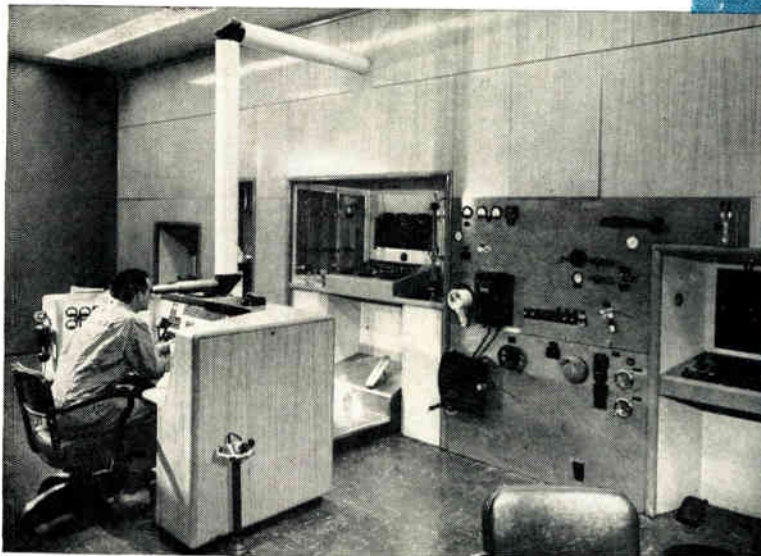
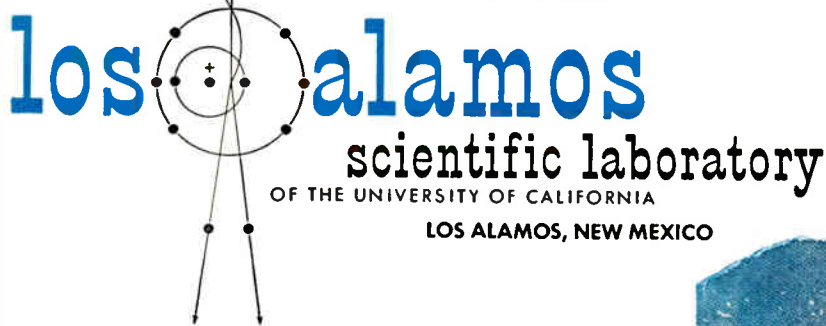

Operator at the control console of the RaLa processing laboratory. The apparatus shown at the right is seen through the periscope.

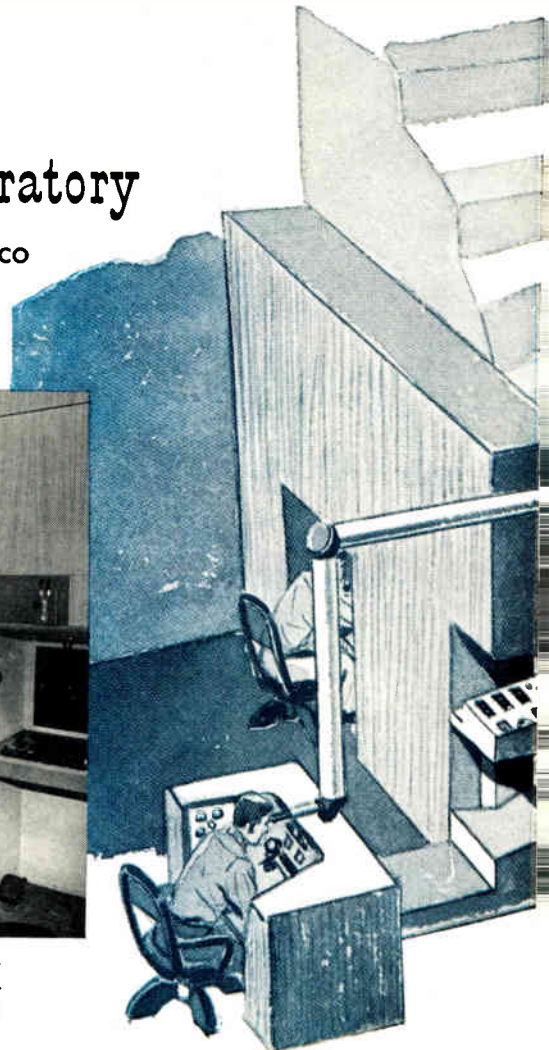

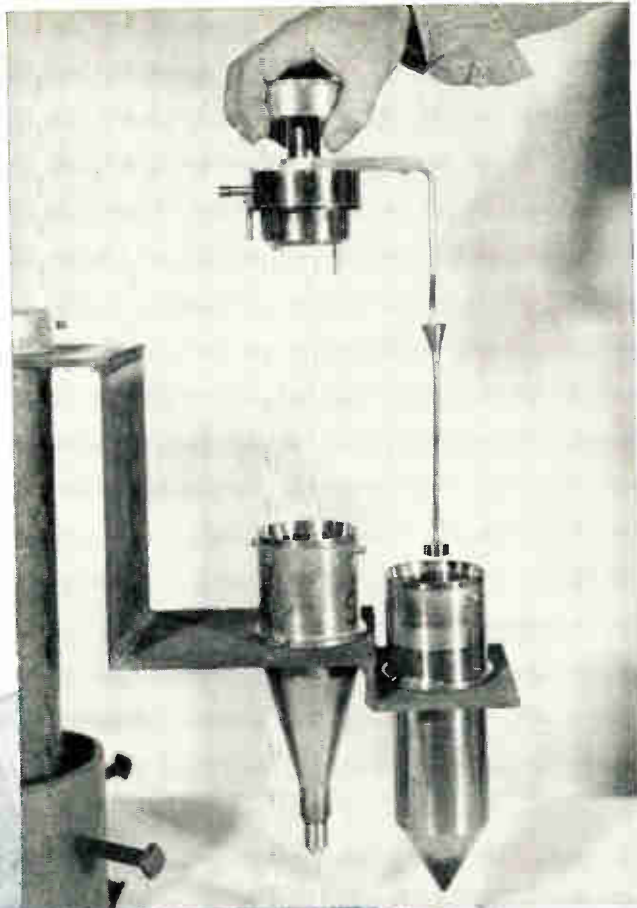

The apparatus to the left is used for precise alignment of the filtering assembly used in hot cells for RaLa processing. When in actual use it is operated by remote control.

Los Alamos Scientific Laboratory is a non-civil service operation of the University of California for the U. S. Atomic Energy Commission.

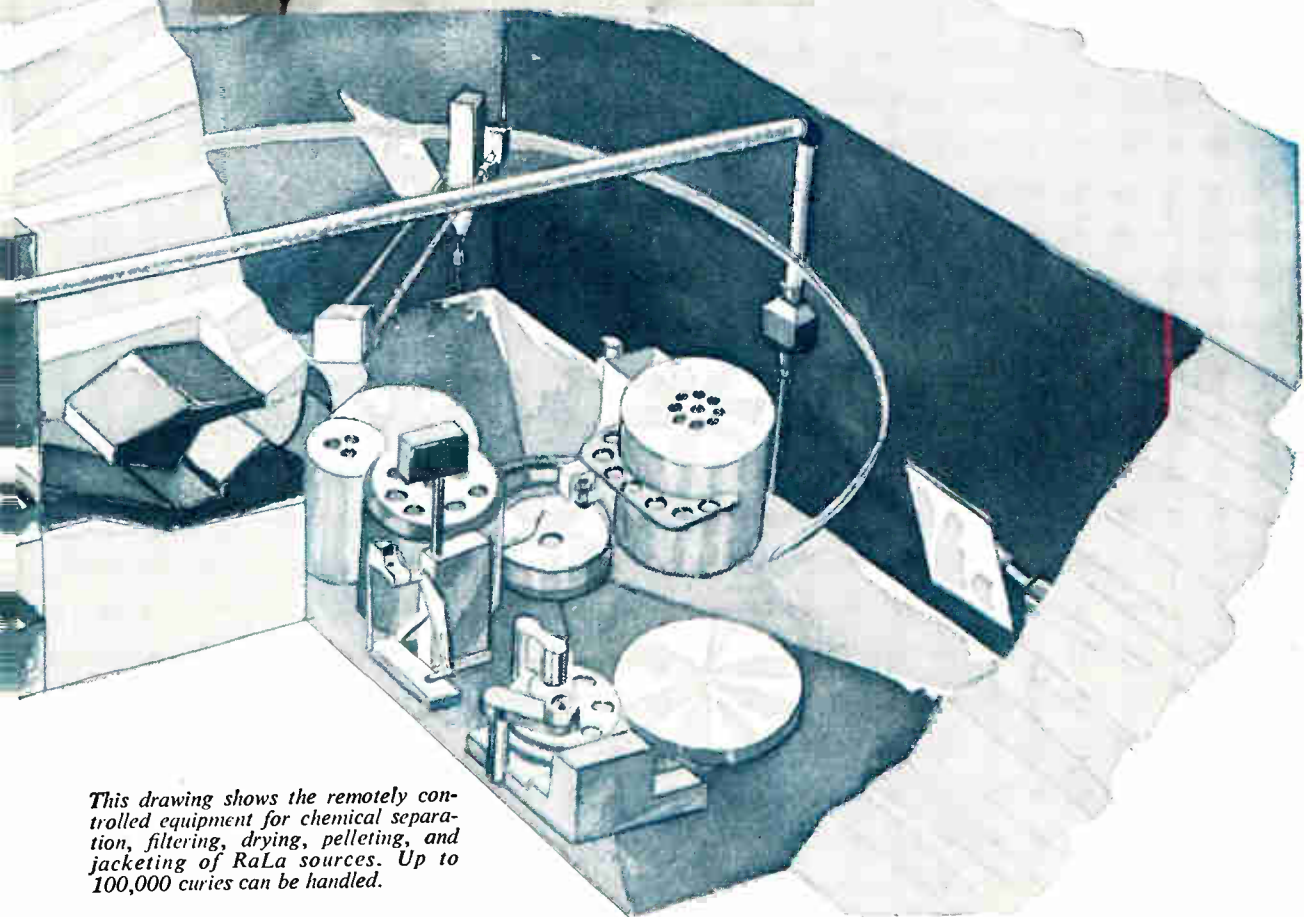

This drawing shows the remotely controlled equipment for chemical separation, filtering, drying, pelleting, and jacketing of RaLa sources. Up to 100,000 curies can be handled.

New Computer For "Vanguard" Project

The "coasting-time computer" that will control the injection of the "Vanguard" satellite into its orbit around the earth at precisely the right moment has been developed by Air Associates, under a sub-contract from the Glenn L. Martin Co.

The new computer will gather flight data during the first stage and thrust period of the second stage of the launching procedure. From this data it will compute the correct coasting time between the end of the thrust period and the jettisoning of the second stage section and firing of the third stage. The third stage provides the additional speed required for injection of the satellite into its earth-circling orbit.

The computer was developed by a team of ten scientists, under the direction of Dr. Wolfgang Harries and Dr. Irving Bogner.

Alaska Submarine Telephone Cable

A new underwater telephone cable system stretching some 1,250 miles from Port Angeles, Wash., to Skagway, Alaska, has just been opened. The new link is a joint project of U. S. Army Signal Corps and the Bell Telephone System. It took over two years to build, and can carry 36 conversations at one time. The system doubles existing radiotelephone and land line facilities between the States and Alaska. Total cost was \$20,000,000.

QUIET PLACE

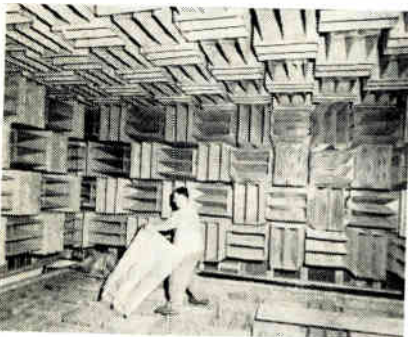

This special anechoic room was recently completed at NBS by the Eckel Corp. Room was constructed for sound studies.

Coming Events

A listing of meetings, conferences, shows, etc., occurring during the period February into March, that are of special interest to electronic engineers

- Feb. 4-6: Establishment and Appraisal of the Management Development Program (Pt. 1), Sponsored by American Management Assoc.; at the Sheraton-Astor Hotel, New York.
- Feb. 4-8: Western Winter Radio-TV & Appliance Market; at the Western Merchandise Mart, San Francisco, Calif.
- Feb. 4-8: Committee Week, sponsored by the ASTM; at the Ben Franklin Hotel, Philadelphia.
- Feb. 5-7: 12th SPI Reinforced Plastics Division Conference, sponsored by The Society of the Plastics Industry; at the Edgewater Beach Hotel, Chicago.
- Feb. 7: Annual Mid-Winter Aircraft Instrumentation Symposium, sponsored by the ISA; at the Garden City Hotel, New York.
- Feb. 7: Operations Research Symposium, sponsored by the IRE Prof. Grp. on Engineering Management and SIAM; at the University Museum, Univ. of Pa., Philadelphia.
- Feb. 7-8: Special Conference on Nucleonics in Industry, sponsored by the American Management Association; at the Hotel Statler, New York.
- Feb. 7-8: West Coast Audio Convention, sponsored by the Audio Engineering Society; at the Ambassador Hotel, Los Angeles.
- Feb. 12-14: Electrical Trade Conference & Exposition; at Washington, D. C.
- Feb. 14: Symposium on Recording of Heart Sounds, sponsored by the IRE & Univ. of Buffalo; at Buffalo, N. Y.
- Feb. 14-15: Transistor & Solid State Circuits Conference, sponsored by IRE, AIEE and Univ. of Pa.; at the Univ. of Pa., Philadelphia.
- Feb. 15-16: Cleveland Electronics Conference, sponsored by IRE; at the Masonic Auditorium, Cleveland, Ohio.
- Feb. 18-21: Annual National Conference, sponsored by The Society of the Plastics Industry; at the Biltmore Hotel, Los Angeles.
- Feb. 19: 13th Annual Quality Control Clinic, sponsored by the Rochester Society for Quality Control; at the War Memorial, Rochester, N. Y.
- Feb. 19-20: Special Meeting in Preparation for FCC's April Hearings, sponsored by the Operational Fixed Microwave Council; at Washington, D. C.
- Feb. 25-27: Special Conference on Electronics in Action, sponsored by the American Management Association; at 1515 Broadway, New York.
- Feb. 26-27: 3rd Conference on Radio-Interference Reduction, sponsored by Armour Research Foundation; at Chicago, Ill.
- Feb. 26-28: Joint Military-Industrial Guided Missile Electronic Test Instrument Symposium; at the Redstone Arsenal, Huntsville, Ala.
- Feb. 26-28: Western Joint Computer Conference, sponsored by the IRE, AIEE and ACM; at the Statler Hotel, Los Angeles.
- Feb. 27-28: Symposium on Nuclear Radiation Effects on Semiconductor Devices and Materials, sponsored by the Advisory Group on Electron Tubes; at Western Union Auditorium, 60 Hudson St., New York.
- Mar. 6-8: Techniques of Supervisory Training (Pt. 1), sponsored by the American Management Association; at the Sheraton-Astor Hotel, New York.
- Mar. 11-13: Establishment and Appraisal of the Management Development Program (Pt. 2), sponsored by the American Management Association; at the Sheraton-Astor Hotel, New York.
- Mar. 11-13: Convention, sponsored by NEMA; at Edgewater Beach Hotel, Chicago.
- Mar. 11-15: The 1957 Nuclear Congress includes: 2nd Nuclear Engineering & Science Congress, sponsored by Engineers Joint Council; 5th Atomic Energy in Industry Conference, sponsored by NICB: International Atomic Exposition, sponsored by AICE, AIMMPE, ASME and AIEE; 5th Hot Laboratories & Equipment Conference, sponsored by the Hot Labs. Committee; all events in Convention Hall, Philadelphia.
- Mar. 18-21: IRE National Convention, sponsored by all Professional Groups of IRE; at the Waldorf-Astoria and Coliseum, New York.
- Mar. 21-23: National Symposium on Telemetry, IRE Telemetry & Remote Control Grp.; at Philadelphia, Pa.

Abbreviations:

ACM: Assn. for Computing Machinery
 AICE: American Inst. of Chemical Engrs.
 AIEE: American Inst. of Electrical Engrs.
 AIMMPE: American Inst. of Mining, Metallurgical & Petroleum Engineers
 ASME: American Soc. of Mechanical Engrs.
 ASTE: American Society of Tool Engineers
 ASTM: American Society for Testing Materials
 IAS: Inst. of Aeronautical Sciences
 IMS: Industrial Management Society
 IRE: Institute of Radio Engineers
 ISA: Instrument Society of America
 NARTB: National Assn. of Radio & TV Broadcasters
 NEMA: National Electrical Manufacturers Assoc.
 NICB: National Industrial Conference Board
 SIAM: Society of Industrial and Applied Mathematics

Having your
ups
and downs?



... if they involve Deposited Carbon Resistors

DALOHM has the answer!

All Dalohm products are carefully designed and skillfully made to assure you of supreme quality and dependability, plus the widest versatility of application.

Outstanding examples of the Dalohm line are these deposited carbon resistors, made for accurate performance where carbon composition resistors are not suited or wire wound resistors too expensive.

You Can Depend On

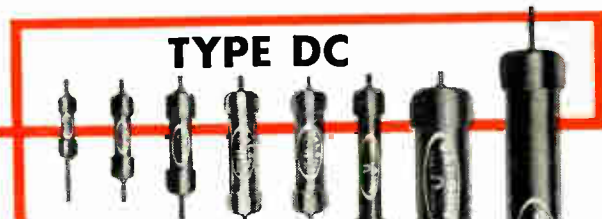

TYPE DC

Pure crystalline carbon film bonded on ceramic rods of special material; provide precision resistance values, low voltage coefficient, low capacitive and inductive characteristics in high frequency applications, extremely high stability and economy

- Resistance ranges from 10 ohms to 50 megohms
- Tolerance 1% or higher as specified
- Five wattages— $\frac{1}{8}$, $\frac{1}{4}$, $\frac{1}{2}$, 1 and 2; eight physical sizes

Write for Bulletin R-24A



TYPE DCH

Essentially the same as type DC except hermetically sealed in a non-hydroscopic ceramic envelope to provide absolute protection against thermal shock, salt water immersion and humidity.

Write for Bulletin R-27A



TYPE DC-5

For extremely high resistance where maximum stability is a prime factor in high voltage applications. Powered at 5 watts; high voltage up to 20,000 VDC; resistance range 1 megohm to 200 megohms; tolerance 1% or up to 10% on request.

Write for Bulletin R-28

**JUST
ASK
US**

You are invited to write for the complete catalog of Dalohm precision resistors, potentiometers and collet-fitting knobs.

If none of our standard line fills your need, our staff of able engineers and skilled craftsmen, equipped with the most modern equipment, is ready to help solve your problem in the realm of development, engineering, design and production.

Just outline your specific situation.

DALE PRODUCTS, Inc.

1304 28th Avenue Columbus, Nebraska, U.S.A.

• In Canada: Charles W. Pointon, Ltd.
6 Alcina Ave.
Toronto, Ont.

• Export Dept: Pan-Mar Corp.
1270 Broadway
New York 1, N. Y.

NEW!---IMPROVED!

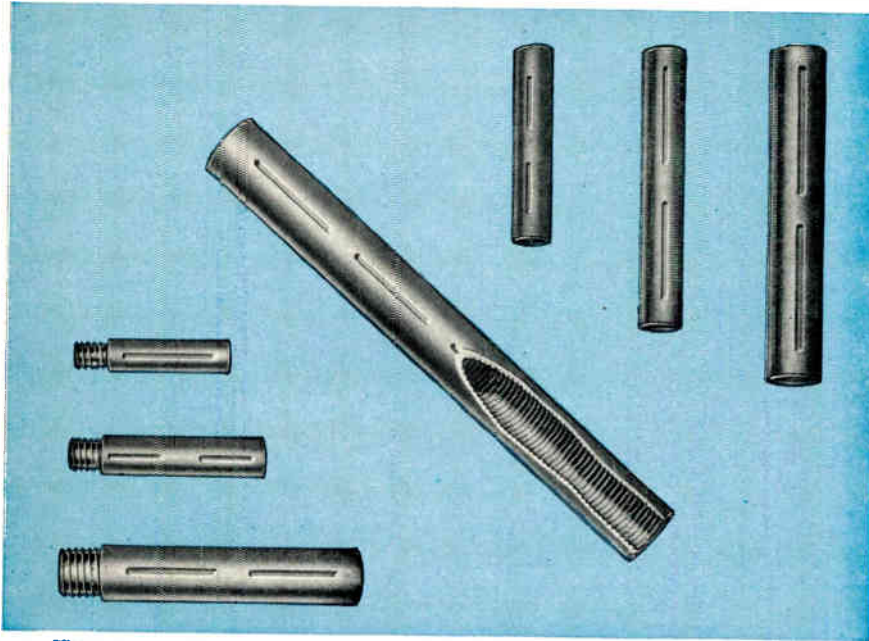

TORKRITE

Your answer for smooth torque without stripping!

NEW TORKRITE tubing is now scientifically brushed and lubricated to give that extra protection which ensures better performance.

IMPROVED TORKRITE is internally threaded and embossed to provide a smooth and constant torque action, engineered to meet every requirement.

ONLY TORKRITE COIL FORMS have these **NEW** built-in qualities.



Write for our latest brochure showing complete line of **CLEVELITE*** Phenolic tubing.

Visit our Exhibit #2317, Radio Engineering Show
Coliseum, New York City—March 18-21

*Reg. U. S. Pat. Off.

THE CLEVELAND CONTAINER COMPANY

6201 BARBERTON AVE. CLEVELAND 2, OHIO

PLANTS AND SALES OFFICES:

CHICAGO • DETROIT • MEMPHIS • PLYMOUTH, WIS. • OGDENSBURG, N.Y. • JAMESBURG, N.J. • LOS ANGELES

ABRASIVE DIVISION of CLEVELAND, OHIO
Cleveland Container Canada, Ltd., Prescott and Toronto, Ont.

Representatives:

NEW YORK AREA: R. T. MURRAY, 604 CENTRAL AVE., EAST ORANGE, N. J.
NEW ENGLAND: R. S. PETTIGREW & CO., 62 LA SALLE RD., WEST HARTFORD, CONN.
CHICAGO AREA: PLASTIC TUBING SALES, 5215 N. RAVENSWOOD AVE., CHICAGO
WEST COAST: IRV. M. COCHRANE CO., 408 S. ALVARADO ST., LOS ANGELES



Books

Radio Telemetry, 2nd Ed.

By Myron H. Nichols & Lawrence L. Rauch. Published 1956 by John Wiley & Sons, Inc., 440 Fourth Ave., New York 16. 474 pages. Price \$12.00.

This book gathers for the first time the basic theory and a cross-section of current practice in measurement and communication in radio telemetry which hitherto have been widely scattered and uncorrelated. In addition, it includes original contributions by the authors, based on their experience gained in telemetering research and development.

Although some of the material appeared in the first edition—a limited offset printing for the USAF—the book is essentially a new work because of its comprehensive coverage. It contains both practical and theoretical considerations involved in the design and development of new equipment. It also discusses better planning for the utilization of available equipment.

The authors present a thorough background in environmental errors and inherent errors, frequency and time domain analysis, modulation and multiplexing, minimum signal strengths and thresholds, sampled data smoothing, and interpolation. On the basis of this background, they analyze existing telemetry practices and equipment and compare them in terms of minimum required signal strength, cross-talk, susceptibility to environmental errors and information efficiency.

Electronic Computers, Principles and Applications

By T. E. Ivall. Published 1956 by Philosophical Library Inc., 15 E. 40th St., New York 16. 175 pages. Price \$10.00.

A non-mathematical introduction to the principles and applications of computers employing tubes and other electronic devices, primarily written for engineers and students with a knowledge of electricity or electronics, but also suitable for business executives. The treatment has been made as general as possible in order to give a broad background picture of the whole field of computing, from which the reader can pass on to more advanced and specialized studies.

Both digital and analog computers are covered, and comparisons are made between the two types. The bulk of the book is devoted to describing their circuitry and construction, while their rapidly developing applications in industry, commerce, and science are also outlined.

Here considerable emphasis is placed on the application to "automation" techniques in industry, and also on the use of analog computers as simulators of control systems. In the final chapter, the future evolution of computers is discussed.

(Continued on page 22)

FIRST silicon transistors meeting NAVY SPECS

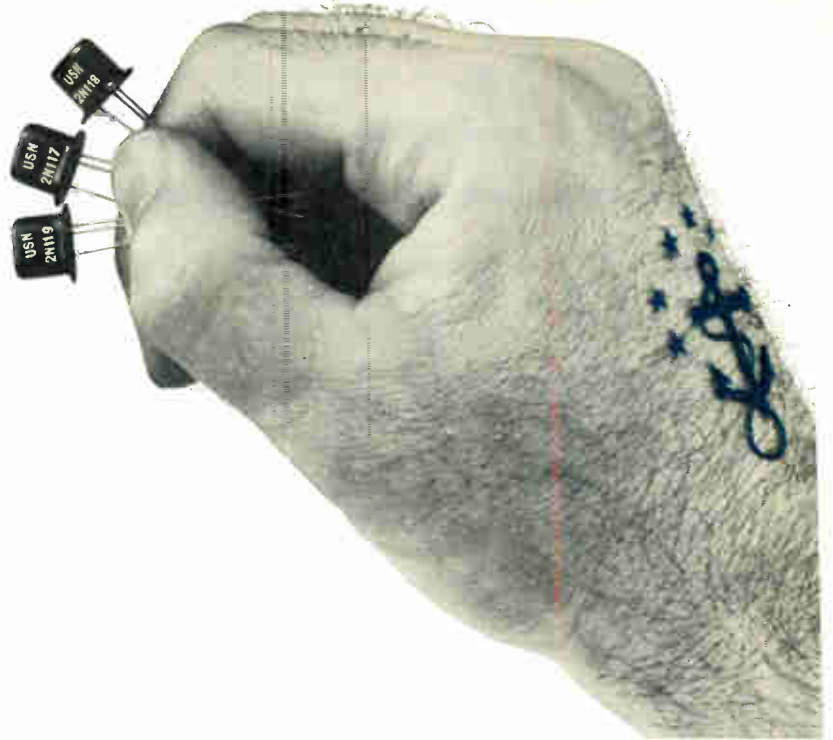

For *reliability* under *extreme* conditions... design with TI's military silicon transistors... built to give you high gain in small signal applications at temperatures up to 150°C. Made to the stringent requirements of MIL-T-19112A (SHIPS), MIL-T-19502 (SHIPS), and MIL-T-19504 (SHIPS) — these welded case, grown junction devices furnish the tremendous savings in weight, space, and power you expect from tran-

sistorization... *plus* close parameter control that permits you to design your circuits with confidence.

All 20 Texas Instruments silicon transistor types have proved themselves in military use. First and largest producer of silicon transistors, TI is the country's major supplier of high temperature transistors to industry for use in military and commercial equipment.

degradation rate tests for TI's USN-2N117, USN-2N118, and USN-2N119

test	condition	duration	end point at 25°C
lead fatigue	three 90-degree arcs	—	no broken leads $I_{CO} = 2\mu A$ maximum at 5V $h_{ob} = 2\mu mhos$ maximum $h_{fb} = -0.88$ minimum (USN-2N117) $h_{fb} = -0.94$ minimum (USN-2N118) $h_{fb} = -0.97$ minimum (USN-2N119) no mechanical defects interfering with operation
vibration	100 to 1000 cps at 10 G	3 cycles, each x, y, and z plane	
vibration fatigue	60 cps at 10 G	32 hours, each x, y, and z plane	
shock	40 G, 11 milliseconds	3 shocks, each x, y, and z plane	
temperature cycle	-55°C to +150°C	10 cycles	
moisture resistance	MIL-STD-202	240 hours	
life, intermittent operation	$P_c = 150 mW, V_c = 30V$	1000 hours, accumulated operating time	
life, storage	150° C, ambient	1000 hours	
salt spray	MIL-STD-202	50 hours	

**LOOK TO TI FOR: SILICON HF, MEDIUM POWER, POWER, AND SMALL SIGNAL TRANSISTORS
SILICON DIODES AND RECTIFIERS • GERMANIUM VHF, POWER, RADIO, AND GENERAL PURPOSE TRANSISTORS**

**pioneer producer of
silicon transistors**



**TEXAS INSTRUMENTS
INCORPORATED
6000 LEMMON AVENUE DALLAS 9, TEXAS**

NEW TYPE H 5-WATT molded composition VARIABLE RESISTOR

With this new development, you get all the advantages of the well-known Allen-Bradley Type J unit, but in a 5-watt rating. The Type H variable solid molded composition resistor is ideal for laboratory or industrial applications where reliability, velvet smooth control, and long life without resistance change are important. The dual track in the Type H control eliminates all moving metal-to-metal electrical contacts, making it outstanding for its low "noise" characteristics, both initially and after long use. The Type H control varies only insignificantly under changing temperature and humidity conditions. Its operating life is far in excess of 100,000 cycles, with no appreciable change in resistance.

You'll have many applications for this new Allen-Bradley quality control. Try it!

Allen-Bradley Co.
1342 S. Second St., Milwaukee 4, Wis.
In Canada—Allen-Bradley Canada Ltd., Galt, Ont.



NEW DUAL TRACK MOLDED ELEMENT GIVES LONGER LIFE ... LESS NOISE

The new Type H control has two *solid molded* tracks—the resistance element, and a collector ring—bridged by double carbon brushes. This dual track assures "quiet" in the control and—if anything, it improves with use!



OTHER ALLEN-BRADLEY VARIABLE RESISTORS



FOR PRINTED CIRCUITS
Type F, ¼-watt variable resistor (½-inch diam). Similar to Type G, below. Slotted screwdriver shaft.

FOR SUBMINIATURE ASSEMBLIES

Type G, ½-watt variable resistor (½-inch diam). Plain or lock-type bushing; plain or slotted shaft. Available with switch.



FLAT, COMPACT DESIGN

Type T, ½-watt variable resistor (1-inch diam). Supplied for hand or screwdriver adjustment.



FOR RADIO AND ELECTRONIC USE

Type J, variable resistor, rated 2 watts at 70 C. Can be furnished with regular or extended shaft. Dual and triple units can be furnished.

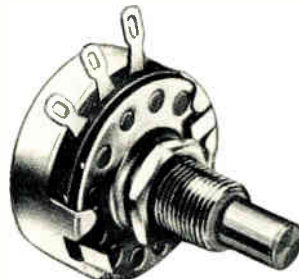

ALLEN-BRADLEY

RADIO, ELECTRONIC, AND TELEVISION COMPONENTS



**bigger things
in smaller
packages...**



Midland

CRYSTALS

**pack king-size performance
in finger-tip space**

"Make it smaller — and make it BETTER!" Miniaturization is a military necessity and an industrial demand for all electronics equipment.

Midland meets it with frequency control crystals of Lilliputian proportions and titanic efficiency. Like their "big brothers" that made Midland first choice in two-way communications the world over, Midland miniatures and sub-miniatures are masterpieces of accuracy, stability and uniformity — everything you want in a crystal — guaranteed by Midland's Critical Quality Control.

Have a special crystal problem? Whether it's in miniaturized or conventional application, our engineering staff is ready to help (including development and production of crystals tailored to your individual requirements.) Get in touch with us.



Midland MANUFACTURING COMPANY, INC.

3155 Fiberglas Road • Kansas City, Kansas

WORLD'S LARGEST PRODUCERS OF QUARTZ CRYSTALS

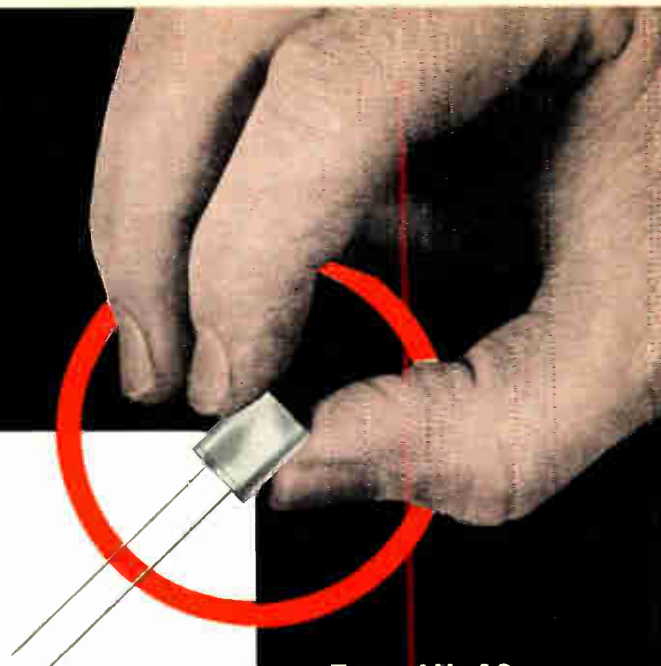

Type ML-18

Range: 5.0 mc — 150 mc

Wire pin diameter: $.017 \pm .001$

Wire pin length: $1.500 \pm .062$

Fixed pin diameter: $.040 \pm .002$

Fixed pin length: $.234 \pm .030$

Whatever your crystal need, conventional or highly specialized, when it has to be exactly right, contact...

TEFLON TAPE

...now
cementable

suggests a
multitude of uses

■ Now, "the material that sticks to nothing" can be cemented to anything (metal, glass, wood, plastics, etc.) with ordinary commercial adhesives (including the pressure-sensitive). Pull test approximately 45 lbs.

This new, treated tape (down to 5 mil. thickness) offers the opportunity for inexpensive, thin-section applications of this material for many services where *TEFLON's unusual dielectric properties, zero water absorption, broad service temperature range (-110° to 500°F) and chemical inertness are desired.

Cementable TEFLON Tape, 5 mil. to 60 mil. in thickness is available in continuous rolls up to 12 in. wide. Sheets are also available $\frac{1}{2}$ -in. thick in sizes to 24 x 24 in.; $\frac{1}{16}$ -in. thick in sizes to 48 x 48 in.

Now—if the problem says "TEFLON", price ceases to be a factor. Specify Cementable TEFLON Tape.

*du Pont Trademark



UNITED STATES GASKET CO.

CAMDEN 1, NEW JERSEY

Books

(Continued from page 18)

Philco Handbook of Tubes and Semiconductors

Published 1956 by Philco Corporation, 18th & Courtland Sts., Phila. 40, Pa. 207 pages, price \$2.00.

The characteristics of over 1950 tubes and semiconductors are presented in this manual. The first section deals with servicing and maintenance, and includes service hints normally acquired only with experience. The next two sections contain the tube base diagrams. Section four lists conventional tubes and their ruggedized equivalents, and points out differences between them. The fifth section contains the tube characteristic charts for receiving, transmitting, and special-purpose tubes. The final section contains information on semiconductor devices—covering approximately 450 crystal diodes, microwave crystal diodes, and transistors.

Mechanical Design for Electronic Production

By John M. Carroll. Published 1956 by McGraw-Hill Book Co., Inc., 330 W. 42nd St., New York 36. 367 pages. Price \$6.50.

The book covers mechanical layout, sheet-metal work, machining, electric and magnetic shielding, resins and other sealing compounds, mechanisms, and electric motors. Also hand and mechanized assembly, conventional and dip soldering, conventional and etched wiring, design of exterior housings, and nonelectrical acceptance tests for military equipment.

Books Received

Analysis of Bistable Multivibrator Operation

By P. A. Neeteson. Published 1956 by Philips Technical Library, EINDHOVEN (Holland). 82 pages. Price \$2.15.

Trigonometry Refresher for Technical Men

By A. A. Klaf. Published 1956 by Dover Publications, Inc., 920 Broadway, New York 10. 639 pages. Price \$1.95.

Wave Propagation

Published 1956 by John F. Rider Publisher, Inc., 480 Canal St., New York 13. 747 pages, paperbound. Price 90¢.

Radio Volume 3

By J. D. Tucker & D. Wilkinson. Published 1956 by The English Universities Press, Ltd., 102, Newgate St., London, E.C. 1. 258 pages. Price 12 shillings, 6 pence (\$1.75).

Profitable Radio Troubleshooting

By W. Marcus & A. Levy. Published 1956 by McGraw-Hill Book Co., Inc., 330 W. 42nd St., New York 36. 338 pages. Price \$4.50.



A major step forward has been achieved by uniting Fairchild precision potentiometers with dynamically balanced and sensitive pressure-sensing elements. The result is a line of superior pressure transducers with potentiometer outputs and featuring all the characteristics of precision, reliability and quality that are identified with Fairchild potentiometers. A specially trained staff of engineers is at your service to consider problems of transducer design and manufacture to meet your specific requirements.



MINIATURE PRESSURE TRANSDUCERS

**Featuring Fairchild
accuracy and reliability**

The TP-200 illustrated is a new and smaller addition to the line of Fairchild Transducers. These components are now available in a wider range of resistances in either linear or functional, single or dual potentiometer output elements. Measuring only approximately 2" by 2", the TP-200 features a single pressure sensitive diaphragm element which actuates one or two precision potentiometers through dynamically-balanced, stable mechanical linkage. It features unitized construction for easy assembly, field calibration and repair. Variations of size, conformation, and pressure ranges for measurement of differential, absolute, or gauge pressures are available. For complete information write Fairchild Controls Corp., Components Division, Dept. 140-77 E.

EAST COAST
225 Park Avenue
Hicksville, L. I., N. Y.

WEST COAST
6111 E. Washington Blvd.
Los Angeles, Calif.



FAIRCHILD
PRECISION POTENTIOMETERS
and COMPONENTS

Electronic Industries' News Briefs

Capsule summaries of important happenings in affairs of equipment and component manufacturers

EAST

KAHLE ENGINEERING CO. announces the addition of a new plant on Hudson Avenue, Union City, N. J. The company's manufacturing shop area will be increased by over 100%.

SPEER CARBON CO., Saint Marys, Pa., has begun construction on a new research and development laboratory in Niagara Falls, N. Y. It is scheduled for completion in the fall of 1957.

REEVES INSTRUMENT CORP., a subsidiary of Dynamics Corp. of America, has installed equipment abroad the U.S.S. Gyatt, the U.S. Navy's Guided Missile Destroyer, which combines for the first time a gun-fire control system with radar guidance equipment.

SYLVANIA ELECTRIC PRODUCTS, INC., has completed transfer of its Radio and Television Div., headquarters from Buffalo to their modern 433,000 sq. ft. TV set plant at Batavia, N. Y.

RAYTHEON MFG. CO. has formed a new Electronics Laboratory at Maynard, Mass., with primary responsibility to design and develop airborne electronic equipment.

IBM CORP. has announced the control of its nation wide service bureau operations has been transferred to a wholly-owned subsidiary corporation to be known as the Service Bureau Corp.

NATIONAL BUREAU OF STANDARDS established the Dielectric Section, a new unit for fundamental investigations of the dielectric properties of matter. The new section will be headed by Dr. John D. Hoffman.

BRISTOL CO., Waterbury, Conn., has opened a new branch factory and warehouse at Houston, Texas—a move which reflects the shifting market for automatic controlling, recording, and telemetering instruments.

GENERAL ELECTRIC CO. will convert its 175,000 sq. ft. Buffalo, N. Y., picture tube plant to the manufacture of transistors early this year.

BRIDGEPORT THERMOSTAT DIV., ROBERTSHAW-FULTON CONTROLS CO., opened a modern \$2,000,000, 180,000 sq. ft. manufacturing plant on a 15-acre site in Milford, Conn. This more than doubles the size and output of the installation it replaces.

PENN-UNION ELECTRIC CORP., Erie, Pa., has started work on an enlarged test laboratory. Completion of the new laboratory is scheduled for this month.

NRC EQUIPMENT CORP. is the new name of the Equipment Div. of the National Research Corp., Newton Highlands, Mass. The change is consistent with the company's policy to decentralize the management of its operating subsidiaries.

DIKEWOOD CORP., a subsidiary of Radiation, Inc., of Melbourne and Orlando, Fla., was incorporated recently in Albuquerque, N. M. It will serve primarily as a consulting agency for the electronics industry, with major emphasis in the fields of guided missiles and avionics.

THE BART-MESSING CORP., Newark, N. J., and the **PENNSYLVANIA TRANSFORMER CO.**, Cannonburg, Pa., have formulated an agreement to work jointly on the design and insulation of SEL-REX germanium, silicon, and selenium rectifiers for large scale electrochemical and electrometallurgical applications.

ARMED SERVICES ELECTRO-STANDARDS AGENCY (ASESA) have located in the Watson area (building 2525) of Fort Monmouth, N. J. The mailing address of the agency remains unchanged.

RONETTE ACOUSTICAL CORP. has acquired the one story building at 190 Earle Avenue, Lynbrook, N. Y. The 10,000 sq. ft. plant is now being re-furnished with modern facilities.

SPERRY GYROSCOPE CO., a division of Sperry Rand Corp., has been awarded a \$6,471,402 Air Force contract for radar systems. The equipment, Sperry's APN-59 airborne radar systems, is believed to be the smallest and lightest for its size and range.

MEASUREMENTS CORP., Boonton, N. J., recently announced that all products of Linear Equipment Laboratories, a wholly-owned subsidiary will be marketed through the substantially larger sales organization of Measurements, Corp.

RADIATION, INC., has constructed a new instrument div. building near Orlando, Fla., adjacent to Pine Castle AFB. It will add 28,000 sq. ft. to company facilities.

GENERAL PRECISION LABORATORY, Pleasantville, N. Y., has been awarded a contract for nearly \$17,000,000 by the Air Materiel Command, Wright-Patterson AFB, Ohio. The contract calls for additional quantities of the GPL developed AN/APN-81 and AN/APN-80 Doppler navigation systems.

MID-WEST

MOTOROLA, INC., Chicago, has been awarded a \$1-million transistor development contract by the Signal Corps Supply Agency. Work on the new contract will be performed by the Semi-conductor Products Div. in Phoenix, Ariz.

COMMUNICATIONS ACCESSORIES CO., Hickman Mills, Mo., a suburb of Kansas City, will move to its newly completed structure in Lees Summit, Mo., this month. The company manufactures toroidal components.

BODINE ELECTRIC CO., Chicago, has opened a new factory located at 2500 West Bradley Place, Chicago. The new building has floor space of 148,000 sq. ft. and will permit the consolidation of all company manufacturing operations under one roof.

MAGNAVOX CO., GOVERNMENT AND INDUSTRIAL DIV., announces the awarding of additional contracts for the completion of the new Magnavox engineering and office building to be located in Urbana, Ill. Occupancy is expected in June of 1957.

THOMAS A. EDISON CO., INC., shareholders gave final approval to a plan to merge with McGraw Electric Co. of Elgin, Ill. The combined companies will be known as McGraw-Edison Co.

GODFREY MFG. CO. has been purchased by W. Stanton Martin. The physical assets have been moved to 1726 North Orchard St., Chicago 14, Ill.

BUSSEY RESEARCH LABORATORIES, INC., Rockford, Ill., has announced the expansion of facilities for serving manufacturers in the electrical, electronic, magnetics, and related fields. Their extensive equipment is placed at the disposal of organizations of all sizes.

WEST

GERTSCH PRODUCTS, INC., has announced the beginning of construction for their new 30,000 sq. ft. plant to be located 3211 S. La Cienega Blvd., Los Angeles, Calif. Occupancy is expected in May, 1957.

TEXAS INSTRUMENTS, INC., Dallas, has completed the installation of a new electronic computer. The high speed device contains some 3,000 semi-conductor diodes, 2,000 vacuum tubes and weighs 5300 pounds.

TRANSVAL ENGINEERING CORP., Culver City, Calif., has acquired exclusive manufacturing rights of the first cartridge-loaded magnetic-tape recorder for airborne installation from General Avionics, Inc., also of Culver City.

FEDERAL TELECOMMUNICATION LABS has established a branch Communications Laboratory at 809 San Antonio Road, Palo Alto, Calif. Director of the new laboratory is W. S. Chaskin, former manager of carrier development at Lenkurt Electric Co.

CBS-HYTRON announced the opening of a new sales office and warehouse at 102 West Roy Street, Seattle, Wash. It is under the direction of Mr. Leo McCabe.

ELECTROMATION CO., Santa Monica, announced the acquisition of the corporate structure of Hallen Corp., Burbank, said to have been the first U. S. firm to enter the magnetic film recording equipment field.

CONSOLIDATED ELECTRODYNAMICS CORP. directors have approved purchase of the major assets of R. A. Castell & Co., Glendale, Calif., electronic components manufacturer. The components firm has specialized in electronic sub-assembly work.

MAGNETIC AMPLIFIERS, INC., announces the formation of its new West Coast Div. located at 136 Washington Street, El Segundo, Calif. Engineering and production of magnetic and transistor servo amplifiers will be accomplished at the facility.

STANFORD RESEARCH INSTITUTE has transformed one of the rolling hills west of Palo Alto into an experimental radar station, with installation of a giant 61-ft. dia. antenna and 100-MC transmitter. The equipment is being used to gather data from meteor and auroral ionization of vhf & uhf and radio signals.

FOREIGN

MULLARD, LTD., are moving into their new headquarters at Mullard House, Torrington Place, London, W.C.1. The move will eventually bring all the departments under one roof.

LENKURT INTERNATIONAL CORP., a new subsidiary of Lenkurt Electric, San Carlos, Calif., has been chartered under the laws of Panama and will have its main office in Panama City.

NUCLEAR ENERGY PRODUCTS DIV., ACF INDUSTRIES, INC., and officials of the Italian Technical Delegation completed signing of a contract calling for installation of a 5,000 kw heavy water research reactor by 1958 as a main facility of the nuclear research center of Comitato Nazionale Ricerche Nucleari of Italy.

AIRCOM, INC., has opened new field engineering, sales & purchasing offices, devoted to the Microwave Div., at 1209 E. Grand Street, Elizabeth, N. J.

HOW TO ADD TO THE Saleability OF MANY ELECTRICAL PRODUCTS

- ... Instruments
- ... Appliances
- ... Small Motors
- ... Radio, TV,
Audio Equipment

TO ENGINEERS, Stackpole Slide Switches in more than a dozen inexpensive types offer many interesting design possibilities for improving product performance.

TO BUYERS of today's instruments and appliances, the convenience of unique and attractive modern switching arrangements exerts strong sales appeal that far exceeds the modest cost involved.

Stackpole Slide Switches cover the 1/2 to 3 ampere range. They vary from simple ON-OFF units to types that provide complicated inter-circuit switching in minimum space—often with less costly mountings than conventional switches. *Electronic Components Division, STACKPOLE CARBON COMPANY, St. Marys, Pa.*

STACKPOLE S - L - I - D - E SWITCHES

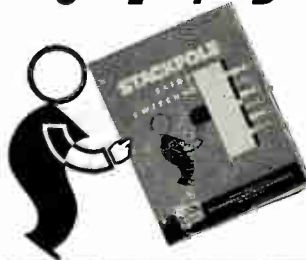

New SLIDE SWITCH DATA

Stackpole Bulletin RC-10D — just out — gives complete ratings, dimensions, modifications, and other specifications for all standard Stackpole Slide Switches. Write for your copy or see your local Stackpole representative

KEY TO CONTACT ARRANGEMENTS



POSITION 1

POSITION 2

POSITION 3

POSITION 4

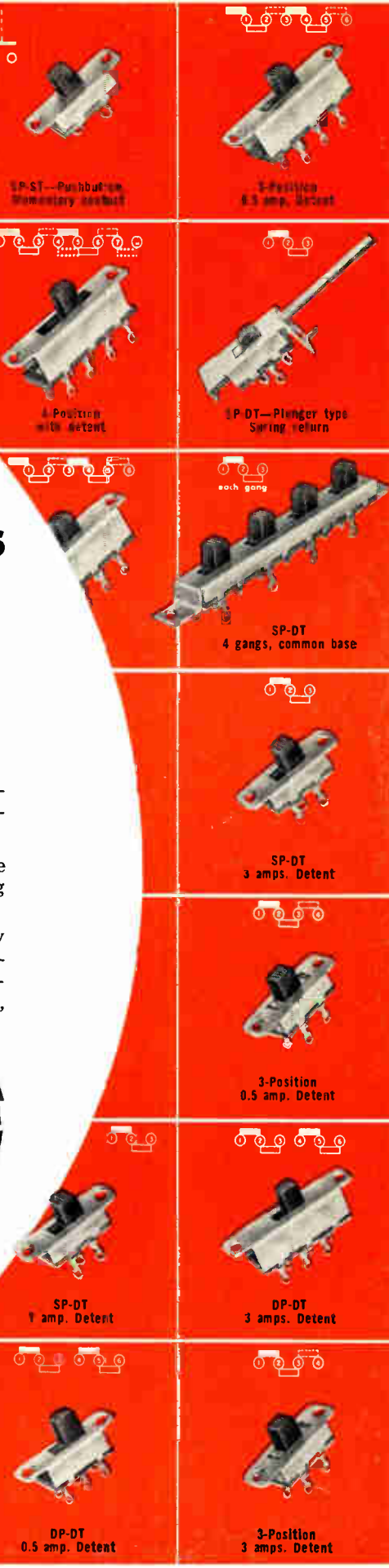

KLEINS

For Every Electrical Need

By using the plier exactly suited to the job, work improves and time is saved. There is a style and size of Klein Plier made to meet every need of linemen, electricians, good workmen everywhere.

The name Klein has stood for the finest pliers for a century... that's why Klein is the standard of comparison by which other pliers are judged. Be sure your order for pliers specifies Kleins.

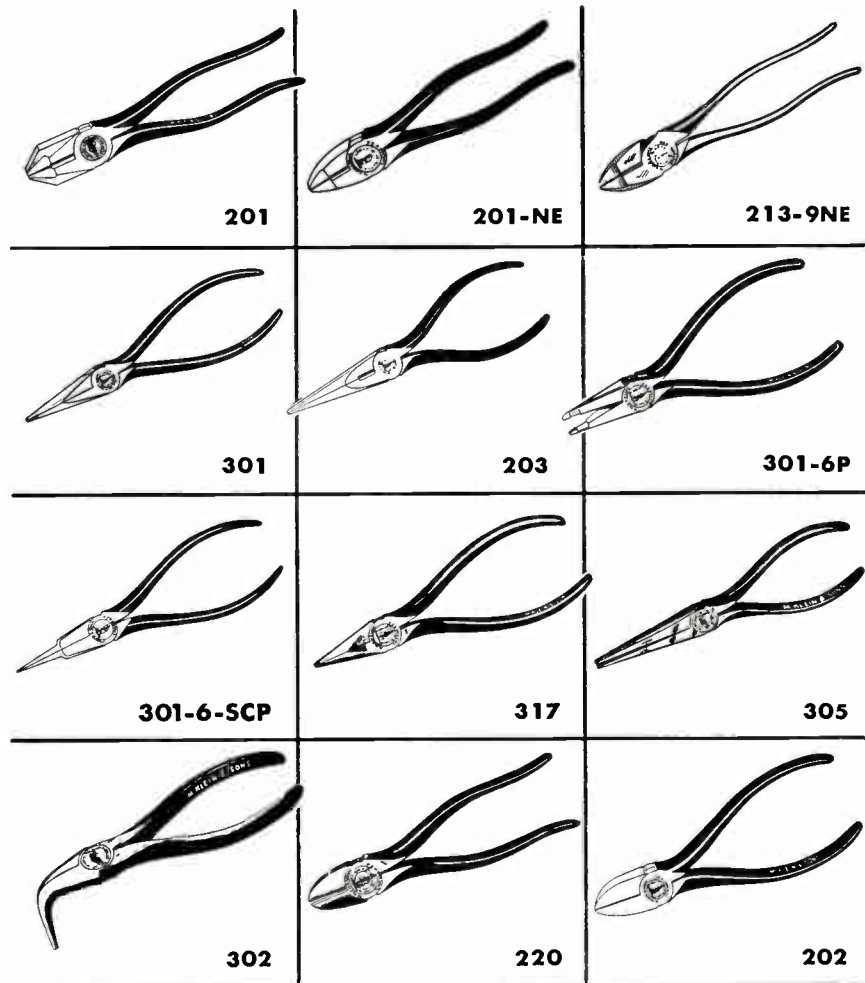

100 years of service to linemen, electricians and industry is back of this new Pocket Tool Guide No. 100. A copy will be sent to you upon request, without obligation.

NEW COIL SPRING PLIERS

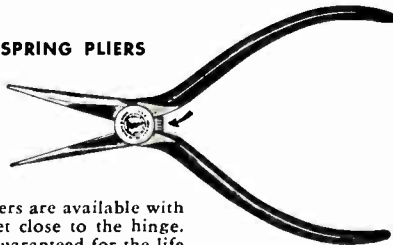

Many Klein Pliers are available with a coil spring set close to the hinge. The spring is guaranteed for the life of the plier. It always keeps the jaws in open position and frees the inside of the handles of any obstruction.

Ask your supplier

Foreign Distributor: International Standard Electric Corp., New York

Mathias **KLEIN** & Sons
 Established 1857 Chicago, Ill., U.S.A.
 7200 McCORMICK ROAD • CHICAGO 45, ILLINOIS



Industry News

James A. Finigan, Jr., has been named General Sales Manager for Electronic Sales for the Remington Rand Univac Div. of the Sperry Rand Corp.

Philip F. Weber to the post of Assistant to the President, Kollsman Instrument Corp.

Robert W. Pearson has been appointed to the newly created position of Deputy General Manager for Operations at AMF, Electronics Div.



R. W. Pearson



J. J. Dowling

Joseph J. Dowling to the post of President, Philadelphia Insulated Wire Co.

Meyer Leifer will now serve as Assistant Director of the Electronic Defense Laboratory of Sylvania Electric Products, Inc.

Richard W. Bellew has been named Director of Sales and Product Analysis of Eldico Electronics, a Division of Dynamics Corp. of America.

Peter R. Potter is now Defense Products Manager, a newly created position, of AMF.

Lorian W. Willey has been appointed Vice-President of Air Associates, Inc.

John Hessel has been named Chief of the Electronics Section, Production Div., NATO, by the State Department.

George C. Sziklai has assumed the duties of Technical Assistant to R. T. Orth, Vice President and General Manager of Westinghouse Electric Corp. Electronic Tube Div.

Joseph General was named head of the National Professional Group on Aeronautical and Navigational Electronics (IRE). Mr. General is Technical Director of the Directorate of Development (Headquarters, ARDC).

E. Weston Hammond is now District Manager of the Worthington Corp. Los Angeles District Office.

Robert B. Wright will now serve as Technical Personnel Director of the Government and Industrial Div. Magnavox Co.

Bryon C. Booth has been elected President of the George W. Borg Corp.

Guy Witter elected as a member of Board of Directors of Altec Companies, Inc.

Paul Stearns Ellison to the new position of Public Relations for Cook Electric Co.

(Continued on page 30)

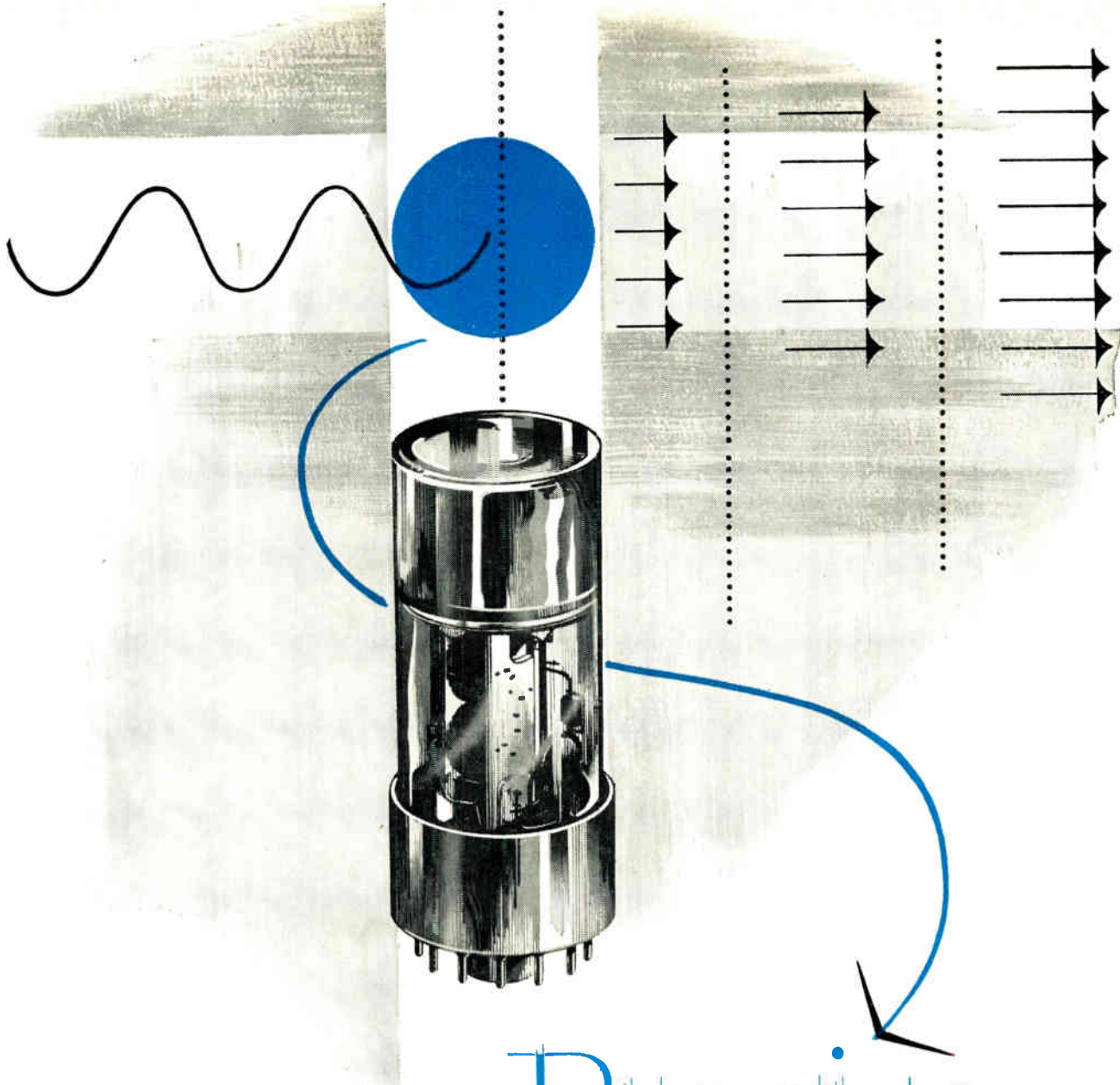

Precise

PHOTOELECTRONICS*

*The conversion of light input to highly magnified electrical output in a dependable, precise relationship.

Depend on Du Mont Multiplier Phototubes for precise quantitative and qualitative measurements. Available in a wide selection of sizes and electrical characteristics for every photoelectronic need.



16"
Type K1328



5"
Type 6364



3"
Type 6363



1 1/4"
Type 6467



2"
Type 6292



3/4"
Type 6365

DU MONT®

Industrial Tube Sales, ALLEN B. DU MONT LABORATORIES, INC. 2 Main Ave., Passaic, N. J.

BURTON BROWNE/New York



EXCLUSIVE WITH
FILTORS, INC.

ONLY PRECISION MACHINED ROTARY RELAY

NO STAMPED PARTS IN THE MOTOR. MACHINED PARTS—ONLY ONE OF THE ADDITIONAL QUALITY CONTROL STEPS TAKEN BY FILTORS IN THE MANUFACTURE OF HERMETICALLY SEALED SUB-MINIATURE RELAYS . . . YOUR ASSURANCE OF GREATEST RELIABILITY.

WRITE FOR CATALOG, FILTORS, INC., PORT WASHINGTON, LONG ISLAND, NEW YORK, PORT WASHINGTON 7-3850

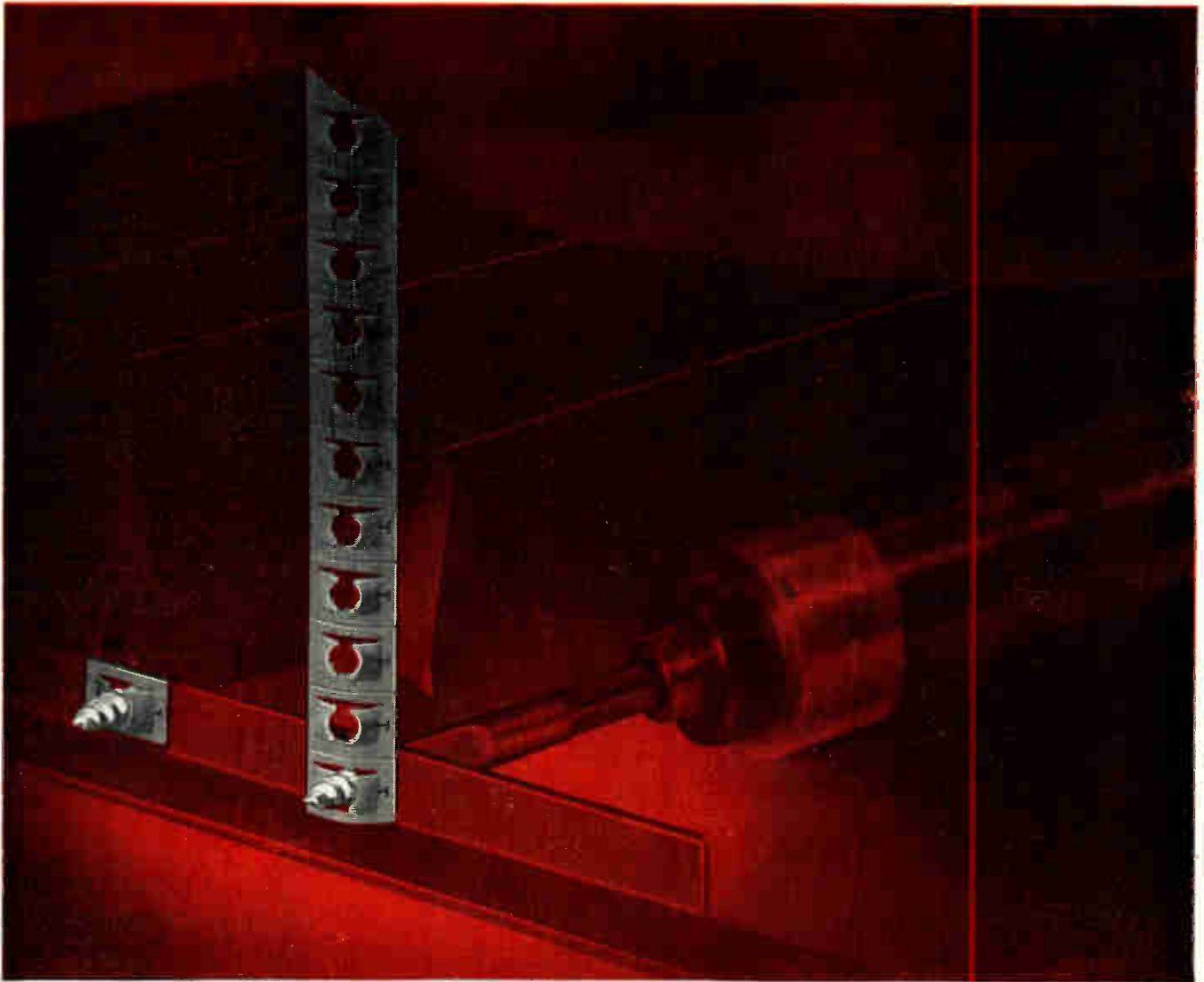

SPEED NUTS® WITH A HANDLE eliminate fastener fumbling!

Multiple-unit strips of Tinnerman Flat-Type SPEED NUTS permit cost-cutting, split-second fastening. That's how Reznor Mfg. Co., Mercer, Pa., saves up to 40% in the assembly of louvers for its Suspended Gas Unit Heaters!

With strip in hand, the operator drives a screw into the end SPEED NUT, easily snaps off the tightened fastener from the strip and quickly places the next SPEED NUT in screw-receiving position. No lost motion feeling or fumbling for single fasteners, spanner or lock washers. Louvers are securely fastened, and are easily adjusted to control air distribution.

This is an example of the versatility of SPEED NUTS. It is also an example of the assembly advantages of SPEED NUT brand fasteners. Over 8000 types give you an answer to almost every

fastening problem. See your Tinnerman representative or write for complete details.

TINNERMAN PRODUCTS, INC.
BOX 6688 • DEPT. 12 • CLEVELAND 1, OHIO

TINNERMAN

Speed Nuts®



FASTEST THING IN FASTENINGS®

Canada: Dominion Fasteners, Limited, Hamilton, Ontario. Great Britain: Simmonds Aerocessories, Limited, Treforest, Wales. France: Simmonds, S. A., 3 rue Salomon de Rothschild, Suresnes (Seine) Germany: Hans Sickingler GmbH "MECANO", Lemgo - i - Lippe.

Industry News

(Continued from page 26)

Fred C. Foy, President, Koppers Company, Inc., to the Board of Directors, of the H. K. Porter Co., Inc.

William E. Kress and John L. Utz to the newly created positions of Market Manager, Philco Corp.

Charles J. Jones has assumed the duties of Sales Manager of the Engineering and Optical Div. of the Perkin Elmer Corp.

John J. Kane is now Advertising and Sales Promotion Manager of the Philco Corp., Radio Div.

Henry E. Sanders has been appointed Sales Manager of Chicago Telephone Supply Corp.

Raymond L. Johnson to the position of Assistant Manager, Contracts Department, Teletronics Laboratory, Inc.

Dr. Benno Heinemann has become Chief Research Chemist for the ESC Corp., specialist in design and development of custom-built lumped and distributed constant delay lines.

Robert J. Sentenac (Glendale, Calif.) and H. E. Van Cleef, Jr. (Chicago) have become District Managers of the indicated offices for Thomas A. Edison, Inc.

Harry R. Clark has joined Westbury Electronics, Inc., as Assistant to the President and General Sales Manager.

G. R. Moore has been appointed Staff Vice President-Sales and Advertising for Thompson Products, Inc.

William L. Allen is now Industrial Sales Manager of Utah Radio Products Corp.

Maj. Gen. Samuel R. Brentnall, USAF (Ret) has been named Vice-President and Assistant General Manager, Military Electronics Div., Motorola, Inc.

Albert W. Ondis has been appointed Eastern Regional Manager for Brush Electronics Co.

Dr. Clarence Zener is now Director of the Westinghouse Research Laboratories at Pittsburgh, Pa.

G. W. Wallin has assumed the duties of President of the newly established Electronic Products Div. of Bell and Howell.

C. Wesley Carnahan to serve as Technical Assistant to H. Myril Stearns, Executive Vice-President and General Manager of Varian Associates.

John F. Hinchey is now Quality Assurance Manager for the Electro-Data Div. of Burroughs Corp.

Ralph Lehman appointed Manager of Aircraft Equipment Sales for the Federal Telephone and Radio Co.

Richard M. Osgood has been appointed Manager of the Waltham Laboratories of Sylvania Electric Products, Inc.

which
pilot
light
to specify?



here's a
quick, easy way
to find the
answer!

Save valuable specification time by selecting your panel indicators from Johnson's "preferred" line. This group contains over 47 separate assemblies carefully selected from Johnson's standard line by many of the nation's top design and development personnel. Available in a wide variety of types, these "preferred" units are immediately available at parts distributors throughout the country, for original equipment or in-the-field replacement. Write for your free copy of Johnson's newest pilot light specification catalog—see how easy it is to select the *right* pilot light . . . fast!

Available types include: continuous indication neon types; models for high and low voltage incandescent bulbs; standard or wide angle glass and lucite jewels in clear, red, green, amber, blue or opal. Specials, including those meeting military specifications are also available in production quantities.



free!
New pilot light catalog — contains complete specifications, prices and technical data . . . everything you need to select the proper unit for original equipment or in-the-field replacement.

E. F. Johnson Company

2208 SECOND AVENUE S. W. • WASECA, MINNESOTA

CODE MODULATED MULTIPLE-PULSE MICROWAVE SIGNAL GENERATOR

Model B 950-10,750 mc

Generates multi-pulse modulated carrier for beacons, missiles, radar... provides 5 independently adjustable pulse channels, 4 interchangeable r-f oscillator heads, precision oscilloscope, self-contained power supplies... all in one integrated mobile instrument.

The Polarad Model B is an essential instrument for testing beacons, missiles, radar, navigational systems such as DME, Tacan, H. F. Loran, etc., where multi-pulse modulated, microwave frequency energy with accurately controlled pulse width, delay, and repetition rate is required for coding.

A fully integrated self-contained equipment with these features:

Four Interchangeable Microwave Oscillator Units—all stored in the instrument... each with UNI-DIAL control... precision power monitor circuit to maintain 1 mw power output reference level... keying circuit to assure rapid rise time of modulated r-f output... non-contacting chokes.

Five Independently Adjustable Pulse Channels—each channel features variable pulse width and delay; has provisions for external pulse-time modulation.

Precision Oscilloscope with Built-In Wide Band RF Detector for viewing the modulation en-

velope and accurately calibrating the r-f pulse width, delay, and group repetition rate. Equipped with built-in calibration markers.

Self-Contained Power Supplies—Model B operates directly from an AC line through an internal voltage regulator. The coded multi-pulse generator is equipped with an electronically regulated low voltage DC supply. Klystron power unit adjusts to proper voltage automatically for each interchangeable band.

Contact your Polarad representative or write to the factory for detailed information.

SPECIFICATIONS:

Frequency Range:
 Band 1... 950 to 2400 mc
 Band 2... 2150 to 4600 mc
 Band 3... 4450 to 8000 mc
 Band 4... 7850 to 10,750 mc
Frequency Accuracy... $\pm 1\%$
RF Power Output... 1 milliwatt maximum (0 DBM)
Attenuator:
 Output Range... 0 to -127 DBM
 Output Accuracy... ± 2 db
 Output Impedance... 50 ohms nominal
RF Pulse Characteristics:
 a. Rise Time... Better than 0.1 microsecond as measured between 10 and 90% of maximum amplitude of the initial rise.
 b. Decay Time... Less than 0.1 microsecond as measured between 10 and 90% of maximum amplitude of the final decay.
 c. Overshoot... Less than 10% of maximum amplitude of the initial rise.

Internal Pulse Modulation:
 No. of Channels... 1 to 5 independently on or off
 Repetition Rate... 40 to 4000 pps
 Pulse Width... 0.2 to 2.0 microseconds
 Pulse Delay... 0 to 30 microseconds
 Accuracy of Pulse Setting... 0.1 microsecond
 Minimum Pulse Separation... 0.3 microsecond
 Initial Channel Delay... 2 microseconds from sync. pulse
 Internal Square Wave... 40-4000 pps (separate output)
Pulse Time Modulation:
 Frequency... 40-400 cps any or all channels
 Required Ext. Mod... 1 volt rms min.
 Maximum deviation... ± 0.5 microsecond
Power Input (built-in power supply) 105/125 v. 60 cps 1200 watts.

Variable width—width of each of 5 pulses can be adjusted independently.

Variable delay—delay between each of 5 pulses can be adjusted independently.



CODE MODULATED MULTIPLE-PULSE
MICROWAVE SIGNAL GENERATOR
Model B

Pulse-time modulation—input provided in each of 5 pulse channels for external pulse-time modulation.

Variable repetition rate—repetition rate of each group of pulses can be varied.

AVAILABLE ON EQUIPMENT LEASE PLAN

FIELD MAINTENANCE SERVICE AVAILABLE THROUGHOUT THE COUNTRY



POLARAD ELECTRONICS CORPORATION 43-20 34th STREET, LONG ISLAND CITY 1, N. Y.

REPRESENTATIVES: Albuquerque, Atlanta, Baltimore, Boston, Buffalo, Chicago, Cleveland, Dayton, Denver, Fort Worth, Kansas City, Los Angeles, New York, Philadelphia, Portland, St. Louis, San Francisco, Schenectady, Syracuse, Washington, D. C., Winston-Salem, Canada; Arnprior, Ontario. Resident Representatives in Principal Foreign Cities

"DAD, WHAT'S
'OLD PRO'
MEAN?"



KESTER FLUX-CORE SOLDER

Leave it to a child to get to the heart of the matter quickly. No gobbledygook or double-talk is going to turn him aside from his single-minded objective.

It's like that with solder. No meager test dependent upon a "sample" or even a "one-line operational test" is going to prove conclusively the merits of a "Johnny-come-lately" solder from

that second source of supply. The wise buyer knows that the solder used on his production line must do the job he requires day-in and day-out without question.

• And KESTER SOLDER has been time-tested and industry-proved for over 50 years.

That's what we mean by "old pro," Sonny!

SEND TODAY for your copy of the 78-page Kester textbook, "Solder ... Its Fundamentals and Usage." It's free!

KESTER SOLDER

Company

4210 Wrightwood Avenue, Chicago 39, Illinois

Newark 5, New Jersey • Brantford, Canada

NEW Militarized Variac

20 Ampere

for 350 to 1200 cycle service

Manufactured to conform with rigid military specifications for shock, vibration, salt spray and tropicalization, including:

- High and low temperature lubrication (mil grease)
- Iridite treated aluminum parts
- Fungicidal treatment of all phenolic parts
- NEW, nickel-plated brush holder

Operates at any frequency between 350 and 1200 cycles.

New brush assembly removable radially for easier accessibility; has low sprung weight, coil springs, pigtails to carry current, improved heat transfer to radiator, limited travel.

As in other "M" high-frequency VARIACS, the M20 Series features stamped base and radiator for improved shock resistance and protection; improved heat transfer between coil and base for cooler operation.



Type M20 VARIAC

Specifications

type M20 Variac

Input Voltage:	115 volts, 350 to 1200 cycles
Load Rating (kva)	3.0
Output Voltage	0-115 or 0-135
Rated Current (amp)	20.0
Maximum Current (amp)*	26.0
No-Load Loss at 400 c. (watts)	27
Dial Calibration	0-115 and 0-135
Angle of Rotation (deg)	319
No. Turns on Winding	169
D-C Resistance, 20°C.	0.153 ohm
Driving Torque (oz.-in.)	30-60
Replacement Brushes	VBT-8 \$2.00
Net Weight (lbs.)	13
Code Word	CAVIL
Price	\$48.00
Ball Bearings (surcharge)	8.00 (add "BB" to Type No.)

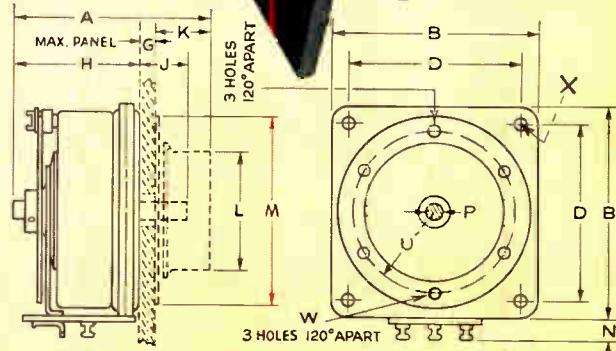

	A	B	D	G	H	J	K	L	M	N	P	R	S	T	U	W	X
M20	5 1/16	7 1/2	6 1/4	1/2	3 9/16	1 1/2	1 5/8	4 1/2	7	3 1/2	1 1/2	5 3/8	#31	5 3/8	3	4 28	3 3/8

*For 0 to line-voltage output connection only

type M20 Variac® Assemblies for 350 to 1200-Cycle Service

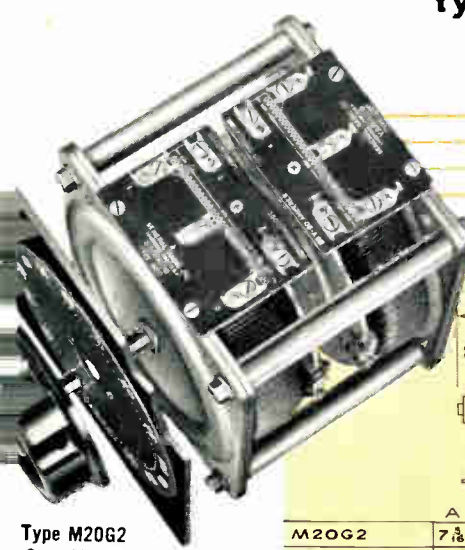

Type M20G2 2-Gang VARIAC

	2-Gang M20G2 Uncased	3-Gang M20G3 Uncased
Dial Calibration	0-10	0-10
Driving Torque (oz.-in.)	60-120	90-180
Net Weight (lbs.)	26 1/2	38 1/2
Code Word	CAVILGANDU	CAVILGANTY
Price	\$107.00	\$155.00
Ball Bearings (surcharge)*	\$ 10.00	\$ 12.00

*Add suffix "BB" to Type Number

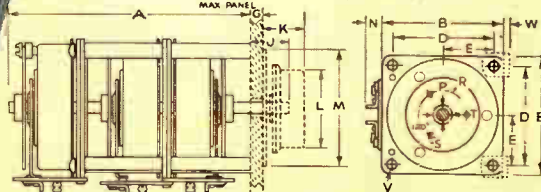

	A	B	D	E	G	J	K	L	M	N	P	R	S	T	V	W
M20G2	7 3/8	7 1/2	6 1/4	3 3/8	1 1/2	1 1/8	4 1/2	7	3 1/2	1 1/2	5 3/8	#31	5 3/8	3	4 28	3 3/8
M20G3	10 1/2	7 1/2	6 1/4	3 3/8	1 1/2	1 1/8	4 1/2	7	3 1/2	1 1/2	5 3/8	#31	5 3/8	3	4 28	3 3/8

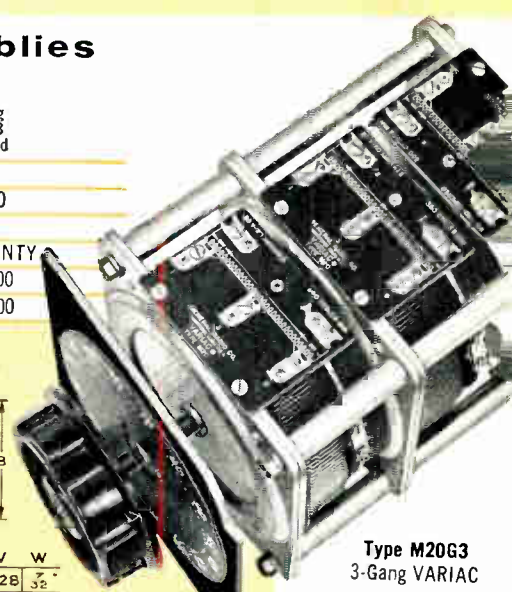

Type M20G3 3-Gang VARIAC

GENERAL RADIO Company

275 Massachusetts Avenue, Cambridge 39, Mass., U.S.A.



WE SELL DIRECT
Prices are net, FOB Cambridge or West Concord, Mass.

Broad Avenue at Linden, Ridgfield, N. J. NEW YORK AREA 920 S. Michigan Ave. CHICAGO 5

1150 York Road, Abington, Pa. PHILADELPHIA

8055 13th St. Silver Spring, Md. WASHINGTON D. C. 1000 N. Seward St. LOS ANGELES 38

IMC...DYNAMOTORS for MISSILES and TELEMETERING

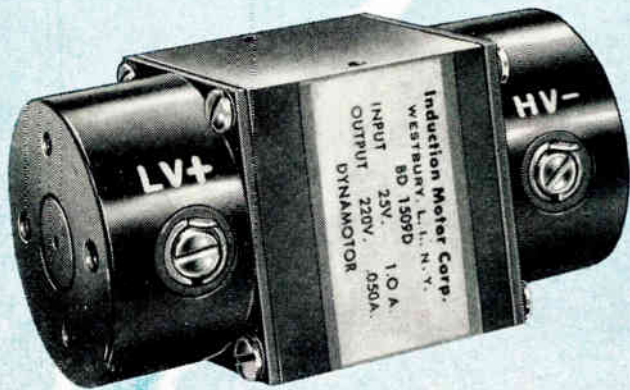

Induction Motors Corp. has developed another new dynamotor series to meet increasingly critical missile and telemetering requirements. The 1500 Frame DC series is designed for applications where light weight, compactness, high reliability and exceptional resistance to vibration and shock are essential.

The BD 1509D shown meets military specifications with regard to resistance to corrosion, salt spray, sand and dust, and other environmental influences.

SPECIFICATIONS • BD1509D

SIZE: 1½" x 1½" x 3".

POWER OUTPUT: 10 w continuous; up to 25 w, depending on duty cycle and cooling.

WEIGHT: 1 lb.

LIFE: 100 hrs. brush life at 50,000 ft.

AMBIENT TEMPERATURE RANGE: -40°C to + 71°C standard.

VIBRATION: 3 g's from 5-600 cps along 3 mutually-perpendicular axes.

CENTRIFUGE: 30 g's in any direction.

MECHANICAL SHOCK: 40 g's in any direction.

Other units in the new 1500 Frame DC series are available in varying voltage outputs to meet a wide range of humidity, temperature, vibration or altitude requirements. Motor design and application consulting service available on request.

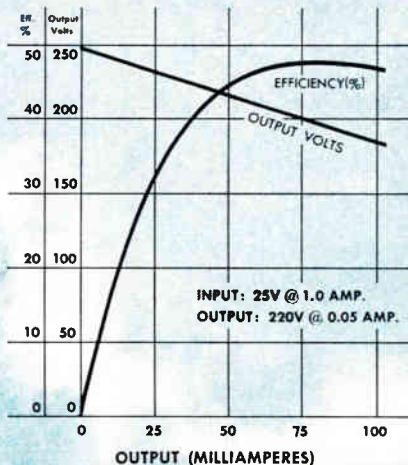

Induction Motors Corp.

570 Main St., Westbury, L. I., N. Y.

Phone EDgewood 4-7070

U.S. LEADS in the number of TV sets, with 39 million, or nearly 80% of the world's total. Other leading countries are England, with 6 million sets, Canada with 2.2 million, Russia one million, West Germany 500,000, France 360,000 and Italy 300,000.

RELIABILITY means all things to all men. In guided missiles they are now talking of a reliability factor of 4999 in 5000. Comparatively speaking, this would mean driving the family car for 14 years without a single flat tire or any other failure.

ENGINEERS and scientists are turning out approximately 60,-000,000 pages of scientific information each year, it was reported at a recent meeting of the Assoc. of Technical Writers and the Society of Technical Writers. Only 1/10,000th of this information is passed on to the man in the street, because of the lack of common bases of understanding.

THE RUSSIANS may denounce capitalism but they apparently have no objection to the products of the West's economic system. At an electronics exhibit in Toronto Soviet Fisheries Minister A. A. Ishkov stepped up to the Canadian Admiral booth and asked the attendant to have one of the new 10-in. portable sets shipped to him at the Kremlin. He was regretfully informed that the differences in voltages and scanning systems made it impossible for him to use the set in Russia.

HI-FI has hit the younger set. One 9-yr. old contestant on a recent TV quiz show requested a high fidelity loudspeaker for each room of her 7 room house. Her parents selected seven University high fidelity loudspeaker systems.

OFFICE OF STRATEGIC INFORMATION estimates that the USSR and its satellites are spending at least \$100,000 per month in the acquisition of published technical know-how from the U.S. One Communist agent alone requested 10,000 items from just one Government source.

(Continued on page 36)

HOW LONG WILL THEY LAST?

COME BACK IN 1971

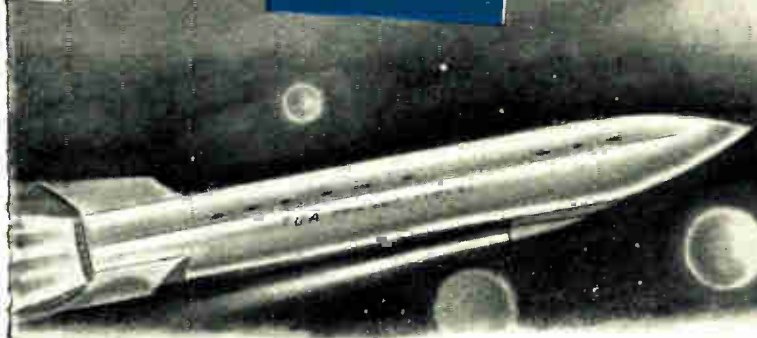
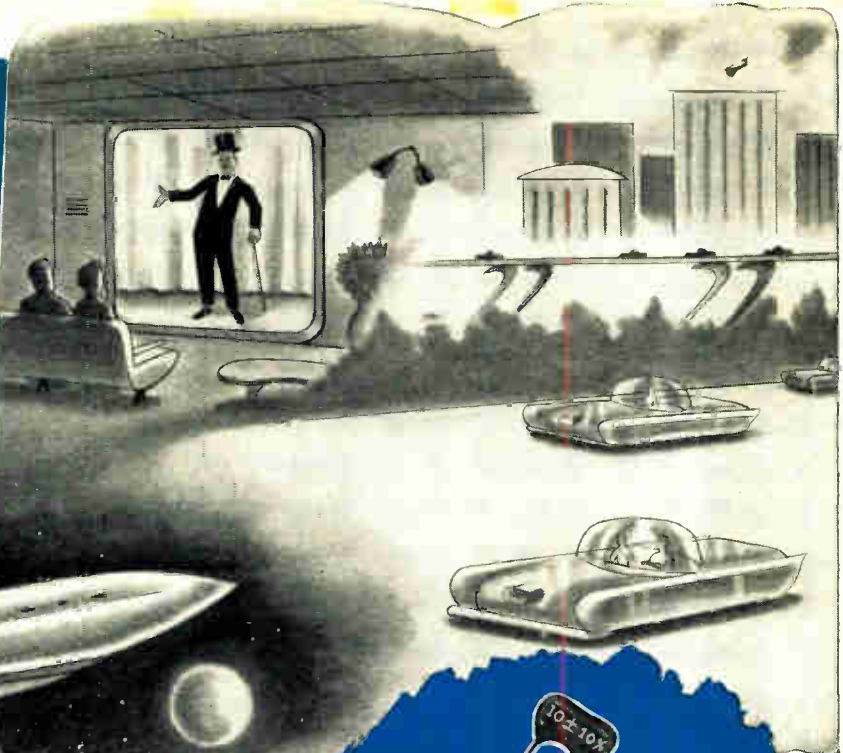

These *EL-MENCO* Dur-Mica Capacitors will still be on the job!

In rigid life tests in which the applied voltage was 1 1/2 times rated voltage and the ambient temperature was 125° centigrade, El-Menco DM-15, DM-20 and DM-30 capacitors out-distanced all normal ratings with each lasting over 10,000 hours. Because of the acceleration of these tests, the life of these capacitors may be equivalent to 15 years or more under normal operating conditions.

New, toughened phenolic casing prolongs life, increases stability over wide temperature range. Made to meet environmental and electrical requirements of RETMA and MIL-C-5 specs. Parallel leads simplify use in television, computers, miniature printed circuits, guided missiles, and countless civilian and military applications.

El-Menco Dur-Mica DM15, DM20, and DM30 Capacitors Assure:

- 1. Longer Life
- 2. Potent Power
- 3. Smaller Size
- 4. Excellent Stability — Silvered Mica
- 5. Peak Performance

We'll be glad to advise you on your specific needs. Put El-Menco Dur-Mica Capacitors to your own tests. See for yourself.



FOR PRINTED CIRCUITS — DM 15 and DM 20 WITH CRIMPED LEADS. Crimped leads specially designed for printed circuits . . . Available for immediate delivery. And lead lengths cut to your specifications.

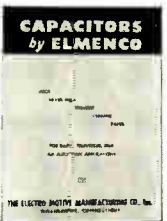

Write for free samples and catalog on your firm's letterhead.



THE ELECTRO-MOTIVE MFG. CO., INC.

WILLIMANTIC, CONNECTICUT

- molded mica • mica trimmer
- tubular paper • ceramic

Arco Electronics, Inc., 64 White St., New York 13, N. Y.
Exclusive Supplier To Jobbers and Distributors in the U.S. and Canada

Tele-Tips

(Continued from page 34)

PHONE INDUSTRY reports the installation of 3 million additional phones bringing the national total to 58 million phones, or 1 for every 3 persons in the U. S.

RUSSIAN - DESIGN electronic computer that does "automatic translation" of texts from English into Russian has been developed at the Academy of Sciences USSR.

ELECTRONIC fuel injection system developed by Bendix will be first introduced on the Rambler Rebel hardtop next spring.

BROADCAST STATIONS are not turning up the gain for commercials, reports the FCC. A survey conducted to satisfy a number of complaint from the public revealed that in only 1 case out of 659 radio and TV stations checked was there overmodulation exclusively during commercials. In 14 cases there was volume-boosting during both programs and commercials. There were 15 cases of undermodulation, four of them in the midst of commercials.

ENGINEER TRAINING centers have been set up in N. Y., Chicago and Winston-Salem, N. C. by Western Electric to keep their engineers abreast of latest developments.

TV SALES COMPETITION is becoming so stiff that TV manufacturers are resorting to bonuses to break down saales resistance. Latest is Sylvania's offer of a \$65 wrist watch with purchase of each TV set.

THE FCC now has 18 monitoring stations. Last year the Commission detected and closed nearly 150 cases of illegal radio operation, gave assistance to more than 100 ships and planes in distress, and took more than 100,000 bearings for different purposes. Through 24 district offices, the Commission made more than 10,000 inspections of radio stations of all types, investigated more than 11,000 cases of serious interference, gave over 52,000 amateur operator examinations and issued over 200,000 commercial operator permits.



BOURNS TRIMPOT®

MODEL 230 HUMIDITY-PROOF

Guaranteed to meet MIL Specs

This completely sealed TRIMPot is manufactured and tested to meet Military Humidity Specification MIL-E-5272A (10 days).

Model 230 features a power rating of 0.4 watt at 50°C and a maximum operating temperature of 135°C. It is available from stock in standard resistance values from 10 ohms to 20,000 ohms.

In addition to reliable performance under severe humidity and salt spray conditions, this instrument will maintain accurate settings during extreme vibration, acceleration and shock encountered in aircraft and missiles.

Each TRIMPot is individually inspected for compliance to guaranteed specifications, and is subjected to rigid quality control sampling tests to verify conformance to all specifications. 25-turn screwdriver adjustment, self-locking shaft, space-saving rectangular configuration and subminiature size are features also found in other Bourns TRIMPots. (Size: $\frac{3}{16}$ x $\frac{3}{8}$ x $1\frac{1}{2}$).

Send for catalog sheet 230.



BOURNS LABORATORIES, INC.

General Offices: 6135 Magnolia Ave., Riverside, Calif.
Plants: Riverside, California — Ames, Iowa

COPR. BL

TRIMPOTS • LINEAR MOTION POTENTIOMETERS • PRESSURE TRANSDUCERS AND ACCELEROMETERS

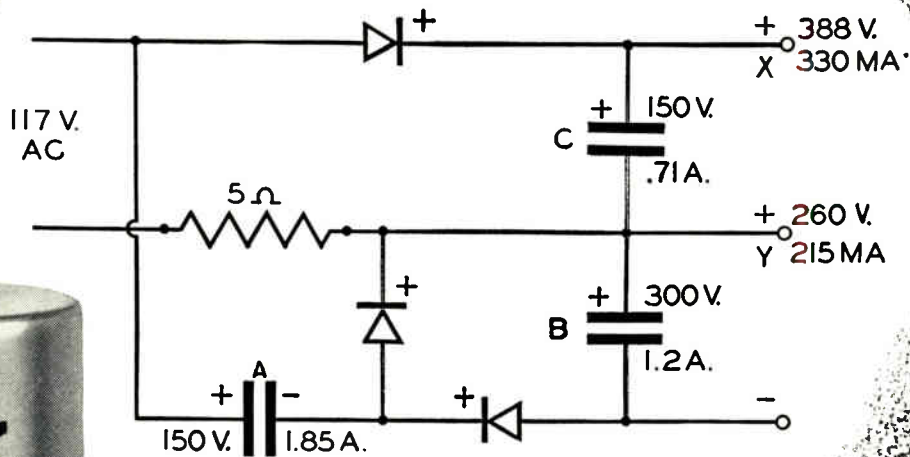
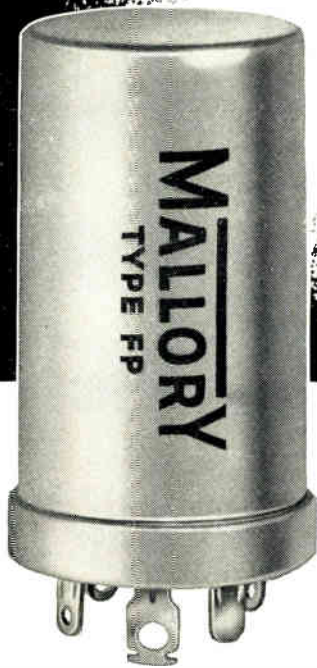

Solve the Voltage Tripler Ripple Current Problem with Mallory FP Capacitors

In the voltage tripler circuit above, the capacitor must handle extremely high ripple currents—and at 60 cycles.

For instance the ripple current in—

Capacitor A is $3\frac{1}{2}$ times the total load current

Capacitor B is $2\frac{1}{4}$ times the total load current

Capacitor C is $1\frac{1}{3}$ times the load at "X"

These ratios are approximate but give some idea for rule of thumb use when selecting capacitor ratings in voltage tripler circuits.

Remember also that silicon rectifiers produce different conditions than those encountered with sele-

num rectifiers. They are tougher on the capacitors. Large values of capacity are needed to handle such ripple currents and engineering attention is needed here if good field performance is to be expected.

The unique ability of Mallory FP Capacitors to handle these severe ripple current values, even at 85°C ambient temperatures, is due to the use of fabricated anode construction.

If you do not have a copy of the new Mallory FP Technical Information Bulletin showing revised ripple current values—write for a copy—or better still let us help you in the initial design by asking for our engineering service.

Expect more . . . get more from



Serving Industry with These Products:
Electromechanical — Resistors • Switches • Tuning Devices • Vibrators
Electrochemical — Capacitors • Mercury and Zinc-Carbon Batteries
Metallurgical — Contacts • Special Metals • Welding Materials

Parts distributors in all major cities stock Mallory standard components for your convenience.

ANNOUNCING THE 104 MEMO-SCOPE

The MEMO-SCOPE Model 104 is a new memory oscilloscope with a selection of 5 plug-in preamplifiers that will satisfy the most critical production, test and laboratory requirements. MEMO-SCOPE incorporates the famous Hughes-developed Memotron direct-display storage tube that captures and retains any number of traces indefinitely at a constant intensity until intentionally erased. Traces are readily visible in a brightly-lighted room, and may be easily photographed for file records.

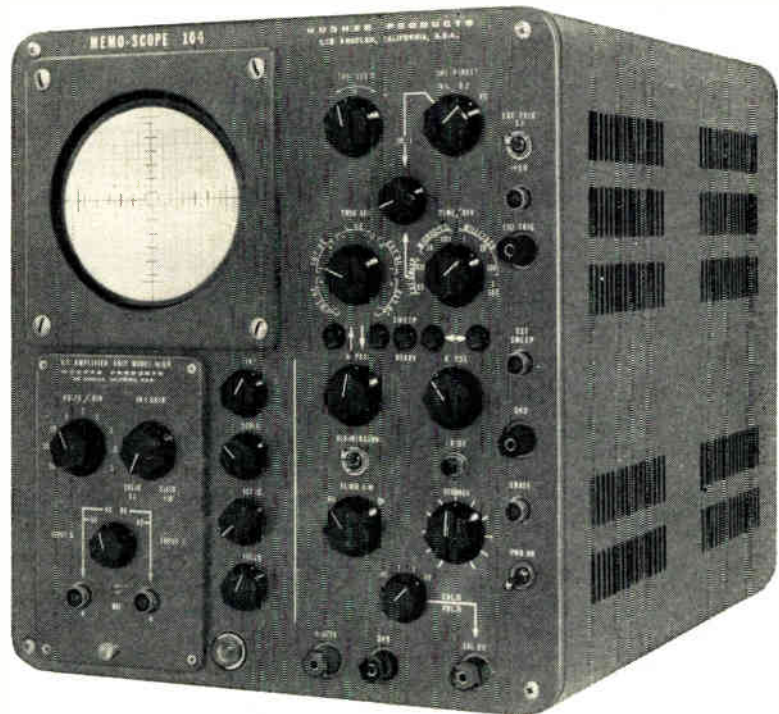

MEMO-SCOPE 104 SPECIFICATIONS

ERASURE: internal waveform generator triggered by front panel push button or by external switch.

DC BLANKING: CRT grid direct coupled to external or internal blanking gate allows beam to be turned off except during sweep and insures constant sweep-time intensity over any sweep duration.

DEFLECTION PLATES: available at rear terminal strip for direct connection.

MAIN VERTICAL DEFLECTION AMPLIFIER: frequency response of DC to 700 kilocycles within 3db. Rise Time of $1/2$ microsecond.

TRIGGERED LINEAR SWEEP: range of 10 μ sec to 10 seconds per division, adjustable continuously or in 18 calibrated steps. Trigger: vertical amplifier signal, AC line or external pulse, either polarity, DC or AC coupled. Minimum external trigger amplitude: 0.1 volt. Neon ready lamp indicates sweep is at left side of screen, ready for trigger.

AMPLITUDE CALIBRATOR: available at front panel terminal—one kilocycle square wave with peak-to-peak amplitude of 0.01, 0.1, 1.0 or 10 volts, within 3%.

BEAM POSITION INDICATORS are four neon lamps showing position of writing beam when not on screen.

ILLUMINATED GRATICULE: scale calibrated in $1/3$ " squares in 10×10 array.

RACK MOUNTING: Model 104 available on standard $14" \times 19"$ relay rack panel.

DIMENSIONS: 13" wide, 14" high, 20" deep. Etched circuit epon-glass electrical chassis. Hinged camera mount optional.

OPTIONAL PLUG-IN PREAMPLIFIERS INCREASE FLEXIBILITY

(All units with frequency response from DC to 250 kilocycles down 3db.)

WB/4. Wide Band, DC.

WB/SE/5. Wide Band, DC plus Speed Enhancement.

HS/6. High Sensitivity—1mv/division differential.

HS/SE/7. High Writing Speed, High Sensitivity.

HS/D1/10. High Sensitivity, Dual Input.

For additional information or demonstration of the new Model 104 write to HUGHES PRODUCTS
ELECTRON TUBES
International Airport Station
Los Angeles 45, California

HUGHES PRODUCTS

© 1957. HUGHES AIRCRAFT COMPANY



recording the "man-made moon" on extra-precision audiotape*

EARLY in 1958 there will be a "new moon" in the sky — a 22-inch sphere circling the earth at a speed of 18,000 mph. Unlike our real moon, this one will be able to "talk" to Earth. And engineers from Army Ordnance Ballistic Research Laboratories at Aberdeen Proving Ground, Maryland will study these messages to learn new facts about our solar system.

This "moon-talk" — radio signals emanating from precision instruments inside the satellite — is so vital that it will be tape recorded for later analysis, interpretation and preservation.

The highest standards of reproduction must be met. There can be no distortion, voids, or other imperfections.

The tape chosen was extra-precision Type EP Audiotape.

The highest professional standards of quality and uniformity extend throughout the *entire Audiotape line*,

making it the best selection for *any* recording application.

Whether you are an engineer recording highly technical information or a neophyte placing his first reel on a tape recorder, Audiotape will speak for itself. It is now available in *five different types* to meet every recording need and every tape budget. *trademark

For complete information on the earth satellite recording project write us for a free copy of the December issue of Audio Record.

AUDIO DEVICES, Inc.

444 Madison Avenue, New York 22, N.Y.

Offices in Hollywood — Chicago

Export Dept., 13 E. 40th St., New York, N.Y.

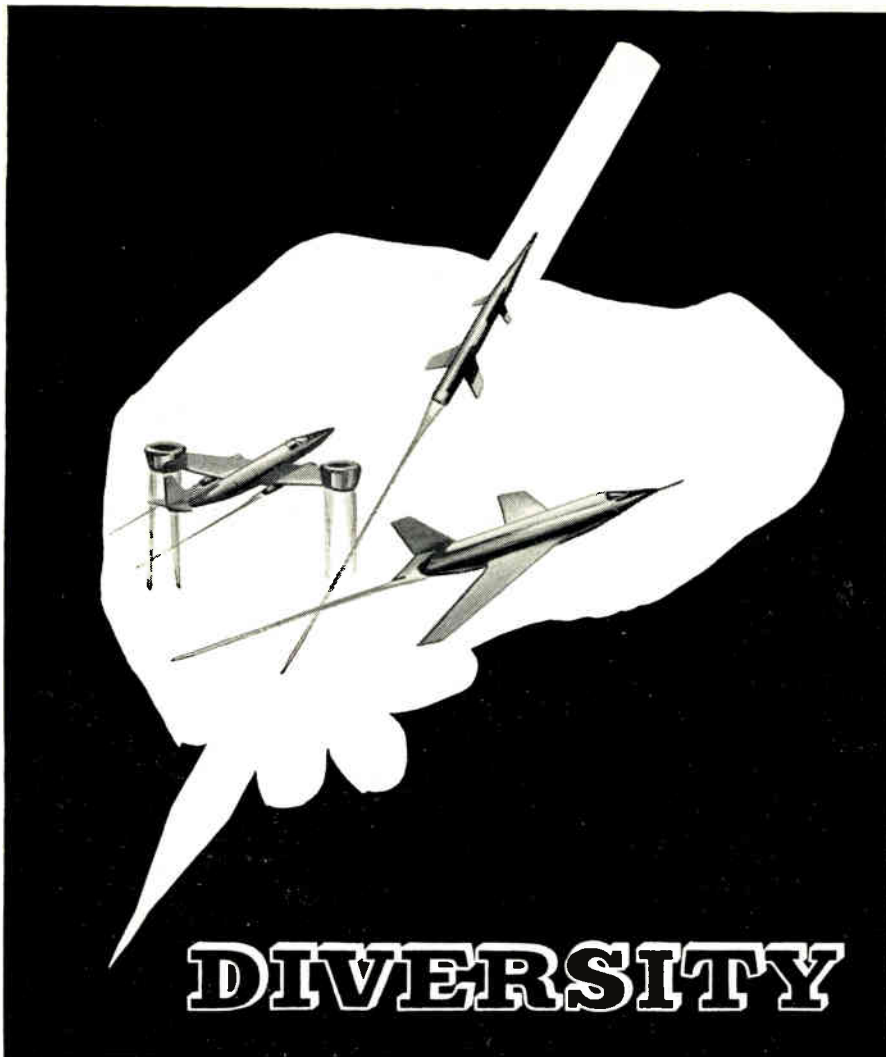

BUILDS JOB INTEREST at **BELL**

Bell's activities are widely diversified—experimental and vertical rising aircraft, rockets and rocket engines, missiles and guidance systems, electronics, servomechanisms and nucleonics to name only a few. Such diversity means broad fields of interest for engineers and technical personnel—insurance against boredom and assignments too limited in scope to let you go as fast and as far as you are capable.

Bell is progressing, growing and expanding. There are openings at all levels and in all fields as listed at the right. If you are looking for a move that offers every opportunity for a permanent career with professional growth and recognition and capable, congenial associates, contact Bell.

Write: Manager, Engineering Personnel,
Dept. R, BELL AIRCRAFT CORPORATION, P. O. Box One,
Buffalo 5, New York.



- Aerodynamicists
- Aeronautical Engineers
- Automatic Control Designers
- Chemical Engineers
- Combustion Research Engineers
- Communications Engineers
- Design Checkers
- Development Engineers
- Digital Computer Development Engrs.
- Dynamic Engineers
- Electronic Engineers
- Electronic Standards Engineers
- Engineering Computers
- Environmental Specialists
- Field Test Engineers
- Flight Test Engineers
- Flight Test Programmers
- Fuel Injection Specialists
- Gear Designers
- Guidance Engineers
- Gyro Specialists
- Heat Transfer Engineers
- Hydraulic Engineers
- IBM Programmers
- Instrumentation Specialists
- Laboratory Test Engineers
- Magnetic Amplifier Specialists
- Mathematical Analysts
- Mechanical Engineers
- Microwave Engineers
- Miniturization Engineers
- Operations Analysts
- Physicists
- Power Plant Designers
- Pressure Vessel Designers
- Project Engineers
- Publication Engineers
- Radar Systems Engineers
- Rocket Test Engineers
- Servo Systems Engineers
- Servo Valve Engineers
- Statisticians
- Stress Engineers
- Structures Engineers
- Specification Writers
- Technical Writers
- Test Equipment Engineers
- Transformer Design Specialists
- Transistor Application Engineers
- Thermodynamic Engineers
- Telemetering Engineers
- Turbine Pump Designers
- Vibration & Flutter Analysts
- Weapons Systems Engineers
- Wave Guide Development Engineers
- Weights Engineers





*Make the
right move...*

check the many advantages of

ALSiMAG[®] Alumina Ceramics

Industry-approved ALSiMag Aluminas are doing an outstanding job in more and more exacting applications calling for **superior electrical characteristics** at high temperatures and frequencies . . . **rugged** resistance to mechanical shock and vibration . . . **chemical inertness** . . . **resistance to repeated hot-cold shock**. ALSiMag Alumina ceramics are **hard**, measuring 9 on Mohs' scale . . . **strong**, offering extremely high compressive, flexural and tensile strengths. **Precision tolerances** can be maintained. Can be supplied in any quantity.



Write for free copy of Bulletin No. 562 which gives complete details on the most popular of the wide range of special-characteristic ALSiMag Aluminas available.

AMERICAN LAVA

A Subsidiary of
Minnesota Mining and
Manufacturing Company



CORPORATION
CHATTANOOGA 5, TENN.
55TH YEAR OF CERAMIC LEADERSHIP

For service, contact Minnesota Mining & Manufacturing Co. Offices in these cities (see your local telephone directory): Atlanta, Ga. • Boston: Newton Center, Mass. • Buffalo, N. Y. • Chicago, Ill. • Cincinnati, O. • Cleveland, O. • Dallas, Texas • Detroit, Mich. • High Point, N. C. • Los Angeles, Calif. • New York: Ridgefield, N. J. • Philadelphia, Pa. • Pittsburgh, Pa. • St. Louis, Mo. • St. Paul, Minn. • So. San Francisco, Calif. • Seattle, Wash. **Canada:** Minnesota Mining & Manufacturing of Canada, Ltd., P. O. Box 757, London, Ont. All other export: Minnesota Mining & Manufacturing Co., International Division, 99 Park Ave., New York, N. Y.

Minneapolis-Honeywell finds.....



At Minneapolis-Honeywell, ReaPak Pails — holding 100 pounds of continuous length wire — replace the conventional spools holding only ten to fifteen pounds.

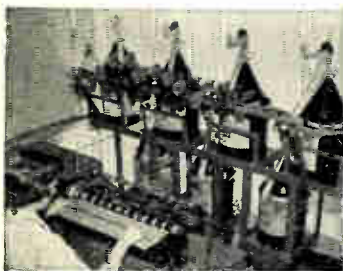

ReaPak is fully adaptable to multiple winding in your plant.



ReaPak is adaptable to single head winding.



ReaPak can be palatized. Another way ReaPak can save you storage space, handling time and cost.



ReaPak can replace 8 to 50 reels or spools. This means faster reloading, less down time.

REAPAK SAVES YOU MONEY

If you wind coils of any type, or are a user of magnet wire of any size from AWG 10 to 30, you will find that ReaPak can help you reduce your costs of production in many ways.

ReaPak gives you up to 500 pounds of continuous length wire. That means you will have less machine down time for re-loading. What's more, because ReaPak gives you longer continuous lengths of usable wire, you'll have fewer "unused ends!"

You can order ReaPak in your choice of insulations. Wire sizes: AWG 10 to 30.

ReaPak containers also give excellent protection during storage, shipping and handling. No small spools for operators to drop and damage.

If you use magnet wire, ReaPak can fit your operation! For complete information, including prices and engineering data, mail coupon or use reader service card number

REAPAK[®] cuts reloading time by 90%

Using REAPAK... the magnet wire that comes in pails...
the world's largest Automatic Control Manufacturer:

- INCREASED COIL PRODUCTION 18%
- SAVED \$19,000 PER YEAR ON WIRE COSTS
- VIRTUALLY ELIMINATED END-OF-SPOOL WIRE WASTE
- CUT RELOADING TIME PER DAY FROM 1½ HOURS TO LESS THAN 10 MINUTES

Minneapolis-Honeywell uses two and one-half tons of wire daily in winding its precision electrical coils for relays, transformers, motors, thermostats and other electrical devices. Before ReaPak, operators handled sixty to seventy spools of wire (each weighing from five to fifteen pounds) every day. Time lost in reloading: 1½ hours daily per operator.

By switching to ReaPak (a continuous length of magnet wire, packaged in pails for high speed dereeling) Minneapolis-Honeywell cut the daily down time needed for reloading and adjustment of wire tension to less than ten minutes.

Wire waste was cut, too. Operators using ReaPak waste less than five feet of wire per pail. This, and other savings made possible by the ReaPak method, enable Minneapolis-Honeywell to save \$19,000 per year. No wonder they have adopted wire in steel pails for all of their coil-winding operations!

Because operators spent less time changing spools and adjusting wire tension, production per machine has increased from 270 to 320 coils per hour.

Company officials say the switch to ReaPak has meant an additional saving of \$2,500 annually in handling and shipping. Empty spools and reels no longer must be returned because ReaPak Magnet Wire comes in disposable metal pails.

One of the first major users of magnet wire to see the advantages of ReaPak, Minneapolis-Honeywell officials are convinced ReaPak will be of even greater value in the near future.

If you are interested in saving time, wire cost, and down time for your company, write for ReaPak information.



This is REAPAK
Three Sizes
to fit your needs

REAPAK 500
Drum size diameter 20 inches, height 30 inches. (With dereeling head, 50 inches.)

REAPAK 250
Drum size diameter 20 inches, height 15 inches. (With dereeling head, 35 inches.)

REAPAK 100
Pail size diameter 12 inches, height 12 7/8 inches. (With dereeling head, 28 inches.)

This is ReaPak—the magnet wire that comes in pails. Now a standard package of the magnet wire industry, it was developed by the Rea Magnet Wire Company, Inc. ReaPak gives you up to 500 pounds of continuous length wire. Cuts reloading time, increases production. Adaptable to single head or multiple winding. No reels to be returned—no deposits required. All wire sizes available from AWG 10 to 30. For full information and how it can fit your operation, write, phone or wire: Rea Magnet Wire Company, Inc.



TELEPHONE: ANTHONY 5201
FORT WAYNE, INDIANA

REA MAGNET WIRE COMPANY, INC.
EAST PONTIAC STREET, FORT WAYNE, INDIANA

I am interested in REAPAK. Please send complete details and specifications. Please have your sales engineer call.

NAME _____ TITLE _____
COMPANY _____
ADDRESS _____
CITY _____ STATE _____



For A-N-Ything in Alnico Magnets Specify "ARNOLD"

Materials

Cast Alnico Magnets are most commonly made in Alnico V, VI or III. Sintered Alnico Magnets usually are made in Alnico II, V or VI. Special permanent magnet materials include Vicalloy, Cunico, and Cunife.

Engineering Data

**Write for your copy
BULLETIN GC-106 B**

Contains useful data on Alnico Magnets, their physical and magnetic properties. Also lists stock items and standard tolerances for cast and sintered magnets.

ADDRESS DEPT. T-72

Your best bet when looking for a source of Alnico magnets and assemblies is Arnold—producer of the most complete line of magnetic materials in the industry. Arnold can supply your need for any size or shape of Alnico magnet, as illustrated by the variety pictured above. Weights range from a few ounces to 75 pounds or more. Die-cast or sand-cast aluminum jackets, Celastic covers, etc., can be supplied as required. Complete assemblies are available with Permendur, steel or aluminum

bases, inserts and keepers as specified—magnetized and stabilized according to the requirements of the application.

A wide range of the more popular shapes and sizes of cast and sintered magnets are carried in stock at Arnold. Unsurpassed plant facilities make possible quick delivery of all special orders. • *Let us handle your magnetron, traveling wave tube and wave guide permanent magnet requirements, or any other magnetic material specification you may have.*

WSW 6445

THE ARNOLD ENGINEERING COMPANY



Main Office & Plant: Marengo, Illinois

Repath Pacific Division Plant: 641 East 61st Street, Los Angeles, Calif.

District Sales Offices:

New York: 350 Fifth Ave. Los Angeles: 3450 Wilshire Blvd. Boston: 200 Berkeley St.

FORGING AHEAD TO NEW TERRITORIES

"Safety Margin"*

electrolytic capacitors

... FOR MINIATURIZED, PRINTED
AND TRANSISTORIZED CIRCUITS



STANDARD TWIST
PRONG MOUNTING
STYLE - EX

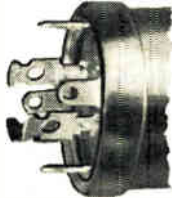

PRINTED CIRCUIT
MOUNTING
STYLE - EZ

NEW ASTRON ELECTROLYTICS

Pioneer efforts in the manufacturing of capacitors over the past years have raised ASTRON to the position of being "tall in the saddle" . . . a leader in subminiature, metallized paper, and molded plastic paper tubular designs.

And now ASTRON looks ahead to the new territories of miniaturized, printed and transistorized circuitry in such applications as car, portable, pocket-type and similar receivers.

New ASTRON Electrolytics have been specially designed to meet their exacting requirements which include small size, extremely low leakage, and long "idling" or shelf life. These rugged, hermetically sealed capacitors supply dependable performance over wide temperature ranges . . . have the ability to withstand vibration and shock.

ASTRON Electrolytics Style EX and EZ are manufactured with strict production controls and only the finest of materials—specially anodized, 99.99% pure aluminum foil, scientifically compounded electrolytic formulas, surgically clean assembly methods . . . "Safety Margin"* protective construction. They are available in a wide selection of capacitance and voltage ratings.

Send today for further technical information. *Please describe your application; it helps us to offer proper assistance to you . . .* when special conditions require, we will design a prototype to meet your specifications.

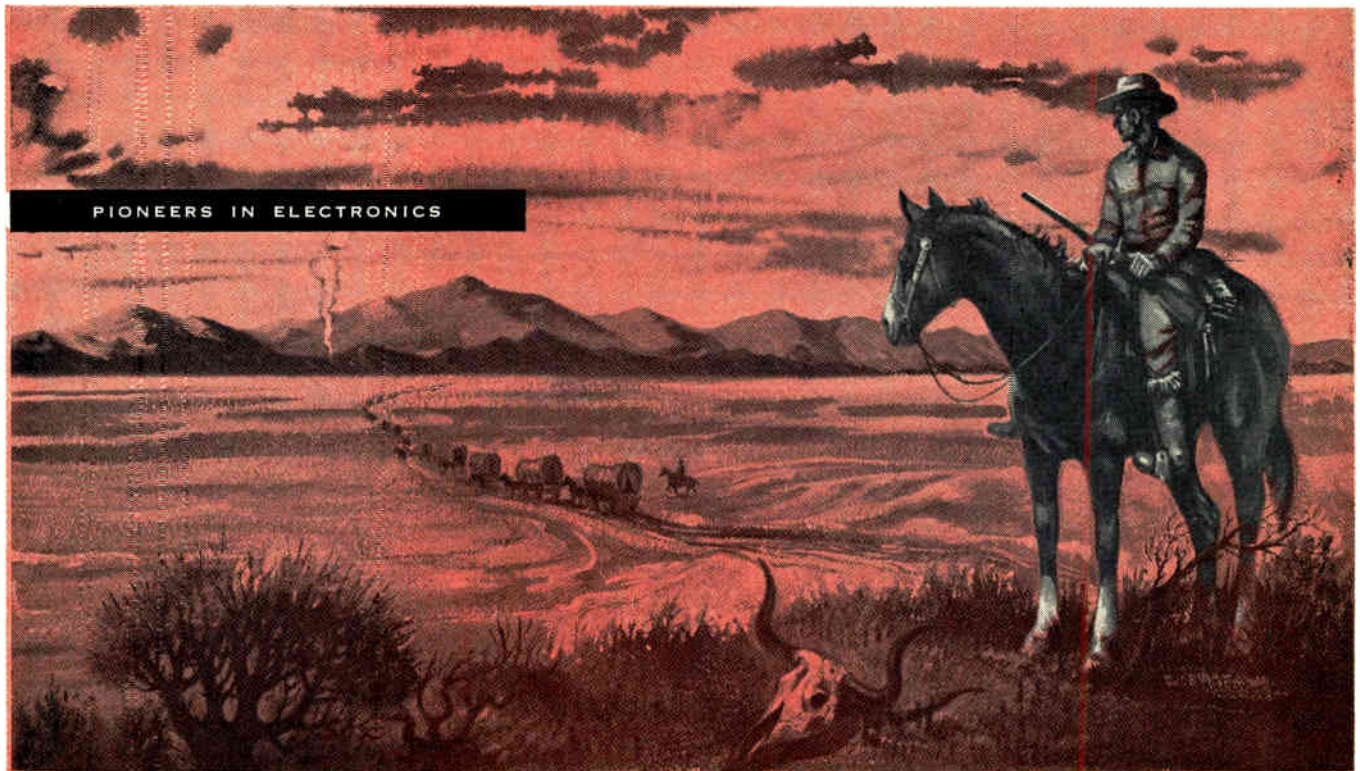

PIONEERS IN ELECTRONICS

Export Division: Rocke International Corp., 13 East 40th St., N. Y., N. Y.

In Canada: Charles W. Pointon, 6 Alcina Ave., Toronto, Ontario

ASTRON

C O R P O R A T I O N

255 GRANT AVENUE

EAST NEWARK, N. J.



A Wholly-owned subsidiary
of ASTRON CORPORATION

PECKVILLE, PENNSYLVANIA

*Trade-Mark

EPR helps

EAI

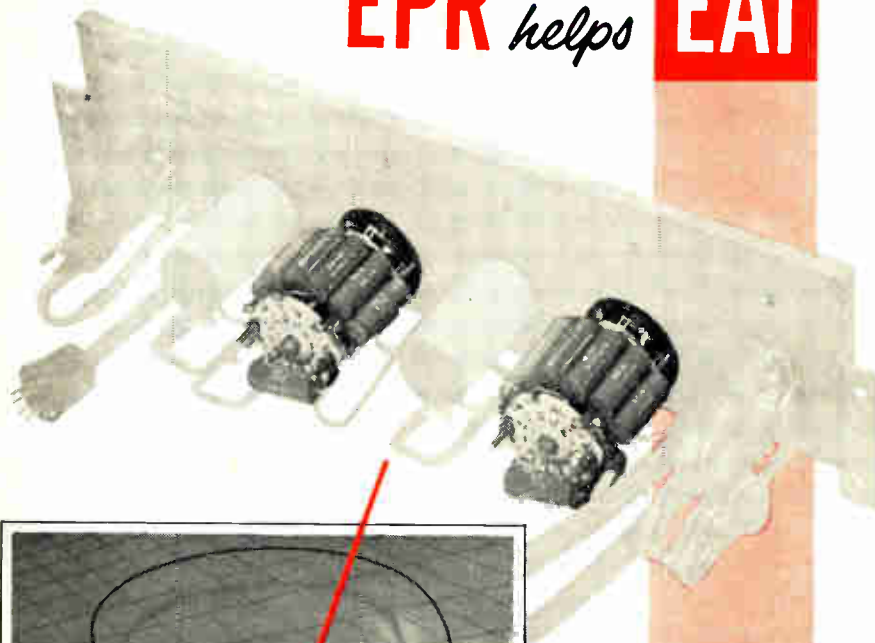

... set the

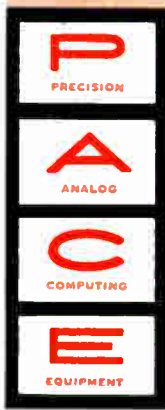

Announcing a new member in a proud family

Once again, setting the PACE. Electronic Associates announces the newest addition to the royal family of recording equipment—the new Variplotter Model 1100D.

Another example of the PACE of Progress set by Electronic Associates, the new Model 1100D Variplotter offers 9 specific, built-in operational advantages, as well as 9 new integral convenience factors, to assure the ultimate in X-Y, table-top recording.

Complete specifications on these 9 operational advantages and 9 convenience factors will be forwarded to you on request.

For details on this and other Variplotter models, as well as information on Analog Computing Equipment, time rental at our Princeton Computation Center, or a visit with our skilled Sales Engineering staff, write Dept. JA-10, Electronic Associates, Inc., Long Branch, N. J.



The Model 1100D Variplotter is an achievement in table top X-Y recorder versatility and performance. In one portable package, is combined all the facilities required for rapid, accurate, graphic recording of any data that can be reduced to electrical form. Data is plotted on a 11" x 17" graph paper, (10" x 15") graph, making available an accurate pen and ink graph for comparison or study.

Close cooperation between the engineering staffs of EAI and EPR on a "common ground basis" resulted in the achievement of a miniature resistor network matched to .05% with a stability of .005% over a eighteen month period.

EPR will be glad to consult with your engineering staff regarding precision wire wound resistors or precision assemblies, built to your requirements. * "mutual understanding of each other's problems and abilities"



Our Principal Product — **RELIABILITY**

Send For Our New Complete Handbook of Precision Wire Wound Resistors.

EASTERN PRECISION RESISTOR CORP.

675 BARBEY STREET, BROOKLYN 7, N. Y.



Personals

Dr. Craig M. Crenshaw has been appointed Chief Scientist for Signal Corps R. & D. He was formerly Director of the Physical Sciences Div., Evans Signal Laboratory, Fort Monmouth, N. J.

Douglas R. Deane is now a senior engineer in the Electronics Dept. of the United States Testing Company's main offices in Hoboken, N. J.

Herbert I. Chambers has been appointed Assistant Chief Development Engineer for Consolidated Electrodynamics Corp. of Pasadena, Calif.

Arthur V. Loughren appointed Vice President of Airborne Instruments Laboratory, Mineola, N. Y. for their new Research Div. He was associated with the Hazeltine Corporation as design engineer, consultant and vice president.



A. V. Loughren



Dr. D. D. King

Dr. Donald D. King, formerly director of the Radiation Laboratory at Johns Hopkins University, has been elected Vice President in charge of research for Electronic Communications, Inc., a wholly-owned subsidiary of Air Associates, Inc. He will be director of the new research lab.

Dr. Frank G. Miller has been appointed head of the engineering laboratory of Hughes Aircraft Company's guided missile laboratories in Tucson, Ariz. He was formerly head of the systems engineering department of Hughes' guided missile lab. in Culver City, Calif.

William J. McBride, Jr., has been made Manager of Klystron Development for Varian Associates, Palo Alto, Calif. William S. Rockwell assumes new responsibilities as Manager of Engineering Services and Harry J. Shalvarjian has been named Industrial Engineering Supervisor for Varian.

Dr. Earle L. Steele appointed Chief Development Engineer of the Device Development Dept. in the Semiconductor Products Div., Motorola, Inc. He will be responsible for the development of transistors, diodes and other semiconductor devices at Phoenix.

Arthur W. Forsberg is now Vice President and Plant Manager of Air-Marine Motors, Inc., Amityville, N. Y.

NEW CONCEPT

Unhampered by traditional thinking, TELECHROME engineers have developed an entirely new concept in telemetering equipment. Today's new environmental conditions and distances for missiles require new designs. TELECHROME units are unequalled in compactness, ruggedness* and dependability. Because of their superior qualities these highly efficient units are replacing equipment of other manufacture.

Direct FM Transmitters Crystal controlled 215-235 megacycles. 125kc deviation.



Model 1462—6" x 4 1/4" x 3 3/4"
50 to 80 Watts



Model 1463—5 1/2" x
3 1/8" x 4"
15 to 30 Watts



Model 1472—4" x 1.5"
x 2.7"
2 Watts

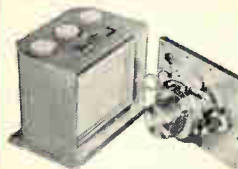

Model 1460—5" x 4 5/8" x 3 1/16"
RF Amplifier
15 to 30 Watts



Model 800—4.5" x 1.3" x 1.4"

SUB-CARRIER OSCILLATOR.
Deviation stability $\pm 1\%$
of band width. Deviation
linearity less than 1% of
band width under all con-
ditions measured from a
straight line drawn be-
tween end points.

Write for
Specifications
& Details

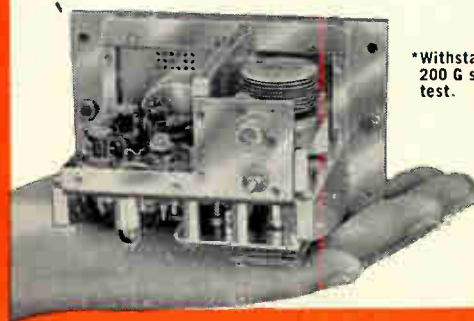

*Withstands
200 G shock
test.

**TELEMETERING TRANSMITTERS
HIGH POWER
IN SMALL PACKAGES**

TELECHROME
INCORPORATED

The Nation's Leading
Supplier of Color
TV Equipment
28 RANICK DRIVE
AMITYVILLE, N. Y.
Lincoln 1-3600

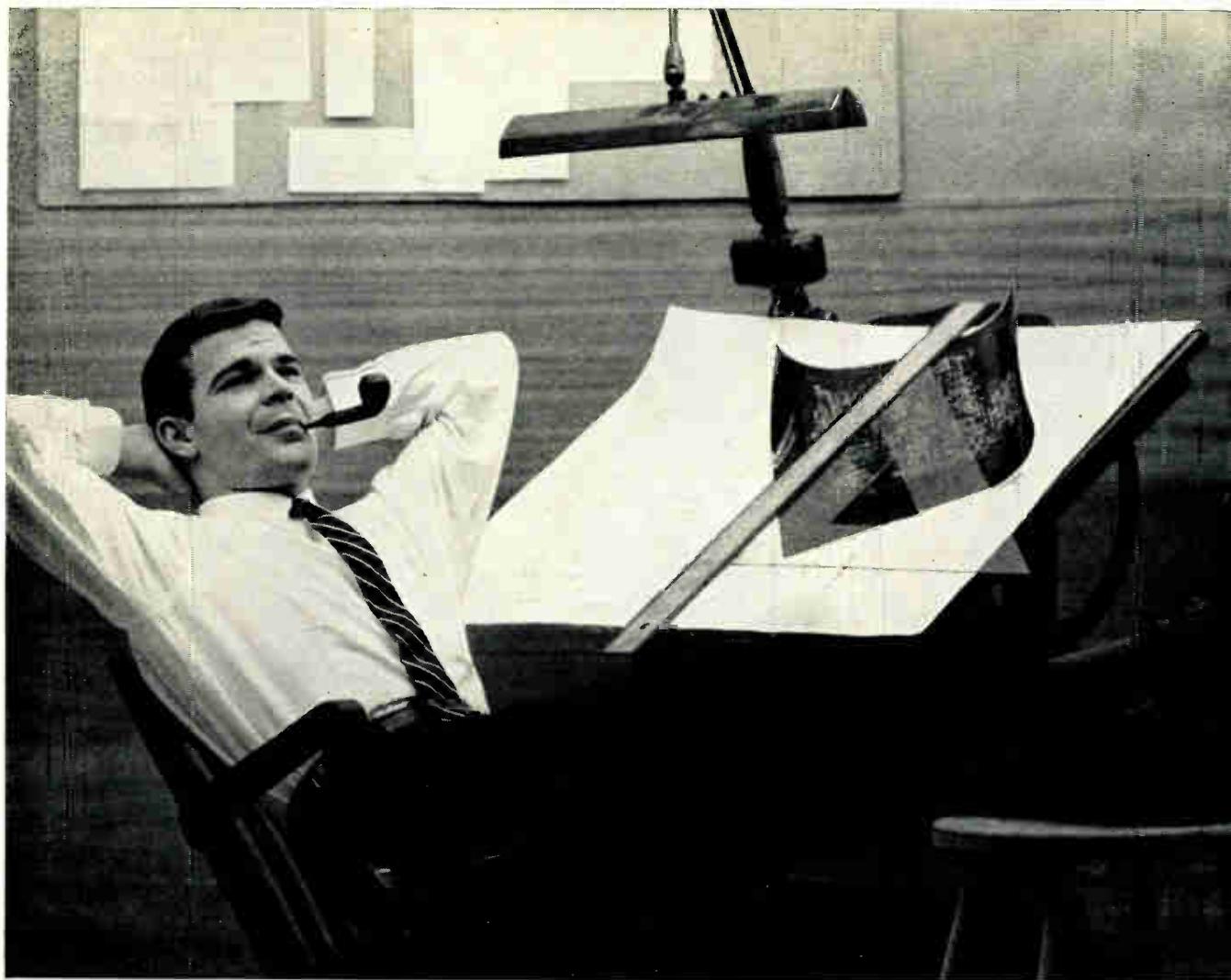

new method solves **DIFFICULT R-F NOISE** *problem*

Of course he's relaxed!

Faced with a new version of the same old r-f interference vs. space-weight problem, he came upon a solution that sidestepped the usual time, trouble, and expense . . . by calling on Sprague.

The perfect solution was found almost immediately among the more than four thousand filter designs already available from Sprague.

Even if his problem *had* required the weeks of research—special measurements and tests—Sprague field consulting service—he would be no less at ease.

With mass production facilities on both the East and West Coasts, deliveries are no problem either.

If you, too, have an interference problem, pick up your phone and call your nearest Sprague Electric Field Engineering Laboratory.

They are located at 12870 Panama Street, Los Angeles 66, California (TEexas 0-7531 or EXmont 8-2791); 224 Leo Street, Dayton 4, Ohio (ADams 9188); 233 Marshall Street, North Adams, Mass. (MOhawk 3-5311).

see

SPRAGUE®

for filters

ELECTRONIC INDUSTRIES

& TELE-TECH

M. CLEMENTS, Publisher • O. H. CALDWELL, Editorial Consultant • B. F. OSBAHR, Editor

Electronic- Communication "Czar"

To coordinate the plans, equipment and needs of the Army, Navy and Air Force into truly JOINT projects, handled in the streamlined, efficient manner of the large corporation, has been the expressed desire of our Defense department for several years. Month by month there is some progress toward this goal. Secretary Wilson, in his recent appointment of a Special Assistant for Guided Missiles moved in this direction. The Guided Missile "Czar," Eger V. Murphree, was needed to scientifically evaluate the progress on various missiles and coordinate the programs of the three departments.

We now believe that Secretary Wilson should enlarge in this type appointment. It would be well to appoint another Electronic-Communication "Czar" to harmonize other defense activities.

The estimated cost of guided missile production, excluding research and development, was nearly a billion dollars for fiscal 1956. For defense electronics as a whole, nearly \$3.5 billion is involved. The importance to the military—and to the taxpayer—of elimination of duplication and concentration of effort on the "right" missiles is realized by all of us. But why stop at missiles?

Growing Reliability

At the Third Annual Symposium on Reliability some 1175 important, high-ranking electronic engineers journey to Washington for two days of papers and technical discussions. This represents a 68% increase over last year's attendance and the 292% increase over that in 1954. The increased attendance points to the unusually strong upward trend of interest in reliability, not only in military equipment but in equipment for the home.

ELECTRONIC INDUSTRIES, as our readers know, has long been an advocate of reliability. Reliability, like Safety, is a desirable quality. It is something everyone wants but it is hard to define and difficult to specify. It is a

With radio, television, radar, radar gun-laying, military avionics, computers, remote control and all the other adjuncts to push-button warfare now being readied, old fashioned military concepts have vastly changed so that the scientist works shoulder-to-shoulder with the General; our electronic manufacturers are also our munition makers and our soldiers are being turned into electronic technicians. The importance to our national defense of this strongly rising trend now points to the desirability of this second "Czar."

To qualify as The Electronic-Communication "Czar" we need a man experienced in planning, in research and development, procurement, manufacture, logistics, training, use, maintenance and electronic reliability for all branches of the military. He would guide the planning for electronics as related to application engineering, manpower, research and development, supply and logistics, and atomic energy. This, of course, is a big job and at present there are probably only two or three men in the United States able to fill it. But, nevertheless, the Defense Department; the Electronic Industries; our Nation needs such a man today.

concept which requires special education, much missionary work and continual preaching—but mostly engineering common sense.

There does not appear to be complete agreement on the units to use in expressing reliability, nor the method of specifying it. Major progress on these matters, however, as a result of the greatly increased thought and work by hundreds of engineers is evident now. With top-management and engineering departments briefed and alerted to the importance of reliability, a steady and gratifying improvement in the life of their end-products is going to be achieved by the electronic manufacturers who plan now for future leadership.

By J. R. ALBURGER

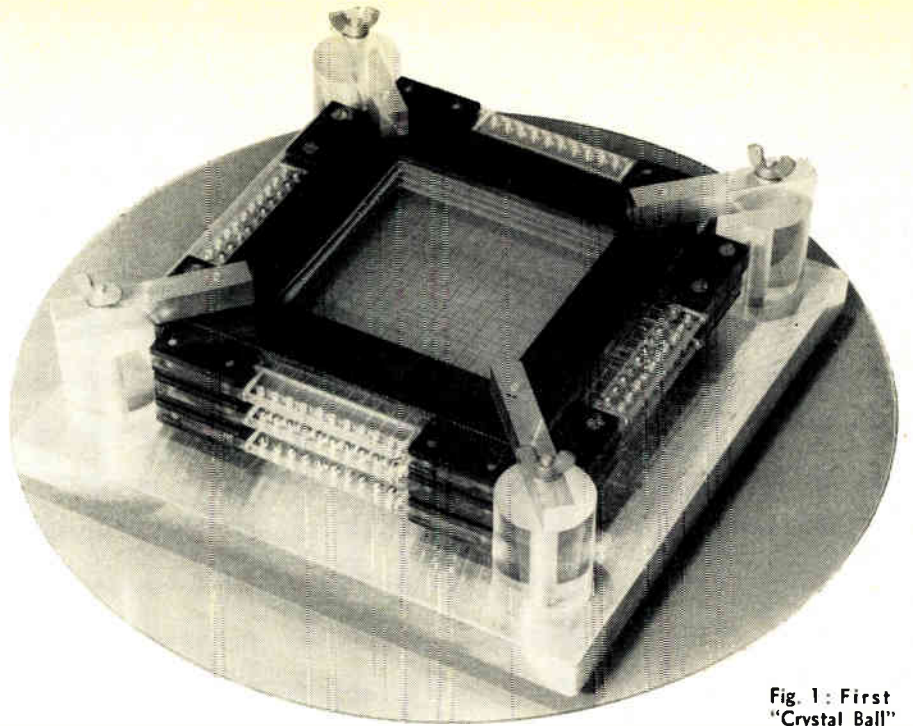

Fig. 1: First "Crystal Ball"

"Crystal Ball" Plots 3-D Curves In Color

New "Electroflor" materials become fluorescent or show visible colors at low voltages. Electroflors, with a matrix of transparent electrodes, form a solid, crystal-clear 3-D display device. Computer memory matrices, digital read out indicators, and electronically controlled light filters have been built



J. R. Alburger, Shannon Luminous Materials Co., Hollywood, California.

Electroflors are a group of new materials which can store applied electrical energy. They may display the stored energy as fluorescence or visible color. They exhibit a "memory" effect which can last as long as five minutes; and the stored data can be read out non-destructively. The electroflor in its quiescent state may be a crystal-clear transparent liquid, or it may be a transparent jelly.

Electroflor Materials

The basic electroflor contains a solvent and an activator. This combination has the ability to store electric energy. If we add an indicator material, the resulting electroflor will fluoresce or give other visible indication

when electrically stimulated. We have now developed about fifty electroflors with a wide variety of fluorescent color, visible color, and data storage characteristics.

Electrical Characteristics

When we apply a small voltage to electrodes in a fluorescent electroflor cell, the electroflor becomes fluorescent near one or both electrodes and glows brightly under ultra-violet light. A reverse pulse which averages the stored charge to zero cancels the fluorescence. We believe this behavior involves polarization of the electroflor by the potential gradient near the electrodes. The polarization causes the electroflor to convert ultra-violet energy to visible light. The brightness of electrofluorescence is linear with the quantity of electric current; that is, the product of current times its duration determines brightness after a pulse. The effect is analogous to charging a condenser through a resistance.

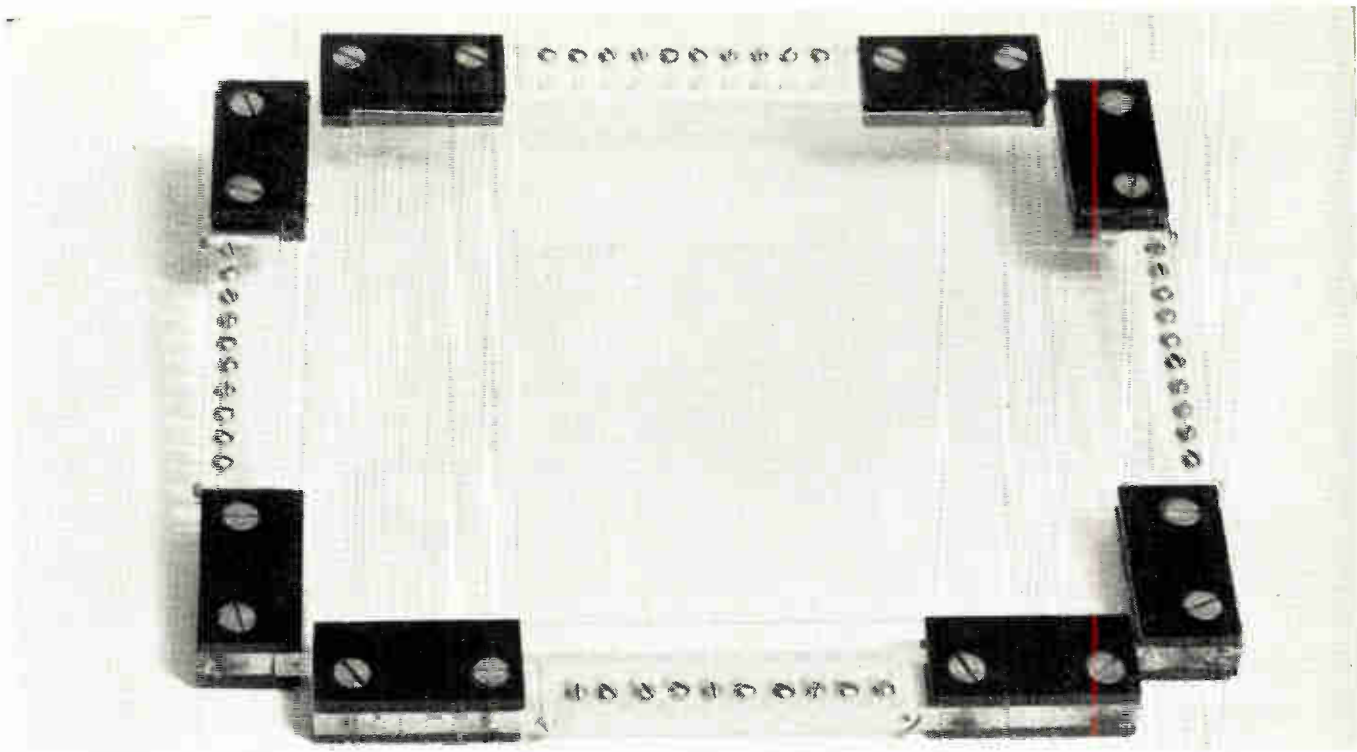
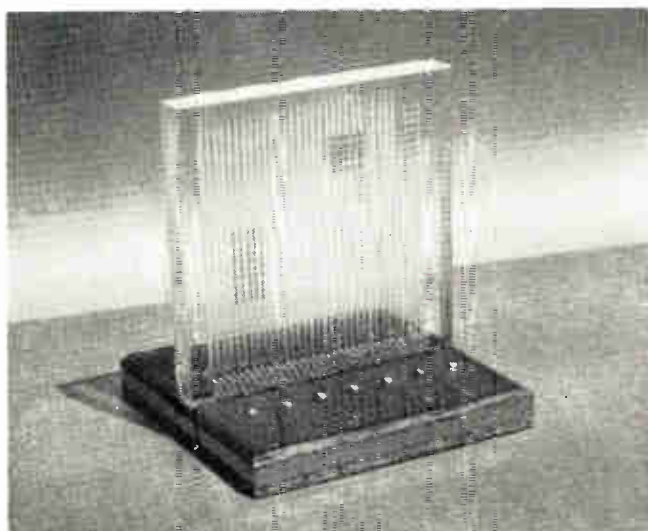

Fig. 2: Experimental memory unit has electroflor in separate cells of separator plate

Fluorescence

Fluorescent electroflors can be activated by long-wave ultra-violet light in the region of 3000 to 4000 AU. We commonly use a mercury arc filtered to emit 3650 AU. Brightness depends on the intensity of black light radiation, and with sufficiently powerful black light the fluorescent glow is extremely bright. We get a brightness comparable to the average trace in an oscilloscope with mercury arc radiation on the order of 10 watts (input power) per square foot of illuminated area. This brightness is about 30 to 40 μ lam-berts. The response to ultra-violet excitation is linear with intensity of u-v radiation, the practical limit being set by temperature rise due to applied radiation.

Fig. 3: Crossed grooves hold electroflor and electrodes



Visible color electroflors require no ultra-violet excitation, but need white light for viewing the produced color.

Fluorescent Color

We have had excellent success in making electroflors with a bright blue fluorescence. Electroflors with green and yellow fluorescence are not yet so well developed, but our work so far convinces us we can develop a complete range of fluorescent colors.

Visible Color

In addition to fluorescent response, we have prepared electroflors in which electrical polarization produces a visible color. This is useful when we wish to project a high intensity image of a display, using visible light for the purpose. We have produced a variety of colors, including subtractive primaries.

Threshold

We find stored electrical energy in the electroflors even with very small applied voltages. However, we must raise the voltage above a threshold point before the zone becomes visible. Above the threshold voltage, the luminous response is nearly linear with voltage and duration of the pulse. Thus, the luminous electroflor responds to pulses of extremely short duration, if the applied voltage is sufficiently high. The maximum practical pulse for present cells is about 2 volt-seconds.

Protection

A voltage pulse of excessive duration or amplitude will overload the luminous electroflor element and cause permanent damage. Under certain conditions, however, the electroflor element is self-limiting. This happens when the activating voltage is not much

"Crystal Ball" (Continued)

greater than the threshold voltage. The activated electroflor develops a voltage potential in opposition to the activating voltage, thus limiting the current through the electroflor. When we use higher activating voltages, we must include some other means of protecting the electroflor from overload.

One possible method is to use the back emf developed across the electroflor element to establish a limiting condition for the following pulse. After activation, the back emf of the electroflor decays along a curve corresponding to the decay of the fluorescent glow. So long as the duration of a pulse is no greater than necessary to polarize the electroflor to full luminosity, the electroflor is not injured.

Data Storage

A fundamental characteristic of electroflors is their ability to store applied electrical energy in the form of electrical polarization. A basic electroflor data element is a single cell containing an electroflor and two inert electrodes. When we apply a pulse of electrical energy to such a cell the electroflor is polarized and electrical energy is stored. We can cancel the polarization by a reverse pulse.

Experimental Cell

Figure 5 shows an early experimental electroflor cell. A sealed glass tube is arranged with two platinum electrodes running through it. One electrode is a strip of platinum, while the other electrode is a fine platinum wire. The relatively wide strip electrode gives a large area over which we can observe the zone of fluorescence or color response.

Data Matrix

A more complex data storage system uses a matrix of crossed electrodes (Fig. 2). Two sets of electrodes are arranged at right angles and in contact with an electroflor. The electrodes do not touch each other but are separated by a cellular barrier layer. The function of this barrier layer is to restrict applied electrical activation

to zones near the intersection of electrodes.

Figure 2 shows electrodes supported on a glass plate, and a barrier layer of plastic punched with holes. In use, the holes are filled with an electroflor and the assembly is sealed.

We can apply electrical information to the various intersection points in the matrix by suitable scanning or by digital selection. Applied electrical pulses then polarize the electroflor. A valuable feature of this storage device is that stored information can be read out

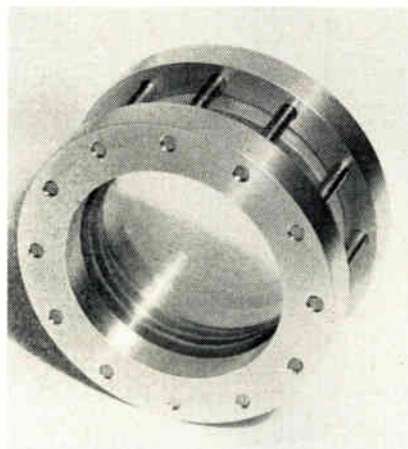

Fig. 4: Electroflor light filter—separate transparent layers give independent control of primary color densities

non-destructively by voltage detection. The electrical energy is stored within the electroflor and is not merely a charge on the electrodes. Polarization of the electroflor gradually dissipates by molecular diffusion; our present cells give a maximum effective memory duration of about five minutes.

Transistor Indicators

Computer equipment using vacuum tubes may employ neon glow lamps for indicating on-off conditions. The present trend toward transistorized computer circuits introduces the problem of an indicator which will function at the low voltages required by transistors. Since electroflors function at only a few volts, they can be used as indicators in transistor circuits. Several experimental indicator cells are shown in Fig. 6.

These cells contain the electro-

flor, a coil of platinum wire, and a central electrode. Upon activation, fluorescent or colored zones appear around the coil. The active electrode can be a conducting transparent coating on the inside surface of the cell.

We have found that extremely short voltage pulses, on the order of a μ sec, will store energy in the electroflor. However, if we wish to produce an observable fluorescence or color effect in present cells, we must apply a longer pulse.

Digital Readout

We can construct a low voltage digital readout cell for transistorized computers by replacing one electrode with a sandwich of ten glass wafers, each with a transparent conductive numeral deposited on it. When we apply a voltage to one deposited electrode, that numeral fluoresces.

Electronic Light Filter

With certain electroflors, and under carefully controlled conditions, we can apply a continuous voltage to the electroflor cell without damaging it. If we apply the voltage through a series ballast resistor, we can cause an equilibrium condition where the zone of fluorescence or color response is generated at the same rate as it is dissipated by molecular diffusion.

We have used this characteristic to construct an electroflor color filter (Fig. 4). This cell uses a sandwich of electrically conductive, light transmissive electrode coatings on glass plates.

The four plate sandwich contains 3 electroflor layers giving 3 visible subtractive primary colors. In the non-activated state, the cell is colorless and transparent. When we apply a suitable potential, the cell shows a color depending on which element is activated. We can obtain any combination of color and intensity, or the 3 primary colors can be activated simultaneously to produce a gray scale with a maximum density of about 3.

This electrically controllable light filter should find use in adjusting color balance in color-film printing, color-television, etc.

Our 2 in. diameter light filter cell has an internal resistance ranging from 50 to 1000 Ω , depending

on applied voltage. The apparent resistance has a peculiar non-linear characteristic, due evidently to polarization of the electroflor by the applied voltage. This resistance is large at small voltages, and small at higher voltages. For example, one cell shows an apparent resistance of 500 Ω at .1 v. and 50 Ω at 1.5 v.

We can vary the internal resistance of a cell by varying the chemical structure of the electroflor. Electroflors having excessively high resistivity usually have a slow response. This agrees with our premise that response is a function of energy storage; high impedance means a slow build-up of energy during an applied voltage.

We believe we can construct fairly large electroflor light-filters, so long as we keep the resistance of the electrodes low compared to the electroflor.

Flat Plate Matrices

Our experiments thus far have led to several ways of making flat plate electroflor displays. Although the electrodes are spaced 1/16 in.

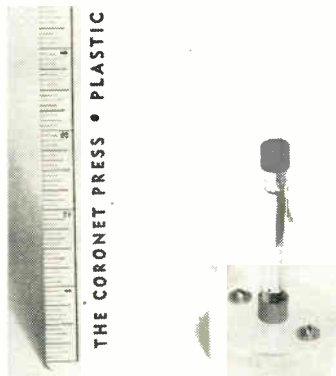
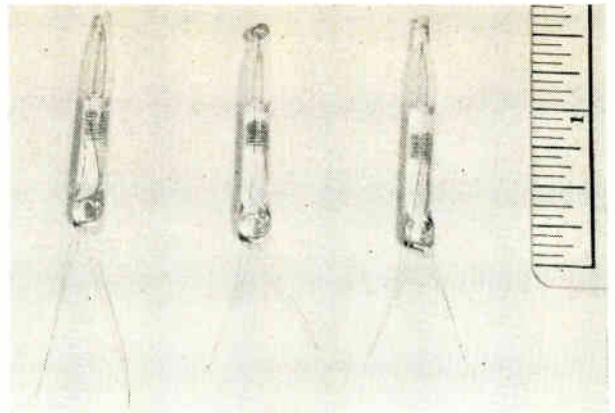

Fig. 5: Experimental test cell is stoppered glass tube filled with electroflor and containing two platinum electrodes

apart in our developmental matrices, we have found no inherent reason this spacing cannot be reduced for greater definition or the introduction of different color layers.

Fig. 3 shows an experimental matrix in which an electroflor is placed in grooves cut in a plastic plate. Fig. 1 shows an experimental three-dimensional matrix built by stacking together 4 such matrices. Each flat matrix is formed by ten leads entering each side of the panel, resulting in 100 intersections

Fig. 6: Spiral electrodes in these low-voltage electroflor indicator cells give a larger volume of generated 'glow'



or indicator points. Total number of indicator points in the solid array is 400.

Leads entering the matrices are No. 36 platinum wires (.005 in. dia.). Preferably the leads should be evaporated metal coatings, thin enough to remain transparent. A full scale solid matrix might consist of panels with 500 leads on each side, requiring an area about 25 in. square. Definition with a 500 line matrix is equivalent to that of a conventional television picture. Maps or other reference data can be inserted under the transparent solid "crystal ball" matrix.

Scanning

Possible scanning procedures for the matrix display include digital tree selector systems and the electron beam switch. At present, the electron beam switch appears more promising because the switching function occurs within a single tube device.

Electronic Crystal Ball

Our use of the term "crystal ball" is not a facetious gesture. It is in truth an accurate description of a new device which can present three-dimensional luminous or colored images within a transparent enclosure. Using transparent electrodes and electroflors, we can now build a three-dimensional matrix which is completely transparent until a signal is applied. Unlike similar displays constructed with gas glow tubes, there need be no optical discontinuities within the "crystal ball."

Different electroflors can be alternated along one axis to give different colors. The practical result is a three-dimensional color display within a durable solid transparent device. Five dependent variables

can be simultaneously plotted in terms of X, Y, and Z position, color, and intensity.

Avionic Aid

There are many cases where a visual three-dimensional display has become essential for rapid, accurate control. One of the most urgent examples is the control of air traffic. Here the conventional plan-position indicator can be greatly improved by addition of the third dimension to represent altitude, and even possibly a color code for different classes of aircraft.

Radar Indicator

We are studying the possibility of a radar indicator to be installed in an aircraft windshield. In this system the electroflor and electrode matrix would be transparent so the pilot could see through the windshield. The ppi pattern would appear as a visible colored image within the windshield.

One of the most pressing problems in connection with radar displays is the matter of viewing the display under high ambient light levels or in broad daylight. Visible color electroflors are a potential solution to this problem.

Present Status

Although many potential uses have been suggested for our new electroflors, our first efforts have been concentrated on the development of data storage and readout units for computers, and military equipment for the observation, guidance, and control of airborne vehicles. At present we are developing prototypes of our electronic light filters, low voltage computer indicator cells, and small data storage matrices.

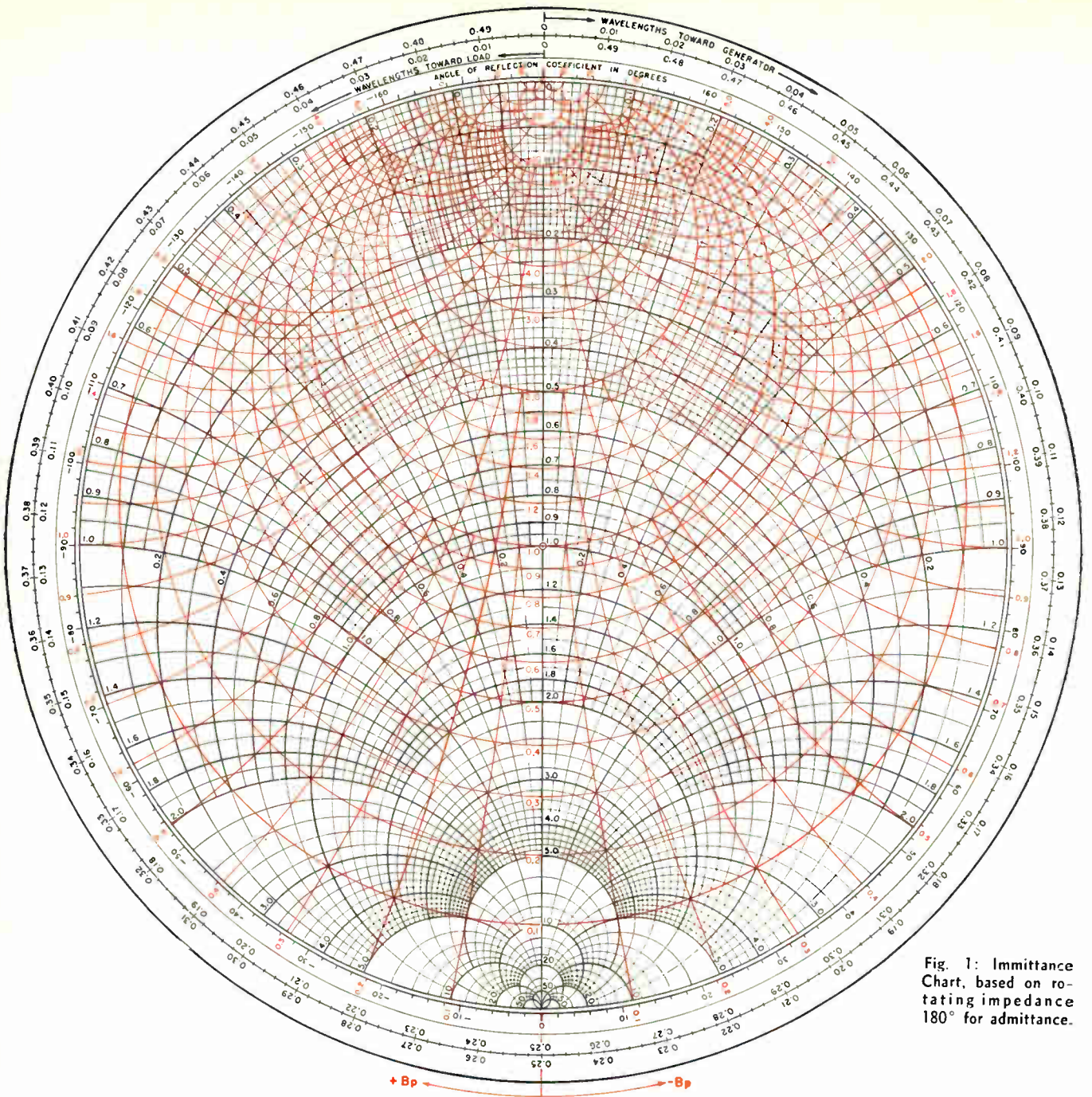

Fig. 1: Impittance Chart, based on rotating impedance 180° for admittance.



H. M. Wasson

The input impedance (Z_{in}) of a lossless quarter wave transmission line of characteristic impedance Z_0 terminated by an impedance (Z_1) is given by:

$$Z_{in} = \frac{Z_0^2}{Z_1}$$

or,

$$\frac{Z_{in}}{Z_0} = \frac{Z_0}{Z_1} = \frac{Y_1}{Y_0}$$

Therefore, $Z_{in} = Y_1$ (Capital Z and Y denote normalized values.)

This relationship shows that the normalized input impedance (Z_{in}) of a terminated quarter wave transmission line is equal to the normalized terminating admittance (Y_1). On the Smith Chart, the Z_{in} of a

terminated quarter wave transmission line corresponds to the point found by plotting the terminating impedance (normalized to the characteristic impedance of the line), rotating* the point 180° (corresponds to quarter wave transmission line), and reading off the input impedance (terminating admittance).

Because of these characteristics of transmission lines and the Smith Chart,^{1, 2, 3} the admittance corresponding to a given impedance can readily be determined by plotting the impedance and then rotating the point 180°.

Development

If the Smith Chart is thought of as being made up by 2 identical transparent layers, properly

Two Smith Charts, reversed 180°, indicate "immittance"—the combination of impedance and admittance—at a single point. Method leads to simple determination of equivalent series and shunt configurations for two-terminal networks.

"Immittance"

New Tool For Network Analysis

By HAROLD M. WASSON,

Electrical Engr.,
RCA Victor Television Div., Cherry Hill,
Delaware Township, Camden 8, N. J.

aligned, then instead of rotating the impedance point to find the admittance, one layer can be rotated 180° and labeled admittance. For each point, then, both impedance and admittance can be read off simultaneously.

Because it includes both impedance and admittance scales, it is appropriately called an Immittance Chart, Fig. 1. To avoid excessive complication, some details are removed from the admittance grid and 2 colors are used. The chart, then, may not introduce great complexity, yet it serves many new uses in addition to the uses of the Smith Chart.

Equivalent Z or Y

For a series connection of impedances Z_1, Z_2, Z_3 , the resultant impedance is equal to $Z_1 + Z_2 + Z_3$.

Conversely, an algebraic sum represents a series connection of impedances. Therefore, $Z = R + jX$ corresponds to a network having a series connection of R and jX .

For a parallel connection of admittances Y_1, Y_2, Y_3 , the resulting admittance is equal to $Y_1 + Y_2 + Y_3$. Conversely, an algebraic sum represents a parallel connection of admittances. Therefore, $Y = G + jB$ corresponds to a network having a parallel connection of G and jB . A point on the new chart (corresponding to both $Z = R + jX$ and $Y = G + jB$) therefore, gives the equivalent parallel network for a given series network and vice versa.

Referring to Fig. 2A, the point A corresponds to the normalized impedance $1 + j1$ and the normalized admittance $0.5 - j0.5$. The impedance $(1 + j1)$ in turn corresponds to the series network in Fig. 2B and the admittance $(0.5 - j0.5)$ corresponds to the parallel network in Fig. 2C. Fig. 2D shows the equivalent networks after de-normalization.

Ladder Network

Because the Immittance Chart has contours of constant conductance and susceptance as well as those of constant resistance and reactance, it is useful for the determination of input impedances of ladder networks. For example, it is desired to determine the impedance (Z_3) resulting from the addition of a resistance ($R_2 = 0.5$) in series with the impedance ($Z_1 = 0.7 + j0.7$). Since the addition of a resistance in series with Z_1 has no effect on the reactive part of Z_1 , Z_3 will be on the same reactance line but displaced along this line a distance corresponding to the sign and magnitude of R_2 .

When Z_1 and R_2 are normalized to the same resistance ($Z_0 = R_0$), the displacement will be 0.5 (R_2)

(Continued on page 78)

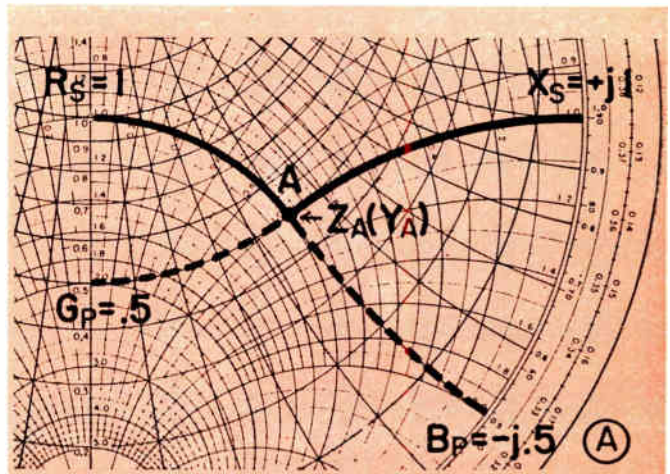

Fig. 2 (A) Pt. A corresponds to normalized impedance $1 + j1$ and admittance $.5 - j.5$; impedance and admittance as series (B) parallel (C) networks, respectively; and, (D) de-normalized equivalents.

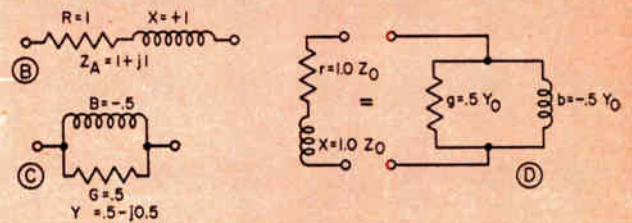
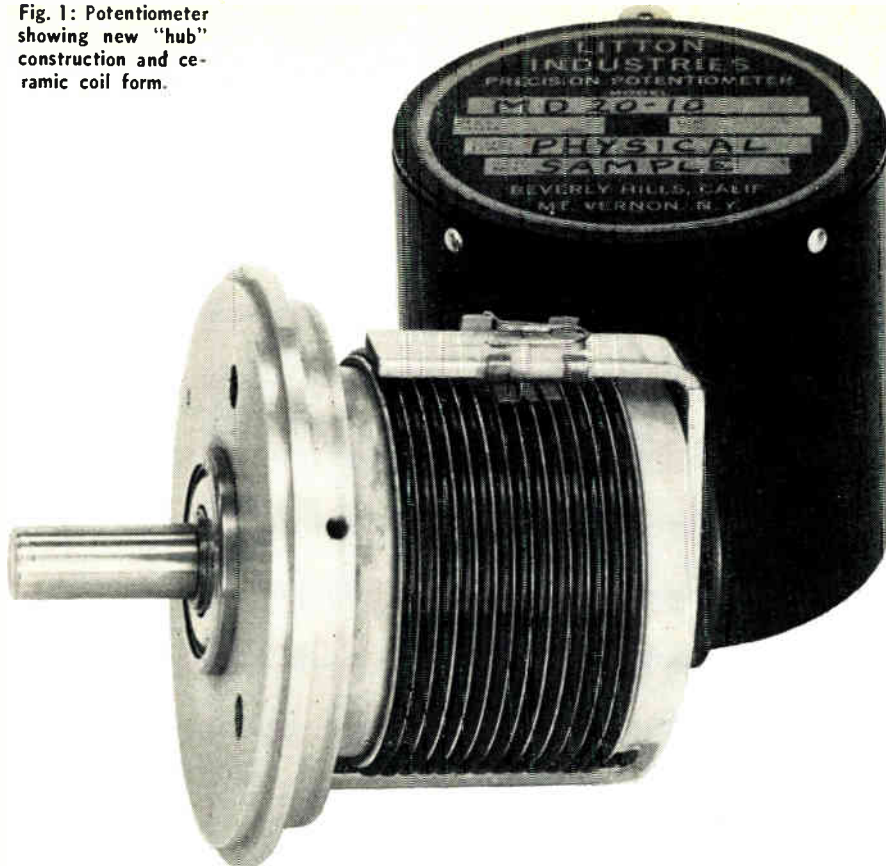

Fig. 1: Potentiometer showing new "hub" construction and ceramic coil form.



New Hub Solves Linearity Problem

A single piece of machined aluminum is the keystone for the bridge to better linearity and higher stability. New winding techniques and a better method of guiding the movable contact are revealed. Even in severe environments, linearity of 0.01% is attained, repeatedly.

By **JAMES W. WEIDENMAN**

and

DAVID S. RATHJE

Components Div., Litton Industries
5873 Rodeo Rd., Los Angeles 16.

Fig. 2: Assembly of a precision potentiometer model requires use of a microscope.



Fig. 3: Resistance coil is wound externally on dimensionally stable ceramic form.

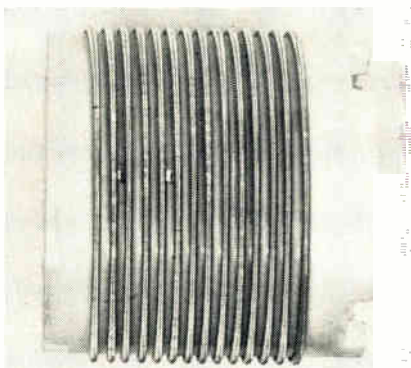
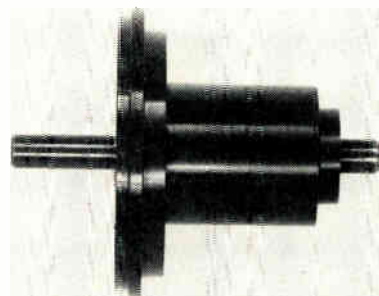

Fig. 4: Machined aluminum "hub" functions as mounting plate and internal support.



TWO of the most elusive goals facing the potentiometer designers today are higher linearity and greater stability.

Considerable experience in equipment operation has pointed to several fundamental problems. Accuracy deteriorates with age. Plastic housings warp due to moisture absorption. Stability is lost over broad temperature changes. Many designs fail under high shock and vibration conditions.

Designing a potentiometer that will maintain stable operation under severe conditions is difficult. It's even more difficult when you attempt to maintain $\pm 0.01\%$ linearity under these conditions.

The design described in this article strives for these goals by a fundamentally new approach. New in these 3 important areas: first, the means of attaining high dimensional and electrical stability; second, the winding techniques used to obtain high linearity resistance coils; and, third, the method of guiding the movable contact around the helical resistance element.

Dimensional and Electrical Stability

First thoughts concerning stability start with the resistance element. In some designs, the resistance element is potted or mounted in a plastic housing. Dimensionally unstable plastic materials frequently cause disturbance of the resistance coil. This is due to moisture absorption or other factors. It may cause serious degradations in noise and linearity. Total resistance may shift and operating life may be substantially shortened.

This difficulty is eliminated by winding the resistance coil on a dimensionally stable ceramic coil form, Fig. 3. This externally wound coil facilitates careful control of the resistance coil during all stages for assembly and test.

To assure maximum stability of the coil form, the material chosen was a chemically inactive, non-hygroscopic and dimensionally stable ceramic. Aging or prolonged shelf life has almost no effect on the material. To maintain stability in operation over broad temperature ranges, the ceramic chosen was selected because its coefficient of thermal expansion most closely approached that of the copper used in the resistance coil mandrel.

Another benefit arises from use of a coil form of this design. Because the resistance coil is externally wound around the ceramic core, there is considerable flexibility in the number of helical turns that can be wound onto the core. The one basic design can easily accommodate 3 gangs of 3 turns, 2 gangs of 5 turns, or even 2 gangs of 10 turns each.

To maintain the stability of the resistance coil under severe shock and vibration, it is necessary to provide a secure mounting for the ceramic coil form. This support is supplied by the new hub structure, Fig. 4.

This hub is a single piece of precision machined aluminum. It functions both as the front mounting plate and as the physical support for all operating parts. The ceramic coil form, slider arm, shaft and ball bearings are all concentrically mounted on this one-piece aluminum hub. The complete assembly is shown in Fig. 1.

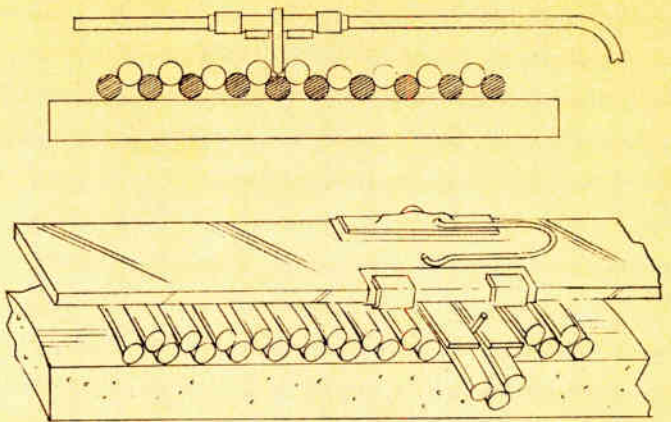

Fig. 5: Movable contact guided by helical wire cuts element wear.

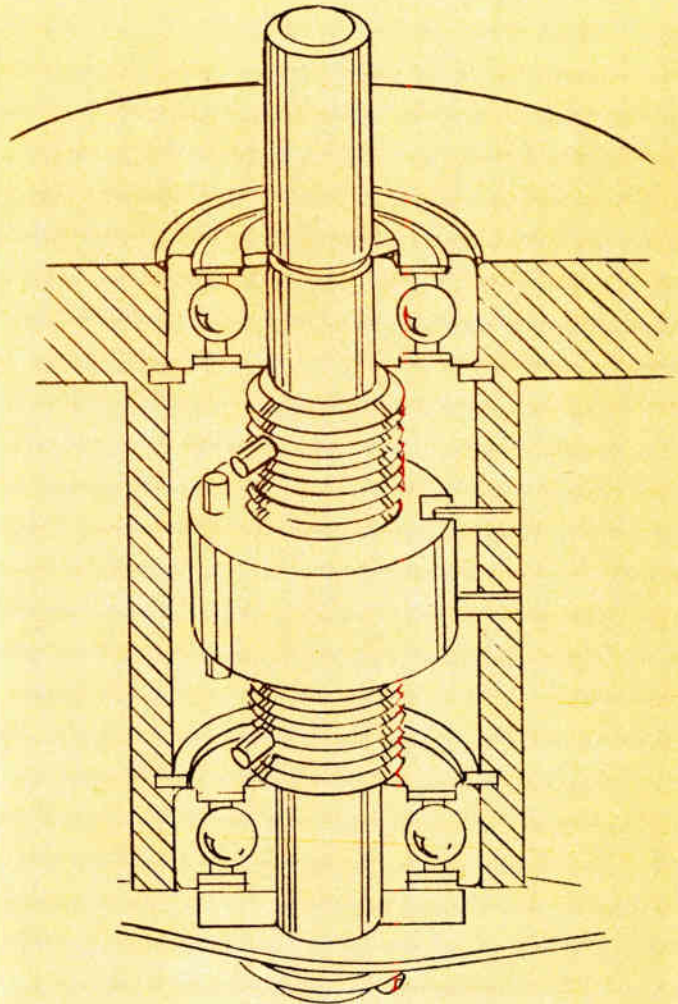

Fig. 6: Positive stops operate without extra force on wiper arm.

Because it is machined in one operation from a single piece of aluminum the hub can be manufactured with great precision. With the accuracies made possible by this hub design, there is a minimum of eccentricity between the helical resistance coil and the moving contact mounted on the input shaft. The ball bearings are both mounted on this one hub structure and can be located with great accuracy. Their positional accuracy is not dependent on the accuracy of assembling numerous independent parts, as is the case with older designs.

(Continued on page 134)

Electronic Eyes Inspect Drinks

Try staring at a spinning wheel of bubbling beverage bottles—the swirling, sparkling liquids are hypnotic. Human inspectors often blink and doze. Now, electronic inspectors can be used and they will take into account such things as variations in bottle color and harmless bubbles, but spot any foreign particles in the liquid contents. Figure 1 shows an electronic inspector for beverages.

The bottle goes in through a timing gate and star wheel. The twenty-bottle turret revolves continuously and spins the bottle to start the liquid swirling. Then the turret stops the bottle's spin, leaving the liquid swirling. The contents of the bottle continue to spin while the electronic inspector sends a beam of light through the bottle to double banks of photocells. The inspection lights and cells move with the bottle during the brief inspection period, then swing back to meet the next bottle in line. There is no relative motion during inspection, so any changes in light detected by the inspecting "eyes" will come from particles in the liquid.

Rejection

Interception of the light falling on the phototubes causes a change of the voltage-current relationship in the phototube circuit. This change is electronically amplified by a pulse amplifier and causes a relay to function. The relay controls a solenoid on the memory mechanism so that whenever a

bottle is to be rejected a pin (one of 20 corresponding respectively to each one of the 20 bottle positions within the turret) is pushed out beyond the face of the memory wheel.

As the rotating turret continues to carry the rejected bottle toward the outfeed side of the machine, the extended pin on the memory wheel travels in synchronism until it intercepts the switch which controls the reject arm solenoid. The arm guides the "rejected bottle" from the main conveyor onto a short conveyor to an accumulation table. In the bottling plant it is necessary at this point to have human eyes analyze the rejects to determine why the bottle was rejected.

Phototubes

The phototubes are mechanically arranged so the cathodes

slight frequency response deviations, are quite similar. A broader frequency response can be tolerated in the lower channel. The output tubes (thyratrons) of the two channels are paralleled so that either can cause the rejection.

Each channel consists of the following stages:

- a) Cathode Follower Input Stage
- b) Triode Signal Amplifier
- c) Balanced Modulator
- d) High Frequency Amplification (three stages)
- e) Thyatron or Trigger Tube.

Circuit Analysis

Signals developed by either group of phototubes are applied to the respective cathode follower for the channel involved, then amplified and channeled to the balanced modulator. A continuous 3

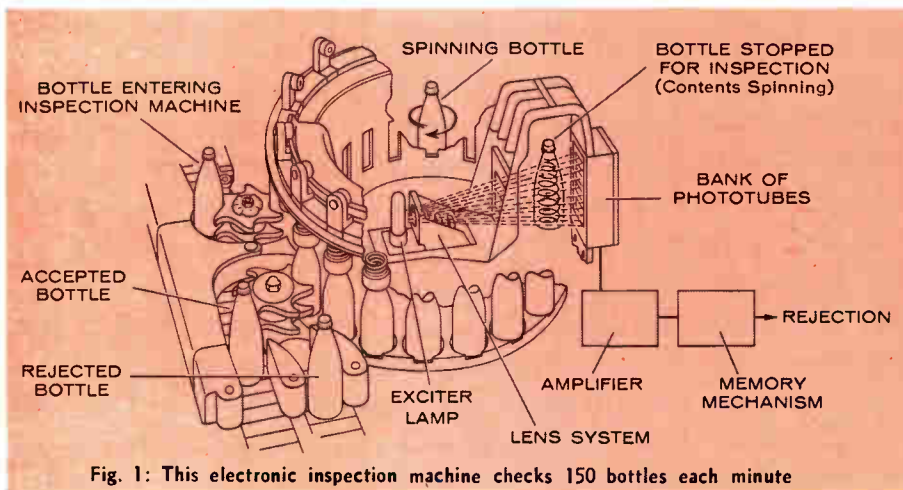

Fig. 1: This electronic inspection machine checks 150 bottles each minute

overlap slightly and encompass all the light passing through the bottle. Electrically they are arranged in an upper and a lower group, each with its own amplifier channel. Separate sensitivity controls permit higher sensitivity in the lower channel to detect glass or other heavy solids and lower sensitivity in the upper channel to compensate for bubble concentrations.

Amplifier

The two channels, except for

Kc carrier frequency is also fed to the balanced modulator, but no output is obtained therefrom unless an input signal is present. The presence of signal produces an amplitude-modulated 3 Kc signal which is "fed" to the three stages of H. F. amplification and finally causes the triggering of the thyatron associated with that channel. Only a relatively narrow band around the 3 Kc range need be handled by the high frequency amplifiers.

(Continued on page 137)

Electronic Probes Check Turbines

M. L. Greenough and J. Johansen at NBS have recently come up with an electronic instrument that checks clearance between rotating and stationary blades inside a steam turbine. They use a mutual-inductance micrometer probe made by printing inductors on a ceramic base.

Turbines

One of the big problems in steam turbines is keeping safe axial clearance between rotating and stationary blades. Rotor and stator blades are supported by the massive rotor and the relatively thin outer casing. This means thermal transients can cause large differential expansions, possibly resulting in interference between the blades. The new NBS rotor probe gives engineers an accurate check on blade clearance by measuring the axial distance from the shrouding around the rotor blade

tips to the base of the outer stator blades. Since conditions at the blade tips are severe—high velocity steam at 700°F—a temperature-resistant probe is essential.

A typical mutual inductance probe contains two coplanar, coaxial coils wound on a dielectric core. An r-f source, regulated with respect to the product of the frequency and current, energizes the primary coil. The ac voltage induced in the secondary coil depends on the distance from the probe to a nearby electrically conducting reference plate. Suitable electronic circuitry then detects and amplifies the output voltage from the secondary coil, and the amplified voltage is indicated on a meter calibrated to give the probe-to-surface measurement in inches or centimeters. The instrument can detect very rapid displacement changes.

To measure the transverse mo-

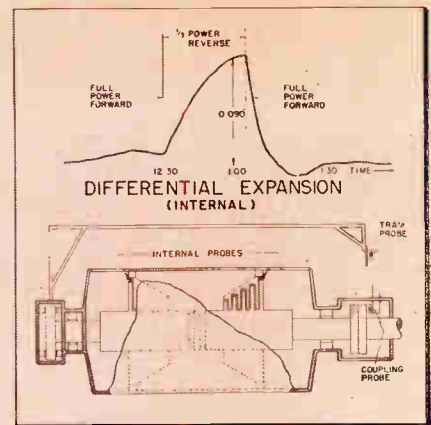

Fig. 1: Vital turbine rotor clearances are checked by electronic inductance probes

tion of the shroud band, the energized primary winding induces voltages in two secondary coils that cover separate halves of the primary winding area. These half-windings are connected in series opposition so that there will be no voltage output when the band around the blades is centered over the probe. This band corresponds to the reference plate of the typical mutual inductance probe.

(Continued on page 86)

Electronic Light — Luminous Capacitors

Electroluminescence may well become the main source of artificial light in the future, according to physicists at Sylvania. In its simplest form, the luminous panel lamp developed at Sylvania consists of a thin sheet of a dielectric material containing a special electroluminescent powder sandwiched between two conducting sheets, at least one of which is transparent. It operates only on alternating current, and its brightness depends on voltage and frequency of the electrical field applied across the dielectric phosphor layer. It bears no physical similarity to any other light source, operating as it does without bene-

fit of filament, bulb, vacuum, gas discharge, or tube. Electronically speaking, it may be called a luminous capacitor.

Enameled Steel

Early developmental models involved at least one panel of conductive glass as an electrode. This imposed severe limitations on manufacture and use of the light. Now, however, Sylvania has found that they can use a piece of enameling steel; coating it with a mixture of phosphor and a ceramic frit, firing this mixture onto the steel, and then spraying the surface while still hot with a solution of a tin

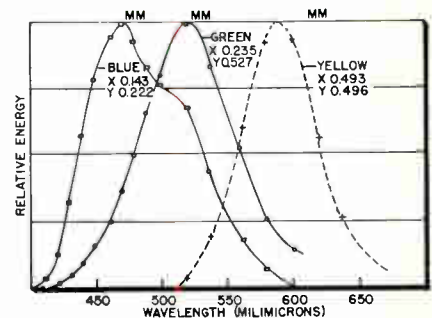

Fig. 1: Spectral energy and trichromatic coefficients of unmodified phosphors, at 60 cps

salt to form a luminous capacitor. The result is a steel-backed sheet of porcelain enamel with a transparent conducting surface of a tin compound. When an alternating potential is applied to the steel backing and the conducting front surface, the phosphor-ceramic becomes luminous.

Advantages

The new process is a great step forward for panel lighting. Its basic cost is much lower. It is not fragile. The steel sheets may be pre-cut or stamped into any desired shape with as many holes, slits, or

(Continued on page 94)

Table 1

Brightness Footlamberts at Given Frequencies

60 Cycles			Volts	400 Cycles		
Green	Blue	Yellow		Green	Blue	Yellow
.1-.3	.08-.25	.05-.1	120	.4-1.0	.3-.7	.1-1.2
.7-1.0	.5-.8	.2-.5	240	2.5-3.5	2.0-3.0	.6-1.5
2.5-3.5	2.0-3.0	1.0-2.0	600	7.0-15.0	6.0-10.0	2.0-4.0



By ROBERT T. HENSZEY

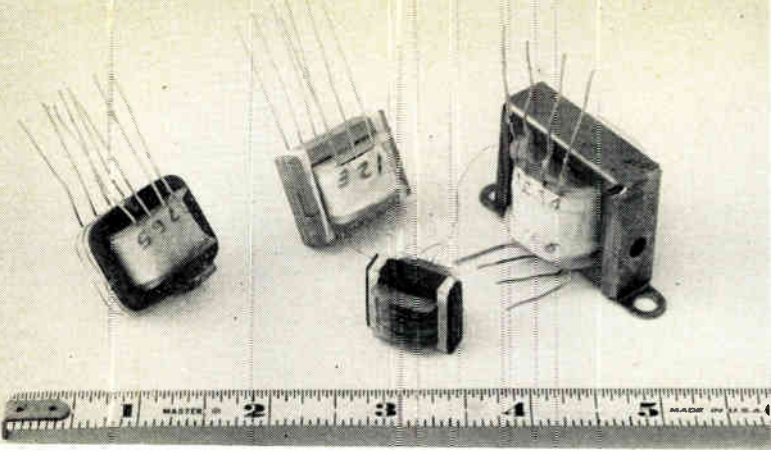

Fig. 1: Samples of miniature transformers designed & wound by the author.

Audio Transformer Design

In developmental work it is definitely an advantage to be able to design transformers quickly and not have to wait for a manufacturer's prototype. With this in mind, a simple step by step procedure has been established such that the design may be completed in only a few minutes.

Transformers suitable for developmental work may be bobbin wound without interlayer insulation and ready for use in a few hours. The production designs can be left to the transformer manufacturer. However, it is important

to consider that the size of a commercial unit may be 30 to 50% larger if producibility, reliability, and life must be considered.

Performance

The primary inductance is of major importance in most audio transformer designs. This is evident by inspection of the l-f equivalent circuit shown on Figs. 2 & 3. A primary inductance which is too low causes phase shift, loss of response and distortion. In specifying inductance, it is important to specify also the ac and dc flux levels, or the ac voltage and the dc current. The reason for this is that the incremental permeability varies with flux level such that the

inductance may easily be changed more than 10 to 1. The inductance may be increased in a transformer wound on a small core by winding many turns of fine wire; however, the efficiency will suffer because of the increased dc resistance. The designer must compromise for his particular application between performance and the minimum size.

If h-f operation is contemplated, leakage inductance and shunt capacitance must be considered. However, no problem should be encountered below 10-20 KC. The amplitude response of several transformers constructed and tested was down less than 1db at 20KC.

The first design may be based upon approximations if exact re-

ROBERT T. HENSZEY, Project Engr., Santa Monica Branch, Instruments Products Eng'g., Grand Rapids Div., Lear, Inc.

Figs. 2(1.) & 3(r.): Phase response and amplitude, respectively, for various values of the ratio of primary source to desired primary input impedance.

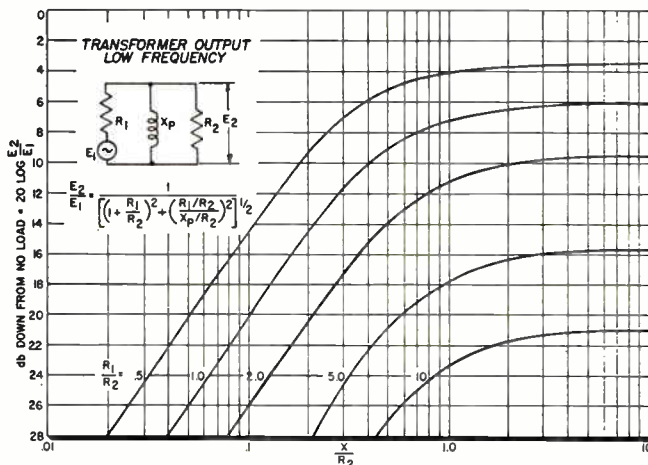
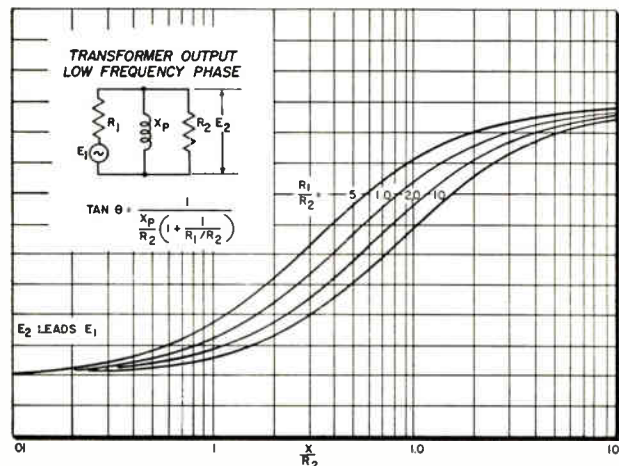

As an aid to the circuit designer, presented here is a step-by-step procedure which enables completion of developmental models in a few hours.

Short cuts

quirements for the transformer are not known. A breadboard test using the first design will yield enough information to make a satisfactory second design. This approach may seem wasteful, but small transformers wound on a standard nylon bobbin are fairly inexpensive for experimental use and may lead to a less expensive final solution when all factors are considered.

Design Prerequisites

In order to design an audio transformer for a particular application, the designer must know:

1. Primary voltage or operating power level.

Fig. 4: Arrangement of the windings on core.

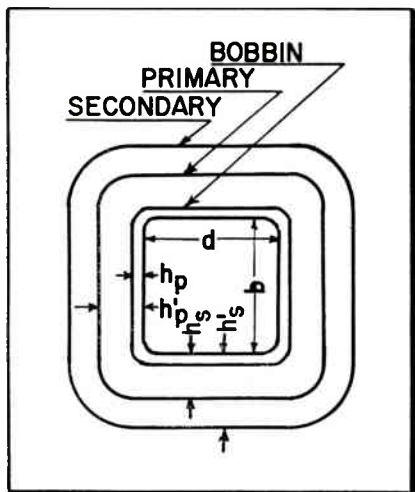

2. Load impedance.
3. Desired primary impedance reflected from the load.
4. Source impedance (i.e., collector or plate resistance).
5. Required phase or amplitude response.
6. DC current in windings.
7. Allowable losses—ac or dc.

The designer also must have available a wire table and the following curves from the magnetic material manufacturer:^{1, 2, 3.}

1. DC magnetization and permeability curves.
2. Incremental permeability curves.

Design Procedure

1. Compute R_1/R_2 and then find X_n/R_2 from the appropriate curve of the amplitude, or phase response, Eq. 1 & Figs. 2 & 3. For many transistor applications, R_1/R_2 will be 10 or greater.

2. Substitute the value of X_n/R_2 from Step 1 into Eq. 2 and solve for L_p . This is the minimum primary inductance for the performance requirements selected in Step 1.

3. Select a core size and material. Table 2 and Table 3 will serve as a guide to the selection. Where power levels of 1 watt, and several milliamperes of dc are required, a grain oriented silicon steel may be better than nickel-iron since the

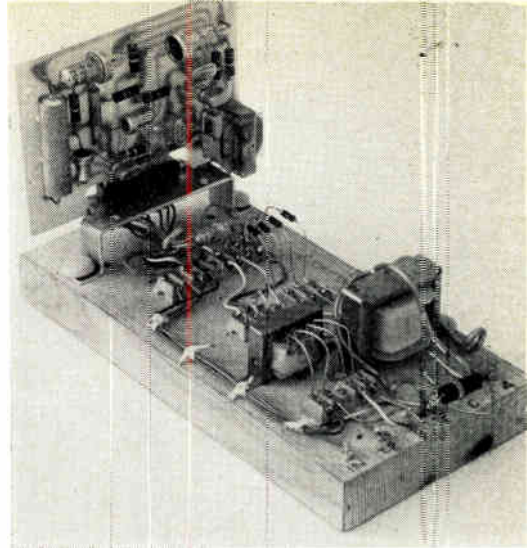

Fig. 5: A transformer bread board application.

permeability of nickel-iron is reduced so much by dc and the necessary air gap.

4. Substitute the value of L_p into Eq. 3 and solve for N_p .

5. Select a wire size and check with Eq. 4 to see if it will fit into the available window space. For most transistor applications it is desired to deliver power from the secondary and not just supply grid voltage. Therefore, the primary copper area will equal the secondary copper area or $N_p cm_p = N_s cm_s$. Otherwise, N_s may be computed from Eq. 5. If at this point there appears to be too much or too little space for the wire, select a new core size and recompute N_p . The value of "k" in Eq. 4 is determined empirically and may vary 10 to 15% with wire tolerance, insulation, and winding technique.

6. If the primary voltage is not known, it may be computed from the power level using Eq. 6.

7. Substitute the value of N_p into Eq. 7 and compute the ac flux density, B_{ac} .

8. Let the dc flux density, B_{dc} , be equal to the maximum desired operating flux density for the core material selected minus B_{ac} , Eq. 8. This allows the minimum air gap to be used. Since the ac permeability decreases with increasing air gap or increasing dc flux density, it may be seen that there is an

Audio Transformer

(Continued)

optimum gap for every set of conditions. However, the minimum gap will be satisfactory for most conditions.

9. Compute the length of air gap with Eq. 9 after substituting the value of B_{dc} . The dc permeability (μ_{dc}) of the same material without air gap is obtained directly from the magnetization — permeability curve of the material selected.

10. Now that l_g is known, the inductance may be computed using Eq. 10. The ac permeability (μ_{ac}) of the core material without air gap is obtained directly from the incremental permeability curves of the material selected. The value of N_{dc} (oersteds) to use in determining μ_{ac} is found on the dc magnetization curve and is the value corresponding to the known B_{dc} . If the computed value of L_p differs from that determined in Step 2, appropriate corrections may be made either by changing the number or turns, or by changing the core area. In either case, if an appreciable change is made, Eqs. 4-10 should be recalculated.

11. Compute the mean length of turn for each winding. Eq. 11.

12. Compute the dc resistance of each winding, using Eq. 12 and the ohms/in. from a wire table. If the dc resistance of the primary is comparable in magnitude to the source resistance, recompute Step 1.

13. Compute the efficiency using Eq. 13⁴.

Numerical Example: The design specifications for a typical transistor amplifier interstage transformer follow:

1. Primary voltage = 6v (max. collector swing).
2. Load impedance = 1000 Ω (input to next stage).
3. Desired load impedance reflected to the primary = 20,000 Ω .
4. Source impedance = 100,000 Ω (collector resistance).
5. Maximum phase shift at 400 cycles, 15°.
6. Primary dc = .8ma; no secondary dc.
7. The efficiency should be better than 75%.

TABLE 1

Audio Transformer Design

Equations	Symbols
1. Response requirements combined with $\frac{R_1}{R_2}$ yields $\left[\frac{X_n}{R_2} \right]$ (See Fig. 1 or 2)	A_e = Effective core area (in. ²). A_e effective = .9 A_e measured.
2. $L_p = \frac{R_2}{2\pi f} \times \left[\frac{X_n}{R_2} \right]$	A_w = Bobbin Window area (in. ²)
3. $N_p = \left[\frac{L_p \left(l_g + \frac{l_c}{\mu_{ac}} \right)}{3.19 A_e \times 10^{-8}} \right]^{\frac{1}{2}}$ 1st approximation for moderate dc let $\left(l_g + \frac{l_c}{\mu_{ac}} \right) = .001$	B_{ac} = AC flux density (gauss) B_{dc} = DC flux density (gauss) E = AC voltage (rms volts) I_{dc} = Unbalanced direct current (amps.) L_p = Primary shunting inductance (henrys)
4. $N_p cm_p + N_s cm_s < kAw$ $\times 1.273 \times 10^6$ $k = .45$ for #35 to 44 HF wire bobbin wound	MLT = Mean length turn (inches) N = Turns P = Primary power level (watts)
5. $N_s = N_p \left[\frac{R_L}{R_2} \right]^{\frac{1}{2}}$	R_L = Load resistance (ohms) R_p = Primary winding resistance (ohms)
6. $E = \left[PR_2 \right]^{\frac{1}{2}}$	R_s = Secondary winding resistance (ohms) R_1 = Primary source impedance (collector resistance, etc.) plus R_p (ohms)
7. $B_{ac} = \frac{3.49 E \times 10^6}{f A_c N_p}$	R_2 = Desired primary input impedance: $R_L + R_s$ referred to primary (ohms)
8. $B_{dc} = B_{total} - B_{ac}$	X_n = Primary reactance (ohms) a = Core width (inches) b = Stack height (inches)
9. $l_g = \frac{.6NI_{dc}}{B_{dc}} - \frac{l_c}{\mu_{dc}}$ where: $NI_{dc} = N_p I_p + N_s I_s + \text{etc.}$	cm = Bare circular mil area f = Frequency (cps) h = Distance from core to inside of winding (in.) h' = Distance from core to outside of winding (in.) l_c = magnetic core length (in.) l_g = Effective air gap (in.) μ_{ac} = Incremental permeability μ_{dc} = DC permeability
10. $L_p = \frac{3.19 N_p^2 A_e \times 10^{-8}}{l_g + \frac{l_c}{\mu_{ac}}}$	(Continued on page 130)
11. $MLT = 2(a + b) + \pi(h + h')$	
12. $DCR = MLT \times N \times \Omega/\text{in.}$	
13. $\eta = \frac{1}{1. \times 1.5 \frac{\left[\frac{N_s}{N_p} \right]^2 R_p + R_s}{R_L}}$ $\times 100\%$ (Approximation including core loss) ⁴	

Fig. 6: Four samples of the many standard nylon bobbins available for square core transformers.

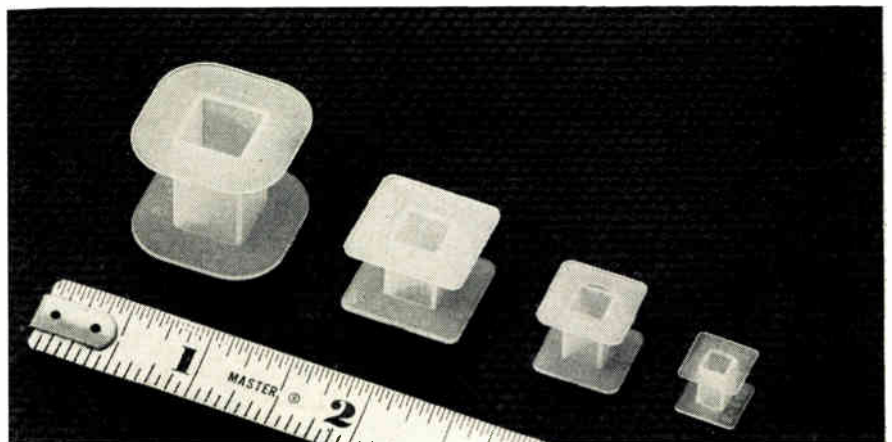

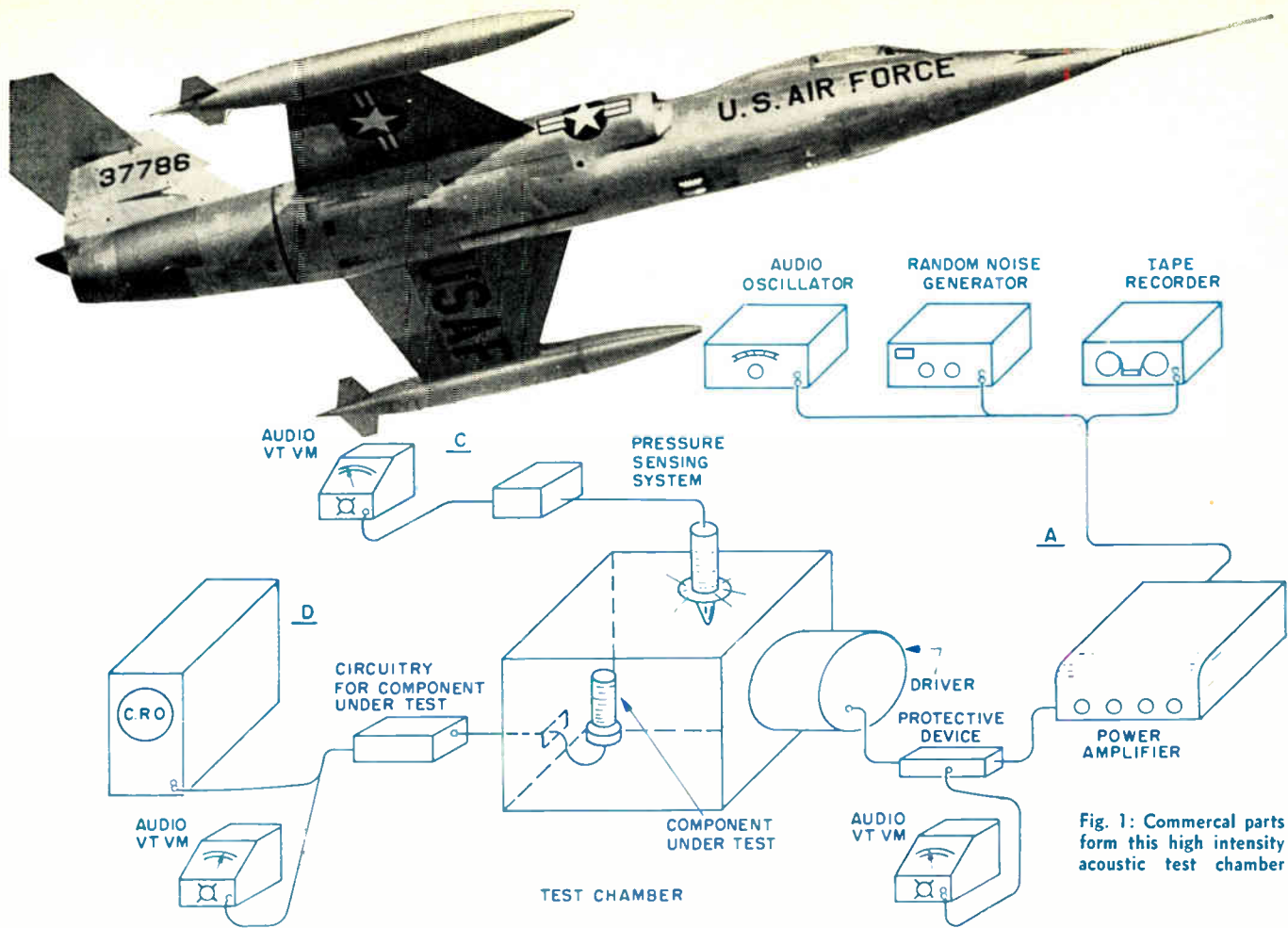

Fig. 1: Commercial parts form this high intensity acoustic test chamber

By R. H. JACOBSON
 Research Engineer Armour Foundation
 Chicago, Illinois

The Scream of a Jet —In a Six-Inch Test Cell

Within a six-inch cube, this new acoustic test chamber duplicates the high sound intensities in an air force jet plane. Tests with the inexpensive laboratory equipment prove large changes can occur in characteristics of electronic components subjected to intense sound

Vibration, shock, and high intensity sound are all met in airborne installations. Vibration and shock testing equipment are now common equipment in electronic test labs. New equipment is needed, however, to duplicate the high intensities of sound present in modern jet aircraft. For such

acoustic excitation tests, the Armour Research Foundation has designed and constructed a high intensity sound chamber.

Principle

The ARF sound chamber is based on the reverberant chamber principle. It uses inexpensive,

commercially available components in a rather simple installation. The basic principle of operation follows:

If an enclosed space contains a sound generator which is radiating sound at a given power P , the sound intensity I will build up until the power dissipated at the

Acoustic Test Cell

(Continued)

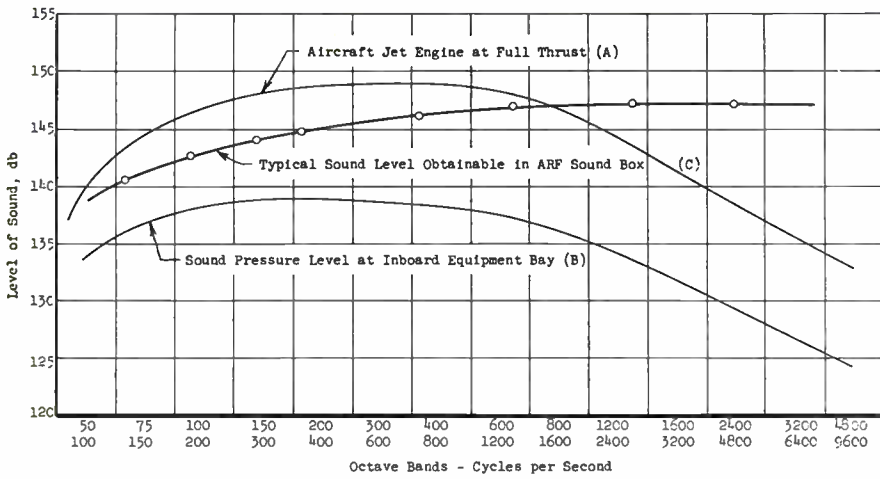

Fig. 2: This graph presents typical sound spectra for operating jet aircraft engines

walls (and in the air) is equal to the input power. If the intensity is assumed to be uniform throughout the enclosure, its value is given by the expression³

$$I = \frac{P}{a}$$

where a is the total absorption in units of area. If P is given in watts and I in watts/cm², the absorption should be expressed in cm² units.

To establish a framework for discussion, it should be noted that the reference level for airborne sound, 0 db, is 10⁻¹⁶ watt/cm². Thus, an intensity level of 140 db represents an intensity of 0.01 watt/cm².

In order to achieve a high sound level with a modest acoustic-power input, a low total absorption is required. This dictates the use of a small chamber with acoustically "hard" walls and construction; that is, with walls and general construction highly reflective or non-absorbing for sound.

Construction

A chamber size of 6 x 6 x 6 in. was selected. The sides of the chamber are constructed from 12-gage sheet metal and are reinforced with 1/2 x 3/4 in. aluminum ribs. For simplicity, in the first experimental model, a standard electronic chassis box 6 x 6 x 6 in. was used.

The end plates, which are removable, are made of 1/2 in. aluminum and are secured by studs extending from the body of the chamber. An Altec-Lansing 730A 40-watt loud speaker driver is mounted on the back plate to provide excitation. In a later configuration, an experimental Jensen unit of somewhat higher power capacity was used. The front plate mounts the connectors necessary to bring leads in and out of the chamber. All joints are made tight in an effort to assure complete closure of the chamber.

Signal Source

The basic signal may come from one of 3 sources: An audio oscil-

lator, which provides single frequency sine-wave input; a random noise generator which provides broad-band sound covering the frequency range of 20 to 20,000 cps (white noise); or a tape recorder which could be used to provide special signal inputs, such as recorded sounds of a jet engine.

The signal source drives a power amplifier which provides the 40 to 50 watts power required to operate the driver. A fuse to protect the driver from overload, and a shunt load resistor to prevent damage to the amplifier, should the driver fail, are located between the amplifier and the driver. An a-f VTVM is placed across the driver input for measuring the input power.

Pressure Measurements

Three gages are used on the cell. Two are barium titanate pressure sensors of ARF design,^{4, 5} the third is an Altec-Lansing condenser microphone designed for measurement of fairly

Fig. 3: Typical operation of the ARF test chamber at 2300 cps

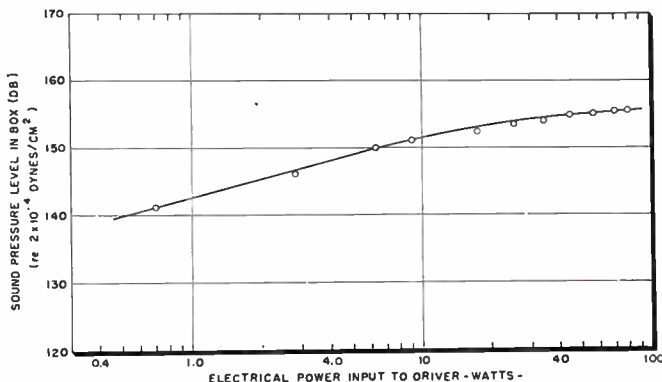
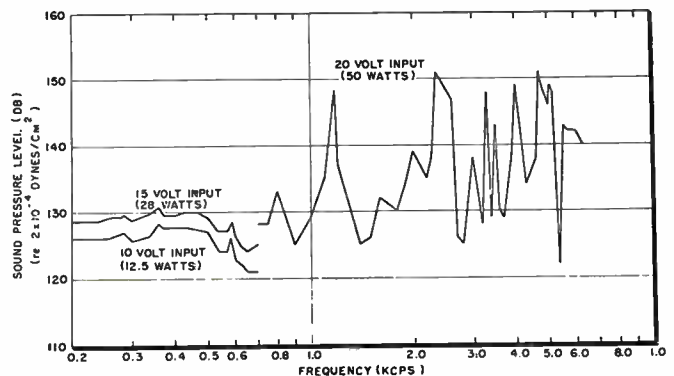

Fig. 4: Calibration curve of experimental acoustic test chamber



level of 140 to 143 db in a frequency band of 20 to 20,000 cps when the random noise generator is used as signal source.

Resonance Effects

Operation from a sine-wave source is particularly useful in determining resonance of components. Figure 3 is based on actual data obtained at 2300 cps, which is one of the chamber resonances. At this resonance, a level of 150 db is obtained with about 7 watts electrical input.

For operation at a single off-resonance frequency, the curve shown in Fig. 3 is displaced downward. Measurements of the "Q" (resonant magnification) of the chamber were made by the bandwidth method and yielded Q values of 47 at half-wave resonance, 80 at full-wave resonance, and 111 at the 2nd harmonic resonance. This is consistent with the sharp peaks seen on the frequency response curve, Fig. 4.

high acoustic pressures. Sound pressure level in the chamber is determined by reading voltage output of the microphone on an a-f VTVM. Since the chamber was first constructed, tightly sealed plexiglass windows have been added to allow visual observations and optical measurements to be made on the component under test. A cathode-ray oscilloscope is used to monitor the wave form of the sound field.

Instrumentation

The component under test is located in the sound chamber, near the windows. Connections between the component and its circuitry are made through the connectors on the back plate, thus preserving a tight seal on the chamber. The circuitry for the component under test is located outside the chamber and appropriate instruments connected to detect the effect of the sound field. The oscilloscope and audio frequency VTVM, shown in Fig. 1, are used for electron tube tests.

Calibration

The sound chamber is calibrated by supplying power at a given frequency to the driver and measuring the sound pressure level in the chamber. Figure 4 shows the frequency response of the sound chamber at several values of constant power input. The variations in intensity at the higher frequencies are caused by resonances within the chamber. Sound pressure levels of 145 to 150 db are obtainable with approximately 50 watts of electrical input. This same power level yields a sound

Typical sound spectra found aboard and in the proximity of an air force jet aircraft are shown in Fig. 2. Curve A shows the average sound level, in each octave band, measured approximately 10 ft from the tail-pipe of the jet engine operating at full thrust. Curve B represents the sound level measured for the same aircraft at the inboard equipment bay. The noise level at the equipment bay approaches 140 db. These 2 curves do not represent the worst possible conditions, but are typical of conditions found in service.

These conditions must be duplicated by a laboratory device to evaluate properly the effect of acoustic excitation encountered in service on electronic components. An average sound pressure level easily obtainable in the ARF sound chamber, both with the random noise generator and with the audio oscillator input, is shown by curve C. This average level is well above the sound level encountered at the equipment locations.

The vibration response of the sound chamber was investigated to be sure that the response of a

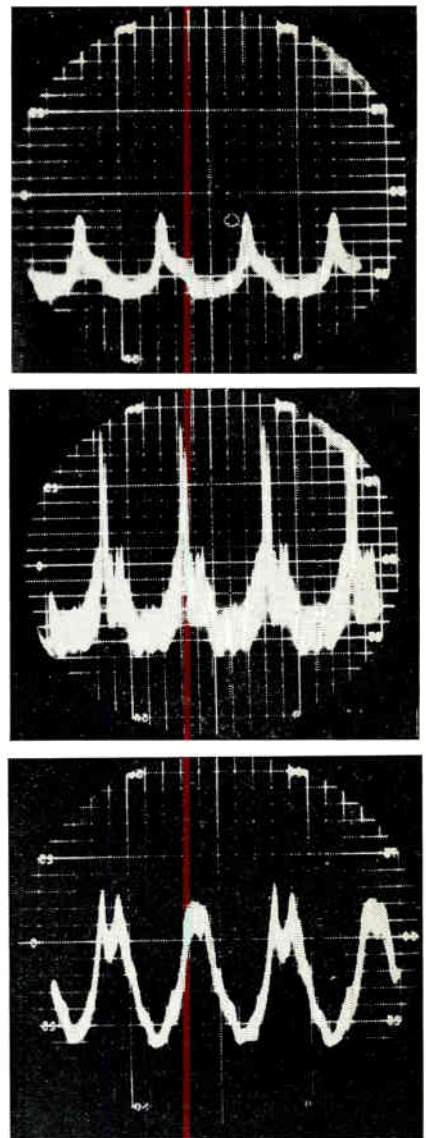

Fig. 5: Contact resistance in 130 db field (top, 950; center, 1100; bottom, 1400 cps)

component mounted in the chamber during a test was due to direct impingement of sound on the component, and not to vibration transmitted through the mounting bracket. A Gulton Model A315 Accelerometer was successively mounted on the rear inside wall of the sound chamber, mounted on the component mounting bracket, and hung by its flexible lead in the chamber without contacting any part of the chamber.

The accelerometer output was measured for discrete-frequency sounds of 120 db at frequencies ranging from 200 to 6000 cps, and with white noise excitation at levels from 100 to 140 db. The result of these tests indicated that the maximum mechanical vibra-

(Continued on page 112)

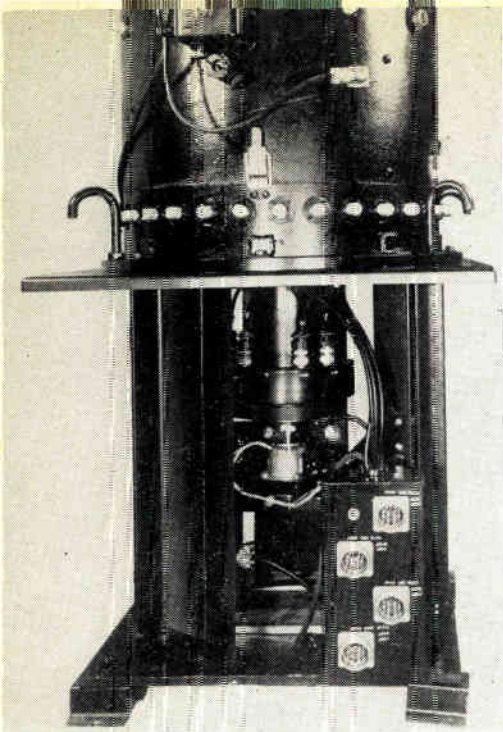

Fig. 8: Scanning switch, the cover removed

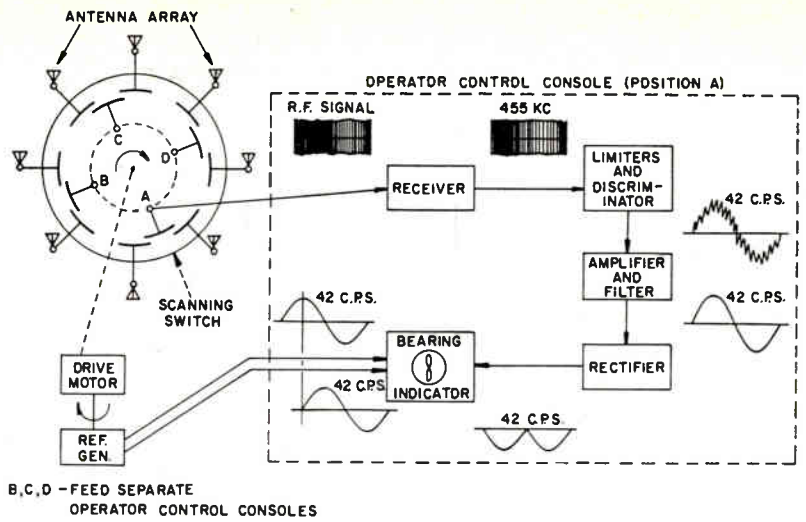

Fig. 9: Diagram of basic Doppler system and derivation of frequency modulated waveform

Applying the Doppler Effect to Radio Direction-Finding

By JOSEPH A. FANTONI and RICHARD C. BENOIT JR.

The effect of a moving antenna is simulated by using a circular array of fixed antennas. By scanning the antennas in sequence and comparing the phase angle differences between the sampled voltages the direction of transmission can be determined and plotted.

Fig. 10: Typical pattern presentations: 1. to r., for no signal, when receiving a signal, and with ambiguity resolved by sensing switch.

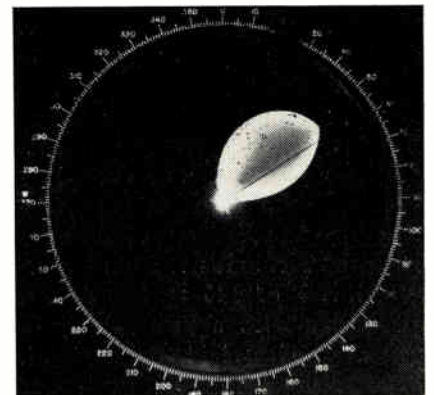
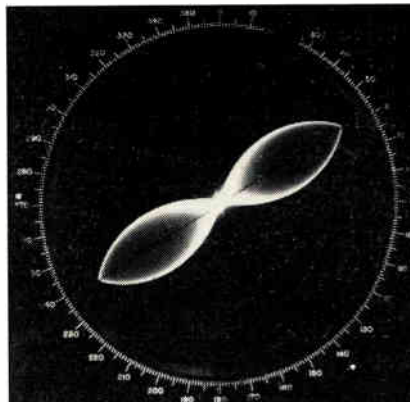
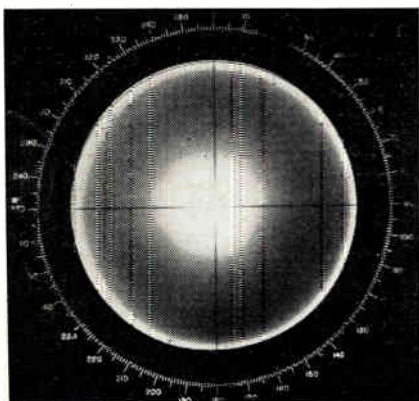

Part Two of Two Parts

The antenna system consists of 31 vertical monopoles, approx. 23 ft. high, equally spaced around the circumference of a circle 150 ft. in dia.

In a quasi-Doppler system of this type, large phase steps between antennas are not desirable. A phase step of 180° would give an infinite frequency deviation and an instantaneous reduction of the discriminator output signal amplitude to zero.

The 31 element array in a 150 ft. dia. circle provides an approximate 0.433 wave length spacing at 30 MC. The system works surprisingly well right up to the cut-off frequency where the phase steps became 180° .

Individual mesh ground mats and a system of 3 wire radials of random length, extending radially from each antenna base, are used to simulate a ground plane.

A standard double-shielded coaxial cable is used with each monopole for connection to the antenna scanning switch. (Fig. 9)

The i-f signal from the receiver is fed to limiter stages to remove any amplitude modulation and applied to a Foster Seeley discriminator. The i-f bearing signal from the discriminator has a fundamental component of 42 cps corresponding to the scanning switch rotational speed. This signal is amplified and filtered, then further amplified and rectified. This signal is applied to the bearing indicator. Bearing sense is accomplished by applying a small unrectified bearing signal to the rectified signal through a phase shifter and by

simultaneously shifting the phase of one of the reference generator signals 180° .

The Doppler principles of operation inherently lack bearing ambiguity. This is introduced in the system by rectifying the detected signal, a requirement imposed as a result of the selected bearing indicator design and display.

Bearing Indicator

The bearing indicator employed is basically of conventional design. It employs balanced modulators and a CRT to translate the input rectified bearing signal envelope having a direction dependent phase into an indication of bearing. A 7 in., flat screen CRT was chosen for this application. It is especially designed for bearing indicator use, having the characteristic of high deflection linearity, which is required to reduce bearing error. A precision alidade is provided for added reading accuracy.

Typical pattern presentations are shown in Fig. 10. Fig. 10A is the "no signal" pattern presentation, whereas Fig. 10B is a typical indicator pattern on receipt of a signal. The propeller tips serve as pointers to indicate bearing. This bearing ambiguity is resolved (as shown in Fig. 10C) by manual operation of the sense switch. The sense pattern is folded away from the direction of signal arrival.

Operator Control Consoles

The operator console, Fig. 11, contains the detector chassis at the top, the bearing indicator, communication receiver, power control panel, and power supplies.



Fig. 11: Console, contains detector chassis, indicator, receiver and power supplies

An i-f deviation indicator, located on the detector panel, is provided to aid the operator in tuning the receiver to the exact frequency of the received signal. This insures that the frequency deviation of the bearing signal is centered on the linear portion of the discriminator curve.

The design is such that 4 operator control consoles can be simultaneously operated using a single antenna array and scanning switch.

Bearing Storage

One of the novel features embodied in this design is a bearing storage or memory system to provide a continuous, steady bearing indication on short duration transmissions, high speed code or carrier shift radio telegraph transmissions.

The bearing storage system employs a magnetic drum which is directly driven from the scanning switch rotor shaft and a record-reproduce head assembly. The recording of the bearing signal, storage and readout function is
(Continued on page 124)

Fig. 12: Threshold signal levels necessary for bearing indications at various frequencies

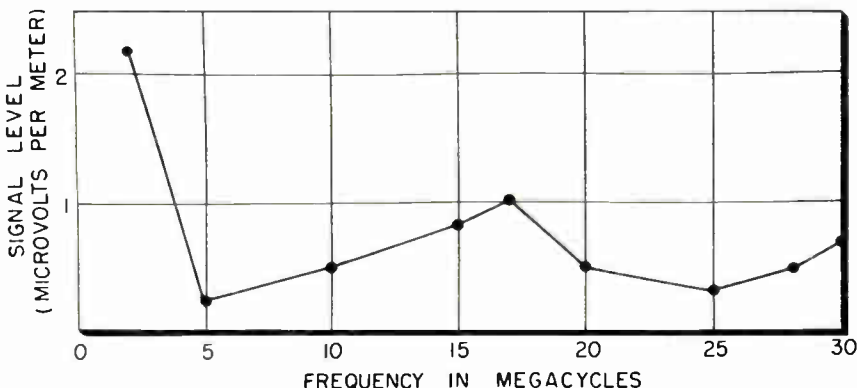

Standardized White Noise Tests

Wide frequency, high-G tests for missile components give simple meter noise readings—are adaptable to large scale testing



By J. ROBBINS

Sylvania Electric Products, Inc., Emporium, Pa.

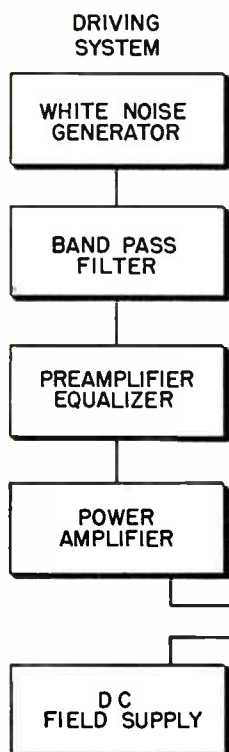

The increasing interest in the vibrational performance of vacuum tubes, as in guided missiles, has created a demand for test methods capable of evaluating tubes over a broad range of vibrational frequencies at relatively high values of acceleration. One possible approach is the use of sine wave vibration, swept over a wide spectrum such as 200 to 2,000 cps. This test is too time consuming for large-scale testing. A rapid sweep rate will produce erroneous noise readings, but if the test is performed correctly it is useful as a design test. Another

Fig. 1: Block diagram of white noise test

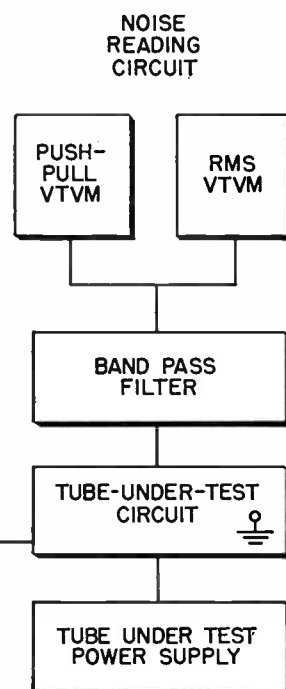

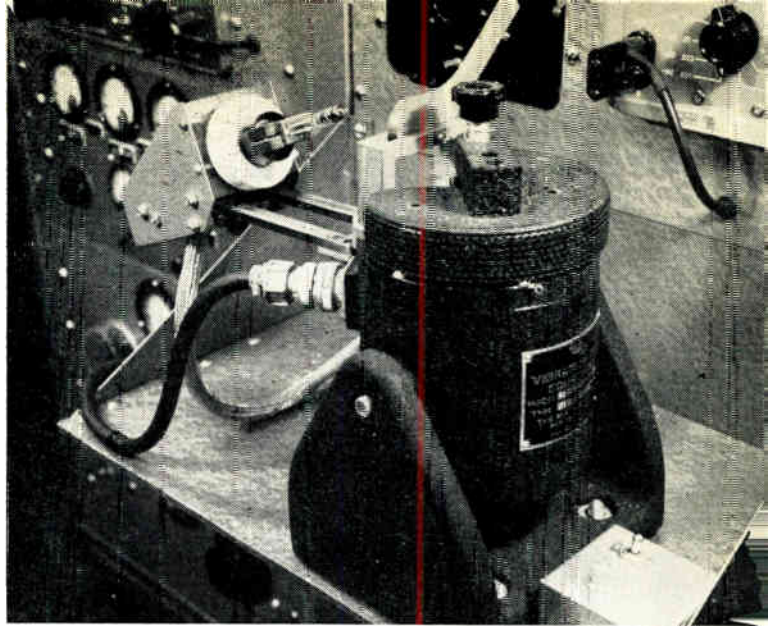
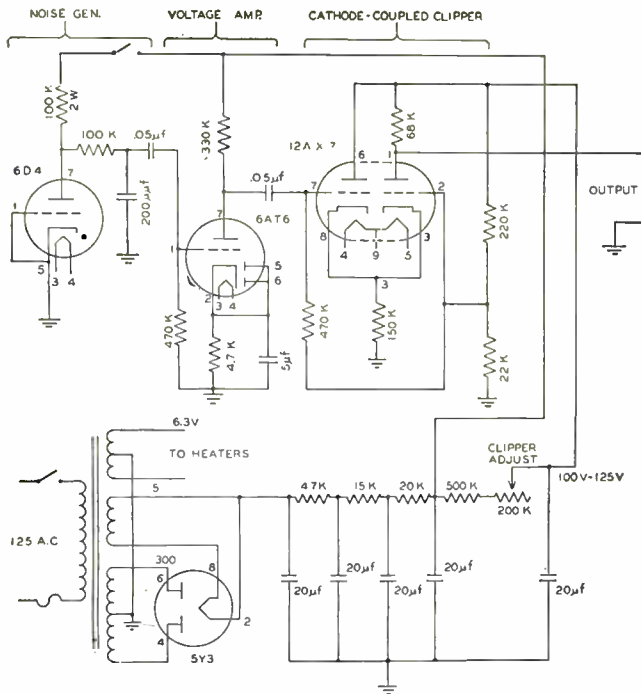

Fig. 3 (above): Audio accelerator unit for the white noise test

Fig. 2 (left): Generator, amplifier, and clipper for acceleration test

technique is the use of magnetically recorded multifrequency vibrational conditions especially for specific known installations; but this method by itself lacks generality. The idea of white noise vibration has often been considered and this approach was followed in a wide frequency vibration test developed by Sylvania under Bureau of Ships Contract NObs 8023. This test is not restricted to any particular tube application, utilizes simple meter type noise readings, and should be adaptable to large scale testing. The test equipment developed is for subminiature tubes, but the test procedure itself is also suitable for any other tube type or component.

White Noise Test

The standard fixed frequency, fixed g level vibration test is defined simply and concisely by the conventional methods. The specified g level (for example 15 g's) refers to the maximum value of acceleration experienced during sine wave vibration at a single specified frequency (for example 40 cps). This type of specification is not directly applicable to a white noise vibration test which necessarily has peak values of acceleration occurring at highly irregular intervals, while the intermediate acceleration values com-

prise a random path in time instead of a sine wave. White noise acceleration is properly a random noise function and can be represented by procedures utilized by S. O. Rice in his article "Mathematical Analysis of Random Noise."¹ The approach is as follows: Let $e(t)$ be the noise function. Consider the instantaneous values of $e(t)$ to be plotted versus time. The resulting plot may be analyzed as a Fourier series over an arbitrary time interval of length T , resulting in one set of Fourier coefficients for the following equation.

$$e(t) = C_1 \cos(\omega_1 t - \phi_1) + C_2 \cos(\omega_2 t - \phi_2) + \dots + C_n \cos(\omega_n t - \phi_n) \quad (1)$$

$$\text{or } e(t) = \sum_{n=1}^N \frac{C_n \cos \omega_n t - \phi_n}{N} \quad (2)$$

$$N \rightarrow \infty \\ \Delta f \rightarrow 0$$

If the analysis is repeated many times for different intervals of time, all of length T , different values of phase angle, ϕ , result. $\phi_1, \phi_2, \phi_3, \dots, \phi_n$ will each assume values which are randomly distributed between zero and 2π radians. Thus in equation (2),

ϕ_n = random phase angle distributed uniformly over the range $(0, 2\pi)$

$$C_n = [2W(f_n) \Delta f]^{\frac{1}{2}}$$

$W(f_n) \Delta f$ = Value of power represented by bandwidth Δf at frequency f_n

$\omega_n = 2\pi f_n$

Δf = Bandwidth associated with the n th frequency component

$e(t)$ = Random noise function. This function can be considered to be either acceleration or its voltage analog.

Equation (2) shows that a random noise function may be viewed as containing a wide spectrum of frequencies and is therefore called "white noise" in comparison to white light which contains all visible wave lengths.

The RMS of $e(t)$ in eq. (2) is easily shown to be

$$e_{RMS} = \sqrt{\sum_{n=1}^N \frac{C_n^2}{2}} \quad (3)$$

where $N \rightarrow \infty$ and $\Delta f \rightarrow 0$

Equation (3) is equally valid when N is a finite number of components, each represented by its RMS value and each associated with a specific band in the spectrum. The RMS value for the entire spectrum is then

$$e_{RMS} = \sqrt{\sum_{n=1}^N E_n^2} \quad (4)$$

where $E_n = \frac{C_n}{\sqrt{2}}$ = RMS value of n th

(Continued on page 114)

STANDARDS RECEIVER

Tube model SR-7 receiver is for receiving radio transmissions from the NBS through stations WWV or WWVH. Sensitivity: Less than 2 μ v of signal is required to produce a sig-

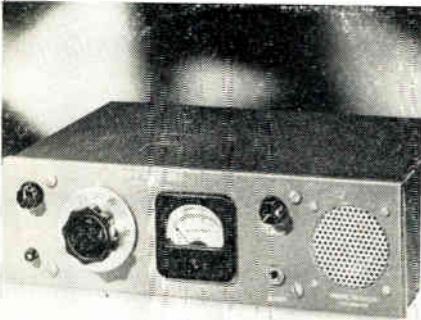

nal-to-noise ratio of 10 db on all operating frequencies. Freq. Coverage: 2.5, 5, 10, 15 and 20 MC, crystal controlled. Selectivity: 6.5 kc at 20 db down. I-F Freq.: 1990 kc and 175 kc. Output: 250 mw into 10,000 Ω load. A. N. L.: Series type noise limiter. Antenna Input: 52 Ω and high impedance. Bench or rack mounting. Specific Products, 14515 Dickens St., Sherman Oaks 2, Calif.

Circle 39 on Inquiry Card, Page 97

SOCKET MOUNTING

A multiple right angle socket mounting for use in conjunction with printed circuits has been designed and is now being manufactured. The multiple mounting can be used for two, three, four, etc., sockets, and similarly can be applied for the mounting of other electronic components such as resistors and capacitors that have not previously been incorporated into the

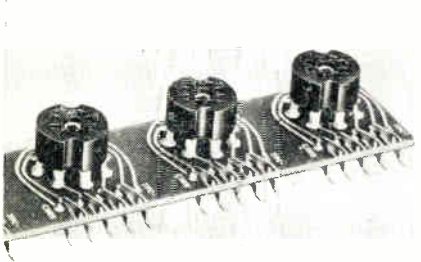

circuit. It can incorporate either sockets of the same or varying sizes, and can be constructed to meet the combinations and specifications required. Cleveland Metal Specialties Co., 1783 E. 21st St., Cleveland 14.

Circle 40 on Inquiry Card, Page 97

ELECTRICAL METER

Instrument is a ruggedized and sealed 2½ in. round basic meter made to meet the requirements of MIL-M-6A and MIL-M-10304A. It features extra high sensitivity, high torque-



to-weight ratio, a minimum number of parts, and a new simplified pressure-method of sealing and ruggedizing. These meters are available in all standard ranges of microammeters, milliammeters, ammeters and voltmeters. Presently meters are produced for original equipment manufacturers only, and also for own line of tachometer generators.. WacLine, Inc., 35 So. St. Clair St., Dayton 2.

Circle 41 on Inquiry Card, Page 97

LOAD ISOLATOR

Model U90 Ferrite Load Isolator is especially designed for new military radar operating in the Ku-Band frequencies. It provides a min. of 10 db isolation over the bandwidth of 16,300 to 16,700 MC at 90 w. average power and 90 kw peak. Insertion loss is 0.7 db max., and the input VSWR is 1.05 max. A simple and compact solution to "Long-Lines" and other



magnetron loading problems caused by lengthy transmission lines or excessive VSWRS. Guaranteed over a range of -55° C to +100° C. Litton Industries, Components Div., 5873 Rodeo Road, Los Angeles 16.

Circle 42 on Inquiry Card, Page 97

ZIPPERTUBING

Used to enclose, identify and protect multi-conductor wiring in the aircraft, electronic or electrical industries. The zipper pull-tab is detachable. Tubing may be "unzipped" and

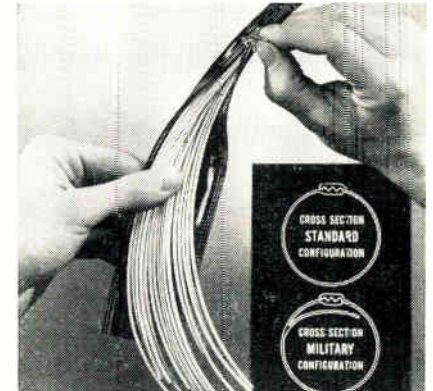

re-used, or permanently sealed with a sealer. When sealed will withstand a linear strength-test of 30 lbs./in. Meets MIL-I-631B and MIL-I-7444A. ID's are from ½ to 4½ in. in increments of ¼ in. Custom cabling for experimental use can also be made up quickly, avoiding prohibitive factory set-up costs. W. A. Plummer Mfg. Co., 752 S. San Pedro St., Los Angeles.

Circle 43 on Inquiry Card, Page 97

PULSE CONVERTER

The Model 8915 Rotostepper, an electro-mechanical shaft positioning device which provides controlled incremental shaft rotation of one 2° step per dc pulse. Rotation is unlimited clockwise or counter-clockwise, and stepping speed is as rapid as 60 steps/sec. with torque output as high as 14 oz. in. Between pulses, shaft position is locked in an accurate shaft



angle by a spring detent. Nominal input of 1 a. at 28 v. dc for a pulse duration as short as 10 msec. will accomplish one 2° step. G. M. Giannini & Co., Inc., 918 East Green St., Pasadena 1, Calif.

Circle 44 on Inquiry Card, Page 97

TRANSDUCERS

Designed for telemetering and other applications requiring high signal levels, these unique resistance-type temperature transducers give outputs up to 5 v. without amplification. Mod-

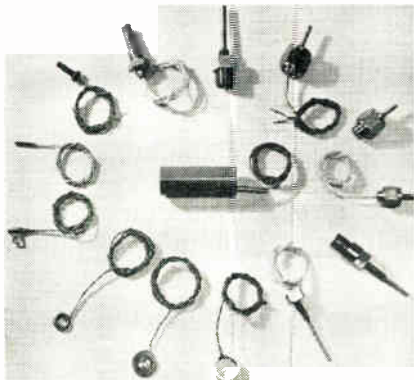

els are available in a wide variety of physical configurations for measurement of surface, fluid, and air temperatures. Standard units cover -320°F to +500°F range with ±2% linearity. Special units are available to 1600° F. Nominal resistance values offered are 100 Ω to 20 K Ω. Units may be used in ac or dc bridge circuits. Arnoux Corp., 11924 West Washington Blvd., Los Angeles 66.

Circle 45 on Inquiry Card, Page 97

VIBRATOR

A new kind of construction is featured in the Series 1600. The design eliminates the usual button contacts. The vibrating reed and side arms themselves, made of special contact alloy, act as the contacting elements. Far greater contact area than previously possible is afforded. Life is increased by 50 to 100 per cent. Sticking of contacts is eliminated, and



wear is distributed over a larger surface. Mechanical hum is held to new low level, due to the lighter vibrating mass and to noise-reducing refinements. P. R. Mallory & Co., Inc., P. O. Box 1558, Indianapolis 6.

Circle 46 on Inquiry Card, Page 97

VOLTAGE REGULATOR

A new transistorized voltage regulator is offered in 2 models of varying current capacities. This precision regulator is designed for use under rugged environmental conditions

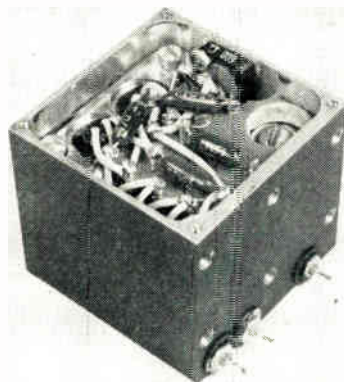

where performance, spacing and weight are at a premium. The circuitry employs a series power transistor and a temperature compensated Zener diode reference voltage. Voltage, current, regulation, size and other parameters may be widely varied to suit specific applications. Input voltage is 27.5 vdc ± 15%. Western Gear, Electro Products Div., 132 West Colorado St., Pasadena 1.

Circle 47 on Inquiry Card, Page 97

ANTENNA

This dual frequency antenna consists of a 24 in. aluminum parabolic dish with 2 individual dipoles. The design of the antenna is such as to allow the dipoles to be adjustable for either horizontal or vertical polarization. One combination of dipole feed and dish covers the frequency range from 1000-1350 mc; the other combination covers from 2750-3000



mc. A type N coaxial fitting is provided on the dipole unit. Similar units can be supplied in other bands, depending on specific requirements. Sage Laboratories, Inc., 30 Guinan St., Waltham, Mass.

Circle 48 on Inquiry Card, Page 97

INDUCTION MOTOR

A split-phase induction motor, designed for use in office machines, blowers, pumps, coin handling machines, etc., has been made available. Ratings are 1/20 and 1/15 HP at



1725 rpm, and 1/30 HP at 1125 rpm. It is available with resilient mounting, thermal overload protection, centrifugal cutout, and attractive gray mottled baked enamel finish. Close tolerance assures efficient operation. Present packaging requires that the motors be sold in multiples of ten. However, single units are available for experimentation. Bodine Electric Co., 2254 W. Ohio St., Chicago 12.

Circle 49 on Inquiry Card, Page 97

TUBE SHIELD

This new sub-miniature tube shield mount is of a right angle design having an integral socket for 3, 4, 5, 6 and 7 pin flat press sub-miniature tubes. The design gives a compact, easy-to-install heat-dissipating clamping mount, ideal for use in confined spaces while permitting ready access for service or tube replacement. The right angle configuration provides

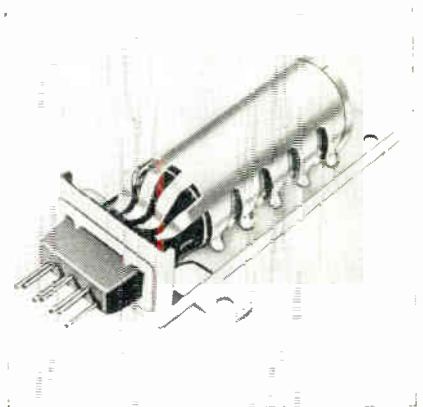

tube retention through a patented metal-to-glass contact method on the bulb along with the precision fit of the socket. International Electronic Research Corp., 145 W. Magnolia Blvd., Burbank, Calif.

Circle 50 on Inquiry Card, Page 97

RELAY TERMINALS

Type 8 relay is now available with printed circuit terminals. Designed to retain all characteristics of fast operation, long life and great reliability, the new model is ideal for switch-

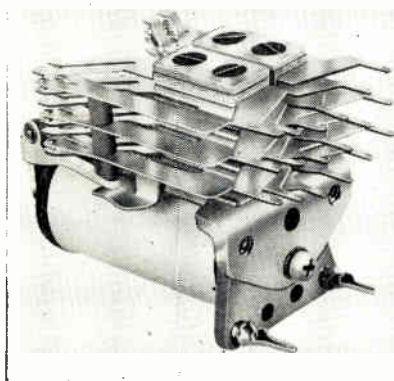

ing current loads. For very low-level loads, gold alloy or other special contact materials, are available. Terminals are tinned for ease of soldering and for ready insertion into circuit board. They are ribbed for added strength, fully supporting the relay and eliminating mounting screws. Terminals for contact springs are spaced for max. clearance. Philips Control Corp., Joliet, Ill.

Circle 51 on Inquiry Card, Page 97

POWER PACKS

A new line of adjustable voltage semiconductor regulated ac operated dc power supplies. These provide a rugged reliable stable source of power for reference applications, transistorized equipment, guided missile service, computer units, and all types of miniature and standard size electronic devices. Available for either 60 or 400 cycle operation, 105-125

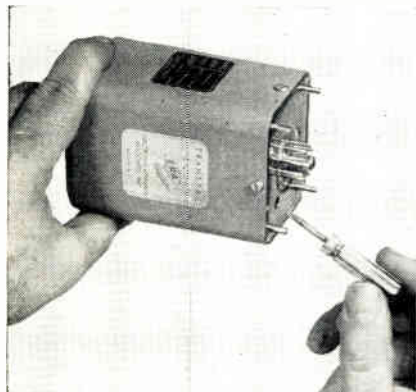

vac input, and for output voltage ranges of 5-10, 10-20, 20-30, 30-40, 40-50, 50-55, at current ratings up to 200 ma. Electronic Research Associates, Inc., 67 East Centre Street, Nutley 10, New Jersey.

Circle 52 on Inquiry Card, Page 97

R-F CHOKES

Individually checked, and providing high Q in small size, a new line of r-f chokes has been developed. These series include solenoids on phenolic and powdered-iron forms and pie-

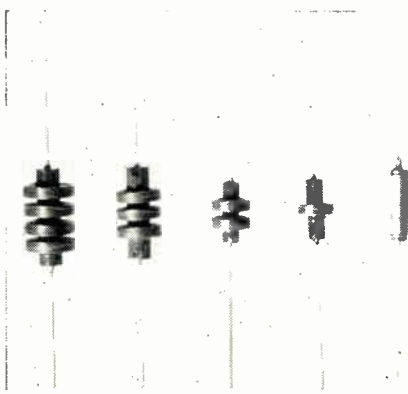

wound coils on ferrite cores, phenolic forms, and powdered-iron forms, all with pigtail leads. Pie-wound coils on ceramic forms have soldering terminals secured to the form. Finish conforms to MIL-V-173A; special finishes can be supplied. Inductance ratings are from 1.1 μ and up. Current ratings are from 50 ma. to 2800 ma. Waters Mfg., Inc., P. O. Box 368, South Sudbury, Mass.

Circle 53 on Inquiry Card, Page 97

COUPLER

A new coupler has been introduced. It is a high power coaxial directional coupler with minimum directivity of 23 db. for the frequency range 100 through 3,000 MC. Available in line sizes from Type N to 3 1/8 in. and will handle full power rating of these line sizes. These high power, high directivity, broadband couplers can be furnished either uni-directional or



bi-directional, with choice of input and output flanges. The V. S. W. R. is less than 1.15 to 1, for main line. Accuracy within 0.25 db at center frequency. Douglas Microwave Co., Inc., 252 E. 3rd St., Mt. Vernon, N. Y.

Circle 54 on Inquiry Card, Page 97

SERVO-MOTOR TACH

An unusually precise servo-motor tachometer generator, featuring a $\pm 0.5\%$ linearity, has been announced. Consisting of a high performance, low inertia, servo-motor directly

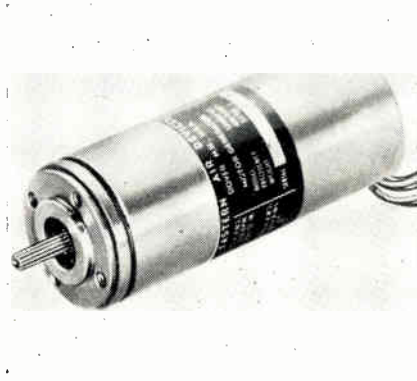

coupled to an induction generator of the drag cup type, this new EAD Size 11 unit is a rugged, one-piece assembly made of non-magnetic stainless steel and equipped with a precision gearhead for lower backlash. Characteristics are lower nulls (0.008 V rms in phase; .015 V rms quadrature and .019 V rms total null). Eastern Air Devices, Inc., 359 Central Ave., Dover, N. H.

Circle 55 on Inquiry Card, Page 97

SPHERE RESOLVER

A new miniaturized precision mechanical ball resolver for analog computation applications. The 0.1248-in. dia. input shaft may be driven up to 100 rpm, and requires less than 5 in.-oz. at 25° C. for an output of 1 to 2 in.-ounces at the 0.187-in. dia. sine and cosine output shafts. The 0.500-in. orientation shaft is concentric with the input and establishes

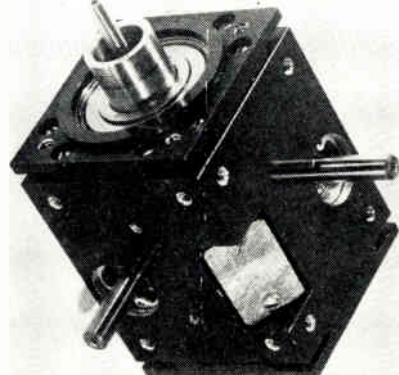

the output relation with an accuracy of $\pm 0.5\%$ over a 360-degree range. It is 1 1/2 in. sq. and 2 1/8 in. long, weighing less than 3/4 lb. Vectron, Inc., 1564 1/2 Trapelo Road, Waltham 54, Mass.

Circle 56 on Inquiry Card, Page 97

PUSH-PULL SWITCH

A new type of line switch, featuring push-pull action, is now available on printed circuit type volume controls. The new switch closes the circuit when the control shaft is pulled

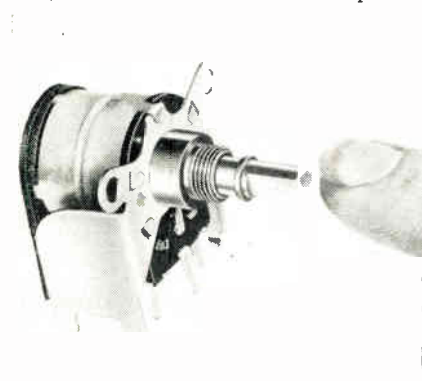

out, and opens the circuit when the shaft is pushed in. This action eliminates need for readjustment of volume every time the radio or television set is turned on . . . also eliminates accelerated wear on the lower end of the resistance element. Unique switch design affords long life and sharp switching action. P. R. Mallory & Co., Inc., 3029 E. Washington St., Indianapolis 6, Ind.

Circle 57 on Inquiry Card, Page 97

ATTENUATOR

Direct attenuation readings over the full wave guide bandwidth with speed and accuracy at millimeter wavelengths are now possible. The attenuator, M174A, is now in production. Operates over the range of 50 to 75 KMC/sec. in RG 98/a waveguide. Featuring bilateral matching, the unit is calibrated to 50 db of attenuation. Max. calibration error is

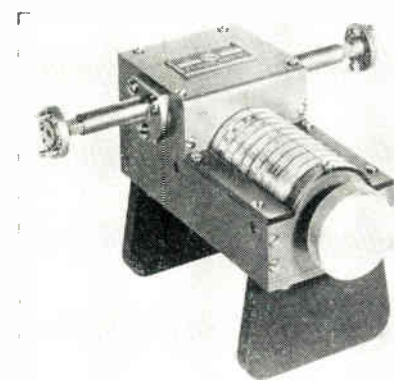

0.1 db or 2% of reading, whichever is greater, while transmission loss is less than 1.0 db and is not included in calibration. F-R Machine Works, Inc., Electronics & X-Ray Div., 26-12 Borough Pl., Woodside 77, N. Y.

Circle 58 on Inquiry Card, Page 97

POWER DIODE

A series of silicon power diodes has been announced. The series is rated to deliver 14 a. to 70 a. (half wave rating) and is available in voltage ratings of 50 PIV to 300 PIV.

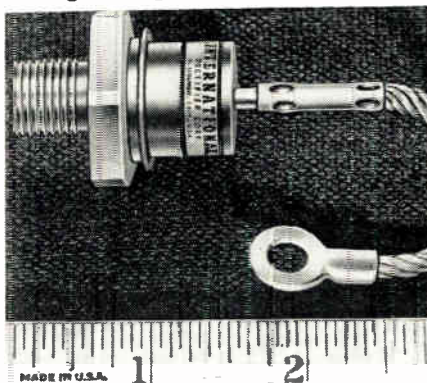

Designed for medium power equipment where high performance, reliability, high efficiency and miniaturization are prime factors. Six diodes assembled on proper heat sinks and connected in a 3 phase bridge can supply 13 kw at 175 vdc with natural convection cooling or 33 kw at 175 vdc when forced cooled. International Rectifier Corp., 1521 E. Grand Ave., El Segundo, Calif.

Circle 59 on Inquiry Card, Page 97

VOLTAGE SUPPLY

An improved model of a constant reference voltage supply which converts ac into a highly stable dc reference voltage is now being produced. Primarily designed for adjustable-speed motor drives, it may be used in some applications to replace standard cells, wet or dry cells, and more extensive electronic regulating systems. When connected to a 115 v. supply



(50 to 400 cps), the unit will supply a reference potential adjustable from 0 to approx. 87 v. and will maintain the desired voltage with a stability of 0.002%. Servo-Tek Products Co., 1086 Goffle Rd., Hawthorne, N. J.

Circle 60 on Inquiry Card, Page 97

BEACON ANTENNA

Model AT-134, 75 mc designed specifically for use with aircraft type marker beacon receivers has been introduced. The Model AT-134 is installed by flush mounting it on the



bottom of an airplane fuselage. The external arrangement is a flanged deep drawn aluminum alloy case, forming the antenna cavity, with the slotted shaft of the variable loading capacitor extending through the closed top of the case to permit screwdriver adjustment and tuning. The flanged bottom is open. Telectro Industries Corp., 35-16 37th St., Long Island City 1, N. Y.

Circle 61 on Inquiry Card, Page 97

COLOR TOGGLE

A new toggle switch featuring a colored plastic toggle is now available in a variety of colors. It enables the manufacturers of electrical appliances to match or blend the toggle switch with the color of their products. Color coding of multi-circuit panel boards is also readily accomplished with the new switch. Available in both single and double pole

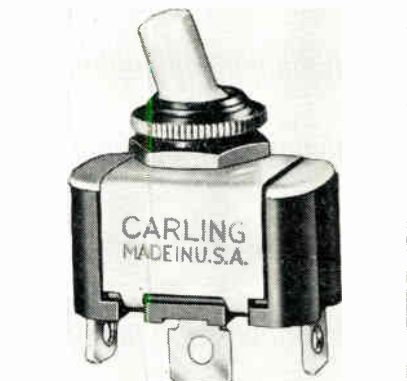

and center off types with ratings up to 20 a. and 1 HP. It can be had with screw terminals or solder lugs, quick dismount spade-type terminals or wire leads. Carling Electric, Inc., West Hartford, Conn.

Circle 62 on Inquiry Card, Page 97

M-G SET

A frequency changing synchronous motor-generator set with features including recovery time of less than 0.15 sec. is now being manufactured. The machine changes 60-cycle to 400-

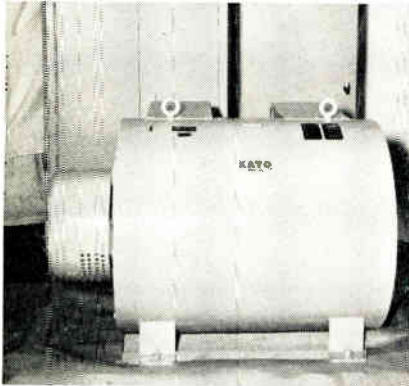

cycle current. Motor and alternator are incased within a common frame with single shaft. The 60-cycle motor is 75 hp. Motor exciter is 1500 w. The 400-cycle generator is 50 kw at 80 per cent power factor and 62.5 kva. The primary source of supply of direct current to excite the field coils of the alternator is obtained from the 60-cycle input. Kato Engineering Co., 1415 First Ave., Mankato, Minnesota.

Circle 63 on Inquiry Card, Page 97

PULSE GENERATOR

Model 502 Pulse Generator, the second in a series of completely transistorized test equipment using printed circuitry is now available. Self-powered by a 22½ v. "B" battery, pro-



viding a useful life of 450 hrs. It provides a pulse length from 0.5 to 3 µsec. in 3 steps with a 20 v. peak into an 800 Ω load. Repetition rate: internal is 50 to 5,000 pps; external from 0 to 5,000 pps. Sync, positive or negative at 1 v. min. to 20 v. peak to peak max. It is housed in a steel case measuring 8½ in. x 5 in. x 4½ in. Cubic Corporation, 5575 Kearny Villa Road, San Diego 11.

Circle 65 on Inquiry Card, Page 97

SCANNER

The Automatic Radioactive Chromatograph Scanner is designed to provide an accurate graphical presentation of the activity distribution along a paper chromatogram tagged



with low energy beta-emitting isotopes. It employs a small flow counter with low background and can accommodate chromatograms up to 3 in. width and 5 ft. length. The instrument is the only scanner which can be operated without window, increasing its sensitivity for C-14, S-35, H-3, etc. considerably. Scanning-head can be removed. Forro Scientific Co., 833 Lincoln St., Evanston, Ill.

Circle 67 on Inquiry Card Page 97

SONIC ANALYZER

Through spectrum analysis of sounds, vibrations and electrical waveforms laboratory and production operations have been speeded up. The LP-1a, provides a logarithmic sweep range of 40-20000 cps. In addition to presenting data graphically, one new feature of the LP-1a, is the optional companion recorder which may be added to make a permanent

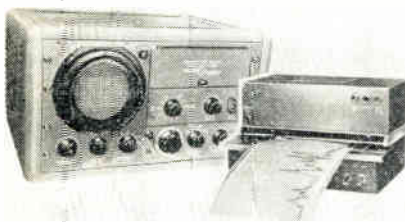

record of waveform content over extended periods. Rate of scan is 1 sec., automatically slowed to 10 sec., 2 min. or 16 min. for recording purposes. Panoramic Radio Products, Inc., 10 S. 2d Ave., Mount Vernon, N. Y.

Circle 64 on Inquiry Card, Page 97

COIL WINDER

A new designed direct drive high speed hand fed coil winder which winds all random, close, solenoid and bobbin coils, as well as space windings on grooved forms, is now available. Speeds up to 7500 rpm are attained by eliminating V-belt drive and mounting motor directly to main shaft. Maximum OD of coils wound is 6 in., wire sizes are 27 to 40 gauge,

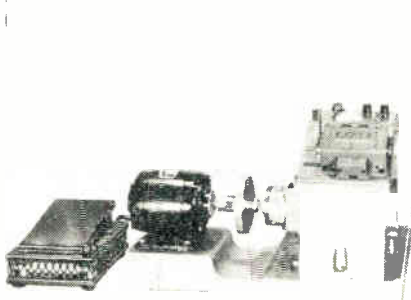

and output end of spindle is ½ in., flatted shaft, accommodating chucks or mandrel adaptors. Foot operated speed control instant re-setting automatic counter. Geo. Stevens Mfg. Co., Inc., Pulaski at Peterson, Chicago 30.

Circle 66 on Inquiry Card, Page 97

TRANSISTOR TESTER

New portable transistorized instrument for measurement of transistor parameters in quality control testing, circuit design, and general trouble shooting has just been announced. Compact KT-1 has been designed specifically for measurement of Beta, h₁₁ and I_{sat}. Instrument is completely self-contained with its own 1 KC osc. and mercury cell power supply. Bat-



tery life of the mercury cell is about 1000 hrs. Printed circuitry has been used throughout, increasing the portability and ease of maintenance of the unit. Baird-Atomic, Inc., 33 University Rd., Cambridge 38, Mass.

Circle 68 on Inquiry Card, Page 97

POWER SUPPLY

A new power supply with steady state regulation accuracy of $\pm 0.01\%$ for computer applications has been announced. This unit has a ripple of less than 50 mv peak to peak and a dc



output of 200 v $\pm 10\%$ at 3 a. The dynamic regulation is: (a) $\pm 1\%$ for a $\pm 15\%$ step change in ac input, (b) $\pm 1\%$ for a 50% load change, and the unit is designed for an ac input of 208/230v, 3 phase, 60 cycle $\pm 15\%$. The power supply also has an extremely low dynamic impedance and incorporates an ultra-fast magnetic amplifier. Perkin Engineering Corp., 345 Kansas St., El Segundo, Calif.

Circle 69 on Inquiry Card, Page 97

COUNTER

The Model 300 Series Totalizing Counters, has been announced. These new instruments are dependable, direct reading, high speed electronic counters especially designed for industrial and special purpose counting. Any electrical, mechanical, or optical event which can be converted into electrical impulses can be totalized. Transducers can be photocells, mag-

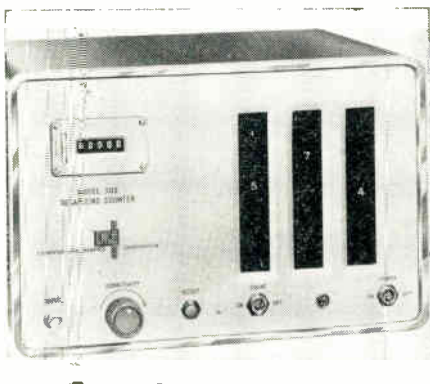

netic coils or switches. Typical applications include: automatic totalizing of production units and measuring the characteristics of engines. Computer-Measurements Corp., 5528 Vineland Ave., N. Hollywood, Cal.

Circle 70 on Inquiry Card, Page 97

CRYSTAL PULLER

Designed for maximum single crystal silicon or germanium production, the unit also has the flexibility and design refinements required for laboratory work. Total quantities of

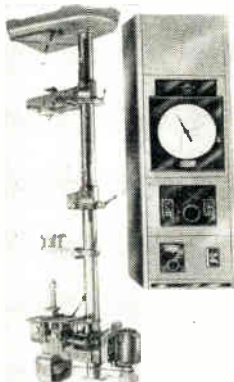

single crystals that can be produced will vary with techniques and requirements of the operator. Production rates of 300 grams of single crystal silicon and excesses of 1000 grams of single crystal germanium per 8-hr. day have been reported. Pulling speed of the device is continuously adjustable, during pull. Precision Tool & Engineering Co., 92-26 180th Street, Jamaica 32, N. Y.

Circle 71 on Inquiry Card, Page 97

RECORDER

Self-balancing strip-chart recorder records within a limit of error of 1% and provides full scale balancing time of 1 sec. The new G-11 was designed for the original equipment manufacturer and also for direct use in laboratory, plant and field applications. The potentiometer model has behind-the-panel span adjustment to any value from 9 to 100 mv. Single,

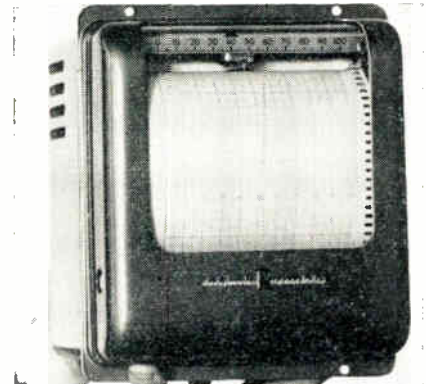

dual and quadruple chart-speed models are available with speeds from $\frac{1}{8}$ in./hr. to 8 in./min. Weight is only 15 lbs. Varian Associates Instrument Div., Dept. 8, 611 Hansen Way, Palo Alto, Calif.

Circle 72 on Inquiry Card, Page 97

TOROID WINDER

The new Model 0-3 operates on an application of the basic patents covering the combination of a smooth grooved winding ring in combination with a circumferential retaining coil

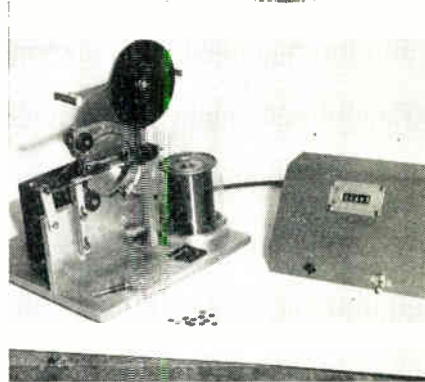

spring. The machine is a highly portable table top model and provides the utmost in versatility and miniaturization, combined with fast, accurate production of coils. Specs: Core size, max OD $\frac{3}{4}$ in., height to $\frac{1}{2}$ in.; Residual hole, Min. 0.055 in.; Wire size, 34 to 45 AWG; Turns counter, Thyatron actuated high speed impulse counter. Donald C. Harder Co., 3710 Midway Drive, San Diego 10.

Circle 73 on Inquiry Card, Page 97

VACUUM GAUGE

A new 1-to-4 station Pirani vacuum gauge with a range from 1 to 2000 microns Hg is now available. Designated Type 2203-03, it gives direct, continuous readings of the total pressure of condensable vapors and permanent gases on two scales—1 to 50 microns Hg and 50 to 2000 microns Hg. The instrument features a new sensing tube which greatly



reduces zero drift, one of the greatest problems in previous hot-wire gauges. Low maximum temperature of 250° C. Rochester Div., Consolidated Electrodynamics Corp., 1775 Mt. Read Blvd., Rochester 3, N. Y.

Circle 74 on Inquiry Card, Page 97

NEARLY 200 TO 1—The fact that non-broadcast radio services now outnumber broadcast transmitters “nearly 200 to 1” was emphasized in a recent statement by FCC Chairman George C. McConnaughey who said “radio is being harnessed to industrial and other business users on a scale never before known.” The Commission chieftain pointed out that radio services “range from speeding transportation of persons and things to checking production and processes,” and cited 116,000 industrial transmitters, 143,000 in the power utilities and petroleum fields, 37,000 air-borne transmitters in aircraft working with 4300 land transmitters, 60,000 ships with over 2100 shore transmitters, 103,000 taxicab transmitters, 25,500 in the trucking field and 59,000 railroad transmitters. The Associated Police Communications Officers also stressed to the FCC that microwave equipment and systems are increasingly important to the public safety agencies of states, counties and cities.

FCC CHANGE POSSIBILITY—Reports that FCC Chairman George C. McConnaughey may retire from the Commission when his term expires next June 30 have arisen in Washington circles with considerable validity for their foundation. It is known that Chairman McConnaughey, who is a former chairman of the Ohio Public Utilities Commission, is desirous of returning to his native city of Columbus, Ohio, to resume law practice with his son. Former Congressman Harris Ellsworth, who served in the House as a Republican Representative from Oregon for over a decade until his defeat in the last election, has been suggested as a successor. Congressman Ellsworth would be eminently qualified for the FCC—in his Congressional service he was a member of the House Interstate and Foreign Commerce Committee which handles communications legislation and FCC affairs and in his private career in Oregon he publishes a newspaper which also operated a broadcasting station.

RADIO POLICY PROBLEMS — “Radio’s growing pains are giving the Commission many regulatory headaches”—this epitomized the dominant theme of the FCC in its 22nd annual report to Congress. The report stresses the growing impact and importance of radio policy and allocations matters on all phases of the Commission’s activity. The FCC reports that expansion of radio communications facilities is causing “acute congestion” in some frequency bands and requests for special frequencies for new services further emphasize the “housing shortage” in certain parts of the spectrum, but points out that new techniques may make it possible to double up on some frequencies now in use and new equipment holds

promise of operating on still higher frequencies. The complex problems involved in single sideband, split-channel, over-the-horizon transmission and extension of microwave facilities require exacting technical consideration. The “mushrooming growth of transmitters coupled with the mounting popularity of electronic devices is causing an unprecedented volume of interference which must be brought under control,” the FCC stated. Kaleidoscopic developments, the Commission emphasized, result in continuing revision of covering rules and regulations.

FORWARD SCATTER POLICY—As a basis for national policy in the assignment of frequencies for ionospheric scatter or “forward scatter” operation, the Telecommunications Planning Committee, the interdepartmental communications planning committee established by the Office of Defense Mobilization, has recently formulated a recommendation of policy for the entire Federal Government, both military and civilian. The policy would permit establishment by the government of six circuits between the United States and overseas or foreign points; would minimize harmful interference to forward scatter research and development; would prohibit use of frequencies for forward scatter fixed circuits by the government between terminals located in the continental United States; would provide for policy review with significant improvements in techniques.

MICROWAVE MEETING—The Operational Fixed Microwave Council, the organization of private microwave users, is meeting in Washington Feb. 19-20 to map its policies and presentations in the FCC’s April hearings on the future use of frequencies above 890 MC. To aid microwave users, the Radio-Electronics-Television Manufacturers Association has engaged Col. Edwin L. White to direct the Microwave Council’s program for the hearings. Col. White, former Chief of the FCC Safety & Special Radio Services Bureau, is now with the consulting engineering firm of Microwave Services, Inc.

WORLD RADIO CONFERENCE—In preparation for United States participation in the 1959 international radio conference to be held at Geneva, Switzerland, FCC Commissioner T. A. M. Craven has been named chairman of the all-important frequency allocations committee, and Dr. F. W. Brown of the National Bureau of Standards as head of the technical questions committee. Raymond Harrell, telecommunications attache, the U. S. Embassy in Mexico City, is the executive secretary of the United States preparatory organization.

*National Press Building
Washington 4*

*ROLAND C. DAVIES
Washington Editor*

CONSIDER a typical design in which there are 1200 packages each of which averages 25 connections—a total of 30,000 connections.

If these are wired by hand in the traditional manner, the time required to wire the device is but one of the very costly aspects of the problem. There are equally important difficulties such as the many varieties of wiring errors due to the human element which will occur even though the wiring is done by skilled technicians and which must be located and corrected by skilled personnel through laborious wire tracing methods.

The tremendous advantages gained by using package organization in an electronic device are reduced appreciably by having to use an inadequate technique for interconnecting these packages.

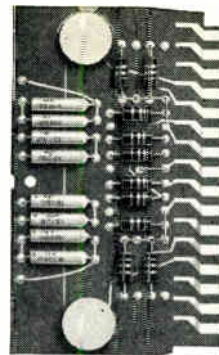

Component board (Typical printed wire package assembly).

NOW THE CINCH PRINT-A-CON

TRADE MARK

INSURES

EASE, PERFECTION . . . INTERCONNECTING IN PACKAGE TYPE ORGANIZATION OF CIRCUITRY

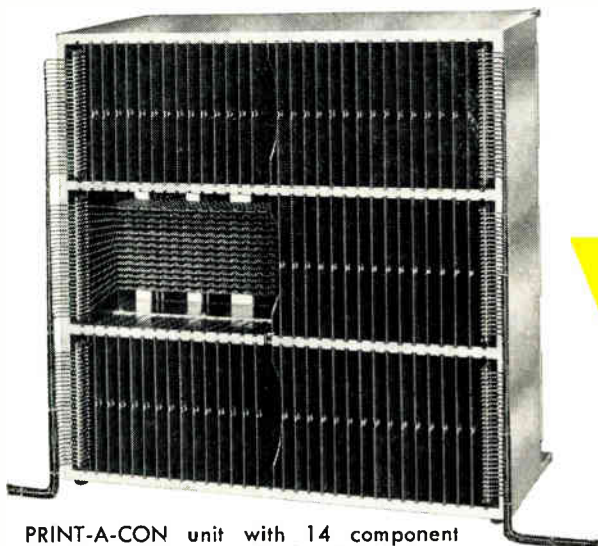

PRINT-A-CON unit with 14 component boards at left removed, showing horizontal and vertical wiring boards in back, also showing a view of the edge connectors mated with the interconnecting boards of the unit. PRINT-A-CON unit shown here is approximately 1½ ft. square by 1 ft. deep.

A multitude of horizontal and vertical wiring paths are available between all points on all component boards in the unit integrally with a means of interconnecting these paths in any desired pattern.

PRINT-A-CON opens the door to countless other approaches in the realm of mass producing complex circuitry and although it was developed initially for use in computers and control devices, its usefulness is not necessarily limited to these.

It is a newly developed component available to the electronics engineer with possibilities as unlimited as the imaginations of those who use it.

Fig. 4—Cutaway showing "short" wires on top side and "long" wires on under side interconnected by an eyelet. This interconnection may also be made by plating through holes which have been punched prior to final fabrication.

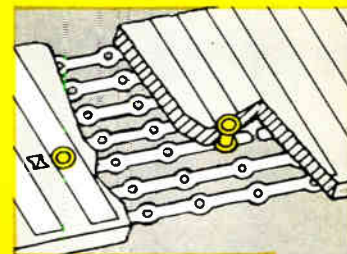

Send for descriptive, illustrated 8-page circular.

Centrally located plants at Chicago, Illinois; Shelbyville, Indiana; La Puente, California; St. Louis, Missouri.



Cinch
ELECTRONIC
COMPONENTS

CINCH MANUFACTURING CORPORATION

1026 South Homan Ave., Chicago 24, Illinois

Subsidiary of United-Carr Fastener Corporation, Cambridge, Mass



Front view of skeleton PRINT-A-CON section showing four component boards, four horizontal wiring boards and three vertical wiring boards.

"Immittance" (Continued from page 55)

units in the direction which increases the R component of Z_1 . Z_3 is therefore plotted on the same reactance line as Z_1 , but displaced along this line a distance corresponding to $R_2 = 0.5$. Fig. 3 shows these points plotted. The contour is labeled $+R_s$ to show the direction to which Z_1 will be transformed when a positive resistance is added in series.

Similar contours can be labeled for the addition of $-R_s$, $+X_s$, $-X_s$, $+G_p$, $-G_p$, $+B_p$, and $-B_p$ (subscripts s and p indicate series and parallel connections, respectively). These contours are also shown in Fig. 3 in the region of Z_1 .

It is to be noted that additional contours can be added corresponding to the addition of transmission line lengths of characteristic impedance Z_0 to the point of the terminating impedance. Also, the contours $+R_s$, $-R_s$, $+X_s$ and $-X_s$ and the contours for the added transmission line are inherent on the Smith Chart. However, the contours $+G_p$, $-G_p$, $+B_p$, and $-B_p$ are included on the Immittance Chart.

To demonstrate the more general use of the Immittance Chart for input impedance calculations, consider the network shown in Fig. 4b.

The procedure for determining Z_{in} is demonstrated in Fig. 4a. The steps are outlined as follows:

1. Plot $Y_1 = 0.2 + j0.4$.
2. Determine $Y_1 - j3$ by traversing the point Y_1 along the constant conductance contour the distance $B(-j3)$ measured by the susceptance scale (in this case $+j0.4 - j3 = -j2.6$).

Fig. 3: The contours of immittance near Z_1 .

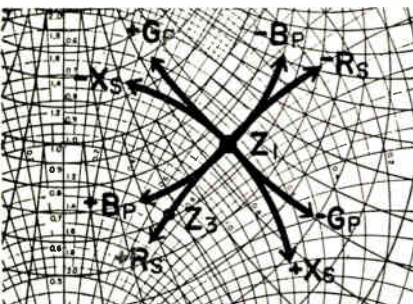

3. Determine $Z_2 (Y_1 + 1 - j3)^*$ traversing the point $Y_1 - j3$ along the constant susceptance contour the distance $G(+1)$.
4. Determine $Z_2 + j0.5$ by traversing the point Z_2 along a constant resistance contour the distance $X(+j0.5)$.

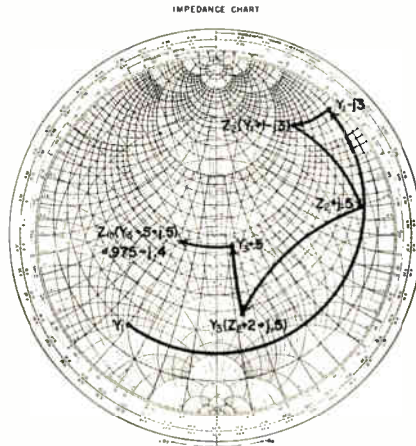
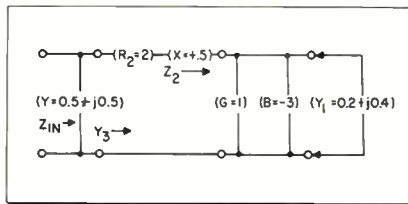

Fig. 4: Graphical determination (A, above) of input impedance of network (B, below).



5. Determine $Y_3 (Z_2 + 2 + j0.5)$ by traversing the point $Z_2 + j0.5$ along a constant reactance contour the distance $R(+2)$.
6. Determine $Y_3 + 0.5$ by traversing the point Y_3 along a constant susceptance contour a distance $Re(Y)$.
7. Determine $Z_{in} (Y_3 + 0.5 + j0.5)$ by traversing the point $Y_3 + 0.5$ along a constant conductance contour a distance $Im(Y)$.
8. Read off the impedance Z_{in} (or Y_{in}).

The description of the above procedure seems tedious because it is intended to show the details. In actual practice the process is very rapid and convenient.

Impedance Matching Box

Since any impedance can be transformed to any other, loss-

lessly, by 2 reactive elements (one in series and one in shunt), an adjustable L network when used forward or backward can theoretically match any impedance to any other. Because of the finite range of adjustable components, such a box will have a restricted matching range. At one frequency, though, or at a band of frequencies, sufficient range of adjustment is available with commercially available components to match most impedances.

Consider the network in Fig. 5 where the capacitors in each arm are the variable elements. The reactance of the series arm can be made to vary from $-jX_1$ to ∞ to $+jX_1$ as C_1 is varied and the susceptance of the shunt arm from $-jB_2$ to ∞ to $+jB_2$ as C_2 is varied. If X_1 and B_2 could be made zero then any impedance could be transformed to any other with the box connected either forward or backward.

With C_1 and C_2 having the range 1 to 35 μf and inductances selected properly, X_1 and B_2 normalized to 50 Ω are 0.29 and 0.42, respectively at 650 MC. To investigate the matching range it is convenient to find the impedance transformable to 50 Ω (or the impedance to which 50 Ω can be transformed). Fig. 6 shows the areas representing the impedances seen at terminals 2,2 when the 50 Ω resistor terminates terminals 1,1.

Contour K_1 is the impedances to which 50 Ω can be transformed by the series arm. Region (A) represents those impedances to which 50 Ω can be transformed when the series reactance is positive and the shunt susceptance is negative; (B) impedances for positive series
(Continued on page 138)

Fig. 5: Impedance matching box schematic.

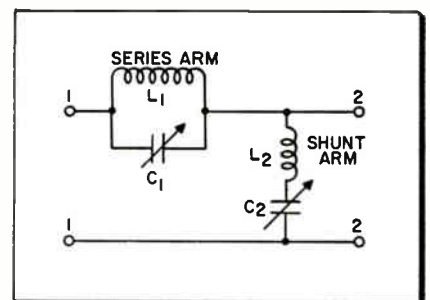

LIMITER AMPLIFIER

Model 100, LIMPANDER JR. is a new high speed, non-feedback, audio frequency limiting amplifier with automatic background noise squelching system. It has a high impedance



input preamplifier that has sufficient gain to produce 30 db of audio limiting, and both high and low level outputs. Its non-feedback circuitry allows a limiting attack time constant of 50 μ sec. with complete stability, that assures no overmodulation and high average percentage modulation. Also designed for conference recording. Electronic Systems Engineering Co., 903 Cravens Bldg., Oklahoma City.

Circle 77 on Inquiry Card, Page 97

YAW RATE TABLE

Yaw Rate Table, Model 80A is a rate of turn table for testing gyros and gyroscopic switches under environmental temperature conditions of -67° F. to 187° F. and altitude conditions of sea level to 60,000 ft. The table is designed to subject a 10 lb. load to rates of from 0 to 300° min and can be used in a 20 in. x 20 in. chamber. Rate fluctuation, or wow, is less than

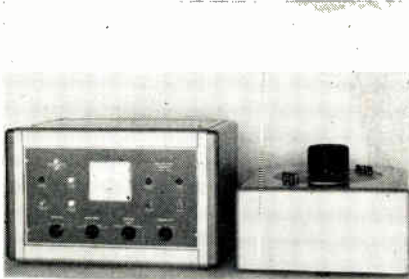

1%. An automatic rate programmer can be supplied as an integral part of the equipment. Control panel & amplifier can be remote. Micro Gee Products, Inc., Box 1005, 6100 W. Slauson Avenue, Culver City, Calif.

Circle 78 on Inquiry Card, Page 97

MARKER-ADDER

Model 220 Marker-Adder, an accessory instrument designed for improving the accuracy and versatility of the conventional sweep generator, signal-marker generator and oscillo-



scope has been announced. It makes for faster and more accurate alignment in TV receivers (both color and monochrome), as well as FM sets, by making the marker pip fully visible in traps and at other zero response points, by preventing the marker signal from overloading the tuned circuits of the receiver. Precision Apparatus Co., Inc., 70-31 84th Street, Glendale 27, L. I., N. Y.

Circle 79 on Inquiry Card, Page 97

POSITION CONTROL

The Dialtrol, a new high accuracy, low cost "follow-up" type of remote control, has been announced. A vernier dial on the face of the control is set to establish accurately the desired position of a valve, variable speed drive control, jack, rheostat, etc. A control motor, with built-in or externally driven potentiometer, adjusts the valve, drive, jack, etc. to the

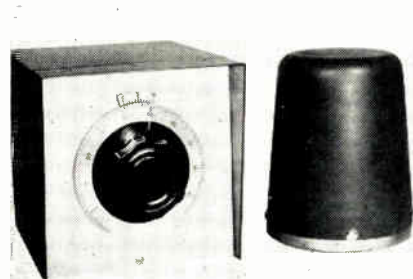

proper setting. Full scale follow-up accuracy of $\pm 1/5$ of 1% is standard but precision multi-turn potentiometers provide accuracies of $1/25$ of 1%. Jordan Co., Inc., 3235 W. Hampton Ave., Milwaukee 9, Wis.

Circle 80 on Inquiry Card, Page 97

CALIBRATOR

A new improved Model M100A-20 Meter Calibrator which provides dc from 0 to 1000 v. at 0 to 200 ma. with 0.01% long time stability, 0.01% line and load regulation, 0.2 msec.

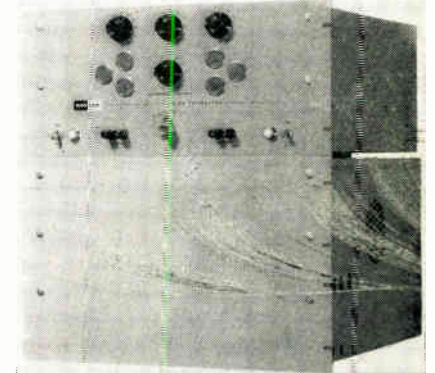

response time, 0.05% calibration tolerance, less than 2 mv. hum and noise, and less than 0.01Ω output impedance. This versatile new instrument employs high gain chopper amplifiers to constantly compare the output voltage with an internal standard cell providing high accuracy and stability regardless of line or load variations. Kay Lab, 5725 Kearny Villa Rd., San Diego 11.

Circle 81 on Inquiry Card, Page 97

SLEEVING CUTTER

The "Little Joe" Sleeving Cutter is a new, compact, bench-type tool of high capacity which cuts all types of insulation tubing including fibre glass and silicon coated nylon as well as small wire and solder—and lengths ranging from $1/32$ in. to 2 in. When in operation the tubing is fed automatically right off the reel through the machine and the cut pieces are

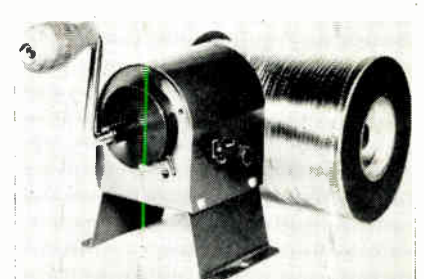

ejected on the other side and can be collected in a small box or receptacle. It's cutting job is razor-like. There are no crushed pieces or spoilage. Macdonald & Co., 1324 Ethel Street, Glendale 7, Calif.

Circle 82 on Inquiry Card, Page 97

ENGINEERS

AC OFFERS YOU SECURITY

GM's long-standing policy of decentralization creates unlimited opportunities for qualified Electrical, Mechanical Engineers and Engineering Technicians.



DEVOTED TO
RESEARCH

AC'S new, modern 225,000 square feet, glass-masonry, aluminum plant (being built in suburban Milwaukee) is another step in GM's Electronics Division's Permanent, Progressive Program.

For a confidential opinion as to how YOU can fit BEST in our Challenging Program write to us today.

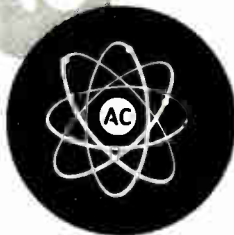

AVIONICS - MISSILE GUIDANCE
- JET ENGINE FUEL CONTROLS - COMPUTERS
- COMMUNICATION EQUIPMENT - CIVIL DEFENSE
AVIATION - AUTOMOTIVE ELECTRONIC PRODUCTS

all offer you personally, opportunities that demand investigation. To arrange personal, confidential interview in your territory, write today to
Mr. John F. Heffinger,
Supervisor of Technical Employment.

AC THE ELECTRONICS DIVISION
General Motors Corporation

Milwaukee 2, Wisconsin

Flint 2, Michigan

Sylvania implements microwave's newest circuit concept with a full line of—

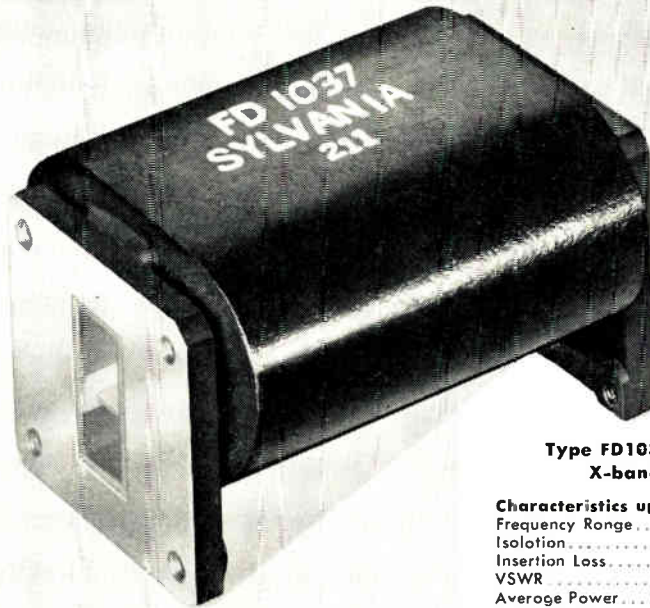

Type FD1037—a 3" broad band X-band ferrite isolator

Characteristics up to 125° C. Ambient Temp.:
 Frequency Range.....8500 to 9600 mc.
 Isolation.....25 db Min.
 Insertion Loss.....1 db Max.
 VSWR.....1.13 to 1
 Average Power.....100 W Max.
 Peak Power.....125 KW Max.

High performance ferrite isolators

FERRITE ISOLATORS increase the reliability of microwave system performance by protecting the microwave power source from other transmission line components' energy reflections.

Sylvania is a leading exponent of this new microwave concept and offers the microwave designer a line of high performance isolators which are the products of a completely integrated program of ferrite research and development.

Research in ferrite materials is carried out in Sylvania's Chemistry

Laboratory, in Flushing, New York.

To this, Sylvania adds basic research on ferrite devices at its Microwave Physics Laboratory, in Mountain View, California.

The developments of these separate programs are integrated into Sylvania's experienced microwave product design and production at Woburn, Massachusetts.

The result . . . a full line of high performance quality ferrite isolators which provide the designer with means for new and improved microwave systems.

**Type FD1013—
2" broad band X-band isolator**

Characteristics up to 125° C. Ambient Temp.:
 Frequency Range.....8500 to 9600 mc.
 Isolation.....10 db Min.
 Insertion Loss.....0.6 db Max.
 Average Power.....100 W Max.
 Peak Power.....100 KW Max.

**Type FD977—5" C-Band Isolator
for Airborne Weather Radar**

Frequency.....5400 mc. \pm 30 mc.
 Isolation.....15 db Min.
 Insertion Loss.....1 db Max.
 Average Power.....125 W Max.
 Peak Power.....125 KW Max.

**Low Power Types for
Microwave Link Applications**

Type FD962...7.1 to 8.0 kmc. Isolation 35 db Min.
 Type FD963...4.6 to 5.0 kmc. Isolation 25 db Min.
 Average Power......20 W Max.
 Insertion Loss......1 db Max.

For complete details and specifications on these Ferrite Isolators, write department ____.



SYLVANIA

SYLVANIA ELECTRIC PRODUCTS INC.
 1740 Broadway, New York 19, N. Y.
 In Canada: Sylvania Electric (Canada) Ltd.
 Shell Tower Building, Montreal

LIGHTING • RADIO • TELEVISION • ELECTRONICS • ATOMIC ENERGY

Bonneville depends on

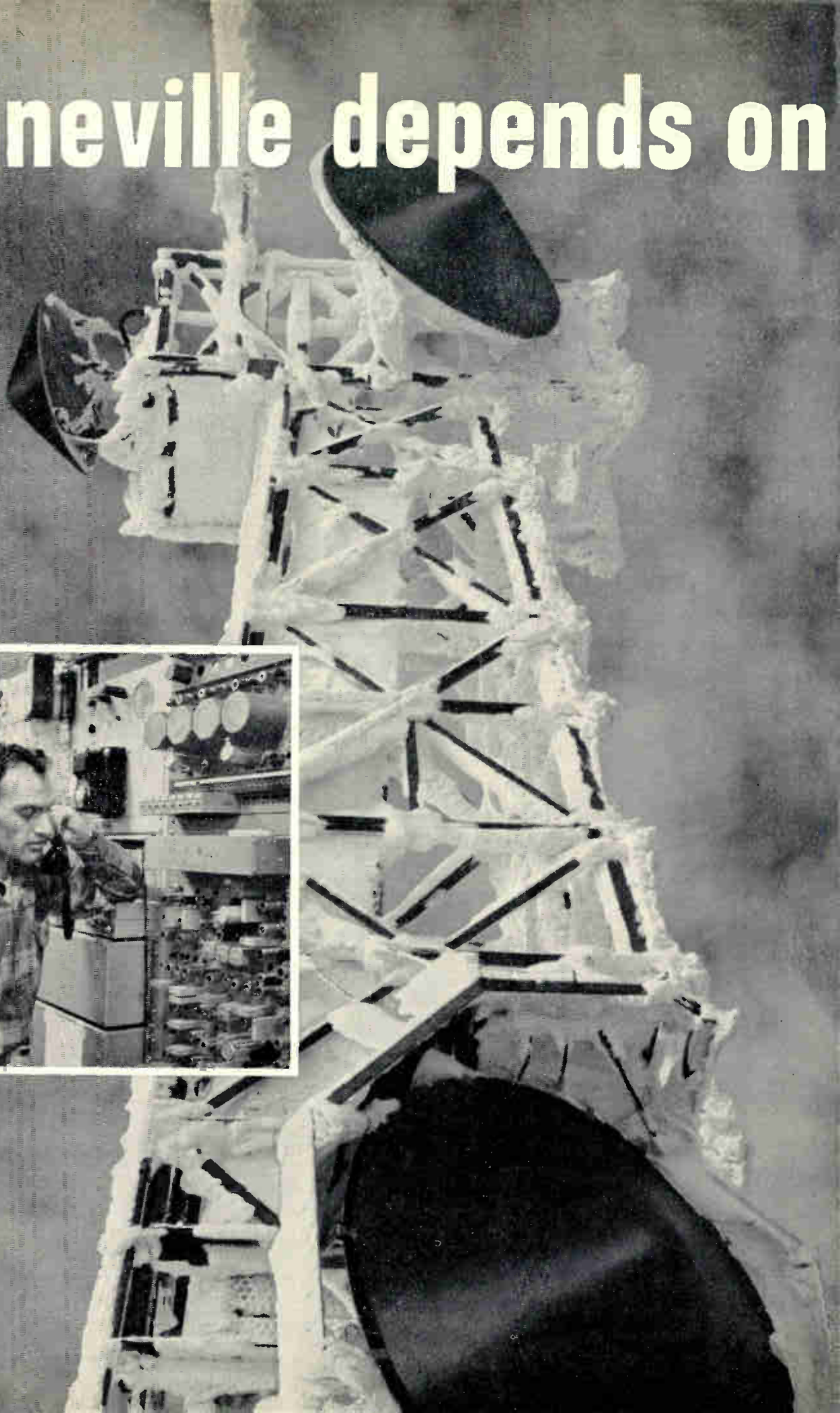

Microwave FOR

**COMMUNICATIONS
TELEMETERING
REMOTE CONTROL
and VHF CONTROL**

a 600-mile microwave system

requiring greatest reliability

There's no icing of these microwave dishes—*not even in the snowbound Northwest*—thanks to a newly developed Philco antenna cover, Thermo-Microdome! Complete de-icing . . . a *must* for reliability in any communications system . . . but only one of many features, including diversity, in the microwave installation of the Bonneville Power Administration.

Here are a few of Bonneville's microwave facilities: An extensive telemetering system in Portland, Oregon, control center for the Federal Columbia River generating and transmission

system, gives instantaneous readings of voltage, frequency and power produced by five distant dams. Sixteen telemetering channels are carried by a single voice channel for 28 hops—one over 60 miles long. Every station is equipped for ten automatic functions including fault reporting, standby-switching and equipment "status check"!

Philco offers a "complete microwave package": Every item of equipment you may need; experienced system planning; installation and service after the sale. Write Department TT for full details.



Bonneville's custom-built Augspurgen microwave station. Durable shelters to house microwave and multiplex equipment, as well as towers, antennas, and reflectors, are available in the Philco product line.



Beside utilities such as the Bonneville Power Administration, Philco has installed extensive systems for leading pipelines, turnpikes, railroads, telephone companies and governmental agencies.

PHILCO—Pioneer and World Leader in Microwave

PHILCO CORPORATION

GOVERNMENT AND
INDUSTRIAL DIVISION

PHILADELPHIA 44
PENNSYLVANIA



In Canada: Philco Corporation of Canada Limited, Don Mills, Ontario

*If forward voltage drop is a problem
in your diode circuitry...see the*



**GOLD
BONDED**

RADIO RECEPTOR

Germanium Diode DR 385

*Available now in
production quantities
for immediate delivery*

with controlled forward voltage drop
between 0.34 and 0.37V at the
10MA level

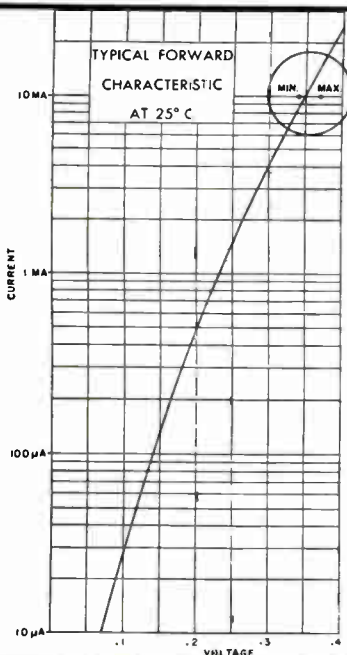

Design engineers working with transistorized circuits, computers and other applications will find that RRco. Type DR 385 has extremely low forward voltage drop as well as other desirable features... The specifications speak for themselves!

Characteristics at 25° C

Forward voltage drop @ 10MA

Minimum	0.34V
Maximum	0.37V
Maximum reverse current at -10V.....	10UA
Peak inverse voltage.....	60V

Maximum Ratings at 25° C

Maximum inverse operating voltage.....	50V
Continuous DC forward current.....	100MA
Surge current for 1 second.....	500MA
Average power dissipation.....	80MW
Derating above 25° C.....	10MW/10° C

*DR 385 exhibits fast transient response and similar diodes
can be offered fully tested to your recovery conditions.*

Further information on DR 385, or any other RRco. diode type will be sent
you at once upon request to section T-2



*In Radio and
Electronics Since 1922*

Semiconductor Division
RADIO RECEPTOR COMPANY, INC.

240 Wythe Avenue, Brooklyn 11, N. Y. • EVERgreen 8-6000

Radio Receptor Products for Industry and Government: Selenium Rectifiers • Germanium Diodes
Thermatron Dielectric Heating Generators & Presses • Communications, Radar & Navigation Equipment

Flush Circuitry

A sample of flush circuitry in 1/32" epoxy glass is available upon request from the Mica Corp., Culver City, Calif. No brochures are available yet, but all requests for information will be handled promptly.

Circle 93 on Inquiry Card, page 97

Turret Punch Press

Ten page booklet describing the latest hand and hydraulically operated punch presses that are of particular interest to electronic manufacturers. The booklet is issued by Rotex Punch Co., San Leandro, Calif.

Circle 94 on Inquiry Card, page 97

Transformer Catalogue

Catalogue 571 contains complete information and specifications on various transformers, reactors and filters. This catalogue issued by Feed Transformer Co., Brooklyn 27, N. Y., is filled with usable tables and graphs.

Circle 95 on Inquiry Card, page 97

Impedance Meters

The Narda Corp., Mineola, L. I., N. Y., has issued a data sheet for two models of coaxial impedance meters in the frequency range of 1500-12,400 MC and six models of waveguide impedance meters covering 2600-18,000 MC.

Circle 96 on Inquiry Card, page 97

Connectors & Sockets

Industrial electronic components catalogue IEC-2 prepared by Amphe-nol Electronics Corp., Chicago 50, Ill., contains 15 pages covering all types of connectors, plugs, sockets and coaxial cable. The catalogue has a very useful quick reference insert specifications chart along with "AN" insert contact arrangements illustrated.

Circle 97 on Inquiry Card, page 97

Galvanometers

Bulletin 1528 gives complete description and uses of galvanometers manufactured by Consolidated Electrodynamics Corp., Pasadena, Calif.

Circle 98 on Inquiry Card, page 97

Slip Rings, Brushes

Miniature precision slip rings and brushes are illustrated along with typical specifications in a four page booklet by the Electronics Div., Iron Fireman Manufacturing Co., Portland, Ore.

Circle 99 on Inquiry Card, page 97

Electron Microscope

A new 12-page brochure giving complete data on the construction and operation of electron microscopes is available from the Instruments Div., North American Philips Co., Mount Vernon, N. Y. In color, the booklet covers such things as the electron optical system, pumping unit, high voltage, magnetic beam wobbler, objective lens, condenser and aperture, and astigmatism.

Circle 100 on Inquiry Card, page 97

Power Supplies

A complete 36-page catalog listing regulated power supplies for laboratory and industry. Fully illustrated, booklet contains specifications, prices and suggested uses. Lambda Electronics Corp., College Point 56, N. Y.

Circle 101 on Inquiry Card, page 97

Instrumentation

Donner Scientific Co., Berkeley, Calif., has issued a four page booklet covering all types of analog computing equipment, accessories and test equipment. Information and prices for the various equipment is included.

Circle 102 on Inquiry Card, page 97

Variacs

Variacs in all sizes, ratings and uses are described in a 24-page booklet from the General Radio Co., Cambridge 39, Mass. Bulletin "O" is complete with specifications and illustrations. The back cover has a quick guide to the desired unit and page number the unit appears on.

Circle 103 on Inquiry Card, page 97

Dot Generator

Foto-Video Labs, Inc., Little Falls, N. J., has released its latest catalog on model V-6 convergence dot generator. Specification sheet contains descriptions of the features, applications, illustration and specifications of the unit.

Circle 104 on Inquiry Card, page 97

Guide To ITV

The new 64-page booklet by Graybar Electric Co., New York 17, N. Y. describes not only a wide selection of video, audio, lighting, transmission, and distribution equipment for ITV systems, but also contains a 15-page guide to types and uses of equipment and accessories. Servicing and maintenance, as well as engineering data on layouts and cost calculations are included.

Circle 105 on Inquiry Card, page 97

Closed-Circuit TV

A 28-page booklet, "RCA High-Fidelity Television," employs color and monochrome photographs, diagrams, and sketches to describe the nature and applications of broadcast closed-circuit TV equipment. Also described in the booklet from Dept. TV-1056, RCA, Camden, N. J., are control consoles, and other associated studio and special effects equipment.

Circle 106 on Inquiry Card, page 97

Test Equipment

More than 200 items associated with cathode-ray oscillographs, record cameras, and other electronic test equipment are described in a 20 page booklet from Technical Products Div., Allen B. Dumont Labs., Clifton, N. J. All types of accessories are shown along with written descriptions, catalogue numbers, and prices for each item.

Circle 107 on Inquiry Card, page 97

Vacuum Pumps

New catalog, No. 752, includes specifications for a complete line of high vacuum pumps, valuable tables of formulas, constants and conversion factors commonly used in vacuum processing, solutions to pump selection and information on continuous oil purification and pump maintenance. F. J. Stokes Corp., 5500 Tabor Rd., Phila. 20, Pa.

Circle 108 on Inquiry Card, page 97

Telesyn Syncros

A 12-page 2-color brochure describes Ford Instrument Co., Div. of Sperry Rand Corp., Long Island City 1, N. Y. standard line of size 1,3 and 5 syncros. Engineered to military and commercial standards, these units are available as transmitters, receivers, control transformers, and differential units.

Circle 109 on Inquiry Card, page 97

Waveguide Switch

Bulletin RS-101 describes a new rotary waveguide switch covering the frequency range 5900-8200 MC. Complete specifications are included in the bulletin from N.R.K. Mfg. & Engineering Co., Chicago 41, Ill.

Circle 110 on Inquiry Card, page 97

Potentiometers

Booklet describes 6 standard model non-linear potentiometers in stock for immediate delivery. Comprehensive tables give complete data on the potentiometers. Non-Linear Data Sheet 54-74 is issued by Helipot Corp., Newport Beach, Calif.

Circle 111 on Inquiry Card, page 97

have fun...save money

Electronic Probe

(Continued from page 59)

The SENIOR speaker system is the outstanding example of what superb audio engineering can achieve... it stands out at the head of its class, producing a thrilling sensation of sound that's amazing in a system of this size. It uses the powerful C12W woofer for full-bodied lows, the 4408 "reciprocating flare" horn speaker for undistorted mid-range, the HF206 Super-tweeter for brilliant highs and the N3 Acoustic Baton 3-way network to keep them in perfect balance. Enclosure is a beautiful piece of furniture embracing the finest principles of phase inversion, direct radiation and rear horn loading. Mahogany \$185.00, Blond \$188.50.



BUILD THIS AMAZING SPEAKER SYSTEM... It's so simple!

The Senior

"DO-IT-YOURSELF" KWIKITS — All you need is a free evening, a "KwiKit," a screw-driver and you can assemble your own version of the famous SENIOR. The KEN-12 kit is the best of its kind on the market today... a truly fine piece of workmanship.

Except for a simplified front frame design, the KEN-12 is identical in acoustic design to the SENIOR speaker system. Finest grade 3/4" Birch used for all finishing surfaces, 3/4" cabinet plywood used throughout. Kit contains: all pre-machined and pre-shaped wood sections; glue; hardware; plastic wood; sandpaper; easy-to-follow instructions. *If you like to build your own and save money then the KwiKit is made to order for you.*

KEN-12 KwiKit \$39.95 net.

THE EN-12 ENCLOSURE is the same enclosure used in the famous SENIOR speaker system without the speaker components. This enclosure is perfect for those who either have speakers or who intend to build toward the SENIOR in successive steps, via P-S-E.

Mahogany \$75.00 net. Blond \$78.50 net. Unfinished \$64.50 net.

THE P-S-E STORY

P-S-E-Progressive Speaker Expansion Plan (a concept first introduced by University) is the most revolutionary development in speaker history.

University speaker components, enclosures and networks have been so uniquely designed that it is possible to start an excellent basic system at low cost, and add to it later—while enjoying immediate listening satisfaction.

P-S-E makes it possible to build up to the MASTER (or any other fine system) in successive, inexpensive steps, using the KEN-15 KwiKit and EN-15.

For the complete, fascinating story of P-S-E please send for FREE illustrated brochure.



THE COMPONENTS THAT PUT THE SENIOR AT THE HEAD OF ITS CLASS



C12W



HF-206



4408



N-3

Eddy currents induced in the band as it approaches the coil assembly set up an opposing field that reduces the mutual inductance between windings. When the band is directly over the center of the probe, the inductance in each half-winding is reduced by an equal amount and no net output results. If the band moves transversely so that the half-windings are unequally covered, the inductance of one coil increases and the other decreases.

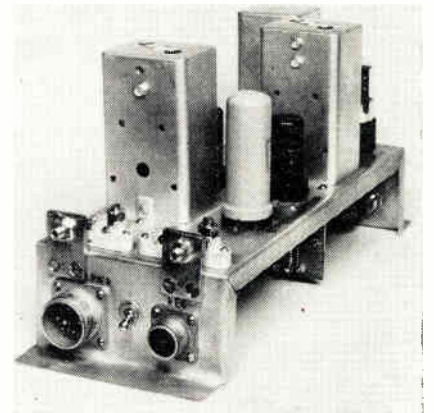

Fig. 2: Electronic chassis for the NBS rotor position indicator

As a result, there is a voltage output which is nearly a linear function of the transverse motion away from the center of the probe.

Sensitivity

However, a change in radial clearance (i.e. when the band moves toward or away from the probe) changes the sensitivity of the probe and introduces error in the measurement. To measure axial motion independently of radial shift, a voltage is generated in the probe which controls the amplitude of the exciting current. This voltage is proportional to the sensitivity for transverse motion, decreases as the radial clearance increases, and remains constant as the band moves transversely.

Dimensions

The rotor position indicator probe is about 3 in. long, 2 1/2 in. wide, and 3/4 in. thick. With respect to the turbine, its length is axial, its width tangential, and its

(Continued on page 90)

LISTEN *University sounds better* **HIGH FIDELITY**

UNIVERSITY LOUDSPEAKERS, INC., 80 SOUTH KENSICO AVENUE, WHITE PLAINS, N. Y.

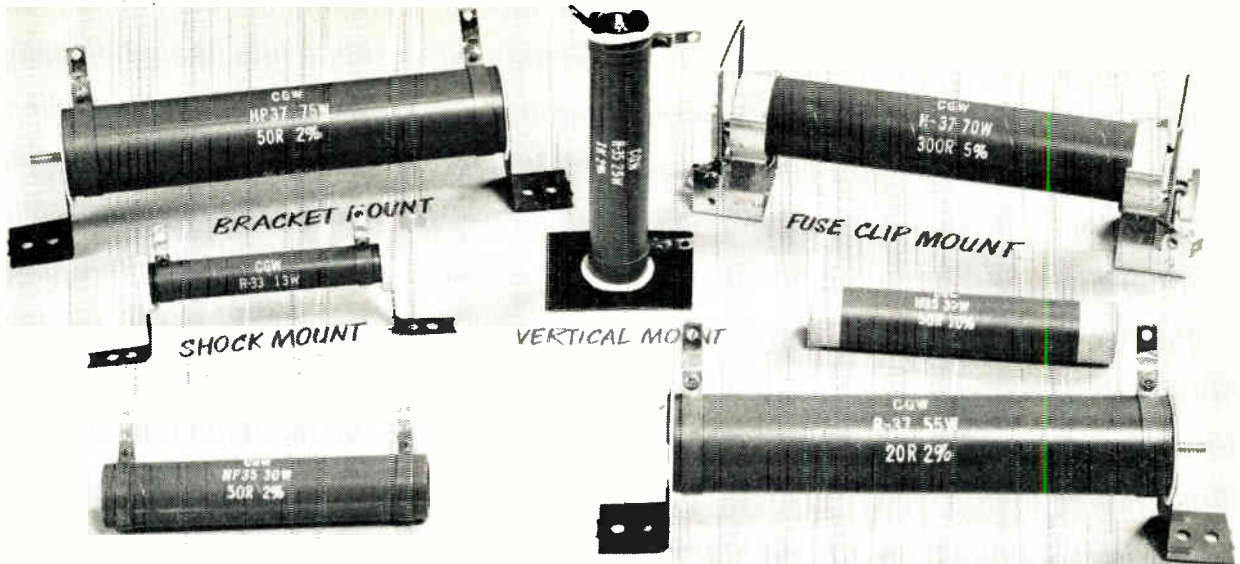

TYPE	RES. RANGE		POWER RATING		LENGTH
	MIN.	MAX.			
R	10 Ω	1,000 K	7-115 W	DC	1½" to 12"
H	10 Ω	1,000 K	7-140 W	AC	1½" to 12"
HP	10 Ω	500 K	17-150 W	DC	3" to 12"

Why Corning High-Power, High-Frequency Resistors meet your most exacting circuit requirements

You'll find Corning High-Power and High-Frequency Resistors designed for stable, long-life service—even under the most difficult operating conditions.

With Corning Resistors you get the highest resistance range for a given physical size compared to wire-wound resistors.

Their thin-film construction makes them inherently non-inductive. The noise level of these resistors is so low it's difficult to measure. The resistive film is a metallic oxide, fused to the PYREX glass core at red heat to form a permanent bond. This special glass insures highest core resistivity even at elevated temperatures, great resistance to chemical attack and to mechanical and thermal shock.

These Corning Resistors are remarkably stable regardless of moisture and humidity.

Other products for Electronics by Corning Components Department: Fixed Glass Capacitors*, Transmitting Capacitors, Canned High-Capacitance Capacitors, Sub-miniature Tab-Lead Capacitors, Special Combination Capacitors, Direct-Traverse and Midget-Rotary Capacitors*, Metallized Glass Inductances, Attenuator Plates.

The chart in the next column gives you a quick idea of their exceptional frequency characteristics.

The ranges and ratings shown in the illustration are for our standard lines, but we can design and build resistors to match your own requirements for all usable frequencies. We've made specials with ratings up to 150 kw. and we can go higher.

Within the standard range of these resistors, we can give you wide variations in mounting hardware. You can get hardware for vertical or horizontal mountings and mountings to absorb mechanical shock and severe vibration. Ferrule-type terminals are available for use with standard fuse clips.

Our catalog sheets give far more complete details than we are able to here. We'll be glad to send you copies with current price lists.

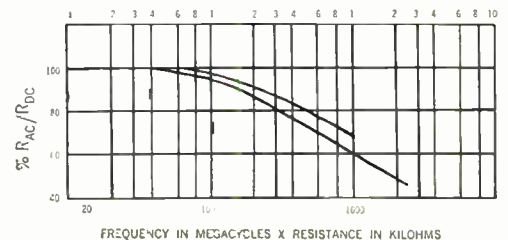

Ask for information on these other Corning Resistors:

Low-Power—3-, 4-, 5-, and 7-watt sizes. Highest resistance range of any low-power resistor.

Type S—Stable performance to 200° C. Meet MIL-R-11804A specs. Values to 1 Megohm.

Type WC-5—5 KW water-cooled. Range, 35 to 300 ohms. Versatile, adaptable.

Type N—Accurate grade. Made to meet all requirements of MIL-R-10509A. Characteristics X and R.

Specials—To your specifications—Co-axial Line Elements, Dummy Loads, HF Elements, Peak Pulse Loads, High-Voltage Resistors.

*Distributed by Erie Resistor Corporation



CORNING GLASS WORKS, 91-4 Crystal Street, CORNING, N. Y.

Electronic Components Department

Corning means research in Glass

Spark Your Spring Sales!

With a display ad in the April IRE issue!

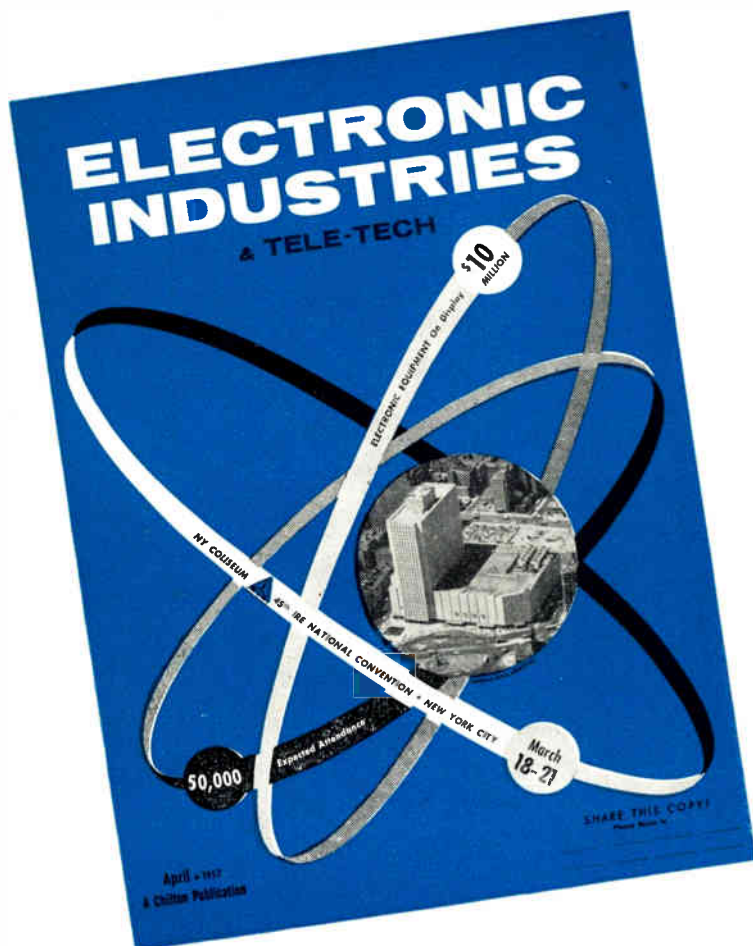

Only **ELECTRONIC INDUSTRIES** offers you these stellar features . . .

- ★ **New Larger Circulation (40,500).**
- ★ **Advance copies distributed at the show.**
- ★ **Largest receptive readership in the rich original equipment market.**
- ★ **Top editorial features prime your prospects.**

**RESERVE YOUR SPACE NOW
IN THE APRIL IRE ISSUE.
AD DEADLINE, MARCH 1.**

Everybody who is anybody in the giant electronic industry will be reading the April IRE Convention issue of **ELECTRONIC INDUSTRIES**. Complete listing of technical papers—complete coverage of all the important events plus up-to-the-minute information on new products introduced at the show will be given in the stellar April issue. What's more, **ELECTRONIC INDUSTRIES'** traditional editorial excellence assures an attentive engineering audience that is primed for your advertising. Your investment in this key IRE number will pay off in handsome sales dividends throughout the coming spring months.

**BE SURE TO VISIT US DURING
THE SHOW AT BOOTH #4303**

**ELECTRONIC
INDUSTRIES**
& Tele-Tech

A CHILTON PUBLICATION

FROM A "CAT'S WHISKER" TO A COLISEUM!

Crystal sets to satellites . . . only decades away from the first primitive experiments looms today's giant 12 billion dollar radio-electronics industry. Now, all 4 floors of New York City's Coliseum are needed to display one year's growth!

The purpose of *The Radio Engineering Show* is to bring new and stimulating ideas in radio-electronics to engineers. To achieve this, more than 200 papers will be presented by 22 professional groups at the Convention's 55 technical sessions. Over 800 new ideas in radio-electronics engineering will also be presented by 834 exhibitors representing more than 80% of the productive capacity of the industry.

Yes, it's big in size, big in scope. Whatever your special interests, attending this Convention can cut weeks off your "keeping informed" time. Plan now to be there.

ATTEND THIS CONVENTION! • *Save time; a whole year's productive effort seen in days!* • *See all that's new in radio-electronics products, developments, and engineering—meet the men responsible!* • *Hear the best technical papers about your specialty!* • *Meet old friends, make new ones, enjoy association and social events!*

REGISTRATION: IRE Members \$1.00
Non-members \$3.00

**MARCH
18-21**

**The IRE National
Convention
Waldorf-Astoria Hotel
and The Radio Engineering Show
Coliseum**

New York City



**PRODUCTION
& 3 lecture halls
INSTRUMENTS
& COMPONENTS
COMPONENT PARTS
EQUIPMENT**



**The
Institute of
Radio
Engineers**

1 East 79th Street, New York 21, N.Y.

To the forward-looking engineer...

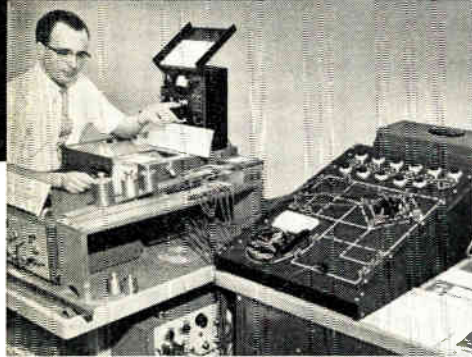
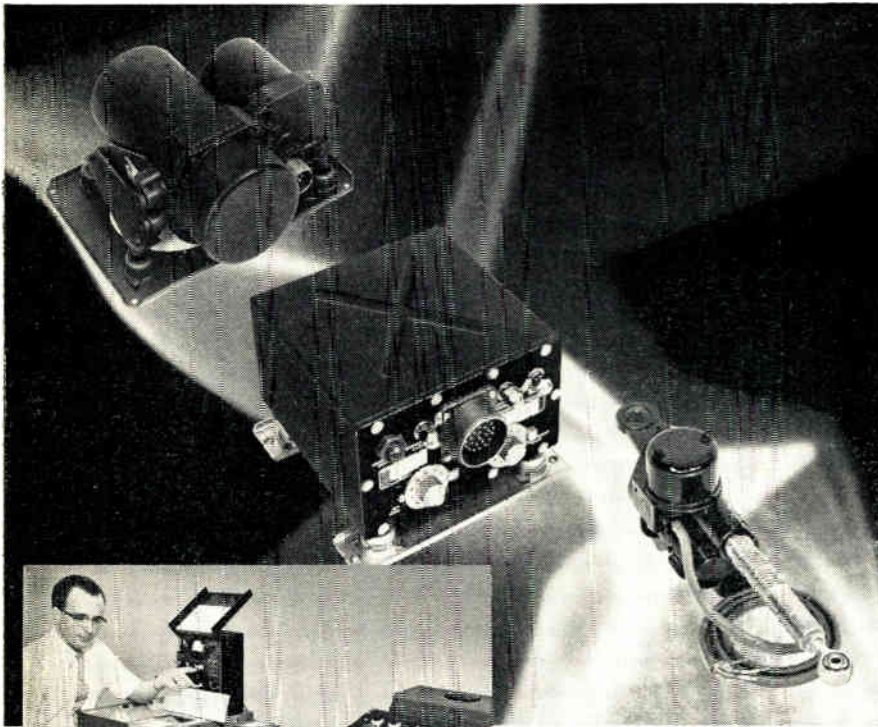

STICK-FORCE REVERSAL problems at sonic speeds are solved by this sensitive, accurate AiResearch air data system incorporating transducer, computer and actuator

Garrett Corporation engineers are constantly called upon to provide solutions for seemingly insurmountable problems. The high degree of respect in which the Garrett engineer is held by his profession is a tribute to the accomplishments of our team.

If you qualify to join us, stimulating assignments in the work you like best are only part of what we offer. We pay a premium for ability. You'll work with the finest research and laboratory facilities at your disposal...live in the most desirable areas in America — California, Arizona, the East Coast.

All modern U.S. and many foreign aircraft are Garrett equipped. We have pioneered such fields as refrigeration systems, pneumatic valves and controls, temperature controls, cabin air compressors, turbine motors, gas turbine engines, cabin pressure controls, heat transfer equipment, electro-mechanical equipment, electronic computers and controls.

We are seeking engineers in all categories to help us advance our knowledge in these and other fields. Send resume of education and experience today to: Mr. G. D. Bradley

THE GARRETT CORPORATION

9851 S. SEPULVEDA BLVD., LOS ANGELES 45, CALIFORNIA

DIVISIONS:

AIRESEARCH MANUFACTURING, LOS ANGELES • AIRESEARCH MANUFACTURING, PHOENIX

AIRESEARCH INDUSTRIAL • REX • AERO ENGINEERING

AIRSUPPLY • AIR CRUISERS • AIRESEARCH AVIATION SERVICE

(Continued from page 86)

depth radial. The coil configuration is printed on a steatite plate, $\frac{1}{8}$ in. thick, mounted at the top surface of the probe housing. The printed pattern of conductors is glazed to protect the silver from erosion by steam. To minimize crossover connections, conductors are printed on the back as well as the front of the plate and connections are made through small holes filled with conducting material. The outgoing leads are brought up through tubes which have been fused into holes in the edge of the plate using a conducting joint compound. The tubes are compressed and spot-welded over the wires.

Life

Under normal turbine operation the probes may last several hundred hours, but when the turbine is frequently subjected to severe transient conditions, such as sudden reversal of direction, the life of the probes may be as short as 30 hours. This, however, is adequate, since the probes are used only for relatively short test runs of the turbine. A few probe failures have occurred from cracking of the ceramic plate. This trouble has been successfully combatted by so designing its supporting frame that the plate is not subjected to distorting forces.

Accuracy Check

The accuracy of the rotor position indicator can be checked only by indirect methods. Rubbing pins worn away by the shroud band indicate clearances that agree with probe measurements, and independent probe measurements at various points also agree. Transverse motion up to 0.4 in. can be measured and a radial shift of 0.2 in. produces an error in transverse measurement of less than 0.02 in. Rivet heads and slots in the shroud band cause no appreciable error, but at low speeds the slots cause severe fluctuations in the output. This flicker disappears above a few hundred rpm; below that speed it can be reduced with suitable filters.

1. Electronic micrometer, *NBS Tech. News Bul.* 31, 37 (April 1947).

* * *

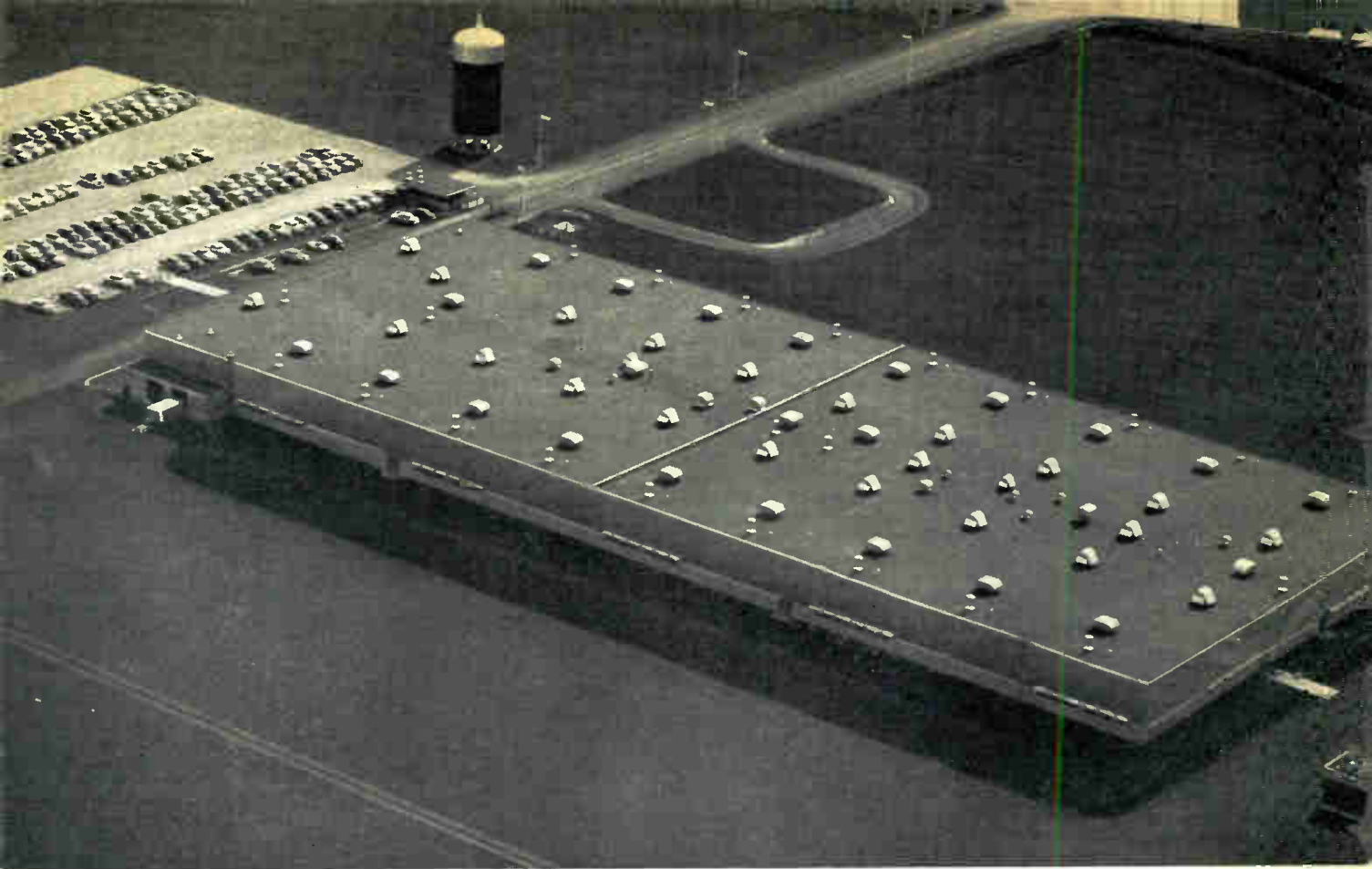

New 2½-acre Owensboro plant is fourth General Electric receiving-tube facility for serving TV manufacturers!

WELL over a million dollars in building costs have gone into General Electric's new receiving-tube factory on the outskirts of Owensboro, Ky. Another large investment is for advanced automatic machinery. Located on a 90-acre site, the plant itself is 500 feet long and 200 feet wide, with special ventilation and air-filtering to keep out dust and lint.

Here the tube needs of TV designers and builders are being met by new facilities unmatched in the industry. Here the prime targets are: still more dependable tube performance . . . even longer tube life . . . even greater values that help to keep down the curve of TV manufacturing costs.

Now, more than ever—from circuit stage through mock-up to receiver assembly—it will profit you to keep in touch with General Electric on *all* your tube requirements! *Electronic Components Division, General Electric Co., Schenectady 5, N. Y.*

Irvine D. Daniels (seated), general manager, General Electric receiving tube department, points out to three members of the G-E field commercial engineering staff—from central, western, and eastern regions—how facilities in the new plant are being systematically brought up to full production. ▼



Progress Is Our Most Important Product

GENERAL  **ELECTRIC**

162-1A1



ELECTRON TUBES FOR SURVIVAL

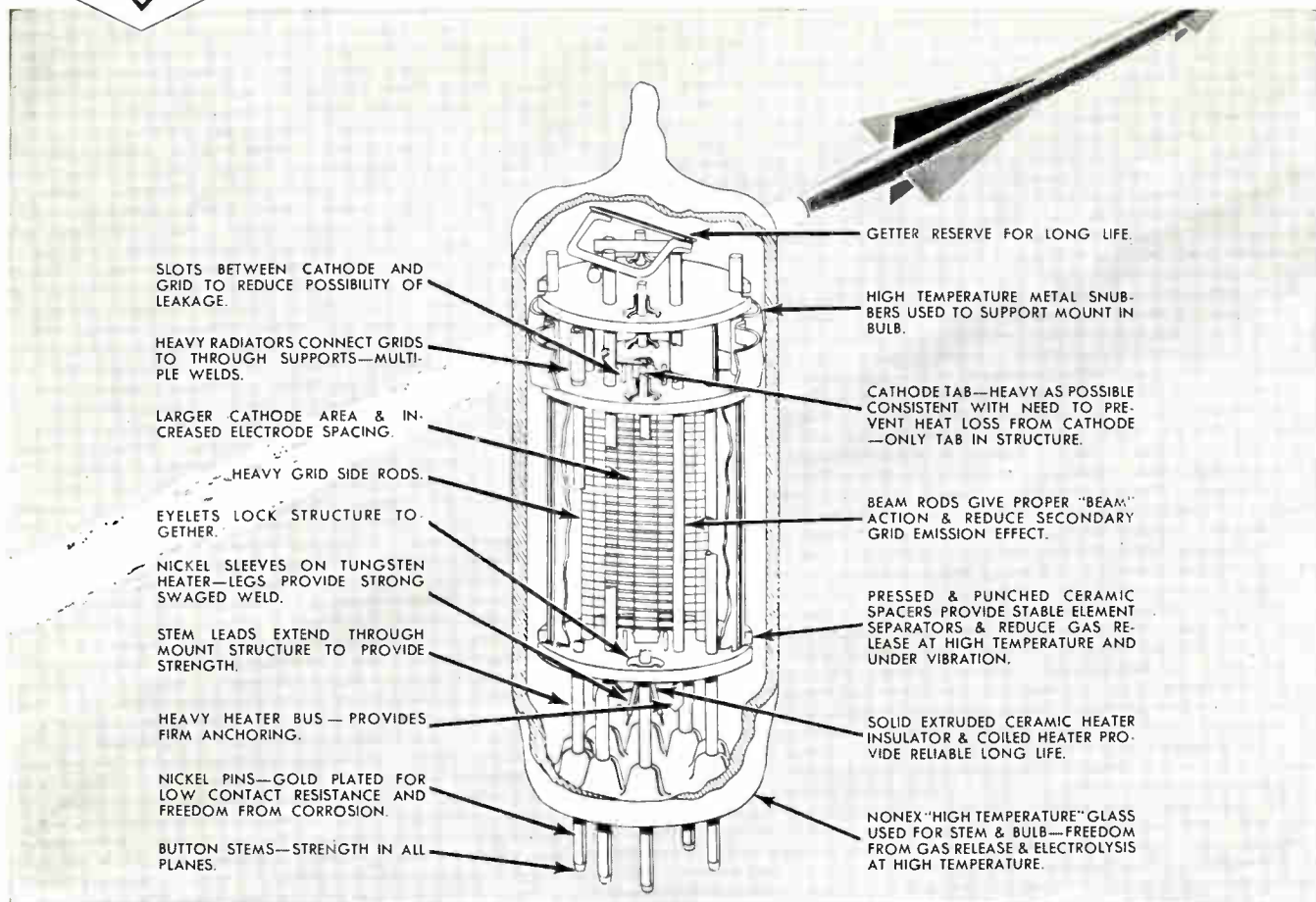

WHY BENDIX* HY-G-300 ELECTRON TUBES ARE BEST FOR EXTREME SHOCK, VIBRATION AND TEMPERATURES!

From the standpoint of design features (see above), these reliable hard glass tubes offer the superior quality needed to survive today's severe environmental demands.

Specifically, Bendix HY-G-300's are designed to withstand the following environmental conditions—bulb temperatures up to 300° C; vibration up to 20G's over the range of 5-2000 cycles; and shock of 200G's having 20-millisecond duration.

For full information about the HY-G-300 line . . . the surest answer to electron tube applications in jet aircraft, missiles and rockets . . . write RED BANK DIVISION, BENDIX AVIATION CORPORATION, EATONTOWN, NEW JERSEY.

*TRADEMARK

West Coast Sales and Service: 117 E. Providencia, Burbank, Calif. • Export Sales and Service: Bendix International Division, 205 E. 42nd St., New York 17, N. Y. • Canadian Affiliate: Aviation Electric, Ltd., P. O. Box 6102, Montreal, Que.

HY-G-300							
TUBES ARE AVAILABLE FROM STOCK							
Bulb Size	Dbl. Triodes Volt Amp.	R. F. Pentodes	Gate Pentodes	Rectifiers FullWave	Beam Power	Power Triodes Passing	
T-12	—	—	—	—	—	6080WB 6082A	
T-11	—	—	—	—	6384 6889	—	
T-9	—	—	—	6853	—	—	
T-6½	6851 6854 6900	6582A	6486A	6754	6094	6877 6900	
Retma Type No.	Retrofit For	Generic Type	E _f	I _f	Bulb	Bendix Type No	
6080WB	6080 6080WA	6080	6.3	2.5	T-12	TE-16	
6094	—	6A05- 6005	6.3	0.6	T-6½	TE-18	
6853	6106 5Y3	5Y3	5.0	1.7	T-9	TE-45	
6384	6AR6 6098	6AR6	6.3	0.9	T-11	TE-27	
6854	6385	2C51 5670	6.3	0.5	T-6½	TE-47	
6486A	6486	6AS6	6.3	0.25	T-6½	TE-43	
6582A	6582	6AK5	6.3	0.25	T-6½	TE-44	
6754	412A	—	6.3	1.0	T-6½	TE-36	
6851	5751	—	6.3	0.5	T-6½	TE-42	
6877	—	Half of 6080	6.3	0.8	T-6½	TE-48	
6900	5687	5687	6.3	0.9	T-6½	TE-54	
6889	—	—	6.3	0.9	T-11	TE-52	
6082A	6082	6082	26.5	0.6	T-12	TE-55	

Red Bank Division



The Most Complete Transformer Line in the World...FROM STOCK



A quarter century of specialized experience and original research has gone into the development of UTC catalog items. Covering the range from tenth ounce units to others weighing hundreds of pounds, UTC stock items are available for virtually every application in the electronics field. Each of these items carries a plus value . . . UTC RELIABILITY, highest in the field.

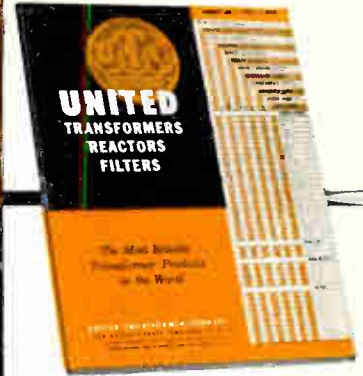

Write for your Copy of Catalog '56



PERMALLOY DUST TOROIDS
Maximum Accuracy and Stability



VARIABLE INDUCTORS
Standard and Hermetic



LOW FREQUENCY INDUCTORS and INDUCTANCE DECADES



LOW PASS, HIGH PASS and BAND PASS FILTERS . . . HERMETIC

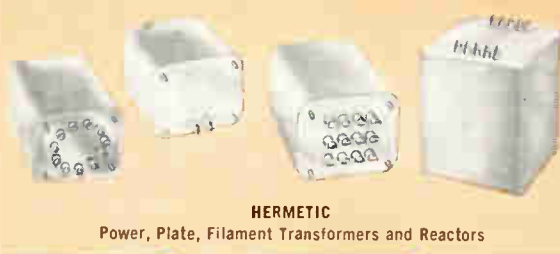

HERMETIC
Power, Plate, Filament Transformers and Reactors



HERMETIC AUDIO COMPONENTS
for Every Application

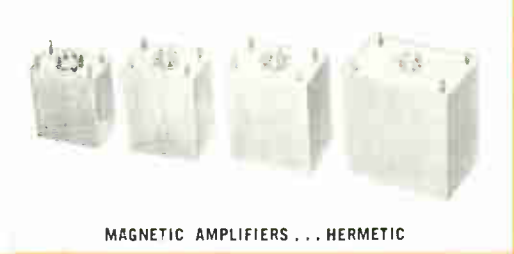

MAGNETIC AMPLIFIERS . . . HERMETIC



PULSE TRANSFORMERS



DOTS
Transistor Transformers
Smallest Size - Highest Power



SUB and SUB-SUB OUNCER TRANSFORMERS
Audio Miniatures



OUNCER and PLUG-IN UNITS



LINEAR STANDARD SERIES
Tops in Fidelity



HIPERMALLOY and ULTRA COMPACT
High Fidelity Favorites



COMMERCIAL GRADE AUDIO and POWER COMPONENTS
for Industrial Use



SPECIAL SERIES . . . Audio and Power Components for the "Ham"

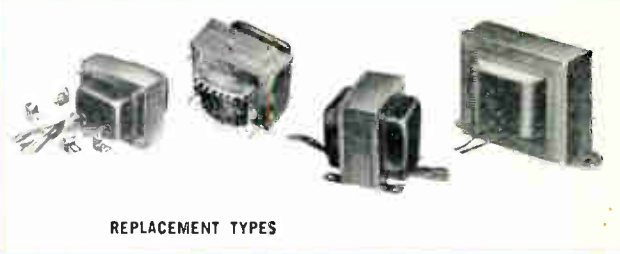

REPLACEMENT TYPES



VOLTAGE ADJUSTERS . . . STEPDOWN and ISOLATION TRANSFORMERS



PHOTOFLASH TRANSFORMERS
MIKE-CABLE TRANSFORMERS



EQUALIZERS

UNITED TRANSFORMER COMPANY

150 Varick Street, New York 13, N. Y. • EXPORT DIVISION: 13 E. 40th St., New York 16, N. Y., CABLES: "ARLAB"

PACIFIC MFG. DIVISION: 4008 W. Jefferson Blvd., Los Angeles, Cal.

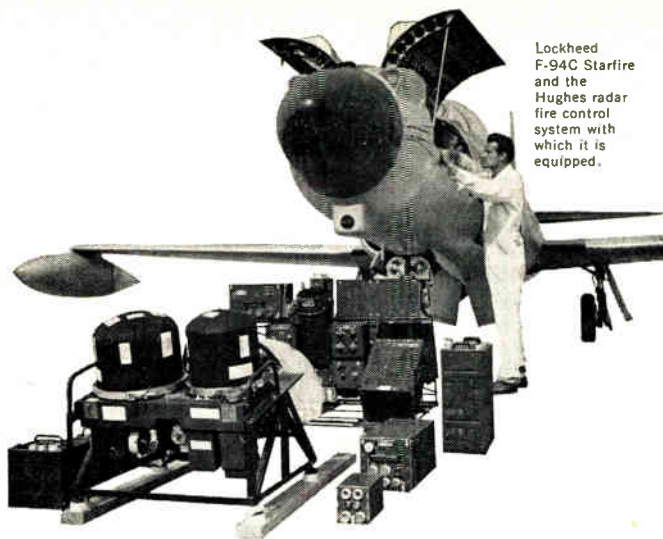

Lockheed F-94C Starfire and the Hughes radar fire control system with which it is equipped.

Hughes has been the leader from the beginning in applying electronic computers to airborne fire control equipment. Today every U.S. Air Force and Canadian continental defense interceptor uses Hughes-developed and Hughes-manufactured systems.

PRODUCT

DESIGN

at

HUGHES

As the intercept problem becomes more and more automatic, additional equipment such as new-type computers, control surface tie-in (CSTI), autopilots, and other units must be integrated into the system. Faster speed and heavier engines dictate more streamlining—and hence less space for electronic gear. The result is even more miniaturization and compact packaging, evolved from special techniques.

This all means that now the product design engineer is more important than ever before. In the Product Design Laboratory he is a vital part of the formal link between the Research and Development activity and the optimum configuration and installation arrangements for the systems "black boxes."

Write to Hughes for information regarding positions open.



RESEARCH AND DEVELOPMENT LABORATORIES
SCIENTIFIC STAFF RELATIONS
Hughes Aircraft Company, Culver City, California

Electronic Light

(Continued from page 59)

slots as are required, or large sheets of the material may be formed and then cut into smaller luminous shapes afterwards. Of particular interest is the fact that lamps formed on very thin sheet steel may then be bent to form rings or other circular forms so long as the ceramic coat is compressed.

Color

At present, Sylvania produces luminous panel lamps in three basic colors—green, blue and yellow. Since there is no arc or glow discharge present in the lamp, the superimposed spectral lines of mercury vapor or fluorescent lamps are not found in the panelescent lamp.

A continuous energy basic emission curve of the color emitted by the particular phosphor is all that

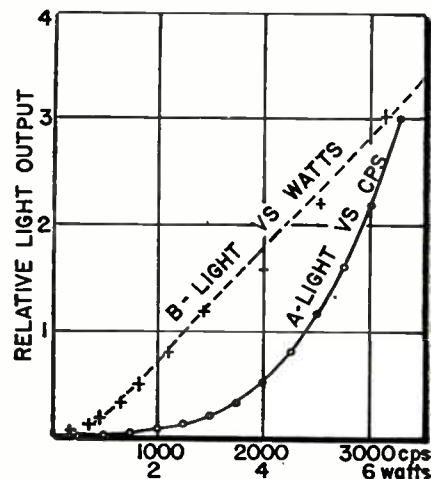

Fig. 2: Variations in light output of luminous panels with frequency

is obtained. The color of the lamp is dependent almost exclusively on the phosphor used.

As the frequency of the supply voltage is increased, there is a shift in color towards the blue end of the spectrum. The magnitude of this shift is dependent on the type of phosphor used.

Filters

The color of panelescent lamps may also be modified to match a particular spectral range by the use of filters applied directly to the lamp. Since this is a subtractive color process, brightness and light output of the lamp will decrease somewhat. The degree will depend on lamp color and the filter used.

(Continued on page 128)

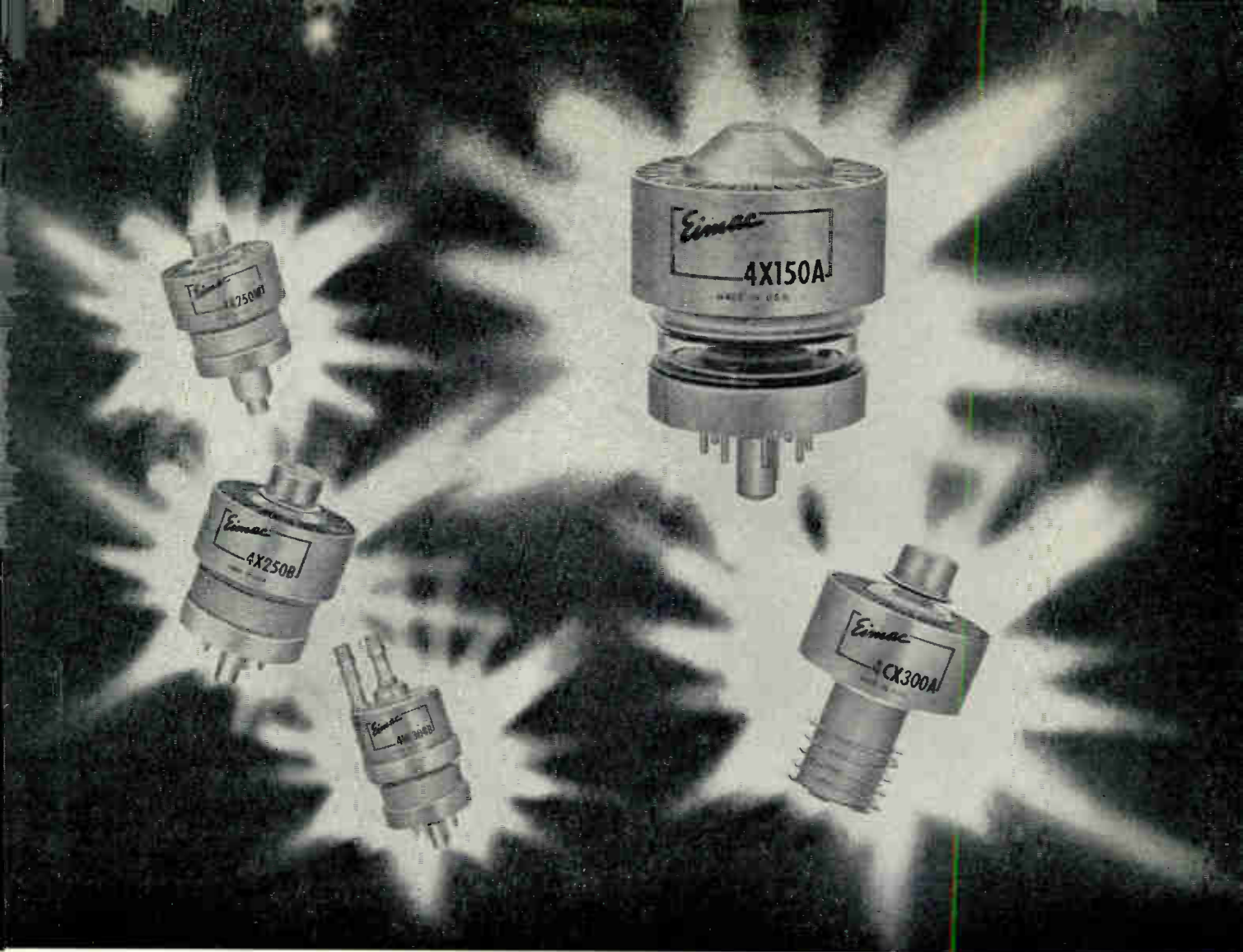

Evolution at Eimac

Back in 1946 Eimac developed and produced the 4X150A—a new concept in power tetrodes. Its immediate acceptance by the industry then, has led to even more popularity now.

But today at Eimac the glass 4X150A is virtually obsolete.

Since 1946 Eimac has constantly improved the 4X150A to the point where it has evolved into a family of superior quality 250w and 300w tubes for operation to 500Mc. Small, compact structure has been retained. In fact, the 4X250 series is interchangeable with 4X150

tubes. Ceramic envelopes make possible greater mechanical strength, better production techniques, and higher temperature processing.

Because "good enough" has never been accepted at Eimac, however, this family of air cooled or water cooled, co-axial or conventional socketed tubes (2.5v, 6v, and 26.5v) is again accelerating the pace in quality, design, and performance, exactly as the 4X150A did a decade ago.

EITEL-McCULLOUGH, INC.
 SAN BRUNO · CALIFORNIA
 The World's Largest Manufacturer of Transmitting Tubes



4X150A

4X150 Series
 4X150A-1946
 4X150G-1949
 4X150D-1952

4W300 Series
 4W300B-1953

4X250 Series
 4X250B-1955
 4X250F-1955
 4X250M-1955
 4CX250K-1956

4CX300 Series
 4CX300A-1956

About a Sawtooth, Clamping and your Efficiency...

Let's look at it this way—What features should an instrument incorporate to make your job easier, help prevent costly mistakes? Take the case of the new PRD Klystron Power Supply. Should we incorporate a sawtooth rather than a sine wave modulation? It's easier to put in a sine wave. However, a sawtooth has the definite advantage of eliminating phasing and blanking problems when the frequency response of a transmission device is to be studied. So, in goes the sawtooth. It's easy enough to get hold of some sine wave modulation which can be applied through the external modulation input.

As for preventing mistakes—consider switching from cw to square wave modulation. Suppose you forget to readjust the reflector voltage . . . Sure, you'll catch the mistake later, but time is lost. The new PRD Klystron Power Supply has an electronic clamping circuit which locks the top of the square wave to the previously chosen reflector voltage. No readjustments to think about, no mistakes.

Want to modulate with pulses—use the external input. The rise time degradation of your pulses will be less than .1 microsecond!

Another point, good regulation! Here's an example: a $\pm 10\%$ line change or *any* load change will cause a reflector voltage change of only $\pm 0.1\%$.

Compare . . . chances are that you'll send in your order for the PRD Type 809, too.

**PolYTECHNIC RESEARCH
& DEVELOPMENT CO., INC.**
202 TILLARY STREET, BROOKLYN 1, NEW YORK
Telephone: ULster 2-6800



The New PRD KLYSTRON POWER SUPPLY

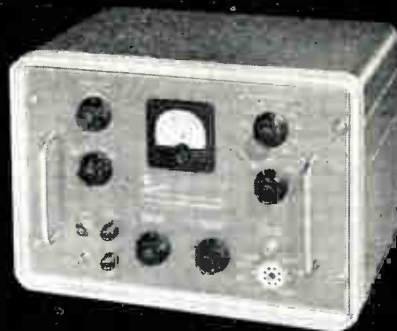

HERE'S WHAT THE TYPE 809
CAN DO FOR YOU —

- Powers most low and medium voltage klystrons — up to 600 V. at 65 ma being supplied and reflector voltages up to -900 V.
- Has electronic readjustment of reflector voltage when changing from cw to square wave modulation — no errors due to forgetfulness
- Has variable square wave, sawtooth and provision for external modulation for pulses
- Affords exceptional stability and regulation at modest cost
- Price \$350.00 F.O.B. New York

(Available from stock. Call or write for new Bulletin.)

Midwest Sales Office:
1 SOUTH NORTHWEST HIGHWAY,
PARK RIDGE, ILL. — TAlcot 3-3174
Western Sales Office:
737-41, SUITE 7, NO. SEWARD ST.
HOLLYWOOD 38, CAL. — HO-5-5287

ELECTRONIC SOURCES

ELECTRONIC INDUSTRIES' exclusive monthly digest of the world's top electronic engineering articles



ANTENNAS, PROPAGATION

N-Terminal Networks: Some Theorems with Application to the Directive Properties of Aerial Arrays, by A. Bloch. "Wirel. Eng." Dec. 1956. 6 pp.

Modern Concepts of the Propagation of Meter Waves by Ionosphere Scattering, by E. L. Cherenkova. "Elektrosviaz." Nov. 1956. This paper is a survey of foreign papers on long-range propagation of meter waves. The discussion includes: 1) the mechanism of ionosphere scattering, 2) experimental data on propagation by scattering.

Effect of the Spread of the Propagation Velocity on the TV Pass Band of a Radio Link, by I. S. Stojanovic. "Ann. de Radio." Oct. 1956. 9 pp. It has been observed that for high modulation frequencies in an FM television link, distortions attenuating the video signal occurred which were attributed to the spread of the propagation velocity over the wave band. The article shows that the differences in propagation velocity results, after discrimination, in amplitude distortion, in agreement with the observation.

Directional Antenna Array and its Supply, by S. Drabowitch. "Rev. Tech." Sept. 1956. 25 pp. Various antenna arrays and their supplies are studied with particular attention to slot antennas for the realization of arbitrary directional characteristics.

Ferrite-Rod Antennas Operate in X-Band, by F. Reggia, et al. "El." Jan. 1, 1957. 3 pp.

Measured Statistical Characteristics of VLF Atmospheric Radio Noise, by A. D. Watt and E. L. Maxwell. "Proc. IRE." Jan. 1957. 8 pp. Instrumentation and observations are discussed.

Pulsed F-M Tests Ultrasonic Propagation, by R. R. Unterberger. "El." Jan. 1, 1957. 3 pp. Equipment for experimental recording and analysis of returned ultrasonic waves as a function of frequency is described.



AUDIO

Audio Transformer Design Shortcuts, by R. T. Henszey. "El. Ind." Feb. 1957. 3 pp. The step-by-step procedure presented in this article enables completion of developmental models in a few hours.

Pulse Method for Power Amplification of Audio-Frequency Waves, by V. V. Malanov. "Radiotek." Nov. 1956. 9 pp. The paper examines the basic principles, the advantages and the performance of a pulse method of power amplification. An investigation is made of the frequency spectrum and the demodulation of the pulses when push-pull pulse-width modulation is used. A method is given for making energy calculations for the amplifier.

Properties of the Recording-Head Field of Tape Recorders, by H. Nottebohm. "El. Rund." Dec. 1956. 3 pp. Based on the preceding computations, the distance of the field in different directions, the frequency dependence of the field, and the direction of the magnetic component are discussed in detail.

A Magnetodynamic Gramophone Pick-up: II. Frequency Characteristics, by N. Wittenberg. "Phil. Tech." Nov. 30, 1956. 6 pp.

The Development of an Apparatus for Measuring Distinctness, by W. Erler. "Hochfreq." Sept. 1956. 7 pp. The apparatus indicates the sound energy arriving within the first 50 msec and the total sound energy. The quotient of these numbers is defined as the distinctness. The circuitry of the instrument is described and shown. Electronic squaring and switching as well as error determination are given special attention.

A New Method for the Investigation of Microphonics, Part I, by I. P. Valko. "Hochfreq." Sept. 1956. 5 pp. According to this method the tube to be tested is subjected to mechanical accelerations with evenly distributed spectral intensity within the interesting bandwidth; thus nearly stationary oscillations result. The limits of the new method are set forth.

On the Information Contents of Consonants, by F. Enkel. "Nach. Z." Nov. 1956. 6 pp. An experimental set-up for hearing tests permitting one to independently regulate the low-frequency speech sounds up to 1000 cycles, corresponding to the band-spectrum of the vowels, and the high-frequency spectrum, corresponding to the continuous consonant spectrum, was used to investigate the information content of the continuous consonant spectrum. It is concluded that the continuous frequency spectrum above 4500 cycles is of considerable importance. Detailed results are presented.



CIRCUITS

Confined Electron Flow in Periodic Electrostatic Fields of Very Short Periods, by K. K. N. Chang. "Proc. IRE." Jan. 1957. 8 pp. An important advance has been made by evolving a method for focusing an electron beam of uniform space charge density with an electrostatic field.

Signal-Flow Graphs and Random Signals, by W. H. Huggins. "Proc. IRE." Jan. 1957. 12 pp. The author points out that familiar techniques used in solving linear systems may also be used to determine some of the statistics associated with complicated Markoff processes and the correlation functions and power spectra of signals arising from such processes.

A Versatile Rectangular Pulse Generator, by G. O. Crawther, L. H. Light, and C. F. Hill. "El. Eng." Jan. 1957. 5 pp. Generates rectangular pulses of 1 microsecond to 12 msec, at repetition frequencies of 1 cps to 150 kc. Includes electronic delay circuit enabling a triggering pulse to precede the main pulse by a short variable period.

REGULARLY REVIEWED

- AEG Prog. AEG Progress
- Aero. Eng. Rev. Aeronautical Engineering Review
- Ann. de Radio. Annales de Radioelectricite
- Arch. El. Uber. Archiv der elektrischen Uebertragung
- ASTM Bul. ASTM Bulletin
- Auto. Con. Automatic Control
- Auto. El. The Automatic Electric Technical Journal
- Avto. i Tel. Avtomatika i Telemekhanika
- AWA Tech. Rev. AWA Technical Review
- BBC Mono. BBC Engineering Monographs
- BC News. Broadcast News
- Bell Rec. Bell Laboratories Record
- Bell J. Bell System Technical Journal
- Bul. Fr. El. Bulletin de la Societe Francaise des Electriciens
- Cab. & Trans. Cables & Transmission
- Comp. Rend. Comptes Rendus Hebdomadaires des Seances
- Comp. Computers and Automation
- Con. Eng. Control Engineering
- Elek. Elektrichestvo
- El. Electronics
- El. & Comm. Electronics and Communications
- El. Des. Electronic Design
- El. Energy. Electrical Energy
- El. Eng. Electronic Engineering
- El. Eq. Electronic Equipment
- El. Ind. ELECTRONIC INDUSTRIES & Tele-Tech
- El. Mfg. Electrical Manufacturing
- El. Rund. Elektronische Rundschau
- Eric. Rev. Ericsson Review
- Fern. Z. Fernmeldetechnische Zeitschrift
- Freq. Frequenz
- GE Rev. General Electric Review
- Hochfreq. Hochfrequenz-technik und Elektroakustik
- IBM J. IBM Journal
- Insul. Insulation
- Iz. Akad. Izvestia Akademii Nauk SSSR
- J. BIRE. Journal of the British Institution of Radio Engineers
- J. ITE. Journal of The Institution of Telecommunication Engineers
- J. IT&T. Electrical Communication.
- J. UIT. Journal of the International Telecommunication Union
- Nach. Z. Nachrichtentechnische Zeitschrift
- NBS Bull. NBS Technical News Bulletin
- NBS J. Journal of Research of the NBS.
- Onde. L'Onde Electrique
- Phil. Tech. Philips Technical Review
- Proc. AIRE. Proceedings of the Institution of Radio Engineers
- Proc. BIEE. Proceedings of the Institution of Electrical Engineers
- Proc. IRE. Proceedings of the Institute of Radio Engineers
- Radiotek. Radiotekhnika
- Radio Rev. La Radio Revue
- RCA. RCA Review
- Rev. Sci. Review of Scientific Instruments
- Rev. Tech. Revue Technique
- Syl. Tech. The Sylvania Technologist
- Tech. Haus. Technische Hausmittelungen
- Tech. Rev. Western Union Technical Review
- Telonde. Telonde
- Toute R. Toute la Radio
- Vak. Tech. Vakuum-Technik
- Vide. Le Vide
- Vestnik. Vestnik Svyazy
- Wirel. Eng. Wireless Engineer
- Wire. Wild. Wireless World

For more information, contact the respective publishers directly. Names and addresses of publishers may be obtained upon request by writing to "Electronic Sources" Editors, ELECTRONIC INDUSTRIES & Tele-Tech, Chestnut & 56th Sts., Philadelphia 39.

A Simple Square-Law Circuit with High Frequency Response, by H. N. Coates. "El. Eng." Jan. 1957. 2 pp. By applying a signal to pentode control and suppressor grids, circuit balances out changes in plate current proportional to signal fundamental and generates component proportional to its square—thus eliminating additional filtering and bandwidth restriction.

Nyquist's Stability Criterion: Proof Using Laplace Transform Calculus, by E. A. Freeman and J. F. Meredith. "Wirel. Eng." Dec. 1956. 5 pp. The Nyquist Criterion of Stability is derived using the methods of the Laplace Transform Calculus.

Frequency Conversion by Means of a Nonlinear Admittance, by C. F. Edwards. "Bell J." Nov. 1956. 14 pp. A mathematical analysis of a heterodyne conversion transducer in which the nonlinear element is made up of a nonlinear resistor and a nonlinear capacitor in parallel. It is concluded that a nonlinear capacitor alone is the preferred element for modulators and that a nonlinear resistor alone gives the best performance in converters.

A Pulse Detector with an L-C Filter, by E. L. Gerenrot. "Radiotek." Nov. 1956. Transient response is examined in the circuit of an ideal detector with an LCR filter in the case where the internal impedance of the current source is taken into account. A method is developed for computing the load voltage when detecting r-f pulses of arbitrary shape. Simple design formulas are given for determining the load voltage and the time required to reach a steady-state condition. The magnitude of the load-voltage "overshoot" and the condition under which it is absent when a rectangular pulse is being detected are determined.

Minimization of Boolean Functions, by E. J. McCluskey, Jr. "Bell J." Nov. 1956. 28 pp. A simplification and extension of the method presented by W. V. Quine.

The Computation of Groups of Lines for Overflow Traffic in Telephone Line Selector Installations, by G. Bretschneider. "Nach. Z." Nov. 1956. 8 pp. A method to compute the telephone lines necessary to take care of the overflow traffic which can not be handled by the preferred groups of lines is presented. The method is based on the consideration of the fluctuations of the traffic distribution.

Wide Band Amplifier Design, by J. Kason. "El. Eng." Jan. 1957. 3 pp. Describes design of wide band amplifier; includes discussion of alternative designs.

A Contribution to the Synthesis of Two-Terminal and Four-Terminal Reactance Networks, by W. Saraga. "Nach. Z." Nov. 1956. 14 pp. A network synthesis computation method is developed which relies on the "unity" points of suitably chosen rational functions. These are the primary design parameters and are correlated with the component values. An extensive study is presented.

A Filter Catalogue, by E. Glowatzki. "Nach. Z." Nov. 1956. 5 pp. Systematic computations on the program-controlled electronic computer of the Max-Planck Institute concerning low-pass filters have been carried through. Several thousand filter designs up to grade 5 with Cauey parameters and general parameters are involved.

An Averaging Method and Its Application to Certain Nonlinear Problems of Radio-Engineering, by Iu. N. Bakaev and P. I. Kuznetsov. "Radiotek." Nov. 1956. 10 pp. The paper briefly develops an averaging method introduced by N. N. Bogoliubov. The effectiveness of this method is demonstrated by applying it to the solution of certain nonlinear problems of radio-engineering (mainly to the investigation of detection processes). In this regard certain other papers are discussed in which various methods of averaging are used. An evaluation is made of the error involved in each of the methods cited.

On the Theory of Relaxation Processes, by A. G. Redfield. "IBM J." Jan. 1957. 13 pp. A general procedure is given for finding the equation of motion of the density matrix of a system in contact with a thermal bath, as for example a nuclear spin system weakly coupled to a crystal lattice.

A Comparison of Statistical and Non-Statistical Prediction, by R. A. Kazarian. "Radiotek." Nov. 1956. 5 pp. The paper compares (in the sense of the mean-square-error criterion) prediction operators which are computed by statistical and non-statistical methods. The extrapolation of a Taylor series is discussed, and the problem of a physically realizable operator is examined.

Silicon Diode Chopper Stabilizes D-C Amplifier, by L. Fleming. "El." Jan. 1, 1957. 2 pp.

Heater Voltage Compensation for D.C. Amplifiers, by J. B. Earnshaw. "El. Eng." Jan. 1957. 5 pp. Examines concept of fictitious voltage source to represent heater voltage fluctuations, and quotes useful experimental results. Gives detailed analysis of three compensation circuits and experimental results.

A Survey of Contact Resistance Theory for Nominally Clean Surfaces, by W. B. Ittner III, and P. J. Magill. "IBM J." Jan. 1957. 5 pp.

Free Oscillations in Simple Distributed Circuits, by A. B. Hillan. "Wirel. Eng." Dec. 1956. 12 pp. The author deals with calculation of waveforms occurring when a progressive wave in a transmission line impinges on a terminating circuit.

A Method of Analysing the Performance of Tandem-Connected Four-Terminal Networks, by P. W. Seymour. "Wirel. Eng." Oct. 1956. 8 pp.

Self-Oscillations at Multiple Frequencies in a System with Two Degrees of Freedom, by G. M. Utkin. "Radiotek." Nov. 1956. 11 pp. The paper investigates a self-excited oscillator which has two tuned circuits encompassed by feedback, and which operates at approximately multiple intrinsic frequencies. The analysis is made in general form on the basis of the method of slowly-varying complex amplitudes. Expressions are obtained for the frequencies of the oscillations, and for their instability as a function of the instability of the intrinsic frequencies and the supply voltages. The paper points out the possibility of utilizing such systems for the division and multiplication of quartz frequencies, as well as for frequency modulation.

The Computation of Linear and Nonlinear Electrical Circuits by Means of the Tabular Method, by V. A. Govorkov. "Elektrosviaz." Nov. 1956. 11 pp. A method is developed for the practical computation of complex electrical circuits to a specified degree of accuracy. The method is applicable to both linear and nonlinear dc or ac circuits that are encountered in automation or communications engineering.

Cascade-Connected H.F. Oscillators, by S. Panzer. "El. Rund." Dec. 1956. 8 pp. The sequence of an h-f self-excited oscillator and a cascade of dc multipliers; i.e., addingly connected half-wave rectifiers, for the generation of high dc voltages with low currents is studied. The oscillator, the dc multiplier stages, their matching, coupling and efficiency are treated. Industrial installations are described.

On Some Aspects of Detection from the Information Point of View, by J. Cauchois. "Ann. de Radio." Oct. 1956. 9 pp. A notion termed "information efficiency" is introduced to determined the quality of a receiver considering the noise and the type of signal to be received. Various methods of detection are discussed with a view to obtained maximum amount of information in the presence of a specific type of modulation and noise.

Applications of Supraconductivity—the Cryotron, by E. Roessler. "El. Rund." Dec. 1956. 2 pp. A short survey of theoretical and practical results obtained in investigations of supraconductivity in this and other countries is presented.

The Admittance Matrix of Passive and Active Networks, by H. Pecher. "Arc. El. Uber." Nov. 1956. 5 pp. Rules for setting up the admittance matrix on the basis of the node theorem are presented and followed by rules to reduce this matrix to one relating to three nodes only. These rules are applied to known tube and transistor circuits.

E and I Regulation with Non-linear Resistors, by G. J. Hegedus. "El. Des." Dec. 15, 1956. 2 pp. The simple circuit described in this article can provide regulation of ac or dc voltages without introducing phase shift or distortion. Circuit consists of a Wheatstone bridge comprising nonlinear elements.

Survey of Mechanical Filters and Their Applications, by J. C. Hathaway and D. F. Babcock. "Proc. IRE." Jan. 1957. 12 pp. Different constructions, applications, and characteristics are described.



COMMUNICATIONS

Flexibility Key to Carrier Frequency Networks, by G. D. Wallenstein. "El. Ind. Operations Section." Feb. 1957. 2 pp. Local terminations and branch-offs require a more versatile arrangement than through traffic only. This article describes a master plan which satisfies needs of all users.

Phase-Shift Radio Teletype, by J. P. Costas. "Proc. IRE." Jan. 1957. 5 pp. Teletype transmission by phase-shift rather than frequency-shift, and reception by coherent or synchronous detection is discussed.

The Selection of Intermediate Frequencies for a Panoramic Radio Receiver, by N. I. Svetlov. "Radiotek." Nov. 1956. 19 pp. The paper examines the problems which are associated with the circuit design of a panoramic radio receiver and analyzes the selection of intermediate frequencies for the receiver. Detailed design parameters are provided and sample calculations are made.

Description and Engineering Details of the Pulse Multiplex Equipment MX.620 for Semi-Fixed Links for 12-24 Channels, by R. Casse and L. Masliah. "Ann. de Radio." Oct. 1956. 20 pp. This pulse multiplex equipment for 12 or 24 simultaneous telephone channels has been developed by the Société Française Radioélectrique for the French Air Ministry. Information on design as well as on the performance is included.

Single-Side-Band Modulation with Subdivision of the Low-Frequency Spectrum, by B. B. Shtein. "Elektrosviaz." Nov. 1956. 9 pp. The paper examines the special features of segregating one side-band by means of multiphase modulation. A detailed analysis of a new system of two-phase modulation is given. In order to simplify the design and adjustment of wide-band phase shifters it is proposed that the low-frequency spectrum be subdivided into two portions which are equal in the logarithmic sense.

A System for Number Transmission When Long-Distance Telephone Communication is Automated, by V. N. Roginsky. "Elektrosviaz." Nov. 1956. 10 pp. The paper discusses a number of problems which are involved in the automatization of inter-city telephone communication. Various systems are examined. A conclusion is drawn concerning the practicability of utilizing multi-frequency coding of the entire number of an inter-city station in the "Soviet Union" network.

Design and Comparison of Basic Circuits for the Suppression of Interference from Stations Operating at the Intermediate Frequency of the Receiver, by I. M. Simonov. "Elektrosviaz." Nov. 1956. 10 pp. This paper takes into account the effect of filters which are included in the preselector circuit upon the voltage transfer coefficient and upon the selection of the circuit parameters. Expressions are derived for calculating the selectivity.

The Interference Rejection of Long-Distance Communications Channels, by Iu. D. Farber. "Elektrosviaz." Nov. 1956. 10 pp. The problem of interference rejection is examined for signals which are transmitted over long-distance channels. It is shown that for telephone transmission the frequency response of typical compressor apparatus is not optimum. Simple methods are recommended for increasing the interference rejection of speech signals.

Theory of Constructing a Radio-Broadcasting Distribution Network, by E. K. Iodko. "Elektrosviaz." Nov. 1956. 6 pp. The paper examines the basic circuits used in building up radio-broadcasting distribution networks: the single link, the double link and the common feed circuit.



COMPONENTS

New Hub Solves Linearity Problem, by J. W. Weidenman and D. S. Rathje. "El. Ind." Feb. 1957. 3 pp. A machined aluminum hub is used to obtain better linearity and higher stability of a precision potentiometer. New winding techniques and a better method of guiding the movable contact are discussed.

On the Concept of Resonance of Piezoelectric Crystal Resonators, by G. Becker. "Arc. El. Uber." Nov. 1956. 11 pp. This study is primarily concerned with series resonance and antiresonance piezoelectric crystal resonators. These concepts are extended, their differences stressed and their characteristic properties discussed.

The Dry Circuit Problem, by W. A. Scism. "El. Mfg." Jan. 1957. 3 pp. Concerning the unpredictable failure of relay contacts to close a circuit handling milliamperes at millivolts. A "Miss" test circuit is illustrated.

A Capacitor Subjected to Voltage Pulses; Heating Calculations, by J. Peysou. "Ann. de Radio." Oct. 1956. 12 pp. The loss angle concept is not readily applied if voltage pulses are fed to a capacitor. The article is concerned with a Fourier analysis of the voltage pulses, and subsequent use of the sinusoidal capacitor formulas to the pulse components. The losses for ideal steep wave forms, inclined waveforms, and modulated waves are computed.

Resistor Evaluation for Critical Applications, by R. Davie, J. P. Gehegan, and A. A. Andriolo. "El. Mfg." Jan. 1957. 4 pp. It is proposed to include evaluation of stability during operating life in assigning tolerance and power ratings to resistors.

Designing Airborne Equipment for Vibration, by S. P. Mercurio, Jr., and M. Belby. "El." Jan. 1, 1957. 3 pp. Chassis design, component placement, and tests of reliability under vibration are discussed.

The Mixer-Commutator, by J. Soffer. "Rev. Tech." Sept. 1956. 9 pp. This apparatus permits the operator to select one of a number of programs available and to feed it to the transmitter antenna. A three-way arrangement is explained.

Problems in the Manufacture of Variable Capacitors, by J. Joffre. "Onde." Oct. 1956. 8 pp. The relationships between various structural features influence the characteristics of a variable capacitor, such as electromechanical properties, microphonic susceptibility, tempera-

ture coefficient and resistance to corrosion, is set forth. Control methods used in the manufacture of variable capacitors are described and various recent capacitor types are presented.

Metallised Capacitors, by A. Kohler. "Onde." Oct. 1956. 10 pp. The properties and method of manufacture of metallised paper capacitors are set forth in some detail.



COMPUTERS

Development of the Electrostatic Clutch, by C. J. Fitch. "IBM J." Jan. 1957. 8 pp. The most useful single property of the electrostatic clutch is its fast response time. It can actuate levers, interposers, print hammers, optical gates, etc., in fractions of a millisecond.

Conventional Logic and Electronic Computing and Switching Installations, by F. Weitzsch. "El. Rund." Dec. 1956. 6 pp. Classical logic is considered and coordinated with the switching operations used in electronic computers. In particular the importance of the gates and their logical analogue is set forth.

The Rheoelectric Analog Method. Possibilities and Tendencies, by L. Malavard. "Onde." Oct. 1956. 9 pp. This intermediate section of the article considers limiting conditions and field singularities. Conform transformations, representation of rational functions and solution of algebraic equations as well as practical applications are discussed.

Considerations on the Principles of Universal Numerical Computers, by F. H. Raymond. "Onde." Oct. 1956. 4 pp. In this intermediate section of an introductory article for non-specialists, the author deals with a general representation of computer formulas and with parallel and series machines.



INDUSTRIAL ELECTRONICS

Electronic Eyes Inspect Drinks, by L. W. Leidy. "El. Ind." Feb. 1957. 1 p. An automatic bottled-beverage inspection machine is described. Unique feature is ability to distinguish between bottle defects and actual contaminants within the liquid.

Japanese Technical Captions, by A. Karp. "Proc. IRE." Jan. 1957. 1 pp. The special Japanese syllabary for "foreign words" is presented, with sufficient information to enable readers to translate technical titles and captions, which are usually phonetic translations from English.

The Use of Analogue Calculations in Problems of Industrial Control, by M. F. Versini. "Bul. Fr. El." Nov. 1956. 9 pp. Experimental studies with electronic circuits simulating industrial calculations are reported. In particular studies of the behavior of motors and generators, for instance the control of the velocity of a rolling mill motor and various control steps in the manufacture of sheet metal, have been carried out.

Thyratrons Control Die-Cutting Machine, by R. W. Bradley. "El." Jan. 1, 1957. 4 pp.

The Central Remote-Control Equipment at 175 Cycles of the French Power System, by M. H. Prigent. "Onde." Nov. 1956. 12 pp. The French electric power supply has normalized its system for the remote control of electric meters and public illumination. The history and present status of this system is expanded; the 40 simple controls afforded by the system are explained, and the first installations are described.

Static D-C References for Closed-Loop Controls, by M. Mamon. "El. Mfg." Jan. 1957. 8 pp. Article discusses references for industrial use based on magnetic components, silicon-diodes, transistors.



MATERIALS

"Crystal Ball" Plots 3-D Curves In Color, by J. R. Alburger. "El. Ind." Feb. 1957. 4 pp. New electrofluor materials are described which become fluorescent or show visible colors at low voltages. A solid, crystal-clear 3-D display device with transparent matrix electrodes has been constructed to plot functions of X, Y, and Z. Other uses include memory matrices, digital readout indicators, and electronically controlled light filters.

Electronic Light—Luminous Capacitors, by R. R. Wylie. "El. Ind." Feb. 1957. 1 p. A description is given of ceramic phosphors which become luminous in an alternating electric field. Rugged light panels using this construction are described.

Ferroxplana, Hexagonal Ferromagnetic Iron-Oxide Compounds for Very High Frequencies, by G. H. Jonker, H. P. J. Wijn, and P. B. Braun. "Phil. Tech." Nov. 30, 1956. 10 pp. New groups of soft magnetic materials, some with upper frequency limits near 2.5 KMC, have been developed. Like ferroxcube and ferroxdure, these materials are prepared by the sintering of metal oxides. Composition and some properties of the new materials are discussed.

Magnetic Materials Push Back Design "Stops", by W. Arrott. "El. Mfg." Jan. 1957. 17 pp. A comprehensive report of the present state of magnetic materials; including discussions of permanent magnets, soft magnetic materials, ferrites and thin films, test methods and apparatus, new devices and components.

The Application of Ferroxcube in Unidirectional Waveguides and its Bearing on the Principle of Reciprocity, by H. G. Beljers. "Phil. Tech." Nov. 30, 1956. 9 pp. Theory and applications of ferroxdure and magnetized ferroxcube at frequencies as high as 1 to 30 KMC are discussed.

New Glass Dielectrics, by W. E. Hauth, Jr., and A. L. Pugh, Jr. "El. Mfg." Jan. 1957. 4 pp. The use of major amounts of titanium dioxide seems to offer improved dielectric constant, low dissipation factor, and moisture stability.



MEASURING & TESTING

Use of Counter Tubes in X-Ray Analysis, by W. Parrish and T. R. Kohler. "Rev. Sci." Oct. 1956. 14 pp. The authors present a thorough review of the more important properties of end-window Geiger counters, side-window proportional counters, and NaI (Tl) scintillation counters. Performance in the 5 to 50 kvp x-ray analysis region is compared. The electronic discrimination method is described, and some practical applications explained.

Electronic Probe Checks Turbines. "El. Ind." Feb. 1957. 1 p. A ceramic-mounted inductance probe has been perfected for use inside steam turbines. Probe and associated circuitry developed at National Bureau of Standards are described.

Film Reader Measures Recorded Radar Echoes, by A. Shapiro. "El." Jan. 1, 1957. 5 pp.

International ELECTRONIC SOURCES

The Scream of a Jet—In a Six-Inch Test Cell, by R. H. Jacobson. "El. Ind." Feb. 1957. 4 pp. Within a six-inch cube, this new acoustic test chamber duplicates the high sound intensities in an air force jet plane. Tests with the inexpensive laboratory equipment prove large changes can occur in characteristics of electronic components subjected to intense sound.

Standardized White Noise Tests, by J. Robbins. "El. Ind." Feb. 1957. 3 pp. Wide frequency high-G tests for missile components are described. Test has been designed for use in large scale testing of production components.

"Immitance" New Tool for Network Analysis, by H. M. Wasson. "El. Ind." Feb. 1957. 3 pp. A chart is presented which permits simultaneous reading of impedance and admittance at a point on the chart, determination of equivalent series and shunt configurations for two-terminal networks, and other valuable information. Derivation and use of the chart are explained.

Ion Source for the Production of Multiply Charged Heavy Ions, by C. E. Anderson. "Rev. Sci." Oct. 1956. 9 pp. A pulsed, cold-cathode ion source has been developed to produce multiply charge ions for use in a linear accelerator.

Measurement of Instantaneous Frequency with a Microwave Interferometer, by H. P. Raabe. "Proc. IRE." Jan. 1957. 9 pp. Analysis and experiments are presented which indicate this method provides a practical method for measuring the frequency and its stability during a radar pulse.

Single-Oscillator Microwave Measuring System, by D. H. Ring. "Bell Rec." Dec. 1956. 4 pp. With the arrangement described, one oscillator is used with a rotating, motor-driven section of waveguide to determine loss and gain at millimeter wave lengths quickly and accurately.

Comparison of the Methods of Computing Pressure Variations Along a Membrane, by H. Jung. "Hochfreq." Sept. 1956. 5 pp. The expressions for the pressure variations may be derived on the basis of the Statistical distribution of the impacts of the air molecules or on the basis of the thermal excitation of the resonance frequencies of the air-filled space in front of the membrane. Discrepancies of the results obtained in the adiabatic case and for the spectral distribution are clarified by an investigation of the effective membrane area.

The Vernier Time-Measuring Technique, by R. G. Baron. "Proc. IRE." Jan. 1957. 10 pp. The author presents an electrical analog of the mechanical vernier scale and illustrates its use to measure the time between two pulses—accurate to 10 millimicroseconds.

Impedance Measurements on HF Diodes as a Function of the Bias, by H. Flietner. "Hochfreq." Sept. 1956. 6 pp. An apparatus, based on standing-wave measurements, is described. The Germanium rectifier is positioned in the terminating short-circuit; the impedance of the crystal holder and of the contacting wire are independently determined. Thus the equivalent circuit of the boundary alone is computed.

Advances in RF Calorimetric Power Measurement, by S. Freedman. "El. Des." Dec. 15, 1956. 4 pp. The use of liquid filled waveguide loads to convert electromagnetic energy into temperature rise of the liquid is discussed.

Fixed-Image Analyzers, by M. Favreau. "Rev. Tech." Sept. 1956. 7 pp. Two types of analyzers for fixed images, those using flying-spot scanners and those using Vidicon tubes, are considered and their performance is compared.

A Blue-Screen Oscillograph, a New Apparatus for Recording Non-Periodic Events, by W. Dietrich. "Nach. Z." Nov. 1956. 4 pp. The blue-screen CR tube MS 17-21 may retain an image for several days; alternatively, the image may be wiped out by electrical heating. The circuit of an oscillograph using this tube is given and the performance data of the apparatus are included.

Equipment for the Continuous Vectorial Display of Alternating Voltages in the Frequency Range 5kc/s to 3 Mc/s, by E. C. Pyatt. "Wirel. Eng." Oct. 1956. 5 pp.

A New Standard for Extremely Low Noise Power in the Microwave Region, by H. Jung. "Hochfreq." Sept. 1956. 3 pp. It is proposed to use thermistors and bolometers for noise measurements, similar to Lane's arrangement. However, the glass tube is arranged parallel to the narrow wall of the wave guide and not parallel to the wider wall.

High Value Resistors and Their Measurement, by G. France. "El. Eng." Jan. 1957. 7 pp. Describes instrument enabling measurement of resistors up to 10^{14} ohms at 10 v. to accuracy of about 1%.

Operational Bridge Gages High Capacitance, by R. L. Konigsberg. "El." Jan. 1, 1957. 3 pp.

Instrumentation Notes for Shock Tests, by A. C. Diechmiller. "El. Mfg." Jan. 1957. 7 pp. Discussion includes measurements of shock and vibration under extreme environmental conditions, and selection of electromagnetic vibration pickups for various application.



RADAR, NAVIGATION

Applying the Doppler Effect to Direction Finder Design (Part 2), by J. A. Fantoni and R. C. Benoit, Jr. "El. Ind." Feb. 1957. 4 pp. A doppler-principle direction finder using an antenna rotation simulation system is described. A circular array of fixed antennas is scanned with a rotating switch.

Pulse Transmitter with Line Spectrum, by H. Fack. "El. Rund." Dec. 1956. 3 pp. It is, sometimes, for instance for Doppler Radar installations, necessary to generate a pulse series in which the phase relationship of the pulse-modulated oscillation and of the modulating pulses is constant. For this purpose 1) a harmonic of the pulse recurrence frequency may be modulated, 2) a phase-controlled oscillator of arbitrary frequency may be pulse modulated, 3) phase-control by a harmonic of the pulse recurrence frequency, and 4) phase-control by an arbitrary frequency oscillator may be used; these possibilities are discussed.

On the Mechanisms of Radar Sea Clutter, by M. Katzin. "Proc. IRE." Jan. 1957. Experimental data on radar sea clutter are presented and a theory evolved.

The Over-All Error in an Adcock Direction Finder, by K. Baur. "Arc. El. Uber." Nov. 1956. 3 pp. In the region in which the travel time difference for the individual antennas is of importance, the maximum direction error is a multiple of the error expected according to the available theoretical error. A theory reconciling this discrepancy is presented and compensating means are provided to reduce the error.



SEMICONDUCTORS

Theoretical Considerations on the Physical Foundation of the Equivalent Circuit for Semiconductor Diodes at High Current Densities, by W. Guggenbuehl. "Nach. Z." Nov. 1956. 3 pp. The transient response of a p-n junction diode for large currents is explained on the basis of a theory developed by A. Herlet. In particular the presence of an inductive effect is derived. The theoretical behavior is shown to agree with available experimental data.

Direct Method of Measuring the Contact Injection Ratio, by O. L. Curtis, Jr. and B. R. Gossick. "Rev. Sci." Oct. 1956. 2 pp. A direct method of measuring the injection ratio of rectifying contacts is described. Added advantage of the method is elimination of the auxiliary contacts customarily used.

A Transistor Radio Receiver Powered by a Thermopile. "Phil. Tech." Nov. 30, 1956. 3 pp. A simple thermopile, placed over the chimney of a kerosene lamp, provides sufficient power for a seven-transistor broadcast receiver. 192 Chromel-constantan thermocouples, connected in series by spot welds, are arranged so the hot junctions project into the rising stream of hot gas, and the cold junctions project into air outside the chimney. Convection currents provide circulation to both sets of junctions. Design of the thermopile is intended to be easily repairable by a "local radio mechanic or smith." The thermopile can generate up to 242 mw at lamp temperatures.

Graphical Method for Computing the Thermal Compensation of Rheostat Transistor Amplifiers, by G. V. Volshillo. V. S. Davydov. "Radiotek." Nov. 1956. 7 pp. A method is given for the graphical computation of rheostat junction-transistor amplifiers, that permits the displacement of the operating point and the variation in gain which are due to temperature fluctuations to be determined from the family of static transistor characteristics. The reverse problem is also solved graphically: on the basis of the static characteristics circuit elements are determined for which the gain of the stage either varies within specified limits or remains constant.

Surface Leakage Current in Silicon Fused Junction Diodes, by M. Cutler and H. M. Bath. "Proc. IRE." Jan. 1957. 5 pp. A method is described for distinguishing between surface and junction currents. Implications and deficiencies of the model are discussed.

Dimensioning of Transistor-Wide-Band Amplifiers, by G. Meyer-Broetz and K. Felle. "Nach. Z." Nov. 1956. 6 pp. Design formulas for multi-stage transistor amplifiers are based on the desired amplification-factor frequency curve. The derivations involve simplifications reducing the agreement of the desired and obtained response; however, the principal course of the amplification factor and its dependence on transistor parameters and operating point is thereby stressed.

Clarification of First-Order Semiconduction Effects Through Use of Electrochemical Potentials, by J. A. Swanson. "IBM J." Jan. 1957. 5 pp. The first-order treatment of conduction effects in semiconductors is simplified. Poisson's equation is shown to be ignorable in the first-order treatment of steady-state effects. Application is given to the Hall effect and to the characterization of probes.

An Analysis of Diffusion in Semiconductors, by S. Zaromb. "IBM J." Jan. 1957. 5 pp. The author questions the assumption that impurity diffusion coefficients do not vary with concentration in semiconductors. It is maintained that interactions between acceptors, donors, electrons, and holes may lead to complicated diffusion equations.

Heat Dissipation from Electronic Equipment, Transistors-vs-Electron Tubes, by E. K. Van Tassel. "Bell Rec." Dec. 1956. 5 pp. Important finding presented in this report is that because of different temperature limits, electron tubes may result in smaller equipment than transistors in some applications.

Designing Transistor D-C Amplifiers, by J. W. Stanton. "El. Des." Dec. 15, 1956. 4 pp. The author discusses a compensating current generator circuit which can be used to compensate for the inherent drift in transistor characteristics and sensitivity to temperature changes.

Thermistors Compensate Transistor Amplifiers, by A. J. Wheeler. "El." Jan. 1, 1957. 3 pp.

Theory of the Swept Intrinsic Structure, by W. T. Read, Jr. "Bell J." Nov. 1956. 46 pp. An analysis is presented for finding electric field, and hole and electron concentrations for reverse biased junctions in which the space charge of the carriers cannot be neglected. The analysis takes account of space charge, drift, diffusion, and nonlinear recombination.

The Equivalent Circuit of a Transistor at High Frequencies, by I. I. Litvinov. "Radiotek." Nov. 1956. 5 pp. The paper examines the problem of taking the frequency response of a transistor into account. On the basis of the transient response the paper determines equivalent circuits for transistors; these equivalent circuits are valid over a wide band of frequencies. Formulas are derived for the calculation of the reactive parameters of the circuits.

Wafer-Type Millimeter Wave Rectifiers, by W. M. Sharpless. "Bell J." Nov. 1956. 18 pp. A wafer-type silicon point-contact rectifier and holder designed primarily for use as the first detector in millimeter wave receivers are described.

Miniature ITV Camera Uses Drift Transistors, by L. E. Flory, G. W. Gray, J. M. Morgan, and W. S. Pike. "EL." Jan. 1, 1957.

The Use of Thermistors to Compensate the Thermal Drift of Self-Excited Oscillators, by P. Guené. "Ann. de Radio." Oct. 1956. 14 pp. Formulas for the calculations of the components to compensate for thermal drift and the variation of the drift are derived. Two numerical examples of drift compensation circuits using thermistors are presented and detailed information on the component and performance values are included. The residual frequency drift can be reduced to 3×10^{-6} per degree centigrade.

Diffusion in Solids—A Breakthrough in Semiconductor Device Fabrication, by M. Sparks and W. J. Pietsenpol. "Bell Rec." Dec. 1956. 6 pp. The authors explain the new technique of diffusing impurities from a gaseous state into the crystal. The new technique opens up possibilities of high operating frequencies and power-handling capacities not previously possible with semiconductor devices.

Negative Resistors with Transistors in the Design of Networks, by H. Ebel. "Nach. Z." Nov. 1956. 6 pp. A report of some available linear negative resistances and their conversion properties is given. In particular transistor feedback circuits are studied. Examples are included.

The Junction Transistor as a Computing Element (Part I), by E. Wolfendale, L. P. Morgan, and W. L. Stephenson. "El. Eng." Jan. 1957. 6 pp. Describes small signal and transient characteristics of transistors, then illustrates use of characteristics in design of basic circuits and use in computer elements.

Transistors Generate Geometric Scale, by E. Gott and J. H. Park, Jr. "EL." Jan. 1, 1957. 4 pp.



TELEVISION

The Impact of Color on Video Switching (Pt. 2), by Albert D. Emurian. "El. Ind Operations Section." Feb. 1957. 4 pp. Compares the common systems of monochrome switching, their comparative abilities to handle color switching, and their position in the switching lineup of a typical studio.

The Control Receiver. Using an Oscilloscope, for Video-Frequency Signals, by J. Beaugrand. "Rev. Tech." Sept. 1956. 5 pp. This control receiver comprises a receiver displaying the image and an oscilloscope assembly for control and measuring purposes. Characteristic features of this apparatus are discussed.

A T.V. Preamplifier, by Ch. Guilbert. "Toute R." Dec. 1956. 3 pp. It is suggested to insert a preamplifier close to the antenna, in the case of a long coaxial cable connecting the antenna with the television set. A preamplifier for this purpose and a coaxial cable simultaneously carrying the amplified signal to the television set and ac power to the preamplifier, as well as a suitable rectifier for converting the ac power to dc power, are described.

Wide-Band Diplex for Television Transmitters, by R. Chesneau. "Rev. Tech." Sept. 1956. 13 pp. The diplex, a high-frequency switch which connects a common antenna to the sound and video outputs of a television transmitter, is studied. A special diplex using two wide-band ring circuits and two cavities is described and its operational characteristics are stated.

Single-Carrier System for Sound and Video, by B. Wolfe. "EL." Jan. 1, 1957. 3 pp. A description of a method for multiplexing sound and video for emergency radiation by visual transmitter only.

The Double Synchronization Generator, by J. Soffer. "Rev. Tech." Sept. 1956. 4 pp. Blanking and synchronizing signals are supplied by this generator. Double features are included to permit continued operation in case of failure of one section of the equipment.

The Black-White Spacing in Single-Side-Band TV Transmission, by D. Buenemann and W. Haendler. "Arc. El. Uber." Nov. 1956. 10 pp. Theoretical and experimental investigations on single-side-band transmission are reported. Picture quality is tested and suggestions for improvement are presented. Transients are considered and time-delay compensation is recommended.

The Television Control Receiver for HF Signals, by R. Fréjaville. "Rev. Tech." Sept. 1956. 5 pp. This receiver converts the high-frequency signal into a video signal and a sound signal; it was designed for studios and studio cars. Its principle of operation is set forth and performance data are given.

Channel-Control Assembly for the Vidicon Camera, by M. Favreau. "Rev. Tech." Sept. 1956. 3 pp. This assembly supplies all required voltages and signals to the camera and feeds the video signal to the mixer or to the transmitter. It comprises a mixer for the blanking and synchronizing signals, a deflection signal generator, an oscilloscope and a power supply.

Retransmitter for Television Systems, by R. Fréjaville. "Rev. Tech." Sept. 1956. 10 pp. A 50 W retransmitter for television signals is described. It was designed with a view to special conditions met with in France.

The 10 kw Television Transmitter C.F.T.H., by I. Afanassieff, J. J. Brieu and M. Guérineau. "Rev. Tech." Sept. 1956. 19 pp. The French standards for television transmitters are set forth. A detailed description of the transmitter developed by the French Thomson-Houston Co. is given. General layout as well as block diagrams are included.

The New C.F.T.H. Camera with Vidicon, by M. Favreau and G. Guillot. "Rev. Tech." Sept. 1956. 7 pp. Mechanical and electronic features of the television camera using a vidicon are set forth.

A New Television System Using Film Incorporating a Vidicon, by J. Taffiet. "Rev. Tech." Sept. 1956. 13 pp. The equipment includes a projector, an optical commutator, a camera, controls, and projection equipment. Some details of each of these components are given.

The P.P.I.-Television Image Converter Developed by S.F.R., by E. Asté. "Onde." Oct. 1956. 7 pp. This converter tube comprises two coaxial guns, one for recording the radar signal on an induced-conductivity type screen and another gun, facing the opposite side of the screen, for deriving a television signal from the screen. The dielectric layer on the

screen is of the order of 0.5μ thick so that the recording beam, accelerated to 10,000 v. may penetrate there-through and equalize the potentials on both sides of the dielectric.

H.F. Spectrum Analyzer for Television Transmitters, by J. Beaugrand. "Rev. Tech." Sept. 1956. 8 pp. The block diagram of the spectrum analyzer, utilizing a heterodyne receiver and an oscilloscope, is presented. Principle of operation and performance are discussed.



TRANSMISSION LINES

Helix Waveguide, by S. P. Morgan and J. A. Young. "Bell J." Nov. 1956. 38 pp. The helix waveguide is composed of closely wound turns of insulated copper wire covered with a lossy jacket. Approximate formulas are given for the propagation constants of the lossy modes. Modes whose wall currents follow the highly conducting helix have attenuation constants essentially the same as for copper pipe.

A Note Concerning the Discontinuities in Coaxial Wave Guides—The Case of the Thin Structure, by A. Leblond. "Ann. de Radio." Oct. 1956. 8 pp. An equation for the input impedance of a rectangular coaxial line looking towards a symmetrical discontinuity is derived. Expressions for thin and thick structures are presented for specific terminating conditions. The concept of a thin structure is given special attention.

Surface Finish and Attenuation of Aluminum Waveguides, by J. Allison and F. A. Benson. "El. Eng." Jan. 1957. 3 pp. Attenuation in air-filled rectangular, drawn aluminum waveguide is measured at 9300 MC, and compared with drawn copper, brass, and electroplated waveguide. Chemical polishing or electro-polishing improves surface finish of drawn aluminum waveguide. Information on surface texture of cast and sprayed aluminum waveguide components is included.



TUBES

IRE Standards on Electron Tubes: Physical Electronic Definitions, 1957. "Proc. IRE." Jan. 1957. 3 pp. The Subcommittee on Physical Electronics presents a group of definitions, including a definition of Electronic as pertaining to devices, circuits, or systems utilizing electron devices (devices in which conduction is principally by electrons moving through a vacuum, gas, or semiconductor).

Conditions for a Minimum Noise Figure in Traveling-Wave Tubes, by J. Labus, R. Lieb-scher and K. Poeschl. "Arc. El. Uber." Nov. 1956. 5 pp. Assuming optimal conditions in the helix space of the tube, the conditions for the preceding drift space, and in particular for its length, for optimum noise figures are derived. A substantially linear potential distribution between the first and last diaphragm in the drift space is suggested to eliminate lens effects and to reduce noise due to the transverse components of the electrostatic field.

Wide-Band TR Tubes with Interdigital Line, by D. Reverdin. "Ann. de Radio." Oct. 1956. 6 pp. To reduce the size of a TR tube for longer waves, an interdigital line is used as TR switch. This line consists of two inter-lacing comb-shaped structures forming a meandering delay-line positioned in a low-pressure enclosure having two windows. The comb teeth and opposing walls form spark gaps. The switch is interrupted by the ionizing action of the sparks and the resulting conductivity of the ion layer at the entrance window.

International ELECTRONIC SOURCES

A Medium Power Traveling-Wave Tube for 6,000-Mc Radio Relay, by J. P. Laico, H. L. McDowell, and C. R. Moster. "Bell J." Nov. 1956. 62 pp. A discussion of a traveling-wave amplifier which gives 30 db gain at 5 watts output in the 5,925- to 6,425-MC common carrier band. Tube description and detailed performance data are included.

A Sensitive Method for the Measurement of Reflection and Stability of High-Gain Traveling-Wave Tubes, by W. Klein. "Arc. El. Uber." Nov. 1956. 6 pp. The input and output impedance variations with frequency, which are a suitable measure for the reflections in the tube since their value far exceeds the reflections, are determined by a specially designed apparatus. A detailed discussion of the wave propagation conditions is presented and experimental results are reported.

Heat Control in Electronic Equipment (Part I), by E. N. Shaw. "El. Eng." Jan. 1957. 11 pp. Reports study of natural methods of cooling compact equipment in order to improve thermal stability and reduce component failures from overheating. Forced ventilation is rejected as defeating miniaturization. Mechanism of heat loss from basic units is explored. Relative effectiveness of loss by conduction, convection and radiation is illustrated by profusely colored plates.

The Coaxial Trochotron, by W. Rentsch. "Hochfreq." Sept. 1956. 5 pp. The electrodes in a coaxial trochotron are circularly arranged. Equations for the electron paths under the effect of the electric and magnetic fields are derived, and its operation explained. Various counting circuits for more than 10^6 pulses per sec. are discussed and a special trochotron for short-time switching purposes is described.

The Technology of Electrostatic Memory Cathode-Ray Tubes, by F. Choffart. "Onde." Oct. 1956. 7 pp. This article is devoted to technology of the component parts of electrostatic memory tubes. The electron gun and target, involving various methods of depositing the dielectric, of manufacturing fine structure grids, and of assembly are treated.

Investigations Concerning Cold-Cathode Counting Tubes, by W. Rentsch. "Hochfreq." Sept. 1956. 3 pp. The tube, filled with rare gas, comprises a series of 10 interlaced, circularly arranged, hollow, U-shaped cathodes surrounding a centrally located anode. These 10 cathodes ignite successively in a glow discharge and after ten input pulses one output pulse is obtained. Its life may be several thousand hours. A circuit incorporating the tube is described.

Electrostatic Memory Tubes, by Ch. Dufour. "Onde." Oct. 1956. 14 pp. The operation of electrostatic memories is explained and different types of memory tubes described, such as the barrier-grid storage tube, the transmission-grid storage tube, the induced conductivity tube for Radar PPI-to-television transformation, and the direct-view storage tube.



U. S. GOVERNMENT

Research reports designated (LC) after the price are available from the Library of Congress. They are photostat (pho) or microfilm (mic), as indicated by the notation preceding the price. Prepayment is required. Use complete title and PB number of each report ordered. Make check or money order payable to "Chief, Photoduplication Service, Library of Congress," and address to Library of Congress, Photoduplication Service, Publications Board Service, Washington 25, D. C.

Orders for reports designated (OTS) should be addressed to Office of Technical Services, U. S. Department of Commerce, Washington 25, D. C. Make check or money order payable

to "OTS, Department of Commerce." OTS reports may also be ordered through Department of Commerce field offices.

When an agency other than LC or OTS is the source, use the full address included in the abstract of the report. Make check or money order payable to that agency.

Tests of Insulating Varnishes for Radio Frequency Uses, by R. B. Owens and R. W. Armstrong. NRL. March 1937. 19 pp. Mic \$2.40, pho \$3.30. (LC, PB 120648)

Influence of Electric Fields on Zinc Sulfide Phosphors, by Sol Nudelman. U. S. Nav. Ord. Lab. Jan. 1955. 114 pp. Mic \$6, pho \$18.30. (LC, PB 120875)

Error-Free Coding, by P. Elias. MIT. Sept. 1954. 14 pp. Mic \$2.40, pho \$3.30. (LC, PB 122975) Report summarizes simple constructive procedures for coding sequences of symbols to be transmitted over noisy channels.

Antenna Studies for Radio Astronomy: Scientific Report No. 1 for the Period 15 Jun - 15 Sept. 1955 Under Contract No. AF 19(604)-1503, by J. W. Warwick and P. W. Carlin. Colo. U. Jan. 1956. 18 pp. Mic \$2.40, pho \$3.30. (LC, PB 1213219)

Effect of Parasitic Currents in Antennas of the UHF Radio Ranges on Horizontal Field Pattern, by H. W. Kohler. CAA. June 1945. 10 pp. Mic \$1.80, pho \$1.80. (LC, PB 122256)

Development of an Improved Crystal Exciter Unit, by C. H. Jackson. CAA. July 1940. 17 pp. Phs \$3.30, mic \$2.40. (LC, PB 122294)

Industrial Preparedness Study of Transistors and Diodes (31 Mar 1952 to 30 Sept 1954), by G. F. Platts, L. M. Downes, and others. GE. July 1955. 402 pp. \$8. (OTS, PB 121291) Continuous reduction furnace gives output equivalent to nine batch-type furnaces. Six-zone metal refining process handles metal too impure to be used in a progressive crystallization furnace—single run produces germanium in excess of 20 ohm-cm. Accurate control of time and temperature of hydrogen diffusion furnace proved highly important.

Investigation of Scattering and Multipath Properties of Ionospheric Propagation at Radio Frequencies Exceeding the MUF, by W. G. Abel, et al. MIT. June 1955. 166 pp. Mic \$7.80, pho \$25.00. (LC, PB 123211) Data from approximately 13,000 hours of operation were analyzed from measurements conducted since late 1951 on several frequencies and paths, predominantly 1000 to 1100 miles in length, in mid-latitudes. Cosmic noise measurements are described.

Mathematical Analysis of the Ring Modulator Circuit, by L. P. Giesler. U. S. Nav. Ord. Lab. April 1954. 18 pp. Mic \$2.40, pho \$3.30. (LC, PB 120866) A solution is obtained for the output current of a ring modulator circuit with arbitrary inputs and arbitrary load resistance.

Pulse Synchronization Equipment and Wide-Band 75 Kc/s T.R.F. Receiver, by S. A. Bowhill. Penn State. Feb. 1956. 26 pp. Mic \$2.70, pho \$4.80. (LC, PB 122188) The pulse synchronization equipment uses the phase coherence of the line voltage at the transmitter and the receiver as a time reference. Detailed circuit descriptions included.

Relaxation Oscillations in Voltage-Regulator Tubes, by P. L. Edwards. U. S. Nav. Ord. Lab. Dec. 1952. 20 pp. Mic \$2.40, pho \$3.30. (LC, PB 122020) Gas-filled voltage-regulator tubes are subject to relaxation oscillations when operated in parallel with a condenser. These oscillations have been investigated and a qualitative description of their mechanism is presented.

Research and Development Study of Gold Bonded Transistors, by P. Toong and R. Yee. Transistor Prods. Aug. 1954. 44 pp. \$1. (OTS, PB 111669) Stable, junction-like transistors with alpha cut-off up to 10 MC and values of alpha up to .95 have been produced by electrically bonding gallium-doped gold wire to opposite faces of a thin germanium crystal.

Microwave Propagation and Absorption in Material Media, by R. Beringer. Yale. June 1955. 6 pp. Mic. \$1.80, pho \$1.80. (LC, PB 122313) Includes bibliography on microwave magnetic resonance and microwave spectroscopy.

PATENTS

Complete copies of the selected patents described below may be obtained for \$.25 each from the Commissioner of Patents, Washington 25, D. C.

Superregenerative Amplifier, #2,772,352. Inv. J. C. Teller. Assigned Philco Corp. Issued Nov. 27, 1956. A relaxation oscillator is connected to render a gaseous discharge tube intermittently conductive. When conducting this tube presents a negative resistance to a tuned circuit connected in parallel thereto and having a positive resistance exceeding the negative resistance to produce superregenerative pulses. These pulses are modified by an incoming envelope-modulated carrier and the variations in the pulses is subsequently detected.

Grid-Structure for Cathode-Ray Tubes Designed for Polychrome Image Reproduction, #2,772,376. Inv. L. J. Cook and L. T. Quaglia. Assigned Chromatic Television Labs., Inc. Issued Nov. 27, 1956. A continuous conductor is wound in coil-like manner across the window area of a frame to form across this area two sets of parallel strands lying in two spaced parallel planes. A rigid bar displaces one of the two sets of parallel strands into the plane of the other such strand.

Communications System Checking Apparatus, #2,773,977. Inv. R. W. Hale. Assigned International Telephone and Telegraph Corp. Issued Dec. 11, 1956. Communication signals and periodic checking pulses of a predetermined time spacing are alternatively received. The pulses operate a relay which controls a motor. A motor-driven cam stops the motor after a predetermined rotation. During rotation the motor causes intermittent closing of an indicating circuit a plurality of times.

Transistor Indicator Circuit, #2,772,410. Inv. J. C. Logue and R. A. Henle. Assigned International Business Machines Corp. Issued Nov. 27, 1956. A glow discharge lamp is connected in series with a resistor and a voltage source. A potential drop is produced across this resistor by means of a transistor collector electrode. A signal potential is applied across the other transistor electrodes to control the collector current and thus the potential drop across the resistor.

Electrical Translator and Methods, #2,773,925. Inv. B. J. Rothlein and F. A. Stahl. Assigned Sylvania Electric Products, Inc. Issued Dec. 11, 1956. The electrical translator consists of a localized inhomogeneity in germanium. This inhomogeneity is produced by exposing the germanium to a zinc granule at about 600° to 800° C, cooling it and removing reaction products of the zinc by etching.

Electromechanical Transducing Arrangement, #2,773,942. Inv. R. T. Christensen. Assigned Zenith Radio Corp. Issued Dec. 11, 1956. A piezoelectric transducer is mounted to pivot in a reference axis. Two diaphragms contact the transducers at spaced points to impart a bending moment thereto in response to balanced concurrent actuation of both diaphragms and a pivoting movement in response to unbalanced concurrent actuation of both diaphragms.

Transistor Signal Amplifying Circuits, #2,773,945. Inv. G. E. Theriault. Assigned Radio Corporation of America. Issued Dec. 11, 1956. A gain control signal is simultaneously applied to two successive stages of a transistor amplifier. A double tuned coupling circuit provides the input for the first stage and a single tuned coupling circuit, tuned to the same frequency range, provides input to the second stage. A flat response output circuit follows the second stage.

Transmitting and Receiving Circuits for Wave Transmission Systems, #2,773,978. Inv. H. T. Friis. Assigned Bell Telephone Labs., Inc. Issued Dec. 11, 1956. The common antenna of a duplex signaling system is connected to a hollow wave guide leading to the generator. A branch hollow-wave guide leads to the receiver. At the beginning of this branch is an iris-coupled chamber resonant to the operating frequency. A spark-gap connected across the chamber is dimensioned to arc and thus short-circuit the chamber at the generator signal level, while remaining in its non-arc condition at the incoming signal level.

Automatic Phase or Frequency Control System, #2,773,984. Inv. J. F. Bigelow. Assigned International Telephone and Telegraph Corp. Issued Dec. 11, 1956. The line-frequency generator for a television receiver comprises a sine-wave oscillator tunable by a variable-reactance tube. The oscillator output is phase-compared to the received synchronizing pulses and the phase-discriminator output is applied to the control grid of the variable-reactance tube.

Color Television Kinescopes, #2,774,003. Inv. H. W. Leverenz. Assigned Radio Corporation of America. Issued Dec. 11, 1956. The surface area of a television screen is made of a phosphor material which will emit light of one color in response to a certain excitation density and light of another color in response to another excitation density. Two electron guns are provided to alternatively supply beam energies of the different excitation densities required.

Magnetostrictive Frequency Analyzers, #2,774,035. Inv. M. R. Richmond and D. Blitz. Assigned Raytheon Manufacturing Co. Issued Dec. 11, 1956. A plurality of magnetostrictive rods, each resonant at a discrete narrow frequency band, is mounted with one end of each rod in a common plane. The signal to be analyzed is applied to all rods and the amplitude of the resulting axial magnetostrictive displacement in each rod is successively sensed and indicated.

Color Television System, #2,771,503. Inv. J. W. Schwartz. Assigned Radio Corp. of America. Issued Nov. 20, 1956. The signal screen comprises alternating light-producing and signal generating strips. The light-producing strips producing different color light and the signal generating strips producing at least two types of signals. The two signals pass through different filters and combine to form a restoration signal which affects the gating of the color signals.

Self-Gating Synchronizing Circuit, #2,771,507. Inv. A. M. Levine and H. Altman. Assigned International Telephone and Telegraph Corp. Issued Nov. 20, 1956. The receiver T.V. synchronizing signal is applied to the grid of a first tube over an RC time-constant circuit. The output of the first tube is applied to the cathode of a second tube and a transformer feedback circuit from the plate of the second tube to the grid of the first tube.

Synthesis of Speech from Code Signals, #2,771,509. Inv. H. W. Dudley and C. M. Harris. Assigned Bell Telephone Labs., Inc. Issued Nov. 20, 1956. A plurality of records for each sound of speech is provided, each record corresponding to the sound as spoken for a different preceding and following sound. Three successive discrete code signals representative of three sounds are simultaneously examined and first the plurality of records associated with the second of these sounds is selected and then a single record is selected for reproduction in accordance with the first and third sounds.

Receiver Tunable over V.H.F. and U.H.F. Television Bands, #2,771,548. Inv. S. Deutsch. Assigned Polytechnic Research & Development Co. Issued Nov. 20, 1956. The receiver contains two shielded transmission lines, each having a short-circuiting slider, the two sliders being ganged for simultaneous operation. The transmission conductor of each line is divided

into a low-frequency section and a high-frequency section. The two sections of one line are connected to the input, and a detector circuit is placed intermediate the output of the first line and the input to the second line. Two electron tubes are connected to the high-frequency and low-frequency sections of the second line, respectively.

Saw-Tooth Generator, #2,771,556. Inv. W. A. Anderson and Ch. W. Harrison. Assigned Bell Telephone Labs., Inc. Issued Nov. 20, 1956. A capacitor is charged at a constant rate through a resistor and discharged at a sinusoidal rate in response to a signal provided by a low-impedance signal generator. The generator is connected between the positive resistor terminal and a rectifier whose other terminal is connected to the junction of the charging resistor and the capacitor.

Quartz Crystal Units, #2,771,561. Inv. D. Q. Fuller. Assigned Pye Ltd. Issued Nov. 20, 1956. An insulating support plate has two conducting metal-paste tracks applied to it. Two conducting electrodes are so arranged in contact with a quartz crystal plate as to have a part of their surface on the same side of the crystal plate so that, when the two units are combined, each electrode contacts one of the metal-paste tracks.

Traveling Wave Tubes, #2,771,565. Inv. J. H. Bryant and B. D. McNary. Assigned International Telephone and Telegraph Corp. Issued Nov. 20, 1956. An attenuator consisting of a concentrated body of resistive material is disposed along certain turns of the tube helix. The central portion of this body only is in direct contact with the helix for maximum attenuation and spaced relative to other helix sections for impedance transition. The body is disposed between at least two dielectric rods which support the helix.

Diode Capacitor Regenerator, #2,771,575. Inv. R. W. Hampton. Issued Nov. 20, 1956. The capacitor is precharged. A normally non-conducting gas-filled diode is caused to conduct in response to at least a predetermined minimum absolute charge on the capacitor. Conduction of the tube changes the potential of the electrode connected to the capacitor by a dc circuit, whereby the capacitor charge is regenerated.

Instrument Landing Systems, #2,771,608. S. B. Pickles and A. M. Casabona. Assigned International Telephone and Telegraph Corp. Issued Nov. 20, 1956. A glide-path generator comprises three vertically spaced antennas. Energy generated by a carrier source is modulated with a first frequency and by a second frequency to produce side-band energy. Both waves are fed to the lowest antenna, and the second band is fed to the central and highest antennas.

Electrical System, #2,772,324. Inv. W. P. Boothroyd. Assigned Philco Corp. Issued Nov. 27, 1956. The two side bands of a carrier are each frequency modulated. Upon reception, the frequency variation of each side band is independently converted into a corresponding phase variation. Heterodyning these two side bands results in a signal having a frequency equal to the difference of the side band frequencies and a phase equal to the phase difference between the side bands.

Automatic Synchronization Apparatus for Long-Time Transverse Magnetic Sound Recorder and Reproducer, #2,772,328. Inv. W. H. Lyon. Assigned the Soudscriber Corp. Issued Nov. 27, 1956. The advancing tape periodically automatically stops its advance for a short time interval to reduce the clearance between successively recorded transverse tracks and the path of a series of recording heads equally spaced in the direction of tape movement. This compensates for misalignment due to shrinkage or expansion of the recording tape.

Correction of Distortion in Push-Pull Amplifiers, #2,772,329. Inv. J. M. Miller. Assigned Bendix Aviation Corp. Issued Nov. 27, 1956. Both tubes of a push-pull amplifier are biased by an ac voltage having a frequency higher than the operating range; the ac voltage is applied in phase to both tubes. The high fre-

quency component is then removed from the output.

Television Camera Tube, #2,765,422. Inv. J. A. Henderson. Assigned International Telephone and Telegraph Corp. Issued Oct. 2, 1956. The picture to be transmitted is focused onto a translucent cathode and the resulting electron image is intercepted by the insulating layer of a grid impressing a voltage pattern thereon which corresponds to the picture. The grid further has a positive conductive layer, both layers being electron permeable, the flooding electrons will pass through the grid and emerge with a substantially amplified electron image.

Actuation of Electromagnetic Relay Means, Particularly for the Projection of Cinematograph, #2,765,429. Inv. T. R. Reading and Wm. J. Foy. Assigned Essoldo Circuit (Control) Ltd. Issued Oct. 2, 1956. Two contact members spacedly engage a running dielectric film, for instance along the edge perforations thereof. These members supply the grid control potential for a tube. The contact members are spaced to alternately establish a rubbing contact with the dielectric film, thus generating, at normal film speed, frictional potential differences between the two members. The grid-cathode circuit is so tuned that the static potential prevents discharge of the tube through the cathode-plate circuit.

Variable Delay Line, #2,765,446. Inv. W. D. Martin. Assigned Philco Corp. Issued Oct. 2, 1956. A magnetic material in colloidal suspension provides the delay line positioned between two spaced electromechanical transducers. To vary the time delay, a variable unidirectional magnetic field is applied to the suspension; the field will increase the velocity of propagation of the mechanical vibration by an amount depending on its strength.

Narrow Band Communication System, #2,766,325. Inv. M. J. Di Toro. Assigned International Telephone and Telegraph Corp. Issued Oct. 9, 1956. To transmit a wide-frequency spectrum signal over a narrow frequency channel, a plurality of different narrow sub-bands of non-contiguous frequency are derived from the wide-band signal. These narrow sub-bands are transposed to contiguous positions to form a signal having a narrow frequency band.

Audio Compressor Circuit, #2,766,331. Inv. W. P. Birkemeier. Assigned Collins Radio Co. Issued Oct. 9, 1956. The input is connected to the screen grid of a pentode which is also connected to the plate supply over a resistor. The plate is grounded over a resistor and feeds an amplifier which supplies a rectifier. Both the control and the suppressor grid of the tube are controlled by the rectifier output.

Automatic Switching Device for Radio, Amplification, and Similar Systems, #2,766,378. Inv. A. T. Sundin and H. N. Nilsson. Issued Oct. 9, 1956. The amplification factor of a first amplifier is reduced relatively to the gain of a second amplifier, both amplifiers feeding a common output. For this purpose, the first amplifier is normally biased for optimum gain, this gain being reduced in response to a signal received on the second amplifier.

Transistor Device, #2,766,410. Inv. B. N. Slade. Assigned Radio Corp. of America. Issued Oct. 9, 1956. A high current gain cut-off frequency for a transistor is secured by spacing the two point electrodes, the emitter and the collector electrode, approximately 0.5 mils apart and using a semi-conductor having a resistivity of approximately 0.5 ohm-centimeter.

Wave Guide Transition, #2,766,432. Inv. R. M. Walker. Assigned Sylvania Electric Products, Inc. Issued Oct. 9, 1956. A circular waveguide section is partially surrounded by a rectangular waveguide section, the two wave-propagation paths being at right angles to one another. A series of connecting apertures are provided in the common wall of the two guides, the apertures being spaced in the direction of energy flow in the rectangular guide and provide coupling.

International ELECTRONIC SOURCES

High Frequency Electrical Oscillator, #2,766,403. Inv. J. F. Skowron. Assigned Raytheon Manufacturing Co. Issued Oct. 9, 1956. The anode of a magnetron comprises a plurality of resonant segments, the output being taken from one of the segments. A plurality of straps electrically connect alternate anode segments. At least one asymmetry is introduced in the straps along a load axis displaced from the output axis by a critical load angle between 30° and 60°, the angle being dependent on the number and location of asymmetries in the anode structure.

Amplifier Circuit, #2,767,255. Inv. A. J. Talamini. Assigned Allen B. Du Mont Lbs., Inc. Issued Oct. 16, 1956. A gain-controlled amplifier output is rectified and a constant dc voltage subtracted therefrom. The difference is amplified and used to control the gain of a variable mu tube in the gain-controlled amplifier by a series connection.

Noise Compensation in Electron Beam Devices, #2,767,259. Inv. R. W. Peter. Assigned Radio Corporation of America. Issued Oct. 16, 1956. Intermediate the gun and the input coupling of a velocity modulation tube operating at a predetermined frequency, a beam noise voltage is derived. A signal path including only passive elements couples the beam noise voltage to the input in a phase to provide at least some compensation at the operating frequency for the beam noise voltage.

Resistance Elements and Compositions and Methods of Making Same, #2,767,289. Inv. P. Robinson. Assigned Sprague Electric Co. Issued Oct. 16, 1956. A small inert resistance particle is produced by covering an inert ceramic base throughout its surface with a uniform pyrolytic carbon resistance film.

Carrier Operated Squelch Circuit, #2,767,310. Inv. R. G. Walker. Assigned Air Associates, Inc. Issued Oct. 16, 1956. A gas-filled diode is coupled to a detector responsive to the amplitude of the rectified carrier, the gas-filled diode being conductive or non-conductive depending on whether or not the carrier-wave amplitude exceeds a predetermined level. A vacuum tube diode is controlled by the gas-filled diode to conduct only when the carrier wave exceeds the predetermined level. The vacuum tube diode in turn controls the audio signal path.

Tracking with Intermittently Illuminated Displays, by J. W. Senders. U. S. Air Force. Oct. 1955. 12 pp. 50¢. (OTS) Subjects performed a tracking test involving the simultaneous control of two indicators by the use of two controls. Their view of the indicators was periodically and simultaneously obscured. The data indicate that performance varies as a direct function both of frequency and relative length of the "on" portion of the cycle.

Color Television, #2,763,714. Inv. P. K. Weimer. Assigned RCA. Issued Sept. 18, 1956. A reference signal generating grid is arranged near and aligned with the different color responsive target areas of a color television pick-up tube. The individual signals developed by the reference signal grid are combined with a signal derived from a return electron beam in individual modulators to produce respective signals representing the different color components.

Color Television Receiver Apparatus, #2,763,716. Inv. K. E. Farr. Assigned Westinghouse Electric Corp. Issued Sept. 18, 1956. A monochrome and two color difference signals are received. The monochrome signal is applied to all three mixer circuits provided, while each of the color difference signals is applied to one of the three mixer circuits. The mixer outputs control the three guns of a tricolor picture reproducing tube.

Loudspeaking System and Amplifying Method, #2,763,720. Inv. A. J. Sanial. Assigned Audio Equipment Co. Issued Sept. 18, 1956. To prevent oscillations within a certain amplification range due to acoustic feedback between a loudspeaker and a microphone, repetitive pulse

signals are generated. Polarity and amplitude of these signals is adjustable, and pulses of a recurrence frequency higher than the loudspeaker range extends are injected into the connecting amplifying channel. This permits reducing instantaneous gain without considerably reducing average gain which is separately regulated.

Semiconductor Signal Translating Devices, #2,764,642. Inv. W. Shockley. Assigned Bell Telephone Labs. Issued Sept. 25, 1956. Two positive-conductivity type semiconductor elements are embedded in a body of negative-conductivity type semiconductor in close proximity. A source connection is made to one of the elements, a drain connection to the other, while the gate connection is made to the body. Suitable biases are provided which establish a space charge region bridging the space between the two elements.

Directional Coupler, #2,764,739. Inv. O. O. Fiet. Assigned Radio Corp. of America. Issued Sept. 25, 1956. The outer conductor of the branch coaxial line is connected to the outer conductor of the main transmission line. A metallic coupling loop is connected through a resistor to the outer wall of the main line; its other terminal is connected to the inner conductor of the branch line. A second metallic shielding loop has both terminals connected to the outer conductor of the main line and together with this conductor surrounds the first loop and electrostatically shields it.

Metallic Lens Antennas, #2,764,757. Inv. N. M. Rust and J. F. Ransay. Assigned Radio Corp. of America. Issued Sept. 25, 1956. A substantially horn shaped wave guide, fed at the apex, is partially divided into a number of parallel wave-guide sections, each an integral number of halfwaves long in the direction of energy propagation. This results in a desired phase distribution relationship at the mouth of the horn.

Sintered Photoconducting Layers, #2,765,385. Inv. S. M. Thomson. Assigned RCA. Issued Oct. 2, 1956. A continuous layer of interlocked crystals of photoconductive material is produced by forming a layer of either sulphides, selenides and/or sulphoselenides of cadmium. The layer is recrystallized in a molten solvent and a silver or copper activator is added. The molten solvent is then removed and the recrystallized substance is sintered.

Dielectric Heating System, #2,765,387. Inv. T. L. Wilson. Assigned National Cylinder Gas Co. Issued Oct. 2, 1956. A metal enclosure contains a movable electrode and a multi-turn coil movable therewith and connected thereto, its other end being connected to the enclosure. The electrode voltage is maintained constant by an exciting coil positioned adjacent to the movable coil for variation of the coupling as the coil is moved.

Inductor for Inductive H.F. Heating, #2,765,389. Inv. D. CH. v. Iperen. Assigned Hartford National Bank and Trust Co. Issued Oct. 2, 1956. The inductor consists of a rectangular box, its top being open. A first flat conductor is connected to one edge of the open top, a second flat conductor being connected to the opposite edge and extending across the open top of the first conductor. The two conductors being connected to the h-f supply.

Hearing Test System, #2,768,236. Inv. R. E. Allison. Assigned Patent Management, Inc. periodically varies the output frequency of Issued Oct. 23, 1956. The frequency modulator an oscillator whose output is periodically interrupted to produce pulses, the modulation periods being shorter than the pulse duration. These pulses are fed to a loudspeaker which converts them into warbled tone pulses uniformly audible to a collectively tested group of persons.

Sound System, #2,768,237. Inv. C. W. Faulkner. Assigned Twentieth Century-Fox Film Corp. Issued Oct. 23, 1956. A system for the simulation of directional sound feeds the same input signal to a sequence of input terminals directly and individually coupled to a corresponding sequence of output terminals.

Further additional channels including delay sections are provided between each input terminal and the two output terminals adjacent the output terminal corresponding to the input terminal in question. This arrangement operates to introduce echos.

Gain Control Circuit, #2,768,248. Inv. A. S. Harris. Assigned Farnsworth Research Corp. Issued Oct. 23, 1956. The input to the first of two tubes having a common cathode resistor is supplied across a parallel resistor-capacitor combination extending between the grid of the first tube and the grounded terminal of the common cathode-resistor. The input to the grid of the second tube is variably connected to this capacitor-resistor combination, the capacitance and resistance varying by proportional amounts. The plate of the second tube provides the output.

High-Frequency Device for Dielectric Heating, #2,768,270. Inv. L. Blok. Assigned Hartford National Bank and Trust Co. Issued Oct. 23, 1956. A coil and the electrodes forming a load capacitance are connected across a variable capacitance to form a tuned circuit. This tuned circuit is inserted between the grid and plate of a tube. A capacitance voltage divider is connected across the capacitor and to the cathode and plate of the tube. A conducting shield surrounds the plate to electrostatically shield it; h-f voltages are applied between the plate and cathode of the tube.

Wave Propagation in Composite Conductors, #2,769,147. Inv. H. S. Black and A. M. Clogston. Assigned Bell Telephone Labs., Inc. Issued Oct. 30, 1956. A multiplicity of alternate conducting and insulating sections are so dimensioned that the conductor can propagate a plurality of conduction current modes of different order. Electromagnetic waves propagating in a conduction current mode of a higher order than the principal order are being employed.

Composite Antenna Structure, #2,769,170. Inv. A. M. Clogston. Assigned Bell Telephone Labs., Inc. Issued Oct. 30, 1956. One radiation element of an antenna comprises a composite conductor made of alternate layers of conducting and insulating materials; one dimension of each conducting layer being small compared to the skin depth. This composite conductor is surrounded by dielectric material matching its propagation velocity.

Dielectrostrictive Signal and Energy Transducer, #2,769,867. Inv. J. W. Crownover and H. W. Koren. Assigned to Sonotone Corp. Issued Nov. 6, 1956. Two bodies of ceramically joined titanate particles, each about one-hundredth of an inch thick, have two metallic surface electrodes fused at elevated temperature to opposite surfaces of each body. A strong flexible elastic sheet metal member is soldered between the two bodies causing at least the adjacent surface strata of the two bodies to be under compressive strain. Both bodies are polarized to near piezoelectric saturation in opposite directions to transduce in aiding relationship upon deflection.

Neutralized Amplifier, #2,769,869. Inv. L. J. Mattingly. Assigned Motorola, Inc. Issued Nov. 6, 1956. A transformer primary is connected between the plate and second grid of an electron tube, the second grid being connected to a power supply and over a neutralizing and by-pass capacitor to ground. Another capacitor connects one terminal of the transformer secondary to the second grid so that the output signal from the amplifier which tends to produce feedback appears effectively across the primary winding. The first capacitor is dimensioned to neutralize the effect of the output signal.

Non-Linear Resistance Device, #2,769,926. Inv. I. A. Lesk. Assigned General Electric Corp. Issued Nov. 6, 1956. A bar of semi-conductive material is provided with two contacts at its opposite ends and a potential is applied between these contacts. A region of opposite conductivity type is placed on the bar intermediate the contacts and an intermediate potential is applied thereto.

ELECTRONIC SYSTEMS ENGINEERS and SCIENTISTS in

RADAR • COUNTER MEASURES • MISSILE GUIDANCE

DATA REDUCTION • AIR DEFENSE • COMMUNICATIONS • UNDERWATER ORDNANCE

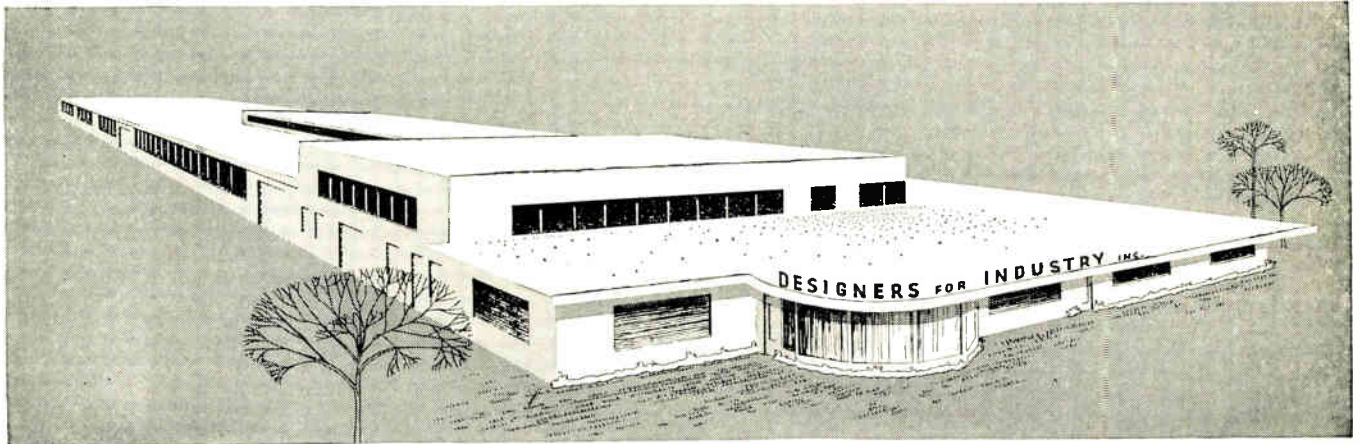

For trained, experienced men (advanced degree preferred) with creative ability, DESIGNERS FOR INDUSTRY INCORPORATED offers challenging work and an unusual opportunity.

We are looking for those who have grown into the systems field via the equipment research and development road — and who have the ability to conceive completely new approaches to highly difficult problems . . . *men who can spearhead major technical break-throughs.*

In return we offer permanent career opportunities at DFI where:

You will work in an independent research and development organization incorporated in 1935 and showing a history of steady growth serving both military and commercial clients

the employees own the corporation (over 70 senior employee-stockholders)

a pension trust and a merit bonus return 62½% of all profits to the employees in a combination of annuities, cash and stock

the "fringe" benefits include such things as a paid vacation schedule providing two weeks per year after one year, three weeks per year after five years and five weeks every fifth year after ten years

professional freedom, mutual trust, challenging work and a dynamic, growing organization are combined into the proper atmosphere for stimulating creative development.

If you are interested write — all information will be treated in complete confidence — to James E. Burnett, Vice President, giving pertinent professional information.



Designers for Industry

Incorporated 1935

4241 Fulton Parkway • Cleveland 9, Ohio

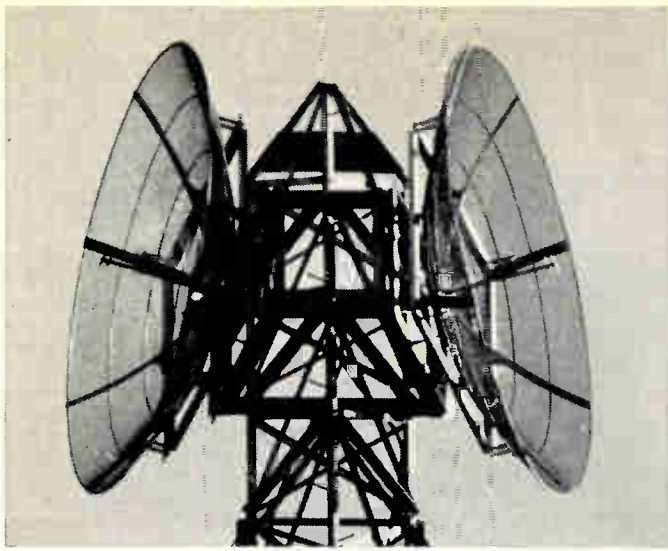

BLAW-KNOX MICROWAVE PACKAGE

brings better telephone service
to 100 communities

Three Blaw-Knox Microwave Transmission Towers are an important part of a recently completed three city-two state microwave-telephone toll system which was engineered, furnished and installed by Lenkurt Electric Company and Automatic Electric Sales Corporation.

This modern system links the Home Telephone and Telegraph Company of Indiana with General Telephone Company of Ohio. Originating at the 200' Blaw-Knox self-supporting tower in downtown Fort Wayne, Indiana, signals are beamed to a 170' Blaw-Knox guyed tower on the outskirts of Antwerp, Ohio. From this mid-point, messages terminate at the 150' Blaw-Knox self-supporting tower in Bryan, Ohio.

Excellent toll service is now provided subscribers in more than 100 Ohio and Indiana communities . . . yet the cost of this efficient microwave-telephone link was less than a normal cable hook-up.

We'd like to help you plan better service for *your* customers. Write today for Booklet 2516, which illustrates Blaw-Knox Microwave Towers and describes Blaw-Knox tower engineering, design, fabrication and erection services.

BLAW-KNOX COMPANY

BLAW-KNOX EQUIPMENT DIVISION
PITTSBURGH 38, PENNSYLVANIA

MICROWAVE TOWERS

Towers for Microwave, AM, FM, TV, Radar . . . guyed and self-supporting . . . steel transmission towers . . . other special structures . . . all custom built for your needs

Member

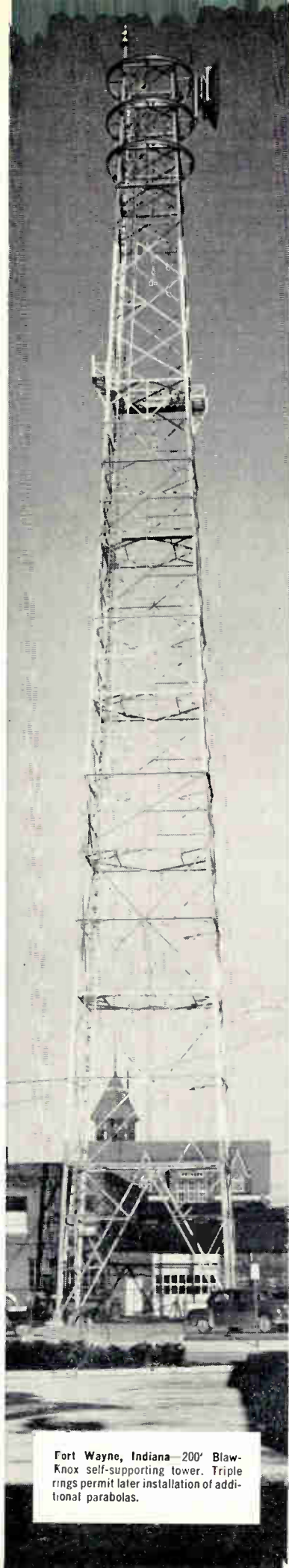

Fort Wayne, Indiana—200' Blaw-Knox self-supporting tower. Triple rings permit later installation of additional parabolas.

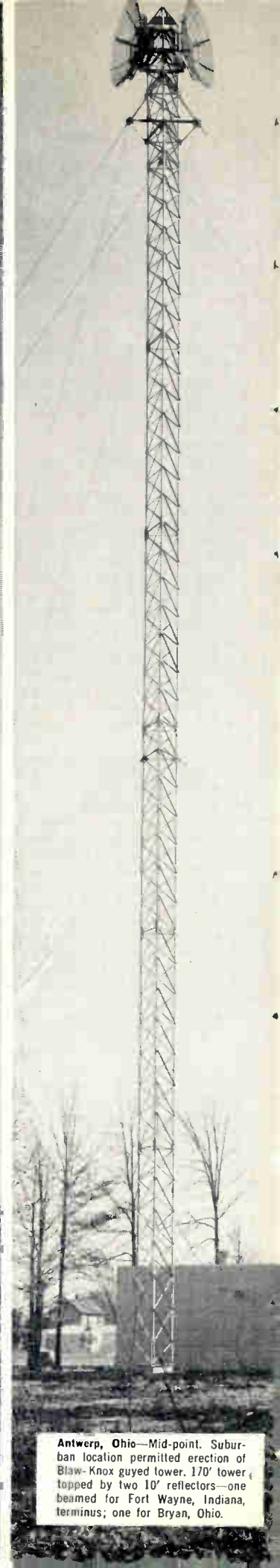

Antwerp, Ohio—Mid-point. Suburban location permitted erection of Blaw-Knox guyed tower. 170' tower topped by two 10' reflectors—one beamed for Fort Wayne, Indiana, terminus; one for Bryan, Ohio.



**EFFICIENT
HEAT
TRANSFER
WITH**



*... an internal thermal gradient
of 1.2° C/watt or less!*

Industry's Highest Power Transistors

Large area, thinness and intimacy of collector contact with large copper base provide the efficient thermal transfer.

Result--an unusually cool collector junction in the Delco Radio alloy-type germanium PNP power transistor. The Delco Radio 2N173 and 2N174 transistors not only have high power handling ability but also low distortion characteristics. Thus, they are ideal for audio as well as your general power applications.

Furthermore, these transistors are normalized to retain their performance characteristics regardless of age. Write for engineering data. Delco Radio transistors are produced by the thousands every day.

TYPICAL CHARACTERISTICS

	2N173	2N174
Properties (25°C)	12 Volts	28 Volts
Maximum current	12	12 amps
Maximum collector voltage	60	80 volts
Saturation voltage (12 amp.)	0.7	0.7 volts
Power gain (Class A, 10 watts)	38	38 db
Alpha cutoff frequency	0.4	0.4 Mc
Power dissipation	55	55 watts
Thermal gradient from junction to mounting base	1.2°	1.2° °C/watt
Distortion (Class A, 10 watts)	5%	5%

DELCO RADIO

**DIVISION OF GENERAL MOTORS
KOKOMO, INDIANA**

ENGINEERS...PHYSICISTS

NEW opportunities at MOTOROLA

YOUR CHOICE OF 3 LOCATIONS

New Motorola research laboratories are expanding, creating outstanding career advantages—your opportunity to get in on the ground floor of a swiftly expanding company. You'll enjoy working in these modern laboratories... with liberal employee benefits, including an attractive profit sharing plan. Salary levels are open and commensurate with ability.

POSITIONS AVAILABLE IN: two-way communications • missile electronics • radio & TV (color) • weapons systems • computer application & design • transistor research & production • microwave systems • servo-mechanisms • physical chemistry • metallurgical eng. • field eng. • electronic sales eng. • drafting, design, & layout • aerophysics • radar & military electronics

PHOENIX, ARIZONA



Outdoor, relaxed living the year-round, with lots of room to grow (on the job and off) in this land of sunshine.

RESEARCH LABORATORY

write to: Mr. R. Coulter, Dept. C. 3102 N. 56th St., Phoenix, Ariz.

SEMI-CONDUCTOR DIVISION

write to: Mr. V. Sorenson, Dept. C.
5005 E. McDowell Rd., Phoenix, Ariz.

RIVERSIDE, CALIFORNIA



Planned communities, modern shopping centers, advanced schools, fine buys in homes. There's room to grow and more fun in Riverside.

write to: Mr. C. Koziol, Dept. C. Box 2072, Riverside, Calif.

CHICAGO, ILLINOIS

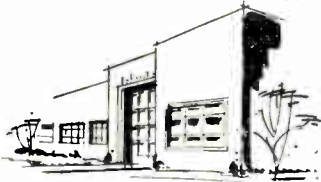

Live a relaxed midwest life in one of the beautiful suburbs, yet have all the "big city" advantages—cultural, social, and educational.

write to: Mr. L. B. Wrenn, Dept. C.
4501 Augusta Blvd., Chicago, Ill.



MOTOROLA

Test Cell

(Continued from page 65)

tory acceleration in the chamber (measured on the back plate at 140 db) was approximately 2g. In most instances, the acceleration was so low that it was considered negligible.²

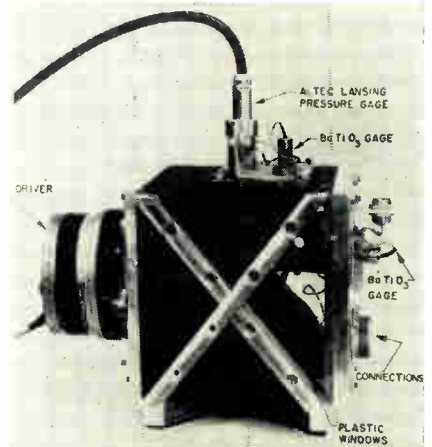

Fig. 6: 40 watt driver powers test cell

A typical use for this equipment is the testing of small relays. Tests already run in the sound chamber have revealed contact resistance variations and in some cases intermittent operation as a result of acoustic excitation at the frequencies and intensities found in military jet aircraft. Typical oscillographs of contact resistance under high level acoustic excitation are shown in Fig. 5.

Original design of the sound chamber was proposed by F. Mintz and was developed at the Armour Research Foundation in collaboration with M. B. Levine.

References

- (1) R. H. Jacobson and F. Mintz. An Investigation of the Effects of Vibration on Relay Operation. Presented at Second National Conference of Electromagnetic Relays, Oklahoma A&M College, Stillwater, Oklahoma, February 24, 1954.
- (2) Armour Research Foundation, Chicago, Illinois. Evaluation of Mechanical Design Level of Electronic Equipment Leading to Vibration and Shock Criteria. Technical Phase Report No. 4 (Report No. 30), December 9, 1954, Project No. K044, Wright Air Development Center, Contract AF33(616)-223.
- (3) Phillip M. Morse. *Vibration and Sound*. McGraw-Hill Book Company, Inc., New York, 1936, p. 312.
- (4) Armour Research Foundation, Chicago, Illinois. Design of a Large Shock Tube. Final Report, Project No. MO37-3, Wright Air Development Center, Contract AF33(616)-266.
- (5) A. Siegelman and F. Mintz. Measuring Shock-Wave Pressures. *The Frontier*. Armour Research Foundation, March, 1954.

* * *



Here's why Electronic Equipment is Safeguarded Best — when Protected by BUSS Fuses

To make sure BUSS fuses will give dependable electrical protection under all service conditions . . . BUSS fuses are tested in a sensitive electronic device. Any fuse not correctly calibrated, properly constructed and right in all physical dimensions is automatically rejected.

That's why BUSS fuses blow only to protect—and not needlessly. Equipment receives maximum protection

against damage due to electrical faults—yet, it is not put out of operation by needless fuse blows.

Most important, the reputation of your equipment for service and quality is not harmed by the faulty operation of poor quality fuses.

Why settle for anything less than BUSS quality fuses? To meet your

needs, a complete line of BUSS fuses is available, plus a companion line of fuse clips, blocks and holders.

For more information on BUSS and FUSETRON Small Dimension fuses and fuseholders . . . Write for bulletin TT. Bussmann Mfg. Co. (Div. of McGraw Electric Co.), University at Jefferson, St. Louis 7, Mo.

***BUSS fuses are made to protect
—not to blow, needlessly***



Makers of a complete line of fuses for home, commercial, electronic, automotive and industrial use.

ENGINEERS: *Electronic & Mechanical* PHYSICISTS

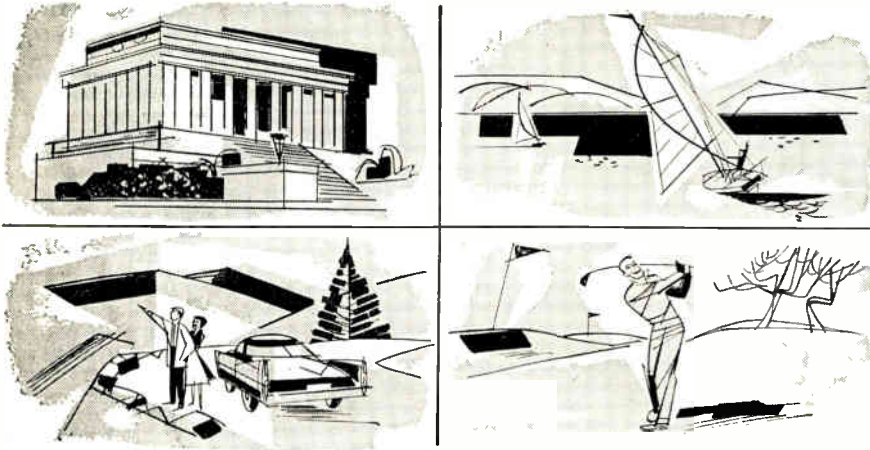

Finer climate & living... yours at MELPAR

Melpar is advantageously located in a residential suburb in Fairfax County, Virginia, 10 miles from Washington, D. C. Attractive new homes and apartments are within a few minutes traffic-free drive of our Laboratories. Modern shopping centers make trips to the city unnecessary except for enjoyment of its many cultural and recreational offerings.

Regardless of whether you choose suburban, country or city living, you'll enjoy our proximity to mountains, beaches, and other recreational and scenic attractions. Our climate is pleasant with its short winters, beautiful spring and fall seasons, and its average summer temperature of only 77°. Outdoor living is enjoyed 215 days of the year.

The Laboratory's "climate" is ideal, too. Our project group basis of organization enables you to participate in *complete* engineering problems and gain diversified experience. The range and complexity of our projects assure you of assignments which will stimulate your creative and analytical talents.

Qualified applicants may visit the area as our guests to inspect Melpar.

We Are Engaged in The Following Fields:

Flight Simulators. Radar and Countermeasures. Network Theory. Systems Evaluation. Microwave Techniques. Analog & Digital Computers. Magnetic Tape Handling. UHF, VHF, or SHF Receivers. Packaging Electronic Equipment. Pulse Circuitry. Microwave Filters. Servomechanisms. Subminiaturization. Electro-Mechanical Design. Small Mechanisms. Quality Control & Test Engineering. Field Engineering. Antenna Design.

For detailed information on Melpar and living in the Washington, D. C. area
Write: TECHNICAL PERSONNEL REPRESENTATIVE

 **MELPAR, Incorporated**
A Subsidiary of Westinghouse Air Brake Company
3631 Arlington Boulevard, Falls Church, Va.
10 Miles from Washington, D. C.

Positions also available at our laboratories located in Watertown and Boston, Massachusetts.

White Noise Test

(Continued from page 69)

component and where the sum of the N components = entire spectrum. If each component contains the same amount of energy as represented by E , the equation becomes

$$e_{RMS} = E\sqrt{N} \quad (5)$$

Before proceeding further it may be useful to list the items that control the character of a white noise function. These are as follows:

1. Bandwidth and location of the frequency spectrum.
2. Total energy content.
3. Distribution pattern of energy within the spectrum.
4. The degree of clipping of random peaks.

For the test developed at Syl-
vania, it was considered most useful to have the energy distributed equally per octave, where one octave means a spectrum interval having a ratio of 2:1 between upper and lower frequencies. This energy distribution realistically balances the relative importance of the different constituent frequencies. Now, if the upper and lower frequencies of the total spectrum are f_2 and f_1 , the number of octaves (represented by N) may be calculated as follows:

$$2^N = \frac{f_2}{f_1}$$

$$\text{or } N = \log_2 \frac{f_2}{f_1}$$

$$\text{or } N = 3.32 \log_{10} \frac{f_2}{f_1} \quad (6)$$

Substituting (6) in equation (5) yields

$$e_{RMS} = E \sqrt{3.32 \log_{10} \frac{f_2}{f_1}}$$

where E = the RMS value for one octave.

Equation (7) can be used to represent acceleration or its voltage analog as obtainable with an ideal accelerometer. This equation can be adapted to any part of the spectrum by choosing values of f_2 and f_1 which define the band area of interest. The use of eq. (7) determines the total energy content if total bandwidth is specified by f_2 and f_1 and if E , the energy per octave, is specified. The final item to be defined is the amount of clipping present. In practical applications the random

(Continued on page 116)

A complete line of power transistors—to meet your specific needs

New rugged terminals—
permit easy soldering of
connections.



New welded case—gives
a hermetic seal for
superior ruggedness and
durability.

Actual size

Honeywell High Gain Weld-Seal Transistors!

The H5, H6, and H7

They're welded—so you can build new ruggedness and durability into your equipment! And the new line of Honeywell transistors gives you superior electrical performance and high, uniform power gain over a wide range of collector current values. You get long life along with outstanding performance.

Take advantage of these new and improved transistors *now*.

Note these new specifications — developed with
the design engineer in mind

	H5	H6	H7
Input Resistance	24 —48 ohms	27—54 ohms	30—60 ohms
Power Conductance	17.5—35 mhos	35—71 mhos	71—141 mhos
Current Gain, Median	30	40	60

(for collector current of 2 amps.)

Also the famous XH10 HIGH POWER
WELD-SEAL TRANSISTOR. The giant of
the industry—with 10 Amp. maximum collector current.

For additional information on the Honeywell transistor line, write or phone for complete specifications, prices and list of current available literature.

UNION, N. J.
MURdock 8-9000
P. O. Box 161

CHICAGO
IRving 8-9266
7350 N. Lincoln Ave.

BOSTON
ALgonquin 4-8730
1230 Soldier Field Rd.

MINNEAPOLIS
FEderal 2-5225
2749 4th Ave. So.

LOS ANGELES
RAmond 3-6611 or
PArkview 8-7311
6620 Telegraph Road

CLEVELAND
TOwer 1-0400
1900 Superior Ave.

MINNEAPOLIS
Honeywell



First in Power Transistors

Only Precision OFFERS YOU HIGHEST QUALITY, LOW COST PAPER TUBING

in
any shape
every size
any length
plus
any ID
every OD
any quantity



**DIELECTRIC KRAFT • FISH PAPER • CELLULOSE ACETATE
COMBINATIONS • PHENOL IMPREGNATED**

Round, square, rectangular, triangular, any shape, any size — Precision Paper Tube Co. can provide *all* your paper tubing needs. Your specifications are met to the most exacting tolerances. Precision Paper Tubes are sturdy, crush resistant, have high tensile strength and excellent dimensional stability.

Send in your specifications for samples. Request Arbor List of over 2000 sizes.

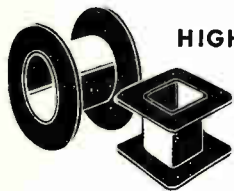

HIGH DIELECTRIC BOBBINS FOR BETTER COILS

Precision-made on specially designed equipment, using the finest materials, to provide maximum tensile strength, light weight, more winding space and other essential electrical and mechanical characteristics.

Furnished in any size or shape. Supplied plain or fitted with leads, slots or holes. Flanges cut to specification, plain or embossed. Tube ends swaged to lock flanges.

Send Specifications for samples. Ask for illustrated folder.

Sales Representatives in:

California, Oregon, Washington: Covina, California, Edgewood 2-4693
Illinois, Indiana, Iowa, Wisconsin, Minnesota: Chicago, Ill., ARmitage 6-5200
Indiana, Ohio: Logansport, Indiana, Logansport 2555
Missouri and Southern Illinois: St. Louis, Mo., VOLunteer 3-2797
Northern Ohio: Cleveland, Ohio, Atlantic 1-1060
New England: Framingham, Massachusetts, Trinity 3-7091
New Jersey, Delaware, Washington, D.C., Maryland,
Eastern Pennsylvania, Virginia, Metropolitan New York:
Jersey City, New Jersey, Swathmore 5-2480
Upper New York: Rochester, New York, BRowning 1-6322
CANADA: Montreal, Quebec, Canada, Walnut 0337
MEXICO: Mexico 6, D.F., Telephone 35-06-18



PRECISION PAPER TUBE CO.

2051 W. CHARLESTON ST. CHICAGO 47, ILL.
Plant No. 2: 1 Flower St, Hartford, Conn.

(Continued from page 114)

peaks of a white noise voltage are limited to some maximum value, often determined by a clipping circuit designed for that purpose. These peaks are neither symmetrical nor uniformly spaced, but a peak-to-peak value may be observed on an oscilloscope. The amount of clipping can be specified in several ways, but for the white noise vibration test developed at Sylvania it is controlled by specifying a peak g value of 15 g's. The other specification parameters used are 100 and 5,000 cps for spectrum boundaries, and 2.3 g's RMS per octave for energy distribution. This latter value was chosen somewhat arbitrarily, but is compatible with the 15 g peak value and is about as high as is obtainable without clipping excessively. The total RMS value can be calculated from the expression

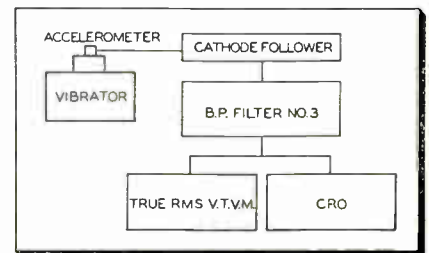

Fig. 4: Acceleration measuring circuit

$2.3 \text{ g's RMS} \times \sqrt{5.6}$, where 5.6 is the number of octaves used. The resultant total value of 5.4 g's produces a ratio of peak to RMS of very nearly twice the 1.4 ratio that is characteristic of a sine wave.

Equipment

A white noise voltage generator, shaping circuits, and power amplifier are used to obtain a complex voltage input which has its spectrum shaped so that it will cause a vibrator armature to move according to the frequency spectrum required for acceleration. A barium titanate accelerometer mounted on the armature is used in setting up equipment to meet these test conditions. The voltmeter used in metering the acceleration should have a true RMS response. The complete system for measuring acceleration (including accel-

(Continued on page 118)

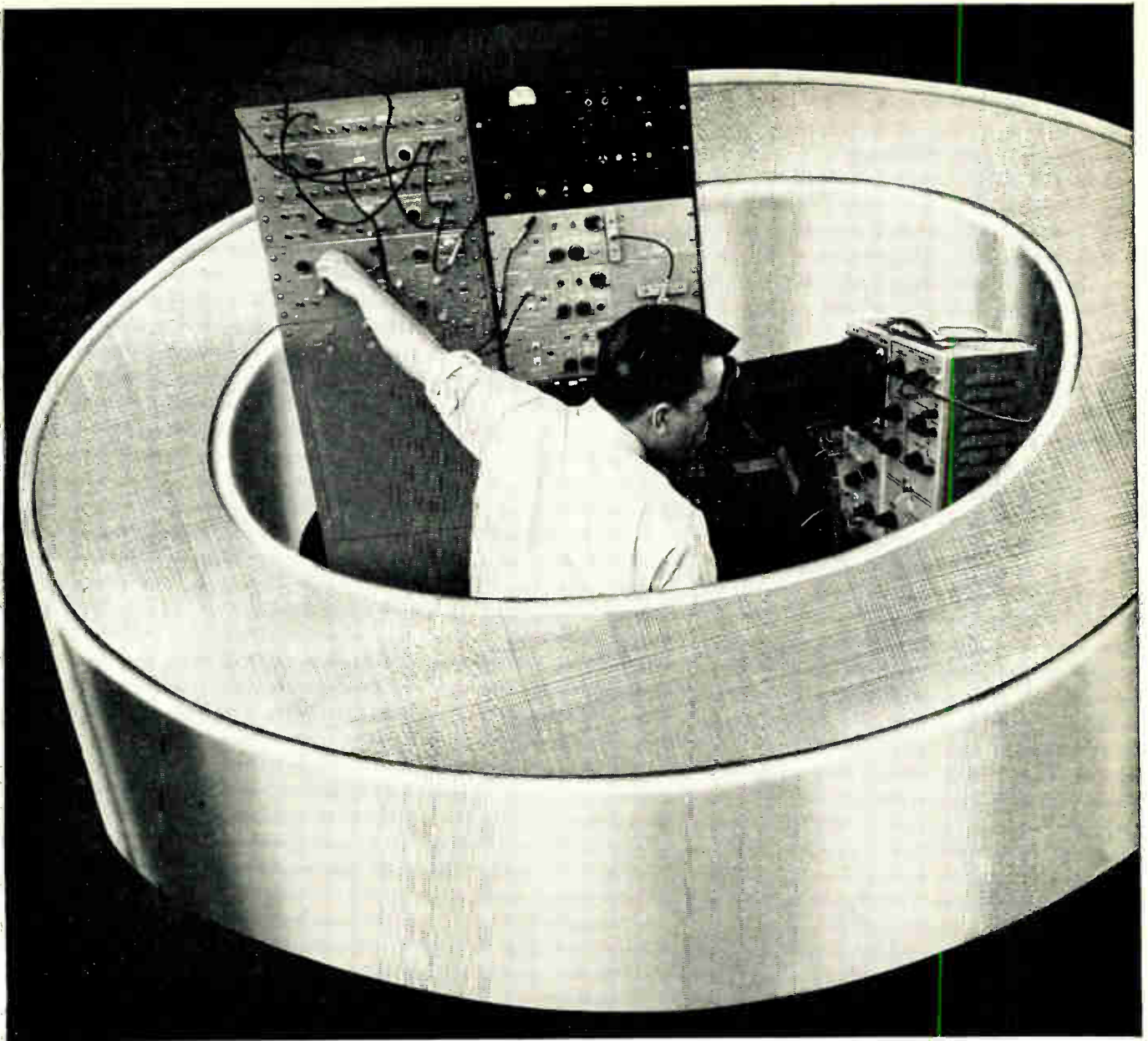

what makes tape wound cores reliable?

Reliability demands physical protection. Magnetic alloys which provide square hysteresis loop characteristics are strain sensitive. Distortion caused by coil winding will disturb precise magnetic characteristics, alter performance. So Magnetics, Inc. has devised a rigid, extra-strong aluminum core box to protect the magnetic core within from winding stresses, thus eliminating distortion.

Reliability demands electrical stability through the years. Suppose guided missiles failed to function in a future emergency because the magnetic properties of tape wound cores had changed. Cores must operate just as effectively years from now as they do today, whether or not they have been in use. Vibration, shock, and temperature changes can endanger such performance. That's why Magnetics, Inc. cushions tape windings with a special inert material in the extra-strong aluminum core box. And that's why it is especially important that our tape wound cores enclosed in aluminum boxes will withstand temperatures up to 450°F.

Reliability demands exacting standards on the part of the manufacturer. Judge a product by the company that makes it. Take a company that has pioneered a core box so advanced that it even permits vacuum impregnation. Take a company whose attention to design detail permits the offer of the *only* Performance-Guarantee in the industry. That's a real definition of reliability. Why not ask us how it will work for you? *Magnetics, Inc., Dept. TT, Butler, Pennsylvania.*

For Full Details, Write For
Catalog TWC-100.A



CABLE: MAGNETICS

WORKING WITH RF?

These Blonder-Tongue accessories are designed as convenient — and often — indispensable aids to the man working with RF cable — in research, development and production.



SOLDERLESS COAX CABLE CONNECTORS and accessories

Cut time and effort making cable connections and splices. The secret is in the 'cinch spring' — a B-T exclusive feature, that grips the conductor lead like a vise. Shield braid makes positive electrical contact, and outer covering is securely clamped and held for maximum mechanical support.

SOLDERLESS COAX CABLE CONNECTORS

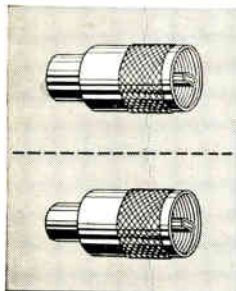

Model P-11S
Standard male fitting designed for use with the following types of coax cable: RG/U 8, 9, 9A, 10, 11, 12, 13, 63, 79, 87A, 114, 117, 133 and 144. \$1.75 list

Model P-59S
Standard male fitting designed for use with the following types of coax cables: RG/U 59, 62, 71 and 140. \$1.75 list

CABLE COUPLER Model MC

A correctly matched, mechanical splice for two similar or dissimilar types of 75-ohm coax cable fitted with P-11S or P-59S connectors. Also used for terminating cable with Terminating Plug MTP-75 or as feed-through in weatherproof housings. \$2.50 list

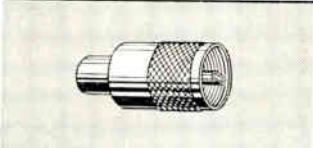
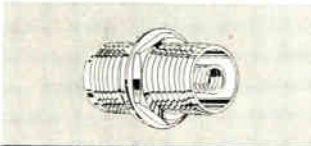

TERMINATING PLUG Model MTP-75

Provides correct termination of 75-ohm cable fitted with P-11S or P-59S connector and MC Cable Coupler. \$2.50 list

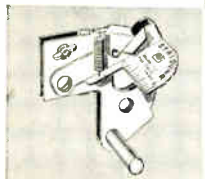

ROTARY CABLE STRIPPER Model S-1
A handy, accurate tool. Quickly and easily strips insulated and shielded wire and cable. Cuts braid clean. Also cuts non-metallic tubing up to 1/2" diameter. \$3.75 list

EXACT MATCH TV ACCESSORIES



ATTENUATOR Model MAT
Provides uniform attenuation from 0 to 45 db, in 3 db steps, in frequency range 0-220 mc. Has 75 ohm 'in' and 'out' fittings. \$22.50 list

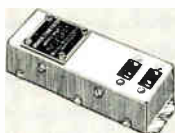

POWER LINE FILTER Model MLF
Provides 60 db RF isolation in frequency range 50-1000 mc, between input and output. Handles up to 5 amps. Has two AC outlets and one BX cable input connector. Can mount in B-T Radiation-proof Housing, Model MRH-A. \$49.40 list



Sold by Radio-TV Parts Distributors and Jobbers
Write for Complete Catalog to Dept. YB-31

BLONDER-TONGUE LABS. • 9-25 Alling Street • Newark, New Jersey
Industrial TV Cameras • TV Systems
VHF and UHF Amplifiers and Converters • TV Accessories

(Continued from page 116)

rometer and associated circuits such as a cathode follower and amplifier must have flat frequency response and linear amplitude response within the requirements expected of the acceleration spectrum itself.

The white noise generator uses a Type 6D4 gas tube as the noise source, a Type 6AT6 as the voltage amplifier, and a Type 12AX7 as a cathode-coupled clipper.

A block diagram of the white noise vibration set is shown in Fig. 1. The noise voltage proceeds from the white noise generator to a band pass filter for establishing the upper and lower frequencies, then through a preamplifier for shaping the active spectrum, next through a power amplifier for obtaining the drive needed for the desired magnitude of acceleration, and finally to the armature coil of the electromechanical transducer. This transducer was originally constructed for generating sine wave vibration at 10 g's for 50 — 5,000 cps. The design, similar to one originated by the National Bureau of Standards, has a helical coil type armature moving in a constant magnetic field. The frequency response curve of this equipment must be free of any conspicuous anti-resonances. When long lead subminiature tubes are tested, the method of holding the tube disposed the tube leads into two horizontal layers of 4 leads each, with the leads clamped at their extreme ends. The tubes are mounted in the armature by inserting the entire bulb into a hole slightly larger than the tube. A split sleeve of phenolic gripping the tube is tightened by a set-screw mounted at the top of the armature. The split sleeve is also surrounded by a metal cylinder which provides some magnetic shielding.

Attenuation

Attenuation, by lead stiffness, of the high frequency vibration g values is not a problem because the required amplitude becomes very small (of the order of micro-inches) for the higher frequencies and because the specification and

(Continued on page 120)

MALLORY

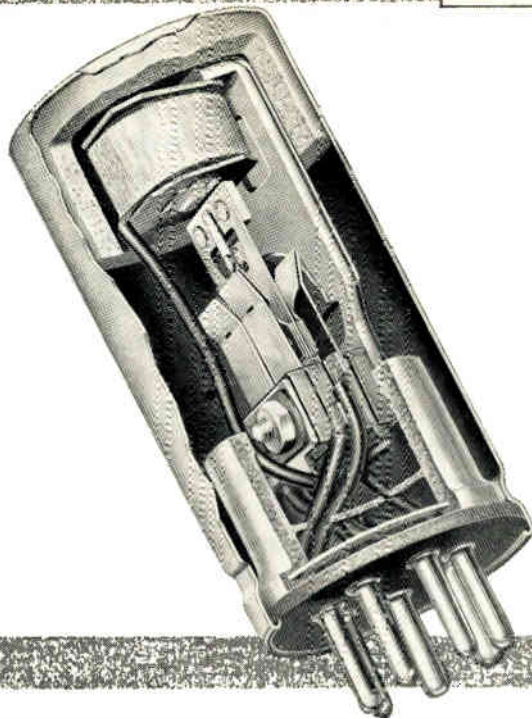

New 1700 series Mallory split-reed vibrator uses special alloy leaves which serve both as contacts and as springs . . . eliminating usual button contacts. Life is greatly increased, constancy of output improved, and driving power reduced.*

**Patent Applied For*

New Heavy Duty Mallory Vibrator

gives far longer life, constant output

For the peak in dependability and performance, plan to use this newest Mallory vibrator in your communications equipment. A completely new idea in vibrator design eliminates conventional contact buttons. The spring leaves themselves . . . made of special contact alloy . . . act as contacting members. This design provides greatly increased contact area, with these important advantages:

Consistently Longer Life. Tests made on heavy duty cycles prove up to 100% greater service can be expected . . . with a high degree of consistency.

Steadier Output. The decreased rate of erosion means less change in contact spacing, less variation in voltage.

Flare-Proof Starting. The new low-mass design permits wider contact spacing to prevent start-up flare . . . without need for greater driving power.

Exceptional Uniformity of characteristics is made possible by the simplified design.

Minimum Size for heavy duty ratings.

The new design is available in the split-reed type shown here, for 6/12 volt service, and in the Duplex heavy duty model without the split reed construction. For full technical data, and for a consultation on your specific power supply requirements, write or call Mallory.

COMPLETE POWER SUPPLIES

It may be that you can save time and reduce over-all costs by employing a complete Mallory Vibrapack® power supply. Vibrapacks can be engineered around the new heavy-duty 1700 series vibrator to give long, reliable service. Design includes precise balancing of critical components. Normal ratings are conservative. Compact-sized Vibrapacks fit readily into crowded layouts. For further information, advise Mallory of your specific requirements.

Serving Industry with These Products:

Electromechanical—Resistors • Switches • Television Tuners • Vibrators
Electrochemical—Capacitors • Rectifiers • Mercury Batteries
Metallurgical—Contacts • Special Metals and Ceramics • Welding Materials

Parts distributors in all major cities stock Mallory standard components for your convenience.

Expect more . . . get more from



USE-FACTOR

Nucleonics
Video Laboratories
Computer Laboratories
Pulse Circuitry

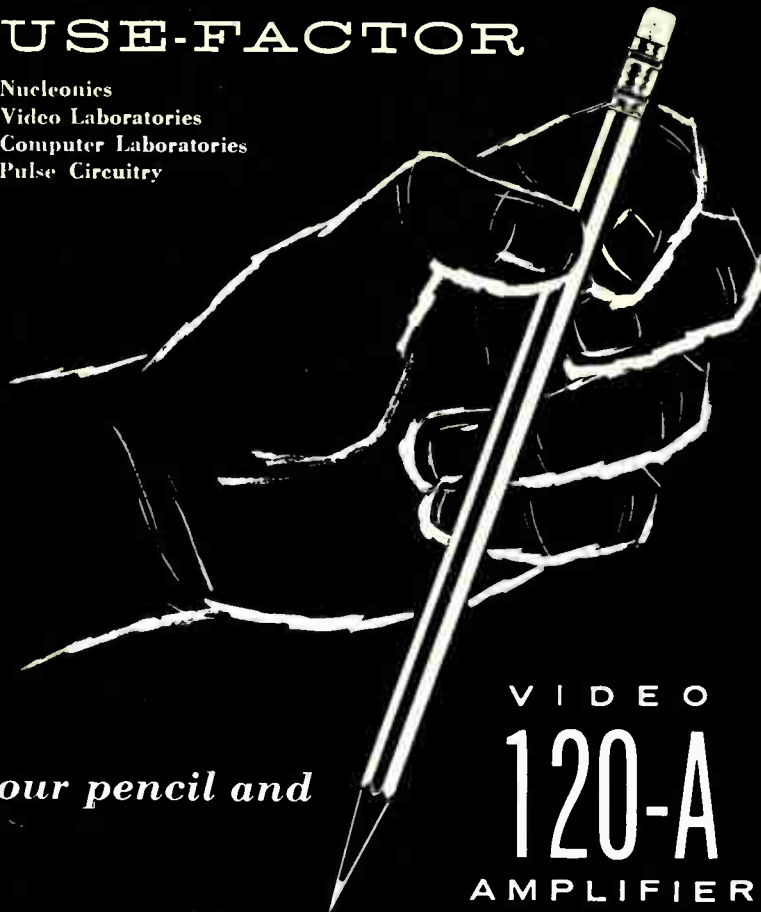

your pencil and

VIDEO 120-A AMPLIFIER



RESPONSE: Within 3 db from 8 cps to 10 Mc/s
10% max. tilt for 15 cps square wave

INPUT IMPEDANCE: Selectable, HIGH: 4 Meg & 20 pfd; LOW: 0-1000 Ω

OUTPUT IMPEDANCE: Selectable, HIGH: 25 pfd load;
LOW: 75 Ω

GAIN: Continuously variable, High- Σ load: 48 db;
Low- Σ load 38 db

OUTPUT POLARITY REVERSIBLE-ELECTRONICALLY REG. SUPPLY 100 Volts pk-to-pk, hi- Σ load; 10 Volts pk-to-pk, LO- Σ load

AMERICAN ELECTRONIC LABORATORIES, INC.

641 ARCH STREET PHILA. 6, PENNA. LOMBARD 3-8780

(Continued from page 118)

equipment calibration deal with the acceleration actually experienced by the moving armature and tube. The lower frequencies are more of a problem than the high ones because the angular deflection of the leads at low frequencies becomes significant and thus limits the g level obtainable with clamped leads. Tube holders are currently available for vibration testing long lead tubes with the plane of vibration perpendicular or parallel to the grid major axis.

Tube Noise Under Test

The vibration noise output voltage from the tube under test is the complex ac voltage generated across a resistor (usually 10,000 Ω) in the plate circuit in accordance with present specifications for vibration test circuit parameters.

The noise output voltage doesn't necessarily have the same bandwidth as the acceleration input and for this proposed test noise frequencies above 10,000 cps are excluded by filter.

The different types of readings that were considered for this test were as follows:

1. RMS value—A voltmeter with true RMS response could be used to obtain a single reading for the total noise over the entire spectrum up to 10,000 cps.

2. Average value—A voltmeter could be used which gives a single reading for the average of the positive values.

3. Sub-band readings—Tube noise spectrum could be divided into sub-bands, each read by method (1) or (2) above.

4. Peak-to-peak value—The noise would have no true peak-to-peak value, but a reading could be obtained which is partly a function of the response characteristics of the measuring instrument.

5. Sonic analyzer readings—Limit values could be assigned for the magnitude of noise frequency components as determined by a sonic analyzer. Different limit values may be used for different sections of the band.

Sonic analyzer readings were used for several months in an ex-

(Continued on page 122)

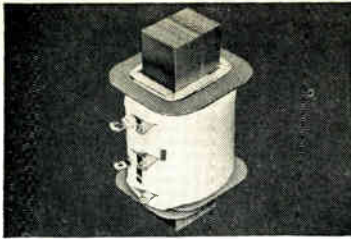

DIELECTRIC STRENGTH. National Vulcanized Fibre gives electrical parts high dielectric strength—plus toughness and excellent forming properties. Has ideal application as insulation.

**NATIONAL
VULCANIZED
FIBRE**

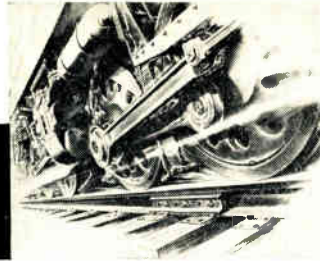

DURABLE—TOUGH—RUGGED. National Vulcanized Fibre rail joint insulation withstands years of continuous exposure and heavy pounding of today's high-speed railroading. Will not corrode or deteriorate.

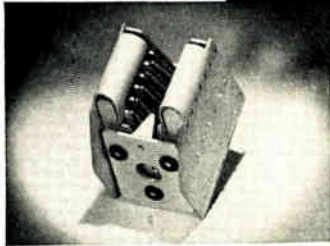

ARC RESISTANCE. In circuit breakers, National Vulcanized Fibre safely curbs electrical arcing without carbonizing or tracking. Easy to bend, punch and form. Light in weight. Heat-and-shock resistant.

FOR MEN WITH IMAGINATION . . .

two
materials
of
unlimited
application

MACHINABILITY—MECHANICAL STRENGTH. New paper-base PHENOLITE not only has excellent arc resistance, but superior machining qualities as well. Great compressive and tensile strength.

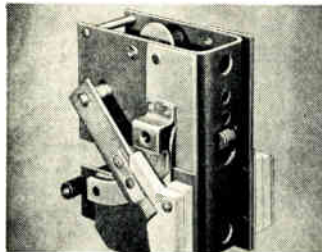

CHEMICAL RESISTANCE. Chemical-resisting grades of PHENOLITE are unaffected by most corrosive fluids and atmospheres. Retain high strength, resiliency and dimensional stability.

Here are six ideas to spur your imagination. They only suggest the many things that are being done better at lower cost with versatile Vulcanized Fibre and PHENOLITE® Laminated Plastic.

The full list of current and new uses for National Laminates would more than fill this page and many more! These are coming up almost every day. For the property range of National Laminates is a designer's dream. Over 80 basic materials grades available in sheets, rods, tubes, rolls, coils or fabricated parts.

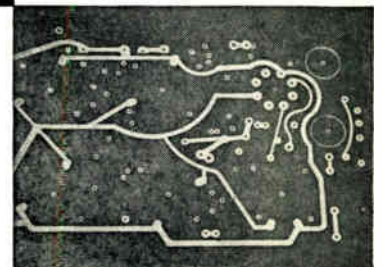

COMPACT DESIGN—ECONOMY—HIGH TEMPERATURE RESISTANCE. Printed circuits made of Copper Clad PHENOLITE permit compact design, simplify production, reduce assembly time.

FREE GUIDE TO LAMINATED PLASTICS

National's new materials comparator chart directs you quickly and easily to the right material for your application.

Compares specific properties of 35 basic materials grades—over 600 property values!

For your FREE copy, write direct to Dept. F.



**NATIONAL
VULCANIZED FIBRE CO.**

WILMINGTON 99, DELAWARE

In Canada: National Fibre Company of Canada, Ltd. • Toronto 3, Ont.

VULCANIZED FIBRE • PHENOLITE LAMINATED PLASTIC • NATIONAL NYLON • PEERLESS INSULATION • KENNETT MATERIALS HANDLING RECEPTACLES • VUL-COT WASTEBASKETS • LESTERSHIRE TEXTILE BOBBINS • VULCOT PRODUCTS FOR THE HOME

If you're seeking a top career in a **UNIQUE** location—

**Look to FTL . . . where you work, live and relax
in beautiful suburban New Jersey . . . only minutes
away from New York City's wealth of scientific,
cultural and entertainment facilities**

Mountains, lakes, ocean beaches, fishing, boating, golf—
all the things a man and his family enjoy—are within easy
reach of the "FTL Community."

At FTL you work in country-like atmosphere . . . in one
of America's great research and development centers . . .
with leaders in electronics . . . with every opportunity to
build a stable and rewarding career . . . as a member of
the world-wide IT&T Engineering Team.

FTL provides group insurance, company-paid medical
and pension plans, tuition refund and many other em-
ployee benefits.

Write today for information on any of the following
interesting assignments now open at Federal Telecommu-
nication Laboratories, Nutley, New Jersey:

Radio Communication Systems • Traveling Wave Tubes
Electronic Countermeasures • Air Navigation Systems
Antennas • Missile Guidance • Computers
Transistors and other Semiconductor Devices
Telephone and Wire Transmission Systems

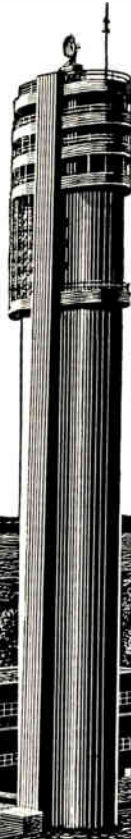

FTL's East Coast Laboratory, Nutley, N. J.
—only 28 minutes from New York City

If you prefer CALIFORNIA—

• Opportunities for relaxed living
and career-building also available at
FTL's West Coast Laboratory . . . with
openings in Digital Computers, In-
ertial Navigation Systems and Infra
Red Systems. Write to 15191 Bledsoe
St., San Fernando, Cal.



MAIL THIS COUPON TODAY

Federal Telecommunication Laboratories
500 Washington Avenue, Nutley, N. J.
Please send literature describing opportunities
and benefits at FTL, in Nutley, New Jersey.

Name _____

Address _____

City _____ Zone _____ State _____

Federal Telecommunication Laboratories
A Division of INTERNATIONAL TELEPHONE
AND TELEGRAPH CORPORATION

(Continued from page 120)

perimental run of production test-
ing, but results were not wholly
satisfactory. The test was time
consuming because each sweep of
the sonic analyzer required 1 full
second and many sweeps were re-
quired to show a good overall pic-
ture of the noise output.

Two types of readings are now
being taken and are proposed for
specifications. The first is a peak-
to-peak value as read on a peak-
to-peak VTVM. The second read-
ing is taken on an RMS VTVM
which has scales marked in volts
RMS but is actually more of an
averaging device.

It must be remembered that rel-
atively high values of noise can
be expected for peak-to-peak read-
ings. For a pure sine wave alone
the peak-to-peak value is 2.8 times
the RMS value and the occurrence
of harmonics even in fixed, single
frequency vibration always tends
to raise this ratio rather than
lower it. Thus a tube with 50 mV
RMS output for 15 g, 40 cps vi-
bration could read over 300 mV
(P-P). An even higher ratio of
peak-to-peak/RMS can be ex-
pected for white noise vibration
output. The ratios are sometimes
10 to 1.

The white noise vibration test
described is currently in use for
a line of subminiature tubes in
small scale production. The form
of the noise specification has been
established and tentative limits
have been determined and are now
in use.

* * *

FCC Problems

Investigation of strange trans-
missions led to a New Jersey town
where, during a football game, the
local team was found employing
walkie-talkies to communicate be-
tween a coach on the ground and
an assistant in the stand. The
bulk of the equipment precluded
its use for transmitting instruc-
tions directly to the quarterback
on the field, which is done by some
football teams under FCC authori-
zations in the citizens or restricted
radiation services. Use of un-
authorized walkie-talkies was dis-
continued.



Synthane laminated plastics report for work

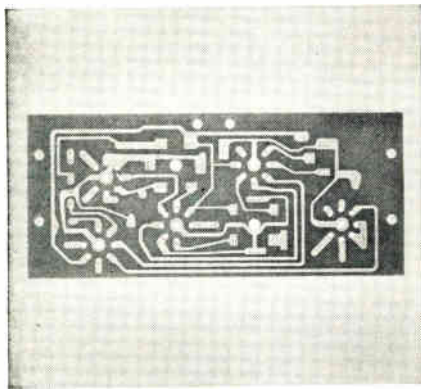

Printed circuit for popular television receiver uses a metal-clad Synthane Laminate. Such a circuit eliminates wiring, wiring errors, saves space and weight.

Since the time when the heart of radio was the crystal and cat's whisker, Synthane laminated plastics have been the recommended insulation in the vital and ever expanding communications industry.

Turn on your TV or radio and Synthane goes to work as insulation in coil forms, transformers, tuners, plug-ins, switches, potentiometers, or as the metal-clad base for the entire printed circuit. Synthane also qualifies for important work in radar, sonar and guided missile applications.

Among the varieties of Synthane laminated plastics are several with insula-

tion resistance and dissipation factor capable of controlling TV's high frequencies—even under tropically humid conditions. But Synthane makes over 30 grades—each with its own proportion of useful mechanical, electrical and chemical virtues. You can buy Synthane laminated plastics in sheet, rod and tube form or avail yourself of our complete fabrication service.

We have a number of interesting and informative folders on Synthane properties and applications. A post card will bring them to you promptly. Synthane Corporation, 1 River Road, Oaks, Pa.



COMPRESSIVE STRENGTH



DIELECTRIC STRENGTH



LIGHT WEIGHT



WEAR RESISTANCE



...industry's unseen essential

SYNTHANE CORPORATION, 11 RIVER ROAD, OAKS, PA.

NEW

magnetically
-controlled

COUNTER -DIVIDER

Magnivider

Using a "ladle-bucket" principle, magnetic cores in the unique Magnivider circuit set a new high of reliability and ruggedness wherever counting, scolding or frequency division is required.



Self-contained Magnivider plug-ins are ideal for your new equipment designs. Compared to conventional four-tube counters, one-tube Magnividers offer

- one-third the size
- 50% less power drain
- twice the reliability
- compatible scales of 9-10-11
- counting rates from 0 to 50 Kc.
- both low and high impedance outputs
- direct cascading without buffers

Magnividers have a wide range of applications

- Random counting
- Preset counting
- Cycle counting
- Frequency division
- Timing chains
- Synchronizing circuits
- Accumulators

Write for our Technical Bulletin 145 to obtain complete information and specifications.

Dept. 101

**MAGNETICS
RESEARCH
COMPANY**

255 GROVE STREET
WHITE PLAINS, N. Y.

Doppler D. F.

(Continued from page 67)

provided as an operator control. The recording process is arranged so that while signals are being received and recorded they simultaneously erase any information previously recorded.

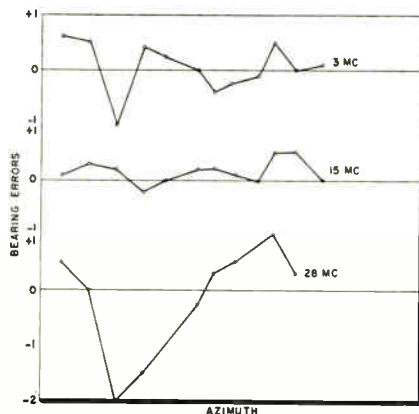

Fig. 13: Bearing accuracy vs. frequency.

System Performance

The results of system sensitivity tests made to determine the received signal strengths necessary to produce readable bearings at various frequencies are shown in Fig. 12.

At some frequencies, the sensitivity measurements appeared to be limited by atmospheric noise rather than receiver noise.

The curves shown in Fig. 13 are typical of bearing accuracy vs. fre-

quency tests. Tests were made using a controlled target transmitter at different azimuths and at distances varying from 1/4 to 1 mi.

Comparison tests conducted by the Signal Corps Engineering Laboratories, using a predecessor experimental model Doppler System, indicated a decided improvement in bearing accuracy over the stand-

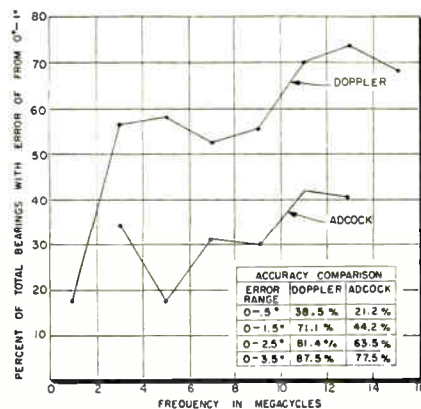

Fig. 14: Comparison of bearing tests.

ard military Adcock h-f direction finder.

Fig. 14 summarizes the bearing accuracy tests. A total of approx. 500 bearings were taken at various times of day on some 150 radio stations distributed in frequency, azimuth, and range. It is to be noted, e.g., that at 7 MC approx. 52% of the Doppler bearing errors are with 1° as compared to approx. 31% in the case of the Adcock system.

(Continued on page 128)

Fig. 15: A typical Doppler direction finding installation.

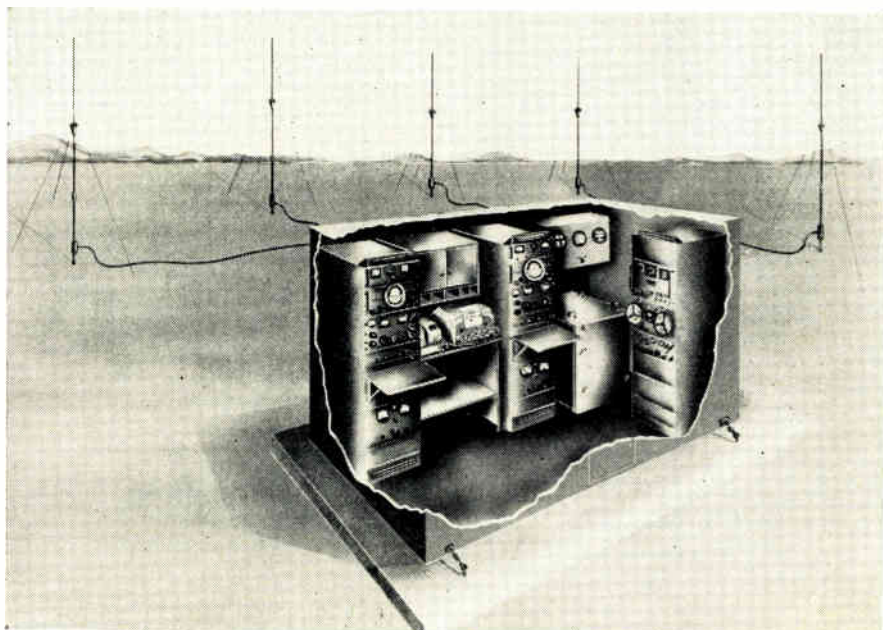

General NEW HI-SPEED SWITCHING TRANSISTORS Assures Computer Reliability

Computer engineers long seeking PNP transistors in applications requiring high current and fast switching will specify General Transistor's new 2N315, 2N316, and 2N317 for peak reliability.

2N317: As developed by General, a typical switching speed of .3 of a microsecond at 400 milliamps of collector current is possible with only 20 ma. of drive current.

The series resistance of these GT transistors, when conducting, is 1/2 ohm; the nonconducting series resistance is as high as 10 megohms with a result that approaches optimum efficiency at high current levels.

Computer manufacturers know they can depend on General's engineering and development as well as their quality and service. That's why GT is the largest supplier of transistors for computers.

CHARACTERISTICS

Parameter	Conditions	Min	Typical	Max
Collector-Base Voltage (Vcbo)	Ic = -25μa, Emitter Open	-20V	-30V	
Collector Cut-off Current (Icbo)	Vcb = -5V, Ic = -400ma	-1μa	-2μa	
D.C. Current Gain (hfe)	Vce = -2V, Ic = -400ma	20	30	50
Alpha Cut-off Frequency (fafb)	Vcb = -5V, Ic = -1ma		20mc	

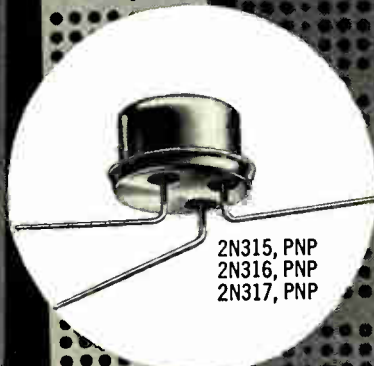
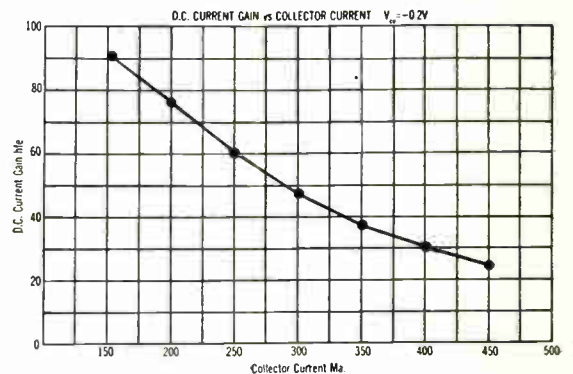
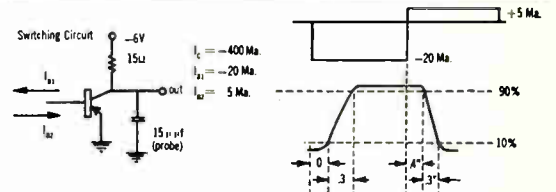

Write for GT's special Computer Transistors Specifications Bulletin.

GENERAL TRANSISTOR CORP.

Richmond Hill 18, N. Y.—Virginia 9-8900

Cable: Transistor New York

A Circuit Breaker Specially Built For Electronic Equipment

Three advantages of this circuit breaker —

- 1 — occupies practically same space as conventional on-off switch, mounts in same punch out.
- 2 — protects equipment as well as controls power.
- 3 — eliminates fussing with fuses.

AIRPAX
PRODUCTS COMPANY
DESIGNERS ENGINEERS
ENGINEERING DIVISION
MIDDLE RIVER 20
BALTIMORE 20
MARYLAND

Circle 158 on Inquiry Card, Page 97

Engineers who know —SPECIFY— Q-max*

A-27 SUPERFINE LOW-LOSS RF LACQUER

*Registered Trademark

THE IDEAL COIL IMPREGNANT

- Q-Max, an extremely low loss dielectric impregnating and coating composition, is formulated specifically for application to VHF and UHF components. It penetrates deeply, seals out moisture, provides a surface finish, imparts rigidity and promotes stability of the electrical constants of high frequency circuits. Its effect upon the "Q" of RF windings is practically negligible.
- Q-Max applies easily by dipping or brushing, dries quickly, adheres well; meets most temperature requirements. Q-Max is industry's standard RF lacquer. Engineers who know specify Q-Max! Write for new illustrated catalog.

COMMUNICATION PRODUCTS COMPANY • INC
MARLBORO, NEW JERSEY — Telephone: Freehold 8-1880
Pacific Coast Branch: 120 SANTA BARBARA ST., SANTA BARBARA, CAL. — Woodland 2-1712-4

Circle 159 on Inquiry Card, Page 97

REPS WANTED

Southern California Manufacturer of copper clad and unclad epoxy glass laminates seeks sales representation throughout U. S., Canada, and Mexico. (Ask for R2-1.)

Four reps wanted for a leading manufacturer of waveguides and accessories, microwave antennas and other microwave accessories. The territories concerned are Chicago and Midwest, Southeast, St. Louis, and the Southwest with Dallas as headquarters. (Ask for R2-2.)

An Eastern firm is seeking reps for industrial test equipment. The territories concerned are in New England, Ohio and Texas. (Ask for R2-3)

Glidden Engineering and Equipment Co., Houston, Tex., representing the Automatic Switch Co. of Orange, N. J., has announced the opening of three new offices in Texas with William E. Flint at Corpus Christi, Ed. W. Tarpley at Fort Worth, and Howard Hebbler at Dallas.

Koessler Sales Co., recently announced the purchase of a building at 818 N. Fairfax Ave., Los Angeles 46, Calif. The new building includes larger offices and demonstration rooms, more warehouse facilities, 3000 square feet of parking and increased telephone service.

Mid-Lantic Chapter of The Representatives, announces the opening of a new office located at 2373 McMullen Circle, Raleigh, N. Carolina, with J. L. Truesdell as southern manager. Edward A. Brogden has been added to the Phila. sales office.

Jones & Granger, Inc., Boston, Mass., in the electrical field in New England, has announced plans to expand the electronics end of their business. They have been in the electronics field on an exploratory basis for the last several years.

G. S. Marshall Co. has been appointed to represent the Radio Corporation of America in the sale of its new Precision Electronic Instruments in California, Arizona, and Nevada.

Herbert L. Dienes Co., Phila., Pa. have just been appointed sales representatives for the Snyder Mfg. Co. They will cover Eastern Pa., So. New Jersey, Delaware, Maryland, D. C. and Virginia.

Land-C-Air Sales Co., manufacturers reps of Tuckahoe, N. Y., announced the completion of another step in their expansion by the addition of Norman Weersing.

Horace C. Johnson is now affiliated with Harold A. Moyer, Haddonfield, N. J.

News of Reps

E. H. Frost named Northeastern District sales rep. in the Electronic Products Sales Dept. of Sylvania Electric Products Inc., New York. His headquarters will be in Hartford, Conn.

William M. Hannah named rep. in the upstate New York area for Tel-Instrument Electronics Corp., Carlstadt, N. J.

Wayne B. Palioca has formed a manufacturers rep. organization with his office located in Concord, Mass. He will represent several well known companies in the New England area.

Ray Dollar has been named a rep. in Florida and Southern Georgia area for the Warner Electric Brake & Clutch Co., Beloit Wis.

Otto Lohkemper is now a rep. for Paraplegics Mfg. Co., Chicago, Ill. and will cover the New York and Philadelphia Areas with headquarters at New Hyde Park, L. I. N. Y.

Bonament Heyda was appointed a rep. in North and South Dakota, Minnesota and Western Wisconsin by Fanon Electric Co., Brooklyn, N. Y.

John G. Twist Co. will represent the Victor Electric Wire and Cable Corp., West Warwick, R. I. in Illinois and Wisconsin.

Clarence J. Dorr has been named sales manager for Glenn M. Hathaway Electronics, Inc., a rep firm located in Cambridge, Mass.

John G. Goode appointed rep. in the New England area, Arthur R. Seidel in the Milwaukee area and Robert W. Baumann in the St. Louis area for WacLine Inc., Dayton, Ohio.

William R. Helms has joined Westron Sales & Engineering, a West Coast rep. firm, as a sales engineer.

William C. Mader has been appointed a field sales rep. in the Chicago office for the Parts Div. of Sylvania Electric Products Inc., New York.

The Hilker Co., Winston-Salem, North Carolina will represent the Kaar Engineering Corp., Palo Alto, Calif. in North and South Carolina eastern Tennessee, and R. S. Puleo, Lynbrook, N. Y. will represent them in New York, Northern Pennsylvania and Northern New Jersey.

Harvey J. Krasner was appointed a sales engineering rep. for Kepco Laboratories, Flushing 55, N. Y.

W. S. Mills, Trenton, N. J. is now representing Diamonite Products Mfg. Co., Canton 2 Ohio, in metropolitan New York and Northern New Jersey.

Robert W. Thompson and Samuel A. Benson were appointed reps in Southern California for the rep firm of Don C. Wallace & William H. Wallace, Los Angeles, Calif.

electronic engineers

SENIOR and JUNIOR

*Continued Expansion
Opens Up New Opportunities with*



Greenwich, Connecticut

Excellent positions are available with the General Engineering Laboratories of American Machine & Foundry Company, a recognized leader in the design, development and manufacture of atomic, electronic and mechanical equipment for the consumer, industry and defense.

If you qualify in any of the fields listed below, investigate these opportunities now:

- *High power radar system development*
- *Tropospheric scatter systems*
- *Microwave theory & component design*
- *Electronic packaging*
- *Missile control and handling systems*
- *Antenna design*
- *Electronic countermeasures*
- *Telemetry*
- *Data handling*
- *Circuit theory*
- *Navigation systems*
- *Instruments*

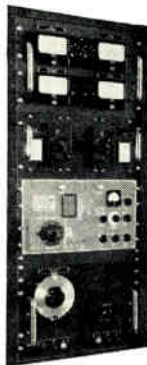

Good opportunities for advancement through advanced education on the premises as well as at nearby graduate schools in addition to a liberal tuition reimbursement plan, excellent employee benefits and an ideal location in Connecticut, surrounded by fine suburban communities. Relocation expenses paid.

Advanced electronic equipment
recently designed by **AMF**

*Please send your resume to Mr. J. F. Weigandt
OR for additional technical information,
contact Mr. D. R. Barker or Mr. H. R. Holloway
NOrmandy 1-7400*

General Engineering Laboratories

American Machine & Foundry Company

Fawcett Bldg. • Fawcett Place
Greenwich, Connecticut

(Continued from page 124)

System Application

In applications such as the Air Force/Air-Sea Rescue Operations, the described Doppler h-f direction finders will be operated as direction finder nets and position fixes on distress transmissions found by triangulation. The individual direction-finder bearings are relayed to a central location for plotting.

Fig. 15 is an illustration of a typical station installation showing 2 operator control consoles, teletype equipment for relaying the bearing information, the scanning switch at the far right corner, and an auxiliary rack containing recording and special-purpose equipment.

Acknowledgments

A major portion of the work described has been carried out as a joint Signal Corps and Air Force effort and the authors wish to acknowledge the help of all their colleagues in making this development possible. It is desired to give credit to the engineers of the General Electric Company for their work and valuable contributions in development of this first practical high frequency Doppler direction finder. The authors wish also to express their appreciation for the valuable assistance and cooperation given by colleagues at the Rome Air Development Center where this paper was prepared.

References

1. P. G. Hansel, *Directional System*, USA Patent #2,481,509; Dated 1949.
2. P. G. Hansel, *Doppler-Effect Omni-range*, Proceedings of the IRE, Vol. 41, No. 12; Dec. 1953.
3. C. W. Earp and R. M. Godfrey, *Radio Direction Finding by the Cylindrical Differential Measurement of Phase*, Jour. IEE, Vol. 94, Part 11A, #15; Mar.-Apr., 1947.
4. Masters Thesis by J. L. L. Boulet, University of Illinois; *Investigation of Doppler Effect in Determining Direction of Arrival of Radio Waves*, Sept. 1947.
5. J. L. L. Boulet, J. M. Anderson, and T. R. O'Meara, *Doppler-Type Direction-Finding*, Tech. Rep. No. 8; Radio Direction-Finding Res. Lab., Dept. of Elect. Eng., University of Illinois; Oct. 1, 1948.

* * *

Electronic Light

(Continued from page 94)

Brightness

The brightness of the lamp depends upon its applied voltage and frequency. Lamps are commercially available at definite voltage ratings. Figure 2 shows typical variation of brightness with frequencies at a given voltage. Lamps designed for use at higher frequencies will give higher brightnesses. Lamps operated at higher voltage will also give higher brightnesses. Table 1 shows typical effects of voltage and frequency at commonly available voltages and frequencies for typical phosphors.

(Continued on page 130)



★ ULTRA LOW capacitance & attenuation

WE ARE SPECIALLY ORGANIZED TO HANDLE DIRECT ORDERS OR ENQUIRIES FROM OVERSEAS
SPOT DELIVERIES FOR U.S.
 BILLED IN DOLLARS—
 SETTLEMENT BY YOUR CHECK
CABLE OR AIRMAIL TODAY



TYPE	$\mu\text{M F/ft}$	IMPED. Ω	O.D.
C1	7.3	150	.36
C11	6.3	173	.36
C2	6.3	171	.44
C22	5.5	184	.44
C3	5.4	197	.64
C33	4.8	220	.64
C4	4.6	229	1.03
C44	4.1	252	1.03

NEW **MX and SM** SUBMINIATURE CONNECTORS
 Constant 50 Ω -63 Ω -70 Ω impedances

TRANSRADIO LTD. 138A Cromwell Rd. London SW7 ENGLAND CABLES: TRANSRAD, LONDON

Circle 161 on Inquiry Card, Page 97



*A new sealed,
 shaft-driven precision
 AC voltage divider
 for accurate positioning
 and calibration.*

Gertsch Rotary RatioTran*

100-turn or 1000-turn models available, both in anodized aluminum cases, sealed against dirt and moisture. Ratio is controlled by a single ball-bearing mounted shaft. An internal mechanical counter provides easy readout. Printed silver switches assure long life and reliability.

- High accuracy... as good as .005% linearity
- High resolution... as good as .0005%
- Low phase shift... less than 1'
- High input impedance... approx. 50 henrys (200 henrys in 1000-turn model)
- Continuous transient-free output

*TRADEMARK

FOR COMPLETE DATA SHEET, CONTACT YOUR NEAREST GERTSCH ENGINEERING REPRESENTATIVE OR

GERTSCH PRODUCTS, INC.

11846 MISSISSIPPI AVENUE
 LOS ANGELES 25, CALIFORNIA

TECHNICAL WRITERS

Fascinating career for persons with a flair for writing plus a scientific education, background and experience in any of the following fields:

RADAR (Communication)

ELECTRONICS

PHYSICS

COMPUTERS

We need writers to prepare instructional and course material on large scale digital computers and related devices. Military training in the field of writing is often satisfactory. Let us decide whether your qualifications meet our requirements. Send complete resume to:

Mr. R. K. Patterson

Remington Rand Univac

DIVISION OF SPERRY RAND CORPORATION
UNIVAC PARK • ST. PAUL 16, MINNESOTA

PHAZOR PHASE METER

Pat. Pend.



MODEL 200 A

PRICE
\$34950
F.O.B.
NEW YORK

- HIGH ACCURACY
- MEASURES FROM 0 TO 360 DEGREES
- READINGS NOT AFFECTED BY NOISE AND HARMONICS
- PHASE SHIFTS OF THE ORDER OF .01° CAN BE MEASURED EMPLOYING SPECIAL CIRCUIT TECHNIQUES
- MEASURES IN-PHASE AND QUADRATURE COMPONENTS SEPARATELY

For further information contact your nearest representative or write for brochure

REPRESENTATIVES

KITTLESON CO., 7614 Melrose Ave., Los Angeles 46, California
JKM, INCORPORATED, 13 W. Hubbard St., Chicago 10, Illinois
BROGER INSTRUMENT SALES CO., INC., 739 Boylston St., Boston 16, Mass.
F. R. JODON, INC., 2902 Porter St., N.W., Washington 8, D. C.
G. G. WILLISON CO., 1821 W. Alabama, Houston 6, Texas
LeeMark Associates, P.O. Box 8467, Kansas City, 14, Missouri

INDUSTRIAL TEST EQUIPMENT CO.
55 E. 11th ST. • NEW YORK 3 • GR. 3-4684

Circle 163 on Inquiry Card, Page 97

Industrial Engineers

Advance in the mushrooming field of

MICROWAVE TUBES

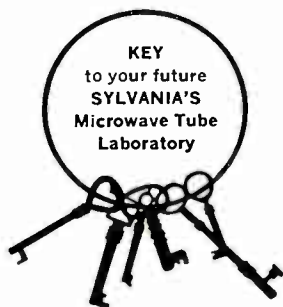

Write Gordon McClure
SYLVANIA ELECTRIC PRODUCTS INC.
500 Evelyn Avenue
Mountain View, California

Circle 164 on Inquiry Card, Page 97

TRACER-GUIDED DRILLING 100 HOLES P. M. WITH NEW HERMES *Engravo*

for printed circuit plates

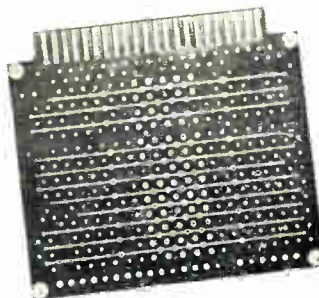

- Pontograph reproduces drill pattern from template in any reduction ratio — assuring high accuracy.

- Allows drilling and routing of different size holes in one operation without changing tools.

Pneumatic attachment with adjustable feed gives high speed production

Ask for catalog H-B-5

Also for tracer-guided
**ENGRAVING
PROFILING
GRAUATING**

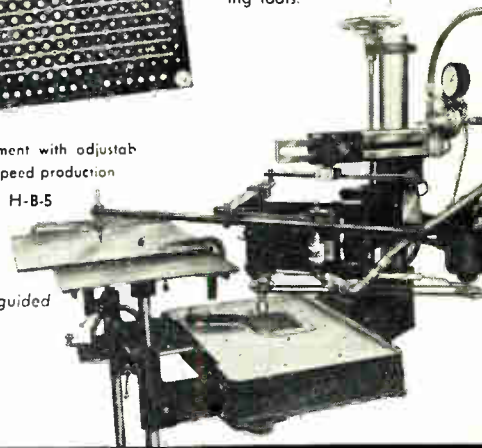

new hermes ENGRAVING MACHINE CORP.
13-19 University Place, New York 3, N.Y.

Circle 165 on Inquiry Card, Page 97

NEW

AMPLI-VISION-TELCON HELICAL MEMBRANE CABLES

FOR EVERY HIGH FREQUENCY APPLICATION



Combining low attenuation with minimum VSWR, Ampli-Vision Telcon Helical Membrane Cables have perfect characteristics for RF use . . . uniform frequency response . . . low temperature coefficient for all electrical characteristics . . . low noise level . . . high signal handling capacity . . . utmost flexibility permitting ease of installation . . . perfectly matched fittings and terminations . . . ALL THIS AT LOW COMPETITIVE PRICES.

Ampli-Vision-Telcon HM series cables consist of an inner copper conductor separated from an aluminum outer sheath by a helical polyethylene membrane. This cable is furnished either with a bare aluminum sheath or a vinyl protective sheath extruded over the aluminum.

CHARACTERISTICS OF AMPLI-VISION-TELCON HM CABLES							
Cable Code	AV6	AV4	AV7	AV8	AV9	AV11	AV10
Characteristic Impedance (Ohms)	75	75	75	50	50	50	50
Nominal Diameter	½"	¾"	1½"	½"	¾"	1½"	3¼"
Attenuation (db/100 ft.)							
1 Mc/s	0.073	0.048	0.024	0.083	0.054	0.026	0.0115
1000 Mc/s	0.7	1.8	1.05	2.9	2.0	1.15	0.67
Power Rating (Kw)							
1 Mc/s	12	21	59	13	24	66	230
1000 Mc/s	0.33	0.57	1.35	0.37	0.66	1.5	4.3
Max. R.F. Voltage Kv.	1.3	2.2	4.5	1.3	3.0	5.5	12
Weight Lbs./1000 ft.:	96	233	575	150	240	630	2360

A complete line of other types of coaxial cables is also available from Ampli-Vision. For complete information write to Dept. K.

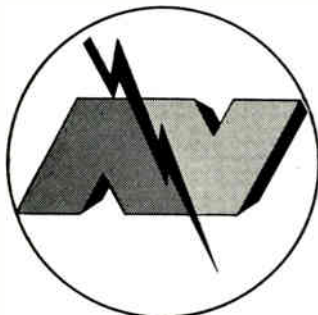

ampli-vision

Products of
International Telemeter Corporation
2000 Stoner Avenue, Los Angeles 25, California
a subsidiary of
Paramount Pictures Corporation

(Continued from page 128)

As a comparison reference point, the brightness of a cool white 40-watt fluorescent lamp is 1900 foot-lamberts. Naturally, the voltage rating of the lamp is dependent on the dielectric strength of the dielectric which contains the phosphor.

Life

The operating life of a panel-essent lamp is very long. The lamp is fundamentally a condenser and will fail only when subjected to conditions which will cause a condenser to fail—high voltage or operation beyond design conditions. There are no filaments to fail, no gases to contaminate and no emissive material to be consumed.

Lamp brightness decreases gradually with use, after an initial gain during the first hundred hours of operation. Typically, the lamp has not fallen below the initial brightness at the end of 9000 hours operation.

The Sylvania Panel-essent Lamp, R. R. Wylie. December 1956.

Transformer Design

(Continued from page 62)

The step by step calculations follow:

$$1. \frac{R_1}{R_2} = \frac{10^{+5}}{.2 \times 10^{+5}} = 5. \text{ Applying}$$

this value to Fig. 2 yields $\frac{X_n}{R_2} = 3$ for 15° max. phase shift.

$$2. L_p = \frac{2 \times 10^4}{2\pi \cdot 400} \times 3 = 24 \text{ Henries}$$

required primary inductance.

TABLE 2
CORE STEEL PROPERTIES

Material	Maximum Operating Flux (Gauss)
Grain oriented silicon	17,000
Silicon	12,000
Med μ Nickel iron	10,000
Hi μ Nickel iron	6,000

3. $L_p I_{dc} = 24 \times .0008 = .019$. According to Table 3, a 187 EI Lamination should accommodate the winding. The lamination selected is a "Carpenter 49", .006 in. 187 EI.

$$4. N_p = \left[\frac{24 (.001)}{3.19 \times .032 \times 10^{-8}} \right]^{\frac{1}{2}} = 4800 \text{ turns.}$$

5. $A_w = .052 \text{ in.}^2$ for the available bob-
(Continued on page 132)

For HEAVY DUTY WORK!
Severest Electrical Services



P-506-CE—Plug with Cap



S-506-DB
Socket with deep Bracket

JONES PLUGS & SOCKETS

500 SERIES
Proven Quality!

For 5,000 Volts, 25 Amperes
per Contact Alterable by
circuit Characteristics.

Socket contacts of phosphor bronze, knife-switch type, cadmium plated. Plug contacts hard brass, cadmium plated. Made in 2, 4, 6, 8, 10, and 12 contacts. Plugs and sockets polarized. Long leakage path from terminal, and terminal to ground. Caps and brackets, steel parkerized (rust-proofed). Plug and socket blocks interchangeable in caps and brackets. Terminal connections most accessible. Cap insulated with canvas bakelite.

Write for Jones BULLETIN 21 for full details on line.



Jones

HOWARD B. JONES DIVISION
CINCH MANUFACTURING CORPORATION
CHICAGO 24, ILLINOIS
SUBSIDIARY OF UNITED-CARR FASTENER CORP.

Circle 167 on Inquiry Card, Page 97



What's new in Commutators and Slip Rings?

We've perfected several new design and manufacturing techniques that are sure to interest you if your project calls for a rugged, precision commutator or slip ring assembly... at a price that will pleasantly surprise your purchasing agent!

The techniques we're so proud of involve a wide choice of insulating materials including fiberglass-epoxy "Tuff-Tube"; seamless conductors of copper, silver, nickel, and gold; amazingly accurate screening, etching; and plating methods; separate or continuous circuits... all combined to result in precision components providing minimum friction and brush noise along with maximum life and accuracy.

Forward your specs and drawings, or better still... call on us for preliminary design recommendations. Sample and prototype orders are welcome.



LAMTEX INDUSTRIES, INC.
51 State Street • Westbury, New York

Circle 169 on Inquiry Card, Page 97

20,000 TRANSFORMER DESIGNS FROM WHICH TO CHOOSE



One good reason for discussing your transformer application with Acme Electric is the possibility that with our background of more than 20,000 designs, we can adapt standard parts to exactly fit special requirements.



For example, the top illustration is that of a 2 KVA 240/480 primary, 120/240 secondary volts, 60 cycle dry type power transformer. The illustration (right) is that of a 1500 watt voltage regulator having a manually adjusted output voltage range from 145 to 240 volts. Basically, the same design, but with modification each unit serves a different purpose.



This is a high voltage power supply for electrostatic dust collecting and air conditioning equipment. Operating on 230 volt single phase, 60 cycle, it supplies 12 KV direct current up to 30 ma. D.C. voltage is adjustable to load.

Your requirements may be more simple than these examples—or more difficult. Send your specifications.

ACME ELECTRIC CORPORATION
892 WATER ST. CUBA, NEW YORK

Acme ACME Electric
TRANSFORMERS

Circle 168 on Inquiry Card, Page 97

New Rhodium Plate Won't Curl, Crack or Peel!



RHODEX

A rhodium plating process that produces *Compressively Stressed deposits . . . developed specifically for industrial applications. RHODEX will materially increase the fatigue resistance of the metal over which it is deposited.

*Patent Pending

SEL-REX CORPORATION
Precious Metals Division

155 Manchester Place Newark 4, N. J.

Please rush descriptive literature and technical data on Sel-Rex RHODEX (Compressively Stressed Rhodium.) E1-2

NAME _____

COMPANY _____

ADDRESS _____

CITY _____

ZONE _____ STATE _____

Circle 170 on Inquiry Card, Page 97

(Continued from page 130)

bin. Use #44 single formvar insulated wire. $N_{p,em} + 2N_{s,em} = 2 \times 4800 \times 3.92 = 3.75 \times 10^5$ kA_w $\times 1.273 \times 10^6 = .45 \times .052 \times 1.273 \times 10^6 = 3 \times 10^4$. Then according to Eq. 4, #44 would not fit. Since no wire smaller than #44 was immediately available, it was decided to make the necessary allowance by decreasing the secondary copper area.

6. Primary voltage specified as 6v.

$$7. B_{ac} = \frac{3.49 \times 6 \times 10^6}{400 \times .032 \times 4800} = 340 \text{ gauss.}$$

8. Since B_{ac} is low, allow B_{dc} to be 5,000 gauss.

$$9. l_g = \frac{.6 \times 4800 \times 0008}{5000} - \frac{1.63}{45000} = .0005 \text{ in.}$$

Using Table 4 as a guide, stack the laminations in groups of 10.

$$10. L_p = \frac{3.19 \times 4800^2 \times .032 \times 10^{-8}}{.0005 + \frac{1.63}{3000}} = 23 \text{ H}$$

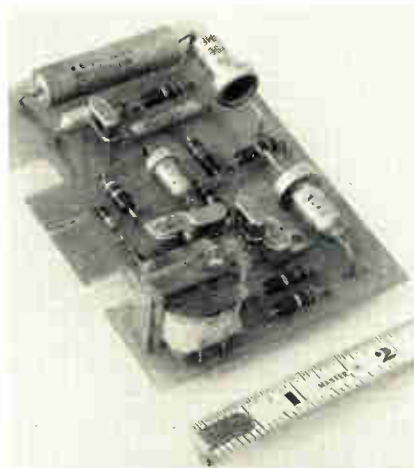

Fig. 7: Developmental circuit application.

The calculated 23 H is close enough to the required 24 H so that no recalculation will be made.

$$11. MLT_p = 2 \times (3/16 + 3/16) + \pi(1/32 + 3/32) = 1.14 \text{ in.}$$

$$MLT_s = 2 \times (3/16 + 3/16) + \pi(3/32 + 5/32) = 1.52 \text{ in.}$$

TABLE 3

PRODUCT OF L_pI_{dc} vs. CORE SIZE

Product	Core Size
L _p I _{dc} = 0.004	.026 in. ² (EI-28-29)
L _p I _{dc} = 0.020	.052 in. ² (EI-186-187)
L _p I _{dc} = 0.080	.070 in. ² (EI-21-25)
L _p I _{dc} = 0	use one size smaller core than that which would be used for L _p I _{dc} = 0.001L.

NOTE: The core sizes listed above are not necessarily optimum and the designer may wish to use a different core for reasons of physical size or electrical efficiency.

Busy Production Engineer Keeps The Line Moving

Direct-from-the-factory product information is the key . . .

he finds it faster in The MASTER!



1546 pages
World's Largest
Electronic Parts
Catalog

Production, design, development engineers and PA's rely on The MASTER. It's the quickest, easiest way to get current, direct-from-the-factory data on all products needed in production and research applications. The MASTER describes, illustrates, lists specifications and prices of over 125,000 electronic items — all systematically arranged for speedy reference.

Get the NEW 1957 RADIO-ELECTRONIC MASTER (21st edition)

at your electronic parts distributor today.

ONLY \$2⁹⁵

The Radio-Electronic MASTER
60 MADISON AVE. HEMPSTEAD, N. Y.
Circle 171 on Inquiry Card, Page 97

Mechanical Specialist

. . . capable of independent design and development work

Now open at the Light Military Electronic Equipment Dept. of G.E.— a high-level position for a mechanical engineer whose individual creativeness sets him apart in his field. This man must be able to originate new designs for military scanning mechanisms for radar and infra-red and direct the development of his projects. He must be resourceful enough to work independently, and capable of following his designs through to production.

A moderate amount of liaison work is connected with this job . . . involving contact with military procurement groups and aircraft industries.

3 years' experience in complex mechanisms for military application is required. A background in optics and infra-red would be helpful. Growth at LMEE depends entirely upon individual initiative.

High salary.

Location: Utica, an upstate New York resort area.

Reply in confidence to:
Mr. John Sternberg, Dept. 876
Light Military Electronic Equipment Dept.

GENERAL ELECTRIC

French Road, Utica, N. Y.
Circle 172 on Inquiry Card, Page 97

12. $DCR_p = 1.14 \times 4800 \times .22 = 1200 \Omega$. Since N_s was not computed in Step (5) it must be computed now. Eq. (5)

$$N_s = 4800 \left[\frac{1000}{20000} \right]^{\frac{1}{2}} = 1070 \text{ T}$$

$$cm_s = \frac{4800}{1070} \times 3.92 \text{ cm} = 17.6 \text{ cm.}$$

Use #38 wire = 15.7 cm

$$DCR_s = 1.52 \times 1070 \times .055 = 90 \Omega.$$

$$13. \eta = \frac{1}{1 + 1.5 \left[\frac{1070}{4800} \right]^2 \times 1200 + 90} \times 100\% = 82\%$$

The transformer was constructed according to the calculated parameters. Because of the compromises made in Step 5 the bobbin window was very full and difficulty was en-

TABLE 4
EQUIVALENT AIR GAPS IN
SMALL LAMINATIONS¹

	Effective Air Gap in. (total)
0.006 inch laminations Core Assembly	
Interleave 1 x 1	.00005
Interleave 3 x 3	.00015
Butt joint with zero gap	.0006
Butt joint with 0.001 in. gap inserted	.0012
Butt joint with 0.002 in. gap inserted	.0022

NOTE: The tabulated data are for laminations having a length of magnetic path of two inches and less.

countered in stacking the laminations. This would have been apparent in Step 12 if the calculated values of N_s and cm_s had been applied to Eq. 4. Comparative performance follows:

Parameter	Calculated	Measured
L_p	23 H	19½ H
Phase Shift	15°	16°
R_p	1200 Ω	1300 Ω
R_s	90 Ω	100 Ω
Eff.	82%	76%

The measured amplitude response was ± 1.5 db from 150 cps to 20 kc.

REFERENCES

1. Magnetic Metals Co., Camden, N. J.
2. Armco Steel Corp., Middletown, Ohio.
3. Allegheny Ludlum Steel Corp., Pittsburgh 22, Pennsylvania.
4. "Audio Transformer Design for Transistor Circuits," by Hitoshi H. Kajihara, Technical Memorandum 1582, Signal Corps Engineering Laboratories, Fort Monmouth, N. J.
5. "Electronic Transformers and Circuits," by Reuben Lee, Wiley and Sons, 1947.

* * *

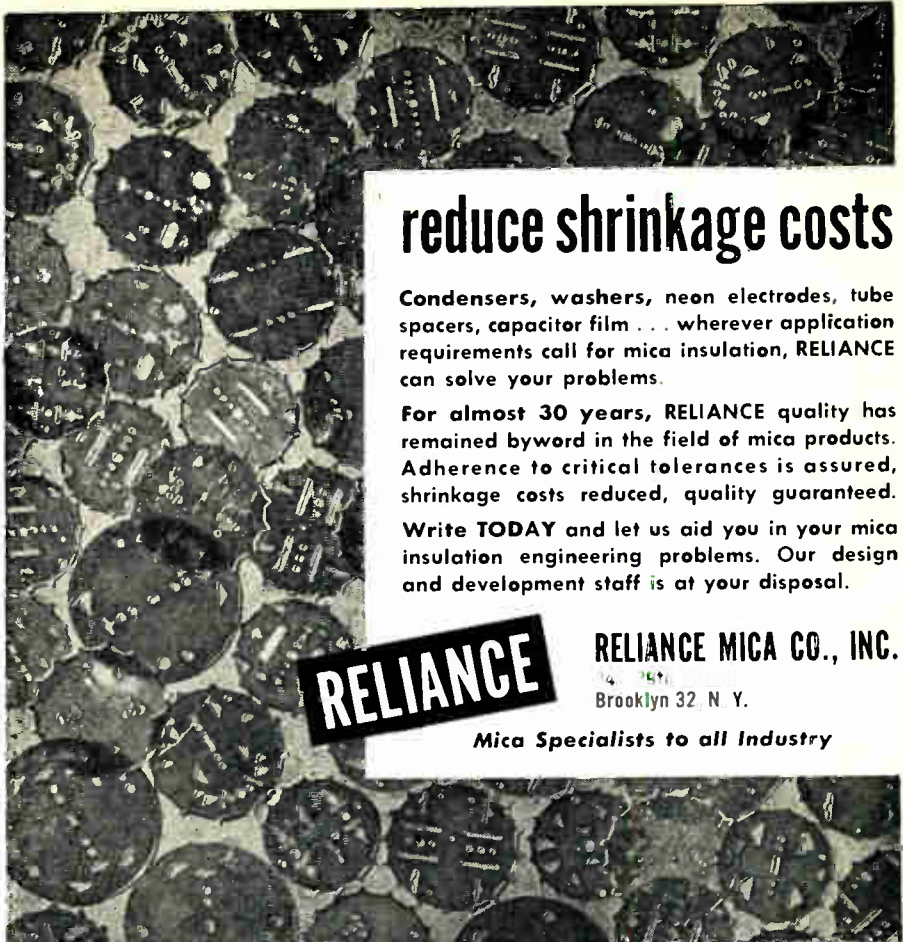

reduce shrinkage costs

Condensers, washers, neon electrodes, tube spacers, capacitor film . . . wherever application requirements call for mica insulation, RELIANCE can solve your problems.

For almost 30 years, RELIANCE quality has remained byword in the field of mica products. Adherence to critical tolerances is assured, shrinkage costs reduced, quality guaranteed.

Write TODAY and let us aid you in your mica insulation engineering problems. Our design and development staff is at your disposal.

RELIANCE

RELIANCE MICA CO., INC.
4 251
Brooklyn 32 N. Y.

Mica Specialists to all Industry

Circle 173 on Inquiry Card, Page 97

ELECTRON TUBE PARTS

Quality!
Dependability!
Service!

Lower cost—closer tolerances through Anton's unique facilities in manufacturing of metal parts for transmitting radar and geiger tubes.

Send drawing of your designs for quotation and take advantage of our production experience in this field.

Anton Machine Works

1226 Flushing Avenue, Brooklyn 37, New York

Standard & Magnetic Parallels • Standard & Adjustable V-Blocks • Diamond Holders • Milled Blanks

THE KAY Microalters

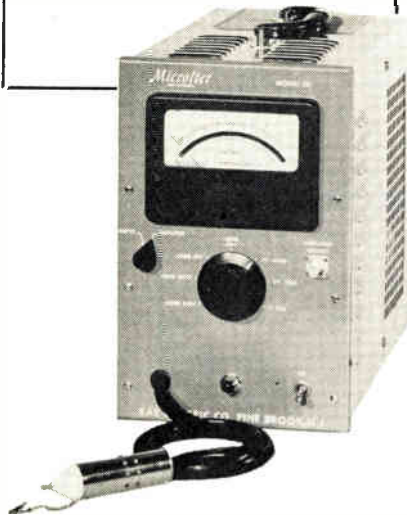

A Line of Wide-Band, High-Frequency, Low-Level Vacuum Tube Voltmeters Employing a High Impedance Probe.

The Microalters permit the measurement of low voltages at frequencies far beyond all existing vacuum tube voltmeters. Two models are currently available, the Model 50 and the Model 50-120. They are non-feed back type voltmeters. However, stabilization is provided for steady state changes and against line voltage variations. The Microalters permit the measurement of low level RF signals. A 7-position switch provides full scale steps of 1, .3, .1, .03, .01, .003 and .001 volts, the lowest reading being 250 microvolts. These ratios permit an easily read meter scale. Special units are available with gain band widths of 70 megacycle millivolts up to a frequency of 250 megacycles.

SPECIFICATIONS

Frequency Range: Model 50: 100 cycles to 50 megacycles.

Model 50-120: 50 megacycles to 120 megacycles.

Direct Reading in voltage or decibels.

Accuracy: $\pm 5\%$ of full scale reading.

Frequency Response: Model 50: ± 1 db.

Model 50-120: $\pm 1\frac{1}{2}$ db.

Voltage Range: 1 millivolt to 1 volt full scale in 7 ranges.

Sensitivity: Will measure down to 250 microvolts.

Input Impedance: Capacitance 5 mmf, resistance loading dependent on frequency (1 megohm at 1 megacycle to 30,000 ohms at 50 megacycles to 5,000 ohms at 120 megacycles).

No Tuning.

The Model 50 may be used as a wide-band video amplifier, maximum output approximately .25 volts at 160 ohms. Gains of up to 40 db.

Prices: Model 50, \$495.00. Model 50-120, \$495.00.

FOB Pine Brook

SEE US AT THE IRE SHOW

BOOTHS 2608-09-10

Write for new Kay Catalog Dept. EI-2

KAY

ELECTRIC COMPANY

14 Maple Ave., Pine Brook, N. J.
CALDWELL 6-4000

Circle 175 on Inquiry Card, Page 97

Linear Pots

(Continued from page 57)

The one-piece hub structure is dimensionally stable because of its aluminum construction and is insensitive to moisture and temperature variations. There are no plastic structural parts to warp and disturb the resistance coil.

To consistently produce linearities as close as $\pm 0.01\%$, it is necessary to wind the convolutions of resistance wire onto the coil mandrel with exceedingly high accuracy. The most accurate potentiometers made today are wound on servo-controlled equipment. There is some "hunting" in all servo-controlled winders, and this "hunting" affects the linearity of the resistance coil. With new techniques, this "hunting" can be substantially reduced and linearity improved.

Most servo-controlled winders make use of "position control" techniques. Position control winding involves measurement of the whole resistance element from the

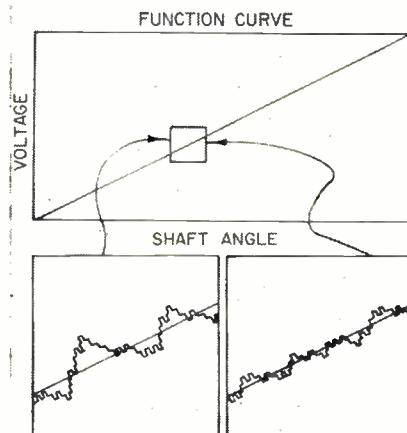

Fig. 7: Servo-controlled winding error reduced by "modified slope control," right.

starting point up to the point being laid or wound at a given instant. This measurement is then compared with a master potentiometer. On the basis of this comparison, corrections are then made to the resistance element being laid.

Fig. 7 shows the "hunting" error associated with "position control" winding equipment. It also shows how this "hunting" error can be reduced by the new technique of "modified slope control."

With this new technique, a few turns of wire at the point of winding are measured together with the

(Continued on page 136)

New!

MEASUREMENTS' FM

Standard

Signal

Generators



MODEL 210 SERIES

Measurements' Model 210 Series of Standard FM Signal Generators is designed for FM receiver measurements in the standard FM band; for measurements on railroad and automobile FM radio systems, research on FM, multiplexing and telemetering equipment. Models are available for use within the limits of 30 to 200 Mc each with a tuning range of approx. 1.2; for example, Model 210-A, 86 to 108 Mc.

FEATURES:

- Wide deviation with low distortion.
- Low spurious residual FM.
- Models covering 30 to 200 Mc.
- Accurate output voltage calibration — low VSWR.
- Operates at fundamental carrier frequencies.
- Vernier electronic tuning.

SPECIFICATIONS:

FREQUENCY RANGE: Five different models, each with tuning ratio of approx. 1.2, cover range from 30 to 200 Mc.

TUNING: Vernier frequency dial, and electronic tuning for frequency deviation.

OUTPUT VOLTAGE: 0.1 to 100,000 μ v.

OUTPUT SYSTEM: Mutual-inductance attenuator with 50-ohm source impedance with a low VSWR.

MODULATION: Selectable 400 and 1000 cycle internal audio oscillator. Other modulation frequencies available.

MODULATION FIDELITY: Frequency deviation response within ± 0.5 db from d.c. to 15,000 cycles, within 3 db to 70 Kc.

RESIDUAL FM: Spurious residual FM 60 db below 75 Kc. deviation.

POWER SUPPLY: 117 v., 50-60 cycles, 45 watts.

(complete data on request)

Laboratory Standards

MEASUREMENTS CORPORATION

BOONTON • NEW JERSEY

Circle 176 on Inquiry Card, Page 97

For Critical Applications a

MINIATURE INDUCTION MOTOR

HOWARD

MODEL 2500

(1/300 to 1/1400 H.P.)



DESCRIPTIONS & APPLICATIONS

Howard 2500 capacitor type induction motors are available in several models to meet various requirements.

- (1) Standard Non-Synchronous Capacitor Motors—For general alternating current applications requiring stable speed induction motors.
- (2) Torque Motors—Equipped with special high resistance rotors for high starting torque and variable speed operation.
- (3) Standard Synchronous Motors—Recommended for instruments and timing devices and other work requiring exact, constant speed.
- (4) Hysteresis Synchronous Motors—For constant speed applications requiring higher starting torque and quieter operation.

Available with or without gear heads with ratios from 6:1 to 3600:1. Write today for complete data.



HOWARD INDUSTRIES, INC., 1730 State St., Racine, Wis.
DIVISIONS: ELECTRIC MOTOR CORP. • CYCLOHM MOTOR CORP. • RACINE ELECTRIC PRODUCTS

Circle 177 on Inquiry Card, Page 97

BEND DRUM RETURN FOR LETTERS FASTER!



3/8" SLOTS
3/4" DEEP ON
1" & 1/2" CENTERS
ACCOMMODATE
SEAMED & FOLDED
DRUM RETURN

CLAMPING BY
FOOT TREADLE

CAPACITY 20 GA.
INCLUDING
STAINLESS

HEIGHT 39"

WEIGHT ONLY
50 LBS. FOR
EASY MOVING

**WHITNEY-JENSEN NO. 99
Letter Forming Bending Brake**

**WHITNEY METAL TOOL COMPANY
734 Forbes St., Rockford, Ill. Since 1910**

Circle 178 on Inquiry Card, Page 97

"No one has ever built a **COMPOUND MELTER** like we need **NOW...**"

"Don't let that throw you. **Sta-Warm** knows how to engineer melting equipment to **NEW** specifications."

For the compound melting
or dispensing tank
that has never been built before...

come
to **Sta-Warm**

Ask Sta-Warm engineers to survey and analyze your compound melting set up with a view to

- ... reducing costs
- ... maintaining steadier output
- ... increasing hourly output
- ... holding melted material to closer tolerances until dispensed or applied.

The broad experience of Sta-Warm compound melting engineers in this highly specialized and complicated field can be made available to you upon inquiry. Their service extends far beyond the recommendation of standard models of Sta-Warm melting equipment. It begins with plant and production survey, if you desire. Inquire today, briefly summarizing your problem. No obligation, of course.

Sta-Warm Electric Co.
222 N. Chestnut Street
Ravenna, Ohio

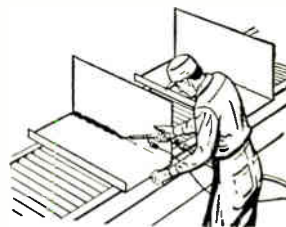

"If You Can Wrap
a String Around
It, Sta-Warm Can
Heat It for You."



**ENGINEERED EQUIPMENT
for melting and dispensing
heated compounds**

Circle 179 on Inquiry Card, Page 97

DRIFT FREE DC μ V AMPLIFIER



The **KAY LAB MODEL 111** amplifier provides the lowest drift of any commercially available broadband d-c amplifier. The unique circuit incorporates **KAY LAB's** proven chopper amplifier system to provide unsurpassed dynamic performance — unaffected by load or gain changes. Available in a single-unit cabinet or a six-amplifier rack-mountable module only 19 inches wide, the Model 111 is ideal for data reduction facilities, or as a strain gage amplifier, recorder driver amplifier, or general purpose laboratory amplifier.

SPECIFICATIONS

- ± 2 μ v equivalent input drift
- Integral power supply
- ± 35 V, ± 40 ma output
- 100,000 Ω input impedance
- 0 to 1000 gain in ten steps
- $\pm 1\%$ gain accuracy
- 5 μ v peak equivalent input noise
- Price (Single) Amplifier \$550.00

Representatives in All Major Cities



5725 KEARNEY VILLA ROAD
SAN DIEGO 11 CALIFORNIA
Circle 181 on Inquiry Card, Page 97

(Continued from page 134)

segment of wire about to be wound. The servo loop functions to hold this segment constant in resistance value.

There is one other technique used in this new design to obtain higher resolution and thereby better linearity. That is to wind a large number of turns of resistance wire onto a mandrel of small diameter.

After winding the resistance coil to high linearity another problem must be eliminated—wear on the resistance coil during operation.

Previous designs use a shoe

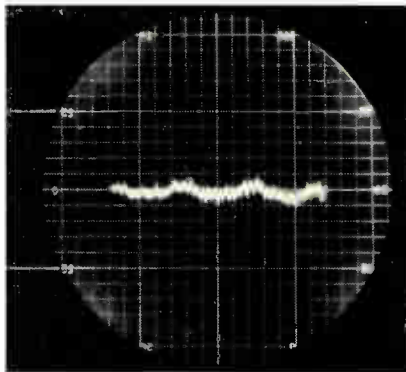
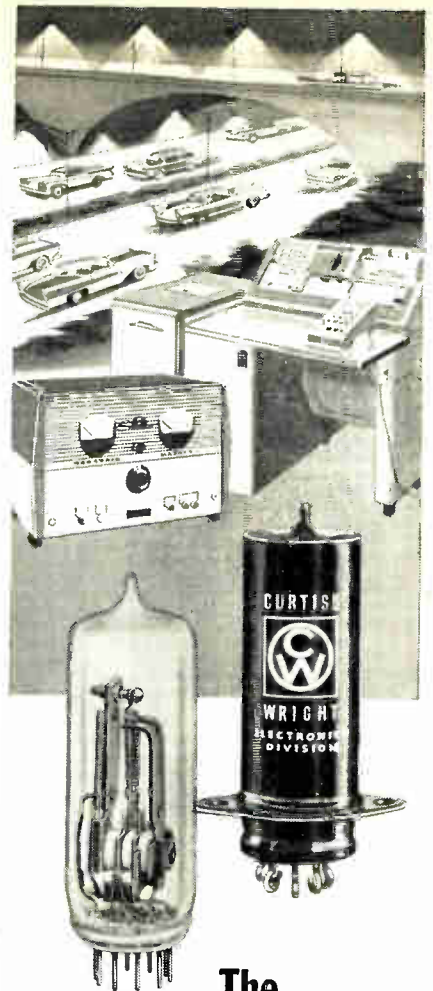

Fig. 8: Oscilloscope shows 0.01% linearity.

riding on the coil to guide the wiper assembly around the helix. This shoe considerably increases wear on the resistance coil. It also frequently damages or dislocates the fine turns of resistance wire and may cause deposition of foreign matter between the convolutions of resistance wire. This is a serious contributor to excessive electrical noise and shortens operating life.

In the new design, Fig. 5, only the movable contact touches the resistance element. In this design the movable contact is guided by a helical guide wire which is wound in the helical groove formed by adjacent turns of the resistance coil. This design reduces wear to a minimum and greatly improves noise characteristics throughout the operating life of the potentiometer.

Use of the new helical guide wire permits use of a unique movable contact, constructed of a low mass single wire with a high resonant frequency. This high frequency response is especially important in applications where vibration is significant.



The Curtiss-Wright "SNAPPER"

THERMAL TIME DELAY RELAYS
FOR COUNTLESS APPLICATIONS

- Eliminates chatter with snap action
- Single-pole, double throw contacts
- Wide ambient range (-65°C $+100^{\circ}\text{C}$)
- For military, commercial and industrial applications
- Metal envelope (7 or 9 pin) miniature or (8 pin) octal
- Glass envelope in 9 pin miniature
- Preset time delays in metal from 3 to 90 seconds, glass from 5 to 60 seconds

Write to Thermal Devices Department
for latest data sheets



Curtiss-Wright has career positions open for
qualified engineers and technicians.

Circle 180 on Inquiry Card, Page 97

Another problem eliminated in this design is damage caused by running the wiper arm up against the stops. One of the best solutions is shown in Fig. 6 where a rugged and positive metal-to-metal stop of traveling-nut design operates independent of the wiper arm. The stops can withstand 500 in.-oz. of static torque without permanent deformation, and their location can be adjusted to within $\pm 1^\circ$ of arc. Action of the stops exerts no extra force on the slider arm.

By means of the above engineering innovations, potentiometers of this design can be consistently produced with linearities as close as $\pm 0.01\%$.

Patent application has been made on the design of this potentiometer.

Electronic Eyes

(Continued from page 58)

amplifiers preceding the thyratrons.

An automatic gain control compensates for variations in bottle color. It is composed of a balanced modulator, amplifier, rectifier, control tube and oscillator. The total phototube current depends upon the light transmitted through the bottle about to be inspected. The voltage developed across a resistor in the phototube circuit is proportional to the total phototube current and serves as a control of the AGC modulator.

The 3 Kc output of this modulator is amplified, and rectified. This voltage serves to bias a control tube. The function of this tube is to amplify the 3 Kc signal in inverse proportion to the bias applied. The output of the two-channel (amplification) modulators is regulated by the 3 Kc signal output of the control tube so that a reduction of tube bias will increase the 3 Kc carrier to the channel (amplifier) modulators. In other words, a decrease in "sample signal" from the phototube results in increased gain in the amplifier channels.

Controls are also provided so the bottler can regulate the gain of the channels, within limits, to compensate for production variables and yet maintain a high degree of inspection efficiency.

The Electronic Inspection of Beer with the type EIM-5B RCA Automatic Inspection Machine, by L. W. Leidy, RCA Service Co., Camden, N. J.

COMMUNICATIONS SYSTEMS ENGINEERS

The expanding scope of advanced communications projects has created several unique positions in fields related to VHF, UHF, microwave transmission and reception, forward scatter and single sideband applications at Hoffman. Electronics engineers with appropriate backgrounds will find these new assignments professionally stimulating and financially rewarding. Please address Vice President of Engineering:

Hoffman LABORATORIES, INC.

A SUBSIDIARY OF HOFFMAN ELECTRONICS CORP.
3761 South Hill St., Los Angeles 7, Calif.
Telephone: Richmond 9-4831.

Circle 182 on Inquiry Card, Page 97

A Reminder

To our readers and advertisers.

Please help us to speed your correspondence by addressing all mail to us at our new address.

ELECTRONIC INDUSTRIES

& Tele-Tech

Chestnut St. at 56th, Philadelphia 39, Pa.



**ANCHOR RING*, CONE and
MAGNET INSULATOR***

**for
COLOR TUBES**

Perfect insulation . . . easy to attach . . . economical. From stock and to your specifications. Also: safety glass mounting channels; dust seals; flexible bumper channels. *patented

36-36 36th St., Long Island City 6, N. Y.
Chicago rep:
Pat Malone, 4000 West North Ave., Chicago, Ill. • SPaulding 2-9892
California rep: W. S. Harmon Co., 121 N. Robertson Blvd.
Beverly Hills, Calif. • CRestview 6-3027

ANCHOR INDUSTRIAL Co., Inc.

Circle 183 on Inquiry Card, Page 97

FREED MAGNETIC AMPLIFIERS

and
SATURABLE TRANSFORMERS

FOR IMMEDIATE DELIVERY

FAST RESPONSE MAGNETIC AMPLIFIERS

2 \sim response Phase reversible

Cat. No.	Supply Freq. C.P.S.	Power Out. Watts	Volt. Out. V. AC	AC or DC signal voltage req'd for full output.
MAF-1	60	13	110	1.0
MAF-6	400	5	57.5	1.2
	400	10	57.5	1.6
MAF-7	400	15	57.5	2.5

SINGLE ENDED MAGNETIC AMPLIFIERS

Cat. No.	Supply Freq. C.P.S.	Power Out. Watts	Sig. req'd for full outp. MA-DC	Total res. contr. wdg. K Ω	Load res. ohms
MAO-1	60	4.5	3.0	1.2	3800
MAO-2	60	20	1.8	1.3	700
MAO-4	60	400	9.0	10.0	25
MAO-5	60	575	6.0	10.0	25

PUSH-PULL MAGNETIC AMPLIFIERS

Phase reversible

Cat. No.	Supply Freq. C.P.S.	Power Out. Watts	Volt. Out. V. AC	Sig. req'd for full outp. MA-DC	Total res. contr. wdg. K Ω
MAP-1	60	5	115	1.2	1.2
MAP-2	60	15	115	1.6	2.4
MAP-3	60	50	115	2.0	0.5
MAP-3-A	60	50	115	7.0	2.9
MAP-4	60	175	115	8.0	6.0
MAP-7	400	15	115	0.6	2.8
MAP-8	400	50	110	1.75	0.6

SATURABLE TRANSFORMERS

Phase reversible

Cat. No.	Supply Freq. in C.P.S.	Power Out. Watts	Volt. Out. V. AC	Sig. req'd for full outp. MA-DC	Total res. contr. wdg. K Ω
MAS-1	60	15	115	6.0	27
MAS-2	400	6	115	4.0	10
MAS-5	400	2.7	26	4.0	3.2
MAS-6	400	30	115	4.0	8.0
MAS-7	400	40	115	5.5	8.0

All units designed for 115V-AC operation

Write for detailed listing, or special requirements, and copies of complete Transformer and Laboratory Test Instrument Catalogs.

FREED TRANSFORMER CO., INC.

1726 Weirfield Street

Brooklyn (Ridgewood) 27, New York

Circle 184 on Inquiry Card, Page 97

"Immittance"

(Continued from page 78)

reactance and positive shunt susceptance; (C) negative reactance and negative susceptance; and (D) negative reactance and positive susceptance.

When 50 Ω terminate terminals 2,2 then Fig. 7 results. In

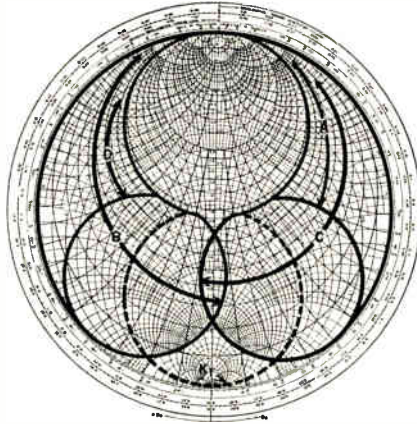

Fig. 6: Areas representing impedances seen at 2, 2 with 50 Ω across 1, 1, Fig. 5.

Fig. 7, K_2 represents 50 Ω in shunt with the susceptance; (A) the region for positive susceptance and positive reactance; (B) for positive susceptance and negative reactance; (C) for negative susceptance and positive reactance; and (D) for negative susceptance and negative reactance.

It is noted that for R_0 at terminals 1,1 the transformed impedance is generally higher; for R_0 across 2,2 the transformed impedance is generally lower.

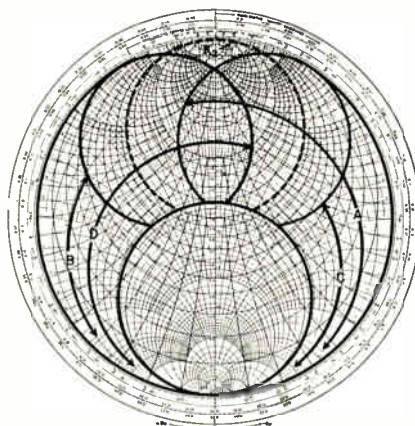
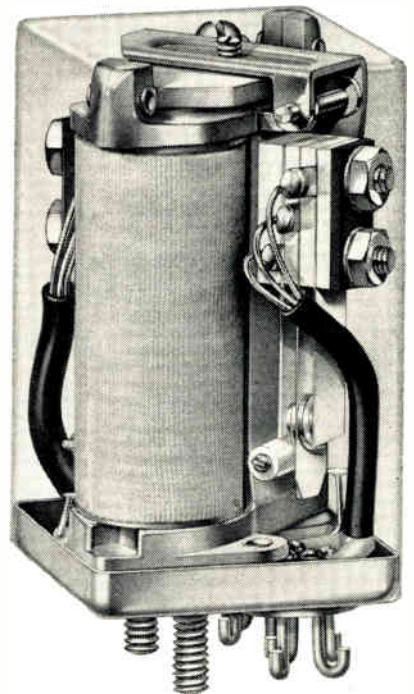

Fig. 7: Results of 50 Ω across 2, 2, Fig. 5.

When the 2 charts are superimposed, it can be seen that "most" impedances can be matched to 50 Ω by using the box. Fig. 8 shows the regions not included in (Continued on page 140)

HIGH Sensitivity RELAYS

for Military Equipment
and
Commercial Applications



- Meet MIL R-5757C and MIL R-25018 specifications.
- Sensitivity down to 6 mw.
- Coil Resistances to 20,000 Ohms.
- Switching Capacities up to 5a., 28 v., d.c.
- Standard contact arrangements to DPDT.
- Same long life and reliability in relays for commercial applications.

All relays may be purchased in a wide variety of terminals and mounting means to suit most applications.

Early delivery of relays built to standard specifications.

WRITE FOR RELAY DATA BULLETIN



MILWAUKEE GAS SPECIALTY CO.

Dept. RI-1, Milwaukee 1, Wisconsin

Circle 185 on Inquiry Card, Page 97

ELECTRONIC INDUSTRIES & Tele-Tech Advertisers—Feb., 1957

AC, THE ELECTRONICS DIVISION, GENERAL MOTORS CORP. 80 Agency—E. H. Brown Advertising	EASTERN PRECISION RESISTOR CORP. 46 Agency—Pulse Advertising	MILWAUKEE GAS SPECIALTY CO. 138 Agency—The Cramer-Krassel & Co.
ACME ELECTRIC CORP. 131 Agency—Scheel Advertising Agency	EITEL-McCULLOUGH, INCORPORATED 95 Agency—Evans McClure & Associates	MINNEAPOLIS HONEYWELL 115 Agency—Foote, Cone & Belding
AIRPAX PRODUCTS COMPANY 126 Agency—Welch, Collins & Mirabile, Inc.	ELECTRO-MOTIVE MANUFACTURING COMPANY, INC., THE 35 Agency—Cary-Snow	MOTOROLA CORP. 112 Agency—Kolb & Abraham, Inc.
ALFORD MANUFACTURING CO., INC. 012* Agency—Engineered Advertising	FAIRCHILD CONTROLS CORPORATION, COMPONENTS DIV. 23 Agency—G. M. Basford	NATIONAL VULCANIZED FIBRE CO. 121 Agency—Harris D. McKinney Advtg.
ALLEN BRADLEY CO., INC. 20 Agency—The Fensholt Advertising	FEDERAL TELECOMMUNICATIONS LAB. 122 Agency—J. M. Mathes, Inc.	NEW HERMES ENGRAVING MACHINE CORP. 129 Agency—Lester Harrison, Inc.
AMERICAN ELECTRONIC LABORATORIES, INC. 120 Agency—Petrick & Stephenson	FILTORS, INCORPORATED 28 Agency—Burton Browne Advtg.	ONAN, D. W., & SONS, INC. 015* Agency—Graves & Associates, Inc.
AMERICAN LAVA CORPORATION 41 Agency—Power & Condon	FREED TRANSFORMER 138 Agency—Franklin Advertising.	PHELPS DODGE COPPER PRODUCTS CORP. 09* Agency—Compton Adv., Inc.
AMERICAN MACHINE & FOUNDRY CO. 127 Agency—Deutsch & Shea, Inc.	GARRETT CORPORATION, THE 90 Agency—J. Walter Thompson Co.	PHILCO CORPORATION 82, 83 Agency—Hutchins Adv. Co.
AMPLI-VISION PRODS. OF INTERNATIONAL TELEMETER CORP. 160 Agency—Allied Advertising Artists	GENERAL ELECTRIC 91 Agency—Maxon Inc.	POLARD ELECTRONICS CORP. 31 Agency—Howard A. Harkavy, Inc.
ANCHOR INDUSTRIAL COMPANY, INC. 137 Agency—Richard & Gunther	GENERAL ELECTRIC 172 Agency—Deutsch & Shea	POLYTECHNIC RESEARCH & DEVELOPMENT CO., INC. 96 Agency—D. C. Smith Adv.
ANTON MACHINE WORKS 133 Agency—Richard & Gunther	GENERAL RADIO COMPANY 33 Agency—K. E. Morang Co.	PRECISION PAPER TUBE COMPANY 116 Agency—Symonds, MacKenzie & Co.
ARNOLD ENGINEERING COMPANY, INC., THE 44 Agency—W. S. Walker Advertising	GENERAL TRANSISTOR CORP. 125 Agency—A. D. Adams Adv.	RADIO CORPORATION OF AMERICA. Cover 4 Agency—Al Paul Lefton Co.
ASTRON CORPORATION 45 Agency—Conti Advertising	GERTSCH PRODUCTS 128 Agency—Bill West Advtg.	RADIO MATERIALS CORPORATION Cover 2 Agency—Turner Advertising
AUDIO DEVICES, INC. 39 Agency—Marsteller, Rickard, Gilbert, & Reed, Inc.	GRAYBAR ELECTRIC 013 Agency—G. M. Basford Co., Inc.	RADIO RECEPTOR COMPANY, INC. 84 Agency—Walter J. Zimmerman & Assoc.
AUTOMATIC METAL PRODUCTS CORP. 140 Agency—Daven Associates	HOFFMAN LAB. 137 Agency—Dan B. Miner Co.	REA MAGNET WIRE COMPANY, INC. 42, 43 Agency—Bonsib Adv.
BELL AIRCRAFT CORPORATION 40 Agency—Baldwin, Bowers & Strachan, Inc.	HOWARD INDUSTRIES, INC. 133 Agency—R. M. Loeff Advtg.	RELIANCE MICA CO., INC. 133 Agency—Richard & Gunther
BENDIX AVIATION CORPORATION, RED BANK DIVISION 92 Agency—MacManus, John & Adams, Inc.	HUGHES AIRCRAFT COMPANY 38, 94 Agency—Foote, Cone & Belding, Inc.	REMINGTON RAND UNIVAC 129 Agency—Mullen & Assoc., Inc.
BELAW-KNOX COMPANY 110 Agency—Ketchum, Macleod & Grove, Inc.	INDUCTION MOTORS CORP. 34 Agency—Molesworth Assoc.	ROHN MANUFACTURING COMPANY 016* Agency—Jackson, Maerr, Peterson & Hall, Inc.
BLONDER-TONGUE LABS 118 Agency—Jack Gilbert Associates	INDUSTRIAL TEST EQUIPMENT CO. 129 Agency—MacBerman Advtg.	STA-WARM 135 Agency—E. T. Geddes
BOMAC LABORATORIES, INC. Cover 3 Agency—Larcom Randall	INSTITUTE OF RADIO ENGINEERS, THE 89 Agency—Raymond Schoonover	STACKPOLE CARBON COMPANY 25 Agency—Harry P. Bridge Co.
BOURNS LABORATORIES, INC. 36 Agency—Allen Dorsey & Hatfield	INTERNATIONAL RESISTANCE COMPANY. 8, 9 Agency—Arndt, Preston, Chapin, Lamb & Keen, Inc.	SEL-REX CORPORATION 132 Agency—Bass & Co.
BURNELL, INCORPORATED 12 Agency—Mohr Associates	J. V. M. ENGINEERING 140 Agency—Symonds, MacKenzie Co.	SPRAGUE ELECTRIC COMPANY 48 Agency—Harry P. Bridge Co.
BURROUGHS CORPORATION 7 Agency—Harry P. Bridge Co.	JOHNSON COMPANY, E. F. 30 Agency—Firestone-Goodman Advtg.	SPRAGUE ELECTRIC COMPANY 4 Agency—Stuart Sande Advtg.
BURROUGHS CORPORATION 6 Agency—B. K. Davis & Brother	JONES DIV., HOWARD, B., CINCH MFG. CORP. 131 Agency—Symonds, Mackenzie Co.	SYLVANIA ELECTRIC CO., MTN. VIEW DIV. 129 Agency—Deutsch & Shea
BUSSMANN MANUFACTURING COMPANY 113	KAY ELECTRIC 134 Agency—Josephson, Gulick & Cuffari	SYLVANIA ELECTRIC PRODUCTS, INC. 81 Agency—J. Walter Thompson Co.
CANNON ELECTRIC COMPANY 10 Agency—Willard G. Gregory & Company	KAY LAB 136 Agency—The Armstrong Co.	SYNTHANE 123 Agency—Arndt, Preston, Chapin, Lamb & Keen, Inc.
CENTURY LIGHTING, INC. 014* Agency—Carter Winter	KESTER SOLDER COMPANY 32 Agency—Paul J. Steffen Co.	TELECHROME 47 Agency—Powerad, Inc.
CINCH MANUFACTURING CORPORATION. 77 Agency—D. T. Campbell, Inc.	KLEIN & SONS, MATHIAS 26 Agency—The Buchen Co.	TEXAS INSTRUMENTS 19 Agency—Don L. Baxter Advtg.
CLEVELAND CONTAINER 18 Agency—Nesbitt Service Company	LAMTEX INDUSTRIES, INC. 131 Agency—Industrial Marketing Assoc.	TINNERMAN PRODUCTS, INC. 29 Agency—Meldrum & Fewsmith, Inc.
COLLINS RADIO COMPANY 05* Agency—W. D. Lyon Company	LOS ALAMOS SCIENTIFIC LAB. 14, 15 Agency—Ward Hicks Advtg.	TRANSRADIO LTD. 128 Agency—Reyne'l & Son, Ltd.
COMMUNICATIONS PRODUCTS COMPANY, INC. 126 Agency—George Homer Martin Advtg.	MAGNETICS RESEARCH, INC. 124 Agency—Egan Advtg.	UNITED CATALOG CO., INC. 132 Agency—Jack Gilbert
CORNING GLASS WORKS, INC. 87 Agency—Charles L. Rumrill & Company, Inc.	MAGNETICS, INC. 117 Agency—Lando Adv.	UNITED TRANSFORMER CO. 93 Agency—Shappe-Wilkes, Inc.
CURTISS-WRIGHT CORP., ELECTRONIC DIV. 136 Agency—Burke-Dawling Adams, Inc.	MALLORY & CO., P. R. 37, 119 Agency—Aitkin-Kynett Co.	UNITED STATES GASKET COMPANY 22 Agency—The Michener Co.
DALE PRODUCTS, INCORPORATED 17 Agency—Ayres, Swanson & Associates, Inc.	MEASUREMENTS CORP. 134 Agency—Frederick Smith Advtg.	UNIVERSITY LOUDSPEAKER, INC. 86 Agency—Promotion Affiliates
DELCO RADIO DIV., GENERAL MOTORS CORPORATION 111 Agency—Campbell-Ewald Company	MELPAR INCORPORATED 114 Agency—M. Belmont ver Standig, Inc.	WHITNEY METAL TOOL COMPANY 135 Agency—Cummings, Brand & McPherson Advtg.
DESIGNERS FOR INDUSTRY 109 Agency—Fuller & Smith & Ross, Inc.	MIDLAND MANUFACTURING COMPANY, INC. 21 Agency—Potts-Woodbury, Inc.	WIND TURBINE COMPANY 011* Agency—Harry P. Bridge Co.
DUMONT LABS, ALLEN B. 27 Agency—Lescarboua Advertising, Inc.		

* In Operations Section only.

**NO MICROWAVE
SPECIFICATION
IS TOO CRITICAL FOR
J-V-M***

***CUSTOM BUILDERS
AND DESIGNERS OF:**

CAVITIES

**MIXERS • DETECTOR MOUNTS
DUPLEXERS • MULTIPLIERS
ROTARY JOINTS • BENDS
TWISTS • OTHER COMPLEX
COMPONENTS & ASSEMBLIES**

Application-engineered microwave parts and complex assemblies are our specialized field. We'll manufacture components to your prints ... or we will design and integrate them into your application.

You can depend on J-V-M for close coordination, guaranteed electrical performance and "know how" that is attested by innumerable assemblies ranging from dc. to 40,000 mc. now in industrial and military use.

FOR EXAMPLE:

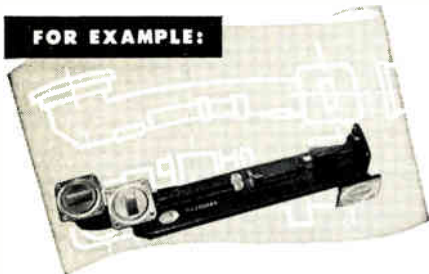

1. Variable vane directional coupler ... sliding vane type ... high directivity—low VSWR.

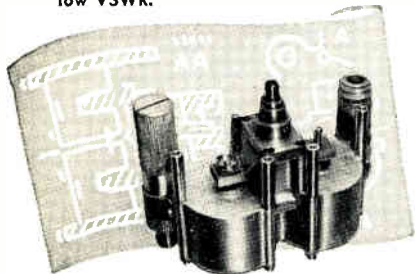

2. Pre-selector-mixer ... S band ... 50 ohm input impedance ... high Q double-tuned ganged cavities ... detector output ... frequency stable from -55° to +85° C.

Get full information on J-V-M standard or custom-engineered microwave parts and components, also complex mechanical assemblies. Request catalog today.

**CUSTOM-ENGINEERED
MICROWAVE
PARTS**



**J-V-M ENGINEERING
COMPANY**

4634 Lawndale Ave., Lyons, Illinois
(Chicago Suburb)

Circle 186 on Inquiry Card, Page 97

(Continued from page 138)

Figs. 6 and 7.

For the determination of admittances with given impedances, equivalent series and shunt networks, the input impedance or bandpass characteristics of ladder networks, the Immittance Chart has greatly decreased the labor involved. It also aids in the overall comprehension of these and many other problems which may be encountered in engineering practice.

Although charts with similar properties can be derived in many forms, the form presented is desirable because contours of equal mismatch loss, of reflection coefficient, of standing wave, and of equal transmission line lengths, may be omitted. These properties can be found, if needed, by use of calibrated scales. Leaving these contours off keeps the chart simple and yet provides means of conversion to and from the excluded parameters.

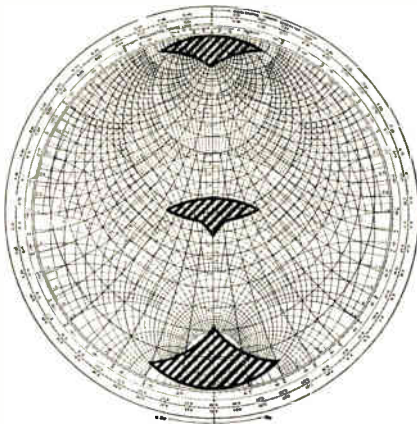

Fig. 8. Regions not included in Figs. 6 & 7.

Another advantage of the form presented is the inclusion of all physical impedance and admittance points on a finite chart. It is believed that with increased familiarity the chart may become more useful for the determination of networks to meet most circuit requirements.

References

* Actually a translation around a circular contour with its center at the center of the chart.

** This notation is adopted to illustrate that a point on the chart corresponds to

$$\text{either } Z_2 = \frac{1}{Y_1 + 1 - j3} \text{ or } Y_2 = Y_1 + 1 - j3.$$

1. P. H. Smith, "Transmission Line Calculator," *Electronics*, January 1939.

2. P. H. Smith, "An Improved Transmission Line Calculator," *Electronics*, January 1944.

3. Joseph Markin, "Smith Chart Applications," *Tele-Tech and Electronic Ind.*, May 1953.

NEW!
**AUTOMATIC'S TYPE BSM
COAXIAL CONNECTORS
FOR SUB-MINIATURE
CABLES**

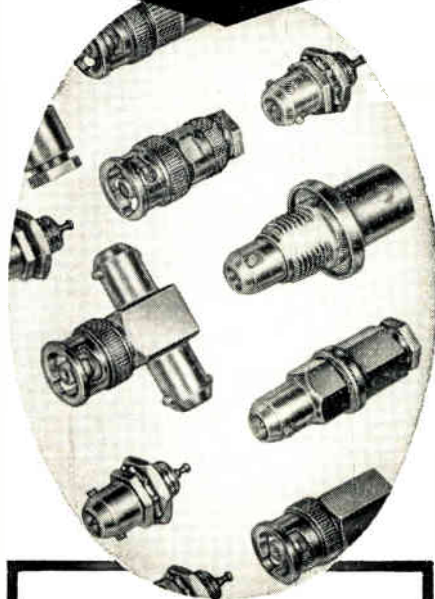

For the first time ... A new series of precision connectors unit-engineered to fit all specifications of sub-miniature cables.

NEW because ...

No special tools required for assembly.

NEW because ...

Foolproof clamping insures accurate alignment ... positive contact ... extra strong grip.

NEW because ...

Unique bayonet lock for sturdier mating ... quick and easy disconnect ... good contact ... accurate alignment.

NEW because ...

Exclusive internal-parts design allows outside dimensions of connectors to remain constant regardless of cable dimensions.

Remember Automatic's Type BSM Coaxial Connectors the next time you have a design that calls for Sub-miniature cables and components. Our engineers are always ready to discuss your special requirements.

WRITE FOR FREE TECHNICAL BULLETIN AND SPECIFICATION CHARTS.



317 BERRY ST., BROOKLYN 11, N. Y. EVergreen 8-0364

Circle 187 on Inquiry Card, Page 97

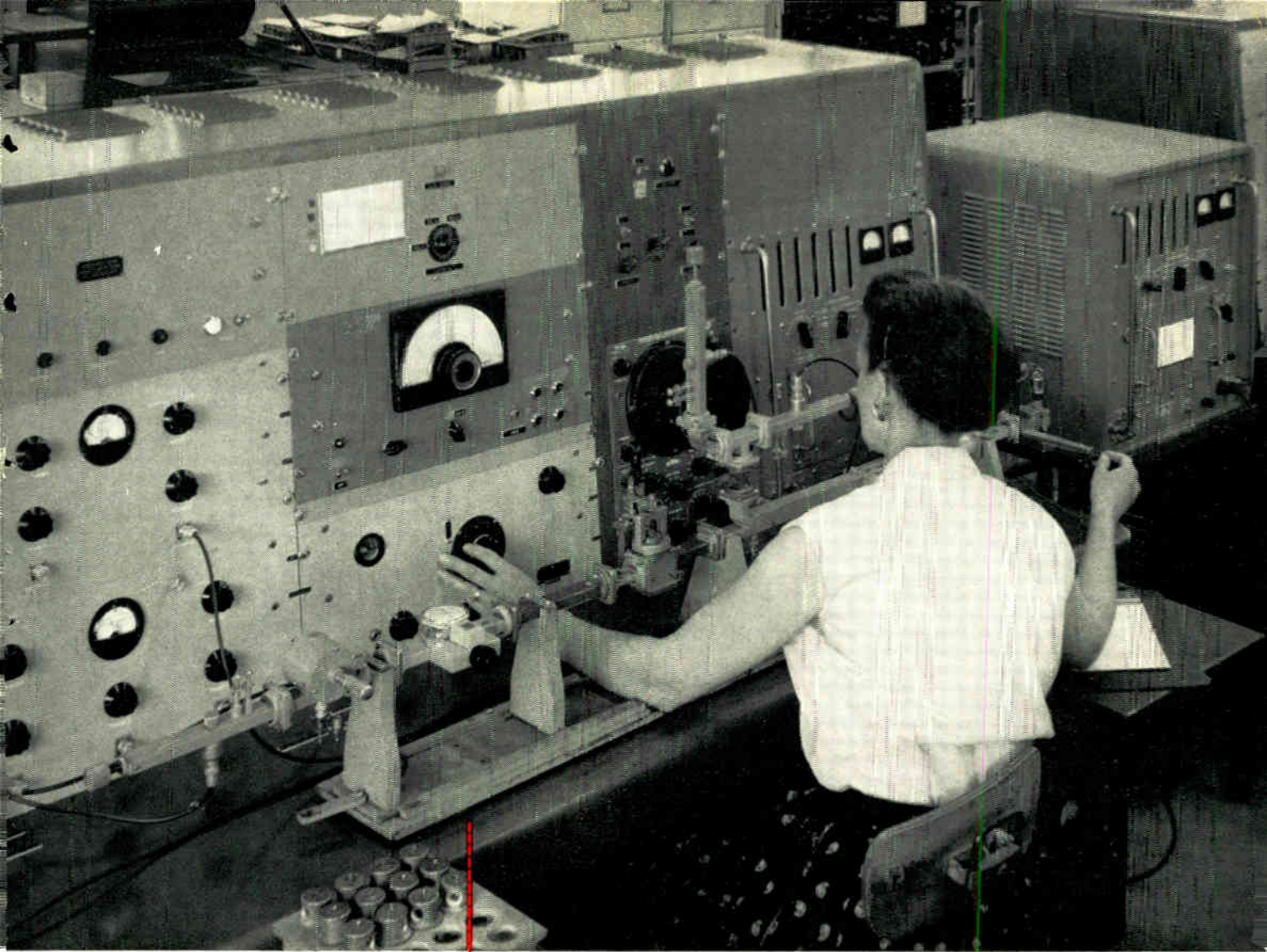

MARGIN FOR ERROR - 1 IN 1,000,000



The special equipment for calibrating and testing radar components used here is precisely accurate to within 1 cycle in 1,000,000.

Designed and built by Bomac test engineers, it typifies Bomac's painstaking emphasis on testing and quality control . . . an emphasis which is largely responsible for the extra measure of dependability in all Bomac microwave products.

***Bomac* LABORATORIES, INC.**
Beverly, Mass.

Positions now open for both junior and senior engineers in microwave tube design and development. The work is challenging, advancement opportunities unlimited, and benefits liberal.

Offices in major cities: — Chicago • Kansas City
Los Angeles • Dallas • Dayton • Washington
Seattle • San Francisco • Toronto

Export: — Maurice I. Parisier, 1860 Broadway, N. Y. 6

DISPLAY BRIGHTNESS . . .

GREATER THAN 1200 FOOT-LAMBERTS

... with the New RCA-6866
5-inch Display Storage Tube



Airport surveillance radar
— capable of being moni-
tored in broad daylight.

"Freezing" transients—for
study in a fully lighted
area.

RCA-6866 Facts
Brightness—1750 foot-
lamberts (av.)
{screen voltage, 10,000v.}
Writing Speed—300,000
inches/sec.
Overall tube length—15 1/4"
Greatest bulb dia.—5 1/4"
(excluding high-voltage
cable)

RCA, a leader in display storage tube research and development, now offers equipment designers the RCA-6866—a direct-view type capable of presenting brilliant, non-flickering displays of electronic information for *as long as 60 seconds after writing stops*. The tube is capable of producing a full, 4-inch diameter display bright enough to study in a fully-lighted room. And it is capable of "writing" fast enough to "freeze" microsecond transients for a length of time adequate to examine and photograph, if desired.

In the RCA-6866, an electrostatically focused writing gun produces the electron beam which

is electrostatically deflected by two sets of deflecting electrodes. A viewing gun produces the electron stream that "floods" the tube electrodes controlling the storage function—and the brightness of the tube display.

If you are working with airplane-cockpit radar-display equipment . . . fire-control radar . . . airport surveillance . . . transient studies . . . data transmission, *including half-tones* . . . or visual communications requiring steady, non-flickering, narrow-bandwidth transmission over telephone-type lines . . . by all means look into the advantages of the RCA-6866.

- EAST:** Humboldt 5-3900
744 Broad Street
Newark 2, N. J.
- MIDWEST:** Whitehall 4-2900
Suite 1181
Merchandise Mart Plaza
Chicago 54, Ill.
- WEST:** Raymond 3-8361
6355 East Washington Blvd.
Los Angeles 22, Calif.

For sales information on RCA-6866—and on other display storage tubes now in development at RCA—contact the RCA Office nearest you. For technical data, write RCA, Commercial Engineering, Sec. E-50-C, Harrison, N. J.



RADIO CORPORATION of AMERICA
ELECTRON TUBES
HARRISON, N. J.