

# TELE-TECH

Formerly ELECTRONIC INDUSTRIES

TELEVISION • TELECOMMUNICATIONS • RADIO

While at the Show . . . Visit TELE-TECH's Home Office . . . 6th Floor

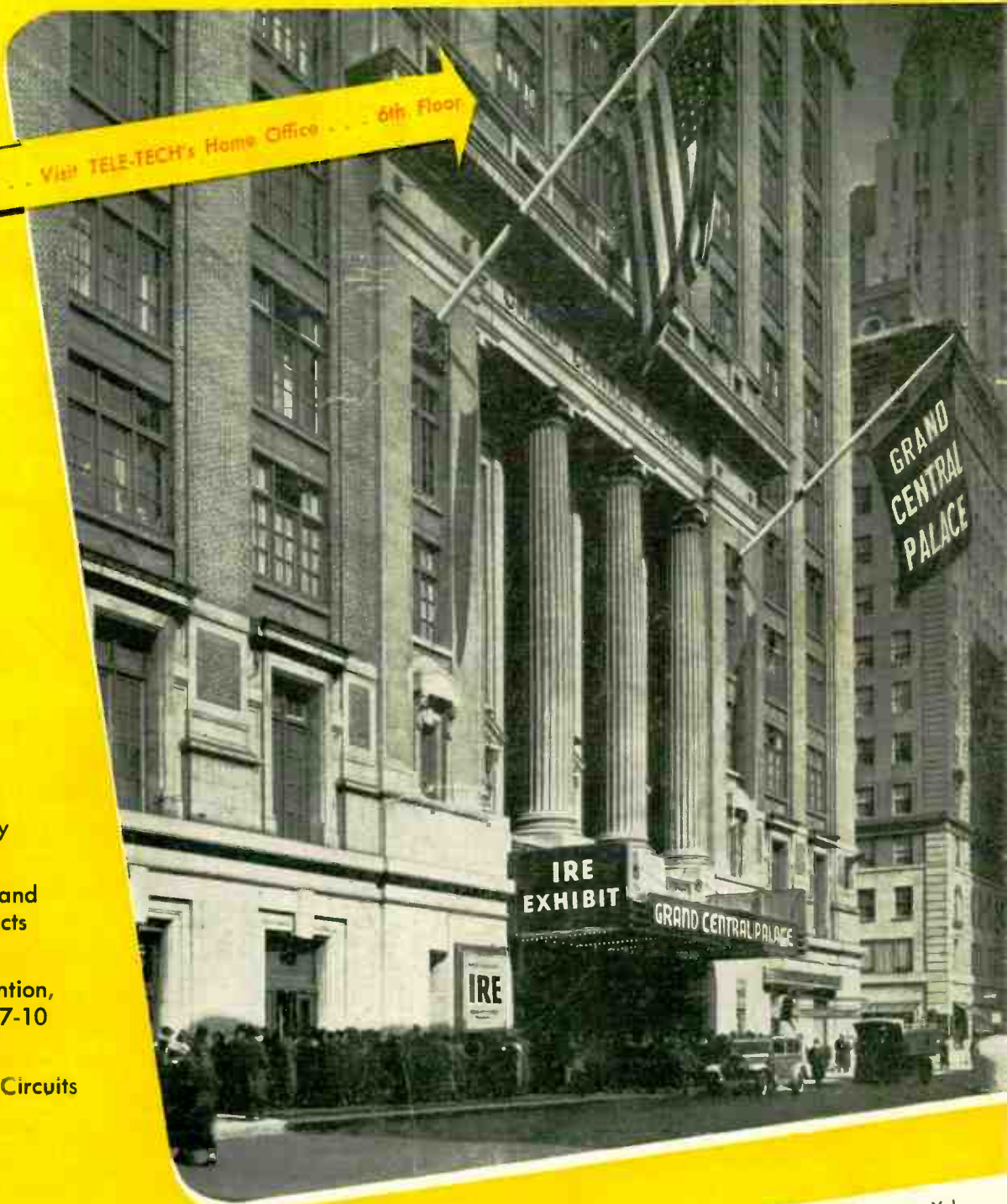

Mobilization of  
Electronic Industry

International TV and  
US Export Prospects

1949 IRE Convention,  
New York, Mar. 7-10

Reactance Tube Circuits

March • 1949

CALDWELL-CLEMENTS, INC.

SHARE THIS COPY!  
Please Route to

# NOW

**all these features in  
ONE GREAT RELAY!**

Independent twin contacts  
for perfect contact operation.

A highly efficient magnet circuit  
for sensitivity and high contact  
pressure.

Coil operating range: up to 300  
volts, D.C., and 230 volts, A.C.

Any controlled circuit arrange-  
ment requiring up to 26 terminals.

Compact design for important savings in space and weight.

Unique armature bearing for long wear under  
severe conditions.

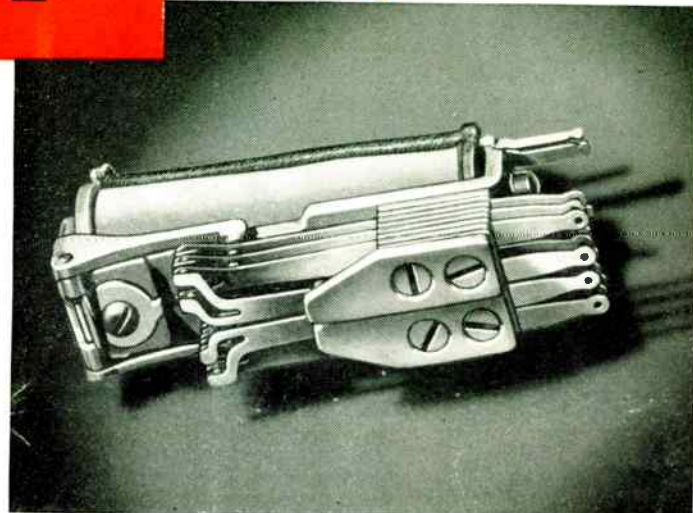

## It's the Class "B" Relay by AUTOMATIC ELECTRIC

Here's a relay that steps out from the crowd—a relay even better than Automatic's widely used, *widely copied*, Class "A" relay. Use the Class "B" for your most exacting application—and discover for yourself its wide margin of superiority in sensitivity . . . dependability . . . compactness . . . versatility . . . and long wearing qualities!

The Class "B" Relay and many others are described in catalog 4071—write for your copy.



### TYPE 45 ROTARY SWITCH

A rotary switch that's new and better! 70 steps a second speed . . . up to 10 (or more) bank levels . . . only one field adjustment. Ask for literature.

**AUTOMATIC**  **ELECTRIC**

Distributors in U. S. and Possessions:  
Automatic Electric Sales Corporation  
1033 W. Van Buren St., Chicago 7, Ill.  
In Canada: Automatic Electric (Canada), Ltd., Toronto



# TELE-TECH

TELEVISION • TELECOMMUNICATIONS • RADIO

MARCH, 1949

Editorial Contents

**COVER:** New York City's Grand Central Palace will house over 200 electronic exhibits during the annual convention of the Institute of Radio Engineers, March 7-10. See page 32.

**ELECTRONIC INDUSTRY MOBILIZATION PLAN** ..... 26  
Munitions board gets outline of procedure for readying all US electronic plants for a war emergency

**INTERNATIONAL EXPORT POSSIBILITIES FOR TELEVISION** ..... *John H. Battison* 29  
Virgin territories, differences in transmission standards, open new markets for all types of television equipment

**IRE CONVENTION AND RADIO ENGINEERING SHOW** ..... 32  
Four-day session from March 7-10 will include 172 paper covering all radio and electronic applications

**A NEW PROFESSIONAL TAPE RECORDER** ..... 34  
Full dynamic range and high fidelity at a slower tape speed, unitized construction and controls featured

**DESIGN AND PERFORMANCE CHARACTERISTICS OF "ELECTRETS"** ... *Edward D. Padgett* 36  
Waxes and resinous materials that retain permanent electric charge promise important new components

**PERFORMANCE CAPABILITIES OF SUPERREGENERATIVE RECEIVERS** ... *G. V. Eltgroth* 40  
Ultimate performance limits, selectivity, and fidelity characteristics of superregenerative receivers (Part II)

**REACTANCE TUBE CIRCUITS** ..... *W. Conley Smith* 44  
Controllable dynamic reactances which find extended applications in filter designs are described with charts

**AD HOC COMMITTEE STUDIES TROPOSPHERIC PROPAGATION** ..... 46

**"ELECTRONTYPE" SPEEDS COMMUNICATION** ..... 47  
"Charactron", new type cathode ray tube, can reproduce printed messages at rate of million words per minute

**TELEVISION AND FCC vs. TROPOSPHERIC INTERFERENCE** ..... 68

**DEPARTMENTS:**

**Tele-Tips** ..... 10

**Editorial Comments** ..... 25

**News** ..... 48, 49

**Washington News Letter** ..... 50

**New Products** ..... 52-61

**Bulletins** ..... 76

**CALDWELL-CLEMENTS, INC.,** Publication Office, Orange, Conn., Editorial and Executive Offices 480 Lexington Avenue, New York 17, N. Y., Tel Plaza 3-1340  
Publishers also of RADIO & TELEVISION RETAILING

# Proper balance can be

## for resistors



*Proper balance can be mighty difficult . . . but not for IRC resistors.*

*Basically engineered for balanced performance in every important characteristic, each IRC resistor type offers outstanding features for specific applications—without sacrifice of any significant factor.*

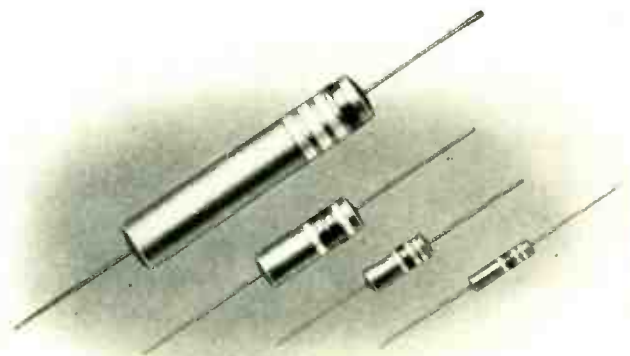

New, ADVANCED Type BT Resistors, for example, are uniformly superior in every important JAN-R-11 requirement. At  $\frac{1}{3}$ ,  $\frac{1}{2}$ , 1 and 2 watts they meet JAN-R-11 specifications for fixed composition resistors. Balanced in every characteristic, small IRC ADVANCED BT's are particularly suited to high ambient temperatures and rigorous television circuits. 12-page Bulletin B-1 gives all the performance facts. Use the convenient coupon.



# difficult

# too!



For close tolerance requirements, IRC Precisions offer a fine balance of accuracy and dependability. Extensively used by leading instrument makers, they excel in every important characteristic. 1% accuracy is standard. Noise level is inherently low, and windings are fully protected against high humidity. Available in a wide selection of ranges and types, as described in Bulletin D-1.

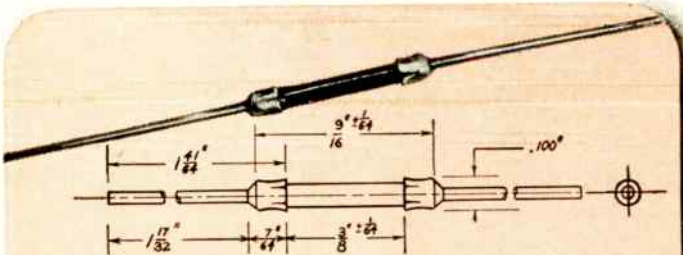

Miniature MPM resistors are IRC engineered for high frequency applications. Their frequency characteristics are outstanding, but absolute balance has been maintained with all other significant electrical characteristics. Thin resistance film is permanently bonded to ceramic rods. Cupped ends of wire lead terminals are cemented to resistor bodies to form axial pigtails. Rated at 1/4 watt, Type MPM's are available in resistance values from 10 ohms to 1.0 megohms. Write for Technical Data Bulletin F-1.

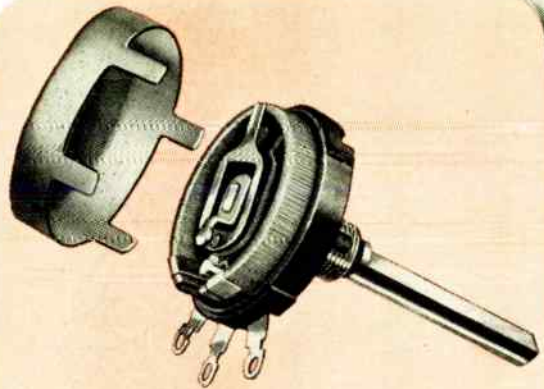

IRC Type W Wire Wound Controls are so carefully balanced, your customers can actually feel the difference. With center tap they are widely used as vertical and horizontal centering controls in television receivers. Design provides maximum adaptability to most rheostat and potentiometer applications within 2-watt power rating. Type W Controls have a 1 1/4" diameter, and 9/16" depth behind panel. Spiral Spring Connector provides positive electrical connection. Bulletin A-2 gives details. Write for your copy.

All standard IRC resistors are readily available in nominal quantities from your local distributor's well-stocked shelves. This is IRC's Industrial-Service Plan



at work, assuring you 'round-the-corner service on your small order requirements. We'll be glad to send you the name of your nearest IRC Distributor.



Wherever the Circuit Says

- Power Resistors • Precisions • Insulated Composition Resistors • Low Wattage Wire Wounds
- Rheostats • Controls • Voltmeter Multipliers
- Deposited Carbon Precisions • Voltage Dividers • HF and High Voltage Resistors

## INTERNATIONAL RESISTANCE COMPANY

401 N. Broad Street, Philadelphia 8, Pa.

In Canada: International Resistance Co., Ltd., Toronto, Licensee

### INTERNATIONAL RESISTANCE COMPANY

407 N. Broad St., Philadelphia 8, Pa.

I want to know more about the IRC Resistors checked below —

- Advanced Type BT's
- Precision Resistors
- MPM High Frequency Resistors
- Type W Controls
- Also send name and address of our IRC Distributor

Name .....

Title .....

Company .....

Address .....



# PROFESSIONAL SERVICES

**WELDON & CARR**  
Consulting Radio Engineers  
**Washington, D. C.**  
1605 Connecticut Ave. MI. 4151  
**Dallas, Texas**  
1728 Wood St. Riverside 3611

**RAYMOND M. WILMOTTE**  
PAUL A. deMARS  
ASSOCIATE  
1469 CHURCH ST., N.W. DE. 1234  
WASHINGTON 5, D. C.

**HERMAN LEWIS GORDON**  
*Registered Patent Attorney*  
Patent Investigations and Opinions  
Warner Building 100 Normandy Drive  
Washington 4, D. C. Silver Spring, Md.  
NAational 2497 SHepherd 2433

**A. F. SMUCKLER & CO., INC.**  
ELECTRONIC & COMMUNICATION  
ENGINEERS & MANUFACTURERS  
202-208 TILLARY ST. BROOKLYN 1, N. Y.  
ULster 5-5141

**FRANK H. McINTOSH**  
710 14th St., N.W.—Metropolitan 4477  
WASHINGTON, D. C.

**A. D. RING & CO.**  
*26 Years' Experience in Radio  
Engineering*  
MUNSEY BLDG. REPUBLIC 2347  
WASHINGTON 4, D. C.

**WILLIAM L. FOSS, Inc.**  
Formerly Colton & Foss, Inc.  
927 15th St., N.W. REpublic 3883  
WASHINGTON, D. C.

There is no substitute for experience  
**GLENN D. GILLET**  
AND ASSOCIATES  
982 NATIONAL PRESS BLDG. NA. 3373  
WASHINGTON, D. C.

**Commercial Radio Equip Co.**  
Everett L. Dillard, Gen. Mgr.  
INTERNATIONAL BLDG. DI. 1319  
WASHINGTON, D. C.  
PORTER BLDG. LO. 8821  
KANSAS CITY, MO.

**McNARY & WRATHALL**  
RADIO ENGINEERS

906 Natl. Press Bldg. Resetar Hotel  
Washington 4, D. C. Watsonville, Calif.

**RUSSELL P. MAY**  
1422 F St., N. W. Kellogg Bldg.  
Washington, D. C. REpublic 3984  
Member of AFCE

**AMY, ACEVES & KING, INC.**  
*Specialists in the  
Design and Installation of  
HIGH-GAIN  
AM, FM, and TELEVISION  
ANTENNA SYSTEMS*  
LONGacre 5-6622  
11 West 42nd Street, New York 18, N. Y.

**GEORGE P. ADAIR**  
*Radio Engineering Consultants*  
Executive 1230 1833 M STREET, N. W.  
Executive 5851 WASHINGTON 6, D. C.

**KEAR & KENNEDY**  
1703 K ST., N.W. STERLING 7932  
WASHINGTON, D. C.

**DIXIE B. McKEY & ASSOC.**  
1820 Jefferson Place, N. W.  
Washington 6, D. C.  
Republic 7236

**ALBERT F. MURRAY**  
Consulting Television Engineer  
All Phases of Television Planning.  
Patent advice in the Electronic Field.  
4707 Windom Place, N. W.  
Washington 16, D. C.  
Telephone: ORdway 4841

 **ELECTRICAL  
TESTING LABORATORIES, INC.**  
*Specializing in technical services to those  
intent upon GOOD QUALITY*  
2 East End Avenue at 79th St New York 21-N.Y.

**FREQUENCY MEASURING  
SERVICE**  
Exact Measurements - of any time

 **RCA COMMUNICATIONS, INC.**  
64 Broad Street, New York 4, N. Y.

# TELE-TECH

TELEVISION • TELECOMMUNICATIONS • RADIO

Formerly ELECTRONIC INDUSTRIES

**O. H. CALDWELL** M. CLEMENTS  
*Editorial Director* *Publisher*

**RALPH R. BATCHER** BERNARD F. OSBAHR  
*Consulting Editor* *Associate Editor*

**H. D. WULFORST** STANLEY GERSTIN  
*Assistant Editor* *Contributing Editor*

CHARLES DREYER, *Art Director*

WASHINGTON, D. C.

**R. C. DAVIES** DR. A. F. MURRAY  
*News Editor* *Consulting Editor*  
National Press Bldg. 4707 Windom Pl.

CIRCULATION

B. V. SPINETTA, *Circulation Director*

M. GROENING, A. DeLUISE  
*Subscriptions, List Compilation*

BUSINESS DEPARTMENT

**M. H. NEWTON** J. J. BROOKMAN  
*Business Manager* *Sales Manager*  
480 Lexington Ave., New York 17, N. Y.

**R. Y. FITZPATRICK**, *Western Manager*  
201 N. Wells St., Chicago 6, Ill.  
Telephone RAndolph 6-9225

S. M. GASKINS, *District Manager*

**VICTOR N. RAISER**, *New England Manager*  
480 Lexington Ave., New York 17, N. Y.

**DUANE WANAMAKER**,  
*So. Calif. Representative*  
610 S. B'way, Suite 623, Los Angeles 14,  
Calif.

**N. McALLISTER**, *Director Reader Service*  
**A. O'ROURKE**, *Production Supervisor*

**W. W. SWIGERT**, *Credit Manager*

**W. KENNETH REYNOLDS** M. TEMMEL

Tele-Tech®, March, 1949, Vol. 8, No. 3  
Regular price per copy 50 cents. Pub-  
lished Monthly by Caldwell-Clements, Inc.,  
Publication Office Orange, Conn., Editorial,  
Advertising and Executive Offices, 480  
Lexington Ave., New York 17, N. Y.  
Direct all subscription inquiries to Orange,  
Conn., or to 480 Lexington Avenue, New  
York 17, N. Y. M. Clements, President;  
Orstes H. Caldwell, Treasurer. Subscrip-  
tion rates: United States and Possessions,  
\$5.00 for one year, \$7.00 for two years.  
Canada (Canadian Funds Accepted) \$6.00  
for one year, \$8.00 for two years. Pan  
American Countries \$7.00 for one year,  
\$9.00 for two years. All other countries  
\$9.00 for one year, \$11.00 for two years.  
Entered as second class matter June 9,  
1947 at the Post Office at Orange, Conn.,  
under the act of March 3, 1879. Copy-  
right by Caldwell-Clements, Inc., 1949.  
Printed in U.S.A. \*Reg. U.S. Pat. Off.



# VITROTEX *Magnet Wire*

WITH **GLASS FIBER** INSULATION

**THAT'S SOFT AS SILK . . . STRONG AS STEEL**



TO WITHSTAND temperatures up to 130° C, Vitrotex magnet wire is insulated with alkali-free glass fibres. This inorganic textile is soft and luxurious—with a tensile strength comparable to that of steel. The servings are bonded with a high grade insulating varnish, to give Vitrotex a smooth abrasion and moisture resistant surface.

The excellent heat conductivity of its glass fibre insulation, high dielectric strength, resistance to moisture, acids, oils and corrosive vapors make Vitrotex the material for windings of superior quality. For further information on the complete line of Anaconda Magnet Wire, write to Anaconda Wire and Cable Company, 25 Broadway, New York 4, N. Y.

41470

## WHY VITROTEX SERVES BETTER

- 1 *Withstands high temperatures*
- 2 *High dielectric strength and insulation resistance*
- 3 *Non-hygroscopic; Unaffected by moisture*
- 4 *High resistance to acids, oils and corrosive vapors*



LOOK TO *Anaconda* FOR ENGINEERED MAGNET WIRE AND COILS

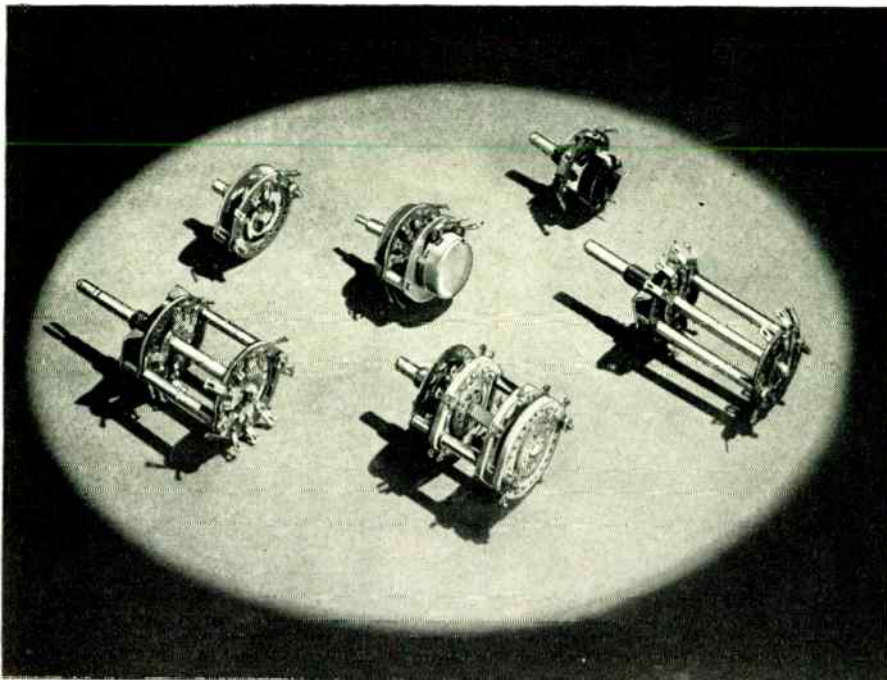

Use a Switch  
Worthy of  
Your Design

*There is no  
substitute for*  
**MALLORY**  
Quality  
Switches!

**M**allory RS switches are designed to give you everything you want—maximum efficient service, substantial construction, precision manufacture. Mallory switches are constructed with cam and ball type index assembly, or with positive indexing hill-and-valley double roller type index assembly. Note these many features of the Mallory RS series which make their dependability and quality known wherever switches are used. These advantages are of extreme importance in television and high-frequency applications where stability is essential.

- Insulation of high-grade, low-loss laminated phenolic.
- Terminals and contacts of special Mallory spring alloy, heavily silver-plated to insure long life at low contact resistance.
- Terminals held securely by exclusive Mallory two-point fastening—heavy staples prevent loosening or twisting.
- Double wiping action on contacts with an inherent flexing feature—insures good electrical contact with the rotor shoes throughout rotation.
- Six rotor supports on the stator—insure accurate alignment.
- Brass rotor shoes, heavily silver-plated—insure low contact resistance.
- All shoes held flat and securely to phenolic rotor by rivets—prevents stubbing—insures smooth rotation—*minimum of noise in critical circuits.*

The Mallory RS series consists of RS-30, RS-40, RS-50, RSA-50, and RSA-60.

#### ENGINEERING DATA SHEETS

Send for the Mallory Engineering Data Sheets on the RS series. They contain complete specifications for available circuit combinations with respective terminal locations, dimensional drawings—everything the engineer needs.

#### SPECIFICATION SHEETS

Specification sheets for all RS switches have also been prepared. These sheets are printed on thin paper to permit blueprinting. The sectional drawings indicate standard and optional dimensions—make it easy for you to order production samples built to your requirements.

Precision Electronic Parts—Switches, Controls, Resistors

**P. R. MALLORY & CO. Inc.**  
**MALLORY**

**P. R. MALLORY & CO., Inc., INDIANAPOLIS 6, INDIANA**

#### SERVING INDUSTRY WITH

Capacitors      Rectifiers  
Contacts        Switches  
Controls        Vibrators  
Power Supplies

Resistance Welding Materials



# a *Revolutionary* method of drilling microscopic holes

that depends on

# NICHROME\*

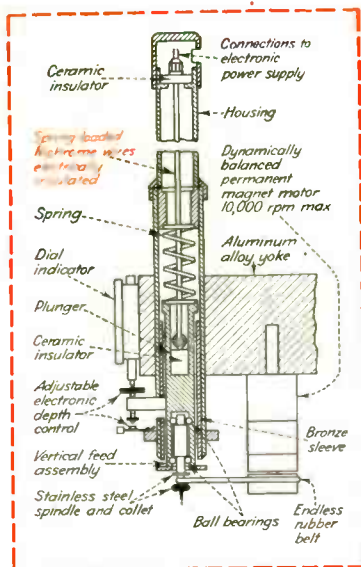

High coefficient of linear expansion of Nichrome V permits maximum vertical movement of spindle with shortest possible length of wire.

High tensile strength of Nichrome V permits use of a spring large enough to furnish sufficient force to drive spindle down.

High heat-resistance of Nichrome V permits heating wire to 1700 F. without permanent elongation—affording substantial drill feed range.

High specific resistance of Nichrome V minimizes heating current required.

Until now, precision drilling of extremely small diameter holes (such as .0016" dia.) has been manually controlled. Even with highly skilled operators, however, drill breakage has been frequent—resulting in waste of time and effort, and damage to work and equipment.

But now comes the revolutionary Microdrill. Relying on sensitive electronic circuits, instead of the human senses of feeling and sight, it operates infallibly and precisely by means of remote electric controls.

Heart of the drill press is a spring-loaded Nichrome V wire which, when heated electrically, expands, thereby lowering the drill spindle. Conversely, when heating current is decreased, it contracts and raises the spindle. Electronic control of the heating current effects extremely smooth vertical travel, the drill being raised or lowered at a precisely adjustable rate.

Holes as small as .0016" in diameter are drilled with utmost ease—drill breakage reduced to a negligible minimum. Time is saved. Costs are cut.

Says the manufacturer, Teletronics Laboratory, Inc., Westbury, N.Y.: "The wire used in the Microdrill must have a high coefficient of linear expansion, high tensile strength, high specific resistance—and must be able to retain its physical and electrical properties at high temperatures. We know of no other wire as suitable for our purpose as Nichrome V."

If you, too, have a product-performance problem, why not consult with us. In addition to Nichrome and Nichrome V, we make over 80 alloys for the electronic and electrical industries. One or more of these may be what you are looking for.

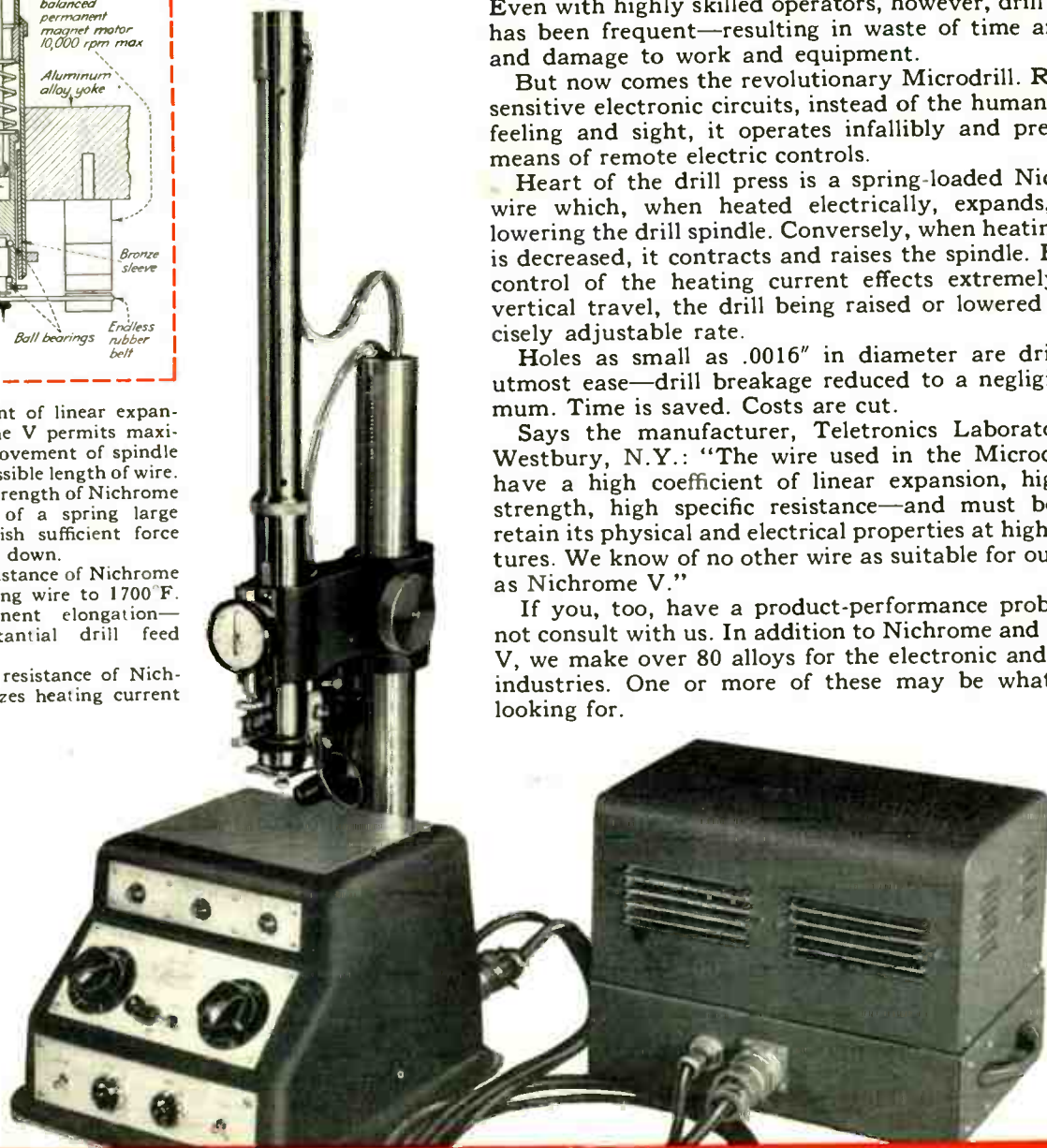

\*Nichrome is manufactured only by

## Driver-Harris Company

HARRISON, NEW JERSEY

BRANCHES: Chicago, Detroit, Cleveland, Los Angeles, San Francisco, Seattle

Manufactured and sold in Canada by

The B. GREENING WIRE COMPANY, LTD., Hamilton, Ontario, Canada

Follow the Leaders to

**Eimac**  
TUBES  
The Power for R-F

# THESE TUBES . . .

# REVOLUTIONIZED TRANSMITTER DESIGN

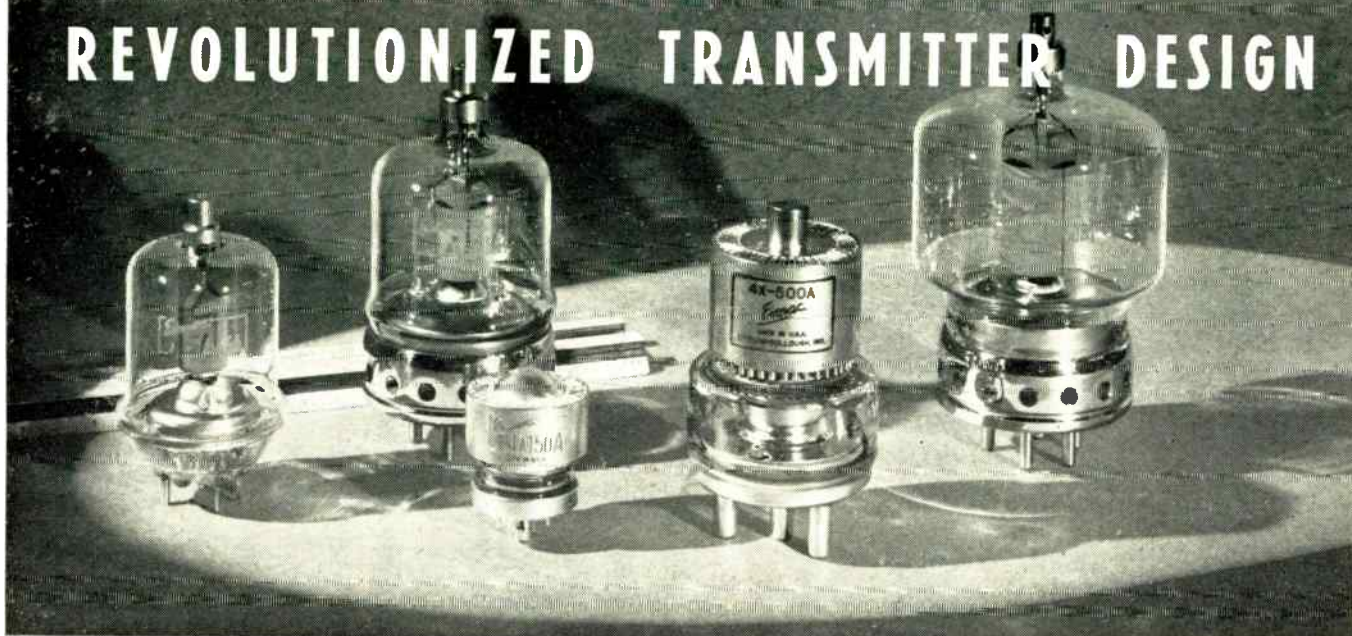

**THE 4-65A . . .** is the smallest of the radiation cooled Eimac tetrodes. Its ability to produce relatively high-power at all frequencies up to 200-Mc. and over a wide voltage range offers considerable advantage to the end user. For instance the same tubes may be used in the final stage of an operator's mobile and fixed station. Two tubes, in the mobile unit operating on 600 plate volts will handle 150 watts input, while two other 4-65A's in the fixed station will provide a half kilowatt output on 3000 volts .

**THE 4-125A . . .** is the mainstay of present day communication. These highly dependable tetrodes have been proven in years of service and thousands of applications. Two tubes are capable of handling 1000 watts input (in class-C telegraphy or FM telephony) with less than 5 watts of grid driving power. In AM service two tubes high-level modulated will provide 600 watts output. For AM broadcast they carry an FCC rating of 125 watts per tube.

**THE 4X150A . . .** is highly versatile and extremely small (2½ inches high). It is an ex-

ternal anode tetrode capable of operating above 950-Mc. As much as 140 watts of useful output can be obtained at 500-Mc. Below 165-Mc. the output can be increased to 195 watts. It is ideally suited as a wide-band amplifier for television and for harmonic or conventional RF amplification.

**THE 4X500A . . .** is a top tube for high power at high frequencies and is especially suited to TV and FM. It is a small external anode tetrode, rated at 500 watts of plate dissipation. The low driving power requirement presents obvious advantages to the equipment designer. Two tubes in a push-pull or parallel circuit provide over 1½ kw of useful output power with less than 25 watts of driving power at 108-Mc.

**THE 4-250A . . .** is a power tetrode with a plate dissipation rating of 250 watts and stability characteristics familiar to the 4-125A. Rugged compact construction together with low plate-grid capacitance, allows simplification of the associated circuits and the driver stage. As audio amplifiers, 2 tubes will provide 500 watts power output with zero drive.

FOR COMPLETE DATA ON ANY EIMAC TUBE TYPE WRITE TO:

## E I T E L - M C C U L L O U G H , I N C .

210 San Mateo Ave., San Bruno, California

Export Agents: Frazar & Hansen, 301 Clay St., San Francisco, California





**E**arly this year the one-billionth Sprague Capacitor rolled off the fast-moving production lines in North Adams.

Fittingly enough, this billionth unit was one of the revolutionary new molded paper tubulars. Throughout the years, it has been engineering progress as typified by this development that has enabled Sprague to attain its present position as one of the largest, most diversified and most dependable sources of capacitor supply.

Other important developments which have helped materially in swelling the total of Sprague production include \*Vitamin Q capacitors for higher voltages, higher temperatures and higher insulation resistance; \*Hypass 3-terminal networks; glass-to-metal sealed capacitors; molded \*Prokar capacitors for sub-miniature assemblies; high-voltage coupling capacitors; electrolytics for dependable operation up to 450 volts at 85°C., and many other types of capacitors.

\*T. M. Reg. U. S. Pat. Off.

# SPRAGUE

Pioneers of Electric and Electronic Progress

SPRAGUE ELECTRIC COMPANY • North Adams, Mass.

# TELE-TIPS

**EXTRA-LOUD COMMERCIALS**, up 15 to 20 DB from regular music volume, are planned for new FM service to New York City buses. Button pressed at station as com-

mercial starts will transmit inaudible tone over air to work relay in each bus receiver, switching on extra amplifier to raise volume during commercial.

**NEW ADLER TUBE** for FM, combining in one glass envelope both limiter and discriminator functions, when applied commercially by Zenith this Fall is expected to greatly simplify FM circuits and construction, with attending repercussions in receiver costs.

**CANADIAN TV** authorities are very desirous of getting television transmitters going in Canada, but the Dominion Parliament at its last session refused to appropriate funds needed. Overtures were then made to U. S. manufacturers to donate a transmitter or set up and operate experimentally such a station, later to become Dominion property. No takers have been found for the offer, so Canadians will for the time being continue to get their video from across the border.

**BOMBER COST HALF ELECTRONIC**—For the rearmament program as a whole—tanks, cruisers, carriers, submarines, aircraft—about 20% of the total cost is scheduled for radio and electronic equipment. But for the Air Force's latest big bombers, the radio-electronic equipment totals 50% of the total outlay, so elaborate are the communications, protective and control devices added to the new designs.

**JUKE-BOX TV**—Restaurant patrons can now purchase six minutes of television entertainment for five cents, through the new Solotone unit developed jointly with Hallicrafters. Sound is wired only to paying booth; rest of non-paying patrons see only silent picture.

**COLOR-BLIND CAMERA-TUBES**—It still seems impossible to determine the color-sensitivity of camera tubes in advance of manufacture, and so scarce and precious are these tubes that every one made must be put to and kept in use. One TV studio had a camera sensitive to blue, another sensitive to red. When a basketball game was being screened in which one side wore blue pants, the other red, the teams suddenly seemed to switch sides every time a camera cut-over was made!

**"BIFOCAL RADAR"** — A commercial radar set with two viewing screens, which give the ability to see near and distant objects at the same time, has been developed at GE's Syracuse, N. Y. plant. Designed for the narrow channels and harbors of the Great Lakes as well as the open ocean, the new set has seven-inch and twelve-inch scopes.

The former gives a radar picture with a two-mile radius at all times and is called a "safety" scope. The larger screen, known as the "working" scope, is adjustable to one-half, one, three, eight, 20, or 40 miles.



Lee Electric & Mfg. Co. says "all parts were selected to meet the customers' stringent specification."

## HEINEMANN

### MAGNETIC CIRCUIT BREAKERS

for

### MAXIMUM PROTECTION AND LONG LIFE

Lee Electric & Mfg. Co., of Los Angeles, realizing the necessity for the most flexible yet unflinching protection of electronic components and equipment, chose HEINEMANN Magnetic CIRCUIT BREAKERS for this battery charger. In case of short circuit or dangerous overload, the breakers trip INSTANTLY, but do not trip on initial surge or temporary excess current. In this application the breakers in the input and output are interlocked, so that operation of either one will remove the unit from the A. C. line.

**Culco Constant Current Battery Charger, Type CE 180 with HEINEMANN Circuit Breakers installed.**

# HEINEMANN ELECTRIC CO.

149 PLUM STREET

TRENTON, N. J.







## SYLVANIA RADIO TUBES IN Motorola RADIOS SPEED THE CAB-DIRECTING MESSAGES!

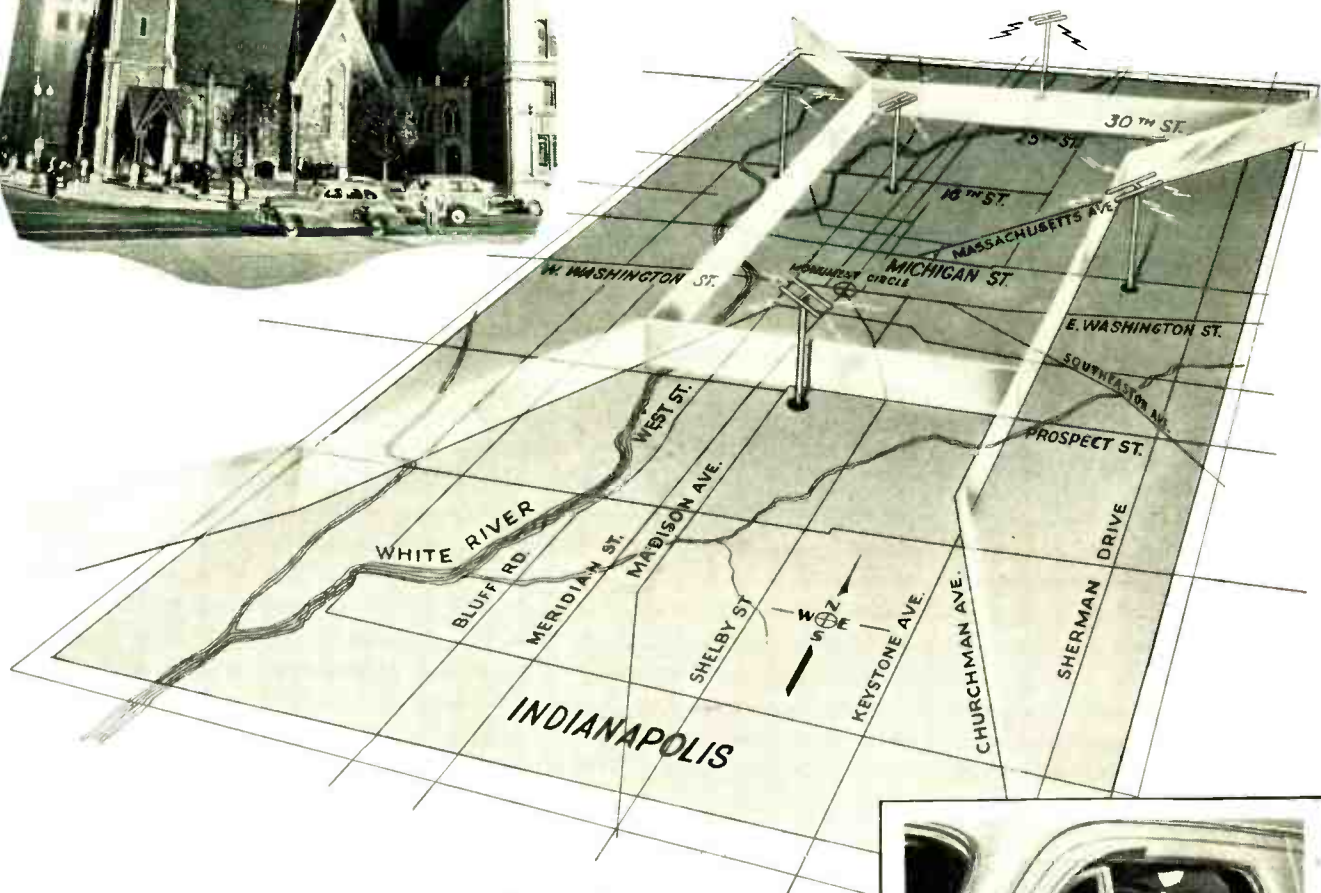

### Red Cab of Indianapolis conducts 5 times more business with "Satellite" 2-way FM system!

THIS advanced system of taxicab dispatching used by Red Cab, Inc., of Indianapolis, Indiana, was especially developed by Red Cab, Inc., with the assistance and technical advice of Motorola Radio Engineers to answer the problem of congestion of the single radio frequency allowed to taxicab operators. Replacing the single central station and its single dispatcher with five independent stations, the system makes it possible for a large cab company to conduct many more times the business and radio dispatching without jamming the air. The five stations are

controlled by a set of toggle switches under the various dispatchers' fingertips so that any number of dispatchers from one to five may be used and so that each dispatcher may select one station at a time or any combination.

And in every set in the 111 radio-equipped cabs, Sylvania's rugged Lock-In Tubes are firmly seated in their sockets, performing admirably day in and day out, under all kinds of jarring road conditions! For information on Sylvania Tubes see Sylvania Distributors, or write Radio Division, Emporium, Pennsylvania.



Red Cab driver receiving radioed instructions for picking up a fare in his district, in city of Indianapolis.

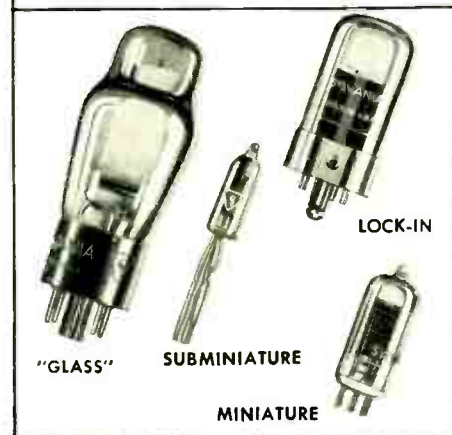

# SYLVANIA ELECTRIC

RADIO TUBES; CATHODE RAY TUBES; ELECTRONIC DEVICES; FLUORESCENT LAMPS, FIXTURES, WIRING DEVICES; ELECTRIC LIGHT BULBS; PHOTOLAMPS

**Reduced studio operating budgets  
...expanded program facilities...  
with the DU MONT MONOCHROME  
SCANNER Model TA-150-A ...**

*the magic lantern*  
**of TELECASTING!**

**$SD+QW = \frac{D}{FWFT}$**   
(Simple Translation)  
**SUPERIOR DESIGN plus  
QUALITY WORKMANSHIP equals  
DU MONT**  
First With the Finest in Television



► Precisely, this latest Du Mont development, the Monochrome Scanner Model TA-150-A, is virtually "The Magic Lantern of Telecasting." It handles test patterns, commercials, station identification, still photographs, cartoons, graphs—any and all non-animated subjects in the only logical and really economical manner.

When driven from a sync generator such as the Du Mont Model TA-107-B, this unit develops an RMA standard composite signal from standard 2 x 2" glass slides. Still-image pickups become a simple, economical, one-man job. The need for costly film trailers and the operation of movie projectors for short bits, are minimized. The Monochrome Scanner soon pays for itself. Definitely, here's a "must" in the money-making telecast setup.

◆ **Early delivery predicated on previous orders**

**DU MONT MONOCHROME SCANNER Model TA-150-A**

A short-persistence Du Mont 10" C-R tube produces a light beam focused by a projection lens on to the glass slide. A condenser lens focuses that light beam after passing through the slide, on to a multiplier-type photo-electric cell. The signal voltage developed is amplified and mixed with blanking and sync pulses, resulting in the RMA standard composite picture signal.

An automatic slide changer handles up to 25 positive or negative 2 x 2" glass slides, operated from local or remote position. The equipment houses the C-R tube and necessary circuits for producing a bright, sharply focused raster on

the tube screen. The raster is kept in constant focus by the focus-stabilizer circuit. Sweep-failure protection is provided by automatically cutting off the high voltage to the tube. The raster is developed by sweep circuits driven by horizontal and vertical pulses.

A switch inserts sync if a composite signal is required, or leaves out the sync if only a video and blanking signal is required for video mixing purposes. Controls to set sync and blanking levels are provided. The control panel carries all necessary switches, fuses and fuse indicators. A fadeout switch sets the fading of the sig-

↑ UNIT CLOSED    ↑ SAME UNIT OPEN

nal to black level when slides are changed for slow, medium or fast rate of change.

The unit is complete with its own high and low voltage power supplies. Operates on 115 v. 60 cycles. Approx. 8.0 amps.

Mounted in standard rack measuring 83½" h. x 22" w. x 18" deep.

ALLEN B. DU MONT LABORATORIES, INC.

**DU MONT**

*First with the Finest in Television*

ALLEN B. DU MONT LABORATORIES, INC. • TELEVISION EQUIPMENT DIVISION, 42 HARDING AVE., CLIFTON, N. J. • DU MONT NETWORK AND STATION WABD, 515 MADISON AVE., NEW YORK 22, N. Y. • DU MONT'S JOHN WANAMAKER TELEVISION STUDIOS, WANAMAKER PLACE, NEW YORK 3, N. Y. • STATION WTTG, WASHINGTON, D. C. • HOME OFFICES AND PLANTS, PASSAIC, N. J.



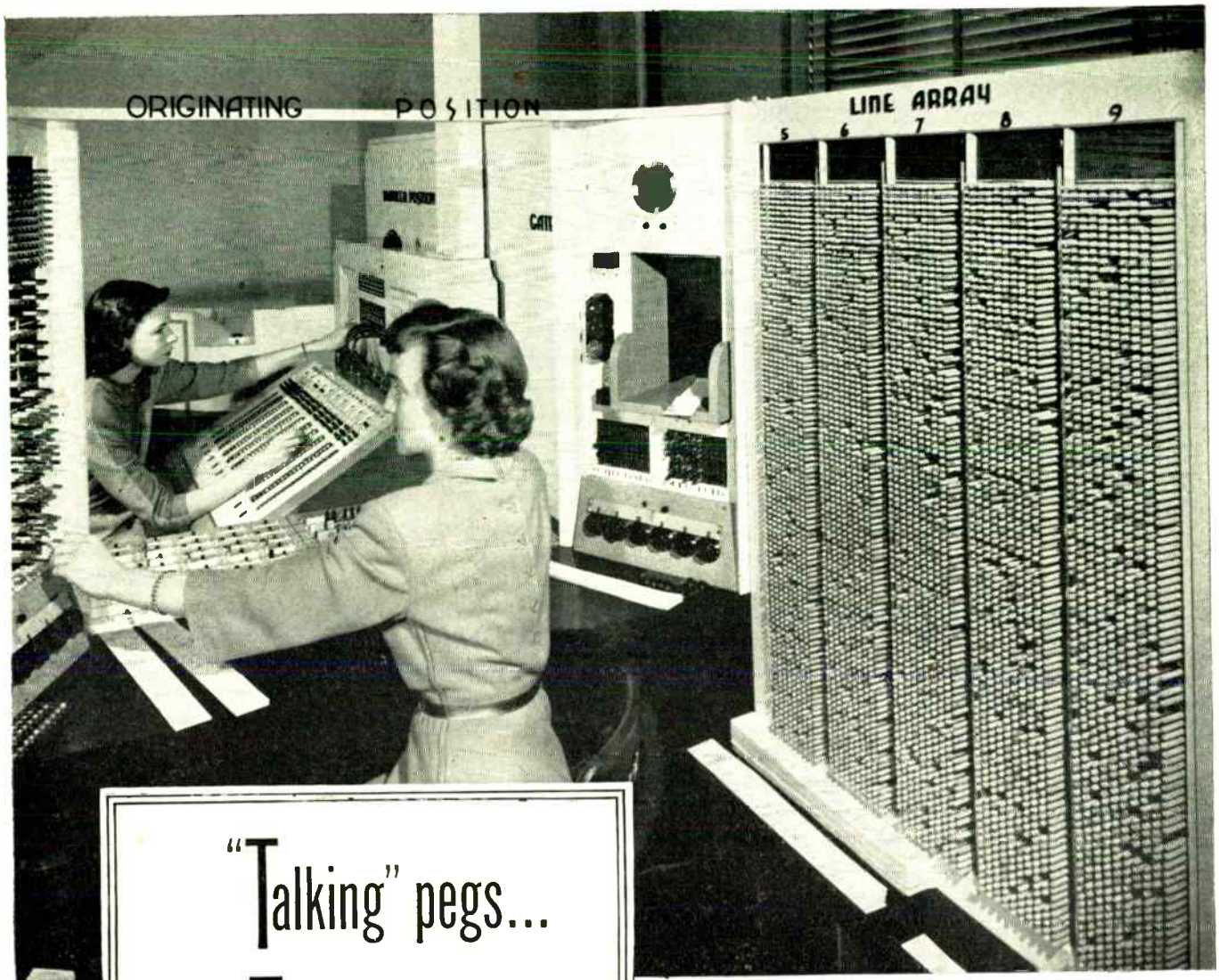

“Talking” pegs...  
 and Talking people

THERE ARE 10,000 pegs in this machine, representing 10,000 subscribers in a crossbar telephone exchange—the latest switching system which handles dial calls with split-second swiftness.

The pegs represent many types of telephone users—two-minute talkers and ten-minute talkers . . . people who dial accurately . . . those who make a false start or two. They are starting a journey through a unique machine which analyzes the performance of dial equipment in a typical central office.

But while an actual crossbar exchange connects your call in a matter of seconds, this counterpart moves far more slowly. It gives the Bell Laboratories engineers who built it time to observe what happens

to each call—where bottlenecks develop, which parts are overworked or underworked, which of the circuits are most used.

In a manual exchange, the number of operators may be changed to meet different traffic conditions. In crossbar, all switching is done by complex electro-mechanical devices, permanently built in. This machine shows how many devices of each kind there must be in a new exchange to give you the best of service with a minimum of expensive equipment.

This traffic-study machine is one of the many ingenious research tools devised by the Laboratories as part of its continuing job—finding new ways to give you better and better telephone service.



**BELL TELEPHONE LABORATORIES**

EXPLORING AND INVENTING, DEVISING AND PERFECTING, FOR CONTINUED IMPROVEMENTS AND ECONOMIES IN TELEPHONE SERVICE

**For dependable television...hour after hour...day in and day out...month after month...**



GROUP I  
Type E



GROUP I  
Type AP

| OPERATING CONDITIONS | Group I                                     | Group I-A                                   | Group II  | Group III  |
|----------------------|---|---|---|--|
|                      | AEROVOX TYPES<br>AP; BT; E; G;<br>S; SC     | AEROVOX TYPES<br>BTN; SCN                   | AEROVOX TYPES<br>AF; APG; MM;<br>MSF; MSQ; MSR;<br>MST; PRS | AEROVOX TYPES<br>GL; PBS; PRSA;<br>PRSB; PRSV; PRV;<br>PT; SCL |
| Temperature Range    | -60° C. to +85° C.<br>(-76° F. to +185° F.) | -60° C. to +85° C.<br>(-76° F. to +185° F.) | -60° C. to +85° C.<br>(-76° F. to +185° F.)                 | -40° C. to +60° C.<br>(-40° F. to +140° F.)                    |
| Humidity             | any, including immersion                    | any, including immersion                    | high  | average  |
| Altitude             | any   | any   | any   |  |

*\*The temperatures given are the minimum and maximum operating temperatures. It is imperative, however, that the minimum and maximum ambient temperatures be stated for each application, as circuit design will affect the allowable temperature range.*



GROUP II  
Type AF



GROUP II  
Type PRS

**AEROVOX**  
*extra-severe-service*  
**ELECTROLYTIC CAPACITORS**

• The above chart was compiled in 1946. It is based on AeroVox wartime experience in meeting the extra-severe-service requirements of military equipment. Likewise the needs of workaday electronic assemblies for industrial purposes.

Found in the AeroVox engineering literature, this chart classifies AeroVox electrolytic types into four groups based on severity of service and cost considerations. Groups I and I-A comprise hermetically-

sealed electrolytics meeting the most rugged conditions of temperature, humidity, pressure and vibration. Group II types compromise between severe-service requirements and cost. Group III types meet cost considerations primarily.

Thus today's television requirements, as regards electrolytics quite as well as other capacitors, have been fully anticipated by AeroVox engineering and production developments of long standing.



• Whether your electrolytic requirements be for extra-severe, severe or just normal service, let AeroVox engineers collaborate in working out the best answer



**FOR RADIO-ELECTRONIC AND INDUSTRIAL APPLICATIONS**

AEROVOX CORPORATION, NEW BEDFORD, MASS., U.S.A.

SALES OFFICES IN ALL PRINCIPAL CITIES • Export: 13 E. 40th St., New York 16, N. Y.

Cable: 'ARLAB' • In Canada: AEROVOX CANADA LTD., HAMILTON, ONT.



# PROTELGRAM FOR PERFECTED LARGE SIZE HOME TV PROJECTION



The 2½" magnetic projection triode 3NP4 has a face as small as a compact and is only 10½" long.

**HERE'S THE OPPORTUNITY THAT MANUFACTURERS OF TELEVISION RECEIVERS HAVE BEEN AWAITING!**

**• • • • • 10 SIGNIFICANT FEATURES • • • • •**

- 1 Flat 16" x 12" non-reflecting picture provides fatigueless viewing from less than 5 feet and upward!
- 2 Wide-angle visibility — square corners.
- 3 True photographic black and white picture quality—no discoloration.
- 4 Compact unit—suitable for table model cabinets.
- 5 Long-life, low-cost picture tube.
- 6 Manufacturers can most economically extend their product range into projection television by adapting their 10" EM chassis for use with PROTELGRAM.
- 7 Easy to service.
- 8 High contrast ratio and broad gray tone range.
- 9 Simple optical adjustment system.
- 10 Quality built after more than 10 years of development.

NORELCO PROTELGRAM consists of a projection tube, an optical box with focus and deflection coils, and a 25 kv regulated high-voltage supply unit, making possible large-size home projection. More than ten years of exhaustive research resulted in this ideal system for reproducing a projected picture. The optical components are designed to produce perfected projection for a 16" x 12" image, the optimum picture size for steady, distant observation and also for proper viewing at less than 5 feet.



Other NORELCO products include standard 10" direct-viewing tubes and special-purpose cathode-ray tubes for many applications.



**IS PICTURE PERFECTION IN PROJECTION**

**NORTH AMERICAN PHILIPS COMPANY, INC.**

DEPT. TT-3, 100 EAST 42nd STREET, NEW YORK 17, N. Y.

IN CANADA: PHILIPS INDUSTRIES LTD., 1203 PHILIPS SQUARE, MONTREAL \* EXPORT REPRESENTATIVE: PHILIPS EXPORT CORPORATION, 100 EAST 42ND STREET, NEW YORK 17, N. Y.

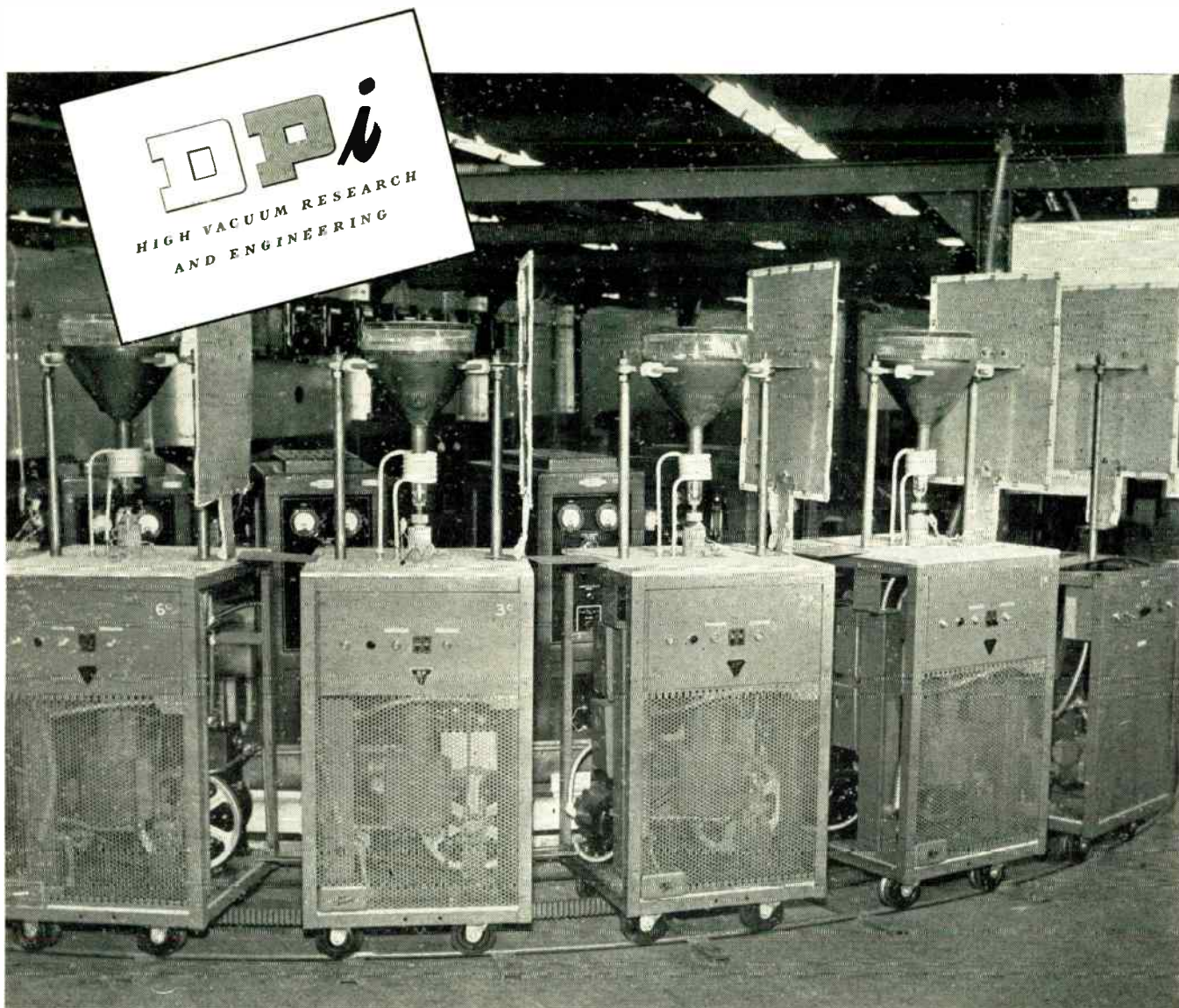

## Breaking the bottleneck of cathode ray tubes

PRODUCTION of picture tubes for television receivers is being speeded up by installation of DPI vacuum systems like the one pictured above. This in-line system is being used for quantity production at the Lansdale Tube Company of Philco Corporation.

A typical exhaust unit will be on display at our booths at the I.R.E. Show at Grand Central Palace, March 7-10. Stop in and see the latest developments in tube processing.

*Visit the*  
**DPI EXHIBIT**  
*at the*

**I. R. E. Show**  
 Booths 227-228  
 Grand Central Palace  
 March 7-10

## **DISTILLATION PRODUCTS, INC.**

777 RIDGE ROAD WEST • ROCHESTER 13, N. Y.

*Distillers of Oil-Soluble Vitamins and Other Concentrates for Science and Industry; Manufacturers of High-Vacuum Equipment*



# Glass bushings Now Available

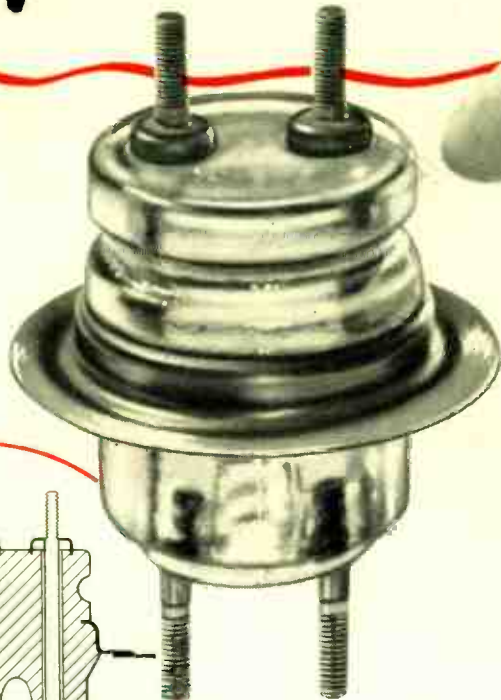

to manufacturers of  
electronic equipment

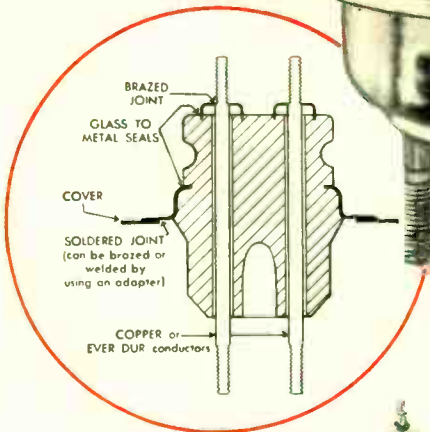

Can be welded, brazed, or soldered to case, forming a strong, permanent, hermetic seal that eliminates moisture problems and often permits more compact, light-weight design.

General Electric now offers to other manufacturers the glass bushings that it has used so successfully on capacitors, rectifiers, modulator and instrument transformers, and other electrical equipment. These bushings are cast of an exceptionally stable, low-expansion glass. Metal hardware is a special nickel-alloy steel, fused to the glass in casting. Bushings are attached directly to the apparatus without gaskets by soldering, welding or brazing the metal bushing flange to the metal case.

The resulting joint between bushing and equipment is permanent, vacuum-tight, and of high mechanical strength. It is especially desirable for equipment subject to vibration, shock, fungus growth or severe changes in temperature. These glass bushings are available to meet dry, 60-cycle, flashover values of from 10 to 50 kv, and in current ratings of 25 and 50 amperes (large sizes up to 800 amperes). They may be single or multi-conductor and can be provided with a top flange to permit mounting tube sockets directly on the bushings. Diameters range from  $1\frac{5}{8}$  to  $3\frac{3}{8}$  inches and weights from  $2\frac{1}{2}$  oz. to 4 lb.

WRITE TODAY FOR BULLETIN GEA-5093

GENERAL  ELECTRIC

W17 15941

The best way to evaluate these glass bushings for capacitors, modulator transformers, and other electronic equipment, is to see them. If you will send us a sketch and ratings of bushings you are now using, we will furnish you with samples of one or more of our standard glass bushings. Bulletin GEA-5093 contains complete listings of our standard designs, allowing you to select the particular bushing you require. Power Transformer Sales Division, General Electric Company, 16-215 Pittsfield, Mass.



# SPECIALTY CAPACITORS

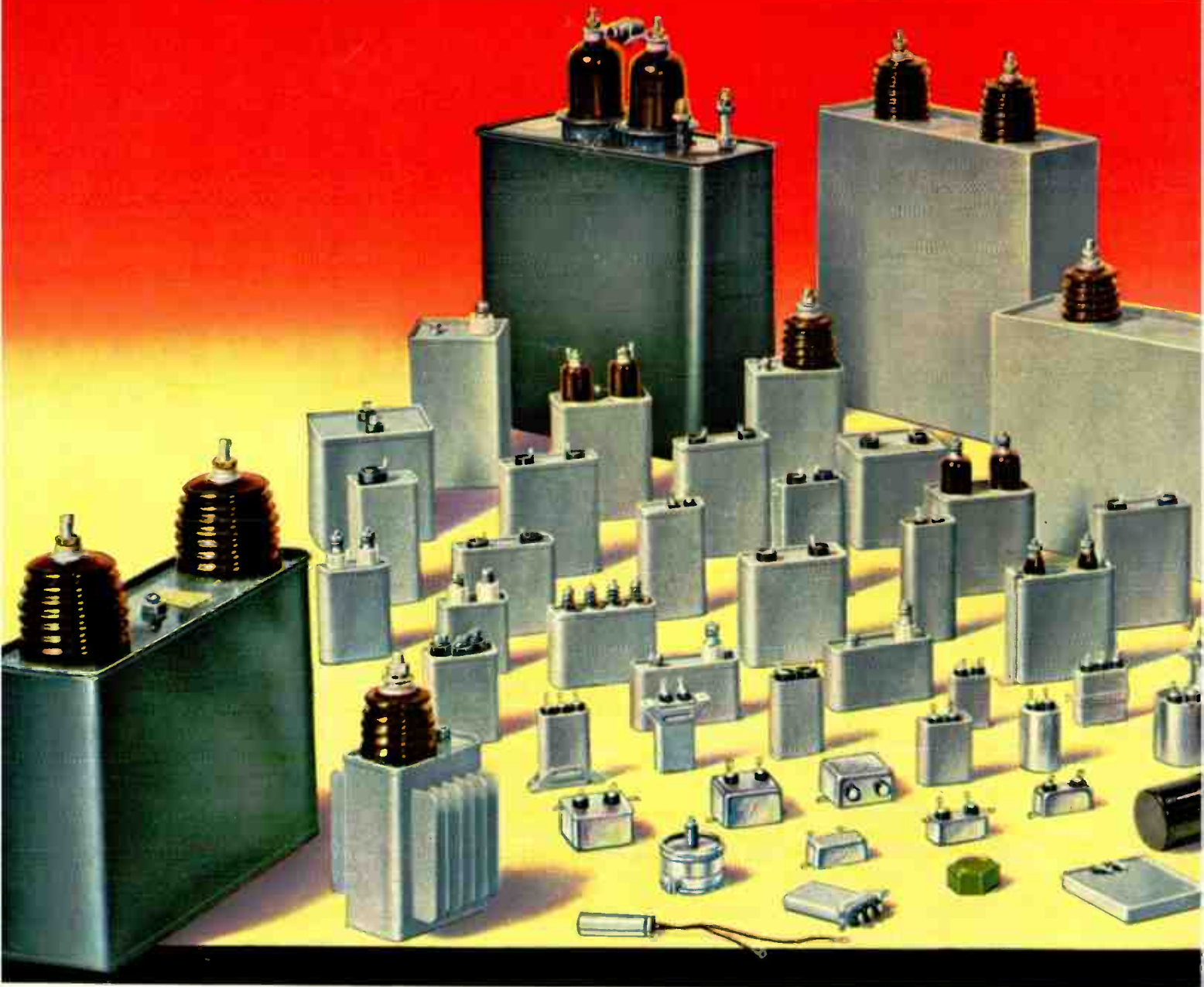

*These publications will be of value to you. GEA-640B—an interesting picture story on capacitors. GEA-2621 and -4357 on d-c capacitors. GEA-2027 on general a-c capacitors. GEA-2526 and -4655 on ballast capacitors. Write Apparatus Department, General Electric Company, Schenectady 5, N. Y.*



**T**HESE are your capacitors. By and large, they are the result of challenges made on the drawing boards of your equipment design engineers—challenges that have led us to new concepts in capacitor development and design.

We have made contributions—the introduction of the liquid dielectrics Pyranol and Lectronol, the development of thin

kraft paper and Lectrofilm, and the use of silicone rubber bushings and gaskets—all evidences of our efforts toward smaller size, lower weight, higher quality, and lower-cost capacitors.

But basically these capacitors have been built to meet your needs. We hope sincerely that you will call upon us whenever we can be of assistance.



**GENERAL**  **ELECTRIC**

HERE'S THE ALL-PURPOSE SWITCH

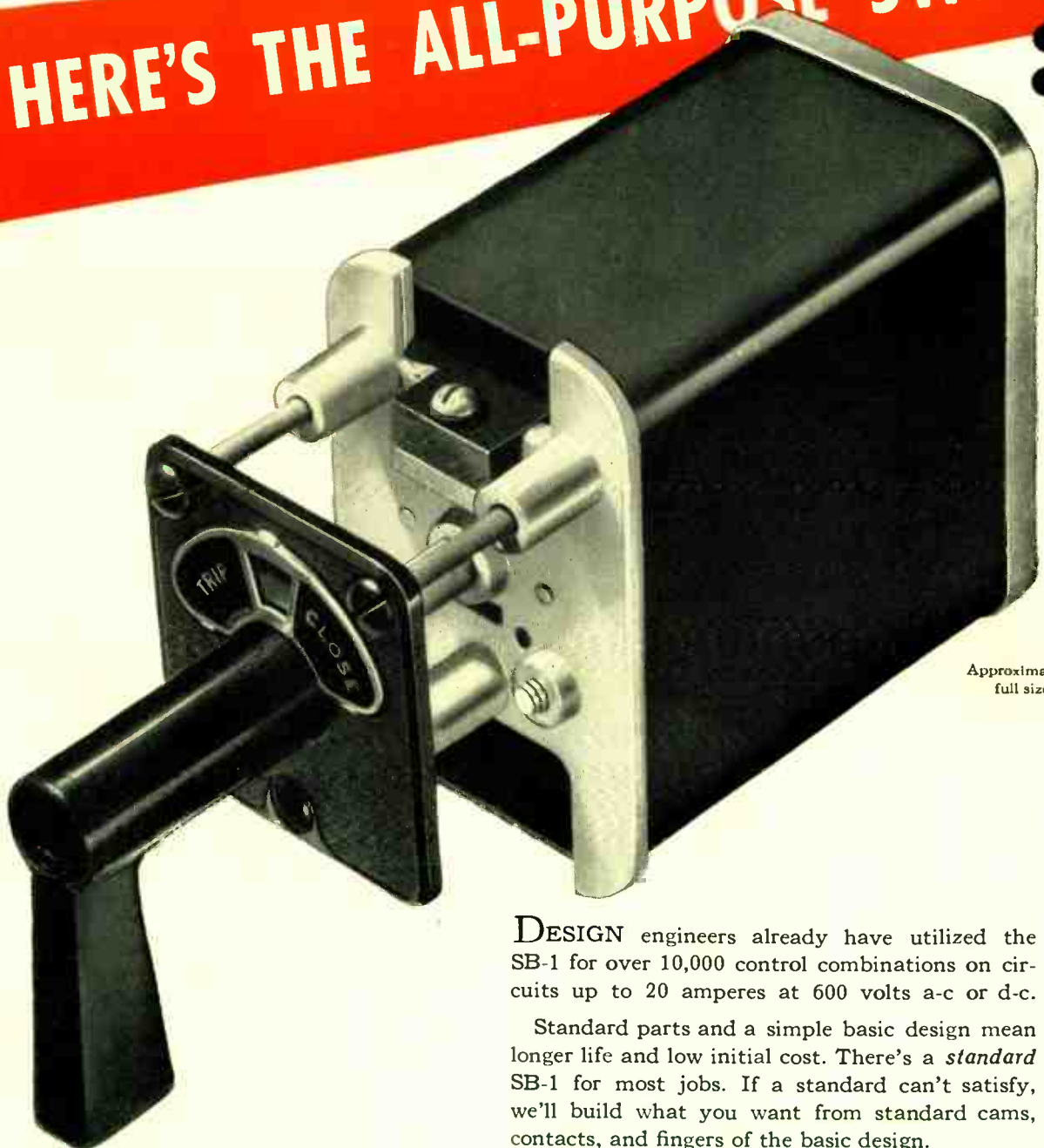

Approximately full size

\* **it's the... CONTROL AND TRANSFER SWITCH**

DESIGN engineers already have utilized the SB-1 for over 10,000 control combinations on circuits up to 20 amperes at 600 volts a-c or d-c.

Standard parts and a simple basic design mean longer life and low initial cost. There's a *standard* SB-1 for most jobs. If a standard can't satisfy, we'll build what you want from standard cams, contacts, and fingers of the basic design.

A variety of attractive switch handles, and water-tight, dust-tight, oil-immersed, fabricated-metal, or explosion-proof housings are available to fit your particular installation problems.

Your nearest G-E sales representative will be glad to assist you in the selection of an SB-1. Also, ask him for a copy of GEA-4746 which gives additional information about the SB-1, or write to *Apparatus Department, Section 856-6, General Electric Company, Schenectady 5, New York.*

GENERAL  ELECTRIC



# Announcing

## THREE IMPORTANT NEW PANORAMIC INSTRUMENTS FOR AF to UHF SPECTRUM ANALYSIS

MODEL  
**SB-7\***

Panoramic Ultrasonic Analyzer, Model SB-7 for easy, fast Ultrasonic Analysis

### FEATURES

- Direct Reading
- Linear Frequency Scale
- Continuously Variable Scanning Width
- Linear and 40db linear log amplitude scale
- Stabilized Frequency Calibrations
- Continuously Adjustable Selectivity
- Wide Input Voltage Range

### USES

- High Frequency Vibration Analysis
- Transmission Line Investigations
- Carrier System Monitoring
- Harmonic Analysis
- Feedback System Studies
- Material Testing
- Telemetry
- Medical Studies

An entirely new instrument, the SB-7 is engineered to meet the urgent demands for panoramic reception of ultrasonics—demands ranging from high speed panoramic analysis of jet engine vibrations to panoramic simplified monitoring of telemetering sub-carriers.

The SB-7, an automatic scanning receiver, graphically presents frequency and level of signals in the ultrasonic spectrum. Special control features enable selection and spreading out of any narrow band for highly detailed examination.

PANALYZOR MODEL **SB-8\*** PANADAPTOR MODEL **SA-8\***

### FEATURES

- Variable Resolution, 10:1 Range
- Long persistence Cathode-ray Tube 5" Screen
- Synchronous or non-synchronous scanning
- Variable Scanning Rates
- Signal Amplitude Compression
- Continuously Variable Scanning Width

### USES

- Analyzing AM and FM Transmitters
- Testing Industrial RF Equipment
- Spotting Spurious Oscillation and Modulation
- Monitoring Communications Frequencies
- Telemetry
- Checking Diathermy Units
- Investigating Pulsed RF Signals

### Versatility PLUS in RF Spectrum Analysis

Incorporating completely new design features to provide long and short persistence Panoramic displays with extremely fine signal resolution, the SB-8 and SA-8 offer increased possibilities in RF spectrum analysis.

Typical new applications include . . . Energy distribution investigations of pulsed RF signals with **low p.r.f.'s** • Side band analysis of AM and FM signals modulated by **low audio frequencies** • Monitoring of signals **very closely adjacent** in frequency.

Both Analyzor and Panadaptor Models are available in the following three types: T-200, T-1000 and T-10,000 having scanning widths of 200 kc, 1 mc and 10 mc respectively.

### PANORAMIC SONIC ANALYZER, MODEL AP-1\*

Complex Audio Wave Analysis with Speed PLUS



Model AP-1 assures faster and far simpler audio analysis by automatically separating and simultaneously measuring the frequency and amplitude of complex wave components.

Whether your problem is investigation of harmonics, transmission characteristics of lines or filters, vibration, intermodulation, noise or acoustics, the startling advantages offered by the Panoramic Sonic Analyzer will provide solutions faster.

**ADVANTAGES:** Quick graphic views of the 40-20,000 cps spectrum are provided once per second • Chances of missing weak or high frequency components are removed • Random changes in wave content can be observed • Operation is comparatively simple • Measures amplitude ratios as high as 1000:1 **FEATURES:** • Logarithmic frequency scale • Linear and linear log voltage scale • Wide input voltage range • High sensitivity • Direct reading • Calibrated for absolute or relative amplitude measurements.

\*Will be on display at the March IRE Convention, Booth 241-2  
Write for Complete Specifications on the above four instruments

**PANORAMIC**  
RADIO CORP.  
10 So. Second Ave.  
Mount Vernon, N. Y.  
Cable Address  
PANORAMIC, NEW YORK  
Exclusive Canadian Representative: Canadian Marconi, Ltd.

For permanent oscillograph records . . .

*it's DUMONT all the way!*



**START** with Type 314 Oscillograph-record Camera. Especially designed for cathode ray oscillograph photography. Maximum convenience. Either single-image or continuous recording. Variable speed, electronically controlled.

Cat. No. 1366-E, with f/1.5 lens, \$1,155.00. Cat. No. 1217-E, with f/2.8 lens, \$980.00.

Or with Type 271-A Oscillograph-record Camera (not illustrated). Single-image. Fixed-focus, f/3.5 lens. Cat. No. 1216-E, with mounting, \$162.50.

**DEVELOP** your films with Type 2512 Motor-driven Processing Unit. Utterly simple. Accommodates up to 100 feet of 35mm. film. Cat. No. 1372-E, \$231.00.

**FINISH** with Type 2514 Portable Drying Rack. Holds up to 200 feet of 35 mm. film. Motor-driven. Provided with heater. Easy rewinding. Unit may be folded up. Carrying case supplied. Cat. No. 1375-E, \$232.00.

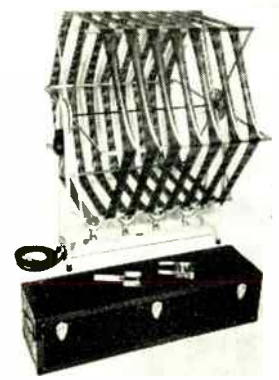

**DU MONT CATALOG ITEMS . . .**

**HIGH AND LOW VOLTAGE OSCILLOGRAPHS:** Amplifier frequency response selectable from d-c to 10 mc. Writing rates up to and exceeding 400 inches/microsecond. Deflection factors as low as 0.01 rms volt/inch. Prices from \$127.20 to \$6,073.75.

**OSCILLOGRAPH POWER SUPPLIES:** Up to 25,000 volts output for application as final accelerating potential to cathode-ray tubes.

**PROJECTION LENS:** Projects oscillograph traces on screen up to 30 feet distant. Excellent for demonstrations and lectures. Applicable to high-voltage oscillographs. Type 2542, Cat. No. 1431-E, \$103.50.

**VOLTAGE CALIBRATOR:** For quantitative measurements. Operates with any oscillograph. Type 264-A, Cat. No. 1240-A, \$39.50.

**ELECTRONIC SWITCH:** Provides

a time-sharing system for oscillograph presentation of two separate traces. Type 185-A, Cat. No. 1072-A, \$105.00.

**LOW-FREQUENCY LINEAR TIME-BASE GENERATOR:** Du Mont Type 215 accessory extends low-frequency range of the time-base of oscillographs. Cat. No. 1189-A, \$215.00.

**SPECIALIZED EQUIPMENT:** Type 279 Dual-beam Cathode-ray Oscillograph presents two entirely separate traces. Cat. No. 1386-E, \$1,294.50. • Type 275-A Cathode-ray Polar Coordinate Indicator employs a circular time-base. Cat. No. 1250-E, \$390.00. • Calibrated scales; constant-voltage transformer; transducers; magnetic shields, etc.

**DU MONT CATHODE-RAY TUBES:** A full line of cathode-ray tubes. A choice of phosphors suited to your particular needs.

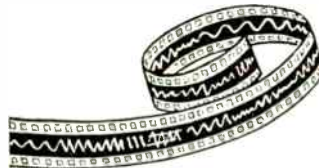

◆ In oscillography, Du Mont can supply you with the *tube*, the *oscillograph*, the *accessory*. Note partial list of standard items.

And if your oscillograph needs are *extremely special*, even to the extent of exceeding the broad range of our standard equipment, Du Mont can now place at your disposal the services of our Instrument Model Shop which is equipped to design, develop and manufacture non-standard cathode-ray equipment, or to modify existing equipment and designs. Consult us.

◆ Detailed literature on request. Equipment demonstrations arranged — no obligation.

© ALLEN B. DU MONT LABORATORIES, INC.

**DUMONT** *for Oscillography*  
 ALLEN B. DU MONT LABORATORIES, INC., PASSAIC, N. J.  
 CABLE ADDRESS: ALBEEDU, NEW YORK, N. Y., U.S.A.



**SOLUTION TO THE TV LEAD-IN PROBLEM!**

*Federal's*  
**Shielded Balanced  
 300-Ohm Lead-in Cable**

**INTELIN K-111**

**Minimizes Noise, "Snow" and "Ghosts"  
 Due to Transmission Line Pick-Up!**

**A MAJOR ADVANCE IN  
 TELEVISION TECHNIQUE**

**Developed by FEDERAL  
 Offered Only by FEDERAL  
 Patent Pending  
 AVAILABLE IMMEDIATELY**

Here is the development for which the industry has been waiting.

It is a *shielded*, balanced 300-ohm line—Intelin K-111—developed and produced by Federal—and only by Federal.

Tests have given positive proof that Intelin K-111 goes far toward solving the lead-in problem that has been a major obstacle to television progress. K-111 protects against transmission line pick-up of ignition, streetcars, fluorescent lights, diathermy and practically every other type of noise, "snow" and "ghosts" which interfere with picture clarity. This new lead-in won't pick up re-radiation from nearby lead-ins in urban areas. In rural areas, where signal strength is weak, Intelin K-111 provides greatly improved reception by reducing the noise level.

Now manufacturers can obtain a lead-in that *protects* the quality performance they build into receivers of 300-ohm input impedance. Antenna kit makers can greatly improve their products. And, by changing to Intelin K-111, servicemen can call a halt to many of the customer complaints that take the profit out of service policies.

Intelin K-111 is also recommended for a pick-up-free connection between antenna post and input stage of FM and TV receivers—and for test equipment and other HF applications. For information, write to Department D-166.



*Federal Telephone and Radio Corporation*

SELENIUM and INTELIN DIVISION, 900 Passaic Ave., East Newark, New Jersey

In Canada: Federal Electric Manufacturing Company, Ltd., Montreal, P. Q.  
 Export Distributors: International Standard Electric Corp. 67 Broad St., N. Y.

# 66-G

## Here's the Recorder You asked for!

The best features of Presto's dual motor gear drive *with the overhead mechanism and turntable of the famous Presto 6-N.*

YES, engineers have often asked us for a compact, economical yet high-quality recorder. Now you may have it in the Presto 66-G for standard and microgroove recording.

Here is a unit ideally suited and priced for the typical broadcast station or large transcription manufacturer. List price, Standard Model, \$996! (\$70 additional for microgroove.)

Here's perfection in total speed regulation and very low mechanical disturbance, thanks to the standard Presto dual motor gear drive. Here's high-quality recording, too, for the 66-G, of course, includes the Presto 1-D cutting head.

You'll find 66-G equal to the most exacting recording tasks when used with suitable amplifiers such as Presto 92-A recording amplifier and 41-A limiter amplifier.



### FOR HIGHEST FIDELITY... IT'S PRESTO DISCS

Microgroove, even more than standard recording, demands a perfect disc. The answer is Presto. For, sixteen years ago, Presto made the first lacquer-coated discs... and today Presto discs are first in quality.



**RECORDING CORPORATION**

Paramus, New Jersey



### READY NOW: Magnetic Tape Recorder

Presto will show its new super quality magnetic tape recorder at Booths 25-26 at the I.R.E. Show, March 7th. Be sure to see it!

Mailing Address: P. O. Box 500, Hackensack, N. J.  
In Canada: WALTER P. DOWNS, LTD., Dominion Sq. Bldg., Montreal

WORLD'S LARGEST MANUFACTURER OF INSTANTANEOUS SOUND RECORDING EQUIPMENT AND DISCS



# TELE-TECH

TELEVISION • TELECOMMUNICATIONS • RADIO

O. H. CALDWELL, Editorial Director ★ M. CLEMENTS, Publisher ★ 480 Lexington Ave., New York (17) N. Y.

## **ELECTRONIC MOBILIZATION NIGHTMARE!**

The next war will be radio-electronic to an extent far outreaching anything we attained during World War II. When the next D-day strikes, hundreds of thousands of intricate radio and electronic devices will have to be ready or quickly completed, the start of a vast outpouring of electronic equipment eventually adding up to many billions of dollars. For, this "next time", there will be no year or two to get ready, after the first assault is made. It is clear therefore that military electronic production must be prepared for, now. Plant management and employes must be familiarized with military needs without delay. But—

**ON ALL SIDES WE ARE BLOCKED**—Today radio manufacturers are busy with peacetime production, notably TV. Engineering staffs are overloaded with current commercial designs. Electronic managements are patriotic, but they must watch payrolls and balance sheets, too. Meanwhile military procurement methods are so complex, involved and bunglesome that it costs hundreds to thousands of dollars for a manufacturer even to look at a set of government specifications, and he has little hope of ever earning back his outlay after going through all the elaborate paper work, bids, contracts and inspections which military regulations impose.

**MILITARY MEN ARE HELPLESS** also, because of peace-time red-tape imposed by top-brass and departmental rules. These regulations (which defeat rather than aid the military purpose), the officers on the procurement firing-line cannot amend or change. And so, (as those who attended the recent Army Day meeting of the Boston AFCA had impressed upon them), the nation and the industry find themselves today in a nightmare of electronic frustration. We see an electronic war bearing down upon us, we know how to make the electronic weapons we need, and we have the factories. But industry and the armed forces cannot find a peace-time way to get started with the vast job on which the nation's future existence may depend!

## **EXECUTIVE ACTION MUST BREAK DEADLOCK**

—To break this needless, senseless deadlock, to get the electronic manufacturing machine off dead-center,—prompt executive action is needed, at top Washington levels. The patriotic radio-electronic industry is ready to do its share, as evidenced by the Electronic Advisory

Committee Plan fully outlined on the following pages. But there will have to be some top electronic planning in Washington, too. Also immediate slashing of the restrictive regulations that are tying the hands of both the military and electronic-production men who are all eager to get going with this vital job!

★ ★ ★ ★

**TO SWELL FM AUDIENCE**—With 750 FM stations now operating and some 966 authorized, a full FM broadcast service is now available almost nation-wide. But the bottleneck persists in the small number of FM receivers yet in the homes of the public. The FM audience could be greatly increased during coming years if every TV set produced were arranged to bring in the 88-108-MC FM band, with video circuits cut off. A great and economical gain for the public would result.

**SERVICE BEGINS IN DESIGN ROOM**—The whole success of television now depends on prompt repair and maintenance of the TV sets in use. Television receivers are complex and sensitive devices and even the best of them need occasional chassis adjustments. This fact needs to be taken into account from the beginning, in designing the TV receiver and its cabinet. Easy access should be provided to all vital parts even if this means hinged sides and removable panels to give convenient and easy servicing of the video innards.

**SALARIES UP**—Engineering starting salaries for 1948 increased 11 percent over similar salaries for the preceding year, according to one Eastern survey. Chemical engineers led off with a starting-salary average of \$264. Mechanical and civil engineers started at \$256. And electrical engineers, mostly in communications and electronic activities, got initial pay checks of \$251, just about the average for all engineering groups.

**QUARTER CENTURY**—In May, RMA will celebrate its 25th Anniversary. Meanwhile our own publishing organization will mark its 28th year in radio magazine work, with a direct line of radio-electrical publications that go back to broadcasting's earliest efforts. In May, therefore, *Tele-Tech* will help celebrate this radio industry milestone with special features looking ahead rather than backward—looking ahead to TV's promise of a second quarter century far eclipsing all that has gone before!

# Radio-Electric Industry

## Munitions Board gets outline of procedure for readying all US radio-electronic plants and facilities in preparation for war emergency

ANY sound mobilization plan should:

- 1) Answer the question as to whether there is CAPACITY to meet the strategic needs of the Military Services and the civilian economy.
- 2) Provide means for determining deficiencies in capacity, in end items, component parts, raw materials, labor and skills, so that remedial steps can be planned PRIOR to an emergency.
- 3) Make the transition from peace to war rapid, effective and smooth.
- 4) Simplify the procurement procedures.
- 5) Keep industry abreast of research and development.
- 6) Finally and most important, prepare all individual elements of industry in peace time for their war time task.

### Manufacturing Capacity

Having determined at the outset what any sound mobilization plan should accomplish, the various suggested means for doing the job have been studied by the Task Committee of the Electronic Equipment Industry Advisory Committee.

Large-scale paper planning (Contingent Contract Plan — Phase I) has been suggested as one of these means, particularly to determine industry capacity. The Task Committee considers that the benefits of such planning can be obtained by other means at much less cost, and because of reduced expenditure of engineering and administrative man hours, with greater industry acceptance.

The Task Committee submits that statistical information, with a working formula for its application, can be obtained at a fraction of the cost of all-out paper planning. This information will provide an adequate working basis for the guidance of Government and industry on this important question of capacity.

The Task Committee regards such a statistical survey as manda-

### Members of Task Committee Which Prepared Plan

George M. Gardner, Wells-Gardner Co., Chicago, Chairman.

Paul F. Hannah, Raytheon Mfg. Co.

H. L. Hoffman, Hoffman Radio Corp.

David R. Hull, Federal Tel. & Tel. Co.

W. A. MacDonald, Hazeltine Laboratories.

Jacob M. Marks, Fada Radio & Electric Co.

R. C. Sprague, Sprague Electric Co.

W. Walter Watts, RCA-Victor.

---

tory and recommends that it be made by Government through an independent agency or agencies, with the cooperation of industry.

When the statistical survey has been completed, then civilian and Service needs should be matched against the capacity of industry to produce. It then becomes the responsibility of Government to determine what remedial steps to cor-

---

### Task Committee Membership Is Experienced

All of the members of the Task Committee had important procurement experience during the War, on either the government or industry sides. Colonels Hannah and Watts carried large procurement responsibility for the Signal Corps; Captain Hull was chief of the Navy Bureau of Electronics. Chairman Gardner, Mr. Marks, Mr. Hoffman and Mr. Sprague conducted important radio manufacturing operations, and Mr. MacDonald pioneered the "leader" type of operation coordinating special production by some 50 concerns.

rect disclosed deficiencies should be taken in peace time.

When M Day comes, mobilization of the electronics industry should have accomplished five fully-coordinated steps:

*First*, the stages of evolution of a product preceding production must have received attention and steps have been taken to insure the continuation of essential research, development and engineering during the emergency.

*Second*, each selected end equipment manufacturer must have necessary technical knowledge or know-how, manpower and facilities to create, design, develop and manufacture needed apparatus.

*Third*, there must be made available to the end manufacturer the necessary special and standard parts, pieces and components supplied at a rate sufficient to meet his needs.

*Fourth*, there must be made available to the parts suppliers sufficient raw materials so that the parts, pieces and components can be fabricated. Such materials must come directly from their natural sources or from a stock pile and be supplied at a suitable rate.

*Fifth*, sufficient engineering, technical and skilled production manpower must be frozen to insure industry's ability to carry out its assigned program in the National defense.

Of these five objectives, by far the most important is the need for know-how as of M Day. This can best be accomplished through action by The Munitions Board and other legally constituted Government agencies to use intelligently the powers now given them in connection with current procurement. This action contemplates:

- 1) Utilizing NOW-existing production facilities in connection with current procurement.
- 2) Participation by industry AS A WHOLE, particularly that major portion of the industry which is



# War Mobilization Plan

**Text of plan as presented to munitions body at Washington February 16  
by Electronics Equipment Advisory Committee, F. R. Lack, chairman**

not now participating in design, development and/or manufacture of military electronics equipment. All companies in the industry, whether small, medium or large, should be encouraged to contribute their fair share to research, development, pilot runs and production.

- 3) Providing to the individual elements of industry a sufficiently uniform flow of work to justify establishment and maintenance of military departments suitably staffed and equipped to handle work loads.
- 4) Following the successful pattern employed in World War II in the electronics industry of providing leadership in educating numbers of companies to the point where they can assume the responsibilities of prime contractors, releas-

ing their primes to devote more time and facilities to research, development and pilot production of new equipments.

- 5) Utilizing to these ends every presently legal aspect of military procurement, including:

(a)—Open competitive bidding invited by advertising, especially in cases where needed apparatus has been completely engineered and requires only production. If apparatus so contracted for is expected to be on the list of equipment to be procured in an emergency, then the successful bidder should appear in the planning as the ultimate producer of this equipment should an emergency occur. This of course should be subject to change as the interests of the Government may require.

(b)—Where highly complex techniques are required, competitive bidding should be among companies on the Services' qualified bidders lists, including small and

large companies, for the protection of Government. Here again the successful bidder should become a part of the mobilization planning for this apparatus.

(c)—Negotiated contracts, where it appears that for reasons of engineering skill or know-how, or unique facilities, such negotiated contracts are in the best interests of Government.

The mechanism by which Government can through the medium of current procurement encourage the industry to acquire the necessary know-how already has been outlined, but further than this, any practical Plan must have as its objective the spreading of this know-how throughout the whole of the industry. To accomplish this, four fundamental steps are required:

- 1) To assure that every company shares the load and that no capa-
- (Please turn to next page)*

HUGE MASS OF PAPER WORK INVOLVED IN PRODUCING SINGLE ELECTRONIC UNIT

## PHOTOGRAPH DELETED BY NAVY CENSOR AS WE GO TO PRESS

After this page was on the press, the photograph in this position, which had previously been approved for publication by the Navy Public Information Office, Third District, had its release summarily cancelled by higher-level orders telephoned from Washington.

The picture showed the tremendous quantity of unduplicated drawings, specifications, orders and correspondence involved in the manufacture of only one small routine piece of government electronic equipment.

This huge mass of paper work, weighing nearly 400 lbs., was inspected by the editor and a group of radio-electronic manufacturers at Boston, Army Day, Feb. 4, and has since been seen, we understand, by other industrial and military groups.

The manufacturing drawings alone numbered 1650 and made a pile 24 inches high,—one of 26 piles of papers involved in getting ready to manufacture this single small electronic unit.

## ELECTRONIC MOBILIZATION PLAN (Continued)

ble company is overlooked or overloaded, the procurement programs of the three Services must be coordinated. Since single service procurement of end items in this "custom-built" industry appears generally impractical, appointment by the Government of a four-man procurement program directing committee is clearly indicated. This should include ranking and qualified officers representing the three Services and one civilian, chosen by the three Service Secretaries, completely divorced from industry but recognized by his former position in industry as being eminently qualified. This four-man committee would be charged with proper coordination and channeling of current procurement to all companies able to handle it.

- 2) The Munitions Board Electronics Equipment Industry Advisory Committee already appointed would make itself available for use as consultants and technical advisors to the four-man Government directing committee, when requested.
- 3) The four-man Government directing committee would recommend to the Services, capable companies in the industry which the Government would ask to assume the responsibility of educating and bringing along other companies, through the medium of sub-contracts.
- 4) To encourage those elements of the electronics industry not now participating, to prepare for their wartime role.

It should be recognized that with the current situation in television it is going to be difficult for Government to persuade the industry as a whole to participate. This is not an industry looking for an added load, particularly if that load requires any appreciable effort from

the highly skilled technical personnel who are already overloaded and of whom there is a shortage. For this reason, the essential element of this Plan, which is the spreading of the know-how, must be implemented by Government in terms that are attractive to the industry.

This Plan presupposes a minimum of paper planning, and a maximum of actual industry experience gained by production of needed equipment. Experience on Government contracting, including design and development, is best secured through actual production in connection with current procurement.

Before production can begin, tools have to be checked and remade, materials and components have to be cut and tried and the organization has to be trained.

For these reasons, Government should procure, provided it is within the current needs of the Services, a pilot quantity of any piece of equipment that appears to have a good chance of military use.

The Task Committee believes that military liaison with industry is essential. This should be established by geographical areas rather than by individual plants.

Industry needs military liaison officers to interpret for its benefit Government's requirements. Military liaison officers necessarily must check Government contract progress, and make indicated inspections.

Such military liaison officers, if properly utilized by both Govern-

ment and industry, can be of great service in such specific cases as arranging draft deferment of key personnel, and advising on Security, thus freeing industry management for full performance of its normal functions. Such liaison should be integrated with existing Service field offices.

By mobilization planning that considers the electronics equipment industry as a whole and not as individual companies, the following results should be accomplished:

- 1) Operation of a majority of the electronics industry for military production under a well-defined and coordinated plan.
- 2) Each prime contractor would have a well-staffed, well-organized military department, susceptible to rapid expansion at short notice.
- 3) Each prime contractor would become experienced in design, development and manufacture of military equipment, in proportion to its ability to contribute.
- 4) Each prime contractor would be responsible by mutual agreement for specified other companies to be used as sub-contractors, thus placing responsibility for education of these other companies in the most experienced hands.
- 5) The capacity of the industry for military procurement would be determined at minimum cost.
- 6) Timely correction of deficiencies in capacity disclosed by comparison of requirements with existing facilities could be instigated by the Services.
- 7) Materials, man power and skills would be made available for immediate industrial mobilization.

## Statistical Analysis of Labor & Material Requirements

The Task Committee has given careful consideration to the problem of establishing the load that may be placed upon *all industry*, to satisfy the needs for electronic

equipment for the military Services in the event of an emergency.

There is already available in Government laboratories, bureaus  
(Continued on page 70)

## MEMBERSHIP OF ELECTRONIC EQUIPMENT ADVISORY COMMITTEE

Fred R. Lack, Western Electric Co., Chairman; Dr. W. R. G. Baker, General Electric Co.; John Ballantyne, Philco Corp.; Frank M. Folsom, Radio Corporation of America; Paul V. Galvin, Motorola; Ray C. Ellis, Raytheon Mfg. Corp.; Max F. Balcom, Sylvania Electric Products Inc.; David W. P. Hilliard, Bendix Radio Division; Walter Evans,

Westinghouse Electric Corp.; Dwight R. G. Palmer, General Cable Corp.; S. W. Gilfillan, Gilfillan Bros. Inc.; W. J. Halligan, Hallicrafters Co.; E. H. Locke, General Radio Co.; H. A. Ehle, International Resistance Co.; A. D. Plamondon, Jr., Indiana Steel Products Co.; Monte Cohen, F. W. Sickles Co.; F. D. Bliley, Bliley Electric Co.; R. C. Sprague,

Sprague Electric Co.; C. A. Warden, Jr., Superior Tube Co.; J. H. Miller, Weston Electrical Instrument Corp.; Paul J. Kruesi, American Lava Corp.; R. O. Driver, Wilbur B. Driver Co.; Jerome J. Kahn, Standard Transformer Corp. in addition to the membership of the special Task Committee shown on list on page 26.



# International Export Possibilities for Television

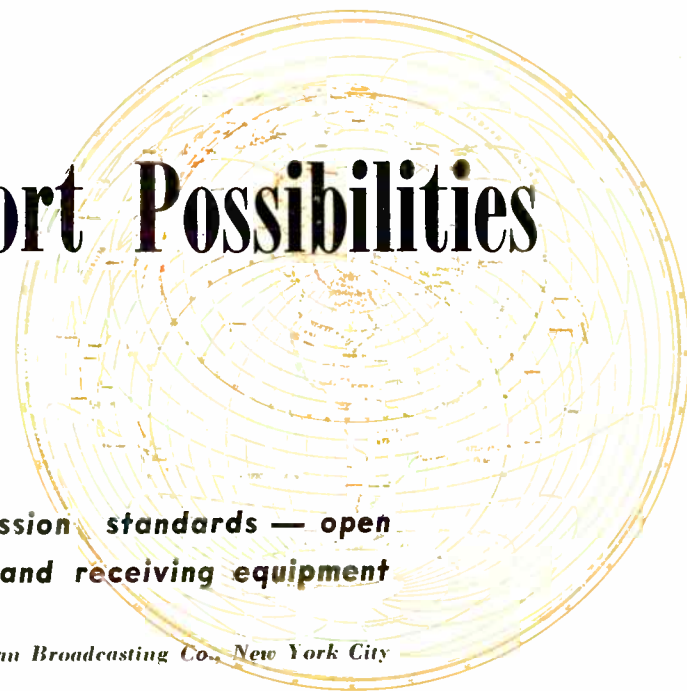

**Virgin territories — differences in transmission standards — open new markets for all types of transmitting and receiving equipment**

By **JOHN H. BATTISON** *Allocations Engineer, American Broadcasting Co., New York City*

THE very rapid growth of television in the United States has astonished not only American engineers and manufacturers, but has excited the interest and imagination of people all over the world. In the three short years since the end of the war the art has come into its own, so that at the end of 1948 over 50 television stations are serving 46,916,200 people in 29 markets, where approximately 900,000 sets are in use.

The only other country that approaches the US in its television operations is Great Britain. Before the war this country had a service that was second to none, but due to the risk of TV transmission interfering with the vital radar installations service had to be suspended during the war. Thus, when peace was declared, TV in Great Britain was still where it was in 1939. However, whatever the industry lost in operations and experience during that time it has more than made up in activity in the export and foreign trade field. The British have ever been a race of exporters and foreign traders, and this instinct combined with their present urgent need to export, has given American business a very strong competitor in foreign markets.

While the sphere of *internal* trade for U. S. firms is good, the *outside* business will require fighting for with all the weapons in the manufacturers' armories. Perhaps the term "inside" as used above is misleading. The intention was to include the whole of the North American continent together with South

## About the Author

*John H. Battison is currently working on a book on "International Broadcasting Practices." His experience with international radio dates back to 1934 when he became affiliated with the old Radio Normandy station in Belgium. Later he joined the firm of E. K. Cole as a receiver design engineer. Then he served with the British Air Ministry and at the outbreak of the war he was flying fighters in the RAF. After six and a half years of combat and transport flying he came to the United States and joined KMBC (Midland Broadcasting Co.) as research engineer. In June, 1947 he became allocations engineer for the American Broadcasting Co. He is presenting a paper on American Broadcasting before the British IRE this month.*

America, excluding Canada, since judging from recent rumors and news items the die is almost cast in favor of British equipment and/or standards in the latter country. However, from a technical point of view as well as a good neighbor policy it would seem that adoption of the same standards as those of the US would result in better programming since they would then become exchangeable, viewers on each side of the border being able to tune in each other's programs, and only one set of receiver standards need be set up. It would appear to be a logical step for all countries of the same continent to adopt the same standards in the interest of international cooperation.

In line with this we find

that GE has applied the theory, and sold a 5 KW transmitter to Radio Televisao do Brasil. This equipment will be used by PRA-9, Rio de Janeiro, with the standard FCC transmission characteristics. It is reasonable to suppose that this sale will not be the last one, and that it presages the adoption of US standards in at least one country. It is not too much to hope that the habit will spread, and that all the countries south of the border will follow suit.

Canada offers a different problem, however. By virtue of her position she has become very similar to the US in many respects, and because of distance from "the old country," has adopted US ideas of radio and standards of living. Probably, left to her own devices the choice would be US standards. After all, as a signatory to NARBA, Canada is bound to follow North American radio practices. But England is making a strong play for this market and has sent Sir Ernest Fiske, the managing director of Electrical and Musical Industries, the company which manufactures transmission equipment for the BBC, to Canada to negotiate the sale of equipment. The decision will probably be forthcoming soon, but with vivid memories of what happened to recent pollsters the author prefers to keep his opinion to himself! Whatever the outcome, it is certain that a large market will exist in Canada, either for receivers, transmitters or both. At present, currency questions act to restrict trade.

*(Please turn to next page)*

## TV EXPORT POSSIBILITIES (Continued)

but these will not exist forever, and many US firms have Canadian branches where US equipment, modified for other standards, if necessary, can be produced. France is a tempting market, and one where just now it would seem that US business should be very much to the fore. There is no doubt that strong efforts are being made to persuade the French to adopt British standards. And the arguments are very reasonable too! After all there are very few receivers in France, and those that there are operate on 450 lines, the standard of 1937. The British 405 line transmission would not be hard to receive with a very slight modification and the difference between 405, 450 and 525 lines is not so much that it can easily be noticed by a layman. It is understood that a recent decision has been made to keep the present 450 lines for the next ten years; however, one can only wait and see. The ultimate goal there is high definition television with 800 to 1000 lines used. The figure 819 lines has been put forward quite frequently, and it seems probable that the regional stations will be set up on this frequency as well as the one in Paris on the Eiffel Tower.

The *pièce de resistance* occurred last summer when the French Thomson-Houston Company picked up BBC transmissions over a distance of 100 miles at Calais. The picture is said to have been quite good and no trouble was found in holding synchronization. This opens

up a new argument in favor of common standards. Doubtless the significance of this has not been lost on politicians of both countries and it may be an additional count against the US salesman. Logic dictates that Europe and England should use the same system, and England has a large audience already.

The Netherlands is a country where television is in a state of flux although standards very similar to ours have been adopted, the only difference being in the frame and line frequencies which are 25 per second and 567 respectively. One transmitter has been installed at Eindhoven and a second one will shortly be erected at Hilversum to serve the center of the country.

The world picture is good for makers of television equipment, but it is no time for the US to rest on laurels of internal achievement. RCA has had its touring team out in Europe for some time and demonstrations have been given in Spain and Italy. Both were very well received and created interest in American achievements. As already reported GE has sold a transmitter to Brazil. But these are hardly even scratches on the surface of the world of television. This continent should be a natural for American persuasiveness, and even if other standards are adopted, the equipment, at least, can be "made in America"!

Australia has authorized television transmitters for six state capi-

tals and tenders have been invited. The initial estimated cost of \$1,600,000 includes 500 receivers. As far as is known no further action has been taken.

Poland is in the market for radio equipment, and has issued a license to Great Britain to import to the value of \$400,000, in radio equipment. Television will soon be seen in Warsaw, work having commenced on its first transmitter.

### Export and Related Costs

One factor which must enter into the considerations of exporters is the return that will be possible for a given expenditure. To the relatively high cost of producing a set must be added the cost of freight and import duties as well as perhaps local taxes. To balance this the standard of living and the actual cost of living must be considered. For example consider a semi-skilled French workman. He earns

### Foreign Television Operations

| Country        | Operating Status    | Remarks                |
|----------------|---------------------|------------------------|
| Brazil         |                     |                        |
| Rio De Janeiro | Expected 1949       | G.E. Equipment         |
| Denmark        |                     |                        |
| Copenhagen     | Expected 1949       | 567 lines              |
| France         |                     |                        |
| Lille          | Expected 1949       | *                      |
| Paris          | On the Air          | *                      |
| Germany        |                     |                        |
| Cologne        | After 1951          | **                     |
| Hamburg        | Expected 1951       | **                     |
| Great Britain  |                     |                        |
| Birmingham     | Expected 1949       | 405 lines              |
| London         | On the Air          | 405 lines              |
| Netherlands    |                     |                        |
| Eindhoven      | On Air-Experimental | 567 lines              |
| Hilversum      | Proposed            | 567 lines              |
| South Africa   | Expected 1953       | ***                    |
| Spain          |                     |                        |
| Barcelona      | Probably 1951       | Probably RCA Equipment |
| USSR           |                     |                        |
| Leningrad      | On the Air          | 441 lines              |
| Moscow         | On the Air          | 441 lines              |

\*Standards and frequencies are still a controversial issue in France. The Compagnie Française Thomson Houston uses 729 lines on 41.49 MC. Phillips has 567 line system on about 61 MC. Sadir company suggests 450 lines and Radio Industrie 819 lines. Compagnie des Compteurs uses 1000 lines in their high definition system. It seems quite possible that final standard will be over 700 lines.

Because there will never be as many stations in the cities of foreign countries as there are in the U.S. spectrum space is not too critical. This allows use of wider channels and consequent improvement in definition.

\*\*625 lines interlaced, 25 frames, 87-100 MC. German TV started in 1928 and had regular programming during the period 1935 to 1944.

\*\*\*Will start as US and UK have agreed on final standards.

This massive and elaborate machine is a telecine installed at Alexandra Palace, Hq. of the BBC Television Service. It televises any standard full-length or short feature film.

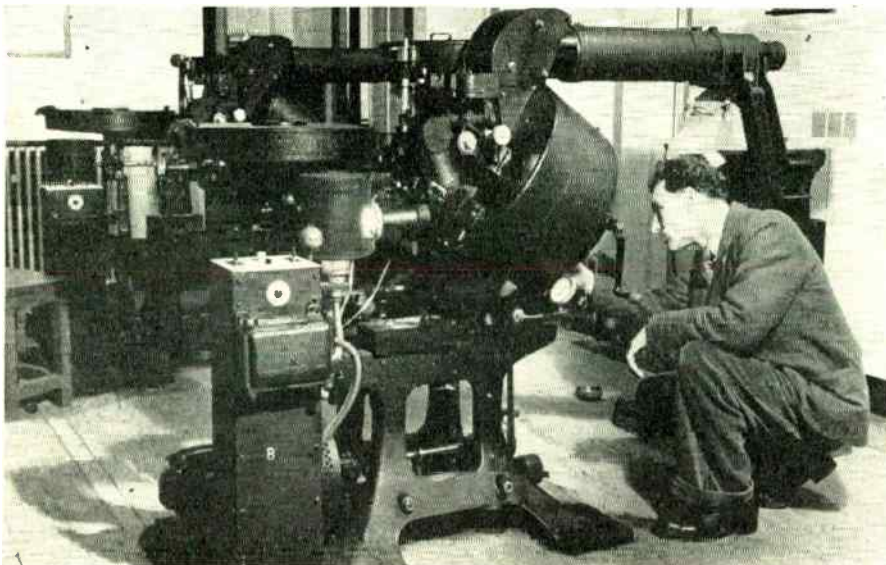



\$27.00 weekly. On this he supports his family. Now compare a US semi-skilled auto worker; he will average three times this amount, and run a car. The nearest the Frenchman gets to a car is a tandem cycle, and radio with one tube missing so he can only get the local station. How can he pay for a television receiver? Yet these men make up the larger part of the populations of many countries. Assuredly, governments will pay for equipment; but how will the men in the street? Belgium is one of the more prosperous countries today but it is doubtful if many people could afford a television receiver. Of course receivers for export can be simpler since most areas will have only one station and therefore the thirteen or seven channels of the home market will not be required. Sets for England for instance need only receive one channel which can be retuned when the owner moves from one region to another. It is not likely that any foreign countries will have more

than one station in any town for many years to come. It should be noted in this connection that the RMA has set up a committee to examine foreign markets.

The table below sets forth the vital statistics for a number of countries. Wherever the cost of living and the wage rates are given it is possible to form an opinion of the export possibilities. These are the latest available figures and are for 1947 unless noted otherwise.

From the point of view of the manufacturer who wants to expand his trade to include foreign television markets there are a number of means at his disposal, any one of which should bring satisfactory results. This presupposes that the manufacturer is one of the smaller firms now manufacturing television receivers rather than one of the big companies which is already well known and has its own foreign distribution organization. It is assumed not many of the smaller firms now making receivers will wish to expend the time and money

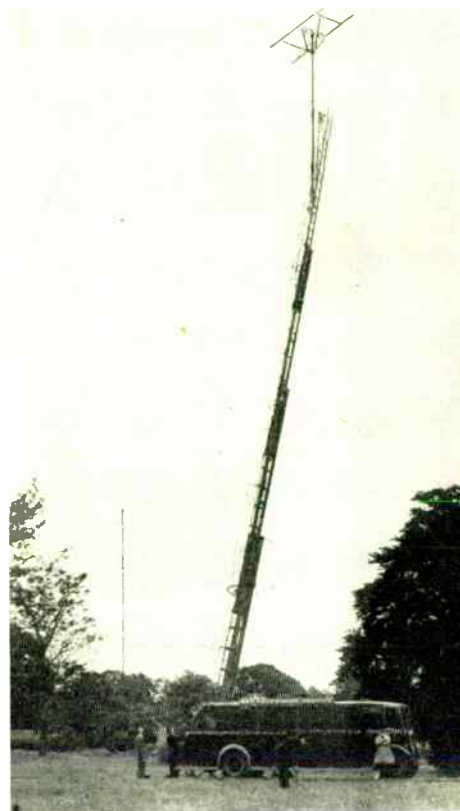

Television outside Broadcast Fleet No. 1. Aerial Van with extensible aerial raised

## Foreign Vital Statistics Table

For Comparing International Export Prospects

| Country            | Type of Currency | Total Imports (Millions) | Imports from U.S.A. (Millions) | Cost of Living | Wages | Radio Receiver Density, 1948 | Population (Thousands) |
|--------------------|------------------|--------------------------|--------------------------------|----------------|-------|------------------------------|------------------------|
| Austria            | Schillings       | 1,048,497                | —                              | 146            | 149   | 13.7%                        | 6,816                  |
| Australia          | Pounds           | 156,781                  | 41,846                         | —              | —     | —                            | 7,414 (1945)           |
| Argentina          | Pesos            | 5,349                    | 2,431                          | —              | —     | —                            | 16,109                 |
| Belgium            | Francs           | 85,528                   | 22,655                         | 339            | —     | 12.6%                        | 8,453                  |
| Bolivia            | Pounds           | 10,959                   | 3,546                          | —              | —     | —                            | 3,590                  |
| Brazil             | Cruzeiros        | 22,789                   | 13,975                         | 157            | —     | —                            | 48,000                 |
| Canada             | Dollars          | 1,820                    | 1,405                          | —              | —     | —                            | 12,307                 |
| Chile              | Pesos            | 1,307                    | 570                            | 403            | 600   | —                            | 5,552                  |
|                    |                  |                          |                                | (approx.)      |       |                              |                        |
| Denmark            | Kroner           | 3,087                    | 605                            | 169            | 189   | 27.2%                        | 4,045                  |
| Eire               | Pounds           | 130,812                  | 29,114                         | —              | —     | —                            | 2,953                  |
| East Africa        | Pounds           | 37*                      | —                              | —              | —     | —                            | 12,152                 |
| Ecuador            | Sures            | 500                      | 178                            | —              | —     | —                            | 3,340                  |
| Egypt              | Pounds E.        | 103                      | 11                             | —              | —     | 0.9%                         | 16,550                 |
| Finland            | Marks            | 46,888                   | 24%                            | 720            | 700   | 14.97%                       | 3,871                  |
| France             | Francs           | 45,781                   | 5,235                          | —              | —     | 14.52%                       | 41,980                 |
|                    | (1938)           |                          |                                |                |       |                              |                        |
| Iceland            | Kroner           | 117                      | —                              | 310            | —     | 26.27%                       | 131                    |
| Italy              | Lire             | 413,804                  | 177,122                        | 4,921          | 5,105 | 4.5%                         | 45,486                 |
| Mexico             | Dollars          | 1,348                    | 1,152                          | —              | —     | —                            | 21,165                 |
|                    | (1944)           |                          |                                |                |       |                              |                        |
| Netherlands        | Guilder          | 42,512                   | 1,195                          | 198            | —     | 15.48%                       | 9,636                  |
| Norway             | Kroner           | 12,057                   | —                              | 159            | —     | 18.22%                       | 3,079                  |
|                    | (1945)           |                          |                                |                |       |                              |                        |
| New Zealand        | **               | —                        | —                              | —              | —     | —                            | 1,676 (1944)           |
| Poland             | Dollars          | 11,704                   | —                              | —              | —     | 3.6%                         | 23,622                 |
| Portugal           | Contos           | 5,735                    | 799                            | 205            | —     | 2.1%                         | 7,185                  |
|                    | (1943)           |                          |                                |                |       |                              |                        |
| Peru               | Gold Soles       | 338                      | —                              | —              | —     | —                            | 7,800                  |
| Spain              | Pesetas          | ?                        | 07                             | 256            | —     | 1.45%                        | 26,491 (1943)          |
| Sweden             | Kroner           | 705                      | 24%                            | 144            | —     | 29.6%                        | 144                    |
| Switzerland        | Francs           | 1,225                    | 136.8                          | —              | —     | 21.87                        | 4,389                  |
| Turkey             | Liras            | 685                      | 228                            | —              | —     | 1.09%                        | 18,860                 |
| Union of S. Africa | Pounds           | 206                      | 30                             | —              | —     | —                            | 11,392                 |

\*This is radio only. US radios comprise 30% of all radios.

\*\*1942 figures show a ratio of 0.7 US to UK imports.

The total average radio receiver density is 8% for a population of 554,500,000 people. (I.B.O. figures).

in transmitter development for a somewhat nebulous overseas market.

Probably the best way of all is to make contact with large retail organizations in the country in question and arrange to have them act as distributors. Naturally this requires very careful investigation by the exporter to assure financial stability. Another similar approach would be to secure the services of a national of the country when he is in the US, and arrange for him to act as an agent.

### Trade Directories Effective

Of course there are various trade directories published in all parts of the world and in many different countries. An advertisement in one of these often brings good results, and most certainly will place a manufacturer's name before a number of possible consumers. The cost for an insertion is not excessive. Details may usually be obtained from the US Dept. of Commerce.

It should be remembered, however, that the large companies are usually well established in most overseas countries, and it takes a lot of hard work for a new company to "muscle in", even in a small way.

(Continued on page 66)

# IRE Convention and

Four-day gathering, scheduled for March 7-10,



WITH "Radio - Electronics — Servant of Mankind" as its keynote, the Institute of Radio Engineers will convene in New York City for this year's national convention on March 7-10. Headquarters of the convention, as usual, will be at the Hotel Commodore and Grand Central Palace. The scheduled technical program includes 28 sessions on subjects embracing virtually every branch of radio-electronics, and six symposia on nuclear science, network theory, electronic computers, radio aids to navigation, semi-conductors and marketing. An aggregate of 172 papers will be presented during the four days that the convention is in session.

The number of exhibitors at Grand Central Palace will exceed last year's by more than 30, providing a total of 216 impressive displays of the latest significant developments in post-war research. Television kits, microwave test equipment, microgroove record changers, tape recorders, and remote-control equipment are only a few of the products which will be exhibited, some for the first time.

Benjamin E. Shackelford, IRE president in 1948, will be toastmaster at the president's luncheon on March 8 and will introduce Stuart Bailey, this year's president. Toastmaster at the annual banquet on March 9 will be Raymond F. Guy, manager of NBC's Radio and Allocation Engineering Dept. Frank Stanton, president of CBS, will be a featured speaker at the banquet. The topic of his address will be "Television and the People."

bridge Field Station, U. S. Air Force, Cambridge, Mass.  
"The Measurement of Current and Charge Distributions on Transmitting and Receiving Antennas"—T. Morita, Harvard Univ.  
"The Diffraction Pattern from an Elliptical Aperture"—R. Adams and K. S. Kelleher, Naval Research Laboratory  
"A Low-Drag Aircraft Antenna for Reception of Omnidirectional Range Signals in the 108- to 122-MC Band"—J. Shanklin, Collins Radio Co., Cedar Rapids, Iowa.  
**Possible Networks I — Synthesis**  
"Amplifier Synthesis through Conformal Transformation"—J. Pettit and D. L. Trautman, Jr., Stanford Univ.  
"Exact Design of Bandpass Networks Using a Coupled Finite-Q Resonant Circuits ( $n = 3$  and 4)"—M. Dishal, Federal Telecommunication Laboratories  
"Network Approximation in the Time Domain"—W. H. Huggins, Cambridge Field Station, Air Materiel Command, Cambridge, Mass.  
"A Method of Synthesizing the Resistor-Capacitor Lattice Structure"—I. L. Fowler, J. T. Fleck, and P. F. Ordnung, Yale Univ.  
"The Design of Frequency-Compensating Matching Sections"—V. Rumsey, Ohio State Univ.

## Instruments and Measurements II — Oscillography

"An Impulse Generator—Electronic Switch for Visual Testing of Wide Band Networks"—T. R. Finch, Bell Telephone Laboratories  
"A 50-MC Wide-Band Oscilloscope"—A. Levine and H. Hoberman, Federal Telecommunication Laboratories  
"A Timing-Marker Generator of High Precision"—R. C. Palmer, DuMont Laboratories  
"The Evaluation of Specifications for Cathode-Ray Oscillographs"—P. S. Christaldi, DuMont Laboratories  
"Photographic Techniques in Cathode-Ray Oscillography"—C. Berkley and H. Mansberg, DuMont Laboratories

## Electronic Computers

"The Binac"—J. P. Eckert, Jr., J. W. Mauchly, and J. R. Weiner, Eckert-Mauchly Computer Corp., Philadelphia, Pa.  
"An Electronic Differential Analyzer"—A. B. Mauee, M.I.T.  
"An Analog Computer for the Solution of Linear Simultaneous Equations"—R. M. Walker, Watson Chemical & Scientific Laboratory, N. Y. C.  
"The Electronic Isograph for a Rapid Analogue Solution of Algebraic Equations"—B. O. Marshall, Jr., Cambridge Field Station, Air Materiel Command, Cambridge, Mass.  
"A Parametric Electronic Computer"—C. J. Hirsch, Hazeltine Electronics Corp., Little Neck, N. Y.

## Symposium: ELECTRONIC COMPUTERS

"The Binac"—J. W. Mauchly, Eckert-Mauchly Computer Corp., Philadelphia, Pa.  
"Mark III Computer"—H. H. Aiken, Harvard Univ.  
"IBM Type 604 Electronic Calculator"—Ralph Palmer, DuMont Laboratories  
"Electrostatic Memory for a Binary Computer"—F. C. Williams, Manchester Univ., Manchester, England  
"Counting Computers"—G. R. Stibitz, 393 South Prospect St., Burlington, Vt.  
"Programming of a Chess Game on a Computer"—Claude Shannon, Bell Telephone Laboratories

## Wave Propagation I — Television

"VHF Television—Propagation Aspects"—E. W. Allen, Jr., FCC  
"Propagation Variations at VHF and UHF"—K. Bullington, Bell Telephone Laboratories  
"Propagation Tests at UHF"—J. Fisher, Philco Corp.  
"A Test of 450-MC Urban-Area Transmission to a Mobile Receiver"—A. Aikens and L. Y. Lacy, Bell Telephone Laboratories  
"Echoes in Transmission at 450 MC from Land to Car Radio Units"—W. R. Young and L. Y. Lacy, Bell Telephone Laboratories

## Possible Networks II — Analysis

"Impedance Curves for Two-Terminal Networks"—E. Michaels, Northwestern Univ.

## TECHNICAL PAPERS PROGRAM

### MONDAY, MARCH 7

#### Systems I — Modulation Systems

"Development of a High Speed Communication System"—Donald S. Bond, RCA Laboratories  
"Distortion in a Pulse-Count-Modulation System with Nonuniform Spacing of Levels"—P. F. Panter and W. Dite, Federal Telecommunication Laboratories  
"Cross-Talk Considerations in Time-Division Multiplex"—S. Moskowitz, L. Diven, and L. Feit, Federal Telecommunication Laboratories  
"Experimental Verification of Various Systems of Multiplex Transmission"—D. R. Crosby, RCA Victor  
"Interference Characteristics of Pulse-Time Modulation"—E. R. Kretzmer, M.I.T.  
"Factors Involved in the Design of an Improved Frequency-Shift Receiving System"—Colin C. Rae, Naval Research Laboratory

#### Antennas I

"Some Properties of Radiation from Rectangular Waveguides"—J. Bolljahn, Univ. of Calif.  
"Elliptically Polarized Radiation from Inclined Slots on Cylinders"—G. Sinclair, Univ. of Toronto  
"A Broadband Transition from Coax to Helix"—C. O. Lund, RCA Laboratories  
"Theory of End-Fire Helical Antennas"—A. E. Marston and M. D. Adeock, Naval Research Laboratory  
"Equivalent Circuits for Coupling of Waveguides by Apertures"—N. Marcuvitz, Polytechnic Inst. of Brooklyn

#### Symposium: NETWORK THEORY

"Modern Developments in the Topology of Networks"—R. M. Foster, Polytechnic Inst. of Brooklyn  
"A Summary on the Status of Linear Network Theory"—E. A. Guillemin, M.I.T.  
"Recent Developments in Broadband Active Networks"—Linville, M.I.T.

"A General Review of Linear Varying Parameters and Nonlinear Circuit Analysis"—W. R. Bennett, Bell Telephone Laboratories

#### Instruments and Measurements I — Microwave

"Measuring the Efficiency of a Superheterodyne Converter by the Input Impedance Circle Diagram"—H. Wheeler and D. Dettinger, Wheeler Laboratories, Little Neck, N. Y.  
"Electrolytic-Tank Measurements for Microwave Delay Lens Media"—S. B. Cohn, Sperry Gyroscope  
"Impedance Instrumentation for Microwave Transmission Lines"—P. A. Portmann, Naval Research Laboratory  
"A Michelson Type Interferometer for Microwave Measurements"—B. A. Lengyel, Naval Research Laboratory  
"A Broadband High-Power Microwave Attenuator"—H. J. Carlin, Polytechnic Inst. of Brooklyn  
"An Absolute Method for Measuring Microwave Power of Low Intensity"—H. Herman, Naval Research Laboratory

#### Audio

"The Reproduction of Sound"—H. F. Olson, RCA Laboratories  
"New Developments in Studio Design in Europe"—L. L. Beranek, M.I.T.  
"The Technique of Television Sound"—R. H. Tanner, Northern Electric Co., Ltd., Belleville, Ontario  
"The Measurement of Nonlinear Distortion"—A. Peterson, General Radio Co.

### TUESDAY, MARCH 8

#### Antennas II

"Antenna Systems for Multichannel Mobile Telephone"—W. Babcock and A. W. Nyland, Bell Telephone Laboratories  
"Wide-Angle Metal-Plate Optics"—J. Ruze, Cam-



# Radio Engineering Show

will include presentation of 172 papers in many phases of radio-electronics

"An Analysis of Triple-Tuned Coupled Circuits"—N. Mather, Princeton Univ.

"The Bridged Parallel-Tee Network for Suppressed-Carrier Servo Systems"—C. F. White, Naval Research Laboratory

"Transient Response of Linear Networks with Amplitude Distortion"—M. DiToro, Federal Telecommunication Laboratories

"Spectrum Analysis of Transient-Response Curves"—H. Samulon, General Electric Co.

## Components and Materials

"Subminiaturization of IF Amplifiers"—G. Shapiro and R. L. Henry, National Bureau of Standards

"New Applications of a Four-Terminal Capacitor"—A. A. Pascucci, Radio Hispano Suiza, S.A. Barcelona, Spain

"Frequency Control Units"—A. E. Miller, Miller Co., N. Bergen, N. J.

"Type 5811 and Type 5807 Tubes, The Smallest Commercial Pentode Amplifiers"—L. G. Hector and H. R. Jacobus, Sonotone Corp.

"Conductive Plastic Materials"—M. A. Color, A. Lightbody, F. Barnett, and H. Perry, Naval Ordnance Laboratory

## Nucleonic Instrumentation

"Industrial Thickness Gauges Employing Radioisotopes"—J. Carlin, Polytechnic Inst. of Brooklyn

"The Design of a G-M Counter Tube for High Counting Rates"—W. Managan, Victoreen Instrument Co., Cleveland 3, Ohio

"Electrometer Tubes and Circuits"—F. H. Starke, Raytheon Mfg. Co.

"Proportional Counter Equipment for Beta Detection"—W. Bernstein, Brookhaven National Laboratory

"A High-Voltage Supplier for Radiation-Measuring Equipment"—R. Weissman and Stewart Fox, Nuclear Instrument and Chemical Corp., Chicago 10

## Symposium: NUCLEAR SCIENCE

"The Fundamental Particles"—D. J. Hughes, Argonne National Laboratory, Chicago 80

"The Detection and Measurement of Nuclear Radiation"—H. L. Andrews, National Institute of Health

"The Effects of Ionizing Radiation on Tissue"—J. P. Cooney, Atomic Energy Commission

"The Application of Nuclear Radiation to Industry"—J. R. Menke, Nuclear Development Assoc., N. Y. C.

## WEDNESDAY, MARCH 9

### Television I

"A Unidirectional Reversible-Beam Antenna for Twelve-Channel Reception of Television Signals"—O. M. Woodward, Jr., RCA Laboratories

"A Method of Multiple Operation of Transmitter Tubes Particularly Adapted for Television Transmission in the Ultra-High-Frequency Band"—G. H. Brown, W. C. Morrison, W. L. Behrend, and J. G. Reddeck, RCA Laboratories

"Transient-Response Tests in the WPTZ Television Transmitter"—R. C. Moore

"The Synchronization of Television Stations"—R. D. Kell, RCA Laboratories

"Television by Pulse-Code Modulation"—W. M. Goodall, Bell Telephone Laboratories

### Symposium: RADIO AIDS TO NAVIGATION

"The Radio Technical Commission for Aeronautics—Its Program and Influence"—J. H. Dellinger, Radio Technical Commission for Aeronautics, Wash., D. C.

"Frequency Allocations to the Aeronautical Services above 400 MC"—V. I. Weihe, Air Transport Assoc., Wash., D. C.

"Experimental Multiplexing of Functions in the 960 to 1600-MC Frequency Spectrum—Its Influence on Weight and Complexity of Equipment"—P. C. Sandretto, International Telecommunication Laboratories, N. Y. C. and R. I. Colin, Federal Telecommunication Laboratories

"The Philosophy and Equivalence Aspects of Long Range Radio Navigation Systems"—M. K. Goldstein, Office of Naval Research

"The Future in Approach and Landing Systems"—H. Davis, Watson Laboratories, Red Bank, N. J.

### Active Circuits I

"G Curves as an Aid in Circuit Design"—K. A. Pullen, Ballistic Research Laboratory, Aberdeen Proving Ground, Md.

"A Direct-Coupled Amplifier Employing a Cross-Coupled Input Circuit"—J. N. Van Scoyoc



Stuart L. Bailey  
President, Institute of Radio Engineers, 1949

and G. Warnke, Illinois Institute of Technology

"Annular Circuits for High-Power Multiple-Tube Generators at VHF"—D. H. Preist, Eitel-McCullough, Inc.

"Considerations on Electronic Multicouplers"—W. R. Aylward and E. G. Fubini, Airborne Instruments Laboratory, Mineola, N. Y.

"Improved Degenerative Regulators"—Y. P. Yu, North Dakota Agricultural College, Fargo, N. D.

### Instruments and Measurements III

"Radar Circuit Powered X-Ray Movie Equipment for Operation at 150 Frames per Second"—D. C. Dickson, Jr., C. T. Zavales, and L. F. Ehrke, Westinghouse

"An AM Broadcast Station Monitor"—H. Summerhayes, General Electric Co.

"The Speed of Electronic Switching Circuits"—E. Williams, Carnegie Institute of Technology and D. F. Aldrich, Westinghouse

"A Magnetostrictive Delay Line"—E. Bradburd, Federal Telecommunication Laboratories

"An Electromechanical Strain-Gage Multiplier"—C. Woods, E. St. George, L. Isenberg, and A. C. Hall, M.I.T.

### Electronics I — Tube Design and Engineering

"Microphonism Investigation"—Lester Feinstein, Sylvania Electric Products

"A Critical Survey of Methods of Making Ceramic-to-Metal Seals and Their Use for Vacuum Tube Construction"—R. P. Wellinger, Univ. of Illinois

"Rugged Tubes"—G. W. Baker, Kip Electronics Corp., N. Y. C.

"An Improved Method of Testing for Residual Gas in Electron Tubes and Vacuum Systems"—E. W. Herold, RCA Laboratories

"Design Factors, Processes, and Materials for the Envelope of a Metal Kinescope"—R. D. Faulkner and J. C. Turnbull, RCA

### Television II

"The Measurement of the Modulation Depth of Television Signals"—R. P. Burr, Hazeltine Electronics Corp., Little Neck, N. Y.

"Development and Performance of Television Camera Tubes"—R. B. Janes, R. E. Johnson, and R. S. Moore, RCA

"An Anastigmatic Television Deflection Yoke and Associated Circuits"—K. Schlesinger, Motorola, Inc.

"A High-Efficiency Sweep Circuits"—B. M. Oliver, Bell Telephone Laboratories

"Progress Report on UHF Television"—T. T. Goldsmith, DuMont Laboratories

### Wave Propagation II

"An Analysis of Distortion Resulting from Two-Path Propagation"—I. H. Gerks, Collins Radio Co., Cedar Rapids, Iowa

"On the Origin of Solar Radio Noise"—A. V. Haeff, Naval Research Laboratory

"Geometrical Representation of the Polarization of a Plane Electromagnetic Wave"—G. A. Deschamps, Federal Telecommunication Laboratories

"Propagation Conditions and Transmission Reliability in the Transitional Microwave Range"—T. F. Rogers, Cambridge Field Station, AMC, Cambridge, Mass.

"A Forward-Transmission Echo-Ranging System"—D. B. Harris, Collins Radio Co., Cedar Rapids, Iowa

### Active Circuits II

"A Laboratory and Analytical Analysis Comparing the L-C Toroidal Filter with the Parallel-Tee Feedback Amplifier Filter"—A. J. Stecca, Naval Research Laboratory

"A Peak-Picker Circuit"—M. J. Parker, Naval Ordnance Laboratory

"Low-Frequency Synchronized Sawtooth Generator Providing Constant Amplitude Sweep with Aperiodic Synchronization Input"—I. Yaffee, Naval Ordnance Laboratory

"High-Power Sawtooth Current Synthesis from Square Waves"—H. E. Kallmann, 417 Riverside Drive, New York 25, N. Y.

"Regenerative Amplifiers"—Y. P. Yu, North Dakota Agricultural College, Fargo, N. D.

"A Rectifier Filter Chart"—R. Lee, Westinghouse

### Instruments and Measurements IV

"High-Impedance Millivolt Measurements above 5 MC"—W. K. Volkers, Millivac Instruments, New Haven, Conn.

"Some Aspects of the Performance of Mixer Crystals"—P. D. Strum, Airborne Instruments Laboratory, Mineola, N. Y.

"A Wide-Band Audio Phasemeter"—J. R. Ragazzini and L. A. Zadeh, Columbia Univ.

"A Device for Admittance Measurements in the 50- to 500-MC Range"—W. R. Thurston, General Radio Co., Cambridge 39, Mass.

"An Improved RF Capacitometer"—E. F. Travis and T. M. Wilson, General Electric Co.

"A Radio Frequency Discharge Phenomena and its Application to Mechanical Measurements"—K. S. Lion and J. W. Sheetz, M.I.T.

### Electronics II — Electron-Tube Cathodes

"The Effects of Various Barium Compounds with Respect to Cold-Cathode Behavior as a Function of Life in a Glow Discharge"—H. Jacobs and A. P. LaRocque, Sylvania Electric Products

"Oxide-Cathode Properties and their Effects on Diode Operation at Small Signals"—G. C. Dalman, Polytechnic Institute of Brooklyn

"Microanalysis of Gas in Cathode-Coating Assemblies"—H. Jacobs and B. Wolk, Sylvania Electric Products, Inc.

"Exposure of Secondary-Electron-Emitting Surfaces to the Evaporation from Oxide Cathodes"—C. W. Mueller, RCA Laboratories

"The Use of Thoriated-Tungsten Filaments in High-Power Transmitting Tubes"—R. B. Ayer, RCA

## THURSDAY, MARCH 10

### Systems II — Relay Systems

"A Microwave System for Television Relaying"—J. Z. Millar and W. B. Sullinger, Western Union Telegraph Co.

"Synchrodyne Phase Modulation of Klystrons"—V. Learned, Sperry Gyroscope Co.

(Continued on page 64)

# A New Professional Tape Recorder

**T**HIS month the Fairchild Recording Equipment Corp. starts production on its new Model 100. Professional Tape Recorder which up to now has been used experimentally by the Columbia Broadcasting System. Combining top quality performance with low tape speed this equipment, through the provision of many new and unusual features, simplifies editing and spotting, provides for exact cueing, and eliminates most if not all of the operational objections heretofore considered inherent in magnetic tape machines.

Fig. 1 shows a top view of the Model 100 and identifies the various surface controls and components. In operation, the tape moves from left to right across the erase, record and playback heads. Conventionally, drive capstans are located between the playback head and the take-up reel and serve to pull the tape across the heads. In this new machine the capstan and pinch roll

assembly are located between the supply reel and the erase head and operate to supply tape smoothly and uniformly across the head assembly to the take-up reel. This new design feature permits wow-and-flutterless operation almost entirely independent of the condition of the tape on the supply reel. This is the result of the combination of an oversize drive motor, a massive (8 pound) fly wheel, and a capstan pinch roll combination which completely eliminates tape slippage, all of which operate effectively to "lock out" tension variations in the supply reel due to sticky splices or non-uniformly wound tape.

The capstan drive mechanism provides, by means of the entirely new "Synchroll" principle, what is claimed to be a new degree of motion stability. Long-term speed variations including the effect of tape creep and slippage are less than 0.1% which permits program timing to within 4 seconds per hour.

The wow and flutter content due to all causes is less than 0.05%. The machine provides for operation in either direction in both the play and rewind positions. Since these reversals can be made almost instantaneously without stopping and without in any way endangering tape breakage, the editing and spotting problems are greatly simplified.

Similarly, the transition from the play or record position to the rewind position can be made almost instantaneously. Heretofore, one of the serious objections to the use of tape for some purposes has been the always present danger of losing part or all of a program as a result of the tape spilling from the roll. This can be eliminated by using two-sided reels, but their advantages are more than offset by the high cost, weight, bulkiness, and lack of stiffness in sizes large enough to handle a half hour or hour program. The use of the conventional removable disc, which is a sort of one-sided reel, considerably facilitates the handling of the tape but does not minimize damage in case of mishandling. The new machine solves this problem by a novel approach. The tape is wound around a core which fits on the hub of the non-removable tape discs, and



Fig. 1: (Above) Top view of the Model 100 Professional Tape Recorder identifies the various surface components and controls.

Fig. 2: Details of mechanism involved in loading or removing tape. Container with tape is placed over spindle (B) so that drive pins (C) engage with holes in tape hub. Carton is then pulled away and the hub-cap (A) is screwed down causing plate (E) to recede against spring tension until the tape rests on disc surface. Newly designed tape storage carton (upper right) greatly facilitates storage, shipping and handling.

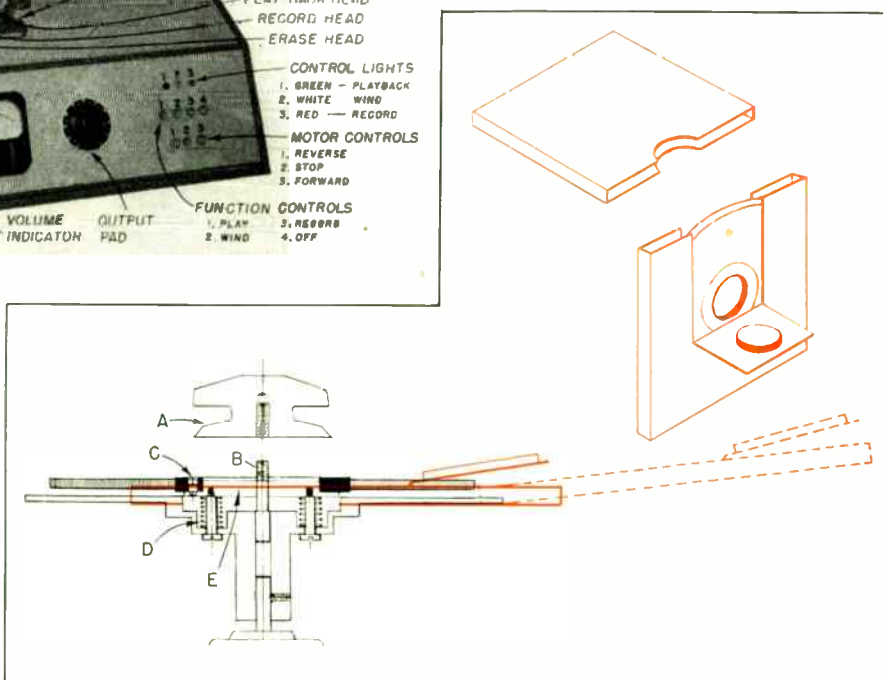



is supplied in a specially designed carton. To place the tape on the machine, the supply disc hub cap is removed, and without removal from the carton, the tape roll is placed on the drive pins as shown in Fig. 2. These drive pins are spring supported and serve to hold the tape approximately  $\frac{1}{8}$ -in. above the supply disc. The carton is then pulled away from the tape and the replacing of the hub cap depresses the tape to its proper operating position. In removing the tape this procedure is merely reversed.

The take-up disc is identical to the supply disc and thus the tape can be loaded or unloaded at either point. Once tape has been joined from the supply to the take-up reels, the threading is completed by simply dropping the tape in place on the recording head plate as shown in Fig. 1.

The hubs have been so designed to take the proposed NAB standard cores so that the tape from other machines can be used if desired and in addition, without change, the standard RMA reels, which are used primarily for  $7\frac{1}{2}$ -in./sec. recording, can be mounted.

### Unitized Construction

An interior view of the complete equipment is illustrated in Fig. 3. Unitized plug-in chassis construction is used throughout and five major components in the form of bias, record and playback amplifiers, power supply and control chassis (left to right, top to bottom) comprise the instrument. The control panel tilts forward on hinges for ready access to the switch and meter connections on the rear, and the top panel may be removed to reveal the motors and driving mechanism. The recording head plate is separately detachable and is attached to the top surface through a six point kinematic (ball and groove) type mount. The entire drive unit including the capstan is similarly a self-contained unit and can be removed by taking out 4 screws. Unitized construction was adopted throughout the design because the equipment is primarily designed for broadcast studio and master control room applications.

In line with this Fairchild has established a factory replacement type service for adjustment or repair work that has to be done on any of the three heads on the recording head plate. The unusual response characteristics achieved by this equipment is due in large measure to the precision design and construction

employed on each individual head assembly which are unique in that both the scanning gaps and inductance are adjustable. The average installation is not equipped for maintenance work of this level and hence it becomes advisable for the manufacturer to perform such adjustments in the interests of unit interchangeability. An idea of the degree of uniformity to which these heads can be adjusted may be seen in Fig. 4 which shows graphically the adjusted response characteristics of three different production type playback heads. In no case will the variation between heads as supplied under this rotating stock plan differ by more than 1 DB. It is important to mention, also, that both the record and playback heads are provided with a means of adjusting the azimuth of the pole piece gap so that tapes recorded on other machines can be played back with a minimum loss in frequency response due to "scanning" effects. The playback head can be adjusted while the machine is in operation and, if a wide range monitor speaker is used, this adjustment may be made aurally for optimum high frequency response in about ten seconds.

Another interesting feature about the head plate assembly is that the

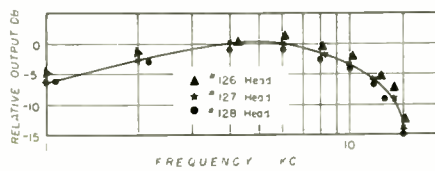

Fig. 4: Variation in adjusted response of three playback heads does not exceed 1 DB

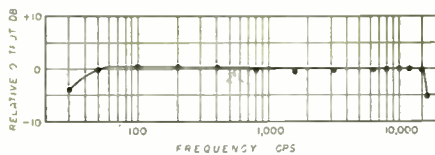

Fig. 5: Overall frequency response of the equipment is from 50 to 15,000 cps  $\pm 1$  DB

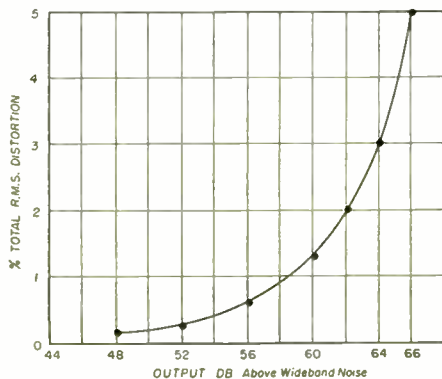

Fig. 6: For 2% total harmonic distortion the noise level is better than 60 DB down



Fig. 3: Interior view of complete equipment shows unitized construction used throughout to speed and ease any required maintenance

only vertical tape guides on the machine are an integral part of this plate and hence the replacement of a head assembly does not require any additional adjustments on the machine.

Fig. 5 shows the overall frequency response of the equipment to be within  $\pm 1$  DB from 50-15000 CPS while the power curve of Fig. 6 shows that when a 1 KC signal produces 2% total harmonic distortion in modulating the tape, the attendant wide band noise level is more than 60 DB below the output signal. In normal operation an audio input level ranging between  $-10$  to  $+20$  DBM is required and the output may be adjusted between the limits of  $-20$  to  $+10$  DBM.

Experience has indicated that there is an optimum bias level for each type of tape which permits the best balance between dynamic range and frequency response and that with a proper bias supply the tape noise level is independent of the bias level. The bias supply on this machine is instantly adjustable and the bias value may be read on the VU meter, thus permitting optimum adjustment for whatever tape is used. This adjustment is usually, except for dubbing purposes where an exact level must be maintained, an unnecessary refinement and repeated tests with a composite reel of tape made up of fifty foot sections of three quite different types of tape has shown that it is almost, if not completely, impossible for the listener to detect the transition

(Continued on page 64)

# Design and Performance

By **EDWARD D. PADGETT**  
East Orange, New Jersey

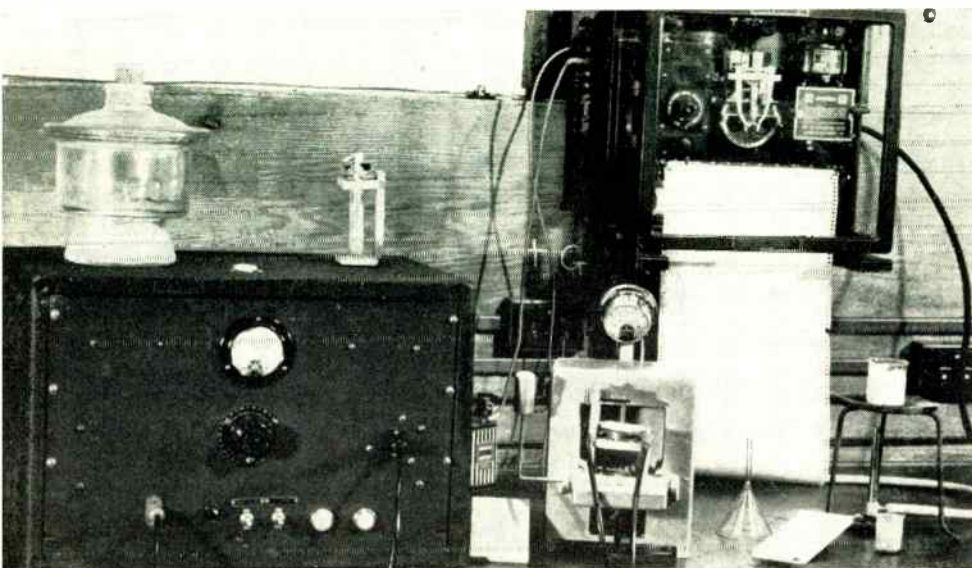

Fig. 1: Apparatus used by author includes power supply, mold, furnace for controlled dielectric cooling, L & N Recording potentiometer and an electret storage desiccator

## Waxes and resinous materials that retain a permanent charge promise a new series of electronic components

**A**N electret is a dielectric body that retains an electric moment after the removal of the applied DC field. This principle, while far from being new, opens intriguing avenues of exploration in electronics research. The word **ELECTRET** was coined and used by O. Heaviside to describe such a permanently polarized dielectric, the electrical analogue of a permanent magnet. However, Eguchi was the first to make and describe<sup>1</sup> practical electrets. They are obtained when certain waxes and resinous materials, such as Carnauba wax, rosin, and beeswax, alone or in mixtures, are melted and allowed to solidify while exposed to a strong, externally applied, unidirectional electric field.

The electric field polarizes the molecules of the dielectric and as the mass solidifies these polarized molecules are frozen into their excited positions. "Free electric charges" then appear on the electret surfaces. That is, at room temperatures one electret surface bears a free charge that is positive in sign

and the other surface has a negative charge. Negligible decay of these charges occurs if the electret

Fig. 2: Graph of approximate field strength at various distances from electret surface

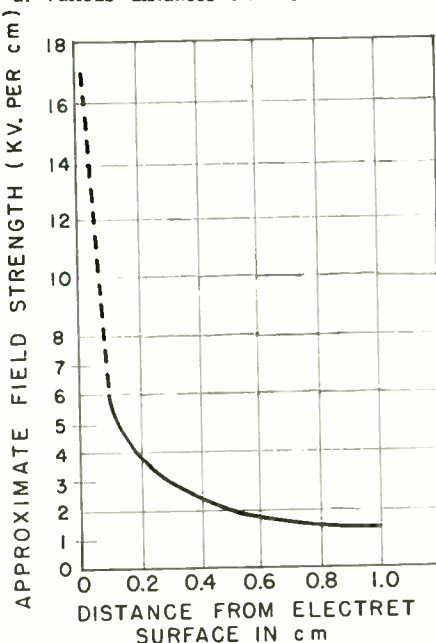

is completely covered with a metal foil "keeper" which short-circuits the polarized surfaces, and serves the same function as the "keeper" on a magnet.

These "free charges" are a form of energy, the amount of which can be measured when mechanical work is done against the charged surfaces. Work done is the product of a force and a distance. In the electrostatic system of units (c.g.s. system) work done is the product of an electrical force and a distance.

If one wishes to induce a charge on the top plate of a capacitor the necessary energy must come from the work done in mechanically displacing one plate in a vertical direction when it is near the charged electret surface. In other words, to induce a charge on the plate, work must be done by moving the plate to or from the electret surface. The sign of the induced charge will be

Fig. 3: Equipment arranged as a capacitor, used to induce charge on electret surface

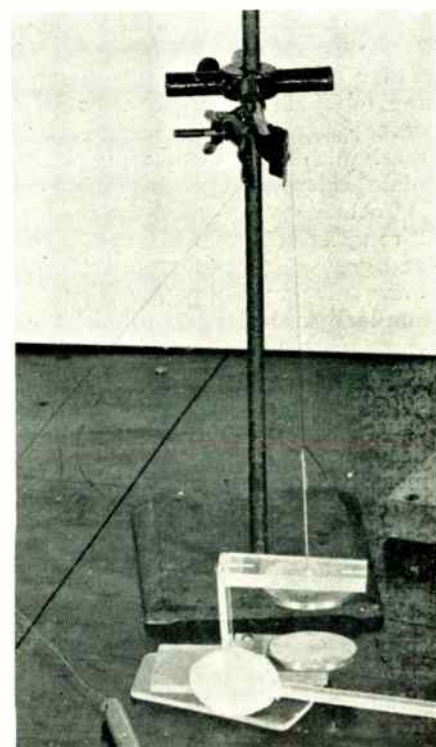

<sup>1</sup>Phil. Mag. (British), Vol. 49, page 178, 1925



# Characteristics of "Electrets"

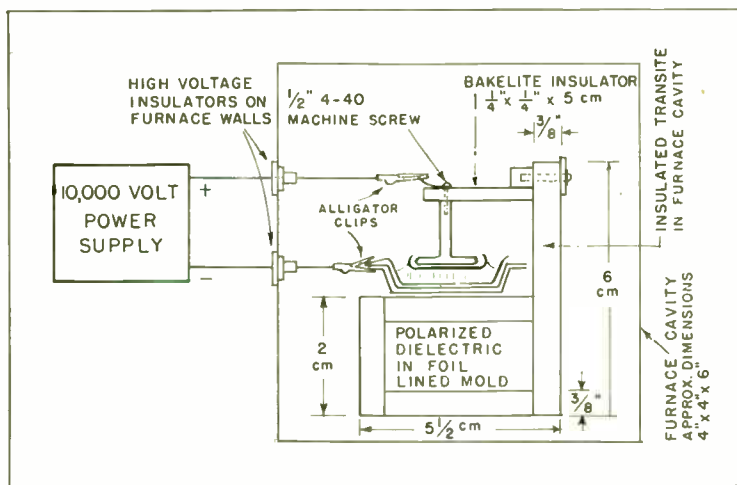

Fig. 4: Details of insulated transite stand and electric furnace which provides controlled dielectric cooling

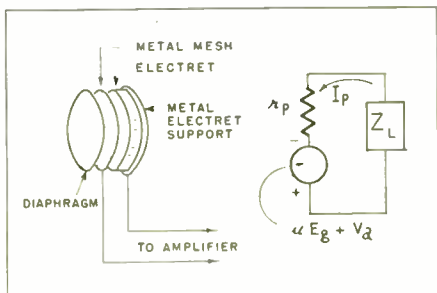

Fig. 6: In microphones electrets replace polarizing voltage sources. Equivalent voltage and amplifier circuit is at right.

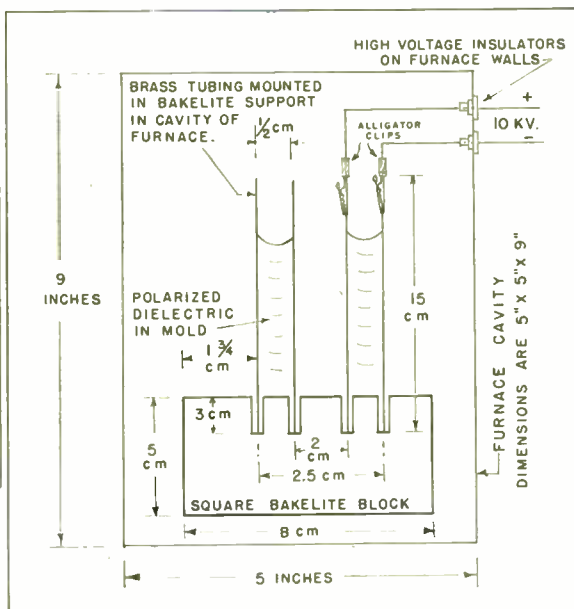

Fig. 5: For cylindrically shaped electrets a mold made from brass tubing approximately 0.030-in. thick is employed

Fig. 7: (Insert) Molten dielectric is poured into mold lined with aluminum and foil. (Below) An external electric field (5 to 10 KV/CM) is applied while dielectric cools slowly

opposite that on the electret surface.

If work is done against this charged surface, an appreciable field strength will exist between the electret surface and the adjacent plate. If the distance between the two is decreased, the field strength will increase. When the distance is 5 mm., for a 9 cm. square electret surface and a 20 cm. square plate, the approximate field strength is 2000 volts per centimeter. When the distance is less than 1 mm. the approximate field strength approaches 20,000 volts per centimeter — a respectable magnitude indeed! A graph of approximate field strength versus distance between the electret surface and the plate appears in Fig. 2.

As measured under ideal laboratory conditions the density of surface charge (total charge on an electret surface divided by electret surface area) on several types of electrets varies from about 0.20 to 6.00 e.s.u./cm<sup>2</sup>. These values may be compared to Lord Kelvin's theoretical maximum of approximately 10 e.s.u./cm<sup>2</sup>.

(Please turn to next page)

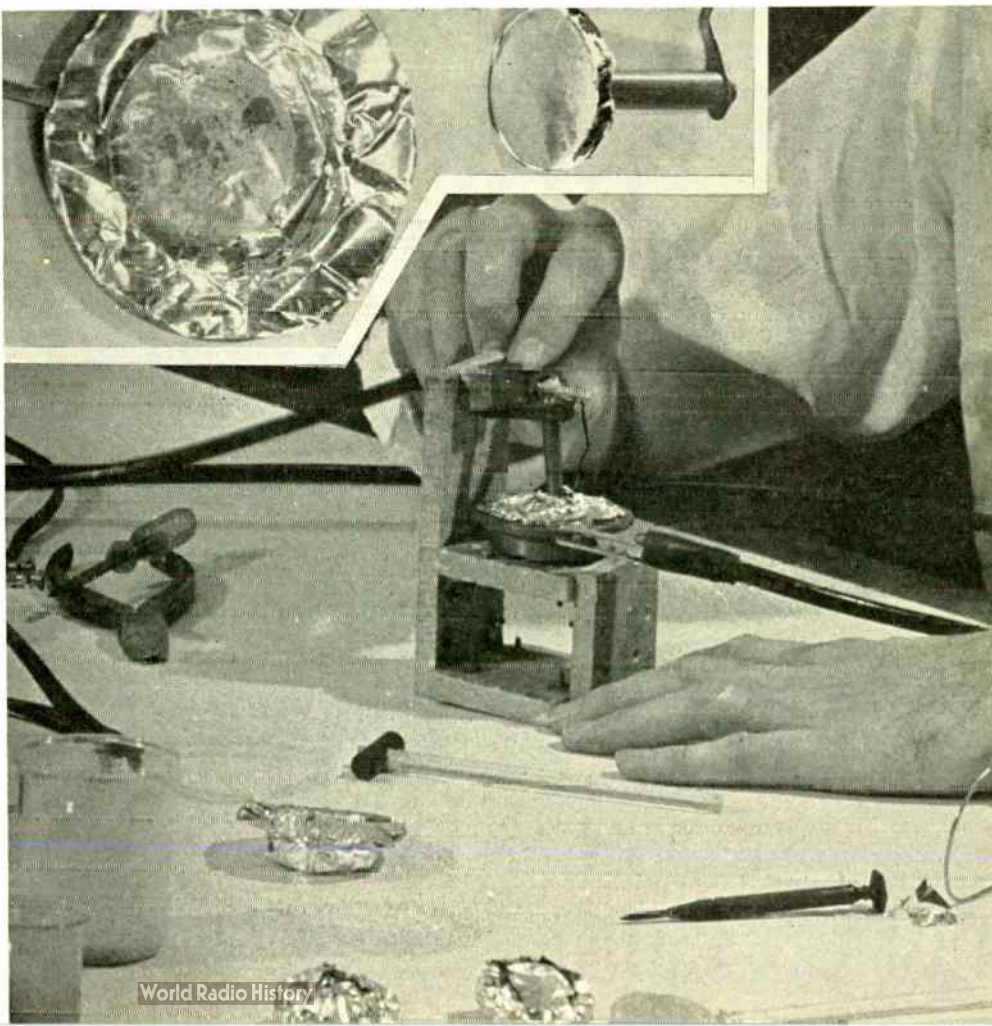

## CHARACTERISTICS OF "ELECTRETS" (Continued)

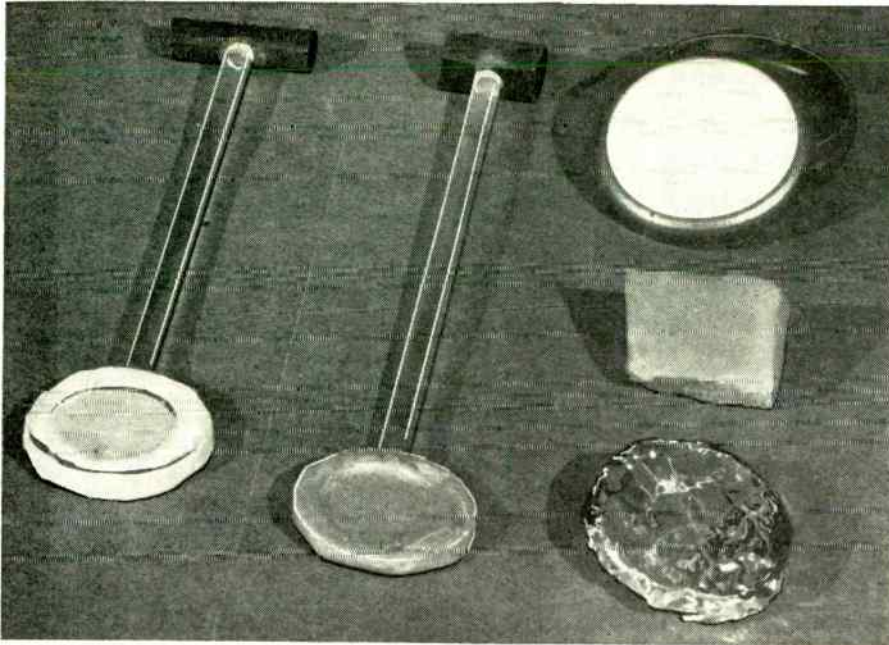
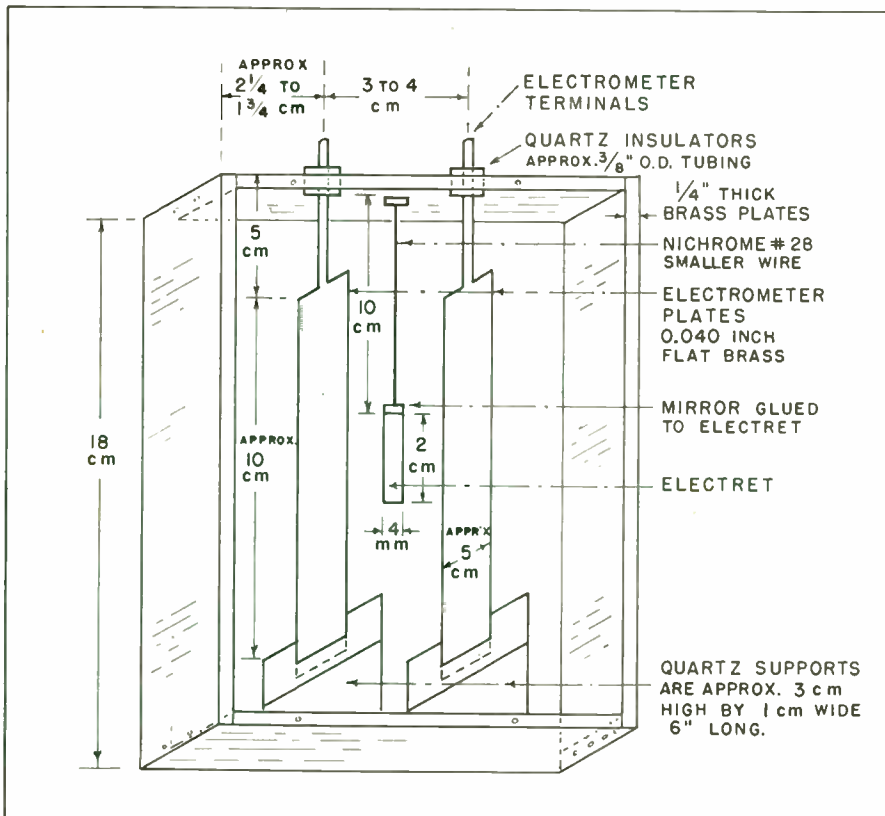

Fig. 8: Disc electrets may be mounted on plastic rods to facilitate handling when making surface charge measurements. Stored electrets are wrapped in metal foil "keepers"

A convenient way to handle electrets, when making surface charge and field strength measurements, is to mount them on Polystyrene handles as shown in some of the photographs, to eliminate discharging them, and avoids the introduction of unnecessary errors into the tests.

Fig. 9: Details of an experimental suspender disc electrometer. The degree of mirror deflection is indicated on a centimeter scale placed 115 cm. away from the electret



While electrets can be made in an interesting variety of sizes and shapes, disc types are the easiest to make and test. Here the molten dielectric material is poured into a metal mold that is actually a parallel plate capacitor. To the mold and its contents, a strong external field is applied from a power supply, as in Fig. 1 which is a photograph of equipment used by the author in making electrets. The units are then allowed to cool slowly (about 2 hours) in a furnace, or oven, to room temperature, using a setup as in Fig. 4. Controlled cooling reduces the cracking tendency of these wax type dielectrics and improves the electrets. In a convenient form shown in photographs, the lower mold electrode is cup shaped and the top electrode is a flat disc. Both are lined with 0.001 inch metal foil (aluminum or tin) to facilitate subsequent handling. The wax dielectrics used in making electrets have a volume contraction of as much as 20% during the cooling process. As it shrinks it pulls the foil with it, and thus reduces the tendency to crack. This shrinkage permits easy removal of the foil lining with the completed electret from the mold.

### Spacing of Electrodes

Eguchi used a circular cup 20 cm. in diameter by 1 cm. deep as the lower electrode. The upper electrode just touched the dielectric surface and was held in place by three insulated strings. Andrew Gemant<sup>2</sup> used a similar mold but with reduced dimensions when he verified Eguchi's claims. Gemant placed three small ebonite spacers 120° apart in the molten wax to maintain a distance of 1.6 mm. between electrodes.

Present tendencies are to eliminate these spacers by mounting the upper electrode on an insulated support or stand (as in Fig. 3). It is necessary to obtain an external electric field that is uniform and uni-directional. The field that exists between two charged, closely spaced, parallel plates meets this requirement. A simple method is to make electrets that are disc shaped. The factor that governs the thickness of an electret is the distance between electrodes at which this externally applied field becomes non-uniform. The surface area of an electret is limited only by practical considerations in the experimenter's mind.

E. P. Adams of Princeton Uni-

2) Phil. Mag. (British) #20, page 929, 1935



versity made cylindrically shaped electrets, using a mold that was a cylindrical capacitor (Fig. 5). Two brass tubes about 15 cm. long were mounted, one inside the other, on a Bakelite block. The molten dielectric was poured into the space between the tubes, which were connected to a 4000 volt power supply. This potential was maintained on the mold until the assembly had cooled to room temperature. For a 5 mm. distance between electrodes and the applied potential difference of 4000 volts, the strength of the external field applied to the dielectric to make the electret was 8000 volts per centimeter.

As in the case of disc electrets, better electrets will be obtained, if the cylindrical mold and the dielectric are cooled to room temperature in a furnace (a cooling time of about 2 hours is satisfactory). To make suitable electrets an external field strength of between 5000 and 10,000 volts per centimeter must be applied to the dielectric and the cooling time must be greater than 1/2 hour.

Electrets find practical use in electrometers and electromechanical transformers, (microphones, etc.).<sup>3</sup>

Electret electrometers are advantageous because of their low capacitances and linear scales. One of Gemant's electrometers had an impedance, at 60 cycles (assuming the capacitance of the system was about 1.1  $\mu\mu\text{f}$ ), of  $3 \times 10^8$  ohms; an ohmic resistance equal to that of the insulation; and a sensitivity of 2 mm. per volt. This instrument was suitable for use as an a.c. voltmeter, or null instrument. Fig. 6 shows one method of assembly. Or, for a simple experimental version, the disc can be mounted between two pieces of 1 mil. aluminum foil and used directly.

### Suspended Disc Electrometer

In a suspended disc electrometer (Fig. 9) an electret and a small mirror are attached to a thin Nichrome wire in and insulated from the brass and Plexiglass case. The electrometer plates are mounted on quartz insulators inside the case. When the plates are charged to the d.c. potential difference to be measured, the electret deflection is proportional to the applied p.d. The mirror deflection is indicated on a centimeter scale placed 115 cm. from the electret. An electric couple

<sup>3</sup> British patents 435,950 and 438,672. See also U. S. patents 1,523,898, 1,702,438 and 1,804,364.

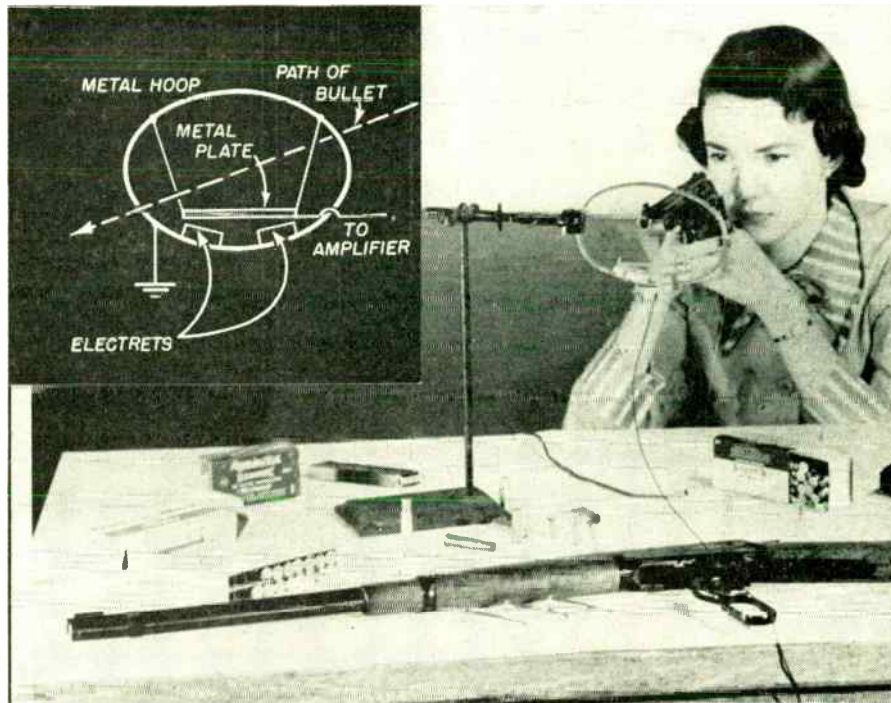

Fig. 10: Testing the electret chronograph system. Sketch of one pair of pickup units is detailed in insert. Electret leads go to oscilloscope or electronic timer amplifier

acts on the electret when the d.c. voltage is applied which rotates the electret until the elastic restoring force of the Nichrome suspension wire is reached. The sensitivity depends in part on the size of suspension wire used.

The dimensions are approximate because an electret 4 cm. in diameter should be cut down until it has uniform polarization throughout its mass. The diameter then might be approx. 2 cm. The fixed plates are moved about with respect to the suspended electret until best performance is obtained.

Gemant described his electret microphone illustrated in Fig. 6 as follows: "... both the diaphragm and the metal mesh possess a certain capacity against the free electret surface, and the ratio of their influenced charge depends on the ratio of their partial capacities. When the diaphragm moves, as the result of an impinging sound wave, the capacity will change and alter the charge ratio. There will be an alternating current in the transformer, which, for small amplitudes, has the same wave form as the acoustical wave. The apparatus acts, therefore, like a "microphone".

Although transformer coupling is theoretically possible it is expensive and rather impractical. High impedance devices of this type tend to pick up hum from nearby 60 cycle outlets and appliances. Electret microphones require no polarizing

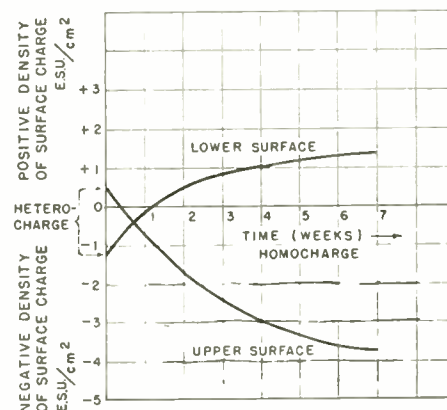

Fig. 11: Graph showing the growth of surface charge for 7 week old Carnauba wax electret

voltages. While they are amazingly interesting devices before they can move from the experimental laboratory to the production line, stabilization of several variables must be solved. Several types have appeared on the market from time to time, however, which contain several modifications for the explanation of electret microphone behavior.

Making electret microphones is a matter of transforming the acoustical energy directed against an electret into an equivalent voltage which is represented by the symbol  $V_A$ . It can be measured by a VTVM placed across the electret. In order to approach the ideal condition of a non-loading, the electret should

(Continued on page 62)

# Performance Capabilities of

Ultimate performance limits, selectivity, and fidelity characteristics analyzed

By GEORGE V. ELTGROTH, Vice President, Eckert-Mauchly Computer Corp., Philadelphia, Pa.

Part I of this article appeared in the February issue.

HAVING now established the oscillation amplitude existing at the time  $t_2$  with signal currents at the resonance frequency impressed, it now becomes necessary to investigate the response to signal currents at other frequencies to establish the receiver selectivity. The circuit of Fig. 7 is again employed for the analysis, with an assumed input current  $i_1$  of the same amplitude as the reference resonance frequency current but of different frequency. The circuit equation now becomes  $D_2 + \omega_0^2 = \omega_0^2 A \sin(\omega t + \alpha)$  whose complementary solution is again given by:  $i_2 = C_1 \sin \omega_0 t + C_2 \cos \omega_0 t$ . Employing (5) again for the derivation of the particular solution:  $i_2 = \omega_0^2 A \sin(\omega t + \alpha) / (\omega_0^2 - \omega^2)$  making the complete expression for the current through the inductance

$$i_2 = C_1 \sin \omega_0 t + C_2 \cos \omega_0 t + \frac{\omega_0^2 A \sin(\omega t + \alpha)}{\omega_0^2 - \omega^2} \dots (10)$$

and for the voltage across the inductance

$$E = L \frac{di_2}{dt} = L \left[ \omega_0 C_1 \cos \omega_0 t - \omega_0 C_2 \sin \omega_0 t + \frac{\omega_0^3 A \cos(\omega t + \alpha)}{\omega_0^2 - \omega^2} \right] \dots (11)$$

At  $t = 0$ , both  $i_2$  and  $E$  are also zero, enabling the determination from (10) that  $C_2 = (-A\omega_0^2 / (\omega_0^2 - \omega^2)) \sin \alpha$  and from (11) that  $C_1 = (-A\omega\omega_0 / (\omega_0^2 - \omega^2)) \cos \alpha$ . Substituting these constants in (11), the complete expression for the voltage is found to be

$$E = LA \left[ \frac{\omega_0^3}{\omega_0^2 - \omega^2} \cos \alpha \cos \omega_0 t + \frac{\omega_0^3}{\omega_0^2 - \omega^2} \sin \alpha \sin \omega_0 t + \frac{\omega_0^3}{\omega_0^2 - \omega^2} \cos(\omega t + \alpha) \right] \dots (12)$$

Some rearrangement of (12) will now be undertaken to place it in form for easy employment.

The first two terms within the parenthesis are of the form

$$m \cos \omega_0 t + n \sin \omega_0 t = \sqrt{m^2 + n^2} \left[ \frac{m}{\sqrt{m^2 + n^2}} \cos \omega_0 t + \frac{n}{\sqrt{m^2 + n^2}} \sin \omega_0 t \right]$$

or letting  $m/\sqrt{m^2 + n^2} = \cos \delta$ ,

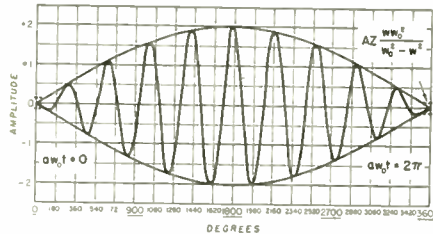

Fig. 9: Relationship of circuit voltage to time. Solid envelope is for zero start angle while dotted lines are for an angle of  $\pi/2$

$n/\sqrt{m^2 + n^2} = \sin \delta$  and  $n/m = \tan \delta$ :

$$m \cos \omega_0 t + n \sin \omega_0 t = \sqrt{m^2 + n^2} \left[ \cos \delta \cos \omega_0 t + \sin \delta \sin \omega_0 t \right] = \sqrt{m^2 + n^2} \cos(\omega_0 t - \delta)$$

$$\tan \delta = \frac{n}{m} = \frac{\frac{\omega_0^3}{\omega_0^2 - \omega^2} \sin \alpha}{\frac{\omega_0^3}{\omega_0^2 - \omega^2} \cos \alpha} = \tan \alpha$$

Within the range of frequencies about resonance for which the selectivity is determined  $\omega_0/\omega$  is sensibly 1, in which case  $\delta = \alpha$  so that:

$$\cos(\omega_0 t - \delta) = \cos(\omega_0 t + \alpha) \dots (13)$$

$$\text{Also } \sqrt{m^2 + n^2} = \sqrt{\left(\frac{\omega_0^3}{\omega_0^2 - \omega^2}\right)^2 \cos^2 \alpha + \left(\frac{\omega_0^3}{\omega_0^2 - \omega^2}\right)^2 \sin^2 \alpha} \dots (14)$$

in which there is introduced for the test angular velocity  $\omega$ , the equivalent quantity  $(1 + a)\omega_0$ , "a" being the decimal deviation between the test frequency and the resonance frequency, (14) now becomes

$$\sqrt{m^2 + n^2} = \frac{\omega_0^3}{\omega_0^2 - \omega^2} \sqrt{1 + (2a + a^2) \cos^2 \alpha} \dots (15)$$

Bearing in mind that  $\alpha$  is an arbitrary start angle inserted to care for the fact that there is no rigid relationship in time between the quench voltage and the signal voltage, the extreme values of (15) may be determined by inserting the limiting values of  $\cos \alpha$ . With  $\alpha = D$ , (15) assumes its maximum value which is

$$\sqrt{m^2 + n^2} = \frac{\omega_0^3(1+a)}{\omega_0^2 - \omega^2} = \frac{\omega_0 \omega_0^2}{\omega_0^2 - \omega^2} \dots (16)$$

and with  $\alpha = \pi/2$ , (15) assumes its minimum value of

$$\sqrt{m^2 + n^2} = \frac{\omega_0^3}{\omega_0^2 - \omega^2} \dots (17)$$

Inserting (13) and (17) in (12) to find the voltage across the circuit with a start angle  $\alpha = D$  it is found that

$$E = LA \left[ \frac{\omega_0 \omega_0^2}{\omega_0^2 - \omega^2} \cos(\omega t + 0) - \frac{\omega_0 \omega_0^2}{\omega_0^2 - \omega^2} \cos(\omega_0 t + 0) \right] = AZ \frac{\omega_0 \omega_0^2}{\omega_0^2 - \omega^2} \left[ \cos \omega t - \cos \omega_0 t \right] \dots (18)$$

With a start angle  $\alpha = \pi/2$ , (13) and (17) are used in (12), giving for the circuit voltage:

$$E = LA \left[ \frac{\omega_0 \omega_0^2}{\omega_0^2 - \omega^2} \cos(\omega t + \frac{\pi}{2}) - \frac{\omega_0 \omega_0^2}{\omega_0^2 - \omega^2} \cos(\omega_0 t + \frac{\pi}{2}) \right] = \frac{AZ \omega_0}{\omega_0^2 - \omega^2} \left[ \omega \sin \omega t - \omega_0 \sin \omega_0 t \right] \dots (19)$$

The expression (18) is employed in determining the selectivity characteristic of the superregenerative receiver, the effect of start angles resulting in the voltage (19) in modifying the selectivity curve being investigated later. Using the cosine law, the envelope of the voltage wave (18) is found to be

$$E = AZ \frac{\omega_0 \omega_0^2}{\omega_0^2 - \omega^2} \sqrt{1 + 2 \cos(\omega - \omega_0)t} = AZ \frac{\omega_0 \omega_0^2}{\omega_0^2 - \omega^2} \sqrt{2 - 2 \cos \omega_0 t} = AZ \frac{\omega_0 \omega_0^2}{\omega_0^2 - \omega^2} 2 \sqrt{\text{versine } \omega_0 t} \dots (20)$$

This envelope is zero whenever  $\omega\omega_0 t$  is an even multiple of  $2\pi$ . On the other hand, it is seen that the envelope of (19) cannot become zero and that its minimum amplitude is

$$E = AZ \frac{a \omega_0^2}{\omega_0^2 - \omega^2} \dots (21)$$

occurring at a time corresponding to the minimum of (20). The difference in the envelope maxima of (18) and (19) is insignificant because of the normally small percentage difference between the impressed frequency and the resonance frequency. The circuit voltage with relation to time is shown in Fig. 9 in which the envelope for a zero start angle is shown in solid line, with the obscuration of the mini-



# Superregenerative Receivers

Second of Two Parts

imum produced by the most unfavorable start angle,  $\pi/2$ , indicated in dotted lines.

## Expression for Selectivity

It will be remembered that there was earlier established the fact that the detector output voltage was controlled by envelope of the voltage wave in the tuned circuit at the time when the shunt resistance presented by tube V1 becomes negative, and that it was therefore concluded that the selectivity could be obtained by comparing the ratio of the voltage envelopes existing at this time in the presence of energy at the resonance frequency, and in the presence of energy at an interfering frequency deviating from resonance.

As will be seen the selectivity is closely related to an adjusted quench frequency which is the reciprocal of the period of wave portion two. For brevity, this will be referred to hereafter as the "quench frequency."

Fig. 10 shows the voltage envelopes for the case of an interfering frequency very close to the resonance frequency. Both curves (a) and (b) are substantially straight lines. The ratio is substantially unity at  $t_2$  and there is no discrimination. In Fig. 11, the interfering frequency has been farther removed from the resonance frequency and the curvature of the interfering envelope is more clearly seen in Fig. 11(b). Here, the ratio of resonance frequency response to interfering frequency response at  $t_2$  is greater than unity, this not being evident from the sketch due to the readjustment of scale.

In Fig. 12, the deviation between resonance and interfering frequen-

cies has been increased to equal the quench frequency. Now there is no response in the tuned circuit to the interfering signal and the indicated selectivity ratio is infinite. Points at which this is the case may be referred to for convenience as extinction points. The significance of the maximum minimum envelope amplitude given by (21) now becomes evident, for it indicates that whenever the start angle is  $\pi/2$ , the most unfavorable angle, the envelope in Fig. 12(b) does not drop to zero, but to some finite value preventing the selectivity ratio from becoming infinite when the deviation frequency is equal to the quench frequency. As there is no means of controlling the start angle, this most unfavorable angle must be assumed in deriving the selectivity ratio at this and other similar points. Taking the ratio of resonance frequency response to the envelope minimum under the most unfavorable conditions as given by (21) determines the discrimination or selectivity against interfering signals producing an envelope minimum at  $t_2$ . This discrimination ratio is

$$Y = \frac{AZ}{AZ} \frac{\frac{a\omega_0^2}{\omega_0^2 - \omega^2} t}{\frac{\omega\omega_0}{\omega_0^2 - (1+a)^2\omega_0^2}} = \frac{t}{2} = \frac{\omega_0 t}{2(-2a-a^2)}$$

As "a", the decimal deviation, is normally fairly small, the equation may be written simply as  $y = \omega_0 t$ . To complete the finding of the attenuation at an extinction point, reference may now be made back to part I, where it was found that  $\omega_0 t$  was equal to  $2\pi$  times resonance frequency/quench frequency. As unfavorable a ratio  $f_s/f_q$  as one might

expect to encounter is 50:1, corresponding to a 500 KC carrier and 10 KC quench frequency. For this condition

$$Y = 314.16 \text{ and } 20 \log Y = 49.94 \dots\dots(22)$$

indicating an extinction attenuation of approximately 50 DB for this condition. Normally,  $f_s/f_q$  may be expected to be in the neighborhood of 500:1, providing far higher extinction attenuations. The selectivity curves which are presented later have been drawn for an assumed maximum attenuation of 50 DB although this corresponds to the most unfavorable operating condition of a superregenerative receiver.

Fig. 13 illustrates the voltage envelopes found in the circuit when the interfering frequency differs from the resonance frequency by 1.5 times the quench frequency. It will be observed that the discrimination ratio is now much less than that for the lower deviation frequency in Fig. 12.

The second extinction point observed when the interfering frequency differs from the resonance frequency by twice the quench frequency is clearly seen in Fig. 14. There is no necessity for further figures, since it is now obvious that further increases in deviation of the interfering frequency merely increase the number of envelope crests and troughs occurring during the zero loss period and successively cause the traverse of additional extinction points. With the above qualitative information concerning the selectivity and the reasons for its existence in mind, the development of the quantitative selectivity relations from equations (9) and

(Please turn to next page)

Figs. 10-14: (Left to Right) Comparison of voltage envelope wave forms showing conditions for a very low deviation between resonance and signal frequencies, and also the conditions where the deviation involved is 0.5, equal to 1.5 times, and twice the quench frequency.

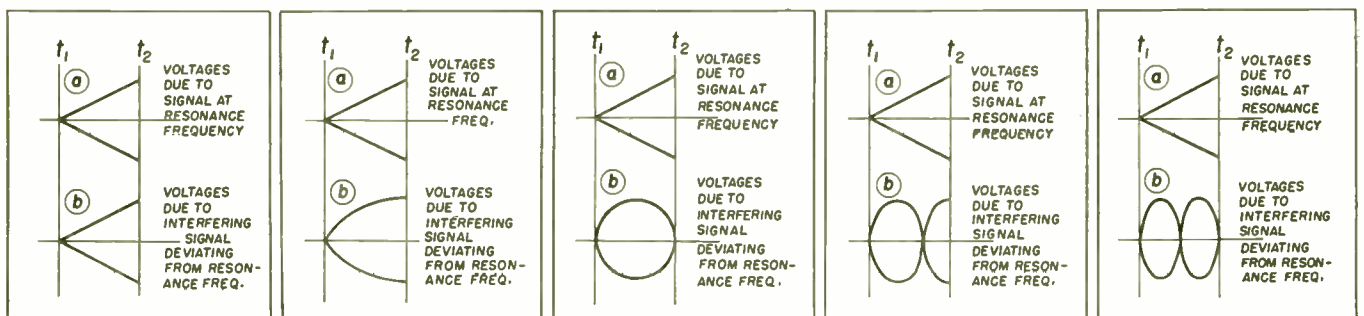

# SUPERREGENERATIVE RECEIVERS (Continued)

(20) will now be initiated.

As stated before, the selectivity ratio is the ratio of the envelope amplitudes produced by energy at the resonance frequency and by energy at the interfering frequency. This ratio may be designated by and written

$$Y = \frac{AZ \frac{\omega_0 t}{2}}{AZ \frac{\omega_0 t}{\omega_0^2 - \omega^2} - 2\sqrt{\text{haversine } a \omega_0 t}} \dots\dots(25)$$

in which  $\frac{\omega_0 t}{\omega_0^2 - \omega^2} = \frac{(1+a)\pi^2}{\omega_0^2 - (1+a)^2 \omega_0^2} = \frac{1+a}{-2a-a^2}$

for which may be taken  $\frac{\omega_0 t}{\omega_0^2 - \omega^2} = -\frac{1}{2a} \dots\dots(24)$

since "a" is small. The error introduced in the selectivity curves by the approximation of (24) is zero DB in the immediate region of the resonance frequency, and is less than two DB for interfering frequencies differing from the resonance frequency by 50%. At this point on the selectivity skirt the attenuation has already reached such values that two DB more or less is of negligible consequence. Also in (23),

$$\omega_0 t = 2\pi a f_0 t = 2\pi \frac{a f_0}{f_q} = 2\pi \times \frac{\text{deviation freq.}}{\text{quench freq.}}$$

Utilizing this, and (23) in (22) the selectivity ratio is found to be:

$$Y = \frac{\frac{\omega_0 t}{2}}{\frac{1}{2a} - 2\sqrt{\text{haversine } a \omega_0 t}} = \frac{a \omega_0 t}{2\sqrt{\text{haversine } a \omega_0 t}} = \frac{\pi \times \frac{\text{deviation freq.}}{\text{quench freq.}}}{\sqrt{\text{haversine}(2\pi \times \frac{\text{deviation freq.}}{\text{quench freq.}})} \dots\dots(25)$$

The negative sign of (24) has been dropped without affecting the results, since it is the ratios of envelopes which are being dealt with, and change in the sign of the envelope term merely indicates in this case a reversal of the phase of the wave within the envelope. The particular significance of (25) lies in the fact that the signal or resonance frequency does not appear in the equation, and that the discrimination ratio is therefore a function only of the ratio between the deviation frequency and the quench frequency. The selectivity of superregenerative receivers is therefore constant on an absolute deviation basis, but not on a percentage deviation basis, as is the case with normal tuned circuits. The value of  $20 \log y$  is plotted in Fig. 1 as the solid line selectivity curve to illus-

trate the attenuation suffered by signals differing from the resonance frequency. Although, according to equation (25) the attenuation of an interfering signal is infinite when the deviation frequency equals the quench frequency, the maximum attenuation shown in the curve of Fig. 15 is 50 DB in accordance with the extinction attenuation predeveloped in (22). Only five secondary responses are shown on either side of the primary response in Fig. 15, it being understood that others continue beyond those shown on either side of the resonance frequency. The dashed line in Fig. 15 is the envelope of the secondary response peaks, and has additional value as indicating a design criterion to be later discussed.

The curves of Fig. 15, which have been experimentally corroborated,

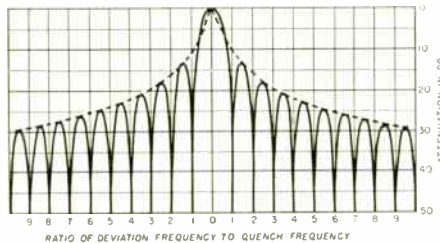

Fig. 15: Graph showing optimum selectivity characteristic of superregenerative receiver

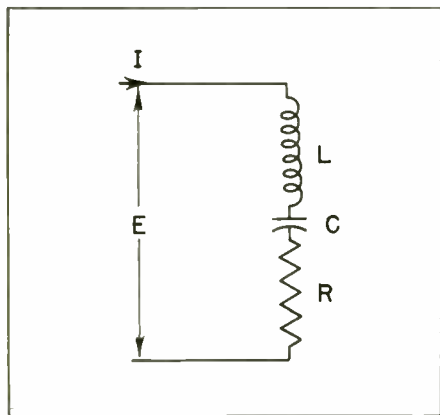
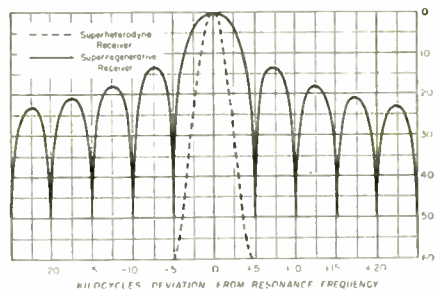

Fig. 16: Series resonant analysis circuit used to develop dashed curve in Fig. 15

Fig. 17: Selectivity comparison between superheterodyne and superregenerative receivers (with 5 KC quench wave) at 300 KC



show that the superregenerative receiver attenuates very strongly interfering signals displaced from the desired signal by integral multiples of the quench frequency, while signals at intermediate points are subject to much less attenuation. If, therefore, the receiver is to be employed in a frequency where, because of regulations, the transmitting stations are spaced in the spectrum at uniform intervals, as in the 540-1700 KC band in the U. S., the receiver may be so designed that when tuned to a desired signal, the extinction points in the selectivity curve coincide with the frequencies of all other channels in the spectrum. The operating selectivity under such circumstances is, to all intents and purposes, that of the primary response rather than that of the envelope of the secondary responses. It is as though a blocking grid were automatically swung into place on every other channel in the spectrum when the desired signal is tuned in, and by taking advantage of this peculiar property of the superregenerative receiver its utility may be extended to frequency bands much lower than hitherto thought possible. Where the channel spacing is irregular and unpredictable, advantage cannot be taken of the special characteristics of the selectivity curve, and in this case the criterion of performance is the envelope of the secondary response peaks.

The dashed curve of Fig. 15 is, as earlier intimated, the envelope of the secondary response peaks, but deviates from this relationship in the primary response region. This curve is of especial significance as it is the selectivity curve of a conventional tuned circuit having a Q equal to 78% of the number of signal cycles elapsing during the zero loss period of the superregenerative circuit with which it is compared.

The dashed curve of Fig. 15 was developed for a simple series resonant circuit as shown in Fig. 16. The current at resonance is  $I = E/R$  and the current for a signal voltage removed from resonance is  $I = E/\sqrt{R^2 + (X_L - X_C)^2}$ . The selectivity ratio  $y = \sqrt{R^2 + (X_L - X_C)^2}/R$  in which the following substitutions may be introduced:  $X_L = (f/f_0)X_0$ ;  $X_C = (f_0/f)X_0$ ;  $X_0 = RQ$  resulting in the expression:

$$y = \frac{\sqrt{R^2 + R^2 Q^2 (\frac{f}{f_0} - \frac{f_0}{f})^2}}{R} = \sqrt{1 + Q^2 (\frac{f}{f_0} - \frac{f_0}{f})^2} \dots\dots(26)$$

$f = (1 + a)f_0$ , in which a is again



the decimal deviation, while  $af_0$  is the deviation frequency, and upon inserting this relation in (26) and reducing, remembering that  $a$  is normally quite small, there is obtained  $y = \sqrt{1 + 16a^2Q^2}$ . By experiment it was found that when  $Q$  in the latter equation was made equal to 78% of the number of signal cycles elapsing during a quench cycle ( $Q = 0.78 f_0/f_q$ ) the resulting selectivity curve passed tangentially through the secondary response peaks of the superregenerative receiver selectivity characteristic. Substituting this value for  $Q$  becomes

$$y = \sqrt{1 + (0.78)^2 16 \left(\frac{af_0}{fa}\right)^2} = \sqrt{1 + 9.734 \left[\frac{\text{deviation freq.}}{\text{quench freq.}}\right]^2}$$

which plots out as the dashed curve of Fig. 15.

This curve establishes the following criterion when, due to irregular channel spacing, the advantage afforded by the presence of the extinction points cannot be realized: if circuits having an operating  $Q$  of  $0.78 f_0/f_q$  are readily obtainable, then a single tuned circuit operating in the conventional manner will afford better selectivity than a superregenerative circuit, while if the reverse is true the best selectivity will be obtained by the use of the superregenerative circuit. For example, the envelope selectivity of a superregenerative receiver operating at 200 KC with a 5 KC quench wave cannot be better than that of a single tuned circuit having a  $Q$  of 31.2. It is known, however, that commonly available circuit components for operation at 200 KC afford much higher operating  $Q$ 's than this, and the ordinary circuit will therefore yield superior results. The picture changes if the operating radio frequency be increased to 20 MC, while the quench frequency is held to 5 KC. The envelope selectivity is now that of a circuit having an operating  $Q$  of 3120, a figure outside the normally attainable range of operating values, and the superregenerative receiver may therefore be expected to perform better than a receiver with a single conventional circuit. Clearly, then, the superregenerative receiver only comes into its own at fairly high frequencies, this being borne out by Figs. 17, 18 and 19 comparing the performance of the superregenerative receiver with conventional superheterodynes of good design.

In Fig. 17 it is evident that the selectivity obtainable with a superregenerative receiver at 300 KC with

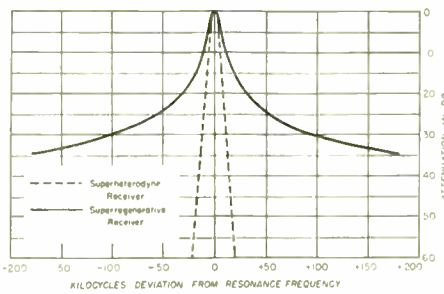

Fig. 18: Selectivity comparison between superheterodyne and superregenerative receivers (with 10 KC quench wave) at 2 MC

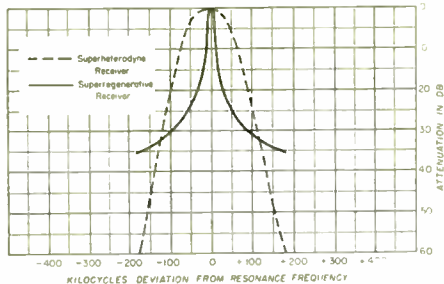

Fig. 19: Selectivity comparison between superheterodyne and superregenerative receivers (with 10 KC quench wave) at 100 MC

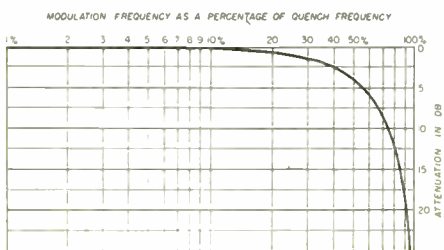

Fig. 20: Modulation frequency attenuation characteristic based on side band attenuation

a 5 KC quench wave is not comparable with that to be derived from a conventional receiver unless use is made of the extinction points in its selectivity characteristic, something permissible only if the operating channels are spaced at uniform intervals.

### Conventional Receiver Superior

In Fig. 18, which compares a conventional type receiver operating at a 2 MC operating frequency with a superregenerative receiver operating at the same frequency and employing a 10 KC quench, only the envelope of the superregenerative selectivity characteristic is shown, and on this basis the conventional type of receiver is seen to be superior. It is to be here noted that potential difficulties due to detuning in the superregenerative receiver are not at once evident from the selectivity characteristic, which is the envelope of the multiple responses occurring; a small amount of detuning may suf-

fice to place the signal at one of the extinction points and interrupt reception. However, with proper precautions in design, the extinction points may be practically eliminated. An example of such a precaution would be the use of a quench wave causing the tube and circuit combination to pass smoothly, rather than abruptly, into the zero loss region. The exercise of such precautions however decreases the selectivity attainable from that illustrated in the envelope curve of Fig. 15, 17, 18 and 19 which represent the ultimate performance limit to be secured under any conditions. Any change eliminating or suppressing the extinction points broadens the actual operating characteristic from these irreducible minima.

The comparison of Fig. 19 between a typical commercially acceptable superheterodyne operating at 100 MC and a superregenerative receiver for the same frequency with a 10 KC quench shows that in this region comparable performance may be secured. As in Fig. 18 only the selectivity curve envelope is presented.

Experience has shown that good modulation response cannot be expected in superregenerative receivers at modulation frequencies exceeding 60% of the quench frequency which is fairly well borne out by the response curve of Fig. 20 illustrating the attenuation of sideband energy due to modulation as a function of the relation between the modulation frequency and the quench frequency, the response at 60% being down about 6 DB. This is a fair approximation, but does not present the full story, as the drop in response is also due to poorer approximation of the modulation wave form as the number of pulses supplied to the detector per modulation cycle decreases. In the designs of Fig. 17, 18 and 19 the quench frequency was selected to afford audio fidelity comparable to that normally delivered by the comparison receivers. The superheterodyne receiver of Fig. 17 provided audio output up to about 2.5 KC, while those of Fig. 18 and 19 were satisfactory up to about 5 KC due to the presence of audio filters, as is the custom in communication receivers.

The best selectivity is secured when as large a fraction of the quench cycle as possible is spent in the zero loss region. This immediately indicates the desirability of

(Continued on page 71)

# Reactance Tube Circuits

Controllable dynamic reactances find extended application in filter designs

W. CONLEY SMITH, Asst. Prof. Electrical Engineering, U. S. Naval Post Graduate School, Annapolis, Md.

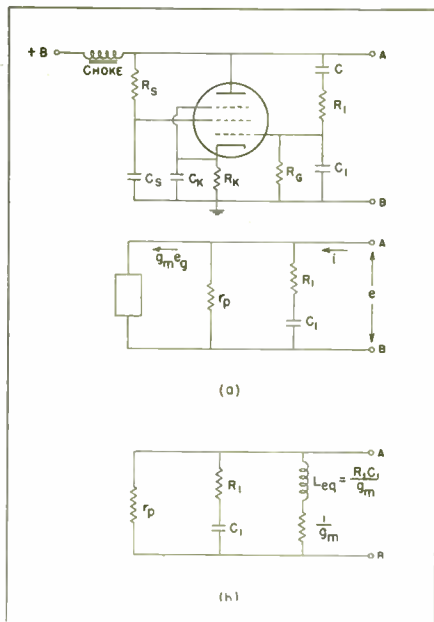

Fig. 1: Typical reactance tube circuit with its dynamic equivalent (current source basis)

FREQUENCY modulation of oscillators by the use of reactance tubes is a relatively old technic of the electronic art. Frequency stabilization and automatic frequency control systems employing reactance tubes are also rather well known to the radio engineer. The use of reactance tubes in general filter circuits, however, is a more recent development of considerable interest. An example is the Scott Dynamic Noise Suppressor circuit<sup>1</sup> which employs such tubes to vary the cut-off frequency of high- and low-pass filters in the audio range.

An electrical analog circuit for studying the performance of a mechanical or acoustical device quite often calls for inductances or capacitances which are variable not only in definite increments but also as a function of time. These variable parameters may of course be

obtained by mechanical means, such as a rotating condenser plate, but except in the simplest cases the design of the mechanical coupling, shape of the plates, etc. is extremely complicated. The rather well known reactance tube circuit is a natural solution. Such a circuit may be made to draw a leading or lagging current and thus present an equivalent capacitance or inductance which is electrically controllable. The magnitude of the equivalent parameter is a function of the circuit constants and the mutual-conduct-

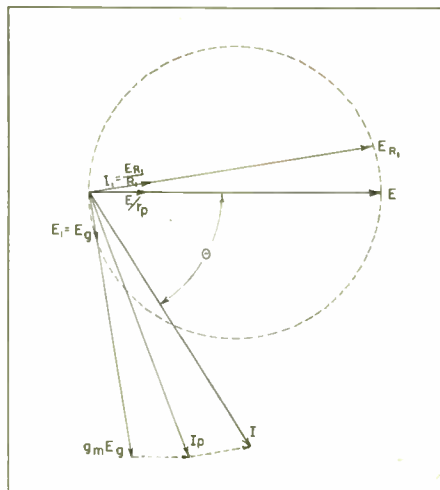

Fig. 2: Vector diagram showing voltage and current relations in reactance tube circuit

ance ( $g_m$ ) of the vacuum tube used. This latter may be made to vary in accordance with a voltage of low value applied as a bias to the control grid or to another element of the tube. If a curve is available showing the value of the mutual-conductance of a particular tube as a function of element voltage, the problem is simplified to obtaining a voltage which will yield a particular  $g_m$  or which will cause it to vary in the required manner.

The broadening field of application of reactance tubes seems to jus-

tify an analysis of their principle of operation and a convenient method for calculating their performance. In Fig. 1(a) is shown a typical reactance tube circuit with its dynamic equivalent on a current source basis. It is assumed that at the frequencies involved only  $R_I$  and  $C_I$  are important, the other circuit elements being necessary to establish and maintain the usual operating potentials of the tube.

When an alternating voltage is applied at the terminals A and B the tube will draw a lagging current because of the coupling to its grid. The vector diagram of Fig. 2 shows this condition. The lengths of the various vectors are exaggerated for the sake of clarity. The voltage  $E$  drawn as the reference vector causes a current  $I$ , to flow in the branch consisting of  $R_I$  and  $C_I$  in series. This current leads  $E$  by a small angle because of the re-

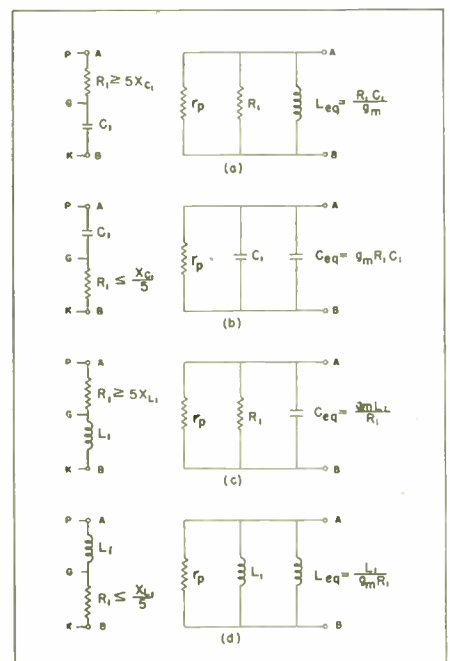

Fig. 3: Additional equivalent reactance tube circuits for different input impedance values

(1) H. H. Scott—"Dynamic Noise Suppressor," *Electronics* Vol. 20 No. 12, Dec. 1947



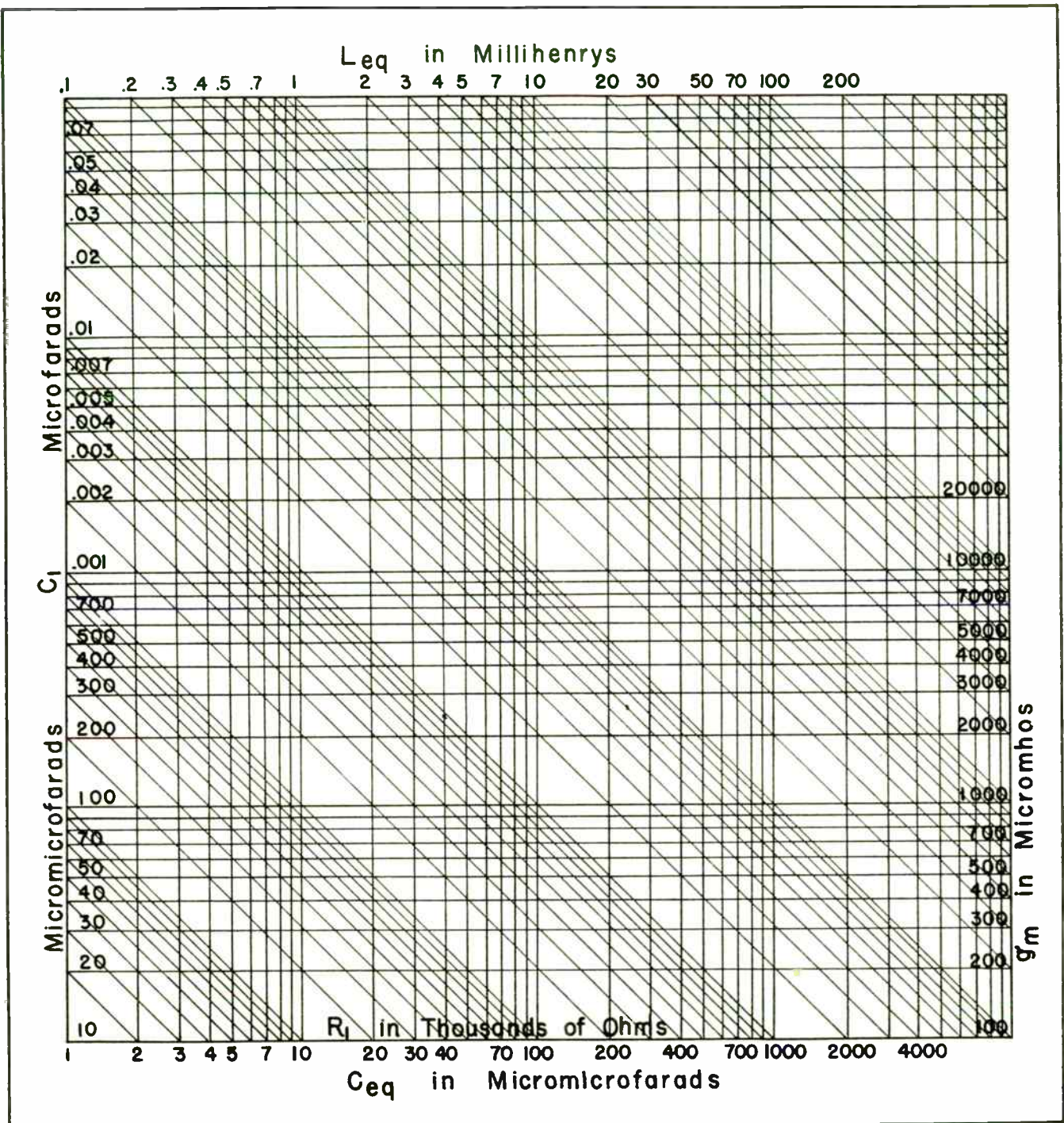

Fig. 4: Chart developed as an aid in computing the equivalent inductance or capacitance of a reactance tube circuit from Figs. 3 (a) and (b). A similar chart can also be prepared easily for those circuits in which  $L_1$  is substituted for  $C_1$  as illustrated by Figs. 3 (c) and (d)

actance of  $C_1$ . It develops a voltage  $E_k = I_1 X_{C_1}$  which lags it by  $90^\circ$  as shown. This is the AC voltage on the grid which by the action of the tube sets up an equivalent current  $g_m E_k$ . The current which the tube draws is then  $I_p = g_m E_k + (E/r_p)$  added vectorially. When the current  $I_1$  is added to this we have the total current  $I$  drawn by the reactance tube circuit which is seen to lag the applied voltage  $E$  by some angle  $\theta$ .

The circuit is not a pure equivalent

inductance because of the in-phase component of  $I$ . It could be made so by a more complicated coupling circuit which would throw the  $g_m E_k$  current vector into the third quadrant, that is lagging  $E$  by more than  $90^\circ$  to compensate for the in-phase component of  $I_1 + (E/r_p)$ . The value of the equivalent inductance, and the magnitude of  $\theta$ , depends upon the circuit parameters as a mathematical analysis will show more clearly.

Applying Kirchoff's current law

to the equivalent circuit 1(a) we obtain:

$$i = \frac{e}{r_p} + \frac{e}{R_1 - iX_{C_1}} + g_m e_k$$

but since  $e_k = -\frac{e}{R_1 - iX_{C_1}}$

$$i = \frac{e}{r_p} + \frac{e}{R_1 - iX_{C_1}} - i \frac{e g_m X_{C_1}}{R_1 - iX_{C_1}}$$

so that the admittance presented at the terminals A-B is

(Please turn to next page)

$$Y_{eq} = \frac{1}{r_p} + \frac{1}{R_1 - i(1/\omega C_1)} + \frac{1}{(1/g_m) + i\omega(R_1 C_1/g_m)}$$

and this is the same as for the circuit of Fig. 1(b) which is therefore a valid equivalent of the reactance tube circuit.

Now if  $R_1$  is made sufficiently greater than the reactance of  $C_1$  (Say  $R_1 \geq 5X_{C_1}$  as suggested by  $\approx$  Hund?) we may write with sufficient accuracy:

$$Y_{eq} = \frac{1}{r_p} + \frac{1}{R_1} + \frac{1}{i\omega(R_1 C_1/g_m)}$$

and the equivalent circuit becomes as in Fig. 3(a).

A similar analysis of circuits where  $R_1$  and  $C_1$  are interchanged, or where an inductance  $L_1$  is used in place of  $C_1$  yields equivalent circuits as shown in Figs. 3(b), (c), & (d). The equivalent inductance or capacitance of any of these circuits may be varied by changing the mutual conductance  $g_m$  of the tube. This is most easily done by varying the grid bias or by applying a control voltage to another grid of the tube.

As an aid in the computation of the equivalent inductance or capacitance of a reactance tube circuit

(2) August Hund—Frequency Modulation, McGraw-Hill

the chart of Fig. 4 will be found useful. This has been drawn for use in connection with the circuits 3(a) and (b). A similar chart for circuits employing an inductance  $L_1$  could easily be made. Fig. 4 is drawn to solve either the relation  $L_{eq} = R_1 C_1/g_m$  or  $C_{eq} = g_m R_1 C_1$ . Its use can best be shown by an example.

Suppose that an equivalent capacitance of 0.01  $\mu f$  is to be achieved by a circuit such as that of Fig. 3(b) where the tube has a  $g_m$  of approximately 6000 micromhos. After 0.01  $\mu f$  is located on the  $C_{eq}$  scale of the chart we trace diagonally to the intersection of the 6000 micromho line projected from the  $g_m$  scale. From this point we drop vertically to the  $R_1$  scale and locate a new diagonal line which represents the product  $R_1 C_1$ . The  $R_1$  and  $C_1$  coordinates of any point on this line will satisfy the relation  $C_{eq} = g_m R_1 C_1$  for the values of  $C_{eq}$  and  $g_m$  assumed. Choosing  $C_1 = 100 \mu f$ ,  $R_1$  must be approximately 16,700 ohms. These values should be satisfactory for frequencies up to about 20 KC as dictated by the condition  $X_{C_1} \geq 5R_1$ . It should be remembered that the  $r_p$  of the tube as well as  $C_1$  are effectively in shunt across this equivalent capacitance. It is obvious that large capacitances can be realized at high frequencies only by using a tube with a large mutual conductance.

To illustrate the use of this log-

arithmic chart for a circuit such as in Fig. 3(a) let us assume that an inductance of 1 millihenry is to be achieved using a tube with a  $g_m$  of 6000 micromhos. Locating 1 millihenry on the  $L_{eq}$  scale we trace vertically to the intersection of the 6000 micromho line projected from the  $g_m$  scale. This point of intersection lies on a diagonal line whose coordinates satisfy the relation  $L_{eq} = R_1 C_1/g_m$  for the values of  $L_{eq}$  and  $g_m$  assumed. Choosing  $C_1 = 500 \mu f$  a value of  $R_1 = 12,000$  ohms is indicated and the circuit of Figs. 3(a) or 1(a) should yield an equivalent inductance of 1 millihenry at frequencies above about 13 KC as dictated by the relation  $R_1 \geq 5X_{C_1}$ . The plate resistance  $r_p$ , as well as  $R_1$  will be effectively in shunt across this equivalent inductance. Large values of equivalent inductance can be realized at low frequencies by using a tube with a low value of mutual conductance.

It is important to note that the inductance or capacitance presented by a reactance tube circuit is dynamic rather than static, in the sense that it cannot store energy. The advantage is that the inductance or capacitance so obtained is controllable by a voltage of low value. It should also be noted that the voltage rating, or power handling capabilities of the reactance is governed by the tube used, being directly dependent upon its plate current rating. This factor, however, is not usually a limitation in filter applications.

## Ad Hoc Committee Studies Tropospheric Propagation

AT the close of the recent FCC Engineering Conference on propagation, new rules and TV allocations an Ad Hoc committee, made up mostly of radio consultants, was appointed under the chairmanship of E. W. Allen, Jr., FCC Eng. Dept. The objectives of this committee, which has met each week, were to consolidate the various views regarding subjects such as: variations in field intensity near the transmitter, due to terrain, buildings, etc.; effects of time variations of the desired signal when one or more interfering signals are present; prediction of Service Field Intensities, taking into consideration terrain effects; and, most important, extension of the FCC Propagation Curves to other frequen-

cies and antenna heights, especially for tropospheric propagation.

The committee has agreed not to discuss Synchronized Carriers. While hoping that this will be a practical help, it apparently will not be used in the new allocation plan. The previously-employed ratios of desired-to-undesired signal, (100 to 1 for co-channel operation, 2 to 1 for adjacent channel) will not be changed.

Why are the conclusions reached by this committee of importance to the U. S. television industry? The short-term reason is that Chairman Coy says the lifting of the "freeze" on new applications waits upon the final report of the committee. The more important long-term reason is that a successful national television

service in the future depends largely on station allocation being based on sound propagation knowledge. Otherwise our programs in our homes will be spoiled by interference from undesired stations when more stations are transmitting and transmitter power is increased. Co-channel interference is already serious in some areas, even with station spacing of 90 to 150 miles. The ground-wave range of a station is predictable, but the more erratic transmission due to the troposphere may give fairly strong signals at distances of several times the line-of-sight range and it is such transmission that the Ad Hoc committee is attempting to scientifically evaluate. So many variables effect tropospheric propagation that no complete theory has been evolved yet and field strength measurements have not been made on a sufficient number of frequencies, nor over a

(Continued on page 74)



# "Electrontype" Speeds Communication

**"Charactron," new type cathode ray tube, can reproduce printed messages at a million word per minute rate**

**A**N ultra-high-speed electronic unit for use in the transfer of messages and data has reached the development stage and is expected to replace many current methods of sending and recording printed material. Equipment can be designed to produce messages in printed form at the rate of one million words per minute, according to J. T. Meaney of Consolidated Vultee Aircraft Corporation, its designer.

The operating principles of one type of Charactron can be represented as a type of cathode ray tube equipped with means by which the ray is converted into shapes of predetermined characters, by a character-shadowing disc in the path of the beam. The cross section of the electron beam conforms to shapes of aperture configurations in this disc when directed through the individual openings. Electron shadows of these characters can then be selectively focused on fluorescent viewing screens.

The individual character openings in the disc, arranged vertically in a line, each have respective shapes and quantity depending on the intended application. Any character is selected for presentation by means of a voltage applied to a pair of selector plates. After the beam is directed through an opening in the disc, its cross section will be representative of a message character, which by the H. and V. deflection plates can be directed to any part of the screen.

In the enlarged portion of the deflector assembly shown, characters "C, D, and E" represent typical openings in the shadow disc. Each vertical plate is common to two individual characters, while the horizontal plates are common to all characters. Thus a series of input signal potentials will produce lines of information on the viewing screen. Such a screen, 8-in. in diameter, could accommodate 60 or more lines, or approximately 150 words. Presentations of this type are in-

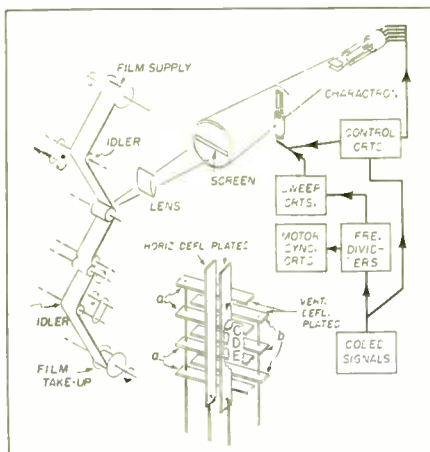

One version of a complete electrontype recorder which displays single line of symbols with space provisions for 70 symbols per line

tended for either projection on larger screens or for recording purposes but increasing the size of characters (and reducing the lines) permits messages to be read directly from the fluorescent screen. The application will determine if other types of displays are more suitable. The size of characters to be used, and the persistence of the screen can also be modified.

## 70 Symbols per Line

One version of a complete Electrontype recorder is shown which displays a single line of symbols, with space provisions for 70 per line. A short persistence fluorescent screen is provided 7½-in. in length and 3/16-in. in height.

Provisions within the tube allow for a selection from 40 different characters the letters of the alphabet, digits 1 to 9, and various punctuation marks. Introducing other characters does not necessarily present a problem. Several hundred may be incorporated in a tube, and it is not necessary that they be arranged in a single straight line as indicated. Viewing the apertures in

the shadowing disc from the face of the present tube, they are lined up at right angles to the rectangular-shaped screen.

Other major units of the complete recorder include: servo-controlled film supply and film take-up mechanisms, film synchronizing circuits and control mechanisms, lens system, input selector and sweep control circuits and the usual power supplies.

Information is taken from the coded signals unit and coupled to control circuits and frequency divider units. The coded signals unit can represent a data memory device, or a radio receiver of coded intelligence. Output from control circuits is coupled to selector plates and vertical deflection plates. Signals from frequency dividers are coupled to sweep circuits and motor synchronizing circuits. Potentials from the sweep circuits control the start and completion of each line in accordance with the rate of received characters.

For the purpose of keeping inertia effects of large rolls of film isolated from film synchronizing mechanisms, servos are employed in film supply and film take-up systems. The lens system between the film and Charactron screen gives (for 35-mm film) a 5 to 1 reduction in the optical system. Exposures do not exceed 1 mm in height, nor 0.5 mm in width.

With 70 exposures per line, when using 35-mm film, it is possible to expose 10,000 characters on 150 mm of film. At input signal speeds of 20,000 characters per second, for instance, the film will only be traveling through the printer at approximately 300 mm per second.

Electrontype recorders can be standard for application of many different varieties. Details of the unit identified as coded signals, however, will vary somewhat. It is well within the realm of sound reasoning to assume that if it is possible to put information into code form, equipment designed around the Charactron may be able to print faster than any other conceivable method.

The Charactron and its application to high-speed signaling was invented by the author, who has obtained United States patents on important features. Until recently, the invention was ahead of certain arts in cathode ray tube development and photography. There no longer appears to be any real obstacles in the way of broad applications of these principles.



# TELE-TECH'S NEWSCAST

## NAB Engineering Conference, Chicago, Apr. 6-9

Dr. William L. Everitt, head of the University of Illinois department of electrical engineering, will be the principal speaker at the National Association of Broadcasters' Engineering Conference held at the Stevens Hotel, Chicago, April 6-9.

Dr. Everitt, whose acceptance of the invitation to address the engineering conference was announced by Royal V. Howard, NAB Engineering Department director, will be heard at the luncheon on Thursday, Apr. 7.

"We are proud and pleased to have Dr. Everitt's acceptance," Dr. Howard said. "He will be remembered by all engineers as a past president of the Institute of Radio Engineers, and as having conducted the famous broadcast engineering conferences held at Ohio State University."

During the late war, Dr. Everitt was director of the operational research staff, office of the Chief Signal Officer, U. S. Army. He was given the Exceptionally Meritorious Civilian Award for this and other wartime engineering work.

Registration will begin on Tuesday, Apr. 6, and a tour of a radio factory in the Chicago area is being arranged for the afternoon, with a party to follow in the evening.

Technical papers, to be presented by outstanding radio engineers will occupy Thursday and Friday, Apr. 7 and 8, and a half day of activity is being arranged for the Conference's final day.

The technical papers will cover all aspects of radio engineering, on a practical and theoretical level, about half of them being devoted to television. Other subjects to be discussed will include magnetic recording, NAB recording and reproducing standards, and the problems of AM and FM radio.

In addition to the formal meetings of the Conference, the largest exhibit of radio and television equipment and services in NAB convention history will open Thursday, Apr. 7.

## FMA at New York, April 1

The FM Association has hired a new executive director at its Washington office and outlined an expanded program for 1949, with special emphasis on programming, time sales and agency relations. As executive director, FM Association has appointed Edward L. Sellers, an ex-Navy aviator who has been radio editor and sales representative for the Associated Press, Washington city news report for the past 17 months.

To assist in establishing and executing the expanded operating program for 1949, the association has retained the Faught Co., New York City, as public relations counsel. FMA's headquarters will be retained at Washing-

ton, D. C., and bulletin service to the members will be expanded, largely by "how-to-do-it" case material in tackling problems most common to FM stations.

In addition to its annual convention in Chicago, the association is planning an "FM Time Sales Clinic" on April 1 in New York City.

## IRE-RMA Meet April 25-27

Some of the newest technical developments in the radio-television industry will be discussed at the annual spring meeting of the RMA Engineering Department and the IRE April 25-27 at the Benjamin Franklin Hotel in Philadelphia.

Technical sessions will occupy the mornings of the three-day conference of radio engineers, and RMA and IRE committee meetings and inspection trips will occupy the afternoons, according to details of the program released by Virgil M. Graham, chairman of the committee in charge. Technical papers which will be presented are:

"A Three Kilowatt Medium Frequency Transmitter Utilizing Iron Core Interstage and Output Circuits"  
F. Deise and L. W. Gregory, Westinghouse Electric Corp.

"The Use of the Cavity Resonator in the Mobile Communications Field"  
Henry Magnuski, Motorola Inc.

"The Symmetron 50 Kilowatt FM Broadcast Amplifier"  
L. D. Balthis, Westinghouse Electric Corp.

"An Instantaneous Deviation Control for Phase Modulation Transmitters"  
Marion Winkler, Motorola, Inc.

"Television Recording Technique"  
R. V. Little, Jr., Radio Corporation of America

"The Ultrascope, Pioneer of Industrial Television Systems"  
M. Cawein and J. A. Good, Farnsworth Television & Radio Corp.

"A New Television Visual Modulator"  
A. J. W. Rhodehamel, General Electric Company

"The Reality of Invisible Forces"  
E. Finley Carter, Sylvania Electric Products Inc.

"High-Efficiency Coolers for Forced-Air-Cooled Power Tubes"  
M. B. Lemeshka and A. G. Nekut, Radio Corporation of America

"Audio Power Amplifier with Positive and Negative Feedback"  
John M. Miller, Jr., Bendix Radio

"Longitudinal Interference in Audio Circuits"  
H. W. Augustadt, Bell Telephone Laboratories

"Commercial PTM Telephone Microwave Link"  
N. J. Gottfried, Federal Telecommunication Laboratories

W. J. Logan, Maritime Telephone & Telegraph Company

## National Telemetry Forum

A new telemetry society, the National Telemetry Forum, has been organized for the purpose of developing telemetry. All organizations having a bona fide interest in telemetry are cordially invited to send representatives to the meetings of the National Telemetry Forum, and to participate otherwise in its activities.

The chairman is W. J. Mayo-Wells, Applied Physics Laboratory, Johns Hopkins Univ., 8621 Georgia Ave., Silver Spring, Md. Meetings are held once every six weeks at different plants, a recent session having been scheduled at the factory of Melpar, Inc., 452 Swann Ave., Alexandria, Va.

## Navy Host to AFCA, March 28-29

With the Navy as the host organization for this year's annual convention of the Armed Forces Communications Association, Washington, D. C., Admiral Louis Denfeld, Chief of Naval Operations, is slated to deliver a feature address at the annual AFCA banquet Monday, March 28.

The AFCA convention headquarters will be the Shoreham Hotel in Washington. On the second day of the convention, those attending the meeting will visit exhibits and demonstrations planned and directed by the Navy at its stations and aboard ships in the Washington area. The business meetings will be held March 28 at the Shoreham.

Since the unification of the armed services, it has been AFCA's policy to rotate the location and host service of the annual affair. The first convention, in 1946, was staged at the Signal Corps center at Fort Monmouth, N. J., and in New York City, while last year's meeting had the Air Force as host at Dayton, O., and the Wright-Patterson Air Force Base.

## Coming Events

**March 7-10—IRE Annual Convention.**  
Hotel Commodore and Grand Central Palace, New York, N. Y.

**March 14-17—Illinois Seventh Chicago Production Show,** sponsored by Chicago Technical Societies Council, Stevens Hotel, Chicago.

**April 6-9—National Association of Broadcasters, Engineering Conference,** Hotel Stevens, Chicago.

**April 11-12—Conference on Industrial Use of Electron Tubes,** American Institute of Electrical Engineers, Statler Hotel, Buffalo, N. Y.

**April 18-20—Midwest Power Conference,** sponsored by Illinois Institute of Technology, Sherman Hotel, Chicago, Ill.

**April 19-21—American Institute of Electrical Engineers, South West District Meeting,** Baker Hotel, Dallas, Texas.

**April 25-27—Fourth Annual Spring Meeting of IRE and RMA,** Benjamin Franklin Hotel, Philadelphia, Pa.

**May 2-4—International Scientific Radio Union and IRE, Joint Meeting,** East Bldg. Lecture Room, National Bureau of Standards, Washington, D. C.

**May 16-19—RMA and Radio Parts Show,** Hotel Stevens, Chicago, Ill. RMA 25th Anniversary.

**June 20-25—American Institute of Electrical Engineers, Summer General Meeting,** Swampscott, Mass.



## NEW NAMES AND ADDRESSES

George Miller has resigned as chief engineer of Televista Corp. of America to enter his own development and manufacturing company with offices and labs at 94 Holland Ave., Elmont, L. I., New York.

\* \* \*

William A. Gray, formerly with Raytheon Mfg. Co. has established a management consulting service at Middlesex Road, Watertown, Mass., planned for the electronic equipment and tube industry, and covering the functions of organization, product promotion and Government programs.

\* \* \*

W. T. LaRose & Assoc., Inc., manufacturers of "Thermal" electronic heating equipment have moved their entire manufacturing plant to new and larger quarters at 31 Ontario St., Cohoes, N. Y. This new location is only one mile from their previous address in Troy.

## Bell Files New Tariffs

New tariffs have been filed by the American Telephone & Telegraph Co. with the FCC, effective March 1, to clarify and amplify the provisions under which the company furnishes channels for television transmission. These filings are based on experience in providing service in recent months and are in line with statements made by the company during the television rate hearing before the FCC. Similar tariffs were also filed by the New England Telephone & Telegraph Co. to illustrate the type of tariff which will be filed by other Associated Companies of the Bell System, to become effective on the same date. The chief changes in the tariffs are:

A) The present tariff includes a provision that the A. T. & T. Company will not interconnect its inter-city television network facilities with the inter-city facilities of other companies, except in areas where the Telephone Company does not have such network facilities available. In the new filing, the conditions under which inter-city channels of other companies may be connected with Bell System inter-city channels are further clarified. The provisions fall into two categories:

1. Where the customer requires television network service for less than three months (usually for particular events and not for continual use), and if the telephone company does not have facilities, the inter-city channels of other companies may be interconnected with telephone company inter-city channels for varying periods up to three months — or until telephone company facilities are available. This depends upon the particular circumstances involved.

2. Where the customer requires television network service for more than three months' duration, and if the telephone company cannot within twelve months extend its facilities to the customer's location, the inter-city channels of other companies may be connected to Bell System inter-city channels for thirty-six months — or longer, if the telephone company does not then have facilities.

In both the above cases, the tariff provisions stipulate reasonable notice from and to customers as well as the periods of inter-connection.

B) Where available inter-city channels are insufficient to care for the requirements of all monthly service customers, usage will be allocated on a quarterly basis. This assures broadcasters the use of the channels for a longer period than the present 30 days, and thus should facilitate their selling network time to advertisers.

C) The areas in which local channel rates of the Bell System apply between television broadcasting stations are in general enlarged and made more uniform by including channels where the telephone exchanges serving the television customers are not more than twenty-five miles apart. As under the present tariff provisions, Bell System customers may use non-telephone company channels within these new areas and connect such facilities with the inter-city and local television networks of the Bell System on an unrestricted basis.

## U. S. Radio Stations and Operators

(as of December 31, 1948—FCC)

| Broadcast Stations                    |                |
|---------------------------------------|----------------|
| AM .....                              | 2,127          |
| FM .....                              | 966            |
| TV .....                              | 124            |
| Experimental TV .....                 | 182            |
| Educational .....                     | 50             |
| Facsimile .....                       | 2              |
| International .....                   | 37             |
| Remote pickup .....                   | 574            |
| Other .....                           | 40             |
| <b>Total .....</b>                    | <b>4,102</b>   |
| Nonbroadcast Stations                 |                |
| Aeronautical .....                    | 25,716         |
| Marine .....                          | 18,256         |
| Public Safety .....                   | 5,316          |
| Industrial .....                      | 3,661          |
| Land Transportation .....             | 3,506          |
| Amateur .....                         | 77,338         |
| Miscellaneous .....                   | *1,747         |
| <b>Total .....</b>                    | <b>135,540</b> |
| Radio Operators                       |                |
| Commercial .....                      | *366,000       |
| Amateur .....                         | 76,666         |
| Special aircraft authorizations ..... | 94,752         |
| <b>Total .....</b>                    | <b>537,418</b> |

\*Estimated.

\*\*Includes authorizations in the Common Carrier Services. (1,101 as of Dec. 31, 1948.)

## New Oscillograph Service

The engineering development and model shop facilities of the instrument division of Allen B. Du Mont Laboratories, Inc., are now available and are offered to the industry for the development, design and construction of special cathode-ray instruments. Establishment of this service is the re-

sult of an increasing demand for special equipment and for special modifications of catalog items. Recognizing the importance of special instruments to the advancement of the art of cathode-ray oscillography, the company has made its engineering design services and Model Shop facilities available for such work. Write to Allen B. Du Mont Laboratories, Inc., Instrument Division, 1000 Main Avenue, Clifton, New Jersey.

## Broadened Tube Standards

The American Standards Association Sectional Committee on Electron Tubes C-60, formerly sponsored by the Electrical Standards Committee, is now sponsored by the Joint Electron Tube Engineering Council, according to Virgil M. Graham, chairman of the Council and director of technical relations for Sylvania Electric Products, Inc.

The committee is being reorganized and its scope is being broadened to include definitions; classifications; methods of rating and testing; dimensions and interchangeability of electron tubes for all applications. The former committee concerned itself only with electron tubes for industrial use.

The new committee will include representatives of the American Association of Electrical Engineers, the American Association of Railroads, Electric Light and Power Group; the IRE; the Joint Electron Tube Engineering Council; the National Bureau of Standards; the National Electrical Manufacturers Association; the Radio Manufacturers Association; Telephone Group; the Army-Navy Electronic Engineering Agency, and liaison from the Canadian Standards Association.

O. W. Pike of the Electronics Department of the General Electric Company has been appointed chairman of the reorganized Committee.

## OPERATING SCHEMATIC OF TELEVISION RECEIVER

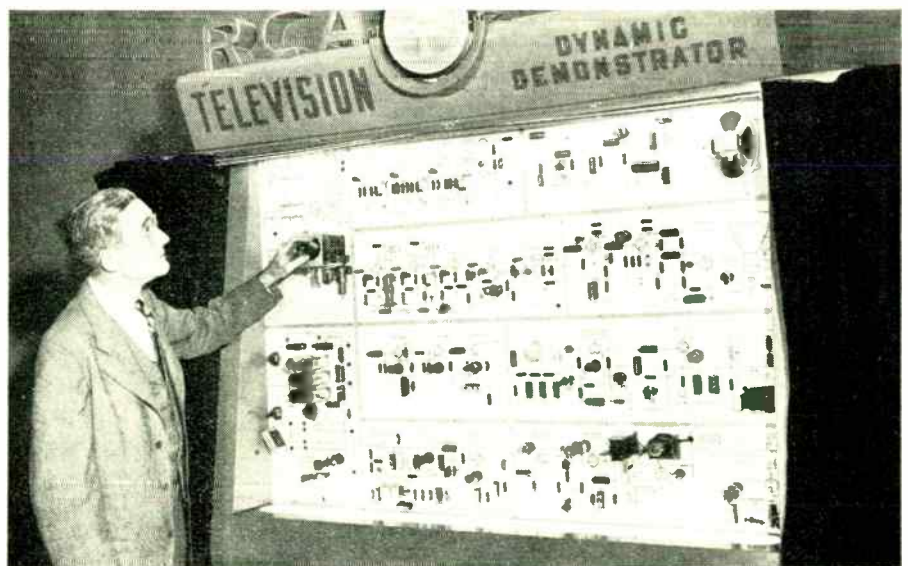

Resembling a giant operating schematic, the RCA Dynamic Demonstrator has every component and circuit of a conventional home television receiver mounted on a 3½ by 5½ ft. board. John Meagher, Tube Dept. specialist designer of the Demonstrator, is shown with the new unit which will aid the training of engineers and servicemen in TV troubleshooting.

# WASHINGTON

## News Letter



Latest Radio and Communications News Developments Summarized by Tele-Tech's Washington Bureau

**TELEVISION ENGINEERING STANDARDS IN MARCH**—Most important development for television in Washington will be the issuance by the FCC of its analysis of the engineering report by the joint industry-Commission "Ad Hoc" committee on propagation, ground wave and tropospheric interference subjects in the VHF portion of the spectrum, and the new Commission television and FM broadcasting engineering standards. This report, given intensive analysis and summarization during latter part of February by FCC Technical Division, is slated for publication early in March. The committee is composed of the topflight radio engineering executives of the IRE and RMA and the conference group has been headed by Edward W. Allen, chief of the FCC Technical (Engineering) Information Division. This timetable indicates that the FCC freeze on video applications may be lifted between April and June and Commission Chairman Coy's hope of UHF television channels being opened before the end of 1949.

**SENATE SUBCOMMITTEE REPORT MEANS POSTPONING FCC PANEL PLAN**—The plan of the Federal Communications Commission to divide into three panels or divisions in its major fields of regulation—broadcasting, common carrier communications, and mobile safety and special radio services—now has to be shelved or maybe even discarded as the result of a highly critical report on the proposal from the communications subcommittee of the Senate Interstate and Foreign Commerce Committee. The Senate Committee, of course, has jurisdiction in the Senate over radio and communications legislation and its words are most weighty when it comes to FCC.

**WOULD NEED SPECIAL CONGRESSIONAL ACTION**—The Senate subcommittee report, filed by Senators McFarland (D., Ariz.) and Tobey (R., N. H.), which received the approval of Chairman Johnson of the Committee, expressed the view that the panel system had weakness in the quasi-judicial procedure of regulation and actually could not be put into operation by the FCC without special Congressional legislation. To expedite the FCC's work load of applications and cases, the Senate subcommittee recommended that a system of legal officials apart from the regular law staff be instituted along the lines of examiners and that the Law, Engineering and Accounting Departments of the FCC be functionalized along the lines of the Commission's workload. In both the latter instances the FCC has been organized in this functionalized setup both under former Chairman Denny, now NBC Executive Vice President, and the present Chairman Wayne Coy.

**NATION'S RADIO MANUFACTURERS AGREE ON MOBILIZATION PLANS**—Nation's electronic-radio manufacturing industry and laboratories have completed their "make-ready" plans for the increased requirements of the military services under the present national defense preparedness program and for mushroomed growth for any war emergency. This was accomplished at the Feb. 16 meeting of the 29-member Electronics Equipment Manufacturing Industry Advisory Committee with the Munitions Board and National Security Resources Board that evolved an overall mobilization plan for equipment and parts production and research activities.

**A. T. & T. TARIFF CHANGES AID BROADCASTERS**—In line with discussions at the recently-concluded FCC hearing on the A. T. & T.'s ban on interconnecting its intercity television links with those of others where telephone company facilities are available, the A. T. & T. has revised its tariffs to protect telecasters who build their own intercity relay systems. The tariff change is that when a telecaster in an area not served by the Bell System TV network requires service for a period of more than three months, and the A. T. & T. does not foresee extending its own links to the telecaster's city within a year, the latter can interconnect any relay he might build with the Bell System facilities for three years. Heretofore, the telecaster could not have interconnected with the telephone company links after they became available. Thus, the new tariff affords opportunity for a three-year amortization of the private system.

**POLYCASTING BY WILMOTTE**—In the January "Washington News Letter's" first item on the deep interest which television has stimulated in Washington officialdom, there was an editorial error in stating that FCC Chairman Coy had publicly commended "polycasting in the UHF band of TV as developed by RCA." The correct reporting of Chairman Coy's remarks before the Television Broadcasters Association should have brought out that the FCC chieftain had commended both "polycasting" as developed by Raymond Wilmotte, a leading radio engineer, and "TV carrier synchronization" as developed by RCA, which are both excellent methods for extending UHF television. The RCA method had been tested very successfully by the NBC ultra-high-frequency video station WNBW in Washington. Mr. Coy also cited in his address Westinghouse's "stratovision" as a medium for the relaying of television programs and increasing coverage beyond the horizon areas.

ROLAND C. DAVIES  
Washington Editor

National Press Building



There's a Beckman

# Helipot

(Trade Mark of the HELICAL POTentiometer)

to simplify YOUR Potentiometer—Rheostat Problems!

HELIPOT'S Wide-Range, High-Precision Control Advantages Available in Many Sizes of Units

**Helipot**—the original helical potentiometer—has proved so popular in modernizing and simplifying the control of electronic circuits, that many types and sizes of *Helipots* have been developed to meet various potentiometer-rheostat problems. Typical production *Helipot* units include the following . . .

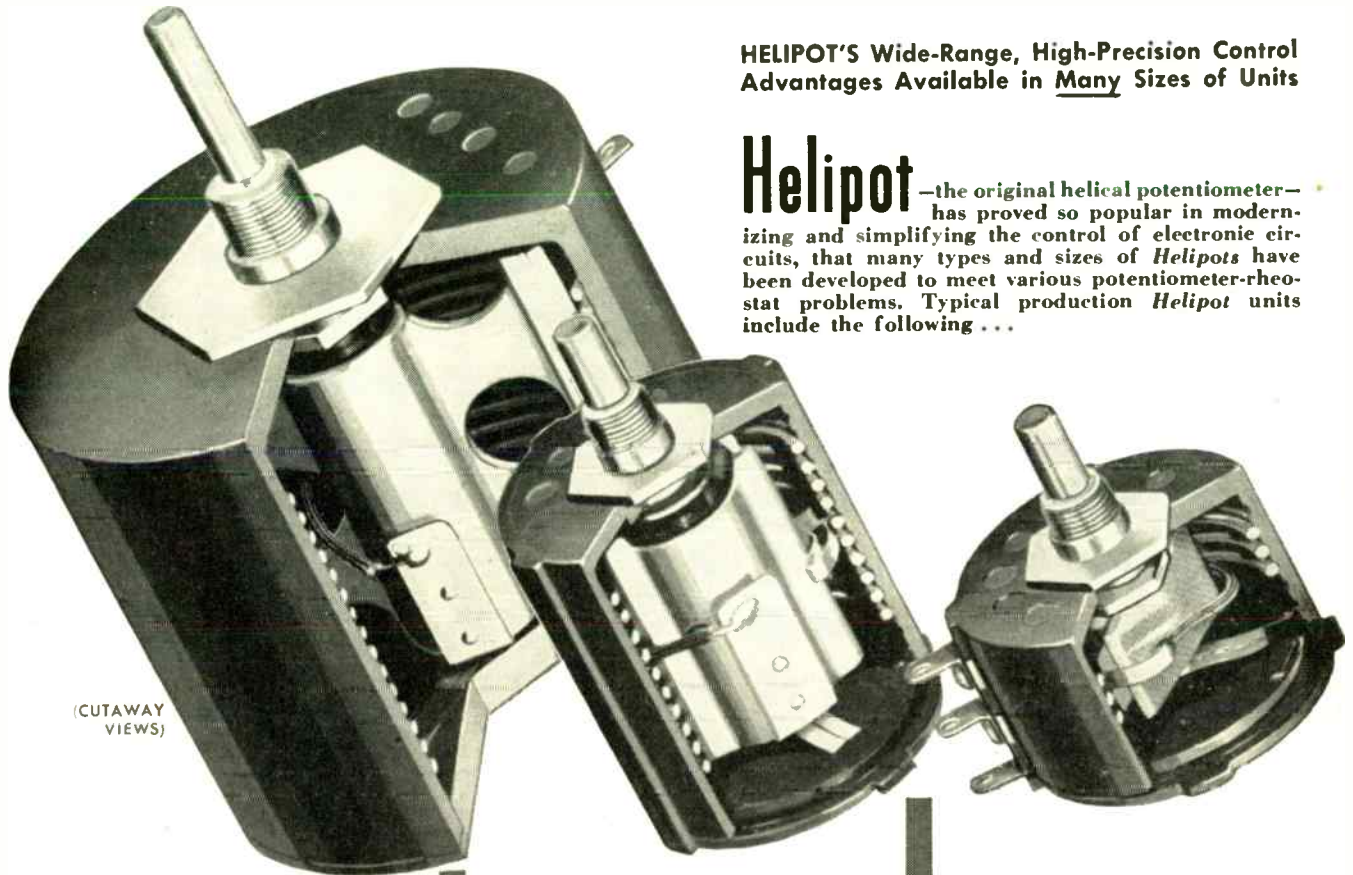

(CUTAWAY VIEWS)

**MODEL B**—Case diameter—3.3"; Number of turns—15; Slide wire length—1.40½"; Rotation—5400°; Power rating—10 watts; Resistance ratings—50 to 300,000 ohms.

**MODEL A**—Case diameter—1.8"; Number of turns—10; Slide wire length—46½"; Rotation—3600°; Power rating—5 watts; Resistance ratings—10 to 100,000 ohms.

**MODEL C** Case diameter—1.8"; Number of turns—3; Slide wire length—13.5"; Rotation—1080°; Power rating 3 watts; Resistance ratings—5 to 30,000 ohms.

### SPECIAL MODELS

In addition to the above standard *Helipot* units, special models in production include . . .

**MODEL D**—Similar to Model B, above, but longer and with greater length of slide wire. Case diameter—3.3"; Number of turns—25; Slide wire length—234"; Rotation—9000°; Power rating—15 watts; Resistance ratings—100 to 500,000 ohms.

**MODEL E**—Similar to Model B, but longer and with greater length of slide wire than Model D. Case diameter—3.3"; Number of turns—40; Slide wire length—373"; Rotation—14,400°; Power rating—20 watts; Resistance ratings—150 to 800,000 ohms.

Send for HELIPOT Literature!



**THE Helipot CORPORATION**  
SOUTH PASADENA 3, CALIFORNIA



**WIDE CHOICE OF DESIGN FEATURES**

Not only are *Helipots* available in a wide range of sizes and ratings, but also can be supplied with various design features to meet individual requirements . . .

- ▶ Available with special length shafts, flatted shafts, screw-driver slots, etc.
- ▶ Can be supplied with shaft extensions at each end to permit coupling to indicating instruments or other devices.
- ▶ May be provided in ganged assemblies of two or three units, all operating from a common shaft.
- ▶ Available with linearity tolerances of 0.1%—and even less.
- ▶ Models A & B can be modified to include additional taps at virtually any point on windings.

. . . and many other special features.

Investigate the many important advantages to be gained by using the *Helipot* in your electronic control applications. Write outlining your problem!

Have you latest data on DUODIAL—The turns-indicating knob dial? If not, write!

# TV & Communications Components

## Television Tuner

A unique combination of inductance and capacity variation is featured in model TF 701, a new television front end tuner. This unit

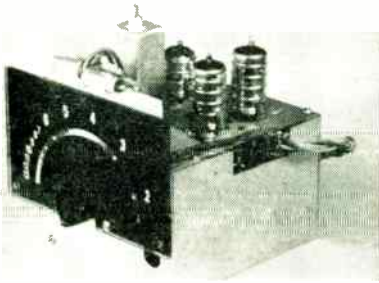

tunes continuously over twelve channels with substantially constant bandwidth. Frequency gaps between channels are bridged in one smooth motion, so that a 150° rotation of the tuning device covers all channels. The unit contains conventional rf amplifier, oscillator and mixer circuits and comes complete with lighted dial and planetary reduction drive.—**Vision Research Laboratories, Inc.**, 87-50 Lefferts Blvd., Richmond Hill, N. Y.

## Remote Control Unit

Turning on the plate power at the transmitter or silencing a particular combination of station receivers are two of the functions per-



formed by the EC-8-A, a new remote control unit. It employs an automatic level control preamplifier to modulate the transmitter and to maintain the maximum allowable signal. There are two separately controlled inputs to the line amplifier circuit; one for station receiver monitoring; another for monitoring auxiliary receivers.—**General Electric Corp.**, Syracuse, N. Y.

## TV Camera Pedestal

Capable of rolling smoothly and silently on 3 rubber-tired wheels, the TD-1A studio camera pedestal provides a convenient and

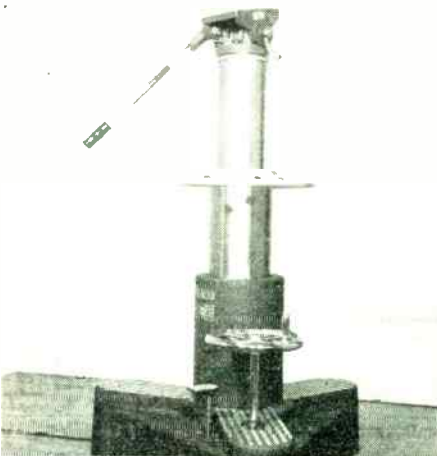

useful mounting for the television camera in the studio or other indoor telecast locations. A crank handle raises or lowers the camera between 49 and 60 in. above the floor. The crane boom on which the camera is mounted can be raised to a height of 74 in. or lowered to 23 in. above the floor.—**RCA Victor Div.**, Radio Corporation of America, Camden, N. J.

## TV Distributing System

A simple low-cost solution to the problem of satisfactorily operating a number of television sets from one antenna is offered by the Multivideo Connector, a unit which operates like a bridging transformer picking up a signal through the insulation of ordinary twin-lead feed-line. One Multivideo Connector is required for each receiver using the same antenna. Connectors are about 80% efficient and give satisfactory coupling so long as there is a 20% reserve of signal in the antenna system. As many as thirty receivers have been operated in a system without mutual interference or cumulative signal loss.—**Reeves Soundcraft Corp.**, 10 East 52nd St., New York 22, N. Y.

## FM Carrier Telegraph

Operation of the model 22 FM or carrier shift telegraph system is free of interference on 18 60-word-per-min. channels between 420

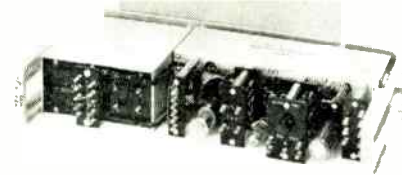

or 2460 cps or 12 75-wpm channels between 425 and 2039 cps. Transmitter, receiver (illustrated), and relays are mounted in separate panels. Multi-section networks incorporating toroidal coils wound on molded iron-powder cores are utilized for filter sharpness. All components are detuned, plug-in relays are used throughout, and circuits are designed to use industrial type tubes.—**Lenkurt Electric Co.**, 1109 County Road, San Carlos, Calif.

## Television Tuner

The Guthman Super Q Television Tuner, an all channel selector, can be mounted ver-

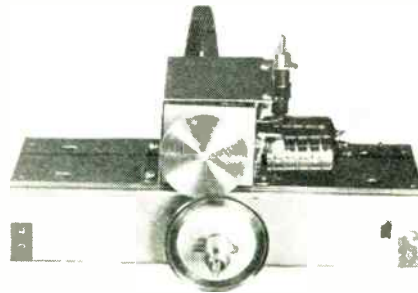

tically or horizontally on a receiver chassis. It has tuned transformer input and no double conversion effects. There is a high frequency switch control and a separate vernier for fine tuning. The design of the unit makes it easily accessible for servicing.—**Edwin I. Guthman & Co.**, 15 S. Troop St., Chicago 7, Ill.

## VHF-FM Receiver

Dual tuned circuits with extremely high "Q" are used throughout model 389-R VHF-FM receiver, a crystal-controlled, fixed-fre-



quency, superheterodyne unit designed for single channel reception. Unlike most 152-162 MC FM receivers, the 389-R utilizes single conversion with resultant circuit simplification and reduction of spurious responses. All but one circuit are capacitor tuned. Chassis is mounted behind a 19-in. relay rack panel, 5 1/4 in. high.—**Communications Co., Inc.**, 300 Greco Ave., Coral Gables, Florida.

## TV Chassis

A television receiver which can use a 10 or 12-in. tube has been designed for custom installation and is supplied complete with

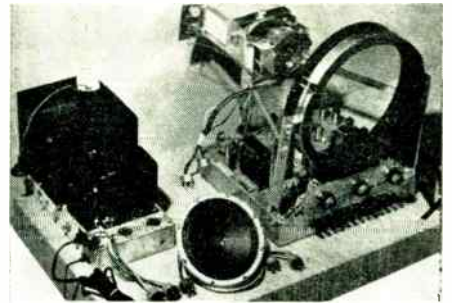

speaker and all tubes (less picture tube). Known as model T-64, it comes in two units: a main receiver chassis and a power supply chassis. Dual focusing provides larger size pictures on the same size tube without abandoning absolute linearity of proportion between width and height. The unit has 19 tubes and 3 rectifiers, not counting picture tube.—**Hallcrafters Co.**, 4401 Fifth Ave., Chicago, Ill.

## Power Supply

Model 252 regulated DC power supply has an output adjustable from 260 to 300 volts DC, negative grounded. Input requirements



are: 115 volts, 60 cycles, 400 watts. With load changes from 400 to 600 milliamps, the output voltage change at any setting is less than 0.05%, varying between individual units from 0.015% to 0.04%. Equal stability exists with respect to minor line voltage changes. Noise level is less than 0.001%.—**Beta Electronics Co.**, 1762 Third Ave., New York 29, N. Y.

## Isolation Transformer

An air insulated isolation transformer has been developed for supplying 60-cycle lighting voltages to antenna tower lighting cir-

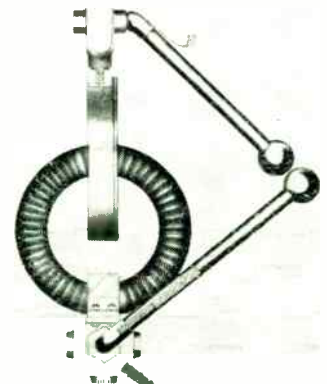

cuits without providing an RF path to ground. Paralleling the unit across a tower base only produces a negligible change in the base impedance of the tower because RF impedance is so great, due to an interwinding air gap. A ball gap lightning arrestor is provided to protect the unit from lightning damage.—**Andrew Corp.**, 363 East 75th St., Chicago 19, Ill.



## New Tubes

### Miniature Pentode

Type 6AN5 is a new miniature pentode (left in illustr.) which may be used in many of the applications for which the metal tube 6AG7 was previously used. In addition, it is

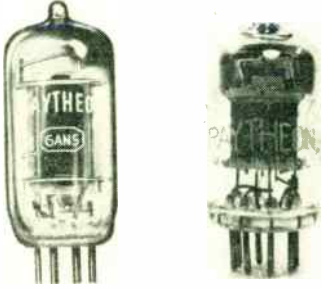

useful at the very high frequencies as a frequency multiplier, wide band RF or IF amplifier, class C RF amplifier, and switching tube for computers. The 6AN5 has a normal plate current rating of 35 MA and a transconductance of 8,000  $\mu$ mbos. Type of 6AK5 (right in illustr.) meets Bureau of Ships specifications and was developed specially for aircraft equipment applications where the standard type 6AK5 had not proved sufficiently dependable. The heater is designed to withstand at least 5,000 on and off cycles at 7.5 volts, and special care is given in production to insure a tube of the highest quality, best performance and longest possible life.—Raytheon Mfg. Co., 60 East 42nd St., New York 17, N. Y.

### Power Triodes

Four new power triodes have been developed with plate dissipation ratings ranging from 0.6 KW to 50 KW. The 5786 (upper left) which is designed for industrial and broadcast service is an improved version of the type 6C24, permitting use with a low-cost blower. It has a maximum plate dissipation of 600 watts. Model 5771 (upper right) has a maximum plate dissipation of 22.5 kilowatts and a thoriated tungsten filament for high emission capability facilitates a saving of almost 70% in filament power. It has a maximum filament

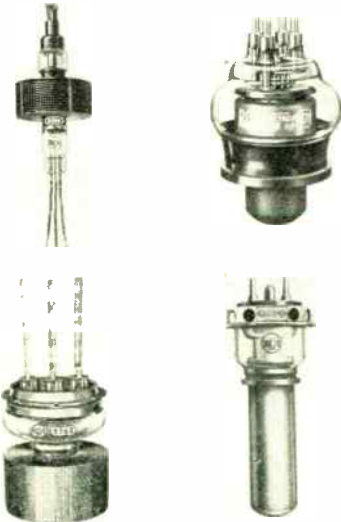

starting current 4.7 times higher than the filament operating current, thus permitting operation without a filament starter. The 5762 (lower left) is a thoriated-tungsten-filament type of forced-air-cooled, grounded-grid power triode designed for FM broadcast and industrial services. It has a maximum plate dissipation of 2.5 KW, and can be operated with full plate voltage and plate input up to 110 MC. Type 5770 is a power triode with a maximum plate dissipation of 50 KW. A strong, cylindrical copper grid support protects the grid from electron bombardment and radiated filament power as well as providing low grid inductance, low plate-filament capacitance, and effective RF shielding between plate and filament in grounded-grid circuits.—Tube Dept., RCA Victor Div., Radio Corporation of America, Harrison, N. J.

"I DID IT . . .

I DID IT . . .

I DID IT!"

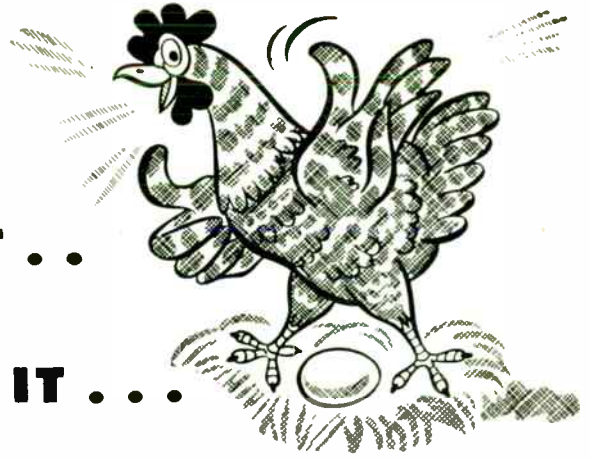

The hen gives herself a good round of applause every time she lays an egg. And well she might — but she couldn't have done it without that little bit of calcium which forms the shell.

Every time a top engineer sees one of his drawing board dreams breaking a speed or endurance record, he says to himself, "I did it — did it — did it!" — and that does not mean he has laid an egg, either.

But that dream could not have materialized — not good — without that little bit of so-essential Mica. And not real good — if that Mica wasn't Macallen.



# MACALLEN MICA

ALL FORMS, ALL QUANTITIES — ALL DEPENDABLE

when you think of MICA, think of MACALLEN

**THE MACALLEN COMPANY** • 16 MACALLEN ST., BOSTON 27, MASS.

CHICAGO: 565 W. WASHINGTON BLVD. • CLEVELAND: 1231 SUPERIOR AVE.

# READ NOISE FIGURE DIRECTLY WITH THE MEGA-NODE (NOise dioDE) A Calibrated Random Noise Source



## HELPS OVERCOME RF FRONT END PROBLEMS

- Extend the range of your high frequency receiver (TV, FM, Radar) by reducing noise. The MEGA-NODE provides a simple method of determining the noise figure. Read the noise figure in db directly from a meter.
- Indicating meter reads db on a linear scale. Choice of several output impedances. Output contains negligible hum.
- Uses: Laboratory, production line testing, development of TV, FM, Radar and other high frequency receivers.

### SPECIFICATIONS

**Frequency Range:** 1 to 220 mc  
**Output Impedances:** 50, 70, 100, 150, 300, ohms and infinity controlled by panel switch.  
**Noise Figure Range:** 0 to 17 db at 50 ohms  
 0 to 23 db at 300 ohms  
**Filament Voltage:** Regulated d.c. used on filament of noise generating tube.  
**Power Supply:** 117±8 volts 60 cps  
**Dimensions:** 8" x 16" x 8"

Price \$295.00 F.O.B. Factory

## KAY ELECTRIC COMPANY

23 MAPLE AVENUE, PINE BROOK, NEW JERSEY  
 CALDWELL 6-4000

### MANUFACTURERS OF

|                        |                      |               |
|------------------------|----------------------|---------------|
| Mego-Sweep             | Megaliner            | Megalyzer     |
| Mega-Marker            | Mega-Match           | Mega-Pipper   |
| Mega-Morker Sr.        | Megolyzer Mega-Motch | Megalyzer Jr. |
| Kay Sound Spectrograph | Mego-Pulser          | Micro-Pulser  |

SEE THESE INSTRUMENTS AT  
 BOOTH 22 IRE CONVENTION

## Sound Equipment

### LP & Standard Reproducers

Models 153 M and R reproducers have been designed for long-playing microgroove records and regular standard recordings. Micro

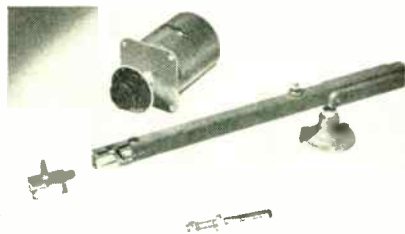

groove recording reproducer (model M) consists of playing arm, head piece, cartridge, rest, and compensating network with four position switch. Components of model R are identical but unit is designated for standard lateral recordings. The compensator network and switch provide proper characteristics for reproducing flat recordings, 78 rpm phono records, NAB recordings, and recordings requiring a large roll off at the high end. The frequency response of the compensator in the various equalizer positions is practically unaffected by the value of the terminating load impedance over a range of 100 ohms to high impedance.—Presto Recording Corp., P. O. Box 500, Hackensack, N. J.

### Magnetic Tape Recorder

A completely new type of recording mechanism, and a compact high gain amplifier unit are two features of the Crestwood Magic Tape

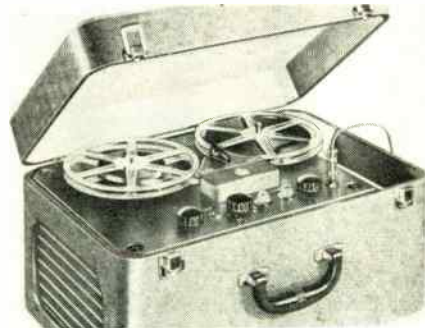

Recorder which faithfully reproduces the full frequency range from 50 to 8000 cycles. The two-channel recording system will transcribe a full hour of recording on a standard half-hour reel. In addition, the machine will also play single channel recordings made on other machines. Rewind time is less than 1½ minutes for the half-hour reel. Automatic erasing device has a safety control that prevents accidental erasing while rewinding tape.—Crestwood Recorder Corp., 218 S. Wabash Ave., Chicago 4, Ill.

### Cueing Amplifier

A new cueing amplifier for transcription turntables provides a local audio signal suitable for monitoring or cueing. Known as the



635-A2, it uses pushpull stages and inverse feedback and will supply 3 watts of audio to a loudspeaker. Frequency response is from 70 to 15,000 cps, ± 1 db. Various voice coil impedances are available and a high impedance output is provided for feeding one or more headsets. A transformer input of 10,000 ohms impedance permits grounded or ungrounded bridging across any low impedance line without reflecting a mismatch.—Fairchild Recording & Equipment Corp., 154th St. & 7th Ave., Whitestone, N. Y.



### Noise Suppressor Amplifier

New changes in the output transformer and chassis finish of model 210-A laboratory amplifier with dynamic noise suppressor have re-



sulted in substantial improvements in performance, without sacrificing any of the compactness and fine design that characterize the unit. The oversize output transformer provides freedom from distortion and reduces hum level to 56 dB below maximum power output under normal operating conditions. Actual hum power level is only 0.05 microwatt.—Hermon Hosmer Scott, Inc., 385 Putnam Ave., Cambridge Mass.

### Auxiliary Speaker

As many as eight Ad-A-Vox auxiliary speakers can be connected to the standard radio set, television receiver, phonograph or amplifier, without altering normal operation and sound quality. Each one of these new units is fully enclosed in a non-breakable cast-aluminum case and contains a quality 4-in. permanent-magnet speaker with volume control.—Tarrytown Metalcraft Corp., 82 Chestnut St., Tarrytown, N. Y.

### Tone Arm

The cartridge of the new Trionic arm for transcriptions and records can be quickly replaced without soldering and no adjustment



of needle force is necessary. A quick-acting weight adjustment makes possible any needle force from 5 grams up. The arm will accommodate any pickup cartridge, magnetic or crystal, not over 3/4 in. wide. Available in 2 sizes, the Trionic can be used with 12-in. records and 16 or 1-in. transcriptions and acetates.—Clarkston Corp., 11927 West Pleo Blvd., Los Angeles 34, Calif.

### Portable Sound System

An acoustical output equivalent to that of a 30-watt portable sound system is provided by the SP-15A, a 15-watt amplifier with a



heavy-duty alnico permanent magnet-type loudspeaker. Two loudspeakers can be attached to the amplifier to give the same high output for large auditoriums or locations requiring greater coverage than can be provided by one loudspeaker.—RCA Victor Div., Radio Corporation of America, Camden, N. J.



## 2 new stars in the field

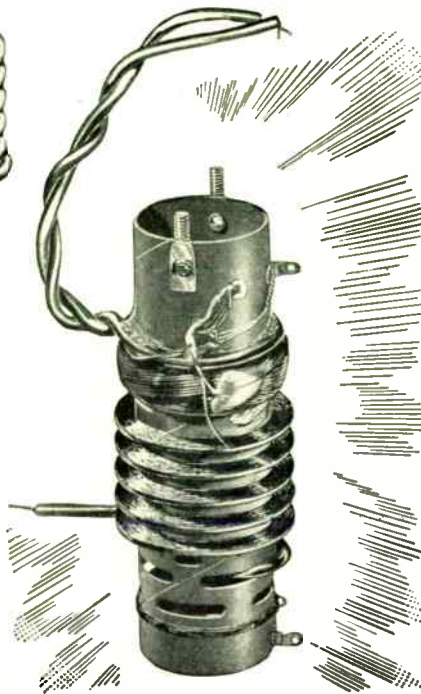

For  
TELEVISION  
RECEIVERS



## Specify COSMALITE\*

Cosmalite Coil Forms give exceptional performance at a definite saving in cost to you.

Punched, threaded, notched and grooved to meet your individual specifications.

See our

Exhibit #220

at the I.R.E. Radio

Engineering Show

Ask us about the many various punching dies we have available.

Inquiries given quick action and specialized attention.

\*Reg. U. S. Pat. Off.

## The CLEVELAND CONTAINER Co.

6201 BARBERTON AVE. CLEVELAND 2, OHIO

- All-Fibre Cans • Combination Metal and Paper Cans
- Spirally Wound Tubes and Cores for all Purposes
- Plastic and Combination Paper and Plastic Items

PRODUCTION PLANTS also at Plymouth, Wisc., Ogdensburg, N.Y., Chicago, Ill., Detroit, Mich., Jamesburg, N.J.,  
PLASTICS DIVISION at Plymouth, Wisc. • ABRASIVE DIVISION at Cleveland, Ohio  
SALES OFFICES: Room 5632, Grand Central Term. Bldg., New York 17, N.Y., also 647 Main St., Hartford, Conn.  
CANADIAN PLANT: The Cleveland Container Canada, Ltd., Prescott, Ontario

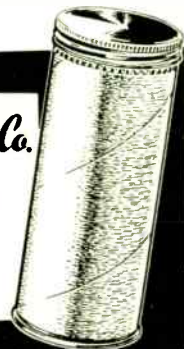

"Tiny—but these  
Phenolite parts sure  
solved that  
tough insulation  
problem\*."

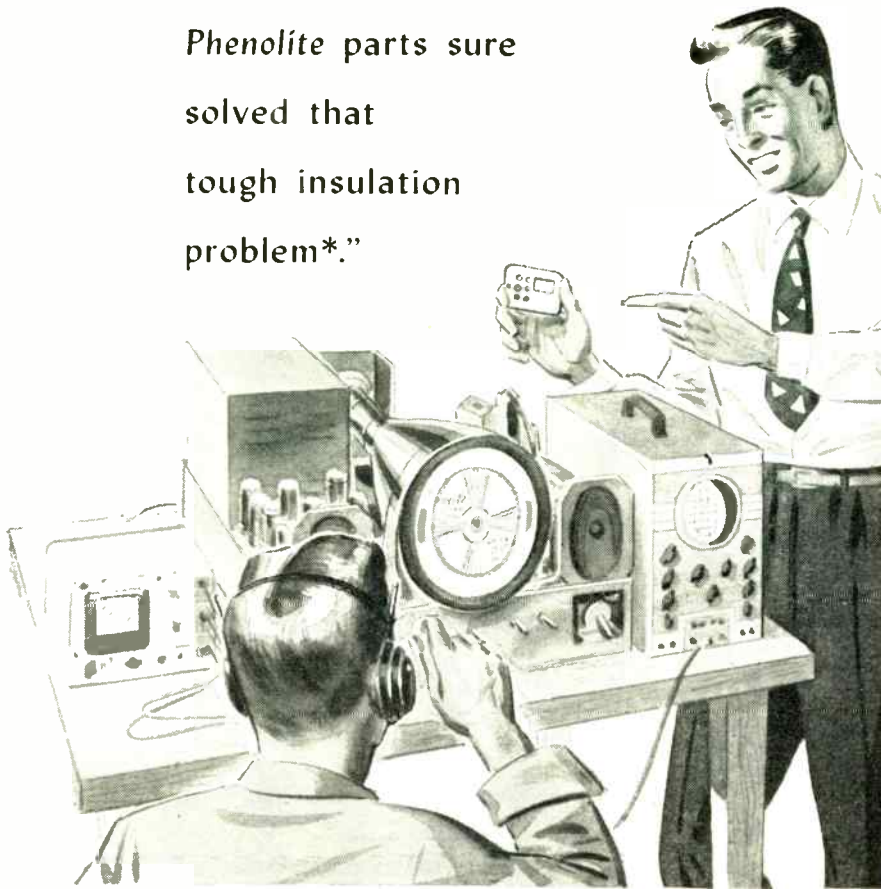

\*Required:

*A material with very high insulation resistance under all atmospheric conditions—with good mechanical strength and ready machinability. Phenolite, laminated plastic, with all these qualities, plus—was the perfect answer.*

In your development of efficient, economical products, it pays to investigate

**PHENOLITE**  
Laminated PLASTIC

About one-half the weight of aluminum, possesses an unusual combination of properties—a good electrical insulator, great mechanical strength, high resistance to moisture; ready machinability. Sheets, Rods, Tubes, Special Shapes.

**NATIONAL  
VULCANIZED  
FIBRE**

A tough, horn-like material with high dielectric and mechanical strength. Excellent machinability and forming qualities, great resistance to wear and abrasion, long life, light weight. Sheets, Rods, Tubes, Special Shapes.

**PEERLESS  
INSULATION**

The first fish paper developed for electrical insulation. Strong, smooth, flexible, with excellent forming qualities. High dielectric strength. Sheets, Rolls, Coils.

*To help you solve your specific development problem—available without obligation—National Research and Engineering Service.*

**NATIONAL VULCANIZED FIBRE CO.**

WILMINGTON



DELAWARE

Offices in

Principal Cities

Since 1873

## Parts for Designers

### Shielded Lead-In

Intelin K-111, a new 300 ohm shielded, balanced line meets the demand for a lead-in that minimizes noise, "snow" and "ghosts" due to transmission line pickup and in many cases eliminates the necessity for expensive

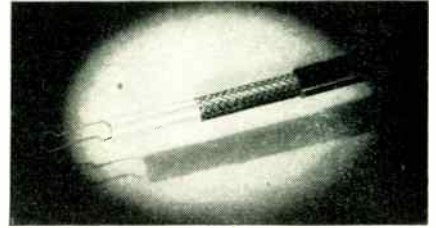

and elaborate antennas. This is believed to be the first solution to the problem of noise introduced in the unshielded 300 ohm lead-in from such sources as automobile ignition, fluorescent lighting, or reradiation from nearby structures. Field tests were conducted in an urban area located near a manufacturing center where a large number of electrically powered equipments are used. When the unshielded line was in use, the picture on the screen was badly disrupted every time any industrial equipment, such as an electric welder, was in operation. However, when the unshielded line was replaced by the K-111, a clear, sharp picture was obtained at all times.—Federal Telephone & Radio Corp., 100 Kingsland Road, Clifton, N. J.

### Mechano-Electronic Transducer

Designed for applications involving the measurement of mechanical vibration, the RCA-5734 is less than an inch long and a little

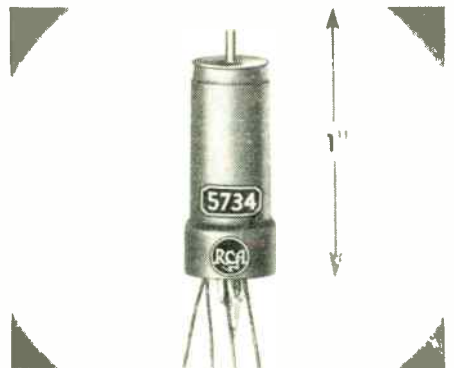

smaller in diameter than a cigarette. It has a deflection sensitivity of 40 volts per degree deflection of its plate shaft. The part of the plate shaft inside the tube has a free cantilever resonance higher than 12,000 cps. With mechanical coupling to the external end of the plate shaft, vibrations up to 10,000 cps may be measured.—Tube Dept., Radio Corporation of America, Harrison, N. J.

### Proportional Time Delay Relay

An initial time delay of one minute is provided by the new Agastat time delay relay and once its timing cycle is complete, should

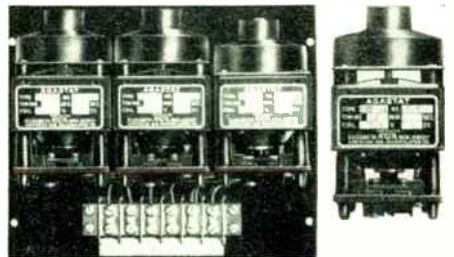

a power failure occur, it switches off immediately. Restoration of power within one to 15 seconds re-establishes the circuit. If a power failure exceeds 15 seconds, a time delay proportional to the length of time of power failure takes place when the power is restored. A combination unit of two proportional and one standard Agastat facilitates a proportional time delay up to five or more minutes.—Agastat Div., American Gas Accumulator Co., 1029 Newark Ave., Elizabeth 3, N. J.



### Rotary Shaft Seals

Series 110 rotary shaft seals have been designed to meet the needs of manufacturers of radio, television, communication and elec-

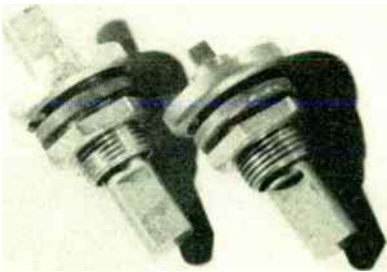

trical circuit controlling apparatus for water-proof and moisture sealed rotating shafts. Miniature in size, they combine the flexibility of rubber in shear, and the sealing quality of rubber vulcanized to metal, with the low frictional resistance of metal against graphite, and the corrosion resistant quality of high grade brass and bronze.—H. & H. Buggle and Co., Madison Ave. & 22nd Streets, Toledo, Ohio.

### Stepping Switch

A new high-speed, spring-driven stepping switch, which may have from 1 to 10 bank levels each comprising 26 contacts, has been

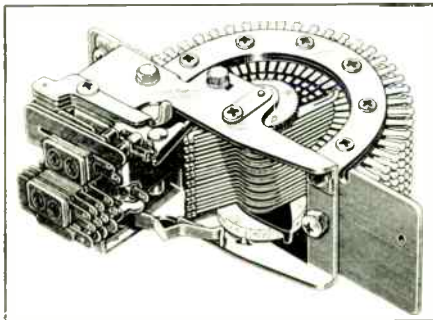

developed. Stepping magnet may be remotely controlled or wipers may be caused to step automatically by interrupting magnet circuit through a pair of interrupter springs on the switch. Switch may be allowed to stay at completion of operating cycle or it may be homed or returned to normal. New features include molded bank levels whose dimensions are controlled with extreme accuracy, an extremely lightweight rotor which reduces mechanical inertia, and the keying rotor parts to prevent shifting.—C. P. Clare & Co., 4719 W. Sunnyside, Chicago, Ill.

### Dual-Electrolytic Capacitors

Stud terminals in place of conventional drive-type terminals for the dual leads have slashed the bulk of the new PRS midret-can

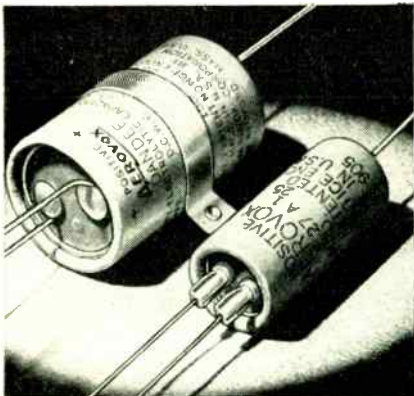

dual-section electrolytics to considerably less than the previous sizes. The new stud terminals to which the usual bare pigtailed leads are positively crimped, have reduced terminal diameters without loss in mechanical strength or change of standard pigtail leads. The space saved by the stud construction reduces the tubular diameter up to 40% of that of conventional design units, and the bulk up to about one third.—Aerovox, Corp., New Bedford, Mass.

# Standard in the RADIO AND TV FIELD



Kester Flux-Core Solders are as modern as today's TV receiver. The latest Kester development is "Resin-Five" . . . a flux-core solder that is absolutely non-corrosive and non-conductive and yet readily solders such metals as zinc, brass, nickel silver, nickel-plate, copper, and ferrous alloys. The most efficient solder made for radio and TV work. Available in all standard and special gauges. Various core sizes can be had to control the amount of flux you need.

#### Free—Technical Manual

Send for Kester's new 28-page manual, "SOLDER and Soldering Technique" . . . a complete analysis of the application and properties of soft solder alloys and soldering fluxes.



## KESTER SOLDER COMPANY

4210 Wrightwood Avenue, Chicago 39, Illinois

Factories Also At

Newark, New Jersey • Brantford, Canada

# KESTER SOLDER

# Choice of 626 Tubular Resistor Values IN STOCK

Hundreds of other Stock Types, sizes and values!



**the Variety! . . . the Range! . . . the Quantity!  
Ready to Meet Your Needs Quickly!**

More Ward Leonard wire-wound resistors have been produced and used over more years than any other make. And records show that quite often a stock unit as the perfect answer to many an industrial need . . . for application, for performance, for economy, for quick delivery. For example: there are 626 Vitrohm tubular stock values in fixed and adjustable types . . . and many others . . . promptly available! It pays to check into them . . . for your requirements.

Contact your local Ward Leonard Authorized Industrial Distributor.

Send now for handy Stock-Unit Catalog D-130

Radio and Electronic Distributor Division  
**WARD LEONARD ELECTRIC CO.**  
53-T West Jackson Blvd., Chicago 4, U. S. A.



The sign of a  
Ward Leonard  
Authorized  
Industrial  
Distributor

## WARD LEONARD

RESISTORS • RHEOSTATS • RELAYS • CONTROL DEVICES

WHERE BASIC DESIGNS ARE RESULT-ENGINEERED FOR YOU

## New Laboratory & Test Equipment

### Dual Channel Oscilloscope

In order to provide maximum flexibility, the deflection amplifiers on model H-2GTC dual channel oscilloscope have been designed

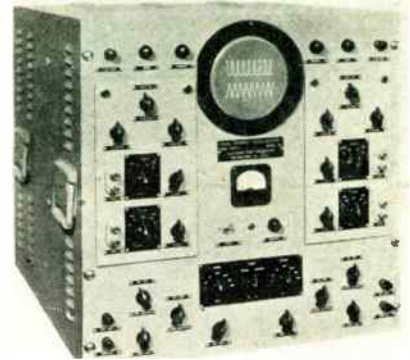

as removable units. Amplifier units consisting of vertical and horizontal amplifiers, having frequency characteristics from either 10 to 100,000 cps  $\pm 1$  DB or 10 cps to 800,000 cps  $\pm 1$  DB are available. This equipment is normally supplied with one of each unit so that frequency coverage from 0 to 1 MC is available. Each channel is supplied with an independently operating sweep generator. Both channels may be switched to the same sweep, allowing the examination of two related phenomena on a common time base. Since this equipment is essentially two oscilloscopes in one, separate controls are provided for independent control of the intensity, focus, and horizontal and vertical position of each beam.—Electronic Tube Corp., 1200 East Mermaid Lane, Philadelphia 18, Pa.

### Bar and Dot Generator

Signals needed for properly adjusting the horizontal and vertical sweep linearity of television receivers are provided by type 2000

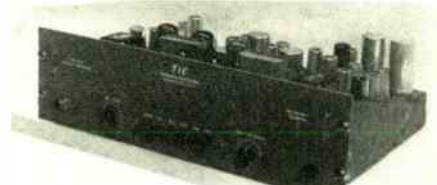

bar and dot generator. This unit is normally used in conjunction with any standard synchronizing signal and monoscope generator or other pattern. Model 2000 operates from the horizontal driving signal and is inserted in the blanking signal line between the "sync" generator and monoscope unit. A control is provided to shift the vertical lines or dots to any position in the field so as to avoid disrupting the horizontal resolution wedge.—Tel-Instrument Co. Inc., 30 Paterson Ave., East Rutherford, N. J.

### Slotted Line

Model 805A slotted line substitutes two parallel planes and a rigid central circular

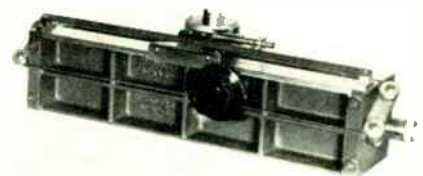

conductor for the conventional coaxial arrangement. This configuration has two important advantages: parallel planes may be made mechanically rigid while also providing a rigid probe carriage; and the central conductor is proportionately larger and thus can be similarly rigid, eliminating tendency to bow. The depth of probe penetration is much



less critical, and carriage inaccuracies are all but eliminated. In this model, the slot opening is less than .001 in. referred to a coaxial system, and this serves to keep the leakage very low. Residual VSWR can be held to less than 1.04. Flat sections or planes are cast, normalized aluminum alloy and they are ribbed to combine strength and light weight. Frequency range is 500 to 4,000 MC and characteristic impedance is 50 ohms. The probe circuit is tunable over the entire frequency range, and the position may be read to 0.1 mm.—Hewlett-Packard Co., 395 Page Mill Road, Palo Alto, Calif.

### Traveling Wave Amplifier

Especially adapted for use in television testing, nuclear instrumentation, oscillography and general laboratory measurements, model 200A

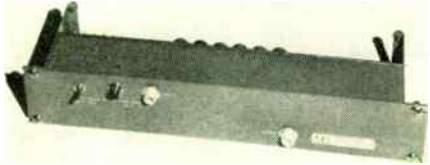

traveling wave amplifier has a bandwidth of 220 MC and a gain of 10 DB per stage. Transmission characteristic is 1.5 DB from KC to 200 MC, and SWR is less than 1 DB over this band. Phase shift in the amplifier is substantially linear within the pass-band, owing to mutual-inductance coupling between adjacent sections. Each stage has a tube complement of six 6AK5 tubes.—Spencer-Kennedy Laboratories, Inc., Dept. TT, 186 Massachusetts Ave., Cambridge 39, Mass.

### Microwave Signal Generator

A direct reading frequency meter and a variable attenuator calibrated directly in DB below one watt have been incorporated in a

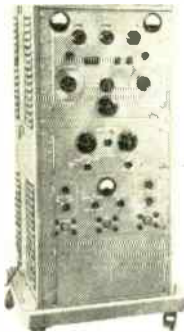

new broad-band microwave signal generator which covers a frequency range from 4200 to 10,300 MC. Military designation of the instrument is TS-600/U. Provisions are made for continuous wave and pulse operations with rise time of 1/10th of a microsecond. The RF attenuator is the waveguide-below-cutoff type with matched resistive loops.—Polytechnic Research & Development Co., 202 Thibault St., Brooklyn 2, N. Y.

### Volt-Ohmmeter

The Kilovoltyst, a recently-designed 30,000-volt test and vacuum tube voltmeter-ohmmeter, has a resistance multiplier block which

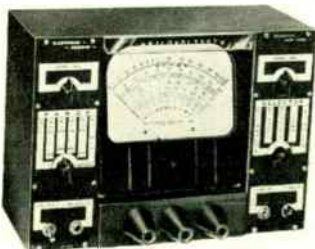

is completely shockproof and will safely withstand 50,000 volts. DC ranges are: 0 to 3-30-100-300-1,000-10,000-30,000 volts. Instrument will measure AC up to 1,000 volts and resistance up to 1,000 megohms. There is a maximum drain of 20 microamps. at 10 and 30 kilovolts. Meter for improved bridge amplifier circuit is individually calibrated for use with set of test leads, DC leads, RF probe and batteries.—Electronic Designs, Inc., Irvington, N. Y.

# New Headset from TELEX...

## NO PRESSURE ON THE EARS

Here's a really new headset: TELEX TWINSET! Sweaty, tiresome "ear-cups" are gone forever! Signal may be piped directly into the ear so that *nothing touches the ear* at all! Matched in-phase magnetic receivers banish listening fatigue—listen for hours in complete comfort with this high-fidelity, 1.6 ounce headset.

An all purpose headset, the unique TELEX TWINSET, is designed for your hearing comfort and exacting headset demands. Obtainable from your favorite parts jobber, or, write Dept. 10, Telex Inc., Telex Park, Minneapolis, Minnesota.

### SPECIFICATIONS:

**Sensitivity**—101 decibels above .000204 dynes per sq. cm. for 10 microwatts input  
**Impedances**—1000 ohms and 64 ohms  
**Construction**—Weight: 1.6 oz. Tenite plastic and bright nickel construction, with headband of Z-Nickel steel wire encased in plastic. Single 5-foot cord plugs into either receiver. Sealed, rustproof diaphragms.

Special Cord with built in miniature Volume Contr l also available

## NEW TELEX TWINSET

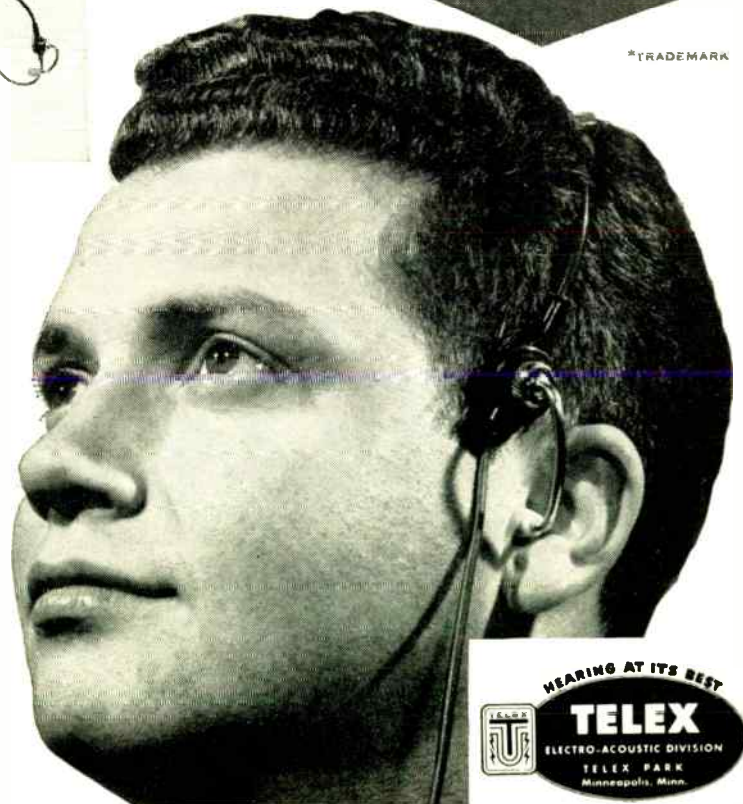

**TELEX, Telex Park, Minneapolis, Minnesota**

Manufacturers of Telex Monoset\* • Telex Pillow Speaker • Telex Precision Hearing Aids



**DILLON multi-low-range universal TESTER**

# DILLON

Calibrated pendulum accuracy for tensile, shear, transverse, and compression tests

Instant reading on large clear dial. Unsurpassed in accuracy among all load measuring devices—precise to 1/2 of 1%—calibrated by dead weight.

The Dillon Tester is designed expressly for low range critical testing in ounces—tenths—kilos. It actually has four scales instead of the usual one or two, divided 0-10 lbs., 0-25 lbs., 0-50 lbs., 0-100 lbs. Comes furnished with stepless speed motor providing draw bar travel of from 0" to 20" per minute—forward or reverse. Has automatic limiting switches, stress-strain recorder, elongation scale and steel stand.

The Dillon multi-low-range universal Tester is the most modern, accurate and scientifically calibrated testing machine available today. Use coupon below for detailed bulletin.

### DIAL SELECTION

| TYPE      | RANGE             | DIVISIONS      | LINEAR SPREAD     |
|-----------|-------------------|----------------|-------------------|
| Ounces    | 10 lb. to 100 lb. | 1 oz. to 8 oz. | 14 1/2 to 22 3/4" |
| Tenth lb. | 10 lb. to 100 lb. | .05 to 5 lb.   | 14 1/2 to 22 3/4" |
| Kilos     | 10 lb. to 100 lb. | .05 to 2 Kg.   | 14 1/2 to 22 3/4" |

Supplied with standard 12" daylight opening; 24", 36", 48" available.

**W. C. DILLON & CO., INC.**  
PRECISION INSTRUMENTS FOR PRECISION TESTING

Complete catalog sent on request



IT'S FOR YOU... FREE TENSILE STRENGTH COMPUTER that tells in seconds the tension at which round or rectangular specimens will break. Complete information on Dillon multi-low-range universal Tester sent along, too.

W. C. DILLON & CO., INC.

5410-TT W. Harrison St., Chicago 44, Illinois

Please send me at once, your FREE Tensile Strength Computer and Complete information on the Dillon Tester.

Name \_\_\_\_\_  
Address \_\_\_\_\_  
City \_\_\_\_\_ Zone \_\_\_\_\_ State \_\_\_\_\_

**For HEAVY DUTY WORK!**  
Severest Electrical Services



P-506-CE—Plug with Cap



S-506-DB  
Socket with deep Bracket

# JONES PLUGS & SOCKETS

500 SERIES  
Proven Quality!

For 5,000 Volts, 25 Amperes per Contact Alterable by circuit Characteristics.

Socket contacts of phosphor bronze, knife-switch type, cadmium plated. Plug contacts hard brass, cadmium plated. Made in 2, 4, 6, 8, 10, and 12 contacts. Plugs and sockets polarized. Long leakage path from terminal, and terminal to ground. Caps and brackets, steel parkerized (rust-proofed). Plug and socket blocks interchangeable in caps and brackets. Terminal connections most accessible. Cap insulated with canvas bakelite.

Write for Jones BULLETIN 500 for full details on line.

**HOWARD B. JONES DIVISION**  
Cinch Mfg. Corp.  
2460 W. GEORGE ST. CHICAGO 18, ILL.



Patents  
Regd. Trade Mark

## THE LOWEST EVER CAPACITANCE OR ATTENUATION

IMMEDIATE DELIVERIES FOR U. S. A.

Billed in Dollars. Settlement by your check. Transaction as simple as any local buy.

**TRANSRADIO LTD.**  
CONTRACTORS TO H.M. GOVERNMENT  
138A CROMWELL ROAD, LONDON SW7  
Cables: TRANSRAD LONDON

| LOW WATTEN TYPES | IMPED OHMS    | ATTEN db/100ft. At 100 Mc/s. | LOADING At 100 Mc/s.      | Q.D.* |
|------------------|---------------|------------------------------|---------------------------|-------|
| A 1              | 74            | 1.7                          | 0.11                      | 0.36  |
| A 2              | 74            | 1.3                          | 0.24                      | 0.44  |
| A 34             | 73            | 0.6                          | 1.5                       | 0.88  |
| LOW CAPAC TYPES  | CAPAC mmf/ft. | IMPED OHMS                   | ATTEN db/100ft. 100 Mc/s. | O.D.* |
| C 1              | 7.3           | 150                          | 2.5                       | 0.36  |
| PC 1             | 10.2          | 132                          | 3.1                       | 0.36  |
| C 11             | 6.3           | 173                          | 3.2                       | 0.36  |
| C 2              | 6.3           | 171                          | 2.15                      | 0.44  |
| C 22             | 5.5           | 184                          | 2.8                       | 0.44  |
| C 3              | 5.4           | 197                          | 1.9                       | 0.64  |
| C 33             | 4.8           | 220                          | 2.4                       | 0.64  |
| C 44             | 4.1           | 252                          | 2.1                       | 1.03  |

HIGH POWER FLEXIBLE

PHOTOCELL CABLE

VERY LOW CAPACITANCE



## New Products

### Positioner and Work Holder

With the Wilton Powrarm, radio and television chassis can be placed at any angle on a 360° horizontal plane, 180° vertical plane

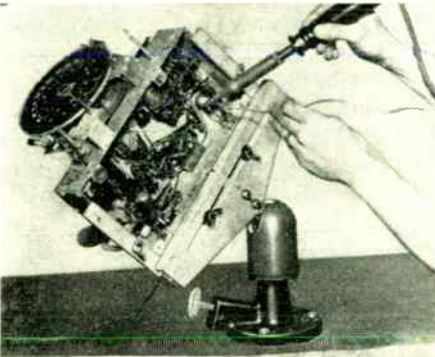

and 260° axial plane and any combination of the positions simultaneously. The fingertip control exerts a pressure up to 6,000 lbs. per sq. in. Special radio chassis attachments (see photo), adjustable from 6 to 18 in., are easily bolted to the floating ball Powrarm.—Wilton Tool Mfg. Co., Dept. TT, 936 Wrightwood Ave., Chicago 14, Ill.

### Torque Indicator

The Torac is a light, compact, high precision instrument which calibrates torque screw drivers and wrenches within its range and



tests the actual tightness of fastenings. Four torque ranges (0-2, 0-5, 0-10, 0-20 pound-inches) and three removable bits are provided. It measures torques in clockwise and counter-clockwise directions. The friction of devices like variable condensers and the starting torque of small motors can also be computed.—Morrill & Morrill, 55 Dey St., New York 7, N. Y.

### Clear Baking Varnish

Particularly recommended as a transformer and coil varnish, Synthite BC-301 clear baking varnish was formulated for applications where excellent heat resistance and exceptional bonding is required. It is composed of phenol formaldehyde resin and selected drying oils and because it cures by polymerization, this varnish will cure throughout to give a solid mass. In addition, it has the capacity of maintaining a high degree of flexibility, even though the film is comparatively hard when cured.—John C. Dolph Co., Dept. 18, 1060 Broad Street, Newark 2, N. J.

### Clip

Both jaws of the Mueller "Twin-Clip" (No. 22) may be opened simultaneously by pressing at the center of the clip or either jaw

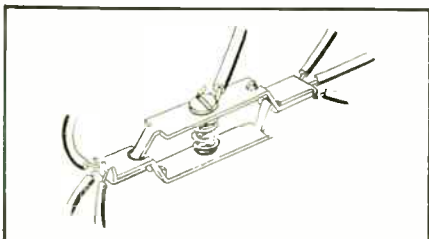

may be opened separately without disturbing the grip of the other. It may be used for making a quick splice, temporary repair hook-ups, hanging and racking articles for industrial processing, or holding identification and record cards. Free samples are available by writing to the manufacturer.—Mueller Electric Co., 1583 East 31st St., Cleveland 14, Ohio.

### Antenna Calculator

A rotary beam antenna calculator has been devised which computes wavelengths (in meters) director length, driven element length, reflector length, half wavelength and wavelength (in feet). One side of the calculator covers from 10 to 17 mc; the other side, 17 to 30mc. In addition, the calculator has a scale showing all values of capacity and inductance required for resonance between five and 60 mc.—Gordon Specialties Co., 542 S. Dearborn St., Chicago 5, Ill.

### Solder

An all-purpose, high-strength metal solder, known as Solderzit, contains its own flux and is available in large size tubes which retail for 50¢. Solderzit is easy to use. Merely clean the surface to be joined, apply Solderzit and heat with soldering iron, torch or match flame.—L & R Manufacturing Co., 577 Elm St., Arlington, N. J.

### Hand Tools

The possibility of faulty electrical connections resulting from operator fatigue or carelessness is eliminated when the "Certi-Crimp"

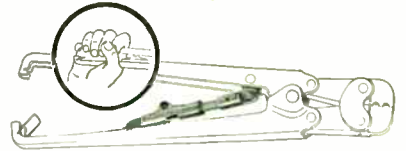

is used for the installation of solderless wire terminals. Feature of the new tool is a simple device that prevents re-opening for admission of a new terminal until it has been completely closed for a perfect crimp on a previous terminal.—Aircraft-Marine Products, Inc., 1609 N. 4th St., Harrisburg, Pa.

## HEPPNER PRODUCTS

for RADIO & TELEVISION

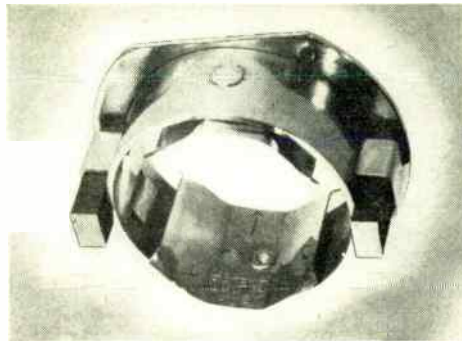

### A new DOUBLE MAGNET ION TRAP

Model 7078—Pat. Applied For  
THE 1949 PACE-SETTER  
IN ION CONTROL

Designed to compensate for shadowing on all sizes of TV picture tubes having magnetic deflection. Field can be rotated 60° in either direction. Can be furnished in any field strength up to 70 gauss. Length of trap not over 1 1/2 inch. Competitively priced.

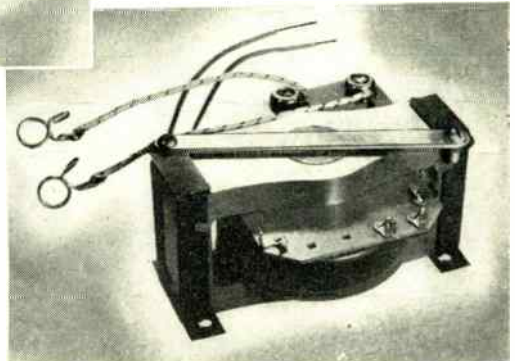

### A new HORIZONTAL OUTPUT TRANSFORMER

Improved design for flyback high voltage supply. Provides the maximum scan of TV tube face. Available for all present sizes of tubes, or made to your specifications.

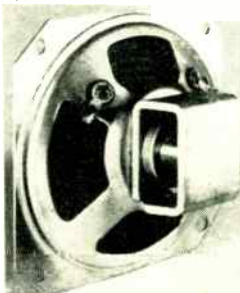

### An Extended Line of SUPER - QUALITY PM ALNICO "5" SPEAKERS

Heppner speakers of the PM type using Alnico No. 5 are high-performance speakers of exceptionally high quality at a reasonable price. Now available in production quantities are 3 1/2, 4, 5, 6 and 4 x 6 inch models.

### ION TRAPS MADE TO SPECIFICATIONS

For use on television cathode ray tubes of 10, 12 and 16 inch size, Heppner is equipped to manufacture ion traps to your specifications, matching any required field strength.

HEPPNER stands ready to work with your engineers in developing allied products.

WE INVITE YOUR INQUIRIES

HEPPNER MFG. CO., 4808 N. Drake Ave., Chicago 25, Ill.

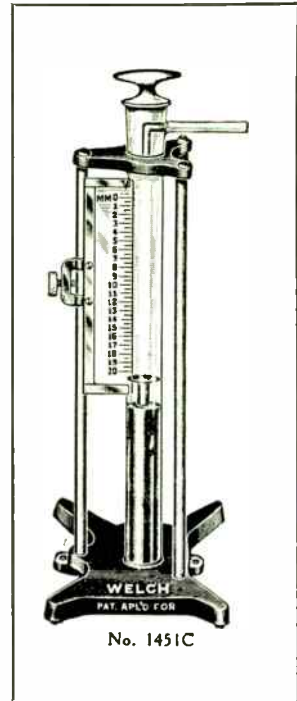

## WELCH DUBROVIN VACUUM GAUGE

**DIRECT READING • SIMPLE TO USE •  
ECONOMICAL • UNIQUE MAGNIFIED SCALE**

This Gauge is principally a straight glass tube mounted on a metal base. The lower half of the tube is filled with mercury, in which is immersed an indicating float. As the air is evacuated through the outlet provided in the upper part of the glass tube, the indicator shows pressure variations directly on the scale. Absolute direct reading and instantly responsive to pressure variations. This gauge is superior to the U type manometer because of the magnification of the scale.

- |  |               |
|--|---------------|
| 1451 C. DUBROVIN GAUGE<br>TYPE A table model, 20 mm.<br>range, 6 to 1 scale, without mer-<br>cury. | Each, \$40.00 |
| 1451 E. DUBROVIN GAUGE<br>TYPE B table model, 20 mm.<br>range, 9 to 1 scale, without mer-<br>cury. | Each, \$48.00 |
| 1451 G. DUBROVIN GAUGE<br>TYPE A wall model, 20 mm.<br>range, 6 to 1 scale, without mer-<br>cury.  | Each, \$40.00 |
| 1451 J. DUBROVIN GAUGE<br>TYPE B wall model, 20 mm.<br>range, 9 to 1 scale, without mer-<br>cury.  | Each, \$48.00 |

### W. M. WELCH SCIENTIFIC COMPANY

1515 Sedgwick St., Dept. J    Established 1880    Chicago 10, Illinois, U. S. A.  
*Manufacturers of Scientific Instruments and Laboratory Apparatus*

## Design of "Electrets"

(Continued from page 39)

work into a resistance of from 1 to 10 megohms.

With careful adjustment electret microphones may be made with a capacitance of the order of 500  $\mu$ f. with an output about that of a high output crystal. A woman's scream into an electret "mike" will give an output of approximately 5 volts peak. Normal conversation gives an output of about 1 volt.<sup>4</sup>

The writer has used electrets in an interesting chronograph for measuring the velocity of projectiles fired from guns. In this apparatus, two elliptically shaped (major axis = 15 cm.) metal hoops are mounted on stands which are separated by a known distance. A small, flat plate suspended inside each hoop by Nylon threads forms a capacitor, the hoop being one electrode and the plate, inside the hoop, the other. These electrodes are connected through suitable amplifiers to an oscilloscope. The arrangement is complete when two electrets are mounted on the inner rims of the two hoops.

The photograph, Fig. 10 with the chronograph being used to test various types of small arms ammunition, shows the unit at the firing line. With both electrodes short circuited, the inner plate is raised to the top of the hoop. The short circuit is removed and the plate lowered to within a few millimeters of the electrets on the bottom of the hoops, thus charging the unit. Assuming its capacity is of the order of a few  $\mu$ f., its impedance is roughly of the order of megohms. When a bullet, or shell, passes through a hoop it changes the capacitance of the charged capacitor and an impulse appears on the oscilloscope screen. After a short time interval the projectile passes through the second pickup and a second impulse appears on the screen. The calibrated oscilloscope gives the time interval; and knowing the distance between hoops it is a simple matter to calculate the velocity of the projectile.

Several uses and advantages of the "free electric charges" on electret surfaces have been described. It should be pointed out that electrets have several properties that may be disadvantageous. For example, the charged surfaces can be

<sup>4</sup>The numerical data presented in this article are experimental. They are presented for purposes of illustration and should not be considered as optimum design figures.

## The Quickest Change ON RECORD(S)



LIKE THE DEMANDS on Television entertainers for speed in changing costumes—there is need for greatest possible ease and speed when phonograph owners change back and forth from LP Microgroove to standard 78 RPM Records. Public satisfaction and convenience demand it. That's why the two-in-one feature of Astatic's new FL Series Long-Playing Pickups is considered of first importance. Each of these amazing units plays both types of recordings . . . and makes the change-over in seconds. There is no changing of needle pressure, no similar adjustments to make. All that the user need do is change cartridges. Takes only seconds, because the FL Pickups' tiny LP Cartridges fix themselves into playing position on the same slip-in principle which firmly joins barrel and cap of many modern fountain pens. Write for new brochure, giving full details, illustrations, on the complete Astatic Long-Playing Line.



**Visit Astatic Booth No. 219 at  
I. R. E. Convention, New York,  
March 7 to 10, inclusive.**

*Astatic Crystal Devices manufactured  
under Brush Development Co. patents*





neutralized, or "discharged", by passing the electret through a flame, or exposing it to x-rays, or excessive humidity. If, after such an exposure, the electret is wrapped in a foil "keeper" it takes from several days to several weeks for the "free surface charge" to build up to its original value. Because of this property the electret probably can be used in certain types of laboratory dosimeters, ionization chambers, and industrial measuring devices. Wax type electrets have relatively low melting points and this property may be useful in certain temperature and humidity control problems. When electrets can be made from higher melting point substances (plastics or glass) they can be used to bias radio tubes.

Scientists do not understand the complete mechanism of the growth of electric charge on the electret surfaces, once an electret has been fabricated. Some electrets have a homocharge while others have a heterocharge. In the former the final charges on its surfaces have the same sign as that on the adjacent charging electrode. In the latter group the final charges on its surfaces are opposite the sign of the adjacent electrodes, as in Fig. 11.

In the growth-of-charge process electrets often show a reversal of the sign on each surface as time passes. The graph of the growth of surface charge on one of the writer's Carnauba wax electrets shows this homo- and heterocharge property as well as the reversal of charge. It can be seen that the sign of the net charge on the electret is negative.

### Wax Type Electrets

It is generally recognized that Carnauba wax is a necessary ingredient in the formation of wax type electrets. Carnauba wax is essentially a mixture of high melting point esters, and esters form electrets that eventually show a homocharge. High melting point alcohols also show a homocharge, too. Experimental evidence shows that there are traces of free alcohols and negligible amounts of free hydrocarbons and free fatty acids present in Carnauba wax. Organic substances with a high acid number (rosin) form electrets that eventually show a heterocharge. Gemant showed that an "addition law of mixtures" holds when electrets are made from mixtures of these individual substances, and that whether an electret shows

a homo- or a heterocharge is a function of the ingredients in the mixture. In other words, a Carnauba wax-rosin electret has the homocharge property of Carnauba, but that property has been modified by the heterocharge property of the rosin that was added to the wax.

The electret property is related to materials that contain polar groups (i.e., -OH, -COOH). Carnauba wax contains such polar groups. Substances that do not contain polar groups (normal hydrocarbons) do not form electrets. Carnauba wax has a crystalline structure and is a unique solid solution—a mixture of a homologous series of esters. Esters are represented by the general formula, RCOOR, where the radical, R, represents the number of carbon atoms in a straight chain. In Carnauba, R averages 28 carbon atoms. The best grade of the material #1 Yellow Carnauba wax has a specific resistance of approximately  $60 \times 10^{13}$  ohm centimeters at 30° C., and a dielectric constant of around 2.66 to 2.83. It is a hard, brittle substance that cracks readily although this cracking can be reduced by adding substances like paraffin wax, rosin, or beeswax.

## SHURE Microphones are the "Field-Proved" Standard in Safety Communications from Coast to Coast

*At the Transmitter—the "UNIDYNE"*

*In the Field—the "100" Series Carbon*



The Shure Unidyne Dynamic, Model "55," is used for more "fixed station" applications than any other microphone made. Pictured above is the radio room of the transmitter station of the Miami Police. Two Shure "UNIDYNES" are used, one for AM, one for FM Broadcasts.



The Shure "100" Series Carbon Communications Microphone is used for more mobile applications than any other microphone made. Pictured above is the "Megacycle Motorcycle" with the first two-way FM radio installed on police Servi-Car by Harley-Davidson Motor Co. Shure "100" Series Carbon Microphone is an integral part of the unit.

Patented by Shure Brothers, Inc.

**Model "55"**  
List Price  
**\$67.50**

**SHURE BROTHERS, Inc.**  
Microphones and Acoustic Devices  
225 West Huron Street Chicago 10, Illinois  
Cable Address: SHUREMICRO

**Model "100" Series**  
List Price  
**\$30.00**

# WHERE X MARKS THE SPOT

# GRAY

announces

its new

# TELOP

(television opaque projector)

also

Sound Effects Turntable

## GRAY RESEARCH & DEVELOPMENT COMPANY

16 ARBOR STREET, HARTFORD 1, CONN.

W. E. Ditmars, President

BOOTH "X" I. R. E. SHOW

## Engineers:

### HERE IS YOUR SOLUTION TO TELEVISION CONDENSER TROUBLES . . .

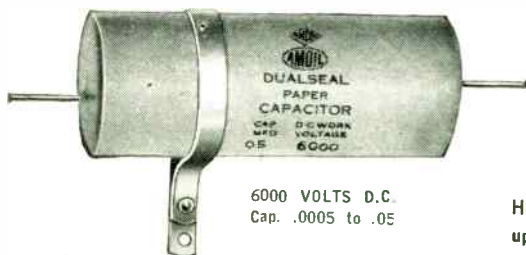

6000 VOLTS D.C.  
Cap. .0005 to .05

### NEW SHIELDED CONDENSER

Completely eliminating any capacity between outer foil and chassis, the new Amcon Shielded Condenser is highly effective in stopping hum or other extraneous signal noise.



THE NEW



### PROCESSED TELEVISION BY-PASS CONDENSER

Here is a new condenser that really stands up under the voltages and temperatures encountered in Television circuits. Amoil Processed, these new capacitors approach closely the electrical properties of fine mineral oil impregnated units. Simple tubular construction with high melting point wax seal results in an attractive price range.

Write for samples and prices of these two new condensers.

## AMERICAN CONDENSER CO.

4410 N. RAVENSWOOD AVE., CHICAGO 40, ILL.



## Professional Tape Recorder

(Continued from page 35)

from one type of tape to another even though all three have been recorded at the same bias setting and at the same recording level. The bias and erase frequency is 60 KC and the erase efficiency is such that the level of a fully modulated 1 KC tone is reduced over 70 DB after erase.

With the exception of the master power switch, push button controls are employed throughout. Red, white, and green indicating lights are also connected to the interlocked control buttons to indicate the status of the equipment in record, wind or playback positions. The control chassis contains a "memory" circuit which through relays and the interlocked switches makes the machine almost fool-proof in operation. For example, if in the wind position with the tape moving at 150-in./sec. the motor reverse button were pressed, electronic dynamic braking takes hold on both the supply and take-up disc motors to bring the tape to a full stop before full speed reversal takes place. This of course minimizes any possibility of tape breakage. Again, if the machine was in playback position and the record button were accidentally pressed, there would be no possibility of accidentally erasing the tape with bias since the mechanically interlocked push-buttons require a definite "setting up" sequence before the equipment will assume the desired operational status. By means of push buttons the single VU meter is made to serve the multiple purposes of reading not only the record and playback levels but in addition, the values of the bias and erase currents. In reading record level the possibility of overloading the tape has been minimized since for this purpose the meter circuit has been somewhat unconventionally designed and the record level is read as it appears directly across the record head without in any way altering the standard meter damping characteristics.

<sup>1</sup> Minnesota Mining & Manufacturing Company  
Tapes #100, #110 and #111.

## IRE Convention

(Continued from page 33)

"Intercity Television Radio Relays"—W. H. Forster, Philco Corp.  
"Video Design Considerations in a Television Link"—M. Silver, H. French, and L. Staschower, Federal Telecommunication Laboratory  
"A Six-Channel Urban Mobile System with 60-KC Spacing"—R. C. Shaw, P. V. Dimock.



W. Strack, and W. C. Hunter, Bell Telephone Laboratories

#### Navigation Aids I

"The Determination of Ground Speed of Aircraft Using Pulse Radar"—I. Wolff, S. W. Seeley, Earl Anderson, and W. D. Hershberger, RCA Laboratories

"The Diurnal Aircraft Approach and Landing System"—L. B. Hallman, Jr., Engineering Div., Wright-Patterson A. F. Base, Dayton, Ohio

"Theoretical Aspects of Nonsynchronous Multiplex Systems"—W. D. White, Airborne Instruments Laboratory, Mineola, N. Y.

"Band-Pass Circuit Design for Very-Narrow-Band, Very-Long Range Direction Finder Receivers to Minimize Bearing Error Due to Receiver Mistuning"—M. Dishal and H. Morrow, Federal Telecommunication Laboratories

"Crystal Control at 100 MC for Aerial Navigation"—S. H. Dodington, Federal Telecommunication Laboratories

#### Symposium: MARKETING

"Market Research"—E. H. Vogel, General Electric Co.

"The Application of Market and Field Research in Product Planning and Design"—O. H. L. Jensen, Philco Corp.

"Sales Planning and Distribution"—Lee McCann, Stromberg-Carlson Co.

"National Advertising"—M. F. Mahony, Maxon's Inc.

"Sales Training and Sales Promotion"—W. E. Macke, Zenith Radio Corp.

#### Electronics III — Electron-Tube Theory

"General Solution of the Two-Beam Electron Wave-Tube Equation"—A. V. Haefl, H. D. Arnett, and W. Stein, Naval Research Laboratory

"Aspects of Double-Stream Amplifiers"—J. R. Pierce, W. B. Hebenstreit, and A. V. Holtenberg, Bell Telephone Laboratories

"On the Theory of Axial Symmetric Electron Beams in an Axial Magnetic Field"—A. L. Samuel, Univ. of Illinois

"Electron Beams in Axial Symmetric Magnetic and Electric Fields"—C. C. Wang, Sperry Gyroscope

"Space-Charge Effects and Frequency Characteristics of CW Magnetrons Relative to the Problem of Frequency Modulation"—H. W. Welch, Jr., Univ. of Michigan

#### Symposium: GERMANIUM AND SILICON SEMICONDUCTORS

"Electrical Properties of Germanium and Silicon"—K. Jark Horowitz, Purdue Univ.

"The Metallurgy of Germanium and Silicon Semiconductors"—J. H. Sealf, Bell Telephone Laboratories

"Theory of Rectification"—F. Seitz, Carnegie Institute of Technology

"Transistors"—W. H. Brattain, Bell Telephone Laboratories

#### Information Transmission and Noise

"Design in Nature as Exploited by the Communication Engineer"—L. A. de Rosa, Federal Telecommunication Laboratories

"Experimental Determination of Correlation Functions and the Application of these Functions in the Statistical Theory of Communications"—T. P. Cheatham, Jr., M.I.T.

"The Transmission of Modulation Through Band-Limited Transmission Systems"—W. P. Boothroyd and E. M. Creamer, Jr., Philco Corp.

"Signal-to-Noise Improvement Through Integration in a Storage Tube"—J. V. Harrington and T. F. Rogers, Cambridge Field Station, AMC, Cambridge, Mass.

"The Theory of Receiver Noise Figure"—L. J. Cutrona, Sperry Gyroscope Co.

#### Navigation Aids II

"Very-High-Frequency Airborne Navigational Receiver and Antenna System"—A. G. Kandorian, R. T. Adams, and R. C. Davis, Federal Telecommunication Laboratories

"Certain New Performance Criteria for Localizer and Glide-Slope Ground Installations"—P. R. Adams, Federal Telecommunication Laboratories

"Phase and Other Characteristics of 330-MC Glide-Path Systems"—S. Pickles, Federal Telecommunication Laboratories

"Principles of Volume Scan"—D. Levine, Federal Telecommunication Laboratories

"The Control of Structural Resonance Effects on the Radio Bearings of an Aircraft High-Frequency Direction Finder"—M. Goldstein, Office of Naval Research

#### Oscillators

"An Analysis of Oscillator Performance under Varying Load Conditions and an Electronic System for Automatic Load Compensation"—E. Mittelmann, 549 West Washington Blvd., Chicago 6

"Low-Power Wide-Tuning-Range UHF Oscillators"—J. N. Pettit and F. J. Kamphoefner, Stanford Univ.

"Reactance-Tube Modulation of Phase-Shift Os-

(Continued on next page)

# A UNIQUE UHF SERVICE

**UHF**

0.03 MC. 3 MC. 3 MC. 30 MC. 300 MC. 3000 MC.

LF MF HF VHF UHF

TRANSMITTERS  
RECEIVERS  
TEST EQUIPMENT  
OSCILLOSCOPES  
ELECTROMYOGRAPHS  
PULSE GENERATORS  
RADAR RECEIVERS  
UHF RADIO SETS  
SIGNAL GENERATORS  
WAVEMETERS  
HARMONIC GENERATORS  
FREQUENCY STANDARDS  
PRECISION EQUIPMENT  
ANTENNAS and MOUNTS  
UHF EQUIPMENT  
ELECTRONIC PRODUCTS  
SQUARE WAVE GENERATORS  
FREQUENCY METERS  
VIDEO AMPLIFIERS  
FIXED FREQUENCY RECEIVERS

LAVOIE LABORATORIES offer you a unique service in that we specialize in the development, design and production of U.H.F. equipment.

Our Engineering Department as well as our shops and shop methods, are geared to U.H.F. production, assuring CORRECT design, PRECISION work and LOW UNIT cost.

We are prepared to collaborate on every phase of U.H.F. work—in the confidential development of new ideas or the re-design of old products. A few, typical, completely-developed LAVOIE products are listed at the right.

If you will address us on your letterhead, we shall be glad to send you a resume of LAVOIE U.H.F. facilities.

VISIT US AT  
BOOTHS  
87 AND 88  
RADIO ENGINEERING SHOW

*Lavoie Laboratories*  
RADIO ENGINEERS AND MANUFACTURERS  
MORGANVILLE, N. J.

Specialists in the Development and Manufacture of UHF Equipment

# ZOPHAR Waxes, Compounds and Emulsions



Materials for potting, dipping or impregnating all types of radio components or all kinds of electrical units. • Tropicalized fungus proofing waxes. • Waterproofing finishes for wire jackets. • Rubber finishes. • Inquiries and problems invited by our engineering and development laboratories.

Zophar Mills, Inc. has been known for its dependable service and uniformity of product since 1846.

## ZOPHAR MILLS, Inc.

ESTABLISHED 1846

117 26th STREET, BROOKLYN, 32 N. Y.



# GERMANIUM DIODES

**Welded Contact  
Self-Healing  
Molded Plastic Case**



ACTUAL SIZE

**G**ENERAL ELECTRIC Germanium Diodes have 3 distinct advantages that are immediately apparent.

- 1. WELDED CONTACT.** Electrical stability is improved through the welding of the platinum whisker point to the germanium pellet. This rigid construction also enables G-E diodes to withstand reasonably severe shock or vibration and makes them practically immune to microphonic effects.
- 2. SELF-HEALING.** G-E diodes return to normal quickly after sudden applications of excessive voltage when not accompanied by excessive current.
- 3. MOLDED PLASTIC CASE.** The non-conducting case simplifies mounting problems and permits greater flexibility of application.

General Electric is prepared to supply high back resistance and high peak inverse voltage units in production quantities.

For complete information on G-E Germanium Diodes write today to: *General Electric Company, Electronics Park, Syracuse, New York.*

*You can put your confidence in—*

**GENERAL ELECTRIC**



(Continued from preceding page)

- “cillators”—F. R. Dennis and E. P. Feleh, Bell Telephone Laboratories
- “A Low-Distortion AF Oscillator”—C. W. Clapp and C. L. Hackley, General Electric Co.
- “An Automatic-Frequency-Control System for Mechanically Tuned Oscillators”—I. G. Stephenson, Airborne Instruments Laboratory, Mineola, N. Y.

### Electronics IV — New Forms of Tubes

- “The Graphophon—A Picture Storage Tube”—L. Pensak, RCA Laboratories

“The Pencil-Type UHF Triode”—G. M. Rose and D. W. Power, RCA

“Practical Applications of the Resonator in the High-Power Transmitter Field”—W. W. Salisbury, Collins Radio Co., Cedar Rapids, Iowa

“The Electron Coupler—A New Tube for the Modulation and Control of Power at the Ultra-High Frequencies”—C. L. Cuccia and J. S. Donald, Jr., RCA Laboratories

“A Low Power Wide-Band CW Magnetron”—L. R. Bloom and W. W. Cannon, Univ. of Illinois

## TV EXPORT POSSIBILITIES

(Continued from page 31)

Quite often the governments concerned are the chief customers, and they frequently rotate their orders between the major suppliers.

England at the present would be a wonderful market for television sets — if a company could afford to tie up considerable capital over there. The demand is very many times greater than the supply. Due to restrictions on the supply of raw materials only about 60,000 television sets a year can be manufactured. And as the new BBC stations in the north of England come into operation the demand will soar. Since the multichannel tuner of our sets is not required costs should be reduced, making possible a cheap set on the lines of the “midget” sets that flooded the market there in 1933 onwards. However, as was pointed out previously, since no money can be taken out of the country it would mean that capital would be transferred to England, to be returned to the US at some very distant date.

In the fields of industry, education, and military application television is destined to become unique. Take for example the US Navy's experiment in training men by television. From a station on Long Island training programs are now transmitted to naval units over a

large part of the east coast, thus enabling hundreds instead of units of men to participate in every lecture! The Murray Dobbins Vocational School in Philadelphia has installed fifteen sets with a switching system that enables the instructors to select any one of a number of programs in any classroom. In England a home television unit has been suggested using a three inch tube and single power supply and sync. generator, with a one inch orthicon at the front door, so that the housewife can see who is at the door! An added feature is the fact that there is a measuring circuit in the video lead which samples the video level. If the level is low, because the light is insufficient, a photoflood lamp is turned on to illuminate the subject. This is really putting TV to work in the home! A military application which has been mooted on the continent, particularly in France it is believed, is an overall application of TV to radar and war planning. Essentially it consists of a master camera scanning the radar screens in the operations rooms and simultaneous scanning of the battle area and maps by second and third cameras. The three signals are mixed at the right levels and positions, and the resultant signal sent to command

## EISLER

SPECIALIZES IN EQUIPMENT FOR THE COMPLETE MANUFACTURE OF

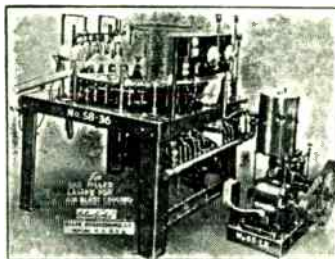

36 HEAD RADIO TUBE EXHAUSTING MACHINE WITH BOMBARDER

INCANDESCENT AND FLUORESCENT LAMPS, LUMINOUS NEON, RADIO, X-RAY, TELEVISION, AND ELECTRONIC TUBES OF ALL TYPES

SPOTWELDERS SIZES FROM 1/4 TO 250 KVA BUTT, GUN, ARC WELDERS

Large or Small Contract Spot and Butt Welding Ask for Our Catalog

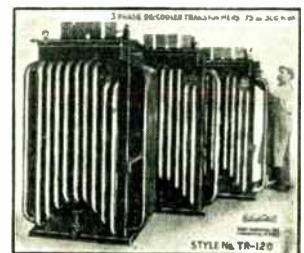

TRANSFORMERS FOR EVERY SERVICE FROM 1/4 TO 250 KVA SPECIAL TRANSFORMERS FOR ELECTRONIC DEVICES

**EISLER ENGINEERING CO., INC., 778 So. 13th St., NEWARK 3, N. J.**



headquarters and any other units desired. The details are of course secret, but it would appear to be a variation of the air traffic control system in which a picture of the area surrounding an airport is sent to pilots in the area.

Of course, therapeutic television is not confined to any country, and Russia is reported to have made considerable use of it in veterans' hospitals and convalescent homes. Incidentally Russia reported early this year that television in the rural areas would have to depend on the amateurs for its operation and support since the cost of supplying such great areas would be impossible. It was suggested that small local stations of approximately 100 watts would be constructed and operated by hams who would be given the equipment by the government. As far as the writer is able to ascertain nothing more has been done along these lines.

#### 42 French TV Stations

It may be of interest to note that Radiodiffusion Française now has a five year plan to provide 42 television stations throughout France. Seven of these will be "Prime" stations, that is they will be capable of originating programs, and the remaining thirty-five will be secondary stations, some of which may be remotely controlled, and some with very few facilities for local program origination. As these stations become operative the market for receivers should open up, probably to a greater volume than France's manufacturers can fill. This should be a very good market for a US manufacturer who could turn out a cheap set with semi-preset tuning.

In conclusion it is stressed that although England is the only other country to have a large television system in operation at present, there does exist a very great potential market for all equipment, both transmitting and receiving in France, The Netherlands, Italy, Spain and Belgium. This does not mean of course that the other European countries should be ignored. Turning to Australia we see that television is commencing, but in all probability by this time the tenders will have been opened and the system and standards chosen. However the five hundred sets called for in the tender will not go far to satisfy the people once they see television; but they will open the gate for thousands more!

# IRN

# magnetic iron powders

**MEPHAM**  
hydrogen  
reduced

**IRN** magnetic iron powders (Mephram hydrogen reduced) are available in 10 different types for high-frequency cores, core material, tele-communication and magnetic applications. . . . All are described in a revised technical bulletin, containing 28 pages of comprehensive data, including performance graphs and engineering reference material of value to designers, manufacturers and users. Your copy of this bulletin will be mailed on request.

Metallurgical and Electronic Division

**IRN** ■

**C. K. WILLIAMS & CO.**  
2001 Lynch . . . . East St. Louis, ILL.

## Over 1000 Sizes

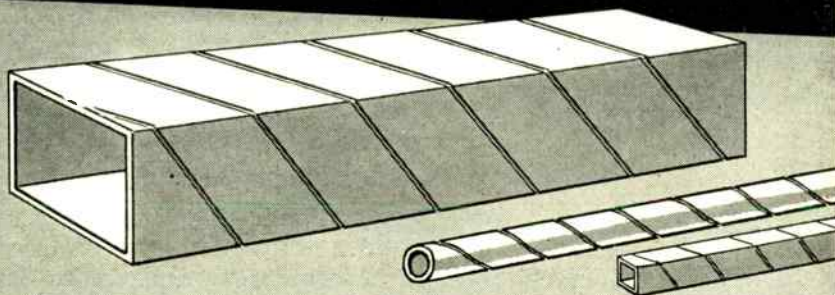

### PARAMOUNT SPIRAL WOUND PAPER TUBES

Square • Rectangular • Triangular  
Round and Half-Round

With a wide range of stock arbors . . . plus the specialized ability to engineer special tubes . . . PARAMOUNT can produce the exact shape and size you need for coil forms or other uses. *Hi-Dielectric, Hi-Strength, Kraft, Fish Paper, Red Rope*, or any combination, wound on automatic machines. Tolerances plus or minus .002". Made to your specifications or engineered for YOU.

Inside Perimeters from .592' to 19.0'

**SEND FOR ARBOR LIST  
OF OVER 1000 SIZES**  
Convenient, helpful listing  
of over 1000 stock ar-  
bors. Includes many odd  
sizes of square and rec-  
tangular tubes. Write for  
Arbor List today. No  
obligation.

**PARAMOUNT PAPER TUBE CORP.**  
617 LAFAYETTE ST., FORT WAYNE 2, IND.  
Manufacturers of Paper Tubing for the Electrical Industry

# Television and the FCC vs. Tropospheric Interference

AS the end of the six month television channel analysis period draws near, engineers in all phases of this field are concerned with the decision on future assignments. A vast amount of material, much of it conflicting, was left in the laps of the FCC engineers. It is presumed they are sorting the grain from the chaff, possibly with the aid of a specially appointed Ad-Hoc committee. (See page 46 this issue.) The position of the FCC is not an enviable one. A satisfactory answer probably means great changes in many communication fields. There seems to be agreement by many of those attending this hearing on certain points: (1) More power needed for TV transmitters; (2) Protect, at least 90% of the time, the 2 mv/m. and if possible the 500  $\mu$ v/m contours; (3) The RCA method of synchronizing of carriers (see *Tele-Tech*, Jan., 1949, p. 29) has great possibilities and the directional receiving antenna is an interesting development; (4) Directional transmitting antennas should

be made use of in the next allocation plan; (5) It is best to make field measurements with a 30 foot antenna so that no conversion factor is involved; (6) The troposphere does play an important part in "long-distance" transmission but its widely varying effect is not well-known and can not be calculated with accuracy at present; (7) Terrain has an effect on field intensity at these frequencies but this variable can only be roughly estimated by using a "terrain factor" the exact value of which is as yet unknown.

The FCC has introduced a number of reports on tropospheric effects and interference. Based on measurements of 42.8 to 700 MC, the long-time fading follows a log-normal distribution. An interesting point was shown that if an earth's radius factor of 10 is employed instead of the usual 4/3 value, Norton's method of calculation of propagation gives results within  $\pm 10$  DB of the measured fields exceeded for 1% of the time. Based

on measurements at 47, 106 and 700 MC their revised TV allocation plan should give considerably less tropospheric interference than the earlier allocations.

An interesting report was introduced into the JTAC group. It recommends; (1) for suburban-rural TV service a signal strength of 500  $\mu$ v/m, co-channel protection of 40 DB. (if carriers are synchronized this drops to 25 DB), adjacent channel protection 0 DB (upper channel) and 6 DB (lower channel); (2) for urban TV a signal of 5,000  $\mu$ v/m, co-channel protection 40 DB, adjacent channel protection same as above; (3) for rural FM a signal of 25  $\mu$ v/m, co-channel protection 10 DB, 1st adjacent channel protection -16 DB, 2nd adjacent channel -40 DB.

Engineers can work out satisfactory allocations only when the policy to be followed has been clearly established. As stated by Lodge (CBS) the questions requiring answer by FCC are as follows: (1) More TV stations or larger areas served? (in other words, competitive broadcasting and multiple program service or freedom from interference by wide separation) (Continued on opposite page)



## of ELECTRO-MAGNETIC CONTROL

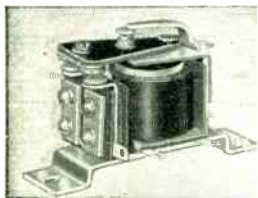

**SERIES 220 RELAY**

This small relay is capable of handling 20 amps at 220 v., the leader in its size and price field for inexpensive, compact, heavy current control. A very widely used small relay for industrial control such as welding machines, x-ray, motor starters, etc.

Write—tell us your control problem. Get specific recommendations.



**SERIES "R" STEPPER**

Used for cycle control requiring continuous sequence repetitive operations; to remotely select and control multiple circuits; can be furnished to rotate continuously, reset automatically or to pulse both clockwise and counter clockwise on the same unit with up to 100 contacts on a disc.

**GUARDIAN ELECTRIC**  
W. WALNUT STREET CHICAGO 12, ILLINOIS  
1607-C COMPLETE LINE OF RELAYS SERVING AMERICAN INDUSTRY



## Safer, Enduring Support! PLUS . . .

. . . exclusive advantages: no shorts! no corrosion! no tearing! Structurally stable C.P.C. 742 Clamps—new permanent support for wiring, tubing. WPB appv'd for lead-ins. Write, wire or phone for samples, prices and Circular 419 today.

Complete stock SARAN PIPE and Pipe Fittings  
1/8" to 3"

**COMMERCIAL PLASTICS CO.**  
MERCHANDISE MART • CHICAGO 54



# Kahle

## ELECTRON TUBE MACHINERY OF ALL TYPES

## STANDARD AND SPECIAL DESIGN

We specialize in Equipment and Methods for the Manufacture of

RADIO TUBES  
CATHODE RAY TUBES  
FLUORESCENT LAMPS  
INCANDESCENT LAMPS  
NEON TUBES  
PHOTO CELLS  
X-RAY TUBES  
GLASS PRODUCTS

Production or Laboratory Basis

Manufacturers contemplating New Plants or Plant Changes are invited to consult with us

### KAHLE

#### ENGINEERING COMPANY

1313 SEVENTH STREET  
NORTH BERGEN, NEW JERSEY, U. S. A.

## CONTINUOUSLY VARIABLE FREQUENCY SOURCE 20 cps to 200,000 cps



### JACKSON

#### Audio Frequency Oscillator

- \* Accuracy — 1 cycle or 2%
- \* Minimum Harmonic Distortion
- \* Resistance Capacity Tuned
- \* 1/2 Watt Output
- \* Less than 1 DB Deviation
- \* Excellent Stability

Used by leading Laboratories, Research Engineers, Colleges and Broadcast stations.

\$135.00 complete

Full details on request.

Jackson Electrical Instrument Co.

Dayton 1, Ohio

(Continued from opposite page)

(2) Will the VHF channels belong permanently to TV? (3) Will VHF planning include the use of UHF channels? (4) If UHF is to be used should it be intermingled in same cities with VHF? (5) Should the VHF plan provide a minimum of three stations per city?

Many other interesting suggestions have stemmed from the mounting experience with the present stations. For example, Gillette recommended: more power on all TV frequencies, especially on high channel stations so that their signal, received on a resonant dipole, will produce a voltage about equal to that received from the low channel stations on a resonant dipole. Also that assigning several stations to large cities be secondary to putting at least one station in small cities. On the other hand CBS studies, contributed through William Lodge, indicated another possibility, that of spacing of co-channel stations 175 miles instead of 150 miles; no assignments in cities unless a minimum of three channels can be assigned, and an UHF study in which the separation was 200 miles (largest cities) and 140 miles on adjacent channels. The number of UHF channels assignable on this latter basis was 231. The number of VHF channels assignable were found to be less than the 92 now available, or the 98 under proposed Docket 8975 but greater than this latter plan when revised for tropospheric effects, for the number then becomes 64.

The mounting number of television applicants is bringing increased pressure on the Commission to lift the "freeze". And this may be done promptly with station spacing for co-channel operation not much different from that now used (150 miles) but with recourse to the above mentioned Synchronized Carriers to reduce interference in those areas where it will be troublesome. To make room for the 312 applicants it appears necessary for the FCC to open a part of the UHF band to black-white television on a commercial basis with standards not greatly different from those now in use. There may be more advantageous ways of interleaving the channels if it is decided to reserve a portion of this band for color in the future. To fit in more transmitters and to reduce interference at receivers the Commission will permit and suggest full use of directional antennas at the transmitters concerned.

# Keep posted on Electron Tubes



## MAIL COUPON TODAY

RCA, Commercial Engineering Section 57CW, Harrison, N. J.

Send me the RCA publications checked below. I am enclosing \$\_\_\_\_\_ to cover cost of those books for which there is a charge.

Name \_\_\_\_\_

Title or Occupation \_\_\_\_\_

Address \_\_\_\_\_

City \_\_\_\_\_ Zone \_\_\_\_\_ State \_\_\_\_\_

- Quick-Reference Chart, Miniature Tubes (Free). (A)
- HB-3 Tube Handbook (\$10.00)\*. (B)
- RC-15 Receiving Tube Manual (35 cents). (C)
- Receiving Tubes for AM, FM, and Television Broadcast. (10 cents). (D)
- Radiotron Designers Handbook (\$1.25). (E)
- Quick Selection Guide, Non-Receiving Types (Free). (F)
- Power and Gas Tubes for Radio and Industry (10 cents). (G)
- Phototubes, Cathode-Ray and Special Types (10 cents). (H)
- RCA Preferred Types' List (Free). (I)
- Headliners for Hams (Free). (J)

\*Price applies to U. S. and possessions only.



TUBE DEPARTMENT

RADIO CORPORATION of AMERICA

HARRISON, N. J.

# RADIO-ELECTRONIC MOBILIZATION PLAN

(Continued from page 28)

and the industry, sufficient information which, when properly compiled and analyzed, will provide satisfactory working formulae from which the labor and material load of the industry may be computed. It is the considered recommendation of the Committee that a simple, direct statistical survey be conducted by a qualified firm of industrial engineers to establish certain facts upon which said formulae may be based.

The electronic industry above all else must have the necessary technical knowledge and skills and developed methods for keeping those skills current to perform intelligently the tasks assigned to it.

The industry resolves into three broad categories:

A) *End equipment manufacturers* who design, develop, and/or deliver the final apparatus.

B) *Parts suppliers* who produce the necessary parts, pieces and components for the end equipment manufacturer.

C) *Raw material suppliers* who provide the necessary materials to the parts supplier and end equip-

ment manufacturer to be fabricated into electronic parts, pieces, components and equipments.

The following illustrates how a few simple facts, once they are determined, may then be applied to establish the facilities, labor and material loads per unit of procurement. Facilities of end manufacturers include:

- 1.—Fully equipped office.
- 2.—Laboratory.
- 3.—Assembly.
- 4.—Packing and shipping.
- 5.—Warehousing.

It is suggested that the engineering survey would establish the following: square feet of equipped space required per worker; billings per square foot of equipped space.

To illustrate, preliminary studies indicate that in a balanced operation, each employee requires from 80 to 100 square feet of factory space, and each square foot of space is capable of producing from \$75 to \$100 of billings annually. It may be concluded that the end manufacturer requires per million dollars worth of billings per year: (a) 10,000 to 12,000 square feet of

equipped space; (b) 100 to 133 skilled employees, single shift operation.

*Operation of end equipment manufacturers.*—A well-balanced electronics manufacturing operation must encompass research and development, production development, pilot runs and production in order to make a worthwhile contribution. A balanced representative load might be as follows:

| Percentage | Type of Contract                      | Engineering Content | Contract Value     |
|------------|---------------------------------------|---------------------|--------------------|
| 10%        | Research and Development              | 60%                 | \$ 100,000         |
| 25%        | Production Development and Pilot Runs | 25%                 | 250,000            |
| 65%        | Production                            | 8-10%               | 650,000            |
|            |                                       |                     | <b>\$1,000,000</b> |

The broad categories under which electronic equipment is produced include: (1) management, engineering and administrative services; (2) materials and parts; (3) assembly, testing, packing and shipping.

It is also suggested that the engineering survey would establish the percentage of the procurement dollar going into each of the above items. In the particular case cited above, these items break down as follows. In this example profits have been spread in the percentages.

(1) Management, engineering and



## INSULATE WITH SYNTHANE

If you require a material for your product or process which must possess superior electrical properties, why not consider Synthane? It may be just what you are seeking.

Synthane laminated plastics have a combination of qualities such as low power factor, high dielectric strength, low dielectric constant and unusually good electrical insulating ability. These, with Synthane's mechanical and chemical characteristics, make it a material valuable for many applications in a wide variety of industries.

If your material requirements are strict and your present materials unsatisfactory, why not investigate Synthane? Just mail the coupon for your copy of the Synthane catalog or write for specific information without obligation.

**SYNTHANE** **SYNTHANE CORPORATION**  
12 River Road, Oaks, Pa.

Please send me a copy of the complete Synthane catalog.

Name \_\_\_\_\_

Name of Company \_\_\_\_\_

Title \_\_\_\_\_

Address \_\_\_\_\_

City \_\_\_\_\_ State \_\_\_\_\_

**SYNTHANE** TECHNICAL PLASTICS

SHEETS • RODS  
TUBES • FABRICATED  
PARTS • MOLDED  
LAMINATED • MOLDED-  
MACERATED

## Quality Iron Cores

— RAD-A-COR —

*For Audio and A.M. Frequencies*

— TEL-A-COR —

*For FM — TV Frequencies*

TOPS IN QUALITY

*Over 12 Years Experience  
Finest of Materials*

IMMEDIATE DELIVERY

*Facilities increased 100%*

*We invite your inquiries.*

## MAGNETIC CORE CORPORATION

144 Highland Avenue      Tel. Ossining 222

OSSINING, NEW YORK

*Manufacturers of*  
ELECTRONIC POWDER METALLURGY



administrative services—24%; (2) materials and parts—64%; (3) assembly, testing, packing and shipping—12%.

Management, engineering and administrative services break down into five classes of professional and/or highly skilled personnel:

(1) Corporate and supervisory management and administrative services—12.3%.

(2) Development engineering — 3.8%.

(3) Mechanical engineering and drafting—3.6%.

(4) Books and publications — 1.2%.

(5) Project engineering—3.1%.

On the basis of the preceding figures, these classes represent 24% of the procurement dollar. It is also suggested that the engineering survey would establish the percent of the procurement dollar represented by each of above five items.

### Materials and parts

Based upon earlier assumptions, these items in raw and fabricated form represent 64% of the procurement dollar. They have been broken down into two lists; one list representing essential electronic components and fabricated parts tabulated from the material list of a cross-section of finished electronic equip-

ment, and the second list including raw or semi-fabricated materials required in such equipment. No attempt has been made to estimate costs per unit of procurement of these items, as this falls squarely on the shoulders of a statistical organization to be employed for that purpose. The tabulations are made in a way which will permit the calculation of space required per worker and the billings each square foot of space is capable of producing.

Raw or semi-fabricated materials may be estimated on a poundage basis, thus providing information to establish the rate of flow of such materials, either from their natural sources or from stockpiles.

### Superregenerative Receivers

(Continued from page 43)

shortening the decay and build up periods. The build-up period may be shortened without difficulty by increasing the regenerative coupling of the amplifier tube V1, but the shortening of the decay period presents more of a problem. Should it be intended to shorten the decay period to 10 cycles at the operating frequency, the flywheel effect of

the resonant circuit must be borne in mind. Usually circuits having a Q of 100 or more will result from the employment of available components and such a circuit will take about 100 oscillation cycles to decay to 1% of the initial oscillation intensity (40 DB down). But, with this circuit, if only 10 cycles are allotted to circuit clearing, stored energy cannot be eliminated completely enough before the initiation of the next zero loss period, causing failure of the circuit to superregenerate and poor selectivity. To guarantee against this possibility some means must be provided for suitably loading the circuit during the decay period. Failure to completely clear the circuit results in obscuration of the extinction points and broadening of the envelope selectivity.

### New Racon Representative

James L. Kearns, Electronic Specialty Representative, has been assigned to cover the territory of Oregon, Washington, western Montana and Idaho for the Racon Electric Co., N. Y. C., with main offices and warehouse in Portland, one field office in Spokane and another in Klamath Falls covering northern California. He is a member of the Professional Engineers of Oregon, AIEE and the IRE.

**from FLAT SURFACES**  
**TO INTRICATE SHAPES**  
**with the New DI-ACRO BRAKE**



- ROK-LOK—sensitive material clamp for accuracy
- DOUBLE-EDGED FORMING BLADE for close reverse bends
- NEW PRECISION STOPS control angularity of bends

This versatile metal forming machine was developed for use in model shops, experimental laboratories and production departments where it often replaces dies for all types of precision forming operations. Di-Acro Brakes will form a great variety of materials including bronze, stainless steel, aluminum and bi-metals.

**WRITE FOR CATALOG.** New edition of 40-page Di-Acro Catalog contains detailed information on all Di-Acro Brakes, Shears, and Benders and illustrates how these precision machines can be used individually or cooperatively for "DIE-LESS DUPLICATING".

◀ DI-ACRO is Pronounced "Die-Ack-Ro" ▶

**DI-ACRO**  
 DIE-LESS DUPLICATING

**O'NEIL-IRWIN MFG. CO.**  
 348 8TH AVE., LAKE CITY, MINNESOTA

**— USE SMALLER BASE to wind more coil wire**

with  
**PRECISION BOBBINS**

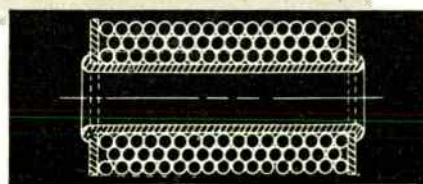

Less space required for same amount of wire as you're using now — size of coil reduced to minimum. Precision Bobbins make a lighter, smaller, a better coil. Number of turns increased. Insulating strips eliminated.

Precision Bobbins are spirally wound and heat treated under compression for greater strength with less weight. Flanges designed in three types. Cores: round, square or rectangular. Precision also makes DI-FORMED PAPER TUBES any length, shape or size. **WRITE TODAY FOR SAMPLES — LARGE DETAILED CATALOG.**

**ROUND**  
**SQUARE**  
**RECTANGULAR**

**PRECISION PAPER TUBE CO.**

2057 W. Charleston St., Chicago 47, Ill.  
 PLANT NO. 2  
 79 Chapel St., Hartford, Conn.

# BRAND NEW EQUIPMENT

AVAILABLE FOR IMMEDIATE DELIVERY

## SYNCHROS

1F Special Repeater, 115 volts, 400 cycle. Will operate on 60 cycle at reduced voltage. PRICE \$15.00 EACH NET  
 1CT Control Transformer, 90/55 volts, 60 cycle. PRICE \$22.50 EACH NET  
 2JIG1 Control Transformer, 57.5/57.5 volts, 400 cycle. PRICE \$2.00 EACH NET  
 2J1H1 Selsyn Differential Generator, 57.5/57.5 volts, 400 cycle. PRICE \$3.25 EACH NET  
 5G Generator, 115 volts, 60 cycle. PRICE \$25.00 EACH NET  
 W. E. KS-5950-L2, Size 5 Generator, 115 volts, 400 cycle. PRICE \$3.50 EACH NET  
 Size 5 Generator, Army Ordnance Drawing No. C-78414, 115 volts, 60 cycle. PRICE \$15.00 EACH NET

## PIONEER AUTOSYNS

AY1, 26 volts, 400 cycle. PRICE \$4.00 EA. NET  
 AY20, 26 volts, 400 cycle. PRICE \$5.50 EA. NET  
 AY30, 26 volts, 400 cycle. PRICE \$10.00 EA. NET  
 AY31, 26 volts, 400 cycle. Shaft extends from both ends. PRICE \$10.00 EACH NET  
 AY38, 26 volts, 400 cycle. Shaft extends from both ends. PRICE \$10.00 EACH NET

## PIONEER PRECISION AUTOSYNS

AY101D, new with calibration curve. PRICE—WRITE OR CALL FOR SPECIAL QUANTITY PRICES  
 AY131D, new with calibration curve. PRICE \$35.00 EACH NET

## GENERAL ELECTRIC D. C. SELSYNS

8TJ9-PDN Transmitter, 24 volts. PRICE \$3.00 EACH NET  
 8DJ11-PCY Indicator, 24 volts. Dial marked -10° to +65°. PRICE \$4.00 EACH NET  
 8DJ11-PCY Indicator, 24 volts. Dial marked 0 to 360°. PRICE \$6.50 EACH NET

## PIONEER TORQUE UNITS

TYPE 12602-1-A. PRICE \$30.00 EACH NET  
 TYPE 12606-1-A. PRICE \$35.00 EACH NET  
 TYPE 12627-1-A. PRICE \$70.00 EACH NET

## PIONEER TORQUE UNIT AMPLIFIER

TYPE 12073-1-A. PRICE \$17.50 EACH NET

## RATE GENERATORS

PM2, Electric Indicator Company, .0175 v. per R. P. M. PRICE \$7.25 EACH NET  
 F16, Electric Indicator Company, two-phase, 22 v. per phase at 1800 R. P. M. PRICE \$12.00 EACH NET  
 B-68, Electric Indicator Company, Drag Cup, 110 volts, 60 cycle, one phase. PRICE \$14.00 EACH NET  
 J36A, Eastern Air Devices, .02V. per R.P.N. PRICE \$9.00 EACH NET

## INVERTERS

12117-4, Pioneer. Input 24 volts D. C. Output 26 volts, 400 cycle. PRICE \$15.00 EACH NET  
 12117, Pioneer. Input 12 volts D. C. Output 26 volts, 400 cycle. PRICE \$17.00 EACH NET  
 12123-1-A, Pioneer. Input 24 volts D. C. Output 115 volts, 400 cycle, 3 phase. 100 V. A. Price \$15.00 Ea.  
 153F, Holtzer Cabot. Input 24 volts D. C. Output 26 volts, 400 cycle, 250 V. A., and 115 volts, 400 cycle, 3 phase, 750 V. A. PRICE \$125.00 Ea. Net  
 MG750, Winchanger, PU16. Input 24 volts D. C. Output 115 volts, 400 cycle, 1 phase, 6.5 amps. PRICE \$35.00 EACH NET  
 149H, Holtzer Cabot. Input 28 volts at 44 amps. Output 26 volts at 250 V. A. 400 cycle and 115 volts at 500 V. A. 400 cycle. PRICE \$39.00 EACH NET  
 149F, Holtzer Cabot. Input 28 volts at 36 amps. Output 26 volts at 250 V. A. 400 cycle and 115 volts at 500 V. A. 400 cycle. PRICE \$35.00 EACH NET

## SINE-COSINE GENERATORS (Resolvers)

FJE 43-9, Diehl, 115 volts, 400 cycle. PRICE \$20.00 EACH NET

## D. C. ALNICO FIELD MOTORS

5071895, Delco, 27 V., 250 R. P. M. PRICE \$3.00 EACH NET  
 5069600, Delco, 27 V., 250 R. P. M. PRICE \$4.00 EACH NET  
 5069466, Delco, 27 V., 10,000 R. P. M. PRICE \$3.00 EACH NET

## D. C. MOTORS

5069625, Delco Constant Speed, 27 volts, 120 R. P. M. Built-in reduction gears and governor. PRICE \$4.25 EACH NET  
 A-7155, Delco Constant Speed Shunt Motor, 27 volts, 2.4 amps., 3600 R. P. M., 1/30 H. P. Built-in governor. PRICE \$6.25 EACH NET  
 5BA1016D, General Electric, 27 volts, 0.7 amps., 110 R. P. M. PRICE \$2.90 EACH NET  
 5064645, Delco Shunt Motor 27 volts, 4000 R. P. M. Reversible, flange mount. PRICE \$4.50  
 C-28P-1A, John Oster Shunt Motor, 27 volts, 0.7 amps., 7000 R. P. M., 1/100 H. P. PRICE \$3.75 EACH NET

## A. C. MOTORS

5071930, Delco, 115 volts, 60 cycle, 7000 R.P.M. PRICE \$4.50 EACH NET  
 36228, Hayden Timing Motor, 115 volts, 60 cycle, 1 R. P. M. PRICE \$3.15 EACH NET  
 Hayden Timing Motor 110 volts, 60 cycle, 4 R.P.M. with Brake. PRICE \$4.00 EACH NET  
 E. A. D. Synchronous Motor Type J33, 115 volts, 400 cycle, 3 phase, 8,000 R.P.M. PRICE \$8.50 EACH NET  
 45629R Hayden Timing Motor, 110 volts, 60 cycle, 2.2 Watts, 1/240 RPM. PRICE \$3.00 EACH NET

## SERVO MOTORS PIONEER DIEHL

MINNEAPOLIS—HONEYWELL IN STOCK

WRITE FOR OUR COMPLETE LISTING!

## INSTRUMENT ASSOCIATES

147-57 41st AVENUE FLUSHING, NEW YORK Telephone INdependence 3-1919

## 2nd ANNUAL PENNY SALE

The biggest money saving sale you ever saw. Add 1¢ to the price and get 2. \$500,000 worth of merchandise thrown into this sale.

For Example:  
 4:1 Audio Ferranti Hi Fidelity 2 1/4" x 2 5/8" x 3" H. Shield plate to grid. Electrostatic shield. No. T39 Ship. wt. 2 1/2 lb. \$1.49—2 for \$1.50  
 50mmf 7500v RCA sulphur dielectric. \$1.95—2 for \$1.96  
 2.000mf 6v Solar plug-in. \$1.69—2 for \$1.70  
 500mf 6v Solar plug-in. \$1.25—2 for \$1.26

Prices net FOB our plant. Include enough for postage and insurance. Write for complete penny sale listings. You'll be amazed at the bargains.

**Universal/General Corp.**  
 365 Canal St., N. Y. 13, N. Y. (Dept. T) Walker 5-9642



## MASTER OSCILLATOR UNITS

M.O. units designed for oper 2-18 mc TBK. Flexible plug in units using type 860 tube in ECO circuit. Tunes 5000 to 4555 kc in 6 bands. Freq. Determining elements are enclosed in shock mounted oven assembly, and has frq monitor PU link coupled to output. Net Wt: 138 lbs. Dim: 21 in. d x 14 1/2 in. W x 25 1/2 in. H. New (with tube)...\$150.00



## POWER EQUIPMENT

STEP DOWN TRANSFORMER: Pri. 440/220/110 volts a.c. 60 cycles. 3 KVA. Sec. 115 v. 2500 volt insulation. Size 12" x 12" 7".....\$40.00  
 PLATE TRANSFORMER: Pri: 117 v. 60 cy. Sec. 17.600 7/144 ma. with choke. Oil Immersed. Size: 26" x 29" x 13" American.....\$120.00  
 FIL. TRANS. UX6899. Pri: 115 v. 60 cy. Sec: Two 5 v. 5.5 amp wdgs. 29 KV test.....\$24.50  
 VOLTAGE REG. Transtat. Amertran type RH 2 KVA load. input: 90 130 v. 50-60 cy. output 115 v.....\$40.00  
 ITE CIRCUIT BREAKER. 115 A. 600 v. Mod KJ  
 UX 6801 (Raytheon): Pri: 110 v. 60 cy. 1 ph. Sec: 22,000 v. 234 ma. 5.35 KVA, Dim: 23" x 24" x 10 3/4".  
 FIL XFMR: Kenyon: Pri: 210 215 220 225 230 235 240 vac. 60 cy. Sec: 11v. 35 amp; 10 v. 35 amp ct; 7.5 v. 35 amp ct; 5 v. 35 amp ct. 2 S-10768.....\$37.50  
 FIL TRANS: KN8767: Pri: 115 v. 60 cy. Sec: 2 wdgs: 5 v 7/8 5 amps each 15 KV Test.....\$15.00

## COAX CABLE

RG 9 U 52 ohms .....\$24/Ft.  
 RG 17 U 52 ohms imp. ....\$48/Ft.  
 RG 57 U Twin Cond. 95 ohms .....\$35/Ft.  
 RG 18 U 52 ohm imp. armored .....\$51/Ft.  
 RG 23 U twin coax. 125 ohm imp. armored .....\$50/Ft.  
 RG 28 U 50 ohm imp. pulse cable. Corona min. starting voltage 17 KV .....\$50/Ft.  
 RG 35 U 70 ohm imp. armored .....\$50/Ft.

## OIL CONDENSERS

1 mfd. 25,000 V., Fast # A6734.....\$99.50  
 2 X .1 mfd. 7000 vdc. 25F774.....\$ 4.95  
 1.5 mfd. 6000 vdc.....\$12.50  
 .25 mfd. 20,000 vdc.....\$17.50  
 10 mfd. 1000 vdc.....\$ 1.79  
 .1 mfd. 6000 vdc. 25F509G2.....\$ 6.60  
 3x10 mfd. delta connected synchro-capacitor. 30 v. 60 cycles.....\$ 4.95

## COMMUNICATIONS EQUIPMENT CO.

131-T Liberty St., New York City 7, N. Y. Dicby 9-4124

## MERCURY CONTACT RELAY

Western Electric D-168479

For applications in all types of high speed switching devices. Long service life. High operating speeds. Large current and voltage handling capacity, uniform and constant operating characteristics under adverse conditions. Hermetically-sealed mercury-wetted contacts in gas-filled glass envelope. Free from moisture, dirt, corrosion and atmospheric pressure. Single pole double throw contacts. 1000 hours at 60 operations per second. Two coils of 700 ohms, and 3300 ohms. Operating current, coils series aiding—6.6 mils. Release current, coils series aiding—5.2 mils. Four page Technical Data on request.



Brand New in Original Cartons, \$4.75

## LINEAR SAWTOOTH POTENTIOMETER

W.E. No. KS 15138



The d-c potentiometer consists of a closed type die-cast aluminum alloy frame consisting of a continuous resistance winding to which electric power is supplied through two fixed taps 180 degrees apart. Two rotating brushes (180 degrees apart and bearing on the resistance winding) and two take-off brushes are provided for the output voltage. Varying the position of the brushes varies the output voltage in accordance with a linear sawtooth wave. The potentiometer is excited with 24-volt direct current, is arranged for panel or bracket mounting, is approximately 3-11/16 inches in diameter, 3 inches deep, 4 3/4 inches long, and has an approximate weight of one pound. External connections are made through a standard AN type connector.

Brand New \$5.75

## ELECTRONICRAFT

5 WAVERLY PLACE TUCKAHOE 7, N. Y. PHONE: TUCKAHOE 3-0044





# Crystals for the Critical

## EVERYTHING YOU WANT IN "STABILIZED" CRYSTALS

High quality — quick delivery — modest cost! All three are yours when you use James Knights Co. "Stabilized" crystals.

Whether you wish standard crystals, or crystals built to your exact specifications, The James Knights Co. is equipped to supply you promptly.

A special production system is maintained to effect greater savings for you on short run jobs.

The James Knights Co. fabricates a complete line of "Stabilized" crystals to meet every need — precision made by the most modern methods and equipment.

Whenever you think of crystals, think of JK "Stabilized" crystals. They're your best bet — your best buy!



A COMMUNICATIONS COMPANY needed precision low frequency crystals to synchronize their facsimile system. The James Knights Co. made the crystals, installed them in ovens, and delivered them promptly.

New James Knights Co. Catalog  
On Request.

The **JAMES KNIGHTS Co.**

SANDWICH, ILLINOIS



## Ad Hoc Committee

(Continued from page 46)

sufficiently long time, nor over a variety of distances, nor in enough different regions of U. S. to satisfy the thorough-going scientists who are being pressed for their decision regarding how these TV frequencies—the same ones that we are now using—are going to act in the future.

Specifically, field data is needed of reception on all frequencies between 54 and 216 MC. at distances between about 50 and 65 miles, 80 to 100 miles and above 110 miles. It would take more than a year to secure it. Fortunately measurements are available at various distances for frequencies in the 45-66 MC, 71-108 and 474-700 MC regions. One group of propagation experts at FCC and another at NBS are using all known means for analyzing and coordinating the existing knowledge, so that, aided by the experienced group of consulting and industry engineers on the committee the final predicted behavior of TV tropospheric transmission will be as exact as it is possible to make it at this time.

If the allocation plan based on such recommendations permits some interference in a few areas in the years to come, recourse can be had to the Synchronized Carrier system and possibly to the use of receiving antennas having high front-to-back rejection ratios. A design of such an antenna which had a ratio of 20 was described recently to the FCC by Dr. Brown of RCA Labs.

With the Ad Hoc committee's report in the hands of FCC, the "freeze" should be lifted by May and Chairman Coy says the UHF television band may be opened for commercial use by the end of 1949. This would mean that during the following two years the number of television stations may reach the undreamed of number of 350 in the U. S. A.

## TV Engineering Clinic

Sixty-nine engineers enrolled in the sixth RCA Television Technical Training Program at Camden, N. J., were awarded certificates recently at closing sessions of the five-day clinic.

The week's training schedule included lecture classes employing the latest techniques of audio-visual instruction, supplemented by tours of the RCA Victor plant in Camden and the RCA Laboratories in Princeton, N. J., where some of 224 equipment items developed for television broadcasting were demonstrated.



## Rotating Radar Antenna AS-18A/APS

... a real bargain for use in television and "ham" beam antennas, radio and television relay networks and experimental V.H.F. work. Includes rotating joint, J-67/APS-15 junction box, RE-5/APA-13 relay box, MX-160/APS-15 heater, CN-18/APA-14A torque unit, 28-volt D.C. drive motor. Reflector diam. 28.5". Shipping wt. 196 lbs. **\$27.50**

net F.O.B.

**SOUTHLAND AERO SUPPLY**  
COMPANY

Box 868, Dept. A

Norfolk, Va.

## TELE-TECH

Reaching the men  
responsible for  
**DESIGN,**  
**MANUFACTURE**  
and **OPERATION** of

ALL

**ELECTRONIC**  
**COMMUNICATIONS**

## CLOSING DATES

- 1st** of preceding months—  
For all ads requiring proofs,  
composition, foundry work,  
key changes, etc.
- 5th** of preceding months—  
For Complete plates only.  
No setting.
- 1st** of month—  
Publication Date

**CALDWELL-CLEMENTS, Inc.**  
480 Lexington Ave. New York 17 Plaza 3-1340



BUILD BETTER ELECTRONIC EQUIPMENT  
with STANDARDIZED



for ALL P. A. NEEDS Par-Metal Equipment is preferred by Service Men, Amateurs, and Manufacturers because they're adaptable, easy-to-assemble, economical. Beautifully designed, ruggedly constructed by specialists. Famous for quality and economy.

READY-TO-USE CABINETS  
CHASSIS  
PANELS  
RACKS

**PAR-METAL PRODUCTS CORPORATION**  
32-62-49th ST., LONG ISLAND CITY 3, N. Y.  
Export Dept.: Roche International Corp.  
13 East 40 Street, New York 16

**205**

Exhibiting Manufacturers

are showing this label on their letters, literature and advertising. The spotlight is on the new at the Radio Engineering Show, come and see —

**ELECTRONIC EQUIPMENT**

Registration \$3. non-members,  
\$1. to IRE members

**RADIO ENGINEERING SHOW EXHIBITOR**  
GRAND CENTRAL PALACE  
AND  
HOTEL COMMODORE  
MARCH 7 to 10  
**1949**

**TELE-TECH**  
Advertisers March 1949

|   |             |
|---|-------------|
| Aerovox Corp. ....                      | 14          |
| American Condenser Co. ....             | 64          |
| Anaconda Wire & Cable Co. ....          | 5           |
| Astatic Corp. ....                      | 62          |
| Automatic Electric Sales Corp. ....     | Cover 2     |
| Bell Telephone Labs. ....               | 13          |
| Caldwell-Clements, Inc. ....            | 74, 76      |
| Cleveland Container Co. ....            | 55          |
| Commercial Plastics Co. ....            | 68          |
| Communications Equipment Co. ....       | 72          |
| Dillon & Co., Inc., W. C. ....          | 60          |
| Distillation Products, Inc. ....        | 16          |
| Driver-Harris Co. ....                  | 7           |
| Dumont Labs., Inc., Allen B. ....       | 12, 22      |
| Eisler Engineering Co., Inc. ....       | 66          |
| Eitel-McCullough, Inc. ....             | 8           |
| Electrical Reactance Corp. ....         | Cover 3     |
| Electronicraft, Inc. ....               | 72          |
| Federal Telephone & Radio Corp. ....    | 23          |
| General Electric ....                   | 17-20, 66   |
| Gray Reseach & Development Co. ....     | 64          |
| Guardian Electric Mfg. Co. ....         | 68          |
| Heinemann Electric Co. ....             | 10          |
| Helipot Corp. ....                      | 51          |
| Heppner Mfg. Co. ....                   | 61          |
| Institute of Radio Engineers ....       | 75          |
| Instrument Associates ....              | 72          |
| International Resistance Co. ....       | 2, 3        |
| Jackson Electrical Instrument Co. ....  | 69          |
| Jones Div., H. B. Cinch Mfg. Corp. .... | 60          |
| Kahle Engineering Co. ....              | 69          |
| Kay Electric Co. ....                   | 54          |
| Kester Solder Co. ....                  | 57          |
| Knights Co., James ....                 | 74          |
| Lavoie Labs. ....                       | 65          |
| Macallen Co. ....                       | 53          |
| Magnetic Core Corp. ....                | 70          |
| Mallory & Co., Inc., P. R. ....         | 6           |
| Milo Radio & Electronics Corp. ....     | 75          |
| National Vulcanized Fibre Co. ....      | 56          |
| Newark Electric Co. ....                | 76          |
| Niagara Radio Supply Corp. ....         | 73          |
| North American Philips Co., Inc. ....   | 15          |
| O'Neil-Irwin Mfg. Co. ....              | 71          |
| Panoramic Radio Corp. ....              | 21          |
| Paramount Paper Tube Corp. ....         | 67          |
| Par-Metal Products Corp. ....           | 75          |
| Precision Paper Tube Co. ....           | 71          |
| Presto Recording Corp. ....             | 24          |
| Radio Corp. of America ....             | 69, Cover 4 |
| Shure Brothers, Inc. ....               | 63          |
| Southland Aero Supply Co. ....          | 74          |
| Spellman Television Co., Inc. ....      | 76          |
| Sprague Electric Co. ....               | 9           |
| Sylvania Electric Products, Inc. ....   | 11          |
| Synthane Corp. ....                     | 70          |
| Telex, Inc. ....                        | 59          |
| Telrex, Inc. ....                       | 76          |
| Transradio Ltd. ....                    | 60          |
| Universal General Corp. ....            | 72          |
| Ward Leonard Electric Co. ....          | 58          |
| Welch Scientific Co., W. M. ....        | 62          |
| Western Electric Co. ....               | 13          |
| Williams & Co., C. K. ....              | 67          |
| Zophar Mills, Inc. ....                 | 65          |

Because it's  
**NOT SURPLUS**  
This is a  
**TERRIFIC VALUE!**

Here's a sensational MONEY SAVING OPPORTUNITY for every Radio Amateur, Experimenter, Industrial User ... while our stocks last, you can buy these two popular tube types AT JOBBERS' COSTS!

Made by nationally known manufacturer, they carry standard RMA guarantee. Each tube is BRAND NEW, individually boxed. At these smashing low prices, we can't reveal mfr's name, but you'll recognize it!



**250TH**  
HI-MU TRIODE  
MODULATOR  
OSCILLATOR  
AMPLIFIER

**\$22.50**  
each  
Two for \$41.95

**100TH**  
HI-MU TRIODE  
MODULATOR  
OSCILLATOR  
AMPLIFIER

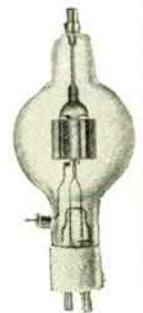

**\$12.38**  
each  
Two for \$22.95

**WE'VE GOT 'EM IN STOCK**  
Ready for immediate delivery!  
Mail orders shipped same day received.  
No C.O.D.'s please, send check or M.O. with order, unless rated. Quantity users write for special prices.

Please mail orders and inquiries to N. Y. Office only:

**MILO**

**RADIO & ELECTRONICS CORP.**  
200 Greenwich St., New York 7, N. Y.  
Phone: BE 3-2980

Branch: 160-13 Northern Blvd., Flushing, L.I.  
Phone: Flushing 8-7425  
Cable Address: MILOELECTRO New York

*telrex* INC.  
CONICAL ANTENNAS

Box 879, Asbury Park, N. J.  
Phone Asbury Park 1-0119

**Model 4XTV**  
"America's Outstanding  
Television Beam"

Model 4XTV is a hi-gain stacked conical "V"-beam. The driven elements are shaped to present a "V" to the incoming wave, preventing a change in the receiving lobe as the frequency increases. The antenna has a front to back ratio of better than 4 to 1 on all frequencies. Nominal center impedance is 150 ohms which is prevented from varying by the conical elements. This not only provides excellent resolution but prevents ghosts or phase shift due to mismatch between transmission line and antenna.

When stations are within a 5 to 15 degree sector (depending on distance from the transmitter) the 4XTV used for maximum efficiency at low frequencies, becomes a much more efficient antenna than a stacked array cut to the high frequencies.

This antenna is stacked to present a 1/4 wave spacing on channel 2 which increases to full wave length spacing on channel 13; the angle of inception is lowered tremendously and high angle response lobes directly above and below the antenna are eliminated.

SEE YOUR DISTRIBUTOR OR WRITE US

**THREE**



send today for this  
big book of values in  
**TELEVISION**  
RADIO, ELECTRONIC,  
INDUSTRIAL, SOUND &  
AMATEUR EQUIPMENT

**NEW 1949  
NEWARK CATALOG**

20,000 items including everything in STAND-  
ARD BRAND equipment! 148 pages packed  
with pictures, charts, and vital information!

**KITS! SETS! PARTS! ACCESSORIES!**

No matter how tiny the part, how tremendous the system... it's listed in this mammoth catalog... the one easy, satisfactory way to always get top-performing, top-value equipment! The most complete essential reference book for pros, hams, hobbyists, novices, oldtimers... anyone, everyone interested in TV, radio and sound equipment!

24-HR. MAIL SERVICE • ONE YEAR TO PAY

**3 GREAT STORES!** Uptown at 115 West 45th Street  
and Downtown at 212 Fulton Street in NEW YORK  
323 West Madison Street in the heart of CHICAGO



MAIL COUPON TODAY

Newark Electric Co.  
242 W. 55th St., NYC

Dept. C26 Please send FREE Newark Catalog to:  
NAME \_\_\_\_\_  
ADDRESS \_\_\_\_\_  
CITY \_\_\_\_\_ STATE \_\_\_\_\_

**BULLETINS**

**High Vacuum Apparatus**

The Central Scientific Co., 1700 Irving Park Road, Chicago 13, Ill., has issued a booklet on its high vacuum apparatus. Included in the 48 pages are suggestions for planning a high vacuum system information on pumping speed, explanation of merit factor, connections and speed of evacuation, and low pressure technique. (Mention T-T)

**Portable Thermal Meters**

Vacuum thermocouples for the measurement of AC or DC is the subject of a bulletin recently-released by the Rawson Electrical Instrument Co., 117 Potter St., Cambridge 42, Mass. (Mention T-T)

**Patch Cords**

A newly-developed line of patch cords, twin patch cords, twin plugs and replacement cords for broadcast work are being manufactured by Trimm, Inc., Libertyville, Ill. The patch cords are described in Trimm's bulletin R-7. (Mention T-T)

**SWR in FM Band**

A new booklet issued by the Gates Radio Corp., Quincy, Ill., entitled "Standing Wave Ratios in the FM Broadcast Band" discusses common causes of standing waves on transmission lines, their detrimental effects, methods of measurement, and means of minimizing their existence. (Mention T-T)

**Magnetic Amplifiers**

Circuits, characteristics, and applications of Vickers magnetic amplifiers are described in a new bulletin published by Vickers Electric Div., Vickers, Inc., 1815 Locust St., St. Louis 3, Mo. (Mention T-T)

**Sized & Formed Products**

A complete line of electric soldering iron replacement tips and spade bolts is the subject of a new bulletin released by Wenco Mfg. Co., 1131 West Hubbard St., Chicago 22, Ill. Simplex strippers and wire cutters are described in another bulletin, No. 8-2844. (Mention T-T)

**Replacement Transformers**

Over 40 major types of replacement transformers, comprising 186 specific units, are described and illustrated in a new catalog published by Crest Transformer Corp., Dept. OT, 1834 West North Ave., Chicago 22, Ill. (Mention T-T)

**Permanent Magnets**

A 28-page illustrated catalog (CDM-2A) describing stocked GE permanent magnets has been issued by the Chemical Dept., General Electric Corp., Pittsfield, Mass. Photographs and pull curves of cast and sintered Alnico magnets appear in the catalog. Special magnetic alloys are described. (Mention T-T)

**Miniature Tubes**

The Radio Receiving Tube Div. of the Raytheon Mfg. Co., 60 East 42nd St., New York 17, N. Y. has published a new miniature tube characteristic chart, listing over 70 tubes. Pertinent characteristics, applications, terminal connection diagrams and outline drawings for every miniature receiving type tube now announced are included. (Mention T-T)

**Switchboardless Generators**

Kato Engineering Co., Mankato, Minn. is mailing catalog sheets on its 175 KW Kato-light AC Generators, specially engineered units which do not ordinarily require a separate switchboard. (Mention T-T)

**Resistance Testers**

Included in a new bulletin published by the James G. Biddle Co., 1316 Arch St., Philadelphia 7, Pa are clear and easily understood descriptions of "Megger" heavy-duty insulation type resistance testers. Bulletin number is 20-20-15. (Mention T-T)

**Replacement Transformers**

Crest Transformer Corp., 1834 West North Ave., Chicago 22, Ill., has completed its new catalog of replacement transformers. Over 40 major types are described and illustrated. (Mention T-T)

**PROJECTION TELEVISION!**

**30 KV RF POWER SUPPLY**

Dimensions:  
Length 14", Width  
11", Height 11 1/4"  
New improved  
unit of exception-  
al regulation. Has  
a focus control  
pot built in for  
use with 5TF4  
Tube. Voltage va-  
riable from 27 to  
30 KV. Supply  
utilizes 6 tubes.



Net Price, including DC Power Supply ... \$99.50

**SPELLMAN F1.9 PROJECTION LENS**



Dimensions: Length 7",  
Diameter 4 1/4".

F 1.9 EF. 5 in. (127.0 mm).  
This lens incorporates in  
barrel a corrective lens for  
use with a 5TF4 projection  
tube. It is easily removable  
for use with flat type tubes.

Lens can be utilized to  
project picture sizes from several inches to 7 x 9  
feet. ONLY \$90 complete with mounting ring.  
Machined slotted mtg. ring for hand focusing  
adjustment \$8.00 extra.



**HIGH VOLTAGE COILS**

Complete with diagram for 10KV  
and 30 KV tripler circuit. Same  
type used in our power supply.  
Net Price.....\$7.75

**HIGH VOLTAGE METER**

A precision made instrument has 4" scale  
and only draws 20 microamps.

Net price.....\$67.50

Send for Free Complete Technical Details

Include 25% Deposit With Order, Balance C.O.D.

**SPELLMAN TELEVISION CO., INC.**  
130 WEST 24th STREET • NEW YORK 11, N. Y.



Foremost technical journal of radio,  
television and tele-communications.

... Greatest number of television and  
tele-communications editorial pages.

... Authoritative treatment of cur-  
rent engineering trends, problems and  
developments. ... Largest engineer-

audience in design, manufacture,  
operation and maintenance of tele-  
vision and tele-communications (15,504  
total circulation monthly C.C.A.).

**CALDWELL-CLEMENTS, INC.**

480 LEXINGTON AVENUE  
NEW YORK 17, N. Y.



IT

**PAYS**



**TO SPECIFY**

**COMPONENTS**

# for Hi-Quality T. V. Performance

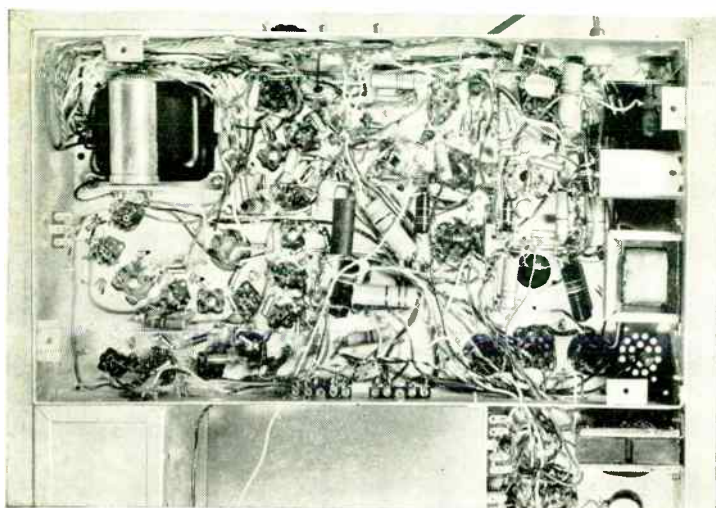

RCA Victor television receiver Table Model 8T241 uses many **Hi-Q** capacitors for Uniform, Dependable reception.

● Not only RCA Victor, but practically every manufacturer of television sets looks to **Hi-Q** Electrical Reactance Corporation for components of *Dependable* quality ... *Precision* tested and *Uniform* capacity.

Today's tremendous demand for high quality **Hi-Q** components is being met at three (3) modern plants equipped with the most modern machines helping supply the needs of the fast growing electronics industry.

Our competent engineering staff is available for consultation with your engineers in the design of newly developed circuits.

A FEW OF THE COMPANIES USING **Hi-Q** ELECTRONIC COMPONENTS

STROMBERG-CARLSON



RCA Victor

Westinghouse  
RADIO TELEVISION

Spartan

CROSLEY

Bendix Radio

Motorola

Tele-tone

Packard-Bell

Admiral

DUMONT

GENERAL ELECTRIC

**Hi-Q** components are specified by over 200 leading manufacturers. Space does not permit listing all of our valued customers.



**Hi-Q COMPONENTS**  
**BETTER 4 WAYS**

**PRECISION** Tested step by step from raw material to finished product. Accuracy guaranteed to your specified tolerance.

**UNIFORMITY** Constancy of quality is maintained over entire production through continuous manufacturing controls.

**DEPENDABILITY** Interpret this factor in terms of your customers' satisfaction . . . Year after year of trouble-free performance. Our **Hi-Q** makes your product better.

**MINIATURIZATION** The smallest **BIG VALUE** components in the business make possible space saving factors which reduce your production costs . . . increase your profits.



## Electrical Reactance Corp.

FRANKLINVILLE, N. Y.

Plants: FRANKLINVILLE, N. Y. — JESSUP, PA. — MYRTLE BEACH, S. C.  
Sales Offices: NEW YORK, PHILADELPHIA, DETROIT, CHICAGO, LOS ANGELES

*Another RCA First...*

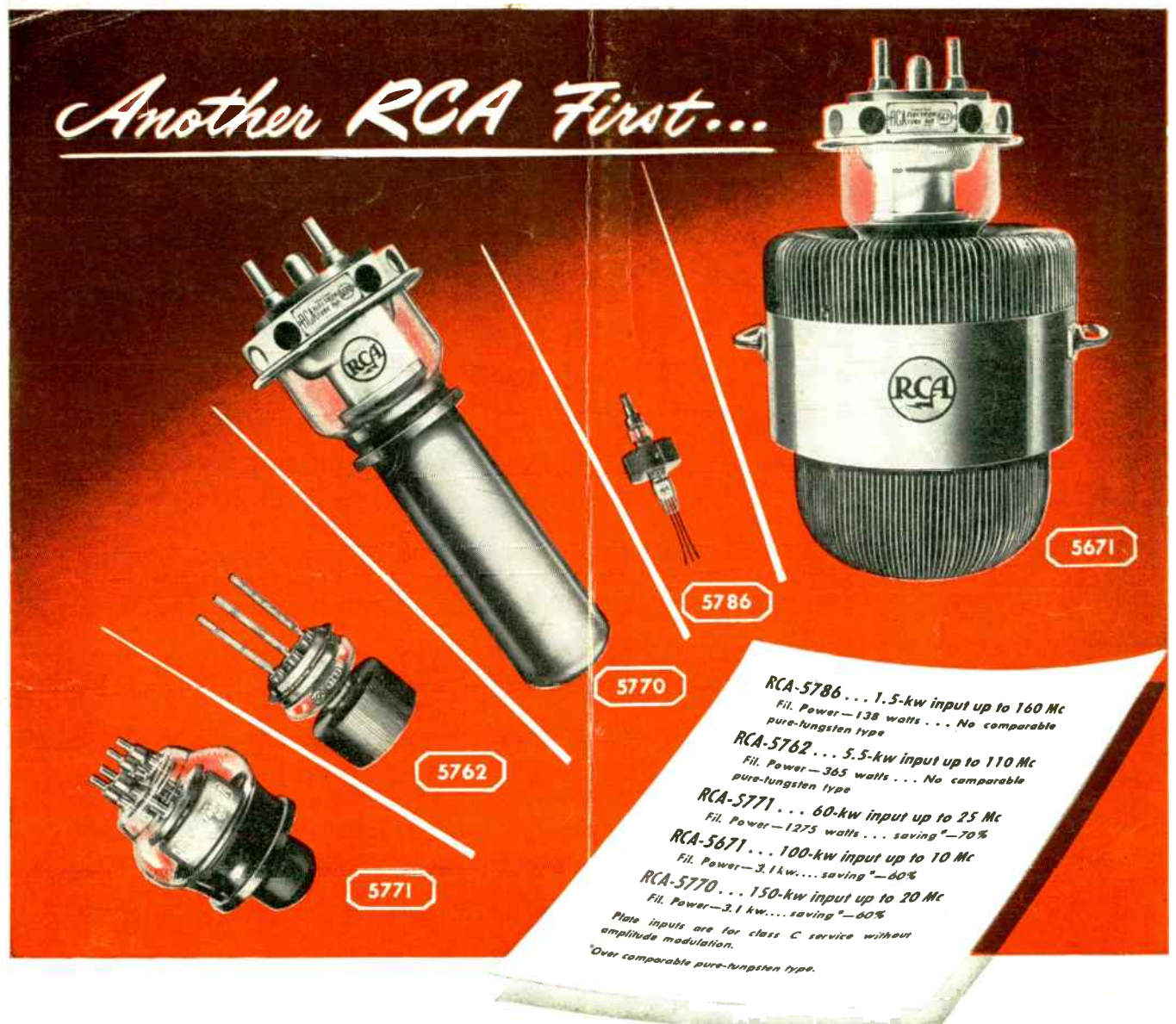

**... the economy of thoriated-tungsten filaments and improved cooling in high-power tubes**

*Here is unparalleled tube value...*

Five new RCA tubes, ranging in power input from 1.5- to 150-kw, and successfully utilizing economical thoriated-tungsten filaments which offer marked savings in filament power and the cost of associated power equipment.

Five tubes with proved features of previous similar types. Two—the 5762 and 5786—have efficient newly designed radiators that permit the use of less expensive blowers.

Five tubes with improved internal constructions that contribute to their more efficient operation and longer service life.

These five new RCA tube types are "musts" for designers of broadcast, communications and industrial electronic equipment where design and operating economies alike are important considerations.

Forced-air-cooled assemblies and

water-jacket assemblies are available for most RCA power tubes.

**RCA Application Engineers** are ready to consult with you on the application of these improved tubes and accessories to your specific designs. For complete technical information covering the types in which you are interested, write RCA, Commercial Engineering, Section 57CR, Harrison, New Jersey.

**THE FOUNTAINHEAD OF MODERN TUBE DEVELOPMENT IS RCA**



**TUBE DEPARTMENT**  
**RADIO CORPORATION of AMERICA**  
**HARRISON, N. J.**