

ELECTRONIC INDUSTRIES

September • 1946

IN THIS ISSUE:

INSTRUMENTATION APPLICATIONS

Production Aids that Are Speeding Up Operations and Stabilizing Quality • Summarizing Modern Methods of Using Today's Electronic Control Equipment • Utilizing the Dependability of Vacuum Tubes

MEASUREMENT AND RECORDING

Standards of Accuracy and Speed Improved with Latest Precision Instruments • The Use of Bolometers in High Sensitivity Temperature Measurements • Applications of Cathode Ray Tubes to Industrial Operations • Instrumentation for Atom Bomb Tests

ENGINEERING AND DESIGN

Probable Developments in Electronic Instrumentation • What Key Industries Expect in New Equipment • Design of Pulse Counting Units • Latest Offerings of Instrument Makers

INSTRUMENTATION CHART SUPPLEMENT WITH THIS ISSUE

Need a Switch with Maximum Insulation?

**This
RS 30 Ceramic
Has It!**

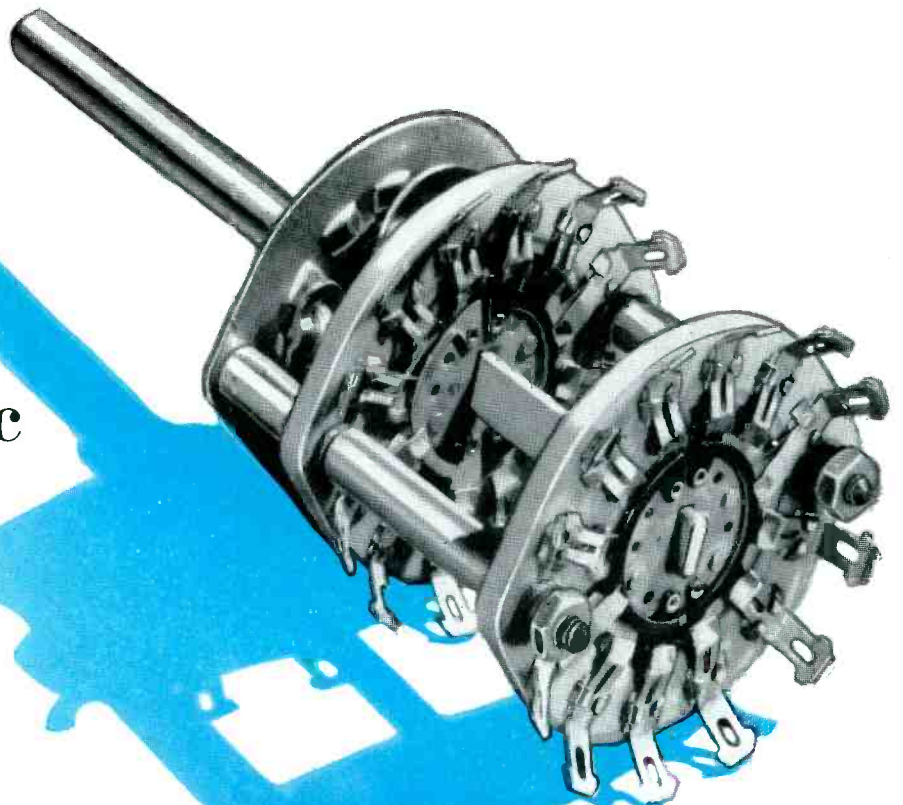

HIGH INSULATION? This switch has it—and something to spare! The ceramic rotors and stators are extra thick, too, for strength and durability.

But maximum insulation would mean very little were it not also coupled with these other advantages:

Compact design . . . Unlimited circuit possibilities . . . Silver-to-silver contacts . . . Double wiping contacts . . . New type rotor support allowing improved rotor and contact alignment . . . Indium-treated, silver plated rotor segments.

Want more details? Send for RS Switch Data Folders and for Specification Layout Sheets. If special help is required, our engineers will be glad to assist you. Standard Mallory Switches may be readily obtained from your Mallory Distributor.

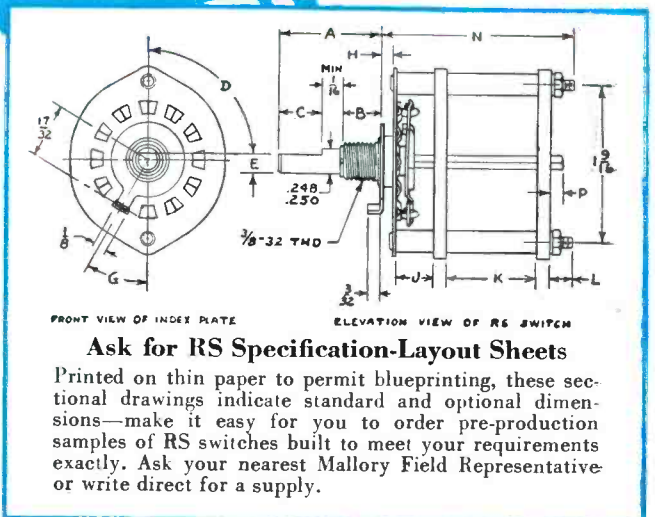

P. R. MALLORY & CO. Inc.
MALLORY SWITCHES
(INDUSTRIAL AND ELECTRONIC)

P. R. MALLORY & CO., Inc., INDIANAPOLIS 6, INDIANA

ELECTRONIC INDUSTRIES

Including INDUSTRIAL ELECTRONICS

Editorial Contents

SEPTEMBER, 1946

| | | | |
|--|-----|--|-----------------------|
| EDITORIAL | 65 | WHAT INDUSTRY SEEKS IN ELECTRONIC CONTROL | 85 |
| Instrumentation Chart—Electronic Toughness—500-kw Broadcast Stations—Electronic Microfilm Library | | Engineers of chemical, petroleum and food producers outline processing problems and instrument needs | |
| INDUSTRY STUDIES CIRCUIT TECHNICS | 66 | THERMAL DETECTORS | 87 |
| Modernized circuits and methods of utilizing electronic effects provide solutions to jobs in many fields | | Newest temperature instruments having extreme sensitivity find numerous uses in industry | |
| ELECTRONIC GAGING, Paul H. Hunter | 68 | RADIOACTIVITY METER, Arthur G. Bousquet ... | 88 |
| New standards of accuracy and speed in dimensional inspection made possible by electronic instruments | | Electronic engineering makes another contribution to development of atomic energy for constructive use | |
| SELECTING PROPER TUBES AND CIRCUITS | 72 | NEW INSTRUMENTATION PRODUCTS | 90-95 and 106-108-110 |
| Survey of factors which must be considered in order to design reliability and long life into equipment | | NEW OSCILLOSCOPE DESIGN | 98 |
| TELEMETERING FOR PROJECT CROSSROADS .. | 76 | Elmer C. Simmons | |
| Dr. J. W. Colton | | Recent circuits derived from radar research are combined in a new instrument for laboratory use | |
| Engineering the elaborate pressure measuring equipment used to record results of Bikini atom bomb tests | | TUBES ON THE JOB | 98 |
| VACUUM TUBES IN INSTRUMENTATION | 80 | Mobile Radio for Trucks—Rubber Weighing—Electronic Wheel Balancing Equipment—Coin Rejector—Stress Measurements on Steel Trusses | |
| R. R. Batcher | | SURVEY OF WIDE READING | 100 |
| Electronic devices heretofore used in industry to duplicate and sensitize other controls, do new jobs | | Magnetically-Controlled Gas Discharge Tubes—Reproducing Sound Film—Powdered Iron Cores—Non-Linear Bridge Circuits as Voltage Stabilizers | |
| ELECTRONIC TRUE DECADE COUNTERS | 82 | NEW PATENTS ISSUED | 102 |
| H. Gregory Shea | | New Books Reviewed | 140 |
| Advances in original Eccles-Jordan flip-flop circuit open the field of counter circuits to industry | | Personnel | 142 |
| Washington News | 104 | New Bulletins | 146 |
| Television Today | 112 | | |
| News of Industry | 114 | | |

Vibration

LOWERS WORKERS' MORALE
SHORTENS MACHINE LIFE
INCREASES REJECTS
CUTS YOUR PROFITS

Control it with

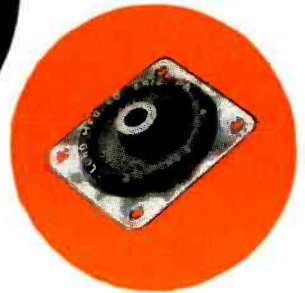
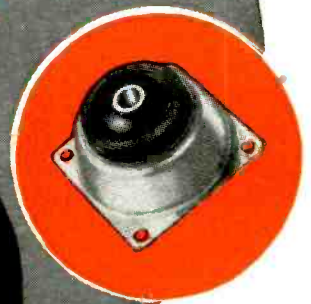
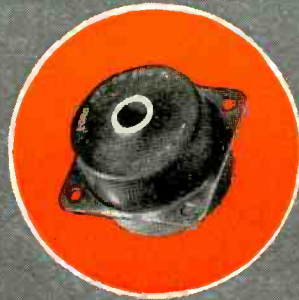

"VIBRATION nerves" are not the only cause of industrial fatigue, but they are a sure cause . . . and controllable, because vibration is controllable. Lord, pioneer in vibration control, has made better working conditions for hundreds of manufacturers, with consequent improved morale, increased output, and lowered employee turnover.

Machines, as well as men, are vulnerable to the destructive forces of vibration. Vibration control improves the quality of the machine's output, lowers maintenance cost, and greatly extends its useful life.

Vibration control is a necessary preliminary to quality control. Better workers and smoothly functioning machines are reflected immediately in the inspector's report of fewer rejects. It all points up to the prime objective of all industrial effort—increased profits.

Lord-engineered vibration control in your plant is a small investment with large and far-reaching returns. Write for Bulletin 104.

Every genuine Lord Mounting carries the name "LORD" embossed in the rubber or in raised letters on the forgings.

IT TAKES BONDED RUBBER *In Shear* TO ABSORB VIBRATION

LORD MANUFACTURING COMPANY

ERIE, PENNSYLVANIA

SALES REPRESENTATIVES
NEW YORK - - - 200 MADISON AVE.
CHICAGO - - - 520 N. MICHIGAN AVE.
DETROIT - - - 7310 WOODWARD AVE.
BURBANK, CAL. - - 245 E. OLIVE AVE.
WASHINGTON - 14TH & G STREETS, N. W.
CANADIAN REPRESENTATIVE
RAILWAY & POWER ENGINEERING CORP., LTD.
TORONTO, CANADA

Originators of Shear Type Bonded Rubber Mountings

TRANSFORMERS of TOMORROW

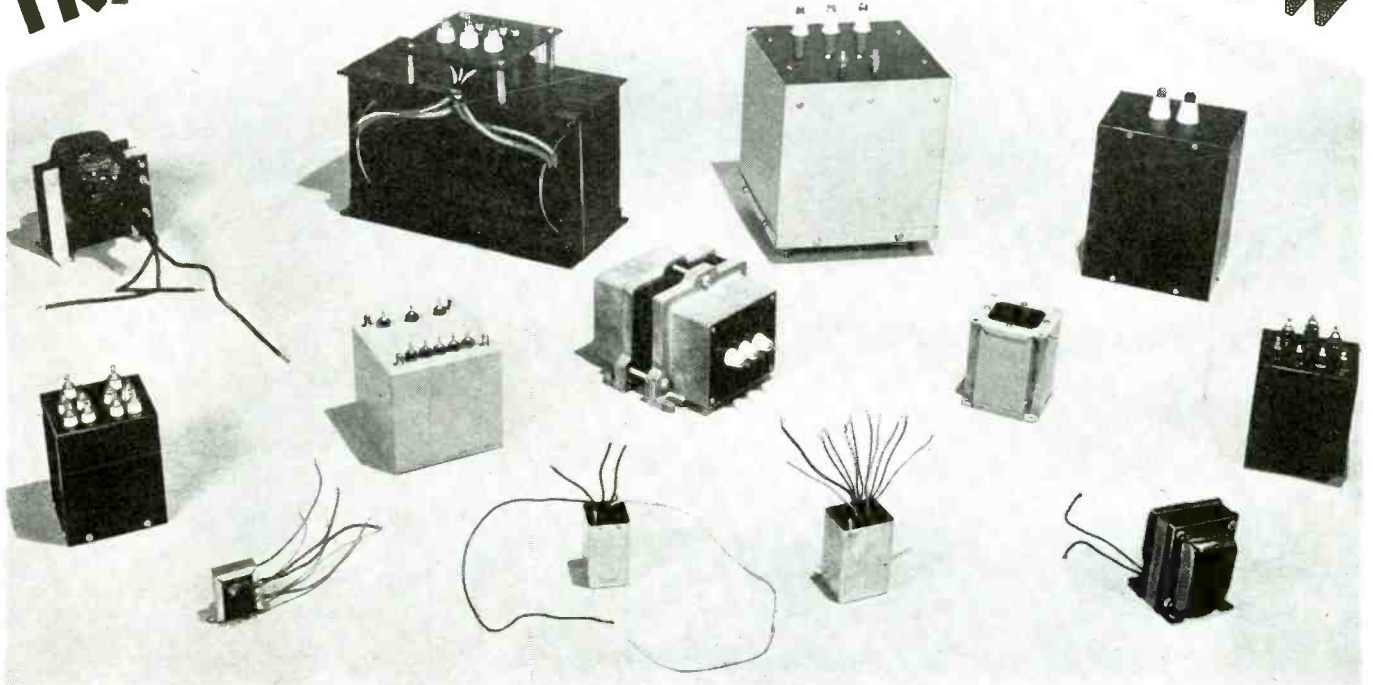

Engineers say

"HERE'S WHY WE CHOOSE K-V"

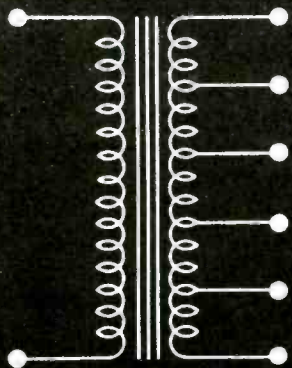

- ADVANCED ENGINEERING AT LOW COST
- MANUFACTURING KNOWLEDGE
- ELECTRICAL AND MECHANICAL STABILITY
- MODEL SHOP AND PRODUCTION FACILITIES
- RIGID INSPECTION AND QUALITY CONTROL
- SPEEDIER DELIVERY

AUDIO COMPONENTS
WAVE FILTERS
MODULATION TRANSFORMERS
SHIELDED BRIDGE UNITS

PHASE SHIFT DEVICES
HIGH Q INDUCTORS
TELEVISION TRANSFORMERS
ELECTRO-MECHANICAL UNITS



TRANSFORMER CO.

1697 FIRST AVENUE

NEW YORK 28, N. Y.

ADDRESS INQUIRIES TO DEPT. B

There is only **ONE** **ISOLANTITE**

"MANIFOLD"

IS THE WORD

for  Service

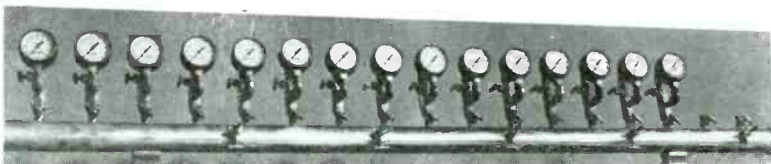

THE unit pictured above is a Dry-Nitrogen Gas Manifold destined for Cowles Broadcasting Company's Station WOL in Washington, D.C., H. P. Foley Company, Contractors. The general design of this assembly was drawn up by Lockwood Greene and Company and Henry H. Lyon, Supervisory Engineer of Station WOL. The final details were laid out and the unit constructed by ISOLANTITE, INC.

This manifold has provision for 3 operating and 2 spare input lines, with 15 operating and 2 spare output lines. Pressurization of all transmission lines is thus controlled from a single location, making high-efficiency operation of the power transmission system a very practical matter.

If YOU have a problem of design or construction in the electronics field, why not drop us a line? We are pleased to offer you, without obligation, the benefit of our long experience.

STEATITE

Our Steatite Products are universally known as being outstanding from a quality standpoint.

Coil Forms, Resistor-Spools, Lead-in, Standoff and Strain Insulators, Tapped Posts—in fact, everything in Steatite whether extruded, machined or pressed.

Refractory Bricks—Unglazed for Electric Stoves—Glazed for Electric Broilers. Made to your specifications—assembled with wire and studs if you desire.

*We are equipped to give you prompt delivery on Standard Parts.
Your request for quotations will receive prompt attention.*

Write to your nearest representative:

HAMILTON PRETAT
4 No. Cicero Ave., Chicago 44, Ill.

ELECTRONIC ENTERPRISES, LTD.
1078 St. Urbain St., Montreal 1, Canada

STEPHEN P. FRICK
126 State St., Boston, Mass.

REYNOLDS & HARRIS
177 State St., Bridgeport, Conn.
401 No. Broad St., Philadelphia, Pa.

W. BERT KNIGHT CO.
908 Venice Blvd., Los Angeles, Calif.
C. E. WHITE CO.
Bulkley Bldg., Cleveland 15, Ohio
MAURY E. BETTIS & CO.
3119 Gillham Rd., Suite A
Kansas City 3, Mo.

ISOLANTITE, INC.

"FOUNDERS OF THE INDUSTRY"

343 CORTLANDT ST., BELLEVILLE 9, N. J.

ELECTRONIC INDUSTRIES

ORESTES H. CALDWELL
Editor

M. CLEMENTS
Publisher

STANLEY P. McMINN
Managing Editor

RALPH R. BATCHER H. GREGORY SHEA
Consulting Editor Associate Editor

JOSEPHA ZENTNER, Ph.D.
Patents and Foreign Reviews

PAUL H. HUNTER WILLIAM MOULIC
Instrumentation Contributing Editor

HENRY JACOBOWITZ E. T. BENNETT
New Products Editorial Records

CHARLES DREYER
Art Director

FRED C. HOFFMAN CARL BUHRER
Editorial Production Circuit Diagrams

ROLAND C. DAVIES
Washington Editor—1290 Nat'l Press Bldg.

READER SERVICE
J. COSIN, H. MIRTEL, M. TEMMEL

CIRCULATION
B. V. SPINETTA
Circulation Director

B. GOLLUB, M. GROENING, B. RUCHAIISKY
Subscriptions, List Compilation

BUSINESS DEPARTMENT
M. H. NEWTON
Business Manager

JOHN SAMBORN R. Y. FITZPATRICK
Sales Manager Western Manager

R. F. WILLETT C. J. STILLMAN
New England Mgr. Eastern Manager

BEN MORRIS
Promotion Manager

N. McALLISTER J. E. COCHRAN
Production Manager Make-Up

W. W. SWIGERT
Credit Manager

W. KENNETH REYNOLDS E. CALLAHAN

Electronic Industries®, September, 1946. Vol. V, No. 9. Regular price per copy 35 cents. Published monthly by Caldwell-Clements, Inc., 480 Lexington Avenue, New York 17, N. Y. M. Clements, President; Orestes H. Caldwell, Treasurer. Subscription: United States and possessions, Mexico, Central and South American countries, \$3.00 for one year; \$5.00 for two years; \$6.50 for three years. Canada, \$3.50 per year; \$5.50 for two years; \$7.15 for three years. All other countries \$5.00 for one year; \$8.00 for two years; \$10.00 for three years. Entered as Second Class Matter, September 20, 1943, at the Post Office at New York, N. Y., under the act of March 3, 1879. Copyright by Caldwell-Clements, Inc., 1946. Printed in U. S. A. ®Reg. U. S. Pat. Off.

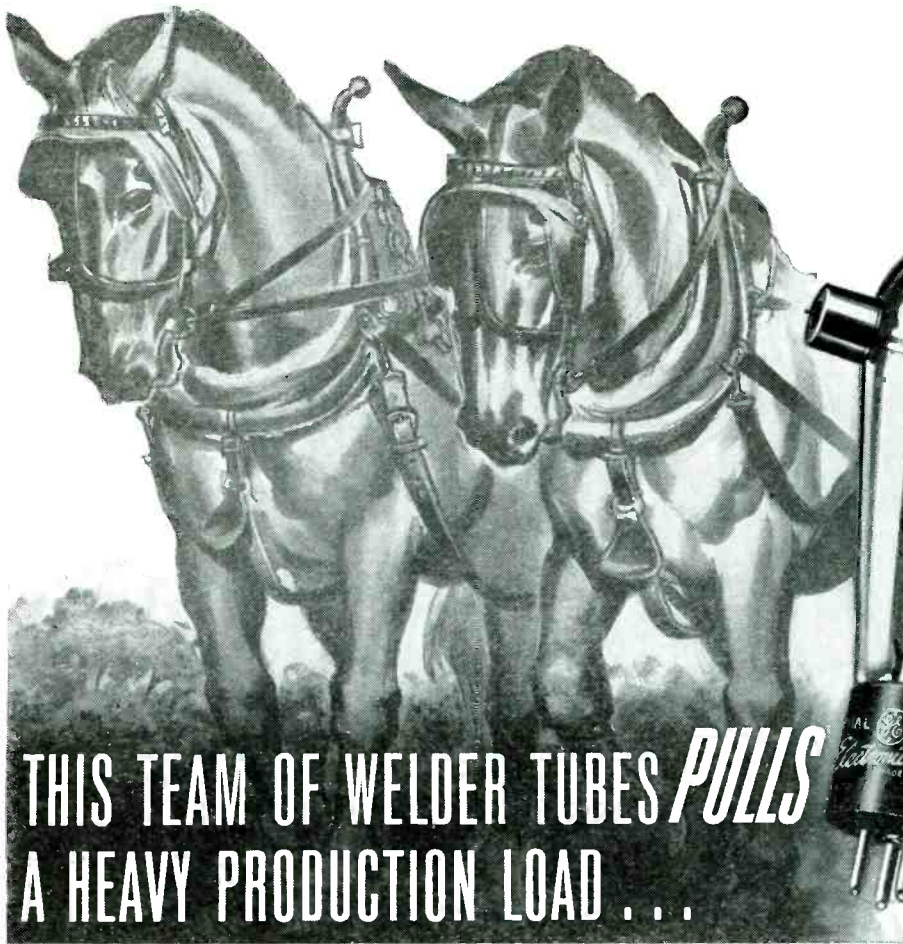

**THIS TEAM OF WELDER TUBES *PULLS*
A HEAVY PRODUCTION LOAD . . .**



***. . . and the team's always on the job, because
of fast G-E service when you need replacements!***

YOUR factory is efficient and up-to-date by reason of resistance welding, as much as any other operation. Welding machines are controlled by electronic tubes like the pair shown here.

These tubes are silent, long-serving, need no upkeep—but now and then one has to be replaced. No more welding can be done till the new tube is installed. If a key part was being handled by that welder—and what part or sub-assembly isn't vital, in today's line production?—then your output stops, while payroll and overhead go merrily on.

So you must have replacement tubes fast. The way to get them

quickly, and keep production up, is spelled **GENERAL ELECTRIC** . . . because there's a G-E distributor or dealer *right in your area* with the tubes you need—and he can deliver them in no-time-flat once you pick up the phone!

They'll be tubes, too, with G.E.'s ironclad warranty to back up their performance. *Better get in touch with your local G-E supply source today.* It's the way to protect your plant against costly shutdowns while waiting for tube replacements. And it's the way to have tube quality that's *the best and most uniform!* *Electronics Department, General Electric Company, Schenectady 5, N. Y.*

LEFT, THYRATRON FG-95 . . . \$19.25

Times the welding "shot". Ratings for welder service are: peak anode voltage 1,000 v, peak anode current 30 amp, average anode current 0.5 amp.

RIGHT, IGNITRON FG-235-A . . . \$95

Opens and closes welder circuit. Max kva demand 1,200, with avg anode current 75.6 amp—max avg anode current 140 amp, with kva demand 400.

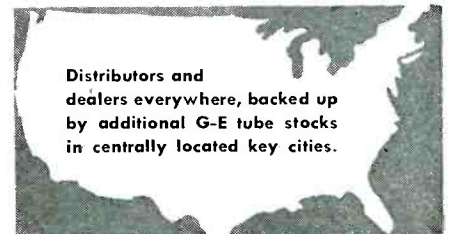

Distributors and dealers everywhere, backed up by additional G-E tube stocks in centrally located key cities.

GENERAL  ELECTRIC

162-E17-8850

FIRST AND GREATEST NAME IN ELECTRONICS

NEW!

WESTON Mutual Conductance Tubechecker and Circuit Analyzer

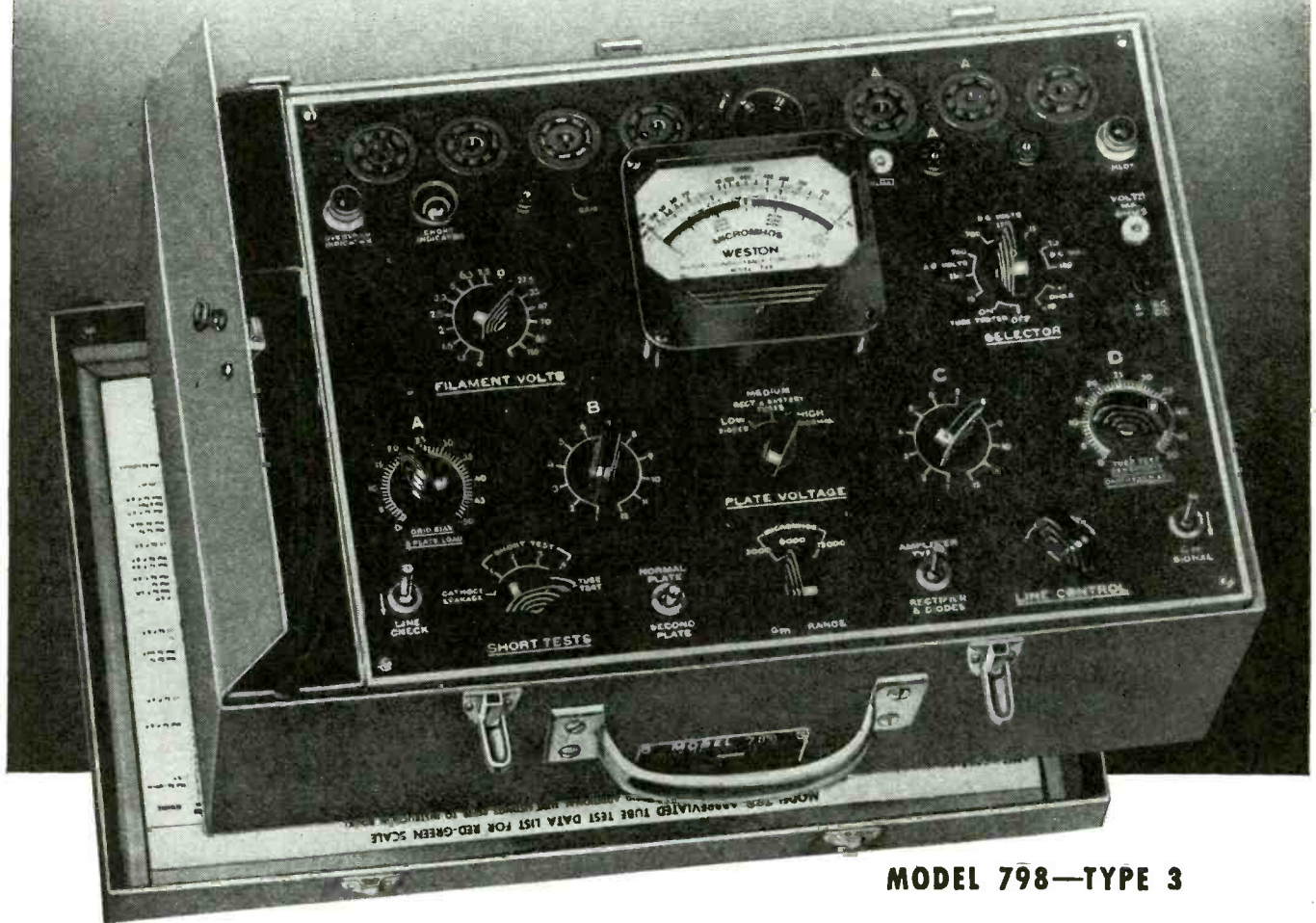

MODEL 798—TYPE 3

Outstanding Features

- ✓ Direct-reading mutual conductance tests, and "Good-Bad" indications.
- ✓ New patented high frequency tube testing circuit.
- ✓ AC-DC volt-ohm-milliamperere ranges.
- ✓ Tests 4, 5, 6, 7 prong octal, loctal, miniature, and acorn tubes... spare octal and miniature sockets.
- ✓ Hot neon leakage test between any two tube elements... neon short check.
- ✓ Adjustable plate, screen, grid bias, and signal voltages.
- ✓ Flexibility in switching simplifies testing present and future tubes.
- ✓ Durable heavy-gauge, light-weight aluminum case.

Model 798 combines broad utility, ruggedness, and dependable accuracy for maintenance of sound and electronic equipment. Detailed bulletin available. Weston Electrical Instrument Corporation, 666 Frelinghuysen Avenue, Newark 5, New Jersey.

Weston Instruments

ALBANY • ATLANTA • BOSTON • BUFFALO • CHARLOTTE • CHICAGO • CINCINNATI • CLEVELAND • DALLAS • DENVER • DETROIT • JACKSONVILLE • KNOXVILLE • LOS ANGELES • MERIDEN • MINNEAPOLIS • NEWARK
NEW ORLEANS • NEW YORK • PHILADELPHIA • PHOENIX • PITTSBURGH • ROCHESTER • SAN FRANCISCO • SEATTLE • ST. LOUIS • SYRACUSE • IN CANADA, NORTHERN ELECTRIC CO., LTD., POWERLITE DEVICES, LTD.

REVERE TUBE FOR ELECTRONIC USES

The tubes shown here happen to be made of aluminum. We also furnish shapes in magnesium, copper, copper alloys and welded steel.

Revere tube may be used for structural purposes in radio equipment, and for parts such as shafts, rivets, soldering and solderless connectors and conductors.

In addition to tube, we also supply to the electronic industry rod and bar, sheet and strip, in copper and its alloys, for use in variable condensers, vacuum tubes, anode radiators, transmitter and receiver shields, sub-bases and similar parts. Of special interest at present is the *new* Revere Free-Cutting Copper, setting new standards in quick, economical and accurate machining.

We have assisted a number of manufacturers in the electronic industry solve difficult problems encountered in the selection and working of aluminum, magnesium, copper and its alloys. Through the Revere Technical Advisory Service similar cooperation is offered to you without obligation.

REVERE

COPPER AND BRASS INCORPORATED

Founded by Paul Revere in 1801

230 Park Avenue, New York 17, N. Y.

Mills: Baltimore, Md.; Chicago, Ill.; Detroit, Mich.;
New Bedford, Mass.; Rome, N. Y. — Sales Offices in
Principal Cities, Distributors Everywhere.

Listen to Exploring the Unknown on the Mutual Network every Sunday evening 9 to 9:30 p. m., EDST.

All aboard...to music!

Santa Fe Trains To Get Radio, Music Systems

In announcing forthcoming installation of musical wire reproducers, radio and public address systems on their passenger trains, Fred G. Gurley, president of the Atchison, Topeka, and Santa Fe Railway, yesterday disclosed that individual outlets will be placed in sleeping cars.

Each roomette, bedroom, compartment, and drawing room will be equipped with push-button selector, a loud speaker, and volume control, so that occupants may have their choice of radio or wire-reproduced popular or semi-classical music, Mr. Gurley stated. A pilot lamp, lighting automatically when the announcement system is in use, will be installed so that passengers may turn the system on if they so desire.

As a forerunner of this innovation, wire reproducing units providing programs of various types of music, will be placed on the Santa Fe dining car 1450 when it goes into transcontinental service on March 10. As soon as equipment and labor are available, the railroad president declared, similar installations will be made on both new and old dining cars, as well as sleeping, chair, and club-lounge cars.

Speakers will be placed in the ceiling of these cars to provide an even distribution of low-level sound throughout the car. The volume will be set at an advantageous point for both the listener and conversationalist, it was stated.

Farnsworth Television and Radio Corporation of Fort Wayne, Indiana, designed the over-all integrated system.

Reprinted from the Chicago Journal of Commerce, March 4, 1946.



New Program Distribution Systems Make Rail Travel More Pleasant; Will Increase Passenger Traffic!

Systems Produced by Pioneers in Quality Sound Reproduction, Communications and Television.

Music now brings its magic to the railway passenger — and gives railroads another tool with which to sell travel by rail!

In announcing the first modern electronic program distribution systems for railroads, the Farnsworth Television & Radio Corporation takes a logical step forward. Known for its superlative phonograph-radios, including The Capehart, for its pioneering in the fields of tonal reproduction, television and other forms of electronics, Farnsworth now extends its engineering knowledge and manufacturing skill to the field of passenger entertainment.

These new systems will meet the varying tastes of passengers and the specific operating conditions of individual roads. Based upon the knowledge secured from railroad-conducted surveys, the most complete Farnsworth system provides four channels for individual selection: one for classical and one for popular music; a third for radio programs; and a fourth for train announcements and travel talks. More simplified Farnsworth Systems are also available.

Farnsworth engineering has met and overcome the problems peculiar to pleasing sound reproduction in passenger cars, including the need for uniform, low-level distribution and automatic compensation for varying ambient noise levels.

With these comprehensive, flexible systems, railroads can now provide passengers with the same standard of entertainment and comfort they expect in their own homes. Farnsworth Television & Radio Corporation, Fort Wayne 1, Indiana.

Farnsworth

MAKERS OF

THE CAPEHART • THE PANAMUSE BY CAPEHART

Other Products Include: Farnsworth Radio and Television Receivers and Transmitters • Aircraft Radio Equipment • Farnsworth Television Tubes
Halstead Mobile Communications and Traffic Control Systems for Rail and Highway • The Farnsworth Phonograph-Radio



THE MODULATION MONITOR

TUBE TESTER 139



SYNCHROSCOPE

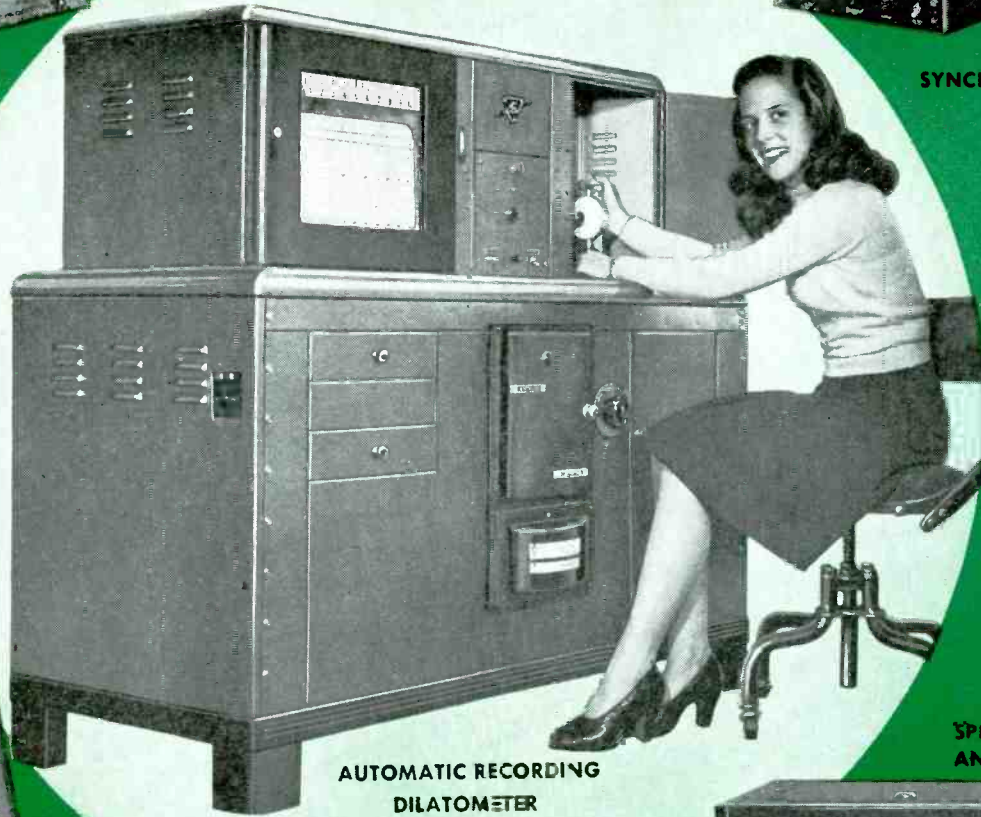

AUTOMATIC RECORDING DILATOMETER

TUBE TESTER 140



SPECTRUM ANALYZER

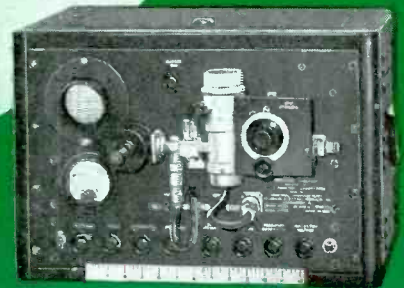

POLYMETEE

THE SAME high quality for which Sylvania Radio Tubes have long been famous has been built into Sylvania Electronic Instruments.

Inquiries are invited. Sylvania Electric Products Inc., Electronics Division, 500 Fifth Avenue, New York 18, N. Y.

SYLVANIA ELECTRIC

Electronics Division . . . 500 Fifth Avenue, New York 18, N. Y.

MAKERS OF ELECTRONIC DEVICES; RADIO TUBES; CATHODE RAY TUBES; FLUORESCENT LAMPS; FIXTURES, WIRING DEVICES; ELECTRIC LIGHT BULBS

**YOU WON'T
BELIEVE IT
TILL YOU
HEAR IT!**

NEW
Western Electric
728B LOUDSPEAKER

The first time you hear this revolutionary Western Electric loudspeaker in action, you'll get an entirely new conception of sound reproduction. It delivers speech and music with such "presence," such emotional quality, that you'll find it hard to believe you're listening to *reproduced* sound!

New design features, developed by Bell Laboratories scientists, make the 728B ideal for broadcast studios and sound systems where high quality reproduction is a "must".

For complete technical details and information on delivery, talk to your Graybar Broadcast Equipment Representative—or write Graybar Electric Company, 420 Lexington Ave., New York 17, N.Y.

— QUALITY COUNTS —



TECHNICAL DATA

FREQUENCY RANGE: 60 to 10,000 cycles.

IMPEDANCE: 4 ohms.

EFFICIENCY: At a distance of 100 feet on axis, the 728B will produce a level of 81 db above 10^{-16} watt per sq. cm. at 30 watts. This level is on a basis of a warble frequency covering a range from 500 to 2500 c.p.s.

COVERAGE ANGLE: 50 degrees.

POWER CAPACITY: 30 watts continuous.

DIMENSIONS: Diameter 12-11/32"; depth 4".

WEIGHT: Approximately 18 pounds.

BAFFLE HOLE DIAMETER: 11".

MOUNTING: An enclosure of approximately 2½ cubic feet of space is required.



S. Walter Co.

144-146 CENTRE STREET
BROOKLYN 31, N. Y.

Tel. MAin 4-7395

At your Service

TO HELP YOU WITH YOUR SHEET METAL FABRICATION REQUIREMENTS

New Machinery, a new plant and the "know-how" Personnel enables us, at this time, to solicit your inquiries regarding Sheet Metal Fabrications.

SHEET METAL PRODUCTS—such as:

INSTRUMENT PANELS, RADIO COMMUNICATION CASES and ENCLOSURES, OSCILLATOR BOXES, CHASSIS and CABINET ASSEMBLIES RACKS and SPARE PARTS BOXES. WATERPROOF CABINETS and BOXES. METAL STAMPINGS, FORMING and WELDING of FERROUS and NON-FERROUS METALS.

We specialize in RADAR and RADIO COMMUNICATION METAL PRODUCTS. "Whistler and Wiedermann Setups" used for economic and speedy production.

We can assure you of excellent workmanship and prompt deliveries. Send us your blueprints and specifications. We shall quote you immediately.

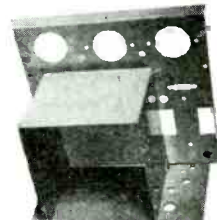

Introducing A New Concept in High Speed Measurement for the Laboratory and Production Line . . .

PANALYZOR

FEATURING
PANORAMIC TECHNIQUE



THE PANALYZOR provides an *instantaneous* visual presentation of static and dynamic characteristics of a band of radio signals in any part of the spectrum. Each signal produces its own characteristic deflection on the Panoramic screen, and each deflection reveals the frequency, amplitude, and stability of the corresponding signal. FM systems are "naturals" for PANORAMIC analysis.

Not only signals, but *any* variation of electrical or physical dimensions, convertible to a variation of frequency, can be more quickly and accurately measured by the PANORAMIC TECHNIQUE.

An outstanding feature of the PANALYZOR, in many applications, is that all necessary information is given *without* the necessity of the operator's balancing or adjusting the test equipment. PANORAMIC TECHNIQUE is economical in time and energy . . . but highly accurate in results.

Several models are available with different sweep-widths from 50kc to 6000kc. Speedwidths up to 20 megacycles available on special order.

Some Applications of the PANALYZOR

PRODUCTION

- Match inductances, capacitors, resistors, and I. F. Transformers.
- Compare components with standards.
- Test Crystals against standards — during grinding.
- Align FM discriminators.

BROADCAST STATION AND LABORATORY

- Study oscillator and transmitter behavior, frequency drift, "supering", carrier shift and modulation.
- Detect residual AM in FM transmitters.
- Detect residual FM in AM transmitters.
- Measure FM deviation.

44 pounds • Price: Complete with tubes and accessories, Model SB-3, with 3" C.R.T. • 13 1/4" x 7 1/4" x 13"
Types T-50 to T-1000 **\$425.00**
Types T-3000 to T-6000 **\$475.00**
(F.O.B. Factory, Tax not included)



Panoramic Reception with the PANADAPTOR

A "Must" for Modern Radio Shacks

Panoramic Reception enables *simultaneous* visual reception of many radio signals, continuously selectable from a broad band of frequencies down to a single frequency. With the PANADAPTOR connected to a receiver, having an I. F. between 450 and 470kc, you can see up to 200kc of the band at once.

Some Typical Applications

- Select QRM-free spots for sending and listening.
- Provide automatic visual and aural monitoring.
- Locate stations whose exact frequencies are not known.
- Enable observation of other fellow's frequencies in three-way or round robin QSOs — acts as an additional tunable receiver.
- Spot replies to your CQs.
- Provide instantaneous "S" meter for CW and PHONE.
- Simplify frequency setting and station monitoring.
- Facilitate netting operations.
- Assist in making adjustments of transmitters and antennas.
- Enable identification and interpretation of transmitter signal characteristics (your own and others).
CW key clicks, noise, frequency shift.
PHONE . . modulation percent, distortion, carrier shift and splatter, spurious supersonic and R.F. parasitics.
FM AM on FM, modulation monitoring.

Model PCA-2. Amateur net price, complete with 10 tubes and accessories, for 115 V., 50-60 cycle operation. **\$99.75**

ONE YEAR GUARANTEE against defects in parts or workmanship (excluding tubes). Panoramic Handbook with full installation, operating, application and maintenance instructions furnished with each PANADAPTOR. PANADAPTOR, featuring PANORAMIC RECEPTION, is the exclusive and original design of PANORAMIC RADIO CORPORATION.

PANORAMIC  **RADIO CORPORATION**

HEAD OFFICE
PANORAMIC, NEW YORK

242-250 WEST 55th ST. New York 19, N.Y.

KNIT MONEL MESH
Shielding Rings
 for h-f electronic applications

HERE'S a war development that was in standard use on high-frequency equipment built for the U. S. Army Signal Corps.

It is shielding of knit Monel mesh to "frustrate straying h-f currents by making them run around in circles until they crawl back into the box."

When used in place of fabricated sheet metal shields, these rings can speed production and assembly... reduce space requirements... simplify disassembly.

Continuous contact is assured by the resiliency of the Monel mesh. Any loss of over-all conductivity due to atmospheric or marine corrosion is minimized by the excellent corrosion resistance of Monel.

And, where fluid seal attachments are needed, designers find that Monel can be satisfactorily bonded to rubber-like materials.

Investigate this new shielding method! Rings of knit Monel mesh can be obtained in all types and sizes to fit individual requirements. For more information write: Metal Textile Corporation, Orange, New Jersey.

THE INTERNATIONAL NICKEL COMPANY, INC.
 67 Wall Street, New York 5, N. Y.

for "PLUMBING" too

One of several interesting possibilities for knit Monel mesh is in the "plumbing" on high-frequency equipment. Knit Monel mesh can be used between the concentric metal tubing used for tuning.

get to know all the—

NICKEL  **ALLOYS**

MONEL* • "K" MONEL* • "R" MONEL* • "KR" MONEL* • "S" MONEL*
 INCONEL* • NICKEL • "L" NICKEL* • "Z" NICKEL* *Reg. U. S. Pat. Off.



GENERAL PLATE *Laminated Wire* Provides Precious Metal Performance at Much Lower Cost

No matter what the application, General Plate Laminated Wire can save you money where precious metal performance is a must. These wires, made from laminated precious to base metal combinations, provide the same performance obtainable by solid precious metals but at a cost only slightly higher than the inexpensive base metal. The precious metal thickness is accurately maintained throughout the entire length of the wire assuring uniformity. Even temper is maintained by strand annealing. General Plate Laminated wire is obtainable in a wide variety of diameters as low as .005 and shapes such as those listed at the right . . . in practically any combination of precious to base metal. Write for information, today.

GENERAL PLATE DIVISION

of Metals and Controls Corporation

50 Church St., New York, N. Y.; 205 W. Wacker Drive, Chicago, Ill.;
2635 Page Drive, Altadena, California; Grant Bldg., Pittsburgh, Pa.

ATTLEBORO, MASSACHUSETTS



ODD SHAPES of wires with suitably spaced projection points are manufactured for contacts of longer lengths than generally used in welding applications.

SHAPED wires for production of pieces heretofore obtained only by a coining operation are produced in a variety of over 1,500 sizes.

SOLDER FILLED (solder center cored) wire for automatic soldering of chain links or other similar wire end solderings are produced in various grades and combinations.

CHANNEL WIRES, for ease in interlocking ends of materials or for covering raw edges of readily oxidized material, are manufactured to customer's specification.

SOLDER FLUSHED wires for ease in soldering tube ends.

ORNAMENTAL WIRES — for decorative purposes.

SQUARES, flats, ovals, hexagons and irregular shapes.

General Plate Division is the pioneer producer of allocated silver on wire, that is, silver in one section of the wire only and not around the entire circumference.

For specific designs and applications of solid precious metal and laminated wires, consult our engineering department.

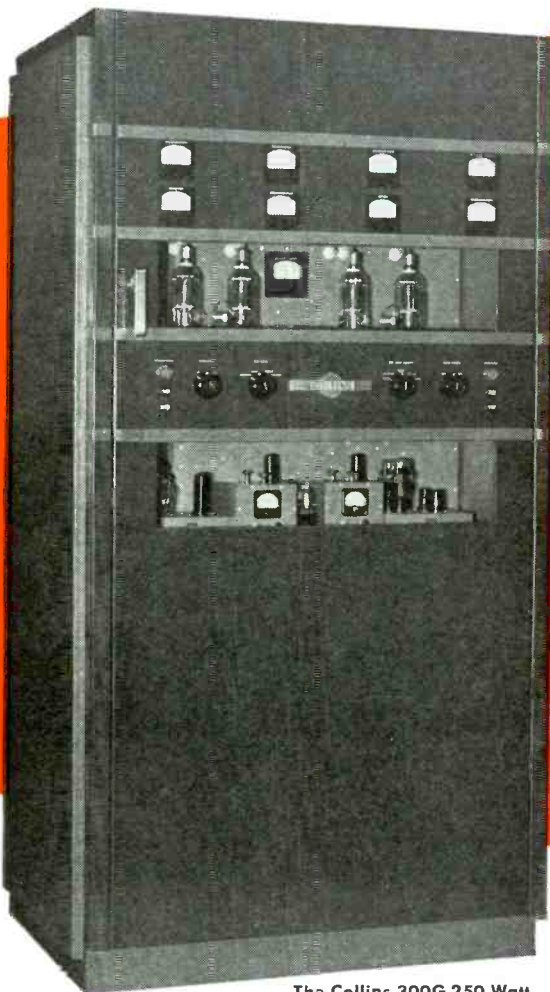

The Collins 300G 250 Watt Broadcast Transmitter

*Your audience
deserves the
best*



The Collins 212A-1 Studio Console

The excellence of Collins broadcast equipment is an accepted tradition, backed by years of reliable service under continuous operation. During the war years, when maintenance was a major problem, owners and operators of Collins equipment found their faith thoroughly justified by the thousands of hours of uninterrupted operation logged on their stations.

The new Collins transmitters and speech equipment reflect the soundest principles of design and construction. By careful attention to detail, and by combining foresight with experience, we have developed high fidelity broadcast equipment that is outstanding for endurance, style, and accessibility.

The 300G 250/100 watt AM transmitter is designed for continuous high fidelity service. The frequency response is within ± 1.0 db from 30-10,000 cps, and distortion and noise are far

better than FCC requirements. Stabilized feedback maintains the excellent performance over variations in operating conditions.

The Collins 212A-1 speech input console is a packaged unit providing simultaneous auditioning or rehearsing, cueing, and broadcasting from any combination of two studios, an announce booth, a controlroom announce microphone, two turntables, and six remote lines. The frequency response of 30-15,000 cps is ideal for AM, FM, and Television applications. The chassis rotates within the end supports, permitting maintenance during operation.

Write today for illustrated bulletins describing these and other Collins broadcast equipments.

FOR BROADCAST QUALITY, IT'S . . .



Collins Radio Company, Cedar Rapids, Iowa

11 West 42nd Street, New York 18, N. Y.

458 South Spring Street, Los Angeles 13, California

FERRIS

Instruments

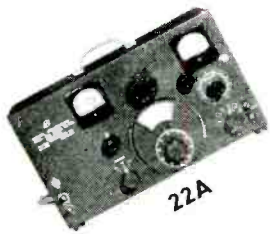

22A



446A



22D



48A

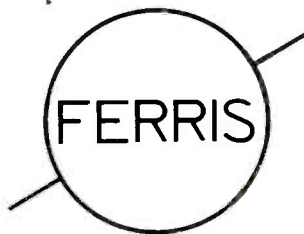

FERRIS



16C

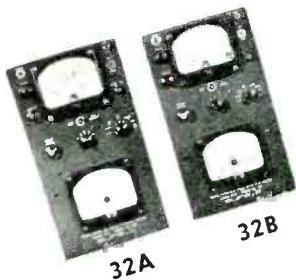

32A

32B



40A

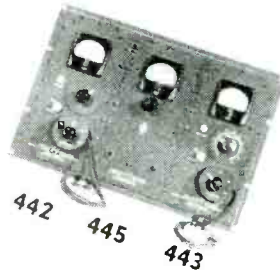

442

445

443



18C



22R

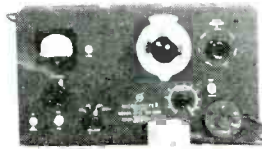

18D



20A



22E

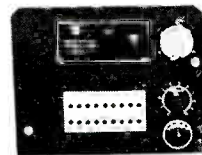

20B



33A

FERRIS
INSTRUMENT CO.
BOONTON, N. J.
U. S. A.



34A

YOU MAY
RECOGNIZE
MANY OF THE
UNITS SHOWN
BUT OTHERS
ARE NEW
AND WILL BE
DESCRIBED IN
THE CATALOG
NOW BEING
PREPARED.

WRITE FOR IT
TO
THE FERRIS
INSTRUMENT
CO.
BOONTON
NEW JERSEY

PLASTICS
 where **PLASTICS** belong



Using Strength, Light Weight, and Finish

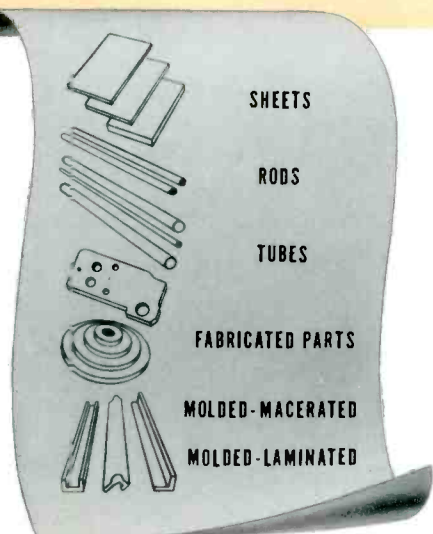

BEFORE nylon graduates to its glamorous occupations the yarn is sized. The machine that applies the size also winds the yarn upon a tube at high speed.

The hundreds of loops of yarn contract as they dry, choking the tube with tremendous force.

Synthane, from which many nylon sizing bobbins are made, easily resists the powerful crushing action of the drying yarn.

Because of light weight, tubes made from Synthane can be started and stopped faster and with less effort. Synthane also takes a variety of surface finishes suitable for use with nylon.

If these few of Synthane's many advantages suggest a place for plastics in your product, let us help you—before you design if possible. Meanwhile, send for the complete Synthane catalog.

SYNTHANE CORPORATION • 12 RIVER ROAD • OAKS • PENNSYLVANIA



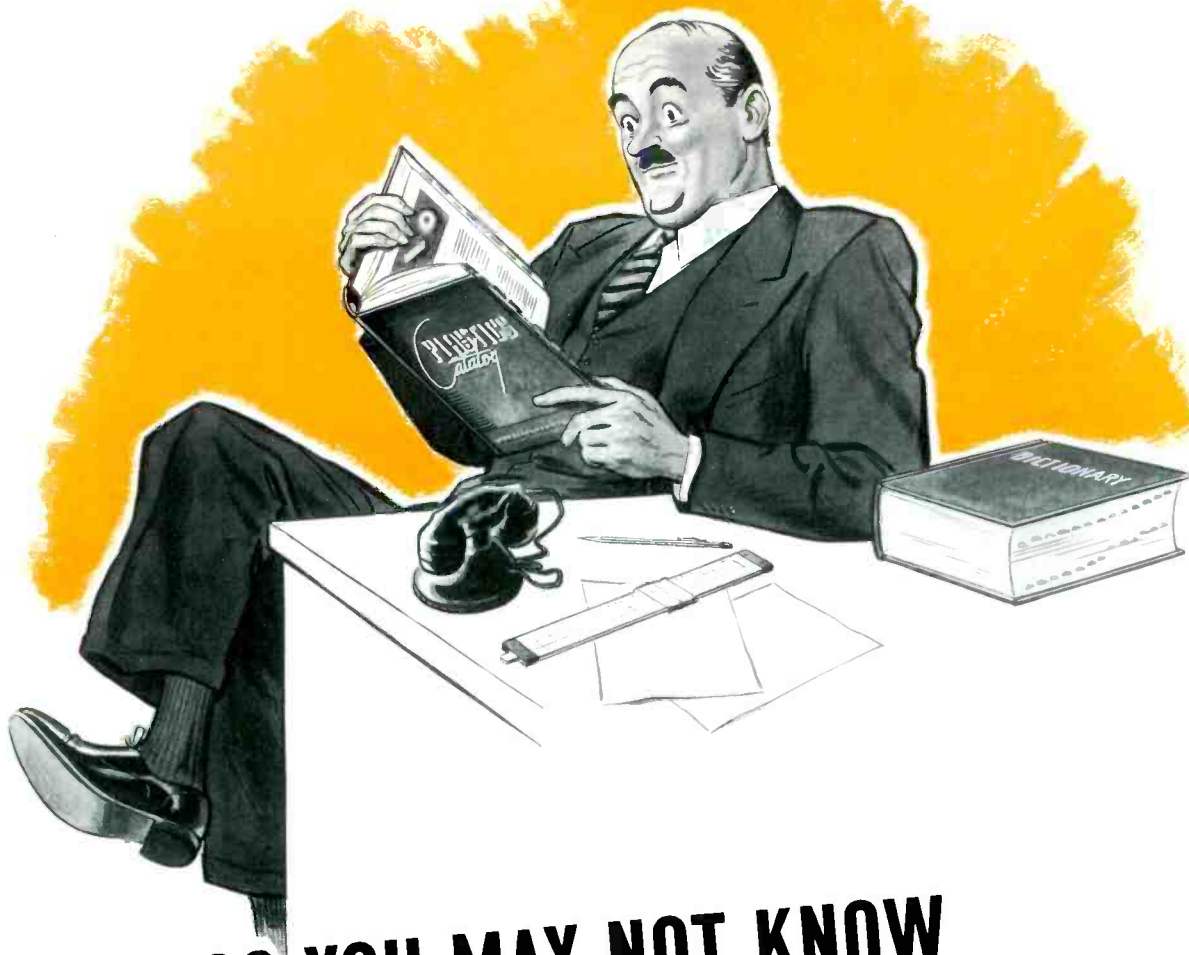

SOME THINGS YOU MAY NOT KNOW ABOUT LAMINATED PHENOLIC PLASTICS

As your copy of *Plastics Catalog** will tell you, the standard types of laminates have been standard for a good many years and "their properties and characteristics are dependably constant."



For instance, you can count on our type of laminated phenolic plastics—Synthane—for excellent dielectric properties—high dielectric strength, low power factor, low dielectric constant. It's also easy to machine.



Strength? Among plastics Synthane is one of that family highest in tensile, compressive, flexural and impact strengths. Compares favorably with metals on strength for weight basis.

*An approximately 1200-page compendium of plastics issued by the publishers of *Modern Plastics*.

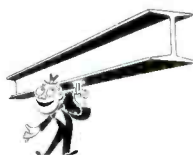

Light weight? The light weight of Synthane is one of its most important properties. Synthane weighs about half as much as aluminum. It has ample strength for electrical applications and for most mechanical uses.



Corrosion Resistant? Yes, Synthane resists nearly all oils and solvents, many acids and salts. Often used because it has a longer life per dollar than comparable materials.

But Synthane really stands out and stands up when you want a combination of all the above (and more) characteristics. If you have an application where these properties of Synthane would be helpful—use Synthane. Always use plastics where plastics belong. Use coupon to get complete Synthane Catalog.

FOR MORE THINGS YOU MAY NOT KNOW

SYNTHANE



PLAN YOUR PRESENT AND FUTURE WITH SYNTHANE
TECHNICAL PLASTICS • SHEETS • RODS • TUBES • FABRICATED



SYNTHANE CORPORATION, 12 RIVER ROAD, OAKS, PA.

Gentlemen:

Please send me without obligation the complete catalog of Synthane technical plastics.

NAME _____

COMPANY _____

ADDRESS _____

CITY _____

ZONE _____

STATE _____

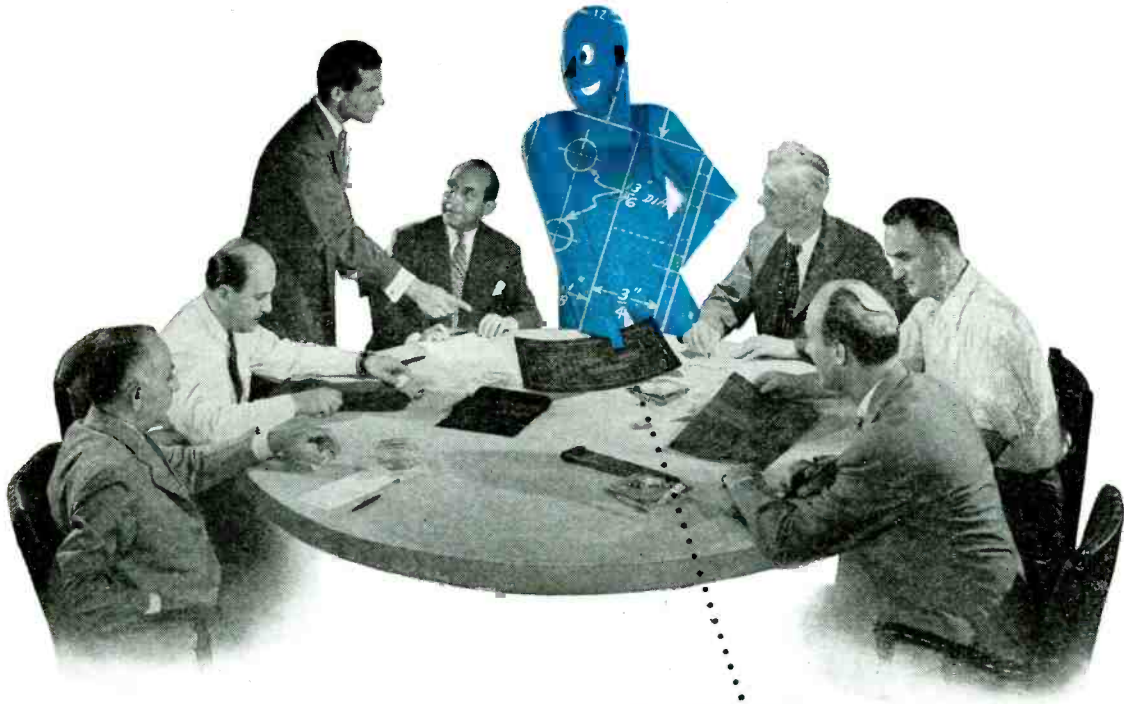

**YOU GET A SQUARE DEAL
AT OUR ROUND TABLE**

When you bring your sheet metal fabrication problems to KARP, you immediately set in motion a "round table" board of experts whose combined specialized skill and experience is without an equal in the field. This group includes the president, chief engineer, chief draftsman-designer, chief toolmaker, plant superintendent, production manager and cost accountant.

These men make a detailed study of your special requirements. They plan, design and engineer the job with your needs and uses in mind. They determine the best manner of producing it, utilizing KARP'S superior equipment and facilities to your greatest advantage.

When your job is finished, it will be correctly designed for its application, handsome, rugged and built for long service life. You will have no costly problem of assembly . . . no need to spend additional time and labor on finishing touches. The job will be COMPLETE, ready for the installation of your electrical or mechanical operating parts with ease and simplicity. No matter how many units you order, every last detail will be absolutely uniform.

This custom service not only gives your product added value, but under KARP methods may often save you money.

Consult us for cabinets, housings, chassis, racks, boxes, enclosures or any type of sheet metal fabrication.



Karp METAL PRODUCTS CO., INC.
Custom Craftsmen in Sheet Metal.

126 - 30th STREET, BROOKLYN 32, NEW YORK

HOW TO BE SURE OF INDUSTRIAL CONTROLS



You can't complete nor ship electrically operated equipment without controls.

There are several precautions you can take to assure having proper controls when needed. First is to deal with a dependable source of supply. Then make your selection from as near stock units as possible to avoid special operations and order at the earliest possible date.

As a leading producer of Electric Controls, Ward Leonard fully appreciates the man-

ufacturer's problem and is doing a remarkable job in the face of present day problems. The line is broad, thus offers wide selection. Engineering Service works in the customer's interest. Production is maintaining the highest possible standards. There is no better source of supply for Electric Controls, than Ward Leonard.



Bulletins are available describing Ward Leonard Relays, Resistors, Rheostats and Motor Controls. Send for the bulletins of interest to you.

WARD LEONARD

RELAYS • RESISTORS • RHEOSTATS

Electric control  devices since 1892

WARD LEONARD ELECTRIC COMPANY
61 SOUTH STREET, MOUNT VERNON, N.Y. • OFFICES IN PRINCIPAL CITIES

FEDERAL'S *Intelin* HIGH-FREQUENCY COAXIAL CABLES offer you all three...

1. LOW LOSSES
2. FLEXIBILITY
3. DURABILITY

K-12 ... the most popular cable for FM and AM antenna transmission lines.

- Copper Conductor — solid or stranded.
- Polyethylene Dielectric between central conductor and outer braid.
- Copper Braid, closely woven over dielectric sheath.
- Outer Jacket of Federal's IN-102, a plasticized vinyl resin, extremely durable with remarkable abrasive resistance, and highly resistant to most acids and alkalis, smoky atmospheres, oils and greases.

INTELIN COAXIAL CABLES are especially designed for high-frequency transmission line service — the vital link between transmitter and antenna.

Their unusually low attenuation losses, obtained by careful selection of dielectrics, conductor spacings, and rigid quality control, assure the most efficient transfer of energy with minimum radiation. They are extra flexible, too — can be bent without cracking at

temperatures as low as minus 30°C. Whatever your operating conditions, you'll find that the extra durability of Intelin cables — their outstanding resistance to abrasion, weathering and corrosion — means long uninterrupted service.

Federal's complete line of many sizes and types of coaxial cables enables you to select the *right* transmission line for practically every field of application. Write today for Bulletin D510 giving complete data and specifications.

PARTIAL LIST OF FEDERAL CABLES COVERING POLICE, BROADCAST AND AMATEUR BAND

| High-Frequency Coaxial Cable Data | | | | | | | | | | | | | | | |
|-----------------------------------|-------------------------------|-------------------------|-------------------------------|------|------|-----|------|------|-------------------------|------|------|------|-----------------|---------------------|------------------|
| Type Number | Characteristic Impedance Ohms | Capacitance Per Ft. mmf | Attenuation Db. Per 100 Ft. * | | | | | | Power Rating Kilowatts | | | | | Physical Dimensions | |
| | | | Frequency in Megacycles | | | | | | Frequency in Megacycles | | | | | Conductor Dia. | O.D. Over Jacket |
| | | | 1.0 | 1.7 | 30 | 100 | 300 | | 1.0 | 1.7 | 30 | 100 | 300 | | |
| K12 | 52 | 29 | .066 | .086 | .425 | .83 | 1.70 | 39 | 30 | 8.50 | 3.0 | 1.5 | .188" | .885" | |
| K13 | 52 | 29 | .058 | .076 | .320 | .69 | 1.45 | 51 | 43.8 | 13.5 | 5.4 | 2.3 | .250" | 1.135" | |
| K14 | 71 | 21 | .070 | .092 | .460 | .93 | 1.90 | 36.5 | 27.8 | 5.55 | 2.71 | 1.34 | .114" | .885" | |
| | | | | | | | | | | | | | Stranded Copper | | |
| K45 | 52 | 29 | .155 | .202 | .900 | 2.1 | 4.20 | 13 | 9.9 | 2.4 | .96 | .480 | .086" | .415" | |
| K49 | 75 | 20 | .182 | .237 | 1.03 | 2.1 | 3.80 | 9.1 | 6.9 | 2.1 | .79 | .435 | .048" | .415" | |

Federal Telephone and Radio Corporation

In Canada:—Federal Electric Manufacturing Company, Ltd., Montreal
Export Distributor—International Standard Electric Corporation



Newark 1,
New Jersey

* Reg. U. S. Pat. Off.

A New Thrill

FOR MUSIC LOVERS

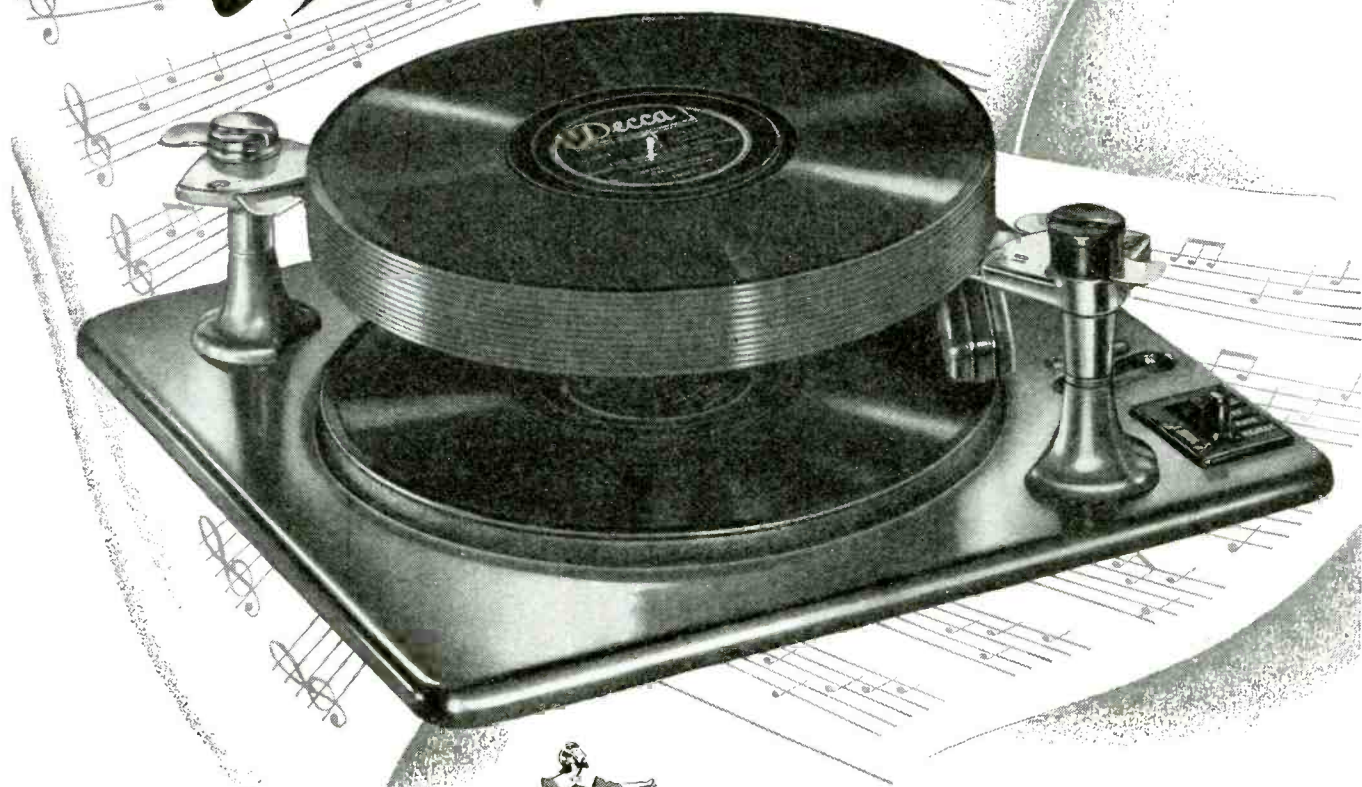

It's a thrill for any music lover to hear his favorite album of records played on a phonograph equipped with a Seeburg Record Changer.

Quietly the records move into place with a minimum of time lost between discs.

Gently the featherweight pickup glides along the grooves, picking up all the subtle harmonies.

Swiftly the constant speed motor brings the turntable up to speed and holds it, permitting no wavers—no wows.

The newly engineered Seeburg Record Changer also brings long life—trouble-free operation. That is why it continues to be the favorite of phonograph manufacturers and phonograph buyers.

Wire Recorder

Sound on a wire as thin as a hair! The new Seeburg Wire Recorder permits perfect home recording of speeches, plays, music—it takes radio programs off the air. One simple control knob makes anyone a skilled sound technician. A new development everyone will want in tomorrow's phonograph.

It Will Be Necessary

for radio manufacturers to make provision in their circuits to accommodate the Seeburg Wire Recorder. We invite inquiries from radio manufacturers.



MINIMUM FRICTION
SILENT
LONG LIFE
CONSTANT SPEED
TROUBLE-FREE OPERATION

Seeburg

RECORD CHANGERS ★ WIRE RECORDERS
J. P. SEEBURG CORPORATION
1500 N. DAYTON ST. • CHICAGO 22

When Your Product Calls for **MINIATURE METERS . . .** Here are **5 REASONS WHY** you should specify **MB**

Because They Are:

1 **SMALLEST IN SIZE!**

The MB moving coil element is only *one inch* in diameter. Housed in anodized aluminum 1-inch cases, you get the smallest instruments made today. And in only a *1½-inch* case, there's room to *self-contain* rectifier, shunt or multiplier.

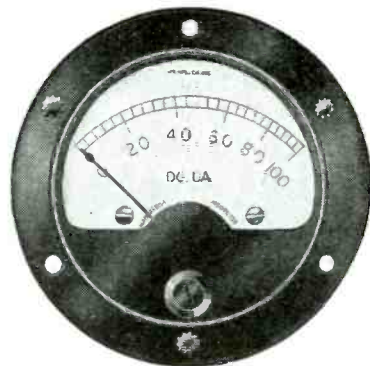

MODEL 152

2 **ACCURATE!**

Built to conform to AWS specifications, accuracy of $\pm 2\%$ of full scale deflection at any point is *standard* with all MB instruments.

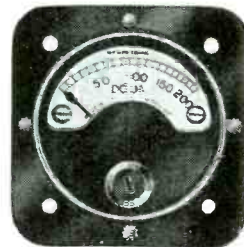

MODEL 101

3 **SENSITIVE!**

Powerful Alnico No. 5 magnet with soft iron pole pieces provides dense, uniform air-gap flux...and the resultant torque from even microampere currents provides MB instruments with sensitive, fast response. What's more, damping characteristics are excellent, for easy reading.



MODEL 102

4 **DEPENDABLE!**

MB instruments are built to last. Not only will the lighter movement withstand shock and vibration better...but, steel-pivoted in sapphire bearings, it also resists wear indefinitely. Sturdy anodized cases are sealed against dust and moisture.

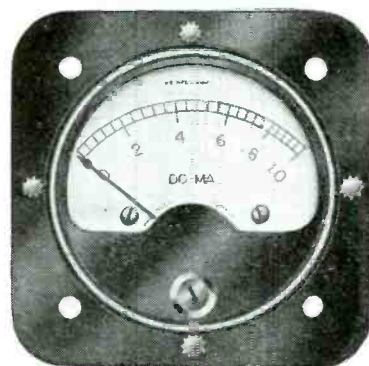

MODEL 151

5 **AVAILABLE IN MANY RANGES!**

1-inch instruments produced in DC ranges from 0-100 microamperes to 0-10 milliamperes. 1½-inch instruments available completely self-contained in all standard ranges, including rectifier AC types.

Let us send you additional information. Write for the new MB catalog with full details and prices on the complete line of MB miniature instruments.

THE
MB MANUFACTURING COMPANY, INC.
331 East Street, New Haven 11, Conn.



MINIATURE ELECTRICAL INSTRUMENTS FOR ANY PURPOSE

IF YOU USE CAPACITORS YOU WILL BE INTERESTED IN . .

SANGAMO PLASTIC MOLDED [LIKE MICAS] TUBULAR PAPER CAPACITORS

PERMANENTLY
SEALED AGAINST:

MOISTURE

CHANGING CAPACITY VALUES

WILL NOT LEAK AT LEAD ENTRANCES



Sangamo, pioneer capacitor manufacturers, were first, in 1923, to design and mold mica capacitors. If you use paper tubular capacitors, you will be interested to know that Sangamo now offers these, too, in plastic molded form. Being plastic molded means that these new paper tubulars are sealed permanently: moisture stays out—capacity values will not change. The resulting advantages are: low power factor—application at higher temperatures—long life—and a smooth, molded, non-dust-catching finish. From an economy standpoint, these new Sangamo Plastic Molded paper tubulars are priced only slightly higher than ordinary types, but readily justify themselves in long-run satisfaction. Specify Sangamo Plastic Molded wherever you use paper tubulars.

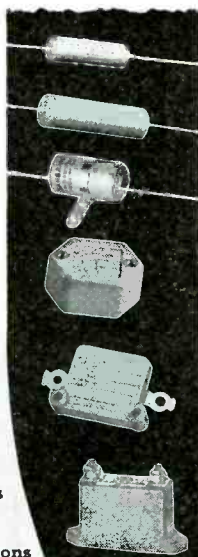

- Receiving Micacs
- Transmitting Micacs
- Silvered Micacs
- Silvered Mica Buttons

WRITE FOR CATALOG LISTING THE SANGAMO LINE

- MOLDED Paper Tubulars
- Metal-Encased Tubulars (Paper)
- Transmitting Oil-Filled
- Bath tub (Oil or Wax-Filled)
- Diaclor (A Paper Transmitting)
- Mineral Oil (For E Characteristics)
- Ballast Capacitors (Paper)
- Motor Starting, for A. C. and D. C.
- Tubular Transmitting (Oil-Filled Paper)
- Tubular Transmitting (Diaclor, Paper)



SANGAMO
ELECTRIC  COMPANY
SPRINGFIELD • ILLINOIS

BETTER CONTROLS THROUGH BETTER RELAYS

High Frequency

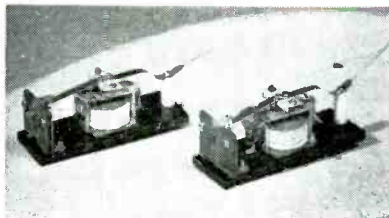

Illustrated above, the newest high frequency relay made by Leach is the No. 1623 (DC) or No. 1723 (AC). Extreme flexibility is possible, since each moveable SPDT contact is separately mounted. Combination of the required number of relays to fit circuit demands is possible by connecting the required number of relays in parallel or series. Many other types of high frequency relays are part of the standard Leach line. Consult catalogue for details.

Time Delay

Thermo element types for use on vacuum tube transmitters or other time delay uses are manufactured with variable delay elements of from 5 to 20 seconds and 20 to 60 seconds. Quick to cool, enabling fast recycling, and manufactured with either AC or DC coils, these standard relays are available now.

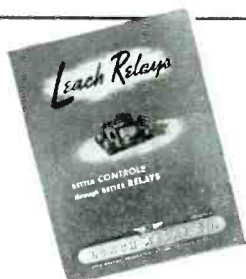

NEW CATALOGUE

For A
Complete
Listing
Send For
This

Control relays, for a host of purposes, manufactured in a wide variety of coil sizes and contact arrangements, are now AVAILABLE FOR PROMPT DELIVERY. WRITE FOR DETAILS.

Midgets



Light weight, and versatile in application, these little relays are available in sizes to handle 2 to 8 Amps., contact load, with either AC or DC coils, and with a variety of contact arrangements.

Latch Type

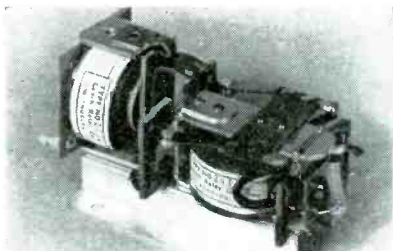

Mechanically or electrically reset, these relays are available with many coil and contact combinations. Useful on numerous devices today, this type is supplied in either AC or DC.



Circuit Control

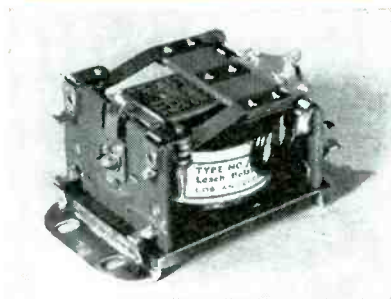

Typical of a wide variety of control relays, manufactured as standard, or to fit customer specifications, the illustrated No. 1127 metal base relay is an exceptionally fast-acting type, and can be used for keying low power radio transmitters. Made for either AC or DC, with contact arrangements up to 4 PDT; they are durable, and can withstand long cycling operations. Coil consumption is 1.5 watts DC or 6 V/A 50-60 cycles, AC.

Sensitive

Widely used in closed circuit alarm systems, or in the plate circuit of electron tubes, or as secondary relays for micro-ampere relays, these low resistance DC relays are inexpensive, sturdy, and can be supplied now.

EXPORT OFFICE

Companies desiring to make export purchases may contact our agent:

WESTEX COMPANY, INC.

15 East 26th Street
New York 10, New York
Cable Address: WESPEXLIN

LEACH RELAY CO.

5915 AVALON BOULEVARD, ★ LOS ANGELES 3, CALIF.

Now you can make Direct-Inking Recordings
from D. C. to 100 cycles per second!

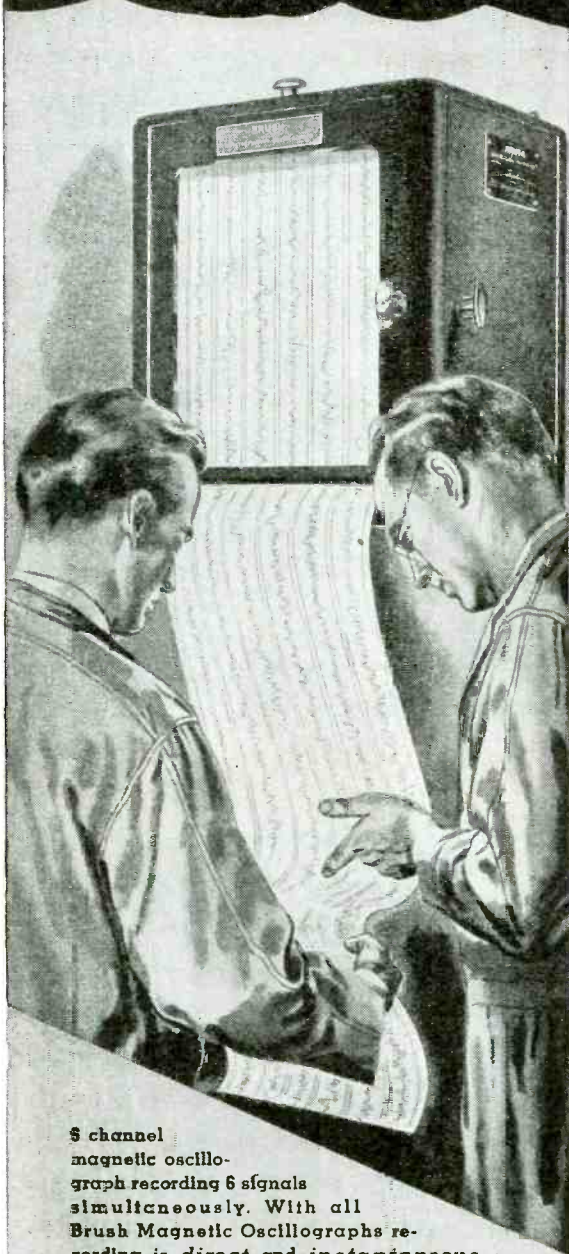

3 channel magnetic oscillograph recording 6 signals simultaneously. With all Brush Magnetic Oscillographs recording is *direct and instantaneous*—may be stopped for chart paper notations.

The
BRUSH DEVELOPMENT
Company

3405 Perkins Ave., Cleveland 14, Ohio

Canadian Representatives:

A. C. Wickman (Canada) Ltd., P. O. Box 9, Station N
Toronto 14

Brush Magnetic Oscillographs Revolutionize Measurement-Recording

Brush Magnetic Oscillographs may be used for detailed recording of virtually every conceivable type of measurement that can be made in the form of electrical impulses. The Magnetic Pen Motor is capable of recording a D. C. signal. Used with the BL-905 amplifier, the frequency range is from .2 to 100 cycles per second. Recordings are *direct, instantaneous, ink-on-paper* graphs.

Usefulness of Brush Magnetic Oscillographs is almost unlimited. Can be used for recording strains, pressures, vibrations, temperatures, light intensity, displacement counting, phase relationships, currents and voltages acceleration and deceleration, inertia and countless other phenomena.

Brush engineers will be glad to work with you in determining the equipment needed to meet your particular problems. Write today for detailed bulletin.

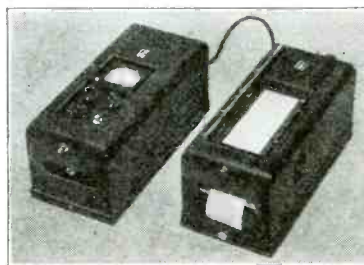

The Brush Single-Channel Oscillograph—ideal for counting, temperature recording, etc. One recording penmotor and pen. Three-speed paper drive, 5, 25, 125 mm per sec. Chart paper $2\frac{3}{8}$ " wide.

The Brush Double-Channel Oscillograph with cover off. Especially suited for synchronizing problems where two simultaneous recordings are required. Two recording penmotors and pens. Three-speed paper drive, 5, 25, 125 mm per sec. Chart paper $3\frac{1}{2}$ " wide.

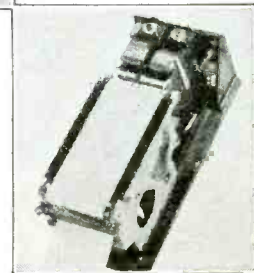

SLOGANS FOR SALE

Advertising isn't our game—or yours. But both of us know millions are spent to put a name or a slogan across. Million dollar appropriations help! But we know of a surer way—a way that costs a lot less—to sell a name.

THE IDEA IS PRODUCT DEPENDABILITY

Don't pass over those words lightly. It isn't a catch phrase. It gets your product's name repeated, favorably, among housewives and business men—the people who buy. It gets the name repeated frequently, on order pads. It rings up cash registers.

Product dependability starts at the bottom. It starts with the tiniest component. And that dependability is something we sell with every C-D capacitor. Why? Because we've been at it longer. Because we have produced more capacitors. Because we have greater engineering and production facilities than anyone else in the field. Keep that in mind when your plans call for capacitors.

CONSULT WITH OUR ENGINEERS

Your requirements can be handled at C-D with greater efficiency and speed. Cornell-Dubilier Electric Corporation, South Plainfield, New Jersey. Five other plants located in New Bedford, Providence, Brookline and Worcester.



CORNELL-DUBILIER
world's largest manufacturer of
CAPACITORS

MICA • DYKANOL • PAPER • ELECTROLYTICS

It counts the Zips in a zipper

Eighteen G-E Neon Glow Lamps for indicators play a vital role in the new Potter Electronic Counter. Used by slide fastener makers to gain exact length and spacing of the fasteners, the dual predetermined Electronic Counter finds many diverse industrial uses. It employs G-E Neon Glow Lamps (1) to reduce current consumed, (2) for extremely long life, (3) to add more sales appeal.



This dual predetermined electronic counter is a product of Potter Instrument Co., 136-56 Roosevelt Ave., Flushing, N. Y.

-and it can improve your product

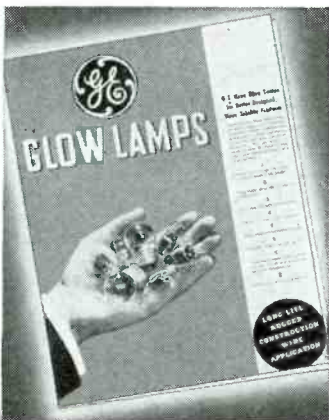
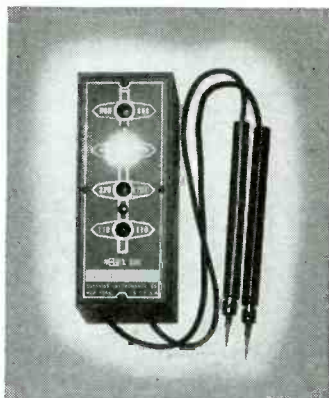
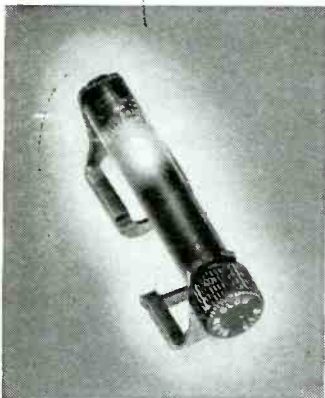

TYPICAL new products improved with G-E Glow Lamps are pictured here. They merely hint at hundreds of other unbelievably low cost applications on home appliances, wiring devices, and many types of industrial equipment. Why not consider the following sales features of G-E Glow Lamps on *your* new products:

1. Distinctive orange red glow, needs no cover glass.
2. Dependable long life—rated at 3,000 hours.
3. Very low current consumption.
4. Variety of sizes and wattages.
5. High resistance to vibration and shock.
6. Usable on AC or DC circuits.
7. Work on regular 105-125 volt circuits without the use of step-down transformers.
8. Practically no heat.

FREE NEW FOLDER describes typical uses for G-E Neon Glow Lamps and gives lamp data. Write address below.

G-E LAMPS

GENERAL  ELECTRIC

Nela Specialty Div. Lamp Dept., 1 Newark St., Hoboken, N. J.

PROVED...

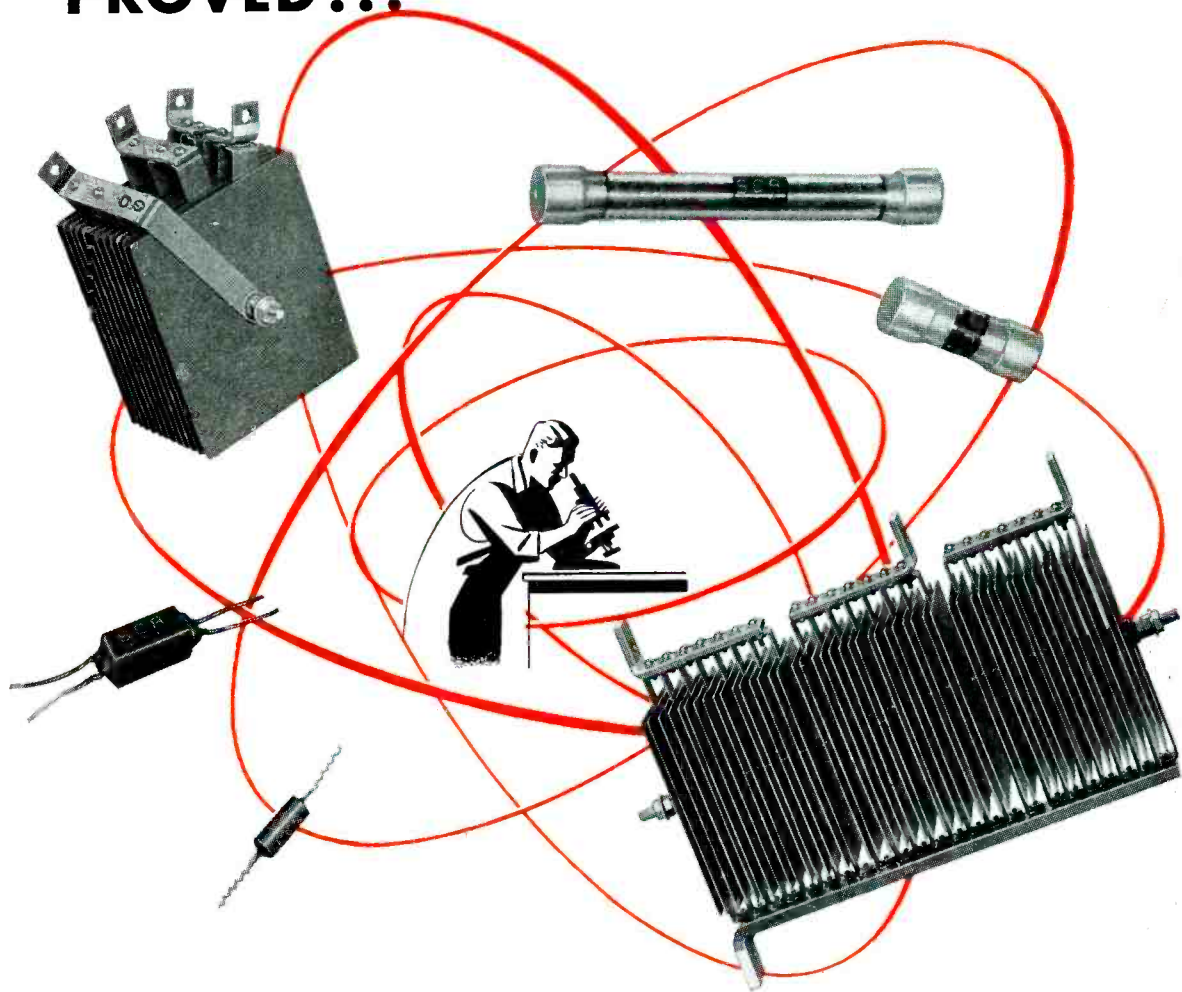

...and IMPROVED

SELENIUM RECTIFIERS

FROM 10 MICRO AMPERES TO 10,000 AMPERES

Manufacturers of a broad line of SELENIUM Power and Instrument Rectifiers, Photo-Electric Cells and allied scientific products.

Solve your rectification problems with SELENIUM. SELENIUM rectifiers are rapidly becoming standard in industry. Check these outstanding features:

- ✓ Permanent characteristics.
- ✓ Adaptability to all types of circuits and loads.
- ✓ Unlimited life—no moving parts.
- ✓ Immunity to atmospheric changes.
- ✓ High efficiency per unit weight.
- ✓ Hermetically sealed assemblies available.
- ✓ From 1 volt to 50,000 volts RMS.
- ✓ From 10 micro-amperes to 10,000 amperes.
- ✓ Economical—No maintenance cost.



SELENIUM CORPORATION OF AMERICA

Affiliate of **VICKERS**, Incorporated
1719 WEST PICO BOULEVARD • LOS ANGELES 15, CALIFORNIA
Export Division: Frazer & Hansen, 301 Clay Street, San Francisco 11, Calif.
In Canada: Canadian Line Materials, Ltd., Toronto 13, Canada



Impromptu Discussions about Miniature Tubes



Of course I'm using a TUNG-SOL Miniature Power Amplifier in this circuit. You can get them now for a wide range of radio receiver applications. They all have high efficiency beam construction and provide for maximum Class A. power output ranging from $\frac{1}{4}$ to $4\frac{1}{2}$ watts. You'll find that miniatures generally give even better performance than the big ones.

Take the TUNG-SOL 50B5 for example. It's designed as the miniature tube equivalent of type 50L6GT. It's outstanding for its power sensitivity and adaptability to AC/DC circuits. In the 50B5 this high performance standard has been maintained with a volume displacement of less than 30%

of the 50L6GT. With the same internal dissipation, the bulb operating temperatures are higher in the smaller envelope but, several type 50B5 tubes may be safely operated in an enclosed cabinet with an ambient temperature as high as 150° centigrade.

Small physical size of the 50B5 and ability to perform in "transformerless" circuits permits unusual applications. Power outputs as high as 1.9 watts afford ample volume for intercommunication systems. Its ability to deliver 130 milliamperes of peak plate current with 5.25 rms. volts signal may suggest use as a trigger tube or to operate control relays.

Either as a tetrode or triode, its transconductance of 7500 umhos means high circuit efficiency. Even though it is designed as a Class A power amplifier, the 50B5 may be adaptable to certain oscillator applications at low and medium frequencies.

If you want the real low down on this or other unusual applications, write to the TUNG-SOL Commercial Engineering Department. You see those fellows are only interested in tubes. They aren't set builders. Your consultations with them are held in strictest confidence.



TUNG-SOL

vibration-tested

ELECTRON TUBES

TUNG-SOL LAMP WORKS INC., NEWARK 4, NEW JERSEY
Sales Offices: Atlanta • Chicago • Dallas • Denver • Detroit • Los Angeles • New York
Also Manufacturers of Miniature Incandescent Lamps, All-Glass Sealed Beam Headlight Lamps and Current Intermittors

DE MORNAY • BUDD STANDARD TEST EQUIPMENT

For Precision Measurements in the Microwave Field

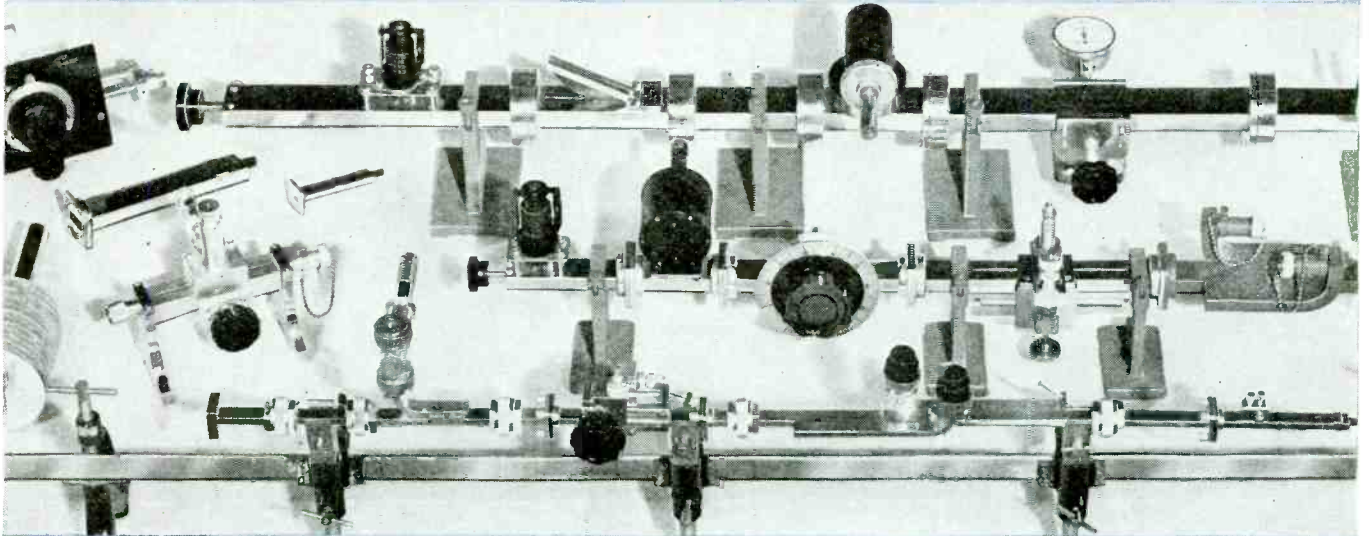

The complete line of De Mornay • Budd standard test equipment covers the frequency range from 4,000 mcs. to 27,000 mcs. It provides all R. F. waveguide units necessary for delicate, precision test work requiring extremely high accuracy in attenuation measurements, impedance measurements, impedance matching, calibration of directional couplers, VSWR frequency measurements, etc.

To eliminate guesswork, each item of this De Mornay • Budd test equipment is individually tested and, where necessary, calibrated, and each piece is tagged with its electrical characteristics. All test equipment is supplied with inner and outer surfaces gold plated unless otherwise specified.

Our greatly expanded microwave research facilities are at your disposal for consultation.

The three test set-ups illustrated above include:

Tube Mount
Flap Attenuator
Frequency Meter
Calibrated Attenuator
Tee
Stub Tuner

Tunable Dummy Load
Standing Wave Detector
Type "N" Standing Wave Detector
Directional Coupler
High Power Dummy Load
Cut-Off Attenuator

Stands, etc.

DE MORNAY
BUDD



EQUIPMENT
FOR
97% OF ALL
RADAR SETS

DE MORNAY • BUDD INC., 475 GRAND CONCOURSE, NEW YORK 51, NEW YORK. CABLE ADDRESS "DEMBUD," N. Y.



DU MONT *First with the Finest in Television*

The Detroit News, founder-owner of WWJ—America's first commercial radio station—will pioneer again, this time giving Detroit its first television station. The new facilities will be built by Du Mont, builder of more television stations than any other company.

When distinguished pioneers in radio broadcasting call upon Du Mont, pioneer and pacemaker in the magnificent new art of television, the selection is a sterling honor and a signal recognition of Du Mont's outstanding achievements and capabilities.

Du Mont will provide a 5 kw video transmitter, 2.5 kw audio transmitter, master control equipment, film projection and pick-up chain, etc. Du Mont will erect a specially designed antenna atop the Penobscot Building, Detroit's highest office structure. All Du Mont's experience ranging from development of the first commercially practical cathode-ray tube to building and programming the world's largest and most completely equipped television studios, is at the disposal of this client. This experience can also be yours.

IF YOU HAVE NOT READ "THE ECONOMICS OF DU MONT TELEVISION," WRITE FOR A COPY

Copyright 1946. Allen B. Du Mont Laboratories, Inc.



ALLEN B. DU MONT LABORATORIES, INC. • GENERAL TELEVISION SALES OFFICES AND STATION WABD 515 MADISON AVE., NEW YORK 22, N. Y. • DU MONT'S JOHN WANAMAKER STUDIOS. WANAMAKER PLACE, NEW YORK 3, N. Y. • PLANTS AND HOME OFFICES, PASSAIC, N. J.

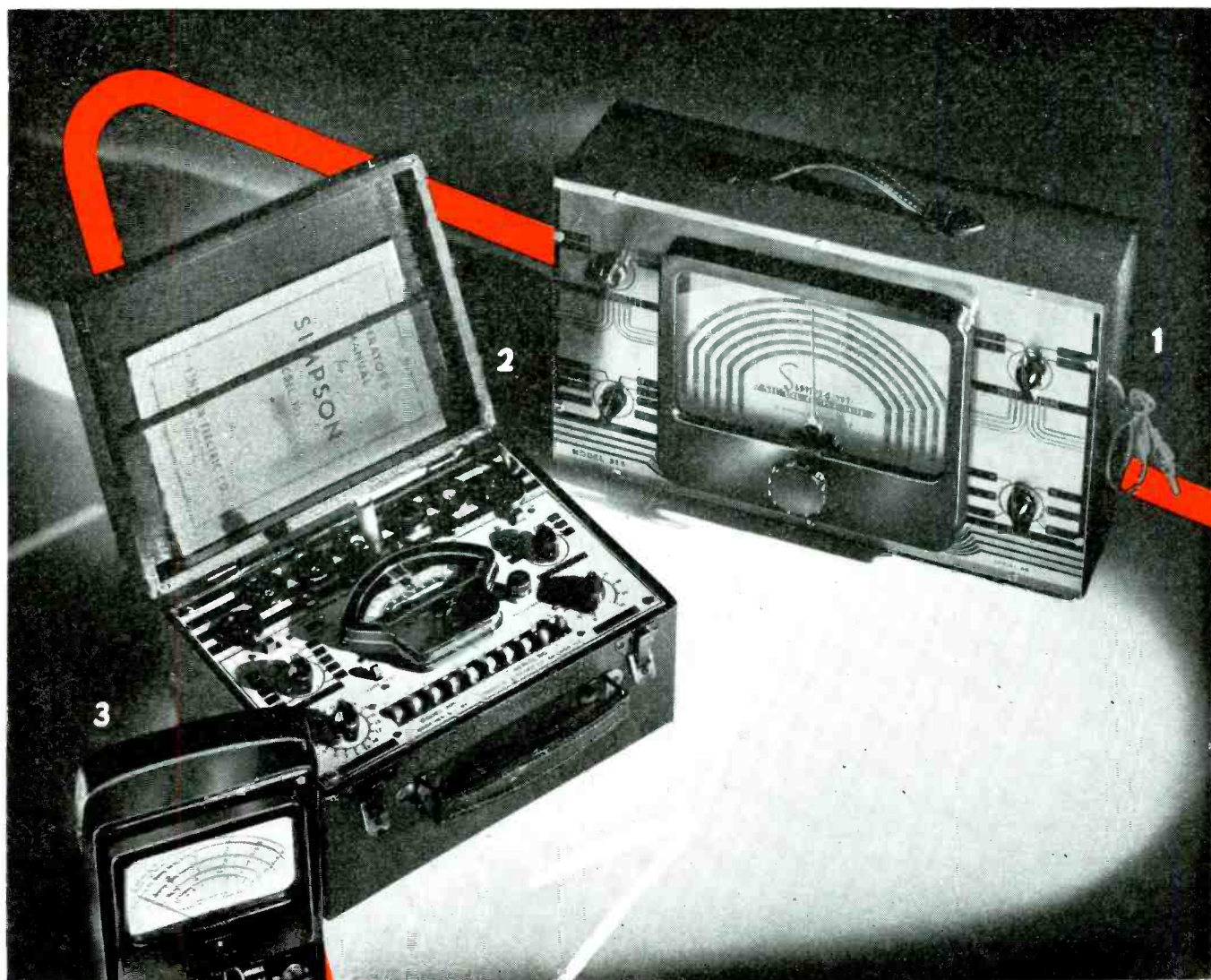

Model 375 Signal Generator.
Designed down to the most minute detail for highest accuracy, greatest stability, minimum leakage, and good wave form\$67.35

Model 335 Tube Tester. Tests all tubes. Provides for filament voltages from 5 volts to and including 250-volts. Spare sockets for future tube developments.....\$46.25

Model 240 High Sensitivity Set Tester. 10,000 ohms per volt. D.C. Voltage range 0 to 5,000 volts A.C. and D.C. Resistance ranges to 20 megohms. Current ranges to 500 milliamperes.....\$38.95

His Simpson "Big 3" ... gives servicemen a real profit-making set-up

● The successful radio serviceman today must have the finest in test instruments for a very practical reason—that's his only hope of present and continued profits. To meet the tremendous volume of business available he must be able to "trouble-shoot" fast and *accurately* every time. Only this can he correct trouble speedily, with satisfaction to the customers.

Simpson offers you, in three basic test instruments, the accuracy and advanced electronic engineering which have given Simpson the proudest name in the industry. They are tried-and-tested examples of the kind of instruments Simpson has always built. Their use will demonstrate that from Simpson alone can you expect "instruments that stay accurate" with construction and design that lead the field.

To dealer and to serviceman alike, Simpson offers today the assurance of continued profits that only quality can give. No Simpson instrument is ever marketed, or ever will be, unless its makers feel that, of its kind, nothing finer can be produced.

Simpson

INSTRUMENTS THAT STAY ACCURATE

SIMPSON ELECTRIC COMPANY
5200-5218 West Kinzie Street, Chicago 44

New FM FREQUENCY MONITORS

for the new 88-108 mc.
and 152-162 mc. Bands

FOR THE
BROADCAST
88-108 mc.

AND
**EMERGENCY
SERVICES**
152-162 mc.



↓
DIRECT READING

*New Members of
the famous Monitor Line*

by Doolittle

MEET FCC REQUIREMENTS

Now it is possible for you to check the new frequencies with utmost speed, ease and precision. These new FM Frequency Monitors meet the FCC requirements for the new 88-108 mc. Broadcast and 152-162 mc. Emergency Service bands. No charts or complicated adjustments are needed—*reading is direct*. Many other DOOLITTLE features assure consistent accuracy and rugged, long life. Write, wire, or 'phone RADcliffe 4100 for full information.

Doolittle
RADIO, INC.

Builders of Precision Communication Equipment

7421 SOUTH LOOMIS BLVD., CHICAGO 36, ILLINOIS

HERE'S A *New Line* OF D-C CAPACITORS

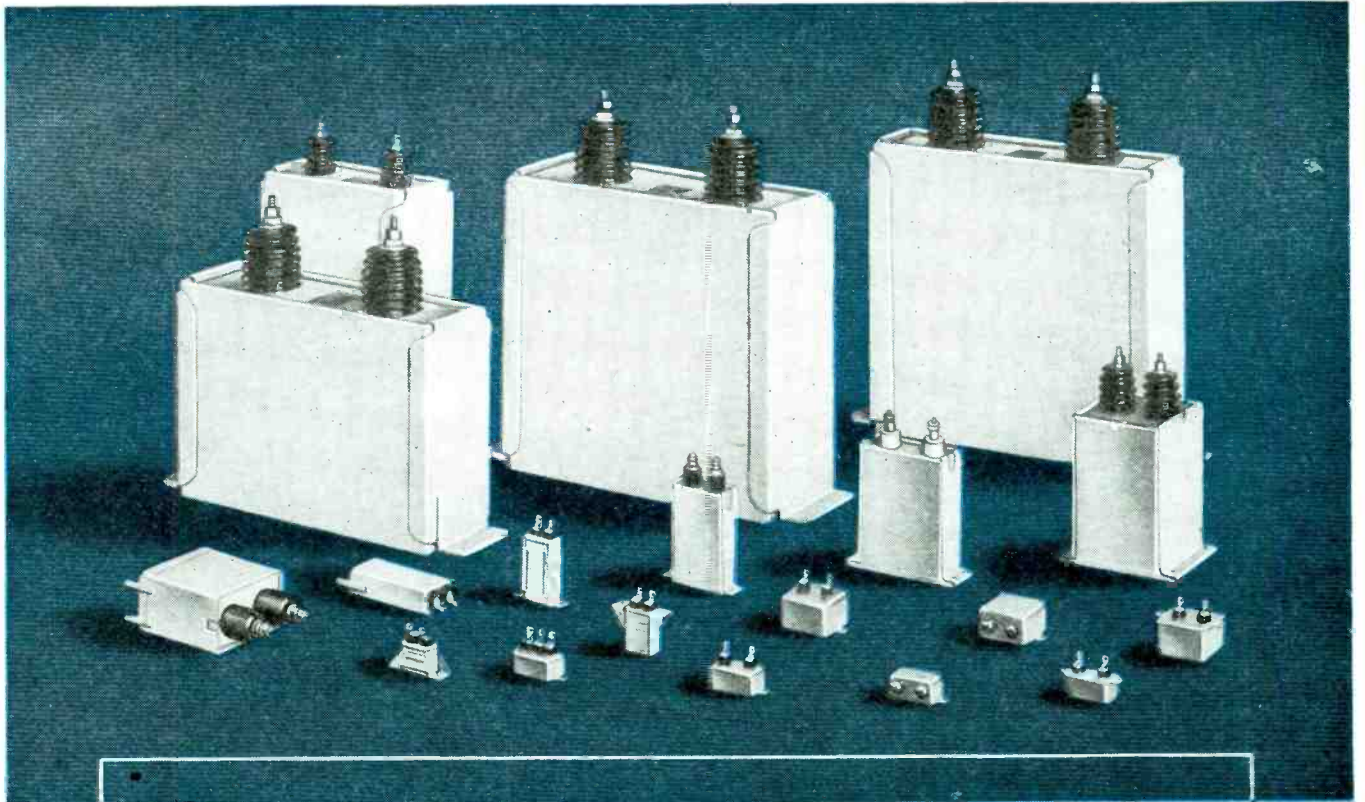

BETTER IN *"Civvies"* FOR HAVING WON THEIR SERVICE STRIPES

It's an open secret among the trade that G-E Pyranol capacitors, which enjoyed such an enviable reputation before the war, are now better than ever!

The reason for this is obvious. Some pretty tough demands had to be satisfied during the war. The strict quality control methods, new manufacturing techniques, and improved materials, instituted at that time have produced outstanding results which General Electric has now incorporated in a new line of Pyranol capacitors designed to meet commercial requirements.

This new listing makes available a wider range of sizes, ratings, and mounting arrangements with characteristics for operation over wider temperature ranges (-55°C to $+85^{\circ}\text{C}$), at altitudes up

to 7500 ft.

These G-E *Pyranol-treated fixed paper dielectric capacitors range in size and shape from bathtub and small rectangular case styles to large, welded steel case designs. Capacity ratings from .01 muf to 100 muf, and voltage ratings from 100 to 100,000 volts are listed. The high dielectric strength and stable characteristics of the special Pyranol-impregnated Kraft paper are hermetically sealed into these non-inflammable units, thus assuring long life.

*Pyranol is General Electric's non-inflammable liquid dielectric for capacitors.

D-C Capacitors

GENERAL  ELECTRIC
407-108-5700

GENERAL ELECTRIC COMPANY
Apparatus Department, Section G407-108
Schenectady 5, N. Y.
Gentlemen: Kindly send me further information on "Fixed Paper Dielectric Capacitors for DC Applications."

Name

Organization.....

Address.....

City..... State.....

Highlights in THE 1946

Jensen LINE

★ *Hypex*
PROJECTORS

★ **COAXIAL**
SPEAKERS

★ *Speech
Master*
REPRODUCERS

★ *Bass Reflex*
REPRODUCERS

★ **HYPEX Projectors** better than ever—more efficient. They have the famous Hypex "flare formula"—not exponential—developed by Jensen acoustical research. Driver units employ the Jensen "Annular" diaphragm, clamped at periphery and center—another exclusive feature!

★ **COAXIAL Speakers.** Now four improved 15" and 12" designs for high-fidelity, extended-range reproduction. High-frequency Control provides instant fidelity adjustment to suit program quality and listener preference. Available in complete Reproducers.

★ **SPEECH MASTER Reproducers.** Designed especially for crisp highly-effective speech reproduction. Desk-, panel-, wall-mounting types in power ratings for low-level and high-level applications.

★ **BASS REFLEX Reproducers.** A complete line of reproducers with speaker installed, or enclosures only, in fine furniture or utility styles—all with the smoothly extended low-frequency range for which Jensen Bass Reflex is justly famous.

*Trade Mark Registered

These are only a few of the many distinguished products in the complete Jensen line. Write for catalogs and data sheets for further information.

JENSEN MANUFACTURING COMPANY

6605 S. LARAMIE AVE., CHICAGO 38, ILLINOIS

In Canada—Copper Wire Products, Ltd. 11 King Street West, Toronto

 **Jensen**
SPEAKERS
WITH **ALNICO 5**

Specialists in Design and Manufacture of Acoustic Equipment

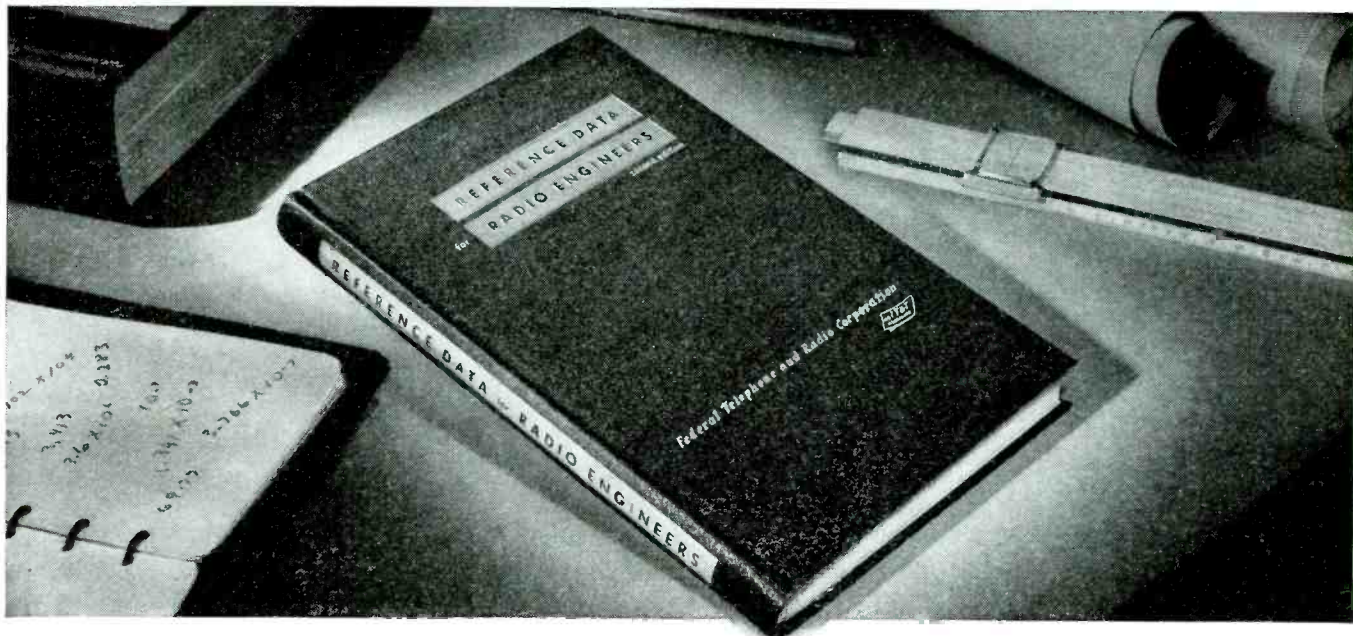

NOW READY—New and enlarged edition "REFERENCE DATA for RADIO ENGINEERS"

Compiled especially for Radio Engineers,
Students of Engineering, Educators, Electronic
Technicians, Radio Amateurs, Inventors.

The second edition of this widely accepted pocket-size handbook . . . revised and enlarged . . . now includes important radio technical data developed during the war.

Compiled jointly by the physicists and electronic specialists of the Federal Telecommunication Laboratories and the International Telephone and Telegraph Corporation, the material in this new book has behind it the technical authority of an organization with international leadership in radio, communications and television.

Enlarged from 200 to 336 pages with over 400 charts and diagrams, it makes available quickly the answers to problems that normally arise in practical radio work. This ready reference feature is one reason why *Reference Data for Radio Engineers*, in its earlier edition, received such an enthusiastic welcome by electronic specialists. Orders totaled more than 50,000 copies. With the wealth of new material now included, the second edition can be of even greater aid to the practicing radio engineer.

Commenting on the first edition, Walter J. Seeley, Chairman, Department of Electrical Engineering, Duke University, wrote enthusiastically:

"It is so chock full of useful data that I am urging all students to purchase their own personal copies . . . fills a long-felt need for a convenient compilation of both mathematical and engineering data, and the combination will be appreciated by all who have to work with radio circuits and their concomitant mathematics. That applies especially to teachers and students and I should not be surprised if it becomes a must in many college courses."

The new, second edition of *Reference Data for Radio Engineers*, in green cloth binding, revised and enlarged to include much new data, is ready now. To order, merely fill in the convenient coupon.

PRICE \$2 (In lots of 12 or more, \$1.60 each)

Federal Telephone and Radio Corporation



Publication Dept., 67 Broad Street, New York 4, N. Y.

PARTIAL OUTLINE OF CONTENTS

General Information. Conversion Factors, Greek Alphabet, Electromotive Force—Series of the Elements, Position of Metals in the Galvanic Series, Relative Humidity, Weather Data, Power Supplies in Foreign Countries, World Time Chart, Radio Frequency Charts, Frequency Band Widths Occupied by Emissions, Tolerances for the Intensity of Harmonics of Fixed, Land, and Broadcasting Stations, Classifications of Emissions, Decibels.

Engineering and Material Data. Wire Tables, Insulating Materials, Plastics; Trade Names, Wind Velocities and Pressure, Temperature Chart of Heated Metals, Physical Constants of Various Alloys and Metals, Thermocouples, Melting Points of Solder, Spark Gap Voltages, Head of Water in Feet, Approximate Discharge Rate, Materials and Finishes for Tropical, Marine Use, Torque and Horsepower.

Audio and Radio Design. Resistor and Capacitor—color codes, Inductance of Single-Layer Solenoids, Magnet Wire Data, Reactance Charts, Impedance Formulas, Skin Effect, Network Theorems, Circuits, Attenuators, Filters.

Rectifiers and Filters. Typical Rectifier Circuit Data, Rectifier Filter Design.

Iron-Core Transformers and Reactors. Major Types, Temperature, Humidity, Pressure Effects, General Limitations, Design of Power-Supply Transformers.

Vacuum Tubes. Formulas, Performance Limitations, Electrode Dissipation Data, Filament Characteristics, Ultra-High-Frequency Tubes, Cathode-Ray Tubes, Preferred Radio Electron Tubes.

Vacuum Tube Amplifiers. Graphical Design Methods, Classification of Amplifier Circuits, Cathode Follower Data,

Resistance-Coupled Audio Amplifier Design, Negative Feedback, Distortion.

Room Acoustics, Good Room Acoustics, Optimum Reverberation Time, Computation of Reverberation Time, Electrical Power Levels Required for Public Address Requirements.

Wire Transmission. Telephone Transmission Line Data, Frequency Allocation Charts, Noise Measurement—Wire Telephony, Telegraph Data.

Radio-Frequency Transmission Lines. Attenuation Due to Mismatch on Transmission Lines, Impedance Matching with Shorted Stub, Open Stub, and coupled sections, Army-Navy List of R-F Cables, Attenuation of Standard R-F Cables, Resistance of Transmission Lines at Ultra-High Frequencies.

Wave Guides and Resonators. Propagation of Electromagnetic Waves in Hollow Wave Guides, Rectangular Wave Guides, Circular Wave Guides, Electromagnetic Horns, Resonant Cavities.

Radio Propagation and Noise. Propagation of Long, Medium and Very Short Waves, Great Circle Calculations, Time Interval Between Transmission and Reception of Reflected Signal, Radio Noise and Noise Measurement.

Antennas. Field intensity from Elementary Dipole, from Vertically Polarized Antenna with Base Close to Ground, Vertical Radiators, Field Intensity and Radiated Power from a Half-Wave Dipole in Free Space, Radiation from End-Fed Conductor of Any Length, Maxima and Minima of Radiation.

Non-Sinusoidal Wave Forms. Relaxation Oscillators, Electronic Integration and Differentiation Methods, Fourier Analysis of Recurrent Wave Forms, Analysis of Common Wave Forms.

Use This Coupon—Order Your Copy Now!

Federal Telephone and Radio Corporation
Publication Dept. AI, 67 Broad Street
New York 4, N. Y.

() I enclose _____ dollars, for which send me _____ copies, at \$2.00 per copy.*

NAME _____

ADDRESS _____

CITY _____ ZONE _____ STATE _____

*For 12 or more copies, sent to a single address, the price per copy is \$1.60

NEW **EBY** MINIATURE SOCKETS

FLAT SADDLE

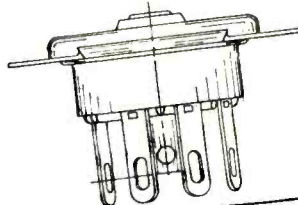
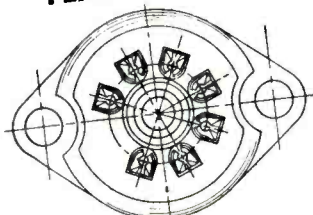

| INSULATOR PART NO. | CONTACTS | |
|-----------------------|--------------|---------------|
| | Phos. Bronze | Beryl. Copper |
| General Purpose | 8323 | 8100 |
| Ceramic | 8326 | 8083 |
| Mica-filled Phenolic | 8327 | 8082 |

SHOCK SHIELD

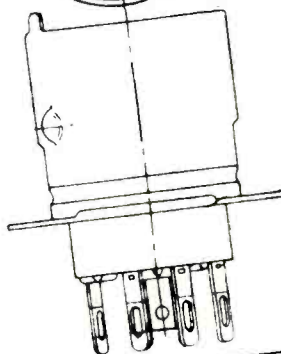
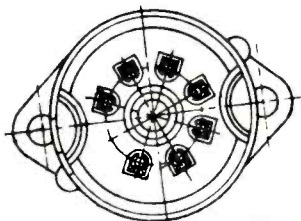

| INSULATOR PART NO. | CONTACTS | |
|-----------------------|--------------|---------------|
| | Phos. Bronze | Beryl. Copper |
| General Purpose | 8322 | |
| Ceramic | 8328 | 7676 |
| Mica-filled Phenolic | 8329 | 7670 |

NON-MICROPHONIC

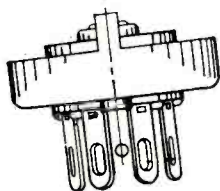
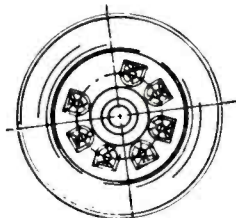

PART NO. 8341

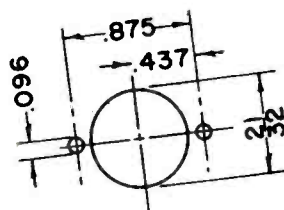

MOUNTING LAYOUT

Flat Saddle
Shock Shield
Non-Microphonic

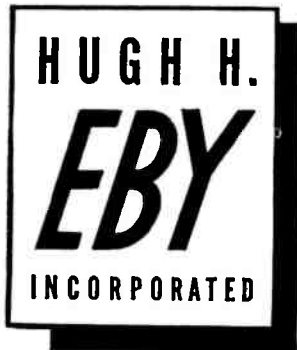

WRITE TODAY for complete details —

HUGH H. EBY, INC.

18 W. Cheltenham Ave. Phila. 44, Pa.

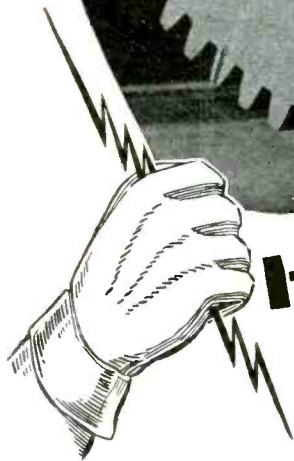
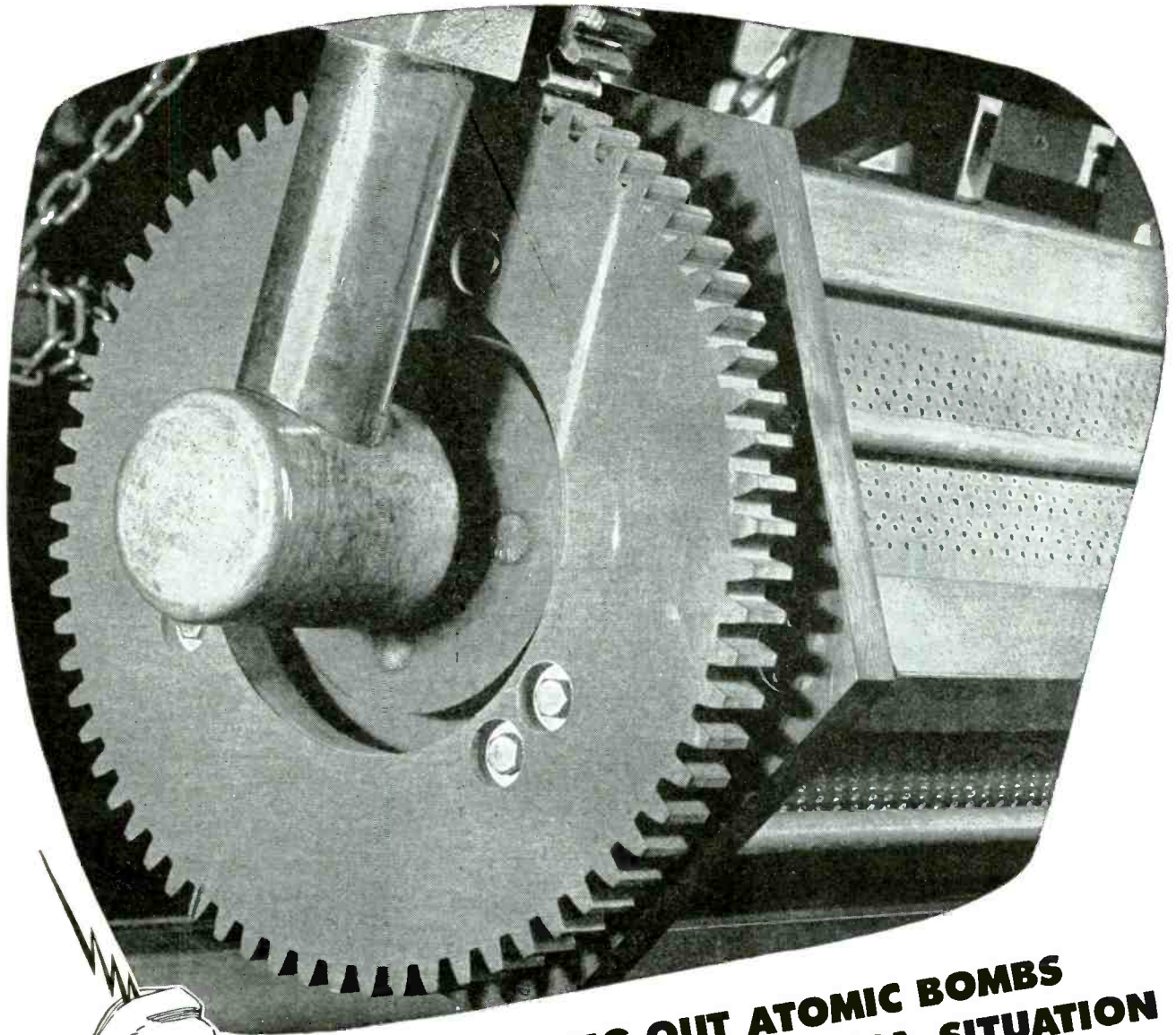

IT ISN'T GRINDING OUT ATOMIC BOMBS BUT IT'S A TYPICAL FORMICA SITUATION

THE apparatus illustrated is a bit of plating equipment dealing with the all powerful if slower acting forces of chemistry and electricity, forces which when on the move have to be handled with better gloves than were ever made of leather. In situations like this one, Formica laminated plastic of high chemical and electrical resistance handles these forces better than any other material available can handle them.

There are many grades of Formica with special properties, from which you can make indestructible gloves to handle dynamic materials in scores of industries where chemicals and electricity are pretty hot to handle. Why not state your problems, or state the properties of the material you require and start a get-together for the purpose of ascertaining if Formica will best fit your needs.

THE FORMICA INSULATION COMPANY, 4673 SPRING GROVE AVENUE, CINCINNATI 32, OHIO



Here is a new line of
FREED PRECISION
 MEASURING
 INSTRUMENTS



NO. 1010 COMPARISON AND LIMIT BRIDGE—for use in both laboratory and production testing of resistors, condensers, and inductors. The manufacturer of components can use it for production tests, the user for incoming inspection and acceptance tests. The instrument is particularly useful for laboratory work (bridge or filters) where very accurate components are required. For precision and production testing, it has many advantages. Power line operation and the visual indicator make the instrument completely self-contained. It can be used in noisy locations. Its small size and light weight make it extremely portable.



NO. 1050 60 CYCLE FILTER—for the calibration of instruments, where the form factor of the applied voltages is important (AC voltmeters and vacuum tube voltmeters), and for the measurement of harmonic distortion of amplifiers, transformers and tubes. The instrument is self-contained, AC operated, and is composed of a constant voltage transformer, a variac, a 60 cycle low pass filter, a decade attenuator, and a 1% AC voltmeter. The constant voltage transformer makes the instrument independent of the line variations. The variac makes the instrument extremely flexible and the decade attenuator makes it possible to vary the output voltage from 0 to 110 volts in increments of 1 volt.

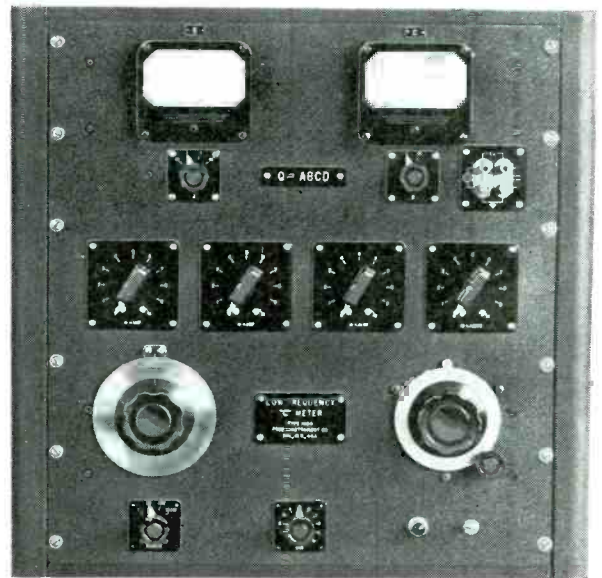

NO. 1030 LOW FREQUENCY "Q" METER—provides a frequency range from 50 to 50,000 cycles, with a range of "Q" measurements on coils from .5 to 500. The "Q" measurement may be made with as high as 50 volts across the coil with an accuracy within 5%. Tuning condenser range up to 11.11 mf. plus 1000 mmf. air variable. The stability and accuracy of measurement is unaffected by line variation.



NO. 1020 MEGOhmmETER—a precision balanced electronic ohmmeter for the measurement of leakage resistance of insulating materials, condensers, cables, motor and transformer windings. The high voltage potential necessary for insulation measurements is included in the instrument. An exceptionally wide range of resistances can be measured on the six overlapping ranges, and is read directly on a 4" meter scale. A relay disconnects the high voltage from the binding posts to eliminate all danger of shock due to exposed high voltage potential.

For Literature
 Please Address
 Dept. E.I.
 INSTRUMENTS
 DIVISION



NO. 1040 VACUUM TUBE VOLTMETER—giant performance in midget size of only 5½" x 5½" x 8". Measures voltages from .001 to 100 volts within 2% accuracy on all ranges and on any point of the scale. Frequency range from 10 to 200,000 cycles. It has a true linear decibel scale from 0 to 20 DB plus a logarithmic voltage scale. New balanced type voltmeter circuit plus inverse feedback in the amplifier results in high stability. Rugged 1 M.A. meter movement is protected against overloads. Input impedance 500,000 ohms shunted by a 10 mmf condenser.

FREED  **TRANSFORMER CO., Inc.**
 72 SPRING ST. NEW YORK CITY 12, N. Y.

MACHLETT ELECTRON TUBES FOR ALL RADIO TRANSMITTING AND INDUSTRIAL PURPOSES



2C-39



ML-891R



ML-893A

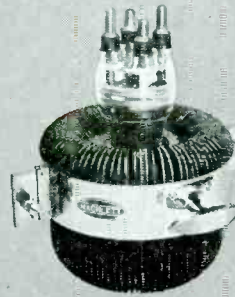

ML-889RA



ML-885A

MACHLETT LABORATORIES, Incorporated, one of the country's earliest producers of electron tubes, and today the world's largest supplier of tubes for X-ray purposes, brings to the radio and industrial fields its half century of electron tube experience. The tubes illustrated are typical examples of the Machlett line of radio transmitting and industrial tubes.

Machlett's comprehensive background of leadership in the design and production of X-ray tubes places it in a most effective position to meet the increasingly stringent requirements of modern electron tube manufacture. The production methods used in the manufacture of quality X-ray tubes are, more than ever before, essential to meet the constantly increasing requirements for higher power, higher frequencies and higher voltages in practically all fields of electron tube application. Processes essential to assure quality, performance and long useful life at voltages of 50 KV and higher, precision assembly of parts for the accurate control of electron stream, complete and permanent outgassing of the assembled tube and its individual parts have long been characteristic of X-ray tube manufacture and inherent in Machlett's design and productive operation. These skills and techniques developed for, and long used in its X-ray activities, now find unique additional value in their application to electron tubes for radio and industrial purposes.

The Machlett background of almost 50 years of continuous electron tube production, modern, laboratory-like manufacturing facilities, and up-to-the-minute experience assures the user that he will receive tubes engineered and processed for a long life of trouble-free operation.

For complete information write our nearest representative, or the factory at Springdale, Connecticut.

MACHLETT LABORATORIES, INC., Springdale, Connecticut



ML-892



ML-207



ML-880



APPLIES TO RADIO AND INDUSTRIAL USES
ITS **44** YEARS OF ELECTRON TUBE EXPERIENCE

PERMANENT MAGNETS MAY DO IT BETTER

MAGNETIZING A PERMANENT MAGNET

The lodestone is the only natural permanent magnet—and was produced by accident centuries ago, when the electrical forces of nature charged this primitive magnetic material with energy. Man-made permanent magnets must be subjected to a controlled magnetizing force in order to utilize efficiently the inherent energy of the material. This process is one of the most essential features in obtaining the maximum efficiency of permanent magnets.

They may be magnetized in a fraction of a second, but should be magnetized to saturation. This may be done by placing them in a magnetic field established by electro-magnets, solenoids, or special coils energized by half-cycled transformers, or condenser discharge or batteries. This applied magnetic field must not only be of sufficient intensity, but also should have proper orientation with respect to the

magnet. For maximum results it is necessary not only to magnetize the magnet thoroughly, but it must be done at a certain point in the assembly operation. For manufacturing purposes it is generally the best practice to magnetize the magnets in the customer's plant, as this prevents demagnetization and collection of foreign matter in handling.

The Indiana Steel Products Company is the world's largest sole producer of "packaged energy," having made more than 24,000 permanent magnet applications; and is uniquely well qualified, both through experience and equipment, to help you in your magnetizing, testing, and magnet aging problems. Our engineers invite you to consult with them. For complete information, write for free copy of our technical "Permanent Magnet Manual." Your request will receive our prompt attention.

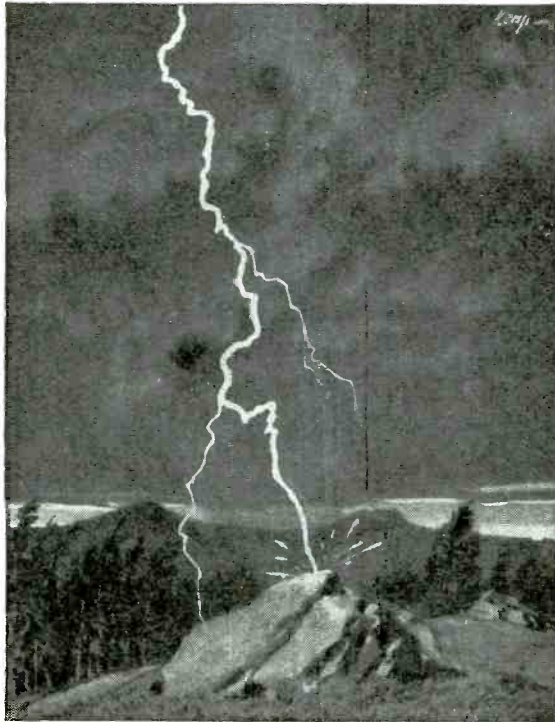

PRODUCERS OF "PACKAGED ENERGY"

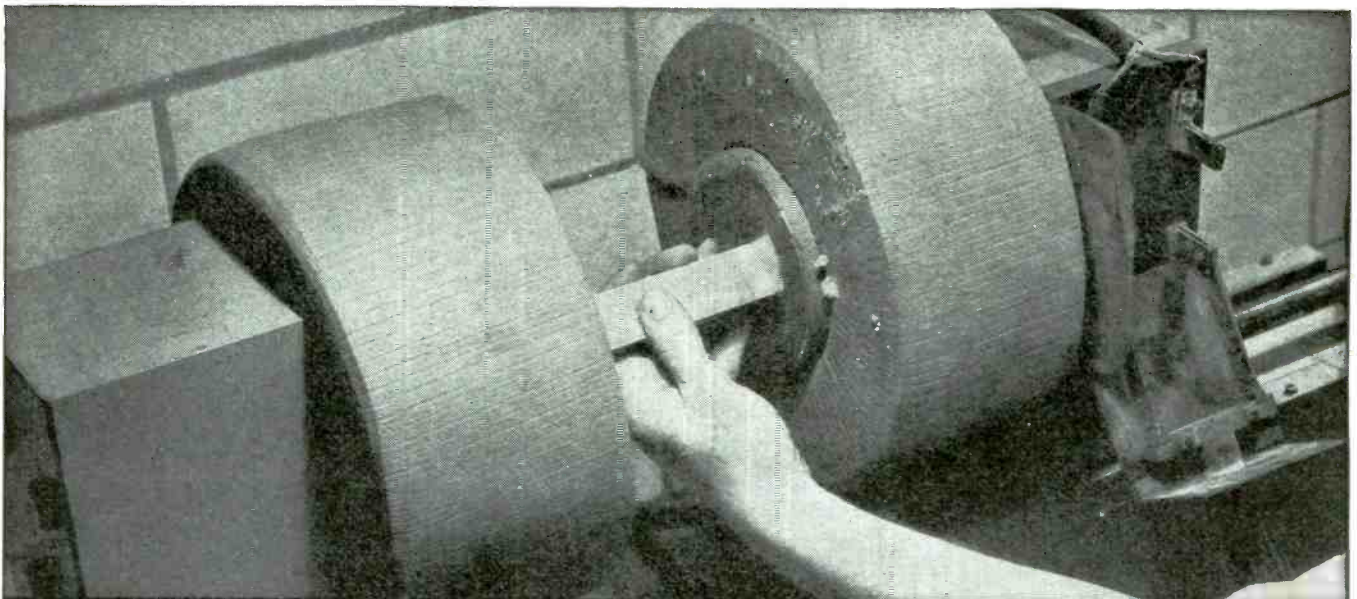

★ ★ ★ **THE INDIANA STEEL**

6 NORTH MICHIGAN AVENUE, CHICAGO, 2 ILLINOIS



PRODUCTS COMPANY ★ ★ ★

Corporation, 1946, The Indiana Steel Products Co.

SPECIALISTS IN PERMANENT MAGNETS SINCE 1910

Meeting Precision Capacitance
Tolerances to Plus/Minus 1% . . .

SILVERED-MICA Capacitors

are molded in brown
XM bakelite.

Silvered Mica Type

These AEROVOX silvered mica capacitors are designed for applications which require precision capacity values and extreme stability. Although they are similar in external construction and dimensions to standard molded XM low-loss bakelite units, they are encased in molded XM low-loss red bakelite for immediate silvered-mica identification. A silver coating is applied to the mica and fired at elevated temperatures. This insures not only a positive bond but permanent stability of the capacitance with respect to time, temperature and humidity. The units are wax-impregnated externally for ultimate protection.

Aerovox silvered mica capacitors have an average coefficient of only .002% per degree C—a remarkably low value; and practically no capacity drift with time. Capacitance values as high as 3000 to 5000 mmf. are attained in higher types. They are ideal for use in circuits where accuracy and stability are prime considerations.



● Aerovox silvered-mica capacitors are designed for the most critical applications requiring precise capacitance values and extreme stability. Although otherwise similar in external construction and dimensions to the smaller molded bakelite units, they are encased in molded XM low-loss red bakelite for immediate silvered-mica identification.

A silver coating is applied to the mica and fired at elevated temperatures. This insures not only a positive bond but permanent stability of the capacitance



with respect to time, temperature and humidity. Units are heat-treated and wax-impregnated externally for ultimate protection against moisture penetration.

Ideal for use in circuits where capacitance must remain constant under all operating conditions. These capacitors are specifically designed for use in push-button tuning, oscillator padding circuits, fixed tuned circuits, and as capacitance standards, etc., where accuracy and stability are prime considerations.

● Write for literature . . .

Average positive temperature coefficient of only .003% per degree C.—a remarkably low value.

Excellent retrace characteristics; practically no capacitance drift with time; exceptionally high Q.

Available in three types, 1000 v.D.C. test: Type 1469, .000005 to .0005 mfd.; Type 1479 (illustrated), .0001 to .001 mfd.; Type 1464, .00075 to .0025 mfd., and .001 mfd. in 600 v. D.C. test.

Standard tolerance plus

minus 5%. Also available with tolerances of plus/minus 3%, 2% and 1%.

Minimum tolerance for capacitances up to and including 10 mmf. (.00001 mfd.) plus/minus ½ mmf. Minimum tolerance available for all other

capacitances, plus/minus 1% or plus/minus 1 mmf., whichever is greater.



FOR RADIO-ELECTRONIC AND INDUSTRIAL APPLICATIONS

AEROVOX CORPORATION, NEW BEDFORD, MASS., U.S.A.

SALES OFFICES IN ALL PRINCIPAL CITIES • Export: 13 E. 40th St., NEW YORK 16, N. Y.

Cable: 'ARLAB' • In Canada: AEROVOX CANADA LTD., HAMILTON, ONT.

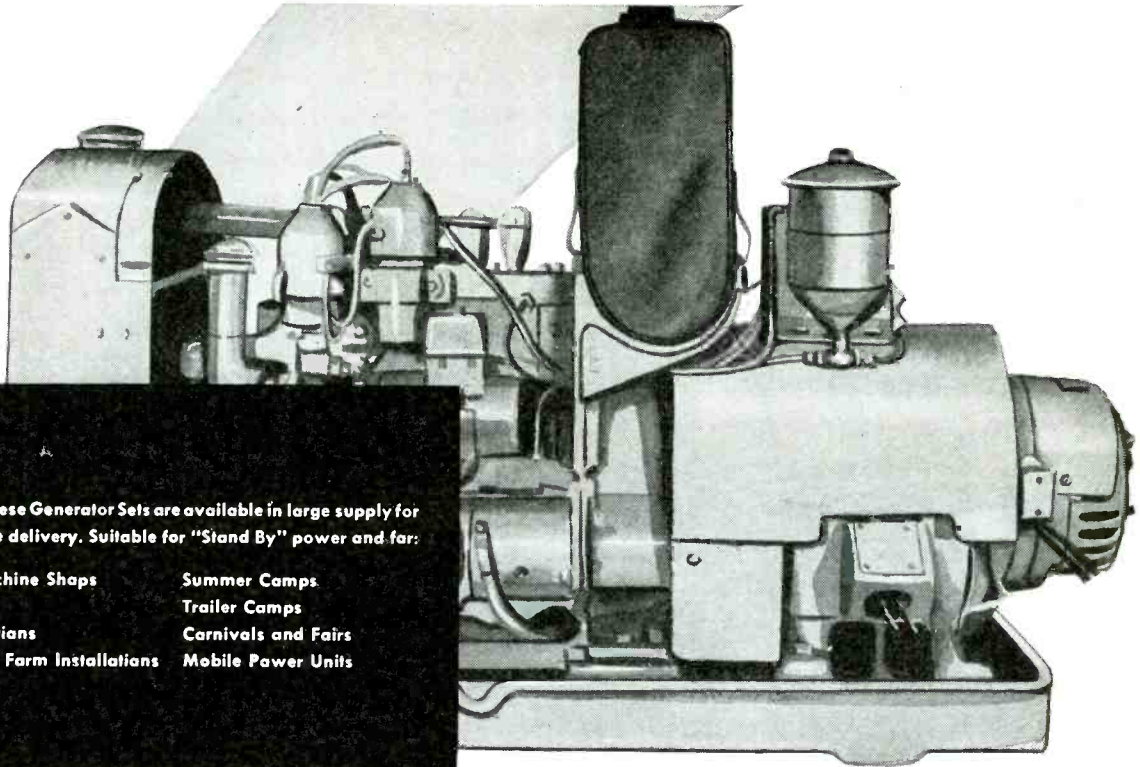

Some of these Generator Sets are available in large supply for immediate delivery. Suitable for "Stand By" power and for:

| | |
|------------------------------|---------------------|
| Small Machine Shops | Summer Camps |
| Saw Mills | Trailer Camps |
| Radio Stations | Carnivals and Fairs |
| Rural and Farm Installations | Mobile Power Units |

- ✓ 120 VOLTS TO 480 VOLTS
- ✓ 1½ KW TO 30 KW
- ✓ FROM \$250 TO \$2500

PORTABLE *Generator* SETS GOVERNMENT-OWNED SURPLUS

Many Generator Sets, produced by well known manufacturers, are now available from government-owned surplus. The majority of them are new, unused sets, and include the following types:

| | | |
|------------------------|--|--|
| Gasoline engine driven | Alternating current, 50 and 60 cycle, single and three phase | 120 Volts to 480 Volts 1½ KW to 30 KW From \$250 to \$2500 |
| Diesel engine driven | | |
| Direct current | | |
| | 120-250 Volts | |

Used sets in good condition at further reduced prices. All items subject to prior sale.

HOW TO PURCHASE:

- 1 If you can claim a priority obtain your priority certificates at the nearest W.A.A. Certifying Office, (contact the W.A.A. Office below for Certifying Office address) and make application to purchase.
- 2 If you do not have priority status simply call any W.A.A. Office below; state the approximate KW rating you desire and the type of machine. You will be told where the machines you wish may be seen and how to complete purchase.
- 3 If the equipment you wish is not available in your local W.A.A. Regional Office—ask to have national inventories checked by the W.A.A. Inter-Regional Division of your local office and wait for notification of availability.

All Portable Generator Sets are subject to priority regulations. VETERANS OF WORLD WAR II are invited to be certified at the War Assets Administration Certifying Office serving their area, and then to purchase the equipment offered herein.

EXPORTERS:

Most surplus property is available to the export market. Merchandise in short supply is withheld from export and if such items appear in this advertisement they will be so identified by an asterisk.

WAR ASSETS ADMINISTRATION

Offices located at: Atlanta • Birmingham • Boston • Charlotte • Chicago • Cincinnati • Cleveland • Dallas • Denver • Detroit • Fort Worth • Helena • Houston • Jacksonville • Kansas City, Mo. • Little Rock • Los Angeles

GOVERNMENT
OWNED
SURPLUS

Louisville • Minneapolis • Nashville • New Orleans • New York • Oklahoma City • Omaha • Philadelphia • Portland, Ore. • Richmond • St. Louis • Salt Lake City • San Antonio • San Francisco • Seattle • Spokane

655-1

It's PRECISION PLUS

IN  MICROWAVE ACCESSORIES

The **PLUS-VALUE** in all A.R.C. equipment is the know-how, the background of knowledge and experience, that makes this equipment outstanding.



A. R. C. 24,000 megacycle Attenuator, showing "Split-Plate" construction.

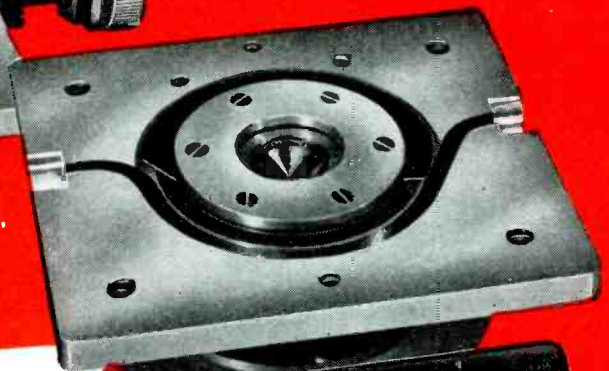

A.R.C. "Magic Tee" — a specialized item of Microwave Plumbing designed and manufactured to the highest standards of precision.

A.R.C. Directional Coupler—another product reflecting in the accuracy of its construction the precision methods employed by A.R.C.



The ever-increasing importance of microwave transmission in the field of electronic navigation, communication, and industrial controls turns the spotlight on the A.R.C. line of equipment and accessories to serve this field.

The A.R.C. 24,000 megacycle attenuator with its unique "split-plate" construction typifies the quality of A.R.C. design and manufacture. This design (patent pending) permits the machin-

ing of the wave-channel to an accuracy impossible to achieve through other methods of construction, while the jointure of the plates themselves is so precise as to leave no possibility of leakage and loss.

A complete line of A.R.C. Microwave Accessories is available. For full details on these and other A.R.C. Radio and Electronic Component Parts, write:

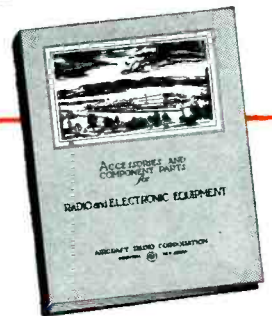

NOW AVAILABLE: free, illustrated catalog of A.R.C. Radio and Electronic Component Parts and Accessories.



AIRCRAFT RADIO CORPORATION

BOONTON, NEW JERSEY





A Mark **OF DISTINCTION**

LONG YEARS of intensive research, development and quality production have firmly established the DOLPH trade mark throughout the Electrical Industry. Behind it stands an enviable record of efficient service and customer satisfaction; of this we are justifiably proud. It is our sincere intention that this record shall continue and that the DOLPH trade mark be found only on Insulating Varnishes and Compounds of the highest quality.

Insulating Varnish Specialists
SINCE 1910

JOHN C. DOLPH CO., 1060 BROAD ST., NEWARK 2, N. J.



Dolph's

There is a High Sensitivity

RAULAND VISITRON

for every photo tube application

The *Rauland VISITRON* family of Phototubes includes the widest selection of versatile types for practical application in the field of light-sensitive devices. (Representative *VISITRONS* are described here briefly.) Whatever the application . . . for industrial electronic control, sound-on-film, or research and development, there is a dependable, high sensitivity *Rauland VISITRON* available to do the job perfectly. *Rauland* phototube engineers are ready to consult with you on your special phototube requirements.

To be sure . . . specify *VISITRON!*



Send for this Descriptive Catalog

This valuable new *Rauland VISITRON* Catalog is yours for the asking. It's packed with informative data on phototube theory, characteristics and circuit applications. You will want this important treatise for your engineering reference library.



R-58 SERIES

Exceptionally dependable for use in electronic control equipment (for counting, sorting, burglar and smoke alarms, etc.) A preferred type for use in 16 MM sound-on-film equipment.



R-59 SERIES

Widely employed in theater sound projection equipment. Popularly used in 35 MM semi-portable systems. Rugged design makes it unusually adaptable to industrial electronic equipment. One of several series of *Rauland VISITRONS* also available for blue and ultra-violet applications.



R-60 SERIES

A dual-type phototube designed primarily for dual sound track systems; ideal wherever dual tube operation is required and space is at a premium.



R-64 SERIES

This rugged phototube in a short glass envelope is recommended for industrial light-operated relay and measurement applications where space is a limiting factor.



R-71 SERIES

One of the most widely used *VISITRONS*. Ideal for sound-on-film applications. Used extensively in electronic control devices for weighing, conveying; illumination controls; safety devices; flame control work; smoke and turbidity measurement controls.

ALSO MANUFACTURERS OF DIRECT-VIEWING AND PROJECTION TYPE CATHODE RAY TUBES

RADIO • RADAR • SOUND •

Rauland

COMMUNICATIONS • TELEVISION

Electroneering is our business

THE RAULAND CORPORATION • CHICAGO 41, ILLINOIS

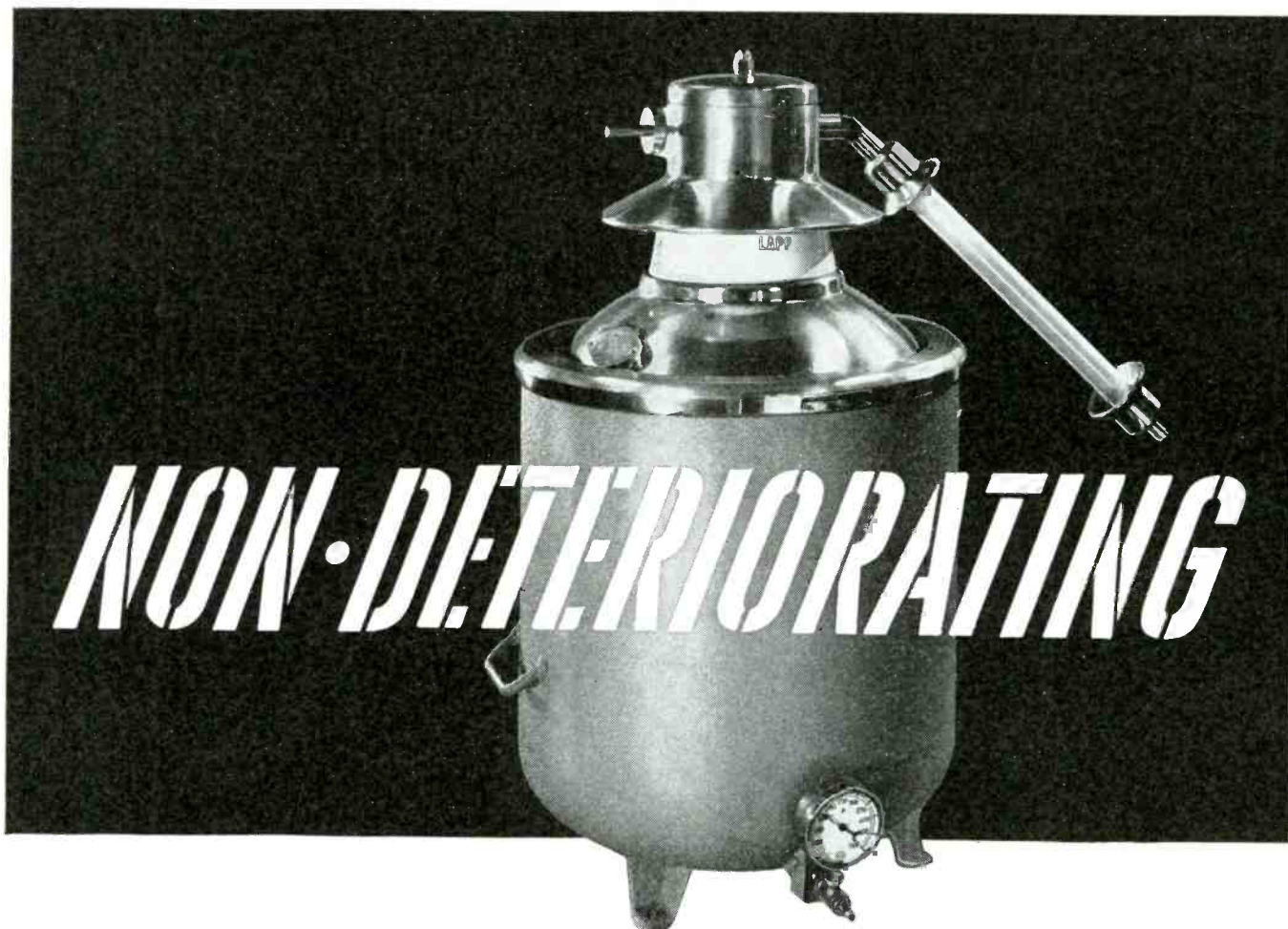

NON-DETERIORATING

.... PUNCTURE-PROOF, FOR LONG, UNIFORM PERFORMANCE.

“Fail-proof” is a reasonable and honest description of the Lapp Gas-filled Condenser. It has no fixed or solid dielectric to deteriorate or puncture, and should out-last any electronic circuit of which it is a part. Also, it offers correspondingly lower loss and economy of power. Not needing to “warm up,” it provides constant capacitance under temperature variation. Variable, adjustable, and fixed capacitance units are available. Fixed condensers have been made with capacitance up to 60,000 mmf., variable and adjustable units up to 16,000 mmf. Current ratings range up to 500 amperes R. M. S., and voltage ratings up to 60 Kv peak. *Above, Unit No. 25,934, rated at 200 amperes, 6500 volts, capacitance continuously variable from 4300 mmf. to 1100 mmf.* Lapp Insulator Co., Inc., Le Roy, N. Y.

Lapp

**INSULATOR CO., INC.
LEROY, N. Y.**

5 reasons

For specifying Westinghouse Selenium rectifiers

By specifying Westinghouse Selenium rectifiers you get the benefits of more than 9 years of continuous research. For instance, this research has definitely determined what the quality of all processing materials must be; also the quantitative elements required for this exclusive Westinghouse manufacturing process. This scientific control of materials and processing has resulted in a Selenium rectifier comparable in excellence to Westinghouse Rectox rectifiers.

Only Westinghouse Selenium rectifiers offer you these advantages:

EFFICIENCY—Unexcelled.

HIGH TEMPERATURE OPERATION—Tests run in excess of 90°C indicate a liberal safety factor for normal ratings, and ability to handle intermittent duty applications where ambient and loading conditions may make high temperature operation desirable.

CONSERVATIVE RATINGS—Successful performance on long time overload tests indicates unusually long life expectancy at normal ratings.

AGING—Selenium Rectifiers, in a period of one year, showed a percentage increase in forward resistance of less than one-half of the increase for the best of other units tested.

LIFE—Conservative ratings and superior aging characteristics of Westinghouse Selenium rectifiers assure a long life.

Ask your nearest Westinghouse office for all the details. Or write to Westinghouse Electric Corporation, P. O. Box 868, Pittsburgh 30, Pa.

J-21381



Westinghouse
PLANTS IN 25 CITIES . . . OFFICES EVERYWHERE

Selenium Rectifiers

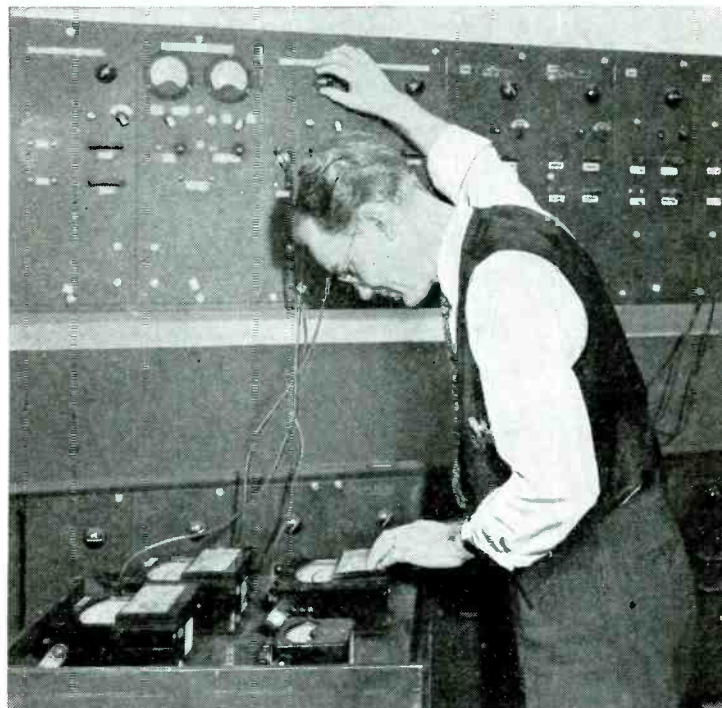

Life test racks at research laboratory for testing actual performance of rectifiers in an operating circuit.

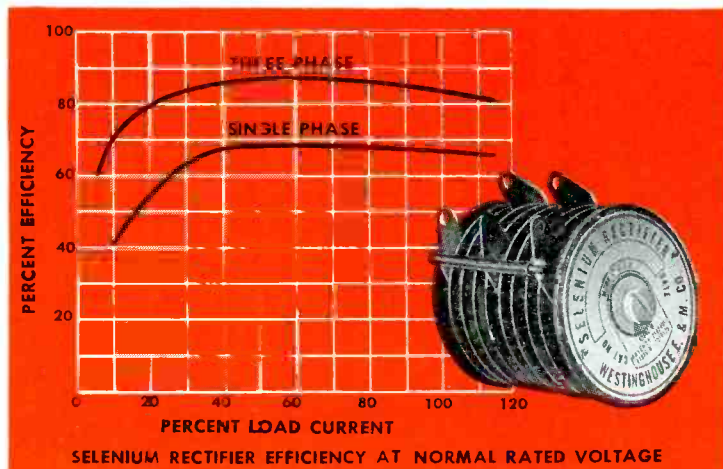

LOW FREQUENCIES
ACCURACY TO 1/1,000th of 1%

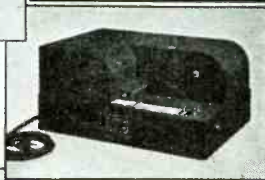
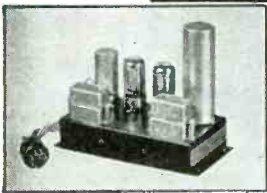
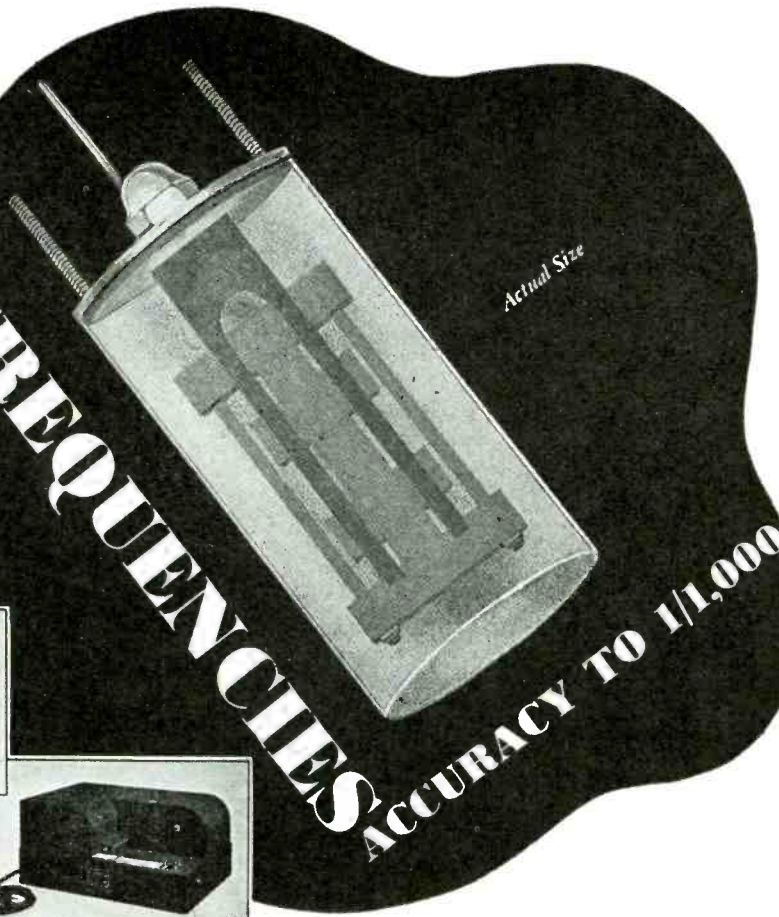

These tuning forks which include new engineering principles, provide frequencies from 120 to 1,000 cycles directly with an unqualified guarantee of accuracy to 1 part in 100,000 over a wide temperature range. (Better than 1 second in 24 hours). Closer tolerances are obtainable on special order.

These tuning fork assemblies are available only in single or multi-frequency instruments of our own manufacture which are de-

signed to test, measure or control other precision equipment by mechanical, electrical, acoustical or optical means.

The dependability of these frequency standards is being demonstrated for myriad purposes in all climates and under all working conditions.

If you have need for low frequency standards of exceptional accuracy, your inquiries are invited.

TOP
FREQUENCY STANDARD
(60 cycle) for use with external power supply

CENTER
CHRONOGRAPH
Records time intervals with resolution to .001 second

BOTTOM
FREQUENCY STANDARD
(120 cycles) with self-contained power supply

American Time Products, Inc.

580 Fifth Ave.

New York, N. Y.

Dist. of Western Electric & **Watch Master** Watch-rate Recorders

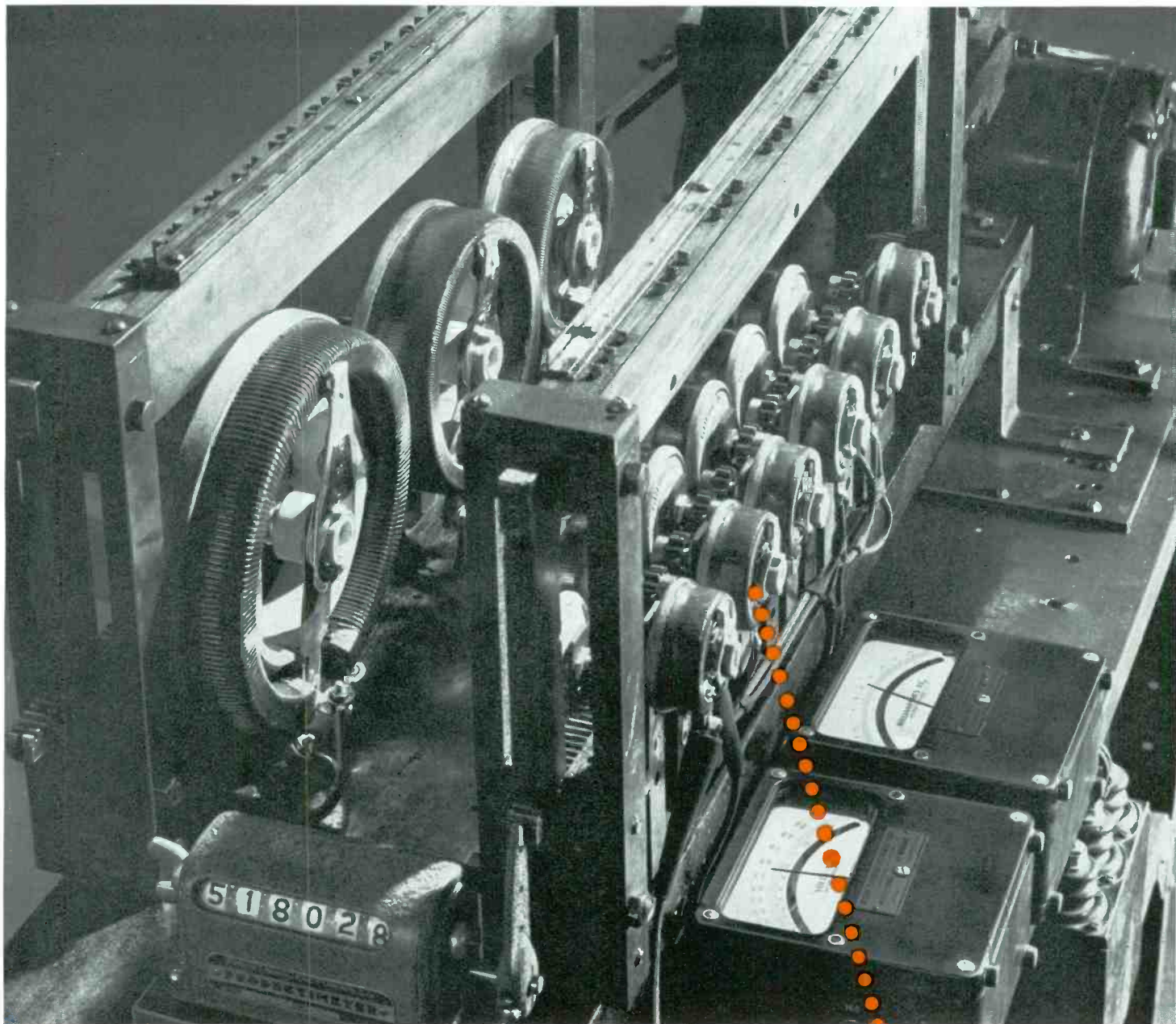

Crowding Years of Rheostat Life ...into a Few Hours

Back and forth... back and forth... twenty times a minute for days and weeks... these Ohmite rheostats are rotated continuously under full electrical load. It's Ohmite's way of condensing a lifetime of grueling rheostat service into a few days, in order to make sure that Ohmite rheostats will stand up under the toughest service conditions. Every new Ohmite rheostat development is pre-tested in this manner on a specially-designed, rotation life testing machine in the Ohmite laboratories before it is released for production. That's just one more reason why you can depend upon Ohmite rheostats for years of un failing, trouble-free life.



Be Right with...

OHMITE

RHEOSTATS • RESISTORS • TAP SWITCHES

Here's why you get YEARS OF UNFAILING OPERATION with OHMITE Rheostats

Ohmite rheostats are engineered to give long, trouble-free service and unmatched smoothness of action. Following are a few of the features that make possible their outstanding performance:

- **VITREOUS ENAMEL BOND**—Core and base are bonded together by vitreous enamel into one integral unit. Each turn of wire is also permanently locked in place by vitreous enamel.
- **METAL GRAPHITE BRUSH**—Perfect contact with negligible wear on the wire is insured by the metal-graphite contact brush (varied to fit the current and resistance) and the large, flat contact surface.
- **LARGE PIGTAIL SHUNT**—Current is carried directly to the slip-ring by a pigtail shunt of ample size, assuring an uninterrupted connection at all times. Large slip-ring minimizes mechanical wear.
- **INSULATED SHAFT AND BUSHING**—High strength ceramic hub insulates the shaft and bushing from all live parts. Underwriters' Laboratories listed models are available.
- **UNIFORM CONTACT PRESSURE**—Tempered steel contact arm forms a long steel spring which assures uniform contact pressure. Universal joint action of the brush maintains "flush-floating" contact.
- **ALL CERAMIC AND METAL CONSTRUCTION**—Ohmite rheostats have a ceramic core, base, and driving hub. There is only ceramic and metal in their construction—nothing to char, burn, shrink, or deteriorate. They are designed for long, trouble-free life.

OHMITE MANUFACTURING COMPANY
4984 Flournoy Street, Chicago 44, Illinois

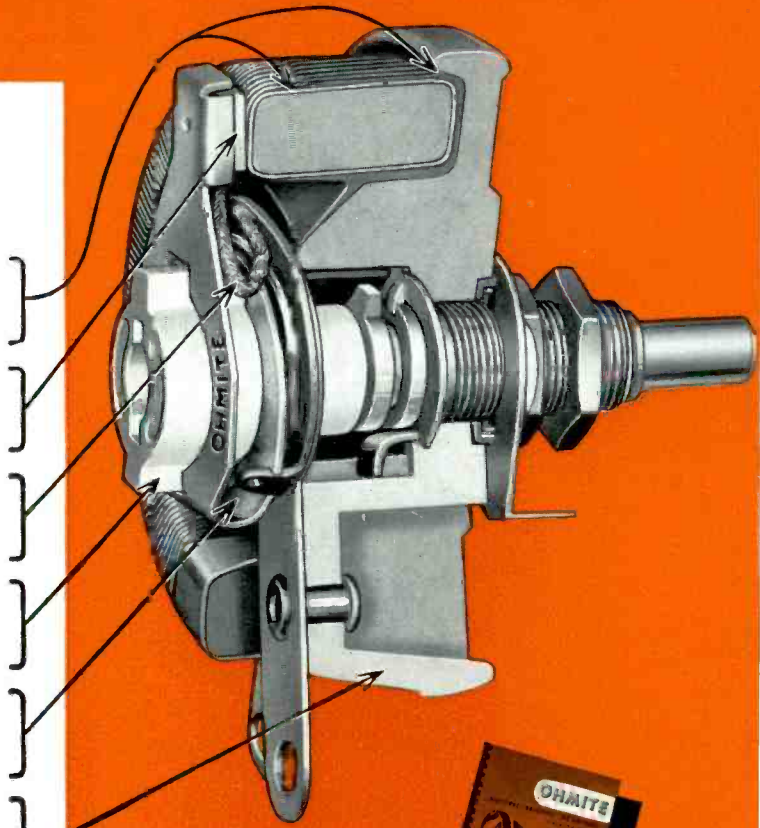

Write on company letterhead for Catalog and Engineering Manual No. 40.

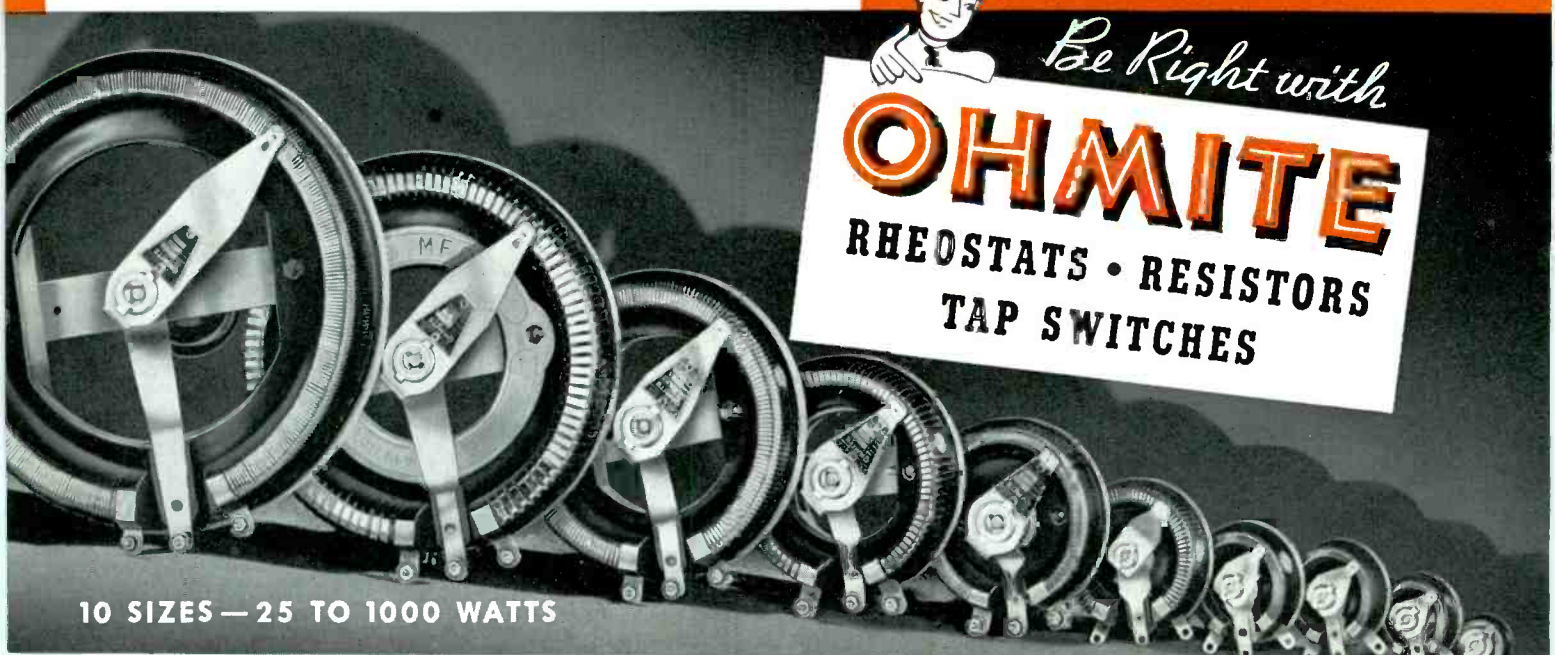

Be Right with
OHMITE
RHEOSTATS • RESISTORS
TAP SWITCHES

10 SIZES — 25 TO 1000 WATTS

DESIGNED AND ENGINEERED AT NO. 1 PLASTICS AVENUE



**MORE THAN 16,000,000
MOLDED OF G-E MYCALEX**

●Here is an example of precision molding a critical component in G-E mycalex and supplying it by the million. The aircraft engine spark plug terminal sleeve had the advantage of being "self-healing" after exposure to prolonged arcing. It lent itself to ground crew maintenance of our warplanes.

This is but one of the many parts molded in G-E mycalex by General Electric during the war. Why not consult G-E engineers, who have perfected G-E mycalex molding techniques, about your insulation problems? You may

heighten the efficiency of your product *and save on over-all insulation costs* by using a G-E mycalex precision molded part.

G-E mycalex, a stone-hard, gray-colored material that is produced by fusing special glass with powdered mica, is now available to you in standard rods and sheets . . . fabricated parts . . . or molded to your own design. A new bulletin tells the whole story of unique G-E mycalex—send for it today. Plastics Divisions, T-13, Chemical Department, General Electric Company, 1 Plastics Avenue, Pittsfield, Massachusetts.

**HOW THE G-E
MYCALEX SERVICES
CAN BENEFIT YOU NOW**

You may order fabrication of sample G-E mycalex parts at surprisingly low cost. Test them yourself in your own equipment. Then, if you decide to specify G-E mycalex, your design can be converted to a molding process which permits speedy and economical production runs.

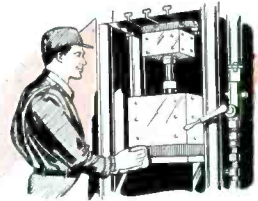

MOLDING SERVICE

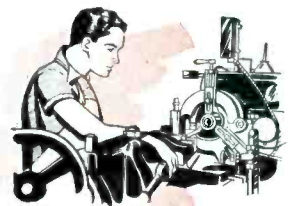

FABRICATING SERVICE

**Get This Unique Combination
of Properties with G-E Mycalex**

1. High dielectric strength
2. Low power factor
3. Prolonged resistance to electrical arcs
4. Chemical stability—no deterioration with age
5. Dimensional stability—freedom from warpage and shrinkage
6. Impervious to water, oil, and gas
7. Resistance to sudden temperature changes
8. Low coefficient of thermal expansion
9. High heat resistance

Samples Supplied on Request



GENERAL  ELECTRIC

CD46-M18

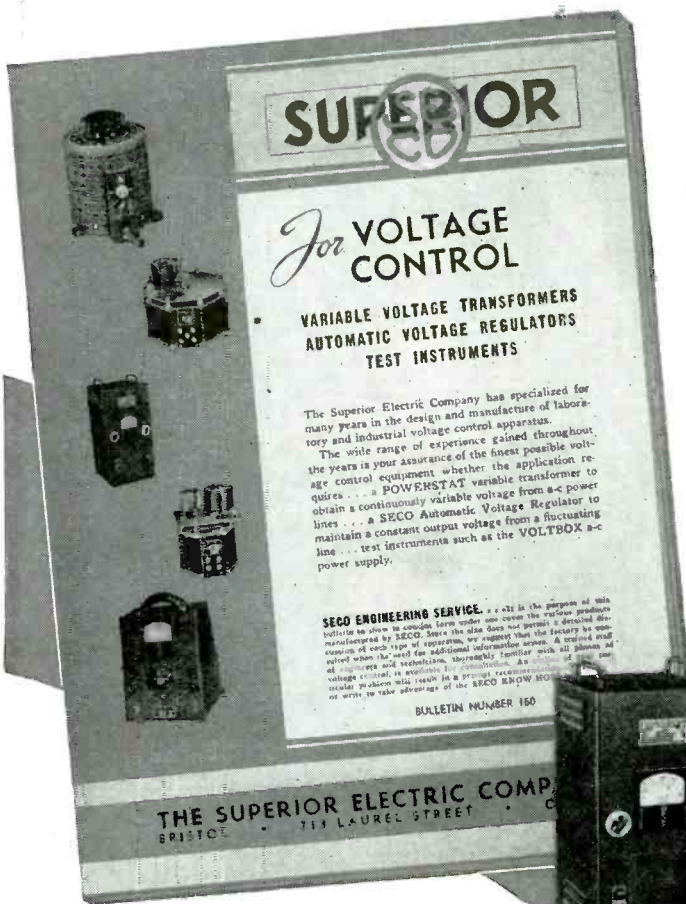

Quick Facts On SUPERIOR VOLTAGE CONTROL

for the
**DESIGN
ENGINEER**

BULLETIN 150...

Contains twelve terse, factual-laden pages of valuable data on the standard line of Superior Electric voltage control equipment. All information has been brought up to date wherever design, electrical or mechanical features have been improved to meet more exacting requirements.

Apparatus described in this bulletin includes all types of POWERSTAT variable transformers, SECO Automatic Voltage Regulators and VOLTBOX a-c power supplies. Operating and electrical characteristics are clearly shown by charts and schematic diagrams. Every design engineer, laboratory technician, and purchasing agent needs the product information contained in Bulletin 150.

Write Dept. IE for your copy today.

**THE SUPERIOR
ELECTRIC COMPANY**
BRISTOL, CONNECTICUT

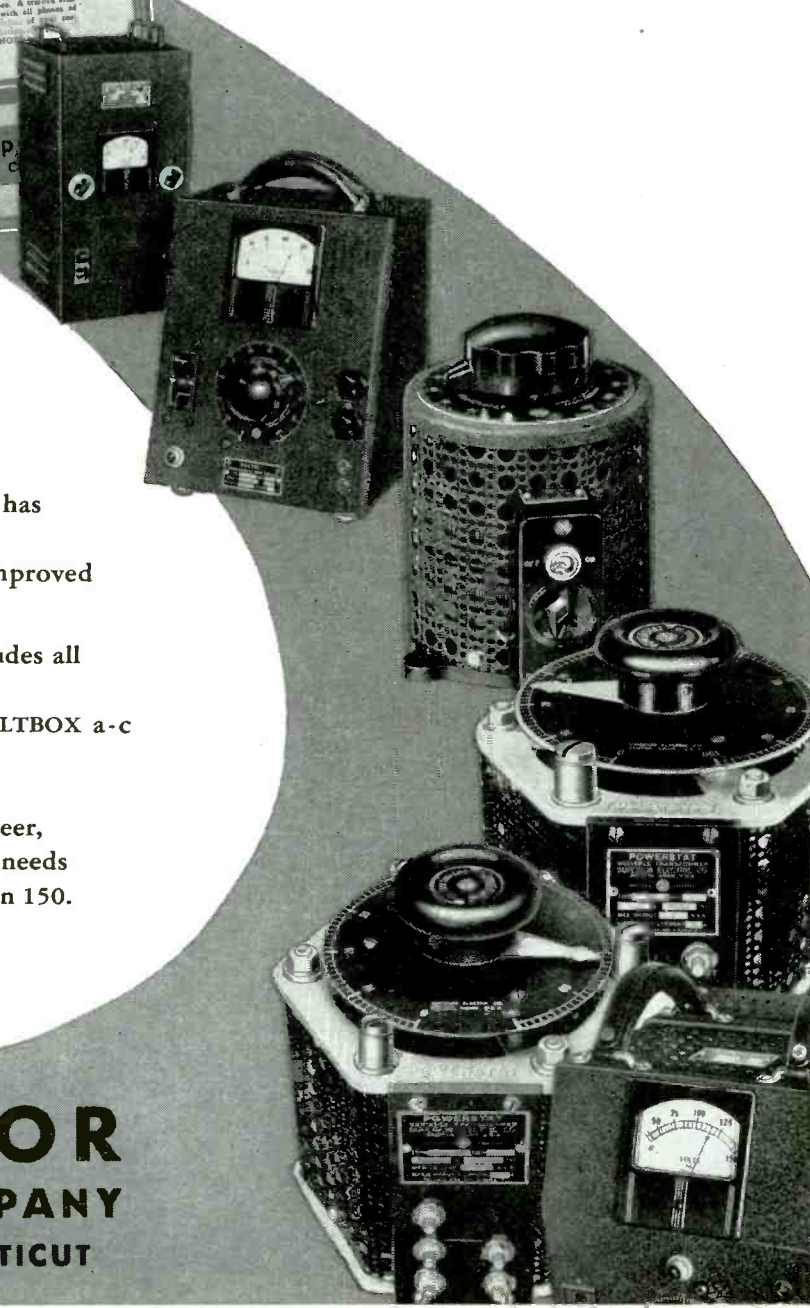

STUPAKOFF

HERMETIC SEALS

meet exacting demands of
MODERN ELECTRONIC DEVELOPMENTS

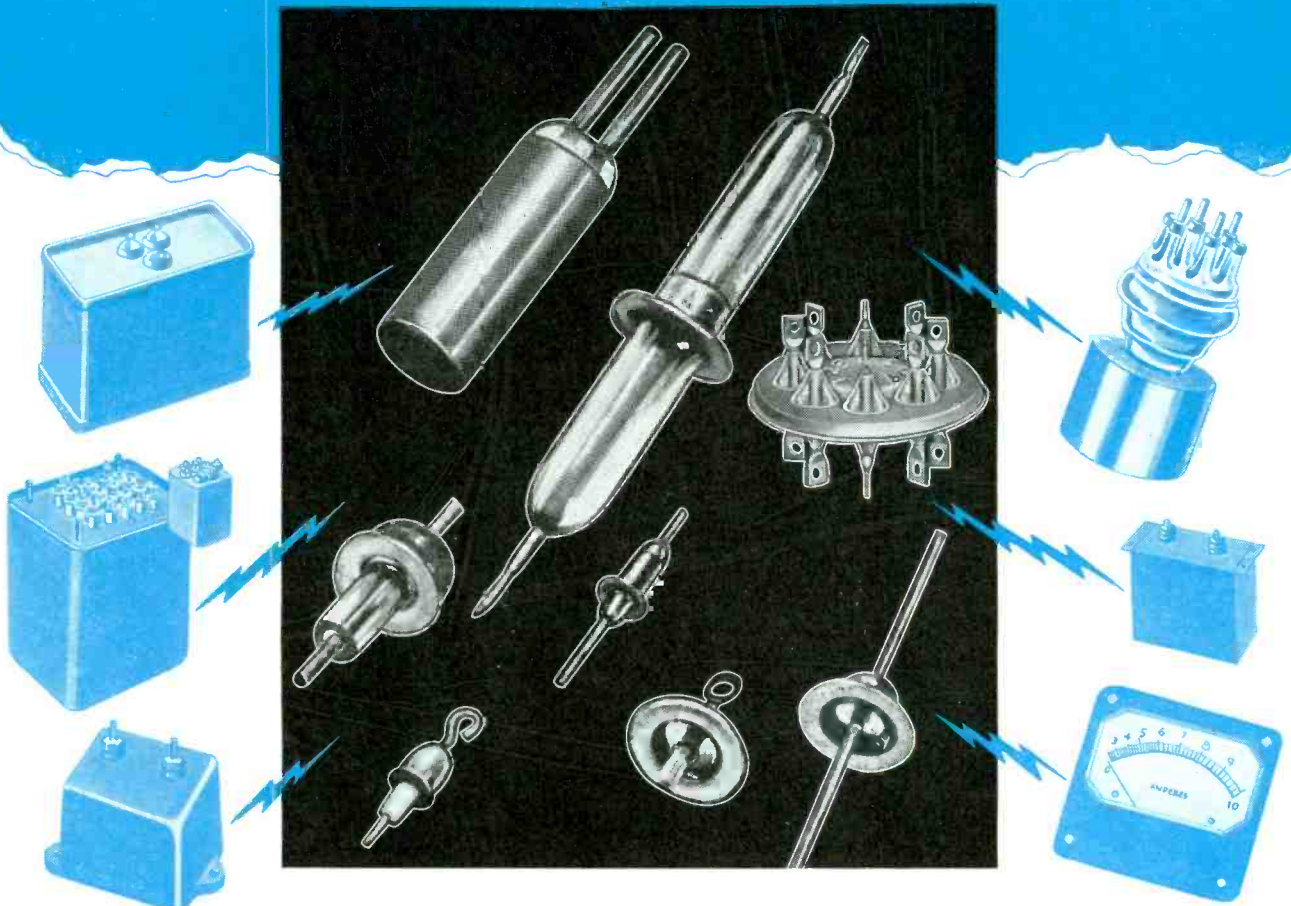

Stupakoff Kovar®-glass seals provide permanently vacuum and pressure tight, insulated electrical lead-ins on products which must be sealed from the atmosphere, even under the most adverse climatic conditions.

Metal-glass terminals are available, or can be made in shapes and sizes to suit your needs . . . with single or multiple, hollow or solid electrodes.

Kovar alloy is also available in the form of sheet, rod, wire, tubing and special shapes for the

manufacturers of electronic tubes and others who have their own glass working facilities.

A line from you as to your sealing problems will enable us to make specific recommendations and supply the applicable literature.

*Reg. U. S. Pat. Off.

Trade Mark No. 337962

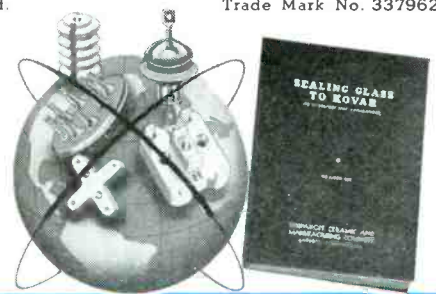

STUPAKOFF

CERAMIC AND MANUFACTURING CO. · LATROBE, PA.

EXPORT DEPARTMENT 13 E. 40TH ST., NEW YORK 16, N. Y. CABLE ADDRESS ARLAB ALL CODES

Eimac
TUBES

THE COUNTERSIGN OF DEPENDABILITY IN ANY ELECTRONIC PRODUCT

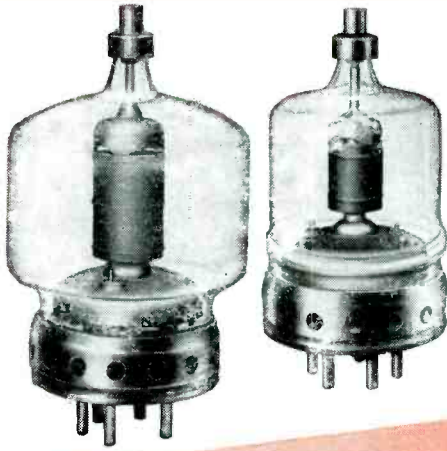

CRYSTAL CONTROL with Eimac tetrodes means pin-point frequency stability plus ready portability for tomorrow's electronic heating units!

This experimental diathermy unit WORKS...and it proves that the easy, simple, SURE way to solve frequency stability problems is with crystal controlled Eimac tetrodes.

In the experimental diathermy application shown here, one Eimac 4-250A tetrode is driven by a simple crystal frequency controlled r-f exciter unit employing a handful of parts and *only two* receiving type tubes. Exciter frequency multiplication plus great power amplification by the Eimac tetrode permits approximately *500 watts output* at 27.32 Mc. And because of the low plate-to-grid capacitance of this tetrode, no neutralization is necessary.

The success of Eimac's experimentation with crystal frequency control through Eimac tetrodes has proved the usefulness of this combination—not only in diathermy—but in industrial electronic heating as well. Eimac's 4-250A, 4-125A or other Eimac tetrodes may well solve your electronic heating problem. Your inquiry will receive full and prompt attention from either Eimac representatives or factory engineers.

Once again—Eimac engineers have pioneered the way to new developments in the electronic field.

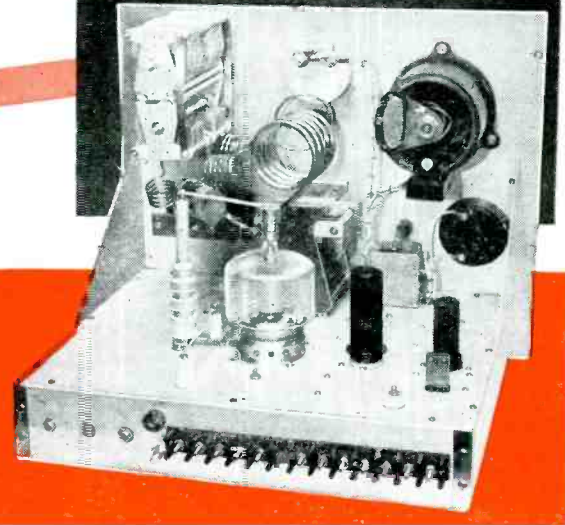
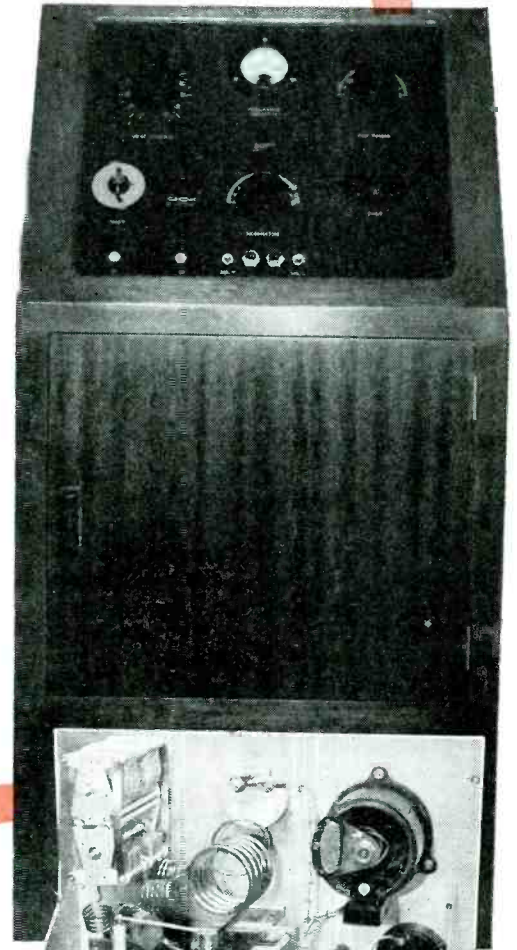

CALL IN AN EIMAC REPRESENTATIVE FOR INFORMATION

ROYAL J. HIGGINS (W9AIO), 600 So. Michigan Ave., Room 818, Chicago 5, Ill., Phone: Harrison 5948.
VERNER O. JENSEN, Verner O. Jensen Company, 26.6 Second Ave., Seattle 1, Wash., Phone: Elliott 6871.
M. B. PATTERSON (W5CI), Patterson & Co., 1124 Irwin-Keasler Bldg., Dallas 1, Tex., Phone: Central 5764.
ADOLPH SCHWARTZ (W2CN), 220 Broadway, Room 2210, New York 7, N. Y., Phone: Cortland 7-0011.

HERB BECKER (W6QD), 1406 So. Grand Avenue, Los Angeles 15, California, Telephone: Richmond 6191.
TIM COAKLEY (W1KQP), 11 Beacon Street, Boston 8, Massachusetts, Telephone: Capitol 0050.
RONALD G. BOWEN, 1886 South Humboldt Street, Denver 10, Colorado, Telephone: Spruce 9368.
JAMES MILLAR ASSOCIATES, J. E. Jovner, Jr. (W4TO) 1000 Peachtree Street, N.E., Atlanta, Georgia.



Guess who didn't know an Adlake Relay was on the job!

AN Adlake Mercury Relay can always be depended on, whether it's in burglar alarms or any of hundreds of other uses.

Whatever your relay needs may be, only Adlake Plunger-type Mercury Relays offer you all these *plus* advantages:

Hermetically sealed; dust, dirt, moisture or oxidation cannot interfere with operation . . . mercury-to-mercury contact; chatterless, silent, impervious to burning, pitting or sticking . . . absolutely safe . . . no maintenance required.

Write today for free, illustrated Adlake Relay folder! No obligation, naturally.

Is there a job here YOU want done?

Adlake Plunger-type Mercury Relays are *proved best* in these and other applications:

Radio transmission • Standard telephone circuits • Precision control instruments • Animated displays • Railroad and traffic controls • Burglar alarms • Heating and ventilating controls • Refrigeration controls • X-ray control • Dry cleaning equipment • Remote and automatic controls • Production line time controls • Photoelectric apparatus • Motor reversing switches • Sign flashers • Electric time controls • Navigation buoy flasher light controls • Surgical lighting controls • Cable electrolysis prevention • Signals and indicators • Electric call systems • Across-the-line motor start switches • Power circuits • Air-conditioning controls • Mill and factory service • Voltage regulators.



THE ADAMS & WESTLAKE COMPANY

ESTABLISHED IN 1857

ELKHART, INDIANA

NEW YORK • CHICAGO

Manufacturers of Adlake Hermetically Sealed Mercury Relays for Timing, Load and Control Circuits

Water's no Worry

When the
DeJUR Miniature's
on the job

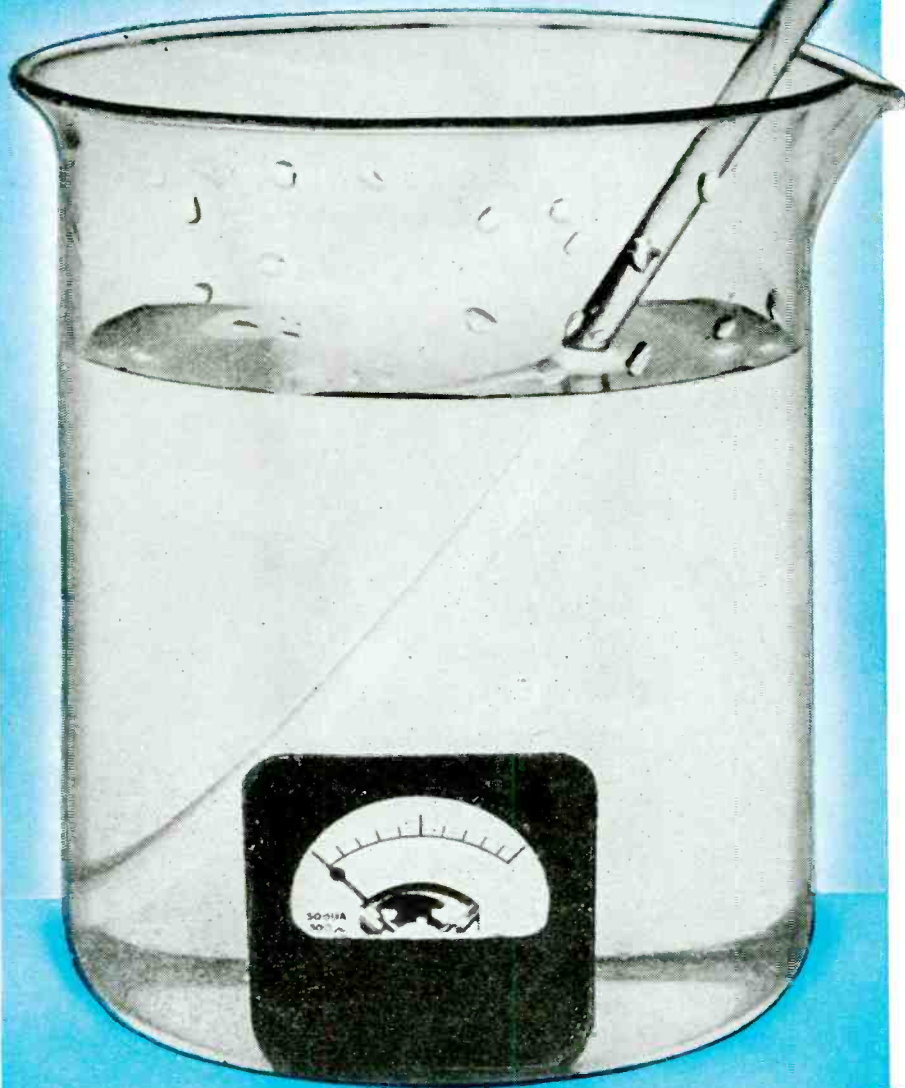

★Send details of your requirements to DeJUR-Amsco Corporation, 45-22 Northern Boulevard, Long Island City 1, New York.

*It's tiny... it's accurate
... and it's waterproof*

The DeJUR 1½" precision panel instrument can be immersed in water at a depth of 30 feet for as long as seven days without harming the mechanism.

Model 120 has a special water-protection design, including locking device for exerting pressure against rubber gaskets on either side of the glass... and a watertight gasket back of the flange waterproofing the juncture between meter and panel. Terminal studs on both models have watertight sealing.

MAXIMUM ACCURACY IN SMALL SPACE

External pivots prevent rocking of the pointer... reduce side friction between panels and pivots... increase bearing life.

Other features: highest-grade Alnico magnets... A.S.A. standards in all respects but size... variety of ranges... self-contained up to 1 ampere and up to 150 volts.



MODEL 112
Square plastic case is designed for screw-mounting.



MODEL 120
Smallest ring-mounted meter available. Metal case.

DeJUR Products



*Their Mechanical Perfection
Protects
Their Electrical Performance*

Now Available -

... the **DUMONT Cathode-Ray Oscillograph** you've been waiting for!

TYPE 241

Specially designed for the observation of audio and video signals. 5" CRT. Provision for grid modulation. Includes front cover, probe, and shielded cable.



TYPE 208-B

General purpose oscillograph. 5" intensifier CRT. High-gain amplifiers. Frequency range extending from very low to radio frequencies. Wide sweep frequency range.

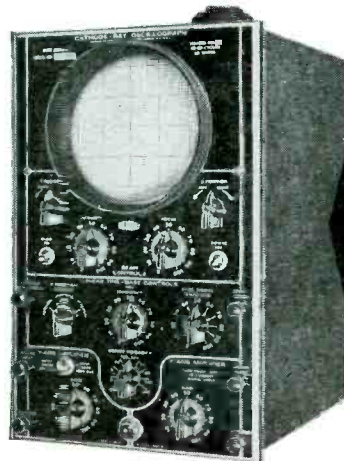

TYPE 224-A

Suitable for studies involving signals such as pulses or square waves, having frequency components as high as 5 mc. 3" CRT. Provision for grid modulation.

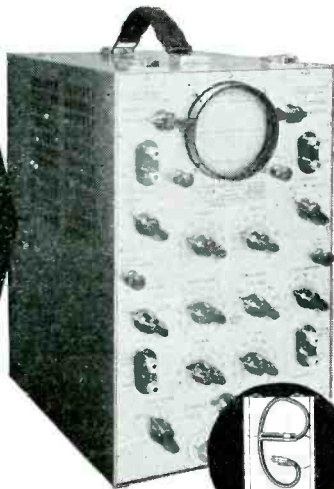

TYPE 248

Micro-second accuracy in a combination oscillograph and synchroscope. 5" CRT. Precision features unrivalled in a commercial instrument. Separate power supply unit.

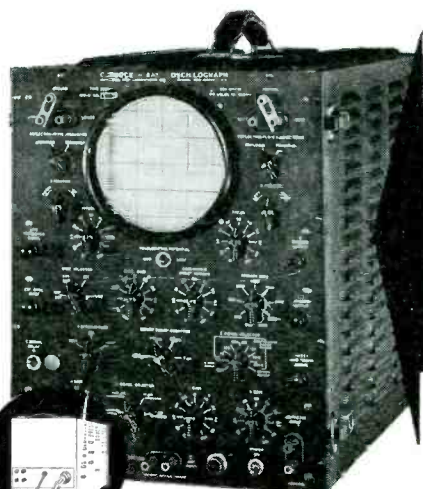

OUR NEW CATALOG GIVES DETAILED SPECIFICATIONS . . . WRITE FOR YOUR COPY!

© ALLEN B. DUMONT LABORATORIES, INC.

DUMONT

Precision Electronics & Television

ALLEN B. DUMONT LABORATORIES, INC., PASSAIC, NEW JERSEY • CABLE ADDRESS: ALBEEDU, PASSAIC, N. J., U. S. A.





...the world's greatest
radio networks



...most efficient
office buildings

● The habit of accuracy is so strong in engineers that drawings which are merely clear and legible are not enough. Creative men want their drawings to look professional, not only in essentials, but in details. K & E has equipment that can help you in both endeavors... drawing instruments and materials so well conceived and precisely made that many engineers and draftsmen regard them as valued partners throughout their professional careers.

For 78 years K & E products have been helping in this way to bridge the gap between thinking and doing, helping to make possible the tools, machines, appliances, construction projects, that mark our civilization. So widely is this true, it is self-evident that every engineering project of any magnitude has been completed with the help of K & E. Could you wish any surer guidance than this in the selection of your own "partners in creating"?

partners in creating

For faster, better lettering you will find a LEROY† Lettering Set a tremendous help. With it you can produce a wide range of lettering styles and symbols with complete

uniformity. Precision lettering need no longer be tedious. For full information write to your nearest K & E Distributor or to Keuffel & Esser Co., Hoboken, N. J.

†Reg. U. S. Pat. Off.

Drafting, Reproduction,
Serving Equipment
and Materials.
Slide Rules,
Measuring Tapes.

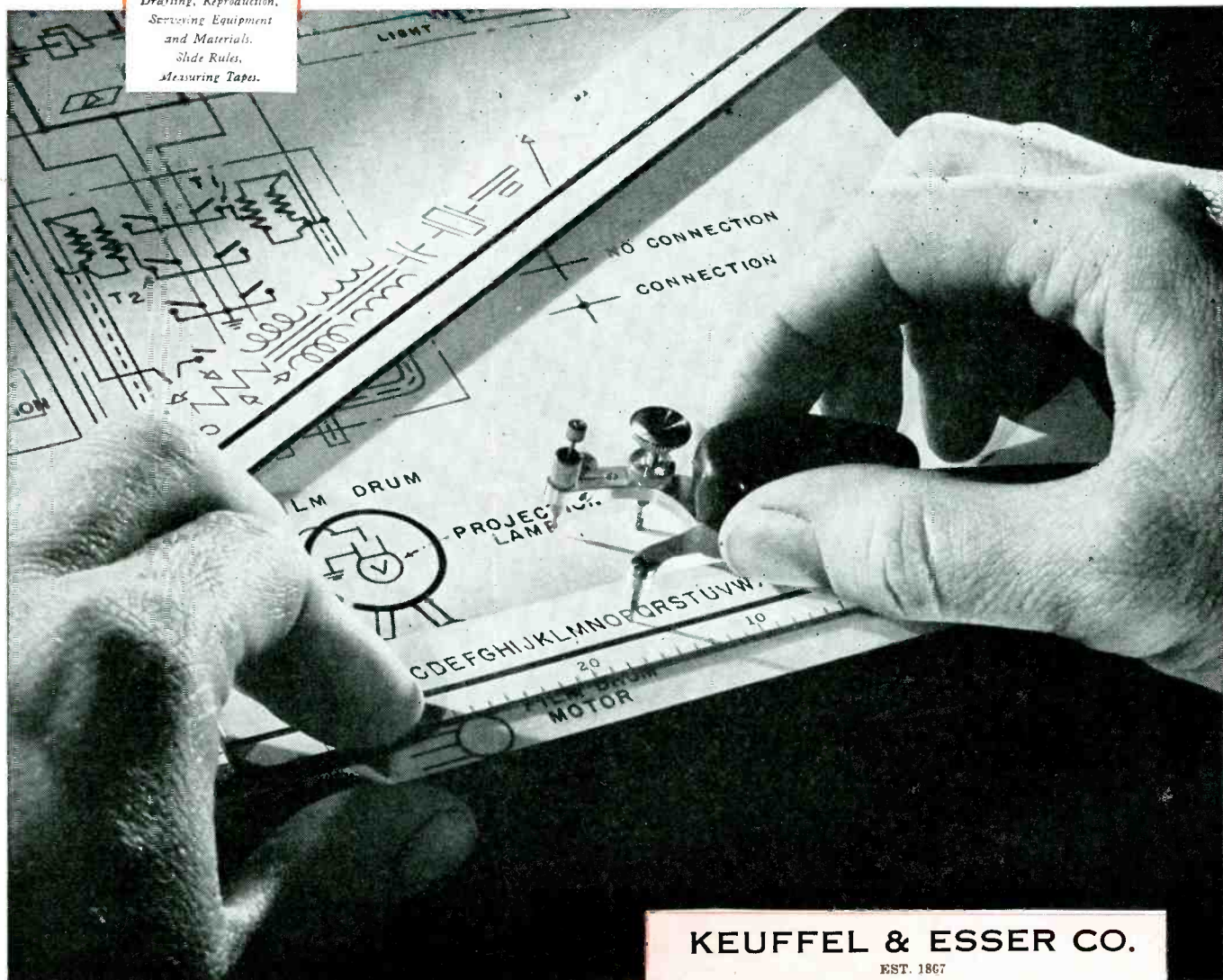

KEUFFEL & ESSER CO.
EST. 1867
NEW YORK • HOBOKEN, N. J.
CHICAGO • ST. LOUIS • DETROIT • SAN FRANCISCO
LOS ANGELES • MONTREAL

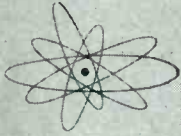

Designers

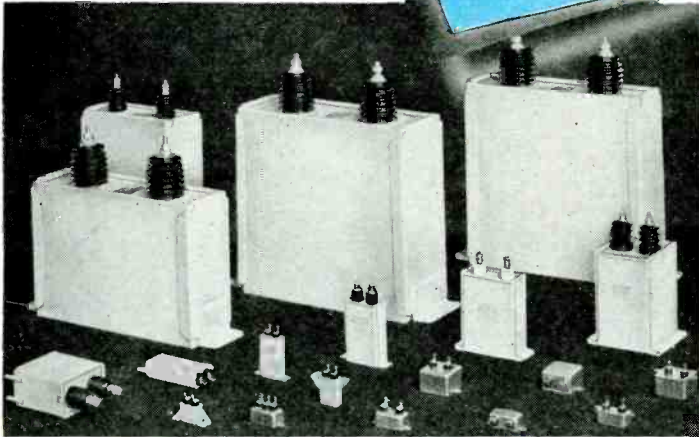

NEW PYRANOL* CAPACITORS

new sizes, new quality

Strict quality control, new manufacturing techniques, and improved materials — the basis of the excellent war-time records of G-E d-c capacitors — are now incorporated in a new line of Pyranol capacitors designed to meet rigorous commercial requirements.

This new line makes possible a broad selection of sizes, ratings and mounting arrangements, with characteristics which permit operation over a wide temperature range (from 85C to -55C), at altitudes up to 7,500 feet. Sizes and shapes range from "bathtub" and small rectangular case styles to large, welded steel-case designs. Capacitance ratings are offered from .01 muf to 100 muf, and voltage ratings from 100 to 100,000 volts. Write *Transformer Division, General Electric Co., Pittsfield, Mass.*



MORE COMPACT COILS

wound faster

Formex* magnet wire, available in all standard wire sizes, puts more turns and more copper in a given coil cross-section area than fibrous-covered wire does, particularly if square or rectangular Formex wire is used. It's a natural where coil shapes require acute angle bends. Higher winding speeds are practical without increasing rejects; time-saving steps are possible that you wouldn't dare use with ordinary magnet wire. In most sizes, first cost of Formex is less than fibrous-covered wire, and only slightly greater than enameled. Check Bulletin GEA-3911.

*Reg. U.S. Pat. Off.

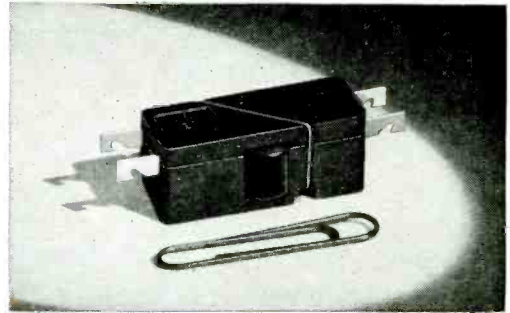

SWITCHETTES do big jobs *in cramped quarters*

G-E manually-operated Switchettes are outstanding for the long life and lightning-fast snap action packed into an unusually small, lightweight case. The Size 1 Switchette weighs only 9 grams, and is approximately 1 1/4 in. by 1/2 in. by 1/2 in. Size 1 Switchettes are available in ratings up to 10 amperes at 24 volts d-c, or 230 volts a-c, and in ten different contact arrangements. Size 2 Switchettes are rated 25 amperes at 24 volts d-c, (230 volts a-c), and are available in three contact arrangements: single circuit, normally open; single circuit, normally closed; and two circuit. Totally enclosed, with screw terminals, size 2 Switchettes measure about 2 by 1 3/8 by 1 inch, and weigh approximately 2 ounces. Write for Bulletin GEA-3818C (Size 1) or GEA-4259 (Size 2).

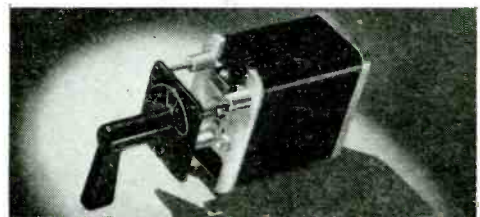

A VERSATILE SWITCH

with 4,000 possibilities

There's a standard SB-1 switch for most of the ordinary control and transfer jobs. Where the number or arrangement of circuits is unusual, special switches can be made from standard SB-1 cams, contacts, fingers, and other parts, giving great flexibility of application. Precision-built parts make even a 40-stage tandem switch easy to operate.

Already more than 4,000 different arrangements of circuits and sequences have been made by varying contacts and cam arrangements. Others can be made to meet your specifications. Write for Bulletin GEA-1631E.

GENERAL  ELECTRIC

Digest

TIMELY HIGHLIGHTS ON G-E COMPONENTS

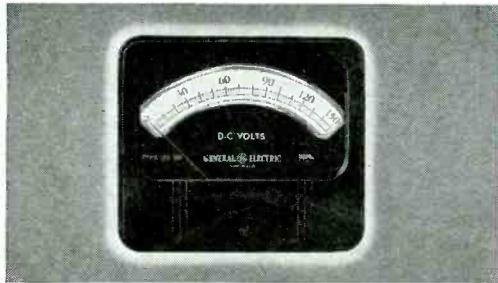

SMALL DC METERS

that are lighted two ways

General Electric Type DO-58 d-c meters are 4 by 4½ inches. Voltmeters are available registering from 0 to 1 volt, to 0 to 750 volts in self-contained models, and up to 30 kv with external resistors. Accuracy is to within 2 per cent of full scale value. The d-c ammeters, milliammeters and microammeters cover a range from 0 to 50 amperes, to 0 to 50 microamperes. Cased in black Textolite with a deep cover, these meters are offered in front-illuminated and rear-illuminated types, with lance-type, pointer-tip standard, and knife-edge and pear-shaped tips optional. These flush-mounted instruments are also available in alternating-current, a-c rectifier and r-f types. Write for Bulletin GEA-4272.



INDUSTRIAL RELAY *does a lot of jobs*

This sturdy, compact industrial voltage relay has a lot of uses, such as controlling pilot circuits in response to remote control switches or thermostats, or for direct control of small motors driving cooling blowers. It may be used as a fractional-horsepower motor starter, or in conjunction with magnetic switches controlling larger apparatus. Rated 10 amperes, continuous, with make-or-break rating of 45 amperes on normally open poles, 20 amperes on normally closed poles, at either 110 v or 220 v a-c. Three contact arrangements — double-pole, double-throw; double-pole, single-throw; and single-pole, single-throw — are available in either open or enclosed models. Write for Bulletin GEA-4668.

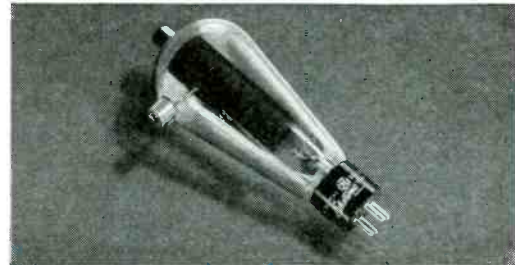

SPLIT-CYCLE CONTROL

of heavy currents

Thyratron Type FG-95 tubes are designed for rapid control applications where available grid power is very small, where it is necessary to actuate the grid from a high-impedance source, and where tube temperature can be maintained at a relatively constant level. This tube's negative grid characteristics mean lower overall power requirements for heavy-duty control work. Peak voltage, 1000 v, peak current 15 amp, average current 2.5 amp. Surge current (for design only) 200 amp for 0.1 second.

Among the applications of Thyatron tubes are resistance welding control, motor control, lighting control, rectification, and power supply for photoelectric relays. Write for Bulletin ETI-125. (For general data on Thyratrons, ask for ETI-116). *General Electric Co., Electronics Division, Syracuse, N.Y.*



DURABLE NAMEPLATES

with beauty built-in

General Electric laminated plastic nameplates are tough, durable, and resistant to impact. They are available stamped, engraved, or printed, in a variety of color combinations. Their appearance is exceptional — both satin and mirror finishes are offered with surfaces that need neither buffing nor polishing. The hard, smooth surfaces of G-E plastic nameplates are easily cleaned. They do an outstanding job for a wide range of diversified applications. For further information, write *General Electric Co., Plastics Division, Pittsfield, Mass.*

GENERAL ELECTRIC COMPANY, Sec. 642-12
Apparatus Department, Schenectady 5, N. Y.

Please send me

- GEA-1631E (SB-1 Switches) GEA-3818C (Switchettes—Size 1)
- GEA-3911 (Formex) GEA-4259 (Switchettes—Size 2)
- GEA-4272 (Small D-C Meters) GEA-4668 (Industrial Relay)

NOTE: More data available in Sweets' File for Product Designers

Name _____
Company _____
Address _____
City _____ State _____

SOLAR PROUDLY PRESENTS

SUPEREX

A NEW

Capacitor Dielectric

SUPEREX★, Solar's superb new oil-impregnant for paper dielectric capacitors, is the result of a long-time program of research and development. Its entry into mass production under rigid standards of quality control marks another Solar contribution to the electrical industry.

SUPEREX gives to the electrical industry a capacitor dielectric material with the following outstanding properties: 1. Low Power Factor; 2. Long Life; 3. High Flash Point; 4. Non-Inflammability; 5. Non-Corrosiveness; 6. Stabilized for Operation at High Temperatures, 85°C for DC, 75°C for AC; 7. High Insulation Resistance; 8. High Dielectric Constant.

Now available to the electrical and electronic manufacturing industries after months of heavy pilot plant production and test by leading capacitor users in the United States, **SUPEREX** stands forth today as the ideal capacitor impregnant for most applications. Tests by those who have already used **SUPEREX** capacitors have won this new material unqualified approval. **SUPEREX** assures outstanding performance in motor phase-splitting capacitors, energy storage capacitors, all light and heavy-duty capacitors used in communication and industrial electronic equipment, and in capacitors for power factor correction.

SOLAR has now completed a new plant for mass production of **SUPEREX** capacitors. This ultra-modern plant with the latest developments in high-vacuum processing equipment, is supplying daily increasing quantities of **SUPEREX** capacitors to those who need the utmost in capacitor performance and reliability.

SOLAR will be glad to tell you how you can utilize the advantages of **SUPEREX** capacitors in your applications. A letter today will bring you the benefit of Solar's authoritative experience in solving capacitor problems.

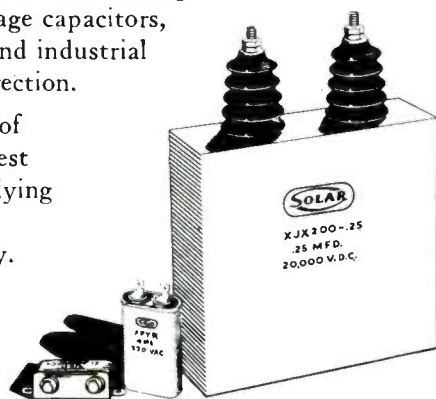

⊕ 1844

*Trade Mark

SOLAR MANUFACTURING CORPORATION

GENERAL OFFICES: 285 MADISON AVENUE, NEW YORK 17, N. Y.
PLANTS AT CHICAGO, ILL.; NORTH BERGEN AND BAYONNE, N. J.

PAPER, MICA AND ELECTROLYTIC CAPACITORS FOR THE ELECTRICAL AND ELECTRONIC INDUSTRIES



ELECTRONIC INDUSTRIES

Including INDUSTRIAL ELECTRONICS

O. H. CALDWELL, EDITOR ★ M. CLEMENTS, PUBLISHER ★ 480 LEXINGTON AVE., NEW YORK (17), N. Y.

Instrumentation Chart Sent You With This Issue

The large wall-chart in colors, included as a supplement with this issue, pictures the whole field of industrial electronic measurement and control. It also reveals some of the reasons for the accelerated trend toward electronic methods in modern industrial processes.

With the aid of this chart, the reader will be enabled to make a basic comparison between certain electronic ways of doing things and the analogous mechanical principles used in earlier control systems, by having his attention directed to system counterparts that at first glance may not be evident from the physical appearance of the components.

Electronic Toughness

When the question of ruggedness of electronic tubes is raised, there is one complete answer to all plant skeptics. For no industrial use of tubes ever will involve the impact imposed by actually shooting the tubes from great guns, as was done with millions of tubes in proximity-fuzes during the war.

The durability of these tubes was such that they were tested at accelerations of the order of 20,000 g (16×10^8 miles-per-hour²). Such tubes, moreover, were not freaks but items of big-scale production. And they were made by practically all of the tube companies that are now supplying industrial tubes for peacetime uses. (One company supplied half a million of these tubes per day!)

The know-how of making electronic apparatus stand up in industrial service is now pretty common knowledge in the art. Tubes are tough and ready for industrial jobs.

500-kw Broadcast Stations

Renewal of WLW's application for its former power of 500 kw (which the Crosley station was authorized to use more than ten years ago), recalls how slow is technical progress when faced by governmental restrictions.

There is certainly little sense in limiting the kw of a great broadcast transmitter serving millions to just about the power developed by a good automobile going up hill! But that is Washington's proud record.

If the power of all U. S. broadcast stations were multiplied tenfold, the inter-station interference pattern would remain unchanged. But AM broadcasters would receive a tremendous advantage in overcoming static, natural and manmade.

Certainly 500 kw and 2000 kw should be the post-war yardsticks for good broadcast performance.

Electronic Microfilm Library

Electronic Industries' engineering articles, from 1942 to 1946, are now available in microfilm, so that some 60 pounds of magazines are compressed into a few ounces of acetate. Eventually it is hoped thus to distill all electronic reference material (now requiring 120 feet of shelf space) down to a mere 12 inches, about one-fifth of a desk drawer!

This "Electronic Engineering Microfilm Library" is proposed as a solution to the old problem in technical research—that of locating wanted periodical literature quickly when needed. Few laboratory libraries contain desirably complete files of electronic literature. The factors of cost, time required to compile a complete collection, storage space, etc., are perhaps among the main reasons why the electronic file in the engineering laboratory is usually underdeveloped. The microfilm library may contain the simple solution.

Electronic Industries' TELEVISION PROGRESS NUMBER Next Month

In October, concurrent with the Television Broadcasters' Association convention and exhibit at New York (Hotel Waldorf-Astoria, Oct. 10-11) and the return of active general interest in television and new television receivers (including a television-electronic show for the public at Grand Central Palace, New York City, Oct. 14-19), new postwar developments in television engineering will be featured by Electronic Industries. Topics scheduled:

Tube Types for Wide-band Amplification — Magnetic Focusing and Deflection Principles
High-voltage Power Sources — Television Instrumentation — Looking Ahead to Color - Television

and a large CHART SUPPLEMENT in colors —

Recent Contributions to Television Progress

INDUSTRY STUDIES

Modernized circuits and methods of utilizing electronic effects provide solutions to difficult jobs in many specialized fields

● During the past five years the need for better, faster and more accurate controls for military units caused a re-evaluation of some of the operating principles in many fields, with the result that electronic methods have made great strides. The old argument against using "fragile" tubes in an important control arrangement has been shattered by the accumulated weight of evidence: tubes able to withstand 20,000 g's in any direction when installed within gun-fired missiles, and tubes having an extended life that permits their continuous service underground or under water, where replacement is tedious and expensive; tubes with notable stability of operating characteristics and others whose sensitivity is advanced to a point where it is no longer necessary or desirable to "push" them to their amplification limits.

The military procurement personnel was not influenced by the awe with which tubes often have heretofore been considered by industrial users. In some cases in the latter field even a single phototube or a simple amplifier was regarded with misgivings. Tubes now are used by the hundreds in a single equipment and have no more glamour than dry cells.

In applying electronic elements to equipment in the field of industrial process control, it is found practicable to "build in" any desired relation between cause and effect, by simple variations of a circuit. It is possible to anticipate and avoid a change, even before it makes itself evident to the primary measuring element, by simply watching all of the main causes for changes, noting variations in loads, temperatures, flow rates, heads, etc., and by the use of mixing circuits to give a positive correction in some particular controlling factors.

Manual control methods are complicated in some processes. For example, it may be necessary to turn A to the right if both B is above a value X and C is less than level Y. This is probably a

WHERE ELECTRONIC CONTROL TECHNIQUES ARE EXPANDING

- (1) Frequency modulated signals as a transfer medium.
- (2) Pulse technics, and the adaptation of Radar principles.
- (3) Amplifiers with gain characteristics following prescribed curves.
- (4) Driftless amplifiers that handle slowly varying or steady state levels.
- (5) Applications of scanning principles.
- (6) Two dimensional recording of correlated effects.
- (7) Feedback principles with prescribed characteristics.
- (8) Generators of ultrasonic power.
- (9) Increased precision of measurements with negligible loading effect by use of a measuring "probe".
- (10) Reduction of measuring lag, by amplifying the output from smaller, less sensitive primary elements.
- (11) Utilization of absorption loss measurements and attenuation to study physical characteristics giving non-destructive test methods.
- (12) High speed counting circuits.
- (13) Ratio and multiple source control circuits.
- (14) Time-variable control, and the utilization of time as the control factor.
- (15) Mathematical computing circuits, ranging from simple integrating or differentiating arrangements to elaborate computing systems.

simple form of instructions to an operator but when the process is six or ten times as complicated, the job is hopeless with manual control. For this reason industrial instrumentation has become a science. It has been the major factor permitting the establishment of continuous production methods.

Control fundamentals

Industrial control consists fundamentally of regulating or keeping at level value, some inherent quality in a process which normally would vary because of changes in the flow rates or characteristics of the factors in the system. Many instrumentation methods are complicated, sometimes because in the usual design procedure use has been made of elements in the system whose characteristics are far from ideal. There can be noted throughout many of the fundamental pneumatic and hydraulic systems where inverse relations,

and nonlinear operating characteristics come up with great regularity. Because of this a whole series of complicated procedures has come about to meet the need for auxiliary correcting elements to make up for characteristic deficiencies in some parts of the system. These range from nonlinearities in the pick-up elements to the actual flow characteristics of the valves, pipes, etc.

In some instrumentation systems, designers have had to cure process variations in much the same manner that a doctor caught with only quinine, sulphur and castor oil at hand, would use. He would have to use one alone or else some combination as he saw fit. Similarly the designer might pick a system having some "floating" control and some "proportional" control with maybe a dash of "rate" added. However, if the combination were selected intelligently good results would be obtained. It may be of interest to note, however, that these

New **CIRCUIT TECHNICS**

WHY ELECTRONIC CONTROL IS GAINING IN POPULARITY

- (1) Electrical signal or control lines are easy to install.
- (2) Speed of response high, and essentially unaffected by distance.
- (3) Only method by which complete centralization of controls and indicators can be achieved.
- (4) Quantities and levels can be checked readily at various points in system using simple, accurate electrical indicators.
- (5) Time, force, displacement and positional information can be converted readily to signal amplitude variations and vice versa.
- (6) Simple electrical networks can be used to modify the control signal to obtain inverse functions, derivatives, etc.
- (7) Provides simple means for combining effects of several diverse primary variables, by addition, multiplication or subtraction, with different weighting factors for each if desired.
- (8) Permits unlimited number of gradation steps of control.
- (9) Control signal is easily applied to modulate radio signals, for remote operation.
- (10) Components of circuits are usually combinations of standard parts.
- (11) No piping to develop leaks with aging, vibration, etc.
- (12) High impedance, low current circuits are widely used, eliminating chances of sparking and explosions, as when electrical controls are used.

On the other hand, Pneumatic, Hydraulic and Mechanical systems have proved useful because they are:

- (1) Established by precedent in existing jobs. Operating experience and long use often make their continued use desirable.
- (2) Explosion proof (no sparking).
- (3) Capable of delivering high power operating and control forces.

effects or their equivalents have not been separately considered in electronic circuits except when it was desired to duplicate existing methods of control.

Following normal design procedure in communication circuits would be to compare the information delivered by the pickup element with the characteristics delivered by the final correcting regulator, and then to develop an amplifier that would deliver power to the latter in accordance with a desired operating curve.

In addition to the possibility of correcting for variations in intermediate effects and the final activator's operating characteristics, the electronic designer can take note of process lags of certain types and thus anticipate the effect of the applied corrective. As an example, in a plant where an unusually long transfer lag was present, a circuit was operated by two suitably placed primary elements (connected in opposition and spanning

the capacity that introduced the lag) which thus altered the rate in accordance with the temperature difference.

Examples such as these show why some electronic circuits contain so many tubes. However, once the electronic system is selected and the basic chassis and power sources are provided, it is not particularly difficult or expensive to add refinements in operation that require an additional tube or so.

With so many obvious features it may be asked why electronic methods have not replaced all other control methods and the thought occurs to many that something must be wrong with the basic principles upon which they function.

It seems to this writer that the know-how in the installation and operation of the earlier non-electronic control systems is firmly established, and, what is probably more important, the development and promotion of electronic systems have been left to process

control equipment companies and instrument companies serving those fields.

Electronic equipment manufacturers themselves have for the most part placed hopes heretofore in selling "packaged" items that they thought would have some appeal to a wide variety of industries. These have most generally failed to create more than passing interest, because (1) the electronic "gadget" failed to operate existing motorized or solenoid operated valves, etc., (2) the specialized items that are intermediate between the electronic instrument and the process were inadequate or even unavailable, (3) the difficulty of adapting universal, or "packaged" items to the particular requirements of the individual jobs was unsolved by either the equipment manufacturer or even the instrument department of the plant because of the lack of sufficient data on the loading characteristics to permit an intelligent selection of the auxiliaries.

Electronic alternates

This state of affairs is changing of late and along several lines. Many old line instrument companies are building up electronic "alternates" to some of their mechanical systems, and in addition many companies that have developed and manufactured intricate control systems for military uses, are now working on industrial equivalents for some of the seemingly useful arrangements. Then again, some of the larger industrial plants which have relied on the reports of electronically-minded individuals or committees to point out useful possibilities, have now been able to retain radio or electronic engineers to follow up suggestions and to develop solutions to some of the important problems.

If this engineer knows tubes and their circuits (and the usual process control problem requires greatly different technics than would be found with high frequency communication services) and is either acquainted with or can get the required process information from associates, he will be able to select or develop what is needed to han-

(Continued on page 122)

ELECTRONIC GAGING

By PAUL H. HUNTER

Instrumentation Editor—ELECTRONIC INDUSTRIES

New standards of accuracy and speed in dimensional inspection made possible by precision electronic instruments

• The usual instruments for measuring thickness or diameters are the caliper, hand micrometer, dial indicator, etc. All these devices seek to transfer sensory perception from touch to vision, the latter having much the greater range. Instruments for precision gaging are of two general types: those having a *measuring* function and those serving mainly as *comparators*. To perform a measuring function, an instrument must be calibrated in terms of some dimensional unit, whereas the comparison function requires only an indication that the piece being gaged is larger or smaller than a reference standard. Comparison instruments achieve maximum accuracy when the sample compared is identical with the standard of comparison. The accuracy of deviation indication from the standard dimension is a function of the stability at which the magnification ratio is maintained, this magnification being ordinarily performed by mechanical means, such as a calibrated screw, or a rack and pinion with high gearing ratio, as in the standard dial gage.

The shortcomings of such gages are well known. The need for contact pressure on the work, in order to determine the "feel" of the instrument, is one variable factor. Dial gages and other instruments depending upon mechanical magnification through a multiplicity of gears, racks, pinions and the like, have numerous points of wear and sources of error, particularly when one instrument must be used over a wide range of dimension. Even with the use of jewel bearings, friction due to mechanical amplification and other factors limits accuracy to about 1/10,000th in. for practical purposes.

Many attempts have been made to reduce weight and friction components by means of light beams. However, even with monochromatic light, the practical length of such

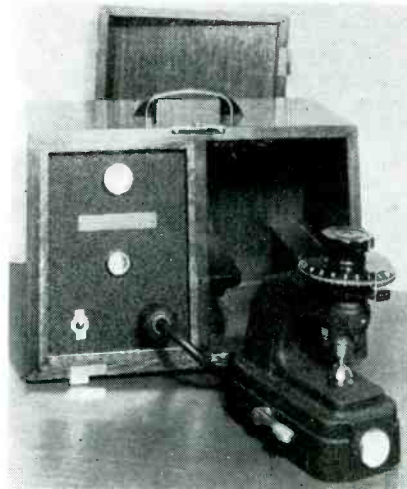

Fig. 1—Carson Electronic Micrometer (Model M)

a beam is about four feet, due to dispersion of single wavelengths of light beyond that point. Another method that extends accuracy by optical methods uses the interferometer to measure the distortion of a cantilever bar bearing on the workpiece. Though increasing scale length considerably, pressure on the work has not been reduced sufficiently for the measurement of soft materials. Instruments such as those developed by Van Keuren have achieved accuracies approaching one-half the wavelength of green light (about 10 micro-inches). However, the determination of beam deflection depends on observation of interference fringes which are approximate sine functions of light intensity and therefore do not provide sharp reference points for measurement.

The next step in the elimination of human observational error is the use of electronics. The basic limitation of light as an indicator can only be overcome by means of shorter wavelengths such as are characteristic of electron emission. This principle led to the development of the electron microscope which, while capable of the highest

order of magnification, does not compete directly with small, portable instruments for rapid gaging.

Various types of electronic micrometers and comparators have been developed within the past few years in response to an urgent need for measuring instruments that will keep pace with the capabilities of modern tools and methods of production. Since space does not permit complete coverage of the entire range of electronic gaging, this discussion will be confined to two currently available types. Other developments in this field will be the subject of future articles.

Electronic micrometer

In the Carson Electronic Micrometer,¹ illustrated in Fig. 1, the setting of the gage head has been made independent of contact pressure or "feel" of any sort in order that repeated measurements of the same dimension by different operators will yield exactly the same result. In addition, the enormous sensitivity of grid-controlled high vacuum tubes has been utilized to extend the range of dimensional perception into regions where even the finest optical instruments are blind. The use of an electronic trigger circuit enables contact indications to be obtained on hard surfaces with absolutely no pressure on the work. The circuit proved adaptable also for measuring soft materials, such as felt or tissue paper, with controllable pressures up to a few ounces.

A requirement that developed as the result of experiments with this instrument was the elimination of all current flow at the point of contact with the work being measured. It was found that the presence of any current tended to build up carbonized layers on the micrometer contact surfaces which soon destroyed the accuracy of determining the moment of contact. These lay-

ers are equivalent to pressure-sensitive variable resistors. With continued use, increased pressures required to overcome the electrical resistance of these carbonized layers were found to cause a shift in the zero calibration of the indicator dial. The only satisfactory and complete solution to this difficulty was to reduce current at the moment of contact to zero.

The Carson electronic micrometer has a conventional micrometer screw of very high lead accuracy, with a special electronic circuit to indicate the precise instant of contact between the micrometer screw and the material being measured (the work). This permits the use of a large diameter dial on which each division of .0001 in. can be spaced widely enough for accurate interpolations down to 25 micro-inches, or less. The electronic circuit (shown in Fig. 2) lights an indicating lamp by means of a relay at the moment of contact. A displacement of 5 micro-inches is sufficient to trigger this relay. Since there is no current to be interrupted, there is no arcing or pitting and the contacts remain permanently clean without servicing.

In Fig. 3, note that the micrometer head is mounted in the upper arm, with an anvil clamped in the base. The head consists of an insulated micrometer screw and nut with a large, plastic dial and knob incorporating uniform scale divisions as part of the molding process. The lower anvil is removable for easy substitution of any special work support and may be retracted by the lever at the left of the base for easy insertion of the work. While most models of the instrument in current production are designed for pressureless contact, one

model was deliberately provided with a standard anvil pressure of two ounces, sufficient to flatten various materials such as photographic film, paper, foils, textiles, fine wire, etc. This type is equally effective for conducting or non-conducting materials, whether hard or soft, while those models in which contact pressure is completely absent are usable only on conducting materials.

The electronic unit, housed in a separate cabinet, uses three standard radio tubes. The control panel incorporates a switch and neon indicator lamp for the power supply and a green bullseye lamp as contact indicator. Another contact lamp is mounted in the base of the micrometer unit for convenience during adjustment of the screw.

The function of the electronic trigger circuit, shown in Fig. 3, can be explained as follows:

Anode and screen currents of both tubes flow through the potentiometer, R_k , in the common cathode circuit. The slider of R_k is adjusted at the factory to place a negative potential on the micrometer head by connecting a microammeter between the head and anvil terminals. The desired zero current flow, as indicated on a three microampere full-scale meter, usually will be obtained when the slider-to-cathode potential is at about fifteen volts. With the micrometer head and anvil separated, V_1 is biased only by its own grid contact potential, E_1 , amounting to one or two volts. When contact is established, the potential, E_2 , between the slider of R_k and the common cathode circuit will increase this bias, reducing current through V_1 almost to zero. In the absence of any other potential source, E_2

would create a current flow of about three microamperes between the head and anvil. The grid contact potential, E_1 , however, is of proper polarity and magnitude to exactly counteract such a current. The source impedance of this contact potential is too high to contribute any appreciable bias, since the grid-cathode resistance is reduced from five megohms to about 500 ohms as soon as contact is made between the head and anvil.

As the anode potential of V_1 rises, in response to increased grid bias, the grid of V_2 goes positive, causing a sufficient increase in current through the relay coil to close the indicator lamp relay.

Electrical contact is established through the work piece itself, when measuring metallic or semi-conducting materials. For non-conductors, electrical contact is established within the gage head when mechanical contact with the work closes the small gap between two elements in the gage head.

An interesting observation made possible by the zero current electronic micrometer was that triggering was brought about before actual mechanical contact. This was studied by placing an electronic micrometer at one end of a 15 in. beam, supported on blocks, which were then subjected to distortion by means of temperature control. By this means, it was possible to study minute deflections, with the result that the phenomenon of space contact was discovered. Examination of a metal specimen coated with machinist's blue (of an almost molecular thickness) under repeated tests established that electrical contact was made, even though microscopic examination showed no break in the fragile

Fig. 3 (right)—Construction of Model M micrometer

Fig. 2 (below)—Simplified schematic of the electronic trigger circuit for eliminating contact pressure errors

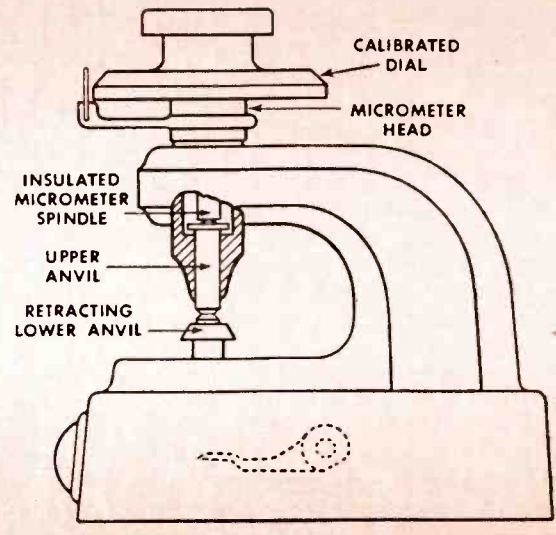
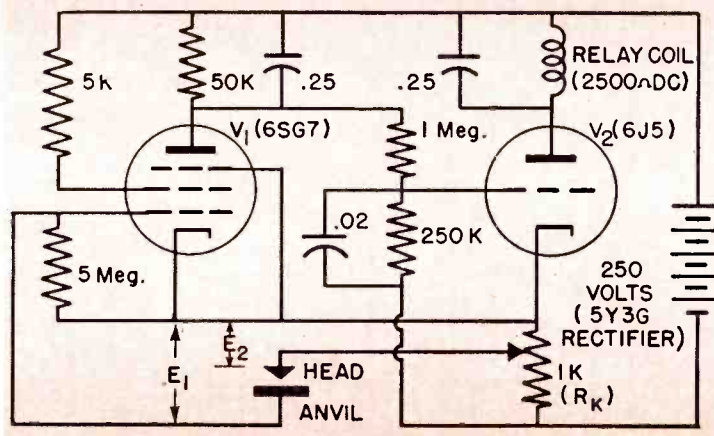

film. Attempts to explain this observation led to three possible theories:

(1) that distortion due to gravitational effects on metallic masses had occurred;

(2) that some electrical capacity that might be associated with physical spacings of a few micro-inches was responsible;

(3) that the molecular boundary of matter might be less sharply defined than previously realized.

Dimensions of this order are, of course, not significant in any present gage block standards. Nevertheless, the ability of manufacturers to produce interchangeable parts of increased precision has, for some time past, exceeded the accuracy of instruments available for measurement of these parts. Major improvements in gaging, such as this electronic micrometer, may therefore open the way for new standards of precision in mass production.

"Visi-limit" micrometer

The use of a micrometer or dial indicator type of gage in the measurement of critical or soft materials always presents two problems. One relates to deformation of, or damage to the part during measurement, with resulting inaccuracy; the other involves the fact that continuous measurement of moving material introduces human errors which are often as great as 100% of the desired dimensional tolerance limitation. The Wilmotte² electronic micrometer has been designed to eliminate these difficulties. Since this instrument operates on a photocell principle, using light as a measuring medium, it possesses the singular advantage of providing accurate measurement without physical contact with the measured part, and thus is particularly suited to the measurement of razor blades, extruded plastic, rubber or plastic-covered wire and other critical or delicate materials. Since there is no physical contact with the part being measured, there is no deformation and therefore no inaccuracy due to this cause.

An example of the application of this micrometer is to be found in the manufacture of safety razor blades. Present methods of measurement of the edge-to-edge dimensions of these blades are incompatible with the high volume production methods because they demand that the production line be stopped in order that an accu-

rate dimensional check be made, and further, that the particular blades so inspected be removed from production and either discarded or reprocessed at additional manufacturing expense. Such spot checks are completely inadequate and are responsible for large shrinkages in material and resulting economic losses.

Other applications of the Model P56 micrometer are to be found in the measurement of coated or bare filament; commercial wire; rod, bar, tube or strip stock of various materials; and paper covered wire. Measurement takes place during the manufacturing process on a continuous basis, while the wire or stock is passing through the machine on which it is being manufactured. Therefore, no limitations are imposed upon the speed of operation.

With suitable modification, the equipment can be applied to production gaging of the thickness of sheet stock of any material at as many points as desired across the width of the sheet. Measurements of this type cannot be made by conventional means.

The Wilmotte "Visi-Limit" micrometer contains three component

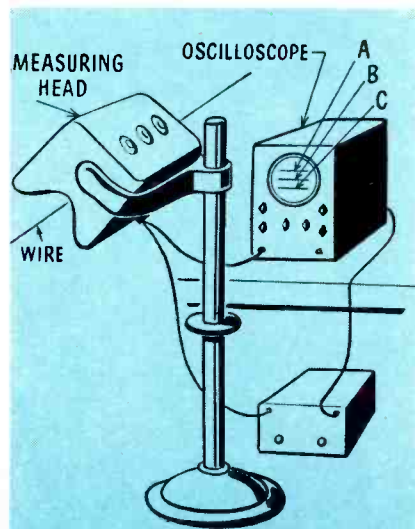

Fig. 4—Wilmotte photo-electric thickness gage

parts: 1. Measuring head; 2. Power supply unit; 3. Oscilloscope.

The measuring head, Fig. 4, contains the measuring aperture over which the material to be measured is fed. This aperture is illuminated by a projection lamp which casts a shadow of the object being measured on the cathode of a photocell which is located behind the measuring aperture. The area on the surface of the cathode which is not in shadow produces a voltage signal across the load resistor of the

photocell. Two other apertures are placed alongside the measuring aperture and these are separately adjustable to represent the positive and negative tolerance limits to which the material must conform.

A scanning disc (Fig. 5) rotates between the apertures and the photocell, exposing each of the three apertures in sequence. As a result of this rotation, three voltage pedestals are fed to the amplifier circuit, each following the other in a time sequence which is synchronized with the disc rotation. At the points in the cycle where the scanning disc changes from one aperture to another, particular care in design is taken so that the total area uncovered at any one time is constant. Several important features result from this fact:

- (1) The photocell emits a voltage signal which is ac in character and allows the use of ac amplification.
- (2) The signal level changes only in proportion to the tolerance of the material under measurement and does not change with respect to the absolute dimension of the material.
- (3) Sensitivity of the instrument is not dependent on the size of material being measured. For example: it is possible to measure a dimension of 0.6 in. or .005 in. within the same accuracy of $\pm .0002$ in.

Each of the three voltage pedestals produced by the photocell is amplified in a common amplifier circuit and is then applied to the vertical deflection plates of an oscilloscope. The sweep voltage is applied to the horizontal plates of the oscilloscope in such a manner that termination of each viewing cycle occurs at the same time that the scanning disc alternates from one aperture to another. Each of these three voltage pedestals now appears as a horizontal line on the face of the oscilloscope screen, and, due to the persistence of the oscilloscope, combined with a rapid scanning rate, the three lines appear as simultaneous and continuous traces.

When the size of the material under measurement changes, the voltage signal represented by the test trace varies proportionately, and causes this test trace to change its position relative to the two limit traces. The two limit traces maintain their relative positions exactly as they have been adjusted for a given production run.

Simplicity of operation is a basic feature of this equipment. The operator of the production machine on which the micrometer is installed has before him a continuous visual representation of the dimensional quality of the product with respect to the tolerance limits set up for manufacture. When variations in the dimension of the product are noted, the operator can compensate for this quickly by making proper adjustments to the production equipment.

The stability of this equipment is due to the following factors:

- (1) Voltage variations which would normally create fluctuations of the scope pattern cause no error, as all three traces move together.
- (2) Gain variations in the scope or amplifier circuits cancel out, as all three signals are amplified in the same channel.
- (3) The use of a single photocell eliminates error due to fatigue, temperature change and other variations which are commonly attributed to the photocell as limiting factors in its use as a quantitative measuring means.
- (4) Vibrations of the material being measured do not cause an error in the measurement. The apertures are such that vibration in the horizontal plane merely changes the position of the shadow on the photocell and does not change its magnitude. The effect of vibration in the vertical plane is minimized by the use of parallel light, which

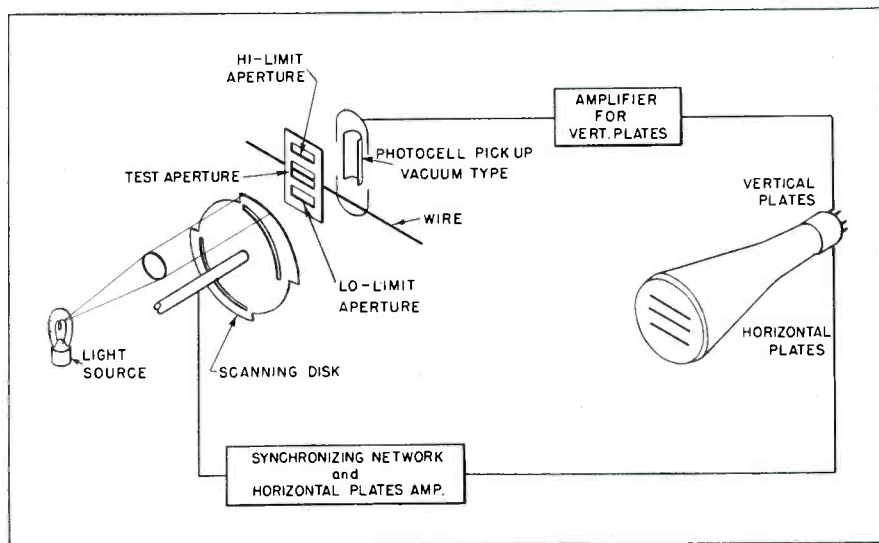

Fig. 5—Photo-electric system of "Visi-Limit" micrometer for continuous gaging of moving materials

avoids a change in position of the material being measured.

It is possible to mount the equipment within four inches of a given extrusion head, or other support, thus avoiding the necessity of using rollers or other supports on the measuring head. A positive air pressure is maintained within the measuring head to prevent accumulation of dust in the apertures. The initial setup of the micrometer for a production run consists simply of adjusting the calibrated test aperture with the aid of a reference standard of known dimension, and adjusting the limit apertures with reference to a given change in the test aperture.

The measuring range of the type P56 micrometer is 0.005 to 0.6 in.,

while the type P56-1 covers 0.6 to 1.0 in. For both types, a dimensional change of ± 0.0002 in. is readily detectable as a change in position of the oscilloscope trace. Accuracy performance is not affected by $\pm 10\%$ variations of 110 volt, 60 cycle supply lines.

Primarily designed for continuous production measurement of the outside diameter of insulated wire, this instrument has found wide application in the measurement of many other products whose standards of quality and economy of manufacture demand careful observation of dimensional tolerances.

¹Patents Nos. 2,290,940, 2,294,831, 2,302,104. Robert W. Carson, Instrument Specialties Co., Little Falls, N. J.

²Raymond M. Wilmotte, Inc., 236 West 55th St., New York 19, N. Y.

NEW TERMS FOR THE RADIO ELECTRONIC VOCABULARY

● Military electronics during World War II developed a picturesque language of its own, confusing to the engineer and generally incomprehensible to laymen. Some of the following nicknames and terms may survive as part of our postwar vocabulary. They are listed here mainly out of respect for the part these devices played in the Allied victory.

AZON — Gravity-powered bomb, steerable in azimuth by radio control.

BAT—Self-guided missile with target-seeking radar control.

BLOCK—Lightweight airborne television system for Naval reconnaissance.

CARPET—An electronic jamming set used against the Germans.

CHAFF—See "Window."

DECCA—British navigational system using continuous waves.

FELIX—Bomb attracted to target by heat.

FISHHOOK—A countermeasure antenna for producing circularly polarized waves.

FLUTE—A smaller edition of the "Tuba".

GARGOYLE — Radar controlled glide bomb with jet engines and target seeking device.

GLOMB—Naval type glider bomb with television control.

GORGON—Stub wing rocket controlled by radio and carrying tar-

get seeking device.

GRASS—The noise pips on a high sensitivity radar receiver scope.

LORAN—Navigational system using pulsed transmissions.

PICCOLO—A smaller edition of "Flute".

RADAR—Radio detection and ranging using pulsed emissions reflected back from target.

RADIOSONDE — Balloon equipped with unattended radio for transmitting meteorological data.

RAZON—Similar to Azon but controllable by radio in both azimuth and range.

RING—Similar to Block, but having greater range.

(Continued on page 130)

SELECTING PROPER

A survey of factors which must be considered in order to design reliability and long life into industrial electronic equipment

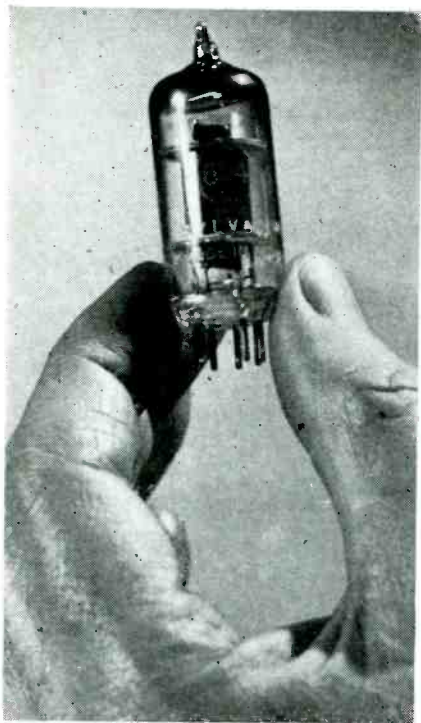

A trend toward using tubes of the miniature type is growing. This one is a thyratron with unipotential cathode

● Because, up to the start of the recent war, electron tubes were generally used only for communication purposes, the literature was devoted mostly to circuit problems at audio and radio frequencies. While many of such circuits may be applicable to certain control and measurement uses where similar considerations occur, there are many places where normal communication considerations do not apply. Military developments have called attention to many of these—radar applications, various aircraft controls, and gun control circuits, which indicate principles easily incorporated in industrial instrumentation.

With low power considerations in mind, there are generally available many regular tube types designed for ordinary receiver and similar communication applications, plus a few special types, such as photo

*Such as the JAN-1A Electron Tube specifications used by the services.

Prepared by engineers of the Advanced Development Laboratories, Sylvania Electric Products Co., Kew Gardens, N. Y.

cells, gas triodes, etc. Much has been done during the war in increasing the reliability of these tubes and disseminating more information in regard to proper tube and associated circuit design considerations.*

For the present, certain characteristics common to receiver types must be observed in designing for control or measurement purposes. It should be recognized that measurement circuits (vacuum tube voltmeters, telemeters, frequency meters, temperature and pressure gages, etc.) may be required to provide high accuracy so that the variables involved in the tubes and other components must be minimized in design.

Magnifying variables

On the other hand for industrial controls of the simple on-off type, as used in certain photocell applications, safety devices and the like, the variable under control is of large enough magnitude that such accuracies are incidental. In more elaborate systems of control the same order of accuracy required in measurements is involved. Here the tube circuits magnify the small changes of some variable which takes place in a circuit where the power is too small to perform the control work directly. In many cases this variable will be non-electrical and the usual primary element available to convert it to voltage or current changes is such that amplification is usually required.

It is the intention of this article to call attention to some of the typical factors to be taken into account in proper design involving electron tubes. Some of these while well known to radio circuit designers, are not listed among characteristics in tube manuals. The most important are:

1. Contact potential.
2. Grid emission and gas.
3. Microphonics.
4. Ruggedness and other physical requirements.
5. Uniformity of characteristics between tubes and with life.
6. Tube and circuit noise.
7. Insulation resistance.
8. Special uses.

Contact potential

Contact potential is an important consideration with tubes used under "zero bias" or very low bias operating conditions. This is generally the case for high gain amplification tubes.

This term contact potential commonly refers to the potential that is required at the grid to just reverse the grid current. The value depends somewhat on the potentials applied to the other electrodes. It is the result of several factors, mainly the work function differential of the grid and of the cathode, and the initial electron velocity, with lesser contributions from gas current, primary grid emission, and the Peltier effect.

During life the work function of the grid surface approaches the work function of the cathode surface because some of the emitting material on the cathode is deposited on the grid and both elements then have nearly the same surfaces. The initial electron velocity decreases if the emitting ability of the cathode decreases with age. Since both of the first two factors generally decrease in magnitude the contact potential decreases in a normal tube with aging. These effects cause the grid to become more negative, whereas gas current and grid emission cause the grid to become positive. During life the tendency is for grid emission to increase whereas any gas occluded in the parts of the tubes generally clears up during life provided the tube is not overloaded.

Many tubes show a contact potential of about 0.8 volts when new and about 0.5 volts after one thousand

TUBES AND CIRCUITS

The requirements for industrial control and measurement purposes can be quite different from those used for radio communication or in equipment operated under the pressure of wartime conditions. Industrial tubes must have much longer life and be more stable in characteristics during life, than required for radio receiver types. They may have to perform under more adverse conditions of temperature, voltage sources and mechanical installation. The tube industry is accorded more recognition to these problems and the future may witness many more tubes designed especially for industrial purposes.

Circuit designers usually consider many operating characteristics not listed in tube manuals. The most important of these are listed and described here from the viewpoint that a good circuit designer will not forget to consider them. A circuit may work without giving any consideration to these points, but in certain cases some customers using the equipment may have difficulties in duplicating original performance as time goes on so it is well to keep all these matters in mind.—Editors.

hours of life. Battery type tubes run at a somewhat lower contact potential mainly because of the additional factor involving the filament drop along the non-unipotential emitting surface. In the normal cathode type tube the measured contact potential may vary from one and one-half to one-half volts depending on operation of the individual tube.

If a high resistance (1 to 10 megohms) is placed from grid to ground and no other form of bias, fixed or cathode resistor type, is used, a voltage approximately equal to the contact potential will appear across the resistor and act as bias. This is called "zero bias" operation. Typical examples of these types of operation are shown herewith. The

grid current with no signal on the cathode type tube is limited to $\frac{1}{8}$ microamp.

As the contact potential of the tube changes, the operating bias likewise will change. Generally for very low signal inputs this will not have too great an effect, but compensation by feedback or other means may be necessary if greater stability during life is required. To keep within reasonable amplifier linearity a shift of contact potential to a lower value will limit the maximum signal that may be applied. This is not only true of "zero bias" operated tubes but also the same order of maximum signal is permitted cathode biased high gain tubes for linear operation. If the signal is too great in this case the

grid voltage will swing past the contact potential value on positive peaks and tend to draw enough grid current to cause nonlinear operation.

When lower grid resistor values are used the effect of contact potential variations on the operating bias (of "zero bias" amplifiers) becomes less. Besides limiting the permissible signal levels the decreased input resistance may adversely effect the signal from the preceding amplifier stage or signal source.

Grid emission and gas effects

Grid emission, mentioned previously, becomes an important factor when tubes with high heater power and plate dissipation (especially cathode types) are involved. In these types the grid sometimes runs quite hot due to its proximity to the cathode. Although its surface is sometimes prepared to inhibit such emission, emitting material from the cathode is eventually deposited on the grid allowing it to become an emitter.

The emitted electrons from the grid (which in amplifier circuits runs at some potential negative to that of the cathode) move to the cathode and return through the grid resistor so as to develop a potential making the grid less negative (relative to the cathode) than otherwise. The resultant increase in plate (and screen) current will increase the temperature of the tube and cause more grid emission resulting in a further increase in grid potential toward the positive grid region, and so on, so that the tube may eventually be destroyed.

Comparison between the contact potential method of biasing and the more usual arrangements

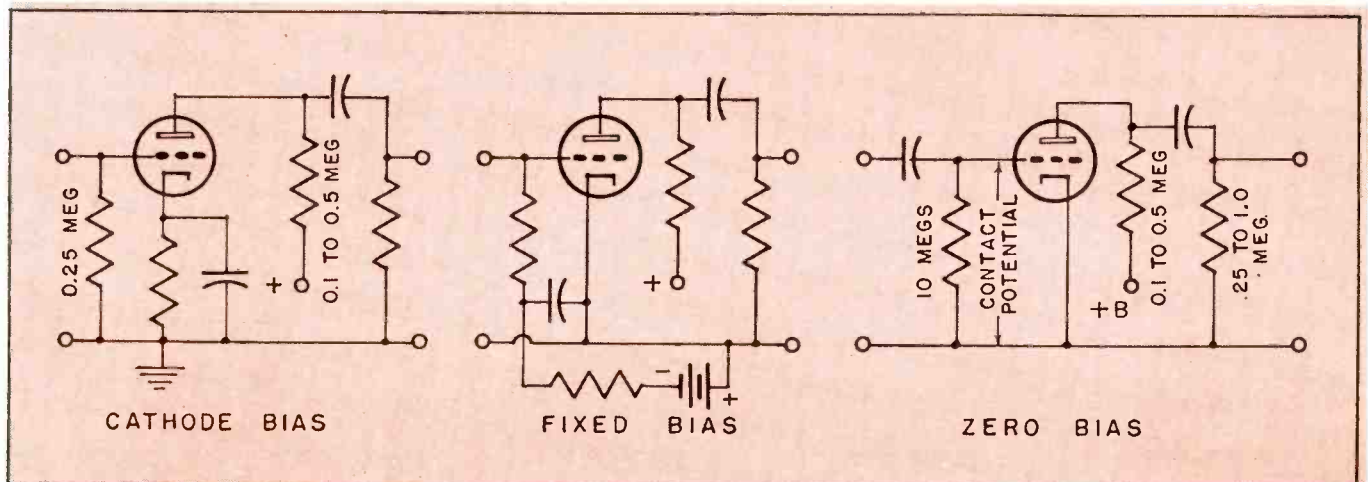

The effect of gas in the grid-cathode space is quite similar, in that electron emission from the cathode, knocking off electrons from the gas molecules converts them into positive ions which move to the grid which is most negative. The resultant removal of electrons from the grid causes grid current to flow through the grid resistor, and makes the grid potential less negative than otherwise.

It is, therefore, important not to use a higher value of grid resistance than specified by the manufacturers if the tube is being operated anywhere near its maximum rated conditions of plate and screen dissipation or temperature. For example, the specified grid resistance for the type 6L6G power output tube is 0.1 megohm if the tube is used with a fixed bias and 0.25 megohms if the tube is used with a cathode bias resistor. In the latter case any increase in plate or screen current will tend to increase the bias due to the cathode resistor drop and tend to counteract the effect of the positive bias increase in the grid resistor. Specially processed tubes would be required to perform satisfactorily with much higher grid resistors than those recommended.

Microphonics

Microphonics or microphonic noise in tubes is caused by relative mechanical motion of critical parts initiated by acoustic feedback or by mechanical shock or vibration of the unit. If all mechanical motion could be prevented within a tube microphonics would no longer exist. To take care of thermal expansion some type of sliding joint must be provided in the direction of the core material with the greatest cross section to prevent the core material from warping during the operating cycle. This joint is usually as good as cost and ease of assembly will permit but this point may be a source of microphonics.

In the filament (directly heated) type of tube a string-like material must be supported close to surrounding elements with provisions for compensating for thermal expansion of the points along the emitter. Therefore, this emitter will act similarly to a vibrating string when subjected to mechanical vibration. With proper selection of emitter material and its supports and applying suitable tension the resonant frequency of this assembly can be moved into the upper audio band and out of the range of operation for many industrial uses.



A light source for a stroboscope, the SN4 is an internally triggered, cold cathode, gas filled thyratron giving maximum illumination

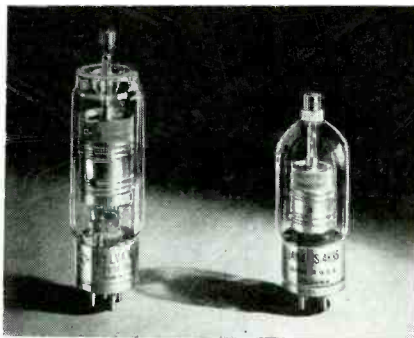

Larger hydrogen filled thyratrons, 5C22 and 4C35 featuring low deionizing time and high peak currents for control or pulsing use

Indirectly heated tubes (cathode types) may be found to have frequency microphonic noise, due to movement of the emitter within the supporting member.

Other predominant types of microphonics start from heavier elements moving within the tube, or from the entire assembly moving within the container. These are usually at a very low frequency and in all tubes are minimized by well supported construction. Further relief is obtained by vibration isolators or shockproof mounting.

Ruggedness

In referring to ruggedness, we usually think of the misuse and abuse that a tube will stand without showing either temporary or

permanent deterioration. If all the elements within a tube could be designed with the same inertia and materials, then as shocks are applied, all parts would distort with uniform displacement, and this distortion would not cause any temporary or permanent deterioration. Naturally this is impossible, so it is necessary to select materials and supports for materials so that with normal use and abuse, parts will not be distorted.

The greater the reduction in mass, the less difficulty will be encountered. This in turn is likely to result in tubes of small size. Any tube design that features ruggedness and small size must necessarily be a series of compromises with respect to load handling characteristics and ease of manufacture. This means that tubes in general should be designed and built for the particular application in mind, and it is not wise to use tubes designed for one purpose for radically different usages. Since this places the industrial circuit designer at a disadvantage as most tubes that are readily available have been developed for radio communication applications, he must prove out his design by adequate tests, supplemented if necessary with information from the tube manufacturers as to lesser-known effects which may be encountered.

Characteristics

When the actual characteristics of a large number of tubes of a given type are examined it will be found that a relatively large difference exists between individual tubes. If a distribution curve is plotted of any particular characteristic, such as mutual conductance, determined at a given set of test conditions, generally it will be found that the familiar probability curve is the result. Although the testing limits at tube manufacturing plants are established to reject tubes whose characteristics fall at the extremes of the distribution curve, some idea of the spread which might be expected can be obtained from inspection of the testing limits on several common tube types as set down in the JAN-1A specifications for vacuum tubes. Two examples are shown opposite. One, the type 7A4 tube, is a medium mu general purpose triode while the other, the type 7B4, is a typical high gain audio amplifier triode. The data on these tubes as obtained from the JAN-1A specifications is shown with the "bogey" value. The minimum and maximum values are

given in JAN-1A and the "bogey" value is that value which is usually published in the handbooks and general tube rating charts.

From the data on the type 7A4 tube it will be seen that three points on the characteristic curve (I_b vs E_b and E_c) of the tube are checked, the principle point being at $E_b = 250$ vdc and $E_c = 8$ vdc. The cut-off test with $E_b = 250$ vdc and $E_c = -24$ vdc is made because the tube may be used in applications where the cut-off voltage is critical.

This test will show the effect of uncontrolled plate current which might be the result of a distorted or damaged grid which would not be noticed at the normal check point. A third test condition $E_b = 90$, $E_c = 0$, determines the shape of the characteristic curves in the low plate voltage, zero bias region. These three operation check points are suitable for selecting tubes for normal radio circuits but in some industrial applications other test points may be warranted.

The plate current limits of the type 7B4 are much wider than those on the type 7A4 tube because this tube generally will be used with a high value of plate circuit resistor and a cathode bias resistor so that the differences in operating points of widely different tubes will be minimized and the stage gain will be fairly uniform between different tubes. Usually the most important limit on the type 7B4 tube is the amplification factor since the tube is often used as a high gain amplifier.

Changing characteristics

It should be noted that the characteristics of the tube are a function of the applied potentials, and with constant dc potentials on the other elements the plate current (and likewise G_m and R_p of the tube) will vary considerably with filament or heater voltage. This is especially true of tubes such as the 7F8, 6J6, 6AK5 and many others

which are designed to have a high G_m factor, with closely spaced elements.

One of the factors that has to be considered in the design of equipment utilizing vacuum tubes is the change in their characteristics with age. There are some general trends here but they depend considerably on the processing and manufacturing technics. It has been observed on a considerable number of receiver tube types that there is an initial drop in the characteristics: G_m , power output, diode emission, or gain, of the tubes when placed on life test. This drop may be as high as 10 or 15%, but the value usually returns to within a few per cent of its starting value at the end of 100 hours, after which there is another falling off of the characteristic of the order of one per cent per 100 hours operation.

After about 300 or 400 hours operation tubes which have not slumped excessively usually level off and become quite stable. These observations indicate that for some industrial applications present types of receiving type vacuum tubes may require additional processing and aging before being placed in equipment.

It is possible in designing equipment to minimize the effects of tube variation. Negative feedback is one of the common schemes for reducing the effect. Amplifiers can be built with very high stage-gain, which is then reduced to the desired value by feeding a portion of the output back to the input in such a phase relation as to reduce the output. This method will make the amplifier more nearly independent of variations of tube and supply voltages. Providing cathode resistance bias for a tube tends to correct for variations automatically from tube to tube and as the tube ages. In such applications as direct-coupled and direct-current amplifiers the use of balanced circuits of the bridge type with high values

of common cathode resistors and other types of feedback again minimize many changes caused by the tubes.

Sources of noise

Random irregular currents introduced into a signal circuit by the amplifier tubes themselves, or any other electrical components, are a source of "noise" so called because it appears as such in communication circuits. The sources of noise present in an amplifier tube circuit are:

(a) Thermal agitation of electricity, which is the fundamental source. This is due to the free charge of any conductor being in random motion and in equilibrium with the thermal motion of the molecules, causing a random voltage to be developed across the terminals of the conductor. The RMS value of this voltage in microvolts is $E = 7.4 \times 10^{-6} \sqrt{TR} (\Delta f)$ where T is temperature in K, R in ohms resistance of the conductor, and Δf the bandwidth of the amplifier following the conductor of resistor.

For example, if the effective grid circuit resistance of the first stage of an audio amplifier is 2 megohms and the amplifier passes all frequencies from 50 to 10,000 cycles/sec., then at 20 degrees Centigrade, the effective noise fed to the first tube grid would be about 25 microvolts. Carbon resistors give values higher than this, due to minute arcing between particles, especially if the resistor has appreciable voltage drop.

(b) The noise introduced by shot effect of the electron stream (also by ions in the electron stream) which is not considered in the equation below, is due to the random rate of arrival of electrons at the plate causing a pulsating current to be superimposed on the average plate current. In pentodes, the division of current at the screen contributes additional noise.

The effective noise voltage at the grid of a tube due to these causes

$$\text{is } E = 16.8 I_b (\Delta f) \frac{F}{G_m} \text{ — microvolts,}$$

where I_b is plate current in milliamperes, (Δf) is bandwidth in cycles/sec., G_m is the mutual conductance in micromhos at the operating conditions, and F is the space charge factor.

Since most tubes operate according to space charge limited condi-

(Continued on page 130)

| | TYPE 7A4 | | | TYPE 7B4 | | |
|---|----------|-------|------|----------|-------|------|
| | Min. | Bogey | Max. | Min. | Bogey | Max. |
| Heater Voltage ... (E_f) volts | | 6.3 | | | 6.3 | |
| Plate Voltage (E_b) volts dc | | 250 | | | 250 | |
| Grid Voltage (E_c) volts dc | | -8 | | | -2 | |
| Heater Current (I_f) ma | 275 | 300 | 325 | 275 | 300 | 325 |
| Grid Current (I_{c1}) μ a dc | 0 | | -1.5 | 0 | | -0.6 |
| Plate Current (I_b) ma dc | 5.5 | 9.0 | 12.5 | 0.4 | 0.9 | 1.7 |
| " " (I_b) μ a dc $E_c = -24$ | 0 | | 20 | | | |
| Transconductance (G_m) micromhos | 2075 | 2600 | 3125 | 1100 | 1500 | 2000 |
| Transconductance (G_m) $E_b = 90$, $E_c = 0$ | 2400 | 3000 | 3600 | | | |
| Emission (I_a) $E_b = E_c = 30v$, ma | 40 | .. | .. | 40 | | |
| Amplification (M_a) | 18 | 20 | 23 | 85 | 100 | 115 |

TELEMETERING FOR

By **DR. J. W. COLTON**

Section Engineer, Research Labs, Westinghouse Electric Corp., East Pittsburgh, Pa.

Engineering details of the elaborate pressure measuring equipment used in recording the results of the Bikini atom bomb tests

● The cataclysmic explosions at Bikini Atoll last July were probably the most thoroughly examined individual phenomena in all of scientific history. Of prime interest to the Navy were the pressures developed by the blast and shock waves, for it is these that are responsible for the primary damage to vessels. In order to obtain quantitative information as to the magnitude and form of these waves it was necessary to have pressure measuring instruments within the area of extensive damage. To assure the securing of a record this information was transmitted by high frequency FM radio to a receiving ship located at a safe distance from the blast.

In the first test a total of 36 complete records of air pressure vs. time were recorded simultaneously from as many instruments located at strategic points on two target vessels. In the second test six records of water pressure vs. time similarly were obtained.

The development and assembly of pressure measuring and telemetering equipment was carried out under the direction of the Westinghouse Research Laboratories, and represents the joint efforts of Princeton University Labs, Cornell Aero Labs, NOTS, and Bureau of Ships.

For the most part the equipment consisted of apparatus previously developed by these groups for various research projects during the war, though the severe conditions of the atomic bomb tests necessitated redesign of some portions of the equipment.

Water blast gear

The shock front which spreads out through the water from the explosion has such speed and is so sharply demarcated that the pressure at a stationary point some distance from the source may rise from zero to thousands of pounds per square inch in a few hundred-thousandths of a second. The subsequent pressure fluctuations may be of important magnitude for as long as one second afterward.

The exceptionally large frequency range, which the telemetering equipment must handle in order to reproduce faithfully this wave, may be emphasized by considering the fact that if the rise of the wavefront occupied one-eighth inch along the record, the record would have to be 500 feet long to get a complete picture. Because of the high frequencies involved, a separate transmitting and receiving system was necessary for each pressure gage.

The pressure measuring device proper consisted of a piezo-electric tourmaline crystal, about $\frac{1}{4}$ in. in diameter, enclosed in a molded rubber case vulcanized to the end of a rubber-covered twin conductor shield cable. About one foot of this cable, with the gage on the end, projected through a packing gland from the hull of the ship below the waterline. Four of these were installed on one target ship, and two on another.

When pressure is applied to the crystal, a charge is developed and is proportional to the pressure. The cable is terminated in a relatively large capacitor, across which the charge develops a small voltage, and by the grid resistor of the first amplifying tube.

The time constant of this resistor-

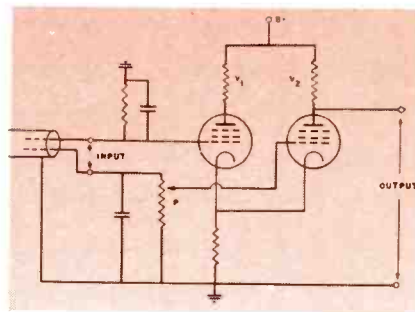
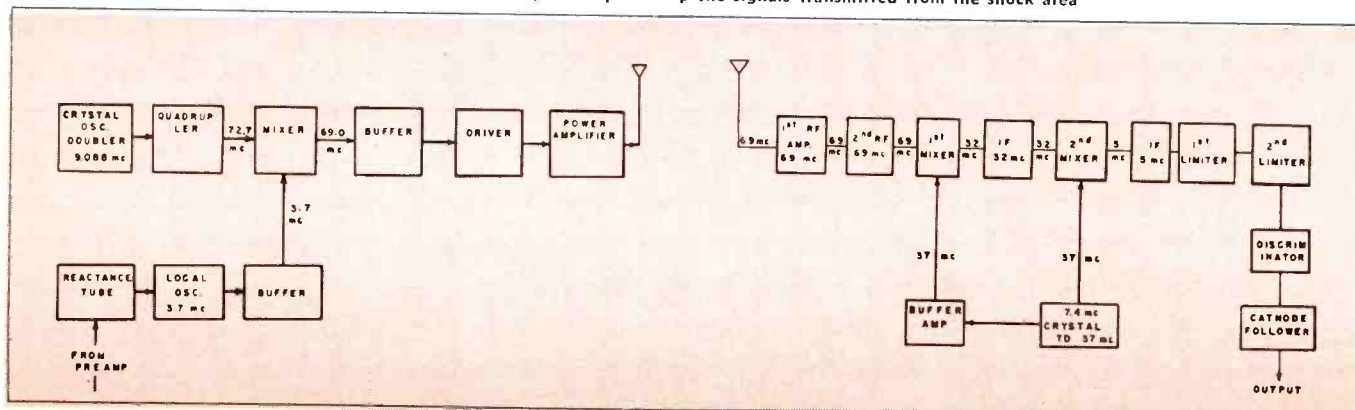

Fig. 1—Block diagram of preamplifier for water blast test

Fig. 2—Block diagram of frequency modulated transmitter for water blast test, separate transmitting and receiving units being used for each of 36 gages
Fig. 4 (right)—Block diagram of one of the FM receivers, which picked up the signals transmitted from the shock area



PROJECT CROSSROADS

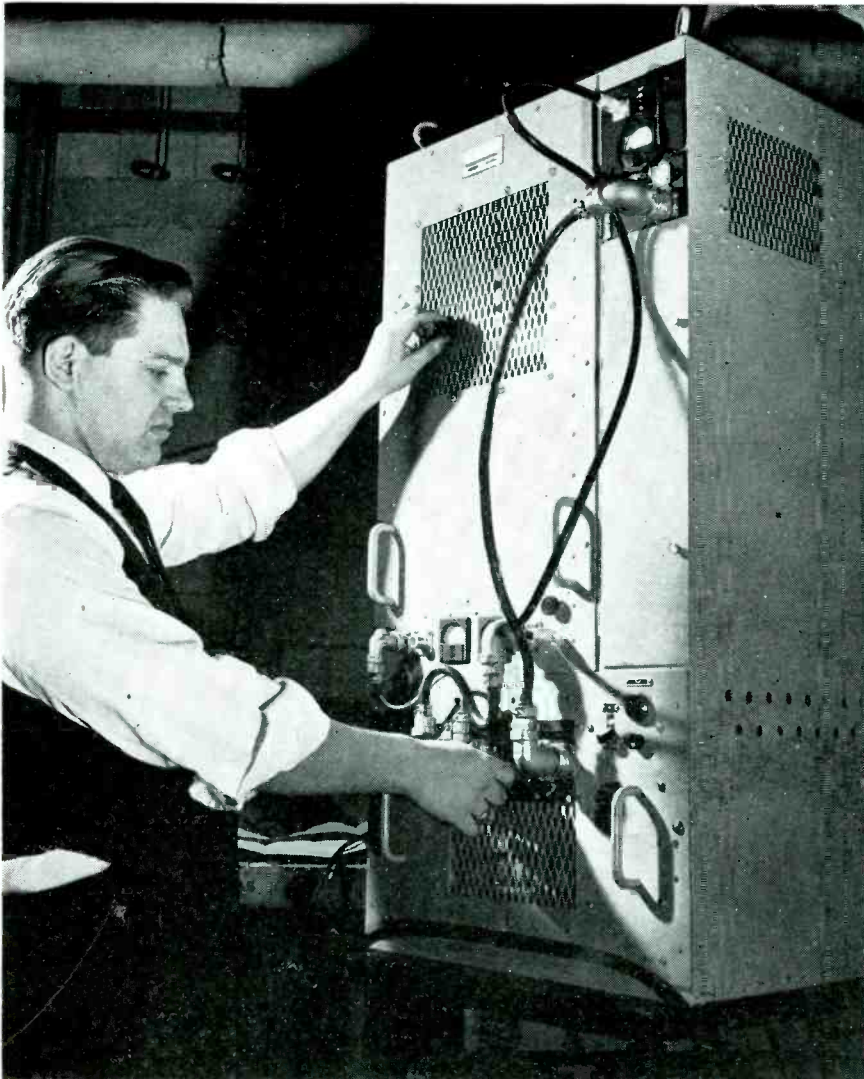

Fig. 3—This FM transmitter, located on the target ship, automatically sent signals of shock intensity to the mother ship, where they were received and recorded. The entire transmitting unit, complete with power supply, was housed in a single cabinet

capacitor combination must be sufficiently large to cause negligible phase shift at the lowest frequency (about 30 cycles). This required a high grid resistor (10 megohms), and to prevent changes due to humidity, the entire preamplifier is contained in a hermetically sealed case together with a drying agent. It has been found that the dielectric material of the cable also generates a charge under pressure. To eliminate this effect, a twisted-pair shielded cable is used, and fed into a special mixing circuit which is responsive only to voltages developed between the two conductors but not to voltage changes between the conductors and the shield. (Fig. 1)

The cathode follower V_1 , is ar-

ranged to have a high following ratio, e.g. 0.9, and carries the cathode of V_2 with it. The potentiometer P on the input of V_2 is adjusted to the same fraction as the following ratio, and thus if the voltages on the input terminals with respect to ground vary together, the grid-cathode voltage of V_2 is not changed, and no output signal is obtained. Any differences in the input voltages, i.e. any signal developed between the input terminals, will appear on the plate of V_2 .

The remainder of the preamplifier is of conventional resistance coupled design with a frequency response from 5 cycles to 50 kc. Well regulated plate supply voltages were a necessity. To avoid possible disturbances from the intense gamma

radiation released by the atomic reaction from which the amplifier would be slow to recover, batteries were used. The preamplifiers were located at the respective gage positions, and their outputs fed through cables to the modulators at the transmitting stations. A block diagram of one of the six frequency modulated transmitters is shown in Fig. 2.

The crystal oscillator operates at 9.088 mc, and doubles in the plate circuit of the oscillator tube. A quadrupler furnishes the mixer stage with 72.704 mc, where it is combined with the local oscillator mid-frequency of 3.704 mc., the resultant 69.0 mc being the operating frequency of one of the channels. The frequency of the local oscillator can be varied ± 150 kc by means of the reactance tube modulator coupled to its tank circuit. The reactance of this tube is varied by the injection of the audio signal directly in its cathode circuit.

Thus the system has a frequency response which extends strictly to dc. The use of a crystal oscillator to furnish 95% of the final frequency and a high-deviation modulated oscillator for the other 5% results in good stability. The final power amplifier consists of a pair of Eimac 4-125A's in push-pull, with a folded quarter-wave line as a tank circuit. The output of the transmitter is 600 watts.

The entire transmitting unit, complete with power supply, is housed in a single cabinet. (Fig. 3). RG-18U cable was run from each transmitter to the vertical dipole antennas mounted as high as possible on the spars of the vessels.

At the receiving ship, only three antennas were used, each handling two adjacent channels which were separated by only .7 mc. These antennas were similar in design to the transmitting antennas, but were fitted with parasitic dipoles to provide directivity and thus extra gain.

The receivers were fixed tuned and had a crystal controlled local oscillator. To provide high sensitivity a double IF system, with the crystal oscillator serving both mixers, was used. Fig. 4 is a block diagram of one of the receivers.

The receivers required careful adjustment and strict adherence to the principles of good layout to prevent oscillation. A signal of 30 microvolts was sufficient to operate

both limiter stages. Since some loss in signal strength was expected due to the use of a single antenna to feed two receivers, and because of the critical nature of the coupling, separate preamplifiers were built for each receiver. These units consisted of a single amplifying stage operating at the channel frequency and were fed in pairs from each antenna by means of tee joints and cables cut to the proper length for optimum distribution.

The discriminator was of the conventional double diode type, and differed from the usual arrangement only by the fact that the output was directly coupled to the grid of a cathode follower. The output of the discriminator was linear over a frequency deviation range of 350 kc each side of center. The bandwidth of the receiver was 250 kc; this set the high frequency limit for the entire system. Though phase shift became apparent at frequencies of about 20 kc, a 10 kc square wave was accurately reproduced by the system, with a rise time of less than 5 microseconds and very slight rounding of the corners.

The recorder on which the final records were produced was capable of handling all six channels. Three double-beam oscilloscope tubes of 5 in. diameter and short persistence blue phosphor were mounted side by side at the bottom of a standard five foot rack cabinet. Two General Radio 651 AE cameras with f/1.5

Fig. 5—These typical traces made by the recorder show fidelity of response to various waves. The 10 kc square wave has a rise time of less than 5 microseconds

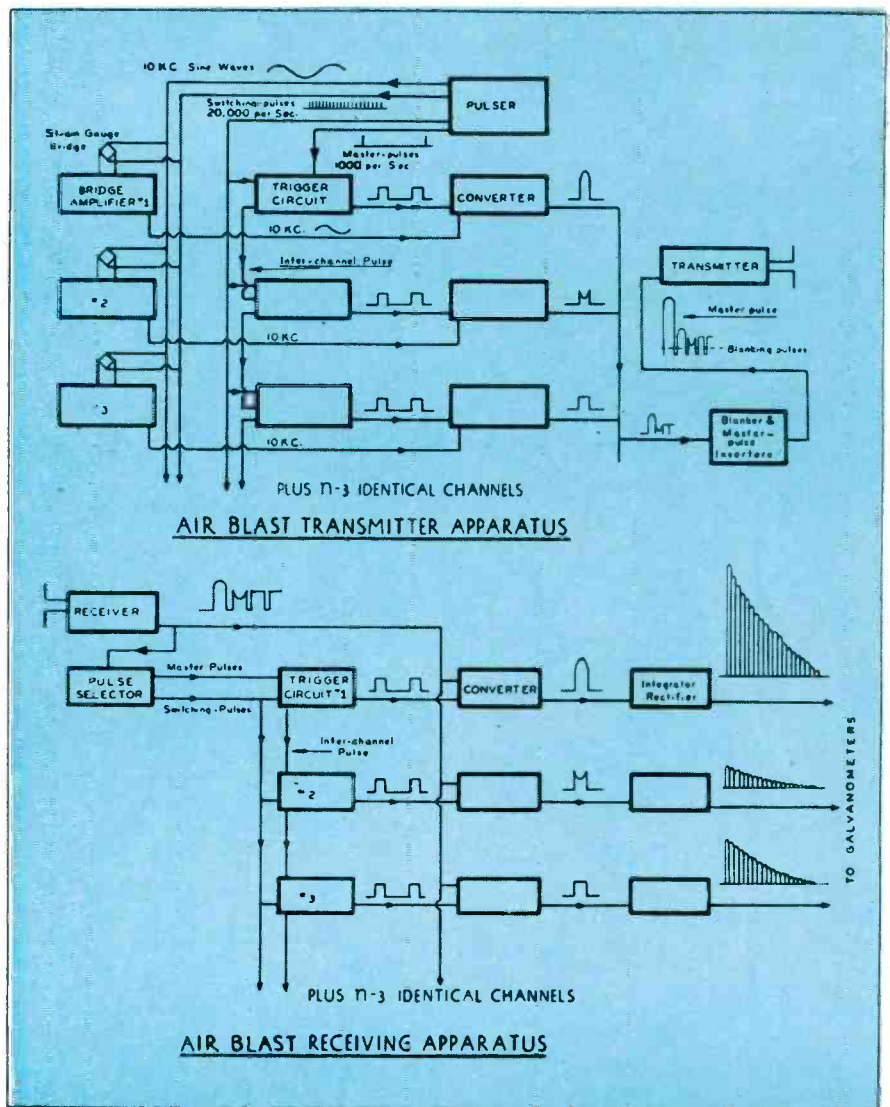
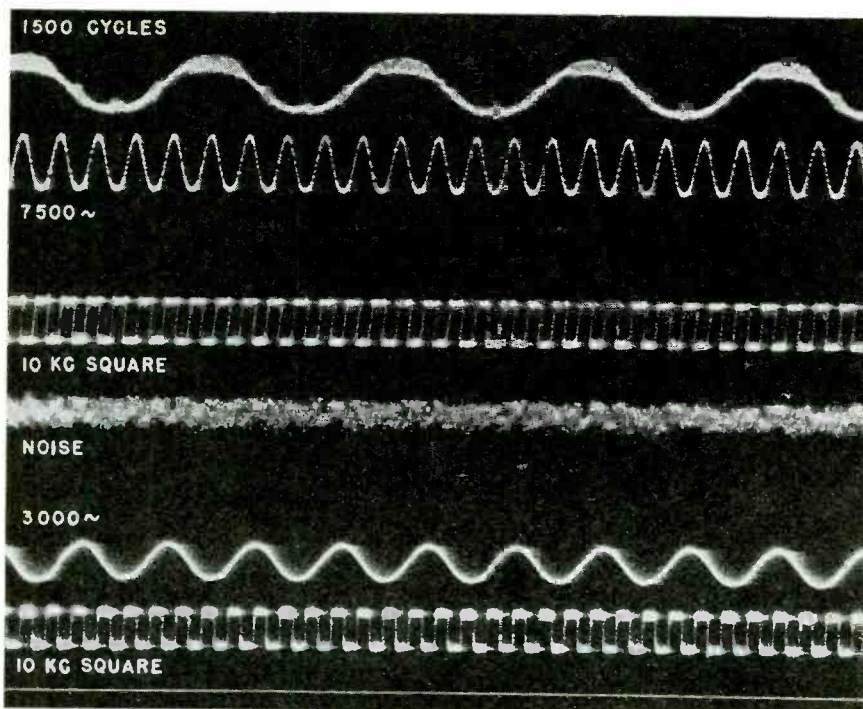

Fig. 6—Block diagram of the air blast transmitting and receiving apparatus

coated lenses were mounted on top of the cabinet to photograph the

faces of the oscilloscope tubes.

In the final analysis the film on which the records were made was the sole product of months of development, assembly, and installation of costly equipment, together with the expenditure of thousands of hours of scientific and engineering effort. To reduce the chances of failure at this critical point, and during the subsequent photographic processing, two records were taken simultaneously. Each camera photographed all six electron beams and the filament of a small lamp bulb, which provided a base line.

The film moved continuously through the camera at a speed of about 30 feet per second. This furnished the time base, and was marked at regular intervals by interrupting momentarily the oscilloscope beam. The beam deflection was of course at right angles to the film motion. One hundred foot rolls of recording panchromatic 35-mm film were used. Since the motor required a short time to accelerate the film to full speed, it was neces-

sary to start the cameras rolling a fraction of a second before the blast. This was done automatically by means of a delay mechanism actuated from the warning signal 2 seconds before the explosion.

The six video amplifiers for the oscilloscopes were two-stage direct-coupled balanced amplifiers using cathode degeneration to minimize drift and unbalance. For test purposes a sawtooth sweep could be applied to any or all of the six beams.

With this recorder a maximum writing speed of $\frac{1}{4}$ in. per micro-second at the oscilloscope face was attained. A sample test record is reproduced in Fig. 5.

Calibration of the complete telemetering system, from the terminals of the crystal gage to the deflection of the oscilloscope beams, was made possible by the provision of a relay at the input terminals. This introduced a known signal derived from a battery and having a value equal to the peak signal expected from the crystal.

A second recorder, similar in nature to the one described but using six three-inch oscilloscopes was developed independently by the group at Cornell. This recorder used 1000 ft. rolls of unperforated film, and was used simultaneously with the first to record disturbances of long duration.

Air blast equipment

The problem of measuring the air pressures developed by the explosion had several features which distinguished it from that of the water pressure. First, the frequency range involved was very much smaller, coverage up to 200 cps being considered adequate. Second, because of the great variations in air pressure expected at different points of the ship, it was desirable to have a relatively large number of measuring stations. Eighteen pressure gages were installed on each of two target ships. These were located on the outside of the hull, both toward and away from the blast, on masts and spars, and on various bulkheads both above and below decks. Each gage was set to give full scale reading at the pressure expected.

The actual sensitive element was a strain gage, a wire of special alloy which changes its electrical resistance when it is elongated. Four of these wires are connected in a bridge circuit, and mechanically mounted in such a way that upon movement of a link, two opposite arms of the bridge are elongated

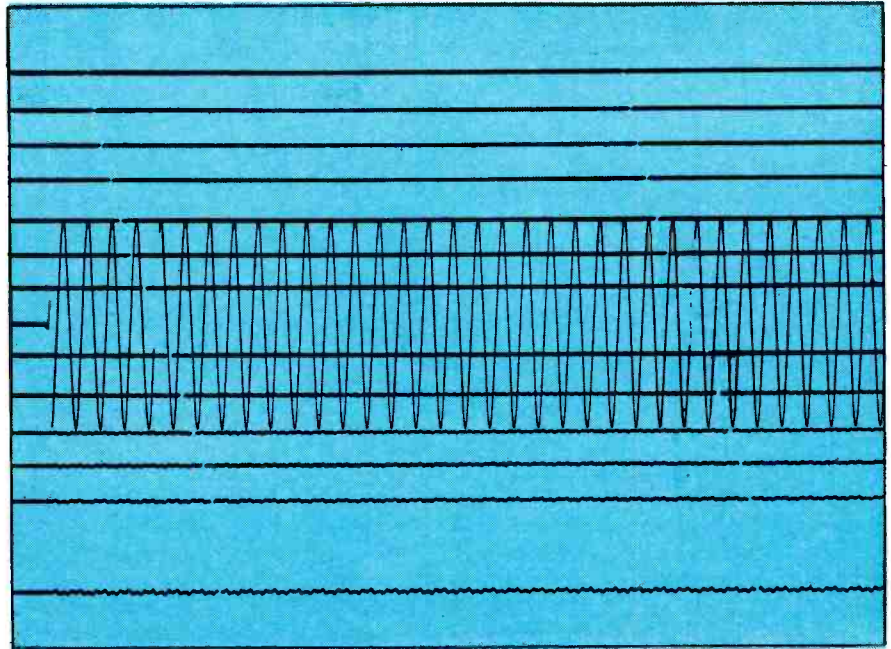

Fig. 7—These fourteen traces record air pressures at as many target locations. While all indications are simultaneous, the timing marks are staggered to aid in identification

while the other pair is shortened. Air pressure is translated into movement of this link by a metal bellows. The whole mechanical system is sufficiently stiff to give a response to pressure variations independent of frequency over the 200 cycle range.

Because of the relatively small frequency range necessary, it was possible in this test to use a multiplexing system which transmitted simultaneously eighteen sets of information on a single frequency modulated radio link. This was accomplished by means of a time-division system consisting essentially of two electronic "commutators", one at the transmitting location and one at the receiving station. These were run in synchronism, the transmitting commutator sampling signals from gages 1 to 18 in order and the receiving commutator distributing the signals in the same order to recorders 1 to 18 at the receiving station.

The whole cycle of commutation is repeated 1000 times a second, and with 20 channels (there are two blank sampling periods) each gage is examined for $\frac{1}{20,000}$ of a second. The upper frequency limit which can be obtained from a single gage is thus determined by the frequency of commutation (1000 cycles) while the radio link must be capable of transmitting and receiving 20 times this frequency. Fig. 6 is a block diagram of the complete system.

The strain gage bridge is excited by a sine wave alternating current of 10 kc. The output of each bridge

is thus a 10 kc wave varying in magnitude in accordance with the applied pressure. The output of each is fed through a tuned amplifier to a converter (or switch) tube whose cathode resistance is common to all the channel converter tubes. Each of these tubes is turned on in succession for $\frac{1}{20,000}$ second, the resulting output being therefore a sampling of all channels. The switching is accomplished by a trigger circuit in each channel.

Each circuit is triggered on in turn by the pulse produced by the circuit of the previous channel when it switches off. After $\frac{1}{20,000}$ of a second the circuit is switched off by pulses fed simultaneously to all channels from a synchronized pulse generator operating at 20,000 pulses per second. To maintain stable operation trigger channel #1 is not set off from channel #20, but is triggered by a master pulse from the pulse generator every $\frac{1}{1000}$ second.

A blanker is inserted in the combined output which effectively cuts a slot in the signal between each channel. This is done to reduce the frequency response required of the radio link thus preventing adjacent channel cross-talk, and to provide synchronizing pulses for the receiving commutator. A master pulse is also inserted by this circuit just previous to the switching on of channel number one. This assures proper phasing of the transmitting and receiving commutators.

At the receiving station, the signal output of the receiver is first

(Continued on page 135)

VACUUM TUBES IN

By **RALPH R. BATCHER**

Consulting Editor, Electronic Industries

In industrial fields, electronic devices, heretofore used largely to duplicate and sensitize other control systems now do many new jobs

● The large chart folded in with this issue illustrates some of the characteristics that account for an accelerated trend toward electronic instrumentation. Since early control systems were developed using either mechanical, electrical, pneumatic, or hydraulic transfer mediums, the tendency among industrial men is to compare the features of the newer electronic methods with those older arrangements.

On the other hand, although electronic circuit arrangements and expedients used in accomplishing the many unusual effects are common knowledge to engineers in the electronic field, equivalent methods of doing the same things by other systems have seldom been analyzed by them, and at present many are handicapped by a lack of knowledge as to specific instrumentation problems.

This is partly because of the wide discrepancy in terms and (in the opinion of many) the cruder symbols and methods of picturing system arrangements used in the books, catalogs, and publications in the industrial process control field.

Much of the information detailed on this review chart is self-explanatory. In general there are shown certain system counterparts and devices whose operation simulates that of some item in another system. In the tables of system quantities shown at the top, items in each horizontal line across the five tables are not identical but in each case they may represent analogous concepts which may make it easier for anyone well versed in any one system to understand quickly the relations in some other field.

Many electrical engineers like to size up operating relations in other fields by thinking — that's the "Ohms law" of the system. Therefore, under each heading, the quantities horizontally aligned with the potential, resistance and current quantities in the first section

COLOR CHART SUPPLEMENT

The Chart Supplement enclosed with this issue of *Electronic Industries* will help in making more easily understandable the many ways that vacuum tubes may be used either as substitutes for other equipment, or to supplement it. To make the picture plain, analogous functions between mechanical, hydraulic and pneumatic methods and their electronic counterparts are illustrated. These feature many electronic methods as currently used, or possible of adaptation for monitoring, control and measurement instrumentation in industrial operations

are related by an equivalent of Ohms law. Power, energy, and quantity of the medium "flowing" likewise are horizontally aligned.

In each group certain interrelations between the items are listed and others may be derived by analyzing the dimensional formulas. There may be differences of opinion as to what is a common unit in some cases since certain quantities are called by several names.

Diagonally across the sheet, in double circles, is pictured a random selection from a wide variety of components and principles used in electronic circuits, with an operational facsimile from another system alongside. These pairs are to be considered as accomplishing similar effects. Specifically, these show:

(1) The basic principle of all control, the introduction of a resistance or pressure drop in a system. This is effective only when a flow occurs, and usually the loss of pressure is proportional to the flow.

(2) A rapidly expanding field of activity for electronic devices is

based on the application of ultrasonic vibrations to the material in a process for mixing, changing molecular sizes, drying, or producing numerous other effects. Measurement of viscosity, moisture content and other factors sometimes is possible by determining the attenuation of ultrasonic waves passing across the mix.

(3) A simple analog between capacity and inductance (momentum) is afforded by this simple filter comparison.

(4) The principle that a rotary pump will regulate flow in a system without regard to pressure or head is in correspondence with that of the constant current device—a pentode which passes a definite current over fairly wide limits, irrespective of the voltage applied to the circuit. This principle is frequently used.

(5) The basic amplifier characteristics found in a simple triode circuit correspond to the fundamental vane and jet arrangement of the pneumatic system. The output pressure or voltage can be varied over fairly wide limits to accomplish other control effects, but is always less than the system pressure or voltage. In the examples shown, a 2-10 lb. variation (or a 20-100 volt change) is obtainable from the system's 18 lb. (or 180 volt) basic potential.

(6) In this floating control system the pneumatic motor simulates a simple split field motor under the control of a balanced-tube field control arrangement. The unbalance voltage, here shown as resulting from the rheostat setting, can, of course, be obtained from other sources.

(7) In a common voltage stabilizer circuit, the potential drop across an electronic tube (triode) is controlled by the amplified version of voltage variations in the system. Any small voltage change in the output circuit immediately

INSTRUMENTATION

affects the amplifier tube and creates a change in the impedance of the control tube to correct the change. A pressure regulator system using a control and pilot valve (or valve positioner) accomplishes a similar effect.

(8) A relaxation oscillator circuit containing a thyatron tube is a common item in electronic systems (oscillograph sweep circuits, etc.). The capacitor charges slowly through a resistor until a potential is reached where the thyatron breaks down and becomes conductive. The charge is thereupon dissipated and a new charging cycle starts. In the hydraulic analogy a tank fills slowly through a resistance or valve, until the float rises to a point where it trips off the dump valve. The tank then discharges rapidly until the flow ceases around the dump valve so that it can reset. The cycle of operation in each case depends on the resistance in the charging lead, and the capacity of the tank or condenser up to the level where the discharge starts. The discharge is usually more rapid than the charge because of the lower resistance in the discharge circuit.

Positional control

(9) Shows two analogous systems of positional control — electronic and pneumatic—that are arranged to guide a mechanism around cams or irregularly shaped templates. In the electronic system* a phototube and light source are focused on a mark on a paper template. A powered traction wheel moves this assembly forward but in a direction controlled by worm gears that are driven forward or reversed as necessary so that the phototube “sees” the marking at all times. To do this, the worm shaft is controlled by a reversible motor operated by the amplified signal from the phototube. This arrangement pulls along a series of gas cutting torches.

In a pneumatic arrangement† a double acting cylinder is driven by air entering one of two adjacent orifices from an air jet moved by a syphon bellows. The movement of the latter is controlled by the air pressure established by a jet-nozzle arrangement, between which

the edge of the template moves. As the latter rotates, the position of the jet is changed by the action of the piston in the cylinder, until the same pressure is reestablished by the syphon.

One of the main features of electronic control is the ease with which the characteristics of the system can be modified (12) to incorporate selected rates on proportionalities by rather simple changes in the amplifier system. An extremely long list of possible modifications could be compiled from existing apparatus diagrams.

Items (14) and (16) show several typical circuits giving amplification rates that follow non-linear curves. With the expansion amplifiers (14) the output can be adjusted to follow a square-law relation to compensate for non-linear effects in some other part of the process, or to apply proportionally-greater corrective influences when the system shows wide departures from normal.

Process variables

These circuits utilize the screen grid control characteristics of pentodes. Oscillation or regenerative feedback is avoided by adequate filtering of the output of the rectifier tube before reinjection into the screen grid control. Such circuits were originally designed for audio amplifiers. Since the process variable in many industrial systems changes at an extremely slow rate, this means that this rectifier and filter must give an extremely smooth output at low frequencies. Attention must be given to its phase shift characteristics as well, to prevent low frequency oscillatory feedback.

A modification of this same method will give logarithmic gain characteristics (16). There are many other ways by which the AVC circuits, so commonly applied to communication amplifiers, can be used in control amplifiers for industrial purposes. These can be made to operate below or above a selected threshold value (or dead zone) as desired.

Frequency is a quantity that can be measured with a precision that is many times greater than that of any other quantity. It is so closely linked with “time” that seven place accuracies can be obtained with relatively inexpensive

setups. Unlike amplitude effects at the usual industrial control speeds, its value remains unchanged while it is being transferred over widely different connecting circuits. For this reason a control medium receiving much attention is that based on using a variable frequency signal as the transfer agent. This principle avoids many of the troubles found with amplitude control when large or variable distances must be covered. In (15) a few typical variable frequency generators are shown. The first uses a syphon bellows or other displacement mechanism to alter the frequency of a stretched wire, the latter being the frequency controlling element of an oscillator. This Vibrotron unit is capable of extremely fine frequency calibration.

Another simple oscillator of the multivibrator type delivers a frequency that is at all times dependent on the temperature of two NTC (negative temperature coefficient) resistors which are commercially available. Frequency changes of the order of several percent per degree (C) are obtainable.

Pressure effects

Two simple methods of altering the output frequency of a feedback oscillator by pressure effects, incorporate syphon bellows to change the capacitance (by directly altering the spacing of the plates) or the inductance (by shifting the inductance of a flat spiral coil near its movable end plate) of the LC circuit of the oscillator. Typical forms of these converters are shown at the center of (15) on the chart.

Below this a method of generating a variable frequency signal in accordance with the light falling on a gas-filled phototube is shown. Such a tube is connected in a relaxation oscillator (similar to item (8) on the chart) in parallel with a capacitor. The latter is charged at a rate depending on the supply voltage and the impedance of the pentode. The discharge point, and hence the frequency, is thus dependent on the light falling on the phototube.

The advice of Professor C. A. Kayan, Columbia University, and Ed. S. Smith, Bendix Aviation Corp., and members of the editorial staff of ELECTRONIC INDUSTRIES regarding this chart is gratefully acknowledged.

*Described in ELECTRONIC INDUSTRIES, May, 1944, p. 127.

†Brief description by Ziebolz (Instruments, Vol. 15, Sept., 1942, p. 342).

ELECTRONIC TRUE

By H. GREGORY SHEA, Associate Editor, Electronic Industries

Numerous recent advances in the original Eccles Jordan flip-flop circuit open up the field of counter circuits for industrial usage

• Binary counters using a pair of triodes in a flip-flop or modified Eccles-Jordan circuit have been described quite fully in numerous articles. However, since these circuits count by powers of 2 some modifying scheme is always necessary to obtain decimal counts. Furthermore, simple connections of low wattage neon lights to the plates of the tubes in the flip-flop circuit for indicating purposes results in an indication that is difficult to read.

This can be seen from Fig. 1 which shows an ordinary binary circuit. One pulse in the input line will make the first double triode change from conduction through A to conduction through B, thereby lighting neon lamp 1. The second pulse turns off lamp 1 and lights lamp 2. The third turns on 1 again so that the numbers from one to ten must be obtained mentally by adding numbers corresponding to the lighting of certain of the neon lamps as shown in the following table.

| Pulse Number | Neon Lamps Lighted |
|--------------|--------------------|
| 1 | 1 |
| 2 | 2 |
| 3 | 1 + 2 |
| 4 | 4 |
| 5 | 1 + 4 |
| 6 | 2 + 4 |
| 7 | 1 + 2 + 4 |
| 8 | 8 |
| 9 | 1 + 8 |

While this sort of an arrangement may work in a laboratory or with specially trained personnel it is not defensible for general industrial work.

What is wanted is a true decade arrangement which will show directly the number of the counts.

Several schemes have been proposed for obtaining this result. One of the simplest is due to I. E. Grosdoff of the Princeton Laboratories of the Radio Corp. of America. Two features are involved. First, a feedback scheme at two points in a four double tube binary counting decade, and second, the interconnection of indicating neon lights into two interacting groups.

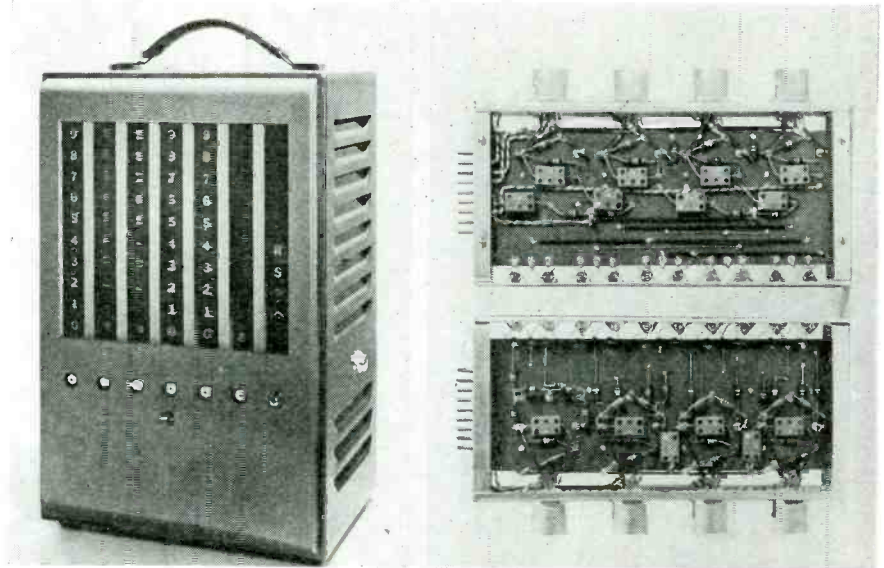

Five digit, two decade counter. Neon lights go on to show number accumulated

Referring to Fig. 2, the feedback lines may be seen running from the third to the second and from the fourth to the third double triode. The effect of this and the order of firing can be followed most easily by means of the diagram of Fig. 3.

It may be seen in this that at the zero position, triodes 2, 4, 6, 8, the right hand sections of each of the four double triode tubes are turned on. The first received signal pulse turns off 2 and on 1. The second turns off 1 and on 2. When 2 goes

Fig. 1—Ordinary Binary circuit. The neon lamp associated with each double triode lights when one side is "on" and goes out when the other side is "on"

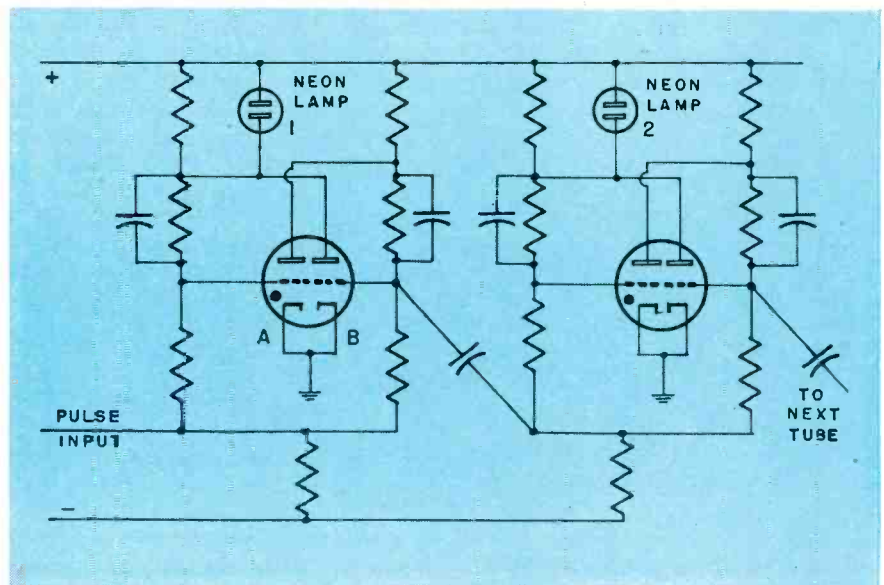

DECADE COUNTERS

on, its plate voltage drops and the consequent negative pulse turns off 4 and on 3.

The third pulse turns off 2 and on 1, while the fourth turns on 2 which turns on 4 which turns on 5 and off 6. When 5 goes on, however, it feeds back to 4 turning it off again and making 3 go on. The rest of the action can be seen at a glance for each succeeding pulse till the 10th which gives settings identical with the beginning state and by turning tube section 8 on initiates a pulse on the output line. This final pulse is applied to the next decade.

Indicating arrangement

Consider the method of connection of the lights shown at the top of the diagram of Fig. 2. All even numbered lights are connected to triode section No. 1 and all odd to No. 2. Thus a high positive plate voltage will be available at the top side of either the even or odd bank of lights for each pulse sent into the decade, since triodes 1 and 2 alternate in becoming conducting at each pulse.

The lower sides of the lamps are connected into pairs, each pair being tied to the plates of two triode sections by individual resistors. If the two triode sections are each in a conducting state with plate voltages low, the voltage difference across the neon lamp is enough to light it.

If, however, only one of the tri-

odes is conducting, there is a voltage drop from the "off" triode through the coupling resistors to the "on" triode. The voltage at the neon lamp is not sufficient to light it under these conditions. This is shown in Fig. 4. At pulse "1", neon indicator 1 is lighted, having 100 v across it because triode sections 4 and 8 are both "on" and their plates are at +80 v. At pulse "2" however, triode section 4 goes out as may be seen in Fig. 3. This raises its plate to 150 v and the base of the 0-1 indicator pair to 115 v. This makes both lamps 1 and 2 go out, the 65 v across 0 being insufficient to light it.

Anyone who has ever set up a flip-flop circuit knows that certain difficulties are apt to arise in connection with it. Particularly, it should be noted that the shape and magnitude of the pulses intended to operate the circuit are important. Failure to pay attention to such questions will result in skipped counts and double or multiple counts.

When section 2 of the first double triode of Fig. 2 is conducting, its plate voltage is possibly 70 v lower than that of section 1. Resistance and capacitor $R_1 C_1$ have about 50 v less across them than $R_0 C_0$. A 10 or 15 v negative pulse will momentarily drive both ends of the capacitors down by this amount because it takes time for capacitors to alter their charge and voltage.

Hence the first result of the pulse arrival is that both tubes are out.

The pulse having ended, both grid and plate voltages begin to rise, but the bottom of C_1 reaches the "turn on" point for section 1 first because C_1 has less charge and voltage than C_0 . If the pulse lingers, however, C_0 and C_1 voltage become equalized and there is uncertainty about which triode will go on first. A similar situation may exist if the pulse is too large. If it is too small

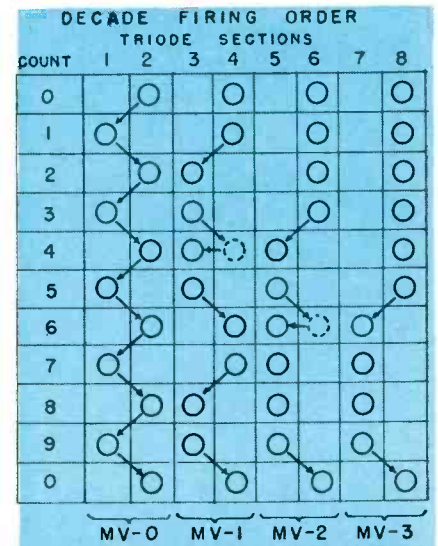

Fig. 3—Order in which the various triode sections go "on" and "off" as successive pulses arrive. Triode sections are shown in Fig. 2

it may not turn off the initially lighted tube. These considerations also govern the choice of capacitor and resistance values. In addition operating time must be considered.

Present counters have a maximum operating speed of possibly 1 to 1.6 mc. Such speeds require particularly careful consideration of component sizes as the capacitors must be very small to have a fast recovery time. Higher speeds have been facilitated by the use of 6J6 miniature tubes as they have low interelement capacities. Operated between +200 and -60 v. on the plate and bias lines, these tubes give very satisfactory results and take little space.

Industrial applications

Numerous processes in industry require the starting and stopping of mechanisms after a predetermined number of processes have occurred. There are several possible ways in which this may be done. Of course, the initiating impulses can be obtained by means of a photoelectric tube or a resistance, capacity or inductance change. But then, the

Fig. 2—True Decade Counter circuit using 4 double triodes and feed-back to the third and fifth triode sections. Neon lamps indicate the correct count directly

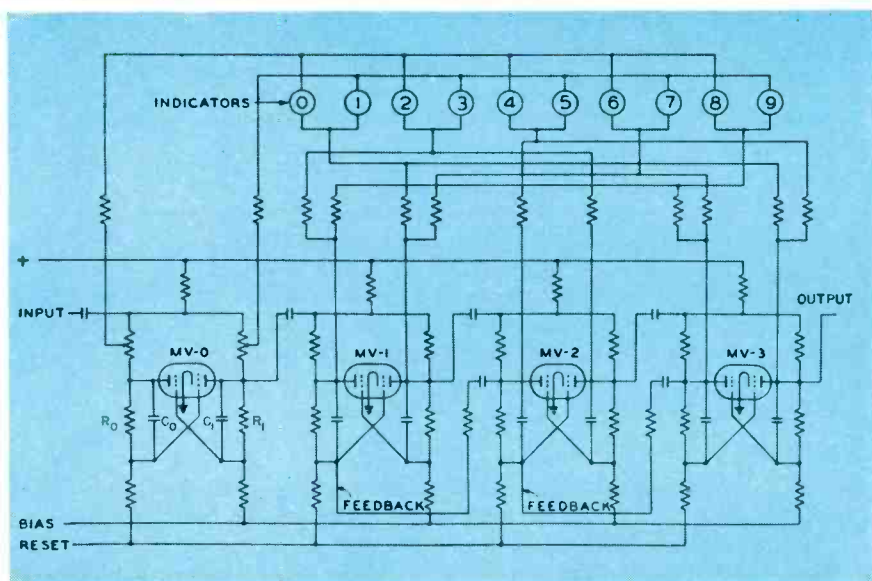

problem arises of how to stop the machine at an exact point as for instance after a certain exact number of links have been put in a slide fastener so it may match perfectly with its mating slide.

Since a counter consisting of several decades will normally deliver an output pulse when all decades are turning from the figure 999 . . . 9, the full capacity of the machine to 000 . . . 0, it is possible to set up in advance on the counter a number which is the reciprocal of the desired number. Then when the

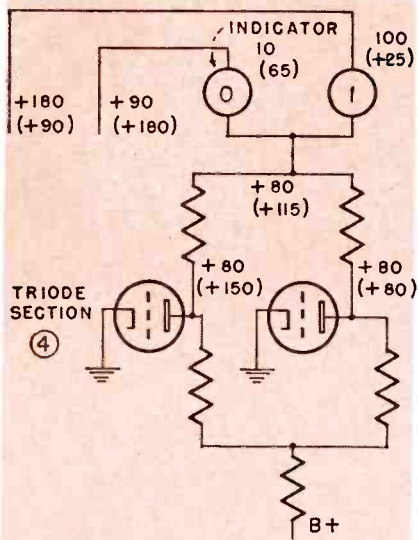

Fig. 4—Voltage variations across the neon indicator lamps which determine "on" and "off" conditions. The voltages in parenthesis are for one pulse later than those not in parenthesis

desired number has been counted off, the counter will reach full capacity.

Another scheme adapted to the circuit of Fig. 2 is shown in Fig. 4 where the indicator lights are shown in a block connected to a 9-point 2-section switch by means of which any pair can be selected. The number desired is set up on the switch for each decade. When this number is reached the decades trigger a group of low impedance tubes such as the 6A3 or 6A5G all connected in series giving a current pulse sufficient to operate the stopping switch.

Pentode circuits

Other counter circuits are available and one which has been described* recently makes use of directly coupled pentode trigger pairs as shown in Fig. 6. In this case the screens are used either to block or permit conduction. The scheme is economical in its use of components but requires twin pentodes or else twice as many single pentodes.

It can be combined in a ring of ten circuits using five twin pentodes

so connected that there is always a continuous group of five "on" and five "off". The group "on" progresses around the circle for each count. The circuit is shown in Fig. 7. Action is obtained by means of positive rather than negative pulses.

When a positive pulse is applied to the grids of Fig. 6, the "on" tube is not affected, but the "off" tube is made conducting and suffers a sharp plate potential drop. This pulses the screen of the "on" tube sharply negative and with proper circuit constants, will cause it to cut off. Such action raises its plate potential and the screen potential of the tube originally "off" thus reinforcing the "on" lighting action.

In Fig. 7 any tube within a group of "on" tubes is kept "on" rather than "off" by the low plate potentials of its neighbor tubes acting through the plate coupling resistors. The tubes most easily triggered are the ones on the ends of a group of 5. The control grids, all connected to the central ring receive positive pulses of limited amplitude. These produce negative pulses at the plates of the "off" tubes, as described above for Fig. 6. Each plate in Fig. 7 is connected through a capacitor to the suppressor grid of the next clockwise tube. The suppressors are all connected to the cathode ring through resistors.

Due to these connections, the only "on" tube whose suppressor

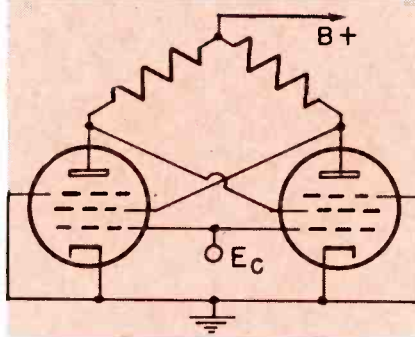

Fig. 6—Binary circuit using pentodes. Low screen voltage of the "off" tube prevents conduction

Fig. 5—Illustrative circuit for producing a pulse to stop a machine at the end of a predetermined number of counts. All the tubes must conduct at once to give the proper signal

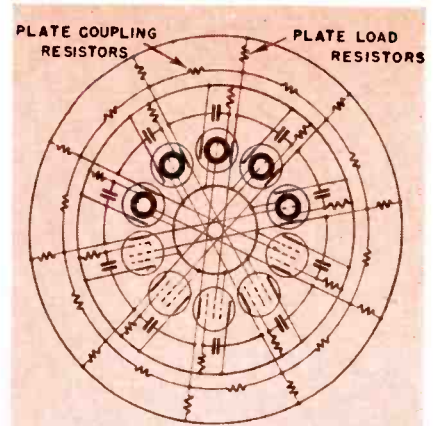
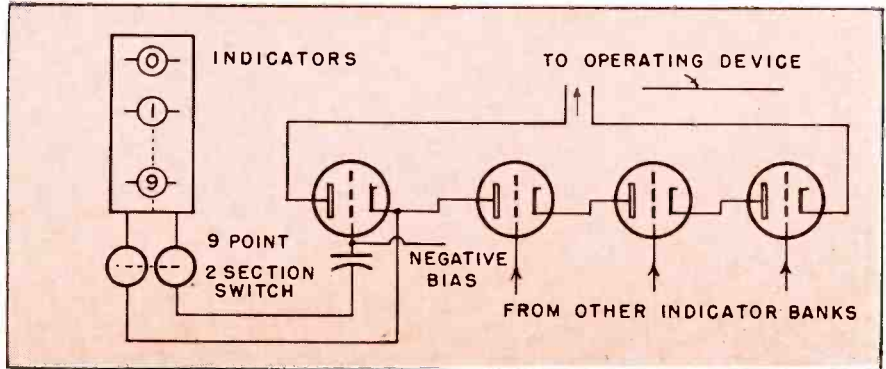

Fig. 7—Ring of 10 counter using pentodes. Each pulse supplied to the main control grid (center) causes the first clockwise "off" tube to go on and the last clockwise "on" tube to go off.

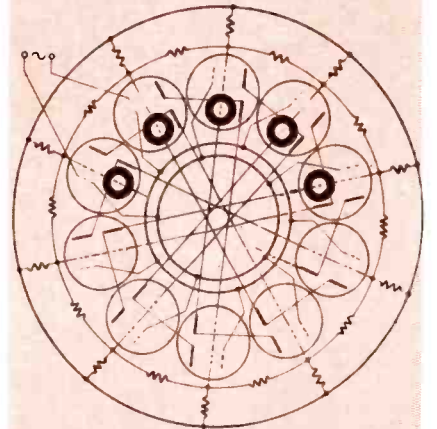

Fig. 8—Ring of 10 circuit using double pentodes and triggered by AC

receives a negative pulse is the left hand end tube. This goes out and its opposite partner goes on thereby advancing the group of "on" tubes one count around the ring.

Variations of this circuit can be used to trigger with alternating current.

This is an interesting possibility and is accomplished with conventional twin pentodes such as 12L8GT in a double ring of ten (Fig. 8). That is, the circuit embodies ten double pentodes. These tubes have common cathodes and screens and

(Continued on page 136)

WHAT INDUSTRY SEEKS IN ELECTRONIC CONTROL

Engineers of chemical, petroleum and food producers outline processing problems and their present instrumentation needs

CHEMISTS WANT SUPER RELIABILITY

By PHILIP EWALD Chemical Engineer, TVA, Sheffield, Ala.

• Chemists and chemical engineers do not need to be sold on the idea of using electronics in their instrumentation. They are ready to accept, in fact they expect, near miracles of measurement to be performed electronically. The invariable query involving a particularly tough problem is "Can't we do it with vacuum tubes or photo-cells?" This attitude stems from the already excellent record of electronics in instrumentation and familiarity with what is done in radio communication using a few dollars' worth of parts.

It also leads to over-optimism as in the case of the chemical engineer who wanted to measure high temperatures in his pilot plant at a minimum cost. He wanted a pyrometer constructed from a \$3 meter movement and a couple of 50¢ vacuum tubes, which, according to his calculations, had enough amplification to operate the meter from thermocouples. He would be satisfied with a 2% maximum error, and was sure the job would not total more than \$15.

Performance paramount

This confidence in electronics is quickly shaken by unreliable performance, particularly in chemical operations. For another example, a low-cost photoelectric turbidity control easily sold itself to an engineer designing a certain installation. Unfortunately it was a direct amplification affair with no balanced bridge or compensation, and was subject to all the vagaries of power line voltage, room temperature and humidity, and component fatigue. After a few days' struggle with the outfit and a couple of consultations with the instrument laboratory, the operator abandoned it.

Reliability is probably the chief

problem of electronic instrumentation. The laboratory man may be content to restandardize his electronic instrument every few readings, but the plant man expects his to run for years with only periodic attention from the instrument laboratory. Good circuit design will not be enough where dirt and cor-

rosion are problems as in most chemical plants. Ordinary tropicalization may, but probably won't, be ample protection. Many a beautiful amplifier and control assembly has been corroded out in a few days' time.

In producing electronic instruments for the chemical industry, the moral might well be—Do a circuit design job theoretically 100% correct, dustproof it, waterproof it, acidproof it, and then find out what else it needs.

OILMEN SEE EXPANDING UTILITY

By L. C. ROESS Beacon Research Lab., The Texas Co., Beacon, N. Y.

• Many instruments using electronic principles, either in whole or in part, have played an important role in research and testing in the petroleum industry. One of the most important, the mass spectrometer, used for the analysis of hydrocarbon gases is coming into use in the studies of hydrocarbon reaction mechanisms which employ heavy carbon (C^{13}) as a tracer element.

Desirable improvements in mass spectrometers would include increased stability and reproducibility in the behavior of the ion source, the use of a modulated ion source or ion beam to allow the dc amplifier following the electrometer tube to be replaced by an ac amplifier, and an increase in overall sensitivity. It is possible that a mass spectrometer based on the principle of the velocity selector, in which pulses of ions are produced by use of radar technics and the various masses separated by measuring the time of flight, could be developed which would have greater stability and reproducibility than the present instrument.

Another important analytical and research tool is the absorption spectrometer, using either ultraviolet or infrared radiation. Considerable improvement in radiation sources, ra-

diation detectors and amplifiers, as well as the development of servomechanism controls to make the instrument operation essentially automatic would be very welcome. The development of much more stable light sources for use with Raman spectrographs, as well as of photomultiplier tubes with a lower dark current, would increase appreciably the accuracy of analysis using the Raman spectrograph. With respect to emission spectroscopy, while the petroleum industry is not faced with the problem of turning out large numbers of analyses of metals, it is following with great interest the development of automatically operating and recording prism and grating spectrographs in the visible region.

Because of the rather laborious calculations frequently encountered in the application of the methods mentioned above to hydrocarbon analysis, the petroleum industry is interested in the development of electronic computers to simplify the application of analytical methods. Although computers now available are excellent, still further increases in speed, and possibly in accuracy, are desirable.

There are a variety of instrumentation systems which now require the use of photographic recording

in order to obtain the desired high speed. The development of higher speed pen-and-ink or direct reading recorders would be of great value to the petroleum industry.

An application of electronics which is becoming of increasing importance to the petroleum industry is the use of amplifiers and electronic counting or scaling circuits with Geiger-Muller counters, both in the measurement of x-ray intensity and also in connection with the tracer studies using radioactive isotopes.

Counting circuits

Here this chief interest lies in the development of Geiger-Muller counters, amplifiers, and counting circuits having shorter resolving times, in order to obtain the increased accuracy and decreased observation time associated with higher counting rates. The carrying out of analyses of organic materials by the measurement of x-ray absorption by means of Geiger-Muller counters or fluorescent screen-photomultiplier combinations is an interesting field requiring further development. The Texas Company has been active in this field and has developed a new type of radiation detector characterized by extremely high sensitivity and reliability.

In the petroleum industry thousands of viscosity measurements are made daily. Although the problem is a difficult one, the development of a device which would permit routine viscosity measurements to be made almost completely automatically, and yet with the precision of the order of 0.1%, which is now commonly obtained, would be of tremendous value to the industry.

Microwave equipment

The application of microwave absorption as an analytical tool, as well as in research, is a field which is just beginning to be explored. It promises to be of great value to the petroleum industry, and electronic problems of the first order must be overcome before this powerful tool can be placed upon a routine basis.

In connection with the testing of fuels and lubricants, electronic devices are finding increasing applications. Knock meters for measuring the intensity of knock in engine cylinders, and pressure measuring and recording devices for recording pressure-time or pressure-volume curves are becoming more and more widely used. There is still plenty of room for electronic progress in this field, particularly the development

of a simple and rigid pressure time indicator capable of being accurately calibrated and essentially independent of fluctuations in the engine temperature.

Since the piston temperature plays an important role in controlling oil deterioration in an engine, a knowledge of it is extremely important in interpreting engine tests of lubricating oils. Therefore, the development of an electronic means of measuring piston temperatures which would not involve the sliding or intermittent contacts which are such a troublesome feature of the methods now in use, would be of great value.

In view of the ever-increasing importance of finding new oil reserves, and of making optimum use of the oil reservoirs now producing, the development of improved methods of geophysical prospecting for new oil fields and of determining the location and capacity of producing sands would be valuable. There is an opportunity for the development of improved well-logging devices and seismic geophysical prospecting equipment.

In the well-logging field both gamma ray and neutron detectors are used. One of the desirable features of these devices is increased sensitivity of the detecting devices

to permit more rapid survey of the bore hole, as well as greater freedom from errors due to high temperature in the well. For off-shore prospecting where the precise location of the drilling rig is important, a variety of radio locating devices which are capable of considerable precision are available.

Corrosion problems

The problem of pipe-line and storage tank corrosion is a perennial one which offers a considerable field for the development of electronic devices for the measurement of the electrical conditions causing corrosion and for the application and control of cathodic protection. There is a need for improved pipe-line locating devices, especially one capable of picking out a particular line in a congested area in which many other lines are located near the desired line, or an instrument capable of locating deeply laid lines.

The application of electronic plant control devices in the refinery is still in its infancy, presumably due to the fairly adequate job done by the pneumatic or hydraulic control systems now used. As the number of refinery processes calling for more accurate control of more complex operations increases, superior

(Continued on page 116)

FOOD INDUSTRY BETTERING QUALITY

By HAROLD K. STEELE

Fleischman Laboratories, New York

• Color is one of the important characteristics of many food products. Although there are now available many color measuring instruments ranging from simple color comparators to precise spectrophotometers, none are satisfactory. The industry needs a sensitive, rugged and foolproof device which can be used for making objective color determinations on all classes of products. The color difference between top quality and ordinary quality is often quite small when measured with the instruments available today, but is none the less visible to the eye of the buying public.

In processing many foods, rapid heating is essential for the production of a top quality product. High frequency heating has been successfully used in some instances, but is still too expensive to have wide application. An electronic blancher that would heat whole fruits or vegetables to the proper temperature for enzyme inactivation in a few seconds while the product was

moving on a conveyor belt is but one of many interesting possibilities. In addition, this form of energy could be used for baking, cooking, dehydration, defrosting, melting, etc., provided efficient and economical equipment can be developed for its production.

The determination of moisture is another test for which electronic methods might be further developed. There are already some instruments produced for this purpose, but they are not in general use. Many products are cooked to a definite moisture content. A rapid automatic control system for such products would almost certainly result in improved quality and lowered costs. Such a control system would be invaluable in the food dehydration industry.

The list of applications for improved electronic methods could be extended indefinitely. There is hardly a process in the food industry that could not be improved by the use of electronic methods.

THERMAL DETECTORS

Newest types of temperature units having extreme sensitivity find numerous uses with radiation indicators in industry

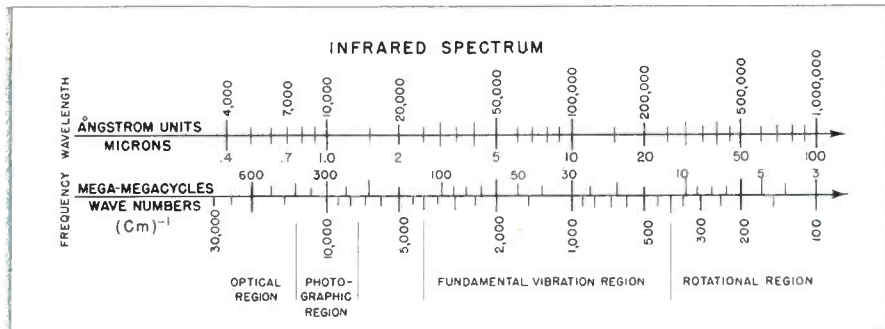

Fig. 1—Comparison of wavelength reference scales used in infrared studies

● In numerous diversified fields of research and measurements, there has been a need for increased sensitivity in a thermal radiation indicator. Developments along several lines have resulted in notable extensions to the measuring range of these devices. Most of these advances have been electrical in nature, which makes them particularly adapted to electronic amplification for making smaller variations known or for operating recorders or controllers.

Resistance thermometers, called bolometers, thermistors, etc., represent one class of instrument either capable of taking note of extremely small changes in resistance, or containing materials that exhibit large changes in resistance with small values of incident heat. Some use has been made of the phenomenon of super-conductivity exhibited by many conductors at temperatures approaching absolute zero.

In some materials such as tantalum the transition between the normal conductivity and super-conductivity states occurs quite abruptly at a definite point (that is reversible) along the temperature scale. If the ambient temperature is critically controlled to within this transition range—(possibly .01 to .02 degree) any small amount of heat applied will cause enormous changes in the relative resistance. This interesting discovery made the phenomenon so valuable a method of measuring small amounts of heat that the difficulties of producing the necessary precisely regulated temperatures between 14° and 16° Kelvin were overcome.

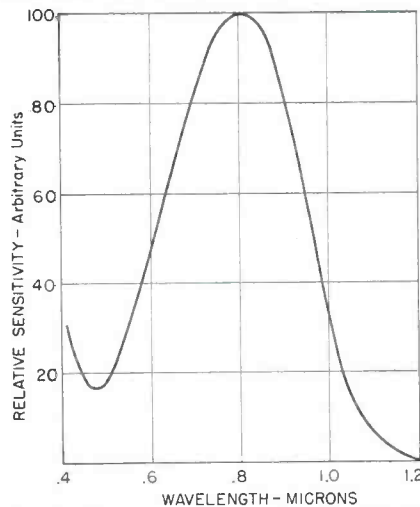

Fig. 2—Typical spectrum curve for type S2 photoelectric surfaces Fig. 3—Dr. J. A. Baker (Bell Laboratories) demonstrates form of flake graphite bolometer having extremely high sensitivity

Another class of bolometer includes thermocouples which deliver a potential in accordance with the laws of Peltier and those of Kelvin. While thermocouples are still serving mainly in applications where sensitivity is not a factor, some work has been done at low ambient temperatures where the sensitivity characteristic is improved because of the increased thermoelectric power and a better resistivity/absolute temperature factor. Other improvements have been along the line of better adaptation to amplification circuits.

Radiometers generally utilize effects of incident heat other than resistance changes. Photoelectric amplification of torsional movements has been used. Developments along the principle of the Hays cell have also greatly increased its sensitivity. Here the absorption of heat by gas filling of the cell alters the contour of a thin film which forms on one wall of the container.

Another method of approach has been to extend the range of photoconductive cells into the infrared region. (See Fig. 1). One, a lead sulfide cell is capable of operating

(Continued on page 116)

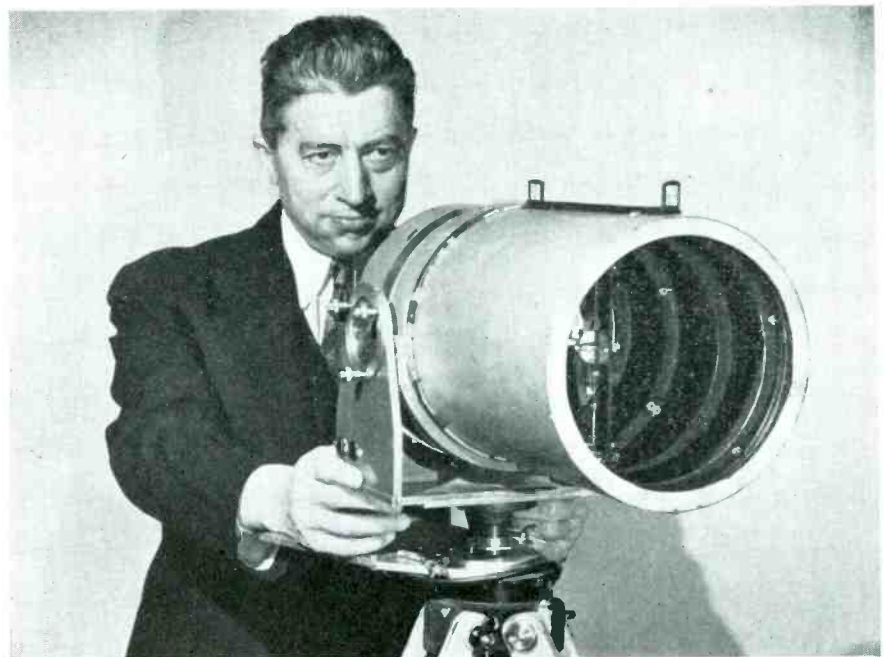

RADIOACTIVITY METER

By **ARTHUR G. BOUSQUET**

General Radio Co., Cambridge, Mass.

Electronic engineering makes another contribution to the development of atomic energy for constructive purposes

● With nuclear research and nuclear engineering programs rapidly being formulated by universities, hospitals and various industrial and government groups, the need for instrumentation in this comparatively new field has increased the importance of the Geiger counter and its associated equipment. The Geiger counter is used to detect and count the bursts of energy and the particles which are emitted from the nuclei of radioactive materials. Two familiar applications are the quantitative measurement of radioactive materials and cosmic ray research.

A most promising field is in conjunction with radioactive isotopes, since the advent of the cyclotron has made possible the production on a usable scale of several hundred such isotopes. The radioactivity of these isotopes provides a tracer, by means of which their course in chemical and physical processes can be followed with the counting-rate meter. The present applications of this technic include problems in medicine, chemistry, geology, meteorology and agriculture. In industry also this counter has been found useful—notably in petroleum prospecting.

The development of the counting rate meter described in this article was started before the war as a cooperative endeavor by interested groups at Massachusetts Institute of Technology and the General Radio Co. Several such instruments have seen service in various projects during the war and improved designs are now being produced on a commercial basis.

Counter operation

If a low voltage is applied to two adjacent electrodes in an ionized gas, the positive ions will be attracted toward the negative electrode and the negative ions will migrate to the positive electrode. If the voltage is just sufficient to

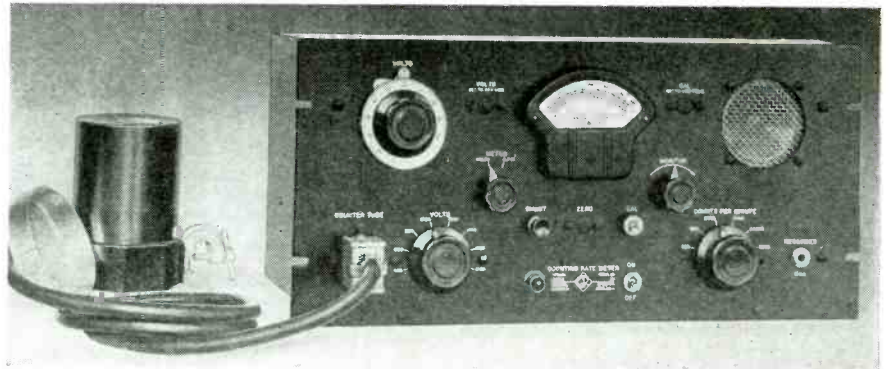

Fig. 1—Panel view of the type 1500-A meter with its associated pre-amplifier and probe assembly

draw the ions out of the area, the device is called an ionization chamber and the current flow is a measure of the number of ions in the field. However, if the applied voltage is sufficiently increased, an ionizing particle or ray will initiate a continuous discharge which stops only due to a reduction of the interelectrode voltage. The device

Fig. 2—Connecting a plug-in type beta ray counter to radioactivity meter pre-amplifier



operating under these conditions is called a Geiger counter.

If a large resistance is placed in series with the voltage source and the Geiger counter, the discharge will quench itself. This is because the electrons produced in the gas by ionization move with high velocity to the positive electrode, altering its potential and leaving a slowly moving positive ion sheath which then travels to the negative electrode. The high resistance prevents the potential of the positive electrode from recovering before all positive ions (which might start new discharges) have been neutralized. A similar quenching action may be obtained by means of vacuum tube circuits.

As a result of this quenching action, each discharge pulse is an indication that a charged particle has entered the counter. Furthermore, there is a regulatory action so that the counter may be operated over a voltage range where the current due to an ionization cycle will be fairly constant. The center of this current "plateau" is the usual operating point of the Geiger counter. Proper counter design is concerned with the resolving time or speed with which the quenching action takes place, its freedom from temperature and humidity effects, the broadness of the plateau, stability,

FOR NUCLEAR RESEARCH

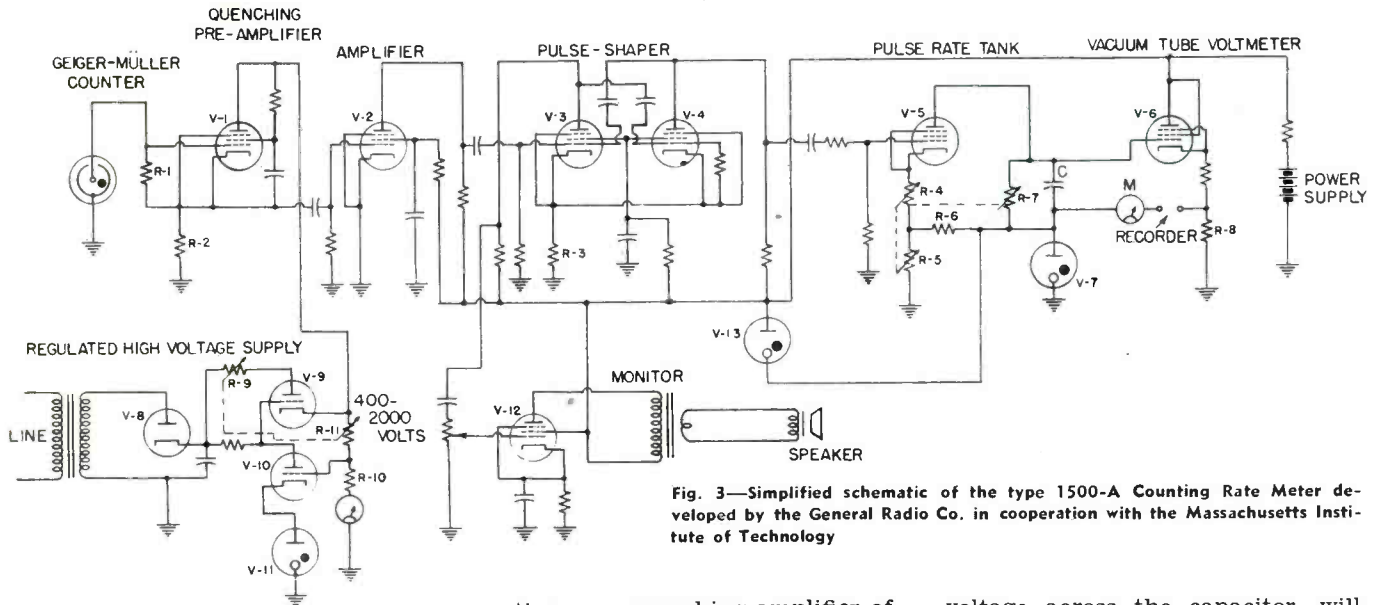

Fig. 3—Simplified schematic of the type 1500-A Counting Rate Meter developed by the General Radio Co. in cooperation with the Massachusetts Institute of Technology

aging characteristics, efficiency and life.¹

In the counting-rate meter to be described, the discharge pulses produce a voltage which indicates at any moment the rate per minute of the incoming pulses. With a voltmeter actuating a pen-and-ink recorder, a running record is obtained, showing the past and present history of the radioactive emissions.

This meter is shown in Fig. 1 and a close-up of a beta-ray counter with its preamplifier is shown in Fig. 2. The plug-in type counter and its preamplifier are housed in a separate small compartment at the end of a cable to provide greater flexibility of operation.

Circuit description

In the circuit of Fig. 3 the Geiger counter is placed in series with R-1 and V-1, the anode of V-1 being connected to an electronically regulated voltage supply consisting of V-9, V-10 and V-11. In the absence of radiation, little or no current flows in R-1, leaving the grid essentially at zero bias with a consequent low voltage drop across the anode circuit and a relatively high voltage across the Geiger tube.

When gas in the Geiger tube becomes ionized as the result of bombardment by nuclear particles, a current flow takes place that can be stopped, or "quenched," only by reducing the applied voltage. This reduction is performed by V-1, op-

erating as a quenching amplifier of a modified Neher-Pickering type.¹ Any current flow through R-1 will increase the grid bias of V-1, thereby reducing the anode current and lowering the voltage drop across the Geiger tube below the critical value required for continuous discharge. This restores the circuit to its quiescent state to await the next impulse. The speed at which V-1 is able to perform its quenching and voltage restoring function safely exceeds the transit time characteristics of the best available Geiger counters.

The output at the cathode of V-1 consists of a sharp negative pulse which is amplified by V-2 and shaped by V-3 and V-4, appearing at the output of V-4 as a greatly amplified positive pulse. Since from this point there is regenerative feedback to the grid of V-3, the output pulses will depend only in their time distribution on the input pulses, but will all be identical in shape and magnitude.

The integrator tube, V-5, is biased beyond cutoff. Each positive pulse appearing at its grid causes a definite amount of current to flow in the anode circuit; hence, the capacitor C in the anode circuit will absorb a definite quantity of charge for each incoming pulse—an integrating process. The resistor R-7, however, introduces a differentiating factor, since it allows the impounded charge to leak out of the capacitor at a given rate dependent on the RC time constant. The residual charge, as indicated by the

voltage across the capacitor, will depend entirely on the rate at which charging pulses have been coming in, since these pulses are all of equal amplitude and duration.

The pulse rate, in counts per minute, is indicated by a vacuum tube voltmeter² connected across capacitor C. This capacitor has been specially wound with polystyrene tape to reduce to a negligible value the effect of its dielectric absorption on the accuracy of differentiation.

The full scale meter current is 5 ma., suitable for operation of most ink recorders, and the range of pulse rates is extended by using different values of bleeder or differentiating resistors at R-7 and by varying the amount of degeneration caused by R-4 in the integrator tube. Full scale ranges of 200, 600, 2000, 6000 and 20,000 counts per minute are thereby obtained. A monitoring loud speaker, shown schematically in Fig. 3, is provided for convenient estimation of the counting rates.

The voltage supply to the counter may be adjusted to any value between 400 and 2000 volts and is electronically regulated to maintain the operating voltage of the Geiger counter at a fixed point near the center of the useful portion of its characteristic plateau.

¹"Electron and Nuclear Counters—Theory and Use," Korff, D. Van Nostrand Co., Inc.

²U.S. Patent No. 2,374,248.

See also "Design and Operation of an Improved Counting Rate Meter"—A. Kip, A. G. Bousquet, R. D. Evans and W. N. Tuttle. Review of Scientific Instruments, Vol. 17, No. 8 (August, 1946).

FOR RESEARCH

What's New for the Industrial Laboratory

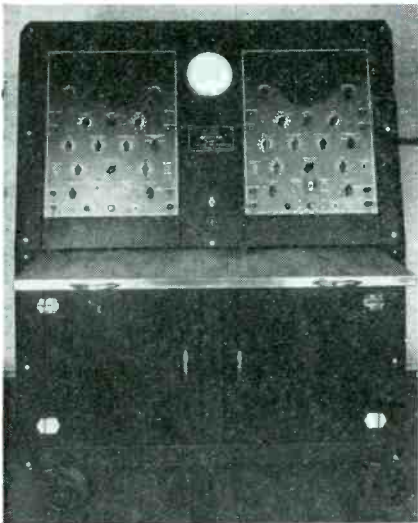

Dual-Channel Oscilloscope

The Electronic Tube Corp., 1200 E. Mermaid Ave., Chestnut Hill, Philadelphia 18, has developed a line of two-channel oscilloscopes for simultaneous display of two phenomena on a single cathode-ray tube screen. Type E-2G47 comprises two standard oscilloscopes coupled to a special dual-gun cathode-ray tube. Independent control of intensity, focus, trace position, sweep rate and deflection sensitivity is possible, since each channel contains its own X, Y and Z axis amplifiers, time base oscillator and power supply. Terminals in the rear permit direct connection to all eight deflection plates as well as the two second anodes.—Electronic Industries

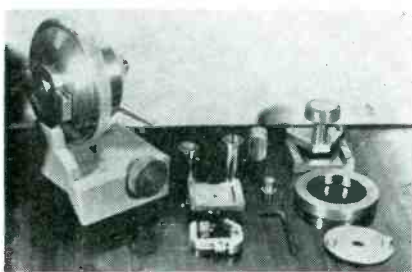

Micro X-Ray Diffraction Camera

As an accessory to the Norelco X-Ray diffraction unit, the North American Phillips Co., Inc., 100 E. 42nd St., N. Y., has designed a special camera that permits detailed study of very small areas of the materials under X-ray examination. The equipment includes a demountable camera unit, the film cassette of which is provided with a beam stop as well as a hose connection for evacuation or gas filling of the film chamber. Special holders enable examination of specimens requiring tension, as well as microtomed sections and other flat objects. The camera kit is supplied complete with a microscope adapter, extra film spacer, wrenches, film punch and instructions, packed in a special instrument case.—Electronic Industries

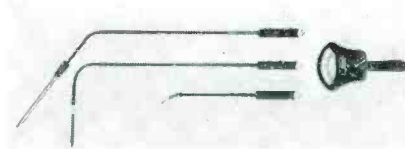

Portable Pyrometer

A portable pyrometer with a choice of plug-in angle extensions has been designed by Wheelco Instruments Co., 847 W. Harrison St., Chicago, Ill. The instrument permits use of a variety of thermocouples by means of straight, 45° or 90° angle extensions. The high resistance meter has scales calibrated from 0° to 600°F for dual iron-constantan and from 0 to 1600 or 2500°F for dual chromel-alumel. Centigrade equivalents are shown on the dial.—Electronic Industries

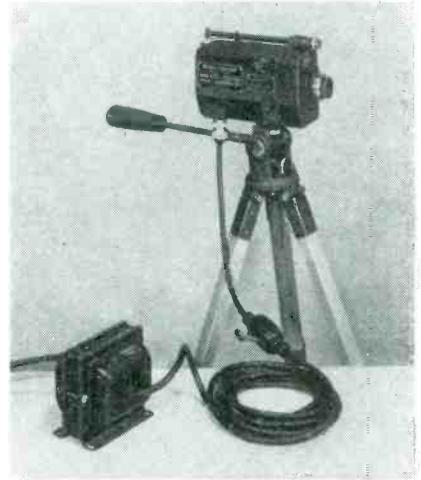

High-Speed Camera

For time and motion study work Bell and Howell Co., 7100 McCormick Rd., Chicago 45, Ill., has brought out the Filmo "Electro" motor-driven 16 mm motion picture camera. The camera is equipped with a 21 mm F 1.9 lens with viewfinder and matching objective. Operating speeds are 1000, 2000 and 4000 frames per minute with calibration in multiples of 1000 frames per minute. A transformer is provided for operation on the ac supply line.—Electronic Industries



Wide Range V-T Volt ohmmeter

The Hewlett-Packard Co., 395 Page Mill Rd., Palo Alto, Calif., has a new Model 410A high frequency vacuum-tube voltmeter, incorporating a special probe diode tube developed by Eimac for this instrument. The probe input capacity has been reduced to 1.3 mmfd, permitting measurements from 20 c/s to 700 mc. An effective ac impedance of 6 megohms is maintained up to 10 mc while the input resistance on dc ranges is 100 megohms. The instrument measures up to 300 rms volts, 1000 dc volts and 500 megohms.—Electronic Industries

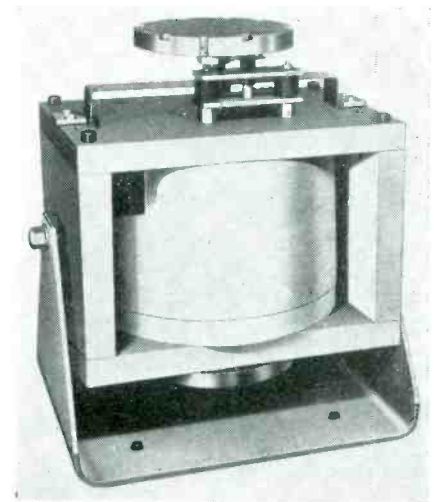

Shake Table

A source of synthetic vibration for testing resonant modes of mechanical structures has been developed by the Vibration Division of the MB Mfg. Co. Inc., 333 East St., New Haven 11, Conn. Known as the MIF vibration exciter and calibrator, this machine has an 8.5 in. diameter table driven by an electro-magnetic vibrator motor capable of imparting forces up to 200 lbs. peak having a maximum excursion of one inch. Mounted on a pivoted cradle, the table and motor are operated by separate motor driven alternators (not shown) which provide variable frequency excitation of the vibration motor over a range from 3 to 500 c/s. The motion of the table is sinusoidal and a signal coil provides an output reference voltage for use in calibrating vibration pickups.—Electronic Industries

AND DEVELOPMENT

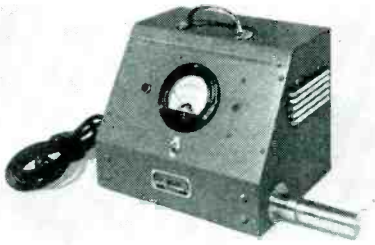

Radiation Intensity Meter

An instrument that serves as indicator of radioactive intensity and gives an audible warning signal when maximum safe dosage values are exceeded, has been developed by Geophysical Instrument Co., Arlington, Va. The device is unaffected by line voltage changes of plus or minus 15 volts. A switch for checking calibrations is provided. The unit consumes 40 watts at 115 V., 60 cycle.—Electronic Industries



Reflection Meter

Spectral reflectance characteristics of materials may be determined by use of the reflection meter in production at General Electric Co., Schenectady, N. Y. The instrument consists of an optical system for viewing the sample, two type PJ-22 vacuum phototubes, an amplifier tube with plate current meter, and nine narrow-bandpass filters for isolating parts of the spectrum. The unit is usable throughout the visible range and has a precision of 0.1% on samples having reflection values from 50 to 100%. Operates on 8 amp., 6 V. storage battery and 135 V. "B" batteries.—Electronic Industries

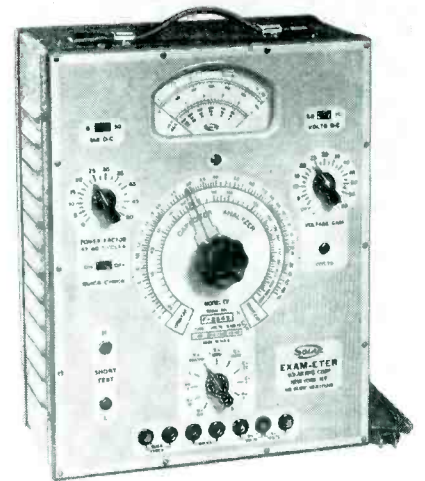

Capacitor Analyzer

Model CF EXAM-ETER, manufactured by the Solar Mfg. Corp., 285 Madison Ave., New York 17, is a capacitor analyzer combining a Wien bridge for capacitor measurement and a Wheatstone bridge for resistance measurement with an ac-dc vacuum-tube voltmeter. The instrument measures capacity from 10 mmf to 2000 mf, power factors from 0-55%, resistance from 100 ohms to 10,000 megohms and has dc voltage ranges up to 550 volts and ac voltage ranges to 50 volts. Shorted, open or intermittent capacitors can usually be located without removal from the circuit and without turning off power to the equipment under test. Leakage current of electrolytic capacitors may also be read on the 4 1/2 in. recessed meter, using a self-contained test voltage source adjustable from 0 to 550 dc volts.—Electronic Industries

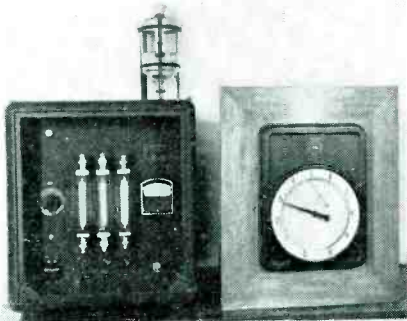

Contamination Checker

Contamination of the atmosphere through carbon tetrachloride, trichlorethylene, chloral etc. may be checked by use of the Westvaco halogenated hydrocarbon analyzer offered by Industrial Instruments, Inc., 17 Pollock Ave., Jersey City, N. J. The semi-portable unit operates on 115 volt, 60 cycle ac supply and consumes approximately 1000 watts. Distilled water is used at a rate of less than 1 liter per hour. Hydrogen consumption is approx. 1 cft. per hour of normal operation.—Electronic Industries

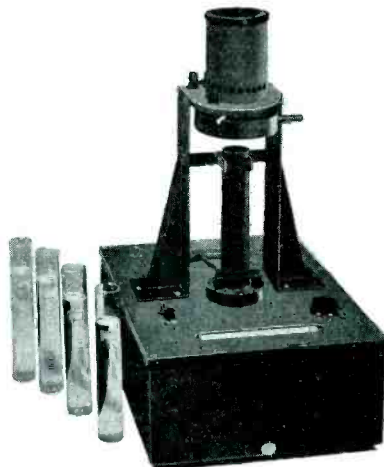

Photoelectric Colorimeter

For measuring light transmission of liquids in Nessler tubes the Lumetron colorimeter (Model 150) is offered by Photovolt Corp., 95 Madison Ave., New York. The photoelectric instrument utilizes a light beam passing vertically through the long liquid column making it particularly suitable for measurement of samples of pale colors or faint turbidity.—Electronic Industries

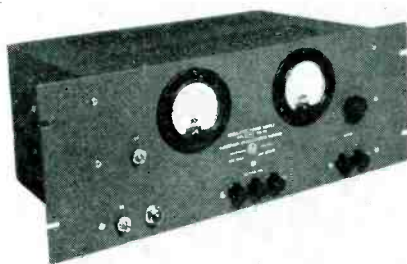

Regulated Power Supply

Electronic Measurements Co., Red Bank, N. J. offers model 200B power supply for operation on 105 to 125 V. ac 50-60 cycles. The unit supplies 0-325 V. dc at 125 ma and 6.3 V. at 6 amps, unregulated. Regulation of the unit is 1% for voltages between 20-235 volts from no load to full load and for line voltage variation from 105 to 125 volts at full load. Power consumption at full load is 220 watts.—Electronic Industries

Fluoroscope

An auxiliary fluoroscope to be used in conjunction with the Searchray 150 unit is being offered by North American Philips Co., 100 E. 42 St., New York. Consisting of a collapsible pipe framework with auxiliary fluoroscopic screen, the device makes it possible to reduce the distance between specimen and tube target to approx. one-half, thus quadrupling screen intensity and improving the clarity of the image.—Electronic Industries



Insulation Resistance Tester

An insulation resistance tester with a range from 0 to 100 megohms which does not require any external power supply is in production at Ideal Industries, Inc., 5194 Park Ave., Sycamore, Ill. A test voltage of 500 volts dc is provided by a small internal hand generator. An electronic voltage regulator controls the voltage at the meter.—Electronic Industries

NEW COMPONENTS

What's New in Instrument Parts and Accessories



Pressure Switches

Three pressure switches of the fixed differential, adjustable differential and reset type for pressure control applications are being marketed by Aerotec Co., White Plains, N. Y. The units consist of a micro-switch rated 100-115 v ac, and a pressure mechanism of the metal bellows type. The switches are available for a wide variety of pressure ranges and contact arrangements.—Electronic Industries

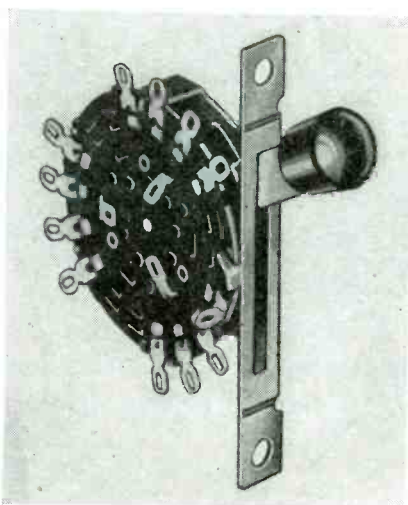

Switches

A new line of lever action switches, series 5000 and 6000, is being manufactured by P. R. Mallory and Co., Indianapolis 6, Ind. The switch has a total of 26 circuit combinations including two, three and four positions. Contacts will make and break 120 ma at 110 volts dc or 50 ma at 250 volts dc and will carry 10 amps. without excessive heating.—Electronic Industries

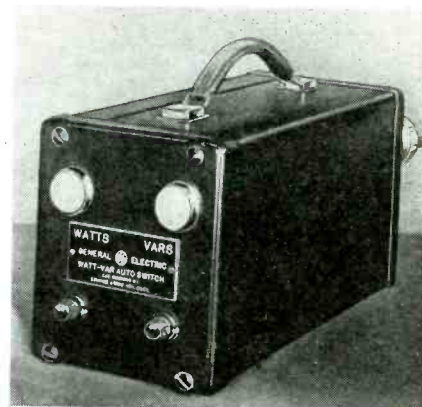

Automatic Switch

The Watt-Var autoswitch, an instrument that permits the recording of both watts and vars on an inkless-type recorder is in production at General Electric Co., Schenectady 5, N. Y. The device consists of two autotransformers, a time switch, two dpdt relays and indicator lamps. The time switch is factory set for 35% of the time on vars and 65% on watts, but may be adjusted to another interval. The switching interval is one complete cycle per minute.—Electronic Industries



Four Gun CR Tube

For industrial applications requiring four separate signal indications the 5Z4P type cathode ray tube has been developed by Electronic Tube Corp., 1200 E. Mermaid Ave., Philadelphia 18, Pa. The tube has a 5 in. screen, electrostatic deflection and focus and is available with screen phosphors P1, P2, P4, P5, P7, P11 and P12. Deflection plates are brought out to 16 separate terminals and a 27 pin special base is used.—Electronic Industries

Additional new products for Instrumentation are described on following pages and also on pages 106, 108 and 110.

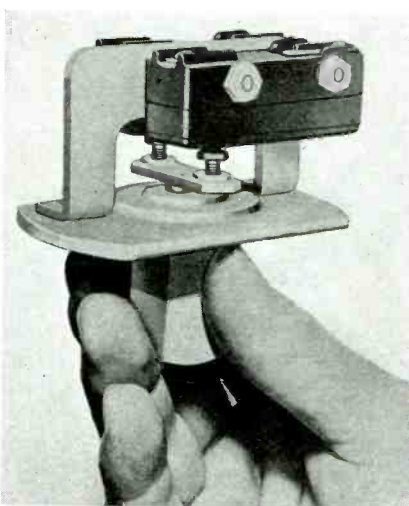

Differential Switch

A two section pressure switch has been developed by Cook Electric Co., Bellows Devices Division, 2700 Southport Ave., Chicago 14, for controlling two separate circuits in response to pressure differentials. Operating on pressures from 1 to 17 psi, the "ID" type switch may be supplied with either element adjusted to on-off differentials from 1 to 10 psi. Maximum current rating is 10 amps. at 120 volts ac and the pressure connection fits standard 1/4 in. female pipe threads. The enclosed, snap action contacts are calibrated to order, but may also be adjusted after installation. Similar switches can be supplied for operation on pressures up to 200 psi.—Electronic Industries

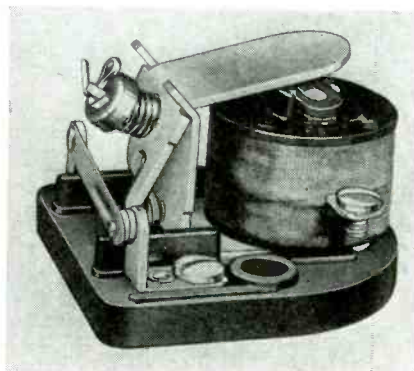

Motor Starting Relay

A voltage actuated motor starting relay, which operates on the back voltage of the starting winding, has been brought out by Potter and Brumfield Mfg. Co., 549 West Washington Blvd., Chicago 6, Ill. After the motor has attained the proper speed the relay disconnects the starting coil from the line. The relay operates over a wide range of line voltage variations. It may be mounted on the motor housing or located at a distance.—Electronic Industries

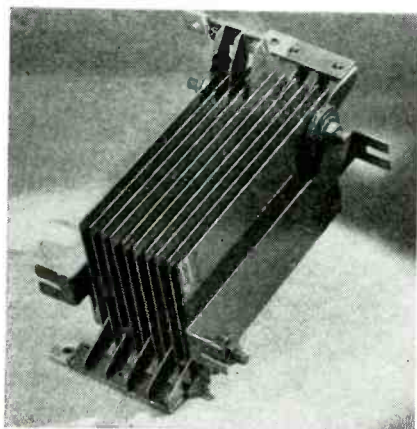

Heavy Duty Selenium Rectifier

A heavy-duty selenium stack with 26-volt plates, double studs and center contact construction is in production at Federal Telephone and Radio Corp., Newark, N. J. Rectangular, square-cornered plates are used for the stack, which may be mounted in a vertical or horizontal position.—Electronic Industries

Pilot Light Assemblies

A series of pilot light assemblies fitted with lightshields to permit direction of a beam of light at any angle is available from Dial Light Co. of America, 900 Broadway, New York 3. Housing and shield of the unit are brass and models with different sizes of shield openings for change in illumination are available. The series is provided with a built-in resistor for use with NE-51 Neon lamps on 110 and 200 volt circuits.—Electronic Industries

for INSTRUMENTATION

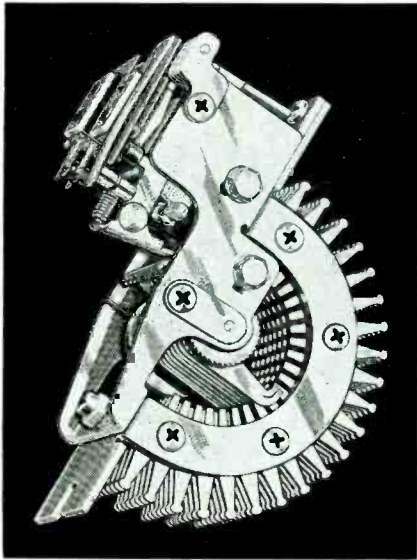

Stepping Switch

A spring driven stepping switch which, in conjunction with an impulsing device, will select any one of 20 or 40 channels and may be used for sequencing, counting and totalizing operations is being offered by C. P. Clare Co., 4719 West Sunnyside Ave., Chicago 30, Ill. Max. operating speed is 60 steps per second with 8 contacts available for a 20 point switch and 4 contacts for a 40 point switch.—Electronic Industries

Thermal Delay Relay

Time delay and control functions are combined in the model 501 thermal delay relay being manufactured by Instrument Div., Thomas A. Edison, West Orange, N. J. Accurate timing is possible with preset delay periods from 2 seconds to 8 minutes. The relay is supplied with either normally open or normally closed contacts and is rated at 6 amps up to 450 volts ac or 250 volts dc.—Electronic Industries Below, left

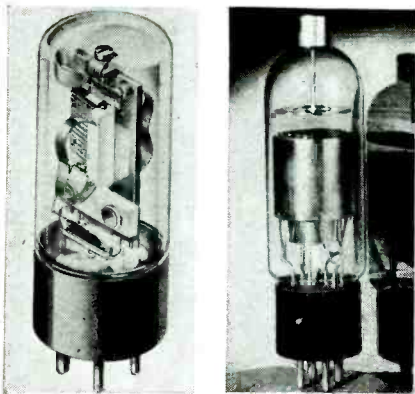

Grid Control Rectifier

Electrons, Inc., 127 Sussex Ave., Newark 4, N. J., has brought out a grid control xenon gas rectifier tube, type EL C3J. The tube has a filament voltage of 2.5 volts, filament current 9 amps., peak forward voltage of 750 v., average dc of 2.5 amps. and a peak plate current of 30 amps.—Electronic Industries

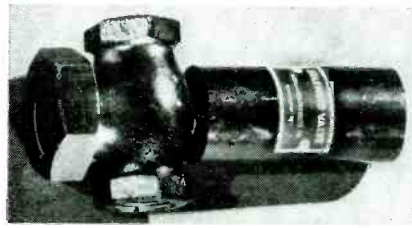

Solenoid Valve

Distillation Products, Inc., Rochester, N. Y., has developed a solenoid valve for high vacuum equipment designed to be used in conjunction with a recording potentiometer. The valve is normally held in an open position, but closes instantly when the electromagnet is energized. It operates on 110 v dc.—Electronic Industries

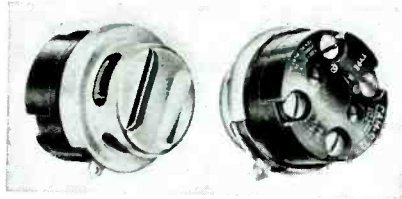

Thermostat

A small general purpose thermostat for 120 to 240 v ac with a current carrying capacity of 1500 volt-amperes has been designed by Cam-Stat, Inc., 2037 South La Cienega, Los Angeles, Cal. The units are 1 9/16 in. in diameter and 1 7/32 in. in depth and may be had for a variety of temperature ranges from -50 to 350° F.—Electronic Industries

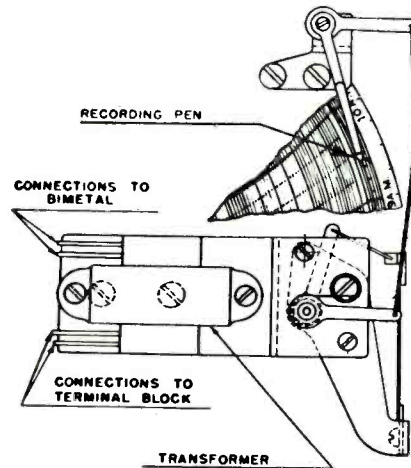

Process Recording Pen

An auxiliary pen for industrial process recorders is available from the Brown Instrument Co., div. of Minneapolis-Honeywell Regulator Co., 4515 Wayne Ave., Philadelphia 44, for attachment to standard Brown instruments. It records on-off cycling of power circuits for energizing pumps, compressors and other equipment, producing a trace that may be correlated with graphs of major process variables recorded on the same chart. It is actuated by a bimetallic strip which warps in response to the passage of current, producing a deflection of about 3/16th in. at 3 1/2 amps., the maximum current rating. Response lag is 10 seconds for maximum "on" deflection and 30 seconds for return to "off" position.—Electronic Industries

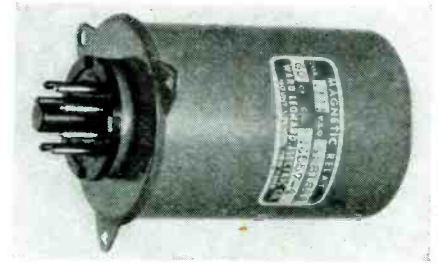

Heavy Duty Relays

Ward Leonard Electric Co., Mt. Vernon, N. Y., is manufacturing "Bulletin 130" relays for heavy duty industrial applications such as light contactor duty, control of single phase motors and other remote or automatic control purposes. Contact arrangements are available from one to four poles, normally open or closed, single or double throw. Operating voltages for dc relays are from 6 to 230 volts and for ac from 6 to 440 volts.—Electronic Industries



Flash Capacitor

The Speed-Pak Capacitron, an energy storage capacitor for high-speed repeating flash bulbs is being offered by Capacitron Co., 849 North Kedzie Avenue, Chicago 54, Ill. The unit, to be mounted behind the flash reflector, is hermetically sealed, oil dielectric.—Electronic Industries

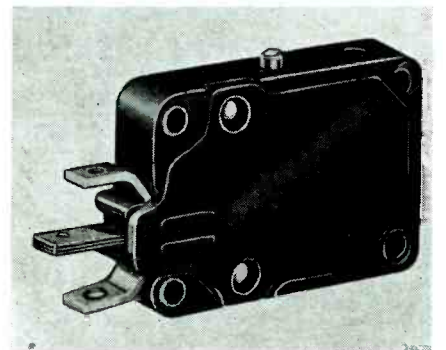

Miniature Switch

An improved snap-action switch is in production at Acro Electric Co., 1308 Superior Ave., Cleveland 14, Ohio, Model "M" is for single and multiple assemblies with single pole, single or double throw contacts rated at 10 amps, 125 volts ac.—Electronic Industries

FOR CONTROL

What's New in Industrial Instruments



Selenium Rectifier

The Spectrifier—a power supply utilizing a full wave selenium rectifier for electroplating applications—has been brought out by Special Chemicals Corp., 30 Irving Place, New York 3. The rectifier provides an output of 6 volts at 100 amps, and operates directly from the 110 volt, 60 cycle, ac supply line. Power consumption is approx. 1100 watts.—Electronic Industries



Induction Heaters

Two new models of electronic power generators of 2 and 15 KW output for heat treating, brazing and soldering are available from RCA Victor Division, Camden, N. J. The illustrated 2 KW unit, model 2-BL, operates at a frequency of 400 kc and is shown complete with applicator unit, generator and foot switch. The 15 KW unit, model 15-BL, has the applicator unit with output current transformer and associated hf elements in a separate console.—Electronic Industries



Photo Timer

Model TM-5-R electronic photo timer for operation with a remote control foot-switch has been developed by Lectra Laboratories, 30 E. 10 St., New York. The unit provides 55 time intervals from .2 to 11 seconds and 50 intervals from 11 to 60 seconds. Accuracy is within .05 sec. or 10% of the pre-set interval. The timer operates on ac or dc.—Electronic Industries

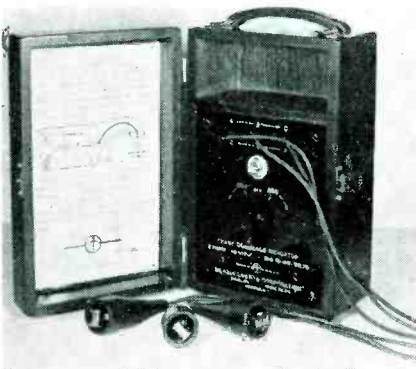

Phase Sequence Indicator

To identify the leading and lagging terminals of a three-phase source of electric power, the Measurements Corp. of Boonton, N. J., has produced a simplified phase sequence indicator having no moving parts. In operation, one terminal of any 220 to 600 volt three-phase supply is connected to the resistive arm of a "Y" type network in the instrument, while the other two terminals are connected respectively to inductive and capacitive arms of the network. By means of a panel switch the reactive arms may be interchanged to place the leading and lagging currents in the resistive arm in either aiding or opposing phase. When in aiding phase, sufficient voltage is developed across the resistive arm to light a gaseous discharge tube connected across this arm. The phase sequence of the terminals is then indicated by the position of the panel switch. The determination of phase sequence is essential to proper connection of the polyphase motors frequently used on industrial equipment, as well as for the operation of watt-hour, power factor and VAR meters on three-phase lines.—Electronic Industries

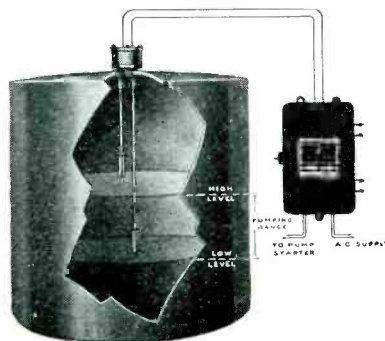

Level Control

Photoswitch level control series 10 for controlling the level of all electrically conductive liquids is in production at Photo-switch Inc., Cambridge 42, Mass. The floatless control operates with low voltage in the probe circuit and may be matched to the specific resistivity of the liquid. A single pole, double-throw relay is provided in the output of the unit which is designed for operation on 115 or 230 volt 50/60 cycle ac.—Electronic Industries

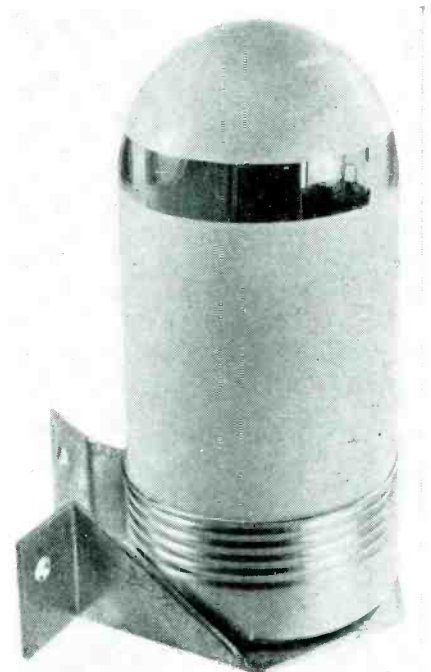

Multiple Street Light Control

A photoelectric control for multiple street lights, which will operate for any preset value of sky illumination from 1/2 to 6-ft. candles, is in production at Fisher-Pierce Co., 82 Ceylon St., Boston 21, Mass. The control functions over a voltage range of 105 to 130 at 50 to 60 cycles and has an incandescent lamp load capacity of 500 watts. It consumes 6 to 7 watts.—Electronic Industries

AND PROCESSING

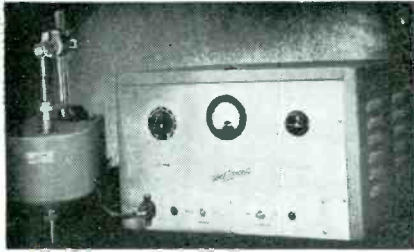

Bench Welder

A stored energy self forging bench welder for spot welding of similar or dissimilar metals and alloys is in production at Vangtronic Corp., 87 Washburn St., Bridgeport, Conn. The welder permits a speed from 30 to 180 spots per minute. It operates on 110 to 120 volt, 60 cycle, ac.—Electronic Industries



Line Voltage Regulator

An addition to a line of ac line voltage regulators is the model 500 now in production at Sorenson and Co., Stamford, Conn. The regulator will maintain output voltage within $\pm 0.5\%$ of adjusted value for variations of input voltage from 95 to 125 and load variations from 50 to 500 va. The unit operates independently of frequency variation up to 10%, has harmonic distortion of less than 5% and a transient recovery time of approx. 4 cycles.—Electronic Industries

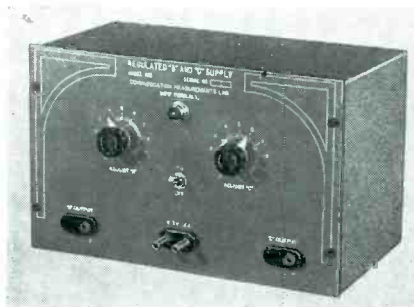

Dual Power Supply

Two independent regulated power sources are provided by the CML 1115 dual power supply developed by Communication Measurement Laboratories, 120 Greenwich St., New York, N. Y. A continuously variable dc voltage from 180 to 300 volts at 70 ma with a ripple of less than 25 MV is available for plate supply. Grid bias is furnished continuously variable from 0 to 75 volts with less than 7 MV ripple.—Electronic Industries



Process Timer

A utility process timer (Type TA) which has a synchronous motor that actuates a pair of heavy silver contacts rated at 1000 watts load has been brought out by Potter and Brumfield Sales Co., 549 West Washington Blvd., Chicago 6, Ill. Available in time cycles from 0-15 minutes up to 0-12 hours, the timer may be set to any desired time interval, the minimum being approx. 1% of full range.—Electronic Industries

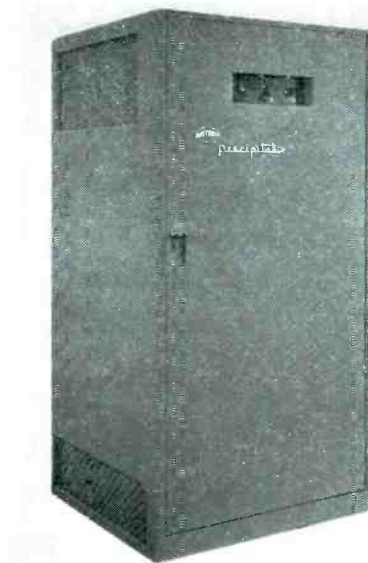

Electronic Precipitator

A 1200 CFM precipitator unit, which is designed to remove 90% or more of all contaminating particles of dust, smoke oil mist, lint or pollen from the air has been developed by the Industrial Electronics Div., Raytheon Mfg. Co., Waltham, Mass. The precipitator is supplied complete with $\frac{1}{4}$ h. p. motor blower, power pack and collector cell for operation on 115 volts, 60 cycle ac. Power consumption is 50 watts.—Electronic Industries



Variable Transformers

General Radio Co., Cambridge 39, Mass., has developed the V-5 series of Variac auto-transformers designed to replace the type 200-C. The new series has been reduced in weight and uses a unit brush, which may be changed without tools. The 115 volt models are rated at 5 amps with a max. current of 7.5. The power rating is .862 KVA.—Electronic Industries

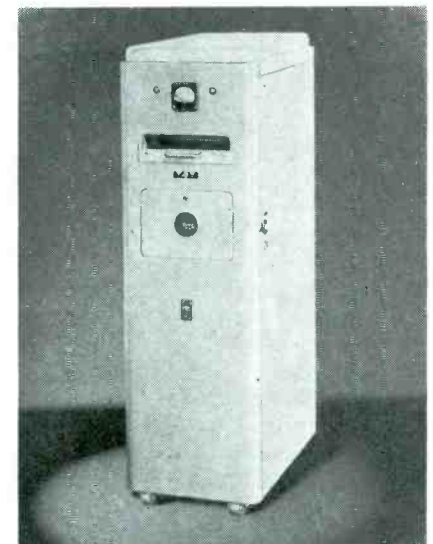

Portable HF Heater

A portable high frequency dielectric heating unit, model 18XO, for the plastics molding industry is in production at Thermex Div., Girdler Corp., Louisville, Ky. The unit has an output of 1 kw and will raise the temperature of approx. 1 lb of general purpose material 170° F in one minute.



Positioning Equipment

DC positioning and indicating equipment to be operated from the ac or dc line is being manufactured by Allis-Chalmers, Milwaukee, Wis. The equipment, which consists of receivers and transmitters, has wide applications in oil fields, steel mills, steam and hydroelectric plants, etc. The relative strength of the magnetic fields of the stator determines the position that the permanent magnet rotor of the receiver will assume.

ELEMENTS OF A NEW

By **ELMER C. SIMMONS**

Browning Laboratories, Inc., Winchester, Mass.

Recent circuits derived from radar research are combined in a new cathode-ray instrument for general laboratory use

• During the past several years the cathode ray oscilloscope has become an indispensable tool in electronic research laboratories. It has proven its superiority over conventional indicating devices in routine test applications where it is able to give simultaneous qualitative and quantitative analyses of electrical phenomena. Recent advances in the electronic art, however, have taken place at such a rate that the average oscilloscope has become inadequate for many applications.

The instrument to be described was designed as a universal laboratory oscilloscope of compact and portable design. A wide variety of time bases is provided to permit observation of the many phenomena encountered in the present-day electronic art. A variety of synchronizing arrangements provides great flexibility. A calibration circuit for determination of input signal amplitude is incorporated as well as numerous other features of interest to the engineer having need of an oscilloscope of universal application.

Sawtooth generator

It has become conventional practice in the design of oscilloscopes to use a thyratron tube type of time base generator to provide suitable

scanning voltage for the cathode ray tube. This type of sawtooth generator has the advantage of simplicity but suffers from noticeable defects which limit its usefulness and range of application. The upper frequency limit of a gas tube

frequencies in obtaining positive synchronization from signals having steep wavefronts or of short duration.

This oscilloscope uses a modification of a multivibrator as a capacitance discharging medium with the charging rate controlled by a constant current pentode. The upper frequency of the generator, in production models, is better than 500 kc per second with a lower limit of 5 cycles per second. A single range of the coarse sweep control covers a frequency spread of better than 10 to 1, which eliminates much of the constant resetting of the sweep range switch when working over a band of frequencies. Provisions are made for synchronization from an external source, or internally from the vertical amplifier, or from the power line frequency. A portion of the sweep voltage is also made available at the front panel for use in frequency modulation work, etc.

Synchronization is positive and noncritical. In fact, it is usually difficult to set the sweep rate controls deliberately to a position between points of locking-in. The sweep frequency will simply jump from one locked position to the next, as the sweep rate control is varied. With synchronization possible at signal-to-sweep ratios up to 20:1, it is possible to display 10



Panel of the Browning Model OL-15 oscilloscope

oscillator has been found to be in the region of 40 to 50 kc per second. At the higher limits of such an oscillator, the ionization time of the thyratron becomes an appreciable part of the total available time between successive sweeps, with corresponding difficulties in retrace elimination. Difficulty, too, has been experienced at the higher

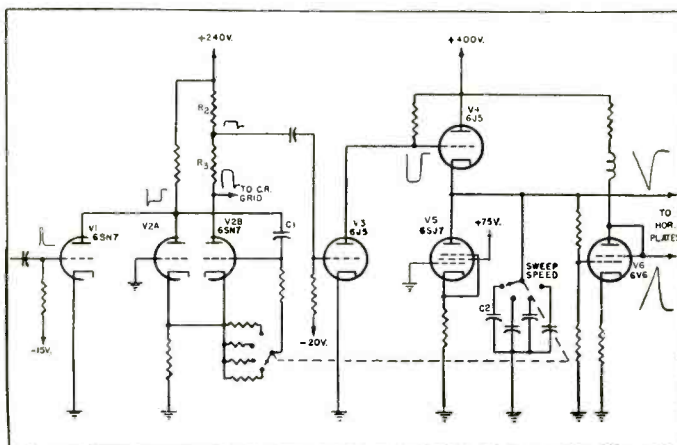
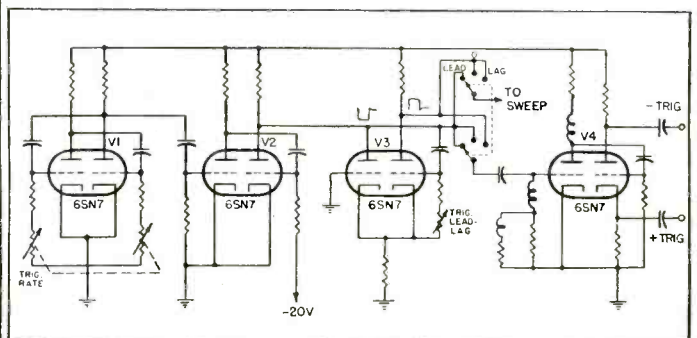

Fig. 1 (left)—Linear time base generator for observing recurrent phenomena

Fig. 2 (below)—Pulse generator for controlling internal or external slave sweeps



OSCILLOSCOPE DESIGN

mc phenomena on the screen so that individual cycles may be examined in detail. On experimental models, frequencies as high as 40 mc per second were viewed with the sweep in synchronism. This feature extends the range of direct waveform observation well into the new television video bands and provides for any increases in band width that are likely to occur in the near future.

Fast sweep

Much of the present investigation in the electronic field is concerned with pulses having a duration of one microsecond or less. Although it is possible to synchronize a sawtooth generator with phenomena of such form, the time duration of such a pulse may be an almost infinitesimal part of the elapsed time between successive pulses. A one microsecond pulse, for example, with a recurrence rate of 200 per second, would occupy one five-thousandth of the time between pulses or, viewed on a 200 cycle sawtooth sweep 4 in. in length, would be less than .001 in. in length. Furthermore, the amount of energy imparted to the screen during the pulse time would be so small that the pulse would be nearly invisible in contrast to the brilliance of the remainder of the sweep. Obviously, such a display would be useless for any sort of analysis of the pulse. The Model OL-15 oscilloscope has provisions for expanding such pulses horizontally

by increasing the speed of that portion of the time base that contains the desired information, while completely eliminating other portions of no immediate interest.

Frequently, it is necessary to work with waveforms of inconstant repetition rates or where successive phenomena may be separated by different time intervals. This oscilloscope provides a sweep separate from the sawtooth generator which operates only upon receiving a triggering impulse. One sweep is produced from each trigger. The initiating impulses may be of either constant or inconstant recurrence rate. Sweeps available are of 5, 20, 100 and 1000 microseconds duration to accommodate a wide range of pulse widths. For operation of the sweep generator, refer to simplified schematic, Fig. 1.

V2B is normally operating with zero bias and develops sufficient cathode-to-ground voltage to reduce the anode current of V2A nearly to zero. A positive impulse applied to the grid of V1 is inverted by V1 and appears as a negative voltage change at its anode and also at the anode of V2A. This is impressed on the grid of V2B through C1, resulting in a decrease in anode current through V2B.

This decrease in anode current results in a drop in the voltage at the cathodes of V2, with a corresponding increase in current through V2A. The voltage at the anode of V2A decreases and continues the process initiated by the

positive impulse at the input of V1. Cumulative action results in V2B being rapidly driven to cutoff. The circuit remains in this condition until C1 discharges to the point where V2B begins to conduct once more. Through cumulative action the circuit returns rapidly to its original stable condition.

The positive waveform appearing at the junction of R2 and R3 is inverted by V3, the resulting negative voltage cutting off V4. This allows C2 to discharge through V5 at a constant rate determined by the electrode voltages of V5. The resulting voltage is applied to one deflection plate and through an inverter, V6, to the remaining deflection plate. The use of push-pull deflection results in improved definition of the image.

This circuit is characterized by ease of triggering, linearity of sweep voltage, and constancy of writing rate over wide ranges of repetition rate. The positive pulse at the anode of V2B is applied to the cathode ray tube grid to brighten the screen only during the forward sweep time.

Trigger generator

Many items of electronic equipment have provisions for being externally triggered. In order that the oscilloscope may be used as a synchroscope with such equipment, an internal generator of positive and negative trigger pulses is provided. These are of approximately

(Continued on page 118)

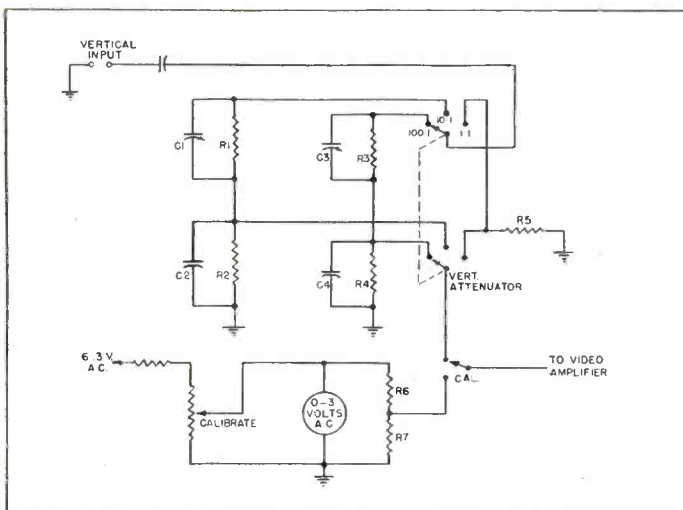

Fig. 3—Vertical input attenuator, showing method of calibrating the video amplifier by substituting a signal of known amplitude

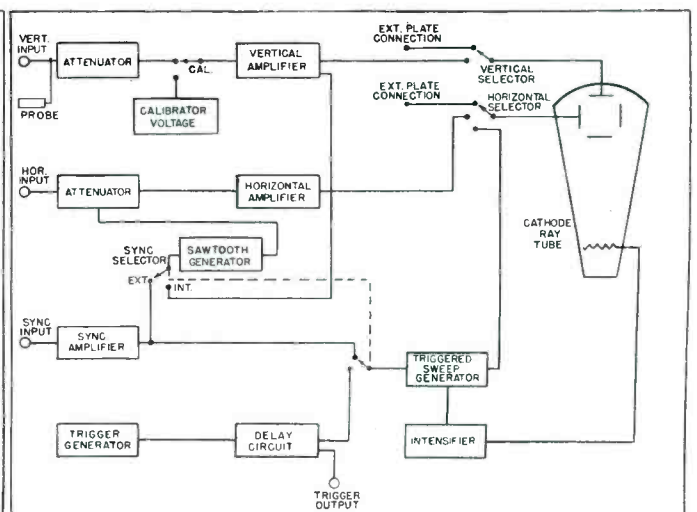
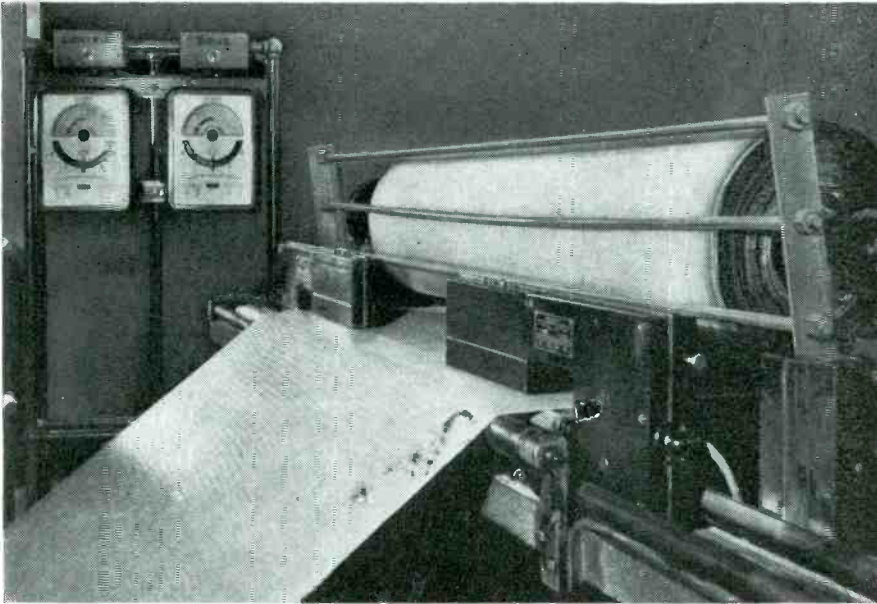

Fig. 4—Block diagram of the complete Model OL-15 oscilloscope. 30 tubes are required, including the type 5LP1 cathode-ray tube

TUBES ON THE JOB



View of calender with dual capacitors for automatic thickness gaging of rubber compounds

Mobile Radio For Trucks

One of the first two-way radio systems for trucks has been inaugurated by the Willet Co. for its trucking operations in the Chicago area. Thus far six trucks have been equipped with two-way radios developed by Belmont Radio Corp., Chicago, Div. of Raytheon Mfg. Co. The FM equipment is designed to operate in the 156 to 162 mc band and has proven itself in a variety of uses. A dispatcher may communicate with any truck at any time and place in the normal operating area of the company. He can

advise the driver of cancellations and new orders while en route. Drivers use the equipment to report tire trouble, mechanical difficulties or fires and other emergencies.

Rubber Weighing

At Lee Rubber & Tire Corp., Conshohocken, Pa., thickness of rubber compounds impressed upon fabric is accurately measured on the basis of ounces per square yard and recorded by a Verigraph—an instrument developed by Foxboro Co., Foxboro, Mass. Dual capacitors,

placed at the take-off end of the calender machine, form part of an oscillator circuit, the frequency of which is changed in accordance with variations in the dielectric of the material passing between the plates. The frequency changes unbalance a measuring circuit and deflect a galvanometer, the pointer of which actuates a clutch arm. This clutch arm rotates a shaft upon which the indicating and recording mechanisms are mounted. A slide wire resistance attached to the same shaft and rotating with it restores the measuring circuit to balance, the amount of restoration being recorded on a chart. The apparatus is set to the correct operating point by means of test samples, zero adjustment being maintained by a standardizing rheostat. The Verigraph eliminates the cutting of numerous samples for hand gaging, thereby permitting closer adherence to material specifications.

Electronic Wheel Balancer

The Alemite Div., Stewart Warner Corp., Chicago, Ill., is marketing an electronic wheel balancer, which represents an important new development for the automotive service industry. By means of this device, designed for one man operation, static and dynamic unbalance may be detected and corrected in less than ten minutes without removing the wheel from the car. A magnetic pickup unit attached to

Two-way radio for trucks operates in the 156 to 162 mc band and uses FM

Equipment placed in position for electronic balancing of front wheel



the axle and adjacent to the wheel transmits vibrations resulting from unbalance in the form of current impulses to a meter indicating the degree of unbalance. The pulses from the pickup are also fed to a four-tube amplifier, the output of which actuates a stroboscopic light. Since the stroboscopic flashes are synchronous with the vibrations, the motion of the wheel is apparently "stopped" and the exact spot out of balance is shown. Corrective weights are then placed opposite this spot. The device determines both kinetic unbalance caused by unequal distribution of weight around the center of rotation, and dynamic unbalance produced by uneven weight distribution in relation to the center line of the wheel. Kinetic (static) unbalance results in vertical vibrations. Dynamic unbalance produces vibrations in a lateral plane at right angles to the center line.

For balancing the front wheels, a motor-driven "wheel spinner", provided with the unit, is placed against the tire tread of one wheel. In balancing rear wheels the car's own engine power is used for rotation. Speed is regulated by a remote control. Since the wheels are in their normal operating position, they are balanced as one unit, including tire, tube, hub cap and brake drum.

Electronic Coin Rejector

A very sensitive electronic coin rejector has been invented and patented by William Hatton of the International Standard Electric Corp.

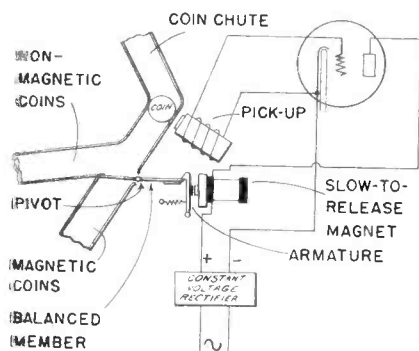

Schematic of electronic coin rejector. Device is sensitive to permeability of coins

The device is responsive to the magnetic characteristics of the coin and may be adapted to either pass or reject coins of high permeability. In the operation of the apparatus the slow-to-release magnet will be operated by the plate current of the vacuum tube which is in turn con-

trolled by a change in flux in the vicinity of the pickup device caused by a high permeability coin. The balanced member will be released and turn on its pivot when struck by the coin which will then drop into the section of the chute marked "magnetic coins."

Thereafter the right-hand lever of the balanced member which is heavier than the left-hand member, will rotate the balanced member back to its original position and the slow-to-release magnet will release its armature, thereby locking the balanced member against rotation. Obviously a low permeability coin will not cause movement of the armature and the balanced member will stay locked so that the coin will slide along it and drop into the chute marked "non-magnetic coins."

Reel Regulator

A new type of electronic drive for wind-up reels has been developed by Westinghouse and was described in an AIEE paper by K. P. Puchlowski. The problem was to maintain winding speed constant regardless of the increase in the diameter of the reel. The job was done by causing the tachometer generator to introduce a correction into the system in such a way that the speed of the motor operating the winding reel is exactly proportioned to the linear speed of the wire as it is wound on. Reel radius increases 2.3 times during the operation.

TACHOMETER TESTING



Five tachometer generators can be tested simultaneously on the testing stand. They are driven by a GE Thy-mo-trol drive, with readings being taken at intervals of 200 rpm



Testing strain gages during preparation for stress measurements on 80 ft. welded trusses

Stress Measurements On Steel Trusses

A total of 144 strain gages were used in recent tests conducted by the Austin Co., Cleveland, to determine and analyze the flow of stresses through welded H-section trusses under load. SR-4 strain gages, made by Baldwin Locomotive Works, were attached to joints at both ends of the first diagonal and other important check points on standard 80 ft. trusses to permit strain measurements as small as one-millionth of an inch in a 1/2 in. length. The gage itself, a tiny loop of copper-nickel wire with a diameter of 1/1000 in., was cemented to the steel surface so that its length would vary in exact relation with strain. The resistance change produced by the stretching of the gage wire was multiplied by electronic amplification to the required amplitude to operate conventional recording devices. Three automatic switching units and three strain recorders developed by the Foxboro Co. were used to record the strain measurements. Each recorder in combination with a switching unit was set up to measure strains at 48 gage points, permitting 144 individual strain readings to be recorded in about two minutes. Approximately 3000 strain measurements were obtained during various phases of loading up to a peak of 254,000 lb., for which the maximum deflection was about 2 in. After removal of the total live load the maximum residual deflection in both trusses was about 1/16 in.

SURVEY of WIDE READING

Electronic news in the world's press. Review of engineering, scientific and industrial journals, here and abroad

Emission from Cesium or Thorium-Coated Tungsten Filaments

Ch. Biguenet (Le Vide, Paris, Jan. & March 1946)

The emissive properties of tungsten filaments coated with a monoatomic layer of either cesium or thorium are reported in great detail. The processes of formation of the monoatomic layer by diffusion from the inside of the wire and by deposition by condensation are explained, as well as the accompanying changes in the work function. Carbonization of coated filaments and its effect on the filament characteristics are investigated.

Magnetically-Controlled Gas Discharge Tubes

R. E. B. Makinson, J. M. Somerville, K. R. Makinson and P. Thonemann, U. of Sydney, Australia (J. of Applied Physics, July 1946)

The discharge between the cathode and anode of a gas or vapor filled tube, initiated by the sudden application of a magnetic field, was

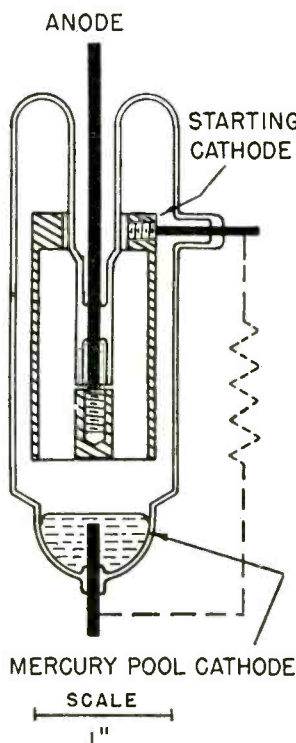

Fig. 1—Magnetically controlled mercury tube

studied with the object to use this type tube as pulse modulators for magnetrons in radar equipment. A satisfactory tube was developed having two coaxial cylindrical electrodes, together with a mercury pool as an auxiliary cathode, see Fig. 1. A glow discharge in the mercury vapor between the cylinders was initiated by a magnetic field pulse, and bombardment of the pool by ions from this glow dis-

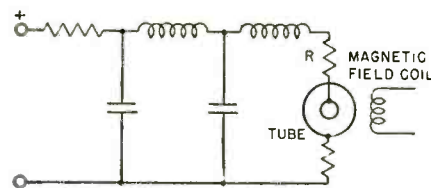

Fig. 2—Circuit used for testing discharge tube

charge produced an arc spot on the pool through which the main current passed. These tubes passed current up to 200 amperes in 2-megawatt pulses of duration 1 to 10 microseconds at repetition frequencies up to 1200 cycles per second with very small power loss in the tube itself.

Performance of the tube was studied in a circuit as illustrated in Fig. 2, which approximated that in which they would be required to operate as radar modulators, where the resistive load R corresponds to the radar oscillator. A magnetic field pulse of peak intensity 350 oersted was sufficient to fire the tube.

Emission from Tungsten Oxide Films

F. Llewellyn Jones (Nature, London, March 23, 1946)

The occurrence of cold cathode emission in a gas from metal surfaces covered with a thin oxide layer or dust opened up the possibility of devising a self-triggering, two-electrode spark gap. With this object experiments were carried out on the electrical properties of tungsten electrodes on which were formed films of oxides of tungsten.

The most effective oxide with regard to electron emission appeared

to be a mixture of the yellow and blue oxides, which together appeared as a white deposit. Further, a polarity effect was found when an oxidized electrode was used in conjunction with clean, smooth tungsten as the other electrode. However, this polarity effect seems not to apply if rough electrodes instead of oxides are used to increase emission, indicating that the mechanism of emission is different for oxidized and for roughened electrodes.

Reproducing Sound Film

W. K. Westmijze (Philips Technical Review, April 1946)

To eliminate noise from specks of dust or scratches on the sound track of sound films, a flying spot scanning method has been developed where only the edges of the track determine the output which is independent of any variations in the transparency inside the track.

A series of light spots move at a high velocity and at regular intervals across the film (see top figure). The photocell will generate approximately rectangular current pulses, as shown in bottom of figure, the intensity of which depends on the light intensity and the duration of which is a function of the width of the track. Variations of the

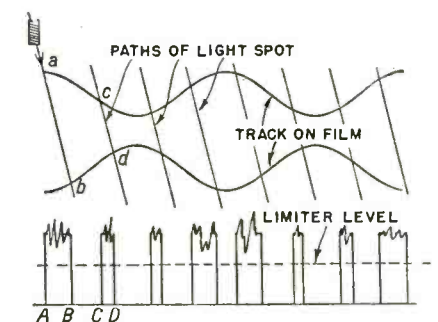

Top—Sound film with light-spot path. Bottom—Photocell output illustrating relations between width of sound track and width of pulses

transparency inside the track produce amplitude variations which are eliminated by a subsequent limiter as is indicated by the dashed line in the drawing.

For conversion of these high fre-

quency pulses into the desired audio signal, the pulses are passed through a low-pass filter which averages over successive blocks for a time interval approximately one quarter of the duration of the highest audio frequency. The result is a strong signal when the square waves are wide and a weak signal when they are narrow as is desired.

The scanning frequency of the light spot must be at least five times the highest audio frequency to be transmitted to assure satisfactory reproduction of sound. It is proposed to use a scanning light spot of 100 micron length (direction of spot movement) and 20 micron width (direction of film movement)

Removing Wire Insulation

E. J. Flynn and G. W. Young (General Electric Review, June 1946)

Various chemical methods to remove the insulating film from Formex wire have been investigated and compared as to speed, cost, convenience and safety of handling. Solvents, liquid strippers, acids, alkalis, acid pastes, fused salts, and glass bonding and cracking, resin solvent combinations, removal by flame and immersion in molten solder are discussed. Some of the chemicals which may be used can be dangerous, hence the advice of a chemist is desirable. The table lists only a few of the many possibilities studied and reported in some detail in the article. The dip intervals stated refer to 0.008 in. Formex wire.

Some preparations are used at room temperatures:

Liquid Strippers (20 sec. dip)

- 18 ammonium hydroxide
27 phenol
- 43 dichloromethane
8 beeswax
- 4 ammonium laurate

Two-Phase Systems (either requires 45 sec. dip)

- 2 parts formic acid (Bottom Liquid)
1 part kerosene (Top Liquid)
- 2 parts formic acid (Bottom Liquid)
1 part E.W. naphtha (Top Liquid)

Acid Pastes

- Nitric acid (15 sec. dip)
- Formic acid (1 min. dip)

Other compounds are used in molten state, such as:

- 51% hydroxide
49% potassium hydroxide
(5 sec. at 275°C. or 2 sec. at 300°C.)
- 50% potassium hydroxide
50% potassium nitrite
(5 sec. at 300°C.)
- 63% potassium iodide
37% potassium hydroxide
(2 sec. at 400°C.)
- Sodium hydroxide (0.2 sec. at 550°C.)
- Potassium hydroxide (0.2 sec. at 400°C.)
- 40% sodium iodide
60% potassium iodide
(0.2 sec. at 600°C.)
- Potassium iodide (0.2 sec. at 710°C.)

Aerial Prospecting

(Bell Laboratories Record, July 1946)

An aerial prospecting device for potential oil and mineral-producing areas has been developed as an outgrowth of a hitherto secret magnetic submarine locator. It draws a continuous record of the magnetic properties of the terrain over which it is flown, indicative of possible locations of natural resources. The device may prove particularly valuable in inaccessible areas as polar regions, jungles and offshore tides-waters, permitting a rapid, large-scale survey of geological structures in these territories. Some 40,000 square miles in this country and Alaska have already been mapped.

Powdered Iron Cores

C. T. Martowicz (Steel, April 1, 1946)

Composition, manufacturing process and characteristics of various types powdered iron cores suitable for high frequency electronic applications are discussed.

Non-Linear Bridge Circuits as Voltage Stabilizers

G. N. Patchett (Journal of the Institution of Electrical Engineers, London, Part III, January 1946)

The paper deals with the theory and design of voltage stabilizers where a Wheatstone bridge, Fig. 1, incorporating one or several non-

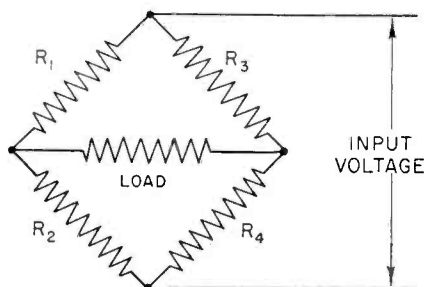

Fig. 1—Diagram indicating arrangement of non-linear resistors in voltage-stabilizing bridge

linear resistors, provides a compensating voltage which is proportional to the change in the input voltage. Four types of resistor combinations studied are listed in table below. In Fig. 2 is shown the general shape

of the output voltage-input voltage relationship of a non-linear bridge circuit; for the present purpose, the circuit constants are adjusted for the bridge to operate at the point "Q".

Detailed information concerning the design of various types circuits and the effects and importance of the various circuit elements is presented. Factors determining the figure of merit (the ratio of the change in output voltage with a change in input voltage) at the

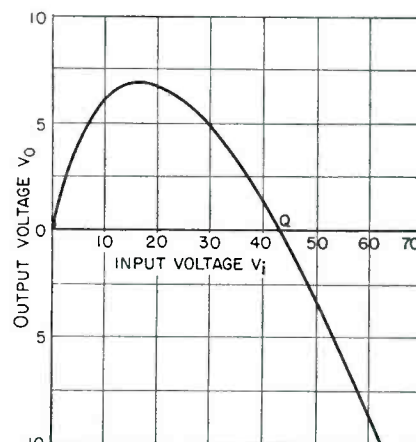

Fig. 2—General shape of output-input voltage relation of a non-linear Wheatstone bridge

point "Q", which should be as large as possible, are considered. Formulas are given for the load required for maximum power output from the bridge for a given change in input voltage.

The non-linear elements which may be used in these circuits have to obey the law: $V = kI^n$. Tungsten and carbon filament lamps, ballast resistors, Thyrites, copper and selenium rectifiers and thermistors obey this law over at least a portion of their characteristics. An extensive table and several charts facilitate design of non-linear voltage stabilizer bridge circuits.

Electronic Governor

G. Newstead (Electrical Engineer and Merchandiser, Melbourne, Australia, February 15, 1946)

The general operational features of electronic devices, called electronic governors, intended for the frequency control of alternators, are explained.

(Continued on page 136)

| Type | R_1 | R_2 | R_3 | R_4 | |
|------|-------------|-------------|-------------|--------------|----------------|
| 1 | linear | linear | $V = k'I^n$ | linear | n arbitrary |
| 2 | " | " | $V = k'I^n$ | $V = k''I^m$ | $n > 1, m < 1$ |
| 3 | " | $V = k'I^n$ | $V = k'I^n$ | linear | n arbitrary |
| 4 | $V = k'I^m$ | $V = k'I^n$ | $V = k'I^n$ | $V = k''I^m$ | $n > 1, m < 1$ |

NEW PATENTS ISSUED

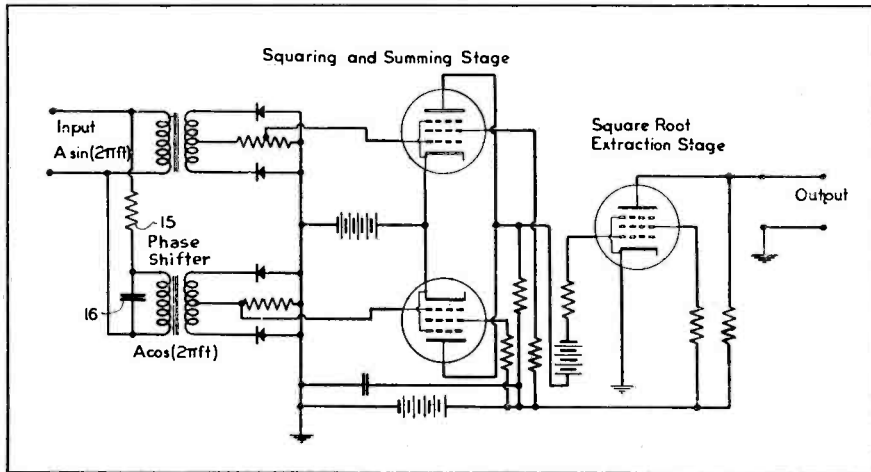

Circuit capable of detecting amplitude modulation if signal and carrier frequencies are very close

Detector

The detector is capable of separating the modulation envelope from a carrier frequency although the modulation frequency and the carrier frequency may be relatively close together. Further no filter is required.

The input wave $A \sin(2\pi ft)$ is applied to a phase shifter 15, 16, introducing a 90 deg. phase shift and providing a wave $A \cos(2\pi ft)$. Both signals are passed through squaring devices (full-wave rectifier and tube combination), the outputs of which are added to obtain a wave of the shape: $A^2 \sin^2(2\pi ft) + A^2 \cos^2(2\pi ft) = A^2$. A square root extraction stage supplies the desired output. In the drawing a particular circuit operating on the principle claimed is represented.

H. Harris, Jr., Sperry Gyroscope Co., Inc. (F) February 1, 1943, (I) April 9, 1946, No. 2,397,961.

Magnetostrictive Radar Clock

The exact measurement of short time intervals of the order of 10 to 1000 microseconds, essential in radar systems, may be performed with considerable accuracy by a simple magnetostrictive arrangement.

Magnetostrictive wave propagation arrangement accurately measures very short time intervals

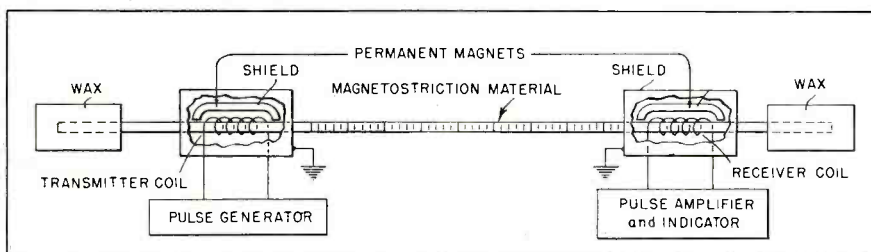

The short pulse, marking the beginning of the time interval to be determined, is applied to the transmitter coil, see figure, and causes expansion or contraction of the magnetostrictive material. Receiver coil picks up the wave and the received pulse is amplified and applied to an oscilloscope. The two wax blocks supporting the magnetostrictive rod act as dampers absorbing the sound wave at both ends so that no reflections take place. The two permanent magnets maintain the magnetostrictive rod magnetized a sufficient amount to secure good magnetostrictive conversion properties.

As the speed of travel of the magnetostrictive wave is equal to the sound wave for the particular material, the sound velocity times the traveling time is equal to the distance between transmitting and receiving coils. If the sound velocity is known, the rod may be calibrated in units of distance or time as desired. Either the sending or the receiving coil and accessories are mounted slidably on the rod so that the received pulse may be made to occur simultaneously with, for instance, the reflected radar pulse. Twice the distance of the object under observation by the radar unit will then be equal to

the distance between the two coils multiplied by the ratio radar wave velocity to sound wave velocity.

M. G. Nicholson, Jr., Colonial Radio Corp., (F) June 23, 1944, (I) May 28, 1946, No. 2,401,094.

Direct Coupled Amplifier

In the present dc multi-stage amplifier successive stages are not operated at progressively higher potentials and the overall amplification of each stage is substantially linear, distortionless and quiet. Each stage consists of an ampli-

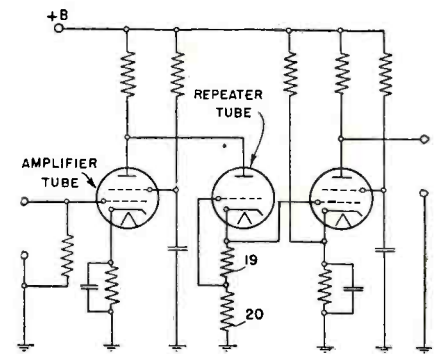

fier tube, the plate of which is directly connected to the plate of a repeater tube which is coupled as a cathode follower. Since resistor 19 is not by-passed, the repeater tube will have a non-linear characteristic, its resistance being a function of the voltage developed across resistor 19. Non-linearity in the mutual-conductance characteristic of the amplifier tube can readily be compensated for by a proper selection of the values of resistors 19 and 20. It will be appreciated that the output of the first stage, consisting of amplifier and repeater, is not at a high positive potential as in conventional dc amplifier. Any desired number of amplifier stages may be connected in cascade.

J. R. Beckwith, Belmont Radio Corp., (F) June 12, 1944, (I) May 21, 1946, No. 2,400,734.

Pulse Generator

It is proposed to generate pulses which are determined by the near zero portions, instead of the peaks of a sine wave. Shorter better defined pulses at constant comparatively long intervals may be obtained because of the steeper slope of the voltage-time curve at these points.

Audio amplifier tubes 5 and 7

(Continued on page 139)

A NEW ECONOMICAL RESISTOR LINE

PERMANENT LOW UNIT COST

CLOSE TOLERANCE LIMITS

PROMPT DELIVERY

QUALITY

IN-RES-CO



TYPE ALA — 3 WATTS

MAX. RES: 25,000 Ohms (Nichrome)
 MAX. RES: 5,000 Ohms (Manganin)
 BODY SIZE: 1 1/8" Lg. by 3/8" Dia.
 MOUNTING: By Axial Leads
 TERMINALS: No. 18 Tinned Copper Leads, 2 Inches Long
 TOLERANCES: Standard 3% (1% at Slight Extra Cost)

TYPE ACA — 6 WATTS

Same as Type ALA except coated with high temperature cement.

TYPE BLA — 5 WATTS

MAX. RES: 50,000 Ohms (Nichrome)
 MAX. RES: 10,000 Ohms (Manganin)
 BODY SIZE: 1 1/8" Lg. by 3/8" Dia.
 MOUNTING: By Axial Leads
 TERMINALS: No. 18 Tinned Copper Leads, 2 Inches Long
 TOLERANCES: Standard 3% (1% at Slight Extra Cost)

TYPE BCA — 10 WATTS

Same as Type BLA except coated with high temperature cement.

Types ALA, ACA, BLA, BCA can be supplied with non-inductive winding with 50% reduction in maximum resistance. Add suffix "N" to code when specifying non-inductive types (ALAN, ACAN, BLAN, BCAN).

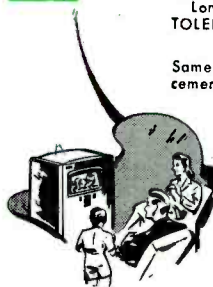

Dependable!

This new line of resistors—designed to meet current demands for small, low-cost, quality units of close tolerance—is immediately available. They cover the full range from 1 watt to 10 watts and 1 ohm to 1 megohm. Designed for long life and stability, these components have hard soldered connections between resistance wire and terminals, assuring permanent noiseless, trouble-free units. These new resistors are engineered for the manufacturer who desires to retain a reputation of top quality and performance in his equipment. Like all IN-RES-CO products they are produced under rigid control by modern facilities. Write for details.

TYPE BX — 1 WATT

NON-INDUCTIVE



MAX. RES: 1 Megohm (Nichrome)
 MAX. RES: 30,000 Ohms (Manganin)
 BODY SIZE: 1-5/16" Lg. by 9/16" Dia.
 TOLERANCES: Standard 3%
 (To 1/10% of Slight Extra Cost)

TYPE CX — 1 WATT

NON-INDUCTIVE



MAX. RES: 500,000 Ohms (Nichrome)
 MAX. RES: 15,000 Ohms (Manganin)
 BODY SIZE: 3/4" Lg. by 9/16" Dia.
 TOLERANCES: Standard 3%
 (To 1/10% at Slight Extra Cost)



INSTRUMENT RESISTORS CO.

29 AMITY STREET, LITTLE FALLS, NEW JERSEY

WASHINGTON

Latest Electronic News Developments Summarized
by Electronic Industries' Washington Bureau

PRICE CLOUDS SOON TO CLEAR—Decontrol of prices of home receivers and parts was goal, anticipated to be achieved by radio manufacturing industry this fall, as a result of the conference between the Radio Manufacturers Association leadership and chief aides of OPA Administrator Paul Porter early last month. Presentations of the industry's viewpoint that freedom from price regulation and full production were the answer to achieve fair prices for the public were made to the OPA top officials and the new Decontrol Board. Some relief came after initial conference in reduction of discount absorption by manufacturers for medium and high-priced sets so retail prices rose an estimated 4%. Manufacturers were "on the mark" for sharp increase in set production this fall, especially in consoles and combinations. August production better than equalled July output which had been somewhat higher than June's figures of 1,378,000 sets which was better by over 200,000 than the prewar production.

CONGRESSIONAL PROBE OF FCC—If Republicans gain control of Congress next session, FCC seems certain to be placed on investigation griddle. Aimed at handling of FM broadcasting and including repercussions on the "upper band" FM controversy was the resolution of Senator Tobey, New Hampshire Republican, friend of FM broadcasting leaders and intensely interested in that field's development. Resolution was introduced too late in session for consideration, but is certain to be revived in new Congress. On House side, several Republicans have their axes out for FCC. Wigglesworth of Massachusetts long has criticized broadcasting regulation processes, while Lemke of South Dakota wants farms to have more FM stations. FCC is striving this summer and fall to clear away its decks to avoid any Capitol Hill storm. (See following items.)

TELEVISION DECADE MARK—Ten years ago last month (August) the FCC conducted its first engineering conference on television frequencies and standards. Of course, the war period interfered with the birth of this industry, although the speeded-up research of the war era will soon bear fruits in a large way and the problems of reconversion, together with the controversy over black-and-white and color video, have slowed up the establishment of stations on the ether. Television has been marking more time recently with regard to FCC actions than the other broadcasting services, but indications are for a substantial number of new TV stations to start operations this fall. FCC would speed Tele. In August the FCC count for television was six sta-

tions on the air; 24 construction permits granted with several stations, like NBC and Bamberger in Washington, ready to start telecasting soon; and 54 station applications pending. The FCC is anxious that TV station operators with already authorized construction permits not "sit on" their channel assignments but start video broadcasting at the earliest date possible. Impetus to television's progress, however, expected to be given by determinations by Radio Technical Planning Board's TV Panel this fall on UHF color engineering standards.

BROADCASTING SERVICES ON MARCH—Washington heat and work do not mix, but the FCC in order to launch broadcasting on its postwar expansion has kept its nose to the grindstone during the entire summer. Statistics of applications with the Commission, already authorized or pending action, tell the story of the outlook of growth in the radio broadcasting fields. AM-standard broadcasting is far from saturated, the FCC figures show—there are 965 stations now on the air; around 300 licenses and construction permits have been granted so far this year; another 300 in the hearing stage; and about 350 applications being processed.

FM BROADCASTING SHIP NOW SEEMS LAUNCHED

—Spurred on by the threats of a Congressional investigation, FCC is concentrating efforts to clear its decks of station applications. The box score stood at the end of August, according to Commission estimates: over 250 stations on the air or under construction; more than 500 conditional grants; and approximately 300 applications in hearing or pending for processing. In tune with this heightened tempo of FCC grants of FM stations is the radio manufacturing industry in the output of FM receivers. Zenith, Stromberg-Carlson, Philco, Freed, General Electric were reported during August to be producing AM-FM combination receivers at the rate of over 10,000 sets a week for each company.

PATENT OFFICE BACKLOG—Huge backlog of patent applications awaiting action by Patent Office, which has risen 81% in past year, is felt to be bad bottleneck in reconversion. Greatest number of pending cases is radio-electronic industry which falls under Patent Office's "radiant energy" division and nonprocessed inventions estimated at over 3500 applications. Division of Patent Office force between Washington and Richmond, Va., is felt major factor in backlog status.

*National Press Building
Washington, D. C.*

*ROLAND C. DAVIES
Washington Editor*

GUARDIAN relays *for every control need*

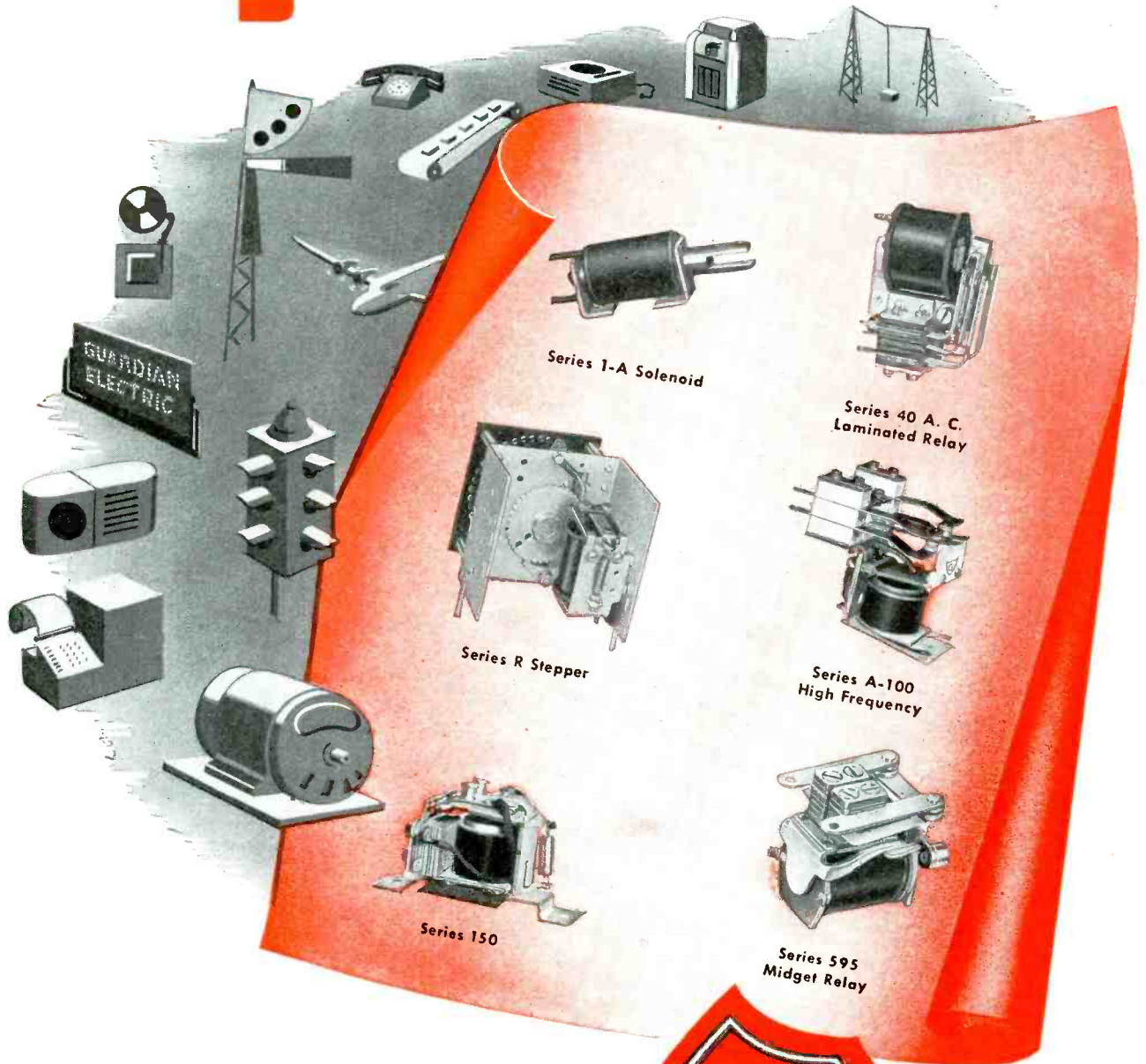

Series 1-A Solenoid

Series 40 A. C. Laminated Relay

Series R Stepper

Series A-100 High Frequency

Series 150

Series 595 Midget Relay

In precision control of today's products you will usually find *standard* type Guardian Relays. Such recognition of *standard* type Guardian Relays by forward thinking design engineers is the result of forward planning by Guardian to produce basic design relays with the highest potential of variations. Thus, in many cases where "specials" were formerly deemed necessary, variations of Guardian's *standard* type relays proved better qualified on *performance—price—delivery*. Guardian controls include a complete line of basic type relays—solenoids—magnetic contactors—switches. If a "special" unit or a complete control assembly is needed, Guardian's expert engineering is at your command. Write for bulletin No. T R-9.

GUARDIAN  **ELECTRIC**
1622-K W. WALNUT STREET CHICAGO 12, ILLINOIS

ELECTRONIC PRODUCTS

Parts, components, materials the manufacturers offer

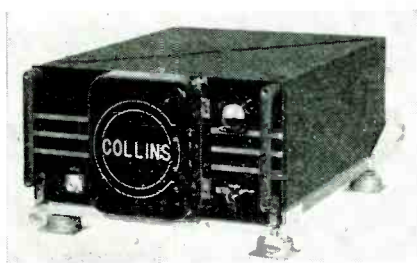

Aircraft Radio Equipment

An aircraft transmitter-receiver type 18S-1 provided with pretuned circuits and ten operating channels with two frequencies each has been developed by Collins Radio Co., Cedar Rapids, Iowa. Covering a frequency range from 2 to 10 mc, the transmitter supplies a power output of 100 watts into a 50 ohm transmission line. The receiver is controlled by a separate group of crystals and operates directly from a 26.5 volt dc source. It is equipped with dual output, automatic noise limiter, AVC and one stage of trf amplification. Total weight of the equipment is 60 lbs. Type 180K-1 antenna loading unit is available as a companion unit for the combination.—Electronic Industries

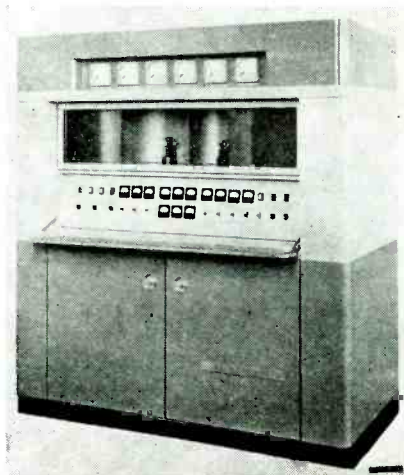

FM Transmitter

New 1- and 3-kw FM transmitters, which maintain close frequency control without use of critically-tuned elements and moving parts, have been developed by Westinghouse Electric Corp., Pittsburgh 30, Pa. The transmitter utilizes standard commercial type tubes in a simple FM circuit containing capacitors, resistors and non-microphonic diode tubes. The rf carrier is generated, multiplied and amplified in 5 steps and a single control adjusts the MO tuning frequency.—Electronic Industries

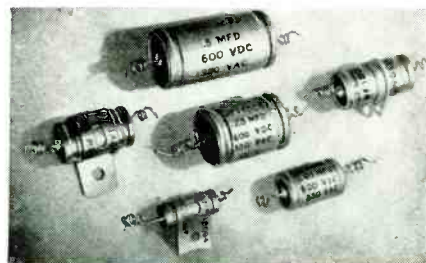

Feed-Through Capacitors

Hermetically-sealed, metal-cased, feed-through capacitors suitable for communications equipment, by-pass, coupling and filtering purposes are in production at Cornell-Dubilier Electric Corp., South Plainfield, N. J. The capacitors range from .01 to .5 mfd and are rated at 600 v dc and 330 v ac, both at 15 amps. The units have low power factor and are not affected by temperatures as high as 85° C.—Electronic Industries



Dielectric Heater

A dielectric heater for plastic preforms, designed for operation at 40 mc, is in production at General Electric Co., Schenectady, N. Y. A water-cooled tube with high overload capacity makes possible use of an average 5 KW output during the entire heating cycle, thus speeding up the preheating operation. A push-button starts the preheating cycle, which is fully automatic thereafter.—Electronic Industries



Wide Range Signal Generator

Model 288X crystal controlled signal generator has been redesigned by Hickok Electrical Instrument Co., 10528 Dupont Ave., Cleveland 8, Ohio, to meet present requirements of FM and television receiver testing. Internal crystals enable frequencies to be checked to 0.01% at intervals of 100 or 1000 kc. The output can be frequency modulated over the entire 0.1 to 160 mc range at deviations of ± 30 , 150 or 450 kc from an internal 60 or 400 cycle source or an external audio oscillator up to 15,000 c/s.; 400 cycle or external amplitude modulation is also available up to carrier frequencies of 110 mc. A self-contained output meter is calibrated from -10 to +38 db and 0 to 140 rms volts and a 0-15,000 c/s audio oscillator is also incorporated. For visual alignment work, a properly phased 60 cycle voltage is provided for synchronizing the oscilloscope sweep.—Electronic Industries



Multiple Connector

A multiple contact connector molded of Melamine plastic is available from Winchester Co., 6 E. 46th St., New York 17. Monoblock type construction permits easy removal of contacts. They can be supplied in two sizes—with 12 or with 18 contacts.—Electronic Industries

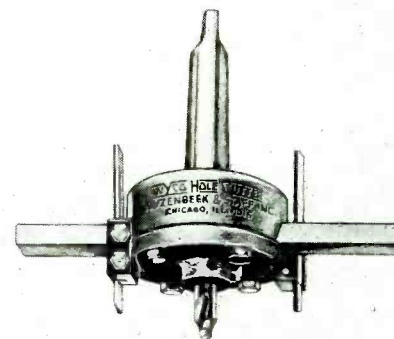

Hole and Washer Cutter

A heavy duty hole and washer cutter, which may be used on steel plate and other materials up to 1/2 in. thickness is in production at Wyzenbeek and Staff, 838 W. Hubbard St., Chicago 22, Ill. The cutter fits on a 1 in. drill chuck and is adjustable from 4 1/2 to 10 in. diameter.—Electronic Industries

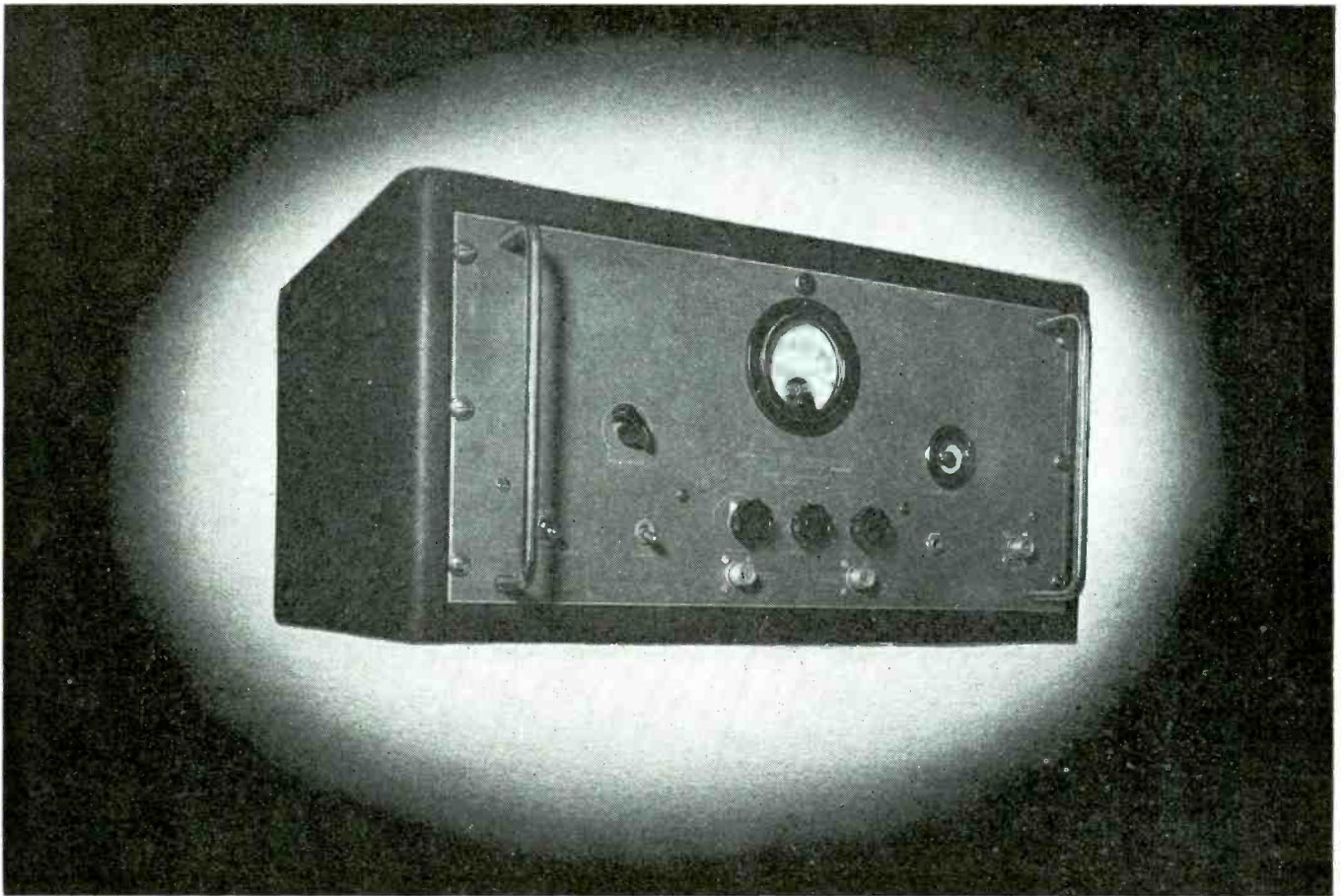

LAVOIE C-200 Harmonic Frequency Generator

Now you can obtain precision calibration up to and beyond 2000 megacycles of receivers and wavemeters at a fraction of the time previously required. Also, by means of a Beat Detector built into the instrument, you can calibrate oscillators and signal generators with equal ease.

The C-200 Harmonic Frequency Generator is a secondary frequency standard, designed especially for calibration work above 100 MC, with an accuracy of .02%. If greater accuracy is desired, the crystal may be supplied with temperature control.

The output voltage is supplied at a UG 58/U, 50 ohm connector with output coupling controls to obtain peak performance for a given harmonic. A milliammeter is incorporated in the instrument to facilitate easy adjustment of the output controls. The output voltage may be either unmodulated, or modulated with 400 C.P.S. internal oscillator. The calibrator provides output voltages every 10 MC, or every 40 MC. This selection is made by a switch on the front panel. The harmonic voltage is in the order of

thousands of microvolts for each harmonic with a value of approximately 50,000 microvolts at 100 MC's and 1500 microvolts at 1000 MC's.

Provision is made for the calibration of signal generators and oscillators by the incorporation of a beat frequency detector in the calibrator. The output of this beat frequency detector may be monitored, either aurally or visually with a tuning-eye indicator.

To facilitate harmonic identification, frequency identifiers can be supplied for any harmonic frequency (multiple of 10 MC) between 100 and 1000 MC. The Identifier is adjusted at our factory.

The C-200 Harmonic Frequency Generator can be used to calibrate signal generators, receivers, transmitters, wavemeters and oscillators. It provides a fast, accurate and easy method of calibrating in 10 or 40 MC steps.

This instrument is supplied with accessories needed for its operation, including tubes, 5 MC crystal, output coupling cable and instruction book.



Write for Illustrated
Descriptive Folder

Lavoie Laboratories

RADIO ENGINEERS AND MANUFACTURERS
MORGANVILLE, N. J.

Specialists in the Development and Manufacture of UHF Equipment

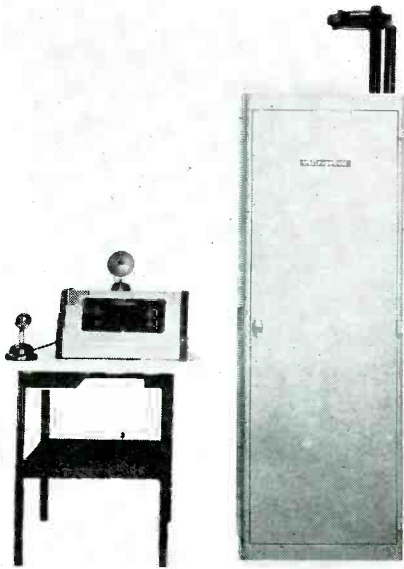

FM Railroad Equipment

Railroad radio equipment consisting of fixed station and mobile assemblies for operation on 117 volts ac is in production at Westinghouse Electric Corp., Pittsburgh 30, Pa. Rotary converters are provided with the mobile units for a 32 or 64 volt dc supply. A crystal controlled oscillator followed by frequency multipliers comprise the fm transmitter, which operates in the 152-162 mc band.—Electronic Industries

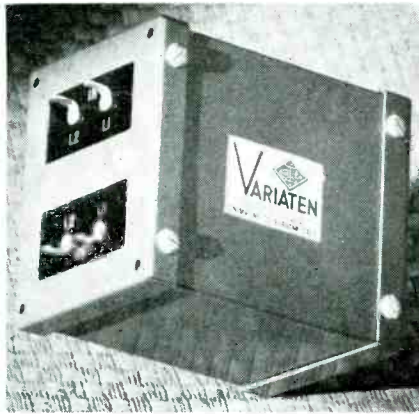

Equalizer

An orthoacoustic equalizer to compensate for high frequency losses in 500 and 600 ohm circuits is available from Cinema Engineering Co., 1510 W. Verdugo Ave., Burbank, Cal. The equalizer provides hf accentuation of approx. 16 db at 10 kc and has an insertion loss of 16 db.—Electronic Industries

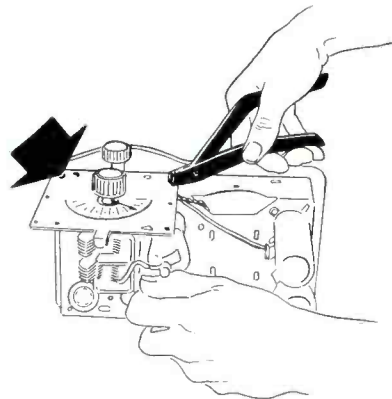

Rivet "Gun"

A light-duty blind rivet gun for small fastening jobs which installs the rivet with a simple pull has been brought out by Cherry Rivet Co., 231 Winston St., Los Angeles 13, Cal. The one-hand plier-like tool installs a 3/32 in. diameter Cherry blind rivet of the pull-through, hollow type.—Electronic Industries

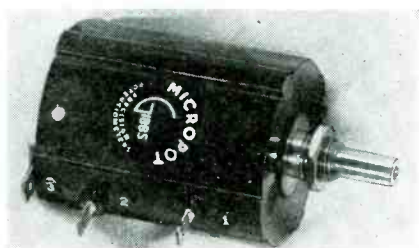

Precision Potentiometer

Developed for wartime applications requiring accurate and permanently calibrated precision controls, the "Micropot", manufactured by Thomas B. Gibbs & Co., Delavan, Wis., provides a linearity of resistance vs rotation of 0.1%. This degree of accuracy is due to the 43 1/2-in. long, spiral wound resistance core which is molded into a bakelite case having a diameter of only 1 3/4 in. and a length of 2 1/2 in. The shaft requires 3,600° (10 turns) of rotation to traverse the full range of resistance, which may be any of several available values from 500 to 30,000 ohms.—Electronic Industries

Railroad Antenna

An antenna for two-way communication between train and fixed station working on the 160 mc band has been brought out by American Phenolic Corp., Chicago 50, Ill. The antenna uses the metal top of the car for its ground plane and has a voltage standing wave ratio of less than 1.5 to 1. The gain is 0.5 decible less than a dipole.—Electronic Industries (Below, left)

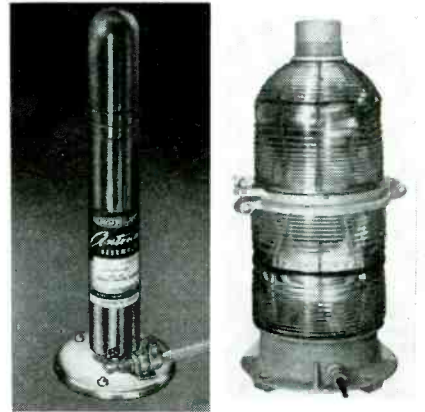

Code Beacon

A 300 MM code beacon complying with CAA requirements for lighting radio towers of 150 ft. and higher has been brought out by Andrew Co., Chicago 19. The light of two 500 watt prefocus lamps is passed through red pyrex glass filters and then radiated in a circular horizontal beam by cylindrical fresnel lenses.—Electronic Industries



Tubular Capacitors

J. P. O'Donnel and Sons, 316 Stuart St., Boston 16, Mass., has brought out a line of paper tubular capacitors available in ranges from .001 to 1.0 mfd and voltage ratings of 200, 400, 600 and 1000 volts dc.—Electronic Industries

Water Resistant Plastic

A thermoplastic material that will not absorb water, developed by Duorite Plastic Industries (Culver City, Cal.), is a combination of ceramic and resinous ingredients, called "Plastiform". Test specimens have been immersed in water for more than three months at a time without taking on enough moisture to register an increase in weight on a delicate chemist's scale. Plastiform can be reheated and recast innumerable times, like metals, without additives. It has a compressive strength of more than 15,000 lbs. per sq. in.—Electronic Industries



Direction Finder

A dual remote control automatic radio direction finder for aircraft is in production at Fairchild Camera and Instrument Corp., Jamaica, N. Y. The 16-tube receiver operates directly from the 28 volt power supply and covers a continuous frequency range from 100 to 1750 kc in four bands. The instrument has a normal antenna sensitivity of 5 microvolts and a loop sensitivity of 25 microvolts per meter. Bearing accuracy is within 1° for nominal field strength. The unit is designed to withstand high altitude effects, tropical deterioration and high humidity.—Electronic Industries

The VIBROTRON

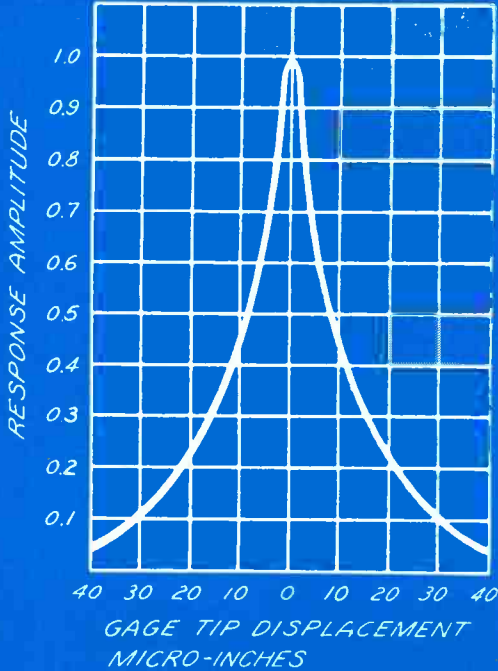

PROBLEM:
 TO PROVIDE A GAGE FOR SORTING STEEL BEARING BALLS IN ACCORDANCE WITH THEIR DIAMETER.
 SENSITIVITY REQUIREMENTS - ACCURATE TO NEAREST MILLIONTH OF AN INCH.
 ACCURACY TO BE UNAFFECTED BY MODERATE TEMPERATURE CHANGES.
 OPERATION TO BE UNAFFECTED BY LINE VOLTAGE CHANGES.
 ONCE SET, TO REMAIN STABLE WITHOUT CALIBRATION.

SOLUTION:
 (a) AUTOMATIC GAGE CONTAINING VIBROTRON.
 (b) CLASSIFYING RELAYS CONTAINING VIBROTRON.

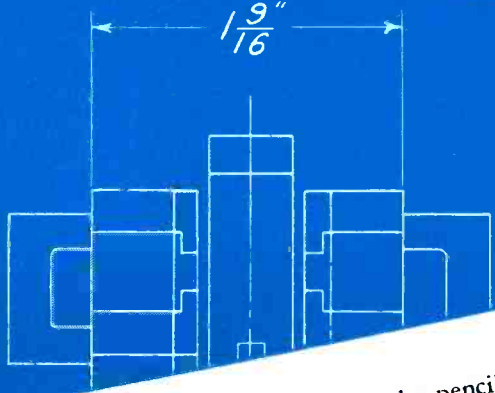

SOME APPLICATIONS OF VIBROTRONS:

- Anemometers
- Barometers
- Cardiographs
- Dew Point Meters
- Extensometers
- Frequency Meters
- Gravimeters
- Hygrometers
- Inclinometers
- Jamin Tubes
- Keying Monitors
- Locating Devices
- Magnetometers
- Null Indicators
- Oscillators
- Pressure Meters
- Q-Meters
- Radiosondes
- Sorting Devices
- Time Controls
- Ultrasonic Generators
- Vibration Analyzers
- Weighing Devices
- X-Ray Controls
- Yield Point Testers
- Zymometers

MEMO: See the small ball tip near the pencil point? It is sensitive to displacement—and we DO mean sensitive. It can detect changes in dimension smaller than one millionth of an inch.

The trick is done with a Vibrotron actuated by the ball tip. The Vibrotron is one of the most versatile instrument components ever devised. It is not sold separately but licensed to manufacturers for incorporation into sensitive instruments. It will do other things beside measure displacement. If you have a problem in instrument design involving the precise measurement of audio frequency—or if you are concerned with the measuring of a quantity precisely at one place and indicating it at a distance, over variable transmission channels, we will appreciate hearing from you. Possibly, we can help you with a Vibrotron designed for your needs.

A description of your problem will incur no obligation. Write on your letterhead, please.

RIEBER RESEARCH LABORATORY
Development Engineers

127 EAST SEVENTY-THIRD STREET, NEW YORK 21, N. Y.

| | | | |
|-----------|-------------------------|------------------------|-----|
| TOLERANCE | DRAWN TRACED CHKD | APPVD DATE SCALE | 718 |
|-----------|-------------------------|------------------------|-----|



Impulse Counter

Tracerlab, Inc., 55 Oliver St., Boston 10, Mass., has developed the "Autoscaler", an instrument for counting and timing a predetermined number of impulses from a Geiger-Mueller tube. The scaling and timing circuits operate automatically for counts of 128 to 4096 impulses and have fully electronic control circuits. Overall resolving time of input amplifier and scaling circuits is less than 5 microseconds. Operating voltages for the Geiger-Mueller tube are supplied by the unit and two controls permit adjustment of threshold and operating potentials.—Electronic Industries

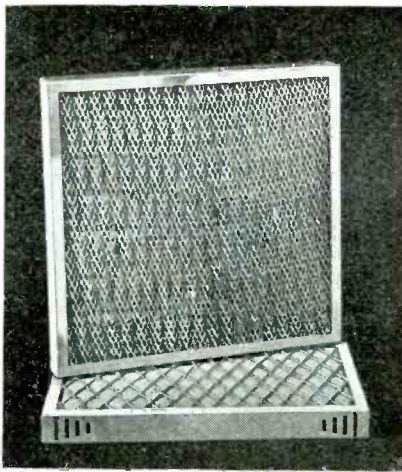

Air Filter

A blower motor filter for radio transmitters is being offered by Air Filter Corp., Milwaukee, Wis. The filter may be used as dry or as viscous filter for extreme dust conditions. The unit, which is designed to trap dust particles and retard moisture is constructed of formed steel frames and may be cleaned.—Electronic Industries

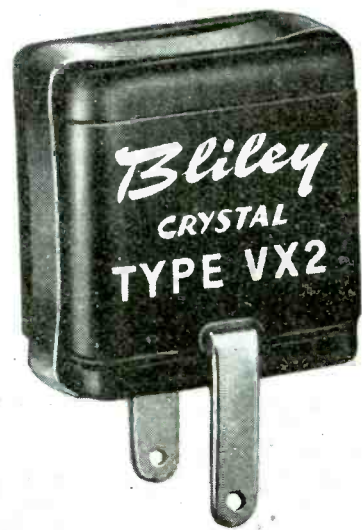

Crystal

A compact crystal unit for use in private aircraft transmitters working on 3105 kc is available from Bliley Electric Co., Erie, Pa. Type VX2 is also supplied in any specified frequency between 3 and 11 mc.—Electronic Industries

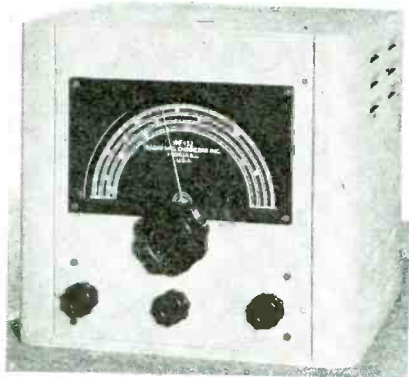

Converter

Radio Mfg. Engineers, Peoria 6, Ill., has brought out the VHF-152 converter for use on the 2-, 6- and 10-meter amateur bands. The preselector uses miniature tubes in a temperature-stabilized double conversion circuit. The tube line-up includes a 6AK5 rf amplifier and mixer, 6AU6 detector and 6J6 oscillator. An antenna change-over switch is provided. The converter has a built-in power supply for operation on 115 volts, 50-60 cycles, ac.—Electronic Industries



Field Strength Recording Drive

For field strength surveys of transmitter service areas, two accessories have been developed by Clarke Instrument Corp., 4236 45th St., N.W., Washington 16, D. C., to facilitate coupling of standard Esterline Angus recorders to auto speedometers. The type 102 recorder drive provides chart speeds of 1, 2, 4, 8 or 16 in. of chart per road mile and is coupled to the speedometer by means of the type 101 Speedometer Tee, a three-way flexible shaft coupling, mounted on the dash or bulkhead of the car. Equipment includes all necessary cables and may be disengaged instantly to permit normal operation of the recorders.—Electronic Industries

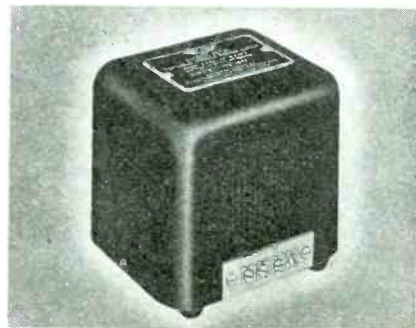

Portable Power Supply

A vibrator-type power supply for amateurs designed to operate from a 6 volt battery source is in production at Electronic Laboratories, Indianapolis, Ind. The unit supplies 300 volts dc at 100 ma with a regulation of 3.8% between no load and full load.—Electronic Industries

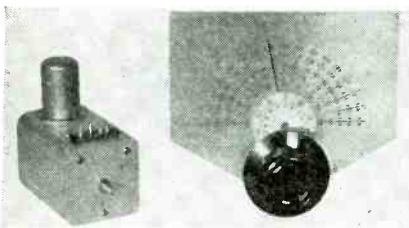

Variable Frequency Oscillator

A permeability-tuned variable frequency oscillator covering the amateur bands in harmonics of 3.2 mc with a stability within 0.015% is being offered by Collins Radio Co., Cedar Rapids, Iowa. A linear range from 1600 kc to 2000 kc is covered in 16 turns of the vernier dial. The 70E-8 provides a usable output of 10 volts for driving a class A rf stage. The instrument is factory-calibrated using a standard checked against WWV.—Electronic Industries



Low-Loss Trimmers

Hi-Q air capacitors developed by the Philips Laboratories in Holland, are now available from North American Philips Co., 100 E. 42 St., New York. The units consist of two sets of concentric aluminum cylinders which are rotatable along a common axis, and have high mechanical and electrical stability. Capacitance range is 3 to 30 mmfd., to 500 mc and higher.—Electronic Industries

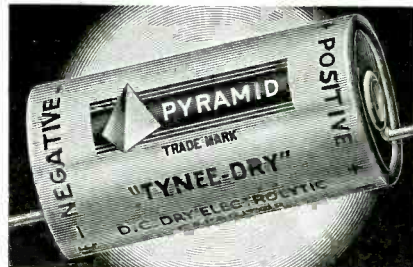

Electrolytic Capacitors

A line of compact, hermetically sealed "Tynee-Dry" electrolytic capacitors in single and dual section types is being offered by Pyramid Electric Co., 415-421 Tonnele Avenue, Jersey City 6, N. J. Units are available from 25 to 525 volts working voltage in sizes up to 100 mfd at 50 WV, 4 to 40 mfd at 450 WV and 8 to 16 mfd at 25-25 WV.—Dual units are rated up to 20-20 mfd at 460 WV.—Electronic Industries

(Continued on page 151)

For precise, positive linkage between instrumentation and control



INDUCTION GENERATOR: when fed from AC source produces voltage proportional to speed of rotation. Used in circuits as velocity control component.



PERMANENT MAGNET GENERATOR: designed as AC potential source. Produces sinusoidal wave form with harmonic content under 2%.



INDUCTION GENERATOR: type designed particularly for use where low residual voltage is required.

MOTOR DRIVEN INDUCTION GENERATOR: powered by 2-phase, low-inertia induction motor. Used as fast reversing servo motor where maximum stall torques of less than 7 oz. in. are required.

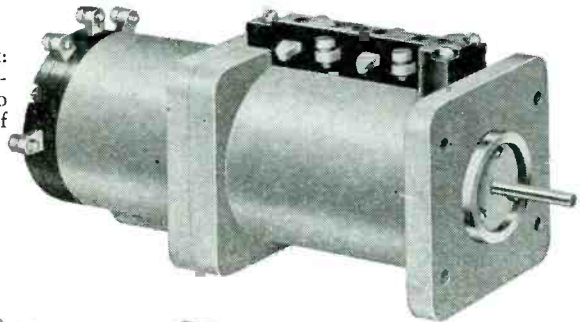

TELETORQUE UNIT — below left: a precision-built, non-motoring, self synchronous unit for remote indication. Accurate to ± 1 degree.

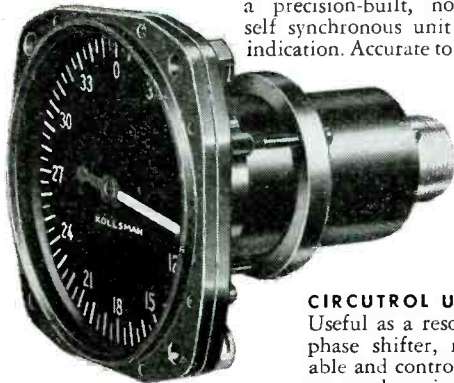

CIRCUTROL UNIT: Useful as a resolver, phase shifter, rotatable and control transformer or phase indicator.

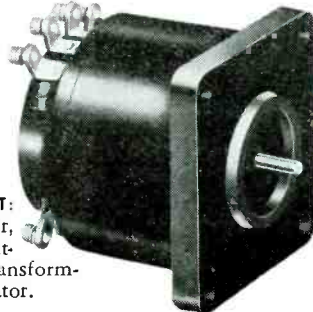

INDUCTION MOTOR: Low inertia, two-phase squirrel cage unit for use as precision servo motor.

KOLLSMAN OFFERS A LINE OF SPECIAL PURPOSE AC UNITS

To meet the varying needs of the electronics engineer in linking instrumentation up to control, Kollsman offers a group of units with sufficiently varied functions to solve a wide range of control problems. In nearly every case, units are available for operation at various voltages and frequencies to fit widely diversified electronic control and remote indication applications. These Kollsman units are the outgrowth of long development in aircraft instrumentation and control and — more recently — Kollsman's considerable work in this field for naval and military applications. They are light in weight, compact, and highly precise, so that engineers working with exact quantities will find them reliable to a high degree. Complete data on any or all of these units may be had upon request. Kollsman Instrument Division, Square D Company, 80-08 45th Avenue, Elmhurst, N. Y.

KOLLSMAN AIRCRAFT INSTRUMENTS

PRODUCT OF

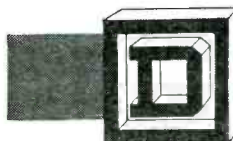

SQUARE D COMPANY

ELMHURST, NEW YORK

• GLENDALE, CALIFORNIA

★ TELEVISION TODAY ★

New Developments in the Video Field

TBA Tele Exhibit Practically Sold Out

Practically all the space (15,000 sq. ft.) allotted to exhibitors at the forthcoming Second Television Conference and Exhibition has been signed for and it appears certain that the affair will be a sell-out both insofar as exhibits and attendance are concerned. The date is October 10 and 11 and the affair is to be held at the Waldorf-Astoria in New York under the auspices of the Television Broadcasters Association. Ralph B. Austrian, general chairman suggests early reservation both for the conference and for hotel rooms which are still difficult to get unless asked for well in advance.

The conference program is a lengthy one with many speakers of national prominence. They will discuss latest developments in the industry with particular emphasis on current trends and future possibilities. There is to be a special luncheon on the first day with a talk by a prominent personality, a luncheon with entertainment on the second day and the annual banquet with surprise features, presentation of the Awards of Merit and an address by a national figure on the last day. Registrants may attend all meetings and food functions, and in addition will receive a copy of the annual TBA Television Book as well as a full transcript of conference proceedings. Registrations may be sent to Ralph Austrian, suite 1038, 500 Fifth avenue, New York; hotel registrations are being looked after by D. K. de Neuf, Raytheon Mfg. Co., 60 East 42d street, New York.

DuMont Video For Detroit's WWJ

Station WWJ, Detroit, will be the first newspaper-owned broadcasting organization to enter the television field. The company has just signed with the Allen B. DuMont Laboratories for a modern television station including master control, video transmitter, audio transmitter, motion picture film studio equipment, film electronic pickup chain, film projecting equipment and a special antenna. The antenna will be atop

the Penobscot building, Detroit's highest structure. The station will be in operation by November 15.

BIKINI TELE



Here, together with Capt. Charles F. Horne, deputy director of communications department of U.S. Navy, are the miniature transmitter (left), with image orthicon tube, used on drone plane, and the receiver installed on the correspondents' press ship for the Bikini atom bomb tests. Both instruments are RCA equipment

French Plan Fax Newspaper Venture

Finch facsimile equipment soon is to be installed for the publication of a radio newspaper in France. Aristide Blank, publisher of France-Soir hopes to blanket France, Belgium and Algiers. The plan is to transmit a master newspaper from a central point to be picked up by radio on Finch receiving duplicator units located at key points. The duplicator unit cuts a stencil, usable on a standard Mimeograph machine for runs up to 50,000. The agreement between the French company and Capt. W. G. H. Finch also provides for the manufacture of Finch equipment in France.

Radar for Stratovision

The Westinghouse-Martin air-plane plan to broadcast television and FM from ships flying over various strategic locations has progressed to the point where an application has been made to FCC for the use of radar equipment for navigational aid. Plan is to use Raytheon radar to keep track of the positions of the Stratovision planes.

Electronic Newspaper Trial in 12 Cities

The electronic newspaper, delivered through the air on radio waves, will be given a trial in more than 12 metropolitan centers early next year it is indicated in an order placed with General Electric for what is believed to be the largest number of facsimile transmitters and receivers ever ordered.

John V. L. Hogan, president of Radio Inventions, Inc., placed the order on behalf of Broadcasters Facsimile Analysis, which is a group including 22 broadcasters and newspapers. This group was organized late in 1944 to study the new medium and develop appropriate transmitters and receivers. This work was done by Radio Inventions both in their laboratories and in the field. G. E. has been asked to make the equipment.

Four 9½ by 12 in. pages of text or photos can be relayed by radio from any FM broadcasting station to the home or office recorders during a 15-minute broadcast with the equipment. Printed pages emerge from a slot in the top of the receiver. A transparent window enables the owner to see the page as it is being recorded.

GE Will Operate Microwave Relay Net

General Electric is to operate the three-station Schenectady-New York microwave radio relay network originally worked out by GE in conjunction with Globe Wireless and International Business Machines Corp. Licenses are to be transferred to GE, which will "prove in" the system, after which Globe may exercise its option to buy the network facilities. Plan is to carry television, FM, facsimile and business machine circuits.

CBS Signs Ford

Columbia Broadcasting System has signed Ford Motor Co. for a series of video broadcasts from station WCBW—in black and white. Broadcasts will cover major sports events held in Madison Square Garden, except boxing.

*Title registered U. S. Patent Office.

LOOK TO HARVEY of CAMBRIDGE

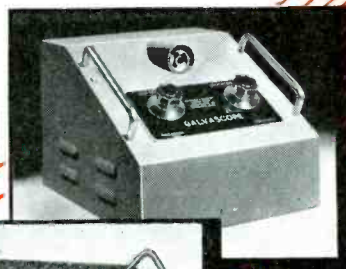

▶ The HARVEY GALVASCOPE provides a vibration-proof, noise-proof, precision method of visually detecting 1,000-cycle bridge balance.



▶ The HARVEY Regulated Power Supply 106 PA is a controllable, dependable source of laboratory D. C. power. Range 200-300 volts at 140 ma.

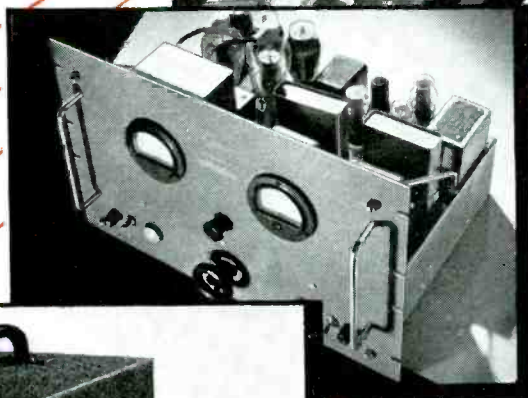

▶ The HARVEY Regulated Power Supply 206 PA, a source of laboratory D.C. power that operates precisely and efficiently in two ranges: 500-700 volts at 250 ma; 700-1000 volts at 200 ma.



▶ The HARVEY Visual Alignment SIGNAL GENERATOR Model 205 TS for development, experimental and servicing work in connection with FM applications, I-F amplifier alignment, and in other uses where a sweep deviated signal source is needed in the frequency range of 100 kc to 20 mc.

Pictured are typical HARVEY of CAMBRIDGE products that are helping industry work better, faster and at lower cost. Some were developed to meet the needs of HARVEY of CAMBRIDGE clients—others the result of HARVEY'S determination to discover the best and surest methods of doing specific jobs.

Write for bulletins

HARVEY RADIO LABORATORIES, INC.

441 CONCORD AVENUE • CAMBRIDGE 38, MASSACHUSETTS



NEWS OF THE INDUSTRY

NAB Slates Session for FM Exclusively

In connection with its 24th annual convention, scheduled for Chicago (Palmer House) Oct. 21-24, National Association of Broadcasters will hold a luncheon and special session devoted to FM exclusively. The convention proper will open on Monday and continue through till the following Thursday, the FM session being held during the afternoon of the first day.

The names of panel members for the special session on frequency modulation broadcasting include Charles R. Denny, acting chairman of the Federal Communications Commission, who will discuss Commission policy concerning FM.

Station promotion and program sources will be discussed by Lester H. Nafzger, general manager of WELD, FM station in Columbus. He is also chief engineer of WBNS in Columbus.

W. R. G. Baker will appear as a representative of the Radio Manufacturers Association to discuss the transmitter and receiver situation.

T. A. M. Craven, vice-president in charge of engineering for the Cowles Stations, will cover the subject of technical operations.

Walter J. Damm, chairman of the NAB FM Executive Committee and president of FM Broadcasters, Inc., will preside and answer questions concerning managerial and operational aspects of FM broadcasting.

Arrangements for the FM panel are being handled by Robert T. Bartley, director of NAB's FM department. It is being set up under joint sponsorship of NAB and FM Broadcasters, Inc.

RTPB Elects

Radio Technical Planning Board re-elected two of its officers at a New York meeting July 10 and added two new ones. J. L. Middlebrooks, recently appointed director of engineering for National Association of Broadcasters, becomes the new vice-chairman, taking the place of Howard Frazier, who left NAB to open his own office as a consulting engineer; and George W. Bailey, executive secretary of IRE and president of the American Radio Relay League, becomes secretary, vice Dr. Wm. Crew of IRE who

served last year. Re-elected were Chairman Haradon Pratt of Mackay Radio and Telegraph Co., and Treasurer Will Baltin of Television Broadcasters Association.

Propose 30 kc Separation for AM

Full agreement between the FCC and the broadcasting industry was reached in the revision of the Standards of Good Engineering Practice for AM-standard broadcasting, it was brought out at an oral argument before the entire Commission August 5. The standards, however, are to be used as a major element of determination in the clear channel broadcasting controversy, final hearings in which are slated for September 8.

The most significant proposal in the revision of the AM engineering standards was the idea of a 30 kc separation for stations in the same area instead of the present 40 kc separation. But it was emphasized by high Commission sources that the 30 kc separation would be used in exceptional cases where technical circumstances proved it beneficial and would not be utilized in connection with existing broadcasting stations or even new ones except with the above qualifications.

Urge OPA Remove FM Set Ceilings

On July 26, the Office of Price Administration ordered price ceilings removed from television receivers for home use "because of the present limited demand due to the few sending stations and limited range, together with very high installation costs and the lack of base-period prices in use in fixing ceiling prices."

Learning of OPA's action on television receivers, the publishers of Electronic Industries and Radio & Television Retailing on July 30 telegraphed Hon. Paul Porter, director of OPA, as follows:

"OPA to be congratulated on removing ceilings from home television receivers. But exactly same reasons stated in your July 26 order—viz.:—limited demand, few sending stations, limited range, and high installation costs,—also apply to frequency-modulation receivers. Hence we respectfully urge that OPA also remove price ceilings from all home radio receivers incorporating FM bands, in order to permit American public to obtain benefits of this great new service to the home and farm.—M. Clements, O. H. Caldwell."

Conventions and Meetings Ahead

American Chemical Society—Chicago, Ill., Sept. 9 to 13. (Alden H. Emery, 1155 Sixteenth Street, N.W., Washington, D. C.)

Instrument Society of America—1946 Exhibit and Conference, Pittsburgh, Pa., Sept. 16 to 20. (Chairman of the Exhibit Committee, Paul Exline, P. O. Box 2038, Pittsburgh 30, Pa.)

American Physical Society—New York, N. Y., Sept. 19 to 21. (Karl K. Darrow, Secretary, Columbia University, New York)

American Institute of Electrical Engineers—Great Lakes District Meeting, September 26, 27, Fort Wayne, Indiana. (H. H. Henline, 29 W. 39th St., New York)

American Society of Mechanical Engineers—Boston, Mass. Sept. 30 to Oct. 3. (Ernest Hartford, 29 W. 39th Street, New York, N. Y. PE 6-9220.)

National Electronics Conference—Edgewater Beach Hotel, Chicago, Ill., Oct. 3, 4, 5.

Television Broadcasters Association Conference—Waldorf-Astoria Hotel, New York, N. Y. October 10 to 11. (Will Baltin, Secretary, Room 1038, 500 Fifth Ave., New York 18.)

Electrochemical Society—Toronto, Oct. 16-19. (Colin G. Fink, Columbia University, 3000 Broadway, New York, N. Y. UN 4-3200.)

American Welding Society—Annual Meeting, New York, N. Y., October 24. Atlantic City, November 17 to 22. (Miss M. M. Kelly, 29 West 39th St., New York, N. Y.)

Electronic, Radio and Television Exposition—Grand Central Palace, New York, Oct. 14 to 19. (Electronic Exhibitors, Harry G. Cisin, Executive Director, 50 Broad St., New York.)

Association of American Railroads, Communications Section—Annual Convention, Hotel Statler, Detroit, November 19-21.

Society of Motion Picture Engineers—60th Semiannual Technical Conference; Hollywood-Roosevelt Hotel, Hollywood, Calif., Oct. 21 to 25. (West Coast, H. W. Moyses; East, Harry Smith, Jr., Hotel Pennsylvania, New York)

National Association of Broadcasters—Twenty-fourth Annual Convention; Palmer House, Stevens Hotel, Chicago, Ill., Oct. 21 to Oct. 24. FM Session, open to non-members; Palmer House, 12:30 P.M., Oct. 21.

Electrical Engineering Exposition—71st Regiment Armory, New York, January 27 to 31, 1947.

Institute of Radio Engineers—Annual Meeting (Commodore Hotel) and Show, (17th Regiment Armory) New York, March 3-7, 1947.

Announcing

**ALTEC LANSING'S MODEL 603
MULTICELL DIA-CONE SPEAKER**



*Built to
Quality Standards*

*Priced for
Popular Appeal*

For those who want a moderate priced speaker that can provide true high quality performance. Here it is—a superb speaker that's surpassed only by the famous Altec Lansing Duplex. Specially designed for limited budgets—Model 603 assures high frequency distribution, frequency response and undistorted reception expected of much higher priced systems. Learn more about the 603.

MODEL 603—Multicell Dia-Cone speakers incorporate a metal high frequency diaphragm and a 15" low frequency cone coupled by a mechanical dividing network to a 3" Voice coil of edgewise wound aluminum ribbon. Write for other details.

NOW AVAILABLE

\$8400

ALTEC
LANSING CORPORATION

1161 N. Vine St., Hollywood, Cal.
250 W. 57th St., N. Y. 19, N. Y.

"KEEP ADVANCING WITH ALTEC LANSING"

EXPANDING UTILITY

(Continued from page 86)

operational characteristics of the electronic devices will justify their use despite the increased cost. Obviously the detailed nature of these plant control systems will vary from one refinery operation to another.

There is a considerable use in the petroleum industry for devices capable of measuring metal thickness or liquid level from only one side of the pipe or tank. The Penetron*, which uses gamma ray scattering and electronic amplifiers and counters, is an example of such an instrument. There is room for improvement in the direction of decreasing the area over which the metal thickness is measured, of decreasing the time required to make a measurement, and of increasing the accuracy with which the thickness can be determined.

In many refining processes the provision of means of measuring quantitatively the amount of water or other foreign materials in the refinery stream is of considerable importance. At the present time, commercial devices capable of making such measurements are either not available or relatively unsatisfactory. The development of such instruments is by no means simple, since they must work satisfactorily in the field under a varied range of conditions. This field is being explored.

The calculation of material and quality balances for a complete refinery is a laborious and time-consuming job which is wasteful of manpower. The development of electronic computers, similar in purpose but not in detailed operation to the network calculators used so widely in the electrical industry, could make possible a great saving in time, and a net increase in the overall efficiency of refinery operation.

*"Penetron Detection of Corrosion," Felix B. Gordon and Philip H. Lipstate Jr., Penetron Service Co., Houston; The Oil Weekly, pages 38-39, June 17, 1946.

THERMAL DETECTORS

(Continued from page 87)

at frequencies in the audio range. It has a maximum response at about 2.5μ . Incidentally, a 923 or any other phototube, having S-2 spectral characteristics has a sensitivity extending up to $.8\mu$, as in Fig. 2.

The two outstanding devices in the resistance variation field are the flake bolometer, (developed by the Bell Tel. Labs. and manufactured by the Western Elec. Co.), and the

columbium nitride strip operating at temperatures approaching absolute zero, developed at Johns Hopkins University.

The former consists of thin flakes of thermistor materials, (in this case nickel, manganese and cobalt oxides). The small sizes of these

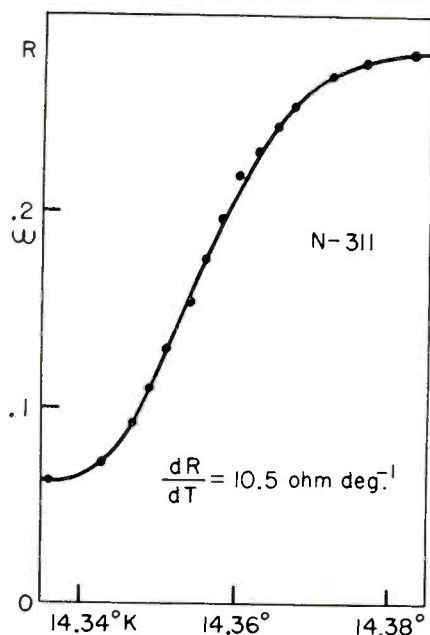

Fig. 4—Characteristic curve of columbium nitride bolometer

flakes make a ten-fold gain in sensitivity possible and moreover, permits high speed responses with a time constant of about .003 sec.

Thermistor materials, comprising certain metallic oxides such as uranium, magnesium, nickel, etc. have been described* with respect to their use as resistors with high negative resistance/temperature

*Electronic Industries, Jan., 1944; p. 76.

characteristics. This effect is retained even with small flakes. They can be prepared to have a wide range resistance from 50 to 500,000 ohms/cm², and with a resistance temperature coefficient as high as 5% /°C. For bolometer use the material was prepared in thin flakes, .0002-.0005 thick and have an area of the order of 1 mm².

The columbium nitride bolometer has a speed of response that permits recording 3000 cycle per sec. signals (down 6db). Columbium, a light gray metal is closely associated with the above mentioned tantalum. A thin ribbon (.2 x 0.01 x .00025 in.) is nitrided in an atmosphere of ammonia or nitrogen and mounted behind a rock salt window in an evacuated container maintained at a temperature in the range of 14 to 15°K. Fig. 4 shows a typical resistance/temperature curve about the point 14.36°K. A typical bolometer prepared in this way had characteristics as follows:

Resistance 2 ohm
Active area 1 mm²
Time constant 5×10^{-4} sec
Heat capacity of ribbon... .25 ergs/°
Minimum detectable radiation pulse, 2×10^{-6} erg which is equivalent to $T = 1 \times 10^{-7}$ degree
 $dr/dt = 10$ ohm/degree

This bolometer is used in a bridge circuit with about 30 milliamperes passed through the ribbon and is so sensitive to heat that it can detect a temperature variation as small as one-millionth of a degree C. It is able to detect the warmth of a man's body a quarter of a mile away, locate ships at night and distinguish factory chimneys by

APPLICATIONS FOR SENSITIVE HEAT RECORDERS

ASTRONOMY—Measurement of radiation from a star.

INFRARED SPECTROSCOPY—Recording selective absorption over a range of frequencies in infrared region to indicate type of gases in the transmission path.

WEATHER STUDIES—Measurement of mean humidity over large distances by recording the attenuation of infrared transmission at selected wave lengths affected by water vapor (6.7μ).

OPTICAL PYROMETRY—Temperature measurements at a distance from furnaces, ingots, etc. using wavelengths not affected by water vapor, smoke, etc. ($8-12\mu$).

INFRARED VISION—Scanning viewed areas to determine presence and outline of heat radiating objects.

NAVIGATION—Applied to sextant for sighting the sun through clouds or to note presence of rocks, icebergs, etc.

RADIO FREQUENCY RESEARCH—Measurement of small radio frequency currents by noting their heating effect.

PHYSIOLOGICAL STUDIES—Involving measurement of small rapid temperature changes in body organs etc.

COMMUNICATION and SIGNALLING—Using infrared or visible light.

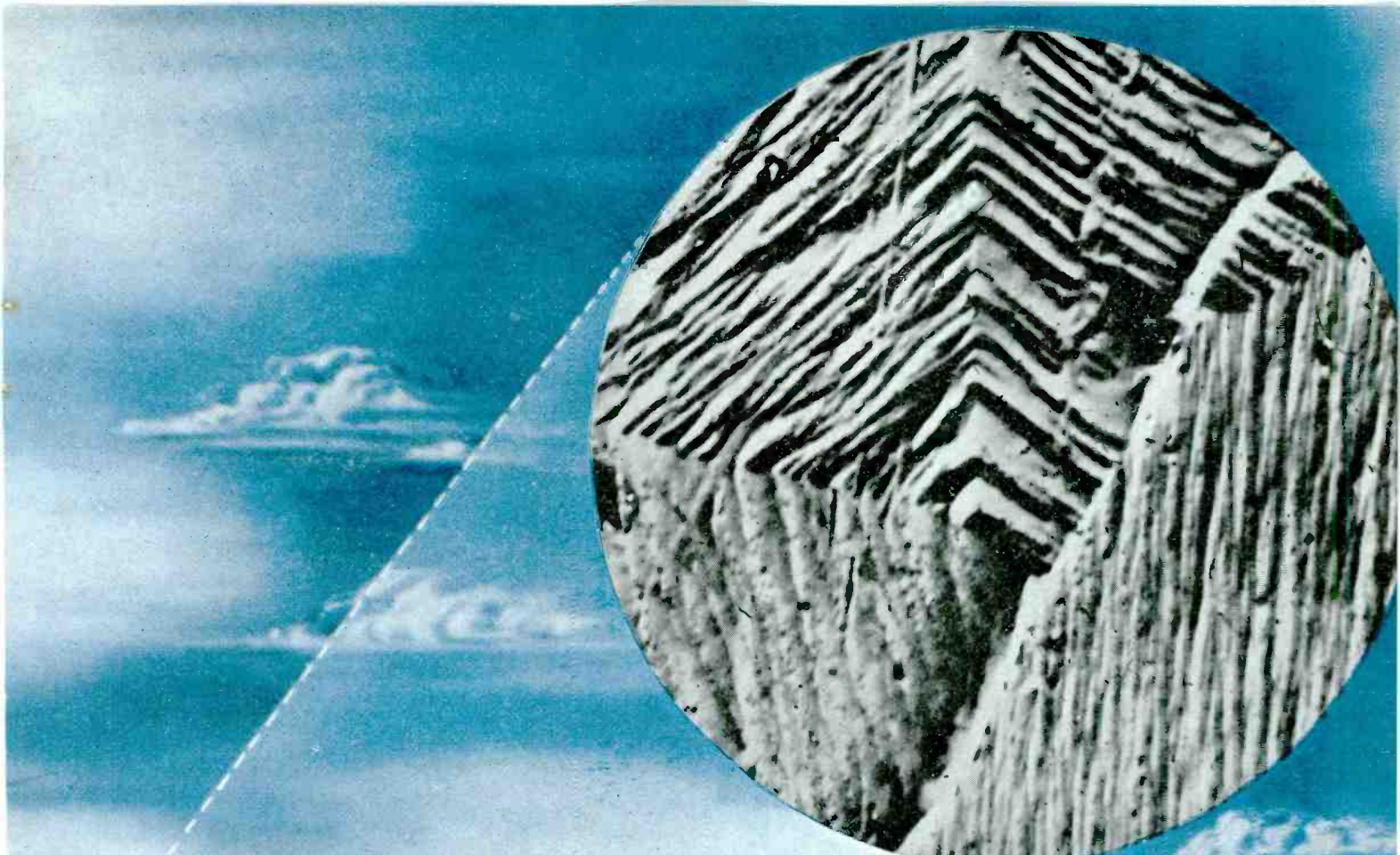

Big Blow-up...

Electronics and Photography work together to produce records like this 47,500-diameter magnification of chromium-iron surface

Magnified 47,500 times, the head of a pin would cover about as much area as a football field. Its apparently smooth surface would show irregularities as startling as these . . .

Electron micrography can produce magnifications even greater than this. The electron microscope, by itself, magnifies as much as 10,000 times and records images on photographic plates. And these images are so sharp, so well defined, that photography can enlarge

them even more—often as much as 20 times more . . .

Because it plays this dual role in electron micrography . . . because it both records and enlarges . . . photography is an integral part of the new technic that is adding so much knowledge of such tremendous value to many branches of industry.

EASTMAN KODAK COMPANY
Industrial Photographic Division
Rochester 4, New York

ELECTRON MICROGRAPHY

. . . another important function of photography

Kodak

ANDREW *Semi-Flexible* COAXIAL CABLE

BETTER ON 3 COUNTS

✓ **LOWER** loss than plastic 30% to 50% less loss than in plastic cables of same diameter.

✓ **GREATER** power capacity Insulation does not melt or soften... develops less heat than plastic cables.

✓ **LONGER** lasting Andrew cables are made entirely of copper and stone, two materials which have unlimited life and which impart the greatest resistance to crushing, corrosion and weathering.

ANDREW "FIRSTS" Here's proof of Andrew Leadership in the development of semi-flexible coaxial cables: 1) First to produce $\frac{3}{8}$ and $\frac{7}{8}$ inch soft temper cables in 100 foot lengths... 2) First to offer continuous coils of unlimited length with factory splicing... 3) First to offer lines shipped under pressure with all fittings attached.

Such continued leadership enables Andrew to offer better semi-flexible coaxial cables; cables that are better than those made from any other materials.

A complete line of coaxial cables, accessories, and other antenna equipment is produced by Andrew.

These are the famous Andrew semi-flexible coaxial cables in $\frac{3}{8}$ and $\frac{7}{8}$ inch diameters (shown in actual size). Because of their better construction and design they are used throughout the world by thousands of broadcast, police, government, and military radio stations as the most efficient device for connecting antenna to transmitter or receiver.



their heat radiation. From high altitudes these thermistor bolometers can scan a completely darkened landscape and indicate the pattern of rivers by the difference in heat radiation between land and water. For these applications the heat is collected in a parabolic reflector, Fig. 3, and focused on the bolometer element, which is connected to an amplifier. The latter transfers the information to an oscillograph or to loudspeakers, or to some form of graphic recorder.

OSCILLOSCOPE

(Continued from page 97)

two microseconds duration and 60 volts peak amplitude. Both trigger pulses are available simultaneously at connectors on the front panel. The trigger generating circuit may be connected through a time delay arrangement to the internal triggered sweep and the two sections operated in synchronism. The action of the delay circuit is such that the output triggers may be made to lead or lag the start of the sweep by continuously variable amounts of time up to approximately 1000 microseconds.

Referring to Fig. 2 for circuit operation: V1 is a conventional multivibrator with a range from 200 to 5000 cycles per second. Output of this generator is differentiated and amplified in V2 and used to trip V3 which functions as a one shot multivibrator with adjustable width. The resistance inductance network in the first grid circuit of V4 is designed to form sharp negative pulses from negative wavefronts of V3. Positive pulses at the first anode of V4 are applied to the second triode which serves as a cathode follower and inverter output.

The triggered sweep circuit of Fig. 1 is arranged to respond to positive input voltage changes. However, the trigger forming stage, V4 of Fig. 2, will produce triggers only from negative grid excursions. When it is desired that the trigger pulses lag the sweep start, then the sweep is initiated from the fixed leading edge of the square wave at the second anode of V3. The trigger pulses will be formed from the negative trailing edge of this wave. The result is an adjustable delay between the trigger and sweep as the width of multivibrator V3 is varied.

To obtain the condition of trigger leading the sweep, the inputs are connected to the first anode of V3.

ANDREW CO.

363 E. 75th ST. • CHICAGO 19, ILL.

Pioneer Specialists in the Manufacture of a Complete Line of Antenna Equipment

Here They Are!

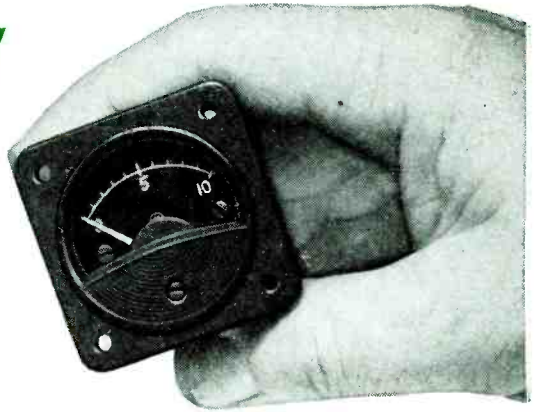
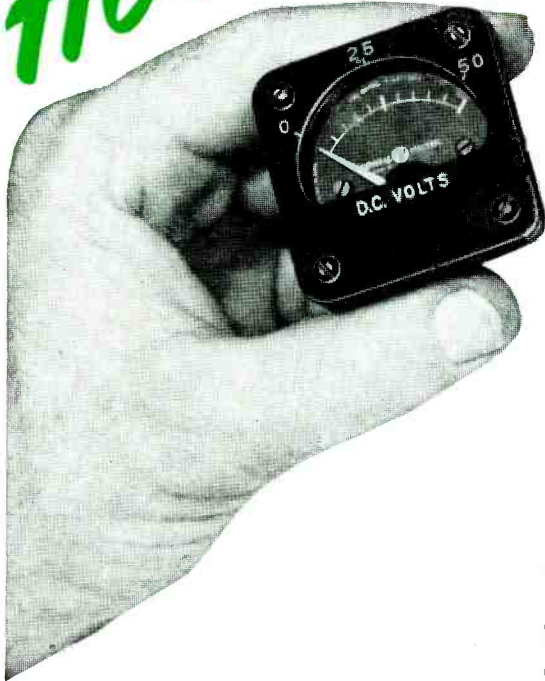

*The New
1/2 INCH*

G-E PANEL INSTRUMENTS

To meet the need for compactness, especially in electronic and communication devices, they have a body diameter of only 1½ inches, are less than 1 inch deep, and weigh only 3 ounces. They are accurate to within ± 2 per cent.

WATERTIGHT

TYPES DN-1, -2, -3

(Left hand, above)

● For applications where equipment may be used in an extremely humid atmosphere, exposed to rain, or accidentally submerged in water. Available for direct-current (DN-1), radio-frequency (DN-2), and audio-frequency (DN-3) service.

CONVENTIONAL

TYPES DN-4, -5, -6

(Right hand, above)

● For use on aircraft and on communications or electronic devices where the instrument is protected. Available for direct-current (DN-4), radio-frequency (DN-5), and audio-frequency (DN-6) service.

These instruments are of the internal-pivot construction, and in addition to small size and light weight, they have all the other desirable features associated with this unique G-E design.

Because of its high torque and large-radius pivots, the element (which is common to both instruments) is well able to withstand vibration. High torque combined with a lightweight moving element results in fast response. Good damping makes for ease and accuracy of reading. Large clearances help to insure reliable operation.

All these features add up to a high factor of merit and all-round excellent performance.

For advance information, ask the nearest G-E office for Booklet GEA-4380, or write to General Electric Co., Schenectady 5, N. Y.

THEY'RE G-E INTERNAL-PIVOT INSTRUMENTS

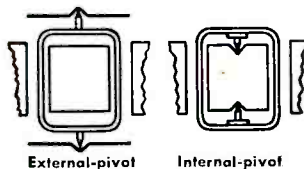

External-pivot

Internal-pivot

One advantage of the internal-pivot design is compactness. Armature, core, control springs, pivots, jewels, balance weights, and pointer form a single, self-contained unit, all parts of which are supported by a cast-camol magnet.



HEADQUARTERS FOR
ELECTRICAL MEASUREMENT

GENERAL  ELECTRIC

7102-R3-0200



By HAYDON AC Timing Motors

HAYDON AC Timing Motors can be made to perform one revolution every 1000 hours or 27 million times as many. Whatever your particular requirement may be, a HAYDON AC Timing Motor can be engineered to fit.

More than a million HAYDON units now measure and motivate industrial operations.

SEND FOR ENGINEERING DATA BOOK

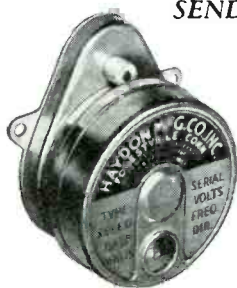

ELECTRONEERED TIMING

Haydon

MANUFACTURING COMPANY
INCORPORATED

Forestville, Connecticut

Trigger and sweep may also be started from opposite plates when no adjustable delay is desired. Circuit constants have been chosen so that operation of the phasing multivibrator is stable over the entire frequency range of the trigger generator multivibrator. Maximum phasing is approximately 1000 microseconds, or 80% of the time between successive cycles, whichever is the smaller.

Vertical amplifier

The vertical amplifier is conventional in design. Care has been taken to maintain wide frequency response consistent with good transient response. Sine wave response is flat within 10% to 4 mc per second with no positive slope at the high frequency end of the frequency coverage. Thus the transient response is such that a 100 kc square wave which rises or falls in the order of 400 volts per microsecond is faithfully reproduced.

Push-pull 807 tubes are used in the deflection amplifier to obtain adequate voltage swings to give a full screen image. The maximum sensitivity obtainable is about .05 rms volts per inch deflection, which has been found adequate for most purposes. A feature which has been added as a convenience is an amplitude calibrating system which makes it possible to check rapidly the peak voltage of a signal being observed. The input system is shown in Fig. 3.

The incoming signal is fed to a frequency compensated attenuator with steps of 100 to 1, 10 to 1, and 1 to 1. A variable ac voltage may be substituted at any time for the fraction of the input voltage appearing across the output of the attenuator. This may be adjusted by means of the CALIBRATE potentiometer until the calibration deflection on the cathode ray tube equals the deflection produced by the input signal. The value may be read on the calibration meter. If this is multiplied by the attenuation factor, the result is equal to the incoming signal amplitude. The values of voltage divider, R6 and R7, have been chosen so that the peak voltage at the junction of the two resistors is equal to the RMS value indicated by the meter, so that the meter effectively reads in peak volts.

Also included is a high-impedance, low-capacity probe for use where a minimum of circuit loading must be maintained.

The input system of the horizontal amplifier is similar to that

Here's How Radio Industry Says "OK"

TO FEDERAL'S NEW MINIATURE SELENIUM RECTIFIER

TYPE-403D2625



NOW being used in radio receivers, voltage multipliers, speech amplifiers, PA systems, electronic organs, business machines — wherever a low-voltage low-current d-c source is required — replacing type 117Z6-117Z3 and other rectifier tubes.

The "landslide" of orders which followed the announcement of this new rectifier means just one thing — another outstanding contribution which fills a great need in the electronic industry. Now, in hundreds of applications, this 5-plate rectifier stack is proving its value — in money saved, reduced assembly time, new space savings, longer life, instant starting. It measures only $1\frac{1}{4} \times 1\frac{5}{8} \times \frac{5}{8}$ inches, and will go into restricted spaces where a tube and socket won't fit.

Though miniature in size, this rectifier embodies "full-scale" quality throughout, with **Center-Contact** construction and all of the other features which have made Federal Selenium Rectifiers the standard of quality in the industry. They're available now — in quantity. Write to department 0000 for prices and data.

CHARACTERISTICS:

Type 403D2625 Rectifier

| | |
|----------------------------------|-----------|
| Maximum RMS Voltage | 130 volts |
| Maximum Inverse Voltage | 380 volts |
| Maximum Peak Current | 1200 ma. |
| Maximum RMS Current | 325 ma. |
| Maximum DC Output | 100 ma. |
| Approximate Rectifier Drop | 5 volts |

Federal Telephone and Radio Corporation

In Canada: Federal Electric Manufacturing Company, Ltd., Montreal
Export Distribution: International Standard Electric Corporation



Newark 1,
New Jersey

WAVEFLEX

*flexible
waveguides*

FOR MICROWAVE TRANSMISSION

WAVEFLEX is the optimum flexible wave guide for microwave transmission in communication, television,

and radar applications on vessels, vehicles, and aircraft. It is particularly adaptable in installations where vibration, shock mounting, or movement are present.

The extreme flexibility of Waveflex permits confinement in "tight" corners without distortion of critical dimensions of size and shape. Small radii bends are possible with practically no change in electrical properties, thus overcoming the loss of energy due to reflection in microwave transmission. Precision construction with silver-plated inner surfaces further reduce attenuation and preserves costly transmission energy.

A new bulletin with specifications is available upon request. Write to: Titeflex, Inc., 539 Frelinghuysen Ave., Newark 5, New Jersey.



Titeflex

WAVEFLEX — THE FLEXIBLE WAVE GUIDE WITH
COMPLETE ELECTRICAL CONTINUITY

used in the vertical amplifier. The frequency response in this section has been maintained substantially flat to one megacycle. Maximum sensitivity is 0.1 rms volts per inch. Push-pull 6AG7's are used to provide deflection voltages.

Miscellaneous features

Among the many features of this instrument are provisions for direct connection to all deflection plates, external connection to cathode ray tube grid, 3000 volt accelerating potential for improved image definition and a voltage regulated power supply for stable hum-free operation. Panel controls have been functionally grouped for operational convenience. Mechanical construction is rugged and designed for both electrical efficiency and ease of servicing. The entire unit is self-contained in a wrinkle-finished steel cabinet 16 x 12½ x 20 in. with a total weight of approximately eighty pounds.

It should be noted that the refinements incorporated in this oscilloscope do not restrict its use to specialized applications but rather supplement the features of a standard oscilloscope, all of which are included with improved operating efficiency. Thus, the instrument will be equally useful for routine testing, production testing, and general application as well as for research on radar equipment, television, facsimile, or other laboratory research of an advanced nature.

INDUSTRY STUDIES

(Continued from page 67)

dle the most urgent problems.

The responsibilities of this electronic designer are great. Whereas, in most radio receivers a large and gradual loss in amplification would do no harm, because auxiliary controls are introduced to stabilize the results (i.e., automatic volume control), a minor variation in some characteristic in an industrial control circuit might throw the whole system into disrepute. A radio receiver designer uses tubes which have been developed for his use, whereas the industrial equipment designer generally also has to use the tubes designed for radio circuits. This is not too serious a handicap, however, since he has hundreds of tube types on the list from which to select.

His serious problem is to engineer the circuit so that normal variations in the operating charac-

Announcing

NEW Electro-Voice CARDYNE

Now you get More Features...
More Advantages than ever... in a Single Head

Cardioid Dynamic Microphone

New E-V developments bring you true cardioid unidirectionality . . . smooth, wide-range response . . . high output . . . and other desirable advantages in a rugged single-head dynamic.

Through the exclusive new E-V *Mechanophase** principle, the CARDYNE virtually eliminates unwanted sounds . . . gives you only the sound you want, with greater definition and fidelity. Substantially reduces background noise and reverberation. Increases effective working distance from microphone. Stops feedback. Permits increased loud-speaker volume. Gives extremely accurate pick-up and reproduction of music and speech . . . indoors and outdoors. Highly suitable for the most exacting sound pick-up work . . . in studio and remote broadcasting, disc and film recording, public address and communications.

Trim, modern, functional design, finished in rich satin chromium. Smooth, firm tilting action. "On-Off" switch. Ruggedly built to withstand severe operating conditions. Available in 50, 250, 500 ohms impedance, or Hi-Z (direct-to-grid, 25,000 ohms). Low impedances balanced to ground. Also available without "On-Off" switch. *Send now for Cardyne Bulletin No. 131.*

CARDYNE II. Model 731. List Price \$75.00
Frequency response, substantially flat, 30-12,000 c.p.s.

CARDYNE I. Model 726. List Price \$55.00
Frequency response, substantially flat, 40-10,000 c.p.s.

No finer choice than

Electro-Voice

ELECTRO-VOICE, INC., 1231-B South Bend Ave., South Bend 24, Indiana
Export Division: 13 East 40th St., New York 16, N. Y., Cables: Arlab



Cardioid (heart-shaped) Polar Pattern. Wide-angle front pick-up, horizontally and vertically, diminishes sharply to dead zone at rear. Sound at rear dead zone cancels out and is not reproduced. Solves everyday sound problems—in a great many applications.

Only the Cardyne Gives You All This!

- New E-V Mechanophase* Principle
- True Cardioid Unidirectional Performance
- Reduces Background Noise, Reverberation
- Stops Feedback—Permits Greater Volume
- Relatively High Output
- New E-V Acoustalloy Diaphragm
- Substantially Flat, Wide-Range Response
- And other E-V Features

*Patents Pending



WIRES

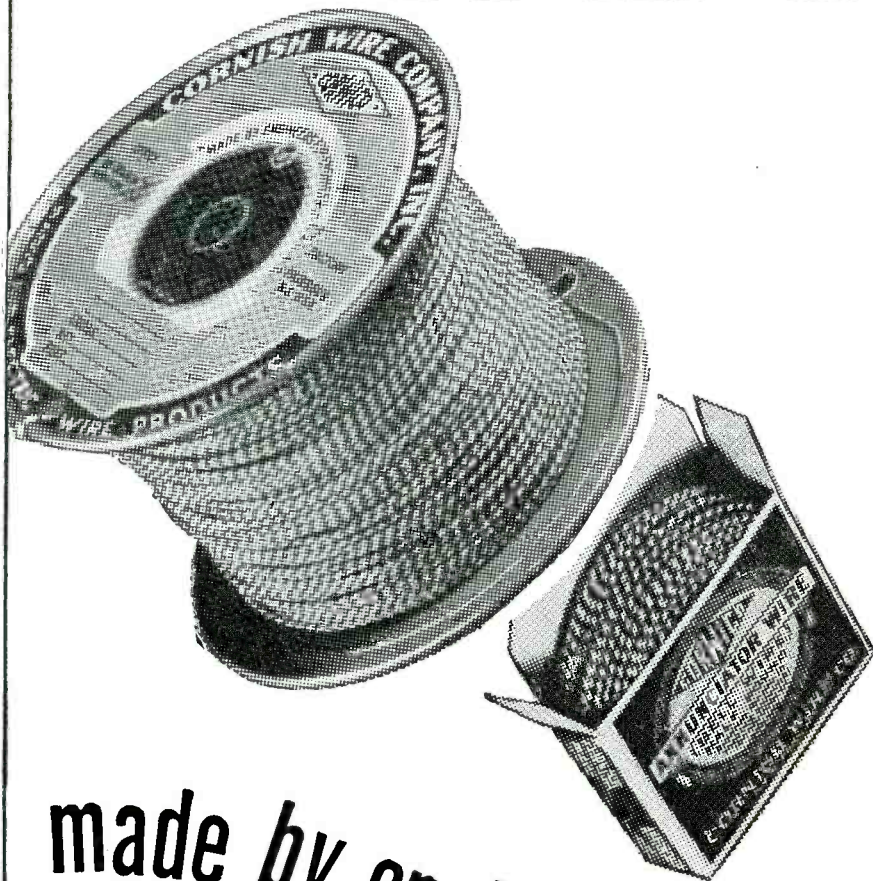

made by engineers
for engineers.....

CORNISH WIRE CO., INC.

15 Park Row • New York City, 7

teristics and possible slow changes in some of the parameters in regular operation, do not influence the results. It must be kept in mind that most of the noticeable effects of aging, etc., can be "engineered out" by circuit expedients.

Packaged units

The above remarks about packaged items do not hold for the large field of specialized industrial measurements. Many instruments are available wherein electronic principles have made valuable contributions to speed and accuracy. Here instrument men can find some form of "packaged" equipments that will measure almost any quantity. Nor do they pertain to the fields of high frequency heating and industrial communication where apparatus is available in almost any size and for any type of service. Another important field exists where electronically operated follow-up mechanisms provide rapid and accurate recorders and controllers. These instruments, of which there are several, are readily adapted to a wide range of applications.

It has been the experience in many plants that a large number of specialized jobs show up that definitely call for electronic methods. These may be in telemetering, timing, counting and in regulation services of all types. Apparatus is available for almost every problem in these groups. Another service for which equipment is readily adapted is that typified by printing registration, packaging and shearing to specified lengths.

Photoelectric controls

The "electronic art" was originally associated in the minds of many with the use of photoelectric devices. This field of application has long advanced out of the gadget stage, due to the availability of reliable instruments for many kinds of applications where light, color and vision are factors.

The opinion still prevails (and once in a while it is true) that doing it electronically is doing it the hard, expensive way. The field of high frequency heating was one that had to buck the problem of operating costs that are negligible for other types of heat. Successful in getting the right amount of heat where it is wanted quickly (as in the center of large masses) dielectric and induction heating is now being seriously investigated for

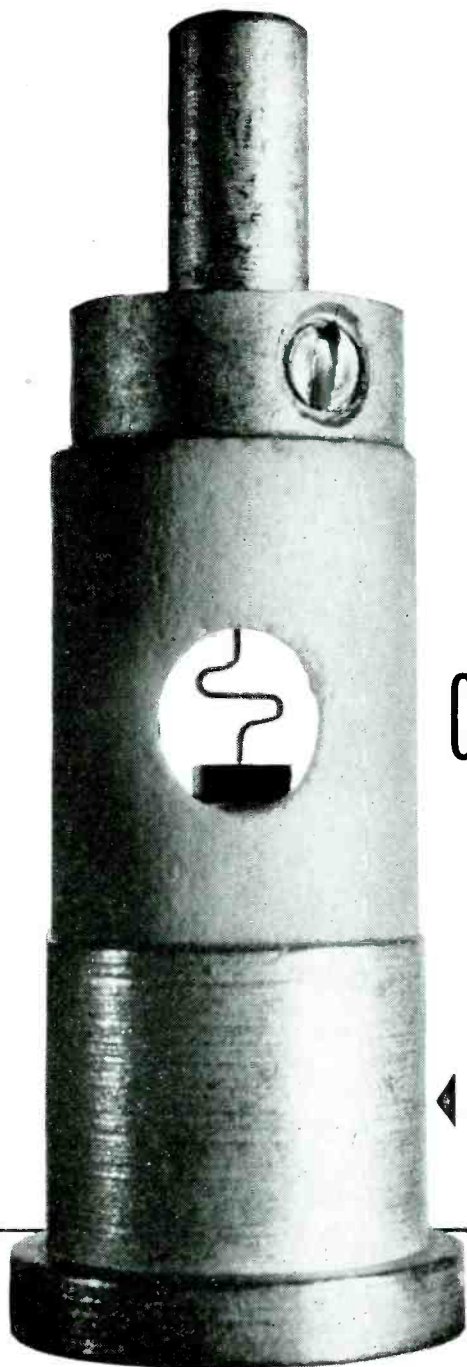

Crystal detector—1946 model

ENLARGED
8 TIMES

ONE INCH



Remember the crystal detector in the first radios — hunting for the right spot with a cat's whisker? For years the detector lay discarded in favor of the vacuum tube. But when microwaves came, and with them the need to convert minute energy to amplifiable frequencies, a Bell Laboratories' scientist thought back to the old crystal.

Silicon of controlled composition, he discovered, excelled as a microwave detector. Unlike the old-style natural crystals, it was predictable in performance, stable in service. From 1934 to Pearl Harbor, the Laboratories developed silicon units to serve microwave research wherever needed.

Then Radar arrived. The silicon crystal came into its own, and found application in long-distance microwave Radar. Working with American and British colleagues, the Laboratories rapidly perfected a unit which the Western Electric Company produced in thousands. It became the standard microwave detector.

Crystal detectors are destined to play a big role in electric circuits of the future. They will have an important part in Bell System microwave radio relay systems. In various forms, they may reappear in radio sets. Here again Bell Laboratories' research has furthered the communication art.

BELL TELEPHONE LABORATORIES



EXPLORING AND INVENTING, DEVISING AND PERFECTING FOR CONTINUED ECONOMIES AND IMPROVEMENTS IN TELEPHONE SERVICE

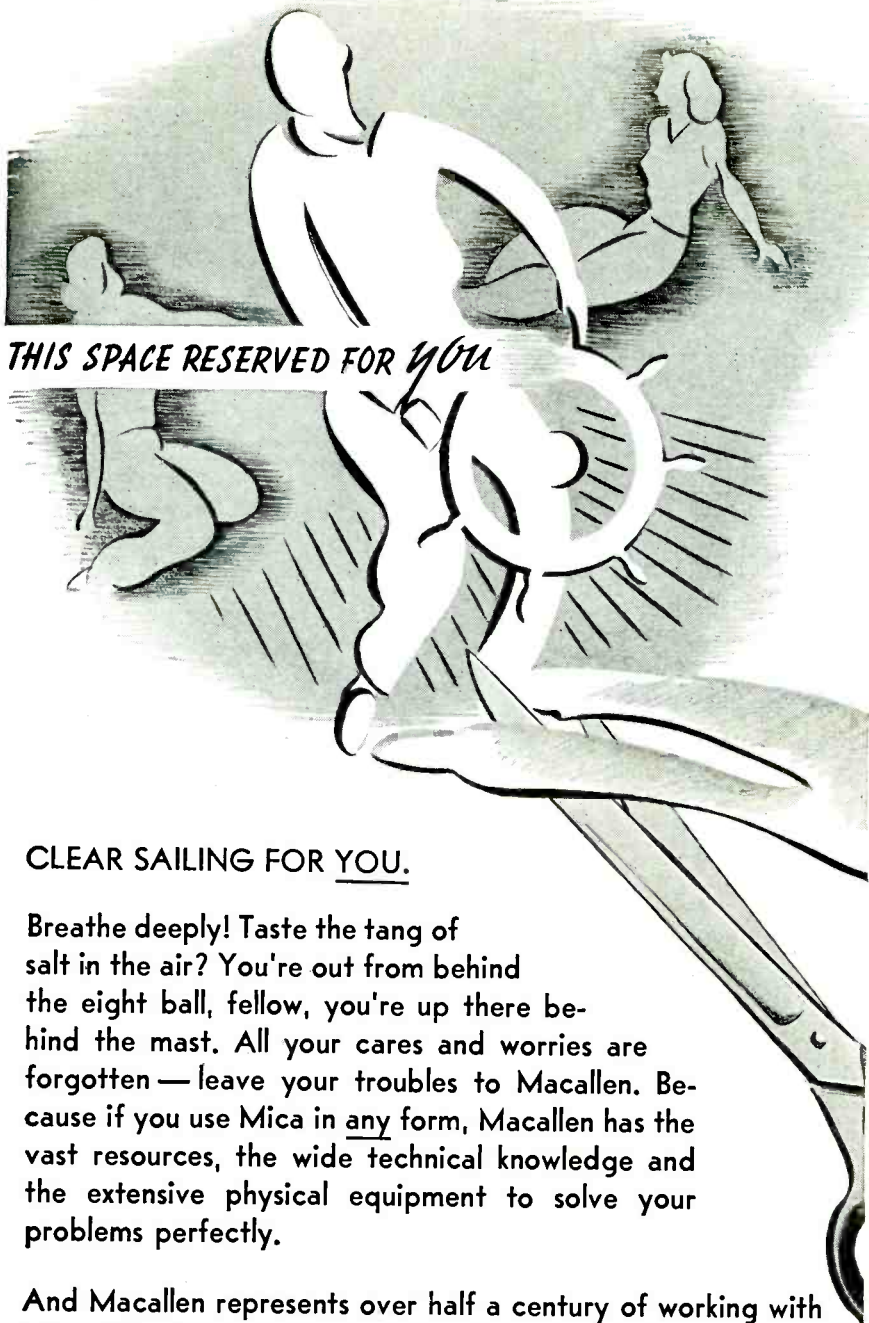

THIS SPACE RESERVED FOR YOU

CLEAR SAILING FOR YOU.

Breathe deeply! Taste the tang of salt in the air? You're out from behind the eight ball, fellow, you're up there behind the mast. All your cares and worries are forgotten — leave your troubles to Macallen. Because if you use Mica in any form, Macallen has the vast resources, the wide technical knowledge and the extensive physical equipment to solve your problems perfectly.

And Macallen represents over half a century of working with Mica. Whether you make motors or generators, condensers or transformers, if you use Mica, then Macallen is your most reliable and dependable source of supply. For clear sailing ahead — leave your troubles to Macallen.

When You Think of MICA, Think of MACALLEN



16 MACALLEN STREET—BOSTON 27

CHICAGO: 565 W. Washington Blvd. CLEVELAND: 2005 Leader Bldg.

services where quick guesses would rule out the method from the matter of economy.

Returning to the industrial process control applications, most industrial plants are considering electronic methods along with the more readily obtainable hydraulic and pneumatic arrangements, to determine if the former have a place in a specific setup.

Relative cost

The installation expense of other systems depends primarily on the availability of suitable operating power. The drive for a final powered unit, such as a valve, may be either an electrical motor, solenoid, diaphragm or pressure operated plunger or cylinder. The cost of tubes, sockets and the usual accessories for a tube circuit may exceed that of a simple diaphragm motor unless conditions require special valve positioners, etc.

Electron tubes and accessories, per se, have been reduced to nominal costs because commonly available types are designed into the control equipment. In view of this standardization the costs of the electronic elements of the control are minor when compared with the expense of producing a few special machined parts which may be needed in either system. No conclusion can or should be drawn without investigation of all factors. Since wartime developments are just now being redesigned into new jobs, the correct answer now may not be the same in even three or six months.

One problem now being experienced by those associated with electronic equipment (producers and users) is providing an answer, the thought that an electronic control system should never have any moving parts, whereas in many cases a great deal of the same sort of apparatus used in other systems is in evidence. True, in some cases where the regulation of heat, power, and light is the end product, full electronic control is possible. In most other arrangements the final activation device can be a motor which again is easily adapted to do most anything that can be done manually since the main purposes of the tubes is to serve as the brain and nerve centers of control.

Finally, there have been large numbers of tube circuits developed to do ingenious things during the past twenty years. Military research and experience have pointed

SYLVANIA NEWS

CIRCUIT ENGINEERING EDITION

SEPT. Prepared by SYLVANIA ELECTRIC PRODUCTS INC., Emporium, Pa.

1946

MODERN SET DESIGN SEEN GREATLY INFLUENCED BY NEW SYLVANIA ELECTRIC T-3 TUBE

*Commercial Version of Proximity Fuze Tube
Is Tiny, Rugged, Has Long Life*

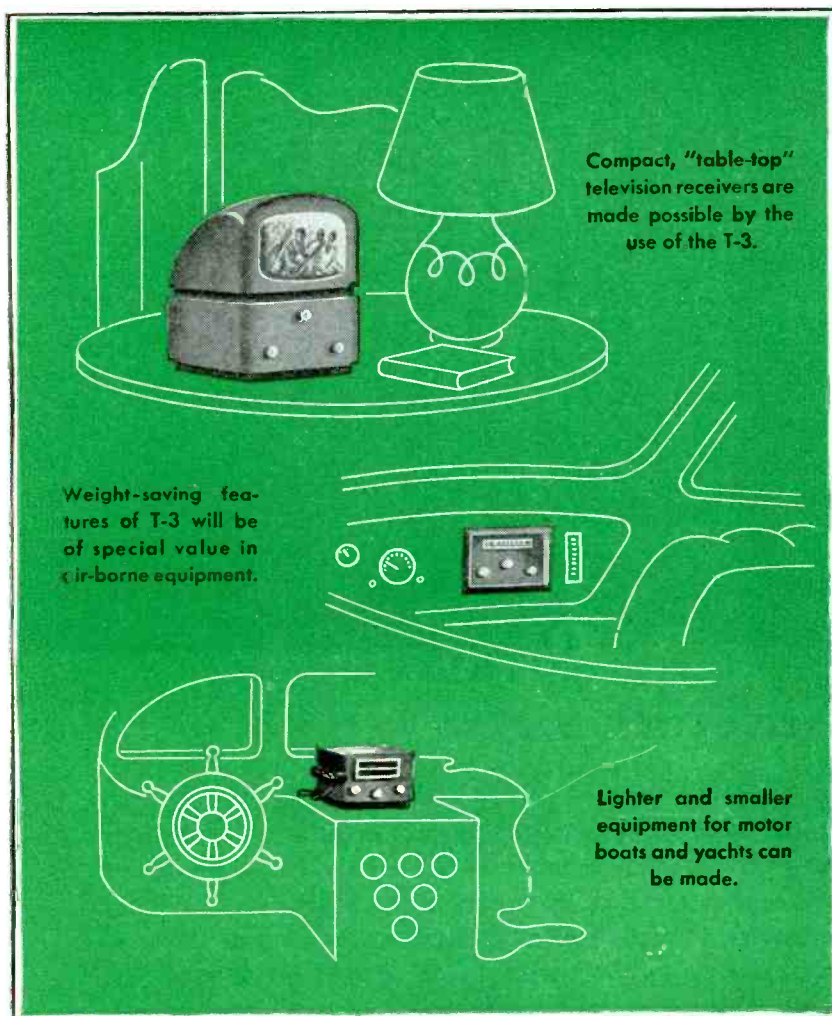

Radio equipment manufacturers are viewing with marked interest the radical reductions in size and weight now made possible in many types of electronic equipment through the use of the sensationally small Sylvania vacuum tube, T-3.

The commercial version of the former proximity fuze transceiver tube is noted for exceptional ruggedness . . . long life . . . ideal suitability for high frequency operation.

Some of the design possibilities opened by the T-3 are shown here. Of course, its potentialities are not limited to these fields.

Write Sylvania Electric Products Inc., Emporium, Pa.

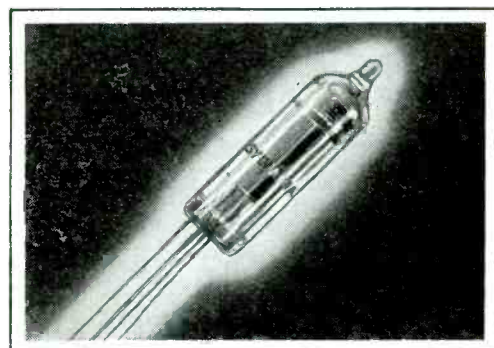

The T-3 tube is shown here in its actual size.

SYLVANIA ELECTRIC

Emporium, Pa.

MAKERS OF RADIO TUBES; CATHODE RAY TUBES; ELECTRONIC DEVICES; FLUORESCENT LAMPS, FIXTURES, WIRING DEVICES; ELECTRIC LIGHT BULBS

STACKPOLE

SINTERED **ALNICO II**

**REAL ECONOMY
FOR SMALL SIZES
AND ODD SHAPES**

... BETTER UNIFORMITY CHARACTERISTICS, GREATER MECHANICAL STRENGTH

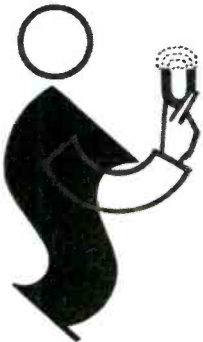

** Licensed under G-E patents*

Here is new help on permanent magnet problems—from one of the largest, oldest and most widely experienced producers of molded and sintered components in the industry.

Stackpole *Alnico II offers notable economy in the production of units up to two ounces. Odd shapes are a specialty. Engineering recommendations based on your requirements gladly submitted.

STACKPOLE CARBON COMPANY, ST. MARYS, PA.

BRUSHES and CONTACTS (all carbon, graphite, metal and composition types)—IRON CORES—RARE METAL CONTACTS—RHEOSTAT PLATES AND DISCS—CHEMICAL CARBONS—WELDING AND BRAZING CARBONS—MOLDED PUMP and FLUID DRIVE SEALS—CARBON RHEOSTAT PILES—COIL FORMS, etc., etc.

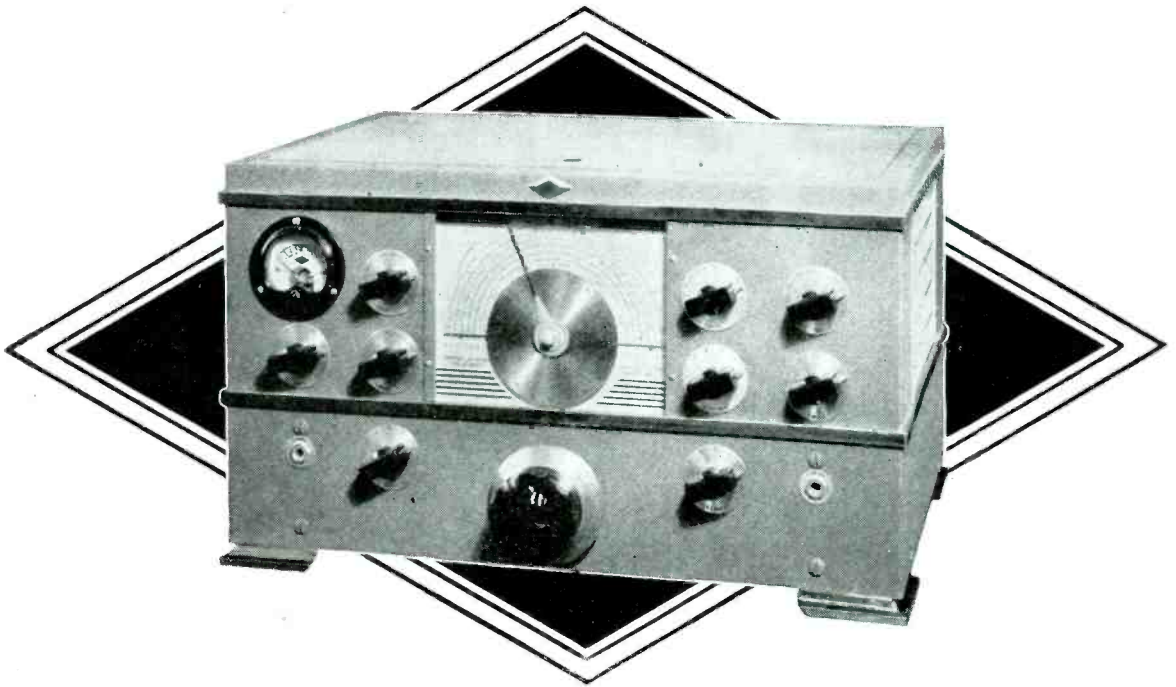

THE NC-2-40C RECEIVER

Back of the superb NC-2-40C receiver stand National's twenty-five years of experience in building to the highest quality. In the NC-2-40C as in other products, National has excellence for sale. Stability and sensitivity are outstanding. Controls are convenient to the hand and smooth in operation. All important auxiliary circuits — wide range crystal filter, noise limiter, S-meter, beat oscillator, AVC — are present in advanced design. You will find the operation of the NC-2-40C a gratifying pleasure and its ownership a source of pride. See it at your dealer's.

NATIONAL COMPANY, INC.



MALDEN, MASSACHUSETTS

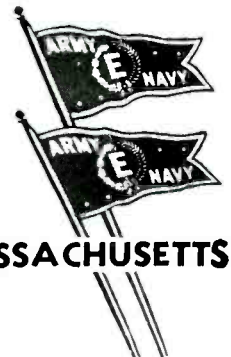

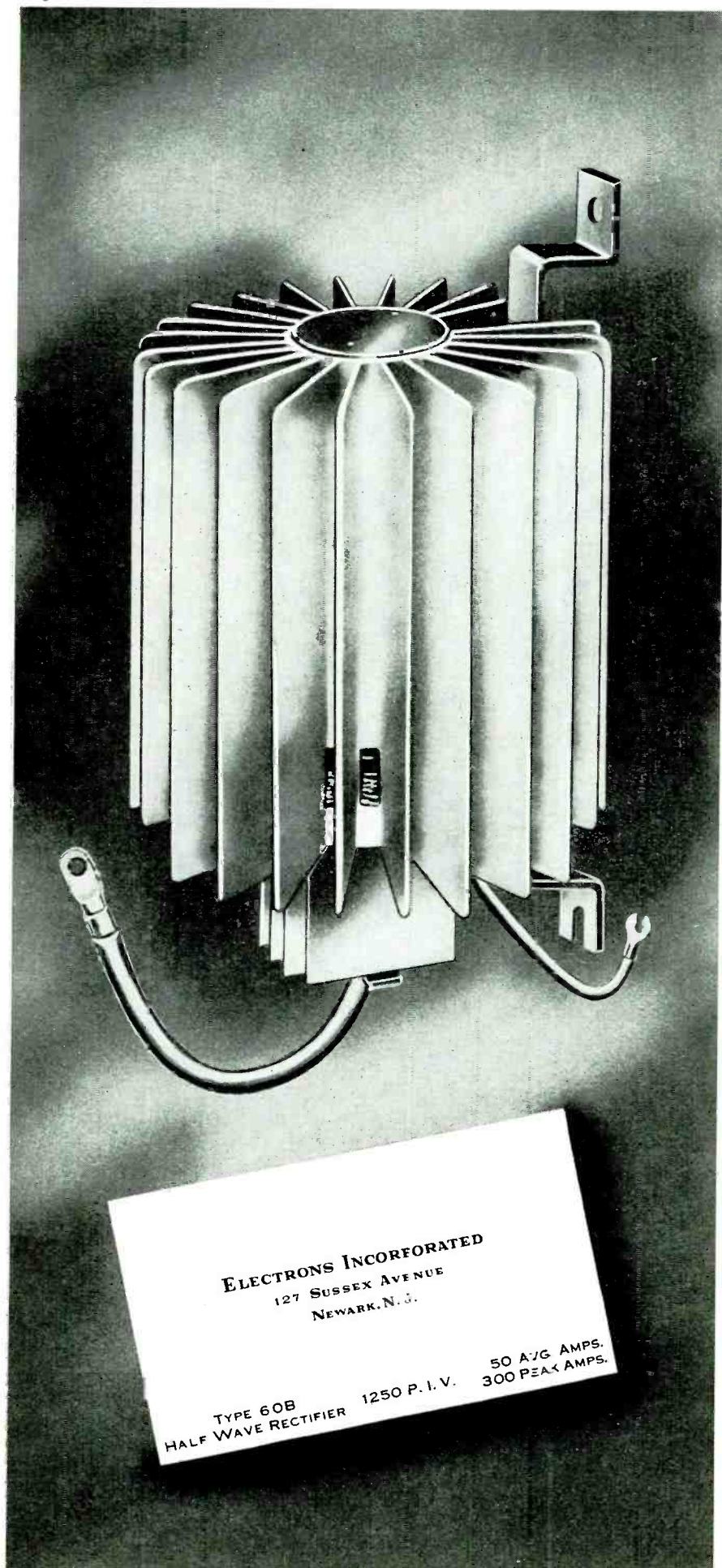

ELECTRONS INCORPORATED
 127 SUSSEX AVENUE
 NEWARK, N. J.

TYPE 60B
 HALF WAVE RECTIFIER 1250 P. I. V. 50 A/VG AMPS.
 300 PEAK AMPS.

out the importance of a number of particular operating principles and circuit technics that should greatly extend the range of application of tubes into new fields. A few of these are shown on the chart in this issue. Further details on these and other tube circuit design arrangements have been compiled in the Handbooks.* R.R.B.

*Electronic Engineering Handbook, by R. R. Batcher and Wm. Moulic, Caldwell-Clements Co., 480 Lexington Ave., New York.

Electronic Control Handbook, by R. R. Batcher and Wm. Moulic, Caldwell-Clements Co., 480 Lexington Ave., New York.

RADIO VOCABULARY

(Continued from page 71)

ROC—Gravity powered bomb controlled by television.

ROPE—Strips of tinfoil about 400 ft. long by $\frac{1}{2}$ in. wide thrown from airplane to confuse enemy radar.

RUG—Another edition of "carpet."

SHORAN—Form of radar in which a mobile transmitter triggers a based transmitter.

SNIPERSCOPE, SNOOPERSCOPE—Military infra-red "seeing eyes" for observation in total darkness.

SONAR—Submarine detection system based on pulsed supersonic signals.

TR TUBE—Gaseous discharge tube for protection of radar receivers during periods of pulse transmission.

TUBA—Super power UHF transmitter for jamming enemy radar.

VT—Variable time proximity fuse detonated by self-contained radio transceiver.

WINDOW—Aluminum strips $\frac{1}{4}$ wave long thrown from airplanes to confuse enemy radars.

TUBES AND CIRCUITS

(Continued from page 75)

tions, the value of F will be less than one. For triodes a value of 0.25 can be used. For sharp cut-off pentodes, a value of about 0.5 can be used to take care of the division of current at the screen (variable mu pentodes will have a still greater value). If, in the above mentioned amplifier tube, the plate current is 2 ma, G_m is 1000 micromhos, and F is 0.5 for a pentode, then the equivalent shot noise voltage would be about 1.2 microvolts, which is less than that contributed by the grid circuit resistance.

Within the past few years many

Now . . . for the **FIRST** time . . . you can

Control

PRESSURES

from **50** to **5000** lbs.
with **ONE** adjustable switch!

APPLICATIONS

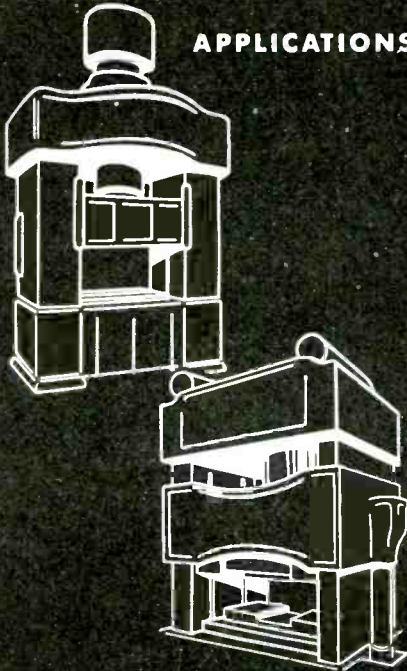

The DiaFlex XPress Pressure Switch opens new fields to designers and users of heavy hydraulic presses, pneumatic tools, machinery and high-pressure equipment. It can be used to control actual operation, to monitor protective devices, to actuate a safety warning or alarm signal. Obvious uses are on large drop hammers, draw presses, forging equipment, machine tools, high-pressure process equipment and pipelines. Perhaps the requirements of your plant or products will suggest others.

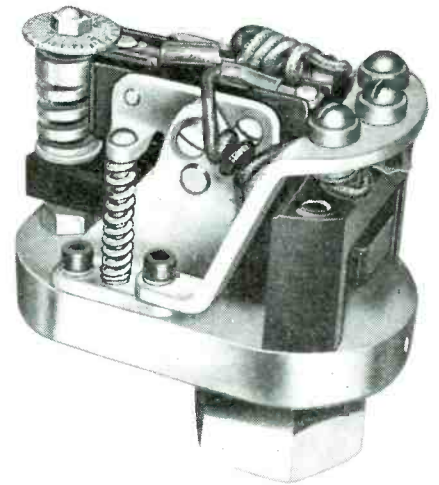

THE NEW **XPress** PRESSURE SWITCH by DiaFlex permits closer control of higher pressures than has yet been possible. Adjustable and sensitive from 50 to 5000 pounds per square inch of gas or liquid pressures, the XPress is unusually compact and sturdy.

DESIGN CHARACTERISTICS

- 1 Operating pressure range 50 to 5000 psi.
- 2 Operating pressure differential less than 10% over entire range.
- 3 Instant dial adjustment at operating pressures.
- 4 Operates on pneumatic or hydraulic pressure impulses.
- 5 Sensitive and accurate within 1/2 of 1% over entire range.
- 6 Compact: only 3 1/2" long x 2" wide by 4" high; weighs only 2 3/4 lbs.
- 7 Enclosed snap action contacts; dustproof and splashproof.
- 8 Rugged: will withstand rough handling and surge pressures up to 6000 psi.
- 9 Threaded pipe pressure connection; Amphenol or conduit electrical connection.

The XPress is but one of a complete line of pressure operated switches by DiaFlex. This division of Cook Electric Company is devoted to the design and production of precision products operated by the flexure of Cook's patented Spring-Life Bellows Diaphragms. You are invited to discuss your pressure control problems with the nearest Cook field engineer, or to write for further information. Please outline your requirements, and request Booklet PB.

DIA FLEX

division of **COOK ELECTRIC COMPANY** Chicago 14

Sales and engineering offices in principal cities.

For GRAND PERFORMANCE

Astatic

DYNAMIC
MICROPHONES

NEWLY DESIGNED
AND ENGINEERED

● Incorporating advanced ideas in operation and design, Astatic DN-Series Dynamic Microphones are highly recommended for a wide variety of communications and public address applications, especially where temperatures vary and high relative humidity is encountered.

Four Models
of different output
impedances, are
available: DN-50,
DN-200, DN-500
and DN-HZ.

Any one of these models is available with the Type G, Grip-to-Talk Desk Stand. Only one model, however, DN-HZ-S, high impedance, is available with the Type S On-Off Switch. Astatic Dynamic Microphones are semi-directional in character, incorporate a unitary moving coil system and carefully proportioned acoustic circuit to highly damp the natural resonance of the moving parts and provide a response substantially flat from 50 to 7,000 cycles. All DN-Series Microphones are sturdy and dependable, relatively low in cost, smartly streamlined, attractively finished in opalescent gray with bright chrome grille, and sure to give long, satisfactory service.

THE *Astatic*
ASTATIC CORPORATION
CONNEAUT, OHIO

IN CANADA: CANADIAN ASTATIC LTD., TORONTO, ONTARIO

special circuits involving vacuum tubes have been developed and have become widely used. These circuits include the cathode follower amplifiers, the grounded grid amplifier, the combination of cathode follower and grounded grid amplifier or the cathode coupled amplifier, various gate, switching or trigger circuits, variable reactance circuits, counting and control circuits.

One type of application of increasing importance is a circuit with an alternating plate supply voltage. A number of applications of this type have been developed and their tube requirements differ from the ordinary application. The plate current that may be used to operate a small motor or some similar device is often quite high. This heats up the tube enough to cause its plate to become an emitter and, on the high negative plate voltage in the reverse half cycle, electrons

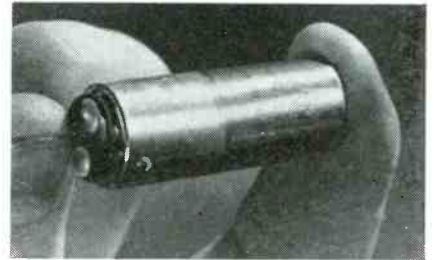

Miniature cold-cathode voltage regulator

may flow in the reverse direction to the grid and to the cathode, causing the tube to lose control. This type of application is one of those that requires different circuit design considerations than is used with standard receiver types, and may require specially designed tubes, if it is necessary to load them up to a point where high temperatures result.

Pulse applications have placed still different requirements on some tubes than have been considered previously. The cathodes have to supply the peak emission current which can be many times higher than the rated average current. Although the average dissipation of tube elements is kept constant, the dissipation in the cathode will be higher than it would be with an equal average current. Certain cathode materials and processing methods have resulted in higher emission capabilities for tubes made available for such applications.

Manufacturing limits on heater to cathode leakage in cathode types are usually given as the maximum



INDUSTRIAL CONTROL RELAYS

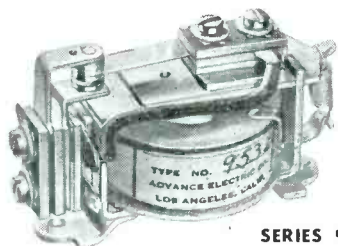

SERIES 950

SINGLE POLE RELAYS

General Circuit control unit, inexpensive, yet highly efficient. Available in either single or double throw, open or closed contacts. Coils—1 to 115 v A.C.—2 to 60 v D.C. Size — 1½-in. x 1½-in. x 2-21/32-in.

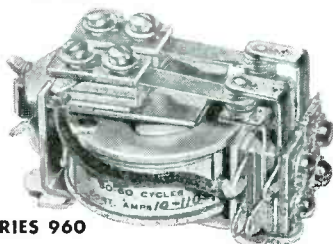

SERIES 960

DOUBLE POLE RELAYS

Small, yet powerful relay suitable for light or power transfer systems. Available in either single or double throw, open or closed contacts. Coils—1 to 115 v A.C.—2 to 60 v D.C. Size — 1½-in. x 1½-in. x 2-21/32-in.

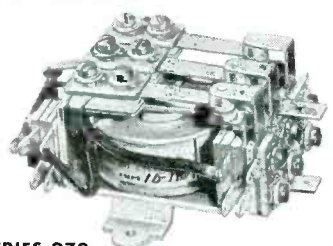

SERIES 970

THREE POLE RELAYS

Very rugged, small relay. Available in either single or double throw, open or closed contacts. Coils—1 to 115 v A.C.—2 to 60 v D.C. Size — 2½-in. x 2¾-in. x 2-15/16-in.

A similar Four Pole Relay (SERIES 980) is available in full range of contact combinations.

Write for catalog and price list

Advance Relays

ADVANCE ELECTRIC & RELAY CO.
1260 W. 2nd St., Los Angeles 26, Calif., U.S.A.

allowable current that can flow between the heater and cathode when 100 to 400 volts (depending on the tube type) is applied between them. Typical maximum current values vary between 10 and 200 microamperes. Difficulty is sometimes encountered in high gain amplifiers, cathode followers, etc., when the circuit permits the heater to cathode leakage to introduce hum into the amplifier. This can be overcome by operating the first stages with fixed bias so that the cathode is at ground potential and any dc leakage is returned directly to ground without getting into the signal circuits. Hum due to heater-cathode leakage can also be overcome by operating the heaters on dc.

If, as in industrial equipment, a high degree of reliability is desired, it is advisable to design the equipment so that the heater cathode voltage never exceeds 100 volts. This can be accomplished by using separate heater transformers having good insulation, and shielding for tubes whose cathodes operate at a high voltage off ground.

Another source of hum pickup in cathode types may be due to heater-grid coupling because of leakage between the elements, plus electron coupling (emission due to contamination of active material in grid or heater), plus capacitive coupling. This can be minimized by using the lowest possible grid circuit resistance consistent with desired stage gain.

Insulation resistance

The JAN-1A specification for leakage resistance in most receiving tubes states that the leakage shall not be less than 10 megohms between any two elements except between heater and cathode where a different limit, varying with the tube type, is specified. The inter-electrode leakage is measured with a potential of either 300 or 500 volts, depending on the rating of the tube involved.

Probably the type of leakage that causes the greatest trouble in conventional circuits is that between the plate or screen and the control grid. For example, assume a tube is being used with 100 volts anode and with a grid resistor of 0.25 megohms. If the plate to grid leakage is 25 megohms then there will be a positive voltage developed across the grid resistor of 1 volt which will be subtracted from the bias voltage.

Interelectrode leakage in conventional receiving tubes usually is a

**CHECK THE PATENTED
FEATURES AND GREATER
ECONOMY OF DRAKE
LIGHT ASSEMBLIES**

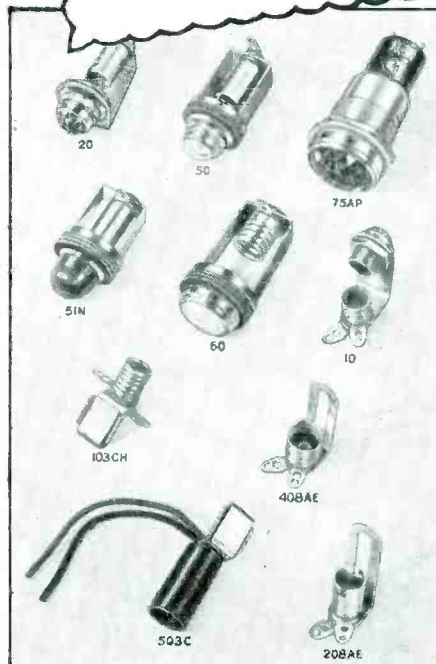

You'll lower production costs yet increase quality and efficiency with DRAKE Socket and Jewel Pilot Light Assemblies. Get the benefit of our patented features . . . of high speed precision methods and machinery developed through 15 years of specialization. Every conceivable type offered in standard and special designs. Refer to the newest DRAKE catalog for complete information. Do you have a copy?

DRAKE



SOCKET AND JEWEL LIGHT ASSEMBLIES

DRAKE MANUFACTURING CO.

1713 W. HUBBARD ST., CHICAGO 22, ILL.

New! B-W Lo-Stretch DIAL CORD



NYLON—Most Stretch



SILK—Medium Stretch



B-W—Least Stretch

A BETTER Dial Cord*

Accurate tests show that our new B-W Lo-Stretch Dial Cord has two-thirds less stretch than Nylon and about one-half the stretch of silk cords of similar diameters.

The constancy of this improved product is an important factor in accurate dial tuning where condenser units are cord driven.

Made in five standard diameters. Black only. 1,000-1,500 yard spools.

*Write for Samples and Prices.

The
BEVIN-WILCOX
Line Company
East Hampton, Conn.

result of getter deposit on the mica separators which causes a leakage path. Tubes have been designed without mica to overcome this difficulty. Tubes of this type mostly rely on glass rods in the tube envelope for alignment of the tube elements, giving interelectrode leakages of several thousands of megohms. However, they are difficult to manufacture and have not been used in great numbers. Also, these tubes may not be rugged enough for some industrial applications. Interelectrode leakage has been reduced in some conventional receiving tubes by cutting slots in the mica or by spraying them with a mica coating to lengthen the leakage path.

In moist locations leakage on the tube base can become great enough to render some types of equipment useless. This is especially bad in equipment that is used intermittently or in battery-operated equipment where the heat generated in the case is slight. A continuously-connected light bulb or resistor can sometimes be used to remedy this. Dirt on the tube case is also objectionable, especially in the presence of moisture. War research on tropicalization showed that simply applied coatings of wax, silicone varnishes, etc., would largely eliminate moisture leakage over the surface of components.

Kesten Leaves CBS Board

Paul W. Kesten has resigned as vice chairman of the board and a director of the Columbia Broadcasting System. He will continue to serve CBS as a consultant.

Kesten joined CBS in July 1930 as director of advertising and sales promotion. In December, 1934 he was elected a vice president; in May, 1937 he was made a director; in October, 1943 he became executive vice president, and in January, 1946 was named vice chairman of the company's board of directors.

Design Consultants

A new firm, doing business as design consultants under the style Hadley, Ryder and Pederson, has been formed in Hartford, Conn. Donald L. Hadley, who will be design director, was formerly design consultant for the Westinghouse Electric Corp.; Carleton B. Ryder, executive director, was formerly coordinator of apparatus design for General Electric; Nicholas R. Pederson was formerly technical supervisor for General Electric.

American Beauty



ELECTRIC SOLDERING IRONS

are sturdily built for the hard usage of industrial service. Have plug type tips and are constructed on the unit system with each vital part, such as heating element, easily removable and replaceable. In 5 sizes, from 50 watts to 550 watts.

TEMPERATURE REGULATING STAND

This is a thermostatically controlled device for the regulation of the temperature of an electric soldering iron. When placed on and connected to this stand, iron may be maintained at working temperature or through adjustment on bottom of stand at low or warm temperatures.



For descriptive literature write

111-1

**AMERICAN ELECTRICAL
HEATER COMPANY**
DETROIT 2, MICH., U. S. A.

BIKINI

(Continued from page 79)

fed to a pulse selector. Here the master pulse is separated out by virtue of its greater amplitude and the negative pulse inserted by the blanker also is separated out. These two sets of pulses are used to operate trigger circuits in a manner identical to that of the transmitter commutator. In this case, however, the inputs of all the converter tubes are common, while their outputs lead to separate tuned circuits which oscillate in a damped fashion at 10 kc between successive pulses. The voltage from the tuned circuit is amplified, rectified, and fed to a recording galvanometer.

The transmitter and receivers proper were identical to the ones used in the water blast test and already described. The entire system was responsive to dc, i.e. a steady pressure applied to the gage on the target ship resulted in a constant reflection of the galvanometer on the receiving ship.

The three recording galvanometers had 14 elements each. Recording was done on specially sensitized photographic paper, eight inches wide and 300 ft. long. Time markers are supplied on the record by interrupting the 14 light beams successively, thus serving also as a method of distinguishing the various traces when they overlap. A sample record is shown in Fig. 7. An automatic calibrating arrangement was also provided for this equipment.

Two automatic selector switches may be set in operation by remote control, one selecting a given channel while the other applies successively 5 equal positive steps of voltages and 5 negative steps. The first selector then proceeds to the next channel, and the process is repeated. A record is thus obtained of the sensitivity of all channels immediately prior to the test.

In addition to the equipment described, literally tons of other apparatus was carried along. This included complete photographic processing materials and dark room equipment for developing and printing the records, spare parts for the telemetering gear, and sufficient test instruments and tools to furnish a reasonably good-sized electronics laboratory. Communication equipment for use between the target and receiving ships during adjustment of the equipment was also supplied. The entire project was planned and the equipment assembled, tested and shipped all within a period of seven weeks.



DO YOU MAKE:

INSTRUMENTS?

| | | |
|---------------|------------------|--------------------|
| Ammeters | Oscillographs | Light Meters |
| Voltmeters | Flux Meters | Cardiograph |
| Galvanometers | Watt-hour Meters | Recorders |
| Seismographs | Flow Meters | Vibration Pick-ups |

RADIO, SOUND AND COMMUNICATIONS EQUIPMENT?

| | | |
|--------------------------------|--------------------------|--------------------|
| Loud Speakers | Sound-powered | Vibration Pick-ups |
| Headsets | Telephones | Polarized Relays |
| Microphones | Telephone Ringers | Generators |
| Hearing Aids | Voltage Regulators | Meters |
| Electrical Musical Instruments | Phonograph Cutting Heads | Magnetron Fields |
| | Phonograph Pick-ups | |

AUTOMOTIVE AND AVIATION EQUIPMENT?

| | | |
|-------------|--------------------|--------------|
| Magnetos | Voltage Regulators | Generators |
| Tachometers | Motors | Magnetic Oil |
| Compasses | Speedometers | Filters |

THESE PRODUCTS?

| | | |
|--------------------------|--------------------------|--------------------|
| Magnetic Separators | Arc Blow-out Magnets | Clocks |
| Magnetic Chucks | Temperature and Pressure | Toys and Novelties |
| Magnetic Conveyors | Control Equipment | Coin Separators |
| Magnetic Clutches | Circuit Breakers | for Vending |
| Magnetic Damping Devices | Limit Switches | Equipment |
| | Holding Magnets | |

IF YOU make any of the above products, you should be interested in finding out how *better permanent magnets* can improve efficiency and reduce costs. Put your design, development or production problems up to The Arnold Engineering Company. Arnold engineers have been of great assistance to many manufacturers and are at your service to advise exactly what Alnico permanent magnet will solve your particular problem.



Write for Technical Bulletin—"Permanent Magnets for Industry," containing valuable data on design, production characteristics and applications of Permanent Magnets.

THE ARNOLD ENGINEERING COMPANY

SUBSIDIARY OF ALLEGHENY LUDLUM STEEL CORPORATION

147 EAST ONTARIO STREET, CHICAGO 11, ILLINOIS

Specialists in the manufacture of ALNICO PERMANENT MAGNETS

Crystalab

TRADE MARK REG. U. S. PAT. OFF.

SPECIALISTS IN SPECIAL CRYSTALS

SUPERSONIC CRYSTALS

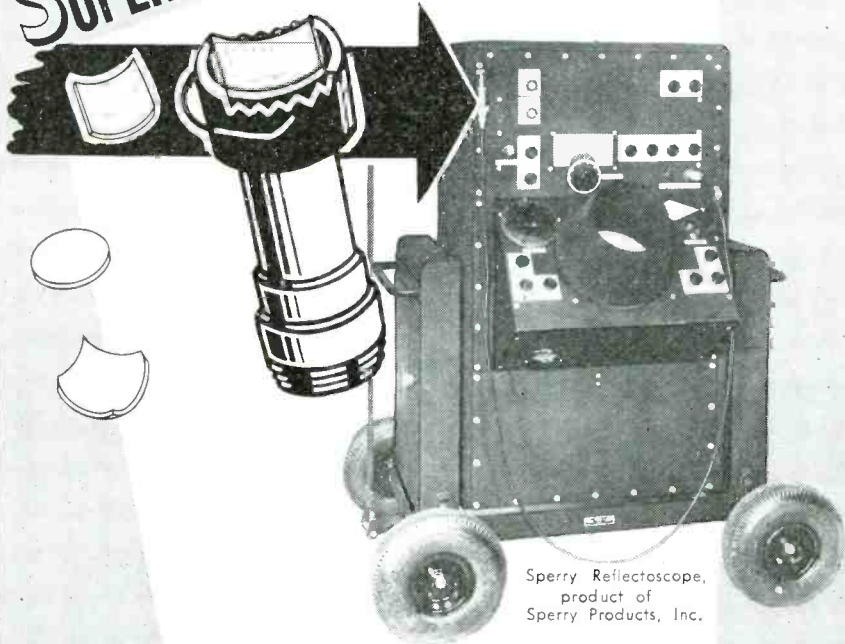

Sperry Reflectoscope,
product of
Sperry Products, Inc.

CRYSTALAB SUPERSONIC CRYSTALS

Excellent examples of CRYSTALAB skill in special crystals are Crystalab Supersonic Crystals such as those used in the famed Sperry Reflectoscope. These Supersonic Crystals are adaptable for a multitude of scanning devices for the detection of flaws in practically all materials. Metal plated on contact surface for longer wear. Radii of curvatures from 1 inch to 1/16 inches with tolerances maintained to $\pm .001$ inches. Crisp, clean, square corners . . . chip free edges. Slight, moderate, or firm damping of crystal as specified by you. Made to your size and shape requirements within physical limitations of piezoelectric quartz. Fundamental frequencies .5MC to 12MC.

Crystalab maintains a complete research and engineering staff to help you solve your supersonic problems.



CRYSTAL RESEARCH LABORATORIES INC.

29 ALLYN ST., HARTFORD, 3, CONN., PHONE 7-3215

DECADE COUNTERS

(Continued from page 84)

the suppressors are internally tied to the cathode. For clarity the grounded cathodes and suppressors are not shown in the circuit and neither are the control grids of the inner groups to which a negative bias is applied.

Negative bias is also applied to the outer pentodes sufficient to cut them off in the absence of signal. AC signals applied to the rings connecting alternate outer grids as shown cause triggering twice during each cycle.

As the plates of "on" tubes are connected to screens of "off" tubes, their potential is low. The converse is true with plates of outer off tubes and hence these pass current when the AC signal arriving is sufficiently large to overcome the grid bias. Such current lowers the plate voltage of the first inner "off" tube in a clockwise direction, turning it on and turning its opposite mate off. Here again the magnitude of triggering voltages is important, too high values tending to trigger the inner tubes directly.

*Design and use of Directly Coupled Pentode Trigger Pairs and Decade Counting Circuits by Victor H. Regener, U. of Chicago, Rev. of Sc. Inst., May, 1946.

WIDE READING

(Continued from page 101)

Selenium Photocells

W. Ch. van Geel (Philips Technical Review, Eindhoven, Holland, March, 1946)

Structure and performance of a blocking-layer selenium photocell are explained and current and voltage curve as function of illumination with the external resistance as parameter are presented. Because of its logarithmic response, the cell is particularly suitable in photographic exposure meters.

A Phototube for Dye Image Sound Track

Alan M. Glover and Arnold R. Moore; R. O. Drew and S. W. Johnson; J. D. Phyfe (Journal of the Society of Motion Picture Engineers, May 1946)

Because of the transparency of dyed gelatin to infrared light, to which conventional sound phototubes are responsive, the necessity for a different type phototube arose to be used with color emulsions.

Three articles dealing with the recently developed blue-sensitive

Toroidal Coils for high "Q"

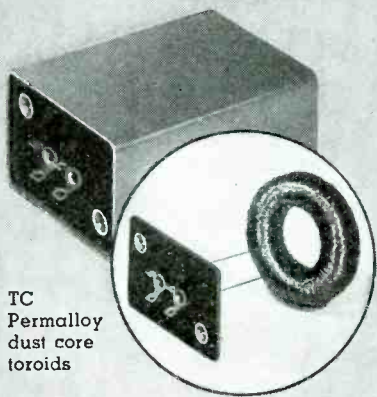

TC
Permalloy
dust core
toroids

Inductance — up to 2 hys.

Frequency—300 cy. to 30,000 cy.
"Q"—55 at 1000 cy.; 150 at 3000 cy.

List Price . . . from **\$4.50** to **\$7.50**
(UNCASED)

TOROIDAL COILS IN FILTERS

Communications:

KF-40 — Keying frequency filters providing over 60 DB attenuation at crossover points between channels. Also discriminators.

Aircraft Radio (Personal)

BF-10—Range filters to permit separation of the 1020 cy. beam signal from voice transmission. Employs unique method of impedance matching permitting use of minimum number of components. Weighs only 10 ounces and measures 1½"x1¾"x3".

Broadcasting:

CE-20 — Transcription equalizers for lateral recordings.

CE-25 — Transcription equalizers for vertical recordings.

The above are designed in accordance with N.A.B. requirements.

Research and Laboratory Instruments

Filters for harmonic analysis on any special type of frequency discrimination.

Burnell & Co.

Designers and Manufacturers of
Electronic Products

10-12 VAN CORTLANDT AVE. EAST
BRONX 58, N. Y. SEdwick 3-1593

phototube, the 1P37, describe its application to transcribing dye image sound tracks recorded on color film for which purpose it was designed. Its performance is compared with that of the standard 868 tube which is sensitive in the near infrared and used for sound reproduction from black-white film. The new gas-filled tube may be readily interchanged with the 868 tube and is also suitable for ordinary silver tracks.

Effects of Humidity on Dielectrics

R. P. Field (J. of Applied Physics, May, 1946)

The formation of ionized water films on dielectrics under conditions of high humidity and the con-

| Material | R | % RH per decade change of R | Recovery time in minutes after 100% RH for | |
|-----------------------------------|-----|-----------------------------|--|--------|
| | | | 1 hr. | 16 hr. |
| | MΩ | | | |
| Hydrocarbon wax, modified | >20 | .0 | .0 | |
| Cellulose acetate butyrate | >20 | .0 | .0 | |
| Silicone rubber | 10 | .13 | | |
| Polytetrafluoroethylene | 3.6 | .17 | 17 | |
| | kMΩ | | | |
| Polystyrene (sheet) | 840 | .13 | .13 | |
| Polydichlorostyrene 2-5 | 29 | 7 | .17 | |
| Hydrocarbon wax | 20 | 13 | .17 | |
| Ethyl cellulose | 13 | 9 | .33 | .5 |
| Cellulose acetate | 7.0 | 6 | 1.0 | 6 |
| Polyvinyl chloride acetate | 5.7 | 12 | 6* | |
| Polystyrene (plasticized) | 5.0 | 4 | .17 | 62* |
| Phenolic, mica-filled | 5.0 | 9 | .17 | 13* |
| Aniline formaldehyde | 4.2 | 4 | .17 | 20* |
| Polyamide | 3.8 | 14 | 200 | |
| Porcelain, glazed | 3.7 | 15 | 2.5* | |
| Glass (high K) | 3.4 | 10 | 17* | 20* |
| Mica | 3.0 | 12 | 11 | |
| Polystyrene (molded) | 2.4 | 10 | .17 | .17 |
| Polystyrene (plasticized) | 2.4 | 8 | .11 | .17 |
| Steatite (L-3) | 1.6 | | .17 | .75 |
| Quartz | 1.4 | | | |
| Polyethylene | 1.3 | 9 | .17 | .17 |
| Phenolic, XX | 1.3 | 16 | 80 | |
| Phenolic, asbestos filled | 1.2 | 9 | 1.5* | 100* |
| | MΩ | | | |
| Phenolic, XXXP | 660 | 15 | 300 | |
| Steatite (L-4) | 640 | | .5 | 1 |
| Phenolic, LE | 500 | 18 | 400 | |
| Phenolic, mica-filled | 320 | 8 | 40* | |
| Steatite (L-4) | 280 | | .33 | |
| Polydichlorostyrene 3-4 | 240 | 6 | .33 | 5.3* |
| Phenolic, cellulose filled | 240 | 10 | 400 | |
| Aniline formaldehyde, glass mat | 240 | 9 | 14 | 1000 |
| Phenolic, C | 220 | 16 | 300 | |
| Vulcanized fibre | 220 | | 6000 | |
| Aniline formaldehyde, glass cloth | 200 | 12 | 3 | |
| Quartz | 190 | | | |
| Phenol formaldehyde (plasticized) | 100 | 12 | 25 | |
| Glass (sintered) | 90 | | | |
| Glass bonded mica | 64 | 18 | 400 | |
| Melamine, glass cloth | 38 | 14 | 300 | |
| Phenolic, mica filled | 30 | 11 | 7* | |

sequent changes in electrical properties of the material are studied. This investigation is concerned with surface phenomena and excludes changes in electrical properties caused by volume absorption which appear only after hours or days, while the surface film forms in minutes. It is established that the film forms very rapidly and that it is the gradual ionization of the film that is observed by measuring the reduction in surface resistivity with time.

In an atmosphere of 100% relative humidity, the conductivity of

Current Conversion WITH ATR QUALITY PRODUCTS

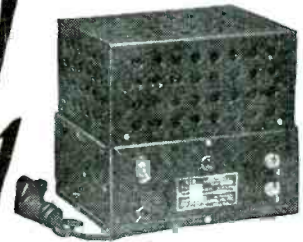

ATR
"A"

BATTERY ELIMINATORS

FOR CONVERTING A.C. TO D.C.

New Models . . . designed for testing D.C. electrical apparatus on regular A.C. lines. Equipped with full-wave dry disc type rectifier, assuring noiseless, interference-free operation and extreme long life and reliability.

- Eliminates Storage Batteries and Battery Chargers.
- Operates the Equipment at Maximum Efficiency at All Times.
- Fully Automatic and Fool-Proof.

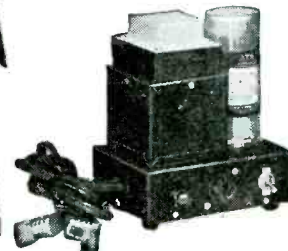

ATR

LOW POWER INVERTERS

FOR INVERTING D.C. TO A.C.

Another New ATR Model . . . designed for operating small A.C. motors, electric razors, and a host of other small A.C. devices from D.C. voltages sources.



ATR

STANDARD AND HEAVY DUTY INVERTERS

FOR INVERTING D.C. TO A.C.

Specially designed for operating A.C. radios, television sets, amplifiers, address systems, and radio test equipment from D.C. voltages in vehicles, ships, trains, planes, and in D.C. districts.

WRITE FOR NEW CATALOG—
JUST OFF THE PRESS!

AMERICAN TELEVISION & RADIO CO.

Quality Products Since 1931

ST. PAUL 1, MINN.

U. S. A.

The
SMALL
like the
LARGE...



in *Vertical* **FULLY MOUNTED
TRANSFORMERS**

FIVE newly-developed vertical shields, accommodating core stacks with $\frac{1}{2}$ " to $\frac{3}{8}$ " center legs, now make it possible for Chicago Transformer to fully-mount both small and large transformers with uniformity.

Now, in radio chassis and similar applications, both small and large units can be vertically-mounted with standardized assembly techniques—with uniform appearance in the finished product.

Adaptable to many variations, Chicago Transformer's complete line of vertical shields allows for either screw or twist-lug mountings and for lead exits through either sides or bottoms of the shields.

CHICAGO TRANSFORMER

DIVISION OF ESSEX WIRE CORPORATION

3501 WEST ADDISON STREET

CHICAGO, ILL.



several dielectrics was observed to reduce within one minute to about ten times its equilibrium value which is attained within an hour. Values of the equilibrium surface resistivity, R , arranged in order of decreasing resistivity, are listed in the first column of the table. The equilibrium value is a logarithmic function of relative humidity; the percent change in relative humidity for a variation in resistivity by a factor of ten is found in the second column of the table. The third and fourth columns give the recovery times in minutes after exposure to 100% relative humidity for one hour and for sixteen hours, respectively. The film is actually very thin and vanishes within 10 seconds at zero percent relative humidity except for thicker films which may be present as a result of dew point condensation; forced ventilation removes this film also within 10 seconds.

As the film forms, both, capacitance and dissipation factor increase. For a quartz bar, the frequency is constant over the audio range and the dissipation factor varies inversely with frequency. The behaviour of L-4 grade steatite, as the frequency is varied, indicates interfacial polarization. Capacitance increases rapidly with decreasing frequency and dissipation factor decreases slower than inversely with frequency. A detailed study was made on an unprotected 1000 micro-microfarad mica capacitor where interfacial polarization could also be established.

Maxon Takes Victor

Victor Electric Products, Inc., Cincinnati, long prominent in the fractional horsepower motor and appliance field, has been acquired through stock interchange by W. L. Maxon Corp., New York. Maxon produces a similar line. Engineering staffs of both companies will collaborate on development of a number of new products in the electro-mechanical field.

Ripley N. Y. Office

The Ripley Co., Torrington, Conn., has established a New York office at 82 Beaver Street. It will be in charge of Frank Rudolph, vice-president in charge of sales, with S. R. Viejo as sales engineer, handling all products of the combined Ripley organizations.

PATENTS

(Continued from page 102)

are biased to cut-off. Alternately the grids are biased positively by the voltage supplied from the audio frequency source and current will flow alternately through tubes 5 and 7, except during very brief and uniformly spaced instants when the audio voltage has zero value. At these instants neither tube will conduct current and the voltage drop across impedance 13 will be a minimum making the plate voltage applied to radio frequency tubes 19 and 21 a maximum. The shape of the voltage at point 15 is indicated

the modulator contains the sum and difference frequencies of the carrier and modulating waves but no component of the original waves nor any harmonics.

H. Toomin, Press Wireless, Inc., (F) September 11, 1943, (I) April 30, 1946, No. 2,399,586.

Standing Wave Ratio Indicator

To measure the standing wave ratio in transmission line 3, the circular shaped transmission line 5 is series connected. Probe 9 rotates in a slot provided in the outer conductor of line 5. Movement of the

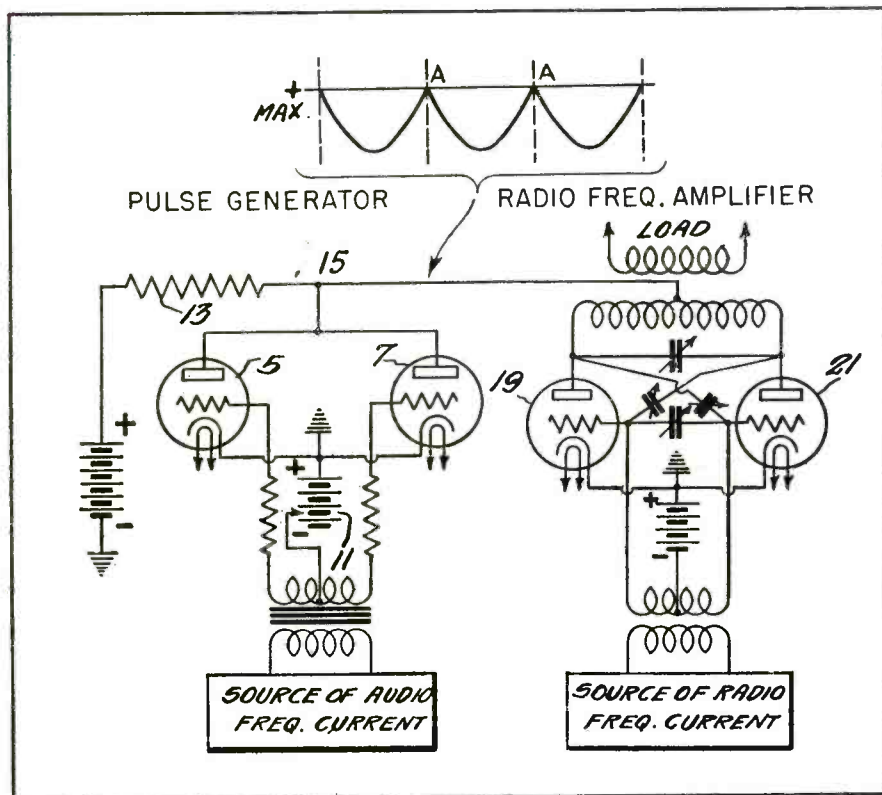

in the diagram, the sharp, short peaks, A, occurring at instants of zero audio frequency voltage. During these peaks only, the radio frequency amplifier becomes operative generating pulses of short duration compared to their period, i.e., they may be made as short as $\frac{1}{2}\%$ of an audio cycle. A suitable circuit for shaping the pulses is also disclosed.

C. W. Hansell and O. E. Dow, RCA (F) March 16, 1938, (I) May 21, 1946, No. 2,400,822.

Balanced Modulator

The double-balanced modulator includes a square-wave carrier which is applied alternately to the cathode resistors of the two modulator tubes, cutting them off at alternate intervals. The modulating signal is applied to the grids in push-pull relation. The output from

probe is controlled by motor 17 which, through the action of cam 19, synchronizes the sweep frequency of oscillograph 15 with the

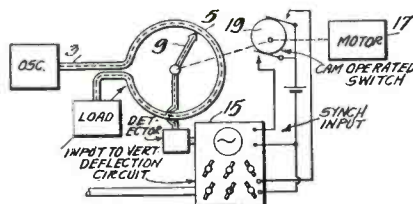

probe movement. Voltages derived from the probe are detected and applied to the cathode ray oscillograph which will show a picture of the standing wave. Subdivision of the cathode-ray tube screen facilitates determination of the standing wave ratio from the shape of the voltage curve.

D. W. Peterson, RCA, (F) October 6, 1943, (I) May 21, 1946, No. 2,400,597.

NEW!

Interior view showing simplicity of making rigid connections

B&W

COAXIAL CABLE CONNECTOR

- Easy to install
- Watertight
- Seals Cable Ends

SERVES AS CENTER INSULATOR ON HALF-WAVE DOUBLET

The new B & W CC-50 Connector does an excellent job of providing a waterproof termination for a coaxial line where it joins the center of a half-wave doublet antenna. Made of cast aluminum with steatite insulation and forged steel eyebolt with easy soldering connections. Weighs only 12 ounces. Absolutely watertight. Write for details.

BARKER & WILLIAMSON

Inductor Coil Headquarters
237 Fairfield Ave., Upper Darby, Pa.

BOOK YOUR SPACE NOW

The First Annual

NATIONAL ELECTRONIC RADIO & TELEVISION EXPOSITION

GRAND CENTRAL PALACE, NEW YORK CITY

OCTOBER 14 THRU 19, 1946

First large-scale display of authentic postwar improvements in electronic equipment, radio and television receivers and related products. An exposition for the benefit of the public, the trade and the industry.

*For full information regarding floor
space and exposition plans, address*

ELECTRONIC EXHIBITORS

H. G. CISIN
V. M. EITONGON
Managing Directors

50 BROAD STREET
NEW YORK 4, N. Y.

Phone
HANover 2-1080

TYPICAL PRODUCTS SUITABLE FOR THE EXPOSITION

Alarms
Amplifiers
Antennae
Aviation
Batteries
Broadcast Equipment
Communication Receivers
Converters
Dials
Dielectric Heating
Direction Finders

Electronic Controls
Electronic Measuring
Facsimile
Flaw Detectors
Germicidal Equipment
Hearing Aids
Induction Heating
Intercommunicators
Kits
Laboratory Equipment
Lie Detectors

Marine
Medical Equipment
Metal Locators
Mobile Equipment
Optical Equipment
Police
Power Supplies
Radar
Railway Press Services
Radio Sets
Record Players

Recorders
Records
Relays
Signalling Systems
Sound Systems
Television
Transceivers
Transmitters
Tubes
X-Ray

YOU CAN NOW GET THESE DAILY ESSENTIALS



(32-JPI)

INSTRUMENT & TESTER SWITCHES

12-14 and 20 position.
Shorting; non-shorting
1-6 decks.

OPERATING TEMPERATURE TESTERS

Automatically compensated,
typical range for ovens,
0-650°F.

400 CYCLE PORTABLES

Accuracy to $\pm 0.3\%$; pocket
size metal case; other ranges.

VACUUM-TUBE FREQUENCY METERS

Accuracy, $\pm 0.25\%$; six
specific bands, to 3600 cps.
No drift.

MOST COMPACT FREQUENCY METERS

Matches standard $2\frac{1}{2}$ " panel
instruments. 60, 120 cps.

ELAPSED TIME—FREQUENCY METERS

$3\frac{1}{4}$ " mounting; encourages
periodic servicing and tube-
life checking.

MULTIPLE RANGE PORTABLES

Standard—4 frequency groups
at 3 voltages. Many special
order variations.

POTENTIOMETER-PYROMETERS

Measures and follows tem-
peratures continuously after
initial balancing.

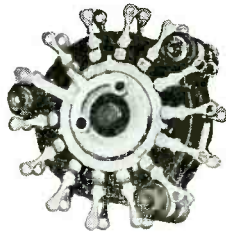

(SS-14-2)



(33-FP9-400 cy.)

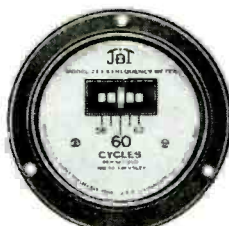

(21-FX-60 cy.)



(60-FP)



(39-VTF)



(31-FE)



(70-PO)

BOOTH #101

... many of these, and others from the J-B-T
line, are now stocked by leading jobbers.

J-B-T INSTRUMENTS, INC.

433 CHAPEL STREET • NEW HAVEN 8, CONNECTICUT

PERSONNEL

Edward N. Wendell has been appointed vice-president of Federal Telephone and Radio Co., Newark, N. J. and assumes full managerial authority over this manufacturing affiliate of IT&T. He has served as radio division manager of FTR and as manager of its telephone division.



Edward N. Wendell

A. J. Eaves

Augustus J. Eaves, formerly development engineer on communications systems for Bell Telephone Laboratories, and for the past 20 years general communications sales manager for Graybar Electric Co., New York, has joined Finch Telecommunications, Inc., New York. He will be director of sales.

Harvey Tullo who recently joined Emerson Radio and Phonograph Corp. as director of purchases has been elected a vice-president of the company. Before joining Emerson he had been with Zenith, Kolster and Pilot.

Ralph P. Glover who recently joined Technology Instrument Corp., Waltham, Mass., will act as liaison between the company's engineering staff and its customers in the Chicago area serving as technical representative there, not as head of the organization's engineering staff as previously reported in error. He will provide technical information to users of the firm's instruments.

Dr. William L. McCracken, recently discharged from the U. S. Army Engineers with the rank of lieutenant colonel has been appointed administrative assistant to C. F. Dinley, Sr., vice president in charge of research and engineering, Detrex Corp., Detroit.

Richard C. Kleinberger has established a consulting engineering practice at 20 Cushman Road, White Plains, N. Y. He will specialize in electronic heating applications.

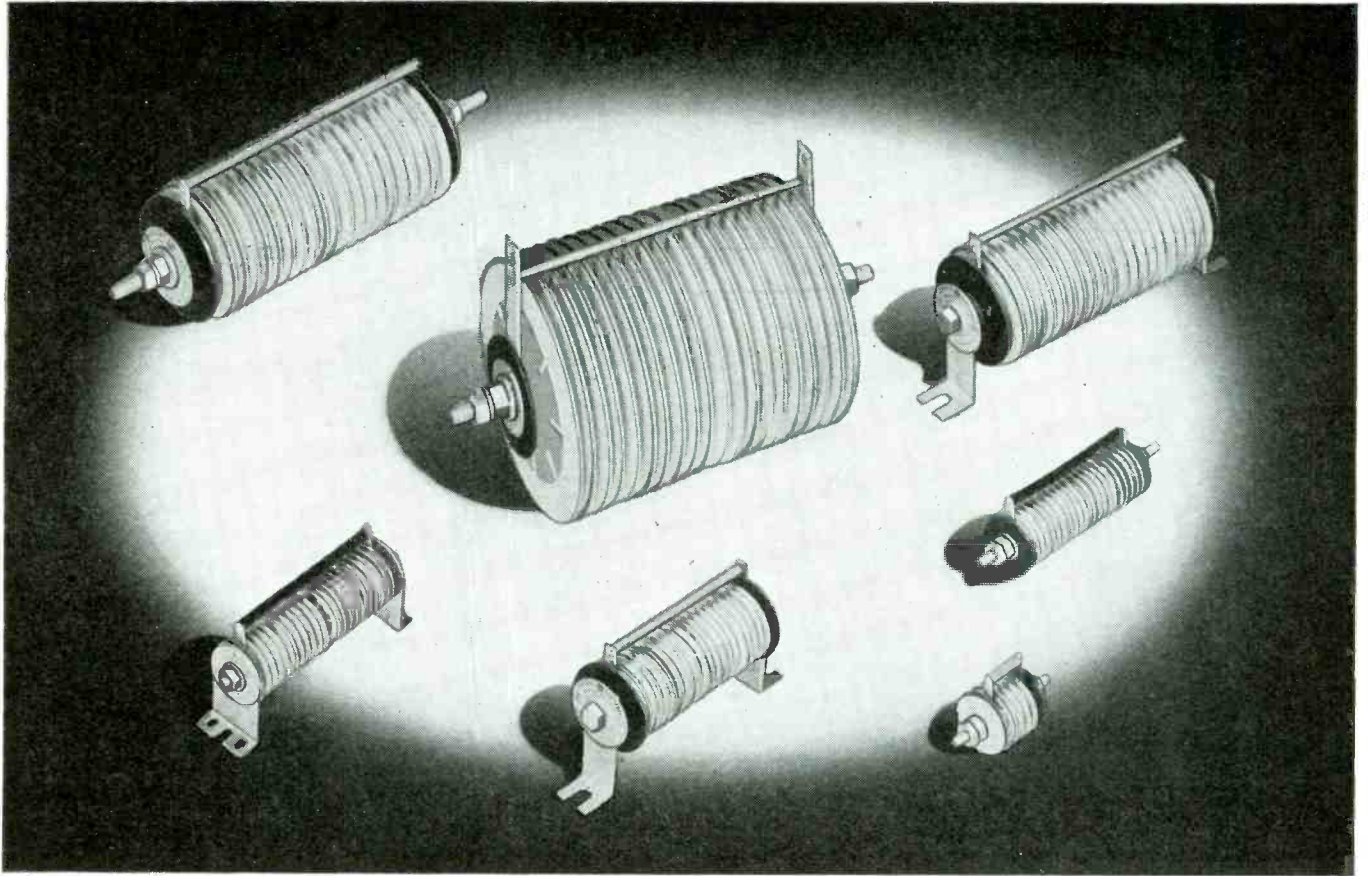

Something You Can Count On . . .



SELENIUM RECTIFIERS

For complete details, send for a copy of our catalog entitled, "G-E Selenium Rectifier Stacks." Address your requests to Section A5612-124, Appliance and Merchandise Department, General Electric Company, Bridgeport, Connecticut.



You can count on G-E Selenium Rectifiers to give you long, faithful, economical service wherever d-c power is required from an a-c source.

Electrically and mechanically they are built and exclusively processed to give dependable operation in either series, parallel or series-parallel connections. Too, they are constructed to withstand wide variances in ambient temperatures, humidities and atmospheric pressures.

Their small size, light weight and quiet operation plus their ability to resist shock and vibration make them ideal for use in radio and electronic fields, solenoids, relays, motors, instruments and numerous other applications.

GENERAL  **ELECTRIC**

Hi-Q CERAMIC CAPACITORS

EACH TYPE SPECIFICALLY DESIGNED TO HELP YOU MAKE BETTER PRODUCTS!

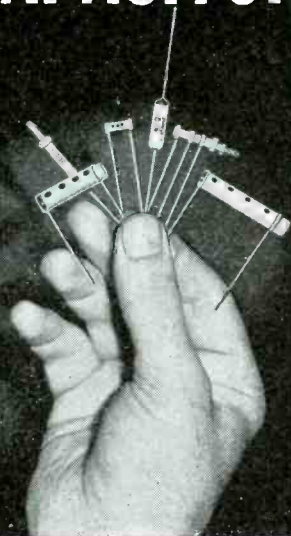

● Hi-Q Ceramic Capacitors are manufactured of titanium dioxide (for temperature compensating types). Electrodes are of pure silver, precision coated. They are individually tested for accuracy of physical dimension, temperature coefficient, power factor and dielectric strength. Available in C. I. type (axial leads) and C. N. type (parallel leads) also Durez coated for fullest protection against extremes of fungus and climatic conditions.

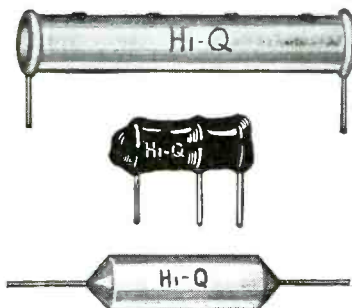

OTHER Hi-Q COMPONENTS

WIRE WOUND RESISTORS



CHOKE COILS



STAND-OFF CONDENSERS

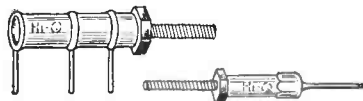

Hi-Q

ELECTRICAL REACTANCE CORPORATION
FRANKLINVILLE, N. Y.

L. M. Persons has been appointed research and development director of the electric products division of the McQuay-Norris Mfg. Co., St. Louis. George F. Platts has been made general manager of operations of the division.

Theodore K. Bergenbauch has been appointed electronics division production manager of Ellinwood Industries, Los Angeles. Until six months ago he was assistant factory engineer in the electronic tube division of General Electric Co., Schenectady.

Stephen Horbach, who for some time has been a member of the engineering staff of Press Wireless, Inc., has been appointed sales manager of Press Wireless Mfg. Co., a subsidiary. Before joining PW he had spent four years with Army Communications.



Stephen Horbach

Lester N. Hatfield

Lester N. Hatfield has been made chief engineer of the Press Wireless Mfg. Co., Long Island City, N. Y. For ten years he was technician and engineer for CBS, before that was chief engineer of station KWSC. He joined Press Wireless in 1945, has been chief sales engineer.

Dr. Royal K. Abbott has been made laboratory director for the General Electric Co., in South America. A member of the Pittsburgh laboratory of GE for the past three years, he left July 15 for Rio de Janeiro, Brazil.

George F. Knowles has joined the design firm of Spectrum Engineers, Inc., Philadelphia as consulting mechanical engineer. During the war he was production manager for Fox Industries, Inc.

Jules Deutsch has been made assistant executive vice-president of Noma Corp., New York. He will have charge of industrial engineering, plant layout and production. Until now, and for the past 15 years, he has been plant manager of the Glolite Corp., Chicago.

Dr. R. O. Curry, acoustical expert, has been appointed audio and acoustical engineer for the Farnsworth Television & Radio Corp., Ft. Wayne, Ind. He previously has been engaged in audio research for the Capehart division of the company.



Dr. R. O. Curry

William M. Myers

William M. Myers has been appointed chief engineer of the receiver division of the Farnsworth Television and Radio Corp., Ft. Wayne, Ind. Before joining Farnsworth in 1940 he had been associated with Crosley Corp. for 11 years as an engineer.

Harry E. Rice has been made chief engineer of the home and aircraft radio divisions of Lear, Inc., Grand Rapids, Mich. At the same time, **Harry S. Jones** was made chief engineer in charge of research and development; and **William J. Perfield** was made head of engineering activities for the company's electro-mechanical division.

Thomas B. Aldrich has been appointed general sales and advertising manager of the Presto Recording Corp., 242 West 55th Street, New York. For the past 10 years he has been factory sales engineer in the New York metropolitan area.

LETTERS

Industrial Servicing

Editor, *Electronic Industries*: The undersigned is a subscriber to your magazine as a help in his business, and finds it very interesting from cover to cover.

In your June issue of 1946—page 4, your Editorial comment titled "Industrial Servicing" was especially noted. It is just with this in mind that the company, of which I am vice-president, was organized in January of this year, when a preliminary survey of the medical and industrial fields showed quite a need for such organization, but no one seemed to want to develop it.

Naturally such organization can be beneficial in more ways than just servicing, hence we organized for sales, servicing, and design where necessary. Servicing has not been profitable, but from the looks of things, will come to its own in the not too distant future.

We feel this kind of organization will be very beneficial, and already we find the industries that were slow in accepting electronics, now do so less reluctantly because we guarantee servicing.—C. R. Maduell, Jr., Delta Electronic Equipment Co., Inc., New Orleans, La.

The Middle Course in Engineering Training

Editor, *Electronic Industries*: Regarding your July editorial, "Theory Versus Handbook Teaching," I am inclined to the thought that most engineering schools nowadays do not follow either the handbook teaching method nor do they stress entirely the teaching of modern mathematical physics. The facts of the matter are that only five to ten per cent of our engineering graduates are in need of highly theoretical training. This small percentage includes the men who are engaged in research work, college teaching, and high-class theoretical design and analysis. The great bulk of the engineering work of the country does not require the more theoretical training.

Our engineering graduates should be trained in the use of their common "tools," English, mathematics, and drawing. They should also be well founded in such "rule" subjects as physics and chemistry. By rule subjects I mean subjects in which basic natural laws are studied. The rest of their time should be given and is given to courses which develop a knowledge of engineering materials and of technical skills because, after all, the prime job of most engineers is to use their technical skills and their tools and follow the basic natural laws or rules to mold from the materials of engineering the engineering structures and products which make the world a better place to live in and make it easier for men to live in it. I would say, therefore, that most universities today follow the middle ground between the two extremes indicated in your editorial.

I have been following *Electronic Industries* with interest, and I wish to congratulate you on a first class paper.—D. D. Ewing, Head, School of Electrical Engineering, Purdue University, Lafayette, Ind.

U. S. GOVERNMENT SURPLUS

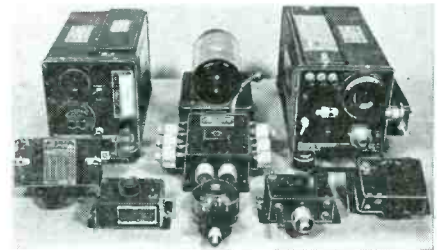

airborne RECEIVER — TRANSMITTER combinations

(#RU 16/GF 11)

Over 1,000 units available, including 700 complete sets, plus maintenance spares, spare tubes, spare coil kits, etc. Excellent opportunity to outfit one or more fishing fleets. Can also be adapted in export for marine work.

Frequency Range { Trans.—3,000-9,050 KC
 { Rec.—195-13,575 KC

Receiver is TRF and can easily be modified for direction-finder operation.

To be sold as one complete lot only. Write or phone for information.

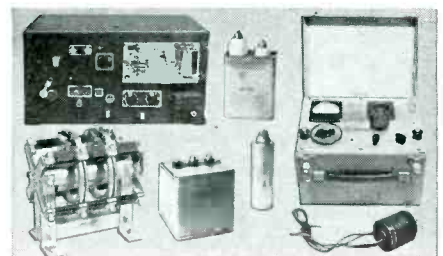

A Warehouse Full of Other
U. S. Gov't Surplus Electronic
Equipment

Inquiries invited from Jobbers, Distributors, Exporters, Priority Purchasers, etc.

ELECTRONIC CORP. OF AMERICA
Central General Agents for
War Assets Administration
353 W. 48th St. New York 19, N. Y.

SMOOTH SPEED

with

Smooth Power

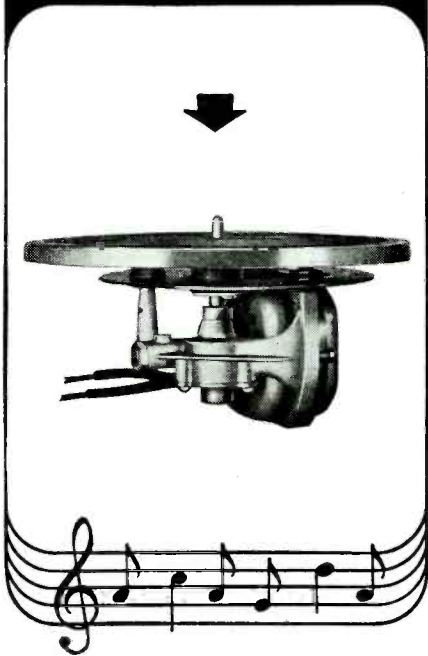

You can be sure of unvarying speed for your phonograph mechanisms when you equip them with GI *Smooth Power Motors*. Test any unit from our wide line, in laboratory or in service, and you'll find it runs with accurate uniformity at its rated speed.

But you want other qualities, too, such as quick pickup, quietness and all 'round velvety smoothness of operation. You get all these in GI motors for phonographs, recorders or record-changers.

For Smooth Speed, standardize on Smooth Power.



THE GENERAL
INDUSTRIES co.

DEPT. ML

ELYRIA, OHIO

NEW BULLETINS

Time Switches

Time switches in a wide variety of types and for application in any field where accurate control is required are illustrated and described in a new four-page bulletin (T-55) just issued by Automatic Temperature Control Co., Inc., 34 East Logan Street, Philadelphia. The bulletin describes and illustrates operation of six of many types including automatic resetting, continuous repeating, dial setting and a special cut cam type which reverses SPDT switch for one minute every five minutes.

Tube Booklet

Characteristics, ratings, prices and warranties of General Electric transmitting and industrial electron tubes are listed in a new 8-page booklet (ETX-10), prepared by the tube division of the company's Electronics department. Tube types are arranged alphabetically in thirteen sections and listed numerically by type number. Description and rating publication numbers are included in the chart of key information concerning each tube type.

Precision Cleaning

Passaic Analytical Laboratories, Inc., Passaic, N. J., has issued a 6-page booklet on precision cleaning by the Eng-Sol method using a high velocity atomized spray. The method consists of spraying a chlorinated hydro-carbon solvent with heated air. It is applicable to bearings, watch-clock mechanisms and all kinds of small parts of this nature.

Panoramic Scanning

Panoramic scanning of a section of the radio spectrum which came into widespread wartime use, is described in great detail in a new 34-page booklet issued by Panoramic Radio Corp., 250 West 55 Street, New York. The handbook describes the construction, function and operation of model PCA-2 Panadaptor unit which is designed for use with any communications receiver. It is well illustrated with diagrams and sketches showing how to connect

the unit, how to adjust it for best operation and the many useful ways in which the principle becomes of practical value in simplifying operating technics. Maintenance and service also are covered.

Radio Components

Three new catalogs have been issued by James Millen Mfg. Co., Malden, Mass., and describe a long line of "designed for application" components and finished products such as frequency standards UHF calibrators, synchrosopes, regulated power supplies and pulse formation equipment. A condensed general catalog covers practically the complete line, with prices. The third catalog is devoted to component parts, variable condensers, insulators, special sockets, chokes, coils, etc., and the line of midget absorption frequency meters.

Split Bearings

A new 30-page catalogue has just been issued by the Split Ballbearing Corp., Lebanon, N. H., giving specifications on sizes, load ratings, etc., on a complete line of divisible race, ball, roller and thrust bearings. Illustrations of actual applications of these bearings in power plants, printing equipment, paper making machinery, rock crushers, etc., are also shown.

These divisible race ball bearings are shown supplementing standard ball and roller bearings, thus eliminating friction type bearings in many applications. They are available in stock sizes from 1/2 in. to 2 1/2 in. and as specials in other sizes.

Mallory's Fifth

Some 50 pages fatter, fifth edition of Mallory's Radio Service Encyclopedia has appeared, listing replacement recommendations for all prewar receivers. It was almost 13 years ago that the first edition appeared and more than 4 1/2 since the last edition was brought out. Like the previous books, this one, running to 480 pages, lists all receivers and gives data on original component equipment as well as replacement information covering controls, condensers, vibrators, tubes, IF frequencies, and a tie-in with data in Rider's Manuals. Publisher is P. R. Mallory & Co., Inc., Indianapolis, Ind.

Micro Switches

Micro Switch, Freeport, Ill., has issued a new catalog (No. 61) fully describing its complete line and illustrating many of the varied uses for Micro switch products. Listed are many types of housings along with varied types of actuators that make possible the use of these products to make machines automatic, for machine limit and control, to aid in positioning materials, to control electrical current and/or temperatures. This catalog is an excellent handbook for design and production engineers, and will prove helpful to time study men as well.

Resistor Chart

An attractive heavy-paper chart either for filing or for wall use and containing complete engineering details on Akra-Ohm precision fixed wire-wound resistors is being offered by the Shallcross Mfg. Co., Collingdale, Penna. Fifty-four different precision resistor types are illustrated and described. Full details are included on countless adaptations for specific engineering purposes. Dimension data, mounting specifications, minimum and maximum resistance values, tolerance, temperature charts, temperature coefficient data and various other factors are arranged in quick, easy-to-find style.

Laboratory Panels

Standard Electric Time Co., Springfield 2, Mass., has issued a booklet (No. 142) on "Laboratory Panels and Associated Equipment". Section I of the 36 pg. catalog gives a listing of parts for panels and miscellaneous items and describes laboratory precision timers and impulse machines. Section II shows a variety of physics, chemistry and electrical laboratory layouts for high schools, vocational and technical schools. Section III illustrates typical panel and equipment installations in a number of colleges and universities.

Communications Receiver

The series 400 Super-Pro communications receiver is described in a folder distributed by Hammarlund Mfg. Co., 460 W. 34th St., New York. Illustrations of components and assemblies are shown and the salient features are listed. A one page insert gives the technical specifications and a circuit diagram of the receiver. Two models are available: SP-400-X covering .54 to

30 mc in five bands and SP-400-SX, with range from 1.25 to 40 mc.

Aircraft Radio Equipment

Bendix Radio, Baltimore, Md., has issued a series of bulletins describing aircraft receivers and transmitters, radio direction finding equipment and vhf antennas. Each folder gives engineering specifications, photographs and dimensional drawings. Included are the RA-1, RA-2D, and RA-10 series aircraft receivers, the TA-2, TA-6 and RTA-1B series transmitters and trans-

ceivers and also the MN-26 series manual radio compass, the MN-31 automatic radio compass and the MS-105A vhf broad band antenna.

Rivet Catalog

Milford Rivet and Machine Co., Milford, Conn., has issued catalog No. 45 R on Split semi-tubular and compression valves. The 16 pg. booklet contains price and dimension tables for a variety of types. Several pages are devoted to helpful suggestions and data on proper rivet setting.

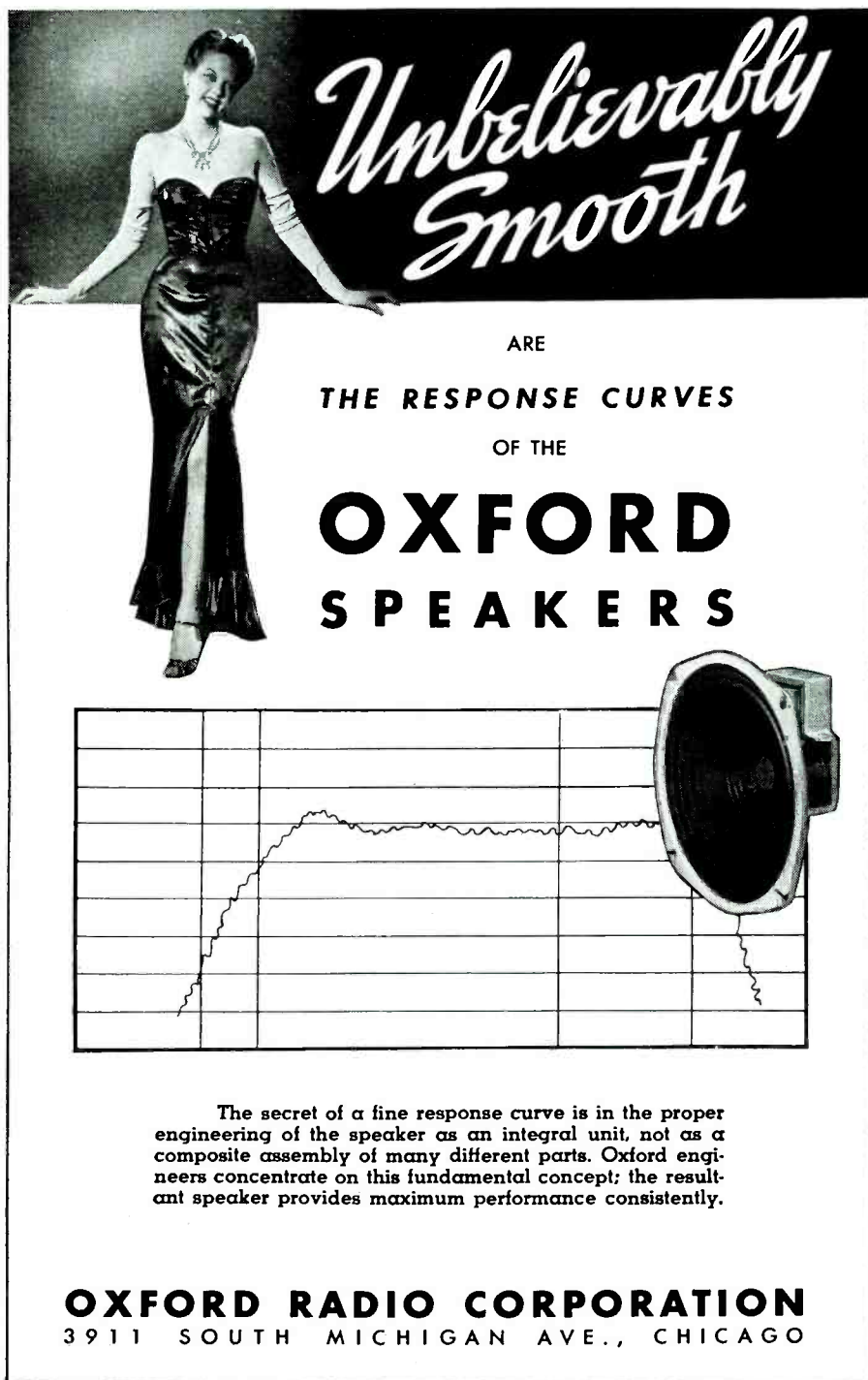

Unbelievably Smooth

ARE
THE RESPONSE CURVES
OF THE
**OXFORD
SPEAKERS**

The secret of a fine response curve is in the proper engineering of the speaker as an integral unit, not as a composite assembly of many different parts. Oxford engineers concentrate on this fundamental concept; the resultant speaker provides maximum performance consistently.

OXFORD RADIO CORPORATION
3911 SOUTH MICHIGAN AVE., CHICAGO

**A new weapon in your fight
to reduce production costs . .**

MARION PORTABLE BENCH-TYPE INDUCTION SOLDERING UNIT



A low-cost, low-powered induction soldering unit, designed for use wherever production soldering of small metal parts and assemblies is part of the job. It increases the quality of soldering operations . . . minimizes time and expense involved . . . requires no experienced help . . . and can effect major production economies in such diverse fields as radio, electronics, jewelry, electrical fixtures, toys, kitchenware, motors, paint brush ferrules, can sealing, etc.

COMPACT... ADAPTABLE... EFFICIENT... ECONOMICAL... SAFE

- It increases the speed of soldering operations—and provides a result often impossible with other methods.
- Produces cleaner work and eliminates many cleaning operations.
- Ideal for use with belt-line or turntable types of automatic feed.
- Inexperienced operators can produce uniform results with greater safety to the operator than is afforded by any other means.
- It is cheaper to operate than a solder pot, consuming only 775 watts at full load and only 100 watts on standby. Power is drawn only when soldering is taking place.
- No moving parts to wear out. Tube replacement costs low. All components are designed with generous safety factor.
- The heater offers less hazard than a soldering iron, and yet does a neater, cleaner, faster job . . . without danger of sparking or radio frequency burns.

\$360.00 F.O.B. Manchester, N. H.
(Foot Treadle Extra)

Each unit is accompanied by a manual which covers not only operating and service information, but also the design of the work coils for fundamental shapes such as square, rectangular, round and oval.

SPECIFICATIONS

Power Supply: 115 volts, 60 cycle ● Size: 15 $\frac{3}{4}$ " x 21 $\frac{1}{2}$ " x 15" ● Mounting: Standard relay rack cabinet ● Weight: 150 pounds ● Power Consumption: 775 watts at full power output, 100 watts standby.

The entire unit is rigidly assembled and mounted to prevent arc-over and failure of components.



MARION ELECTRICAL INSTRUMENT CO.

MANCHESTER, NEW HAMPSHIRE

EXPORT DIVISION • 458 BROADWAY • NEW YORK 13, N. Y., U. S. A. • CABLES: MORRANEX

IN CANADA: THE ASTRAL ELECTRIC COMPANY, SCARBORO BLUFFS, ONTARIO

Powdered Iron Cores

A new descriptive booklet on powdered iron cores and their uses has been issued by Henry L. Crowley & Co., Inc., West Orange, N. J. In addition to a technical explanatory section in the front, a large number of charts are included showing effective permeability-frequency relations for the various powder and binder combinations maintained as standard.

Sections are devoted to effect of addition of adjusting screws, uses of copper cores and to a new low cost core called "croloy". Detailed outline drawings of a large number of stock sizes of cores are included.

Recording Discs

Audio Devices, Inc., 444 Madison Ave., New York, has issued a 24-page brochure that presents its five types of recording discs. In addition there is much technical data of a practical nature concerning proper cutting methods and the reason for faults that develop. There is also a section devoted to the company's line of recording styli and playback points.

Die-Less Publication

O'Neil-Irwin Mfg. Co., Minneapolis 15, Minn., has published a catalog (No. 46-10) summarizing developments in the Di-Acro system of forming without dies. Complete descriptions and illustrations of benders, brakes and shears as well as an unusual application of two benders being operated simultaneously are included. The flexibility of the machines makes them suitable for model shops, experimental laboratories and production departments.

Radio Reception Equipment

A series of four bulletins containing two new additions to the line has been published by Radio Mfg. Engineers, Inc., Peoria 6, Ill. One covers the RME 84, a new 8-tube communications receiver with a frequency coverage from .54 to 44 mc. The new VHF-152 converter for the 2, 6, and 10 meter amateur bands is described in another bulletin. The converter uses miniature tubes in a double conversion system. The revised DB 20 preselector, which has a tuning range from .55 to 33 mc, and the RME-45 communications receiver are covered in the remaining two bulletins.

FIND OUT

Find out, without obligation, what the Marion Induction Soldering Unit can do for you. Forward your specifications and sample parts for analysis and soldering. A complete analysis will be made and recommendations will be returned to you within one week.

Retaining Rings

Technical Data concerning varied applications of 7 basic retaining ring types are contained in a 48 pg. catalog distributed by Waldes Kohinor Inc., Long Island City 1, N. Y. Of interest to engineers and product designers the catalog includes comparative charts on material characteristics, critical dimensions, thrust loads and impact tests. A reference table gives correct retaining ring size and number for commonly used ball bearings.

Photo-Electric Devices

A folder describing a number of photo-electric devices is available from Worner Electronic Devices, 609 West Lake St., Chicago 6, Ill. Features and applications are listed for a general purpose unit, the "Anti-Sabotage Sentinel" and the "Combustion Supervisor" control.

Lighting Controls

Electronic control of theatre lighting systems is described in Bulletin 74, issued by Ward Leonard Electric Co., Mount Vernon, N. Y. Included are various types of control consoles and panels for use with the Ward Leonard Hyster-set system of reactance dimmer switchboards for smooth, pre-set programming of lighting effects.

RF Thermocouples

American Thermo-Electric Co., 67 E. 8th St., New York, has issued a 10 pg. booklet describing their complete line of vacuum thermocouples for the measurement of low and high frequency ac power. Data on heater current, dc thermojunction voltage and heater resistance is supplied for 86 different types of vacuum thermocouples suitable for use at frequencies from 0 to over 50 mc.

Capacitor Catalog

Sprague Products Co., North Adams, Mass., has issued a 40 pg. catalog—the first in five years—listing their complete line of capacitors, resistors, filters and test instruments. Photographs, dimensional drawings and tables of electrical specifications illustrate the descriptions of standard and newly developed types. A large part of the booklet is devoted to a listing of dry electrolytic, paper, oil transmitting, mica and miscellaneous capacitors. Also described are the line of Koolohm resistors, in-

terference filters and mounting hardware. The back page is devoted to the Tel-Ohmike resistance and capacitance analyzer. A separate price schedule is enclosed.

Square Loop Antenna

An 8-bay square loop antenna providing a power gain of 9 is described in a 16 pg. booklet available from Federal Telephone and Radio Corp., Newark 1, N. J. The advantages of the antenna are explained and transmission feed line arrangements and constructional details are discussed in detail. Included are charts of power gain vs. loop separation, radiation pattern diagrams and a table listing electrical and mechanical specifications for 1 to 8-bay antennas.

Plastics

The Plastics Div. of General Electric Chemical Dept. has issued a beautifully illustrated, colored brochure summarizing the progress in design, moldmaking and manufacturing technics of plastics. In twenty pages a review is presented of the phases plastic materials undergo from their earliest conception as a research project, through the development, design, moldmaking and manufacturing stages. Typical finished products made by compression, injection and low pressure molding as well as laminated materials are shown.

Controls

Bulletin A-1, for the IRC, catalog is available from International Resistance Co., 401 North Broad St., Philadelphia 3, Pa. Type H Fingertip controls, with the resistance element molded in the control knob, are described and a taper chart and dimensional sketch is included. The back of the bulletin covers type SH Fingertip switch. The compact components are designed for mounting on an insulating bracket or panel.

Selenium Rectifiers

Federal Telephone and Radio Corp., Newark 1, N. J., has issued a bulletin explaining the use of a miniature selenium rectifier to replace high vacuum rectifier tubes in ac-dc and console radio receivers. The bulletin gives a number of suggested applications and circuits ranging from half wave to full wave bridge circuits. A chart comparing the regulation of the selenium stack with the 25Z6 tube is included.

TUBES! TRANSFORMERS! CONDENSERS!

NEW CATHODE RAY TUBES!!
Made by North American Philips



| Type | Approx. List | Your Cost |
|-----------------|--------------|-----------|
| 2AP1 | 6.25 | 3.95 |
| 3BP1 | 15.00 | 3.95 |
| 3FP7 | 27.00 | 5.35 |
| 5BP1 | 20.00 | 4.95 |
| 5BP4 | 27.00 | 5.95 |
| 5CP1 | 48.00 | 4.95 |
| 5CP7 | 45.00 | 6.00 |
| 5FP4 | 32.00 | 6.25 |
| 5FP7 | 35.00 | 6.00 |
| 5JP1 | 50.00 | 13.50 |
| 5JP2 | 48.00 | 13.50 |
| 5LP1 | 41.00 | 8.00 |
| 5JP4 | 40.00 | 8.95 |
| Also: 813 | 37.00 | 10.00 |
| 723a/b Klystron | 38.00 | 7.75 |

We have many of these tubes in Manufacturers quantities. Inquire.

PARTS AND COMPONENTS

IF crystal filter, for BC-312, complete with crystal and IF circuit, resonant at 470KC. Sells for the low price of . . . \$ 9.95

Cardwell Transmitting Condenser type TC-300-US. Maximum capacitance 300 mmf. 2 in. spacing between plates list 40.50. Our Price \$ 9.85

BC-603 FM receiver. 85 per cent complete, less tubes front panel and tuning condensers. With complete instruction book and cabinet \$ 5.25

Modulation transformer: 811's to an 8.13. \$ 5.00
Driver transformer: 6V6 to a pair of 811's \$ 3.00

HI-VOLT plate transformer: ½ wave rectification 115v-60c/3200v @ 150 mils. Made by Kenyon 9.95

HOOK-UP WIRE. From 16 to 22 gauge glass braid covered. \$1.00 per hundred feet. min. order \$ 1.00

SILVER BUTTON MICA CONDENSERS. stud. mtg. (Erie/Centralab.) 175-180-185-245-335-360-370 mmfd 400vdc each \$.05
lots of 100 4.50
lots of 1000 37.50
minimum order \$1.00

HI-VOLT plate transformer, made by Amertran. 115v-60 cycle input. Secondary is 6200v-ct-700 m.a. There is also a tap at 2850 volts. Specially priced at \$39.95



CONDENSERS

| | |
|--------------------------------|-------------------------------|
| 6 mfd 600 vdc. 1.35 | .4 mfd 1500 vdc20 |
| 8 mfd 600 vdc. 1.75 | .1-1 mfd 7000 5.00 |
| .05 mfd 1000 vdc35 | 2. mfd 220 vac.75 |

Oscilloscope Transformer, Ideal for 7 inch tubes. 9000 volts @ 10 ma. This unit, list for \$25.50 ls. \$11.95

C-D Condenser Special. 4000 mfd @ 30 vdc. Listed at \$13.50 released for \$ 3.40

Deflection and focussing coils for the 5FP7. These coils are being used by all large manufacturers in their latest types of television sets. One set of coils \$ 7.95

SEND FOR CATALOG

All merchandise guaranteed. Mail orders promptly filled. All prices F.O.B. New York City. Send Money Order or Check. Shipping charges sent C.O.D.

COMMUNICATIONS EQUIPMENT CO.

131B Liberty St., New York 7, N. Y.
Telephone WH 4-7658

Liberty LEADS AGAIN

**DECADE
BOX**



The model OF-113 Decade Box is an instrument designed to service by substitution any condenser in a radio receiver from .0001 mfd mica unit or a 40 mfd filter unit. There are 82 individual mica and oil filled paper condensers arranged in 13 isolated net works, non-interlocking, permitting servicing of from one to 13 condensers at the same time. No electrolytic condensers have been used in this instrument thus, no need to observe polarity when making tests. A whole shop full of condensers in one box.

\$ 99.50

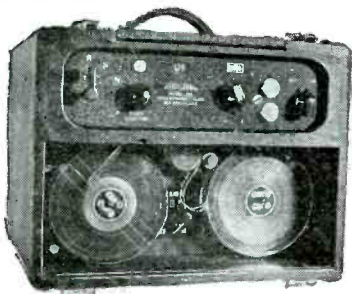

FILMGRAPH

Filmgraph, a sound device for recording and reproducing sound on film instantaneously and at low cost.

Filmgraph recordings are reproduced with high fidelity and in volume from a whisper to tones loud enough to fill an auditorium. The sound track is indented, not cut, into the film and the recording may be played back instantaneously without treatment or processing of any kind.

Filmgraph is a complete portable recorder and reproducer equipped with amplifier, speaker, microphone, cables, and controls. Filmgraph can also be used as a public address system. Designed to operate on 110 Volts at 60 cycles AC or from any other current by using a suitable converter or step down transformer.

\$ 400.
and up

TERMS: 10% DEPOSIT WITH ORDER—BALANCE C. O. D.

LIBERTY SALES CO., INC.

115 WEST BROADWAY · NEW YORK 13, N. Y.

Finch Tests Airborn Facsimile Transmission

The first attempt at publicly demonstrating airborne reception of facsimile transmission, staged middle of July by Finch Telecommunications, Inc., and Capital Airlines, didn't quite make it, though the failure was no fault of Finch's. It was the weather man's. Arrangements had been made to fly Finch



Capt. W. G. H. Finch (left) president of Finch Telecommunications, Inc., and Richard E. Fell, vice-president of Capital Airlines, at first airborne facsimile demonstration

equipment in a four-motored ship out of Newark airport for the reception of transmission from the Finch FM station WGHF in New York. But CAA would not permit the ship off the ground. Nevertheless, the test went on with the ship on the runway and was successful in every respect despite the absence of altitude at which the receiving antenna was strung under the belly of the ship. Plan is for Capital Airlines to use the equipment during regular flights for the reception of in-flight bulletins both for the guidance of pilots and, through reception of news bulletins, etc., for the edification of passengers. WGHF already is regularly broadcasting "Airpress" on 99.7 mc, plans to expand the service.

ISE to Distribute Times Fax Equipment

Telephoto and facsimile equipment manufactured by Times Telephoto Equipment, Inc., New York, is to be distributed in foreign countries by International Standard Electric Corp., world-wide manufacturing and sales organization of International Telephone and Telegraph Corp. ISE is set up to handle sales and distribution of electronic equipment in some 75 countries.

Silver Polishing Without Burnishing

The accidental use of a silver plated wire in cleaning phosphor bronze electrolytically has given birth to a new polishing process that may revolutionize the silver industry. Credit for developing the method goes to Dennis R. Turner, youthful physicist in the electronics department of the Research Laboratories of the Westinghouse Electric Corp.

Profitable accident

Turner had added cyanide to an electro-cleaning solution when dime-size phosphor bronze diaphragms for microwave tubes proved particularly difficult to wash. One of the diaphragms had been suspended in the bath, through which alternating current was passing, by a strand of wire previously used to immerse some object being silver plated. The wire was a dull white in appearance as silver plate always is before being polished. But when the phosphor bronze diaphragm was lifted out of the solution the piece of wire had taken on a high luster.

Metal articles to be silver plated are immersed in a bath of silver cyanide plating solution and negative current sent through, causing a deposit of pure silver upon the objects. When they are removed from the bath, they are evenly plated with silver but are white and lusterless. They must be buffed by hand on a revolving wheel treated with some sort of buffing compound to impart the necessary shine. Buffing not only entails an extra handling of every piece but the loss of a certain proportion of the silver through abrasion.

New method

With the new method, the silver plated object is immersed in a bath of silver cyanide solution normal to the regular plating operation. Instead of sending negative current through the bath as in plating, however, positive current is applied in about four times the amperage used to plate the metal, but not continuously. The positive energy is applied for a few seconds, discontinued, then sent through again, and this intermittent action repeated for several cycles. When the article has reached its peak of luster, it is taken out of the bath, rinsed, and dried. The entire operation takes little more than a minute.

ELECTRONIC PRODUCTS

(Continued from page 110)

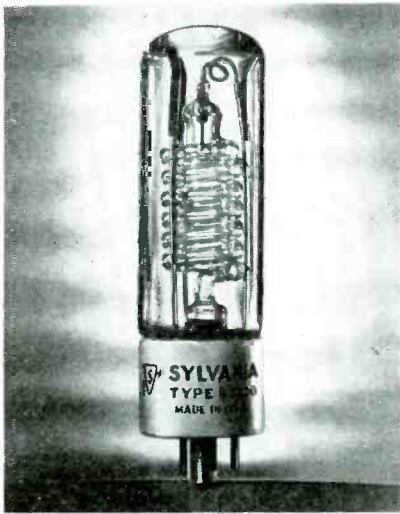

Flash Tube

A xenon gas discharge flash tube, which provides flashes of 1/5000 second duration with a peak light output of 12 million lumens for photographic, airport and signaling applications is being manufactured by Electronics Div., Sylvania Electric Prods., 500 Fifth Ave., New York 18. The tube may be operated in a condenser discharge circuit and has an average rated life above 10,000 flashes.—Electronic Industries



Microwave Equipment

New lightweight microwave equipment, including an oscillator and hand intensity meter for a study of electromagnetic radiations at an ultra-high frequency, has been developed by the Specialty Division of General Electric Company's Electronics Department at Syracuse, N. Y. Designed for schools and radio instructors as a part of the Division's electronic educational line, the equipment weighs only 4 lb. It operates on a frequency of about 2400 mc. Using a "lighthouse" tube, the oscillator cavity is mounted directly on a small case containing a transformer and attenuator, and bears a dipole antenna and 8-in. reflector. Completely self-contained and portable, it operates directly from 110 volt, 60 cycle alternate-current. The intensity meter consists of a crystal detector and microammeter.—Electronic Industries

INSTRUMENTS YOU CAN AFFORD TO USE

...on everyday jobs

INEXPENSIVE

ACCURATE

RUGGED

**EASILY REPAIRED
IN CASE OF MISUSE**

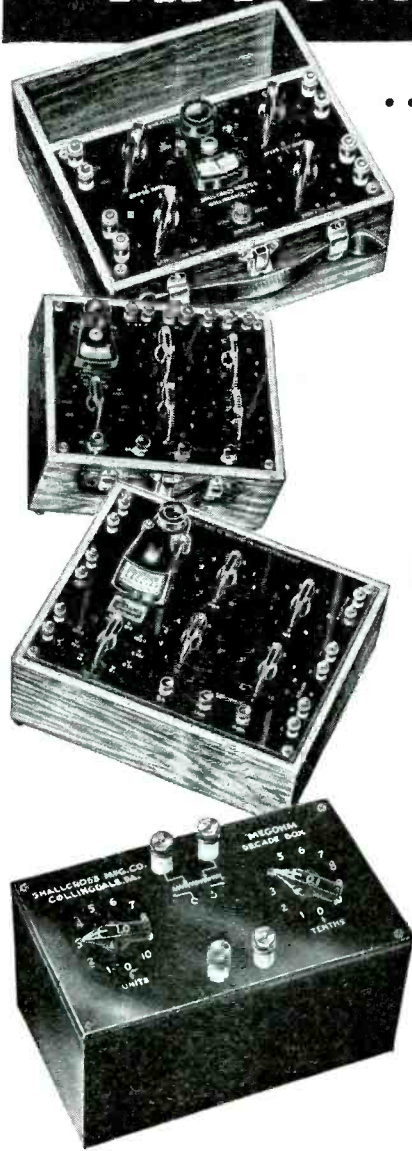

Hundreds of production line testing jobs and field investigations, in addition to laboratory tests require dependable instruments of a type that don't have to be kept under lock and key because of their extreme delicacy and high cost. Shallcross answers this need with many types of

**BRIDGES — DECADE BOXES
RESISTANCE STANDARDS
DECADE POTENTIOMETERS
HIGH-VOLTAGE TEST EQUIPMENT, etc.**

These instruments are accurate for every commercial and laboratory need up to the point of the most exacting research in pure physics. They are rugged, easy to operate and decidedly moderate in price. In case of misuse, they can quickly be repaired to full efficiency by any reasonably competent individual without the expense and delay of returning them to the factory.

WRITE FOR BULLETINS

- Bulletin 810, Shallcross Resistance Standards*
- Bulletin 825, Resistance Decades*
- Bulletin D-1, Bridges*
- Bulletin LRT, Low Resistance Test Sets*
- Bulletin G, Electrical Measuring Apparatus for schools and colleges*

SHALLCROSS MFG. CO., DEPT. EI-96, Collingdale, Pa.

SHALLCROSS

Electrical Measuring Apparatus • AKRA-OHM Resistors • Precision Switches • Electronic Engineering

BRILLIANT PERFORMANCE

that never grows dim

TURNER MODEL 211 DYNAMIC MICROPHONE

Designed and engineered for the user who wants finest reproduction under a variety of conditions, the Turner 211 Dynamic is the answer to the demand for a high fidelity yet highly rugged microphone.

Turner engineers utilize an improved magnet structure and acoustic network to extend the high frequency range and raise the extreme lows. A specially designed precision diaphragm results in unusually low harmonic and phase distortion without sacrifice of high output level.

Field tested under the most difficult operating conditions, the Turner 211 Dynamic is not affected by temperature or climate. Its response remains free from peaks or holes from 30 to 10,000 cycles. Adapted to both voice and music pickups, the Turner 211 is the ideal companion for quality recording, sound system, public address and broadcast equipment.

Ask your dealer or write

THE TURNER COMPANY

904 17th Street N. E., Cedar Rapids, Iowa

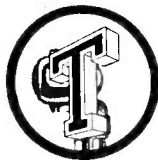

TURN TO TURNER FOR THE FINEST IN ELECTRONIC EQUIPMENT

Licensed under U. S. Patents of the American Telephone and Telegraph Company, and Western Electric Company, Incorporated.

SPECIFICATIONS

- Output Level: -54DB at high impedance (1 volt/dyne/sq. cm).
- Frequency Response: Flat within ± 5 DB from 30-10,000 cycles.
- Impedance: 30-50 ohms, 200 ohms, 500 ohms, or high impedance.
- Case: Salt-shaker type, chrome satin finish, 90° tilting head.
- Cable: 20 ft. heavy duty with removable type connectors.
- Uni-directional
- Mounting: 5-27 thread (Standard Thread).



VHF Aircraft Receiver

A single channel, crystal controlled vhf receiver for airline communications and traffic control which may be set up for any frequency in the 108 to 132 mc band, has been developed by Federal Telephone and Radio Corp., Newark, N. J. The receiver has a superheterodyne circuit with adjustable level squelch and has a selectivity characteristic permitting 100 kc channel spacing.—Electronic Industries

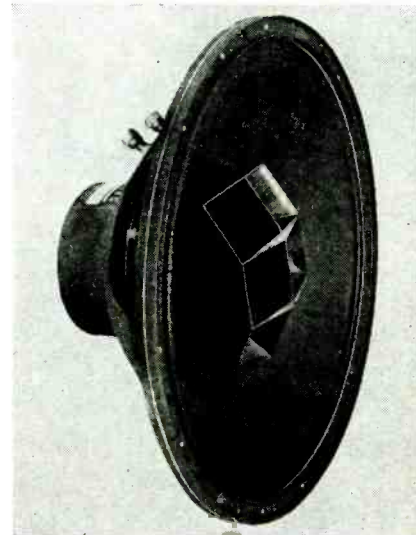

Multicellular Speaker

Altec Lansing Corp., 250 W. 57th St., New York (19), has brought out the first of a new series of loudspeakers—model 608 multicell Diacone. The unit, which is of the permanent magnet type, has the properties of a 2-way multicellular speaker system, consisting of a metal hf diaphragm and a low frequency cone coupled by a mechanical dividing network and driven by a 3 in. voice coil wound of aluminum ribbon.—Electronic Industries

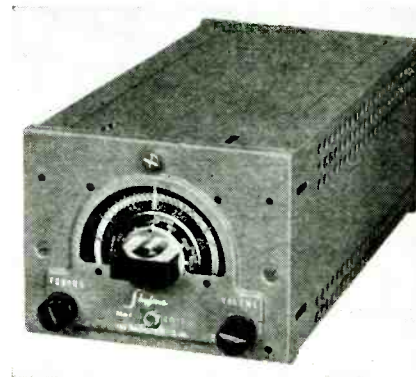

Personal Aircraft Radio

The Skyfone model CA-2 a light-weight radiophone designed for personal aircraft is in production at Hallierafters Co., 43 East Ohio St., Chicago 11, Ill. Weighing less than 8 lbs. the Skyfone covers the radio range frequencies, control tower frequencies and beacons for navigational purposes, and includes a broadcast band. The receiver is designed to withstand a wide range of temperatures, humidity and vibration.—Electronic Industries

THERE'S A **DRAKE** SOLDERING IRON FOR EVERY TYPE OF ELECTRONIC WORK

From that mighty mite



the Drake No. 400 to the high speed production "honey"



the Drake No. 600-10 there is a high quality Drake Soldering Iron "just right" for the job.

Drake Heat Controls and the Drake "Magic Cup" Stand are important soldering aids.



SEE
**YOUR RADIO
PARTS JOBBER**

DRAKE ELECTRIC WORKS, INC.
3656 LINCOLN AVE. CHICAGO, ILL.

A NEW KILOVOLT METER 0-30 KV D.C., LOW DRAIN



Model 101

For use in:

● Television ● Electrostatic Precipitation ● Geiger-Mueller Counters and all circuits requiring a low drain, high voltage meter.

SAFE: 10" handle permits measurements on live circuits.

SENSITIVE: 20 μ a full scale. Less than 1 μ a/KV.

STABLE: Resistor encased in newly developed non-hygroscopic compound.

RUGGED: Switch shorts meter in transit.

COMPACT: 11" x 5" x 7".

LOW COST: \$59.00.

Write for descriptive literature

BETA ELECTRONICS CO.

1762 THIRD AVE. NEW YORK 29, N. Y.
Manufacturers of KV meters; Portable 0-30 KV power supplies; Electronic Microammeters

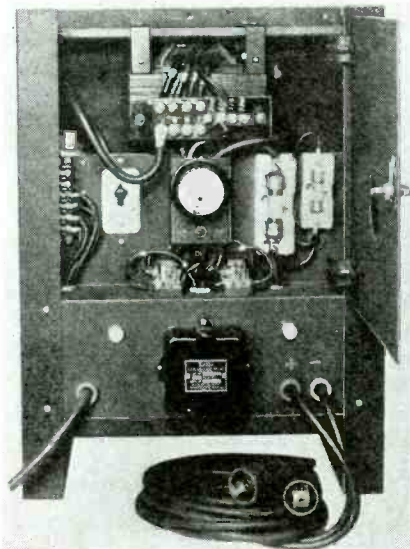

Battery Charger

An automatic two-rate industrial truck battery charger for either lead-acid or Edison type batteries has been designed by Federal Telephone and Radio Corp., Newark, N. J. The unit will charge six-cell, 250 ampere-hour, lead-acid batteries to capacity in 8 hours and ten-cell, 250 ampere-hour Edison batteries in 7 hours. It operates on 105-125 volt, 60 cycle, single phase ac.—Electronic Industries

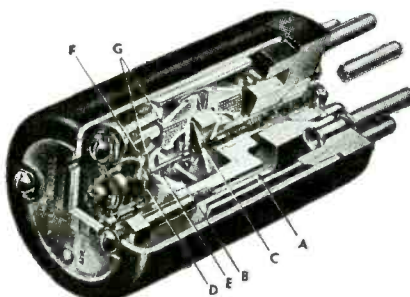

Low Current Relay

For operation on currents of thermocouple and photocell magnitudes where compactness, light weight and vibration stability are important, a Sensitive Relay (Model 103) has been developed by the Instrument Div., Thomas A. Edison, Inc., West Orange, N. J. The relay design is based on an inversion of the d'Arsonval galvanometer type meter movement, where the permanent magnet swings and the coils are stationary.—Electronic Industries



Microphone Transformer

Newcomb Audio Products Co., 2815 S. Hill St., Los Angeles, Cal., has a plug-in type microphone transformer interchangeable for high or low impedance inputs for use on their amplifiers. Use of long lines and better frequency response regardless of cable length are made feasible by the triple alloy shielded units.—Electronic Industries

OUTSTANDING VALUES

RADIO · ELECTRONIC
and **COMMUNICATIONS SUPPLIES**

Order **TODAY**—Immediate Delivery

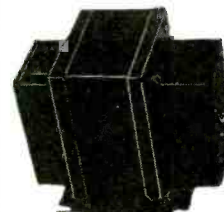
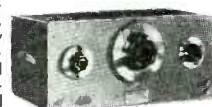

PLATE TRANSFORMERS

6200 Volt CT—700
Mils, 110 Volts 60
Cycles tapped primary
2 KVA. Amer-
tran. Limited Quantity.
\$39.95

HEWLETT-PACKARD AUDIO OSCILLATOR MODEL 200B

Frequency range 20
cycles to 20,000 cycles
in 3 ranges. A
Precision Laboratory
Instrument. Complete
with tubes and
power supply, re-
conditioned and
guaranteed by Niaga-
ra. Special **\$75.00**



SWINGING CHOKE

Langevin Swinging
Choke—9/60 hen-
ries 400/50 mils.
DC resistance 72
ohms**\$12.75**

ADDITIONAL BARGAINS

DYNAMOTOR

12 Volt dynamotor 235 Volts out at 90 mils.
Complete with filter mounted in can 6 1/4 x
5 3/4 x 3 1/2" with cover**\$2.95**

CONDENSERS

Johnson 150DD 70 split-stator 150 MMF per
section 7000 Volt condenser. Your cost..\$8.95
.003 Sangamo Type H conds. 2500 Volts
working—5000 V test**\$0.45**

TRANSFORMERS

Plate transformer 1450 volts CT at 420 mils
built by Kenyon..\$7.95 ea. or two for **\$15.00**

TUBES

Combination Eimac VT 127/100 TS tubes in
stock. 100 watt plate dissipation—85% ef-
ficiency and mycalex socket designed for
100 TS**\$4.50**
6AK5 tubes. Yours for only**\$1.98**

MISCELLANEOUS

1000 KC. TB cut xtal in holder. Very desir-
able item, many uses**\$4.95**

11 position switch, 4 deck low loss, bakelite.
\$1.25

Zero center microammeter 100 microamp
each side Black dial 2 1/2"—radium numbers.
A good buy at**\$3.95**

110 Volt relay AC coil allied DPDT. Con-
tacts will handle 10 amps.....**\$1.65**

Antenna insulators Birnbach #470 W
7 1/4" long 1" diameter holes spaced 5"
apart. Each \$0.35 or 4 for.....**\$1.00**

Quantity orders on any
of above items invited.

ALL PRICES F.O.B. OUR
WAREHOUSE NEW
YORK CITY, NEW YORK

Write for our latest
bulletin 8ED

NIAGARA RADIO SUPPLY
160 Greenwich St., New York 6, N. Y.
BOWLING Green 9-7993

Designed for



Application

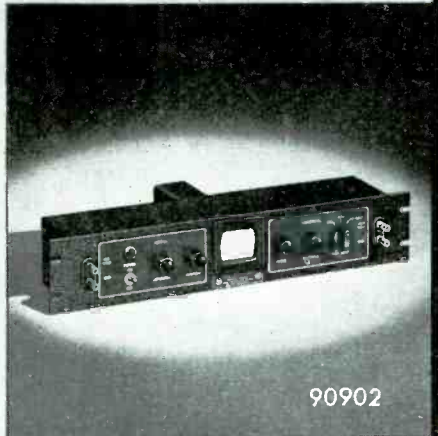

90902

**90900 Series
Cathode Ray Oscilloscopes**

The No. 90902 and No. 90903 Rack Panel (3 1/2") Oscilloscopes, for two and three inch tubes, respectively, are inexpensive basic units comprising power supply, brilliancy and centering controls, safety features, magnetic shielding, switches, etc. As a transmitter monitor, no additional equipment or accessories are required. The well-known trapezoidal monitoring patterns are secured by feeding modulated carrier voltage from a pick up loop directly to vertical plates of the cathode ray tube and audio modulating voltage to horizontal plates. By the addition of such units as sweeps, pulse generators, amplifiers, servo sweeps, etc., all of which can be conveniently and neatly constructed on companion rack panels, the original basic 'scope unit may be expanded to serve any conceivable application.

**JAMES MILLEN
MFG. CO., INC.**

MAIN OFFICE AND FACTORY
**MALDEN
MASSACHUSETTS**

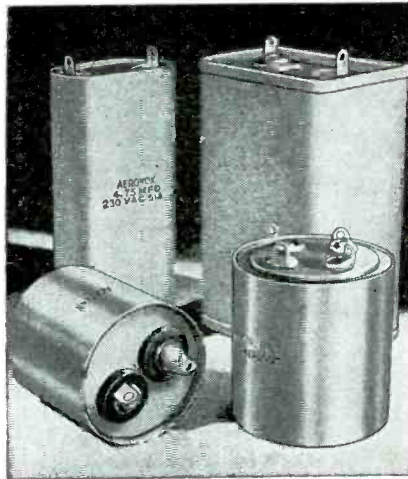

Capacitors for Fluorescents

Extra-rugged capacitors for fluorecent lighting service available to all standard types have been brought out by Aerovox Corp., New Bedford, Mass. The units are impregnated with Hyvol, a synthetic high-dielectric compound with very stable characteristics. The containers are made of heavy steel, plated for protection.—Electronic Industries

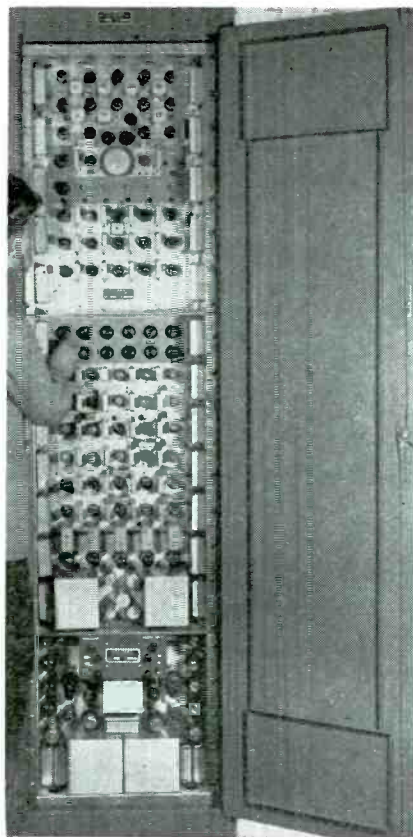

Synchronizing Generator

A synchronizing generator (Model PT 101) for television receiver production testing and similar applications is available from Polarad Electronics Co., 135 Liberty St., New York. The unit provides 525 line, interlaced, 60 fields, 30 frames, RMA synchronizing pulses held to the required tolerances. The generator is complete with a 3 in. oscilloscope and a dual regulated power supply in one rack and operates from a 115 volt 50-60 cycle ac power source.—Electronic Industries

**SPECIALISTS IN
INSTRUMENTS
AND INSTRUMENT SUPPLIES**

**INDUSTRIAL
ELECTRICAL
ELECTRONIC**
Lab Standards
Portable, Panel
Switchboard
Special

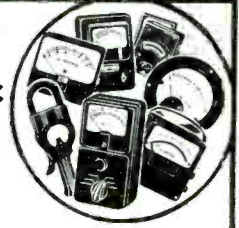

RAPID DELIVERY

from EXTENSIVE STOCKS of a complete line of high quality

- Voltmeters • Ammeters
- Industrial Analyzers
- Ohmmeters • Frequency Meters
- Bridges (Wheatstone)
- Megohmmeters • Pyrometers

Also Special Instruments to Order.
Consult us about your requirements.

Write for descriptive Bulletins

ELECTRO-TECH

Equipment Co.

117 LAFAYETTE ST., NEW YORK 13, N. Y.

**GLASS
INSTRUMENT
BEARINGS**

GLASS "V" BEARINGS
made and set to your
specification



We specialize in the manufacture and mounting of all types of sapphire jewel bearings.

We welcome your inquiries

RICHARD H. BIRD & CO.

Incorporated

Manufacturers of Jewel Bearings
for thirty years

1 SPRUCE STREET
WALTHAM, MASS.

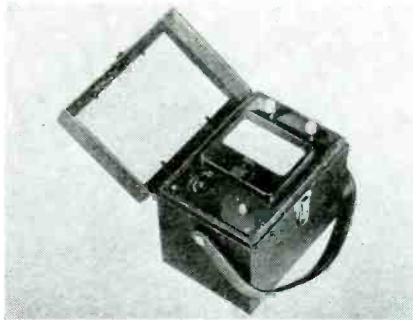

Insulation Resistance Meter

Insulation resistance may be checked to 50,000 megohms by use of the portable self-contained Model 261 vibrotest brought out by Associated Research, 231 So. Green St., Chicago 7, Ill. A test voltage of 500 is provided by two dry-cells and a charging circuit speeds testing of capacity circuits. The unit is designed to withstand temperatures from -40°F to $+140^{\circ}\text{F}$.—Electronic Industries

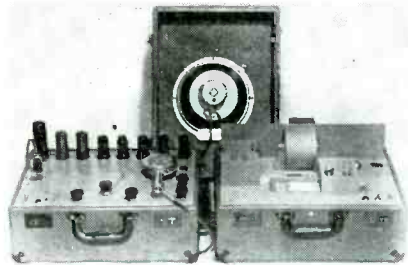

Warble Tone Oscillator

Sound Apparatus Co., 233 Broadway, New York 7, has developed an electronic warble tone oscillator designed for use in connection with power level and automatic frequency response recorders for electro-acoustical, speaker and microphone measurements. The equipment includes a speaker, microphone and associated preamplifier, built into a portable case.—Electronic Industries

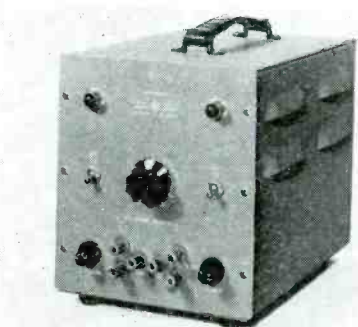

Laboratory Power Supply

Model 710A regulated power supply, manufactured by Hewlett-Packard Co., Palo Alto, Calif., is a small, light-weight (18-lb.) source of regulated voltage for general laboratory and production use. Output is continuously variable from 180 to 360 volts, and will remain constant to within 1% for loads of from 0 to 75 ma., and for line voltage changes of $\pm 10\%$. Total noise and hum is less than 0.005 volts. Either positive or negative output terminal may be grounded and the unit also provides 6.3 volts ac, center tapped.—Electronic Industries

Check Your Requirements

WEBSTER ELECTRIC CARTRIDGES
MEET THEM FOR:

- WEIGHT
- RESPONSE CHARACTERISTICS
- VOLTAGE OUTPUT
- DIMENSIONS AND MOUNTINGS
- TYPE OF TERMINALS
- TYPE OF GROUND
- TRACKING PRESSURES



● The Webster Electric line of cartridges offers a complete selection to meet the requirements of your present day designs, for you are able to select a cartridge with your requirements for all of the above characteristics.

Webster Electric Cartridges are carefully designed and manufactured under highest quality standards. They have been on the market for years, and during this time have proved their value for long life and top performance.

You'll find that all models offer exceptionally uniform response over a desired range of frequencies, and are made to give low distortion and minimum needle noise.

In addition to the Webster Electric line of cartridges, complete tone arm assemblies of improved design are available for incorporating in new equipment.

For full information on both cartridges and tone arms, write today to Webster Electric Company, Racine, Wis.

(Licensed under patents of the Brush Development Company)

WEBSTER
RACINE



ELECTRIC
WISCONSIN

Established 1909

Export Dept. 13 E. 40th Street, New York (16), N. Y. Cable Address "ARLAB" New York City

"Where Quality is a Responsibility and Fair Dealing an Obligation"

ALL IN ONE PACKAGE



You've got a lot of "sharp" instruments in a small space when you buy the Jackson Model 637. In addition to complete tube testing, it combines 9 functions and 27 ranges, readily selected by push buttons that save time and guesswork.

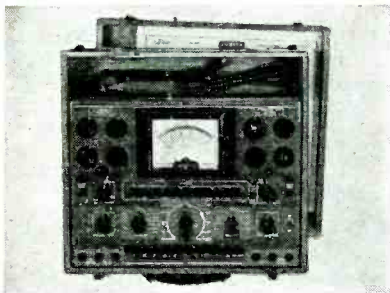

MODEL 637 DYNAMIC OUTPUT TUBE TESTER

with complete universal meter ranges

1—Dynamic Output Tube Tester—accurate, thorough. 2—Ballast Tube Tester—finds shorts or burn-outs. 3—High-sensitivity Neon Continuity Tester. 4—Condenser Tester for finding shorted or leaky condensers. 5—Multi-range A.C. Voltmeter: 0-10/100/250/500/1000/2500. 6—Multi-range D.C. Voltmeter: 0-10/100/250/500/1000/2500. 7—Decibel Meter—Ranges from minus 10 to plus 14/10 to 34/30 to 54. 8—Multi-range D.C. Milliammeter 0-1/10/100/250. 9—Ammeter Range—0 to 10 amperes D.C. 10—Triple Range Ohmmeter 0-3000/300,000/0-30 megohms.

Automatic Push Button Selector—permits instant use of any range. Remarkably fast; reduces chance of mistakes.

Full Range Filament Selection—from $\frac{3}{4}$ V. up to and including 115 V. . . Filament selector marked directly in volts at each position.

Tests All Tubes—all of the popular receiving types and television amplifiers, including Bantams — Miniatures — Loctals — Single Ended — and High-Voltage Filament Types. Provision for many more. Two spare socket positions are provided on panel.

"Dynamic" Method of Test is more accurate, frequently finds "poor" tubes which might pass for "good" in ordinary testers.

New High-Voltage Power Supply—permits using higher plate voltages (over 200 V. for some types), giving more accurate results.

Most Improved Type of Switching System—Spare circuits and switch positions are provided for future use on different tubes.

Controls Easy to Use—You don't waste time figuring out the next move.

Illuminated Meter Dial easy to read. Noise test jacks provided. Dimensions: $14\frac{3}{4}$ " x $13\frac{3}{4}$ " x 6". Weight 14 pounds.

Accessories—Complete with self-contained battery (for ohmmeter), and test prods.



Equalizer

A diameter equalizer capable of equalizing 8 db at 5 in. disc diameter to zero db at 12 in. diameter at 10,000 cycles is in production at Cinema Engineering Co., 1510 W. Verdugo Road, Burbank, Cal. Type 3991 is adjusted automatically as the cutting head moves across the recording disk. The unit has an impedance of 500 ohms and insertion loss is 10 db.—Electronic Industries

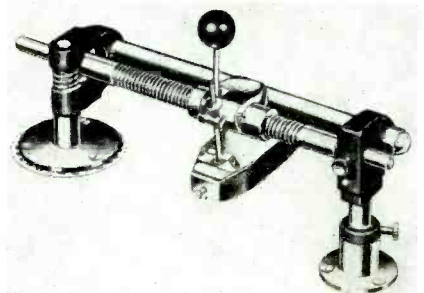

Recording Mechanism

A low-cost instantaneous recording mechanism has been brought out by Techno-Craft Prods., 200 Hudson St., New York 13. The unit is provided with cutting needle angle adjustment and has a cutting pitch of 110 lines per in., outside-in. A 12 in. and a 16 in. model are available and any one of four Astatic cutting heads can be furnished.—Electronic Industries

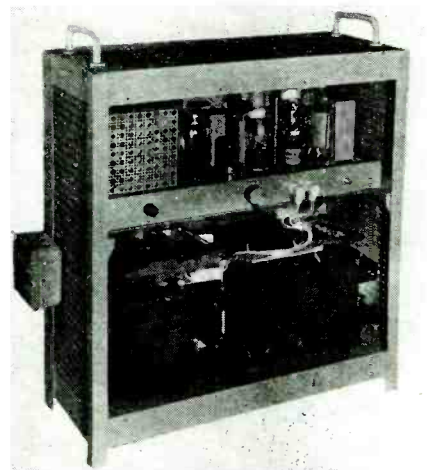

Line Voltage Regulator

The model 5000-2 electronic voltage regulator developed by Sorenson & Co., 375 Fairfield Ave., Stamford, Conn., is designed for 230-volt applications within a load range from 500 VA to 5 KVA. The unit is unaffected by lagging power factor variations or frequency changes between 50 and 70 cycles and has a harmonic distortion of less than 5% total.—Electronic Industries

JACKSON

Fine Electrical Testing Instruments

JACKSON ELECTRICAL INSTRUMENT COMPANY, DAYTON, OHIO

- SOFT SOLDER RINGS AND PREFORMS
- SILVER SOLDER RINGS
- COPPER BRAZING RINGS



For Use With
Flame, Oven
or Induction
Heating

Large range of wire sizes carried in stock for immediate fabrication into Rings and Preforms.

**ELECTRONIC SPECIALTIES
MANUFACTURING COMPANY**
123 North Main Street, Elkhart, Indiana

NEW MODEL

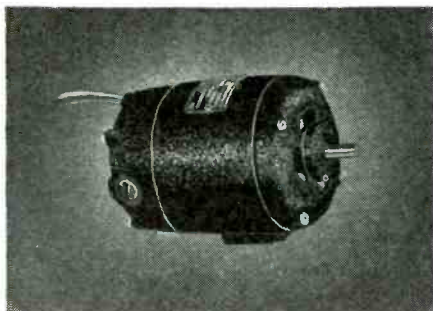

ELNICO TYPE ALP
TYPICAL PERFORMANCE CURVE

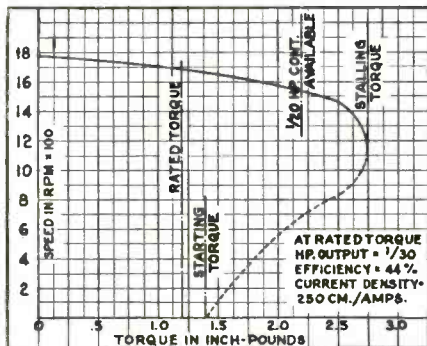

Type ALP-191; 110 volt 60 cyc. single-phase Capacitor start & run; Motor Capacitor Value 4.25 Mfd. Curve #235. Elnico ALP Frame Motors are 3 3/8" x 4-5/16" capacitor start and run, two and four pole AC motors, internal fan cooled. Continuous duty rating—as induction motor to 1/30 h.p. at 1700 r.p.m.; as synchronous motor to 1/60 h.p. at 1800 r.p.m. Substantially higher ratings are available at speeds of 3400 and 3600 r.p.m. respectively. Also, higher rating for intermittent duty.

ELECTRIC INDICATOR CO.
STAMFORD, CONNECTICUT



Conductivity Bridge

The electrical resistance method of measuring soil moisture is used in model RC-12C soil moisture conductivity bridge developed by Industrial Instruments, Inc., 17 Pollock Ave., Jersey City 5, N. J. The battery-operated, portable unit will measure soil moisture from field capacity to the air dry state, corresponding to a resistance range from 0.2 to 2,500,000 ohms. A CR tuning tube is used as balance indicator of the 1000 cps ac bridge.—Electronic Industries



New Unimeter

The Electronics Dept. of the General Electric Co., Syracuse, N. Y., has a new version of the well known Unimeter for measuring ac and dc voltage, dc current, resistance and decibels. Full scale ranges are 2.5 to 1000 dc volts at 20,000 ohms per range-volt; 2000 ohms to 20 megohms and 0.5 to 500 ma., while a separate capacity coupled jack provides ac ranges from 2.5 to 1000 volts and 3 to 52 decibels, based on a 6 mw, 500 ohms zero reference level.—Electronic Industries

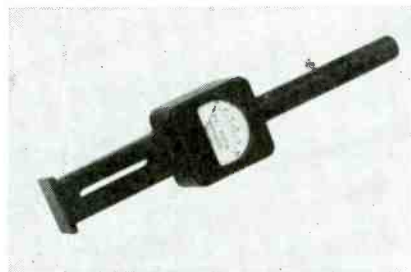

R-F Probe

For exploring relative field strength in the neighborhood of high power rf equipment, the Radio Frequency Laboratories, Inc., Boonton, N. J., has introduced Model 200 R-F probe. An overall length of 11 in., including a probe element 5 in. by 3/4 in. diameter, permits access to confined spaces. Two crystal rectifiers in the tip operate a Weston Model 506 meter, giving indications at frequencies up to 1500 mc. will withstand overloads equivalent to 10 times full scale deflection and is insulated to protect operators when probing high voltage power circuits.—Electronic Industries

Here's the Way to Spot Weld Instrument and Precision Equipment



- Vangtronic Self-Forging Stored Energy Spot Welder shown above is one of many used by The Foxboro Co., one of the largest instrument manufacturers.
- Welds are now being made which heretofore were practically impossible.
- This welder is desirable for small, precision parts, especially where dissimilar metals are utilized. . . . Welds without distortion, discoloration or change of crystallization structure.

Write for descriptive literature.

THE
VANGTRONIC
CORP.

**87 WASHINGTON STREET
BRIDGEPORT 5, CONN.**

Proper tools
simplify the
hard problems

VX Series

Subminiature tubes

... now available as pentodes, tetrodes, triodes and diodes operate at 10 milliamperes filament current, 10^{-14} amperes grid current, and have an extremely high grid resistance of 10^{16} ohms or greater.

Developed for the finest in instrumentation—solving the problem of making new and intricate circuits simple and feasible.

Victoreen vacuum sealed hi-megohm resistors have filled the void of quality resistances in a range from 100 to 10,000,000 megohms. Used wherever resistors of these values require unusual stability with relatively low temperature and voltage co-efficients.

Write for our free technical data booklet on tubes and resistors.



THE VICTOREEN INSTRUMENT CO.

3800 PERKINS AVENUE
CLEVELAND 14, OHIO

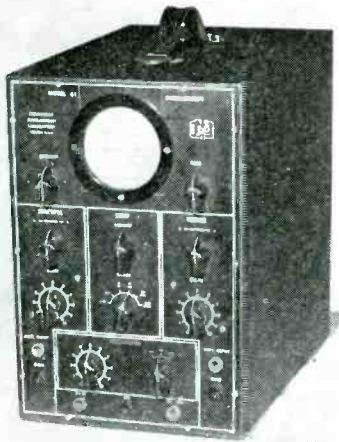

General Purpose Oscilloscope

The Electronic Development Labs, 2655 W. 19th St., Chicago, is manufacturing a new portable cathode-ray oscilloscope having a 3 in. viewing screen. Features include a linear sweep oscillator of the multivibrator type and extended range vertical and horizontal amplifiers. The sweep range is 10 to 60,000 c/s, amplifier response 10 to 150,000 c/s (-2 db.) and sensitivity 1 volt rms per inch of deflection. Tubes are of the "lock-in" type with the exception of one 5Y3 rectifier and the type 3AP1 cathode-ray tube.—Electronic Industries



Aircraft Analyzer

A portable aircraft analyzer for simultaneous checking of generator voltage, field current, regulator, generator relay, instruments and wiring of any plane is available from Airquipment Co., Dept. BK, 2820 Ontario St., Burbank, Cal. The analyzer may also be used as dc voltmeter with a 30, 300 and 1500 volt range or as an ammeter up to 300 amps.—Electronic Industries

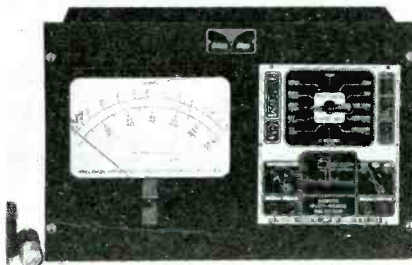

Circuit Tester

Series 864, ac-dc laboratory circuit tester is in production at Precision Apparatus Co., 92-27 Horace Harding Blvd., Elmhurst, N. Y. The instrument has a 9 in. rectangular meter and provides 41 ac-dc, volt-, milliamps-, ohm- and db meter ranges at a sensitivity of 5000 ohms per volt. Measurements are possible up to 6000 volts ac-dc, 20 megohms, 12 amps., and 70 db.—Electronic Industries

HOPP Plastic RADIO DIALS

DIAL WINDOWS, NAME PLATES, GAUGES, CALCULATORS, SCALES, CHARTS, ETC.

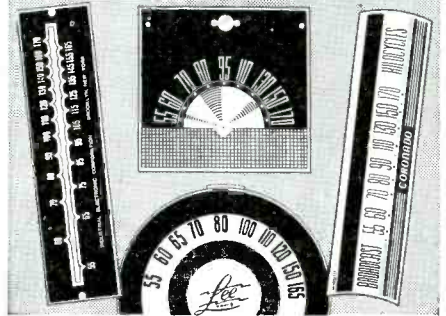

PLASTIC RADIO DIALS have endless possibilities in design, size, shape and color combination. Attractive and durable, our radio dials, windows and scales are preferred by many leading Radio manufacturers.

Not only for dials, but for numerous other electronic and electrical applications, Laminated Plastics are preferable.

Consult with our artists and engineers regarding applications for your particular purpose. Or... send us your blue prints or samples for quotation.

THE HOPP PRESS, INC.
460 W. 34th STREET, NEW YORK 1, N. Y.
ESTABLISHED 1893

JELLIFF Resistance WIRE



ALLOY "A"

Nickel-Chromium alloy, resists oxidation at elevated temperatures up to 2100° F. Also used for fixed non-magnetic resistors. Resists chemical corrosion by many media. Specific resistance 650 Ohms C.M.F.

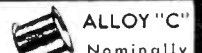

ALLOY "C"

Nominally 60% Nickel, 15% Chromium, balance iron. High resistance to oxidation and corrosion. Widely used for resistors for radio, electronics, industrial equipment and domestic appliances. Operating temperatures up to 1700° F. Specific resistance 675 Ohms C.M.F.



ALLOY "45"

Copper-Nickel alloy with constant resistance over wide range of temperatures. Specific resistance 294 Ohms C.M.F.; temperature coefficient 0.00002 Ohms per deg. F.; 32-212 deg. Used in winding of precision resistors, rheostats, and electrical measuring devices.



KANTHAL

Exclusive manufacturers and distributors of KANTHAL wire, ribbon and strip. An alloy containing Iron, Chromium, Aluminum and Cobalt... for operating temperatures up to 2462° F. Three grades, A-1, AS, DS; resistivity 872, 837, 812 Ohms C.M.F. respectively at 68° F.

AS FINE AS .0006" FOR ALLOYS, 'A', 'C', '45'

All alloys are produced in high-frequency type furnaces, and are furnished bright, dull, or anodized finish; also with enamel, silk or cotton insulation.



THE C. O. JELLIFF
MFG. CORP.

SOUTHPORT, CONNECTICUT

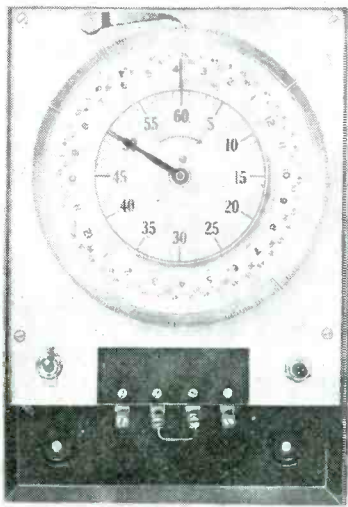

six bands with provision for replacing the 540 to 1600 kc band with a 40 to 54 mc range. The receiver includes a crystal controlled secondary standard, has 18 miniature tubes and a turret type rf amplifier. It is self-contained except for the speaker, power output being 8-10 watts. Other features include a series diode noise limiter, crystal filter and IF amplifier, tone controls, temperature compensated oscillator, phono input, Panoramic adaptor, provision for control of external relay, tuning meter, mechanical linkage provisions through extension of shafts out back, threshold squelch circuit, wide bandspread, control locks, 8-in. PM speaker.—Electronic Industries

Sweep Frequency Record

A new method of evaluating the frequency response of phonograph playback

equipment has been developed by the Clarkstan Corp., 11927 W. Pico Blvd., Los Angeles 34, Calif. Special vinylite pressings of a frequency modulated signal have been prepared for use with a cathode-ray oscilloscope, permitting continuous observation of playback frequency response during adjustment and testing of phonograph reproducers, amplifiers, audio equalizers, etc. The range of 100 to 10,000 c/s is scanned continuously at the rate of 20 sweeps per second, with a 200 microsecond pulse at the start of each sweep for synchronizing the oscilloscope time base oscillator. The recording is at constant amplitude below 500 c/s and constant velocity above this frequency, conforming to the N.A.B. specifications within 1 db. Frequency varies logarithmically with respect to time and is identified by marker pulses at intervals of 2,000 c/s. These pressings are available in either 10 in., 78 rpm, or 16 in., 33 $\frac{1}{4}$ rpm types.—Electronic Industries

Program Time Switch

Zenith Electric Co., 152 W. Walton St., Chicago 10, Ill., is manufacturing a program time switch (type PR-24) which operates automatically to periods as close as five minutes throughout the twenty-four hours. The timer repeats daily requiring no resetting.—Electronic Industries

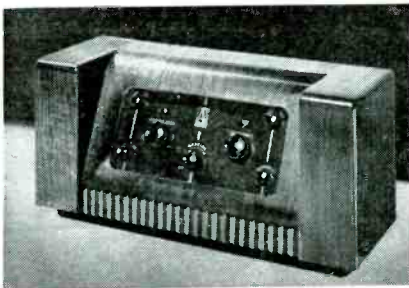

Audiometer

Audio Development Co., 28833—13th Ave., S. Minneapolis, Minn., is producing a new type of 100% dial-operated audiometer for accurate tests of hearing acuity. The instrument supplies a pure, continuous test tone at the six A.M. A. frequencies and has additional half-octave steps in the higher frequency range to 11,584 c/s. Hearing loss is evaluated in 5 db steps, maximum attenuation being 100 db from 512 to 4096 c/s, 80 db from 256 to 8192 c/s and 70 db from 128 to 11,584 c/s. No readjustment of the zero reference level is required when changing frequencies.—Electronic Industries



Communications Receiver

Allen D. Cardwell Mfg. Co., Plainville, Conn., has brought out a new communications receiver (Model CR-54) that covers all frequencies between 0.54 and 40.0 mc in

Ingenious New Technical Methods

To Help You with Your Reconversion Problems

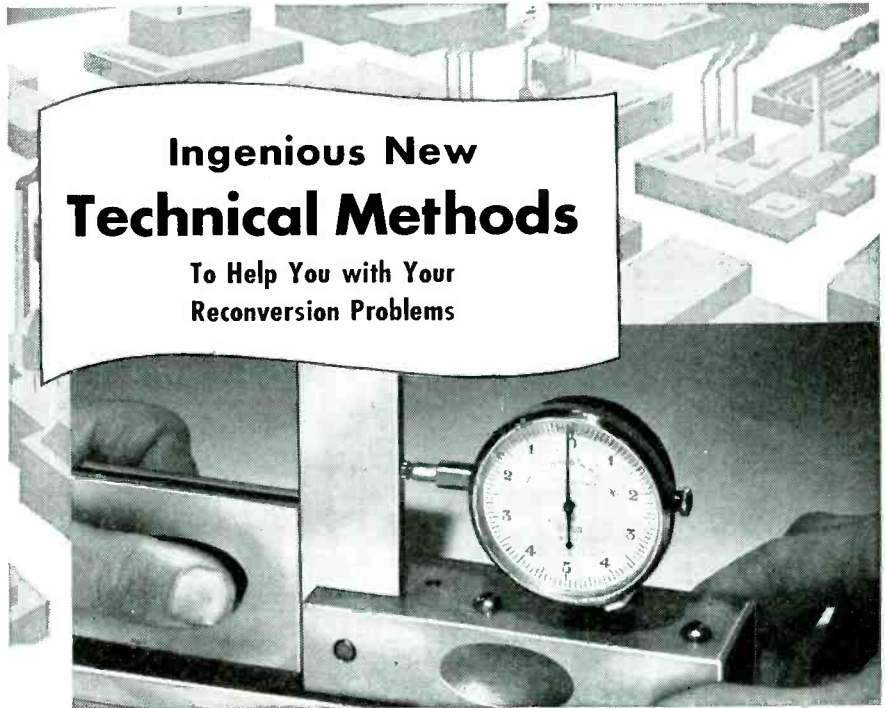

New Micro Square Instantly Checks Right Angles to One 10,000th Inch!

Ideal for precision testing, the Acro Micro-Sine Square quickly and accurately checks right angle work to 1/10,000th inch within a given distance. Its standard indicator dial instantly registers error, location of error, and amount of correction required. Designed for tool and die shops, machine shops and testing laboratories, it also provides a standard for checking master squares, tri-squares and tools.

The Acro Micro-Sine Square is very simple to operate, saves hours of time. Made of hardened tool steel, in ground and lapped precision construction. Available in two types: (1) Standard precision gauge in tenths, (2) Lever indicator in thousandths. Both complete with master checking blocks and carrying cases.

On precision jobs, requiring a static position and mental alertness, workers undergo nervous tension which often results in fatigue. Tests have shown that the act of chewing helps relieve tension—helps workers stay alert, thus increasing their efficiency to do more accurate work. For this reason, many plant owners urge workers to chew Wrigley's Spearmint Gum on this type of job.

You can get complete information from Acro Tool and Die Works
4554 Broadway, Chicago 40, Illinois

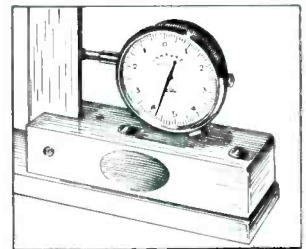

Standard Indicator Dial



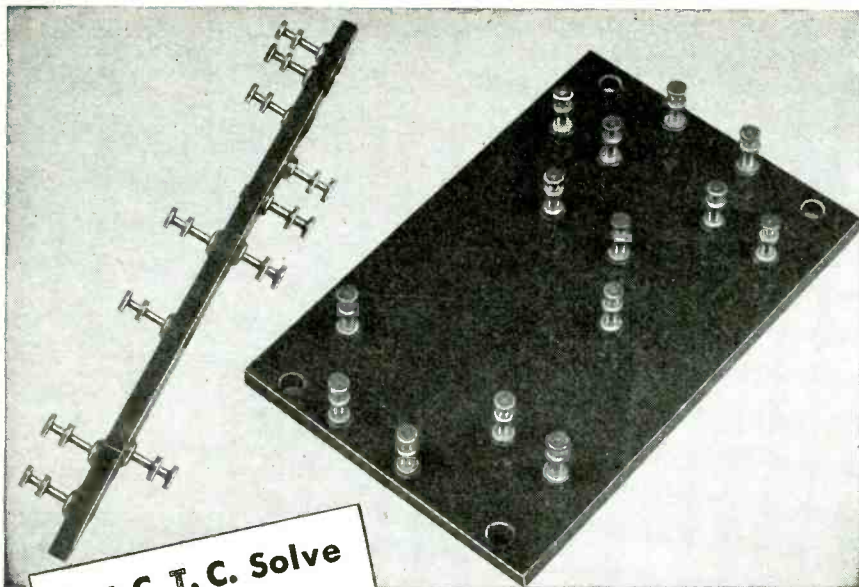

**Let C. T. C. Solve
Your
TERMINAL
BOARD
Troubles**

You'll save time and money if you order your Terminal Boards ready-made from C.T.C. Just send in complete specifications and in short order you'll receive perfectly cut and finished linen bakelite boards with quick soldering C.T.C. Lugs firmly anchored in exact position and ready to use.

Boards can be furnished with any type of C.T.C. Lug and in a variety of thicknesses.

Write for complete information or, better still, send us your specifications and let us show you just how inexpensively and quickly we can meet them.



CAMBRIDGE THERMIONIC CORPORATION
441 Concord Avenue • Cambridge 38, Mass.



Dynamic Microphone

The Cardyne, a single-head cardioid dynamic microphone is being offered by Electro-Voice, South Bend, Ind. The output level of the unit is 53 db below 1 volt/dyne/cm². Units can be supplied with impedances of 50, 250, 500 and 25,000 ohms. Two models are available, model 731 with a frequency response substantially flat from 30 to 12,000 cps and model 726 having a response from 40 to 10,000 cps.—Electronic Industries

MANUFACTURERS! EXPORTERS! DISTRIBUTORS!

**Electronic and Radio Components
Available in Quantity!**

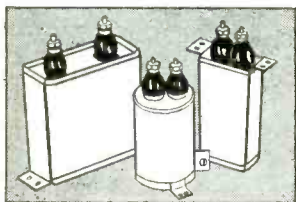

PYRANOL CONDENSERS

Standard Make: General Electric, Cornell-Dubilier, Aerovox, etc. Oil-filled and hermetically sealed.

| Catalog No. | Capacity | Voltage | *Manf. List Price | Your cost each in lots of | | |
|-------------|------------|---------|-------------------|---------------------------|-------|-------|
| | | | | 50 | 100 | 250 |
| 3C6 | 4 Mfd | 600 | \$ 6.60 | \$.80 | \$.70 | \$.60 |
| 3C7 | 6 Mfd | 600 | 8.10 | 1.15 | 1.05 | .90 |
| 72C637 | 10 Mfd | 600 | 10.80 | 1.35 | 1.20 | 1.00 |
| A9C173 | 15 Mfd | 600 | 17.65 | 2.25 | 2.00 | 1.80 |
| 35C311 | 2 Mfd | 1000 | 6.00 | .90 | .80 | .70 |
| A9C174 | 10 Mfd | 1000 | 12.00 | 2.25 | 2.15 | 1.95 |
| D1C276A | 4 Mfd | 1500 | 10.00 | 2.25 | 2.15 | 1.95 |
| A9C171 | 10 Mfd | 1500 | 18.00 | 2.95 | 2.75 | 2.50 |
| 76C787 | 4 Mfd | 2000 | 10.80 | 2.95 | 2.75 | 2.50 |
| 76C791 | 10 Mfd | 2000 | 22.00 | 4.60 | 4.35 | 4.00 |
| A4C124 | Dual 1 Mfd | 3000 | 18.80 | 2.95 | 2.75 | 2.50 |
| 63C574 | 1 Mfd | 3600 | 26.50 | 2.45 | 2.25 | 1.90 |
| 92C782 | .1 Mfd | 7000 | 28.00 | 2.45 | 2.25 | 1.90 |

*Based on present C. D. List Prices—Sorry—No Less Than 50 Units Sold.



**WESTINGHOUSE
RELAYS**

Glass Enclosed
4 PST 115 V AC
20 AMP. CONTACTS
List Price \$21.50

Price—
25 Units—\$7.65
50 Units— 6.65
100 Units— 5.65



**LEACH POWER RELAYS
NO. 6104 TYPE**

115 V AC 30 AMP.
CONTACTS 115 V
20 AMP. CONTACTS 220 V
List Price \$14.00

Price— 25 Units—\$5.00
50 Units— 4.25
100 Units— 3.85

HEINEMANN CIRCUIT BREAKERS

120 AC 35 AMP.
CAT. NO. AM-1510R-35
Price— 25 Units—\$3.55
50 Units— .50
100 Units— .45

INQUIRIES FOR QUANTITY ELECTRONIC PARTS INVITED. WRITE DEPT. EI-9.

ELDICO of New York, Inc.
44-31 DOUGLASTON P'KWY.
DOUGLASTON, N. Y.

FM Channel Numerology

Basic mathematical advantages of the new FM channel numbering system.

Since the Federal Communications Commission has instituted a channel numbering system for the new frequency modulation allocations in the 88 to 108 mc band, the public will soon be confronted with FM receiver dials bearing such numbers as 213, 289, 254, etc. The new system (illustrated in the accompanying chart) constitutes a major advance in the art of high frequency measurement and will no doubt place electronic engineering on a new (and more exclusive) plane of scientific endeavor.

The new units of frequency bear a simple algebraic relationship to the old "megacycle" units, as will be shown. If we let cu = channel units, and f = the corresponding frequencies, in megacycles per second, we can make the general statement:

$$f_{(cu=0)} = f - cu\Delta f \quad (1)$$

By inspection of Table 1, $\Delta f = 0.2$ (mc). Selecting any corresponding

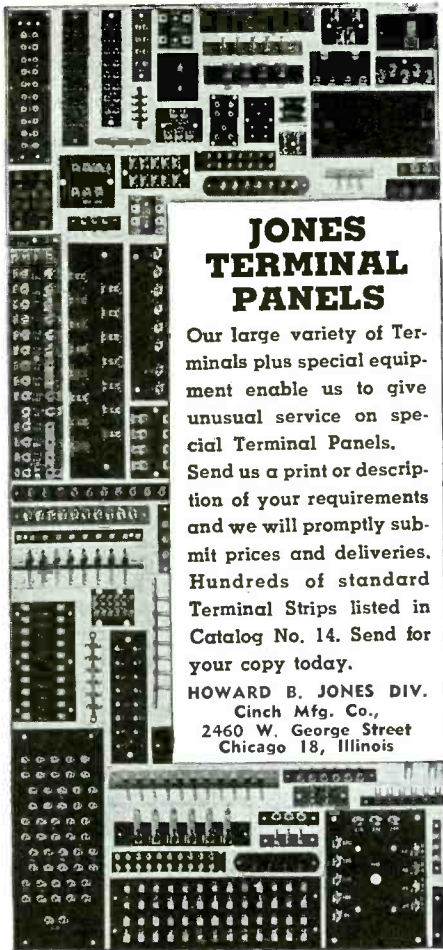

**JONES
TERMINAL
PANELS**

Our large variety of Terminals plus special equipment enable us to give unusual service on special Terminal Panels. Send us a print or description of your requirements and we will promptly submit prices and deliveries. Hundreds of standard Terminal Strips listed in Catalog No. 14. Send for your copy today.

HOWARD B. JONES DIV.
Cinch Mfg. Co.,
2460 W. George Street
Chicago 18, Illinois

— MICO — ENGRAVER

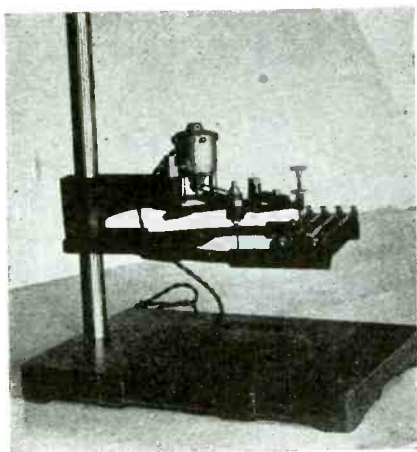

For lettering panels of steel, aluminum, brass, or bakelite, or for marking finished apparatus.

Prompt delivery. Catalogue on request.

Mico Instrument Co.

84 TROWBRIDGE ST.
CAMBRIDGE, MASS.

values of cu and f from Table 1, such as $cu = 230$ and $f = 93.9$, and substituting these, together with the numerical value of Δf , we have:

$$f_{(cu=0)} = 93.9 - (230 \times 0.2) = 47.9 \quad (2)$$

The curve of dcu/df obviously contains a constant, k , equal to 47.9, therefore:

$$f = cu\Delta f + k \quad (3)$$

$$= 0.2cu + 47.9 \quad (4)$$

Expressing (3) in terms of cu , we have:

$$cu = \frac{f - k}{\Delta f} \quad (5)$$

which we know to be

$$c = \frac{f - 47.9}{0.2} = 5(f - 47.9) \quad (6)$$

Of course, values of cu below $cu = 201$ are imaginary, since FCC assignments start with channel number 201. Therefore Table 1 deals only with real functions of cu . Future assignments below number 201 will, in all probability, follow a different mathematical law, since the science of frequency allocation must be flexible enough to keep step with the rapid advance of electronic engineering.

Some ultra-conservatives may not appreciate the advantages of substituting simple round numbers for the now obsolete megacycle units of frequency. However, the writer is convinced that the FCC practice of expressing radio frequencies in terms of "cu" (channel units, not copper) should be extended to FM engineering in general, thus eliminating the more cumbersome cycles, kilocycles, megacycles, etc. When referring to channel units per second, the abbreviation "cup/s" should be used, while for uhf work, the abbreviated form should be $cu\text{hfp/s}$.

Aside from the many engineering advantages of the improved FM numerology, the following business aspects of the new system should be noted:

(1) The term "megacycles" will no longer frighten prospective buyers of FM sets.

(2) FM engineers will have a distinctive unit of frequency, not easily confused with units used by other branches of the physical sciences.

(3) Test equipment manufacturers can add an FM dial scale to their signal generators that will bear no confusing relationship to any other dial scale.

(4) Slide rule manufacturers will have a potential market for gadgets that will solve problems in terms of "cu".

CUSTOM MADE COAXIAL CABLE and TUBING

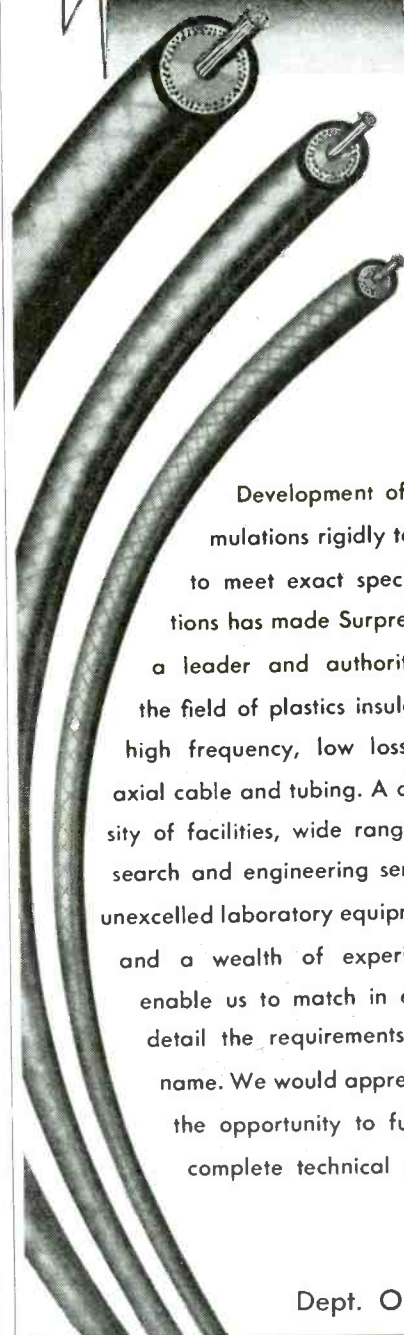

Development of formulations rigidly tested to meet exact specifications has made Surprenant a leader and authority in the field of plastics insulated, high frequency, low loss coaxial cable and tubing. A diversity of facilities, wide range research and engineering service, unexcelled laboratory equipment, and a wealth of experience enable us to match in every detail the requirements your name. We would appreciate the opportunity to furnish complete technical data.

Dept. O

84 Purchase St., Boston 10, Mass.

(5) Newsstands can supply monthly horoscopes showing where new broadcasting allocations stand with respect to the zodiac.—P.H.

**TABLE I.
CHART FOR CONVERTING CHANNEL
NUMBERS TO MEGACYCLES**

| Channel No. (CU) | Frequency (MC) | Channel No. (CU) | Frequency (MC) |
|------------------|----------------|------------------|----------------|
| 201..... | 88.1 | 251..... | 98.1 |
| 202..... | 88.3 | 252..... | 98.3 |
| 203..... | 88.5 | 253..... | 98.5 |
| 204..... | 88.7 | 254..... | 98.7 |
| 205..... | 88.9 | 255..... | 98.9 |
| 206..... | 89.1 | 256..... | 99.1 |
| 207..... | 89.3 | 257..... | 99.3 |
| 208..... | 89.5 | 258..... | 99.5 |
| 209..... | 89.7 | 259..... | 99.7 |
| 210..... | 89.9 | 260..... | 99.9 |
| 211..... | 90.1 | 261..... | 100.1 |
| 212..... | 90.3 | 262..... | 100.3 |
| 213..... | 90.5 | 263..... | 100.5 |
| 214..... | 90.7 | 264..... | 100.7 |
| 215..... | 90.9 | 265..... | 100.9 |
| 216..... | 91.1 | 266..... | 101.1 |
| 217..... | 91.3 | 267..... | 101.3 |
| 218..... | 91.5 | 268..... | 101.5 |
| 219..... | 91.7 | 269..... | 101.7 |
| 220..... | 91.9 | 270..... | 101.9 |
| 221..... | 92.1 | 271..... | 102.1 |
| 222..... | 92.3 | 272..... | 102.3 |
| 223..... | 92.5 | 273..... | 102.5 |
| 224..... | 92.7 | 274..... | 102.7 |
| 225..... | 92.9 | 275..... | 102.9 |
| 226..... | 93.1 | 276..... | 103.1 |
| 227..... | 93.3 | 277..... | 103.3 |
| 228..... | 93.5 | 278..... | 103.5 |
| 229..... | 93.7 | 279..... | 103.7 |
| 230..... | 93.9 | 280..... | 103.9 |
| 231..... | 94.1 | 281..... | 104.1 |
| 232..... | 94.3 | 282..... | 104.3 |
| 233..... | 94.5 | 283..... | 104.5 |
| 234..... | 94.7 | 284..... | 104.7 |
| 235..... | 94.9 | 285..... | 104.9 |
| 236..... | 95.1 | 286..... | 105.1 |
| 237..... | 95.3 | 287..... | 105.3 |
| 238..... | 95.5 | 288..... | 105.5 |
| 239..... | 95.7 | 289..... | 105.7 |
| 240..... | 95.9 | 290..... | 105.9 |
| 241..... | 96.1 | 291..... | 106.1 |
| 242..... | 96.3 | 292..... | 106.3 |
| 243..... | 96.5 | 293..... | 106.5 |
| 244..... | 96.7 | 294..... | 106.7 |
| 245..... | 96.9 | 295..... | 106.9 |
| 246..... | 97.1 | 296..... | 107.1 |
| 247..... | 97.3 | 297..... | 107.3 |
| 248..... | 97.5 | 298..... | 107.5 |
| 249..... | 97.7 | 299..... | 107.7 |
| 250..... | 97.9 | 300..... | 107.9 |

**Instrumentation Meet
Schedules 30 Papers**

The preliminary technical program for the Instrumentation for Tomorrow conference and exhibition slated for Pittsburgh's William Penn Hotel during the five days starting September 16, covers nine general subjects and includes more than 30 papers. The list of exhibitors, numbering over 100, was published in *Electronic Industries* for August. The tentative conference program follows:

MEASUREMENT AND CONTROL

"Design of Instrument Air Supply Systems for the Process Industry"—W. C. Ludi, Standard Oil Development Co.

"Control of Reactors"—E. E. Rowland, Office

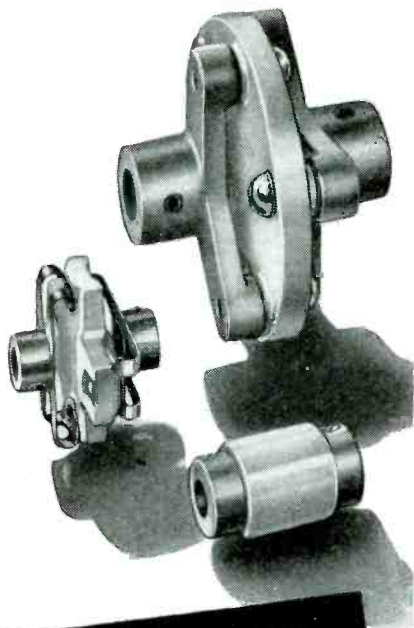

*Shaft
Couplings*

A link between control and variable circuit element, shaft coupling design can be an important factor in proper functioning of electronic equipment.

Illustrated are but three of many Johnson insulated shaft couplings; among them units providing a high degree of flexibility but freedom from backlash common to others resembling them; rigid types where accurate shaft alignment is required and torque may be high; bar types for high voltages or very high frequencies. All are characterized by best steatite insulation properly proportioned for electrical and mechanical strength, by accurate metal parts finished to stand salt spray test, and by those little evidences of Johnson engineering and manufacturing skill that are most appreciated only after use and comparison.

Ask for Latest Catalog



E. F. Johnson Co. Waseca, Minn.



HEYCO SOLDERING LUGS

Available in various sizes and shapes. These copper lugs are easy to apply. Samples free.

HEYCO STRAIN RELIEFS

Three low-cost types. Prolong appliance life... Improve product performance... Act as grommet. Samples and literature.

HEYMAN MANUFACTURING CO.
520 Michigan Ave. Kenilworth, N. J.



Plasticraft
**MACHINED
PARTS**



**LUCITE • VINYLITE • PLEXIGLASS
POLYSTYRENE • ACETATE**

Complete facilities for machining, marking, finishing—plastic sheet, rod or tube—any size, shape or quantity.

Send us your prints for quotations.

**PLASTICRAFT
PRODUCTS COMPANY**

BAKELITE & PLASTICS
PARTS & SPECIALTIES

MANUFACTURED • FABRICATED
PRINTED • HOT STAMPED • ENGRAVED

20 Hudson St., New York 13, N. Y.
WOrth 2-1837

ALLIED

for everything in Electronics and Sound

Equipment for Research
Development • Maintenance

1946 Catalog FREE

Largest Stocks • Complete Service From one Central Supply Service

Leading industrial and engineering firms depend on the ALLIED Catalog as their Buying Guide for everything in radio, electronics and sound. Lists more than 10,000 quality items . . . radio and electronic parts, vacuum tubes, tools, test instruments, audio amplifiers, accessories . . . complete lines stocked by a single reliable source. Try ALLIED'S expert, specialized industrial service. Send for FREE Catalog now!

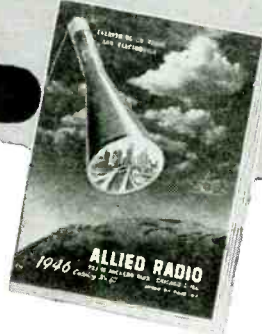

Sound Equipment

See ALLIED'S wide selection of Intercom, Paging and Public Address systems. Models for every industrial purpose.

Everything in Radio and Electronics

ALLIED RADIO CORP.

833 W. Jackson Blvd., Dept. 32-J-6, Chicago 7, Illinois

Send for
Your
**ALLIED
CATALOG**

ZOPHAR

Waxes, Compounds and Emulsions



Materials for potting, dipping or impregnating all types of radio components or all kinds of electrical units. • Tropicalized fungus proofing waxes. • Waterproofing finishes for wire jackets. • Rubber finishes. • Inquiries and problems invited by our engineering and development laboratories.

Zophar Mills, Inc. has been known for its dependable service and uniformity of product since 1846.

ZOPHAR MILLS, Inc.

ESTABLISHED 1846

117 26th STREET, BROOKLYN, 32 N. Y.

are to be presented by a long list of authors well known in the industry.

The Conference is sponsored by the Illinois Institute of Technology, Northwestern University and the University of Illinois, together with the Chicago sections of IRE and AIEE. Dr. J. E. Hobson, Armour Research Foundation, is chairman of the board of directors of the gathering; W. O. Swinyard, Hazlett Electronics Corp., is president.

In addition to the speakers whose papers are listed below, addresses on "Electronics and the Future" will be made by Dr. E. U. Condon, director of the National Bureau of Standards; on a subject to be announced, by Dr. F. L. Hovde, president of Purdue University; on "Physics of Today Becomes the Engineering of Tomorrow," by G. G. Suits, vice-president of General Electric Co.; and on "Microwaves and Radar," by J. O. Perrine, vice-president of Bell Telephone Laboratories. Remainder of the program follows:

TELEVISION

Color Television—Latest State of the Art—Dr. Peter Goldmark, Columbia Broadcasting System
Westinghouse Color Television Studio Equipment—D. L. Balthis, Westinghouse Electric Corp.
Television Transmitter for Black and White and Color Television—N. Young, Federal Telecommunication Lab.
Stratovision System of Communication—C. E. Nobles, Westinghouse Elec. Corp., and W. K. Ebel, Glenn L. Martin Co.
The Electrostatic Image Dissector—Dr. H. Salinger, Farnsworth Television Radio Corp.
The Use of Powdered Iron in Television Deflecting Circuits—A. W. Friend, Radio Corp. of America

ANTENNAS AND WAVE PROPAGATION

Problems in Wide-Band Antenna Design—A. G. Kandoian, Federal Telecommunication Lab.
Slot Radiators—Dr. A. Alford, Consulting Engineer
Propagation of U.H.F. Signals—W. B. Lodge, Columbia Broadcasting System
Radio Propagation at Frequencies above 30 MC—K. Bullington, Bell Telephone Laboratories
Interference Between VHF Radio Communication Circuits—W. R. Young, Jr., Bell Telephone Laboratories
Aircraft Antenna Pattern Measuring System—Otto Schmitt, Airborne Instruments Lab.
Improvements in 75 MC Aircraft Marker Systems—B. Montgomery, United Airlines

MICROWAVE GENERATORS

Continuous-Wave U.H.F. Power at the 50 KW Level—Prof. W. G. Dow, University of Michigan
Microwave Frequency Stability—Dr. A. E. Harrison, Sperry Gyroscope Co.
An All-Metal Tunable Squirrel-Cage Magnetron—Dr. F. H. Crawford, Williams College
Design of Wide-Range Coaxial-Cavity Oscillators Using Reflex Klystron Tubes—J. W. Kearney, Airborne Instruments Lab.

AIR-NAVIGATION SYSTEMS

Automatic Radio Flight Control—F. L. Moseley, Collins Radio Co.
Aerial Navigation—P. Adams and R. I. Colin, Federal Telecommunication Lab.
Teleran-Air Navigation and Traffic Control by Means of Television and Radar—D. H. Ewing and R. W. K. Smith, Radio Corp. of America

RADIO RELAY SYSTEMS

Development of a Microwave Relay Communication System—G. G. Gerlach, Radio Corp. of America
Multiplex Broadcasting—D. D. Grieg and A. D. Kandoian, Federal Telecommunication Lab.

BARCOL

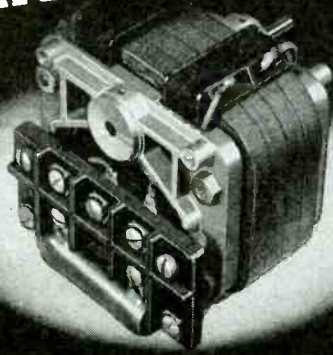

NEW HEAVY-DUTY SMALL REVERSING MOTORS

These shaded-pole type reversing motors are designed with a high starting torque for heavy duty service. The full load rating of the model shown is 1900 r.p.m., 0.15 lb. in. torque, 0.0045 h.p., drawing 55 watts at 115 volts, 60-cycle a.c. Starting torque is 0.22 lb. in. Reversal is accomplished by externally switching the shading coil circuit. These motors are ruggedly built with die-cast end plates, ball bearings, 3/16" shaft, and precision construction throughout. Other sizes with larger output ratings are available. Send for data sheet.

BARBER - COLMAN COMPANY
ROCKFORD • ILLINOIS

EISLER EQUIPMENT*

complete and diversified for every phase of electronic manufacture!

TRANSFORMERS in all types—furnace, distribution, power, phase changing, air, oil, induction, water cooled, plate, filament and auto-transformers. Filter chokes and inter-phase reactors.



Transformers supplied from 1/4 to 300 KVA.



EISLER Compound Vacuum Pump.

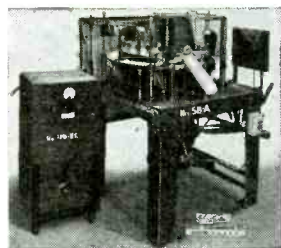

24 Head Radio Tube Exhausting Machine.

*EISLER machines are in use and in production by 99% of all American radio tube and incandescent lamp manufacturers and throughout the world.



EISLER Spotwelders from 1/4 to 250 KVA.

CHAS. EISLER
EISLER ENGINEERING CO.
778 South 13th Street Newark 3, New Jersey
(Near Avon Avenue)

USE WAA SURPLUS

when you
are stymied
... waiting
for



CAPACITORS

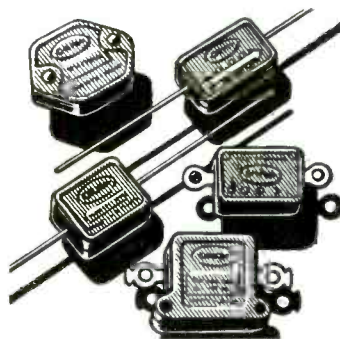

... overcome
production
delays—and
gain a substantial
saving!

The vast stocks of WAA surplus capacitors available NOW include all types, all sizes—whatever you need in any quantity you can use. As Agents of the War Assets Administrator, Tobe Deutschmann Corporation places these enormous stocks—products of all the principal manufacturers—directly at your disposal.

Capitalize on the opportunity offered by the sale of WAA surplus capacitors . . . gain a saving on the unit cost—probably on the identical unit you now employ in your production . . . and by speeding production, avoid costly delays in delivery.

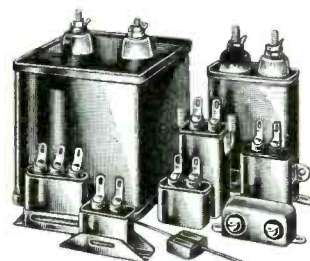

In quality, WAA surplus units are equal or superior to commercial items. All units have passed government inspection to Army and Navy specifications—a reinforced quality assurance.

In liquidating WAA capacitor surplus, Tobe is acting directly as Agents of the War Assets Administrator—not as a surplus re-sale enterprise . . . and our quarter-century experience in the production of capacitors for the electrical and electronic industries is available to aid in filling your needs from the huge surplus stock.

WRITE . . . WIRE . . . PHONE
FOR IMMEDIATE SHIPMENT

TOBE DEUTSCHMANN CORPORATION

Acting as Agents of War Assets Administrator Under Contract No. S1A-2-34

Telephone Canton 0820 — Teletype Canton 280
Canton, Massachusetts



**MANUFACTURERS OF RADIO, ELECTRICAL
AND ELECTRONIC COMPONENTS**

VOKAR Corporation

7300 HURON RIVER DRIVE DEXTER, MICHIGAN

MICRO-MIKER

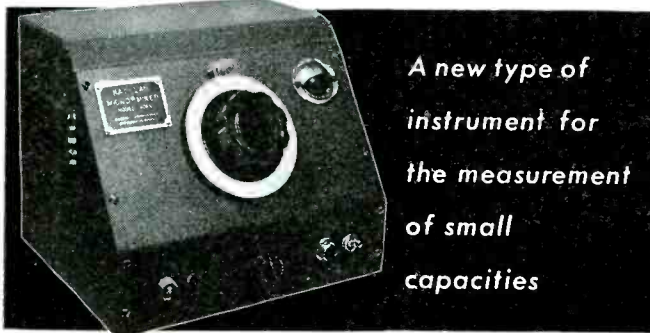

*A new type of
instrument for
the measurement
of small
capacities*

1. Measures capacities from 1 to 230 Micro-Micro-Farads by direct substitution.
2. This capacity is measured at the end of a shielded cable, thereby eliminating connection errors.
3. Wiring capacity in an amplifier may be measured without disconnecting the load resistor. Condensers as small as 1 MMF may be measured when shunted by a 1500 ohm resistor.

Write for Bulletin 4A

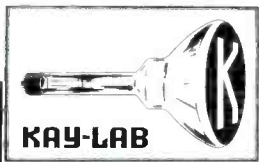

KAY-LAB

KALBFELL

LABORATORIES
941 ROSECRANS STREET
SAN DIEGO 6, CALIFORNIA

Manufacturers Representatives are invited to reply.

The Cyclophon—J. J. Glauber, Federal Telecommunication Lab.
The Theory and Design of Several Types of Wave Selectors—N. I. Korman, Radio Corp. of America

FREQUENCY MODULATION

A Permeability-Tuned 100 MC Amplifier—Z. Benin, Zenith Radio
VHF Tuner Design—G. Wallin and C. W. Dymond, Galvin Mfg. Co.
Front-End Design of FM Receivers—I. J. Kaar, General Electric Co.
FM Limiter of the Locked-in Oscillator Variety—D. Smith, Philco Radio & Television

MOBILE RADIO COMMUNICATION

A panel on selective-calling systems in mobile radio communication will be included.

INFRARED COMMUNICATION SYSTEMS

Modulation of Infrared Systems for Signaling Purposes—Dr. W. S. Huxford, Northwestern University
Photo Detectors for Ultraviolet, Visible, and Infrared Light—Dr. R. J. Cashman, Northwestern University

RECORDING AND FACSIMILE

Review of Facsimile Developments—H. F. Burkhard, Camp Coles Signal Lab.
The Reduction of Background Noise in the Reproduction of Music from Records—H. H. Scott, Technology Instrument Co.
Recent Developments in Magnetic Recording—Dr. R. B. Vaile, Jr., Armour Research Foundation

THEORETICAL DEVELOPMENTS

Bunching Conditions for Electron Beams with Space Charge—Dr. L. Brillouin, Cruft Lab., Harvard University
Generalized Boundary Conditions in Electro Magnetic Problems—Dr. S. A. Schelkunoff, Bell Telephone Laboratories
Conformal Transformations in Orthogonal Reference Systems—Dr. C. E. Roys, Illinois Inst. of Technology

INDUSTRIAL APPLICATIONS

Large Electronic DC Motor Drives—M. M. Morack, General Electric Co.
Electronic Speed Control of AC Motors—W. H. Elliot, Cutler-Hammer Co.
The Electronic Contour Follower Control—J. Morgan, General Electric Co.
Production Test Facilities for High Power Tubes—W. L. Lyndon, Radio Corp. of America

ELECTRONIC INSTRUMENTATION

A Method for Changing the Frequency of a Complex Wave—E. L. Kent, C. G. Conn, Ltd.
Cathode Ray Oscilloscope as a Research Tool—W. L. Gaines, Bell Telephone Laboratories
The Pressuregraph—A. Crossley, Alfred Crossley Associates
The Notch Wattmeter—D. F. Bowman, Hazeltine Electronics Corp.
The Mechanical Transients Analyzer—G. D. McCann, Westinghouse Electric Corp.
Detectors for Buried Metallic Bodies—L. F. Curtis, Hazeltine Electronics Corp.
High Performance Demodulators for Servomechanisms—K. E. Schreiner, M.I.T. Servomechanism Lab.

HIGH FREQUENCY HEATING

Ignitron Converters for Induction Heating—R. J. Ballard and J. L. Boyer, Westinghouse Electric Corp.
Microwaves and Their Use in High Frequency Heating—T. P. Kinn, Westinghouse Electric Corp.
Dielectric Pre-Heating in the Plastics Industry—D. E. Watts, G. F. Leland and T. N. Wilcox, General Electric Co.
The Problem of Constant Frequency in Industrial High Frequency Generators—Dr. E. Mittelman, Illinois Tool Works

NUCLEAR PHYSICS

The Betatron Accelerator Applied to Nuclear Physics—Dr. E. E. Charlton and W. F. Westendarp, General Electric Co.
Some Fundamental Problems of Nuclear Power Plant Engineering—E. T. Neubauer, Allis-Chalmers Co.
An Accelerator Column for Two to Six Million Volts—R. R. Machlett, Machlett Laboratories.

SPECTROSCOPY AND MEDICAL APPLICATIONS

The Use of Radioactive Materials in Clinical Diagnosis and Medical Therapy—J. T. Wilson, Allis-Chalmers Co.
The Mass Spectrometer as an Industrial Tool—Dr. A. O. Nier, University of Minnesota
Cathode Ray Spectrograph—R. Feldt and C. Berkeley, DuMont Laboratories

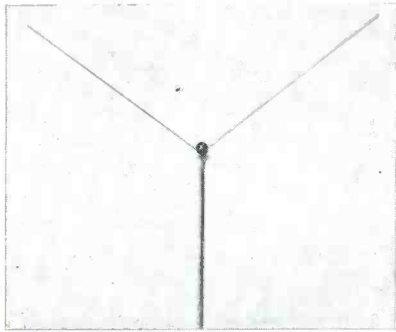

ANTENNAS for FM and Television

"FM and Television Bulletin No. 4612" gives complete details of two new type Premax Antennas, one of which will give satisfactory performance on BOTH FM and Television. Send for it today.

Premax Products

Division Chisholm-Ryder Co., Inc.
4612 Highland Ave., Niagara Falls, N. Y.



Plastics for Electronics

ENGINEERING
DESIGNING
MOLDS
MODELS
FABRICATION &
ASSEMBLIES

Submit prints for quotation

U.S. PLASTICS CORP.

2835-59 W. IRVING PARK RD.
CHICAGO 18 ILL.

COMPRESSION & INJECTION
MOLDING

Tocco Reorganizes Heating Division

Ohio Crankshaft Co., Cleveland, has reorganized its Tocco heating division and created a commercial engineering department which will plan all phases of basic engineering on induction heating projects. The new department will be headed by Harry T. Keller, for the past 25 years in charge of engineering standards for Buick Motor Co. Other changes involve promotion of Dr. Harry B. Osborn, Jr., formerly research and development engineer, to be sales manager of the division; John T. Vaughn to be research and development engineer; A. H. Pittaway to be laboratory superintendent; and John Gibbons to be office supervisor. Tinkham Veale continues as head of production engineering and A. O. Wood as chief engineer.

Lynch Re-enters Trade

Arthur H. Lynch, long time (and still) New York manager for the National Co., Malden, Mass., has joined forces with J. Allen Biggs to form Lybig Sales Corp., and will do business as the selling representatives of several manufacturers, from headquarters at 136 Liberty Street, New York. Lynch is president of the organization and Biggs, who recently left International division of RCA, is vice-president. Current accounts include representation of Radio Music Corp., East Portchester, N. Y. (phono pick-ups); Islip Radio Mfg. Co., Islip, Long Island (marine radio equipment); Taybern Equipment Co., New York (electronic megaphone).

One in Five FM Channels Reserved

Following a public hearing held July 12, 1946, the Federal Communications Commission has adopted an order withholding for the period ending June 30, 1947, the assignment of one out of every five Class B channels which have been tentatively allocated for various areas throughout the United States.

Under the reservation plan no reservation of channels will be made if a maximum of four channels is indicated for a particular area in the December 19, 1945, order. However, if at least five but no more than nine channels are indicated for an area, one channel will be withheld for the period ending June 30, 1947. Two channels will be withheld if 10-14 channels are listed;



**Plug-In Sensitive Relays--
More Compact
Than Ever Before**

SIGMA Type 41 RO (DC); 41 ROZ (AC)

NEW FEATURES OF THIS DESIGN:

- Fits octal socket.
 - Outline dimensions: $1\frac{1}{4}'' \times 1\frac{1}{4}'' \times 2''$ above socket.
- Permits lining up contiguous relays as close together as the smallest octal sockets will permit.

Features of All SIGMA Series 41 Relays:

- DC sensitivity: — 0.020 watts (min. input.)
 - AC sensitivity: — 0.1 volt-ampere (min. input.)
- One standard 110 volt AC model draws about 1.5 milliamperes.
- Contact ratings up to 15 amperes on low voltage.
 - High quality construction — mechanically rugged.
 - Very low cost.



SIGMA
Sigma Instruments, Inc.
Sensitive RELAYS
74 Ceylon St., Boston 21, Mass.

**A MUST IN EVERY LAB . . .
ON EVERY SERVICEMAN'S BENCH . . .
IN EVERY SERVICE KIT . . .**

A pocket-size

OSCILLOSCOPE

The **POCKETSCOPE**

- So **SMALL** in size (4" x 6³/₈" x 10")
- So **LIGHT** in weight (5³/₄ lbs.)
- So **COMPLETE** in performance
- So **INEXPENSIVE** in price
- Plus **WIDE-ANGLE VISION**: on shelf, on floor, on bench
- Plus **RETRACTABLE LIGHT SHIELD**: for increased visibility.



A 2" "pocket-size" 'scope incorporating the cathode ray tube, vertical and horizontal amplifiers, linear time base oscillator, synchronization means and self-contained power supply.

FOR DELIVERY:

Contact your nearest jobber. If he doesn't have the **POCKETSCOPE** available, contact us direct.



WATERMAN PRODUCTS CO.
INCORPORATED
PHILADELPHIA 25, PENNSYLVANIA

three, if 15-19 are listed; and four, if 20 are listed.

Persons desiring to be considered for the reserved channel or channels in a given area may submit their applications prior to June 30, 1947. Such applications will be received, will be assigned a file number, and will be placed in a pending file for consideration after July 1, 1947. However, they will not be given the status of pending applications for the purpose of giving the applicant any legal or equitable right as an applicant during the interim period. Applicants for reserved channels, who file at any time during the interim period, will be given equal consideration regardless of the dates upon which their respective applications were filed.

Thomas Lord Heads Lord Mfg. Co.

Thomas Lord, vice-president of Lord Mfg. Co., Erie, Pa., has been elected president of the company to succeed his father, H. C. Lord, who becomes chairman of the board, announces B. M. Hartman, secretary-treasurer. The company is the outcome of inventions and developments of H. C. Lord, starting in 1919. Primary purposes of these inventions have been to protect equipment and sensitive apparatus from shock and to prevent the transfer of noise and vibration to adjoining structures and areas. Early researches developed joints between metal parts, the joint accommodating the movement caused by the distortion of rubber, thus avoiding lubricants. A feature of the Lord inventions is rubber bonded to metal. The company now manufactures a large variety of both standardized and specially designed products with a wide range of applications in the field of vibration control.

Water Repellent Materials

Dri-Film water-repellent materials comprise a series of General Electric products made in the course of its developments in the silicone field and were first used during the war for the treatment of ceramic insulators for radio and other communication equipment used by the armed forces. Insulators, of course, lose effectiveness when exposed to high humidity. One of the most recent applications was for hearing-aids in which Dri-Film is used to treat vacuum tubes.

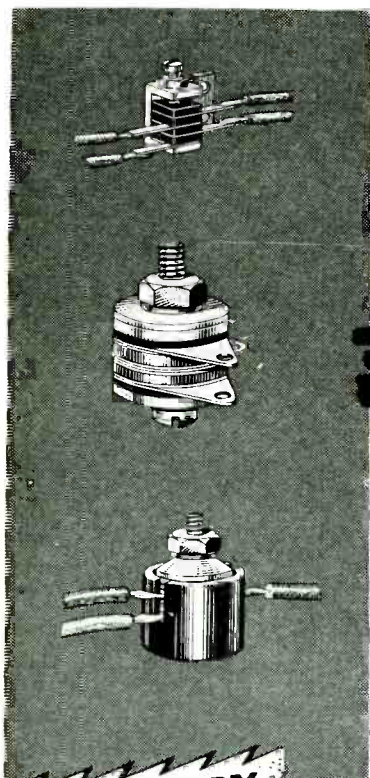

ELECTROX LOW CAPACITY RECTIFIERS

Quality units, made by one of the oldest manufacturers of dry disc rectifiers. You can rely absolutely on ElectroX Rectifiers for all types of electronic applications — such as instruments, test sets, precision measuring equipment and similar uses.

Order from Your Parts Supplier
Or Write Direct for Bulletin 446

**ELECTROX
DIVISION**

SCHAUER MACHINE CO.

2077 Reading Rd. - Cincinnati 2, Ohio

LOOKING FOR TIME AND LABOR-SAVING IDEAS?

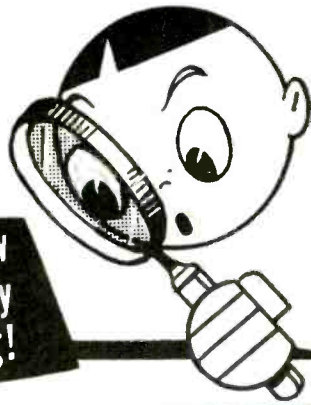

Get this new
Free Ever Ready
Label Catalog!

Page after page
of practical ideas
for the smoother,
safer, simpler
functioning of all
departments from
office-to-factory.

Have a copy on
the desk of all
your key men!

Write today for
a FREE COPY.



EVER READY Label CORP.
151 EAST 25th STREET NEW YORK 10, N. Y.

Electronic

RADIO ALARM, Inc.

1920 LINCOLN-LIBERTY BUILDING
PHILADELPHIA 7, PA.

Rittenhouse 6-3480

UNLIMITED PROTECTIVE SYSTEMS for
YOUR COMPLETE PLANT

A SPECIAL ROOM
OR SPECIFIC OBJECT

RADIO ALARM is a: TAMPER-PROOF, CAPACITY OPERATED
INTRUSION DETECTION and SIGNALLING SYSTEM

Will Cover Any Requirement—Large or Small

RADIO ALARM sets up a radio-frequency field that
detects changes of capacity, giving the advantage
of a remote alarm. The sensitive field cannot be
penetrated without giving an alarm.

Automatically compensates for weather changes.

Operates from 110-volt a.c. or built-up battery
supply.

14 Years' Experience in Manufacturing and
Installing Electronic Radio Alarms for In-
dustry, the Government and Residences.

ELECTRONIC WORK OUR SPECIALTY

Write—Wire—Phone for further information

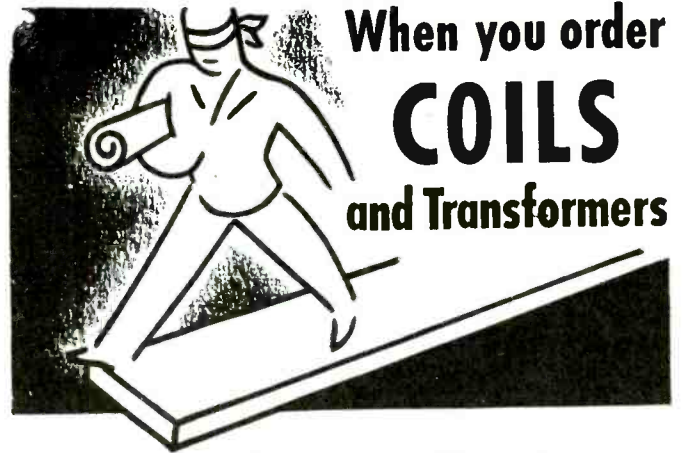

When you order
COILS
and Transformers

Avoid the "Deep End" with your
SPECIFICATIONS

★ Don't tread the unknown path of insecurity when seeking a source
for coils and transformers. Choose wisely. First, by selecting an expe-
rienced specialist in coil and transformer construction. Here, at the
Gramer Company, we are qualified and ready to furnish a produc-
tion sample built to your exact specifications.

*How a Production Sample Can
Pave the Way to True Uniformity
of Product . . . Faster Production*

A production sample by Gramer will permit you to check every phys-
ical and electrical characteristic of your coil or transformer in actual
operation. You get precision winding, uniformity of mounting brackets
or housings, leads and solder lugs positioned for quick and easy assem-
bly. You get a prompt quotation. Arrange now for such a production
sample, followed by quantities where each unit is identical to all others.



LOW VOLTAGE
TRANSFORMER



RELAY COIL



POWER
TRANSFORMER

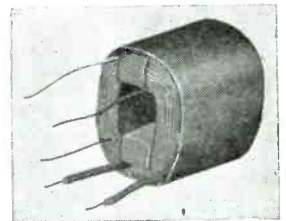

LAYER WOUND
COIL

GRACOIL

"One Good Turn - or a Million"

Write for New Circular — No Cost — No Obligation

THE GRAMER COMPANY

Established in 1935

Electrical Coils and Transformers

2732 N. PULASKI RD., CHICAGO 39, ILL. U. S. A.

DON'T RISK COSTLY DELAYS



1. VOLTAGE TRANSFORMER 2. VOLTAGE CONTROL 3. RECTIFYING TUBE

DEPEND UPON W-J FOR YOUR

Radio and Electronic Supplies

"GETTING THE GOODS" is a highly developed specialty here at W-J! Our procurement experts are well known, well liked among manufacturers, and well trained in the job they have to do. That's why *W-J Emergency Service* is rapidly becoming the sole source of supply for more and more industrial buyers of Radio and Electronic parts and equipment. If you need speedy, intelligent, *friendly* cooperation . . . an organization well qualified and equipped to serve you better, mail or wire your orders to us. We'll consider them as merchandise needed in an emergency.

WALKER-JIMIESON, INC.



Dept. D, 311 S. Western, Chicago 12

Gentlemen: Please send me your new 100 page Reference Book and Buyer's Guide, FREE.



Company

Address

Individual

Engineers Inspect Foreign Equipment

A large number of officials and engineers and research experts of leading radio-electronic manufacturing companies, together with high government officials and Army and Navy top-ranking officers, attended the exhibit of more than 300 items of German and Japanese electronic and communications equipment in the main lobby of the Department of Commerce Building in Washington during August. The exhibit was arranged by the Technical Industrial Intelligence Branch of the Commerce Department's Office of Technical Services in cooperation with the U. S. Army Signal Corps and the Naval Research Laboratories under direction of Edwin Y. Webb, Jr., Chief of the TIIB Electronics and Communications Unit.

Former NEID Men Open as Consultants

Electronic Associates, Inc., has been organized and will establish headquarters in Princeton, N. J., to function as engineering consultants on radio and industrial electronic equipments. President is Lloyd F. Christianson; Arthur L. Adamson is vice-president, secretary and treasurer; Joseph R. Troxel is vice-president and commercial manager; Charles M. Shedlbauer is chief engineer. All were formerly members of the Army's New Equipment Introductory Detachment (NEID). A temporary laboratory has been located at 61 Brighton Avenue, Long Branch, N. J.

Bus Owners Permitted Own Radio System

Public service bus companies are to be permitted by FCC (1) to use a cooperatively-owned communications organization, (2) to use an existing general communications common carrier—such as the telephone companies, (3) to apply for, and use if granted permission, individual communications facilities. These things were decided by FCC on July 11, following hearings held a month previously. Hearings were held to determine whether the country's bus companies should be required to use existing common carrier facilities, and whether they should be required to share frequencies with other users, such as trucks. FCC said no to both. It is expected now that National Bus Communications, Inc., which

brought about the decision, will go ahead with plans for the establishment and equipment of a cooperatively-owned system to serve such bus owners as elect to use the service. Such a system involves the use of a microwave repeater arrangement. It is pointed out by FCC that in virtually giving the go ahead to Nabco, that organization's specific plan has not been definitely approved, that bus operators will not be required to use such services, that FCC is not bound to limit licensing to any single industry-formed entity. Frequency allocations have not been made, will be within the band allocated for general mobile radio service, must await further hearings.

To Make Rectifiers

Charles R. Ogle, formerly with the rectifier department of the Benwood-Linze Co., and more recently with the P. R. Mallory Co., has formed his own company and will do business as Electronic Rectifiers, Inc., from headquarters at 737 North East Street, Indianapolis, Ind. Associated with him is Paul B. Freeman, formerly in the rectifier engineering department of Mallory. The new company will manufacture a new type of magnesium copper sulphide rectifier, later to be supplemented by other products.

Vokar in East

An Eastern office has been opened by Vokar Corp., Dexter, Mich., Precision Parts Co., Ann Arbor, Mich., and its Chicago subsidiary, Carter Radio Division. It will be in charge of Henry D. Sarkis. The new office, located at 43 Water Street, New York, will serve the Eastern Atlantic states.

National Union Adds Home Sets

National Union Radio Corp., Newark, N. J., has added receiving sets to its line of electronic equipment and parts. Model G-619, 6-tube ac-dc receiver is the first of a series of 5 diversified models soon to be announced.

DX Radio Moves

General offices and production facilities of DX Radio Products have been moved to 2310 Armitage Avenue, Chicago. The business is to be housed in a new building which represents an increase of 20,000 sq. ft.

For the Man Who Takes Pride in His Work

MODEL 2432 SIGNAL GENERATOR

Another member of the Triplett Square Line of matched units this signal generator embodies features normally found only in "custom priced" laboratory models.

FREQUENCY COVERAGE—Continuous and overlapping 75 KC to 50 MC. Six bands. All fundamentals. **TURRET TYPE COIL ASSEMBLY**—Six-position turret type coil switching with complete shielding. Coil assembly rotates inside a copper-plated steel shield. **ATTENUATION**—Individually shielded and adjustable, by fine and coarse controls, to zero for all practical purposes. **STABILITY**—Greatly increased by use of air trimmer capacitors, electron coupled oscillator circuit and permeability adjusted coils. **INTERNAL MODULATION**—Approximately 30% at 400 cycles. **POWER SUPPLY**—115 volts, 50-60 cycles A.C. Voltage regulated for increased oscillator stability.

CASE—Heavy metal with tan and brown hammered enamel finish.

There are many other features in this beautiful model of equal interest to the man who takes pride in his work.

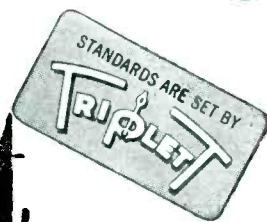
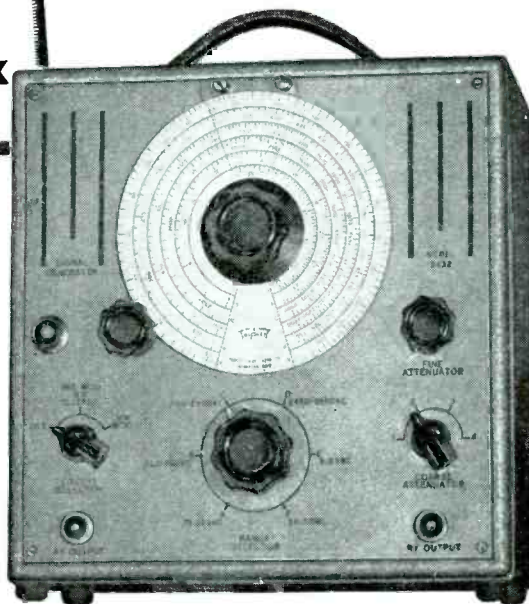

Triplett

ELECTRICAL INSTRUMENT CO. BLUFFTON, OHIO

Fahnestock Clips
RADIO'S GREATEST CONVENIENCE

FAHNESTOCK SPRING BINDING POST GRIPS THE WIRE BY THE ACTION OF A SPRING

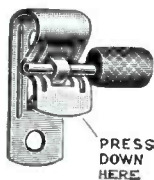

No tools required to make the connection. Grips the wire with just the right pressure for good electrical contact. Simply press down, insert the wire and let go. Does not injure wire, hence connection can be made or opened as often as desired. Available in large variety of types and sizes to fit any radio purpose and any requirement as to position, space or method of attachment. You will find them in the better sets.

Positive contact; cannot jar loose. Brass or bronze — nonrusting.

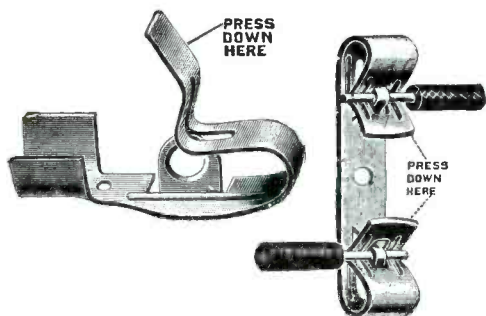

FAHNESTOCK ELECTRIC COMPANY, Inc.

46-44 ELEVENTH STREET, LONG ISLAND CITY 1, N. Y.

Please send us at once, Descriptive Literature, Prices and Delivery Schedule on

FAHNESTOCK CLIPS

For
Name
Address
City State

The FINEST MICROPHONES

for P.A. and RECORDING!

AMPERITE VELOCITY MICROPHONE WITH PATENTED ACOUSTIC COMPENSATOR



New P.G. DYNAMIC WITH NEW SUPERIOR ELIPSOID PICK UP PATTERN!

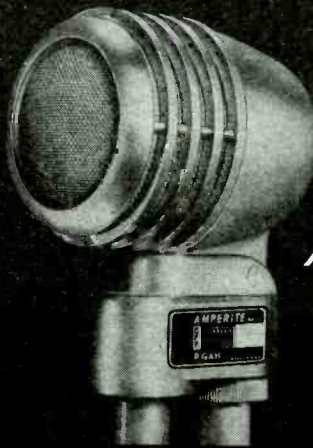

AMPERITE KONTAK MIKES IDEAL FOR AMPLIFYING STRINGED INSTRUMENTS USED WITH ANY AMPLIFIER AND WITH RADIO SETS.



ASK YOUR JOBBER . . . WRITE FOR FOLDER

AMPERITE

561 BROADWAY NEW YORK



WIL-FM is First in St. Louis Area

Edward F. Classen, Jr., sales engineer for R.E.L. Equipment Sales, Inc., 612 No. Michigan Avenue, Chicago, calls attention to the fact that radio station WIL-FM is the first FM broadcaster in St. Louis, having put out its initial program on June 20 and since carried a 7-hour daily schedule. The station is owned and operated by Missouri Broadcasting Corp. Meantime, Federal Telephone and Radio Corp. has sold to and is installing a 50kw FM station for KWK and a 10kw station for WEW, both to be on the air later in the summer. Advertisements in our August issue, necessarily prepared many weeks before publication, had stated that the latter two stations are "the first two FM stations in the St. Louis Area", whereas actually WIL-FM was the first St. Louis station to broadcast.

Decide German Patent Situation

During July, a twelve-nation conference was held in London to determine the treatment to be given German owned patents granted in the respective countries. An accord was reached which will become effective upon acceptance by three countries besides France, the Netherlands, the United Kingdom, and the United States, which have already signed.

A principal provision of the accord is that all patents issued by an adhering Government which were wholly German owned, shall be either dedicated to the public, or placed in the public domain, or continuously offered for licensing free of royalty to the nationals of all adhering Governments. All rights are granted on a reciprocal basis in all adhering countries.

It is to be expected that in the United States, the third alternative will be followed of offering former German owned patents for licensing free of royalty. This will involve no change in the licensing procedure which has been followed during the war as to U. S. citizens by the U. S. Alien Property Custodian, and there will be no change in the status of existing licenses already granted. Licenses will continue to be subject to an administrative charge of \$15 per patent, which has been made heretofore upon the grant of a license, but without requirement for payment of royalty. The new feature will

VACUUM TUBE VOLTMETER

MODEL 62

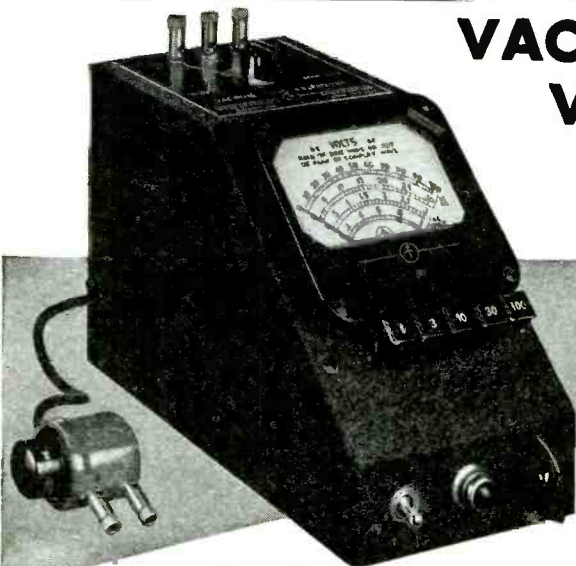

SPECIFICATIONS:

RANGE: Push button selection of five ranges—1, 3, 10, 30 and 100 volts a.c. or d.c.

ACCURACY: 2% of full scale. Useable from 50 cycles to 150 megacycles.

INDICATION: Linear for d.c. and calibrated to indicate r.m.s. values of a sine-wave or 71% of the peak value of a complex wave on a.c.

POWER SUPPLY: 115 volts, 40-60 cycles—no batteries.

DIMENSIONS: 4 3/4" wide, 6" high, and 8 1/2" deep.

WEIGHT: Approximately six pounds. Immediate Delivery

MANUFACTURERS OF
 Standard Signal Generators
 Pulse Generators
 FM Signal Generators
 Square Wave Generators
 Vacuum Tube Voltmeters
 UHF Radio Noise & Field Strength Meters
 Capacity Bridges
 Megohm Meters
 Phase Sequence Indicators
 Television and FM Test Equipment

MEASUREMENTS CORPORATION

BOONTON NEW JERSEY





**magnetic
iron
powders**

The high magnetic performance, exceptional Q and high permeability assured by Mephram magnetic iron powders (hydrogen reduced) is daily advancing them into wider use in high-frequency, telecommunication and magnetic applications. . . . Strictly controlled production and attractively low prices suggest consultation with the Mephram Technical Staff. . . . No obligation. *Send for literature.*

G. S. MEPHAM CORPORATION
Established 1902 • East St. Louis, Illinois

Kahle
ENGINEERING COMPANY
ELECTRON TUBE MACHINERY
All types, standard and special design.

Specialists in equipment and methods for the manufacture of:

| | |
|--------------------|----------------|
| RADIO TUBES | NEON TUBES |
| CATHODE RAY TUBES | PHOTO CELLS |
| FLUORESCENT LAMPS | X-RAY TUBES |
| INCANDESCENT LAMPS | GLASS PRODUCTS |

On Production or Laboratory basis

1307-1315 SEVENTH ST., NORTH BERGEN, N. J., U. S. A.



TERMINALS
for
ELECTRIC WIRES

SMALL METAL STAMPINGS
in accordance with your blueprints

PRECISION PARTS
from Modern Equipment

PATTON-MacGUYER CO.
17 VIRGINIA AVENUE PROVIDENCE 5, R. I.

**THERE ARE NOW
A FEW POSITIONS OPEN
FOR
ELECTRON TUBE
ENGINEERS**

who have a background of experience and responsibility in the design and production of high and ultra-high frequency electron tubes, including magnetron and related micro-wave devices, and who are seeking advancement on the basis of ability, ingenuity and accomplishment. For a limited number of men of this type Machlett Laboratories has something unique and attractive to offer.

*Address Executive Offices—
Engineering Division—*

MACHLETT LABORATORIES, INC.
Springdale, Conn.

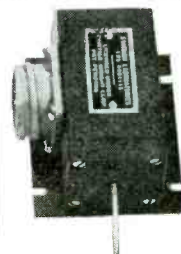

The STATHAM GAGE
Model YE

Displacements as minute as 0.000008 in. or Force Changes as small as 0.02 oz. are readily detected by the Statham Gage without expensive electronic equipment. Complete system for remote indication or recording comprises Statham Gage, dry cells, and microammeter or recording galvanometer.

These small precision instruments are ideal for incorporation into testing equipment. They are extremely stable and, once calibrated, can be relied upon to produce accurate data so long as they remain undamaged.

We also make Pressure Transmitters and Accelerometers based on The Statham Gage. Write, describing your proposed applications. Our Engineering Department is experienced in the application of our instruments and will be pleased to cooperate with you.



STATHAM LABORATORIES INSTRUMENT MAKERS 8222 Beverly Boulevard
Los Angeles 36, Calif.

SYRACUSE UNIVERSITY

Openings in the Department of Electrical Engineering

The College of Applied Science, Syracuse University, is seeking candidates for two positions in its Department of Electrical Engineering, one of which will include the Chairmanship of the Department.

It is desired that each applicant have the following qualifications, although it is not expected that all will be fully met:

1. Have Ph.D. or D.Sc. degree.
2. Have had considerable experience as a teacher in the field of Radio Engineering, including broad experience in the use of radio equipment and apparatus.
3. Possess considerable formal training in, and ability to use higher mathematics.
4. Have had considerable background and training in Electro-magnetic theory.
5. Have had a few years' experience with commercial organizations as design or development engineer on radio equipment.
6. Age range preferred, 35 to 45 years.

Address correspondence to:

LOUIS MITCHELL, Dean
College of Applied Science
Syracuse University, Syracuse 10, New York

ENDURANCE

Your profit from the use of any kind of equipment hinges on its quality of performance — and on its *endurance*. Electronic Engineering Company transformers are built *ruggedly* to give *lasting* service under all conditions. If you have special and difficult transformer problems, feel free to make use of the finest engineering talent and most complete electronic laboratories. Write or call today.

"SPECIALIZED
Transformer
ENGINEERS"

3223-9 WEST ARMITAGE AVE.

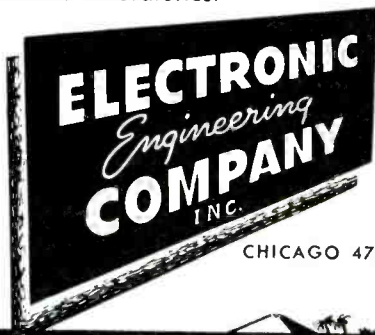

CHICAGO 47, ILL.

be that such licenses granted by the U. S. Alien Property Custodian will now be open to a citizen of any adhering country. That is, products manufactured in adhering European countries, embodying such German inventions, may be imported into the United States under this procedure without restrictions based on vested U. S. patents covering such German invention.

Likewise, reciprocally, there will be no patent restriction in any adhering country to prevent the use in that country of an invention of previous German ownership, by a U. S. citizen, which would otherwise prevent a U. S. citizen from exporting to that country a device embodying the German invention. This removes what would have been a serious patent barrier to international trade in products embodying these German inventions. In some cases, tariff laws provide for the exclusion of products infringing domestic patents, without opportunity to litigate the validity of the patents.

Other countries which participated in the conference were Australia, Belgium, Canada, Czechoslovakia, Denmark, Luxembourg, Norway, and the Union of South Africa. Russia did not participate.

★ **Radar Navigator on Boston Steamer**

The first excursion steamer to have the benefit of a "magic pilot," whose efficiency is as great in darkness and fog and storm as in daylight and clear weather, now is operating out of Boston Harbor. The S. S. Steel Pier, excursion steamer which daily plies the 100-mile round trip distance to and from Provincetown, has been equipped with a General Electric electronic navigator.

Raytheon Radar Navigates Tanker

Extending peacetime applications of radar, the Raytheon-equipped SS Atlantic Mariner has just ended the first test run by any ocean-going American commercial tanker equipped with radar. One of thirteen 560-foot tankers operated by the Atlantic Refining Co., the Atlantic Mariner installation emphasizes the advantages to be gained in the use of radar. Operating the tankers at an average cost of \$2,400 per day, it takes a comparatively small saving in running time to cover the cost of equipment and installation.

★ *Have You Seen The Solar System?*

It's a bi-monthly magazine of authoritative information on new developments in the capacitor field. Simply fill in the coupon below if you'd like to receive this *easy-to-read*

technical publication regularly at your home or at your office.



Ⓢ 1689

E1

Solar Manufacturing Corporation
285 Madison Avenue, New York 17, N. Y.

Gentlemen: Please send me the SOLAR SYSTEM regularly, starting with the current issue.

Name.....

Address.....

City..... Zone No..... State.....

San Francisco Radio-telephone Experiments

The Pacific Telephone and Telegraph Co. is conducting experiments in the San Francisco Bay region to determine the practicality and layout of a mobile radiotelephone service. Half-wave transmitting antennas were installed at a 500-ft. elevation atop its building in San Francisco. The transmitter will have sufficient power to reach Oakland, Berkeley, Alameda and other communities across the bay as well as towns to the south. A number of test vehicles will survey conditions. The area, with several peaks better than 900 ft. high, offers a number of problems. Operations are expected to show how many sub-stations will be necessary



The flagpole ornament has nothing to do with the coax antenna being installed for West Coast cross-bay radiophone system

for adequate coverage and whether the service meets a public requirement.

The metal sphere, shown in the picture, has nothing to do with the antenna, but is simply a flagpole ornament too familiar a landmark to thousands of residents to be scrapped.

High Titania Dielectrics

A paper on high titania dielectrics was presented by Eugene Wainer at the Eighty-ninth General Meeting of the Electrochemical Society at Birmingham on April 11-13. The properties of titania and its

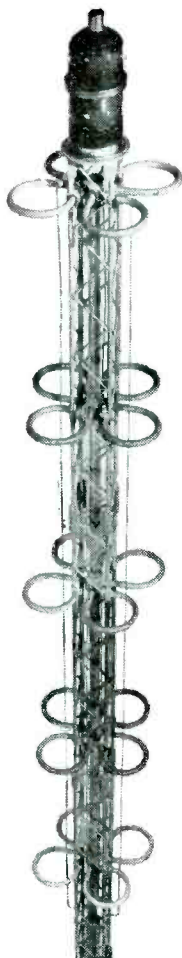

OH BOY!
YOU'RE LUCKY!



IN CLOVER... with a Western Electric CLOVER-LEAF ANTENNA

You'll be in clover when you get your new 54A CLOVER-LEAF FM broadcast antenna! Bell Telephone Laboratories designed it with lots of important features. Here are twelve of them—look 'em over:

1. High Efficiency.
2. Circular azimuth pattern.
3. Simple to install.
4. Minimum maintenance.
5. Exceptionally rugged design.
6. 50 KW power capacity.
7. No multiple transmission lines.
8. No phase correcting lines or networks.
9. No balancing lines.
10. No field or factory antenna tuning.
11. No insulators—full lightning protection.
12. No end seals.

They even wrote a booklet about it. Want one?

ASK YOUR
GraybaR
BROADCAST REPRESENTATIVE

FINE RADIO PARTS

Ask for
Our
New
Catalog

Still far behind in deliveries—
but making every effort to dis-
tribute fairly to all customers.
Send for this new catalog.

MERIT COIL & TRANSFORMER CORP.
TELEPHONE
4427 North Clark St. Long Beach 6311 CHICAGO 40, ILL.

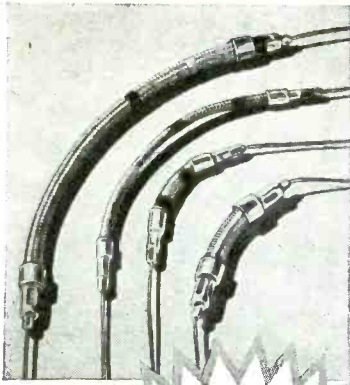

GLASOHM
flexible
resistors

★ Exclusively Clarostat! These flexible glass-insulated wire-wound resistors spell **tougher** components for **fighter spots**. Fibre-glass core and fibre-glass braided covering. Nothing to char or burn. Self-supporting when soldered in place. Especially handy for point-to-point wiring. Ideal for attenuators or step-by-step controls. Truly midget power resistors.

In two ratings: Series FXG, 1 watt per winding inch; Series FYG, 2 watt.

Maximum resistance per winding inch: Series FXG, 750 ohms; FYG, 1500 ohms.

Minimum resistance per winding inch: Series FXG, 1/4 ohm; Series FYG, 1/2 ohm.

Both types supplied to any reasonable length.

Patented "Clinch-Grip" ferrules and 2" pigtail leads, standard.

★ **DATA on request . . .**

Postwar Engineering Bulletin No. 105 gives complete specifications. Copy on request. Meanwhile, submit your problems or requirements for our collaboration.



CLAROSTAT MFG. CO., Inc. · 285-7 N. 6th St., Brooklyn, N. Y.

EIGHT CHANNEL MICROWAVE RADIOPHONE ANTENNAS

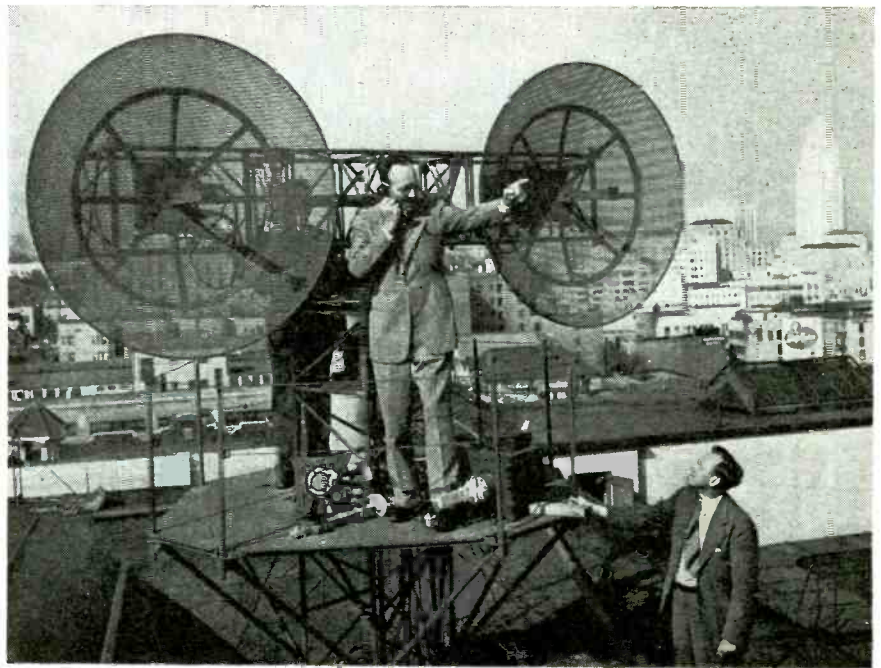

Receiving and transmitting antennas for the Los Angeles-Catalina Island UHF system

compounds, frequently used as substitutes for capacitor grade mica, were discussed. Widespread applications are made possible through the variables that can be introduced in a synthetically prepared product. Electrical characteristics of these materials, their compositions, methods of manufacture, and commercial applications were described. An attempt was made to explain the reason for obtention of the electrical properties involved and particularly the effect of various additions. Correlations between this explanation and experiments were given.

Coating for Glass Transmits Electricity

A revolutionary development in glass research, revealed by Pittsburgh Plate Glass Co., involves use of a transparent coating, called Nesa, that conducts electrical current. The coating makes it possible to heat the entire area of a panel of glass, as in a windshield, for example, thus preventing the formation of ice on the outside or fog on the inside. The coating may find additional uses in electrical equipment; it does not affect visibility through the glass.

FM TRANSMITTER PRODUCTION LINE



General view in the Newark (N. J.) plant of Federal Telephone and Radio Corp.

TOLL EQUIPMENT
 ■
 TRAFFIC COUNTERS
 ■
 TRAFFIC SURVEYS
 ■

Time Delay and Counting Circuits
 Designed for Special
 Applications

■
**THE ELECTRONIC SIGNAL
 COMPANY**

*Designers — Manufacturers — Maintainers
 of Electronic Equipment*

483 Willis Avenue, Williston Park, N. Y.
 Phone Garden City 6633

BAACH-INTERNATIONAL

EIGHT HEAD HOT-CUT FLARE MACHINE

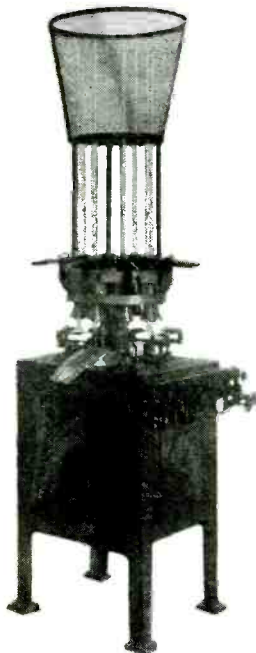

Automatic throughout.
 Can be synchronized with auto-
 matic Stem machine.
 Accommodates eight full lengths
 of glass tubing.
 Cuts off and flares in one op-
 eration.
 Production, 1000 flares per hour.
 Made in two sizes: *Miniature
 machine*, for miniature flares and
 fluorescent starters, and *Stand-
 ard machine* for standard size
 lamps, fluorescent and radio
 tubes.
 Range of *Standard Machine*:
 Glass tubing 35 to 42 gauge
 Length of flares 5 mm to 80 mm
 Forms flares up to 47 mm diameter
 Net weight 1500 pounds
 Boxed 1700 pounds

INTERNATIONAL MACHINE WORKS

*Manufacturers of High Vacuum Pumps, Automatic Machinery for
 Incandescent Lamps, Electronic Tubes since 1916.*
 2027-46TH STREET, NORTH BERGEN, N. J., U.S.A.
 Tel. UNION 3-7412. Cable Address "Intermach" North Bergen, N. J.

EXPORT

ATTENTION MANUFACTURERS

Are you interested in having your products sold in the
 foreign markets of the world?

EXPORT

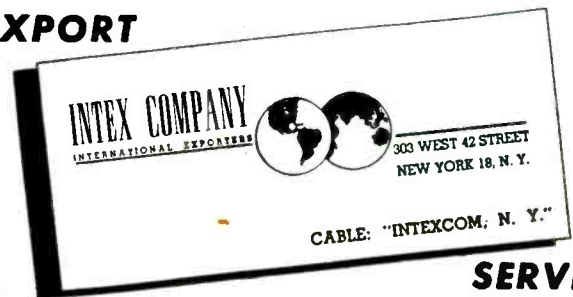

SERVICE

The Intex Company acts as direct factory export representative for
 a number of allied but non-competitive manufacturers in the Radio,
 Electronic, Electrical and allied fields and we handle all details
 such as:

- Financing
- Sales Promotion
- Foreign Correspondence
- Permits
- Shipping
- Export Packing

Send us your literature and write us regarding your product.
 Your letter will bring our prompt response. All inquiries will be
 kept strictly confidential. References exchanged.

INTEX COMPANY
 303 WEST 42ND ST. NEW YORK 18, NEW YORK
 Cable: "Intexcom, N. Y."

FOR SALE

Electrical coil manufacturing business. Ample
 stock of raw materials. Completely equipped
 and established business. Lease on 12,000 sq. ft.
 in a sprinkler-controlled building good until Oc-
 tober 1949 at 22¢ per sq. ft. Centrally located
 in downtown Chicago. Price: \$40,000. Contact

BUSINESS BROKERS CO.

(Not Incorporated)

120 S. LaSalle St., Chicago 3, Ill. • RANdolph 2555

18 YEARS IN RADIO



Latest developments in radio and elec-
 tronic parts and devices, newest "Ham"
 gear, "Gadgets" to delight the experi-
 menter, bargains in war surplus
 goods, all in new catalog for you.



BURSTEIN-APPLEBEE CO.,
 1012 McGee, Kansas City 6, Mo.

Send me FREE new B-A Catalog. EL. IND

I AM _____
 STATE CONNECTION IN INDUSTRY _____
 NAME _____
 ADDRESS _____
 TOWN _____ STATE _____

**BIG
 CATALOG
 FREE**



Relays for every purpose—hundreds of types and sizes—completely cataloged and available for immediate delivery at a fraction of their original cost! This vast stock has been procured from Government contract termination sources and has been approved by JAN inspection.

These relays were built to the very highest standards of precision by the nation's leading manufacturers of this type of equipment. All are new, unused and fully guaranteed. Write for our Relay catalog or send your requirements by wire or letter.

We also have available for immediate delivery a complete selection of G. E. Switchettes, Micro-Switches, and selenium rectifiers suitable for relay operation and other D. C. applications.

Government Contract Termination Material

Our tremendous stock of radio and electronic components includes a wide selection of the following items:

- | | | |
|------------|--------------------|-----------------|
| Condensers | Wire-Cable | Transformers |
| Resistors | Transmitting Tubes | Volume Controls |
| Switches | Tube Sockets | Vibrators |

WELLS SALES, INC., 4717-N. W. MADISON STREET • CHICAGO 44, ILLINOIS

THE UP-TO-DATE METHOD

for obtaining swiftly an accurate record of the frequency characteristic of any audio apparatus or complete installation is

TO USE OUR MODEL FR FREQUENCY RESPONSE RECORDER

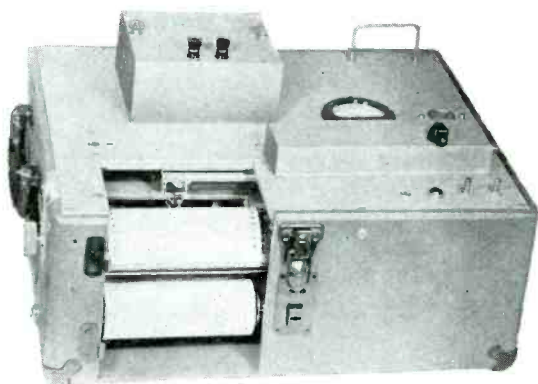

FULL TECHNICAL DATA ON THIS INSTRUMENT IS PUBLISHED IN OUR NEW CATALOG WHICH WILL BE MAILED ON REQUEST.

DO NOT FAIL TO INVESTIGATE THIS VERSATILE MEASURING APPARATUS.

SOUND APPARATUS COMPANY

233 BROADWAY

NEW YORK 7, N. Y.

Designers and Manufacturers of Graphic Recording Instruments and Accessories.

WTCN'S FM ANTENNA



Foshay Tower (Minneapolis) topped by 8-element square loop FM antenna, manufactured by Federal Tel and R Corp., for 3 kw radio station WTCN

New Tele Film

A new type of motion picture film especially for use in the production of pictures to be transmitted by television has been developed by E. I. duPont de Nemours and Co., Inc., Wilmington, Del. The film has a special emulsion designed to give greater detail in both highlights and shadows. NBC's New York WNBT used the film for the first time July 15 in telecasting pictures of a Washington ceremony, the reel being flown to New York for the purpose.

West Coasters Plan Electronic Trade Show

West Coast electronics manufacturers are planning for their second annual trade show which is scheduled for Los Angeles October 18-20. Affair is to be staged in the Elks Temple building and it is expected that 113 exhibits will be arranged. D. D. Durr is show director and the Tabery Corp., 3443 South Hill street, is managing the function.

Tube Data

A folder of catalog sheets giving complete technical data on a dozen of its Gammatron tubes (general and special purpose triodes, beam pentodes and rectifiers) has been issued by Haintz and Kaufman, Ltd., South San Francisco, Cal. Included are circuit diagrams and suggested operating data.

ELECTRONIC INDUSTRIES

Advertisers, September 1946

| | Page | | Page |
|--|-------------|---|---------|
| Adams & Westlake Company | 58 | Jackson Electrical Instrument Co. | 156 |
| Advance Electric & Relay Co. | 133 | JBT Instruments, Inc. | 142 |
| Aerovox Corp. | 43 | Jelliff Mfg. Corp., C. O. | 158 |
| Aircraft Radio Corp. | 45 | Jensen Mfg. Co. | 36 |
| Allied Radio Corp. | 164 | Johnson Co., E. F. | 162 |
| Altec Lansing Corp. | 115 | Jones, Howard B., Div. Cinch Mfg. Corp. | 161 |
| American Electrical Heater Co. | 134 | Kahle Engineering Co. | 173 |
| American Television & Radio Co. | 137 | Kalbfell Laboratories | 166 |
| American Time Products, Inc. | 50 | Karp Metal Products Co., Inc. | 19 |
| Amperite | 172 | Keuffel & Esser Co. | 61 |
| Andrew Co. | 118 | Kollsman Instrument Div., Square D Co. | 111 |
| Arnold Engineering Co. | 135 | K-V Transformer Co. | 3 |
| Astatic Corp. | 132 | Lapp Insulator Co., Inc. | 48 |
| Barber-Colman Co. | 165 | Lavoie Laboratories | 107 |
| Barker & Williamson | 139 | Leach Relay Co. | 25 |
| Bell Telephone Laboratories | 125 | Liberty Sales Co., Inc. | 150 |
| Beta Electronics Co. | 153 | Lord Mfg. Co. | 2 |
| Bevin-Wilcox Line Co. | 134 | Macallen Co. | 126 |
| Bird, Richard H. & Co. | 154 | Machlett Laboratories, Inc. | 41, 173 |
| Boonton Radio Corp. | 163 | Mallory & Co., Inc., P. R. | Cover 2 |
| Brush Development Co. | 26 | Marion Electrical Instrument Co. | 148 |
| Burnell & Co. | 137 | MB Mfg. Co., Inc. | 23 |
| Burstein-Applebee Co. | 177 | Measurements Corp. | 172 |
| Business Brokers Co., not Incorporated | 177 | Mepharm Corp., G. S. | 173 |
| Cambridge Thermionic Corp. | 160 | Merit Coil & Transformer Corp. | 175 |
| Chicago Transformer, Div. Essex Wire Corp. | 138 | Mico Instrument Co. | 161 |
| Clarostat MFG. Co., Inc. | 176 | Millen Mfg. Co., Inc., James | 154 |
| Collins Radio Co. | 15 | National Co., Inc. | 129 |
| Communications Equipment Co. | 149 | Niagara Radio Supply | 153 |
| Concord Radio Corp. | 163 | Ohmite Mfg. Co. | 51, 52 |
| Cornell-Dubilier Electric Co. | 27 | Oxford Radio Corp. | 147 |
| Cook Electric Co. | 131 | Panoramic Radio Corp. | 12 |
| Cornish Wire Co., Inc. | 124 | Patton-MacGuyer Co. | 173 |
| Crystal Research Laboratories, Inc. | 136 | Plasticraft Products Co. | 162 |
| DeJur-Amsco Corp. | 59 | Premax Products | 167 |
| DeMornay-Budd Inc. | 31 | Div. Chisholm-Ryder Co., Inc. | 167 |
| Deutshmann Corp., Tobe | 165 | Radio Corp. of America | Cover 4 |
| Dolph Co., John C. | 46 | Rauland Corp. | 47 |
| Doglittle Radio, Inc. | 34 | Revere Copper & Brass Inc. | 7 |
| Drake Electric Works, Inc. | 153 | Rieber Research Laboratory | 109 |
| Drake Mfg. Co. | 133 | Sangamo Electric Co. | 24 |
| Dumont Laboratories, Inc., Allen B. | 32, 60 | Schauer Machine Co. | 168 |
| Eastman Kodak Co. | 117 | Seeburg Corp., J. P. | 22 |
| Eby, Inc., Hugh H. | 38 | Selenium Corp. of America | 29 |
| Eisler Engineering Co. | 165 | Shallcross Mfg. Co. | 151 |
| Eitel-McCullough, Inc. | 56, 57 | Sigma Instruments, Inc. | 167 |
| Eldico of New York, Inc. | 160 | Simpson Electric Company | 33 |
| Electric Indicator Co. | 157 | Solar Mfg. Corp. | 64, 174 |
| Electrical Reactance Corp. | 144 | Sound Apparatus Co. | 178 |
| Electronic Corp. of America | 145 | Stackpole Carbon Co. | 128 |
| Electronic Engineering Co., Inc. | 174 | Statham Laboratories | 173 |
| Electronic Exhibitors | 141 | Stupakoff Ceramic & Mfg. Co. | 55 |
| Electronic Radio Alarm, Inc. | 169 | Superior Electric Co. | 54 |
| Electronic Signal Co. | 177 | Suprenant Electrical Insulation Co. | 161 |
| Electronic Specialities Mfg. Co. | 157 | Sylvania Electric Products, Inc. | 9, 127 |
| Electrons, Inc. | 130 | Synthane Corp. | 17, 18 |
| Electro-Tech Equipment Co. | 154 | Syracuse University | 173 |
| Electro-Voice, Inc. | 123 | TAB | 179 |
| Ever Ready Label Corp. | 169 | Titellex, Inc. | 122 |
| Fahnstock Electric Co., Inc. | 171 | Triplet Electrical Instrument Co. | 171 |
| Farnsworth Television & Radio Corp. | 8 | Tung-Sol Lamp Works Inc. | 30 |
| Federal Telephone & Radio Corp. | 21, 37, 121 | Turner Co. | 152 |
| Ferris Instrument Co. | 16 | U. S. Plastics Corp. | 167 |
| Formica Insulation Co. | 39 | Vangtronic Corp. | 157 |
| Freed Transformer Co., Inc. | 40 | Victoreen Instrument Co. | 158 |
| General Electric Co. 5, 28, 35, 53, 62, 63, 119, 143 | | Vokar Corp. | 166 |
| General Industries Co. | 146 | Walker-Jimieson, Inc. | 170 |
| General Plate Division | 14 | Walter Co., S. | 11 |
| Gramer Co. | 169 | War Assets Administration | 44 |
| Graybar Electric Co. | 175 | Ward Leonard Electric Co. | 20 |
| Guardian Electric Mfg. Co. | 105 | Waterman Products Co. | 168 |
| Haydon Mfg. Co., Inc. | 120 | Webster Electric Co. | 155 |
| Harvey Radio Laboratories, Inc. | 113 | Wells Sales, Inc. | 178 |
| Heyman Mfg. Co. | 162 | Western Electric Co. | 10 |
| Hopp Press, Inc. | 158 | Westinghouse Electric Corp. | 49 |
| Indiana Steel Products Co. | 42 | Weston Electrical Instrument Corp. | 6 |
| Insulation Manufacturers Corp. | Cover 3 | Wilmette Manufacturing Co. | 180 |
| Insuline Corp. of America | 140 | Wrigley Co., Win. | 159 |
| International Machine Works | 177 | Zophar Mills, Inc. | 164 |
| International Nickel Co., Inc. | 13 | | |
| Intex Co. | 177 | | |
| Isolantite, Inc. | 4 | | |
| Instrument Resistors, Inc. | 103 | | |

"TAB"

That's a Buy

PIONEER INSTRUMENT AUTOSYN BENDIX CK5G AY101D paired transmitter & Recvr. New g'vt insp. for tele-metering or remote signalling operates 24-28V-400cy or 18-24 Volts 60cycles complete with all gearing. Gov't cost over \$100. "TAB" special \$2.95

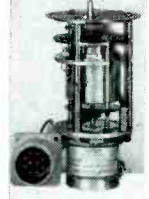

GE transformers 115V60cy pri. all high V. insltd. including chokes—New Navy insp. 115V60cy pri. 6.3V8A Secondary H.V. ins. \$1.65 Cased, Sec. 1600V2ma, 2.5V6A, 6.2V.6A... 2.95 Open Fr. 6.5V8A, 5V3A, 6.5V6A, 2.5V1.75A... 2.95 830vct, 125ma, 6.3V6A, 6.3V1A, 20V.6A, 5V3A... 3.50 6.3V8.75A, 6.3V3A, 6.3V.6A, 6.3V.6A, 6.3V.6A... 3.95 Auto-Trans 115, 160, 170, 180, 1.95-1.73A... 2.95 900Vc.t., 6.3Vc.t., 5v.c.t., 127 WATTS... 2.95 10 henries 100ma 200 ohms H.V. ins... .95 10 hy 250ma 110 ohms open frame K54J-205... 1.40 10 hy 250 ma 100 ohms Cased 68G393... 1.65 2.65 hy 800ma 10.3 ohms K43J232... 2.95 115V60c pri. 250vct.25ma, 6.3V1A, Small... 1.95 Thordarson 8HY150ma 200 ohm TL3C30, 2 for Thord HiFi PP6L6 outpt. 3800 pri; 3.4.6.8, 16, 125, 250, 500 Freq30/20000cy G'insp... 3.00 S. Dunn Keying relay Vacuum 15000V15A AN 78CCA 101&GL1S21 GE Vac. Switch (\$39)... 4.50 Molded .01 mfd 600V cond 100 for \$6; 1000... 30.00 Assm'n't pots mfgd AB-J 50to 1meg, ten for... 2.50 Kurman adj 1000cy AC source complete new G'I... .97 Magnetron JAN2J32 new W'stghse gtd (\$154)... 19.95 WE new 1N26 crys "K" radar bd1cm (LP\$9.95)... .75

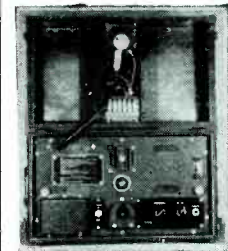

Complete New Code practice set in trunk McElroy AN/GSC-TI operates on 6, 12, 24, 115V DC & 115, 230 V AC for classroom, camp or club Code practice, gives both visual, blinker and audio adjustable freq. tone. Loud speaker also earphones connection. Room for phones and keys output good for at least 100 students. Brand new Gov't insp. Power supply with two Vibrators worth the price alone. TAB Special \$22.50. Gov't cost \$197.

New S.C. 138 Keys 98c.
Headphones W.E. 509 Hi Imp 8' cord & plug, \$3.95
SC Headphones with Rubber cushions... 1.90
SCPI JAN insp new with Duo-Dieheptal socket 7.50
3BP1 JAN insp new with Duo-Dieheptal socket 3.95
Punched chassis 16 3/4"x6"x3"—35c;
16 1/2"x13"x2" .65
Oil Cond 3mfd2000VDCWV Wstghse&CD two for 5.00
"TAB" Strobo-Flash parts & Kits
Strobo-Flash lamp equal #5 flash bulb... \$11.50
High voltage strobo-flash transformer... 10.00
Filament Transformer Rectifier... 3.25
Time delay relay rectifier filaments... 1.49
Condsr oil 30mfd 660VAC 2800WVDC... 8.10
Rectifier Tube, Cap, socket, 866A... 2.15
Trigger H.V. insulated relay 115V.AC... 3.95
Kit basic parts Strobo-tube, H.V. Trans, HV capacitors, Rectifier tube&Trans, H.V. wire pun hed chassis, fuse post, diagrams... 39.95
Aerovox 500mfd200DCWV Type R02 (6.10)... 1.20
MTD XTALS 2 to 10 mc's \$0.85 @ 4 for... 3.00
Magnetic dual ckt bkr 8 amp&25amp G'1(\$12)... 2.25
Navy sea trunk 12"x22 1/2"x18" used L.N... 3.95
Cond mica .01mfd2500V test 4(LP\$3.40)2 for 1.00
2RCA866AS, fil trans, sockets & Millen Caps... 7.00
National 1M8 300ma RF Choke 10—; 3 for... .90

| V | OHMS |
|-------|--------|
| 0-3 | 1000 |
| 0-10 | 10000 |
| 0-30 | 100 M |
| 0-100 | 1 Meg |
| 0-300 | 10 Meg |

ELECTRONIC VOLT-OHMMETER BRAND NEW U. S. ARMY TYPE 1-107-F PRECISION UNIT. "TAB" special \$29.70 Additional V.T.V.M. Loctal tube 1 LE 3/SP Sig C \$1.15.

\$1 Min. order FOB N.Y.C. Add Postage all orders and 25% deposit. Whitehall 3-3557. Send for catalog 300. Specialists in International Export, School, College & Industrial trade. Buy thru "TAB" and save.

"TAB," Dept. 9
SIX CHURCH STREET, NEW YORK 6, N. Y.

Wilmotte "Visi-Limit" Electronic Micrometer

An important advance in the field of measurement. Manufactured for direct installation on the production line for continuous indication of outside diameter of wire, tubing or rod, edge-to-edge dimensions on machined or extruded parts, strip stock, thickness of sheets.

Size range of standard unit is .005" to .600" in diameter. Items of other sizes can be accepted through special design. Tolerance limits are + or - .0002" without

physical contact with the part being measured. No limitations of speed of operation are imposed, nor are there any inaccuracies due to deformation of the part.

The "scope" screen presents, as three parallel lines, the desired tolerance requirements (A and C) with the measured quantity (B). No error is introduced by line voltage fluctuations or circuit changes since all three traces maintain their relative positions.

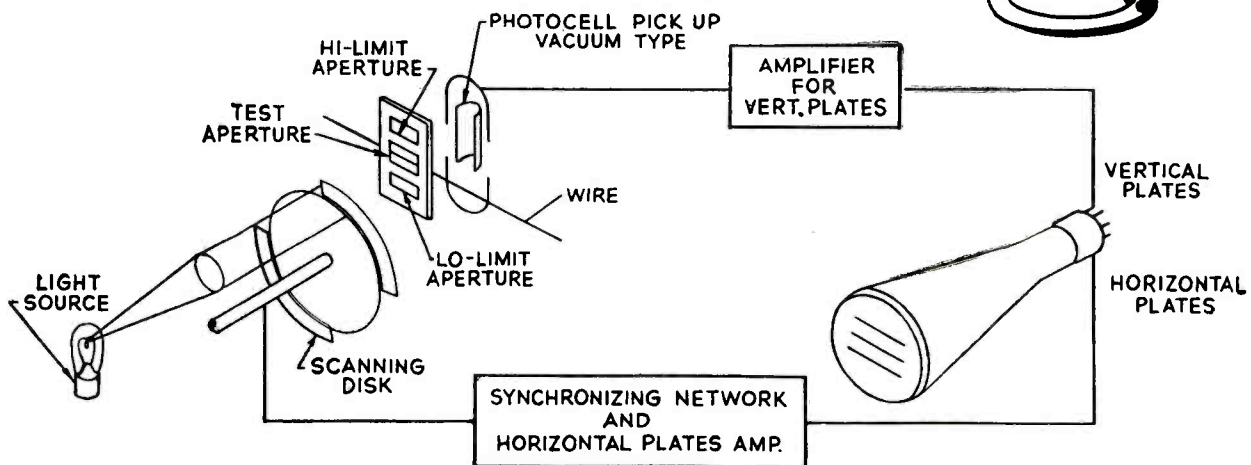
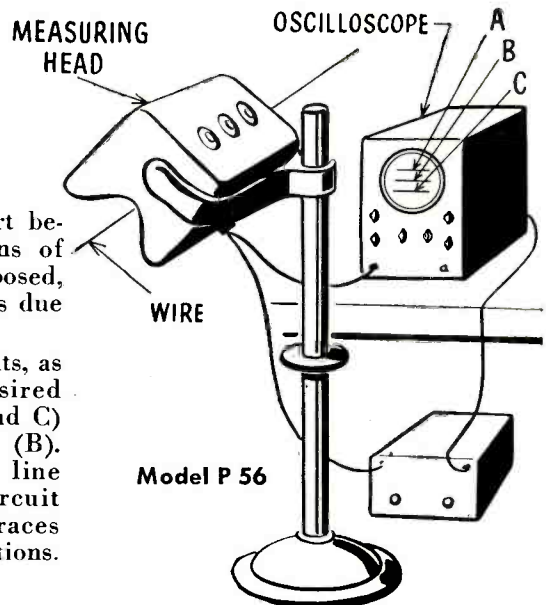

Wilmotte "Visi-Limit" Curve Tracer

Model P 52

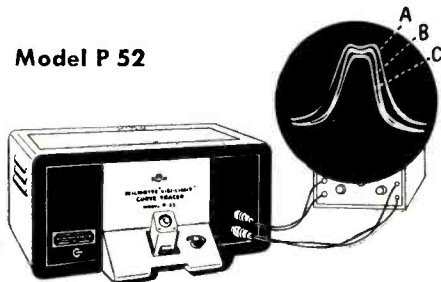

For rapid alignment of I.F. coils of frequencies from 85 kc to 11 mc. Operator adjusts test trace (B) to fall between traces of limit coils (A and C), set up to production specifications. Defective coils immediately detected. All error is eliminated as circuit changes or line voltage

variations affect all three traces equally.

Standard equipment includes one plug-in oscillator assembly at frequency specified by purchaser, and jigs for limit and test coils having "pig tail" leads. Jigs for special applications furnished to purchaser's specifications.

We Look Forward

to the forthcoming exposition conducted by the
INSTRUMENTS SOCIETY OF AMERICA

at which we shall have the pleasure of meeting you and demonstrating these industrial electronic devices.

William Penn Hotel

PITTSBURGH, PA.

SEPT. 16-20, 1946

BOOTH No. 65



WILMOTTE MANUFACTURING COMPANY

1713 KALORAMA ROAD, N. W.

WASHINGTON 9, D. C.

LABORATORIES - RAYMOND M. WILMOTTE INC., NEW YORK, 236 W. 55TH ST. - WASHINGTON, 1469 CHURCH ST., N. W.

A BIGGER HOME FOR THE CLEVELAND IMC ENGINEER . . .

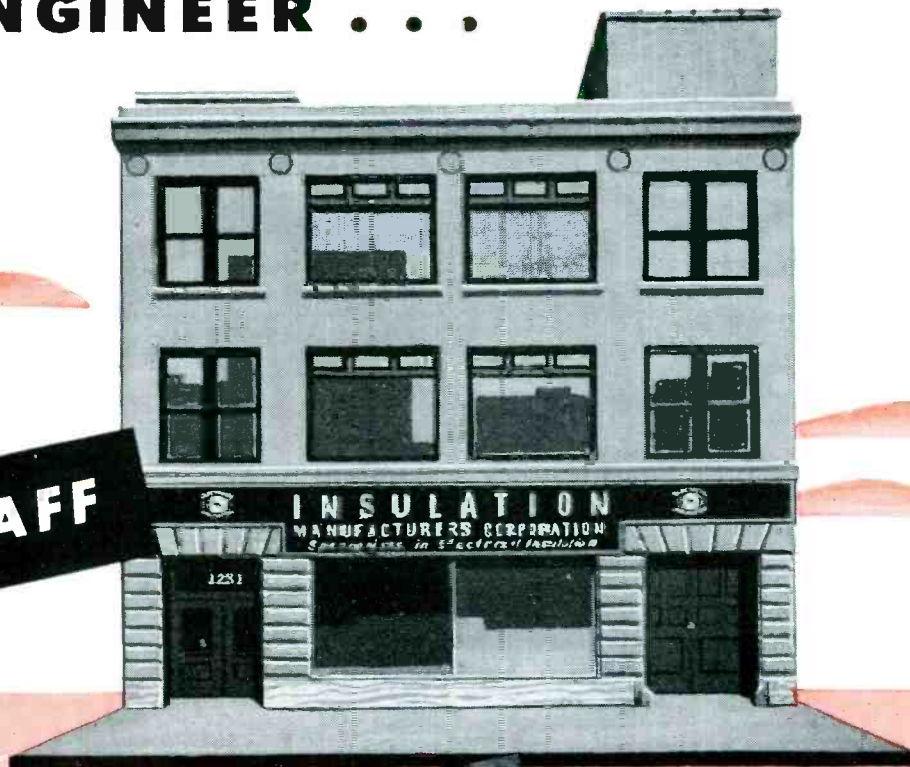

ON YOUR STAFF



BUT NOT ON YOUR PAYROLL

The increasing demands for IMC services and products have been calling for more space and greater facilities. Result... IMC has moved its Cleveland office into its own building at 1231 Superior Avenue. In so doing, extra space has been allowed for warehousing a complete stock of IMC electrical insulating materials to provide better service and faster deliveries. Whether you're near Cleveland, or in another territory, the IMC engineer can help you. He's always ready to—

1. Assist you in the selection of the best insulating material for your job.
2. Familiarize you with its proper application.
3. Suggest ways to eliminate waste.
4. Help you increase your production.

Call on him whenever you need a specialist's help on your insulation problems.

INSULATION
MANUFACTURERS CORPORATION

*CHICAGO 6
565 W. Washington Blvd.

ELECTRICAL INSULATION

*CLEVELAND 14
1231 Superior Ave., N. E.

Also in Dayton, Detroit, Milwaukee, Minneapolis, and Peoria

IMC PRODUCTS: Vortex Varnished Cloth and Tapes—Varslot Combination Slot Insulation—Varnished Silk and Paper—Fiberglas Electrical Insulation—Manning Insulating Papers and Pressboards—Dow Corning Silicones—Pedigree Varnishes—Dialflex Varnished Tubings and Saturated Sleeveings—Wedgie Wood Wedges—National Hard Vulcanized Fibre and Fishpaper—Laminated Bakelite—Permacel Adhesive Tapes—Asbestos Woven Tapes and Sleeveings—Inmanco Cotton Tapes, Webbing, and Sleeveings, and other insulating materials.

How to select RCA Phototubes



PHOTOTUBES have found such a wide variety of applications that many types have been developed to meet special needs. The complete RCA line includes both gas and vacuum phototubes, with various spectral responses and a variety of sizes and shapes. And for applications requiring extreme sensitivity, RCA supplies multiplier phototubes with various spectral responses within the red to ultra-violet region.

Color Sensitivity: The cathode coating material and the envelope glass determine color sensitivity. RCA phototubes fall into four "color groups":

| Use | Tube Types | Maximum Color Sensitivity |
|---|---|--|
| With incandescent lamps —and for infra-red application | Vacuum: 917, 919, 922, 925 Gas: 1P40, 1P41, 868, 918, 920, 921, 923, 927, 928, 930 | Red and infra-red |
| With incandescent lamps —and for infra-red application | Vacuum: 1P22, 926 Gas: 1P29 | Blue light. Approximates the human eye |
| With light source for colorimetry application | Vacuum: 1P39, 929, 934. Gas: 1P21, 1P37, 921-A | Blue light. Very sensitive to incandescent light at a color temperature above 2700° K. |
| For ultra-violet measurement | Vacuum: 1P28, 935. | Same as above, but special glass envelope permits high ultra-violet sensitivity |

Vacuum-or-Gas or Multiplier-Type: Several important factors to be considered in selecting the general type of phototube for a service are given in the following table. Specific values should be considered in selecting a specific tube type.

| Characteristic | High-Vacuum Type | Gas-filled Type | Multiplier Type |
|--|--------------------------------|-------------------------------------|--------------------------------|
| Sensitivity | Low | Medium | Very High |
| Current Output | Low | Medium | Very High |
| Amplification | 1 | Up to 10 | Up to 2,000,000 |
| Relative signal-to-noise ratio (including amplifier stage) | Low | Intermediate | High |
| Anode Volts | Up to 500 | Not over 90 | Up to 1250 |
| Distortion (audio) | Negligible | Appreciable in some cases | Negligible |
| Frequency Range | Limited by capacitance effects | Limited by gas amplification effect | Limited by capacitance effects |

Gas phototubes are, at present, extensively used for sound-on-film reproduction and for relay work. Vacuum types are widely used where high sensitivity is not needed; for precision measurements where stability of calibration is essential; and for high-speed work.

Sensitivity: The sensitivity of a phototube may vary according to whether the light change is abrupt or continuous. *Static sensitivity* is the quotient of anode direct current divided by constant light input. *Dynamic sensitivity* is the quotient of the variation

of anode current divided by the variation of light input. The sensitivity of gas phototubes drops off at high audio frequencies.

Optical Systems: The performance of phototubes can be greatly improved by the judicious choice of a suitable optical system.

Mechanical Features: As illustrated above, several types of tubes are available. Space, vibration, directional requirements, insulation, etc., all may affect phototube selection.

Phototube Life: RCA phototubes are inherently sturdy, long-lived tubes and, when operated under recommended conditions, give very reliable service.

Application Hints: Here are a few general suggestions for applying phototubes:

1. In general, for measurement work, a vacuum phototube is required because of its high stability of performance; for relay work the high sensitivity of a gas-tube often determines its choice, since high stability is of minor importance.
2. In sensitive relay and measurement circuits where tubes must respond to very small amounts of light, avoid external leakage currents. Keep tube terminals and sockets clean. Erratic leakage currents will affect results.
3. In amplifiers where low leakage is important, select top cap types such as the RCA 917, 919, or 935.
4. Shield phototube and leads to amplifier or relay tubes when amplifier gain or phototube load resistance is high.
5. Where high-frequency response is important, keep phototube leads short to minimize capacitance shunting of output.
6. For constant calibration of high-precision vacuum phototube devices, keep anode potential at or below 20 volts. Keep incident light spread over wide cathode area. Keep current density below 10 uamp. per sq. in.
7. Choice of circuit constants should be based on tests with the equipment operating over the expected range of line-voltage variation, and should provide sufficient circuit adjustment or safety factor to allow for normal characteristic variations between tubes.
8. RCA voltage-regulator tubes can improve phototube circuit performance.
9. Anode characteristic curves on phototubes can be used to predict average performance under given operating conditions.
10. The phototube types underlined in the color tabulation are recommended as RCA Preferred Types for design considerations.

WHAT PHOTOTUBE DO YOU NEED?

If you have a specific application problem or wish further published information on RCA Phototubes and how to use them, write RCA, Commercial Engineering Department, Section D-71, Harrison, N. J.

THE FOUNTAINHEAD OF
MODERN TUBE DEVELOPMENT IS RCA

RCA PRINCETON LABORATORIES



TUBE DEPARTMENT

RADIO CORPORATION of AMERICA

HARRISON, N. J.