

The TALKING MACHINE WORLD

For the
makers &
sellers of
talking
machines

Published Each Month by Edward Lyman Bill, Inc., at 373 Fourth Ave., New York, November 15, 1920

*The instrument by which
the value of all musical
instruments is measured*

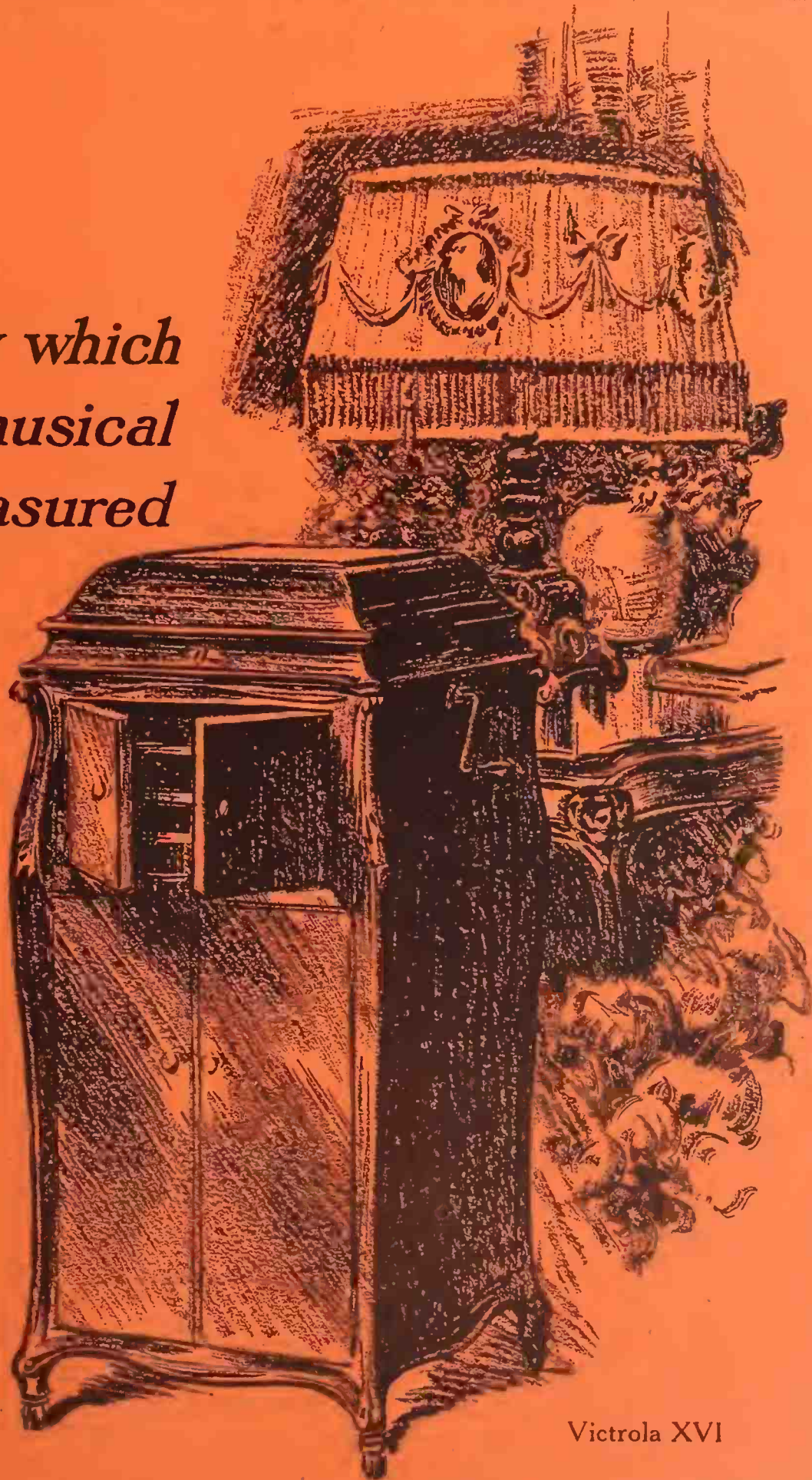

This trademark and the trademarked word "Victrola" identify all our products. Look under the lid! Look on the label!

VICTOR TALKING MACHINE CO.
Camden, N. J.

Victrola XVI

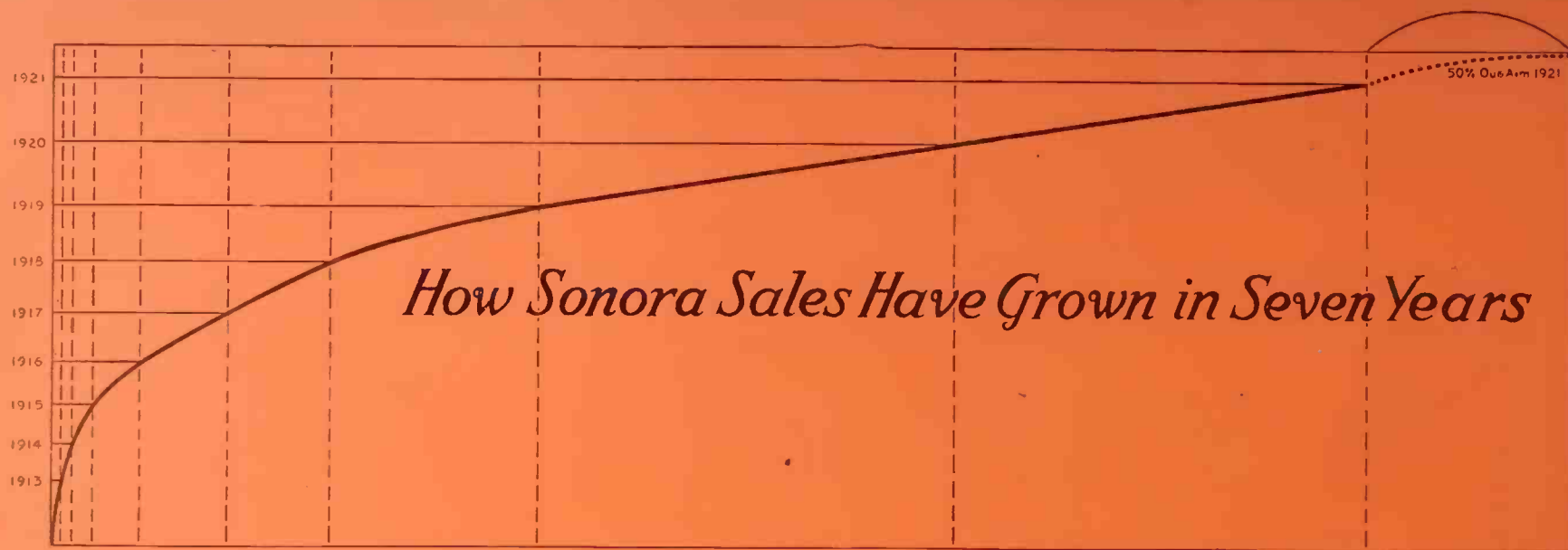

Curve showing steady and remarkable growth of Sonora sales

More Popular Than Ever

THIS is a chart that will make you think. It shows why Sonora is a leader in the phonograph industry. It indicates a natural healthy growth resulting from the public's confidence in the Sonora. It reveals that Sonora Sales of 1920 will be over double those of 1919. It gives you an idea of how *you* can build up your business if you handle the



The Highest Class Talking Machine in the World

Sonora's great popularity is due to the extraordinary merit of this instrument. In tone, design and important features, Sonora is supreme. You don't have to worry about a store full of slow selling phonographs when you stock Sonoras.

The Sonora sells readily (without offering "easy" payments to induce sales), keeps up your bank balances, and builds up a substantial business for you.

New dealers are being added. Write today regarding a Sonora agency. Magnificent upright and period models \$75 to \$1800.

Sonora Phonograph Company, Inc.

George E. Brightson, *President*

NEW YORK: 279 BROADWAY

Canadian Distributors: I. Montagnes & Co., Toronto

Sonora is licensed and operates under BASIC PATENTS of the phonograph industry

The Talking Machine World

Vol. 16. No. 11

New York, November 15, 1920

Price Twenty-five Cents

MISS CLOUD WITH PUTNAM-PAGE

Former Manager of Victor Idea Shop Now in Charge of Dealers' Service Department

Miss M. A. Cloud, who has been doing field work in record business building for the Putnam-Page Co., Victor distributors, Peoria, Ill., and who was formerly in charge of the Idea Shop, at the Victor factory, has been appointed manager of the company's reorganized dealers service department. This department will be unique in that it comprises in a suite of rooms on the second floor of the Putnam-Page building



all of the business features known to the Victor trade, including advertising, educational work, an Idea Shop and complete display of dealers' helps.

All of the Putnam-Page staff will contribute their experience to this department and Miss Cloud will have able assistance, especially in the work of record business building. The department management will not interfere with Miss Cloud's field work, as she will have as a direct assistant in the dealers' service Miss Rose Herndon, who has had an extensive experience with the Putnam-Page Co. and in the management of retail record departments.

SONORA DEMAND CONTINUES ACTIVE

President of Corporation Tells of Business Increase—Unfilled Orders Still Large—Labor Costs Big Item in Production at Present

In contrast to the depression in sales reported by some manufacturers, the president of the Sonora Phonograph Co., Inc., reports authoritatively that the business done in August and September, 1920, was over double that done in the corresponding months of 1919, and 1919 was the largest year Sonora ever had. October up to the month's close was in the same proportion, with no lessening of the demand for Sonoras.

Reports from Sonora dealers throughout the country show that there is no accumulation of stock and the dealers in general are demanding most of the models in larger quantities than the company is able to produce them. It is reported that unfilled orders on record October 1, 1920, were one-third greater than those on the books on the corresponding date in 1919. It is pointed out further that the Sonora Co. is obliged to use only skilled workmen and labor costs to-day have a tendency to increase rather than decrease. Until there is a material reduction in labor costs, which are the largest item in the manufacture of Sonora phonographs, there will be no reduction in list prices.

PRAISE MICKEL VICTOR SCHOOL

Mickel Bros. Co., of Des Moines, Ia., has just closed additional classes in Victor salesmanship under the direction of Miss Mayme Jardine. Dealers from all over the State have been enthusiastic in their praise of the benefit derived from this sort of service and a number have sent from five to seven of their employes to take the instruction. Several hundred students have finished the course and other classes, both in Des Moines and Omaha, are being arranged now.

Among the recent incorporations in the New York City trade is that of the Goormanola Phonograph Co. with a capital of \$10,000. H. and V. Goorman, B. Rothblatt, 1785 Sedgwick avenue, Brooklyn, are the incorporators.

BRUNSWICK CHRISTMAS DISPLAY

Attractive Window Material Prepared for Use of Dealers at Christmas Season—Bright Colors and Yuletide Messages the Keynote

The Brunswick Christmas window display, as created for the Brunswick-Balke-Collender Co. by Einson Litho, Inc., New York, strikes a note that is in harmony with the spirit of the Yuletide season. As may be seen from the accompanying photograph, the central figure of the display is the Brunswick phonograph with Santa Claus represented coming up out of the instrument as from the top of a chimney, holding in his hands gifts of music. Below the instrument is a large tag representing the usual decorative gift tag, with the inscription: "A gift to mankind—dedicated to add joy, beauty and contentment to the family home. The Brunswick phonograph is the gift supreme to all humanity." Beside this tag is a wreath of holly, bright with red berries.

The window card at the left of the display reads: "The spirit of joy will find a permanent



Brunswick Christmas Window Display

abiding place in the home where there is a Brunswick." At the right is an appropriate quotation from Charles Dickens: "I will honor Christmas in my heart and try to keep it all the year." Special provision is made for the display of a number of records around the base of the central figure. On the whole, the display breathes the spirit of Christmas and will be received gladly by Brunswick dealers throughout the country.

THE BUSINESS OF THE FUTURE

Genius of To-morrow Will Go From House to House and Make Records of the Family

Some genius, some day, says the New Rochelle Daily Star, will take a picture camera and a recording phonograph and start out and make a lot of people in the world very, very happy. This genius will go from house to house and make pictures and records. He will take father's and mother's voice and enshrine it and their faces and figures as they go about their tasks. And he will print from the negatives for reproduction on the screen and make reproducing records for the phonograph. And then, many years afterward, maybe, children no longer privileged to see the figures or hear the voices of the parents may, nevertheless, recall their shapes and voices and in the hush experience a new reverence for fatherhood and motherhood and for the untiring devotion which made possible their own place of greater comfort and opportunity in the world.

The man who delays in answering the telephone does not catch the straight tip. The Lucky Man gets it. Don't procrastinate.

TALKING MACHINE EXPORTS GROW

Exports, Including Records, for Eight Months Ending August 30, 1920, Total \$5,081,872

WASHINGTON, D. C., November 5.—In the summary of exports and imports of the United States for the month of August, 1920 (the latest period for which it has been compiled), which has just been issued, the following figures on talking machines and records are presented:

The dutiable imports of talking machines and parts during August, 1920, amounted in value to \$60,875 as compared with \$37,501 worth which were imported during the same month of 1919. The eight months' total ending August, 1920, showed importations valued at \$608,197 as compared with \$292,755 worth of talking machines and parts during the same period of 1919.

Talking machines to the number of 5,411 valued at \$209,793, were exported in August, 1920, as compared with 7,041 talking machines, valued at \$198,702, sent abroad in the same period of 1919. The eight months' total showed that we exported 51,403 talking machines, valued at \$2,507,433, as against 38,352 talking machines, valued at \$1,255,920, in 1919, and 49,025 talking machines, valued at \$1,477,222 in 1918.

The total exports of records and supplies for August, 1920, were valued at \$208,875, as compared with \$252,910 in August, 1919. For the eight months ending August, 1920, records and accessories were exported valued at \$2,574,439; in 1919, \$2,232,743, and in 1918, \$1,486,191.

\$250,000,000 SPENT FOR MUSIC

Tax Report Shows That This Sum Was Expended in 1919 for Pianos, Organs and Phonographs—Luxury Tax Totals \$22,700,000,000

World readers who like statistics may be interested in a report from Washington regarding luxury tax returns. This report declares that in the past year, that is, in 1919, the public spent one-quarter of a billion dollars, or \$250,000,000, on pianos, organs and talking machines. Automobiles cost \$2,000,000,000, while perfumery and cosmetics to produce smooth complexions and ruby lips cost \$750,000,000. To cap the climax they tell us that joy rides, races and pleasure resorts cost us \$3,000,000,000. The total sum represented by the luxury tax was \$22,700,000,000, which represents quite a little fortune in itself!

NEW JERSEY CORPORATION

The Albertone Phonograph Co., 150 East State street, Trenton, N. J., was recently incorporated with a capital stock of \$25,000 for the purpose of manufacturing a new phonograph with special exclusive patented features. Most of these are related particularly to the tone. The incorporators are Albert Hughes, the inventor of the machine, Charles C. Kulp and Clarence Connell.

EDISON JOBBERS IN NEW HOME

PORTLAND, ORE., November 3.—Edison Phonographs, Ltd., Edison jobbers in the Northwest, have moved into the recently completed three-story warehouse and office building at the southwest corner of Thirteenth and Everett streets, a portion of which they have leased for a term of years. The structure is of brick and cost in the neighborhood of \$60,000. The two lower floors occupied by the Edison jobbers cover over 20,000 square feet of floor space.

Gibbons & Owens, Brooklyn, N. Y., have been incorporated with a capital of \$50,000 to do a business in talking machines. The incorporators are M. W. and E. A. Gibbons and M. W. Owens, 246 Rutland road.

Developing a Prospect List That Produces the Greatest Results in Sales

By J. F. Smith

There are almost as many ways of compiling a prospect list for talking machine and record sales as there are prospects, and it naturally follows that most of these varied methods are not alone too expensive for practical purposes, but are not calculated to produce the greatest results.

Securing the name and address of every visitor to the store is, of course, the most direct method of building up a prospect list, although frequently such a method does not provide a sufficient number of names to keep a sales staff busy. The person who enters a store to make a purchase, or even look around, has given direct indication of being interested in talking machines or records, and therefore offers the best possibility for a sale. It sometimes happens, however, that ordinary visitors are a bit chary about revealing their names and addresses in fear that they will be annoyed by salesmen or find themselves on a "sucker" list to receive a mass of literature of all kinds. The proportion of those who hesitate to give their names and addresses freely is sufficiently large to warrant the development of some plan for getting such information without arousing suspicion.

A dealer in New York State has adopted a method that appears to be working out most satisfactorily. As the customer is escorted to the booth to hear the new records, and perhaps have a machine demonstrated, he or she is informed that it is the policy of the house to permit the customers to try out records by themselves and free from the importunities of the salesman, unless the presence of the latter is really desired. The dealer, or his salesman, then takes particular pains to explain to the customer the method of starting and stopping the type of machine which the store handles. Here is where the trick comes in. The customer who owns that same type of machine immediately announces the fact, in order to show familiarity with the method of operation. Nine times out of ten the owner of another type of machine voluntarily names the make owned in explaining that there is some slight difference in controlling the mechanism.

"Of course you receive our monthly record bulletin regularly?" inquires the salesman, and he has a pad and pencil at hand to take down

the name and address in the event that the customer is not already on the list. The byplay regarding the starting and stopping of the machine gives the necessary information as to the make owned, and this is duly entered on the card. Some customers hesitate about registering on the basis that as owners of other makes of machines they are not entitled to the free mailing service. "But we want you to keep in touch with the records we receive and have on sale, regardless of the make of machine you own," states the salesman. "That is a part of our service to the musical public." And then the name is forthcoming.

Where outside makes of machines are owned by record customers there is opened the way

A Prospect List That Has Been Carefully Built Up and Watched Is an Asset of Great Value to the Dealer

for the possible sale of a larger or more improved model from the store's own stock at a later date. The monthly supplement service also builds up a friendly feeling that is calculated to make the recipient a booster for that particular dealer among his friends, and there are always in sight sufficient record sales to make any such attention well worth while.

In building up the prospect list the question to be considered is not simply the obtaining of a great number of names and addresses, but rather the obtaining of selected names and addresses of people who, for some reason or other, may be legitimately expected to become purchasers of machines and records. To mail literature to the addresses on lists supplied by various agencies, or to lists taken at random from

the telephone directory or other sources, proves an expensive process, especially in view of the present high cost of printing.

It is, of course, quite right to send announcements regarding a new store, a change of location or other matters of that character to as large a list as possible, simply as a matter of record, but when it comes to business-building literature of the expensive sort, such as record supplements, etc., there should be some definite reason for sending out each piece.

As it is impossible to do business with every person who enters the store, so likewise is it impossible to expect to list among live customers everyone on the prospect list. A certain percentage of responses is to be expected as a legitimate return for the effort expended in following up that list, and a careful combing out of the deadwood that makes itself apparent after a short time among the names on the prospect list will serve to keep wastage down to a minimum.

Under present conditions, with the buyers' market prevailing and dealers finding it necessary to actually go after business, a prospect list that has been carefully built up and carefully watched is an asset that cannot be valued too highly. It furnishes the basis for any aggressive sales campaign.

TO OPEN STORE IN CEDAR RAPIDS

E. C. Mittvalsky, of Cedar Rapids, Ia., will soon open an exclusive Victor store in a large building adjoining his present place of business. Miss Frances Mittvalsky has taken the Mickel course in Victor merchandising in preparation of taking charge of the store, which will open shortly. Booths, counters and racks are being installed and indications point to one of the prettiest stores in that section. Mr. Mittvalsky is located in the Bohemian section and he will cater to that class of trade.

The American Odeon Corp., New York, has been incorporated under the laws of New York State to manufacture talking machines and phonographs. The capital is \$5,000 and the incorporators are C. Hennepan, W. Pilgrim and J. Schlechter, 10 Wall street.

Reasons Why NYACCO Albums Are the BEST

[In Six Chapters]

CHAPTER V

The Fifth consideration in the making of the NYACCO album showing the 10" pocket inserted into a 12" cover, gives the cabinet a uniform appearance when equipped, although with 10" and 12" albums.

Watch next issue for the sixth Chapter

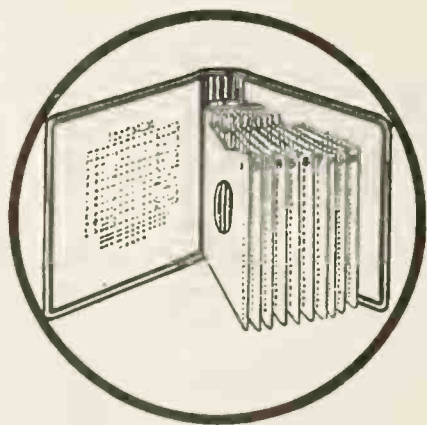

Executive Office
23-25 Lispenard St.
New York, N. Y.

New York Album & Card Co.

Chicago Factory
415-17 S. Jefferson St.
Chicago, Ill.

DISTRIBUTORS:

Boston, Mass.: Boston Talking Machine & Accessories Co.
Chicago, Ill.: T. J. Cullen
Cole & Dunas Music Co.
Cleveland, O.: Cleveland Talking Machine Co.

Milwaukee, Wis.: Yahr & Lange Drug Co.
New York, N. Y.: Plaza Music Co.
Philadelphia, Pa.: Penn Phonograph Co. Inc.

Pittsburgh, Pa.: C. C. Mellor Co.
Standard T. M. Co.
Spokane, Wash.: The Northwest Phonograph Jobbers, Inc.
Washington, D.C.: E. F. Droop & Sons Co.

“Will there be a Victrola in your home this Christmas?”

There's a lot in the power of suggestion, and we are again using this phrase in our advertising to suggest the Victrola for Christmas.

We get the people thinking “Victrola” and every Victor retailer benefits by it.

“Victrola” is the Registered Trademark of the Victor Talking Machine Company designating the products of this Company only.

Warning: The use of the word Victrola upon or in the promotion or sale of any other Talking Machine or Phonograph products is misleading and illegal.

Important Notice. Victor Records and Victor Machines are scientifically co-ordinated and synchronized in the processes of manufacture, and should be used together to secure a perfect reproduction.

Victor Wholesalers

- | | |
|--|---|
| Albany, N. Y.Gately-Haire Co., Inc. | Milwaukee, Wis. ...Badger Talking Machine Co. |
| Atlanta, Ga.Elyea Talking Machine Co.
Phillips & Crew Piano Co. | Minneapolis, Minn..Beckwith, O'Neill Co. |
| Baltimore, Md.Cohen & Hughes.
E. F. Droop & Sons Co.
H. R. Eisenbrandt Sons, Inc. | Mobile, Ala.Wm. H. Reynolds. |
| Birmingham, Ala. ..Talking Machine Co. | Newark, N. J.Collings & Co. |
| Boston, Mass.Oliver Ditson Co.
The Eastern Talking Machine Co.
The M. Steinert & Sons Co. | New Haven, Conn..The Horton-Gallo-Creamer Co. |
| Brooklyn, N. Y.American Talking Mach. Co.
G. T. Williams Co., Inc. | New Orleans, La....Philip Werlein, Ltd. |
| Buffalo, N. Y.W. D. & C. N. Andrews.
Buffalo Talking Machine Co., Inc. | New York, N. Y.Blackman Talking Mach. Co
Emanuel Blout.
C. Bruno & Son, Inc.
Charles H. Ditson & Co.
Knickerbocker Talking Machine Co., Inc.
Musical Instrument Sales Co
New York Talking Mach. Co
Ormes, Inc.
Silas E. Pearsall Co. |
| Burlington, Vt. ...American Phonograph Co. | Omaha, Nebr.Ross P. Curtice Co.
Mickel Bros. Co. |
| Butte, Mont.Orton Bros. | Peoria, Ill.Putnam-Page Co., Inc. |
| Chicago, Ill.Lyon & Healy.
The Rudolph Wurlitzer Co.
Chicago Talking Machine Co. | Philadelphia, Pa....Louis Buehn Co., Inc.
C. J. Heppe & Son.
The George D. Ornstein Co.
Penn Phonograph Co., Inc.
The Talking Machine Co.
H. A. Weymann & Son, Inc. |
| Cincinnati, O.The Rudolph Wurlitzer Co.
Ohio Talking Machine Co. | Pittsburgh, Pa.W. F. Frederick Piano Co.
C. C. Mellor Co., Ltd.
Standard Talking Mach. Co. |
| Cleveland, O.The Cleveland Talking Machine Co.
The Eclipse Musical Co. | Portland, Me.Cressey & Allen, Inc. |
| Columbus, O.The Perry B. Whitsit Co. | Portland, Ore.Sherman, Clay & Co. |
| Dallas, Tex.Sanger Bros. | Richmond, Va.The Corley Co., Inc. |
| Denver, Colo.The Knight-Campbell Music Co. | Rochester, N. Y.E. J. Chapman. |
| Des Moines, Ia.Mickel Bros. Co. | Salt Lake City, U.The John Elliott Clark Co. |
| Detroit, Mich.Grinnell Bros. | San Francisco, Cal..Sherman, Clay & Co. |
| Elmira, N. Y.Elmira Arms Co. | Seattle, Wash.Sherman, Clay & Co. |
| El Paso, Tex.W. G. Walz Co. | Spokane, Wash.Sherman, Clay & Co. |
| Honolulu, T. H. ...Bergstrom Music Co., Ltd. | St. Louis, Mo.Koerber-Brenner Music Co. |
| Houston, Tex.The Talking Machine Co. of Texas. | St. Paul, Minn.W. J. Dyer & Bro. |
| Indianapolis, Ind. ..Stewart Talking Machine Co. | Syracuse, N. Y.W. D. Andrews Co. |
| Jacksonville, Fla. ..Florida Talking Machine Co. | Toledo, O.The Toledo Talking Machine Co. |
| Kansas City, Mo. ...J. W. Jenkins Sons Music Co.
The Schmelzer Co. | Washington, D. C. ..Cohen & Hughes.
E. F. Droop & Sons Co.
Rogers & Fischer |
| Los Angeles, Cal. ...Sherman, Clay & Co. | |
| Memphis, Tenn.O. K. Houck Piano Co. | |



Victrola VI, \$35
Mahogany or oak.



Victrola IX, \$75
Mahogany or oak

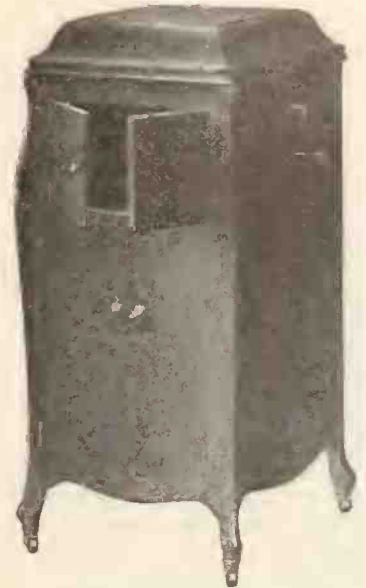

Victrola XI, \$150
Mahogany, oak or walnut



Victrola XVI, \$275
Victrola XVI, electric, \$337.50
Mahogany or oak

Victor Talking Machine Co.

Camden, N. J., U. S. A.



ALL RECORD CUSTOMERS ARE ALBUM CUSTOMERS



MAKING THEIR SELECTION

A Place for Every Record and Every Record in its Place

Albums are an **Indispensable Requisite** in the talking machine business and wherever records are sold. Practical and handy. Save time and records. A **profitable adjunct** to the business.

We manufacture disc Record Albums to fit cabinets of all sizes and styles. With the indexes they are a complete system for filing all disc records.

We have unexcelled manufacturing facilities, and considering quality our prices are the lowest. Write us, giving quantity you may desire, and we will quote prices.

OUR ALBUMS ARE MADE TO CONTAIN VICTOR, COLUMBIA, EDISON, PATHE, VOCALION AND ALL OTHER DISC RECORDS

NATIONAL PUBLISHING CO., 239 S. American St., PHILADELPHIA, PA.

CHICAGO OFFICE: 508 S. Dearborn Street

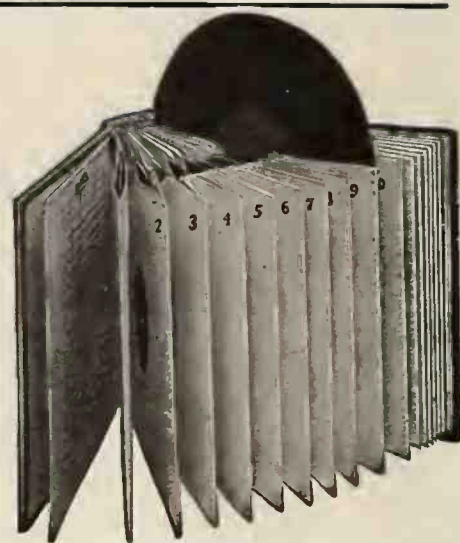

THE PERFECT PLAN

H. C. TRADER JOINS BUEHN STAFF

Well-known Edison Man Now With Buehn Phonograph Co. in Pittsburgh

PITTSBURGH, PA., October 18.—Announcement has just been made that Harvey C. Trader, who is well known throughout the Edison trade in



Harvey C. Trader

the East, has rejoined the staff of the Buehn Phonograph Co., Edison jobbers in this city, and will act in the capacity of field representative. Mr. Trader's experiences since becoming as-

sociated with the Edison business have been wide and varied. In 1914 he joined the staff of more than one hundred field demonstrators then employed by the Edison Laboratories and shortly after succeeded in obtaining the permission of the late H. J. Heinz to demonstrate the New Edison on the famous H. J. Heinz Pier at Atlantic City, N. J. Mr. Trader also has had extensive Edison retail experience.

BAXTER PIANO CO. ENLARGES

The Baxter Piano Co., of Davenport, Ia., has just installed a complete equipment to handle its rapidly growing Victor business. The space devoted to the department is about thirty-five feet by forty feet in the front part of the store, with ten booths arranged along each side. The entire department is carpeted and the furnishings are in mahogany and white.

CARUSO CONCERT IN OMAHA

A large crowd of music lovers of Des Moines, Ia., took advantage of the Caruso concert given in Omaha under the auspices of Mickel Bros. Co., on October 12. Special trains were arranged in charge of H. B. Sixsmith, of Mickel Bros. Co.

MISS EVELYN ASHBY IN CHARGE

Miss Evelyn A. Ashby, formerly of the Morris Sanford Co., Cedar Rapids, Ia., has been given charge of the Crary Hardware Co., Boone, Ia. Miss Ashby has had a number of years' experience in Victor work and is very popular amongst the members of the trade in the State.

EFFECTIVE SIGNBOARD PUBLICITY

Des Moines Victor Dealer Uses Large Sign Opposite His Store to Good Advantage

DES MOINES, IA., November 5.—Chase & West, Victor dealers of this city, are using some very effective publicity exploiting the merits of the



Chase & West Sign Next to Theatre Victrola. One of the most notable features is a large sign painted in colors. This sign, which is pictured herewith, is twenty-five feet square and is located directly across the street from the Chase & West store and next to the Majestic Theatre. The subject of this sign is changed every six months and has been found most effective in bringing in new business to the store.

Most everybody in creation is open to influence by commonsense talk

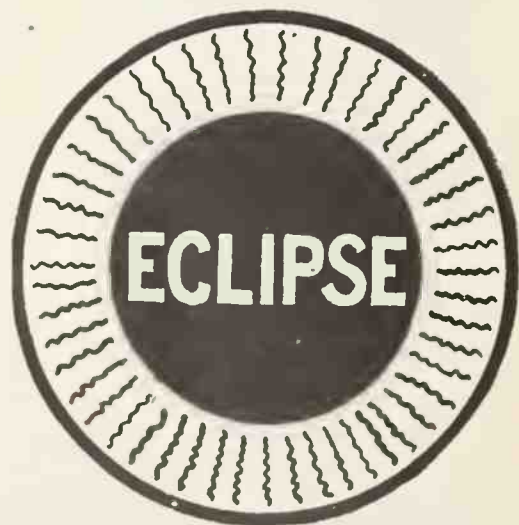

CONCENTRATE!



THE ECLIPSE MUSICAL CO.

Victor Wholesaler

Cleveland, Ohio



Victrola IV, \$25
Oak



Victrola VI, \$35
Mahogany or oak



Victrola VIII, \$50
Oak



Victrola IX, \$75
Mahogany or oak



Victrola X, \$125
Mahogany, oak or walnut



Victrola XI, \$150
Mahogany, oak or walnut



Victrola XIV, \$225
Mahogany, oak or walnut



Victrola XVI, \$275
Victrola XVI, electric, \$337.50
Mahogany or oak



Victrola XVII, \$350
Victrola XVII, electric, \$415
Mahogany or oak



**“Will there be a
Victrola in your home
this Christmas?”**

The big question that gives impetus to your holiday business—that is backed by the force of Victor advertising.

An all-important question for thousands of people all over the country—and for Victor retailers everywhere.

“Victrola” is the Registered Trade mark of the Victor Talking Machine Company designating the products of this Company only.

Warning: The use of the word Victrola upon or in the promotion or sale of any other Talking Machine or Phonograph products is misleading and illegal.

Important Notice. Victor Records and Victor Machines are scientifically co-ordinated and synchronized in the processes of manufacture, and should be used together to secure a perfect reproduction.

Victor Talking Machine Co.

Camden, N. J., U. S. A.



PUBLISHED BY EDWARD LYMAN BILL, Inc.

President and Treasurer, C. L. Bill, 373 Fourth Ave., New York; Vice-President, J. B. Spillane, 373 Fourth Ave., New York; Second Vice-President, Raymond Bill, 373 Fourth Ave., New York; Assistant Treasurer, Wm. A. Low.

J. B. SPILLANE, Editor

RAYMOND BILL, B. B. WILSON, W. B. WHITE, Associate Editors

L. M. ROBINSON, Advertising Manager

L. E. BOWERS, Circulation Manager

Trade Representatives: WILSON D. BUSH, C. CHACE, EDWARD LYMAN BILL, V. D. WALSH, E. B. MUNCH, CHAS. A. LEONARD, SCOTT KINGWILL, A. J. NICKLIN

Western Division: Republic Building, 209 So. State Street, Chicago, Ill. Telephone, Wabash 5774.

Boston: JOHN H. WILSON, 324 Washington Street

London, Eng., Office: 2 Gresham Buildings, Basinghall St. W. LIONEL STURDY, Mgr.

The Talking Machine World has regular correspondents located in all of the principal cities throughout America.

Published the 15th of every month at 373 Fourth Ave., New York.

SUBSCRIPTION (including postage): United States, Mexico, \$2.00 per year; Canada, \$3.00; all other countries, \$4.00. Single copies, 25 cents.

ADVERTISEMENTS: \$5.50 per inch, single column, per insertion. On quarterly or yearly contracts a special discount is allowed. Advertising pages, \$150.00.

REMITTANCES should be made payable to Edward Lyman Bill, Inc., by check or Post Office Money Order.

NOTICE TO ADVERTISERS—Advertising copy should reach this office before the first of each month. By following this rule clients will greatly facilitate work at the publication headquarters.

Long Distance Telephones—Numbers 5982-5983 Madison Sq.
Cable Address: "Elbill," New York.

NEW YORK, NOVEMBER 15, 1920

SHAPING THE FUTURE OF THE INDUSTRY

OUTSIDE influences may be expected to have their effect on conditions in the talking machine industry these days. In fact, they always do to a greater or less extent, but it rests largely with the members of the trade themselves as to what condition the retail trade is to be found in after the holiday rush is over and things have settled down for the new year. The activity and good judgment shown in sales and advertising campaigns, as well as the aggressiveness of these campaigns, will all have weight in shaping the future of the industry.

If the retail advertising in the trade in general is kept on a high plane—if the appeal is made through the lure of music and the quality of the instrument rather than upon prices and terms—the publicity may be expected not only to bring business, but to keep the trade on a high plane and out of the hands of the price-cutter and the long-term specialist. The sales campaign should be conducted along equally direct lines, for even though the supply of instruments should equal the demand, the practice of selling goods on a clean basis, with sales on music and quality, instead of prices and terms, will prove the saving grace.

The retailer who under present market conditions quotes special low prices and long terms in an effort to bolster up business is doing a distinct injury to himself and to the trade in his immediate vicinity, without enjoying any real benefit in the long run. He may build up a temporary volume of sales, but he does so at a sacrifice of profits and arouses in the public a distrust of talking machine prices. The result is not a rush to buy, but rather the development of a tendency to wait a while longer and see if there will not be a reduction in other lines and by other houses.

If the trade enters into the new year with prices and terms firm, and on a basis that will produce the proper margin of profit under prevailing buying and operating costs, then the coming year may be viewed with more or less composure. If, on the contrary, the present season sees a letting down of the bars in the matter of retail selling standards, then the coming year will find the trade in a chaotic condition and in a position to suffer from any untoward general business developments that may appear. Members of the trade generally can best protect themselves and their industry by holding tight, keeping on the right course and maintaining the industry in the high position it has enjoyed in the past.

ANENT THE MAINTENANCE OF PRICES

DURING the month a number of talking machine manufacturers have made it quite evident that they cannot legitimately, and therefore will not, participate in any move for price reduction at this time, because of the fact that there has not been, and apparently will not be for some time, any noticeable reduction in production costs. Official statements have been issued by several manufacturers setting forth their position and announcing that wholesale prices will be maintained.

Labor is the most expensive element in production to-day, and until there is a reduction in labor costs, not perhaps through lower pay, but through the medium of increased efficiency, there can be no material reduction in talking machine or record production costs. The human element enters more largely into the making of talking machines than it does into the majority of products, and therefore labor costs assume increased importance.

Unlike other industries there has been no inflation or profiteering in the talking machine trade. It must be remembered that the manufactured products now on the market, and those that will be on the market for the next six months, have been made at the highest possible cost of production as far as labor, lumber, metals and other materials entering into the manufacture of machines and records are concerned.

The present situation is one that impels a real campaign of education on the part of the manufacturer, jobber and dealer, to the end that the public may be competent to recognize that talking machines of quality and recognized value cannot be produced and sold at lower prices than are demanded to-day.

There exists to-day a tremendous purchasing power throughout the country that is still in a large measure undeveloped, and which can be reached if all the members of the trade realize the importance of getting after trade in a vigorous way and bringing the merits of their products to the attention of the purchasing public in a manner that will win consideration. It is a time that calls for strenuous men—men who are not affected psychologically by the trend in other industries—men who possess absolute faith in the business in which they are engaged and who like to labor in the sunshine rather than in the gloom—men who can plan and work along optimistic, successful lines.

PLANS COMPLETED FOR HOLIDAY BUSINESS

THE talking machine retailer who has not yet completed his plans for holiday business may be said to be distinctly out of luck, for in most localities Christmas buying is already in evidence. The more aggressive retailers have in fact practically forgotten about their holiday campaigns so far as preparations go, for these campaigns have been mapped out and launched, and the only things to bother about now are the results. The question of the moment is not Christmas business, for that will take care of itself, but rather the business that is to be gotten after Christmas—the sales that must be gone after during the period of reaction that usually follows the holidays.

The problems that face this trade for the most part are problems of next year rather than of this. The business building that is going on is for 1921 and the years that follow. Campaigns cannot be inaugurated successfully over night. They require long, careful preparation to insure their success. With the bare six weeks before the New Year rolls around, the problems of the coming twelve months are close upon us. These problems do not apparently call for a revolution of business tactics, but they do call for thought and preparation.

TALKING MACHINE FAVORED FOR DANCING

SINCE the dancing masters at their recent convention in New York took occasion to condemn the prevalence of the craze for "jazz" music as being the cause of questionable forms of dancing, all those interested in the publishing or distributing of music have been busy "passing the buck" and endeavoring to evade responsibility for the naughty, naughty music. The discussion has now reached the point where the talking machine record has been credited with being the real cause for the popularity of the fox-trot and its companion dance, the "shimmy."

Instead of being to the discredit of the talking machine, the fact, in a sense, proves flattering, for it is an admission that the talking

machine record is the greatest medium in the country for bringing dance music into the home. The melody and rhythm offered by the average dance record, played by some noted orchestra, are in the main far superior to the work of local aggregations of musicians. The record, too, brings orchestral dance music into the home and offers a dance tempo that is correct, quite in contrast to the ordinary pounding of a piano, even where a pianist can be found who is willing to offer himself, or herself, as a sacrifice that others may indulge in the light fantastic.

Dance music with so-called "jazz" elaborations is offered through the medium of the talking machine record because the dancing public demands this music. The heavy sales of such records prove that point, for in the catalogs there are to be found many records of less lively dance music that frequently remain upon the shelves of the dealers. Certainly the talking machine cannot be responsible for the sort of dancing that certain types of citizens select to indulge in to the accompaniment of records. Even the stately waltz is to-day used as an accompaniment for forms of dancing that would have given grandma-heart failure.

To condemn the makers of records for the wave of so-called vulgar dancing is as logical as to condemn hardware manufacturers because burglars use, for lawbreaking purposes, the tools they have made legitimately. The great trouble is that the reformers classify all the popular dance airs as "jazz," and yet many of the popular numbers of the day are anything but jazzy in character. They forget that "jazz" describes a method of orchestration and of playing rather than of a type of song. Some mighty staid old classic melodies have been "jazzed" to a point where they make the product of the present-day song writer seem tame and innocuous.

THE BUYER'S MARKET IS NOW HERE

THE business tide is on the turn. The seller's market is giving way, and in many cases has given way, to the buyer's market, but it is gratifying to note that so far the talking machine trade has in all essentials stood firm, to the credit of both those who make and those who sell machines and records. There have been cases of price cutting, and in several cities, particularly in the West, this practice has been generally indulged in. Investigation proves that this backsliding has been due generally to purely local conditions and not to any general wave of price recession. There may come emergencies that demand action in the form of readjustments that shall prove to the disadvantage of the trade, but no such emergency exists at the present time.

Conditions that have affected other industries are, many of them, conditions that in no sense relate to the talking machine or music business and only their indirect effect will be found in this industry of ours. It is time, however, for clear thinking and for putting the business house in order. Careful preparation to meet any eventuality is a sign of good business and not of a panic. The public is buying advertised lines of machines and records—not so rapidly

as a few months ago perhaps—but nevertheless in sufficient quantities to keep business going along nicely. It will be found in many cases that if the money which would ordinarily be sacrificed in price shavings were put into stronger advertising and sales campaigns business would benefit materially thereby.

READJUSTMENT OF WARTIME TAXATION

ONE of the factors that have contributed in no small measure to increased selling cost of talking machines and records is the continuance of wartime taxation, and it is felt generally by business men of the country, and for that matter by the public, that the time has come for a readjustment of Federal taxes in order to lighten the burden on the people as a whole.

The talking machine trade has suffered more than some other industries under the war taxation program, because of the excise taxes that have been levied upon machines and records. These taxes are in addition to the income and excess profits taxes and other levies made upon the business. The prospects are that during the next session of Congress, which convenes in December, the question of having these wartime taxes either materially reduced, or eliminated altogether, will be fought out to a finish. In this fight the members of the talking machine trade will have to do their share and present an organized front to make their demands emphatic.

The Music Industries Chamber of Commerce is already planning a campaign to render assistance in the fight before the next Congress, and it might be well for talking machine interests not already affiliated with the Chamber to seek some means for participating in the work of that organization in tax matters at least.

With the war at an end two years ago, it is about time the business men of the country found out why wartime taxation is still necessary and why further economies in Governmental departments cannot be effected to the end of making extraordinary revenues unnecessary.

GREATER RECOGNITION FOR MUSIC

THAT the daily press of the country is displaying a keener and more friendly appreciation of music, and of the interest held by the majority of readers in matters musical when presented understandingly, is constantly becoming more evident. Not only have several scores of newspapers adopted the policy of conducting regular "Music in the Home" pages for the purpose of treating musical matters in a popular vein, but many newspapers have found it worth while to devote sections of their editorial pages at intervals to a discussion of music, and particularly of a new phase of music and its relation to industrial efficiency and the welfare of the public as a whole.

This new attitude of the press is particularly significant as it is to be accepted as reflecting a new appreciation of music on the part of the general public. If there were no public interest in music newspapers would quickly cease to feature the art.



Copyright, 1920, Silas E. Pearsall Co., New York

Fur Lined Victrolas

I'm all bundled up for helping the winter Victrola circulation. So remember to keep your body temperature at 98°; your Victrola sales at 100° and have your bank account boiling at 212°.

Pearsall Service gives you everything for winter profits except fur lined Victrolas.



SILAS E. PEARSALL COMPANY

DISTRIBUTORS

WHOLESALE ONLY

Victrolas and Victor Records

10 East 39th Street, New York

The Dealer Who Doesn't Hold His Home Trade Should Know the Reason Why :: By Fred Parsons

In the world to-day one seldom receives something for nothing and all things are usually bought and paid for. Especially is this true in merchandising. The man who does business with all his energy and vim doesn't expect to have his neighbors come to him simply because they are neighbors. The local talking machine dealer to-day realizes that he has a product that is valuable, and it is up to him to see to it that he impresses this fact upon the community in which he lives. There is good reason why the local dealer should be given preference—why people at home should trade at home before going elsewhere—but there never was and never will be a good reason why people should do business with their home dealer if he is one of those individuals who howl whenever they find that they are not patronized by everybody. The dealer who is on the job every minute has no time to dream over what might have been. He gets out and works.

If he doesn't get the volume of trade he thinks he should have, then he knows that something is wrong with his methods. He does not begin to complain like a spoiled child—he sets his brain to work to remedy the fault. Instead of allowing his grouch, if he has any, to get the best of his intellect and make him rave over the fact that his friends are going elsewhere with their dollars, he sets to work to head off this straying business and find out just what the matter really is. Take a simple illustration of childhood which everyone will remember. Who is there who does not remember and condemn the "cry baby" of his younger days, who, if he did not get what he wanted immediately, began to wail and refuse to play any more? That sort of baby is the

forerunner of the retailer who makes the loudest noise about the trade going away from home.

The dealer must sit down and look into his business. If his goods and prices are right, then his trade is wandering away from him for some other reason. Perhaps he has made no effort to convince the people that his goods and prices are just and equitable. He may have neglected some small items of service which would have

If People at Home Do Not Buy of the Home Merchant, Something Is Wrong With His Merchandising Plans

saved the day. At any rate, there is some fault somewhere and he is the one who must find it out. The majority of people will not go away from home to trade if they are convinced that they are getting a fair return for their money at the local store. There are always a few who will trade in other places, but the percentage is so small that they should not cause the dealer any concern.

To tell your home people that they should trade with you because you are a home institu-

tion, because you pay taxes there, because you support the church, the town hall, and so on, is not the better part of wisdom. Your argument only strengthens them in their belief that you expect to get their money without giving full value in return. Such talk is not business. People buy where they can find the best market and they are not disposed to support the shirking merchant. Realizing this the live dealer will do everything possible to make his store radiate his own personality and beliefs. He will have his windows attract the attention of the public, and he will have his sales force reflect his attitude. He will make his friends realize by experience that his store is the place where they will get considerate treatment. Experience is the greatest teacher and one or two little things which impress the customer because they are examples of real service will do more than anything else to win that person's trade. Likewise, if the first impression is an unfavorable one, the chances of eradicating it and winning back the trade are very small.

So the local dealer can remember this: if the people at home do not buy of the home merchant, there is something wrong with his merchandising.

A NOVEL VICTOR DELIVERY TRUCK

Mark W. Duncan, Victor dealer of Albia, Ia., has lately purchased a new delivery truck and built a large Victrola which can be fastened to the rear for delivering instruments. The Victrola is thoroughly padded and can be adjusted to hold any size instrument together with a large supply of records.

Sound travels round*

(always has and always will)

AUTHORITIES in acoustics have long recognized that sound travels in spiral or circular waves.

In making the Emerson Music Master Horn *round* the makers of the new Emerson Phonograph have, therefore, simply gone back to first principles. They have, so to speak, taken a tip from Nature.

Not only have they fashioned the Emerson Music Master Horn *perfectly round*. They have taken another tip from Nature, and fashioned it of spruce—*solid spruce*.

From the earliest times spruce has been recognized as the most resonant—the most vibrant—the most sound-amplifying of woods.

The Emerson Music Master Horn is made of specially-selected, kiln-dried,

rounded, resonant spruce—*solid spruce*—*not veneered*.

It is worth while calling attention to the fact that *every* Emerson Phonograph—from the sturdy table model to the most luxurious period model—has this built-in, solid-spruce, round sound chamber or horn—the acoustically correct Emerson Music Master Horn.

Hear the Emerson Phonograph at your earliest opportunity. Note how the Emerson Music Master Horn, by virtue of its peculiar construction, brings out the little musical details so often slighted in reproducing.

Send for loose-leaf catalog describing the new line of Emerson Phonographs, and explaining the scientific principle of the round Emerson Music Master Horn.



MODEL, No. 20

Emerson Record Sales Company, Inc.

Exclusive distributors of Emerson Standard 10-inch Gold Seal Records in the Metropolitan territory

206 Fifth Avenue, New York City

* Elements of Acoustics (Lees), pages 10-11.



Stewart Road Signs

*The Salesman
that Never Tires*

Greet the travelers through your city with this declaration of Victor Supremacy. Let the roadsides reflect your name as an established dealer in the world's greatest musical instrument. Hundreds of Victrola prospects travel the highways in your county *daily*. Appeal to them through this full-color, impressive but inexpensive road sign!

Victrolas EXCLUSIVELY
VICTOR RECORDS

Look inside the lid

If it hasn't this trademark,
it isn't a

Victrola

The World's Greatest

Musical Instrument



Traycrafts
NOBLESVILLE,
INDIANA

An exact replica of a Victor Dealer's Stewart Signs on the Noblesville roads.

**Make Your Name Noted for
3 Years**

Measuring 48 inches by 48 inches with the top panel standing 8 inches above the board, each of these signs is the most impressive advertisement of its size to be met on the road. The display surface is of the toughest known sign metal, weather-proofed with a patented preparation called STABRIGHT. Similar signs are known to keep bright and clear for *THREE YEARS*. The price of each sign is only

\$16.95

*F. O. B. our factory
at Kokomo, Indiana*

ORDERS FOR LOTS LESS THAN 10 NOT
DESIRED. AT THIS RATE 10 SIGNS
WILL FOR 3 YEARS PREACH YOUR
MESSAGE TO THE DRIVING PUBLIC
AT THE COST OF NOT MORE THAN
50 CENTS A MONTH.

Stewart Road Signs are only a part of the
Stewart Sales Service. All forms of sales pro-
motion known in modern advertising methods
available here for Victor Dealers.

Address all orders promptly to

**Stewart
Talking Machine Co.**
Exclusive Victor Jobbers

Indianapolis - Indiana

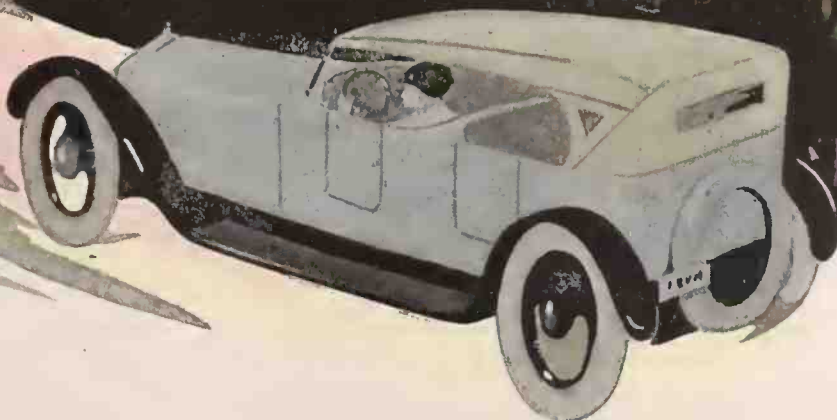

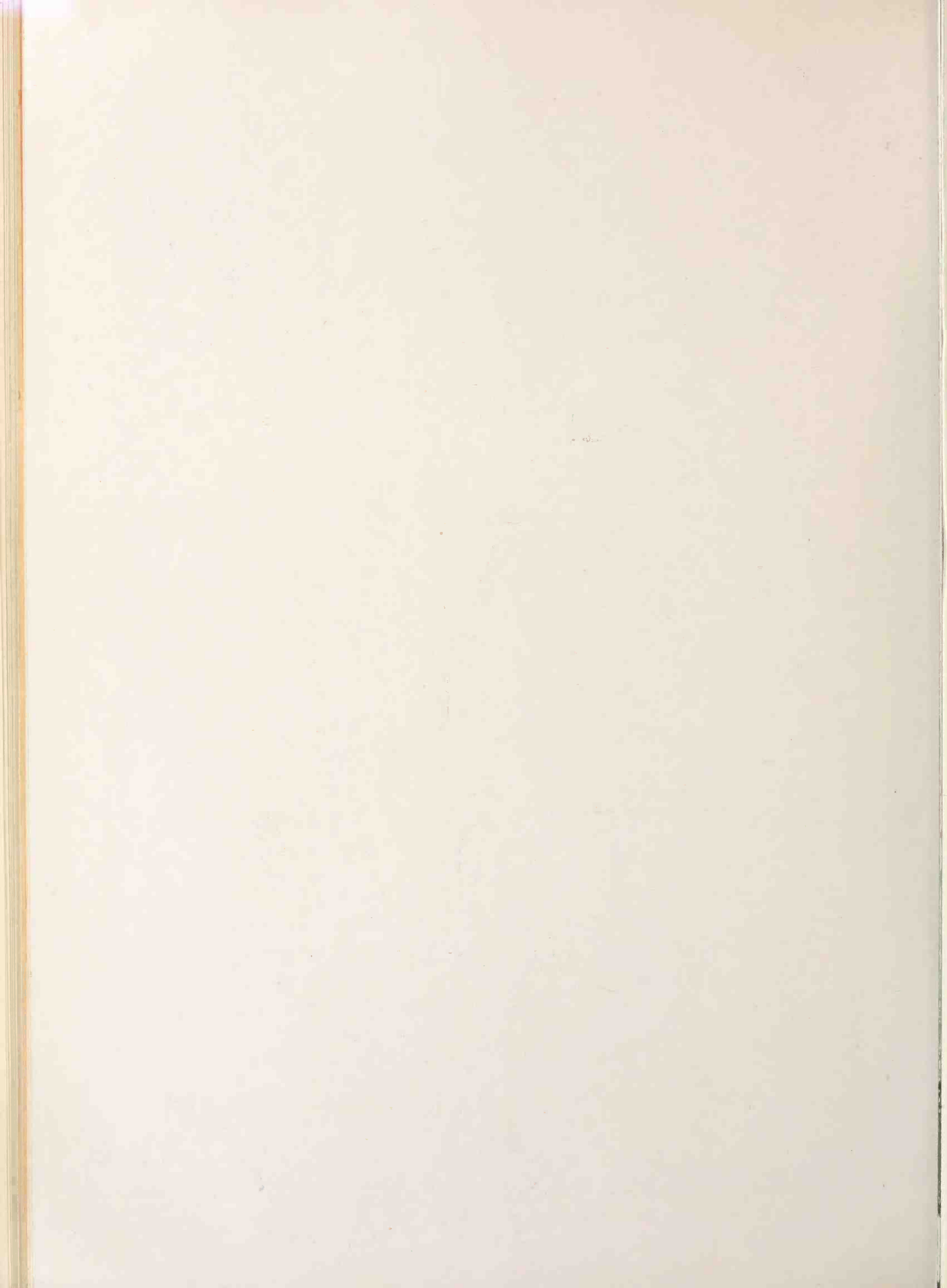

ART DISPLAYED IN STORE ARRANGEMENT AND EQUIPMENT

The Newly Opened Victrola Shop of the Baldwin Co., Cincinnati, Emphasizes How the Classic or Modern Store Makes a Wide Appeal to Discriminating Purchasers

CINCINNATI, O., November 5.—The classic and modern store for the sale of talking machines and records has become a very important part of the retailer's endeavors to-day. An artistic environment associated with this phase of retailing appeals to a distinctly desirable class of trade. The dealer desiring to make a direct approach to a class of customers that will be of value to him should consider that the more attractive his store is made the larger will be the appeal to the real people who are buying machines and records. There's a reason.

The Victrola Shop of the Baldwin Co., the newest store selling talking machines and records in this city, and which was recently opened to the public, as referred to in *The World* last month, is an ideal retail sales-room and demonstration parlor. As the name implies, it will handle Victor records and Victrolas exclusively. The decorations, as can be noted

by the two views herewith, are not only attractive, but they are also artistic. The fixtures of the Adam period are of the most pleasing design and are finished in old ivory. The sales section, for records, is fitted up with a counter and rack, and has easy chairs and a most inviting appearance. There are eleven booths, three of them being set aside for the demonstration and sale of Victrolas, and the others for the demonstration of the records. There is a most complete stock of these carried here, and a specialty is being

made of carrying at all times any records that might be called for.

There is a reception room in the rear of the store and here one may rest and find comfort while being shown a machine, or enjoy a little rest while on a shopping tour. The interior has been made "different" from many other stores of this kind, and an air of refinement and coziness prevails that is soothing and at the same time an inviting one to the public.

One feature noted here is the display in glass closed panels of the records issued for the past three months, so that the customers can tell at a glance what has been issued by the manufacturers in the present and two preceding months. The entire setting is artistic and offers a place of cheery surroundings for the trade aside from being the last word in interior setting.

Something in the way of an innovation has

been adopted in the selection of the members of the salesforce. They are educated in music and are familiar with the operas and other classic selections. In this way they are able to tell the customers something of the history of the pieces being demonstrated or asked for, and are



General View of Baldwin Victrola Shop—Booths in Rear



Baldwin Reception or Rest Room

able to assist in the choice of any high-class record that is called for. This is an idea that can be made to bear fruit, as the salesforce is fully equipped with the essential knowledge to help the customer make an intelligent selection.

The store is under the management of Sherman B. McLaughlin, who has recently come from New York, where he was identified for four years with the John Wanamaker establishment. Some years ago he was employed by the Baldwin Co., and is, therefore, familiar with the methods employed here. The store adjoins the piano house of the above company on Fourth street.

THREE ELEMENTS IN EVERY SALE

Every sale is composed of three parts:

- 1.—The approach.
- 2.—The demonstration.
- 3.—The close.

It doesn't make any difference whether the approach consists of two words, "Good morning," and the demonstration—"Here's the goods, you need them," and the closing—"Sign your name here," these three elements are in every sale of talking machines or records.

Warren G. Pollard has just entered partnership with Harry Clarke, Victor dealer at Anamosa, Ia.

TRANSPORTATION



DIFFICULTIES disappear for our customers in spite of the shortage of 350,000 freight cars. ¶ This new truck, the latest addition to our equipment, hauls Victrolas and Victor Records from the factories at Camden to our headquarters in Newark. From this point they will be distributed to dealers in Northern New Jersey and Northeastern Pennsylvania only, insuring uniform service. . . .

BRIGGS

COLLINGS AND COMPANY

VICTOR DISTRIBUTORS

CLINTON & BEAVER STS. PLUM BUILDING NEWARK, N. J.

Columbia

Doubly Welcome

Now we have special Christmas envelopes, with an appropriate and beautiful design in color, in which to enclose the Columbia Records your customers buy as Christmas gifts. Our wide, effective Christmas advertising in the newspapers and magazines is your surety and guarantee that Columbia Records as Christmas gifts are now recognized and welcomed from coast to coast. Put some of



In a Christmas

Records

Christmas Gifts

these Christmas envelopes filled with your choicest Columbia Records on your counters and in your windows where they can be seen. Their cheery colors will stimulate trade and clinch many extra sales this holiday season. If you display these envelopes you'll find that many strangers and regular customers will do all their Christmas shopping right inside your store.

COLUMBIA GRAPHOPHONE COMPANY
New York
Canadian Factory: Toronto

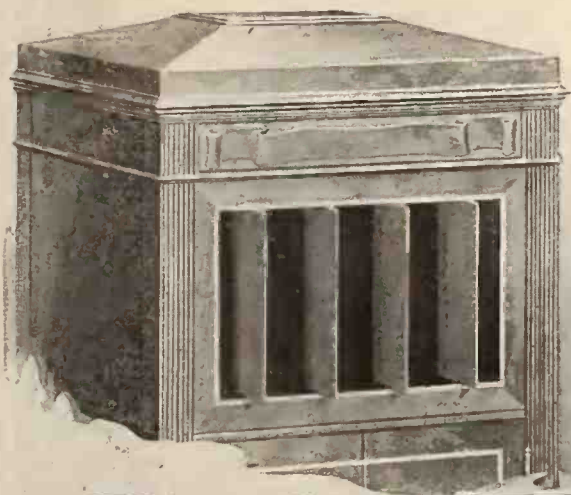

Gift Envelope

One of Several Dozen

Letters
received
by us
from en-
thusiastic
Jobbers
and
Dealers

It
will
pay
you
to

STOCK REFLEXO BLUE STEEL NEEDLES

*(Write for Samples and Prices
of Reflexo Needles and Polish)*

REFLEXO PRODUCTS CO., Inc.

347 Fifth Avenue

At 34th Street New York City Suite 1003

Canadian Distributors: The Musical Mdse. Sales Co., Toronto
Foreign Export: Chipman Ltd., 8-10 Bridge St., New York City

"With the desire to serve our community in every possible way, we dedicate this big Department Store to you."

H. H. SCHROEDER, PRESIDENT
R. W. HALBACH, VICE-PRESIDENT
E. F. HALBACH, SECRETARY
GEORGE GABRIEL, MANAGER



May 28, 1920.

Cole & Dumas Co.,
54 W. Lake St.,
Chicago, Ill.

Gentlemen:

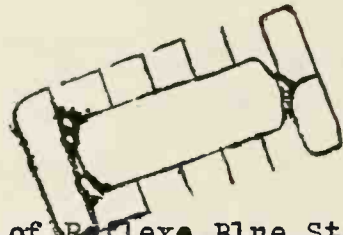

We received your box of Reflexo Blue Steel needles and to say the least we believe them to be far better than anything we have yet tried.

We believe you will make no mistake in handling them as they have only been on our counter two hours and we have sold over a dozen packages.

Kindly send us another box.

Yours very truly,

HALBACH SCHROEDER CO.

EHW/HKL

E. H. Williams
Per.....
Manager Sales and Service Department
for Brunswick.

The
"BLUE STEEL" NEEDLE
that "Holds the Record" for popularity

PLAYS TEN RECORDS

Single Idea Window Display Most Effective in Selling Machines and Records :: By Walter Fay

It would not do, of course, for the talking machine dealer to inform his customers and prospects that they had one-track minds, unless he was desirous of quitting business suddenly, but the fact remains that in presenting his machines and records for the consideration of prospective customers through the medium of window displays or newspaper advertising, the dealer who works on the theory that the majority of people have one-track minds and therefore presents for their consideration only one type of machine and one special record at a time, will be surprised at the results.

There is a distinct tendency among those in the trade who give particular thought to their advertising and window displays to concentrate on one article or upon one thought, for by so doing they find that they are able to drive a particular idea home with greater force. A dozen or two of the popular records may be placed in a window, and a number of sales result. If only one record is featured, however, it will be found that the sales of that particular record will jump to big proportions, and proper salesmanship can be relied upon to keep the other records on the list moving at the same time.

It seems as though the average person hates to take the time and trouble of reaching a decision in the matter of making a purchase, and when a dozen or so records are displayed, each with some strong advertising matter, the passer-by may stop to look, but does not take the trouble to select from the dozen a record that makes a special appeal and then go in and buy it. If, however, one of the popular records from the current month's list is made the center of an effective window arrangement, the passer-by has only one thing to think about and is more inclined to come in and buy. This is not a matter of theory, but an established fact, and the result is that a surprisingly large number of talking machine retailers go to considerable trouble to feature one record with particular emphasis in their advertising, depending upon that record to bring the customer into the store where he can be approached on other numbers.

There are some records, of course, that lend themselves most happily to special window displays. The latest of these perhaps is "The Love Nest," and scores of dealers took occasion to

place in their windows their own conceptions of what the song is supposed to typify. But there are others just as adaptable.

There is hardly a talking machine salesman who has not had the experience of playing over fifteen or twenty records for a customer who came in undecided as to just what was wanted, and then found that with so many records at hand the customer could not make a final decision. Where the range of selection was limited to half a dozen records or so he found that the proportion of sales was much higher, there being less room for debate.

To declare in advertising that machines range in price from a few dollars to several hundred

Concentration in the Window Display Helps Customer Make Up His Mind and Saves Dealer Much Time and Effort

dollars means nothing to the prospect unless he can see what machines are offered at the price he is able to pay. Here, too, it is found that the attractive featuring of one type of machine, with the price and terms plainly stated, and its appropriateness for certain surroundings and purposes explained, proves more effective than the indiscriminate advertising of a poor line. With the machines featured one at a time, the prospect is pretty sure in the long run to have brought to his attention one particular model that in size, price and general adaptability is calculated to meet his individual requirements. For the dealer who does not believe in concentration, a study of the merchandising efforts in other lines should prove profitable.

In haberdashery he is shown many cravats, but as soon as he indicates the type he prefers, he finds offered him for selection two or three

cravats. The salesman knows that he can select one from the three in a few minutes, but to select one from the entire stock might require an hour. The shoe salesman never dumps his entire stock in front of the customer. He first finds out the sort of shoe favored and then brings out one pair at a time. The same rule holds good with the tailor if he knows his business.

In selling merchandise, as in anything else, the wise way is to strive to please the majority, therefore working on the basis that the majority of people have one-track minds when it comes to selecting their purchases means following the line of least resistance.

JOSEPH SHEA NOW A BENEDICT

Editor of The Tonearm Marries Miss Angela Campana in Bridgeport, Conn.

BRIDGEPORT, CONN., November 4.—The wedding of Miss Angela Campana, daughter of Mr. and Mrs. Charles N. Campana, of Myrtle avenue, and Joseph Shea, editor of The Tonearm, published by the Columbia Graphophone Co., took place yesterday at the Sacred Heart Church at 9 o'clock.

Mrs. Anthony Gallagher, nee Miss Elsie Campana, attended her sister and Mr. Gallagher acted as best man. Following the ceremony, a breakfast was served at the Campana residence for the immediate families and a few friends. After a honeymoon trip the couple will make their home on Haddon street.

CHANGED TO PIERINGER & BENEDICT

The firm of J. S. Pieringer, Bedford, Ia., has been changed to Pieringer & Benedict. The Victor business has been growing to such proportions that Mr. Pieringer found it necessary to have assistance in order to give the business the attention it deserves. Mr. Benedict is with the Benedict Piano Co., which conducts stores in Clarinda and branches in a number of towns in southwestern Iowa.

Slipshod management begets slipshod help, and carelessness even in the smallest details is never unnoticed by the employer.

The Sort of Service

THAT MAKES FOR

Better Victor Merchandising

—DITSON—

VICTOR EXCLUSIVELY

OLIVER DITSON CO.
Boston - - - Mass.

CHAS. H. DITSON & CO.
New York - - - N. Y.

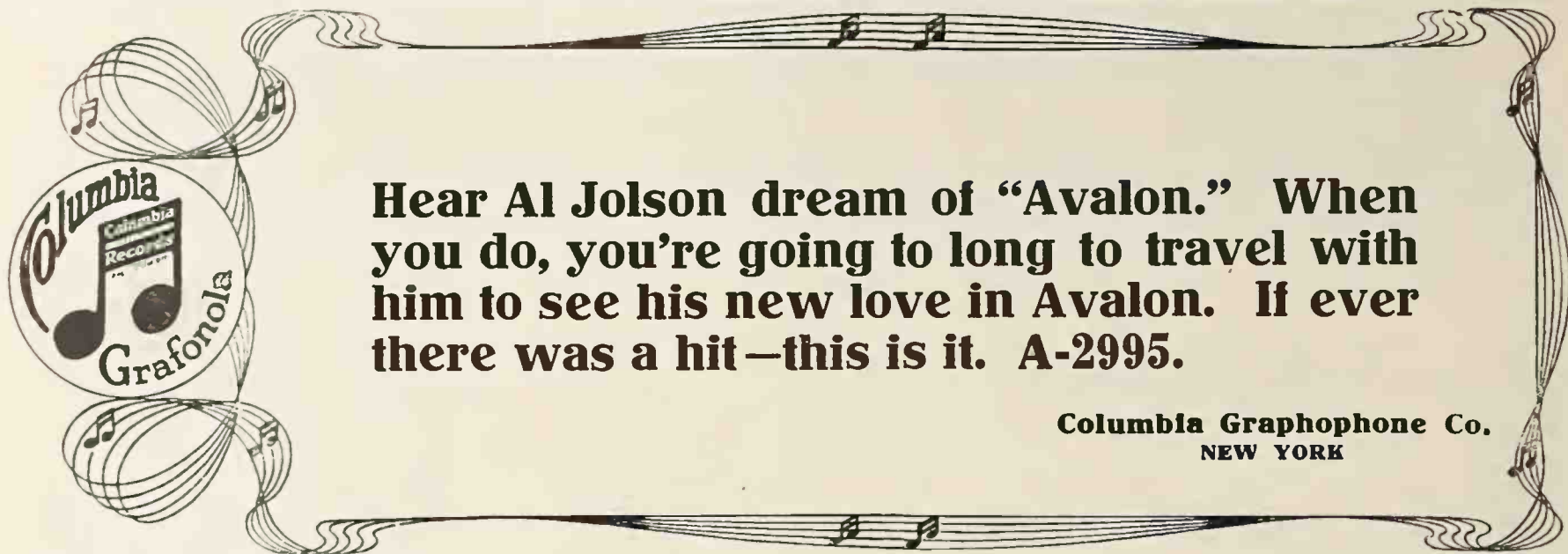

Hear Al Jolson dream of "Avalon." When you do, you're going to long to travel with him to see his new love in Avalon. If ever there was a hit—this is it. A-2995.

**Columbia Graphophone Co.
NEW YORK**

OPENS VICTOR SHOP IN DALLAS

Corpus Christi Talking Machine Man Now Has Attractive Dallas Establishment

DALLAS, TEX., November 5.—The Lester Gunst Co. has opened an exclusive Victor shop here at 1018 Elm street with Lester Gunst in charge. Mrs. Waskom and Miss Darnell are assistants, both of whom have had valuable experience in their chosen line and large personal acquaintance in Dallas. Mr. Gunst comes from Corpus Christi, where for a number of years he was engaged in musical merchandising. He has fitted his shop in especially good taste, distinctive in design and in color treatment.

The architectural design of the interior fittings is a mixture of the Colonial and Gothic. The woodwork is paneled and the tops of the panels are in base relief. Several pillars carry out the Colonial effect.

The general color scheme is old English ivory and the new shade of French lemon. The hangings are taupe and Bavarian blue and beige and the carpet taupe. The electric fixtures consist of side brackets and assist materially in creating a beautiful harmony of light and color.

There are six demonstrating salons furnished in wicker with cretonne covers, and the entire establishment has a most artistic atmosphere.

NOW TESLOW MUSIC HOUSE

Kellogg Music House at Cresco, Ia., Sold to Herman A. Teslow

Herman A. Teslow has just purchased the business of the Kellogg Music House, Cresco, Iowa, and in the future the business will be known as the Teslow Music House. Both Mr. and Mrs. Teslow are graduates of the Mickel School of Victor Salesmanship. The store has been completely renovated and is considered the best equipped music store in Northwestern Iowa.

SUGGEST NOON-HOUR CONCERTS

Spare Half-hour After Lunch Might Be Utilized by Dealer for Daily Record Concerts

In the "Suggestion Department" of System for October T. F. Moriarity presents the following "tip" for dealers who desire to expand their business:

"I would arrange for two or three entertainments each week, starting at 12.30 p. m. and ending at 2 o'clock. Some of the latest records would be played, as well as those that might be requested from the audience."

"To attract a crowd I would send announcements around to the manufacturing plants, business offices and stores and would invite all music lovers to be present for the entertainments."

"Since most people lunching out at noon have half an hour or more to spend after they have eaten, I'm certain that my store would be well filled at each performance by people really interested in records; people who had come to buy, provided I could present the proper incentive to buy."

"When the public could be certain that there would be an entertainment each rainy noontime they would depend on my store as a pleasant place to pass their spare time. Instead of waiting impatiently at their eating place or going back early to their work they could take advantage of my invitation and pay my store a visit."

"It's only natural that these little performances would attract extra business for me and would advertise my place throughout the city. And, best of all, my investment would not need to be large."

J. M. ROSS IN IOWA TERRITORY

James M. Ross, of the traveling department of the Victor Co., has been assigned to Iowa for this season. His work will keep him in Iowa for a few weeks before he leaves for a short visit with the Nebraska dealers.

McCOY'S A GENERAL MUSIC HOUSE

Hartford Establishment Carries Out Beliefs of Manager A. P. McCoy in Attractive Manner

HARTFORD, CONN., November 5.—A. P. McCoy, manager of McCoy's, of this city, is an ardent enthusiast over the general music house idea. The warerooms on Asylum street carry out this theme in a striking manner. McCoy's carries Victor talking machines, Kranich & Bach, Knabe, Mehlin, Estey, Ludwig, Laufer and Kurtzmann pianos and also conducts large sheet music and player roll departments as well. The musical merchandise department is advantageously situated immediately at the right of the main entrance and faced by the sheet music department. The balance of the main floor is given over to the talking machine department. Unico demonstration rooms and record-filing equipment have been installed throughout and this, together with tasteful hangings and decorations, gives a very pleasing effect. The piano salons occupy the entire second floor and vie with the talking machine department in their attractiveness. The third floor is devoted to the player-piano and music roll departments. Three sound-proof demonstration rooms have been installed. The fourth floor is devoted to the repair department. The lighting effects on each floor are a strong contributing factor in the general attractive appearance of the warerooms.

Manager McCoy reports that, although these warerooms were opened only a few months ago, they have been firmly established in the foremost ranks of the music trade of this city. Their patronage already includes some of the most influential people in the city and the volume of business transacted has passed all expectations. Mr. McCoy is very enthusiastic over the future and is planning an energetic campaign to cover the holiday season.

W. P. Moore has opened a modern music store in Hartsville, S. C.

Mr. Dealer are you selling the Record Flasher? It is very much in demand and invariably sold when properly presented to your customers.

The Record Flasher is easily attached to any phonograph; it gives an abundance of illumination, it makes cumbersome operations easy and simple in darkest corners where phonographs are usually placed.

Beautifully finished in Nickel and Gold.
Packed (12) to a unit package may be assorted.

RETAIL PRICES { Nickel finish without battery - \$2.25
Gold " " " - \$3.00
Batteries each - - - - - \$.75

Regular Trade Discounts to Dealers.
When writing always mention your distributor.

Manufactured by

STANDARD ACCESSORY CORPORATION
355-357 East Water St. - - - - - Milwaukee, Wis., U. S. A.

ORDER FROM YOUR JOBBER

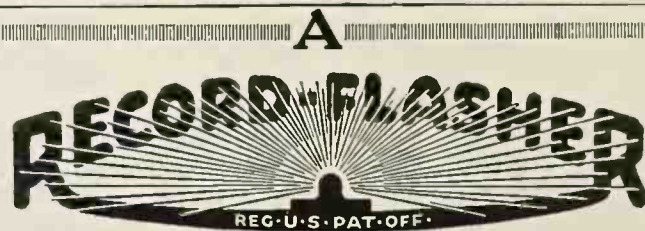

SHOULD BE ON EVERY TALKING MACHINE

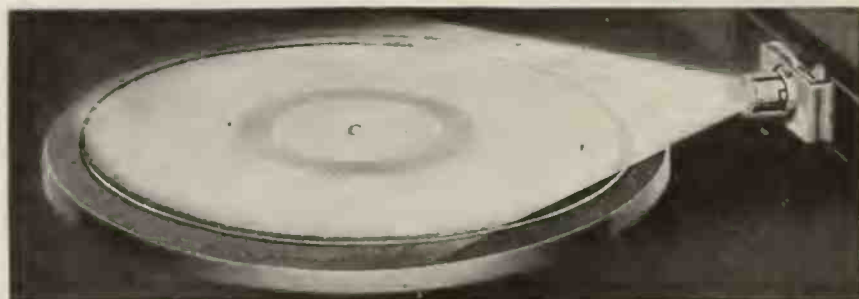

IT'S NECESSARY—VERY NECESSARY

The Heywood-Wakefield

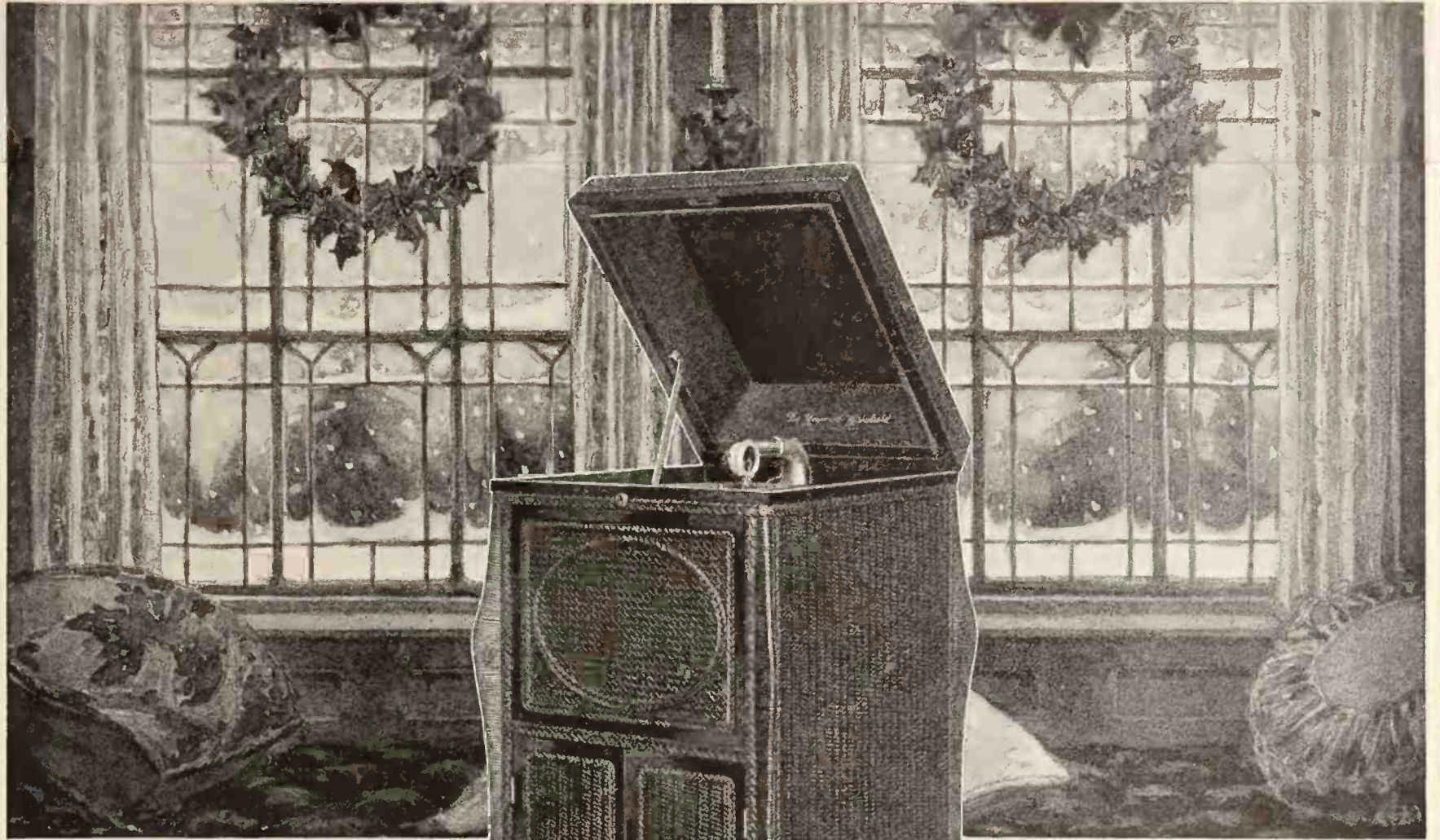

AT Christmas, more than at any other time, a multitude of shoppers are seeking for something that is different and beautiful.

In the Heywood-Wakefield your customers will find an instrument with a rare beauty of tone and remarkable decorative qualities.

Its cushioned reproducer, built to parallel the human organs of sound, brings out every detail of a record, no matter how delicate, with perfect ease. Its non-

resonant cabinets of reed are artistically fashioned, and finished in many different color schemes. Your customers may choose any cabinet colored to harmonize perfectly with their own style of furniture.

Progressive merchants realize the advantage of having this instrument in their Christmas line.

The Heywood-Wakefield is made under the Perfek'tone patents. For details of models, prices and specifications, address today the nearest office of

HEYWOOD BROTHERS AND WAKEFIELD COMPANY

New York Philadelphia Boston Baltimore Buffalo Chicago Portland, Ore. San Francisco Los Angeles

Factories: Gardner, Mass.; Chicago; Wakefield, Mass.

When you visit Atlantic City see all models of the Heywood-Wakefield at the Perfek'tone Store, 517 Boardwalk

Sales of Music in Combination With Records Prove Most Successful With Many Dealers

Some time ago an article appeared in The Talking Machine World anent an inquiry from a dealer who suggested that it would be a good plan to furnish the words of the songs demonstrated on records in the talking machine stores. It was pointed out at that time that the words of the songs are usually copyrighted and their unauthorized use would make the dealer liable to a heavy penalty. Considering the subject in a broader way, the idea, however, has much merit, and in commenting upon it, The Puritan describes the plan of one dealer as follows:

"Still, the advantage of having the words, exactly as engraved in the record, clearly printed and available for anyone who wanted them, so strongly impressed a Kansas music dealer that he obtained the names of the publishers of every vocal selection represented by the new records he received, and the price of the sheet. With this list before him he was able to direct buyers of records to the publishers of the words and music.

"Some people would think that it would have been better to obtain the printed words and music and sell them direct, but the dealer believed that this would involve the carrying of a great quantity of sheet music for which he might not have a ready sale, and he contented himself with the list referred to, as a starter.

"In the music stock of this store, however, the dealer had the vocal score of many of the best operatic selections and well-known songs. He listed these to correspond with his record stock list, and when a person bought a record of which he had the printed words it was a very easy matter to sell both the record and the words and music.

"There is no doubt that the enjoyment of a new song (or an old one, for that matter) is considerably increased by knowing the words as the record is played. It is a great temptation also for the listener to 'sing it' with the talking machine, if he can sing at all. It is a delightful pastime also for a few members of a family to follow the singing of a fine

Handling the Music of the Records Opens Up a Trade Field That Is Not Only Interesting But Often Profitable

quartet, duet or chorus, and it is well worth the dealer's while to introduce this agreeable diversion in his store, because it leads to sales of both record and music.

"It needs very little explanation. When a record is chosen by a customer the sales person consults his list, and finding that he has the music, informs the customer that 'We also have the words and music of this record; would you not like to have it so that you can follow the words exactly?' Or, when a piece of music is being sold, tell the buyer that 'This piece has

been reproduced on the ——— phonograph, would you like to hear it?' If the party owns a machine the chances are good that he will buy the record.

"It requires some intelligent work to carry out this plan, because the maker of the records must give the name of the publisher of the exact words sung in the particular record, unless it is a standard selection, when it can be found through the usual trade lists kept in every well-managed music store. Other talking machine dealers will, of course, have to do more hunting but it will repay them for the trouble."

This is a species of service that involves some trouble to the dealer or salesman, but it means the opening up of a wide sphere of knowledge and where the dealer installs sheet music it means the development of a very nice and profitable side line without the investment of a great deal of money.

The talking machine record to-day is an educator. It virtually brings the singers of songs into the home, and those who hear them are just as anxious to have the words and music of these songs as if they had heard these same artists in the flesh in grand opera or a vaudeville theatre. The possession of the music makes the record more interesting and at the same time it often affords an opportunity to the buyer of the music to accompany the singer of the record on the piano in his own home. Thus the handling of sheet music in conjunction with records opens up a field that is most interesting.

The man who forgets to call loses the largest order. The Lucky Man gets it. Be mindful.

— S t r a t f o r d —

THE SHAKESPEARE OF PHONOGRAPHS



Natural and Perfect Reproduction

is an outstanding feature of the STRATFORD. With it you are assured of natural quality and volume; of purity and clearness of tone; of the actual reproduction of the original selection.

No foreign tone is added; no natural tone is eliminated—but there is reproduced—

exactly what is on the record.

It is the phonograph the trade has wanted—because it is the phonograph which satisfies the desire for the best.

DEALERS

GET OUR PROPOSITION
IT WILL INTEREST YOU

THE STRATFORD PHONOGRAPH COMPANY
ASHLAND MANUFACTURERS OHIO

OKeh Records

Mr. Public Opinion

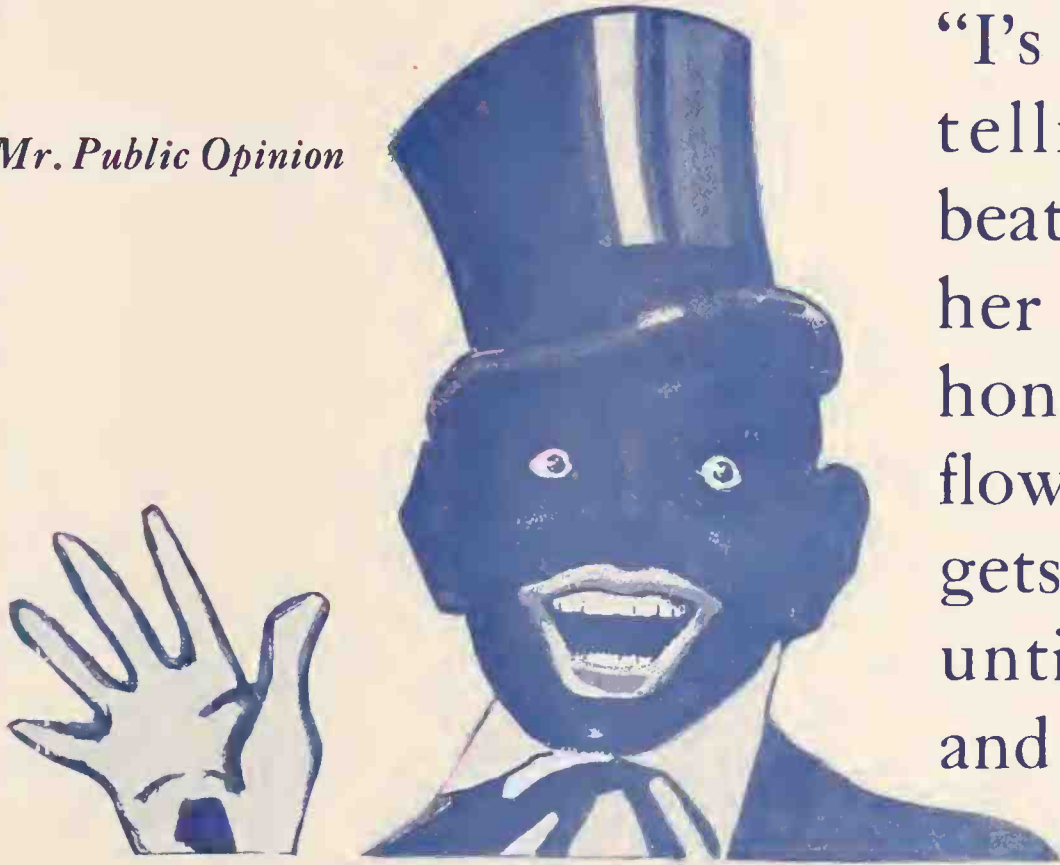

"I's heard Blues, but I's telling you **Mamie's** beats 'em all. O! man, her voice is as sweet as honey! It jes flows and flows and ev'ry note gets richer and richer until I can just sit back and expire with joy."

MAMIE SMITH BLUES

- | | | | |
|--------------------------|---|--|---------------------------------|
| 4113
10 in.
\$1.00 | } | THAT THING CALLED LOVE | Mamie Smith with Orchestra |
| | | YOU CAN'T KEEP A GOOD MAN DOWN | Mamie Smith with Orchestra |
| 4169
10 in.
\$1.00 | } | CRAZY BLUES | Mamie Smith and Her Jazz Hounds |
| | | IT'S RIGHT HERE FOR YOU (If You Don't Get It—
'Taint No Fault O'Mine) | Mamie Smith and Her Jazz Hounds |

GENERAL PHONOGRAPH CORPORATION

OTTO HEINEMAN, President

25 West 45th Street New York City, N. Y.

Factories: Newark, N. J. Elyria, Ohio Putnam, Conn. Springfield, Mass. Kitchener, Ont.

Branch Offices: Chicago, Ill. Toronto, Can. London, Eng.



VICTOR ARTISTS WIN ST. LOUIS

"Best Sellers" in Personal Appearance Attract Immense Audience in Sainly City—Local Victor Dealers Pleased at Success Attained

St. Louis, Mo., November 3.—The Victor dealers of this city scored most emphatically in the appearance recently in this city of the "Eight Victor Artists" in person. A huge audience heard these artists, so popular with the users of Victor records at the Odeon, and the story of "how they were made to work overtime" is so well told by the well-known critic, Alfred C. Wegman, in one of the local papers that it is worth repeating in part. Mr. Wegman pointed out that this entertainment made St. Louisans aware of the fact that the "open season" for concerts is now on, and added:

"Talking machine devotees put down \$2.20 per seat at the box office much in the same spirit in which the movie fan pays a high price to see the screen favorite on the stage.

"The artists may be heard quite as well at home by means of the Victor record, but evidently, as when screen stars are under consideration, the people seized the opportunity to come into closer contact with their favorite. Some of the enthusiasts were not content to merely hear their pet records personally delivered, but flocked 'back stage' during the intermission to shake by the hand these 'best sellers.'

"Billy Murray, tenor, who puts over the 'snappy stuff,' and who, on this occasion, introduced all the 'artists,' himself included, seemed to be the prime favorite, on and off the stage.

"He held an impromptu reception 'behind,' while on the stage he held 'em in the hollow of his hand. He scored especially big when he celebrated in song, and by expressive movements, the charms of his 'Little Bimbo Down on the Bamboo Isle,' and he won 'em also with the 'A B C D Blues' and other lively ditties.

"For all of the singers, and for the instrumentalists, the numbers programmed served merely as starters. Two or three numbers had to be added by everybody to satisfy the clamorous crowd.

"Henry Burr's mellifluous tenor pleased particularly in 'Blue Diamonds,' which was one of the several sentimental ballads with lilting refrain delivered by him. He came together with another tenor, Albert Campbell, in 'Feather Your Nest,' and the two had to sing the refrain at least three times before Monroe Silver was allowed to come on for his famous Cohen songs and stories.

"Campbell, Burr and John Meyer, baritone, make up the Victor's 'Sterling Trio,' and with Frank Croxton added they become the Victor's 'Peerless Quartet.' These singers submitted late favorites, and 'Swanee' was so riotously received that they followed it up with more quartets of the same kind.

"Frank Croxton used his rich bass in negro songs of a religious flavor, of which 'Dah's 'Gwintter Be a Lan'slide' was the one programmed.

"The excitement created by the singers was

evidently not unexpected, as the 'boys' all had extra numbers ready, which they seemed very willing to contribute.

"The instrumentalists, however, also came in for a big share of the enthusiasm. Fred Van Eps showed what can be done with, and to, a banjo, and Frank Banta, in the words of Mr. Murray, 'stepped on the dominos.'

"Mr. Banta's accompaniments were always sufficient and never spilled over in the least. He showed rare discrimination and repression whenever he formed the background for the singers, but cut loose with much spirit in a 'futuristic rag,' entitled 'Cubist.' The success this won brought forth more piano solos—jazzy tunes interlarded with what is the popular idea of modern harmonies, and all in syncopated rhythm. It all lasted two hours or more, but nobody made a move to leave the hall until the curtain fell on the last number."

TO REPRESENT THE 'ELECTROPHONE'

H. K. Lorentzen of New York Appointed Eastern Distributor of This Electric-Driven Phonograph—Speaks of New Connection

H. K. Lorentzen, 60 Grand street, New York City, who for a number of years has specialized in an exclusive line of talking machine cabinet hardware, was recently appointed Eastern distributor of the "Electrophone," manufactured by the Lakeside Supply Co., Inc., Chicago, Ill. The Electrophone is a cabinet machine with an electric-driven motor, perfected in a manner so as to allow the mechanism to be driven on any current. The new distributor has made arrangements in his local plant to demonstrate the various "Electrophone" models, and a large number of machines have been placed with representative dealers in the metropolitan districts.

H. K. Lorentzen, head of the above firm, in speaking of the Electrophone, said: "These machines are of the highest quality, and the motor is exclusive and meets the requirements of all technical experts. Our decision to take over this line was only made after a thorough investigation of its merits. The success the manufacturers have already had with this machine demonstrates it as a product having great salability. The holidays are close upon us, and we expect to realize a large volume of business from the distribution of this machine in connection with our already well-known line of cabinet hardware and accessories."

INSTALLS UNICO EQUIPMENT

The Arnold Jewelry & Music Co., of Ottumwa, Ia., has just installed a complete Unico equipment consisting of four booths, record racks and record counters. A space approximately twenty feet by fifty feet has been devoted to the department and Miss Nellie Kirkhart has been placed in charge of the department. Carl Dalin is manager of the store.

The Cheshire Music Co., Rockford, Ill., has increased its booth capacity to ten, all of which are handsomely equipped.

TOYS for CHRISTMAS

Immediate Shipments

Something for the Children at Christmas That Brings in the Parents and Makes You New Customers

It will pay you to show these novelties dancing in your windows from Thanksgiving to Christmas.

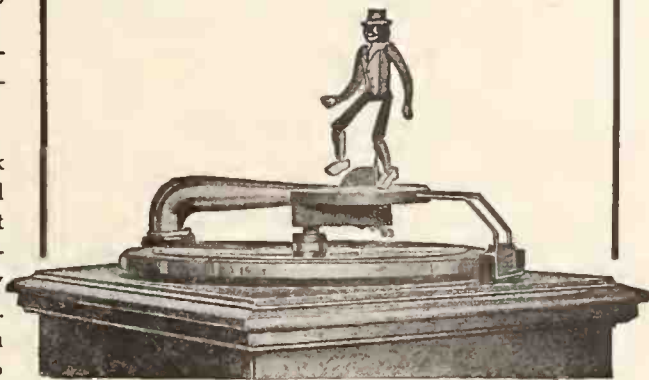

RAGTIME RASTUS
PATENTED MARCH 16, 1915.

An Automatic Dancing Darky Doll for Talking Machines

Rastus does one hundred different steps while the music is playing. Delights Children and amuses the older people, too. The funniest dancing toy ever made. Attractively painted in four colors.

Ragtime Rastus, Item 100A \$1.65

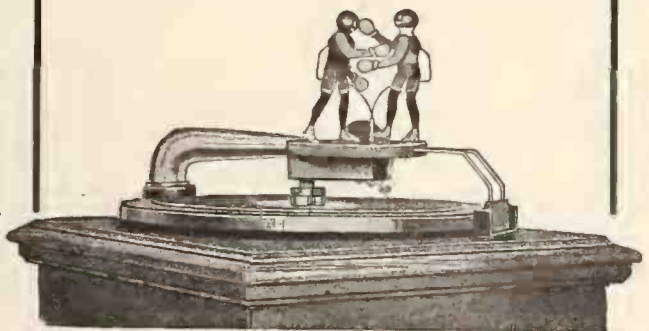

THE BOXERS
Patented March 16, 1915

Amusing Novelty for Talking Machines

These little Boxers are very realistic and create lots of fun. They do all the different blows and steps known. Put on a good lively record and these little figures box away in lively fashion

Boxing Darkies, Item 100B \$1.75

Combination Rastus and Boxer

Two Toys in One—Our Biggest Seller

Dancing Rastus and Boxing Darkies, the two sets of figures combined with one dancing mechanism. All in one box. Very popular.

Combination Rastus and Boxers
Item 100AB \$2.00

NOTE: These toys fit standard machines and can be put on or taken off in five seconds and do not injure record or mar machine. Fit all Columbia and Victor models. Edison machine requires special disc, 25c. extra.

Wholesale and Export discount in dozen lots of one kind or assorted 33 1/3%. In 3 doz. lots of one kind or assorted 40%.

NATIONAL COMPANY

Mechanical Specialty Manufacturers
Cambridge 39 BOSTON, MASS.



AUTOMATIC STOPS

The simplest and most efficient Automatic Stop on the market. They give excellent service, are easily installed and are absolutely guaranteed.

Send 50 cents for Sample Stop

Kirkman Engineering Corporation
484-490 Broome St., New York

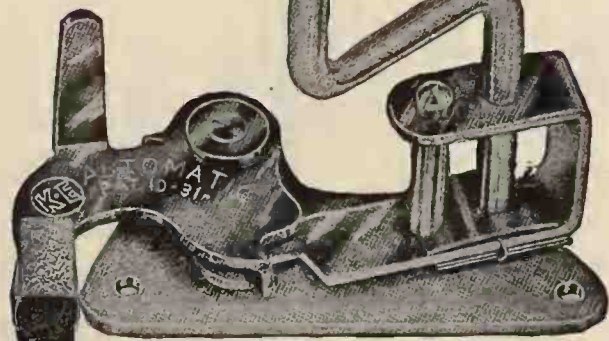

Announcing a New Victor Sales Promotion Service

Two Victor Windows Each Month

for **\$1⁰⁰** per day

Window trims worked out by experts and distributed exclusively by "Standard" in this territory. Spectacular, brilliant windows that dovetail with the Victor national and local advertising, and attract to your store the business created by this advertising.

Does not require a window expert to erect. Anyone can set up or change trim in half hour. Each display comes to you absolutely complete—all material supplied—with full instructions, selling talks for your salespeople, newspaper copy and suggestions for direct mail literature.

This service begins with the effective Christmas window shown below, and is followed by a new and original display every two weeks.

Get This Xmas Display in Time for the Holiday Season



Imagine These Displays in Your Show Windows!



*Exterior View of Metropolitan
Opera House, New York*



*Interior View of Metropolitan
Opera House, New York*



*Prison Scene from
IL TROVATORE*

Ask for complete information

STANDARD TALKING MACHINE CO.
PITTSBURGH, PA.

*Territorial Representatives of
REINCKE-ELLIS COMPANY
Exclusive Selling Agents for the
BINGER COMPANY*



Four Fundamental Points Necessary for the Successful Conduct of a Business :: By R. S. Baas

In the talking machine business there are four fundamental points necessary for the successful conduct of your business; namely, the line of merchandise you handle, store location, interior equipment and service, and it is along the line of store equipment that I wish to say a few words.

Is your store a cheery, comfortable and inviting place in which to make a purchase? Does it win the confidence of your customer as soon

rooms should be about 9 x 12, which will permit of displaying several different models without too much crowding, and these should be in the rear. If your store space permits, by all means have the booths arranged on both sides of the store, as it adds greatly to the general appearance. And be sure to have enough booths to care for the rush trade.

Your record stock is one of your best adver-

phere to your store. Tastily decorated walls and ceiling, floor coverings that are at once attractive as well as serviceable, furniture that in addition to being substantial should be of good taste; all so arranged and blended in color as to make your store the show place of your community—such a store will prove your best business getter.

Above all things, keep your store clean and

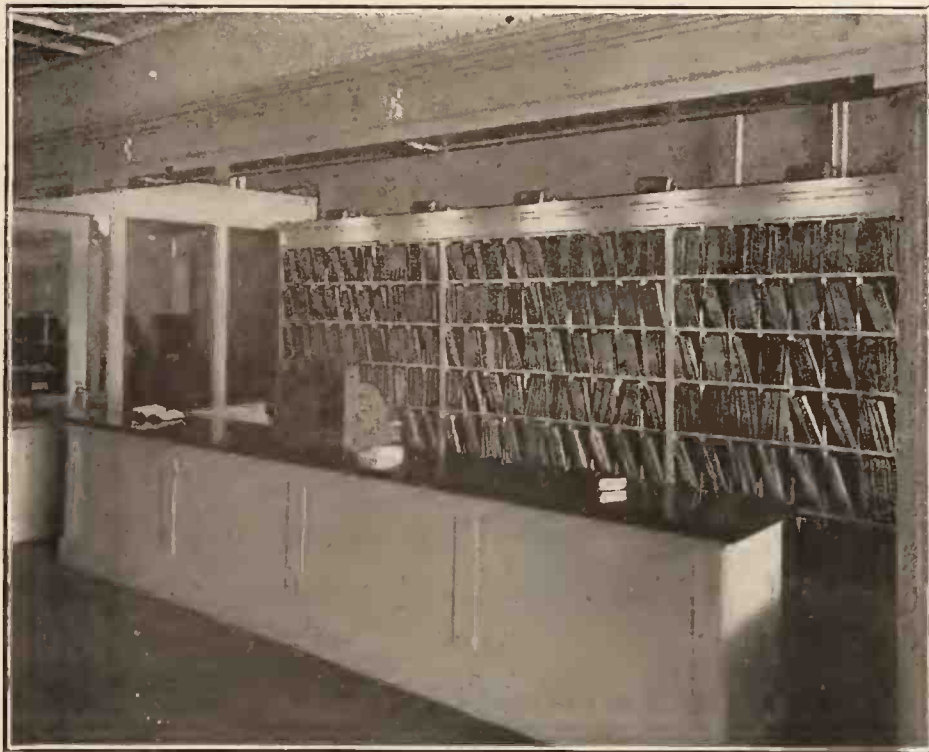

Two views of the installations in R. S. Baas's store in Rock Island, Ill., following the lines laid down in this article. The equipment shown costs upward of \$10,000 and is entirely in keeping with the stock handled in the store. The reception room shows attention to details of comfort. The demonstration booths are seen on either side of the main aisle and the record rack is placed just behind the first booth, the idea being to bring the customer far enough into the store to see what it is really like. The close-up of the record rack and counter shows arrangement of record stock.

as he enters? Is it arranged to afford the utmost in convenience and quick service to your patrons? If not, then you are behind the times in the field of talking machine merchandising. Because the first impression counts the most, I would suggest having the front part of your store furnished somewhat on the order of a cozy living room of a home. Do not use it for a machine display if you can avoid it. A machine buyer never objects to going to one of the rear booths for a demonstration.

Necessarily you must have demonstrating rooms for the machine as well as the record customers. Naturally record rooms do not need to be as large as machine rooms, but be careful not to get them too small, as very few customers enjoy hearing records in too small a room. I believe record rooms should be at least 6 x 9, and if you have sufficient room, 9 x 9, with a 7½ or 8-foot ceiling. Your machine

tisements. Have it as near the front of your store as is consistent with appearances. Some dealers have it immediately in the front, but I believe putting it just behind the first booth is best, as in this way your customers come far enough into your store to get a good impression at every visit, yet it is not asking them to go too far to be served. Be sure to have a service counter in front of your record stock. It saves time both for your customers and your clerks. A record stock so placed in the store will save many steps and permit of quicker and better service. Providing your store proper is not too long, say not over seventy-five feet, have the office in the rear. Your customers will not object to going to the rear to pay their bills, and the longer you can keep them in the store the greater are the chances for additional sales.

All this must be worked out in a color scheme that gives a cheery, restful and pleasant atmos-

bright. Don't have a dirty floor or dusty machines and furniture. Remember you are doing business mostly with women, and they will go to the store that is best kept every time. You are selling a product that is the finest merchandising proposition in the world. Give it a proper setting and the business will come to you.

BUYS THOS. J. PERRY BUSINESS

The Star Drug Co. has just purchased the business of Thos. J. Perry, Williamsburg, Ia. This concern handles both the Victor and Edison lines and will continue to work the community with the same activity as before.

The retail business of the Florida Talking Machine Co. in Jacksonville has been purchased by W. E. Arnold.



SOUTHERN DISTRIBUTORS

Pathé **PHONOGRAPHS**  **and RECORDS**

GRAY & DUDLEY CO.

Write Today for Agency Proposition

NASHVILLE - - - TENNESSEE

Edison Message No. 81

Edison Phonograph prices, since 1914, have increased only 15%, including War Tax.

The increased price of raw materials since 1914 has been absorbed by Mr. Edison, and the Edison Phonograph business has been made stable because of his action.

“Edison Stood the Gaff”

THOMAS A. EDISON, Inc.
ORANGE, N. J.

Ponselle and Hackett can't be beat. You'll say so when you hear their duet from *Aida*—"O terra addio." Your trade will agree with all of us on this record. Columbia-49734.

**Columbia Graphophone Co.
NEW YORK**



CLAUDIA MUZIO WITH EDISON

Celebrated Dramatic Soprano of Metropolitan Opera Co. Joins the Ranks of Exclusive Edison Artists—Announcement by Edison Co.

Claudia Muzio, of the Metropolitan Opera Co., and one of the leading dramatic sopranos, has joined the ranks of exclusive Edison artists, it



Miss Claudia Muzio

has just been announced by the Edison Laboratories.

Although still at the beginning of her career, Miss Muzio already is credited with many triumphs and her art publicly recognized on three continents. Throughout the entire Edison trade it is considered a matter of pride that Miss Muzio should have allied herself with the Edison phonograph and the announcement has been greeted with considerable enthusiasm.

Since her sixth year Miss Muzio has lived and grown up among operatic surroundings. Her mother was once a member of the Metropolitan

chorus and her father was stage manager for many years. While she was still in her teens this young artist knew by heart the different scenes, plots and stage settings and was letter-perfect in every detail long before she ever began to think of singing. Now, though still in her twenties, she has become inseparable from the artistic history of the Metropolitan and has a repertory of more than thirty different operas.

Miss Muzio has made sensational hits at the Metropolitan Opera House in "Tosca," "Aida," "Trovatore," "La Traviata" and other operas, and has also appeared in the principal French and Italian operas in Italy, France, England, Cuba and the North and South Americas.

Announcement as to the probable date on which the first of Miss Muzio's Re-creations on the New Edison are to appear has not yet been definitely made.

KNOWS RECORDS BY NUMBER

Dealers' Ability to Supply Correct Number for All Songs Amazes Layman

"Talk about lightning calculators and human adding machines," remarked a man who had just purchased a record in a downtown store, "it strikes me that none of them has anything on these talking machine men when it comes to a test of memory.

"Go into any of the phonograph stores and ask for a certain record. It may be 'Peeping Through the Knothole in Papa's Wooden Leg' or 'Why Did They Build the Ocean So Close to the Shore?'"

"You ask for the record by name, of course, but he says, 'you want 77,136,' and he never even looks at the catalog to refresh his memory.

"This strikes me as remarkable, for there are hundreds in stock and the record man seems to have at his finger tips the number of them all. How he does it is a mystery to me, but I suppose that is part of the business."

VOCALION ARTISTS IN FAR WEST.

Miss Easton and Mme. Sundelius Call on Vocalion Dealers While Touring Pacific Coast

SEATTLE, WASH., November 1.—Florence Easton and Marie Sundelius, well-known opera artists, who have recently been touring the Pacific Coast with the Scotti Grand Opera Co., have taken occasion to call upon a number of dealers in the Aeolian-Vocalion, inasmuch as both



Marie Sundelius at Standard Co. Store

artists make Vocalion records. Both Miss Easton and Mme. Sundelius called upon the Simon Piano Co., Vocalion dealer in Spokane, and when the company reached Seattle, Mme. Sundelius not only called upon the Standard Furniture Co., local Vocalion dealer, but took occasion to have her picture taken while listening to one of her late records. While a guest of the Standard Co. Mme. Sundelius was entertained by Herbert Schonfeld and E. C. Johnston, manager of the phonograph department.

The progress of the Scotti Grand Opera Co. along the Pacific Coast has been marked by a stimulated demand for the Vocalion records.

Our Complete Stocks of

Emerson Records

assure prompt service and quick deliveries

*Western Iowa and Nebraska Dealers
Write TODAY for this Agency*

CARPENTER PAPER COMPANY
OMAHA Distributors NEBRASKA





*The Most Rapidly Growing
Phonograph Business
in the World*

Partial view of the Pathé Grand Avenue plant, devoted exclusively to the production of Pathé Records.



These two factories, both of which are in Brooklyn, are Pathé Headquarters.



In addition Pathé Phonographs are manufactured in twenty other plants adjacent to Pathé Distributing points throughout America.

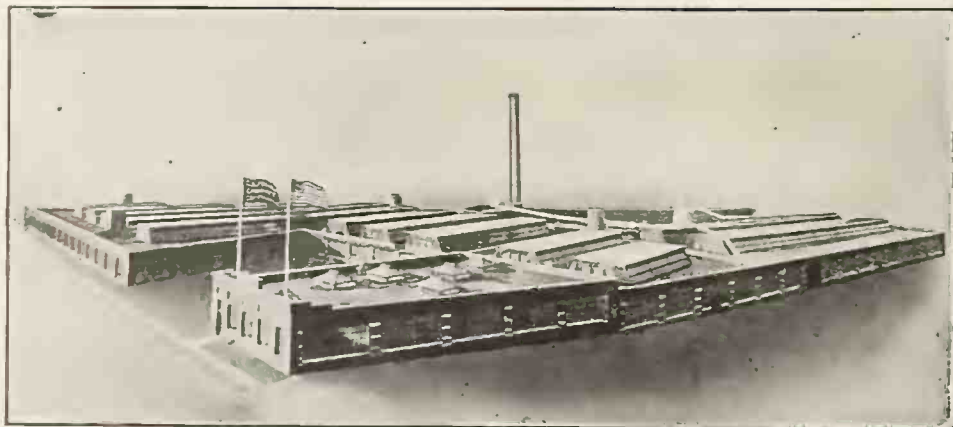

Pathé Cabinet Plant, Metropolitan and Flushing Avenues, Brooklyn, covers 6 acres of ground space.

PATHÉ FRÈRES PHONOGRAPH CO.

10-56 GRAND AVENUE

BROOKLYN, N. Y.

Mr. Phonograph Dealer:

Don't tie up with anybody that is standing still or going back.

If you haven't handled phonographs, or you contemplate taking on another one, join forces with Pathé.

Pathé is coming faster than anyone else in the business—Pathé is progressive, live and up-to-date, and has made money for Pathé dealers.

Pathé has put over \$5,000,000 into this business in the last year in order to take care of its expanding business. Note chart below how its sales are growing.

Profits in the last twelve months were over \$1,000,000 as certified to by Ernst & Ernst, Public Accountants. Pathé has jobbers all over the United States. *Pathé has a few places open—still room for progressive dealers.*

COMMUNICATE WITH THEM AT ONCE.



Comparative Increase by Years



Sales Increase 1920 over 1915=2125%



PATHÉ FRÈRES PHONOGRAPH CO.

10-56 GRAND AVENUE

BROOKLYN



WALLACE BROWN NOW WHOLESALE VOCALION MANAGER

Accomplished Talking Machine Executive, Prominently Associated With the Wholesale and Retail Trade in Detroit, Appointed to Important Post in the Aeolian Co.'s Organization

The Aeolian Co. announced recently the appointment of Wallace Brown, formerly of Detroit, as manager of the wholesale Vocalion department of the company, with headquarters at Aeolian Hall, New York, Mr. Brown assuming his new duties on October 18.

Mr. Brown, be it said, is well known in the talking machine trade, with which he has been



Wallace Brown

actively connected for over six years, first as manager of the Edison Shop in Detroit and more recently as proprietor of four Brunswick phonograph shops in that city. For a time, too, he also served as district manager for the Brunswick in the Detroit territory.

Mr. Brown's experience, both in the wholesale and retail fields, should prove of distinct value

to him in his work of distributing the Vocalion, for he not only understands the problems of wholesale distribution, but likewise the problems of the local dealers.

With an increased output of both machines and records to support it, the campaign on the Vocalion has developed rapidly, and the Aeolian Co. has built up a wide system of distribution for that product. With Mr. Brown in charge the campaign will be enlarged materially.

TAKE OVER CANTON MUSIC STORE

CANTON, O., November 3.—Samuel Mirkin, formerly manager of the International department, Cleveland, O., branch of the Columbia Graphophone Co., and H. Horwitz, complaint manager of the Ohio Sample Furniture Co., of Cleveland, have taken over the operation of the Mirkin Music Store, 122 Cherry avenue, S. E., it is announced. The store was formerly operated by Mirkin Bros. Mirkin, who will be manager, is a native of Springfield, Ill.

NEW MANAGER APPOINTED

Charles W. Hughes, Mechanicville, N. Y., has just announced the appointment of R. C. McDougall to take charge of his retail phonograph department. This department is growing rapidly and Mr. Hughes expects to do a big business between now and Christmas with the Aeolian-Vocalion, for which he is the agent in Mechanicville.

It will pay any man, no matter how big his store, to see as many customers personally as his time will allow. People like to do business with the head of the concern.

URGES LARGER UNITED STATES AID

J. H. Tregoe Says United States Should Aid in Development of Foreign Trade in a Practical Way—Benefits Are Manifold

The Government should devote a larger share of its income to the promotion of foreign trade, J. H. Tregoe, secretary-treasurer of the National Association of Credit Men, says in a message to members of that institution. Comparison of the appropriation for agricultural purposes and that expended for cultivation of foreign trade shows a disparity hardly warranted by the difference in importance of the two, he argues. More money spent intelligently on foreign trade would help agriculture as well as business generally is the credit men's opinion. Mr. Tregoe also says in his communication:

"The magnificent distances of our country, giving us the greatest free trade zone in the world, have led to a sharp distinction in the public mind between domestic and export business. Foreign trade has not been necessary to us and we have not been compelled to think in terms of foreign trade.

"Now we must change the drift and grasp the fact that the increase in our population and the attraction of proper immigration are dependent upon a continuous development of our industries, and this development calls for more than a broadening of our market beyond domestic bounds, if prosperity is to be kept at a high standard. The market, both at home and abroad, should be kept continually in mind and all resources and powers of the nation devoted to their development.

"Side by side with the increase in export trade there should be a development of foreign credit technique, that we may be able to do business on credit terms and in competition with other commercial nations."

Nights are getting longer—but days until Christmas are getting shorter!

**THE NEW MODEL E
GARFORD PHONOGRAPH**
The Greatest Value on the Market
IMMEDIATE DELIVERIES IN ANY QUANTITY



New Model "E" Garford Phonograph
Plays All Makes of Records Superior Tone Quality
Write for Proposition
The General Phonograph Mfg. Co.
ELYRIA, OHIO

LAMPAGRAPH



The Sensation of the New York Electrical Show

We are now ready to make deliveries of the Lampagraph—the most artistic instrument ever presented to the trade.

Jobbing territory now being allotted.

WRITE OR WIRE TODAY

Lampagraph Company Rialto Theatre Building **St. Louis, Mo.**

CHICAGO OFFICE: Republic Building

Various Methods of Increasing Talking Machine Sales Interestingly Described

By
Wm. Bliss Stoddard

A merchant need not be located in a big city to get excellent results from his talking machine department. A. E. Robertson, situated in the thriving little town of Carberry, Man., says that talking machines sell well at all seasons if the dealer has sense enough to play them up properly and adopt the right appeal for each season. This Fall the autoists and all lovers of the open are taking to the woods on Saturdays and Sundays so Mr. Robertson has arranged a campfire window. There is a background of branches, and in the foreground a camp fire all ready to light. Various guns, sweaters, and other outing paraphernalia are scattered about, and on a box is placed a portable phonograph. To the box is attached a card:

HAVE SOME GOOD MUSIC WITH YOUR BIG CAMP FIRE

A Phonograph takes little room and furnishes lots of enjoyment.

His advertising complemented his display, and was addressed directly to week-enders and picnic parties:

MIGHTY FEW PEOPLE CAN AFFORD TO TAKE AN ORCHESTRA OR BAND TO THEIR PICNICS

But anyone can afford band and orchestral selections, as well as music for games and dancing, if they take along a portable phonograph. Make your picnics happy milestones in your children's lives.

TAKE ALONG A PORTABLE MACHINE

It is easy to carry and its tone is ample in volume for outdoor games and dancing. Come in and let us demonstrate it to you.

Advertising Quality Goods

So much is being said about "prices" these days, and so many are laying much stress on lower prices, that it is interesting to get the views from another angle—and from a small town dealer at that. Lawn's Music Store, San Juan, Cal., has a well arranged window display. It is set to represent the corner of a music room, with a rug, a tall palm, a floor lamp with spreading shade, and an easy chair drawn up beside a Victrola. Several records are placed on the chair and on the floor—and the whole atmosphere is that of a home where ease and comfort abound. The window is of the open back variety, and on the floor behind the window there is spread a large rug, several palms, and three or four easy chairs, while against the wall is a talking machine cabinet with a large selection of records. The machine is kept in operation continually, and a card in the window says:

MUSIC ADDS TO THE COMFORT OF EVERY WELL REGULATED HOME

Drop in whenever you have time and listen to some beautiful records played on the Victrola. Then pick out at your leisure, from our large stock, others you would like to have played.

The newspaper advertising of the firm is equally dignified in tone and stresses quality above all. A recent double column ad, with an abundance of white space, advised:

The merchant who is always talking about the cheapness of his wares is apt to be selling cheap goods.

WE TALK QUALITY

when talking about our Talking Machines
Come! Look! Judge!
At the same time, if you want to compare prices for like quality, we are not afraid of results.

"You will note that we do not quote prices, either in our printed ads or in our displays," said the manager. "We aim to impress upon prospective patrons first of all that it is best to get a GOOD machine, one that is in harmony with the furnishings, and that it will be a pleasure to hear day after day. Then, when we have thoroughly sold them on quality, we quote the price, and this is usually an agreeable surprise, as we

are no higher than other firms who are continually harping on prices."

Windmill Display

Anything in motion always attracts, and this fact led McNeil & Co., Stockton, Cal., to originate a window display that gained them considerable publicity. In the background were placed branches, and in front of them a cardboard windmill with arms three feet in length. To each arm was fastened a number of the late records, with the name and price of each, and as the arms slowly revolved, half a dozen new records were brought into view. Down the front of the window was a border of rocks, and between them, each record elevated at an angle of less than forty-five degrees, were two long rows of vocal and instrumental records, which presented the appearance of rippling waters of a stream. To each record was fastened a card with the name and price, and a card suggested:

THE MILL WILL NEVER GRIND WITH THE WATER THAT HAS PASSED

Don't continue to grind out old records, but come in and look over our big assortment, and stock up with a new and fresh line.

Publicity Through Old Machines

A very effective plan for increasing his talking machine sales was recently inaugurated by a Philadelphia music dealer. He inserted an advertisement in the papers, and backed it up with a large card in his show windows, offering one of his latest model talking machines to the person owning the oldest machine. There were scores of responses—which showed that there were lots of people who needed new machines. The name and address of each contender

was taken, and when the oldest machine had been determined, a full history of its purchase was obtained. The machine, together with the new model given as a prize, was displayed in the show window, and a cut of the two, together with a human interest story regarding the old machine, was worked into a very effective newspaper ad. The list of people having old machines made very good prospects, and to each of them was sent literature specializing on the good points of the later models, together with the offer to send them a new machine on three days' trial, in order that they might compare it with the one in their possession. "Comparisons are odious," truly said the manager of the talking machine department, "and it was surprising the number of machines that were sold by this plan. People had become so used to their wheezy and cracked machine that they didn't realize how good the new ones were until brought into direct comparison. It was the best sales stunt we have pulled off this season. At least we think so."

INSTALL OGDEN RECORD RACKS

C. E. Bomberger, of Dallas Center, Ia., has just installed a complete outfit of Ogden sectional record racks. Mr. Bomberger is also Mayor of Dallas Center and "His Honor" reports an unusual demand for Victrolas and records. Miss Louise Cartano, Victor dealer at Springville, Ia., has also completely remodeled her Victor department and installed several sections of Ogden cabinets. Both dealers are pleased with the business outlook.

Telephones { 275 } Morningside
 { 276 }
 { 6890 }

METROPOLITAN VICTOR
WHOLESALE



REPAIRING
POLISHING
ADVERTISING
SALES-PROMOTION
WINDOW-DRESSING
SIGN MAKING

KNICKERBOCKER
TRADE SERVICE DEPARTMENT

138-140 West 124th Street New York City

Connect your store with the Victor Advertising Campaign on Tungs-tone stylus by using this slogan

**"FOR PERFECT SOUND REPRODUCTION
Play Your VICTOR-RECORDS on the VICTROLA
with a VICTOR TUNGS-TONE STYLUS"**

The most valuable Advertising Slogan to every Victor Retailer. Use it on the bottom of your letters, on your record delivery bags, on your supplement envelopes, on signs in your show windows and inside your store, on billboards, newspaper ads, theatre curtains, and, in fact, on any other medium available.

YOURS FOR SERVICE

Knickerbocker Talking Machine Co.



"INSTANT SERVICE"

*A Distinctive Service
on the famous*

AEOLIAN-VOCALION

Service to dealers by return express, freight or parcel post shipments of these distinguished products. *The*

VOCALION RECORD

Playable on All Standard Makes of Phonographs

Service in the fulness of its meaning is characterized by our distinctive "INSTANT SERVICE" on all shipments. *The*

MEL-O-DEE MUSIC ROLL

O. J. DEMOLL & CO.

Wholesale Distributors

WASHINGTON, D. C.

Instant Service

*Orders sent by return express,
freight or mail, day received*

In Salesmanship the First Question Counts Most—Make It Win Confidence

By W. Edgar Bates
Reading, Pa.

Not long ago a salesman came into the store and said to me, "You wouldn't be interested in the ——— talking machine, would you?" A perfectly simple question, and the easiest in the world to answer. A short "No" fitted right in with the question—in fact it seemed to be expected!

The mental condition, the spirit in which we approach a prospect, has much to do with the success with which we handle that prospect. If we tackle a sale prepared or expecting to be turned down, why, of course, we'll be turned down! Many people are naturally backward upon any point requiring a definite decision. They may want a talking machine, may desire it above all things, but are too prone to consider the expense or some sacrifice involved. If we put the question to them half-heartedly, so that their answer is prepared for them, the sale naturally will not be made. We have made up the prospect's mind for him, have helped him to decide the question along the line of least resistance.

If the salesman had said, "This ——— talking machine is just the thing for Reading, etc.," and then had led up to the point of closing the sale, my refusal would not have been so simple a matter. I should have had to exercise my gray matter thinking up reasons why Reading did NOT need this particular make. The chances are, if it were a really good proposition, I might not have been able to think up a single reason. As a matter of fact, I never had a chance to learn the merits of this instrument. But the big question had been answered before it was asked—right in the salesman's own mind!

Someone has said, "Faith is the lever that moves mountains." How true this is—the red, virile faith that says, "You should," instead of "Would you?"

This faith has two sides. First is your faith in the merchandise you are selling, and then

there is that great big confidence—I do not mean over-self-assurance—in your ability to put it across. After all, true salesmanship is making the other fellow feel as you do about the goods that you're selling. You are assured that he should buy—make him see it that way, too! I do not mean that you should appear to dictate, but should state your proposition and lead up to the closing so that the easiest answer is a "Yes," or its equivalent. That is the right kind of a sale—a sale that sticks.

There is no room in the brotherhood of salesmen for the fellow who sells a man something which that man should not have at that particular time. That is simply unloading goods—not selling. It may be clever, may be the result of a lot of brilliant talking—but it is not salesmanship. After that man has bought what he does not want, what he cannot use or cannot afford, how is he going to feel toward the fellow who put something over on him? Is he coming back again, is he going to send his friends to buy? Not by a long shot!

Salesmanship often partakes more or less of hypnotism, and how are you going to hypnotize when you yourself are not under the spell of what you are selling? If we have the utmost faith in our goods, a great big enthusiasm for our line, more often than not we virtually will a "Yes" from our prospect. It would be impossible to get stirred up watching a ball game played by a half-hearted set of players. One would much rather leave the grounds and go home! If I see the salesman before me has little or no faith in his line, why, of course, I am going to see very little attractive about it.

However, watch our step as we will, how easy it is to tumble! Only the other day I found myself saying to a customer, "You don't know of anyone who is thinking of buying a talking machine, do you?" There it was again! the same old question, requiring no effort to answer. After

all, it's only a habit, this asking of negative questions. By close application a habit can be overcome. It requires watching and a right about face when we slip.

Let's study our method of selling, remember and repeat the good points—correct and forget the bad features. We can also learn a lot from the other fellow—guard against his mistakes, and copy him when he does well.

Above all, let us approach our prospect with faith and confidence, so that we do not put a refusal into his mouth!

BRUNSWICK SOCIAL CLUB CONCERT

Prominent Artists Heard at Initial Meeting of Brunswick Men Employees

The first get-together meeting of the Brunswick Social Club, which was held early last month in the company offices in Chicago, proved to be the start of a series of very interesting gatherings for the men employees of the Brunswick-Balke-Collender Co. The first meeting was a complimentary evening of music given by well-known artists. Wives and friends were invited and the evening was enjoyed by all. Among the artists appearing at the affair were Miss Mary Welsh, contralto; Arthur Boardman, tenor, of the Chicago Grand Opera Company; Day Williams, 'Cellist, formerly with the Chicago Symphony Orchestra; Carl Marcus, interpretive reader, and Henry Purmont Eames, musical director of Brunswick records. It is planned to hold meetings weekly, and the enrollment of the club is growing rapidly.

It is better to be an active, well-paid canvasser than a poorly paid, inactive salesman in the wareroom.

Puritan

Distributors for the Puritan Phonograph in Western Pennsylvania, So. W. New York, Western Maryland, Virginia and West Virginia

3 for \$1.00

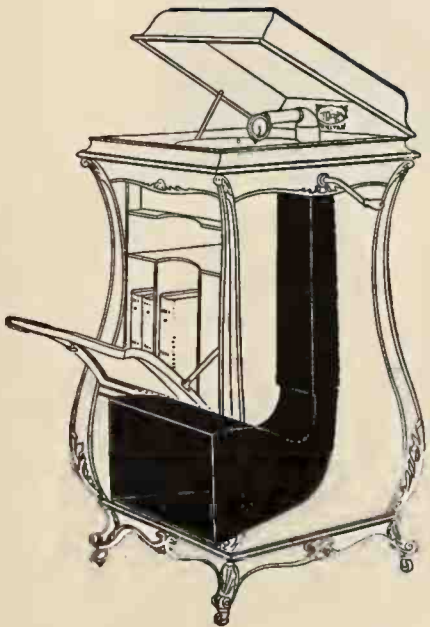

Special—Player Rolls and Records

Melodee and Universal Player Rolls and Opera-phone Records. Latest popular dance numbers, songs, waltzes, etc.—also standard favorites and Hymns while they last—\$33.33 per 100, either records or rolls. Order now for your Christmas trade.

NEEDLES

BRILLIANTONE WALL KANE TONOFONE VIOLAPHONE VALLORBES VELVETONE
Record Brushes—Repeater-stops—Record Albums

Reed Efficiency Furniture Demonstrating Rooms Counters Racks
Our Specialty—Write for catalog

UNIVERSAL DISPLAY FIXTURES FOR YOUR EVERY NEED—40% OFF LIST

THE REED COMPANY INC.

5748-50 Ellsworth Avenue

::: ::: :::

Pittsburgh, Pa.

Eight beautiful models, ready for immediate shipment.
Each unit manufactured in Puritan's own factory and every part is guaranteed.

The Puritan Phonograph (the phonograph which literally speaks for itself). There is richness and purity in the reproduction—quite different from other instruments—that invariably pleases the listener. The most critical music lovers declare that such smoothness, clearness and volume of tone has never been produced by ordinary phonograph. (Write us for catalog and dealership.)

The CHENEY

ALL MUSIC FINDS FULL AND TRUE EXPRESSION IN ITS MELLOW TONES

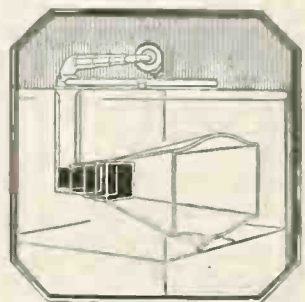

The Cheney Orchestral Chambers

The Sales Value of The Cheney

Music dealers who sell THE CHENEY accredit a large portion of their sales success to the fact that the complete instrument is built in the Cheney factories, where unvarying quality and accuracy of construction are maintained. The period style cabinets are fashioned with rare beauty and skill. Matching this is the perfection of the tonal system and the purity of the tones it plays. These facts, set forth by distinctive advertising, have given THE CHENEY unusual sales value

THE CHENEY TALKING MACHINE COMPANY • CHICAGO • NEW YORK • DEALERS EVERYWHERE

FOR the information of the trade in general, we take pleasure in announcing that plans for reaching a broader market have now been matured.

As the result of our long continued efforts to meet the tremendous demand for CHENEY Phonographs and our rapid development of plans for their future manufacture and marketing; we now feel in position to assure the trade an uninterrupted supply of CHENEY instruments at all times.

We take this occasion to acknowledge our appreciation of the public's unqualified approval and acceptance of THE CHENEY.

The CHENEY

ALL MUSIC FINDS FULL AND TRUE EXPRESSION IN ITS MELLOW TONES

CHENEY TALKING MACHINE COMPANY · CHICAGO · NEW YORK · DEALERS EVERYWHERE



"Fair One" and "Gypsy Moon" are two of the catchiest fox-trots that Ted Lewis' Jazz Band ever unloosened. Everybody's going to hum them after they hear them. A-2998.

**Columbia Graphophone Co.
NEW YORK**

Why Not Turn the Spotlight on Your Efforts?

Written for The World by B. J. MAY

"Something for you?" That is heard every day, and undoubtedly heads the list of foolish questions. Of course the customer wants "something" or why should he come into your store?

Close cousin to the above is the query, "What kin I do for you?" If customers wish to reply in the same strain they would say, "You can't do nothing for I." Why not say, "Good morning, can I be of service to you?" or "What is your pleasure to-day?"

The expression (supposed to be a clinching argument), "I like that machine myself," or, "I have that very same model in my home," is the height of poor salesmanship, for the customer is not buying to suit your taste, but his own. What may please you may not appeal to him.

Sure death to sales efforts is the cocksure air some storekeepers assume when a customer enters. Their very air seems to say: "Now get ready to buy and buy quickly, for I have not much time to waste on triflers."

Remember you will find two sorts of customers—those who rely on their own knowledge of merchandise and those who depend upon the sales person.

How are you going to recognize them? Sometimes the customer tells you by asking a question. Sometimes you find out for yourself by volunteering information.

After the sale has been made and you have handed the customer the change, comes the momentary gap in the conversation, that lull in the bargaining sense which always reminds one of a ship whose engines have stopped and which,

momentarily, seems without a guiding hand. Watch his face as you wait upon a customer and notice the effect of your talk and the manner in which you display your goods. Put yourself in the customer's place and see if you would be satisfied with the way you have made the sale.

LIVE NEW VOCALION DEALER

Ginsberg Furniture Store, Des Moines, Ia., Plans a Strong Campaign on That Line

Among the many new agencies for the Aeolian-Vocalion recently established in the Middle West is the Ginsberg Furniture Store in Des Moines, Iowa.

This business was originated by L. Ginsberg thirty-two years ago in a very small way. As the sons grew up they entered the business and in 1915 the firm was incorporated as L. Ginsberg & Sons. In 1916 the present building on Walnut street was erected with a foundation constructed to hold twelve stories.

The firm is what is called a close corporation, as all stock is owned by L. Ginsberg and four sons. Their volume of sales has increased 400 per cent in four years. They are enthusiastic about the Vocalion and have an elaborate campaign on the way for this Fall and Winter.

NEW "LUCKY 13" CATALOG

The Lucky 13 Phonograph Co., whose executive offices are now at 503 East Nineteenth street, and whose factory is at 314 Avenue A, New York City, has just forwarded to the trade a new catalog covering the various products manufactured and distributed by that organization.

The "Cleartone" line of machines, which the company manufactures, is given a prominent position in the new booklet, and reproductions of the various models appear. Illustrations also of a number of talking machine motors are shown, as well as some representative tone arms and sound boxes. Talking machine accessories as well as small parts are included in the list, and the prices of the products also appear.

APPOINTED ARTO DISTRIBUTOR

The Fulton Talking Machine Co., 255 Third avenue, New York, has just been appointed a distributor of Arto records, manufactured by the Arto Co., Inc., Orange, N. J. These records are distributed in conjunction with the Arto word rolls, a product of the Standard Music Roll Co. of the same city.

The Fulton Talking Machine Co. has some special sales plans which are being forwarded to the trade. In addition samples of the products are sent to interested dealers.

SEND FOR ILLUSTRATED PRICE LIST
AND FREE SAMPLE

"GLOBE" TRANSFER NAME PLATES

DEALERS EVERYWHERE APPLY THEM
ON PHONOGRAPHS, PIANOS, ETC.

GLOBE DECALCOMANIE CO.

263 SUSSEX ST., NEWARK, N. J.

U D E L L

The
Standard
of
Cabinet
Quality



The
Udell Works
1205 28th Street
Indianapolis, Indiana

No Change in Quality

The very quality that made
BRILLIANTONE NEEDLES
the world standard by which all
steel needles are judged is the
exact same quality that is being
put into them to-day.



The fact that W. H. BAGSHAW CO. are
the manufacturers of **BRILLIANTONE
STEEL NEEDLES** is certification of their
high quality and superior workmanship. Our
confidence in the satisfaction to both dealer
and customer is best evidenced by our
MONEY BACK GUARANTEE.

Write for samples and prices to your nearest distributor
If he cannot supply you, write direct to us

SALES AGENTS

BRILLIANTONE
STEEL NEEDLE CO. of America,
Incorporated

347 FIFTH AVENUE,
NEW YORK SUITE 1003
AT 34th STREET

Canadian Distributors: The Musical Mdse. Sales Co., 79 Wellington St. W., Toronto
Foreign Export: Chipman Ltd., 8-10 Bridge St., New York City

Electric Signs Are a Vital Business Asset

By EINER GRAFF

With some electric fans still buzzing to relieve the oppressive heat and humidity during October we will frankly admit that it requires effort to imagine a street filled with men, women and children wrapped in furs and heavy overcoats, their breath freezing, all carrying bundles, hurrying to and fro to purchase Christmas gifts.

Christmas shopping differs from general shopping in that it is not confined chiefly to women. The fact that the things bought are to be gifts—pleasant surprises for friends or relatives—makes it imperative for men as well as women to shop. Most men are employed during the day and have little time to shop except during evenings. In order to accommodate them most stores remain open several weeks before Christmas.

Christmas has always been a period of good cheer. Long before the advent of Christianity

festivities were held at Christmas time in Northern Europe. It is a brief period of the year when our unselfish and generous impulses are supposed to dominate our actions and thoughts. The spirit is "good will towards men."

Our aim is to make others happy. Our psychological make-up is such that we associate cheer with light and brightness. Places for merry-making are brilliantly lighted. We always have more courage and cheer on a bright morning when the sun has risen than after the sun has set.

If there is not an attractive electric sign in front of your place of business now you are losing the advertising value that an electric sign could give you. This may mean the loss of many dollars in potential profits. An electric sign would draw to your store the Christmas crowds bent on purchasing goods. They would

be attracted to it by brilliancy of the illuminated sign.

Blue and white porcelain-enameled steel signs can be seen satisfactorily either by day or by night. They are visible at a considerable distance from your place of business and will attract the attention of hundreds of persons. The sign also serves to identify your business place—it acts as a guide post. It is not uncommon for persons in giving direction for finding a place to advise to "look for the sign." Porcelain blue and white enameled steel signs do not fade and they last indefinitely.

Be prepared for the crowds of Christmas shoppers. Add to the Christmas cheer. Brighten your business front with an electric sign.

PENN-VICTOR DOGS SAVED THE DAY

Crowds at Mayer Opening Get Souvenirs, Due to Efficiency of Knickerbocker Service

The Penn-Victor miniature dogs through the medium of the Knickerbocker Talking Machine Co. came to the rescue of A. H. Mayer at the recent opening of his attractive new warerooms at Fifty-second street and Ninth avenue, New York City, which was referred to in last month's World. About 8:30 p. m. on the opening day the place was crowded to the sidewalk, and, although souvenirs to commemorate the opening had been ordered, they had not arrived. It luckily happened that A. Davega, vice-president of the Knickerbocker Talking Machine Co., Victor wholesaler, and M. Berlow of the sales staff of that company paid their respects to Mr. Mayer at that time and the latter confided his trouble to the two representatives of the Knickerbocker Talking Machine Co., who immediately demonstrated Knickerbocker service by jumping into their auto and returning to Knickerbocker headquarters, where they loaded up the car with Penn-Victor dogs. They arrived back at Mayer's warerooms at 9:15 and found the crowd bigger than ever. In order to keep the crowd moving and allow the others to inspect the new warerooms, the reverse of the usual procedure was followed and Mr. Mayer announced that everyone would receive a Penn-Victor dog as they left the warerooms. The opening was a huge success and the service of the Knickerbocker Talking Machine Co. in the emergency was much appreciated by Mr. Mayer.

FAULTLESS

PIVOT BEARING

CASTERS

Casters that roll easily across the floor—and smoothly. No clatter—no unsteadiness.

Simple construction—no complicated parts to get out of order, nothing to retard easy movement. Strong—plenty of metal in required places to resist strains.

Silent—neat appearing—a real necessity to YOUR talking machine, these FAULTLESS CASTERS.



Full Size—C-65

Made with leather, fibre, felt, steel and lignum vitae wheels. A word from you puts all our caster experience at your service and brings you a copy of Faultless Catalog "G".

**FAULTLESS
CASTER COMPANY**

EVANSVILLE, INDIANA

"Move the FAULTLESS Way"

Eastern Sales Office:

Geo. Mittleman, 200 Fifth Avenue, N. Y.

Why Break Records? Just File Them!

That is if you have the wonderful Record filing system which is a feature of

The Marvelous MAGNOLA



Watching the Music Come Out

This is only one feature of many that will command your interest and attention. Let us send you handsome illustrated catalog and information as to our plans for helping you to make money with MAGNOLA.

MAGNOLA TALKING MACHINE COMPANY

OTTO SCHULZ, President

General Offices

711 MILWAUKEE AVENUE
CHICAGO

Southern Wholesale Branch

1530 CANDLER BLDG.
ATLANTA, GA.

Why Brunswick dealers are optimistic

Because they realize that they have by far the most profitable phonograph and record franchise obtainable today, and the one with the greatest future.

Because in the Brunswick Ultona, the Brunswick Oval Tone Amplifier, and the unrivalled excellence of the Brunswick cabinet, they realize that they have the most exclusive and the most compelling selling arguments in the phonograph world.

Therefore they are looking forward to a record volume of business this season. And so we look for those Brunswick dealers who are fully prepared, who have taken advantage of our various co-operative sales helps, and who are willing to go out after the business, to have the biggest year they have ever had.

Times have changed. There is no longer a seller's market. Business must be solicited, but there is lots of it there for the aggressive dealer.

THE BRUNSWICK-BALKE-COLLENDER COMPANY

General Offices: 623-633 South Wabash Avenue, Chicago

Branch Houses in Principal Cities of United States,
Mexico and Canada

Canadian Distributors: Musical Merchandise Sales Co.,
79 Wellington St., West, Toronto

New England Distributors: Kraft, Bates and Spencer, 156 Boylston St., Boston, Mass.

The two features that won for Brunswick

In these two exclusive betterments Brunswick achieved what all phonograph makers have sought for years.

The first, the Ultona, is a playing arm which enables you to play any make of record with equal facility. It plays all records just as they should be played, including, of course, Brunswick Records.

It can be said, with truth, of several phonographs, that they can play any make of record. But in all cases except that of The Brunswick this statement implies some bothersome attachment.

The Ultona is an integral part of The Brunswick. There is nothing to take off or put on. And the Ultona is counterbalanced, doing away with those defects in reproduction which come from too much rigidity.

The second big feature, the Brunswick Oval Tone Amplifier, is an all-wood tone chamber, seasoned and moulded by a special process. It is made light and resonant, like a violin. It allows sound waves to expand and amplify in a natural manner, because it obeys laws of acoustics not thoroughly considered by old-time methods.

These two improvements combine to make the Brunswick Method of Reproduction unique in the phonograph field. They bring new tone standards. Harshness and metallic noises are effectually banished. Tones are clear, sweet and penetrating. Syllables are distinct and the most delicate shadings of tone are faithfully reproduced.

The Brunswick is the last evolution of the phonograph, the instrument of today and tomorrow. Brunswick dealers are building a business upon unshakable foundations.



The ULTONA
Playing a Brunswick Record

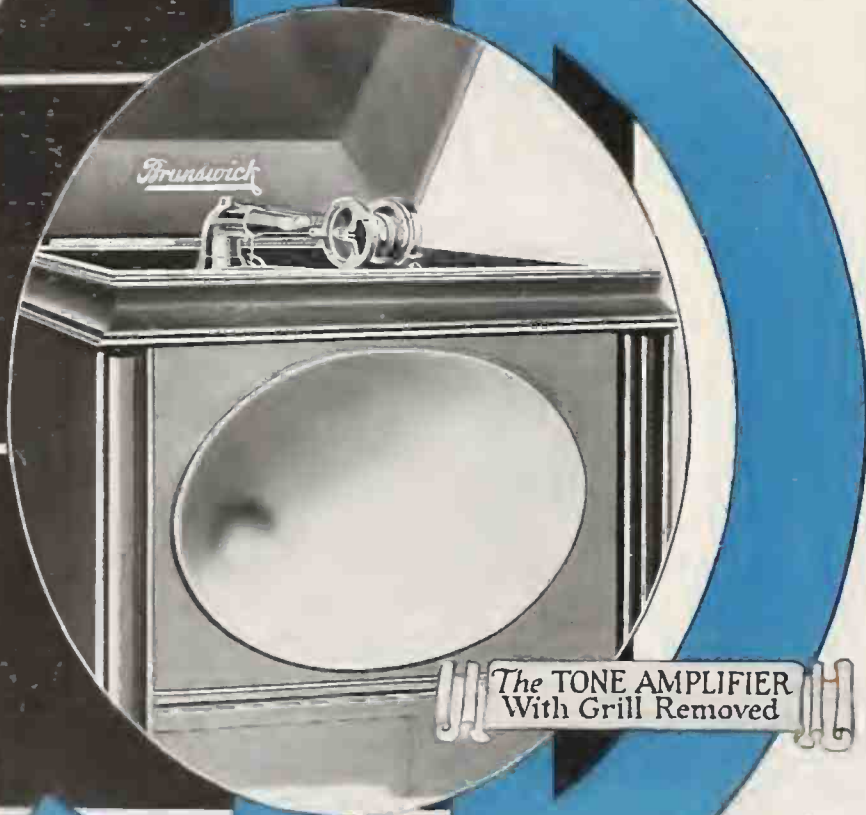

The TONE AMPLIFIER
With Grill Removed

THE BRUNSWICK-BALKE-COLLENDER COMPANY

General Offices: 623-633 South Wabash Ave., Chicago

Branch Houses in Principal Cities of
United States, Mexico and Canada

Canadian Distributors: Musical Merchandise
Sales Co., 79 Wellington St., West, Toronto

New England Distributors: Kraft, Bates and Spencer, 156 Boylston St., Boston, Mass.



Above—Brunswick Phonograph factory at Dubuque, Iowa. Other Brunswick Phonograph factories—Muskegon, Mich.; Chicago, Ill.; Rockford, Ill.; Knoxville, Tenn.; Toronto, Canada. Record factories—Long Island City, N. Y.; Jersey City, N. J.

Brunswick

PHONOGRAPHS AND RECORDS

56 Publications

24,000,000 readers every month

Ask the average man to name all the phonographs he ever heard of. He will probably name half a dozen. They are the well-advertised phonographs.

Those in the trade know that there are a hundred or more. But the people have never heard of them.

People nowadays have many things to claim their attention. Many are naturally inclined to delay and forget. They require some incentive to prompt action and decisions.

Brunswick advertising gives them that incentive. It moves them before they hear The Brunswick. Brunswick advertising has always been educational. It explains just how finer tone is obtained in The Brunswick.

People are constantly interested in

something better. The betterments in The Brunswick are of such a radical nature, the differences are so great, that people are quickly fascinated by The Brunswick story.

And The Brunswick lives up to its advertising. The superior quality of Brunswick tones is evident to anyone who makes a comparison.

Behind every Brunswick Phonograph and Brunswick Record stands the force of our tremendous advertising campaign.

The Brunswick dealer begins business with a proved proposition. There are no elements of uncertainty. His success is assured by the success of The Brunswick.

Brunswick has never been associated with the ordinary. Brunswick could do no less than make a super-phonograph.

THE BRUNSWICK-BALKE-COLLENDER COMPANY

General Offices: 623-633 South Wabash Avenue, Chicago

Branch Houses in Principal Cities of United States,
Mexico and Canada

Canadian Distributors: Musical Merchandise
Sales Co., 79 Wellington St., West, Toronto

New England Distributors: Kraft, Bates and Spencer, 156 Boylston St., Boston, Mass.



Brunswick Record Plant, Jersey City, N. J.

Artists and organizations making Brunswick Records

Mario Archer Chamlee
 Leopold Godowsky
 Max Rosen
 Virginia Rea
 Theo. Karle
 Dorothy Jardon
 Marie Tiffany
 Richard Bonelli
 Elizabeth Lennox
 Irene Pavloska
 Elias Breeskin
 Irene Williams
 James Sheridan

Al Bernard
 Ernest Hare
 Ida Heydt
 James Congdon
 Elliott Shaw
 Fred Van Eps
 Rudy Wiedoest
 Arthur Fields
 Thornely Crane
 Chas. Hare
 William Robyn
 All Star Trio

Isham Jones Rainbo Orchestra
 Green Bros. Novelty Band
 Vernon Trio
 Criterion Male Quartette
 Collegiate Choir
 Shannon Four
 Toots Paka Hawaiians
 Elshuco Trio
 Carl Fenton's Orchestra
 Palace Trio
 Brunswick Military Band
 Green Bros. Xylophone Orchestra
 Paul Biese's Novelty Orchestra
 Rodemich's Orchestra

Brunswick Records themselves will show you how the Brunswick Studios have overcome scientific and mechanical difficulties in securing

faithful reproduction of the talent of the artist. They can be played on any instrument using steel or fibre needles.

THE BRUNSWICK-BALKE-COLLENDER COMPANY

General Offices: 623-633 South Wabash Avenue, Chicago

Branch Houses in Principal Cities of United States, Mexico and Canada

Canadian Distributors: Musical Merchandise Sales Co., 79 Wellington Street, West, Toronto

New England Distributors: Kraft, Bates and Spencer, 156 Boylston Street, Boston, Mass.

FEATURES PERIOD DESIGNS

November Edison Display Material Links Period Cabinets With Fine Furniture

In their national magazine advertising for November, the Edison Laboratories depart from their interesting series of events proving the realism of the New Edison, and say something about good furniture and Edison cabinets.

Interlocking with this very reasonable adver-



Edison Window Features Period Cabinets

tising subject, the November Edison window display sets forth the beauty of Edison cabinets and invites inspection. The center piece of the display resembles a wooden panel of oak. The inscription is in imitation carved letters that appear to be actually carved into the background. The side panels are perfect enlargements of the very fine Davenport illustrations used in the magazine advertising. The coloring is a scheme of light tints that creates a delicate and very unusual effect. The side panels of this display are exceedingly ornamental and will probably be preserved by Edison dealers for interior store decoration.

JACOBS INCORPORATES IN DOVER

Jacobs is the name of a new concern which has been incorporated under the laws of Delaware to sell talking machines. The capital is \$75,000 and the incorporators are Samuel Shusman, David Slumm, Darby, Pa., and Joseph Jacobs, Philadelphia.

McLOGAN-PEARCE CO.'S NEW STORE

Clyde Trowbridge to Manage Third Store of Peninsular Music House

CALUMET, MICH., October 18.—The McLogan-Pearce Music Co., Houghton County's well-known music dealer, has announced that arrangements have been practically completed for the opening of the new store at Iron Mountain, which will make a chain of three business places conducted by this concern in the upper peninsula.

This new retail music store will occupy a building on Ludington street, the main business street in the city, and will be made the chief musical center of that district. The store will occupy two floors, thirty by sixty feet, and will carry a large line of talking machines and records, as well as pianos and general musical merchandise.

The new store will be under the management of Clyde Trowbridge, one of the most capable piano men in the upper peninsula. Mr. Trowbridge, who has had charge of the Hancock

store, will take up his new duties about the first of November.

FLORENCE EASTON AS SOLOIST

Florence Easton, the distinguished prima donna soprano of the Metropolitan Opera Co., and noted Vocalion record artist, has been engaged by the New York Symphony Orchestra under Walter Damrosch, as the first soloist of the season on Sunday afternoon, November 7. Miss Easton has been winning triumphant successes in leading roles with the Scotti Grand Opera Co., now on tour.

The Victor talking machine dealers of Peoria, Ill., are looking forward with a great deal of interest to the concert of the Eight Victor Artists, who will be heard in concert in that city on October 25 and 26.

In order to make your advertising really pull, you should see that your salesmen push.

**A "Sure Results" Sale Plan
FREE
and
SUPERB QUALITY
make the
LAWSON**



"The Dealer's Delight"

Manufactured by piano makers of 40 years' highest standing, experts in tone production and mechanical detail.

Every LAWSON PHONOGRAPH is finished and polished like the finest pianos.

LAWSON dealers have exclusive territory and biggest direct-from-factory discounts as well as real service.

Write today to

Lawson Piano and Phonograph Corp.

Office and Factory

2572 Park Avenue, New York City

CLAUDIA MUZIO BACK IN U. S.

Prominent among those who arrived in New York on October 22 on the S. S. "Martha Washington," from Rio de Janeiro, was Claudia Muzio, who, it is said, has signed up to sing exclusively for the Edison phonograph.

Miss Muzio has been in South America since June, where she went from Paris. Her first New York appearance will take place on October 31, at Madison Square Garden, when she will participate in an interesting program.

Never wink at the overcharging of a customer. Reprove an employe as quickly for an error in your favor as for one in favor of the customer.

The
Schmelzer Company
Kansas City, Missouri

Exclusively Wholesale
Victrolas and Victor Records



Invincible

Italian Renaissance,
Verona

Minuet

The instrument that holds the leadership!

SONORA has more important features of construction than any other phonograph. Note for example, that Sonora uses an ALL BRASS tone arm instead of an inferior-toned cheap, porous, brittle, zinc-lead-tin casting. Also observe that Sonora cabinet sides are $\frac{3}{4}$ " thick instead of $\frac{3}{8}$ " like most other makes of phonographs.

These are two of many details on which Sonora is spending this year over one million dollars more than most other manufacturers in order to secure the very highest quality, and Sonora's quality is never slighted in order to speed production.

The phonograph that sells easily for cash and keeps bank balances high, is the

While sales of other phonographs may have lagged, Sonora has never had the least difficulty in disposing of its entire output and has never been able to satisfy completely the waiting dealers.

Sonora's many models offer the widest range of selection and through heavy, continuous and distinctive advertising, Sonora is favorably known to millions of prospective buyers.

This season's increased production may enable us to add more dealers. If you are interested in handling The Highest Class Talking Machine in the World we suggest that you take the matter up at once.

THE INSTRUMENT OF QUALITY
Sonora
 CLEAR AS A BELL





Nocturne



Sheraton Kenilworth



Grand

Write today to the jobber covering your territory regarding a Sonora agency

American Hardware & Equipment Co.,
Charlotte, N. C.
North Carolina and South Carolina.

Gibson-Snow Co.,
Syracuse, N. Y.
State of New York with the exception of towns on Hudson River below Poughkeepsie and excepting Greater New York.

W. B. Glynn Distributing Co.,
Saxtons River, Vt.
States of Maine, New Hampshire, Vermont and part of Massachusetts.

Griffith Piano Co.,
605 Broad St., Newark, N. J.
Northern New Jersey.

Hessig-Ellis Drug Co.,
Memphis, Tenn.
Arkansas, Louisiana, Tennessee, Mississippi.

Kiefer-Stewart Co.,
Indianapolis, Ind.
Entire State of Indiana.

Lee-Coit-Andresen Hardware Co.,
Omaha, Nebr.
State of Nebraska.

M S & E,
221 Columbus Ave., Boston, Mass.
Connecticut, Rhode Island and Eastern Massachusetts.

The Magnavox Co.,
616 Mission Street, San Francisco, Cal.
Washington, California, Oregon, Arizona, Nevada, Hawaiian Islands, Northern Idaho.

Sonora Distributing Co. of Texas,
Dallas, Texas.
Western part of Texas.

Sonora Phonograph Co., Inc.
279 Broadway, New York.
Distributors for Greater New York.

Southern Drug Co.,
Houston, Texas.
Southeastern part of Texas.

Southern Sonora Co.,
310-314 Marietta St., Atlanta, Ga.
Alabama, Georgia and Florida.

Southwestern Drug Co.,
Wichita, Kans.
Southern part of Kansas, Oklahoma (except 5 N. E. counties), and Texas Panhandle.

C. L. Marshall Co., Inc.,
82 Griswold St., Detroit, Mich.
409 Superior St., Cleveland, O.
Michigan and Ohio.

Minneapolis Drug Co.,
Minneapolis, Minn.
States of Montana, North Dakota, South Dakota, Minnesota.

I. Montagnes & Co.,
Ryrie Bldg., Toronto, Canada.
Canada.

Robinson-Pettet Co., Inc.,
Louisville, Ky.
State of Kentucky.

C. D. Smith Drug Co.,
St. Joseph, Mo.
Missouri, Northern and Eastern part of Kansas and five counties of N. E. Oklahoma.

Smith, Kline & French Co.,
Philadelphia, Pa.
States of Pennsylvania, Maryland, Delaware, District of Columbia and New Jersey south of and including Trenton, Virginia and West Virginia.

Strevell - Paterson Hardware Co.,
Salt Lake City, Utah.
Utah, Western Wyoming and Southern Idaho.

C. J. Van Houten & Zoon,
Marquette Bldg., Chicago, Ill.
Illinois and Iowa.

Yahr & Lange Drug Co.,
Milwaukee, Wis.
Wisconsin, Upper Michigan.

Moore-Bird & Co.,
1751 California St., Denver, Colo.
States of Colorado, New Mexico and Wyoming east of Rock Springs.



The Highest Class Talking Machine in the World

Licensed and operating under BASIC PATENTS of the phonograph industry

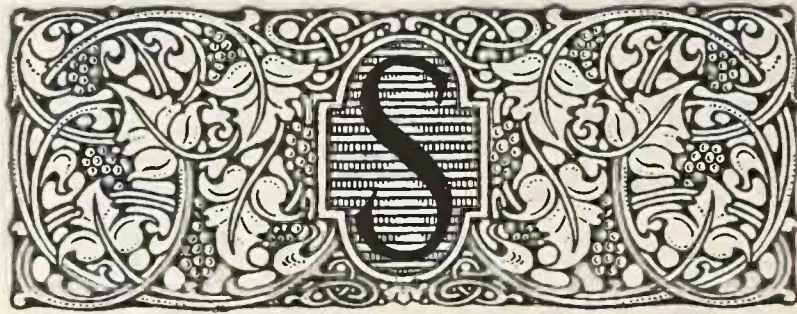

Bargain Competition

THE Stephenson Precision-Made Motor does not enter into bargain competition. It stands squarely upon merit. During this period of reconstruction, the price of the Stephenson Motor will be determined by the same policy that has always determined its price. A policy that expects equitable return for capital invested and effort expended; a policy that demands that one hundred percent value be given for money received; a policy that states that always shall price be governed by production costs.

At present no reduction in price of the Stephenson Motor is contemplated. For Stephenson inventories today are held at less than present day market values; Stephenson labor today is paid a wage consistent with present day living costs.

The Stephenson Motor was not designed as a bargain motor, but rather as a Precision-Made Motor. It is not manufactured today as a bargain motor to meet bargain competition and never shall be.

STEPHENSON DIVISION
DE CAMP AND SLOAN, INC.
1 West 34th Street
New York City

MANUFACTURERS OF THE STEPHENSON PRECISION-MADE MOTORS AND TONE ARM AND SOUND BOX

Catering Intelligently to the Needs of the "Particular" or "Fussy" Customer :: By A. A. Shaw

It is conceded by the majority of dealers and salesmen that the record department of their business is invariably the most "trying." In the hurry to attend to many customers, it is sometimes a little annoying to a dealer to meet one who is exceedingly "particular" about details. He is apt to style such a person as "fussy" or "cranky." Yet that very customer, fully satisfied, may, and probably will, prove a more valuable asset to the dealer's business than one who is not disposed to be "particular."

The shrewd business man is he who can handle his customer's peculiarities with the utmost ease, deliberation and respect. A little study of human nature will show that the "fussy" individual is usually the most talkative one when fully satisfied and that talk is more than likely to be in praise of a house that gave him, or her, the most careful consideration.

A well-known and successful business man in New York has instructed all of his clerks to call him whenever they get hold of a "fussy" individual. No matter how busy he is he arranges to wait on the "particular" customer, and so skillfully does he handle him that eventually these "fussy" customers are turned over one by one to "Mr. Smith" or some other patient salesman (who realizes the difficult, or responsible, task of being very considerate) with the result that the record business of this house has grown to large proportions because of the entire satisfaction everyone receives who deals with it.

One of the great steamship lines between New York and Southampton has issued a series of printed instructions to all its employes aboard ship, and the dominant note is summed up in these significant words: "The patrons of this line pay your salary and mine; there could be no . . . steamship line without patrons, therefore it behooves every employe from the lowest to the highest to treat every patron with the utmost respect and attention, and never enter into any dispute. If a difficulty arises immediately seek a superior officer and introduce the patron to him, and let no word or look show anything but courtesy and respect."

In the talking machine industry it is equally true that a satisfied patron is a valued asset. It pays to satisfy every customer. If you have sold a machine, follow it up and see that it is giving satisfaction. If you get a hurry-up re-

quest by telephone or otherwise, you should follow it up yourself later in the day; see that it has been filled. If the party has a telephone, call him (or her) on the phone and see that satisfactory service has been given. If certain records are wanted on a particular day or hour follow them up; see that there is no slip up in the service. Particular requests should never be lost sight of until satisfaction is absolutely insured, and every detail carried out to the letter.

Sometimes it may seem that these little matters are not worth the care and attention of those

The Customer Who Is Fully Satisfied Will Always Prove a Most Valuable Asset to a Dealer's Business

who occupy responsible positions in the house, particularly when the busy season is on. But that is a mistake—they are highly important. A personal touch, a personal message from someone occupying a responsible post, makes the customer satisfied. It creates a confidence in the house that nothing else can do.

Another feature that a satisfied customer appreciates is to have some forethought of his or her needs. If you know of some reason why a certain record will be acceptable on a specified occasion let your forethought be brought to the patron's attention and ask if it may not be included in the order or sent by special order. In fact, there are a hundred and one ways of studying how to make satisfied customers, and it is just as essential to the success of a business as it is to study how to keep a good balance at the bank. The latter is impossible unless your customers are satisfied.

In the rush of business for the past few years when demand exceeded supply, there was a tend-

ency on the part of many salesmen to be indifferent to customers' needs. It was not the case of giving the customer what he wanted, at least in records, but to supply what was in stock. The situation has now changed, and the store that is going to hold trade and augment it is the one that has made it a point to cater to the needs of "particular" customers, and to cater to them intelligently.

HAYNES DISPOSES OF INTERESTS

Richmond Edison Jobber to Retire From Active Business—Long With Edison Organization

C. B. Haynes, president of the C. B. Haynes Co., Inc., Richmond, Va., and an Edison jobber of many years' standing, has sold out his interests in the business to E. Bowman, until recently secretary and treasurer of the company, any will retire from active business.

Many years ago Mr. Haynes entered the Edison organization in the capacity of traveling representative for the National Phonograph Co., as the Edison Laboratories were known before Thomas A. Edison, Inc., came into being. In 1907 he entered the jobbing business and established an organization in Richmond, which is the same from which he now retires.

Mr. Bowman has been associated with Mr. Haynes for a number of years and needs no introduction to the Edison trade in his territory.

CHANGES IN MERIDEN STORE

Thos. H. Woolley Adds New Booths for Columbia Demonstration—M. R. Reinholdt Now in Charge of Repair Department

MERIDEN, CONN., November 3.—The Grafonola store of Thomas H. Woolley, 71 East Main street, has been undergoing several changes. On one side of the store a number of sound-proof booths have been built, and each comfortably furnished for the convenience of customers who wish to select records in private.

Mr. Woolley has secured the services of M. R. Reinholdt, formerly mechanical instructor and automatic stop expert of the Columbia Graphophone Co., to take charge of the repair department of the store.



HERE IT IS

The

**FLETCHER UNIVERSAL
TONE ARM and REPRODUCER**

Gives Proper Playing Weights for all Records. No Adjustment Screws or Springs.

SAMPLES \$8.00

Specify 8½" or 9½" arm

FLETCHER-WICKES CO., 6 East Lake Street, Chicago, Illinois

THE GEORGE McLAGAN FURNITURE CO., STRATFORD, ONTARIO, EXCLUSIVE CANADIAN AGENTS

MODERN QUARTERS OF R. MONTALVO IN NEW BRUNSWICK

Twenty Soundproof Booths, Commodious Auditorium, Children's Room and Rest Rooms Among Features of New Establishment in New Jersey—A Story of Successful Business Building

What a live dealer can accomplish in the development of a talking machine business in a moderate-sized city is well illustrated in the case of Ramon Montalvo, of New Brunswick, N. J., who some weeks ago held the formal opening of his elaborate new Temple of Music in that city. Mr. Montalvo started in business in New Brun-

s- eighty feet, seating several hundred people, and a number of special features, including a special children's room where the little ones may hear and select suitable records. There are also two attractively furnished rest rooms on the first floor, one for men and one for women. Of the soundproof demonstration rooms five



1. Ramon Montalvo in His Office. 2. Auditorium. 3. Children's Room. 4. The Store Proper. 5. Main Showroom

swick in a very modest way only a few years ago, and through the adoption of modern business methods, and the display of an aggressive spirit, soon found things coming his way. Constant expansion has been the result, and the new Temple of Music offers concrete evidence of his success.

The new building at 101-107 Albany street has an impressive front, and the interior is equipped in a most elaborate manner with a battery of twenty soundproof booths for the demonstration of machines and records, commodious and artistic display rooms, a recital hall, forty by

are fitted up in accordance with period styles, such as Adam, Colonial, Gothic, etc., to be used for the display of period model machines of those styles. The recital hall is so arranged that the chairs can be cleared away and the floor used for dancing. Magnavox transmitters have been installed in the auditorium in order to amplify the talking machine music for dancing purposes.

A well-equipped repair department has been installed in the building to take care of the repair work of the main store and branches, and this with elaborate offices completes the equipment.

The Temple of Music features Victor, Edison and Vocalion machines and records. The Aeolian line of pianos and Pianolas is also handled, as well as music rolls and sheet music. Frequent recitals are given to acquaint the public with the new things in the record and roll lists, and those conducting musical affairs in general are encouraged to use the recital hall. Mr. Montalvo has built his business on the basis of service, and at the present time has a fleet of nine automobiles making deliveries in and about New Brunswick and taking care of the requirements of his branch stores in Perth Amboy and Plainfield, N. J.

Mr. Montalvo is fortunate in having an efficient staff to assist him in carrying on the business. E. D. Coots is the store manager, R. W. Cowdrill is manager of the sheet music department and Miss Evelyn Beel has charge of the record department.

ELIZABETH ASSOCIATION SUCCEEDS

Every Dealer in City Now a Member—C. M. Tremaine Addresses the Last Meeting

ELIZABETH, N. J., October 30.—At the last meeting of the recently organized Music Merchants' Association of Elizabeth, it was announced that everyone of the seventeen dealers in the city had become affiliated with the Association and that a constructive program of association work was being formulated.

The speaker of the evening was C. M. Tremaine, director of the National Bureau for the Advancement of Music of the Music Industries Chamber of Commerce. Mr. Tremaine, in the course of his talk, emphasized particularly the necessity of concentrated effort on music advancement just now to counteract the effect of the apparent slowing down of business.

Mr. Tremaine told of the work of his Bureau, and urged that a music memory contest be started in Elizabeth. The local music merchants are at present planning to make use of the co-operative advertising campaign inaugurated by the Bureau.

MAKING PARROTS MORE VERSATILE

Now they are teaching a parrot to talk more profusely by listening to a talking machine record. When the time comes and the master of the house can no longer stand the same old parrot line of talk, he has a new record made with appropriate sentiments recorded thereon and places it on his machine. The instrument is then placed near the parrot's cage and the lesson begins and is repeated until the bird is educated. What next?

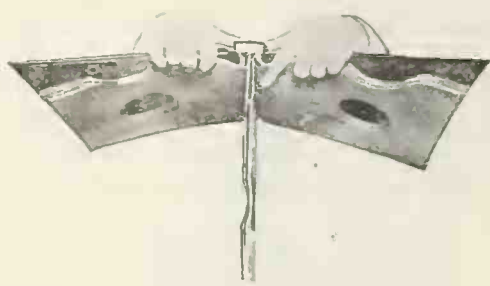

Write for details, prices and exclusive selling arrangements on Peerless Big Ten—send in the coupon—today.

P. A. #1
Gentlemen:
Please write me fully about Peerless Big Ten and quote prices.

Name
Address
Town

ANNOUNCING

PEERLESS BIG TEN

A full-sized, twelve-inch album to take ten-inch records and maintain uniformity in the record compartment of fine phonographs that have twelve-inch shelves.

Not an album of ten-inch leaves in a twelve-inch binder but one actually built up to the large size throughout, in a scientific and practical manner.

The ten-inch record sets into an individual compartment in the twelve-inch leaf, fitting as snugly as a lady's glove.

Peerless Big Ten lies perfectly flat when opened at any page, is doubly reinforced at the backing and is otherwise typical of Peerless quality.

Dealers: Here is your chance to appeal to the large majority of your record customers who buy popular, ten-inch records.

Manufacturers: Why not remove the lost objection to your instruments which now contain only the large albums?

PHIL RAVIS, President

Peerless Album Company
43 to 49 BLEECKER ST., NEW YORK CITY

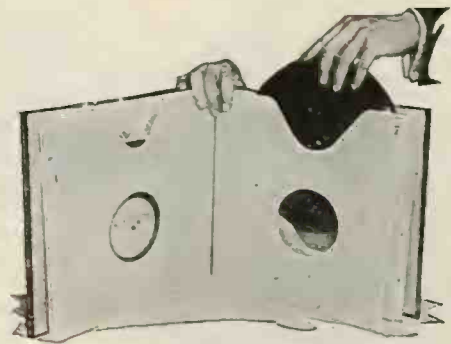

REPRESENTATIVES:

BOSTON

L. W. Hough, 20 Sudbury Street

CHICAGO

W. A. Carter, 57 E. Jackson Blvd

SAN FRANCISCO

Walter S. Gray Co., 942 Market St.

TIME FLIES

"thus sang Omar as he smote his bloomin' Lyre"



ARE you going to be able to meet competition this Holiday Season?

AND will the line you carry be able to give you your share of the Phonograph Business?

*The new Vocalion Lateral Cut Records—
the new Vocalion Period Models—
the prestige and the national advertising of*

The AEOLIAN COMPANY

all go to make a Vocalion dealer's franchise an extremely valuable one.

THE AEOLIAN COMPANY

529 South Wabash Avenue
Chicago, Ill.

The World's Largest Manufacturers of Musical Instruments

Just tear off this corner — fill in and mail

The Aeolian Co.,
529 So. Wabash Ave.,
Chicago, Ill.
Gentlemen: I am interested in your dealer's prop-
osition. Please send me complete information.

Name.....
City.....
State.....
Date.....

WILLIAM WALTER DINWIDDIE DIES

Was Associated for Thirteen Years With Thos. A. Edison—A Noted Astronomer and Engineer—Born in Charlottesville, Va.

William Walter Dinwiddie, who was associated with Thomas A. Edison in experimental work for more than twelve years and who, at one time, was division manager of the disc recreation manufacturing division at the Edison Laboratories, passed away early last month at St. Mary's Hospital, Orange, N. J., following an operation.

Mr. Dinwiddie was also, at one time, an expert astronomer in the United States Naval Observatory at Washington, D. C., and, in 1903, was a member of an official expedition to Sumatra, where instruments he devised were used in making photographs of an eclipse. He was a member of a similar expedition to Spain in 1904.

Mr. Dinwiddie was born in Charlottesville, Va., and was educated at the university of that State. He was also a member of the American Society of Mechanical Engineers.

DIRECT FACTORY PRICE—JUST MENTION THE QUANTITY

MOTORS	CASTINGS	} TURNABLES MOTOR FRAMES TONE ARMS HORNS and THROATS	Stylus Bars
TONE ARMS	Grey Iron		Screw Machine Parts
REPRODUCERS	and Brass for		Talking Machine Hardware

Direct Quantity Importations On { JEWEL and STEEL (Bulk or Packed)
PHONOGRAPH NEEDLES
GENUINE RUBY BENGAL MICA

EASTERN REPRESENTATIVE
CHERINGTON MFG. CO.
IRONCLAD MOTORS

D. R. DOCTOROW

Vanderbilt Ave. Bldg.
51 East 42nd St., New York
Tel. Vanderbilt 5462

CLOSES GLOVERSVILLE BRANCH

Albany Will Now Be Headquarters of the American Phonograph Co.

The American Phonograph Co., until recently Edison jobber in Albany and Gloversville, N. Y., has permanently discontinued its branch at Gloversville and the entire business of the jobbing organization hereafter will be conducted

from the Albany headquarters. It is the belief of the company that the consolidation will result in improved service to Edison dealers located throughout that section.

COLUMBIA DEALERS IN NEW YORK

Chicago Representatives of Columbia Graphophone Co. Visit Eastern Headquarters—Entertained at Banquet and Theatre Party

Twenty-seven Columbia dealers from Chicago territory, accompanied by John McKenna, manager of the Columbia branch in Chicago; F. Blimke, of the Chicago sales staff; L. Sebeck, who is in charge of the international records department in Chicago, and J. Kapp, head of the record department, arrived in New York Tuesday, October 12, for a visit to the Columbia executive offices, factory and recording laboratory.

The visitors spent Wednesday at the mammoth Columbia plant in Bridgeport, and attended an informal luncheon at the Hotel Stratfield at which brief addresses were made by the factory executives. The dealers were amazed at the tremendous progress which has been made at the Columbia factories during the past year, and were deeply impressed with the efficiency which characterizes each and every department of the Columbia manufacturing organization.

Thursday was spent at the Columbia executive offices, where George W. Hopkins, general sales manager of the company, and the members of his department conferred with the dealers on the sales and merchandising situation in their respective localities. The dealers also visited the recording laboratory, and called at Widener's Columbia Shop, Fifth avenue and Thirty-seventh street, one of the finest retail establishments in the country.

On Thursday evening a banquet was held at the Hotel Pennsylvania, at which Mr. Hopkins gave one of his usual effective talks, which was enthusiastically received by the dealers. A theatre party on Thursday evening was the closing number to the dealers' program, which completed a visit that was replete with practical value for every dealer who was able to make the trip.

HE SHALL NOT PASS

No arrogant man shall pass through the portals of Mercantile Success. He who is an arrogant employer shall have servile employes. What a prize combination for repelling trade!

Cultivate the idea of faith in your own ability to sell. Have quiet confidence but no cheek of the brassy kind.

THE Fletcher Alltones Needle

Each Needle Plays Loud, Medium or Soft

This is the only semi-permanent needle made which has ALL TONES in one



Patent Pending

Retail Price per card of four needles . . . 25c.

Boxes of 100 cards to dealers . . . \$15.00

Less 2% for cash with order

Valuable Selling Helps Free to Dealers

Send order for trial box of the Highest Class Needle Made



Soft



Medium



Loud

POSITIONS FOR PLAYING

Valuable Territory Open For Responsible Jobbers

For information, samples or orders address

In New York Territory
order from our jobber

Andrew H. Dodin

Incorporated

28 Sixth Ave.
New York City

**Fletcher Alltones Needle
Co., Inc.**

205 Travis Street
San Antonio - - Texas

ACME-DIE

- CASTINGS -

ALUMINUM-ZINC-TIN & LEAD ALLOYS

AcmeDie-Casting Corp.
Boston Rochester Brooklyn N.Y. Detroit Chicago



Here's the Christmas song of the year, "Holy Night, Peaceful Night," sung by Jeanne Gordon. It's the season's song to round out Christmas cheer. Order today. Columbia 79373.

Columbia Graphophone Co.
NEW YORK

NO PRICE REDUCTIONS

Columbia Co. Notifies Dealers That No Decrease in Grafonola Prices is Apparent at the Present Time—Branch Managers in Town

Columbia dealers were notified recently by the general sales department of the Columbia Graphophone Co. that there was no prospect of any change in the price of Grafonolas, at least up to January 1. This information was given to the trade in response to inquiries received regarding the company's plans for the future, and the present cost of labor and raw material makes any price reduction unlikely.

During the past few days several of the Columbia branch managers visited the executive offices, and conferred with Geo. W. Hopkins, general sales manager, as to the business situation in their respective territories. Among these callers, all of whom were optimistic in their predictions for the future, were A. B. Creel, New Orleans; J. L. DuBreuil, Cleveland; W. S. Parks, of Baltimore, and Westervelt Terhune, Atlanta. Other callers at the executive offices this week were L. S. Blythe and E. R. Smith of the Kansas City, Mo., sales staff.

TRADE EXPANSION IS REPORTED

ANSONIA, CONN., November 3.—The Mellowtone Needle Co., of this city, manufacturer of the Superb semi-permanent stylus, has established many agencies for the sale of its needle, although this new product was only introduced to the trade several months ago. As the name of the company would indicate the tone of this stylus is soft and mellow and the needle has found much favor among owners of talking machines. However, dealers throughout the country report that an insistent demand is manifested for loud tone needles for playing dance records. In order to meet this demand, the Mellowtone Needle Co. is placing on the market this month a new loud tone needle. This company is preparing at its factory in this city an attractive display card for dealers' counters which is expected to furnish additional sales help for this needle. In the interest of efficient distribution the Superb semi-permanent stylus will be distributed through the medium of jobbers. Several jobbers have already been appointed and plans are well under way for the appointment of others to territories still open.

**REPAIRING
AND
REPAIR PARTS**
for all makes of
Talking Machines

BOND'S GRAPHOPHONE SHOP
38 Arcade :: Nashville, Tenn.

OPENS PATHE WAREROOMS

W. A. McKenney Installs Unico Demonstration Rooms and Filing Equipment in His Establishment—Inaugurates Advertising Campaign

ATHOL, MASS., November 1.—W. A. McKenney, who has been established for many years as a jeweler in this city, has opened attractive Pathé warerooms at 424 Main street, this city. An installation of Unico demonstration rooms and filing equipment has been made which is an exact copy of the equipment found at the headquarters of the Commonwealth Phonograph Co., Pathé distributors of Springfield, Mass., who supplies them. This new dealer has already effectively taken advantage of the Pathé advertising campaigns suggested from the headquarters of the Pathé Frères Phonograph Co. in Brooklyn and finds they are bringing him excellent returns. The Pathé department is under the direct supervision of Mrs. McKenney, who is scoring a big success.

FEATURES "TEN LITTLE BOTTLES"

Will A. Watkin Co. in Dallas Has Clever Display of Columbia Record

The Will A. Watkin Co., Dallas, Tex., recently had a very effective window display featuring Q R S player rolls and Columbia records, one of them being Bert Williams' popular hit, "Ten Little Bottles." The display showed a player-piano made out of Q R S rolls, a Bert Williams poster with ten bottles containing ten different drinks—(so the sign said, anyway). The window was designed by W. R. Long of the Grafonola department.

VAN STIGHT MADE MANAGER

C. Van Stight has just been given charge of the talking machine department of the Davidson Co., Waterloo, Ia. Mr. Van Stight was formerly manager of the Des Moines Talking Machine Co., and has had a number of years' experience in Victor merchandising.

"LIBROLA"

A Library Table PHONOGRAPH

This line affords the dealer an opportunity to develop high-class profitable business.

The "Librola" is being handled by progressive dealers everywhere. Write for prices and open territory.

*Immediate
Delivery in
Mahogany*



No. 250T. Patent applied for. To retail at \$250
Usual discount to dealers.
48" long, 28" wide, 31" high. Finished all around
Oak, Mahogany or Walnut

We are ready to make immediate deliveries. Send in your orders today.

SEABURG MANUFACTURING COMPANY
JAMESTOWN, NEW YORK

Gennett

RECORDS

"The difference is in the tone"



The Joyous Lilt

of the new Gennett Dance Records is giving lovers of the dance a new delight. And Gennett vocal and instrumental selections, too, breathe the very life and soul of the artist.

Selections from the New November List

- | | |
|--|---|
| 9072—Down the Trail to Home Sweet Home (Ball). Bell and Sharpe, Tenor and Baritone Duet—Orch. Accompaniment. | 9076—Aloha Land (Walter Herzer). Ferrara, Franchini and Green, Hawaiian Guitars and Xylophone. |
| When Honey Slings An Old Time Song (Carey). Ballard, Tenor, Tenor, Soprano Duet—Orch. Accompaniment \$1.00 | Hawaiian Twilight (One Step). (Sherwood and Vanderstoof). Ferrara and Franchini Hawaiian Guitars \$1.00 |
| 9073—The Simple Simon Party (Montgomery). Billy Murray, Tenor Solo—Orch. Accompaniment. | 9077—The Broadway Blues (Morgan and Swanstrom). Read 'em and Weep (Bernard and Haenschen). Al Bernard, Tenor—Orch. Accompaniment \$1.00 |
| A Hundred Years Ago (Ringle, Schofer and Bennett). Arthur Hall, Tenor—Orch. Accompaniment \$1.00 | 9078—My Little Blimbo (Donaldson and Clark). Billy De Rex, Tenor—Orch. Accompaniment. |
| 9074—Souvenir of Switzerland (Liberati). Columbia (Polka) Pietro Capodiferro. Cornet Solos, accompanied by Florida's Orchestra \$1.00 | You Ought to See Her Now (Pease, Nelson and Russak). Arthur Hall, Tenor—Orch. Accompaniment \$1.00 |
| 9075—Rose of Spain (Brown, Pezloff and Miller). June Melley (Fox Trot). Intro.: Can You Tell (Miller, Brown and Sullivan). Ray Miller's Black and White Melody Boys \$1.00 | 9079—Nearer My God to Thee (Mason). Charles Hart and Elliott Shaw, Tenor, Baritone Duet—Orch. Accompaniment. |
| | Where Is My Wandering Boy Tonight (Lowry). Chas. Hart, Tenor Solo—Orch. Accompaniment \$1.00 |

Hear these and other new Gennetts at any Starr dealer. No obligation.

THE STARR PIANO COMPANY, Richmond, Indiana

NEW YORK CHICAGO LOS ANGELES BIRMINGHAM DETROIT
CINCINNATI CLEVELAND INDIANAPOLIS LONDON, CANADA

TED LEWIS SCORES IN INDIANAPOLIS

Columbia Dealers Take Advantage of Appearance of Famous Jazz Aggregation to Feature Records Made by the Band Grafonola.

INDIANAPOLIS, IND., November 5.—The Ted Lewis Jazz Band, which appeared recently at the Shubert Murat Theatre in this city, has been making history



Ted Lewis and His Jazz Band

for Columbia dealers, who took advantage of the appearance of this popular and exclusive Colum-

bia artist to use extensive publicity in the newspapers. Several concerts were held in Columbia establishments, and this timely publicity produced splendid results.

The Indianapolis News contained a full-page advertisement featuring Ted Lewis' Jazz Band and the Columbia records made by this internationally famous organization. On one afternoon during its engagement at the Shubert Murat Theatre, Widener's Grafonola Shops secured the services of Ted Lewis' Jazz Band and gave a concert at their store, which attracted a very large crowd and which succeeded in selling a large quantity of Columbia records made by this band. In addition this enterprising Columbia dealer carried a special advertisement in the Indianapolis News featuring the Ted Lewis concert to be held in his store.

All of the Columbia dealers in Indianapolis presented a special Ted Lewis window display during the week of his engagement in this city, and this concentrated advertising stimulated the sale of Ted Lewis records far beyond all expectations.

RUSSIAN PEASANTS LIVE IN STYLE

Bring Food to Town and Trade It for Pianos, Silks and Fine Clothes

"One of the peculiarities of our topsy-turvy life in Russia now," says a letter from Petrograd, mailed in a roundabout way a few months ago, "is that the peasant villagers are assuming all the refinements that were found only in the cities heretofore, and are acquiring all the luxuries, silks, ribbons and even grand pianos, that once belonged to the city, exchanged now by the city for food.

"The peasants come to the city bringing food, and bringing also their list of the things they want. They examine the quarters of the bourgeoisie critically; they demand nickel-plated beds of spacious proportions and with spring mattresses; they will consider none but those made of the softest wool; they select the finest dresses and one ambitious villager specified that the

piano which he wanted must be a baby grand to fit the corner in his kitchen, while talking machines of expensive type are also demanded.

"Moving picture houses, theatres and music halls have been built hurriedly in the villages, and are flourishing, while those in the city are falling into ruin."

TWO OPTIMISTIC WESTERNERS

C. E. Goodwin, manager of the Phonograph Co., Chicago, and M. M. Blackman, manager of the Phonograph Co., Kansas City, both prominent Edison jobbers, were visitors at the Edison Laboratories recently. Both Mr. Goodwin and Mr. Blackman are highly optimistic over the prospects for the future and expressed complete satisfaction over the outlook for a record-breaking holiday business.

Advertise the truth, for the truth is big enough to stand without any camouflage.

Buying and Selling

The choice of Phonograph and Furniture buyers is influenced by distinctively designed parts and trimmings. Purchasing agents can co-operate with their own sales departments by supplying accessories and fittings that quicken the dealer turnover.

Phonograph Accessories

For Immediate Delivery—Needle Cups and Double Spring Motors, capable of playing three 12-inch records.

Also—Lid Supports, Automatic Stops, Tone Rods, Knobs, Escutcheons, Sockets, etc.

Furniture Trimmings

A complete offering in all the Period and Commercial Furniture Lines.

Refrigerator Hardware

All sized Locks and Hinges.

Samples and complete information on request

Grand Rapids Brass Company

Grand Rapids, Michigan

New York: 7 E. 42nd St.

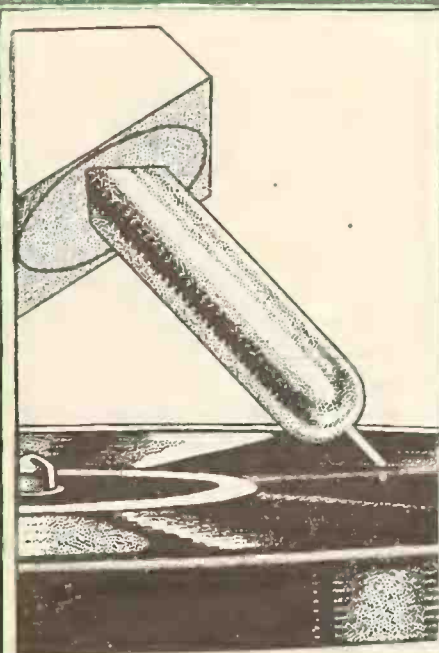

THE INSTRUMENT OF QUALITY
Sonora
CLEAR AS A BELL

Semi-Permanent

NEEDLES

are recognized as being the leaders. They play many times, do away with the inconvenience of frequent needle changing, and having parallel sides they do not increase in diameter, thereby increasing the life of the records by reducing wear to a minimum.

Sonora Semi-Permanent Needles are steadily advertised, they're in demand, they give the utmost satisfaction and each sale brings you a good profit.

Loud, Medium, Soft

25c per card of 5 40c in Canada

FREE!

Write us and learn how you can obtain this handsome needle container free.



Sonora Phonograph Company, Inc.

GEORGE E. BRIGHTSON, President
New York, 279 Broadway

Canadian Distributors: I. Montagnes & Co.
Toronto

CAUTION!

Beware of similarly constructed needles of inferior quality.

FREEPORT STORE HOLDS OPENING

Effig & Ives Launch Victor Store in Thriving Long Island Town—Biltmore Hawaiian Orchestra the Feature of the Musical Concert Program on the Opening Day

The Freeport Music Store, now under the direction of Effig & Ives, held its formal opening on October 23 in Freeport, L. I. The opening event was marked by a notable musical concert given by prominent artists, the featured group being the Biltmore Hawaiian Orchestra. Many guests took advantage of the opportunity and invitation and attended, which helped to make the affair a great success. The new store has most attractive quarters and on the opening night the decorations and flowers lent a festive air to the occasion. The Victor dog had his share in the ceremonies and was in evidence on all sides. This exclusive Victor shop has had a good introduction to the people and under its efficient management its trade will grow rapidly. Officials of the American Talking Machine Co. and the New York Talking Machine Co., Victor jobbers, and others attended.

BLUE RIBBON GOES TO EMERSON

Wins Highest Award at Fresno County Fair and Exposition Last Month

LOS ANGELES, CAL., November 1.—With I. Lessor, the energetic special representative of the Western Jobbing & Trading Co., in charge of the exhibition booth at the Fresno County Fair and Exposition, Emerson phonographs and records were not allowed to hide their light or music under a bushel. The judges were so impressed by the exhibit and the excellence of the product in appearance and tone that they awarded the first prize to those products.

NEW JONES-MOTROLA PRICES

Manufacturers Make Cut in Response to Expressed Opinion of Jobbers

Jones-Motrola, Inc., New York City, manufacturer of the well-known electric winding device of that name, recently completed a careful canvass of various jobbers situated in different trade centers of the country regarding future sales plans. It was the general consensus of opinion among these jobbers that any reduction in the retail price of the Motrola would have a very favorable effect upon increased sales. Jones-Motrola, Inc., has completed the extensive addition to its factory equipment which has allowed a substantial increase of production.

Victor Dealers—



will find in our new wholesale store every facility for the marketing of

VICTROLAS and RECORDS

Our New Location at
Penn Avenue and 12th Street
brings our wholesale department to within one block of the Pennsylvania Station.
Be Sure to visit the Model Victor Sales Room on the first floor.

Mellor's

PITTSBURGH, PA.

Figuring the production costs now possible with these increased facilities and anticipating the large increase of sales which will be possible, the Jones-Motrola Co. has decreased the price of the Motrola to \$30.

BAXT PHONOGRAPH CO. FORMED

The Baxt Phonograph Co., Inc., of Boston, has incorporated to deal in talking machines and phonographs. The capital is \$50,000 and the incorporators are Oscar Serman and Celia Serman, of Cambridge; Morris Shapiro, William Baxt, Alexander Shapiro, Maurice Gordon, Morris Levinson, Louis Kalis, Pauline Shapiro and Abraham Adler, of Dorchester, and Harry Tarlow, of Brockton.

INCORPORATED IN BOSTON

George B. Stone & Son, Inc., Boston, Mass., have incorporated with a capital of \$50,000 to do a general business in musical instruments. The incorporators are George B. Stone and Paulina R. F. Stone, of Everett, and Charles E. Lawrence, of Belmont.

SMALL GOODS INCREASE SALES

Talking Machine Dealers Find a Line of Musical Merchandise a Paying One

Buegeleisen & Jacobson, New York City, musical merchandise wholesalers, report that their campaign to interest the talking machine dealer in musical merchandise has brought forth many favorable responses. These dealers have found that the addition of a line of musical merchandise has not only induced new trade to enter their warerooms, but has produced additional sales from their regular customers. One dealer reports that he has found musical merchandise of particular interest to the younger folks through such instruments as the harmonica, ukulele, violin and banjo. These young folks, he finds, not only need supplies, but are a natural approach to the older folks to buy talking machines and records.

If you expect your employes to be enthusiastic about the store and the business see that you give them some reason to be. Nothing will starve to death much quicker than enthusiasm.

The Philwey "Rekord Phile"

Is an Indispensible Requisite in the Modern Phonograph of Today



IT embodies all the good features necessary in a practical and serviceable phonograph record file.

The keys are numbered from one (1) to the number of record spaces contained in the file, and are placed at an angle so the numbers are seen at a glance.

The Partitions are metal bound, dampness will not affect them, they will protect the records from scratching and warping. The partitions are alternately light and dark, so as not to confuse the eye when returning the records to their proper spaces.

No wires or springs are used in its construction, and there is only ONE moving part.

The Philwey "Rekord Phile" will be a big asset to your business, as the possibilities of increase in sales are practically limitless. Why not go into details with us NOW?

PHILWEY MFG. CO. Inc. 75 South Ave. Rochester, N. Y.

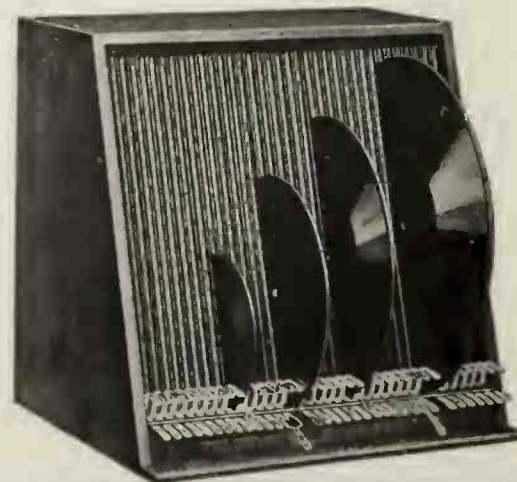

The Windsor Phonograph



Queen Anne

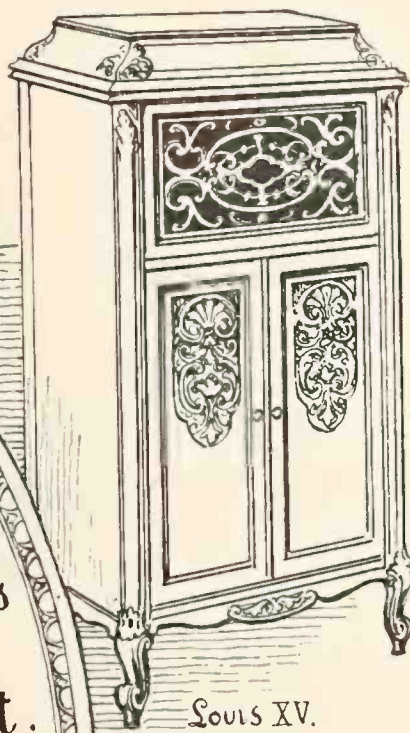

Louis XV.

The
Windsor
is the original Period Design
PHONOGRAPH.
It is a musical Instrument as
perfect
as human skill can make it.
It is a beautiful, well made
Piece of Furniture,
made by a Firm which for 35 years
has produced the best Furniture
in America.
All its productions are made of
Solid Wood.
All Carving and Finishing
done by hand.

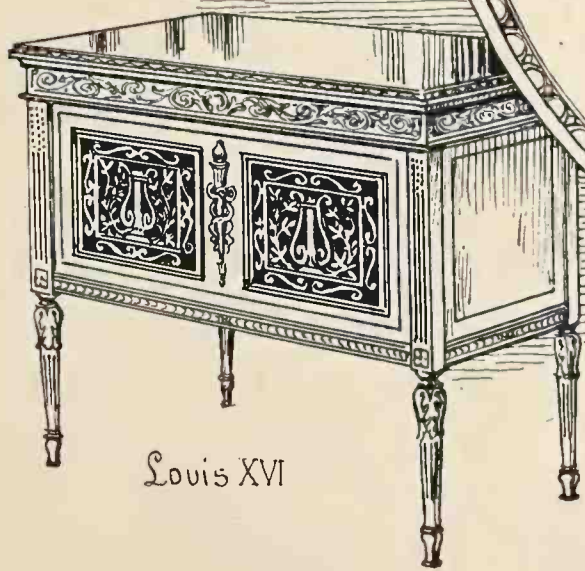

Louis XVI

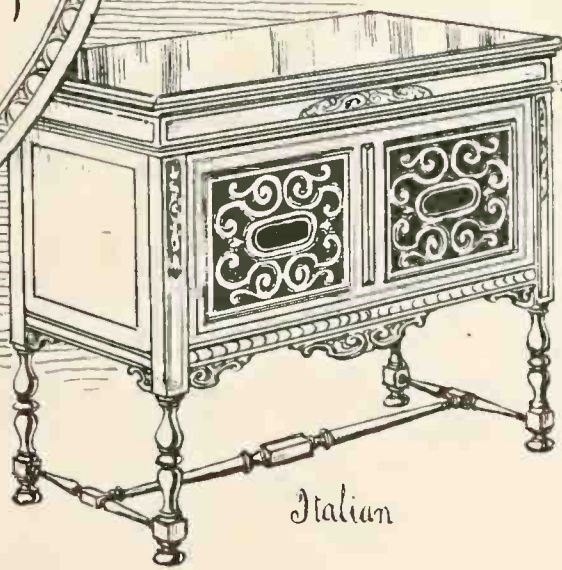

Italian

made by

The Windsor Furniture Company, CHICAGO, U.S.A.

Sold only through Dealers.

Disc Record Manufacturers ATTENTION

If you are not satisfied with your product—

If some part of the manufacture needs perfection—

Let me help you.

I was the pioneer to introduce the present disc record into Europe in 1901. Successful factories were erected in England, France, Spain, Germany, Austria, and Brazil under my management. I know the record business from A to Z, and can straighten out your difficulties.

The present system of permanent masters was perfected in my laboratories in 1904 and has never been improved upon.

The double-sided record was my patent and brought out in 1903.

If you want the best to be had in recording machines; if you want the latest development in pressing records from shells; if you want increased record production in power-driven presses—I can help you.

*Complete installations
taken charge of*

F. M. PRESCOTT
RIVERDALE, N. J.

Phone Telegrams
No. 2 Pompton Lakes Prescott, Pompton Lakes
N. J. N. J.

PROMINENT ARTISTS APPEAR AT AEOLIAN DEDICATION

Official Opening of New Factories of the Aeolian Co., in Meriden, Conn., Marked by Elaborate Concert by Vocalion Artists—New Plants Are the Acme of Efficiency

MERIDEN, CONN., November 3.—An event of unusual importance recently was the formal dedication of the two new additions to the large plant of the Aeolian Co. in this city, one of the new buildings being devoted to the manufacture and storage of Melodee music rolls and the other to the production of Vocalion records.

The dedication ceremonies were participated in by over 1,000 Aeolianites who gathered to

departments. The printing department is most modern in equipment, and in addition to furnishing labels for music rolls also takes care of much of the company's stationery.

The new Vocalion record factory is a two-story building, 42 x 60, also of reinforced concrete. The installation of a mezzanine floor provides additional space. The new building was designed especially to meet the demands of rec-



Artists Who Appeared at Dedication of New Aeolian Co. Factories in Meriden, Conn., Recently Left to right: Oscar Adler, Edward Falck, Charles Hart, May Peterson, Wilfred Glenn, Elliot Shaw and Gino Baldini

enjoy an elaborate concert by Vocalion record artists, among them May Peterson, the prima donna soprano; Wilfred Glenn, basso; Charles Hart, tenor; Elliot Shaw, baritone, and Oscar Adler, violinist. The program was arranged by Gino Baldini, of the Vocalion recording studio, and was in charge of Edward Falck, musical director of the recording studio. The concert was given on the top floor of the new music roll building, which was spacious enough to hold the large audience without crowding. Dancing followed the concert.

The new buildings will prove welcome additions to the Aeolian Co. plant, and provide the desired facilities for increased production. The larger of the buildings, a four-story reinforced concrete structure, is 120 feet long by fifty feet wide, and each floor is connected with the old plant by a direct doorway. The first floor will be used for the storage of music rolls and has a capacity of 250,000 rolls. The remaining three floors will be used for the manufacture of rolls, and will house the finishing, printing and cutting

ord manufacturers, and is equipped with a ventilating system that removes every particle of dust through special flues. Grinding machinery and record presses are now being installed. The equipment when entirely completed will enable the company to increase its record output.

DEATH OF RICHARD COLLINGS

Richard Collings, one of the founders of Collingswood, N. J., and a relative of L. W. Collings, president of Collings & Co., the Victor distributors of Newark, N. J., died recently at his home in Collingswood, N. J., at the age of seventy-eight. He was a member of the New Jersey Bridge and Tunnel Commission.

THROWING LIGHT ON TIMELY TOPIC

The candle loses nothing of its light by lighting another candle. Just so with us—we do not lose but rather increase our capacity for friendship by being friendly.

EQUIP YOUR TURNTABLES WITH

A. W. B. BOULEVARD VELVETS

ADD TO THEIR QUALITY AND ATTRACTIVENESS



A.W.B.

Boulevard
VELVETS

GRAND PRIZE—GOLD MEDAL, ST. LOUIS EXHIBITION

VELVETS, VELVETEENS, PLUSHES

WRITE FOR SAMPLES AND PRICES

A. WIMPFHEIMER & BRO., Inc.
450-460 Fourth Avenue, New York

ESTABLISHED 1845



Widdicomb Early American Art Phonograph

Widdicomb

PHONOGRAPH

The Aristocrat of Phonographs

The Widdicomb Phonograph is made in Art Models, both upright and console types, in the more popular and better known styles of period conception. Dealers should write for the facts of the Widdicomb franchise.

PHONOGRAPH men who have heard the Widdicomb, say that the Widdicomb Amplifier marks a new epoch in the musical development of the phonograph.

For the first time in phonograph history the Widdicomb Amplifier does full justice to the lower as well as to the higher musical tones.

When playing an orchestral record on the Widdicomb the deeper, richer tones are given equal prominence.

This is a feature readily appreciated by music lovers. It is, in a large measure, responsible for the growing and ever widening popularity of the Widdicomb.

Let us give you the details of the Widdicomb franchise. You will find this information worth having.

The Widdicomb Furniture Co.
Grand Rapids Michigan

Established 1865—America's Finest Furniture Designers

H.K. Lorentzen

Manufacturer of
Exclusive Cabinet Hardware and Accessories
60 Grand Street
New York City

Eastern Distributor for the

ELECTROPHONE

The machine with the **SILENT** electric driven motor

Dealers' Terms on Request

BECK WITH PLATT MUSIC CO.

Popular Talking Machine Man Welcomed Back to Coast Trade Circles

LOS ANGELES, CAL., November 1.—P. H. Beck, one of the most popular talking machine men in southern California, has returned to this city after an absence of about six months. Mr. Beck, who was at one time president of the Retail Talking Machine Men's Association, has become manager of the Victrola, small goods and sheet music departments of the Platt Music Co. He was welcomed back to Los Angeles by a host of friends.

OPENS STORE IN HEMPSTEAD

John Bieling, Well Known in Talking Machine Trade, Opens Exclusive Victor Store

John Bieling, formerly of the Haydn and American Quartets and also for some time with the New York Talking Machine Co., has opened an exclusive Victor store in Hempstead, L. I. His experience in the trade and in the Victor line will be of great assistance to him in his new venture and his friends have expressed their best wishes for his success. Numerous guests attended the opening, among them being representatives of the New York Talking Machine Co. and C. Bruno & Son, Inc.

PRODUCE CLEVER ACROSTIC

A. J. Levine, a Pathé dealer of Brooklyn, has suggested the following arrangement evolved from the word "phonographs" which is worthy of notice:

- P—atience in consummating sales.
- H—ouse-to-house canvass and follow-up.
- O—rderliness in stock-keeping.
- N—ovel in display and "Newsy" in advertising.
- O—ne specialty for each sale and for each advertisement.
- G—ood-will is a silent salesman.
- R—eciprocity between dealer and customer.
- A—dvertise to profit from its cumulative effect.
- P—opularize Music—propaganda is subtly effective.
- H—onesty—You can't fool some of the people even some of the time.
- S—ell phonographs, for nothing sells itself!

The successful man to-day is the practical man. If you are not already familiar with the working side of your business, begin the study of it now.

A Welcome Visitor To Victor Dealers

THE USOSKIN MONTHLY WINDOW CARD SERVICE is a welcome visitor each month in the store of hundreds of Victor dealers. They greet its arrival as they would the acquisition of a top-notch salesman.

That's just what this service is, too—a salesman that is on the job for you from morn 'till night for thirty days. Ask us to tell you more about it.

Photographs and details gladly sent upon request.

USOSKIN LITHO, Inc.
230 WEST 17th ST., NEW YORK CITY

COLUMBIA AGENCY IN LANCASTER

LANCASTER, PA., November 5.—The Keystone Furniture Co., West King street, has been appointed Columbia representative for this city, according to an announcement recently made by the company. In the handsome showrooms the entire line of Columbia instruments is on dis-

play. One of the features of the Keystone Grafonola service is the department where all accessories for Grafonolas and phonographs may be purchased. Special introductory offers are being announced in the daily newspapers. A large record library is maintained and this part of the Columbia service is carefully kept up to date.



FEDERAL ELECTRIC SIGN



—9 Months to Pay

The first payment brings you the sign—you have the 9 months to make the final payments. Pays for itself many times over—

—Draws Trade Like a Magnet

Sparkling at night and glistening in the daytime, it tells the people for blocks in each direction that you are up-to-date and modern. It tells your name and business day and night—it draws prospective customers past less attractive stores to you. It works for you as an energetic salesman, while your competitors are lost in darkness.

Note the beautiful embossed letters. The entire sign is made of porcelain enameled steel—brilliant white letters on a blue background. Practically indestructible—will not rust, peel, rot or fade—never needs refinishing. Costs only a few cents a day for electricity—There is no other maintenance expense. An occasional washing keeps it like new.

Gain a step on competition—get your sign up now. Send the coupon for full information—no obligation.

Tear Off and Mail Coupon Now

FEDERAL ELECTRIC COMPANY

Representing Federal Sign System (Electric) : 8700 South State St., Chicago, Ill.

Please send me full information on Porcelain-enameled Steel Sign for my business. Explain your 9-months-to-pay Plan

Name.....City.....State.....

Street and No.....Business.....

Store Frontage.....No. of Floors.....

T. M. W. 11



DECEMBER RELEASES

Oké Records

- | | | | |
|-----------------------------------|--|-----------------------------------|--|
| <p>4183
10-in.
\$1.00</p> | <p>THE LOVE NEST (Intro. Chorus of "Mary," from musical play "Mary") (Tenor with Orch.) Lewis James</p> <p>I WOULD LIKE TO HAVE A GIRL LIKE YOU LIKE ME (Tenor with Orch.)
Sam Ash</p> | <p>4191
10-in.
\$1.00</p> | <p>WHEN YOU AND I WERE YOUNG, MAGGIE (Tenor with Orch.)
Henry Burr with Peerless Quartet</p> <p>THE OLD OAKEN BUCKET (Vocal Quartet) Shannon Four</p> |
| <p>4184
10-in.
\$1.00</p> | <p>A PICTURE OF MOTHER (Tenor with Orch.) Henry Burr</p> <p>WAIT'N FOR ME (Male Trio with Orch.)
Sterling Trio</p> | <p>4192
10-in.
\$1.00</p> | <p>ALONG THE WAY TO WAIKIKI (Hawaiian Guitar Duet) Ferera-Franchini</p> <p>HAPA HAOLE HULA GIRL (Hawaiian Guitar Duet) Ferera-Franchini</p> |
| <p>4185
10-in.
\$1.00</p> | <p>FEATHER YOUR NEST (Tenor Duet with Orch.) Campbell-Burr</p> <p>WHEN I FOUND YOU (From musical comedy, "Poor Little Ritz Girl") (Contralto-Baritone Duet with Orch.)
Helen Clark-Joseph Phillips</p> | <p>4193
10-in.
\$1.00</p> | <p>THE TEDDY BEARS PICNIC (Characteristic) Conway's Band</p> <p>MARCH OF THE TOYS (From musical show, "Babes in Toyland") Conway's Band</p> |
| <p>4186
10-in.
\$1.00</p> | <p>MOONLIGHT IN MANDALAY (Tenor-Baritone Duet with Orch.) James-Shaw</p> <p>SWEET LUANA (Vocal Duet with Hawaiian Guitar Accom.)
Jane Neilson-Lewis James</p> | <p>4179
10-in.
\$1.00</p> | <p>LAUGHING VAMP (Fox-trot)
Rega Dance Orchestra with Incidental Saxophone by Nathan Glantz</p> <p>KAMEL-LAND (Fox-trot)
Green Brothers' Novelty Band</p> |
| <p>4187
10-in.
\$1.00</p> | <p>KENTUCKY (Baritone with Orch.)
Ernest Hare</p> <p>HONOLULU EYES (Vocal Duet with Orch.) Jane Neilson-Lewis James</p> | <p>4180
10-in.
\$1.00</p> | <p>THE BLACKSMITH RAG (With the "Anvil Chorus") (Fox-trot)
Green Brothers' Novelty Band</p> <p>BOW-WOW (Puppy Love) (One-step)
All Star Trio</p> |
| <p>4188
10-in.
\$1.00</p> | <p>DRIFTING (Tenor with Orch.) . . Henry Burr</p> <p>WHEN YOUR SHIP COMES IN (Tenor Duet with Orch.) Campbell-Burr</p> | <p>4181
10-in.
\$1.00</p> | <p>SILVER WATER (Fox-trot)
Rega Dance Orchestra with Incidental Saxophone by Bennie Krueger</p> <p>IN OLD MANILA (Fox-trot)
Green Brothers' Novelty Band</p> |
| <p>4189
10-in.
\$1.00</p> | <p>ROCK OF AGES (Contralto-Baritone Duet with Orch.) . . . Helen Clark-Joseph Phillips</p> <p>I NEED THEE EVERY HOUR (Vocal Duet with Orch.)
Charles Henry-James Jordon</p> | <p>4182
10-in.
\$1.00</p> | <p>TELL ME, PRETTY GYPSY (From "Ziegfeld Follies of 1920") (Medley Fox-trot)
Rega Dance Orchestra</p> <p>ROCK ME IN A CRADLE OF LOVE (Fox-trot)
Ray Miller's Black & White Melody Boys</p> |
| <p>4190
10-in.
\$1.00</p> | <p>LEAD, KINDLY LIGHT (Vocal Quartet)
Peerless Quartet</p> <p>JESUS, SAVIOUR, PILOT ME (Tenor with Orch.) Henry Burr</p> | | |

GENERAL PHONOGRAPH CORPORATION

OTTO HEINEMAN *President*

25 West 45th Street, New York City, N. Y.

Factories: Newark, N. J. Elyria, Ohio Putnam, Conn. Springfield, Mass. Kitchener, Ont.
Branch Offices: Chicago, Ill. Toronto, Can. London, Eng.



FIRST BIRTHDAY OF THE ARTO CO. TOSCANINI AND ORCHESTRA TO RECORD FOR VICTOR CO.

Company Has Developed With Great Rapidity During First Year of Existence

The Arto Co., of Orange, N. J., manufacturers of the Arto talking machine record, recently celebrated its first anniversary. The company has just forwarded to the trade data concerning the history of the progress of the organization in one year's time. It already has a factory which has reached quantity production in the pressing of both talking machine records and music roll flanges, and in addition it will shortly break ground for a new wing to the plant, which will be closely followed by a large building, towering far above the other structures in the neighborhood.

The company states its records are stocked by hundreds of dealers and the trade has taken kindly to its specialty of quick releases of current hits. Besides the executive offices at the main factory, 29 Central avenue, Orange, N. J., the Arto Co. also has a New York office at 1604 Broadway.

Famous La Scala Orchestra, Which Is Coming to the United States This Fall for a Concert Tour With Toscanini as Director, Will Be Heard Later Through Medium of Victor Records

Through arrangements just concluded by officials of the Victor Talking Machine Co. with the managers of Maestro Arturo Toscanini and the La Scala Orchestra of Milan, Italy, it is expected that a series of Victor records will be made by these artists this Winter. Toscanini and the La Scala Orchestra will tour the United States this coming Winter and will appear in all the principal musical centers. During this visit a number of records will be made by the La Scala Orchestra, under the direction of Maestro Toscanini.

Few men have had a more brilliant career than Signor Toscanini, who is recognized as one of the foremost conductors of the day. During the time he was conductor of the Metropolitan Opera Co. he gained an enviable reputation both for the quality of the productions and the rare skill displayed in interpreting and directing the musical masterpieces. His return to the

United States will be awaited with interest by all lovers of music. Further announcements as to the final details of the arrangements for making these special records will be given in the near future.

CHANGE TITLE OF COMPANY

The Emery Dry Goods Co., which has been in business in Orange, Mass., for over thirty years, will, after November 1, be known as Emery's Music Store, with Fred C. Emery as sole owner, as before. This firm carries a fine line of Victorolas, pianos, sheet music, etc.

WINDOW DISPLAY OPPORTUNITIES

The Christmas season offers almost unlimited possibilities for original thought and treatment in window display.

In your neighborhood, many of the million and a half readers of these magazines have been sold the Motrola idea. Well?



WE'VE got 'em interested by advertising—the rest is up to you Remember that a Motrola display in your window or store will act as the reminder that completes the sale.

We furnish all the window cards, counter cards, booklets and sales boosters you can use. Write for folder showing the newspaper ads we have prepared for advertising your store and information on what we can do to boost your profits.

Realizing that every live dealer wants a few Motrolas on hand since the Motrola has become the vogue in the public interest, we are prepared to do our part in the way of deliveries.

Jones-Motrola, Inc.
29 West 35th Street
New York

57 E. Jackson Blvd.
Chicago
6019 Hollywood Blvd.
Los Angeles

226½ Peachtree St.
Atlanta
83 E. Woodbridge St.
Detroit

GAS vs. ELECTRICITY

The Old versus The New

Not so long ago people who electrified their houses kept gas there too. They weren't quite sure of electricity.

ONE of the "Big Four" phonograph companies had the same doubts about electricity when they decided to try TRU-TIME MOTORS on a few machines. The original purchase was one thousand motors. But when, of the initial order

Not one was returned*

this company, thoroughly convinced, placed a second order for TEN THOUSAND additional motors.



has swept aside all objections to electric phonograph drives. Can you think of anything more an electric phonograph drive should do than is contained in

Our Guarantee

To maintain constant turntable speed at any voltage from 70 to 140 volts, alternating or direct current, through every variation in current on commercial lighting circuits.

To run without heating up.

To maintain the exact speed intended for the record.

To need no adjustment, oiling or attention for at least two years and to function satisfactorily under any condition of proper usage if the seals of the motor remain unbroken.

To be invisible—no unsightly mechanism outside the instrument.

When you are offered a motor—any make, any type—ask the manufacturer to give you the same guarantee and have him PUT IT IN WRITING.

**THE TRU-TIME MOTOR IS TO THE PHONOGRAPH
WHAT THE CONDUCTOR IS TO THE OPERA**

Manufacturers—Write for Complete Description

EFFICIENCY ELECTRIC CORP.

149 Broadway, New York

Factory: Lowell, Mass.

* This is a strong statement made in a conservative way. It means that not a single motor has been returned to us, the phonograph manufacturer or the dealer, for any cause. It means that the TRU-TIME MOTOR has given absolute satisfaction.



A Few TRU-TIME MOTOR Points:

Reasonable in price.
Now in production.
Never needs oiling.
Never changes speed.
Silent and invisible.
3 point suspension in mounting.
Driving spindle to fit any make of turntable.
Speed control can be placed any desired location.
Only 2 revolving parts.



"The Japanese Sandman" is an Oriental Lullaby, the latest vaudeville hit crooned by Nora Bayes. Coupled with "You're Just as Beautiful at Sixty as You Were at Sweet Sixteen." Both of these songs show Nora Bayes to be better than the best. Order big. A-2997.

**Columbia Graphophone Co.
NEW YORK**



"TREMENDOUS ASSETS IN DEVELOPING MUSICAL TASTE"

Thus the Boston-American Refers to the Talking Machine in an Editorial of Unusual Force, and Adds: "If They Make It Well and Truly the Makers Are Honest Servers of Humanity"

The editorial writers of the daily papers throughout the country are displaying increased appreciation of the value of the talking machine as a great educational factor. Their tributes are especially well worth emphasizing inasmuch as practically a few years ago the talking machine was ignored by the editorial writers and featured almost exclusively by the cartoonists.

We have recently quoted extracts from a number of daily papers, in which the musical possibilities of the talking machine were dilated upon, and it is a pleasure to clip the following editorial comment from the Boston American of recent date:

"It is the fashion of the supercilious to sneer at the talking machine and the player-piano. There is no field where the snob rages more unchecked than the field of art. People who do not know anything else about music and pictures or letters know how to turn up their noses. They forget that the act of all acts of which the human mind is capable, requiring the least brains and the minimum of culture, is ridicule.

"As a matter of fact, the innumerable discs of talking machines flying over the land like so many Ezekiel wheels are the most tremendous assets in developing musical taste. For taste, or culture, or whatever you call maturity and sophistication in the finer arts of life, is entirely a matter of saturation.

"You cannot learn to judge pictures by at-

tending lectures and listening to someone tell you what to think. The only way is to go to the galleries or private collections where the masterpieces are and look at them, and go again and again. You like what you know. And familiarity weeds out the commonplace and breeds the love of perfection.

"As life becomes stabilized we turn more and more to the world of beauty for our satisfactions. And in this turning of the national soul away from the earth toward the sun, canned music has no inconsiderable part.

"Democracy has a soul as well as a system. Democracy has a spiritual purpose; it is not organized altogether for the purpose of giving to every man a cow and an acre. And the spiritual purpose of democracy's soul is to spread the opportunity for the best things to all of the people.

"In this sense the truest culture and the most wholesome is not to carve grotesque statues for the Summer gardens of millionaires or the dim interiors of art galleries, but to make the surroundings of the common people beautiful.

"Monarchy serves God by exalting the king. Democracy serves God by exalting the people.

"Whoever, then, will make beautiful chairs, tables, bedsteads, carpets, plates, tea cups, houses, shops and other things that have to do with the daily life of the people; whoever will accustom them to beauty and good taste is the truest artist.

"And exactly so the makers of so-called 'canned music.' If they make it well and truly, they are honest servants of humanity and worthy of their reward."

VICTOR CONTRACT FOR GIGLI

New Italian Tenor Coming for American Tour and Will Record for Victor Records

Beniamino Gigli, a new Italian tenor, who has made a wonderful success in Europe and South America, and who will make his debut at the Metropolitan Opera House in the early part of the coming season, is under contract to record for the Gramophone Co., Ltd., London, England, in which the Victor Talking Machine Co. has recently acquired a half interest. The terms of the agreement with the new artist provide for a certain amount of his services for recording in this country. Consequently, the trade may expect some remarkable records to be added to the Victor catalog this Winter or in the Spring.

NEW SALES MANAGER ON COAST

F. L. Valentine has been appointed sales manager of the retail phonograph department of the Starr Piano Co., Los Angeles, Cal. Mr. Valentine was well known in San Francisco, where, until recently, he was sales manager for the Hauschildt Music Co.

Can you teach others about the things you yourself do not know? That is why the man at the head of the business should know how to do the things at its foot.

JUST THINK

WHAT IT MEANS TO USE A

DE-LUXE-NEEDLE

Plays 100-200 Records Without Changing

Absolute Reproduction of Tone

Positively No Wear on the Record

Will Play Any Record Using Steel Needles

Let the De Luxe speak for itself and send for samples



Full Tone



Medium Tone

DUO TONE COMPANY, Inc.

Sole Manufacturers of De Luxe Needles

ANSONIA, CONN.

Three for 30 cents

Liberal Discounts

ENTERTAINMENT

MAGNAVOX

PUBLIC SPEAKING

Music and Voice Telemegafones

Columbia Beach Park,
Portland, Ore., May 29, 1920.

The Magnavox Company,
2701 East 14th Street,
Oakland, Cal.

Gentlemen: You have no doubt been informed that we purchased one of your Telemegafones through Sherman Clay & Company of Portland. This sale was brought about through our effort to locate something that would amuse our patrons on the afternoons when the crowds were light. The writer and Mr. Addis of Sherman Clay & Company went to the Beach yesterday and made a sort of a trial of the machine, which seems in every way satisfactory. It is really marvelous the distance which your machine will carry sound on our beach. For your information, the Columbia River is more than a mile wide. We placed this machine on our Boardwalk with the horn throwing the sound across the river, 300 feet from the shore line. We walked down the Beach not less than 700 or 800 feet and could hear the records played as clearly as if they were in one's own home.

Yours very truly,

SAND ISLAND AMUSEMENT CO.,
By (Signed) JOSEPH M. RIEG.

Type MV-1

Outfit does not include phonograph, or battery

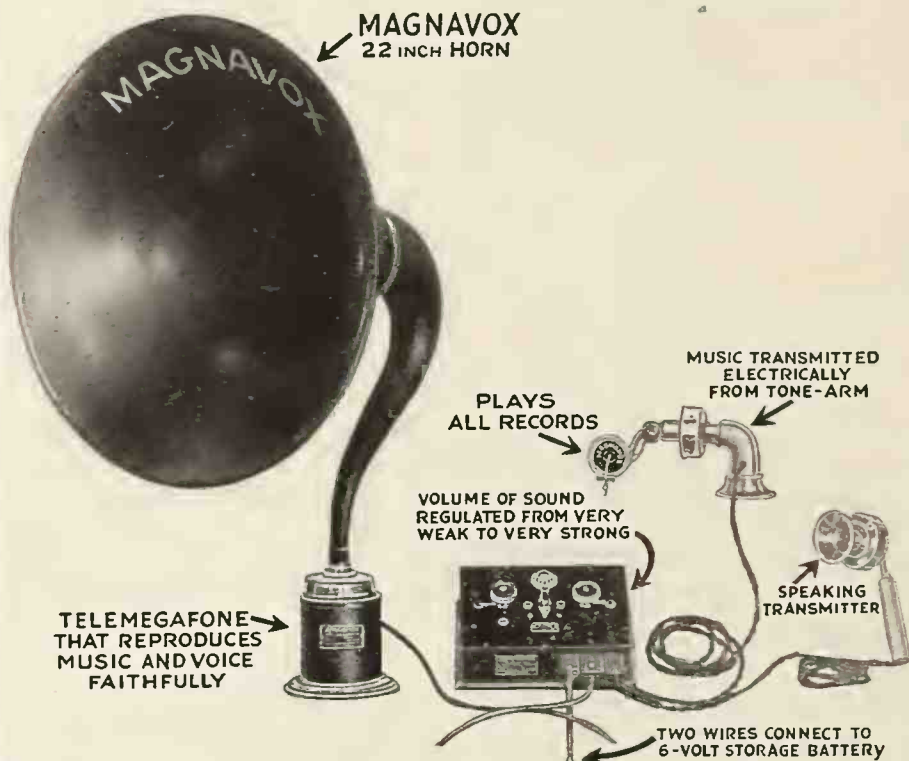

OGDEN CITY PUBLIC SCHOOLS

Ogden Utah, May 24, 1920
Glen Brothers-Roberts Piano Co.,
Ogden, Utah.

Gentlemen: As Superintendent of the Ogden City Public Schools, I congratulate you on your wonderful demonstration of the MAGNAVOX in Lester Park on Monday last.

At one time there were three May Pole sets of little tots—about seventy-five in all—dancing to the clear, hell-like music of the MAGNAVOX, and every one of the thirteen hundred spectators heard the music as clearly and distinctly as the children dancers.

For school work and dancing purposes the MAGNAVOX is a complete success.

With my hearty endorsement for school work with this new invention, I beg to remain,

Sincerely yours,

(Signed) W. KARL HOPKINS,
Superintendent.

Increase the Volume of Any Phonograph Many Times

For
Entertainment In
THE HOME
THEATRES AND PARKS
BLOCK PARTIES
MUNICIPAL PLAYGROUNDS
DANCE HALLS AND
ON SHIPBOARD OR
ANY PLACE WHERE
NOVELTY ENTERTAINMENT
IS DESIRED



For
**Public Speaking and
Announcing In**
HOTELS AND CLUBS
SCHOOLS AND COLLEGES
PARKS, CAMPS AND
SUMMER RESORTS
OR ANY PLACE WHERE
THE UNAIDED HUMAN
VOICE IS INSUFFICIENT
TO TALK TO ALL

Dealers and Distributors

BOSTON, MASS.—Musical Supply and Equipment Co.
DALLAS, TEXAS.—Sonora Distributing Co.
DAYTON, OHIO—J. W. Sands Co.
DETROIT, MICH.—C. L. Marshall Co.
INDIANAPOLIS, IND.—Kiefer-Stewart Co.

MINNEAPOLIS, MINN.—Minneapolis Drug Co.
NEWARK, N. J.—Griffith Piano Co.
NEW YORK—Electrical Supply and Equipment Co.
PHILADELPHIA, PA.—Philadelphia Showcase Co.
TORONTO, CAN.—I. Montagnes & Co.

WICHITA, KAN.—Southwestern Drug Co.

THE MAGNAVOX COMPANY

2701-2765 East 14th Street

Oakland, California

Pacific Coast Distributors of Sonora Phonographs

Putting the Selling of Talking Machine Records on a Scientific Basis

By Miss G. Airy
Koerber-Brenner Co., St. Louis

I wonder what some clever cartoonist who is just a buyer of records could do with his experiences with a record salespeople's mistakes. I wonder what he would have done with the girl who, when asked by a family man for orchestra records for his boys, said that about the only thing they had was Joseph C. Smith's; or the girl who says "Pagleachee" and rests her weary elbow on the top of a beautifully finished mahogany machine and chews gum fervently while she remarks "Ain't it hot?"

I am talking in this paper to dealers and managers, not to salespeople, for in the end if your clerk says Pagleachee it is your fault much more than hers. Just what chance have you given her to learn, or what inspiration have you been to her? Have you ever stopped to explain to your people why it is to their interest to work for the interest of the house? Have you impressed it upon them that a satisfied customer who buys one record is a better investment than the customer who buys two but carries away a feeling, perhaps subconscious, of having been poorly waited on?

Have confidence in your manager. If she deserves the name she deserves your confidence that she is doing it right, without explaining each step. Give her more responsibility. Ordinarily she is in touch with the situation, especially the record situation, as you cannot be if you have other interests, as most of you have. If at the end of a given period financial results are what you expect she has proved worthy of the responsibility. If not it is then time to inquire why.

Then there is the matter of salary. The time is coming, in fact, is upon us, when the public who buy our goods are going to demand record salespeople who fit the merchandise, who can intelligently discuss their goods. And unless you supply that type of person the public is going to the place where they do. And you can't get that type for bargain square prices.

Salesmanship is the ability to influence people. It is mental. No one can become the highest type of salesman who cannot think constructively—that is, in a logical manner. Ability is acquired, grown, developed. No person is a natural born salesman. Some of your people will acquire this knowledge without your help, outside of office hours. But the majority will not. What are you

going to do with them? Let them drift, finally discharge them, to try again? You are wasting a lot of raw material—a pretty expensive proposition these days.

The knowledge of your salespeople is either organized or disorganized, systematic or haphazard, which decides whether or not they are scientific salesmen.

Science is organized knowledge, the accidental use of a scientific principle is haphazard knowledge. Moreover, selling power begins with knowledge of the goods you wish to sell. If you do not know the goods you have for sale, how

Comments and Suggestions on Successful Record Selling of Direct Interest to Talking Machine Dealers

do you hope to make others know them well enough to want to buy them?

One of the first mistakes made by salespeople is to play the same records for everybody.

Another mistake on the part of salespeople is to play the same kind of record for everyone regardless of the type of customer. This is illustrated by a list of slow-moving records posted by a manager one morning. One energetic young lady decided that she would head the list in the number of these sold and she played all of them for anyone who would listen. I think that she did more harm than good. The fault, of course, lay primarily in the list itself. They were all the same kind of records, when they should have been so varied as to have at least one to fit any kind of customer. But to do this each salesperson must know the contents of the records as well as the numbers and names.

In visiting record departments and asking members of the force to pick out slow-selling

records for discussion, I have had this comment: "Here is one that nobody ever asks for." If your salespeople are playing only records asked for they are a detriment to you. The record clerk needs to know and then to think faster than the customer. Give information before it is asked for.

Now comes the question, "How am I to do it? How can I get my salespeople to increase their knowledge?" Give them time. Lend them the inspiration of your presence once a week. See that they have all the literature that comes into the house at their disposal. I know one girl supposed to be the manager of her department who had never seen any of the suggestions for using the artist post card that we have been sending out for several months. How can she manage a department if she does not get the literature belonging to it? Systematize their study so that they will waste no time. This business, more than any I know of, calls for calmness of manner, dignity and self-possession.

Moreover, the study of records requires concentration, a certain amount of research, seclusion from interruption. The feeling that you are going to be called any minute must be absent. Next consideration is, can we spare the time? Among the questions sent out to these same salespeople was, "What do you do during the first hour in the morning?" I found that about one-fourth of the time was taken in cleaning and filing records, slightly more than that in book-keeping, about the same in waiting on customers. The rest of the hour was spent in answering the 'phonc, dusting, and other trivial things. What I wish to show, and what I know you will discover if you will give it a thorough trial, is that anything done that first hour can and will be done just as easily at a later time. Dusting, filing records, book work can be interrupted without disastrous results. Hearing records cannot.

I challenge you to try this for one month beginning this week. Get your salespeople together and tell them that until further notice they are to be ready at the opening hour to spend one hour in getting ready for the business of the rest of the day. Divide your force and let half of them use this hour for one week, the other

(Continued on page 56)

Choose Wisely and Succeed

Dealers who sell the Brooks Automatic Repeating Phonograph are making money because they have an instrument that combines all the good features of every other machine with many points of value not found on any other.

The Brooks plays and repeats automatically any make of record any desired number of times, then stops automatically with the tone arm suspended in the air.

- It has large, easy-rolling casters.
- It has doors equipped with ball catches.
- It is finished equally well back, front, sides and top.
- It has ample space back of the shelves, accessible through rear door.
- It has an efficient tone volume regulator.
- It is equipped with a lever device permitting use with or without automatic repeating feature.

- It plays six to eight ten-inch records with one winding.
- It has a tone quality not excelled by any other machine, regardless of price.
- It has the most accessible working mechanism. It can be removed for oiling by loosening four thumb screws.
- It has a counterbalanced lid support (no braces needed).

Dealers in New York State and immediate vicinity are advised to communicate with us very quickly if they are interested in a big sale of phonographs this season.

The Walters & Barry Corporation

256 Main Street

BUFFALO, N. Y.

We are the LARGEST Distributors of Brooks Automatic Repeating Phonographs in the United States.



The First Really Complete Phonograph

PUTTING SELLING OF RECORDS ON A SCIENTIFIC BASIS

(Continued from page 55)

half this next week. Be sure that each group hears the same records and does the same studying, if possible under the direction of one of the older members of the staff. To be sure that this is done make out an outline for them to follow, listing the records to be heard, articles or books to be read, talks to be heard. But first of all demand that it is to be systematic. If you start out to do it every day, let nothing interfere, no matter how important it may seem.

Just a word to the salespeople in the trade. Sometimes I find that it is hard for proprietors to co-operate with their salesforce because the salesperson does not take criticism kindly. If an effort is made to try to remedy things which perhaps you cannot see, meet your employer half way. Show that you welcome criticism as a means to growth. The average employer has not time to spend cutting rotten spots out of bad apples. A criticism is a compliment. He has

noticed you and thinks you worth saving. If you have a "grouch at the boss" demand a conference with him and thrash it out. It will create less disturbance and you will feel better than if you had told the story to half a dozen sympathetic hearers.

To summarize, my plea is for better salesmanship resulting in more records sold. To accomplish it:

1. Send one or more of your salespeople to Camden for two weeks. Demand results.
2. If that is financially impossible at the time send them to St. Louis for a week. Demand results.
3. Observe an "improvement hour" systematically.
4. Pay your record clerks in proportion to the work you expect.
5. Give of your own time and personality to your clerks.

THE "SUN" LIGHTS THE WAY ON SALESMANSHIP PROBLEM

Discusses in Its Usual Interesting Way G. W. Hopkins' Remarks That the Brunette Salesman Succeeds Best in the South and the Blond Salesman in the North—What Do World Readers Think?

That black-haired salesmen succeed better in the South and light-haired salesmen in the North was the statement of George W. Hopkins, general sales manager of the Columbia Graphophone Co., New York, in his address before the Executive Club of Chicago at its luncheon at the Hotel Sherman on October 22. "Salesmanship is simply the ability to read human nature," he said. "The business man of to-day to be successful must know the relative value of the shady or the sunny side of the street. Modern business is built on the platform of service to the other fellow."

The statement concerning the relation of color of hair and salesmanship proved so interesting to one of the editorial writers of the Sun, New York, that he stole enough time from

his political spellbinding to compose the following editorial:

"The ability of the dealer in so-called 'canned music' to sell his assorted stock of machines and records, the male and female of the phonograph species, has long challenged the admiration of the professors of salesmanship. Possibly because so many people enjoy a noise even if they do not understand music, the phonograph dealer has a deep lake in which to cast his nets. The actual and undisputed beauties of the best quality of mechanically reproduced music are so efficiently supplemented by the vast quantity of cheerfully noisy records that the receipts of these dealers have long been the envy of the mere banker or bricklayer.

"Naturally, any hints as to the way the phono-

graph dealer does it command attention and respect. One of these princes of salesmanship, a general sales manager, in fact, made a speech lately in Chicago upon his own learned profession and gave the information—quite as valuable because it was casual and 'contributory'—that black-haired salesmen did better in the South and light-haired salesmen in the North. This is one of the magic bits of concrete information which are worth more than all the professional essays in the world. This general manager defined salesmanship as 'the ability to read human nature,' and said a successful business man 'now needed to know the relative value of the shady or the sunny side of the street.' What are synthetic paradoxes like those statements worth compared with the information about the proper regional distribution of black-haired and light-haired salesmen?

"It is a fact that, while enormous numbers of woman buy phonographs and records, a very great number of men also buy them. The phonograph salesman cannot hope to depend on any sex-complex to fill his order sheet, and the general fact seems to be that since there is more black hair than light hair in the South the black-haired salesman does better there, because the salesman's personality, being more like that of everybody else in the neighborhood, does not take the public's attention away from the goods to be sold; thus the goods get sold with less effort. Whatever the process by which the result is arrived at, this sales manager's statement of fact is the most interesting which has been heard of late. Does this classification apply only to the phonograph business? Let other sales managers be heard from, in order to swell the volume of general business; everybody would profit by it."

NEW MONTREAL COLUMBIA DEALER

R. E. Bennet, Montreal, Can., has recently opened Grafonola parlors at 3 St. Viateur street, and will handle the Columbia Grafonolas and records.



A WALNUT TALKING MACHINE CABINET

The finest phonograph is appropriately encased in

AMERICAN WALNUT

"The Cabinet-wood Superlative."

AN "added attraction" to the rich beauty of AMERICAN WALNUT as an appropriate encasement for such a fine example of a

Phonograph Cabinet

as is illustrated here, is that of *permanence*—or, "fidelity to fashioned form." AMERICAN WALNUT does not warp, shrink or swell.

The doors or drawers in an AMERICAN WALNUT Cabinet will never stick or refuse to slide. It's an impressive selling argument—a clincher. *

* Manufacturers of high grade cabinets and phonographs appreciate this fact.

Send for valuable data for manufacturers—or data for dealers. Also the WALNUT BOOK de luxe, an instructive treatise on Walnut and Walnut Furniture. Free.

Write to the producers of American Walnut Lumber, the

AMERICAN WALNUT MANUFACTURERS' ASSOCIATION
Room 1022 616 So. Michigan Boulevard Chicago.

Tonofone

IS NOT A SUBSTITUTE—IT HAS
NO EQUAL—NO OTHER IS LIKE
IT—IT IS “TRIED AND TRUE”

No more need for “Loud,” “Soft” and “Medium”
needles—no more need for changing needles after
playing one record

Tonofone

THE NEEDLE WITH THE FLEXIBLE POINT

HAS SOLVED THE PROBLEM

One TONOFONE will play 20 to 50 REC-
ORDS—any disc records ON ANY PHONO-
GRAPH and reproduce the ORIGINAL TONE
PITCH and volume, be it LOUD, MEDIUM,
or SOFT.

and

THE POINT being FLEXIBLE and SOFTER
than the RECORDS, will neither WEAR NOR
INJURE THEM—in fact

THE NEEDLE WEARS — THE RECORDS DON'T

A Very High Authority Writes:

“I have found no needle which transmits the
full tone value of the record as does the
Tonofone. Its elimination of surface noise
and accurate reproduction makes it supreme
for demonstrating purposes.”

**Our Wholesale Distributors Cover the Earth
They Reach Every City, Town and Hamlet All Over the World**

If you are not already using and selling this needle
that everybody's talking about, ask us for full partic-
ulars and the address of our nearest distributor.

INVENTORS AND SOLE MANUFACTURERS
R. C. WADE CO.
110 SOUTH WABASH AVENUE
CHICAGO
PHONE RANDOLPH 2045

BUSINESS PROGRESS IN ALBANY

Method by Which the Strand Temple of Music Has Won Quick Success in That City

ALBANY, N. Y., November 6.—The Strand Temple of Music, 121 North Pearl street, this city, which recently celebrated its first business anniversary, is at present in the hands of the carpenters and decorators, and when the alterations are completed there will be made available a number of additional demonstration booths to take care of the growing trade.

The success of the Strand Temple of Music, which features the Victor line exclusively, has



Interior of Strand Temple of Music

been due both to good salesmanship and good advertising, for Al. Edelstein, manager of the shop, is a firm believer in service and publicity in getting and keeping trade.

The advertising campaign is so arranged that some particular subject, or some particular group of records, is featured in each advertisement. Recently the Strand celebrated what was termed Dance Week, and throughout the week the fact was emphasized in specially designed advertisements that had a strong appeal.

Window displays of elaborate and expensive character, and changed frequently, also constitute a means of publicity that is not in any sense overlooked. The various big holidays, such as Easter, Fourth of July, Labor Day, Thanks-

Do You Throw Money Away?

It is not a popular pastime—but still it is unconsciously done by many who just don't know that *Repair Parts* can be bought for less

**RENE MADE SPRINGS AND PARTS LAST LONGER
COST LESS**

RENE MFG. CO.

Montvale, N. J.

giving, etc., are always featured in special window displays, as are local events of timely interest.

A recent window arrangement emphasizing Victor supremacy is reproduced herewith, together with a view of the main salesroom of the store just before the decorators went to work on the alterations.

The selling plan adopted by the Strand serves



A Typical Strand Window Display

to put the record customer at ease and to stimulate self-service in some measure. Unless otherwise desired, the customer is given a half-dozen records or so, some of which have been asked for particularly, perhaps, and is then escorted to one of the booths. The customer is then

invited to try over the records at leisure. This plan is found to work better than that of having a sales person constantly in attendance, as though anxious to get the customer out of the store, and has brought results and increased record sales. Of course, the point is made of getting the name and address of each visitor so that the name can be put on the record prospect list regardless of the make of machine owned by the customer.

SCOTTI VISITS PHONOGRAPH SHOP

San Francisco Dealer Secures Visit From Noted Tenor During His Appearance There

SAN FRANCISCO, CAL., November 3.—During the appearance here of Antonio Scotti in grand opera the Phonograph Shop, Victor dealer, at 109 Stockton street, secured the presence of this distinguished artist at the store, where he spent an hour with the sales force, telling them about his records and his work. The Phonograph Shop made good use of this fact by announcing in excellent advertisements that its sales force was ready to inform the public as to Signor Scotti's choice of recordings and assist anyone in the selection of their favorite records. James L. Loder, manager of the shop, found this a very fine bit of publicity and said that the sale of Red Seal records was greatly stimulated by it.

NEW ARTO RECORD DISTRIBUTORS

The Fulton Talking Machine Co., 253 Third avenue, New York, was recently appointed distributor of Arto records and Arto music rolls. The company has forwarded to the trade an announcement of a specially arranged sales plan, which has already brought numerous responses. In addition to handling the above product manufactured by the Arto Co., Inc., and the Standard Roll Music Co., of Orange, N. J., the Fulton Talking Machine Co. also carries a complete line of motors, tone arms, needles and accessories, as well as several models of talking machines.

Any method of telling people the advantages of your store is advertising. The method that tells the most people, most effectively, at the least price is the best advertising.

Ward's Khaki Moving Covers

Distributors
BRISTOL & BARBER, INC.
111 E. 14th St., New York City



Grade "D" Cover with No. 3 Straps.

THE C. E. WARD CO.

(Well-Known Lodge Regalia House)

101 William St., New London, Ohio

Also Manufacturers of Rubberized Covers
and Dust Covers for the Wareroom

- YAHR & LANGE DRUG CO.
207-215 E. Water St., Milwaukee, Wis.
- COHEN & HUGHES, INC.
Washington, D. C.
- BECKWITH-O'NEILL CO.
Minneapolis, Minn.
- STREVELL-PATERSON HARDWARE CO.
Salt Lake City, Utah
- C. L. MARSHALL CO., INC.
Beckman Bldg., Cleveland, O.
Butler Bldg., Detroit, Mich.
- THE REED CO.
237 Fifth Avenue, Pittsburgh, Pa.
- C. J. VAN HOUTON & ZOON
140 S. Dearborn St., Chicago, Ill.
- SONORA DISTRIBUTING CO. OF TEXAS
Dallas, Texas
- CHAS. H. YATES
311 Laughlin Bldg., Los Angeles, Cal.
- W. D. & C. N. ANDREWS
Buffalo, N. Y.
- SACHS & CO.
425 So. Wabash Ave., Chicago
- SHERMAN, CLAY & CO.
741 Mission St., San Francisco, Cal.
- JOHN A. FUTCH CO.
35 Auburn Ave., Atlanta, Georgia
1500 South Boulevard, Charlotte, N. C.
630 Washington St., Jacksonville, Fla.
- ORTON BROTHERS MUSIC HOUSE
Butte, Mont.
- GRAY & DUDLEY CO., Nashville, Tenn.
- ASSOCIATED FURNITURE MFRS.
St. Louis, Mo.
- W. J. DYER & BRO., St. Paul, Minn.
- AMERICAN PHONOGRAPH CO.
Burlington, Vt.
- JOSEPH BARNETT & CO., Cedar Rapids, Ia.

ROTTEN STONE

We are the only miners and manufacturers in this country of Rotten Stone for use in Phonograph Record making. Our product is now in use by practically every record manufacturer in this country. We are also headquarters for all other minerals for record making and everything we handle is made especially for this purpose and absolutely guaranteed. Expert advice given upon any formula.

KEYSTONE MINERALS CO.

41 Union Square, New York City



GENERAL PHONOGRAPH CORPORATION

OTTO HEINEMAN, *President*

25 West 45th Street - - New York

FACTORIES:— NEWARK, N. J. ELYRIA, O.
PUTNAM, CONN. SPRINGFIELD, MASS. KITCHENER, ONT.

CHICAGO

TORONTO

LONDON, ENG.



SATISFACTION

Our Silent Salesman

1921 Meisselbach Models

NOW READY

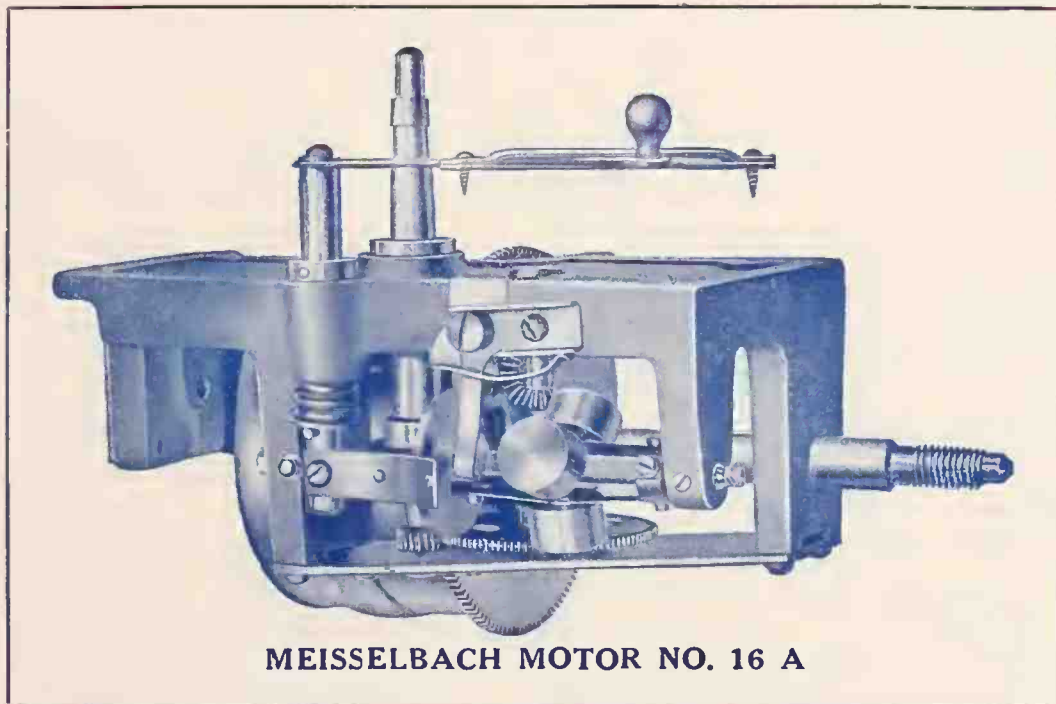

MEISSELBACH MOTOR NO. 16 A

The Last Word in MOTOR Perfection

QUALITY—Our Slogan

SERVICE—Our Watchword



GENERAL PHONOGRAPH CORPORATION

OTTO HEINEMAN, *President*

25 West 45th Street - - New York

FACTORIES:— NEWARK, N. J. ELYRIA, O.
PUTNAM, CONN. SPRINGFIELD, MASS. KITCHENER, ONT.

CHICAGO

TORONTO

LONDON, ENG.



DONALD HANNA'S IMPORTANT POST

Popular Salesman Now Covering Virginia and West Virginia for Philadelphia Show Case Co., Selling This Company's Line

Donald Hanna, who for five years was connected with the Sonora Phonograph Co., Inc., is now covering the States of Virginia and West Virginia for the Philadelphia Show Case Co., which is a division of the Smith, Kline & French Co. After being with Sonora for several years, Mr. Hanna served with the A. E. F. in France



Donald Hanna

and on his return represented the Hillman Phonograph Co., of Wheeling, W. Va.

The Philadelphia Show Case Co. now represents Sonora in Virginia and West Virginia and in his new position Mr. Hanna will have the advantages of a thorough familiarity with the territory and a personal acquaintance with the men who sell Sonoras in these States. Besides handling Sonoras, he sells Okeh records and Melodee music rolls. Mr. Hanna will have the backing and co-operation of an extremely efficient jobbing organization which can be relied on to give exceptionally satisfactory service to dealers in the territory covered.

Lester D. Leverich, advertising manager of the Columbia Co., returned recently from a visit to the Toronto branch of the company, where he conferred with A. E. Landon, Canadian branch manager, regarding publicity plans for the coming year.

BRUNO

The Victor product is like the Rock of Gibraltar. It is paramount to-day, and will always remain so.

BRUNO

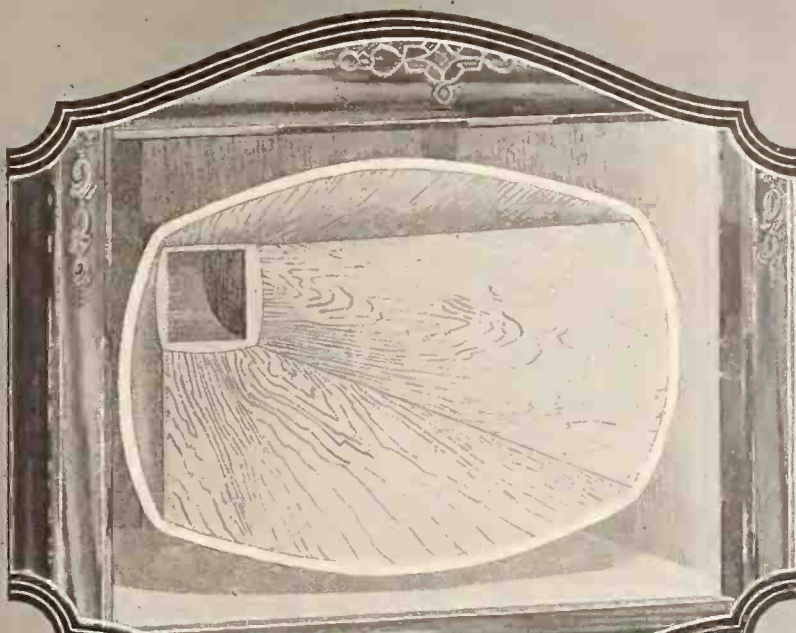

HARPONOLA

The Way to Make a Profit

in the talking machine business is to get a machine that is absolutely reliable from a mechanical standpoint, with a sweet, full tone, and encased in a rich, substantial cabinet—and get it at the right price.

The Harponola, with its alluring golden spruce horn, provides exactly what we mention above.

Such a machine will turn you a good profit if you display and demonstrate it to a percentage of your trade daily.

There is nothing intricate about the proposition. It is a matter of straight commonsense.

THE HARPONOLA CO.
101 MERCELINA PARK
CELINA, OHIO
EDMUND BRANDTS, President

A limited amount of jobbing territory now open. Get our combination proposition on Harponolas and Okeh Records.

The PHONOGRAPH with the **GOLDEN VOICE**

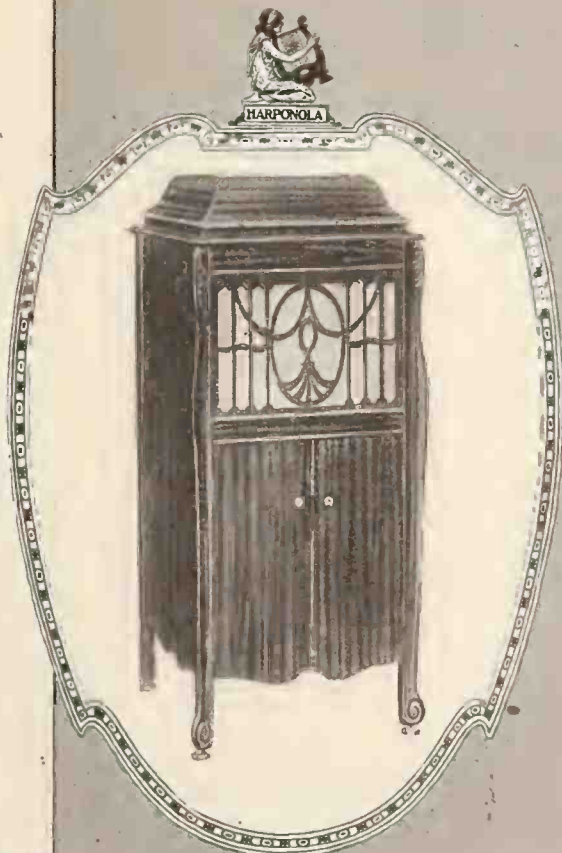



MANUFACTURERS OF PHONOGRAPHS & RECORDS

PHILO E. REMINGTON
PRESIDENT
JAMES S. HOLMES
VICE-PRESIDENT
MARC B. THOMAS
SECRETARY-TREASURER



OFFICE OF THE
SALES MANAGER

EXECUTIVE OFFICES
1662-1664-1666 BROADWAY
NEW YORK
TELEPHONE CIRCLE 2700

Why Mr. Remington and his friends
invested \$1,000,000⁰⁰ in this business.

After an exhaustive study of the Phonograph
field, from every angle, we decided to confine our-
selves to the highest possible grade instruments,
and to that end invested a million dollars.

Most of the hundreds of thousand Phonographs
now made are ultra commercial and but two
or three makers have attained tonal value.

The Public easily discovers Remington super-
iority by a comparative test.

Dealers, who desire to add to their prestige
and profit, should always sell the best - no
customer willingly buys an inferior article,
if he knows it.

Write for our exclusive Agency proposition,
as territory is fast being assigned.

Very Truly Yours,
Remington Phonograph Corporation,
Everett S. Holmes,
Sales Manager.

INTERMOUNTAIN VICTOR DEALERS FORM AN ASSOCIATION

Recent Gathering in Salt Lake City Attended by Dealers From Utah, Idaho, Colorado and Elsewhere—Association Elects Alvin Beesley President—J. Elliott Clark Co. Entertains Assemblage

SALT LAKE CITY, UTAH, November 1.—All who attended the convention of Intermountain Victor dealers last month at the Hotel Utah, this city, are enthusiastic over its success. It was one of the liveliest and most interesting conventions ever held here. Dealers from Utah, Idaho, Colorado and other Intermountain States were present. From the early opening hour until the wee hours of the morning after there was a continuous round of education and pleasure. Splendid talks were given by prominent figures on the various phases of the Victor business. Following the morning session a proposal from one of the dealers was made that the gathering be made an annual affair and that an association of all Intermountain dealers be formed. This suggestion met with the hearty approval of all present, with the result that a committee was named to nominate officers and draw up by-laws for the organization. The meeting adjourned for luncheon as guests of John Elliott Clark.

The afternoon session opened with a report from the nominating committee who named as officers the following: President, Alvin Beesley, Beesley Music Co., Salt Lake City; vice-president, H. W. Vorbeck, Grand Junction, Colo.; treasurer, Thomas J. Holland, Glen Bros.-Roberts Piano Co., Ogden, Utah; secretary, Fred A. Bain, John Elliott Clark Co., Salt Lake City. Executive committee: C. B. Sampson, Sampson Music Co., Boise, Idaho; R. K. Logan, Logan Music Co., Twin Falls, Idaho. All members were in accord with the selection of names and accepted them as officers for the first year of the organization.

Following this election the program was continued. Very interesting talks were given by Francis W. Kirkham, director of vocational education, State of Utah, and Eugene Giles, vice-president of the National Copper Bank, Salt Lake City, and others. During the afternoon business session the ladies were entertained at a theatre party.

In the evening the entire assemblage was the guest of the John Elliott Clark Co., Victor wholesalers, at a banquet and dance on the Hotel

Utah roof. Gilbert N. Swett, traveling representative of the Victor Talking Machine Co., the speaker of the evening, gave an interesting talk on the Victor business of the past and future.

Dealers were strong in their praise of the fine entertainment provided and are all looking forward to the 1921 session.

The subjects discussed and the speakers assigned during the various sessions were as follows:

"Better Music for the Home"—L. R. Taylor, Provo; Alvin Beesley, Salt Lake.

"Increasing Record Sales in Spite of Shortage"—T. J. Holland, Ogden; Fred A. Bain, Salt Lake.

"Repair Demonstration," Fred A. Bain, John Elliott Clark Co.

"Advertising"—Albert Skankey, Salt Lake.

"Clinching the Sale"—Albert Kirk, John Elliott Clark Co.

"Merchandising From the Jobbers' Standpoint"—John Elliott Clark.

"Stock Keeping and Ordering"—C. R. Pike, Salt Lake; T. J. Holland, Ogden; R. K. Logan, Twin Falls.

"The Victrola in the Schools"—Francis W. Kirkham, director vocational education, State of Utah; Ellis Johnson, Manti; Beth Erickson.

"Accounting"—Lincoln J. Kelly, Salt Lake City.

"Canvassing"—C. L. Nielson, John Elliott Clark Co.

NEW SERVICE CATALOG FOR DEALERS

Ross P. Curtice Co. Issues a Unique and Most Convenient Volume for Use of Retail Trade in the Ordering of Various Accessories

A service catalog of distinctly unique character intended for the use of Victor dealers has just been compiled and issued by the Ross P. Curtice Co., Victor wholesalers, Omaha, Neb. The new volume of twenty-eight pages is completely filled with illustrations and descriptive matter relative to the various accessories which the Victor dealer has occasion to order from time to time, these accessories including outdoor signs, various forms of display material, Unico store equipment, record racks, needle

IN THE
HANDY
CAN



NYOIL

FOR YOUR
PHONOGRAPH

**Made in Our
Watch Oil
DEPARTMENT**

which for half a century
has made 80% of all the
watch, clock and chromom-
eter oil used in America.

The Best Oil For Any Talking Machine

In refining, Nyoil is given the same care as our famous watch oil receives. All gums and impurities are removed, leaving it

Colorless, Odorless and Stainless.

Housekeepers say they would not be without Nyoil because it is best for phonographs and sewing machines—for polishing furniture and woodwork and is odorless and will not stain. It is free from acid and will not gum, chill or become rancid. Sportsmen find it best for guns because it prevents rust.

NYOIL is put up in 1-oz., 3/4-oz. and 8-oz. Bottles and in Quart and Gallon Cans.
For Sale by all Talking Machine Supplies Dealers
WILLIAM F. NYE, New Bedford, Mass., U.S.A.

"Factory and Jobbers' Sales Classes"—L. R. Taylor, Provo; Fred A. Bain, John Elliott Clark Co.

"The Financial Situation"—Eugene Giles, vice-president National Copper Bank, Salt Lake City.

"From the Factory Standpoint"—Gilbert N. Swett, traveling representative Victor Co.

cutters, materials for window displays, pennants, various books issued in connection with Victor records, such as "Music Appreciation for Children" and "The Victrola Book of the Opera," photographs of famous Victor artists, record cabinets and repair parts. Each of the many items listed in the book is carefully numbered, and there is provided for the use of the dealer a special form of order sheet.

The new catalog represents a distinct advance in the matter of dealer service and gives the retailer a complete and convenient list of the things he is likely to need in his business. Every item is price marked, and a fixed discount is announced in order that the dealer may know just what he is ordering and how much it will actually cost him.

The G. & B. REPRODUCER WORLD'S FINEST REPRODUCER

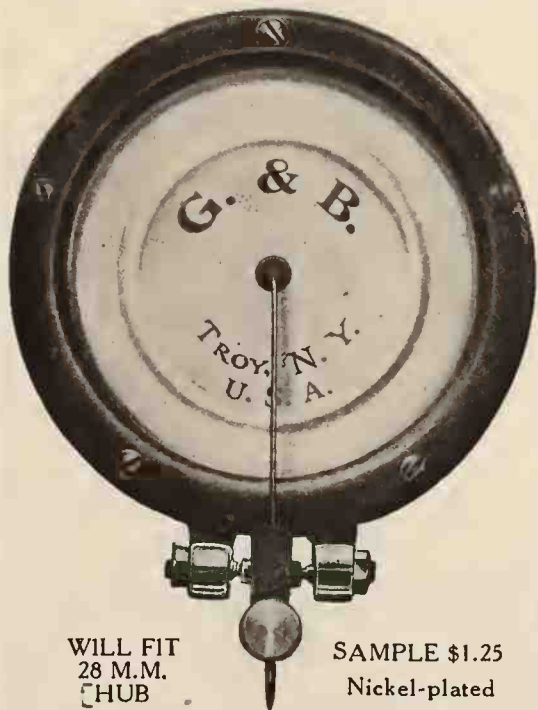

WILL FIT
28 M.M.
HUB

SAMPLE \$1.25
Nickel-plated

Send for quantity price

GEIER & BLUHM

ESTABLISHED 1906

Manufacturers of Scientific and Mechanical
Instruments

Die Casting and Plating

TROY, NEW YORK

REYNALDS

MOBILE VICTOR DISTRIBUTOR ALA



HIS MASTERS VOICE

MISSISSIPPI
ALABAMA
FLORIDA



Here she is again—Marion Harris—in two “blue” songs, both of different color, melody, and tone, “Sweet Mamma (Papa’s Getting Mad)” and “I Told You So.” Order while the ordering’s good. A-3300.

Columbia Graphophone Co.
NEW YORK

FOUR NOTED SINGERS NOW EXCLUSIVE VICTOR ARTISTS

Albert Campbell, Henry Burr, John Meyer and Frank Croxton Signed Up by Victor Co.—Have Had Tremendous Success in All Parts of the Country in Recital and Concert Work

Of great interest to all Victor dealers and Victor record enthusiasts is the announcement made by the Victor Talking Machine Co. that the popular record artists, Albert Campbell,

singing as the Sterling Trio, the American Quartet and the Peerless Quartet. Few artists have become so universally recognized and acclaimed during the past year as these talented

a part of the organization of eight Victor artists who have appeared in concerts in many cities these entertainers have gained a following which any artist could well be proud of. Campbell, Burr and John Meyer combine their efforts in the Sterling Trio, and when Frank Croxton is added the company becomes the Peerless Quartet. Both together and as individual singers these artists rank among the best and their rec-



Albert Campbell



Henry Burr



John H. Meyer



Frank Croxton

Henry Burr, John Meyer and Frank Croxton, will, after November 1, be exclusive Victor artists. These singers have scored a tremendous success through their records and in person in almost every large city in the country,

singers and the securing of their exclusive services for a period of years by the Victor Co. insured the high quality of the popular record catalog of the company.

During their trips throughout the country as

ords are to be found in practically every private record collection.

The securing of these four artists as exclusive Victor record makers follows the signing up of Billy Murray last Spring.

DEMAND FOR NEEDLES GROWS APACE

ANSONIA, CONN., November 5.—Duo-Tone Co., Inc., of this city, sole manufacturer of De Luxe needles, reports that the demand for this semi-permanent needle has reached very large proportions and continues with unabated zeal. The De Luxe semi-permanent needle has now been

on the market several years and is now sold in every State in the country. J. H. Bartholomew, secretary and general manager of the company, in speaking of the success with which this needle has met, stated that it could probably best be attributed to the careful maintenance of the quality of the needle at all times. Although in the past the scarcity of material made this

task difficult Mr. Bartholomew reports that all obstacles have been overcome and the quality of the needle has been kept uniformly high.

Rommele Bros., Richmond Hill, N. Y., opened a Victor store in that section on October 30 and have installed a very complete line of machines and records.

New! New! APEX Fibre Needle Cutter

Cuts with the grain to the point.
Makes the use of fibre needles as cheap as steel.
No variation in angle or size of cut.
Does not crush the shell.

Small Size—Simple Construction
For sale through jobbers and dealers.

Retail Price \$1.50

Manufactured by

W. H. WADE 14 N. Michigan Avenue CHICAGO

New! New! Patents Pending.

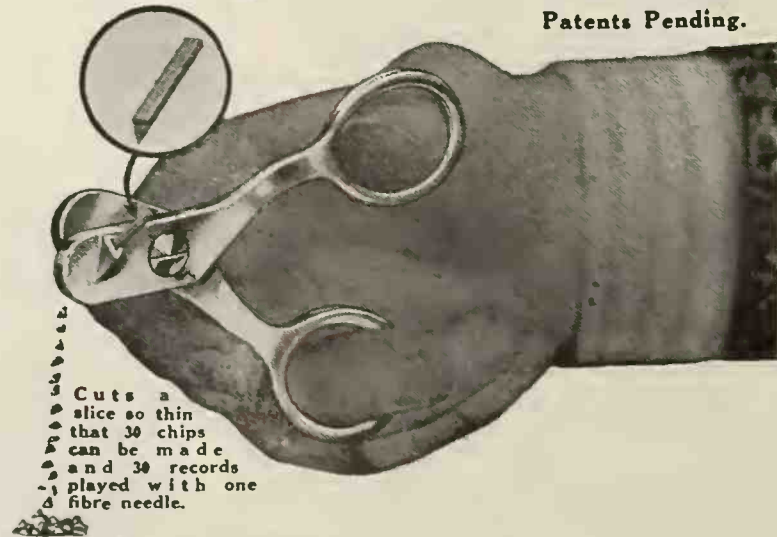

Cuts a slice so thin that 30 chips can be made and 30 records played with one fibre needle.

What We Will Do for YOU

Our product is one of the highest quality. It carries exclusive patented features that create sales. We offer extremely liberal profits and prompt shipments. A permanent connection with an organization of long experience equipped with a department of dealer helps. And—"the Regina will play any record better than you have ever heard it played before."



825

**EIGHT MODELS
\$40.00 TO \$350.00**

REGINA Phonograph

**READ OUR OFFER AND
FILL COUPON BELOW**



901

The Regina is equipped with a new unique type of reproducer of velvety superfine tone. So clear—so rich, in fact it is Nature's Tone in phonographs. The central position of the reproducer prevents wear and friction on all records. Plays all disc records without any special attachments whatsoever.

The Ball-bearing Tone Arm moves readily across the record with almost no friction, thus increasing the life of the record.

Perfect Tone Expression



Manufacturers of Musical Instruments for Over a Quarter of a Century

TO RESPONSIBLE DEALERS—we will ship a sample Regina Phonograph on ten days' trial for demonstration and approval. Freight charges to be paid by consignee.

Use coupon below, marking (x) if you want a sample machine or catalog and prices.

THE REGINA CO.

47 W. 34th St., New York :: 209 S. State St., Chicago

REGINA CO., 47 W. 34th St., New York
 Sample Phonograph Catalog and Prices
Please send at once
Bank references
Name
Address
City

BRUNO

Familiar Trade-Marks —and Others

BECAUSE an article bears a trade-mark it is by no means evidence that that article has earned a reputation or possesses real merit.

There are a number of none too scrupulous manufacturers and agents who are aware that the public has been educated to place added value on articles because trade-marked and are plying their trade with base infringements and imitations bearing "flowery" and high-sounding names. All this is detrimental to the interests of the legitimate dealer and purchaser, and, like the H. C. of L., it "hits" most everybody. Fortunately, the laws of supply and demand will sooner or later relegate this element into oblivion—a place well suited to the kind—while the article or instrument of proven merit continues triumphant on its successful course.

In America, in Europe, in Africa, in fact, the world over, the public recognizes the value and general superiority of an instrument or any merchandise bearing a *familiar* trade-mark—the sight of a well-known trade-mark bringing a positive assurance of quality.

From the very inception of the industry, this world-famous trade-mark



has always stood for supreme quality and has designated the products of the Victor Talking Machine Company, and, so, through its use, all peoples have come to know of and identify the greatest and mightiest musical instrument of all time—the Victrola.

The Victor trade-mark—a symbol of stability, integrity and sterling value—is to be found on all Victor products. Look for it "under the lid" or "on the label", and pass the word along.

C. BRUNO & SON, Inc.

351-353 Fourth Avenue

New York

Victor Distributors to the Dealer Only

OKEH THANKSGIVING DISPLAY

Holiday Theme Well Illustrated in Special Material for Okeh Dealers—Mamie Smith and Her Jazz Hounds Featured in Display

To stimulate Thanksgiving holiday trade Okeh record dealers are receiving from the General Phonograph Corp. a window display created by Einson Litho, Inc., New York, which is unusually effective both in design and color effects. The large center panel features a giant



Attractive Okeh Thanksgiving Display Window

Okeh record with an immense cornucopia from whose mouth issues a riotous crowd of revelers dancing, singing, playing—all led by a proud, high-stepping, multi-colored turkey. In addition to the centerpiece there are five other units, one of which prominently features the Okeh star, Mamie Smith, colored queen of syncopation, and her jazz hounds. Okeh dealers are finding this series of window displays excellent trade bringers and the General Phonograph Corp. is now considering the extension of this valuable service to all Okeh record dealers.

"Was your daughter's musical education a profitable venture?" asked Smith.

"Rather!" said Brown. "I bought the houses on either side of us at half value."—Pearson's.

E. R. JOHNSON BACK FROM ENGLAND

President of Victor Co. Gives Further Details of Acquisition of Gramophone Co.'s Interests

The New York daily newspapers are now giving publicity to the taking over by the Victor Co. of half of the interests of the Gramophone Co., of London. The first announcement was made at the jobbers' convention at Atlantic City in July and appeared in the report of this meeting published in *The Talking Machine World*. Eldridge R. Johnson, president, and Walter J. Staats, secretary of the Victor Co., have been appointed directors of the British concern.

Mr. Johnson, who has recently returned from England, said that the Gramophone Co.'s plant in Russia, which was originally located in Riga, when the Germans entered that city, was moved to Moscow, where, he said, the Bolsheviks confiscated the property, moneys and wares, valued at more than \$3,000,000. The Hanover, Germany,

plant during the war was transformed into a munition plant, but has resumed its former activities. All of the company's plants in Europe are again operating, Mr. Johnson said.

THE BRUNSWICK IN ARIZONA

LOS ANGELES, CAL., November 2.—Dan Voorhees, special Brunswick representative from the Los Angeles branch, has just returned from a trip through Arizona. He reports that the sale of Brunswick phonographs and records is excellent, mentioning, among others, the Cass Redewill Co., of Phoenix; Phillips Reed Drug Co., Nogales; United Drug & Music Co., Globe; Jerome Drug Co., Jerome; M. A. Andrews, Yuma, and the Needles Drug & Jewelry Co., Needles, Cal.

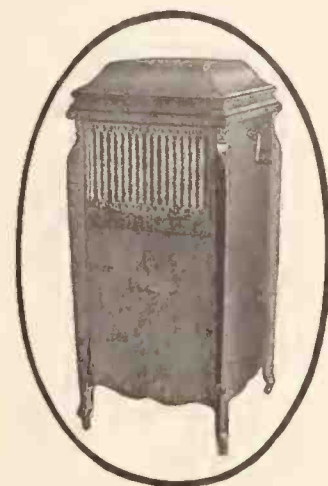

BLANDIN

AS pianos and violins vary in tone ability, so do phonographs. The reproducing ability of the Blandin Phonograph is controlled by its sound chambers. You will understand why it is advancing to a leadership when you hear a piano, violin or voice reproduced on this instrument.

Racine Phonograph Co., Inc.
RACINE, WISCONSIN.



A WIRELESS TELEPHONE CALL

LOS ANGELES, CAL., November 2.—The Music Trades Association enjoyed a new experience recently. W. H. Richardson, president of Richardson's, Inc., called up Secretary Farquharson on the wireless telephone from Catalina Island. The conversation was as plain and distinct as if the speakers were connected by wires in the same building instead of across the ocean, thirty miles relayed on the wire. Mr. Richardson, accompanied by Reginald Barker, famous Goldwyn Studio director, had crossed to Catalina for a few days for fishing and recreation, stopping at the St. Catherine Hotel.

It pays to try a little harder. As a rule men use only a small part of the powers they actually possess.

**CUT YOUR
COST IN
HALF**

USE

NEULOPES

IN PLACE OF
RECORD DELIVERY BAGS

THERE'S A SAVING

H. G. NEU & CO.

PAPER TWINE
ENVELOPES

108 Worth Street

New York

Franklin 2049



The great **MUSIC BOX** *novelty*
A YOUNG MAN'S FANCY
 One of the *season's best* **Fox Trot Tunes**
 Published by **LEO. FEIST Inc., FEIST BLDG New York**

YOU CAN'T GO WRONG WITH ANY FEIST SONG

ATTITUDE OF VICTOR CO. TOWARD PERIOD VICTROLAS

In "Voice of the Victor" the Company Sets Forth the Reasons for Adhering to Certain Forms in the Designing of the Cabinets for the New Period Victrolas

The attitude of the Victor Co. towards the development of the period Victrolas, which has been accepted as a guide in the adaptation of authentic period motifs to special Victrola cabinets, is thus set forth interestingly in the leading article in the October "Voice of the Victor":

Period furniture is probably classified in the mind of the average man along with Japanese prints, vintage wines, or any of the other things for which he doesn't expect to have any considerable use—but people with leisure, taste and money to spend on home designing find themselves compelled to take period furniture into account just as the music student finds that he can't get very far in music without bumping up against Beethoven, Bach and Mozart.

It is rather interesting to note that for the most part when we think or speak of period furniture it is the handicraft of the eighteenth century that we have in mind. Truly enough earlier centuries had contributed interesting and valuable designs, but perhaps because our mode of life and our mental attitudes have so changed we seldom go back further than the Renaissance for our examples. The eighteenth century produced a considerable number of master craftsmen who did for domestic architecture what the master composers did for music—they established certain fundamental forms.

"There were no Victrolas in Chippendale's time, but what we have done is to build Victrolas as we conceive Chippendale or Sheraton would have built them," is the way Eldridge R. Johnson himself has stated the case. Of one thing we may all be very sure and that is that they would have built them primarily as the musical instruments they are, and not as cupboards, chests or tables—which they are not.

Why does a Victrola take the particular form which has now become so familiar to so many people? The Victrola that is built with no other consideration than that of producing the best instrument within the bounds of commercial possibility? Is it accident? Assuredly not. Design, then! Not quite—it is due to evolution.

The form of any Victrola has a very definite and indeed integral relationship to its own particular needs, to the particular function it was designed to perform. Would you expect a violin which had been vitally changed in appearance to be still the same instrument, still perform its designed functions, with the same excellence? No. You feel morally certain that the violin in its own characteristic form was developed, not to please the eye, not to cater to the dweller in cramped quarters, not as a matter of fact to cater to anyone, but for the single purpose of producing the best quality of tone available and the greatest accuracy of pitch.

If the Victrola needed more amplifying surface or surfaces of an entirely different shape,

we should assuredly use them. If a better result could be secured by using less than that is what we should do, and there would in either case be a resulting change in the dimensions. Why? Because it would look better—because it would fit better between the fireplace and the door? Not at all—but primarily, or indeed, wholly because it would do better work. To straddle is to compromise, and it necessarily is something less than the best. Give the compromise idea the benefit of the doubt. Consider it in what is one of the most acceptable forms—it is still something less than the best. Take, for instance, a combination pool and billiard table. Would anyone choose such a table for a tournament—of either billiards or pool? It is perfectly true that on such a table one may play pool or one may play billiards—that is, pretty good pool or pretty good billiards, but neither with the greatest possible degree of satisfaction.

There is no more justification for making a Victrola in the form of a medieval buffet than there is for making a violin in the form of a hatrack. The Victrola is not a commercial hope—it is the development of a quarter century,

and every step on the way has been taken with whole-hearted sincerity, an honesty of thought and action that is the one sure foundation for all human effort. We know that a given diameter of diaphragm requires a given amount of amplifying space, elastic in part of its journey, rigid in others—that a given progression of taper in a tone-arm or in a floating horn gives precisely this, that or the other form of reaction. We know that in order to reflect, to give back the tones given to it, there must be a motor which shall give not merely a circular motion but a circular motion with a predetermined application of power. We know, in short, that the best possible reproduction cannot be secured haphazard, but that it is the result of a most delicate co-ordination of many factors, to which co-ordination all other considerations must be sacrificed and in which there is assuredly no room for extraneous purposes.

Given these things, and the need, or, perhaps it would be better to say, the desirability, of space for the storing of records—the Victrola must necessarily have certain dimensions, and having certain dimensions it must necessarily take a certain form. Those dimensions, that form were determined—by what? By the function it was supposed to perform, and that, we believe, is the one first principle in all art and in all craftsmanship that is worthy of the name.

CABINETS WITH OR WITHOUT EQUIPMENT

WE CAN SHIP IMMEDIATELY LARGE or SMALL QUANTITIES



These High Grade Cabinets, made in Mahogany, Walnut and Oak, built up to the standard for which our product is noted

For Descriptive Matter Address

FUEHR & STEMMER PIANO CO., 2701 So. Wells St., Chicago



REG. U. S. PAT. OFF.

*The Standard by Which All
Phonograph Motors are Judged and Valued*

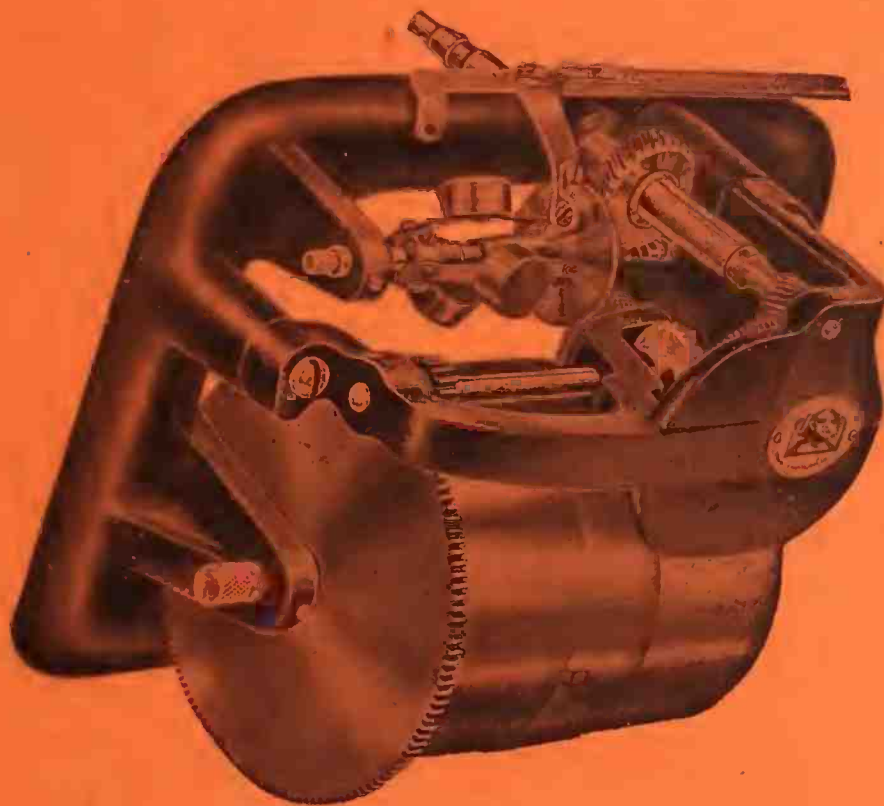

The Acknowledgment of Sphinx Superiority

The basic principles of the Sphinx are so manifestly in accord with accepted engineering principles; its construction is so simple, sturdy and enduring; its performance under the severest tests so extraordinary in efficiency and uniformity, that, *upon first demonstration*, its superiority is freely acknowledged by phonograph manufacturers, distributors, dealers and purchasers. Such unanimity of approval and indorsement is unique in the history of the phonograph.

Investigate the Sphinx NOW; prompt deliveries are assured.

SPHINX GRAMOPHONE MOTORS, Inc.

512 Fifth Avenue

••

••

••

••

New York



MAGNAVOX MEETING WITH SUCCESS

Sound Amplifier Being Used by Dealers Everywhere—May Be Adapted to Many Uses

The Magnavox Co., of Oakland, Cal., manufacturer of the Magnavox, an extraordinary sound amplifying device, is meeting with exceptional success. The device has been used frequently by public speakers, but the talking machine dealers throughout the country are evincing the keenest interest in the possibilities of the Magnavox in their business.

In fact the most popular use of the Magnavox has been in connection with the talking machine. A simple and efficient set of instruments has been devised which can be readily attached to any talking machine, and by the simple turn of a switch reproduce a band record of a volume equal to that of the band which made the record.

The equipment used for the amplification of talking machine music has been termed the "Magnavox Music and Voice Telemegafone, type MV-1." It consists of a special tone arm adaptable to any talking machine, together with a sound box, a control box used to control the power and regulate the volume, and the Telemegafone with its horn which reproduces the amplified sound. The nature of the equipment is electrical, exceedingly small power is required to operate the set, and it is standardized to be used with a six-volt storage or automobile battery. A battery of average size will play 450 twelve-inch records before it needs recharging.

The places where an enlarged volume of phonograph music can be used are many. The utility of the Magnavox in amusement parks, Summer resorts, hotels, clubs, schools and public institutions of all kinds has been demonstrated already. Dancing in private homes and in halls of any size becomes immediately practicable with a Magnavox Telemegafone.

Many music dealers use the MV-1 equipment to demonstrate the phonograph records to people in the street and reports received indicate that this unusual device is responsible for a great increase in the sale of records.

The Booth Felt Company, Inc.

Mechanical Felt Products

- Turntable Felts
- Motor Felt Washers
- Motor Brake Felts
- Needle Rest Felts
- Cabinet Strip Felt

We carry a large stock of well assorted merchandise which insures prompt deliveries.

If interested in Velour or Velveten Discs we can supply them.

FACTORIES

BROOKLYN, N. Y.
463-473 Nineteenth Street

CHICAGO, ILL.
732 Sherman Street

A construction engineer for a Western power company writes enthusiastically that with the Magnavox attachment the men can hear the music all over the camp and that this serves to relieve the monotony of camp life.

A proprietor of a Summer resort uses the Magnavox in place of a band and people living over a mile from the resort say that the music can be heard clearly and distinctly.

I. Montagnes & Co., Sonora distributors in Canada, introduced the Magnavox in the Dominion recently. The Magnavox equipment was

placed in the speakers' stand and enabled Sir Auckland Geddes, British Ambassador to the United States, to speak to an enormous crowd at the opening of the Toronto exhibition of 1920.

A New York visitor at Toronto relates the following experience: "I had just come out of the Government building at the fair and hearing what I thought to be a very excellent quartet at some distance, apparently near the Graphic Arts Building, I decided to go over and see who the singers were. I was much astonished to discover that the music came from a Magnavox placed in a bandstand in the center of the grounds. I had no idea that I was listening to mechanical music until I saw the instrument."

SONORA FOR FORD SISTERS

Geo. L. Hirtzel, Sonora dealer of Elizabeth, N. J., recently sold a Louis XVI De Luxe model to the Ford Sisters, one of the head-line acts on the Keith vaudeville circuit. The instrument was shipped to their home at Forest Hills, L. I., and they are planning to use it in creating new dances for next season's tour.

The Ford Sisters are nationally prominent as they have not only attained signal success on the Keith Circuit, but have also been one of the headline acts in the Winter Garden in New York. The sale of the Sonora to these well-known artists adds another name to the long list of stars who have purchased Sonora instruments this year.

SHOWS BRUNSWICK IN NORWALK

George P. Eells, prominent Norwalk, Conn., hardware dealer and real estate agent, has taken the agency for Brunswick phonographs and records and has started business in room 201 of the Commercial Building, where his real estate offices are located. Mr. Eells has received a large supply of machines and records which he is demonstrating to local friends. The agency is for Norwalk and vicinity.

APPOINTED "WARD" DISTRIBUTORS

The C. E. Ward Co., New London, O., manufacturers of covers for talking machines, announced recently that the Knight-Campbell Music Co., Denver, Colo., has been appointed distributors for the company's product. This concern is one of the best known talking machine houses in the far West, and will institute an aggressive campaign in behalf of these covers.

Coin-Operated Electric Phonographs

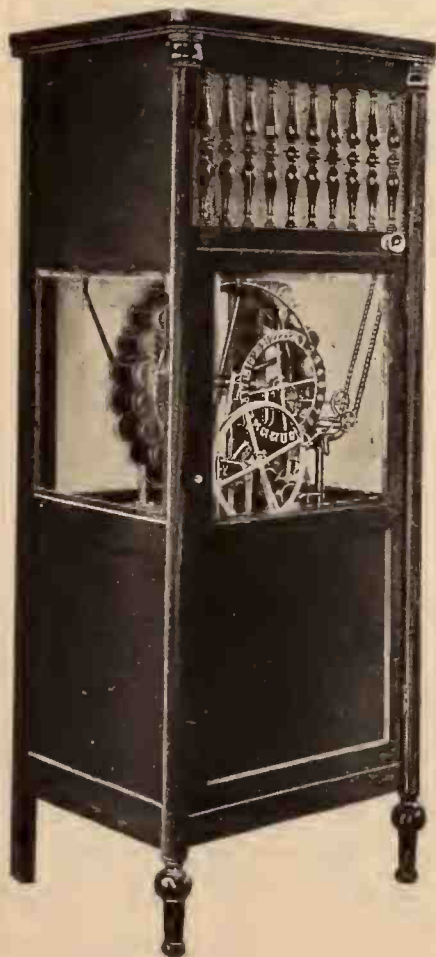

Earn Big Profits

Thousands of public places, amusement halls, etc., need coin-operated machines.

Are you able to fill this demand?

Territory is now being assigned to progressive dealers and operators.

Electric Phonograph Co., Kalamazoo, Mich.

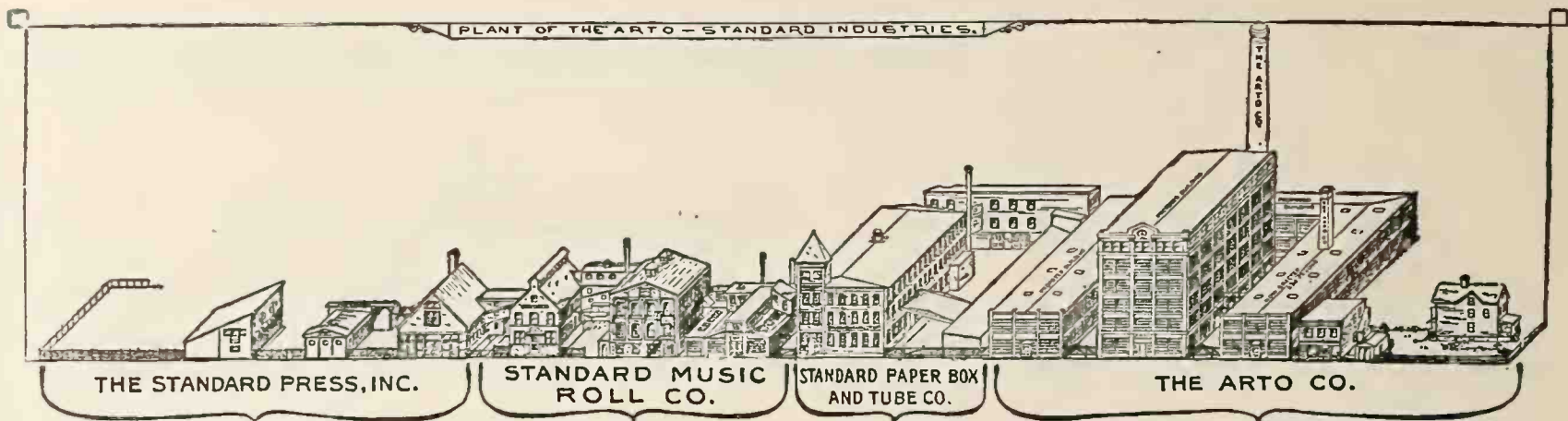

A 4 Company Guarantee--

To Dealers In Phonograph RECORDS and MUSIC ROLLS:

The STANDARD PRESS, Inc.

To any dealer becoming a stockholder in the ARTo Co., the newest and most promising member of the ARTo-Standard Industries, we guarantee to do any kind of commercial printing at a specially low price. Such printing as pertains exclusively to either ARTo Phonograph RECORDS or MUSIC ROLLS we will do entirely FREE OF CHARGE, the dealer simply paying the wholesale price of the paper. Ask for further details.

STANDARD PAPER BOX & TUBE CO.

For any dealer owning 5 or more shares of stock in the ARTo Co. we will make paper boxes, paper tubes, record envelopes and paper specialties of any kind at a specially low price. If same pertains exclusively to ARTo RECORDS and MUSIC ROLLS we will supply same at the exact cost to us.

STANDARD MUSIC ROLL CO.

We have purchased \$140,000. of the capital stock of The ARTo Co. and already it has proved to be the best investment we have ever made and to those dealers who are old customers of ours and who become partners with us in the new and great ARTo Co. we guarantee special discounts on and preferential delivery of all types of music rolls made by us. We also guarantee any contracts made by the ARTo Co. with dealers. In one year the ARTo Co. has made far greater progress than any other company and we guarantee the accuracy of its first annual report recently issued. We estimate that every one thousand dollars invested in ARTo stock NOW will become worth one hundred thousand dollars in from 10 to 20 years and in the meantime earn dividends at an increasing rate. This estimate is based on all of the ARTo dealers and ourselves giving the new enterprise our fullest support.

The ARTo Co.

We guarantee the accuracy of our first annual report recently printed. From the marvelous progress which we have made in one year we leave dealers and the public to estimate the progress which we will make from now on with their aid and with the aid of the three successful and strong companies whose guarantees are given above.

Send for Literature

The ARTo Co.

New York Office, 1604 Broadway

∴

Factories: Orange, N. J.

NEW PLANT FOR LYRAPHONE CO.

Record Company Purchases Large Modern Building in Newark, N. J., and Will Increase Record Output Many Per Cent

NEWARK, N. J., November 5.—The Lyraphone Co. of America, 117 Mechanic street, manufacturer of the Lyric lateral records, recently closed negotiations for the purchase of the plant of the American Piston Ring Co., this city, the building taking in a square block with executive offices on South Eleventh and Woodland avenue.

The building is most modern in construction, and will lend itself admirably for record manufacturing purposes. The Lyraphone Co., which some time ago purchased additional equipment, is already installing it in the new plant. After production in the company's new home is well under way, the entire mechanical equipment will be moved to the new quarters. The South Eleventh and Woodland avenue building is most centrally located, and has the shipping facilities which will aid the company in caring promptly for jobbers' and dealers' wants.

With the acquisition of this new floor space in addition to the recent purchase of a Canadian plant, the Lyraphone Co. of America announces an increase of over 500 per cent in its record production. The company during the last several months has made a specialty of getting out the latest song and instrumental hits at the quickest possible moment after their release, and in quantity lots. This in addition to its standard and foreign record catalog placed the company in a position whereby it became necessary to greatly increase production.

The Lyraphone Co. has arranged with the Hansen Advertising Agency of this city to carry on a national advertising campaign, which is to be supplemented by local advertising in both jobber and dealer territory. A large sum has already been appropriated for this purpose. The initial efforts in this direction have been cards placed in conspicuous positions in New England territory and in addition to the advertising as outlined above, much material in the way of sales helps for dealers has already been arranged.

SCHOOL CHILDREN HEAR RECORDS

Newark High School Pupils Visit Talking Machine Store to Study Record Music

NEWARK, N. J., November 5.—As a means of fostering the use of records in education, the class in musical appreciation in the South Side High School here attended a record demonstration at the Landay store, under the direction of Branson De Cou, manager. For an hour the instructor played records and explained each and its relation to the general subject. The demonstration was received with so much enthusiasm by the pupils that it is planned to hold other lessons each week.

VISITS TRADE IN PENNSYLVANIA

J. Harris, secretary of C. Bruno & Son, Inc., Victor wholesalers, New York City, recently visited the Victor factory at Camden. From there Mr. Harris went to Stroudsburg, Pa., where he met E. G. Evans of the Bruno sales staff, who had motored down from New York. Mr. Harris and Mr. Evans called upon the Victor dealers in Wilkes-Barre, Hazleton and surrounding territory. They returned with a pleasing report of conditions in that territory. The vacation of the anthracite miners is over and the dealers are optimistic to a very high degree and expect a record holiday business.

RECORD OF "WHISPERING" A HIT

LOS ANGELES, CAL., November 2.—Dan Voorhees is much elated over the success in the sale of the records of "Whispering," a selection which originated here and was written and composed by an Angeleno. Phonograph companies were all urged some months ago to record this selection, but it takes some little time to persuade the East that good things sometimes originate in places removed from "Little Old New York." Thousands of the "Whispering" record have already been sold here, as elsewhere, and thousands more will be sold. The honor of "first out" goes to the Emerson Co., and its dealers were correspondingly elated.

OPENS AGENCY FOR COLUMBIA

MT. VERNON, WASH., November 2.—A new music store has been opened in the Pay Streak block with a complete line of Columbia Grafonolas and records. The office rooms have been completely renovated and repapered. The store is owned by F. J. Mills, of Sedro-Woolley, and will be under the direction of F. J. Murphy, assisted by Miss Hedvig Hammer.

A CASE IN POINT

How much better you like the railroad whose officials are uniformly courteous and obliging without expecting constant tips! Just so the women feel regarding stores.

ARTO RECORDS



ARTO WORD ROLLS

Into the Home—

- ARTO Music Rolls bring JOY
- ARTO Phonograph Records bring AMUSEMENT
- ARTO Profit-Sharing Certificates bring PROSPERITY

ARTO 10 INCH PHONOGRAPH RECORDS

THE LATEST SONG AND DANCE HITS for DECEMBER, 1920

VOCAL RECORDS

- Feather Your Nest. (Johnson-Brockman-Kendis) Tenor Solo, Orch. accomp. Arthur Hall } 9026
- Broadway Rose. (West-Fried-Spencer) Tenor Solo, Orch. accomp. James Price
- Old Pal, Why Don't You Answer Me? (Lewis-Young-Jerome) Tenor Solo, Orch. accomp. Charles Harrison } 9027
- All She'd Say was Umh-Hum. (MacEnery-King-Zany) Baritone Solo, Orch. accomp. Ernest Hare
- Profiteering Blues. (A. Wilson-I. Bibb) Tenor Solo, Orch. accomp. Billy Murray } 9028
- Hiawatha's Melody of Love. (G. I. Meyer) Duet, Orch. accomp. Charles Hart and Elliott Shaw

DANCE RECORDS

- Grieving for You. Fox-trot. (J. Gold) Moulin Rouge Orchestra } 9024
- Bring Back My Love Dreams. Fox-trot. (J. Grandel) Selvin's Novelty Orchestra
- The Japanese Sandman. Fox-trot. (R. A. Whiting) ARTO Dance Orchestra } 9025
- Darling. Fox-trot. (C. Schonberg) Selvin's Novelty Orchestra
- La Veeda. Castilian fox-trot. (C. Alden) ARTO Dance Orchestra } 9029
- Railroad Blues. Fox-trot. (C. L. Roberts) ARTO Dance Orchestra

STANDARD INSTRUMENTAL AND VOCAL RECORDS

- Adeste Fidelis. Christmas Hymn. Henry Burr and Peerless Quartet } 3050
- Agnes Dei. Soprano Solo, Orch. accomp. Mme. Dei Sarto
- Sweetest Story Ever Told. The. (R. M. Stults) Soprano Solo, Orch. accomp. Louise Patterson } 3009
- Beautiful Isle of Somewhere. (J. B. Pounds-J. S. Fearis) Tenor Solo. Henry Burr
- Little Grey Home in the West. (H. Lohr) Soprano Solo, Orch. accomp. Ida Height } 3047
- In the Gloaming. (A. F. Harrison) Soprano Solo, Orch. accomp. Louise Patterson
- Souvenir. (F. Drdle) Violin Solo, Piano accomp. Vera Barstow } 3048
- Berceuse. From "Joelyn." (B. Godard) Violin Solo Vera Barstow
- Officer of the Day (R. B. Hall) Arto Military Band } 3049
- Sunny South. Medley of Plantation Songs. (J. B. Lampe) Arto Military Band

Ask for the Complete Catalog of ARTO Records

THE ARTO CO.

Factories: Orange, N. J.
New York Office: 1604 Broadway

CABINETS

Highest Grade
Moderate Prices
Immediate Deliveries



46 in. high
19 1/2 in. wide
21 1/2 in. deep

One of Our Popular Models

Send us your specifications today. We can fill promptly orders for Genuine Mahogany, Quartered Oak and American Walnut Cabinets.

We use only five ply selected wood. Eight models in the line. The finest cabinets at moderate prices.

The Celina Specialty Co.
CELINA, OHIO

THE SATURDAY EVENING POST

Look at the instruments in a Modern Orchestra

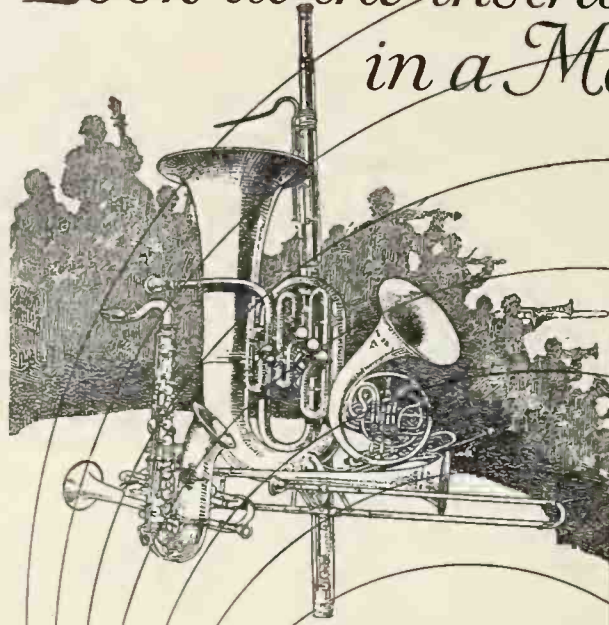

EMERSON
Phonograph

Standard Model 20
Mahogany
Faded Oak
with Emerson Music
Master Horn, Emerson
Tromb-Thru, Emerson
Tone Arm, Emerson
True Tone Reproducer,
Emerson Special Gold-
Edge Clamp-Ring Turn
Table, Emerson New
Style Patented 21st Cen-
tury Filing System,
Emerson Perfect Tone
Control, Emerson Flash
Microboard.
Other Emerson
Models with Emerson
Music Master Horn,
\$80 to \$1,000



THE French horn—*round*. The trombones, tubas and trumpets—*round*. Saxophones and clarinets, flutes and oboes, euphoniums and bassoons—all *round*.

Why?

Before the Pyramids were reared man was fashioning musical instruments *round*—in blind obedience to a law of acoustics which is as old as the world itself.

"Sound," says Nature*, "travels in spiral waves, like the waves that spread out in circles when a pebble is thrown into still water."

In accordance with this natural law, the Emerson Music Master Horn is made *round*. It has no corners for the music to echo in—no obstructions for it to strike against. *All* of the music must flow smoothly and clearly from the round Emerson Music Master Horn.

Be sure to hear the new Emerson Phonograph. Enjoy the latest Emerson hits (below) as interpreted by the Emerson Music Master Horn. The music which flows from its full, round throat of solid spruce is a revelation in tone *quality* and tone *volume*.

- 10257 Cuban Moon. Fox Trot All Star Trio
- 10245 Tell Me Little Gypsy—Medley. Fox Trot . . . Vernon Trio
- 10246 Fair One. Fox Trot Eddie Kuhn's Dance Specialist
- 10254 Avalon. Fox Trot Plantation Dance Orchestra
- 10248 Hold Me. Fox Trot All Star Trio

* Principles of Physics (Magni) Page 215
* Elements of Acoustics (Leri) Pages 10-11

SEND for the Emerson loose-leaf catalog which describes in detail the eight splendid instruments which at present compose the line of Emerson Phonographs. Special stress is laid on the round Emerson Music Master Horn, which has been well called the "soul" of the Emerson Phonograph.

EMERSON PHONOGRAPH CO., INC.
NEW YORK CHICAGO
226 Fifth Ave. 115 South Wabash Ave.

Makers of
Standard Emerson 10-inch
Gold Seal Records

The Emerson Phonograph

In the *Saturday Evening Post*

ISSUE OF NOVEMBER 13th

will appear this full-page Emerson advertisement—the fourth in a series of national announcements on the new line of Emerson Phonographs, and the *round* Emerson Music Master Horn.

The analogy between musical instruments and the Emerson Music Master Horn will appeal strongly to people's common sense.

A moment's thought will bring to mind numerous examples to prove the soundness of this analogy. The tom-toms of savage tribes—the horns and trumpets of the ancients—the brasses and woodwinds of the modern symphony orchestra—all are *round*.

This ad will go far to "sell" the Emerson Phonograph to people in your city. You can depend on the Emerson Music Master Horn to back up all the complimentary things you choose to say about it.

Seeing is selling nowadays. People obey that impulse to buy. So install a Self-Service Fixture if you want to see your records move.

**Columbia Graphophone Co.
NEW YORK**



SWISS MOTOR EXPERTS STUDY OUR FACTORY METHODS

Major Albert Paillard and Edouard Jacques Co-operate With Sonora Manufacturing Departments—Tell of Conditions in Europe—Entertain G. E. Brightson and Staff at Dinner

Having delayed his trip until the large additions to the phonograph motor plants located at Yverdon were completed, Major Albert Paillard, of St. Croix, Switzerland, who manufactures motors for Sonora, recently arrived in this country accompanied by his technical expert, Edouard Jacques.

They are spending some time co-operating with the Sonora manufacturing departments in various cities in this country and will make a study of American factory methods to see if there are any good new ideas which they can take back with them. In the course of a chat Mr. Paillard said that the new motor factory at Yverdon should soon have a capacity of about 100,000 motors a year and this is exclusive of the other large plant at St. Croix, which is also kept busy to capacity supplying the motors needed by the Sonora phonograph. Both motor plants are only thirteen miles apart and one can walk from St. Croix to Yverdon in about two hours, as this is down hill.

The number of employes at these Swiss plants will soon go up toward the thousand mark. Major Paillard, whose family has been in the musical instrument and musical instrument parts manufacturing business for a great many years, has little labor difficulty. As an extraordinary illustration of this it may be mentioned that recently one of their employes who had been with them for a great many years died. The six pall bearers were employes of the plant and these six men had been in the employ of the Paillard Works for 252 years. There are twelve men in the plant who have been with the company for more than forty years.

"Business in some lines is not up to normal," said Major Paillard. "The watch business is not very good. Owing to the drop in value of foreign exchange many markets are closed to

Swiss products. Russia was once a big buyer of Swiss watches but there is nothing doing there now. The embroidery industry was at a standstill during the war with Germany but is now starting up again.

"There are not as many tourists in Switzerland as there were before the war but the number is gradually increasing. The money from the recent Swiss loan placed in the United States is going toward the electrification of railroads and ultimately all the roads in the country will be operated by electric power furnished by the inexhaustible water supply of the Swiss mountain streams.

"In England the Summer has been a rather dull one, business being subnormal. America is not only the leader in the manufacture of phonographs but is, of course, the best market for them as well. England now has a 33 1/3 per cent duty on talking machines and quite a number of continental concerns are establishing English manufacturing branches.

"German goods—talking machines, sound boxes, etc.—are going into England and are being purchased when the price is lower than English-made products.

"Shipments from Switzerland to America are coming through in fairly reasonable time now, the journey taking about four weeks from Antwerp, Belgium, to New York. This is very fast compared with the time which was made during the war. During 1918 we had to send a man—a tracer—with each freight car we loaded so as to be sure that our shipments were not lost or got on the boats for which they were not intended. During the war we were lucky if the time taken for transportation from the Sonora factory to New York was not over three or four months.

"Abroad there are few fine stores devoted ex-

clusively to phonographs. The buyer gets this instrument in department stores, bicycle stores, musical instrument stores, etc., but to devote a whole establishment to the sale of nothing but talking machines is something which has yet to be 'sold' to the merchants across the Atlantic."

M. Jacques, when unaccompanied by Major Paillard, was under a disadvantage as he does not speak a word of English, but before the American trip is over he expects to be able to get along fairly well. Mr. Jacques has been associated with the Paillards for many years. Originally his efforts were devoted to the manufacture and perfection of music boxes, but in 1897 he began work on mechanisms for phonographs of the cylinder type and has been engaged on this type of mechanism for the last twenty-three years.

M. Paillard and M. Jacques were the hosts at a dinner recently given by them to Geo. E. Brightson, president of the Sonora Phonograph Co., Inc., and members of the Sonora executive staff, at the Hotel Brevoort. The visitors expressed their appreciation of the courtesies extended to them and Mr. Brightson replied, expressing the pleasure of the Sonora Co. in having them here and complimented them on the splendid co-operation which they are giving in manufacturing. M. Paillard and M. Jacques sailed October 20 on the steamship "Adriatic" for home.

CO-OPERATE WITH THE ARTISTS

Notable artists, well known through their talking machine records, will be heard throughout the country this Winter, and it behooves up-to-date dealers to take advantage of their appearances and bring their records to the attention of the purchasing public. This co-operation, if properly developed, will do much to help business and to popularize particularly the records made by these artists. A word to the wise is sufficient.

FOUNDED 1835

ARMSTRONG'S



Distributors

There are numerous reasons why Pathé Dealers are satisfied. Write today for full information.

ARMSTRONG FURNITURE CO.
59 and 61 North Main Street
Memphis, Tenn.



Queen Anne Console

What the Granby Selling Franchise Really Means

Here are some pertinent facts which will interest you.

1. The very best phonograph product, tonally and structurally, which ample capital, master designers and master craftsmen can produce.
2. A manufacturing plant which may be considered a model of its kind—with an equipment and facilities that could not be improved upon.
3. Advertising and Selling support—the character and variety of which, mean maximum sales in every territory in which our Trade Aids operate.
4. Absolute loyalty to our distributors and every promise made rigidly kept.
5. Prestige and Profits for you—and an indestructible asset in the Granby name and fame.

The gist of our proposition is just this:—we put ourselves in *your* place when we developed the Granby and what is back of it. We therefore know exactly what *you* want and offer you a selling franchise which has 100% value for you—a franchise which will tremendously grow in value, year after year.

Get the details NOW.

Don't make a move until you do.

Write or wire.

GRANBY PHONOGRAPH CORPORATION
 ☒ N O R F O L K - V I R G I N I A ☒

.. Factory · Newport News..

IMPORTANT CHILDREN'S RECORDS

Columbia Educational Department Issues Instrumental Music for Children's Use—Valuable Contribution to Record Library

The educational department of the Columbia Graphophone Co. has just issued a set of eight records comprising thirty-two instrumental selections for children, and constituting the best known music of Schubert, Gounod, Mozart, Tschaikowsky, Schumann, Beethoven, Grieg and others. The selections are so simplified and adapted that they represent the most inspiring medium for teaching standard music to children.

The recording of these selections was made under the personal direction of the teachers of Horace Mann School of Teachers' College, Columbia University, and with the official endorsement of Professor Patty S. Hill, director of the kindergarten-primary department. These teachers have given much time and thought to the choice of the music, the proper instruments to bring out the salient characteristics of the music and to the interpretation. The value of these recordings lies in the fact that the music has not been chosen because of its rank and quality and merely fitted to the child mind. Those elements of these great compositions which may be fitted to the child's experience and need have been so adapted and assembled in each composition that they have in fact been remade for the child, at the same time preserving the charm, quality and integrity of the music.

The compositions have been grouped under six heads: Music for marching, music for interpretation, music for bands, music for skipping, music for appreciation and lullabies. Because of the common use of the Grafonola in the school room and the fact that pianos are frequently not included in the school equipment, the score of the music has been adapted from the piano text and rewritten for such instruments as the violin, flute, clarinet, bassoon, etc. The tempo of each is retained as if played on the piano. Each selection is short enough to

retain the child's interest, and their chief claim lies in the simple charm of the rendition. They are essentially children's music, so selected, adapted and interpreted as to furnish a real basis for permanent love of the best.

This entire set of records is a real and vital contribution to musical literature, not only for the school but for the home. It affords the

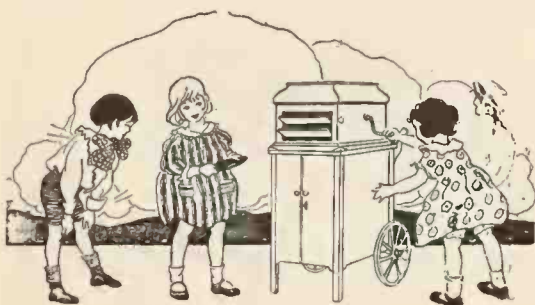

Music for the Children

dealer a new and effective appeal to his trade, not only because of the quality of the records themselves, but as another tie with his customers to the product issued by the Columbia recording laboratories.

METHOD OF USING STICK SHELLAC

Injuries to Varnished and Polished Cabinets May Be Repaired Easily

The use of stick shellac is an efficient method for repairing injuries to the wood, such as filling cracks, crevices, etc. It can be had in practically any shade to match every kind of finish. It comes in one-half inch square sticks and is applied in the same manner in which a tinsmith applies his solder. The ideal tool to use is an electric soldering iron, but if this cannot be had an alcohol flame is good. A candle is not satisfactory because the wax often drops off into the shellac, and the candle grease smokes and discolors the wax. After the injury in the wood is filled with this colored shellac, it should be carefully sanded to even the surface. It can then be finished in the usual manner.

STORY HOURS FOR CHILDREN

Enterprising Sonora Dealer Finds Unique Idea Successful—Plan Stimulates Interest in Sonora Product and Is of General Good

PEKIN, ILL., November 6.—The Celeste Music Co. of this city, Sonora dealers, recently completed an interesting campaign introduced to attract the attention of the children of this city. For two mornings each week the children were invited to attend a story hour at which educational records were featured. Mrs. Julia A. Catron was in charge of this work, and arranged splendid programs for the enjoyment of the children. The children were introduced to the musical qualities of the Sonora, and on one occasion each child was presented with an attractive Sonora folding card with a small silk flag.

F. C. Muehlenbrink, owner of the Celeste Music Co., has had twenty-five years' experience in the music business, and both he and Mrs. Catron, who is a member of the firm, are leaders in advancing the musical interests of the community. Referring to the story hour for children, Mr. Muehlenbrink said:

"We are well pleased with the story hour. It has brought us before the public in a different way; it gives us new prospects, and some new record customers, and will become an established factor in the community, stamping our music house as progressive and as a constructive element in the community. We receive some very pleasing expressions from music teachers, and people who are quick to recognize the educational value of the work. The music hour requires time, preparation, patience, etc., but we feel well repaid."

WHAT ADVERTISING REPRESENTS

Advertising is more than merely filling white space with type—make it carry your message as you would have your neighbor understand it easily and perfectly.

Do you want these good Customers?



Playing hill-and-dale record

Edison Owners are good Customers for YOU if you sell them the

KENT Master Adapter

The illustrations show how it is instantly adjusted to play ANY kind of disc record.

And when these Customers come back for more and more records they'll tell you that the "Kent Master" plays each record *at its best.*

That pleases *them* and pays *you*.

May we tell you about it?



Playing lateral-cut record

Here is another message to

DEALERS and MANUFACTURERS

Besides the Kent Master Adapter we manufacture several other attachments for Edison and Victor Machines, as well as Tone Arms and Sound Boxes. When you know about these you will agree that they "Win their way by their play." Furthermore, we carry large stocks of steel, sapphire and diamond points.



Registered in U S Pat Office

F. C. KENT COMPANY

IRVINGTON, N. J.

DEALER GETS SEVEN TRUCKLOADS OF EDISON MACHINES

DEMAND FOR PARTS IN AUSTRALIA



Delivering Edison Phonographs to C. A. Ensenberger & Son, Bloomington, Ill.

Trade Commissioner Reports Demand for Talking Machine Parts and Accessories

There is at the present time a growing demand in Australia for Canadian and American talking machine parts and accessories, according to a report received from Assistant Canadian Trade Commissioner C. Hartlett, of Melbourne. The information he conveys will be of interest to manufacturers on this side of the border who desire to do business with Australia. Mr. Hartlett says:

"The talking machine is in great demand with the music-loving Australian and, like the piano, from the cheapest to the most expensive instrument, it is known in almost every home both in the city and country. So far only the cabinet has been made in Australia, and in beauty of native woods suitable for the purpose and excellence of workmanship the result compares more than favorably with the average imported article. Many attempts have been made to manufacture the various parts of the mechanism but have so far not met with success. A large number of talking machines are assembled locally from imported parts and in addition large quantities of parts are required for repair purposes.

"The parts in demand practically cover the complete mechanism—motors, tone arms, reproducers, tone control, lid support, springs, etc. The demand is particularly large for two or three-spring motors, three-quarter and one-inch springs, governor springs and mica diaphragms of all sizes, which are very difficult to procure, and the trade would welcome quotations from Canadian manufacturers of these parts. On reliable authority it is stated that at the present time there is an excellent opportunity for Canadian manufacturers to do business in the parts mentioned, particularly as it is understood that they turn out the same sizes and quality as at Dayton, Ohio, which is now supplying the bulk of Australian importations.

"Manufacturers desirous of testing the Australian market are therefore invited to furnish this office with quotations and, if possible, with a sample set of springs, etc. Quotations should be on the basis of f.o.b. steamer at ocean port so that landed costs can be readily computed at this end. The samples will come forward much more expeditiously and at a cheaper cost by Canadian parcel post than by any other shipping method."

GETTING SALES LITERATURE READ

One House Places Stories and Anecdotes on Wrappers of Its Literature in Effort to Get It Read—Finds This Method Helpful

It has been the constant complaint of men who send out sales literature to dealers that this literature too often finds its way into the wastebasket unread, thereby wasting the efforts of the manufacturer and losing to the dealer an opportunity to learn something valuable. A large retail firm out West that is sending out an almost steady flow of sales literature to its customers and prospects finds the following method helpful in getting the various folders,

circular letters, brochures, supplements, catalogs, etc., to the proper source. On every wrapper containing one or more of the aforementioned, the firm prints a newsy anecdote or some particularly witty remark or joke, designed to attract the attention of the party to whom the wrapper is addressed. The humor generally appeals to the dealer and it is found that very seldom does the literature reach the waste paper basket until it at least has been perused and studied by the customer or prospect.

The dealer who sees the manufacturer's ad only in consumer publications forms his own opinions of the manufacturer's policy. These opinions are apt to be unfavorable.

MAIN SPRINGS

Guaranteed to be made of the highest grade carbon steel procurable. Prices quoted are possible only because of our immense purchasing and distributing powers.

	1	6	12	25	50	100
	each	each	each	each	each	each
No. 28 3/4"x.022x9 feet, for small motors, pear shape hole	.40	.38	.37	.35	.33	.31
No. 29 3/4"x.022x10 feet, for Small Columbia, Universal, Vanophone, Pathé, etc. Pear shape hole	.45	.43	.42	.40	.38	.35
No. 30 7/8"x.022x10 feet, for Blick, Wonder, Meisselbach motors No. 9 and No. 10. Square hole	.50	.47	.46	.44	.42	.40
No. 31 1"x.025x9 feet, for small Columbia. Pear shape hole	.60	.54	.52	.50	.48	.45
No. 32 1"x.020x13 feet, for small Victor. Pear shape hole	.60	.54	.52	.50	.48	.45
No. 33 1"x.025x12 feet for Pathé, Heineman, Meisselbach and Vitanola. Pear shape hole	.75	.70	.67	.60	.55	.50
No. 34 1"x.025x14 feet, for Sonora, Silvertone, Thomas, Saal and Dayton motors. Oblong hole	.80	.75	.70	.65	.60	.55
No. 35 1"x.028x10 feet for Columbia machines, all styles. Pear shape hole	.60	.54	.52	.50	.48	.45
No. 36 1"x.025x9 feet, for Meisselbach No. 12. Oblong hole	.60	.54	.52	.50	.48	.45
No. 37 1"x.025x16 feet, for Meisselbach, Saal, Silvertone, Thomas, Sonora and Dayton motors. Oblong hole	.90	.85	.83	.80	.75	.70
No. 38 1"x.025x16 feet, for Vitanola. Pear shape	.90	.85	.83	.80	.75	.70
No. 39 1"x.028x11 feet, for Edison Standard. Pear shape	.65	.59	.57	.53	.50	.47
No. 40 1-3/16"x.028x16 feet, for Heineman and Pathé. Pear shape	.95	.90	.88	.85	.80	.75
No. 41 1 1/2"x.027x25 feet, for Edison Diamond Disc. Pear shape	2.00	1.80	1.70	1.65	1.55	1.50

(If the above are desired in assorted sizes, the quantity price will be allowed.)

Write for our latest catalogue, now on the press, containing hundreds of needed repair parts. Ask for catalogue W.

EVERYBODY'S TALKING MACHINE CO.
38 North Eighth Street PHILADELPHIA, PA.

Stewart

Talking Machine Company

JOBBER
for the
Victor
Talking
Machine
Company



Indianapolis

COTTON FLOCKS
.. FOR ..
Record Manufacturing
THE PECKHAM MFG. CO., 238 South Street
NEWARK, N. J.

"PEERLESS BIG TEN" PLEASURES

New Improved Type of Record Album Appears to Meet a Long-Felt Want

Phil Ravis, president of the Peerless Album Co., with executive offices at 49 Bleecker street, New York, and factories in New York and Chicago, recently stated to a representative of The World that their new album, known as the "Peerless Big Ten," has met with widespread approval by the manufacturers, distributors and dealers in the Middle West, who have ordered liberally of this new product. The results so far obtained have shown that time spent in developing this innovation in record albums is to be rewarded.

The new style record album has been designed to provide for the uniform outside appearance of ten and twelve inch record albums, while the interiors are arranged for the purpose of handling one particular size. In the past the rule has been for manufacturers to equip cabinet phonographs with record albums of twelve inch size, and while the ten inch record would of course slip into the envelopes designed for the twelve inch size, the smaller records would not fit and the effect would not tend toward neatness or convenience.

The Peerless "Big Ten" album for ten inch records has the same outside dimensions as the twelve inch record album, but the compartments inside are designed to hold the ten inch records firmly and securely. The production of the new album meant considerable experimenting, and the installation of much new machinery in the factory.

These albums are also produced in sets, lettered in gold on the back from "A to G" and from "A to H." Each set consists of five "Peerless Big Ten" to hold ten inch records and the balance regular twelve inch books, making an ideal equipment for flat shelf cabinet machines.

WILL CONCENTRATE ON SONORA

The sales division of the Sonora Phonograph Co. was advised recently by the C. W. Fischer Furniture Co., of Milwaukee, that it had decided to concentrate on the Sonora line exclusively in the future. This concern had hitherto handled several lines of talking machines.

The C. W. Fischer Furniture Co. is one of the leading retail furniture houses in Milwaukee, and is located in the leading business section of the city. A gigantic Sonora advertisement on the wall of the Fischer store attracts the attention of thousands daily, and this sign is one of the links in the intensive advertising campaign that has been introduced by this dealer in behalf of Sonora product.

J. W. BOOTHE TELLS OF PROGRESS

LOS ANGELES, CAL., November 2.—J. W. Boothe, general manager of the music department of Barker Bros., returned last week from an auto trip through the San Joaquin Valley to San Francisco. Mr. Boothe visited the Fresno branch, where he found business in first-class shape. He was much impressed by the excellent progress made by the Emerson phonograph and records all through the country, as well as in San Francisco. The Emerson phonograph was recently awarded first prize at the Fresno Exposition.

NEEDLES

WE MANUFACTURE

Diamond needles for Edison
Sapphire needles for Edison
Sapphire needles for Pathe

in stock ready for delivery

MERMOD & CO., 874 Broadway, N. Y.

FOREIGN MUSIC ROLLS

FOR YOUR

FOREIGN RECORD TRADE

MEANS INCREASED SALES

THE NEW

MONO ROLL

OFFERS

JEWISH

POLISH

ITALIAN

AND

GERMAN

Folk Songs, Dances and Classics, recorded with a faithfulness that arouses memories of the homeland. Many selections recorded from manuscript.

ALL ROLLS 88 NOTE OPEN CUT, FIRST QUALITY

\$.75 to \$1.75

Liberal trade discounts from the latest bulletin, each with the words on a separate card for singing.

GERMAN		POLISH	
M 2000	Das Heidenröslein (Volkslied)..... \$0.75 <i>Von Goethe</i>	M-R 1000	Gdy Narod Do Boju! (Marsz).... .75 <i>By A. Szuszczywicz</i>
M 2001	Ich Weiss Nicht Was Soll Es Be- deuten (Die Lorelei)..... .75 <i>Von Heinrich Heine</i>	M-R 1001	Marsz Narodowy Polski75 <i>By J. Z. Krygier</i>
M 2002	Wenn Ich Mich Nach Der Heimat Sehn (Der Tyroler und Sein Kind)75 <i>Von Jos. Ferd. Nesmüller</i>	M 1002	Stanislawa Polka75 <i>Arr. by J. Messina</i>
M 2003	Wie Die Blümlein Draussen Zittern (Volksweise)75 <i>Von Franz Abt</i>	M 1003	Co Ja Winna (Mazurka)75 <i>By S. Trymolski</i>
M 2004	Ich Hatt Einen Kameraden (Volk- slied)75 <i>Von Ludwig Uhland</i>	M 1004	Podkoweczki Dajcie Ognia (Mazur) <i>By K. Namyslowski</i>75
M 2005	Steh Ich in Finstern Mitternacht... <i>Von Wilhelm Hauff</i>75	M-R 1005	Marzenia Rozkoszy (Walc)75 <i>By A. Szuszczywicz</i>
M 2006	Still Ruht Der See..... .75 <i>Von H. Pfeil</i>	M 1006	Cieszmy Sie Polka75 <i>By W. Osmanski</i>
M 2007	Immer Noch Ein Tröpfchen (Schot- tische)90 <i>Von W. Hinsch</i>	M 1007	Marzenia Mlodosci (Walc)75 <i>Arr. by W. K. Grigaitis</i>
M 2008	Darf Ich Bitten (Schnell Polka).. <i>Von A. Czibulka</i>90	M 1008	Dziadunio Polka75 <i>By K. Namyslowski</i>
M 2009	Electrisch (Schnell Polka) Aus "Die Landstreicher"90 <i>Von C. M. Zieherer</i>	M 1009	Oberok Do Bialego (Polish Dance) <i>By K. Namyslowski</i>75
M 2010	In Flagranti (Schnell Polka) Aus "Die Landstreicher"90 <i>Von C. M. Zieherer</i>	M 1010	Warszawska Polka75 <i>Arr. by W. K. Grigaitis</i>
M 2011	Marsch-Polka. "Auf der Kirmess" Aus Volksliedern zusammengesetzt M 1021 Overture "Schauspiel" (It. Dram- matico) 1.25 <i>By Chr. Bach. Arr. by Ellis Linder</i>	M-R 1011	Wieniec Melodyj Narodowych 1.25 <i>By Urbanek. Arr. by K. W. Grigaitis</i>
	ITALIAN	M 1012	Wesola Wiesniacka Polka75 <i>Arr. by E. Owczarski</i>
M 1022	Bolero d' Amore (Italian Song)... .75 <i>By R. Falvo</i>	M 1013	Faworitka Polka75 <i>Arr. by W. K. Grigaitis</i>
M 1023	'O Marenariello (Italian Song).... .75 <i>By S. Gambardella</i>	M 1014	Nowy Rok Polka75 <i>By J. Wisniewski</i>
M 1024	Santa Lucia (It. Barcarolla)..... .75 <i>Arr. by Nino Gavitti</i>	M 1015	Ognisty Mazur75 <i>By B. K. Namyslowski</i>
M 1025	Nuttata 'E Sentimento (Italian Bal- lad)75 <i>By G. Capolongo</i>	M-R 1016	Pieszczotka Polka75 <i>By A. Szuszczywicz</i>
M 1026	'O Sole Mio! (It. Canzonetta)... .75 <i>By E. di Capua</i>	M 1017	Pliszka Polka75 <i>By Fr. Zikoff</i>
M 1027	Nun T' Affaccia (It. Serenata)..... .75 <i>By Luigi Fragna</i>	M 1035	Ladna Helcia Polka75 <i>Arr. by W. K. Grigaitis</i>
M 1028	Torna a Surriento (It. Canzonetta). .75 <i>By E. de Curtis</i>	M 1036	Dziarska Chlopcey Mazur..... .75 <i>Arr. by W. K. Grigaitis</i>
M 1029	Speranze rerdute (Valse Italiano)... .75 <i>By A. Morelli</i>	M 1040	Polish Dance Medley No. 1..... .90 I. Polonez Kosciuszki II. Cieszmy Bracia Nadzieja
M 1019	La Benedizione del Pugnale (From Les Huguenots) 1.25 <i>By G. Meyerbeer. Arr. by Ellis Linder</i>	M 1041	Polish Dance Medley No. 2..... .90 I. Mazur (z op Skalmierzanki) II. Mazur (Zuch Stach)
M 1020	Rosa Della Spoza 1.25 <i>By Lavalle. Arr. by Ellis Linder</i>	M 1042	Polish Christmas Hymn. Wsrod Nocnej Ciszy (Pastoralki)..... 1.00
M 1021	Overture "Schauspiel" (It. Dram- matico) 1.25 <i>By Chr. Bach. Arr. by Ellis Linder</i>	RUSSIAN AND MALO-RUSSIAN	
M 1039	Mari, Mari! (Italian Song)..... .75	M-R 1037	(Potpourri-iz-Russkich-Piesen No. 1) 1.75 <i>Played by Louis Dubrow</i>
		M-R 1038	(Potpourri-iz-Malo Ruski-Piesen No. 1) 1.75 <i>Played by Louis Dubrow</i>
		HEBREW	
		M-R 1030	Mazel Tov Mechutonim (Hebrew- Bulgar Dance) 1.00
		M-R 1031	Die Frehliche (Hebrew-Bulgar Dance)75
		M-R 1032	Chupeh Tanz (Hebrew Dance)..... .75
		M-R 1033	Kolomeika Tanz (Hebrew Dance)... 1.00
		M-R 1034	A Russiche Schehr No. 2 (Hebrew Dance) 1.10

MADE BY

THE ROSE VALLEY COMPANY

55th Street & Hunter Avenue - - Philadelphia, Pa.

New York Office—1367 Broadway—SAM H. SPECK, Manager.

Use the
Magnavox
 to Increase **O** Your Sale of Records

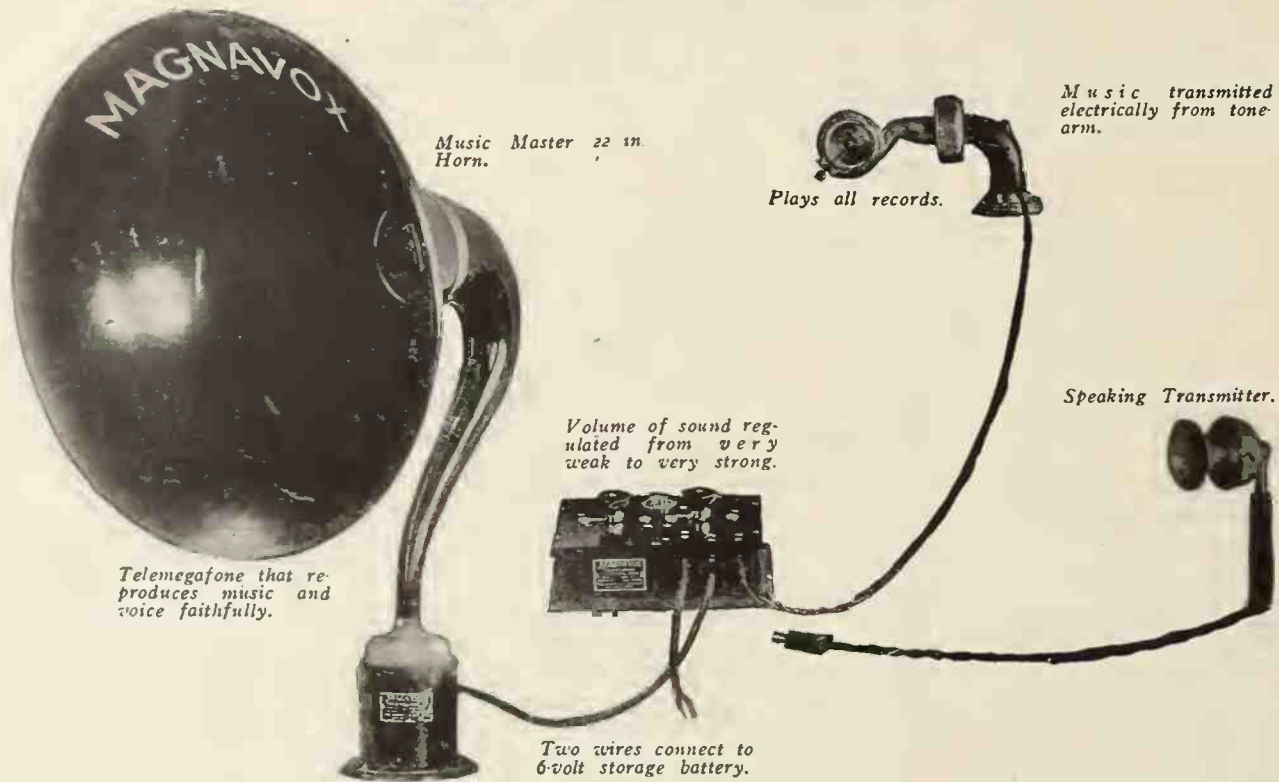

WITH the Magnavox Telemegafone the volume of sound can be so magnified that it will fill a big auditorium. In a quiet locality a record can be heard distinctly a mile away. Yet the sound can be so modulated at will that it will become a mere whisper.

The Magnavox will attract business to your store. You can play the new records of the month to a big crowd. With its speaking attachment, the one who plays the record can give the title, its price and any other selling talk so that everyone in the crowd gets it.

The Magnavox is easy to operate and very simple. An ordinary 6-volt auto battery supplies the needed current.

See the Magnavox for entertainments at clubs, summer resorts, camps, parks, on steamships, in theatres. It's great for dances. With the speaking attachment the Magnavox is valuable for use in schools, class rooms and lecture halls.

Get in touch with moving picture houses, theatres, and the leaders of amateur theatricals in town and sell them the Magnavox. There's big profit for you as a Magnavox agent.

Bulletin 22520
 tells the whole story.
 Write for it.

Distributors for New York and New England

J. O. MORRIS CO., Inc.

1270 BROADWAY NEW YORK

TALKING MACHINE A VITAL AID IN AMERICANIZATION

The Educational Department of the Victor Co. Adds "Americanization" to Its Already Wide Field of Activities—How Music Can Serve in Winning the Foreign Born to American Ideals

In its work of serving the cause of education and music, the educational department of the Victor Co. has recently turned its attention to the new and important field of Americanization, and in this connection has published a booklet entitled "The Victrola in Americanization."

Following the splendid pioneer endeavors of the Division of Immigrant Education, the work known as Americanization has been gradually enlarged and ramified until to-day it is one of the outstanding thoughts occupying American minds everywhere. It is the subject of national and State legislation. It has been accepted by the entire school system from kindergarten to university. Churches, clubs, boards and chambers of commerce, employers, and communities everywhere are realizing the need of the amalgamation of all the people into a national unity of calm, sane, unswerving loyalty and an awakening to a realization of the responsibilities of American citizenship.

In carrying on the work it was quickly de-

termined that there is no medium so attractive and efficacious in aiding the cause of Americanization as music. There is nothing so universal in its appeal. Through music one can meet every newcomer on common ground, and through it one can touch the magic chord of their love of their folk-arts, and by leading them to a knowledge of American songs and dances, bring them to an appreciation of American ideals, institutions and history.



"The League of Nations"—27 Nationalities at Rusk School, Houston, Texas, Presenting a Patriotic Program, the Music Being Supplied by the Victrola

termined that there is no medium so attractive and efficacious in aiding the cause of Americanization as music. There is nothing so universal in its appeal. Through music one can meet every newcomer on common ground, and through it one can touch the magic chord of their love of their folk-arts, and by leading them to a knowledge of American songs and dances, bring them to an appreciation of American ideals, institutions and history.

The Educational Department of the Victor Co., in studying the question of Americanization, points out that this work may be carried on through four distinct avenues, namely, by hearing much music of other lands, forming a basis of contact and understanding; through group singing of songs of the birthland of the newer

citizens, singing English translations of these songs, and in singing the American folk and patriotic songs; through the dances of America and other lands, and through a study of the music epochs of American history. It points out that the Victrola can serve most excellently in each of these fields. The Victor catalog furnishes an almost unlimited list of the choicest music of every country of the Old World, sung and played by the great artists, oftentimes using native instruments and characteristic effects.

For group singing, for instance, there are long lists of folk and patriotic songs from many lands, most of which are obtainable with English words. A collection of band records for community singing gives a splen-

did list of our own familiar and patriotic songs with strong accompaniment phrased perfectly for singing. These records have formed the very backbone of the Victor Co.'s work in national and State "drives" for the advancement of education in this country.

Among the folk dances there are records of a hundred or more, representing the ancient play spirit of all peoples to which have been added over thirty of the old Colonial country dances of America's own early period of development. Through the extensive foreign catalog, the Victor serves a clientele of persons speaking thirty-four different languages and dialects with music played on native instruments and sung or played by native artists.

Almost every epoch of American history has been marked by music. Music of this character is to be found also, beautifully recorded with the utmost fidelity to historical significance. Such music illuminates and vivifies the historic background of American life.

In line with this Americanization work with the Victrola, Saul Birns, a public-spirited Victor dealer of New York City, recently made a gift of two Victrola XXV's and a library of records to the Commissioner of Immigration at Ellis Island. Mr. Birns relates that not long ago he was present at the regular open-air Sunday concert which is arranged by Commissioner Wallis to entertain the immigrants of all nations who are detained at Ellis Island awaiting final disposition of their passports. Mr. Birns was profoundly impressed with the noble and worthy work of the commissioner. As he listened to the concert, he noticed the beaming faces of the great mass of immigrants and saw wonderful expressions of happiness, enthusiasm and



Mme. Schumann-Heink Sings for the Immigrants at Ellis Island

© Underwood & Underwood Victrola XXV, gift of Mr. Saul Birns, at foot of stage. did list of our own gratefulness. Some kindhearted foreign artists sang some selections familiar to their ears and they were completely carried away with enthusiasm and appreciation. This disclosed to Mr. Birns the vital need that music is to these newcomers waiting at our gates, and in order that this need should not go unsatisfied, Mr. Birns presented Commissioner Wallis with two Victrolas and a library of appropriate records. One of these machines is now used in the dining room and the other at the open-air concerts.

How music brings the foreigner into accord with American sentiment was demonstrated at the Sunday concert recently, at which many distinguished visitors from Washington and New York were present. The concert was opened by playing "The Star-Spangled Banner" on the Victrola, and instantly there arose and stood at attention 20,000 immigrants, who showed marked reverence for our national anthem, and for the country that is so democratic as to begin at its very doors to welcome the strangers who desire to make America their home.

"The Victrola in Americanization" referred to above is part of the Victor Co.'s free educational service to its dealers, who in turn distribute it gratis to the general public.

Ormes
Really
Means
Exceptional
Service



"Look Under the Lid!"

The time has come when a dealer who tries to sell some other line of Talking Machines and Records alongside of Victrolas and Victor Records deliberately invites his customers to suspect him of "substitution."

ORMES, Inc.

Exclusively Wholesale

26 East 125th Street

NEW YORK

The Cathedral Phonograph Is Being Acclaimed Everywhere. And Here Are the Reasons, Mr. Dealer and Mr. Jobber

SO rapid has been the demand for Cathedral Phonographs that it was necessary to double production the first year.

Telegrams and letters from jobbers and dealers in all parts of the country continually ask for sales territory.

The Cathedral is the one phonograph that meets the public's demand for an instrument that plays *any* record *perfectly*, rivalling the desires of the maker of the record.

The Cathedral is a new step in phonograph development. This wonderful instrument is achieving an individual distinction that wins immediate popularity.

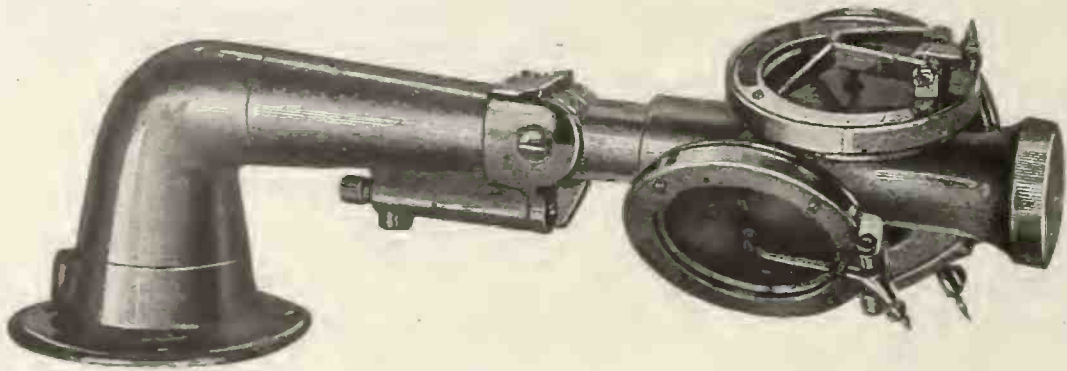

Only in the Cathedral Will You Find This New Reproducer

THE Cathedral Reproducer not only plays every record perfectly but gives the record prolonged life.

A slight turn of the rotating handle and the Cathedral Reproducer automatically adjusts itself for the record desired—diamond point, sapphire ball or steel needle type.

And rotating the handle is as simple as placing the record on the turn table. The reproducer responds with scientific exactness giving the proper tone arm length, degree of pitch and weight at point of contact.

The Cathedral Tone Arm balances, by means of a counter balance valve, so correctly that the playing point rides always in perfect equilibrium bringing forth the music by its light groove touch, without *scraping*. With no perceptible playing wear, the record is given the greatest length of life.

The Cathedral Resonator reflects all tone waves with perfect distinctness eliminating sympathetic vibrations and detracting sounds.

Cathedral designs mark a new art adaption in structural beauty. Each Cathedral design is reminiscent of the famous French Cathedrals after which the various models have been named.

We can fill prompt orders and would suggest an immediate wire from jobbers and dealers regarding details. An aggressive advertising campaign as well as the exceptional features of the Cathedral assist in the marketing.

Address our General Offices.

Cathedral Phonograph Co.

GENERAL OFFICES: OMAHA, NEB.

Factories:

MARION, O.

CHICAGO, ILL.

MILAN MODEL

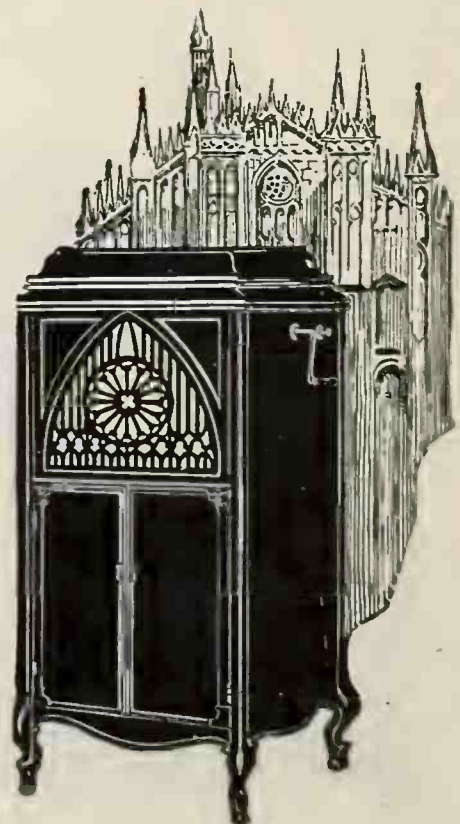

EDISON ARTISTS POPULAR QUARTER OF A CENTURY AGO

An Interesting Photograph of a Number of Old-Timers in the Record-Making Field When the Industry Was in Its Salad Days

Those members of the trade who have been continuously connected with the industry for the past quarter of a century will be interested.

There are many who were well and favorably known in older days, but quite a few of them are in the public eye to-day. The picture is quite



Edison Artists of Twenty-five Years Ago

(1) Joe Belmont, whistler; (2) Nick Scholl, trombone; (3) A. Zimmerman, cornet; (4) A. W. Lipp, yodeler; (5) Byron G. Harlan, tenor; (6) Frederick W. Hager, violin; (7) Arthur F. Collins, baritone; (8) S. H. Dudley, baritone; (9) W. C. Denning, baritone; (10) M. Guarini, tenor; (11) Wm. Tuson, clarinet; (12) Will N. Steele, recitations; (13) Jim White, comic recitations; (14) W. H. Miller, Mgr. Recording Studios; (15) Geo. Broderick, bass; (16) Frank Kennedy, Dutch comedian; (17) Al. Sweet, cornet; (18) B. Russel Throckmorton, recitations; (19) H. N. Emmons, chimes; (20) R. R. Brooks, banjo; (21) Samuel Siegel, mandolin; (22) Albert Benzler, piano; (23) Senorita Godoy, Spanish songs; (24) Joe Natus, tenor; (25) W. F. Hooley, bass; (26) May Kelso, contralto; (27) J. J. Fisher, baritone; (28) Will F. Denny, tenor; (29) John Bieling, tenor; (30) Miss Margaret Newton, soprano; (31) Fred Bachman, piano; (32) Geo. W. Johnson, Whistling Coon; (33) H. D. Madeira, baritone; (34) Frank S. Mazziotta, piccolo; (35) Frank P. Banta, piano; (36) Chas. D'Almaine, violin; (37) Geo. P. Watson, yodeler; (38) Dan W. Quinn, baritone; (39) Harry MacDonough, tenor; (40) E. N. Favor, tenor; (41) A. C. Campbell, tenor; (42) Jere Mahoney, tenor.

we feel sure, in the accompanying photograph of some of the artists who recorded for the Edison phonograph some twenty-five years ago.

a treasure and will bring back many memories of the old Edison cylinder days, when the industry was in its infancy.

ADVERTISING TO KEEP CONFIDENCE

Schmidt Music Co. Uses Publicity to Keep Industry on High Plane—Such Advertising Needed in Days of Business Uncertainty

These are days when hysterical and scare-head advertisements are wont to occur, especially in the daily newspapers in various sections of the country. Advertising of this character serves only to further undermine and shake the confidence of the public in merchants of every class. In recent issues of the daily papers in Davenport, Ia., the Schmidt Music Co., a concern which has long been noted for its intelligent and forceful advertising, carried advertising designed to restore public confidence in honest merchandising and keep the music industry on the high plane where it so properly belongs. The theme of the ad was a letter received from a satisfied customer who had had reason to test the Schmidt guarantee and found it all that it claimed to be. In a time of uncertainty in business circles a house that has an established reputation for honesty and fair dealing is the house that will get the trade of the general public. This is the attitude and belief of the Schmidt Music Co.

TO HOLD TONE-TEST IN COLUMBUS

COLUMBUS, IND., October 26.—A tone-test to demonstrate the accuracy of Edison phonograph productions will be held at Crump's Theatre November 12, under the auspices of the Pearson Piano Co. The artists who will appear are the Fleming Sisters Trio and Hardy Williamson, soloist.

PAYS TO BE PUNCTUAL

No engagement is so unimportant as not to be worth punctuality. Be on hand when you agree to be, and you can demand punctuality in others.

E. C. HOWARD WESTWARD BOUND

E. C. Howard, sales manager of the Granby Phonograph Corp., who was a recent visitor to New York City, reports that the Granby Phonograph Corp. is continuously adding to its list of dealers and that it finds conditions very favorable. Mr. Howard is on his way to Chicago.

Enthusiasm overcomes despondency and generates hope, courage and self-confidence.

ILSLEY'S GRAPHITE PHONO SPRING LUBRICANT

Ilseley's Lubricant makes the Motor make good
Is prepared in the proper consistency, will not run out, dry up, or become sticky or rancid. Remains in its original form indefinitely.
Put up in 1, 5, 10, 25 and 50-pound cans for dealers.

This lubricant is also put up in 4-ounce cans to retail at 25 cents each under the trade name of

EUREKA NOISELESS TALKING MACHINE LUBRICANT

Write for special proposition to jobbers.

ILSLEY-DOUBLEDAY & CO., 229-231 Front St., New York

FAVOR BIG EXPORT CORPORATION

American Bankers Back McHugh Plan for \$100,000,000 to Develop Trade Abroad

WASHINGTON, D. C., October 30.—Banking interests of the country, including all classes of the financial institutions represented at the American Bankers' Association in convention here, last week aligned their strength behind the proposal for the creation of an American foreign trade corporation. When the proposal was laid before the convention, indorsed by the committee appointed to study the plan of John McHugh, of New York, the delegates unanimously voiced their approval of the project and urged the taking of immediate steps to put the plan in force.

The plan calls for the organization of a \$100,000,000 corporation to finance the nation's trade.

When the McHugh plan was presented to the conference, and unanimous approval was given to the extension of financial aid for the development of foreign trade, President R. S. Hawes, of the Association, proposed the appointment of a committee for the purpose of directing the organization of the corporation. This proposal also was approved without dissent, and announcement soon is to be made of the personnel of the committee to be appointed.

DOING A SATISFACTORY BUSINESS

HOLYOKE, MASS., November 1.—Although one of the newest dealers appointed by the Commonwealth Phonograph Co., Pathé distributors of Springfield, Mass., A. J. Bourque, who recently opened attractive warerooms in this city, is establishing an enviable business in Pathé products. Mr. Bourque did not wait for the opening of his warerooms, but had sold six Pathé machines before that event. Since then he has made good use of the Pathé sales helps with excellent results.

Good luck will help a man over a difficult spot if he jumps hard enough.

for PERFECT SOUND REPRODUCTION

play Victor Records
on the Victrola
with Victor

TUNGSTONE STYLUS

TALKING MACHINE CO.

Exclusively Wholesale

BIRMINGHAM

ALABAMA



The First Releases

All the New—the Popular—the Quick Sellers Appear on Lyric Records First.

The Lyric Record is all quality—a record of the highest standard—backed by a most efficient sales organization—and national as well as local advertising.



Immediate Deliveries

Our new factory, occupying a whole square block, will shortly be opened and this will assure heavy deliveries over the holidays—any quantities of hits now.

Our Jobbers Are Ready to Serve You

Let us place before you our trade arrangement. It is interesting and means quick sales and profits.

LYRICS ARE ALWAYS THE FIRST

Lyraphone Co. of America

117 MECHANIC STREET : : NEWARK, N. J.

THE NEW FOX TROT HIT
by the writers
of "BUBBLES"
"LONESOME"
ETC.

"Feather Your Nest"

Featured by Vaudevilles
most prominent Headliners

Published by
LEO FEIST Inc.
FEIST BLD'G NEW YORK

*"You can't go wrong
with any Feist Song"*

TIMELY SONORA PUBLICITY

Sonora Dealers Furnished With Practical Trade Helps—National Outdoor Display Campaign Materially Augmented—Holiday Suggestions

The advertising department of the Sonora Phonograph Co. announced recently that the Sonora national outdoor display advertising

falo, Cleveland, Detroit, St. Joseph, Louisville and St. Louis. Standard advertising designs will be used so that the same advertisements will appear simultaneously throughout the country. Frequent repaints and new layouts in color schemes will maintain interest and prevent these expensive signs from "growing stale." The Sonora advertising division has just prepared a very attractive display piece that is now

S. R. DAVIS HEADS MULTITONE CO.
Prominent Business Man Succeeds E. J. Sailstad as President of This Wisconsin Company

EAU CLAIRE, Wis., November 6.—Stephen R. Davis has been elected president of the Multitone Mfg. Co., manufacturer of the Multitone phonograph, in place of Edward J. Sailstad, founder of the concern, who is believed to have been burned to death August 27 when a cottage in which he was spending a short vacation was destroyed by fire. The insurance companies, in which Mr. Sailstad carried policies amounting to more than \$75,000, are withholding payment pending a thorough investigation of reports indicating that he may still be alive. Mr. Davis is secretary of the Dells Pulp & Paper Co. at Eau Claire and is interested in other large manufacturing corporations.



Two Pages From the Christmas Folder

campaign had been increased materially. In addition to the cities already covered by this type of Sonora advertising, a campaign is being started on the boards of Boston, Syracuse, Buf-

being sent to Sonora dealers for use during the holiday season. The screen design shows a Sonora period model in a handsomely furnished apartment, and the harmonious setting is sure to attract favorable comment. The height of the screen is twenty-six inches, the center panel being twenty-one inches wide and the outside panels ten inches wide, making a total length of forty-one inches. This screen constitutes a timely help for stimulating holiday business.

There has also been mailed to Sonora dealers recently an artistically printed leaflet in several colors, designed in the Christmas spirit. This leaflet can also serve as a catalog of the Sonora upright sales, as six of the upright models are illustrated and described. The leaflet is designed to fit as an envelope enclosure and can be used to advantage by progressive dealers.

OCCUPYING NEW QUARTERS

The Lorraine Phonograph & Supply Co., Inc., New York, has moved from 17 West Forty-second street to larger quarters at 581 East 161st street.

If you are doing your best and still success is not yours there is something wrong with your method. Get down to rock bottom with yourself and find out what it is,

BUYS LINTNER'S MUSIC SHOP

The Jersey Music Co., Victor dealer in Bloomfield, N. J., has recently purchased Lintner's Music Shop in South Orange and will install new equipment in that store in the near future. A complete line of Victor products will be carried. Clark Price will supervise the opening of the new branch.

The New England Musical Instrument Trading Co., importer and jobber of talking machine needles and accessories, has moved into new quarters at 123 East Twenty-third street, a few doors west of its former building.

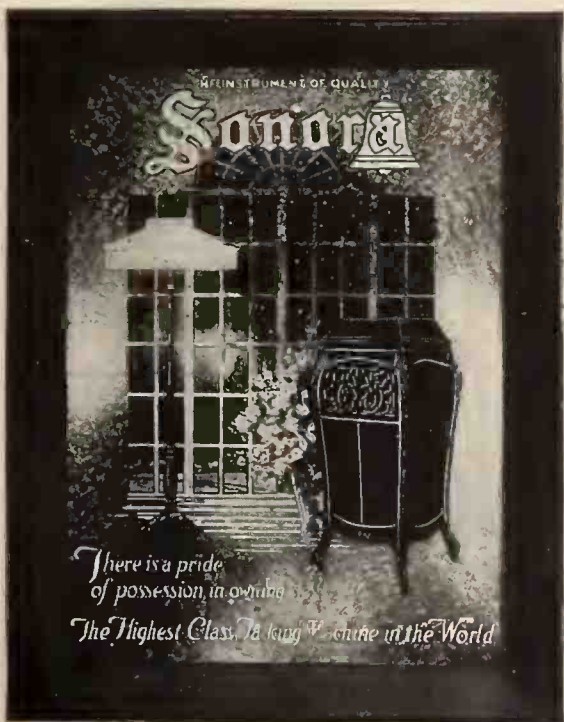

Sonora Screen Design

BRUNO

Thousands of firms are spending millions of dollars each year in advertising. Not that they haven't other good use for the money, but because they have learned that "it pays to advertise." What is your publicity campaign, Mr. Victor Dealer?

BRUNO

Crystal Edge MICA Diaphragms

THE STANDARD OF QUALITY AND SERVICE

PHONOGRAPH APPLIANCE CO.

174 Wooster Street, New York

MAKE FARM LIFE MORE ATTRACTIVE

Music Can Play Important Part in Checking Undue Movement Toward Cities Is Belief of Pennsylvania Supervisor of Music

As a step in the campaign to make farm and rural life more attractive so that the migration toward the cities may be stopped the State Supervisor of Music in Pennsylvania has expressed himself as believing that music can do a great deal in the movement. It should be made possible for children and adults to receive instruction in music, in his opinion, and in a recent speech to teachers he said: "I have in mind a rural school in Pennsylvania where this plan is

being followed. A competent man is employed to teach instrumental music. He gives both class and individual instruction. The school has three orchestras, of which the first and most proficient is the smallest. It comprises eight members. The second consists of fourteen players. On special occasions these pupils are coached to unite with the first orchestra. The third is the beginners' orchestra. It is elementary in character. It numbers from six to twelve players. The school also has a mandolin club of nine members.

"The report of the Music Section of the Educational Congress recently held begins with this statement of its cardinal principle: 'The end of public education in music is appreciation. Any

course in school music which permits its students to go forth after graduation without a distinct and well-defined appreciation of music has totally missed its mark. Many supervisors and teachers of music in the public schools of our cities and towns are lost in a hopeless maze of technicalities. Their ambition seems to be to get pupils to 'read music at sight.' Such teachers are without real purpose.' Observation has shown me that the teacher of the modest country school is sometimes accomplishing more that is of real worth in music than is her 'graded course' sister in the city. All that the rural teacher needs for her happy purpose is enthusiasm and a phonograph."

The Pennsylvania Department of Public Instruction has prepared a list of educational phonograph records. The department has also undertaken a project to establish a circulating library of talking machine records. Parcels of ten or a dozen records, together with analytical and fully descriptive literature on the phases of music covered by them, will presently be available to teachers in rural schools.

GOING OUT AFTER BIG BUSINESS

Manager of Brunswick Department of Davenport, Ia., Store Orders Large Stock

F. A. Mulford, manager of the Brunswick department of J. H. C. Petersen's Sons Co., Davenport, Ia., writes that he is in accord with the editorial in the October issue of The Talking Machine World urging dealers not to indulge in "gloom" talk, but go out after business. He also says that his department is making plans for a volume of business larger than he dreamed possible a few years ago. He has shown his confidence in the result by placing 185 Brunswick machines in the sales department. An attractive booklet, "Have You Music in Your System?" has been prepared and is being sent out to all music lovers of his territory.

Don't argue. Argument breeds bad blood and convinces no one. It rather strengthens both parties in their original positions.

What More Can You Ask

All the features that go to make a talking machine *Profitably Salable* you will find as regular equipment of *Magnola*: "Built by Tone Specialists."



Watching the Music Come Out

Complete description of all these features is to be found in our *handsome illustrated catalog*, which we should like to send you. May we? Ask us to tell you our plans for your benefit!

MAGNOLA TALKING MACHINE COMPANY

OTTO SCHULZ, President
General Office 711 MILWAUKEE AVENUE CHICAGO
Southern Wholesale Branch 1530 CANDLER BLDG. ATLANTA, GA.

ASTORIA MAHOGANY LUMBER & VENEERS

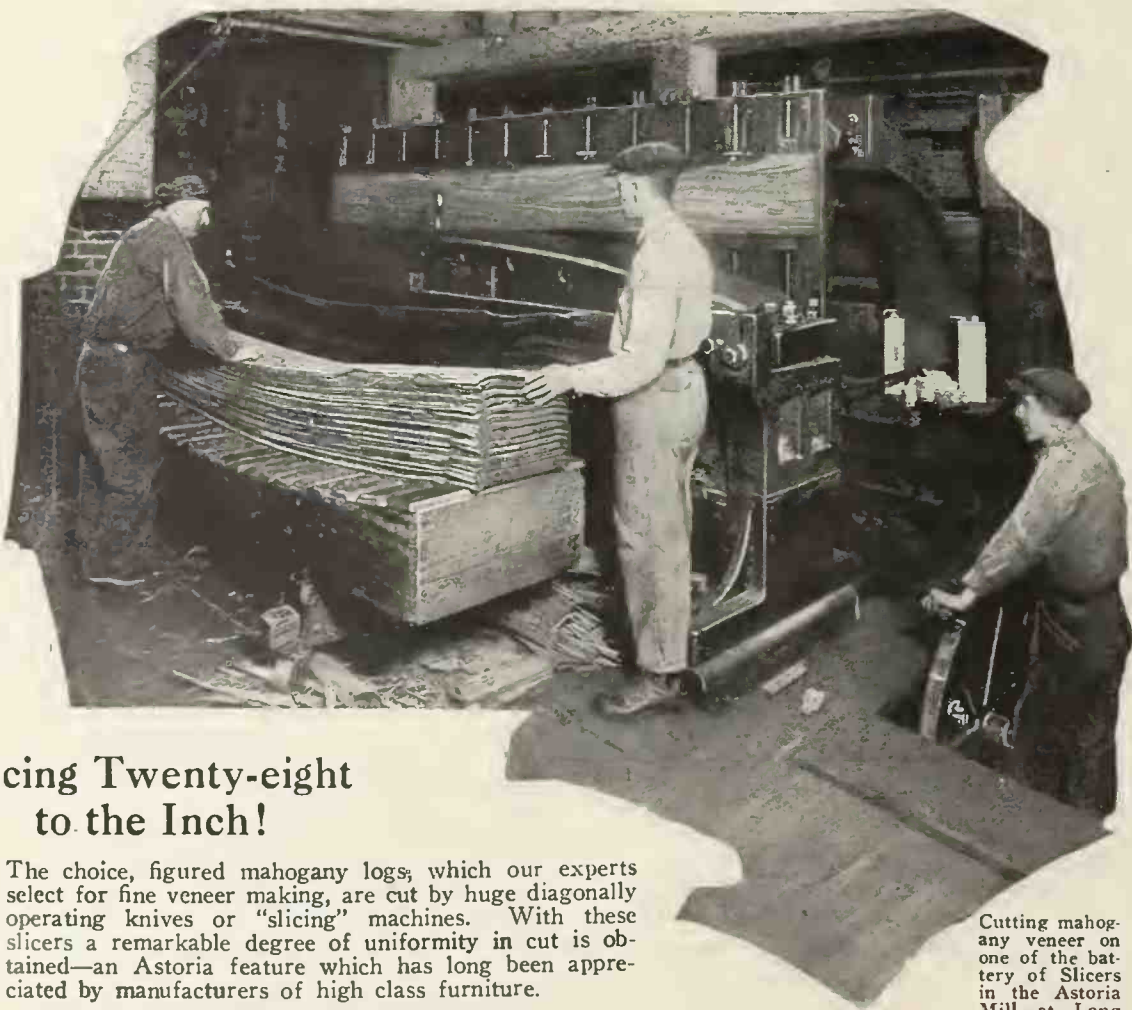

Cutting mahogany veneer on one of the battery of Slicers in the Astoria Mill at Long Island City.

Slicing Twenty-eight to the Inch!

The choice, figured mahogany logs, which our experts select for fine veneer making, are cut by huge diagonally operating knives or "slicing" machines. With these slicers a remarkable degree of uniformity in cut is obtained—an Astoria feature which has long been appreciated by manufacturers of high class furniture.

This uniformity of cut is but another element in the service which for over a quarter century has made us the largest complete mahogany lumber and veneer organization in the United States.

Astoria Mahogany Company, Inc.

1031 Steinway Ave., Long Island City, N. Y.

Successors to
Huddleston-Marsh Mahogany Co. Astoria Veneer Mills and Dock Co.
F. W. Kirch, Inc.

BRANCHES—44 North Market Avenue, Grand Rapids, Mich.
2256 Lumber Street, Chicago, Ill.

Mills and Yards, Long Island City, N. Y.



GENERAL PHONOGRAPH CORPORATION

OTTO HEINEMAN, *President*

25 West 45th Street - - - New York

FACTORIES:— NEWARK, N. J. ELYRIA, O.
PUTNAM, CONN. SPRINGFIELD, MASS. KITCHENER, ONT.



BRANCHES:

CHICAGO

TORONTO

LONDON, ENG.

DEAN NEEDLES

THE BEST

IN

NEEDLE PROPOSITIONS

MR. JOBBER:

We make and deliver needles of superior quality. Needles that are uniform in size and of the highest grade carbon steel. Needles that take the most delicate note in a selection. Our needles are unexcelled by comparison. They are the famous **DEAN Needles**. Put up in your own envelope, or in our Needle of Quality, Truetone, or Puritone envelopes.

Also the well-known Petmecky needle:—All tone variations. Write for our attractive proposition.

GENERAL PHONOGRAPH CORPORATION

OTTO HEINEMAN, *President*

25 West 45th Street - - - New York

FACTORIES:—
PUTNAM, CONN.

NEWARK, N. J.
SPRINGFIELD, MASS.

ELYRIA, O.
KITCHENER, ONT.

BRANCHES:

CHICAGO

TORONTO

LONDON, ENG.

CHANGES IN THE PRICES OF EDISON DISC RE-CREATIONS

Increased Prices on Certain Classes of Re-Creations and Price Reductions on Other Classes Announced by the Edison Laboratories—To Be Effective on November 15

Official announcement has been made by the Edison Laboratories that, effective November 15, the prices of certain classes of Edison Disc Re-Creations will be advanced in the United States, while, at the same time, the prices of other classes will be decreased. The announcement, which is signed by William Maxwell, vice-president, has occasioned little surprise throughout the Edison trade, however, since both jobbers and dealers have previously been forewarned of the necessity of making the coming change.

Justification for a change in prices at this time and for the establishment of what are expected to be reasonably permanent selling prices is found in the following excerpt from Mr. Maxwell's announcement:

"We have received perhaps a dozen letters, or telegrams, advising us that the present is not a propitious time to advance prices on anything. However, we are quite sure that neither our dealers nor the public desire us to continue indefinitely to manufacture Edison Re-Creations at a loss. Most of you know that our prices on Re-Creations have been what is commonly called 'nominal'—in other words, arbitrary prices, which had no particular relation to the cost of production. To be perfectly frank, the reason for this was that we did not have a true manufacturing operation and to have established selling prices, on the basis of actual manufacturing costs, would have been more or less of a business absurdity. We have now reached a point where we have a true manufacturing operation, and we are able to discover what our actual manufacturing costs are. They are still too high to afford the basis of appropriate selling prices, and we are looking forward, into next year, to an ideal manufacturing operation, with full capacity output. By thus discounting the future we are establishing prices which we feel

sure will always be the selling prices of Edison Disc Re-Creations.

"Please bear in mind that these prices are not based upon our present manufacturing costs, but are based upon what we hope our manufactur-

ing costs will be under well-nigh perfect manufacturing conditions."

The new list prices in the United States will be as follows: Re-Creations now listed at \$1.15 and \$1.70 will be advanced to \$1.35 and \$1.85 respectively; those listed at \$2.25 will remain the same and those now higher than \$2.25 will be decreased to the latter price.

Mr. Maxwell's announcement has been received with considerable interest in the trade.

SOTHERN AND MARLOWE TO BE HEARD THROUGH RECORDS

Distinguished Shakespearean Actors Engaged in Making Records of the Dramas and Comedies of the "Bard of Avon" for Educational Purposes at the Victor Laboratories

PHILADELPHIA, PA., November 1.—Edward H. Sothorn and Julia Marlowe, noted Shakespearean actors, now in this city, have made public the fact that they are at present engaged in making records of Shakespearean dramas and comedies for educational purposes. The records are being made at the Victor Talking Machine Co. plant in Camden.

Mr. Sothorn said that the records would be furnished schools and used in the regular English courses. He expressed the belief that this innovation would lead to the stimulation of a new interest in the Bard of Avon's works.

"The method of teaching Shakespeare heretofore in schools," he continued, "has been very poor, the average student learning only to mumble the passages in a half-hearted sort of way without being taught the philosophy and meaning. When they hear those same passages, however, recited for them in the school room by actors who have given their lives to the study of Shakespeare, a new interest will be kindled. The human touch in the great master's works will be felt."

Mr. Sothorn refuted the idea that the public would ever grow away from appreciation of the heavier drama. "If the drama should be driven off the stage by the musical comedy, as some people predict, the fault would not lie with the public, but with the actors themselves. Actors

to-day don't display the ambition or perseverance they used to.

"If they go to a manager and assert they can play Hamlet or some other difficult part, and the manager turns them down, they give up the ghost immediately, and go into some other line of endeavor or join a musical comedy where the work is easy. What they ought to do is to save till they get enough money to form a company of their own. Then they could demonstrate to the manager their ability. This is the kind of ambition the stage needs to-day if the great masters' works are to live."

INTERESTED IN NEW EQUIPMENT

M. L. Boris, of the Period Tone Arm Corp., 55 West Seventeenth street, New York City, in a recent statement said that despite the fact that there apparently had been some overproduction in the manufacture of talking machines, he had found the trade very interested in new equipment for the coming year. "The fact that our company is making specially designed tone arms and sound boxes," he said, "seemingly has met the approval of many manufacturers, as it adds to the individuality of their product. We have been able to deliver considerable equipment for the Fall season, and every indication points to an enlargement of our business."

Mr. DEALER

THE customer likes them—that's the proof. We receive hundreds of letters like this. He wants more. Here's a trade worth your going after strong. The movie "fan" spends money willingly on his fad. It's easy to sell three for a dollar. No demonstration necessary. Properly displayed Talking-Photos sell themselves.



Immediate Deliveries for Holiday Sales

Staunton, Ill.

Talking Photo Corp,
New York, N. Y.

Just-received my three records I sent-for

Mae Murray
Gloria Swanson
Mary Miles Minter

I think they are splendid!
Am sending two dollars more, for which please send the six records I have marked.

Yours for success,
Charles
220
St.

Just received the three records I sent for"

"I think they are splendid"

"Am sending two dollars more."

STANTON
NOV 11 AM
1920
ILL

Talking Photo Corp.,
334 5th Ave.,
New York City.

'Pat' Wheeler, pres.

NOW—
 your
Window Display
Problem
is Solved!

VICTOR DEALERS in other territories, may obtain this SERVICE from your local wholesaler, or direct from The Reincke-Ellis Co.
Exclusive Sales Agents

45 East 34th St.
 NEW YORK

215 No. Michigan Ave.
 CHICAGO

THE *Binger* COMPANY
Victor
 Sales Promotion
SERVICE

This is a complete SALES PROMOTION PLAN all worked out for you in advance: co-ordinating your merchandising, your window displays and your store interior displays, your newspaper advertising, your direct mail publicity and your personal selling—and dove-tailing these all important functions of your business into one well-oiled PROGRAM. Live-wire VICTOR dealers can not afford to be without this Service.

VICTOR DEALERS— This Service is designed *exclusively* for you. We heartily endorse it. Mail in the coupon on the opposite page— or ask our salesman.



Victor Wholesalers
Exclusively

NEW YORK
Talking Machine Co.
 119 West 40th St.



Imagine

this beautiful display in your store window just in time for the Christmas buying season.

—and picture

this interior view of the Metropolitan Opera House, reproducing an actual performance.



This Service begins with the effective Christmas window shown above, and is followed by an entirely new and original display every two weeks. An interesting book, illustrated with photographic reproductions of displays in actual colors and fully describing the PLAN in complete detail— what the service is, what you get, what you pay— will be sent to any Victor dealer postpaid upon receipt of the coupon below.

DON'T DELAY—The Service for ensuing year begins with the Christmas window. It will be shipped in ample time for you to make your holiday trim.

CHICAGO
Talking Machine Co.
12 N. Michigan Av.

Start with the Christmas Display send in your order to-day

Now Your Wins

New York Talking Machine Co. N. Y.
Chicago Talking Machine Co. Chicago

Gentlemen:
Please send me a copy of the BOOK describing The Binger Co. VICTOR Sales Promotion Service.

Name _____
Address _____

NEW YORK JOBBERS GET TOGETHER

**Dinner at Palais Royal Proves Great Success—
Babu Makes Its Debut**

As a result of a little idea of H. C. Ernst, of the New York Talking Machine Co., that it would be a clever idea for Victor jobbers and other associates to get together some night in the Palais Royal, to see and hear Paul Whiteman, the new exclusive Victor artist, and his orchestra, over one hundred jobbers and their friends had a most enjoyable reunion on Monday night, October 25.

By the time Mr. Ernst closed his booking office for reservations, half of the spacious ballroom of the Palais Royal had been engaged. As the many guests seated themselves, they were surprised to find a strikingly beautiful hand-

Babu made her debut. This little device, which is almost human in its action, clothed in the robes of the Orient, dances a most original dance which is in keeping with her costume. It was announced that this little device will shortly be put on the market by the Reincke-Ellis Co.

Long after the last course of the bountiful repast had been served, the assemblage remained in order to enjoy, to an even longer period, the music of Whiteman's orchestra.

It might not be out of place here to incidentally thank Mr. Whiteman for the little glasses of pleasure stimulator which he had distributed at the places of all of those present. Those who attended were: Mr. and Mrs. Green, L. L. Spencer and mother, Mr. and Mrs. McCreedy, Mr. and Mrs. Elmer Howell, M. P. Fitzpatrick, Mr. and Mrs. Schoonmaker, Mr. and Mrs. Blackman, Mr. and Mrs. Johnston, Mr.

Mrs. E. Blout, Mr. and Mrs. Cass B. Riddel, Miss Grace Riddel, S. A. Wessel, H. L. Brennan, V. Burnett, G. Henderson, L. Bill and Mrs. Raymond Bill, Joe Bryant, Miss Annalu Burns, Miss Madelyn Sheppard, Mrs. Whiteman, Mrs. Coff, Miss Brown, Princess Watahwaso.

WHISTLING AS A MUSIC BAROMETER

Schools Use Talking Machines to Teach Children Good Music and Whistling of Ragtime Ceases—Experience Worthy Emulation

Another wrinkle in the use of the talking machine in education in the schools is set forth as a suggestion to supervisors of music. The story comes from the Indianapolis News and is as follows: "Whistling carpenters and others who work out of doors are common enough. Whistling indoors is regarded as a crime by many fellow-workers who have nervous temperaments and find neighborly whistling a distraction. Not long ago the supervisor of music in the public schools of an Indiana city undertook to raise the standard of public whistling, and contended that he had been successful in his efforts. He found, in walking about the town where he lived, that boys of various ages were prone to whistle. Some of them whistled off key, while others maintained the tune readily enough, yet their selection appalled the music teacher. He placed talking machines in the school buildings and began teaching the youngsters something about good music. He found that all they needed was an opportunity to hear something worth while. Some time later he made a whistling survey and reported that boys who formerly whistled ragtime were then giving their attention to standard overtures. Many would welcome such results elsewhere."



Gathering of New York Victor Jobbers at Palais Royal

painted photograph cut-out of Paul Whiteman facing them as a place card. This place card was the gift of L. C. Crone, president of the Binger Co. On the bottom of the card ran the following little quibble:

Paul, bow in hand—see him stand—ain't he grand?
Whiteman is his name—great his fame—and his game!
Have no regrets, modest violet—for what you get for
fiddling puts all others to shame.
Others can yiddle—but you and your fiddle make all
New York wiggle, again and again.

During the time the elaborate menu, which had been especially prepared for the occasion, was being served, Paul Whiteman started a competitive move by inducing the people to forsake their tables and trip the light fantastic to the tune of his splendid orchestra.

At one time during the banquet the lights were turned out and a spotlight was thrown on the Victrola which stood in the corner of the room. Upon the turntable, over the record, Miss

Robbins, George Thau, F. C. Oliver, Mr. and Mrs. Palmer, Mr. and Mrs. Bowes, H. Nolan, Mr. and Mrs. Geissler, Mrs. Levy, Mr. and Mrs. Ernst, Mr. Mason and Miss Pierson, Holbrook Blinn, Mr. Fontan, Mrs. Florence Meehan, Mr. and Mrs. Murchie, J. J. Davin, Geo. Deacon, Halstead Williams, Mr. and Mrs. Haussler, Mr. and Mrs. Evans, Mr. and Mrs. Harris, Mr. and Mrs. Crone, Mr. and Mrs. Steinfeld, H. B. Haines, Miss Helen Brundage, J. Davega, Mr. and Mrs. A. Davega, Jos. Schwetz, B. R. Forster, G. T. Williams, S. W. Williams, Wm. Miller, W. H. Barker, R. H. Morris, Mr. Offerman, Harry A. Heineman, Mr. and Mrs. L. W. Collings, Mr. and Mrs. Spillane, Mr. and Mrs. Lamor, Mr. Dunham, Bernard Levitow, Miss Mason, P. E. Carlson, Mr. Hamilton, Miss Croneur, C. R. Wagner, Mr. and Mrs. Joe Galway, Mr. and Mrs. Wm. Scherman, Mr. and

REMOVE TO NEW QUARTERS

The New England Musical Instrument Trading Co., which does a jobbing business in musical instruments and talking machine needles, has moved to new quarters at 123 East Twenty-third street, a few doors from its former home. The company was recently incorporated and Philip Jacobson, the former manager, has been elected president. David Olschen has been elected vice-president, and Harry Feinberg has been appointed manager.

HOW DO THEY PLAY JAZZ?

A one-note band has often been considered as a great curiosity. However, in Russia bands exist composed of performers upon horns which according to reports are capable of producing only one note or tone.

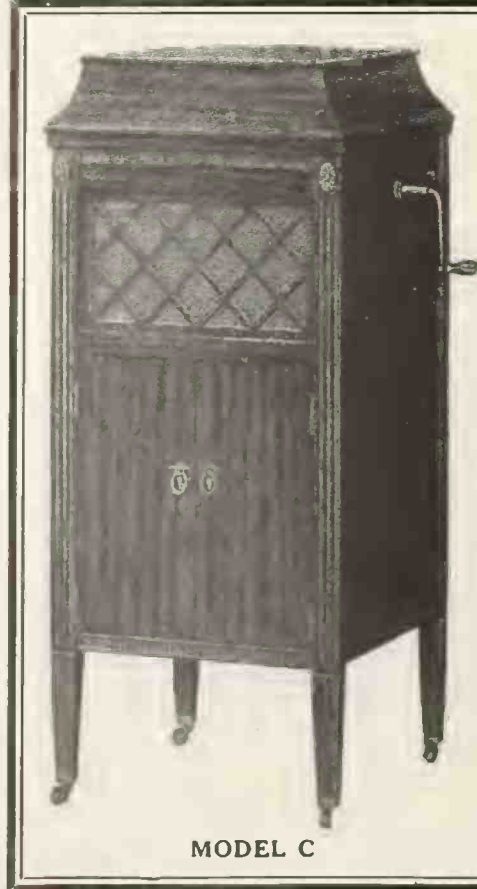

MODEL C

Lyrolian
MARVELOUS TONE QUALITY

PLAYS ALL RECORDS
Six Beautiful Models

We offer attractive proposition to
DEALERS and DISTRIBUTORS

We can make immediate shipment for the holiday trade.

Distributors Wanted in Several States

AMERICAN TALKING MACHINE CO., Inc.

GENERAL OFFICES AND FACTORY

BLOOMSBURG, :: PENNA.

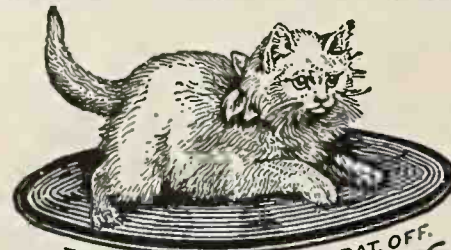

NEVER SCRATCHES

WE ARE DISTRIBUTORS FOR
LYRIC LATERAL RECORDS

Dealers Supplied on Short Notice
Supplying you with Bulletins, Hangers, Cut-outs and Advertising Matter is one feature of

LYRIC SERVICE



Retail Price \$1.50

BUBBLE BOOKS "that Sing"

TREMENDOUS HOLIDAY SALES ASSURED
Wire Orders Today—IMMEDIATE DELIVERIES

HAVE you enough Bubble Books to supply the enormous demands the nation-wide advertising campaign planned for Bubble Books will create?

Right now Bubble Books are the fastest selling merchandise for child amusement on the American Market. The demand actually is greater than the supply. At least three million Bubble Books will go into American homes between now and January 1st.

You should have your share of the profits to be made by distributing Bubble Books in the homes in your city.

When you sell one Bubble Book you start a customer who is a prospect for all of them. This means a unit sale to you of at least \$18.00.

If you have not already done so place your order today for Bubble Books "that sing." Each Bubble Book is complete in itself, a story beautifully illustrated, verses, rhymes, and three real phonograph records come in each one.

Consolidated Talking Machine Company, Inc.
227-229 W. Washington Street Chicago, Illinois

Special Offer

Bubble Book Display Stands

MERCHANDISE correctly and attractively displayed is two-thirds sold. To help you display your Bubble Books to the best advantage we are offering two specially designed display stands free.

Each stand is finished in black enamel and is equipped with a lithographed card. The larger one, in addition to most effectively displaying Bubble Books, holds a stock of 75 books and the small display stand holds 12 books. Place upon your counter either one of these stands and they are bound to make many sales. Send in your order today for the display stand you can use.



Consolidated Talking Machine Co., Inc., Chicago, Ill.

WHOLESALE ORDER BLANK

Enter our Order and ship via (Freight) (Express) (Parcel Post):

- | | |
|---|--------|
|Bubble Books (Less than a Gross) each..... | \$1.00 |
|Bubble Books (One Gross or more) each, including one No. 1 Display Stand Free | .95 |
|Bubble Books (Five Gross or more) each, including one No. 2 Display Stand Free | .92 |
- Quantity as follows:
- | | |
|---|--|
| ...No. 1—The Bubble Book (Tom, Tom, the Piper's Son, Jack and Jill, Mary and Her Little Lamb) | ...No. 7—The Funny Froggy Bubble Book (The Frog Who Would A-Wooling Go, The Frog and the Crow, The Carrion Crow.) |
| ...No. 2—The Second Bubble Book (Simple Simon, Little Bo-Peep, Old King Cole.) | ...No. 8—The Hanny-Go-Lucky Bubble Book (The Milk Maid, The Ploughboy, The Jolly Miller.) |
| ...No. 3—The Third Bubble Book (Miss Jennia Jones, The Farmer in the Dell, Lazy Mary.) | ...No. 9—The Merry Midgets Bubble Book (Daddy Long-Legs and Floppy Fly, The Fly and the Bumble-Bee, The Spider and the Fly.) |
| ...No. 4—The Animal Bubble Book (The Three Little Kittens, The Three Little Piggies, The Three Blind Mice.) | ...No. 10—The Little Mischief Bubble Book (The Little Girl Who Had a Little Curl, Oh Dear! What Can the Matter Be? Bobby Shaftoe's Gone to Sea.) |
| ...No. 5—The Pie-Party Bubble Book (Little Jack Horner, The Queen of Hearts, Good King Arthur.) | ...No. 11—The Tippy-Toe Bubble Book (The City Mouse and the Country Mouse, Tabbyskins, Old Mother Hubbard.) |
| ...No. 6—The Pet Bubble Book (Little Pussy, Little Doggy, Cork-a-Doodle-Do) | ...No. 12—The Gay Games Bubble Book (The Mulberry Bush, Oats, Peas, Beans, London Bridge.) |

Signed.....
Street and No.....
City..... State.....

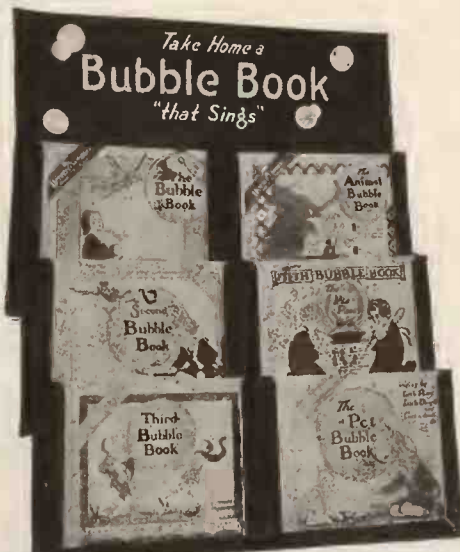

Bubble Book Display Stand No. 1. Complete for counter or wall display with attractive lithographed card at top—packed in corrugated paper case. 30-day Free Offer—with orders for one gross or more.

Bubble Book Display Stand No. 2. This stand revolves and has a capacity of 75 Bubble Books, three books to a compartment, with lithographed card in frame at top—packed in special wooden case complete. 30-day Free Offer—with orders for five gross or more.

NO EVIDENCE OF BUSINESS SLOWING UP IN BUFFALO

Dealers Optimistic About Winter Trade—Report Large Demand for Records—Burley & Biesinger's New Store—Columbia Dealers Meet—Danielson's Opens Up—Blue Bird Branch—Other News

BUFFALO, N. Y., November 4.—On the whole, there is not apparent in the talking machine business here the slump that has come in many other kinds of merchandising. The dealers report that business is generally active. One of the reasons for the continued good business is that rural trade keeps up. Jobbers here are sending many instruments to the smaller towns. The farmers, with their crops harvested and the money for them in their pockets, are preparing to while away the long Winter evenings with music.

There is a brisk business in records. "Whispering" seems to be the prime favorite here at the present writing, many of the dealers reporting that they are totally unable to supply the demand for it.

A fine new store has been opened in the thriving business section at Grant and Ferry streets by Burley & Biesinger. This concern's principal business is in Victrolas. In the new store at 332 West Ferry street there are fourteen handsome talking machine booths. The appointments of the store are of the finest, and it will compare favorably with any of the downtown stores of its size.

Extensive alterations are under way at the store of the Robert L. Loud Co., 569 Main street. Eight booths for the demonstration of talking machines are being arranged on the first floor, and a handsome new case for records has been set up. An electric elevator is also being installed. These alterations in the building involve a total outlay of about \$40,000.

The first of the regular monthly meetings of Columbia dealers, under the auspices of the Columbia Graphophone Co.'s local branch, was held on the evening of October 26 at the Hotel Lafayette. There were fifty-one dealers represented at this meeting despite inclement weather. Many helpful ideas were exchanged by the dealers in the course of the evening, and they listened to some interesting talks. W. H. Lawton, local branch manager, spoke on "Advertising;" G. W. Peace, assistant manager, took as his topic "Columbia," and W. T. Duffy, Dealer Service supervisor, gave a talk on "Dealer Service."

The Blue Bird Talking Machine Co. of Los

Angeles has opened a branch here at 680 Main street. Nathan H. Satuloff is the general manager of Buffalo and New York State. He and Burton H. Corbett, national director of sales for the company, are working on the establishment of a distributing business that will cover all of the State from this city. The organization will contain in its personnel a retail manager and a number of competent wholesale managers and general road salesmen. The organization is being put on a stable basis.

Ted Lewis and his jazz band, who were at the Shubert-Teck Theatre last week with the "Greenwich Village Follies," gave a concert in the store of the Household Outfitting Co. here, which has a large phonograph department. Mr. Lewis is a Columbia artist. He and his band drew a big crowd to the store.

C. Fred Danielson, who for seventeen years has been in the music business at Jamestown, has opened a new store there. The new store is located at 15 East Third street, and in it there is a large stock of Victrolas on display. There are eight demonstration rooms for phonograph customers. With the opening of the new store Mr. Danielson will abandon the Victrola shop at 516 Cherry street. He will, however, continue to operate his store at 17 North Main street.

A movement has been started among Columbia dealers here to have Art Hickman and his famous jazz band stop off at Buffalo on their way to San Francisco and hold a concert in one of the city's larger halls.

J. C. Ross, formerly Dealer Service supervisor at the Columbia branch here, has opened up the Music Shop and has been given a Columbia franchise.

WINS SUCCESS IN HIS OWN STORE

Eugene B. Holmes Building Up a Substantial Business in Roslindale, Mass.

Eugene B. Holmes, who opened a piano and talking machine store of his own at 22 Corinth street, Roslindale, Mass., in July of this year, reports that he has already built up a very substantial business. Mr. Holmes is well qualified

BRUNO

Along certain lines, it may be questionable whether to "lift the lid", but there can be no doubt when speaking of talking machines. Teach the public, Mr. Victor Dealer, to "lift the lid" to make sure it's a Victrola.

BRUNO

to operate a successful store, inasmuch as he was for thirteen years buyer for the talking machine and musical merchandise departments of the Jordan Marsh Co., of Boston, and for three years retail manager of the Pathé department of the Hallet & Davis Piano Co., that city.

WHY CUSTOMERS STOP BUYING

Some Concerns Now Make Efforts to Find Out Just Why Patrons Have Discontinued Their Purchases for Certain Periods

Believing that when a steady customer suddenly stops buying there may be something wrong that can be remedied, a number of merchants who make use of mailing lists are taking occasion to inquire just why the patronage has ceased. A New York concern, for instance, recently sent out a letter to all those who had not been credited with purchases during the past six months. The letter was worded somewhat as follows:

"In looking over our books we find that you have not been credited with any purchases in this store for several months. We hope we are wrong, and that you have been numbered among our customers even though a record was not made of the fact.

"In the event that you have not visited our store recently, we presume there must be some reason and ask that you present the facts in order that we may make such changes in our service as will meet with your approval."

The letter is distinctly friendly in tone, and there is included in it a return postcard with space where the customer may fill in any reasons why he has ceased patronizing the store. A careful check was made in one instance, and it was found that only one or two customers had any real reason for being unfriendly to the store. In every such case a satisfactory adjustment was made. In a number of instances customers upon receiving the letter took occasion to come into the store to explain the circumstances that had caused them to stop buying for a certain period. The sum total of the effort was that buying on the part of those who had been standing pat was stimulated. Perhaps there is an idea here for the talking machine dealer.

RECENT BROOKLYN INCORPORATION

The Phonograph Products Corp., Brooklyn, N. Y., has secured a charter and will begin business with a capital of \$30,000. The incorporators are L. T. Lombra, C. J. Lally and G. Van Zandt, 50 Court street.

AUTOMATIC COVER SUPPORT

No. 1287

Latest Improvements Make This Support More Desirable Than Ever

**Continuous Hinges
Automatic Stops
Needle Rests, Etc.**

Finished in

- GOLD
- SILVER
- NICKEL
- COPPER
- BRASS

Write for Catalogue

WEBER-KNAPP CO.
JAMESTOWN, N. Y.





Only *Dalion* Has this Sales-Compelling Feature



This year, of all years, is a triumph for the more-than-ordinary phonograph. With purse strings wide open, with buying uncurbed, and with *Dalion's* powerful advertising in *Cosmopolitan*, *Atlantic Monthly*, *Century*, *Harper's*, *Photoplay*, *Review of Reviews*, *Scribners* and *World's Work*,

all full pages

our liberal Dealer Franchise becomes a golden opportunity. Full details mailed promptly on request. Write *now*.

ON no other phonograph is there anything so convenient or practical. Its unrivaled handiness and simplicity has made the Auto-file the most powerful sales-getter on any phonograph today. The unprecedented success of *Dalion* dealers attests to its gigantic selling power.

Instantly offers the desired record. Replaces the ragged, uncouth envelopes—the puzzling peek-a-boo slot file—the clumsy hide-and-seek albums. Avoids all confusion, for no record compartment can be pulled forth until the first is replaced. Nothing to get out of order. Finished in finest cabinet woods. Compact and of large capacity, holding 70 records.

It is the sales-getter extraordinary—and coupled with exquisite beauty and fidelity of tone, artistic cabinetry, and superb mechanical excellence, it spells d-e-a-l-e-r-s-u-c-c-e-s-s.

Write to

Milwaukee Talking Machine Mfg. Co. *Milwaukee*



Want to hear a violin talk? Then get Toscha Seidel's violin solo, Scharwenka's "Polish Dance." Seidel is there when it comes to bringing out the splendor of these dances. How many? Columbia 78747.



**Columbia Graphophone Co.
NEW YORK**

CHAMBER OF COMMERCE PROTESTS NEW TAX INCREASE

General Manager Alfred L. Smith Appears Before Meeting of National Industrial Conference Board and Argues Against Plan to Double Present Taxes on Musical Instruments

The Music Industries Chamber of Commerce has taken prompt and energetic action to oppose the proposal of the Tax Committee of the National Industrial Conference Board, which held its second annual session at the Hotel Astor, New York, last month, to double the excise tax on musical instruments.

The Chamber sent a strong letter of protest to the National Industrial Conference Board, with the result that the Chamber was at once invited to send a representative to the conference held subsequently to discuss the excise tax proposals from the standpoint of the music industry. The general manager of the Chamber, Alfred L. Smith, appeared before the conference and pointed out that the proposals to increase the tax burden of a certain few industries violate the principles of equality which the committee itself laid down in its report. He stated that there should be no form of tax revision which makes possible relieving all industry of the burden of the excess profits tax by imposing additional tax burdens upon industries now taxed higher than the average.

The Chamber is planning to file more extended arguments with the National Industrial Conference Board, whose tax committee will soon bring out a final report, which, it is hoped, all business in this country will get behind at the coming session of Congress, in order to present one plan of tax revision. Needless to say, any such plan, backed by the members of the National Industrial Conference Board and other important trade associations, would receive marked consideration from Congress, and it is very important that the committee realize its mistake in increasing the excise taxes on certain classes of industry, including the music industry.

The National Industrial Conference Board represents thirty-nine national and State associations of manufacturers, with a combined membership of over 50,000. Its tax committee has been working for many months on this subject, and has had the assistance of many of the recognized tax experts of the country. The report of the committee will be revised in the light of the discussions at the recent tax conference, after which a final report will be gotten out which, if approved by the National Industrial Conference Board, will constitute its program of tax revision.

The most important recommendation, which all business men will undoubtedly approve, is the repeal of the excess profits tax, which would lose to the Government \$900,000,000 of revenue, and the minor recommendations bring the total net reduction in revenue to \$1,032,000,000. In order to offset this reduction in revenue, the report recommends the following:

1. Increase corporation income tax to not more than 16%, except in case of public utilities subject to regulation, on which rate should remain 10%; present exemption of \$2,000 to be abolished. (The excess of this rate over that of the normal rate on individuals to be in lieu of the surtax on partners and sole proprietors.) \$550,000,000
2. Stamp taxes, Schedule A, quadruple rate under subdivisions 1-9 inc., 11, 12 and double rate under subdivision 10..... 134,000,000
3. First-class postage rate, increase to 3 cents 72,000,000
4. Cigarettes, increase from \$3 to \$5 per M 70,000,000
5. Tobacco, increase from 18 cents to 24 cents per lb. 8,000,000
6. Musical instruments, candy, chewing gum, photographic supplies, toilet soaps and soap powders, jewelry, motion picture films, etc., increase to 10 per cent tax on all articles now

taxed at lower rates under Sections 900, 905 and 906, except automobiles, trucks and accessories.....	70,000,000
7. Perfumes, cosmetics, patent medicines, etc., increase tax under Section 907 from 1 cent to 2 cents for each 25 cents	6,500,000
8. Automobiles and trucks, special annual excise tax on use of, equivalent to 50 cents per H. P.; Federal license for use in interstate commerce to be granted (new tax)	100,000,000
9. Gasoline, 1 cent per gallon (new tax) ..	45,000,000
10. Sugar, 2 cents per lb. (new tax).....	200,000,000
11. Coffee, 2 cents per lb. (new tax).....	28,000,000
12. Tea, 10 cents per lb. (new tax).....	10,000,000

Total additional revenue.....\$1,293,500,000

At the tax conference the most strenuous objectors to this report were the advocates of a general sales tax, whose proposals, however, did not appear to be received by the conference nearly as well as the plan of the Committee. The suggestions relative to the increases of Excise Taxes met with little opposition, except from the National Automobile Chamber of Commerce and the Music Industries Chamber of Commerce, but it has been reported that the arguments of these two organizations have convinced individual members of the Committee of the wisdom of changing the Excise Tax proposals.

From now until the time that new tax legislation is passed, the Chamber will be constantly active at Washington, and with all representative groups of business interests working on tax matters, in order to prevent discrimination against the music industry.

Alfred L. Smith's Arguments

In his address before the committee, Mr. Smith called attention to the announced plan of the organization to have proposed new taxes "ethical" in the effects of their application, in other words, to follow along the lines of justice and equality, and then said:

"The organization which I represent—the Music Industries Chamber of Commerce—consists of eleven national trade associations cov-

(Continued on page 92)

VICTOR DEALERS—

Suggestion for your New Year's Resolution—

"On and after January 1st, 1921, we will handle VICTOR EXCLUSIVELY."

THE TOLEDO TALKING MACHINE CO.

WHOLESALE EXCLUSIVELY

TOLEDO, OHIO



PROTESTS PROPOSED TAX INCREASE

(Continued from page 91)

ering the entire music industry, and our products, the piano, phonograph and certain small instruments with silver parts, are subject now to a 5 per cent excise tax. I may say with confidence that while their use is widespread and general, and their distribution well established, their sale is substantially curtailed by the imposition of excise taxes, and the entire tax cannot be normally passed to the consumer in its exact amount. To double this tax will certainly curtail the sale of these products seriously, and compel those engaged in the industry to decrease their reasonable margin of profit.

"The only reason which your committee gives for increasing the excise taxes on our products is contained in the following extract from your report: 'Most of the commodities, the sale of which is now taxed under Title IX, are subject to a rate of 10 per cent, but there are a certain few which are only taxed at 3 per cent or 5 per cent, although there is no special logic or reason in this differentiation. It is proposed, therefore, to increase to 10 per cent the tax on the sale or lease of commodities now taxed at less than 10 per cent.' However, there is a very good reason why the excise taxes vary in amount with different commodities, and this reason is the fact that Congress, as a matter of experience, has found out that it is impossible to select any appreciable list of commodities on the basis of the test already mentioned. Consequently, they have had to apply the so-called 'luxury test,' which your committee states is incorrect in principle. As can readily be seen, it is very difficult to determine what is and what is not a luxury. The list of commodities now subject to excise taxes shows commodities which certainly are not luxuries. Furthermore, it does not contain many commodities which conform to your test as well as, or better than, those which are taxed, and which are certainly more in the nature of luxuries than many of the commodities taxed.

It is certainly absurd to tax as a luxury the piano necessary for the child to obtain the proper musical education, or the band instrument on which the musician depends for a living, while at the same time the toy with which the child amuses himself goes tax-free.

"The typical piano or phonograph is not the expensive concert grand or the phonograph de luxe. The great bulk of these products go into humble homes, where they become the most potent factor in keeping the home together, especially when the children grow old enough to be allured by outside attractions unless there is a pleasant home life. Many of our products are essential to proper religious worship. Persons buying these products have to make, for them, large investments, and an appreciable tax such as is now imposed bears very seriously upon the consumer, who is usually of a humble station in life.

"There are only a very few industries which can entirely maintain sales and pass the whole burden of an excise tax of any size to the consumer. To all industries not falling in this very restricted class the excise tax is unjust. If the excise tax plan must be retained, it would be especially discriminating to increase the taxes on those few industries which happen to be taxed at present rather than including the scores or possibly hundreds of those which fall as much within the test outlined by your committee as do those now taxed.

"However, from a practical standpoint of raising the necessary revenue, there are more serious objections to the proposal to increase materially the tax burden of a few industries rather than to spread it as much as possible over all. According to the estimates of your committee, the increases in present excise taxes will amount to only \$154,500,000 out of a total of \$1,293,500,000. Furthermore, if these figures estimate the increase in revenue proportionate to the increase in the tax rate, or nearly so, they are entirely too high. For instance, a 100 per cent increase in the tax on pianos and phono-

graphs will produce far less than a 100 per cent increase in taxes, for it will tend to dry up the sources of taxation. In view of this, does the estimate made of the increased revenue warrant the imposition of additional taxes to industries already taxed more than the average?

"Good taxation requires imposing taxes as widely as possible in order to prevent unduly heavy taxation from suppressing the taxable unit. To the extent that this plan advocates increasing the tax burdens of industries already taxed more than normal, the principles of good taxation are violated.

"We respectfully urge your committee to use every effort to find suitable additional sources of taxation, so as to avoid increasing the tax burdens of those industries already the subject of special taxation; and we offer you our full and hearty co-operation in any way in which we can be of service to you in this work. On the other hand, justice to our industry will require the most energetic opposition to any proposed legislation which will raise the revenue lost by the abolishment of the excess profits tax by increasing the taxes on a few industries which are already subject to special taxation."

BOLTON IN CHARGE OF RECORDING

It was announced this week that Anton Heindl, manager of the recording division of the International record department of the Columbia Graphophone Co., had severed his connections with the company. Mr. Heindl has not yet announced his plans for the future.

R. F. Bolton, sales manager of the Columbia International record department, who has been in charge of sales and advertising, will also assume charge of the recording division, taking over Mr. Heindl's former activities.

Worry has spoiled a good many otherwise first-class business men. If a man would succeed he should learn to keep out of things which cause fruitless worryment.

GARFORD "BABY" PHONOGRAPHS

A Popular Line of Toy Phonographs

Nothing More-Nothing Less

The "BABY" Model RETAILS AT \$6

MODEL X RETAILS AT \$12



CLOSED

A Splendid Dealer Proposition Is Available

GENERAL PHONOGRAPH MFG. CO., Elyria, Ohio

RECEIVER FOR J. E. CRAYTON & CO.

Charlotte Talking Machine Concern Makes Petition and American Trust Co. Is Appointed

CHARLOTTE, N. C., November 5.—Judge William F. Harding has signed a petition drawn by stockholders of J. E. Crayton & Co., 217 South Tryon street, dealers in talking machines, pianos, sewing machines and other supplies, asking that the American Trust Co. be appointed receiver for the company.

The receivership affects both J. E. Crayton & Co. and a branch office in Raleigh. The assets of the firm here are reckoned at about \$75,000 and the liabilities at \$45,000. It is the hope of the receivers, it was said, to continue the business as a going concern. It was one of the allegations of the petitioning stockholders that enough money to maintain the business safely could not be obtained. The receiver has not announced any change as impending in the management of the business and a representative of the receiver said it was the intention to continue the business along the same lines as at present so far as practicable.

The firm was formerly a partnership between J. E. Crayton and John W. Todd. It has been incorporated within the last year.

VOLLEY BALL AT COLUMBIA PLANT

Noon-Hour Recreation at Bridgeport Wins Favor of Employees

BRIDGEPORT, CONN., November 4.—Under the leadership of Mrs. Julia Dungan, recreation programs are arranged for the young men and women of the Columbia Graphophone Co. During the sunny noon hours volley ball is most popular sport and brings into play the bigger muscles. Many of the young women, who are highly paid specialists, work through the day with the delicate micrometers, finely adjusted microscopes. They wind coils which takes the speed and exactness and cut the sapphire points which must be so perfect. In contrast the noon hour games arouse the greatest enthusiasm. Volley ball is played with the heavy sphere just a little lighter than the medicine ball and it is batted with the hands over the tennis net fastened over the heads of the contestants.

Among those who are participating in the games, which are to be increased when new courts are added, are Miss Elizabeth Yates, Miss Polly Walker, Miss Harriet Munzer, Miss Ada Reid, Miss Mary Guerin, Miss Bertha Creevey, Miss Viola Luccarelli, Miss Alice Renstram, Miss Annie Pistey, Miss Gussie Meyers, Miss Pauline Creevey, Miss Doris Matthews, Miss Eleanor Baltovitch, Miss Mary Vidol and Miss Elizabeth Traill.



SAPPHIRES IMPORTED

BALLS	POINTS
20 c. each	20 c. each
16 c. in dozen lots	18 c. in dozen lots
13 c. in hundred lots	15 c. in hundred lots
12 c. in thousand lots	13½ c. in thousand lots

942 MARKET STREET
SAN FRANCISCO, CAL.



Operaphone

DECEMBER, 1920

POPULAR VOCAL

21189 \$1.00	{ In Babyland (Perkins). Baritone, Drch. accomp. Ernest Hare Old Pal (Why Oon't You Answer?) (Lewis-Young-Jerome). Tenor. Drch. accomp. William Prescott
21190 \$1.00	{ Jinga-Bula-Jung-Jing (Lewis-Young-Jerome). Tenor, Drch. accomp. Billy Jones I Know the Reason Why (Porter). Male Quartet, Unaccomp. The Harmonizers
21191 \$1.00	{ What Cha Gonna Do When There Ain't No Jazz? (Leslie-Wendling). Soprano, Orch. accomp. Stella Jasper Read 'Em and Weep, from "Come Seven" (Bernard-Haenschen). Tenor, Orch. accomp. Al Bernard
21192 85r	{ My Dear Old Rose (Robe-Winne). Baritone, Drch. accomp. Elliott Shaw Let Your Sadness Turn to Gladness (Creamer-Layton). Tenor duet. Orchestra accomp. Lewis James and Charles Hart

DANCE

31167 \$1.90	{ Avalon (Jolson). Fox-trot. Ted Gilbert's Dance Drch. Sudan (Pollack). Fox-trot. Joe Johnson's Novelty Dance Drch.
31168 85c	{ When I Found You (Romberg). Waltz. Joe Johnson's Novelty Dance Drch. Didn't You? from "Sweetheart Shop" (Felix). One-step. Ted Gilbert's Dance Drch.
31169 \$1.00	{ Rose of Spain, from Ed Wynn's "Carnival" (Brown-Fazioli-Miller). Fox-trot. Melody Band In Old Manila (Mary Earl). Fox-trot. Ted Gilbert's Dance Orchestra

HAWAIIAN

61113 \$1.00	{ Malanai Anu Ka Makani (Hawaiian Melody) "Lanai's Cold Winds," Hawaiian Guitars Kawaha (Hawaiian Melody). Hawaiian Guitars
-----------------	--

INSTRUMENTAL

51145 \$1.00	{ Medley of Country Reels, Intro: "Kelton's Reel," "The Devil's Dream," "Arkansas Traveller," "Old Zip Coon," "Chicken Reel," "Fairy Dance Reel," "Half-Penny Reel." Violinist, Piano accomp. Michael Donovan Medley of Country Jigs; Intro: "St. Patrick's Day in the Morning," "Mysteries of Knock," "Moll in the Wad," "Tivoli," "Jackson Fancy," "Garry Owens," "Haste to the Wedding." Violinist, Piano accomp. Michael Donovan
51143 \$1.00	{ Under the Leaves (Sous La Feuille) (Francis Thome). Cello solo. Emanuel Balaban at piano. Bernard Altschuler Melody in "F" (Anton Rubinstein). Cello solo. Bernard Altschuler Emanuel Balaban at the piano.
51144 \$1.00	{ Souvenir (Franz Brdla). Violin solo. Irving Weiss Pianoforte by. Daniel Lieberfeld Humoresque (Dvorak, Op. 101, No. 7). Violin solo. Irving Weiss Pianoforte by. Daniel Lieberfeld

COMIC

19101 \$1.00	{ No News; or, What Killed the Dog (Wills). Comic Monologue. Victor Fletcher The Three Trees. Descriptive Story. Victor Fletcher
-----------------	---

OPERAPHONE CO. INC., LONG ISLAND CITY, N. Y.

Write for Your Nearest Distributor

24 SELECTIONS

12 DOUBLE DISCS

ISSUED EACH MONTH
PROMPT DELIVERIES

OPERAPHONE CO., Inc., Long Island City, N. Y.

NEW PHONOGRAPH SHOP IN TULSA

Most Elaborate Quarters Provided for the New Edison in That Progressive City

TULSA, OKLA., October 29.—The Phonograph Shop, Inc., of this city, which was formally opened recently to the public, is heralded as being one of the most beautiful phonograph stores west of New York, and much of its attractiveness is credited to the ideas and efforts of Perry Chapman, the manager. The announcement of the opening was made through the medium of full page advertisements, and over 3,000 visitors were registered on the opening night. A brass band held forth in front of the



General View of Store

store to attract the crowds, and impromptu phonograph concerts were given inside.

The front of the store is of fancy tile brick, and the show window has many small panes of glass instead of the usual plate glass front. The effect of this is both unique and pleasing. At the left of the entrance is an Edison Re-Creation sign painted on glass by a local artist. On entering the store there is seen in the center a beautiful colored fountain surrounded by palms and Edison art models, as well as laboratory models. Tops of the booths are decorated



View of the Phonograph Salon

with floral pieces and foliage of a permanent character. At various points are set urns in each of which is concealed a blue electric light which sets off the foliage to advantage.

Immediately back of the show windows is the principal sales room, while the offices are in the rear of the store. Beautiful velvet hangings separate the various rooms, and the furniture consists of selected oak and wicker up-

holstered in old rose to harmonize with the draperies. The stock of Re-Creations is carried in a spacious aisle back of the record demonstrating rooms, with an entrance from each room.

Mason Little, secretary-treasurer of the Phonograph Shop, Inc., of Oklahoma City, Tulsa, Ardmore, Muskogee and Shawnee, came from Oklahoma City to attend the opening and to congratulate Manager Chapman upon the excellent arrangement.

NEW FLORIDA BRANCH FOR STARR

Jacksonville Store to Be Occupied November 15 Will Be Distributing Center—Building One of the Best in City—Holdgate Manager

JACKSONVILLE, FLA., October 30.—Keeping in line with the steady growth of its business in this State, the Starr Piano Co. will open its new headquarters in the Starr Piano Co. building, 808 Main street, about November 15, according to A. J. Holdgate, district manager.

With the completion of the building now under construction it will be one of the most modern and complete of its kind in the South, and will be used as a distributing point for various agents in all sections of the State, as well as agencies in South Georgia. The company will move from its temporary headquarters at 15 North Ocean street, where it has been located for about a year.

Because of the great demand for its musical instruments in Florida and the possibilities for a wider field, the new building was erected and plans for a Statewide sale of its instruments will begin almost immediately. There are branches in Miami and in Tampa, with agents in every part of the State. If the growth of the business is as unusual as in the past, other branch offices probably will be located in other Florida cities, according to Mr. Holdgate.

Located between Union and State streets on Main street, the building is of the modern type, with three stories and a large concrete basement. The building is twenty-six feet wide and one hundred feet long, ample room for the company's present plans for distribution in the State, according to Mr. Holdgate.

Mr. Holdgate came to Jacksonville a little over a year ago and first introduced the Starr musical instruments in this State on a large scale. He will have charge of the entire district, and under his supervision officials of the company believe the organization will continue to make rapid strides.

The organization is the first of its kind to make this city a distribution point for scores of cities and hundreds of miles of territory ranging from the Apalachicola River up into southern Georgia.

Originate your own ideas and carry them out. You may be able to copy your neighbor's plans, but it is very doubtful if you can copy his success.

MUSIC AND RECORD CARRYING CASES



Made of embossed fiber, reinforced with metal and hard fiber. Brass-nickled catches and loops, metal covered handle.

Record size 3 x 12½ x 12½", No. 204
Sheet Music Size 3 x 11 x 15", No. 203

Write for Prices and latest catalogue

J. D. HUNT MFG. CO.

Mass. & Davidson Sts. Indianapolis, Indiana

Manufacturers of all kinds of Musical Instrument Cases and Covers

HENRY BURR VISITS GEO. CHEATLE

Henry Burr, one of the best known exclusive Victor artists, recently was the guest of George Cheatle, formerly of the Chicago Talking Machine Co., now a Victor dealer in Springfield,



A Snap Taken at Mr. Cheatle's Home

Ill. While on the Western tour with the Eight Famous Victor Artists, Mr. Burr stopped off to see Mr. Cheatle, and it was at this time the photograph of Mr. Burr and Mr. Cheatle shown here was taken.

Anything worth doing is worth doing well. This applies to your own talking machine organization.

Deliveries from Stock of High-Grade Low-Priced Table Machines
THE GREATEST VALUES ON THE MARKET



WONDER No. 15

WONDER No. 15—All metal machine, splendid tone quality, cast iron cabinet and cast iron frame motor. *Universal* tone-arm playing all records.

WONDER No. 23—Highly polished mahogany finished cabinet, all cast iron frame, *worm gear* motor. High-grade *Universal* tone-arm.

Priced from \$4.20 up

Mahogany covered table machines from \$18.00 up, with double spring motor

Write for catalog and dealer's proposition



WONDER No. 23

WONDER TALKING MACHINE CO., Inc., 109 East 12th St., New York

Are Your Windows Tight Asleep OR

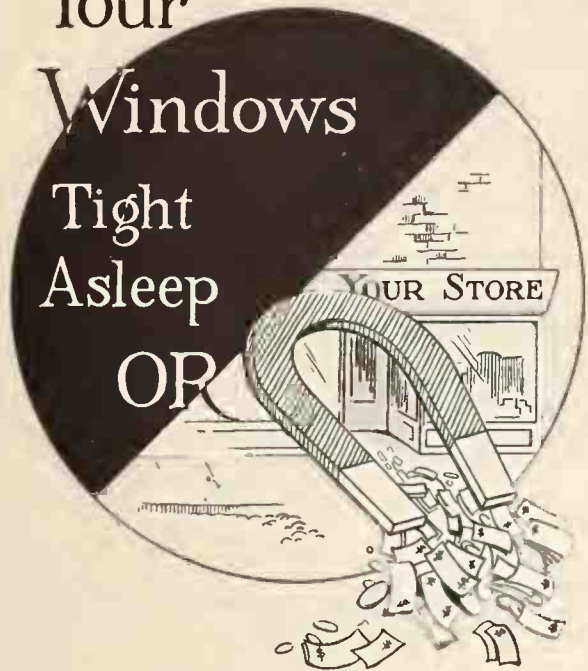

Opening Window—Christmas Display

Would You Like to See Your Windows Pull "Big" Every Week in the Year?

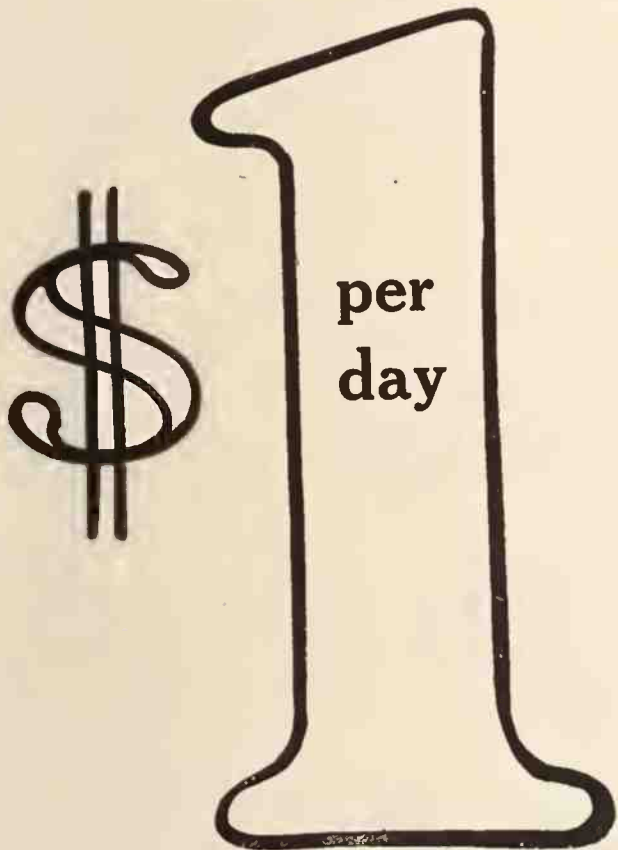

Yes, that's all it costs. If it helps you to sell only 3 black seal records per day, or only 1 No. 11 Victrola every 2 months—just that small amount of additional business will more than pay for this complete service for one full year.

You have had window display suggestions galore.

You have been advised to do this, that and the other thing to make your windows work for you as they should.

But no one has ever yet presented to you a complete, fully worked out, effective, economical, practical, window display service that has met the full and hearty approval of experienced men who know and understand the needs, requirements and conditions of the talking machine industry.

Here is that service:

THE *Binger* COMPANY
Victor
Sales Promotion
SERVICE

26 NEW AND ORIGINAL VICTOR DISPLAYS

A COMPLETE CHANGE EVERY 2 WEEKS

All Material Supplied

THE CLEVELAND TALKING MACHINE CO.

CLEVELAND, OHIO

Victor Distributors



Wholesale Exclusively

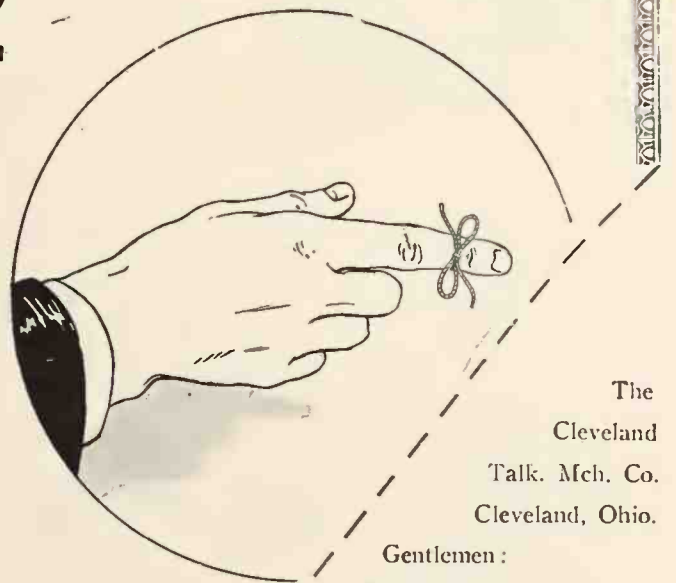

The Cleveland Talk. Mch. Co. Cleveland, Ohio.

Gentlemen:

Please send me full particulars about The Binger Co., VICTOR Sales Promotion SERVICE

Name

Address

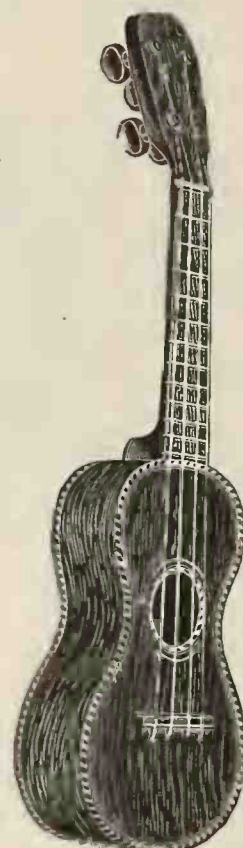

Phonograph Dealers

Install a Rent Payer in Your Shop

In these days of high rents, the months seem shorter and the visits of the landlord more frequent.

You can make his visits less burdensome by installing a RENT PAYER in your store.

With a very small investment on your part, you can start a Musical Merchandise Department in your present Phonograph Shop, and become the neighborhood center for all Musical Instruments and Supplies—Harmonicas, Banjos, Ukuleles, Guitars, etc., and all Accessories.

They are quick sellers and yield a liberal profit.

They will pay your rent and then some.

They will make repeating customers.

They will add to the attractiveness of your displays.

They will bring more people to your store.

Write to Department P for our suggested assortments of Harmonicas, Violins, Mandolins, Ukuleles, Banjos, etc., and all Accessories specially selected for Phonograph Shops.

We make up assortments for any size shop.

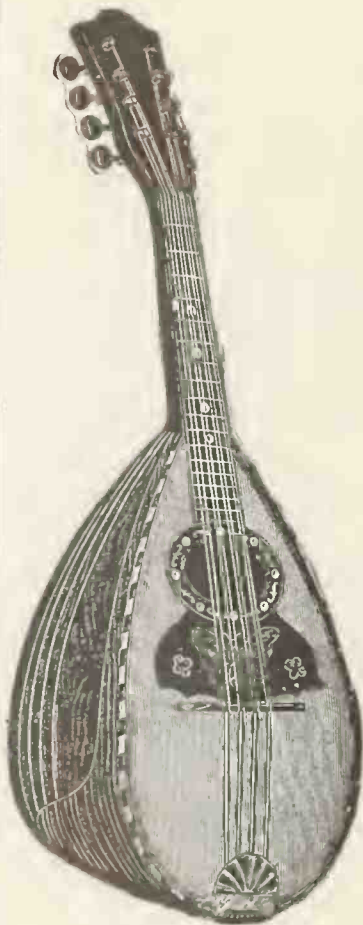

BUEGELEISEN & JACOBSON

Musical Merchandise

WHOLESALE, IMPORTERS AND EXPORTERS

5-7-9 Union Square

:

New York, N. Y.

LATEST GRANBY LITERATURE

Handsome New Volume Just Being Sent Out Which Is Admirable in Its Literary and Typographical Aspects—Tells of Company's Broad Plans for Development of Business

The Granby Phonograph Corp., of Norfolk, Va., is a firm believer in the power of the printed word presented in artistic dress. This is forcibly illustrated in the latest piece of literature which will soon be sent out to the trade and which is worthy of a place in the foremost ranks of talking machine literature. It is a superbly printed volume, nine by twelve inches,

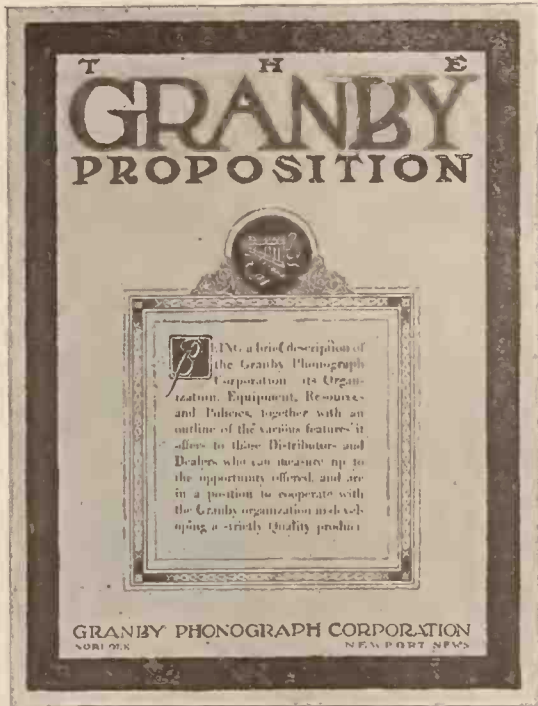

Rough Idea in Black of Granby Cover

with a cover design of more than ordinary attractiveness in gold and red, of which only a very meager idea can be received from the accompanying illustration. Briefly, from a typographical and artistic standpoint, superlatives can only be applied to this very beautiful volume.

This piece of literature is supplementary to the regular catalog and is entitled, "The Granby Proposition," and takes up the following subjects in their proper sequence: "Promises and Performances," "The Granby Institution," "The Granby Phonograph," "Equipment," and "Real Co-operation With the Distributor and Retailer." Under the latter heading the energetic plans of this company are summarized. While

national advertising is not immediately planned, it will probably be entered into upon the completion of the thorough distribution of the Granby phonograph and the completion of the sales organization. In each territory where the Granby phonograph is represented a local newspaper advertising campaign will be conducted based upon the probable number of prospects in such territory, the initial purchases of the dealers in the territory and the amount of business developed by the dealer in conjunction with the campaign. The advance outlines of these newspaper advertisements show that they are of a character that will creditably represent the Granby line. Supplementing the newspaper campaign, material will be furnished the dealer that will intensify the desire of the prospective purchaser to own a Granby phonograph. This literature will include catalogs and folders, window displays and a series of cards in rotogravure illustrating the various period designs and appropriate settings. These cards show exactly how Granby phonographs will look in different surroundings and will serve as a guide to the prospective purchaser in selecting the proper model to conform with the room in which the phonograph is to be placed.

In the center spread of this volume illustrations of eight Granby models are shown—four upright and four console instruments, while a bird's-eye view of the large and efficiently laid out manufacturing plant of the Granby Phonograph Corp. is shown on the inside back cover.

Announcement is also made of the early issuance of "Melodie," a monthly house organ of the company. This magazine will contain articles of interest to persons musically inclined, and its mission, of course, will be to keep the Granby phonograph in the minds of prospects.

This new Granby literature will find a hearty welcome from dealers as undoubtedly it will prove of great value as a sales help.

PAYS TRIBUTE TO ITS EMPLOYEES

Tampa Hardware Co. Uses Full Page Advertisements to Introduce Department Heads to the Public and Emphasize Loyalty of Workers

The Tampa Hardware Co., Tampa, Fla., recently devoted a full page advertisement to introducing the public to the men in charge of the various departments of the company's business, and to paying tribute to the loyalty of its employes. Of the four men whose portraits were shown on the page was J. A. Bryan, Jr., sales manager of the Columbia Grafonola department.

WE have unusual opportunities to offer salesmen of proven ability.

With manufacturing facilities now fully developed we are finally in position to take on new business.

We will consider only men of broad sales experience, capable of earning substantial incomes, who desire to form permanent connections.

Appointments will be made with desirable men upon receipt of applications that sell.

CHENEY TALKING MACHINE COMPANY - CHICAGO-NEW YORK



Delivery Envelopes

*Art Series
New Designs*

NEW LIST OF RECORDS

Every 60 Days

Very Good Victor Records

We Will Be Pleased to Play Any of Them for You

1411-12	Swiss Lullaby	Victor	1.00
1413-14	Swiss Lullaby	Victor	1.00
1415-16	Swiss Lullaby	Victor	1.00
1417-18	Swiss Lullaby	Victor	1.00
1419-20	Swiss Lullaby	Victor	1.00
1421-22	Swiss Lullaby	Victor	1.00
1423-24	Swiss Lullaby	Victor	1.00
1425-26	Swiss Lullaby	Victor	1.00
1427-28	Swiss Lullaby	Victor	1.00
1429-30	Swiss Lullaby	Victor	1.00
1431-32	Swiss Lullaby	Victor	1.00
1433-34	Swiss Lullaby	Victor	1.00
1435-36	Swiss Lullaby	Victor	1.00
1437-38	Swiss Lullaby	Victor	1.00
1439-40	Swiss Lullaby	Victor	1.00
1441-42	Swiss Lullaby	Victor	1.00
1443-44	Swiss Lullaby	Victor	1.00
1445-46	Swiss Lullaby	Victor	1.00
1447-48	Swiss Lullaby	Victor	1.00
1449-50	Swiss Lullaby	Victor	1.00
1451-52	Swiss Lullaby	Victor	1.00
1453-54	Swiss Lullaby	Victor	1.00
1455-56	Swiss Lullaby	Victor	1.00
1457-58	Swiss Lullaby	Victor	1.00
1459-60	Swiss Lullaby	Victor	1.00

Very attractive proposition to Jobbers

Write for trial shipment

Order NOW For Xmas.

CLEMENT BEECROFT
5546 North 5th Street
PHILADELPHIA

The Tampa Hardware Co. is jobber for Columbia Grafonolas, records and supplies for the entire State of Florida, with the exception of Jacksonville, and during the five years that Mr. Bryan has had charge of the department the business has increased from \$10,000 to over a quarter of a million dollars annually.

LINE FORMS TO THE RIGHT!

The will of a rich eccentric gentleman has been found leaving \$15,000 to be divided equally among all artists whose first names end in "scha." Experts are figuring upon awarding 19 cents each to every artist thus found.

MASON WITH FORBES & WALLACE

Alexander Mason, who was in the talking machine business in Springfield, Mass., for several years and for the past two years in New York, has returned to Springfield, accepting a position in the Victrola department of Forbes & Wallace.

PACIFIC COAST PHONOGRAPH DEALERS!

THE AEOLIAN COMPANY of CALIFORNIA

455 Mission Street

San Francisco

Are Prepared to Appoint Dealers in

**CALIFORNIA—ARIZONA—NEVADA
WASHINGTON—OREGON—IDAHO**

for

The **AEOLIAN-VOCALION**

The new and greater phonograph



Style 310
Price, \$110



Style 620
Price, \$225

*The New
Lateral Cut
VOCALION
RECORD*



*Plays on
All Standard
Types of
Phonographs*



Style 430
Price, \$135



Style 720
Price, \$285

Vocalion representation will, in the near future, be at a premium. The superiority of the Vocalion itself in musical quality, durability, appearance, and "selling" features, like the Graduola, etc., the superiority of Vocalion Records, and the magnificent national advertising being carried on in the *Saturday Evening Post* and other mediums, is having a steady, strong, cumulative effect.

Progressive merchants who would appreciate the opportunity to handle a product which will be not only exceedingly profitable, but will add measurably to the prestige of any establishment.

DISTRIBUTORS FOR

MELODEE Music Rolls

MELODEE song rolls have printed words, NOT STENCILED —are equipped with unbreakable, pressed steel spool ends.



Style 540
Price, \$195



Style 820
Price, \$350

The Aeolian Company of California	455 Mission Street, San Francisco.
Gentlemen: Kindly send us catalogues and prices of the AEOLIAN-VOCALION, RECORDS and MELODEE MUSIC ROLLS.	
Name.....	
Street.....	
City.....	

The Trade in **BOSTON** *and* **NEW ENGLAND**
 JOHN H. WILSON, Manager
 324 WASHINGTON ST., BOSTON, MASS.

BOSTON, MASS., November 3.—Business has shown a better tone during the past month than in some time, which perhaps was to be expected. The Advertising Clubs of New England, which held a two days' convention here, put some "pep" into business, for these publicity advocates made it plain that to talk business was in large measure to create business, and few, if any, who attended the conferences but went away the better for listening to some of the optimistic speakers. Other business bodies, too, have been holding forth in this city and have similarly played their part in instilling a more courageous feeling into trade circles.

With the election out of the way everybody is looking for an improved condition of affairs, for, as a topic of conversation, sometimes to the detriment of business, it is a thing of the past. People now can settle down to a more normal state, and the tension over—for it has been a tension, truly, in some quarters—a bid can be made for business without this interrupting factor intruding itself.

Machines and records from most of the factories have been coming along in adequate quantities and some of the biggest distributors are displaying beautiful period models, one that the Steinert house has been showing of the Adam period being among the handsomest pieces of furniture—for it is sure to have a distinguishing place as such in any home—that the writer has seen in a long time.

British Visitors Entertained

The Boston Victor representatives had the pleasure the middle of the month of entertaining three of the officers of the Gramophone Co., Ltd., of London, England, who were in this country in the interests of the deal with the Victor Co., which has since been successfully put through. These guests were Collin Cooper, president of the board of directors; C. Alfred Clarke, general manager, and A. T. Lack, sales manager. Accompanying the guests were Ralph L. Freeman, director of distribution of the Victor Co.; Bedford G. Royal and Walter J. Staats, directors; J. S. MacDonald, sales manager, and Ernest R. John, manager of the advertising department. The party came to Boston from Camden, N. J., in a private car, and

Steinert Service Serves

WHOLESALE



"HIS MASTER'S VOICE"
REG. U.S. PAT. OFF.
 Mod. F. MARCA INDUSTRIAL REGISTRADA

HEADQUARTERS

M. STEINERT & SONS CO.
 35 Arch Street :: :: :: :: :: Boston

while here they were delightfully entertained by the Victor representatives, a visit to all the Victor headquarters being a part of the program.

A luncheon given at the Hotel Touraine brought the guests into close touch with the Boston trade, those present including Alexander and Robert Steinert and Kenneth E. Reed, of the Steinert house; Henry Winkelman and Clarence A. Woodman, of the Oliver Ditson Co.; George A. Dodge, G. Hovey Dodge, Herbert Shoemaker and C. H. Farnsworth, of the Eastern Co., and C. E. Estabrook, Victor representative, who acted as courier for the guests while they were in town. On leaving Boston after a

pleasant visit the English visitors made arrangements to call on the Buffalo trade.

Fred E. Mann Visits Dealers

Manager Fred E. Mann, of the Columbia Co., has been on a two weeks' trip through his territory, including western Massachusetts, Maine and Vermont, spending his time among the salesmen of these sections. He found considerable enthusiasm over the general situation, with everyone looking for a good holiday business.

Victor Artists a Hit in Concerts

These have been busy days for Kenneth Reed, wholesale manager of the Victor department of the Steinert Co., for with the concerts on of the Eight Famous Victor Artists he has been here, there and everywhere. On the evening of October 28 he was in Brockton, where a well-patronized concert was given and on the following night he hied away to Portland, Me., where another concert was given. This concert was changed from the original schedule which gave that date to Woonsocket, R. I. The Boston concert was at the Majestic Theatre, Sunday, October 31, and was the triumph of the series. It was not only largely attended, the tickets having gone well from the various Victor shops where they were for sale, but the program was thoroughly enjoyed and the artists were generous with their encores. Altogether the Steinert Co. and Kenneth Reed in particular, who has put a lot of time and thought into the plans, may well be proud of the success of the undertaking.

Sonora Billboard Advertising

An extensive billboard campaign is to be entered upon by the Sonora Phonograph Co., Inc., in conjunction with the Musical Supply & Equipment Co., the distributors for this part of New England: The plan is to have illuminated signs as well as those which can be easily read in the daytime. The first sign of any prominence already is to be seen on the top of a building in Park street, a short distance back from Tremont street, in the downtown section of the city.

Manager Joseph H. Burke, Boston branch manager of the Musical Supply Co., is away
 (Continued on page 101)

*"New England Service for
 New England Dealers"*



The Eastern Talking Machine Co.
 VICTOR WHOLESALERS
 85 Essex Street BOSTON

IT is gratifying to hear dealers express admiration for Eastern Service. It proves in spite of present handicaps that men do appreciate our efforts in bringing our work to its present, valuable state.

1870
1920

Established 1870

Oldest and Largest
Manufacturers of
Talking Machine
NEEDLES
in the World



"Fifty Years of Needle Making."

"If a Talking Machine Needle could be
made better, Bagshaw would make it."

W. H. BAGSHAW CO.

INCORPORATED 1917

LOWELL, MASS.

W. H. BAGSHAW
COMPANY
LOWELL, MASS.



Holiday Profits

PATHÉ Phonographs and Pathé Records afford an unusual opportunity for Holiday profits.

Certain desirable territory now open. Write, wire or telephone us, we are in position to enable a few more dealers to cash in on Holiday business.

Complete Stock Immediate Service

Hallet & Davis Piano Co.

146 BOYLSTON STREET, BOSTON

New England Distributors for
Pathé Phonographs and Pathé Records.

New York Office:
Hallet & Davis Bldg., 18 East 42d Street



THE TRADE IN BOSTON AND NEW ENGLAND—(Continued from page 99)

on a ten days' trip through the West, getting as far as Chicago. This is his second trip West within the past month. The October business in the Sonora instrument is reported to have been excellent.

Lively Meeting of Columbia Dealers

One hundred and seventy-five Columbia dealers enjoyed the October meeting, which was held on the 13th at the Copley-Plaza in Copley square. Fred E. Mann, manager of the Boston branch, was the leading spirit, and in his bright and businesslike talk he emphasized the need of more intelligent use of real merchandising principles in the retail trade and told of certain evils which have crept into the business which need correction. The value of the use of trucks in handling outside business came in for a measure of attention, as already this method of doing business has been used most successfully by a large number of Columbia

dealers in the New England territory. J. L. Du Brueil, manager of the company's Cleveland branch, was a guest and gave an interesting talk, and Assistant Manager Donnelly, of the Boston branch, and Mrs. Grace Drysdale also spoke, the latter discussing the educational work that is involved in properly presenting the talking machine proposition before the public, this being her special field of activity with the Columbia. The entertainment was provided by Eddie Brown, violinist, and selections from the December issue were played.

Doing Well With the Pathé

The Lenox Jewelry Co. in Bromfield street is meeting with gratifying success with the Pathé which it took on a while ago. This department is in charge of F. A. Colahan, who is a brother of Retail Manager Stephen A. Colahan at the Hallet & Davis Pathé headquarters in Boylston street. At this Bromfield street store there are several booths conveniently fitted up at the rear of the establishment and the holiday trade is promising very well.

Shoemaker Again a Landsman

Herbert Shoemaker has taken his shell out of the waters of the Charles River, and his swift work on the Basin is brought to a close for the season. Already he is looking ahead to next Spring when he can resume this delightful pastime, and he hopes to make an even better record for miles rowed than last Summer. Then there are the prizes that may come his way if he enters some of the competitive races!

The business of the Eastern Talking Machine Co. showed up well for October, and November is expected to show splendid aggregate sales.

C. C. Harvey Co. Improvements

The C. C. Harvey Co. in Boylston street has just fitted up a handsome new room in its talking machine department which shows a high order of artistic appreciation. The windows have been hung with soft iridescent pink draperies and comfortable easy wicker chairs

upholstered in robin's egg blue invite a prospective purchaser to enjoy any one of the Victor, Brunswick or Edison instruments.

(Continued on page 102)

SHEET MUSIC Musical Instruments Phonographs

KIMBALL PHONOGRAPHS

Made by the makers of
the famous
"KIMBALL PIANOS"

*New England shipments made
from Boston*

New England Piano & Phonograph Co.

"Everything in Music"
405 Boylston St., Boston, Mass.

Send for Descriptive Circular

Curry DEMONSTRATION BOOTHS
AND RECORD CASES
IN STOCK OR TO ORDER

"SOUND PROOF"

FRANK B. CURRY
72-74 Dedham St. Boston, Mass.

LONG

MUSIC CABINETS
See Display Ad in This Issue

Peerless Record Album
See Display Ad in This Issue

SPECIAL
I am prepared to ship all orders on either line promptly.
Send your orders for both these lines to
L. W. HOUGH, 20 Sudbury St., Boston, Mass.
New England Representative

THE TRADE IN BOSTON AND NEW ENGLAND—(Continued from page 101)

The window of the Harvey Co. contains a striking display of these three instruments, and in order that the passer-by may quickly distinguish their identity each one can be traced to the back wall of the window, where the ribbons of any single color are boldly centered against the name of the instrument. Thus the Brunswick ribbons are of pale yellow; the Edison are white, and the Victor are lavender. Manager Francis White of the Harvey talking machine department reports the October business to have shown a notable increase over September.

Ainslie a Football Rooter

Manager R. O. Ainslie of the Pathé was one of the enthusiastic rooters at the big Harvard-Center football game on the Harvard stadium on Saturday, October 23, and it wasn't for Harvard either, for his wife is a Kentucky woman and several of the members of her family came East for the game. Of course they were sorry to see the Center College team lose, but all agreed that they put up a wonderfully fine game.

Pathé Distribution Grows

The local Pathé distribution is coming along very well according to report. A new connection which the house has just made is that of J. S. Condinko, Cambridge street, Cambridge, Manager Colahan of the retail Pathé is most enthusiastic over the Actuelle, and in the interests of promoting this new attachment to the Pathé he spent several days in Providence, R. I., lately.

New Repair Shop Opened

The Beach Talking Machine Repair Shop is a new establishment located at 6 Beach street, this city, and conducted by E. F. Walker, who has under way several inventions. He is the inventor of a diaphragm that is claimed to be indestructible and which has been favorably commented on.

New England Co. Expands

The talking machine business at the New England Piano & Phonograph Co. is making

HORTON-GALLO-CREAMER CO
NEW HAVEN  **CONNECTICUT**

VICTOR SERVICE SPECIALISTS

LIKE Thanksgiving Day,
 Horton-Gallo-Creamer
 Victor Service is 'a New
 England institution.

considerable headway. In order to make room for the Kimball line considerable additional floor space at the rear of the Boylston street store has been provided through the construction of a balcony into which the executive offices will be moved. Manager Faux has lately opened a new branch store in Lowell, located at

144 Paige street, which is in charge of Pierce Cummings, who lately had been traveling through New England for the house.

Now the E. B. Shiddell Co.

The Musical Products Co. by that name no longer obtains here, but in its place at the old location, 142 Berkeley street, one notes the

SUPREME PHONOGRAPH-SUPREME PATHÉ RECORDS

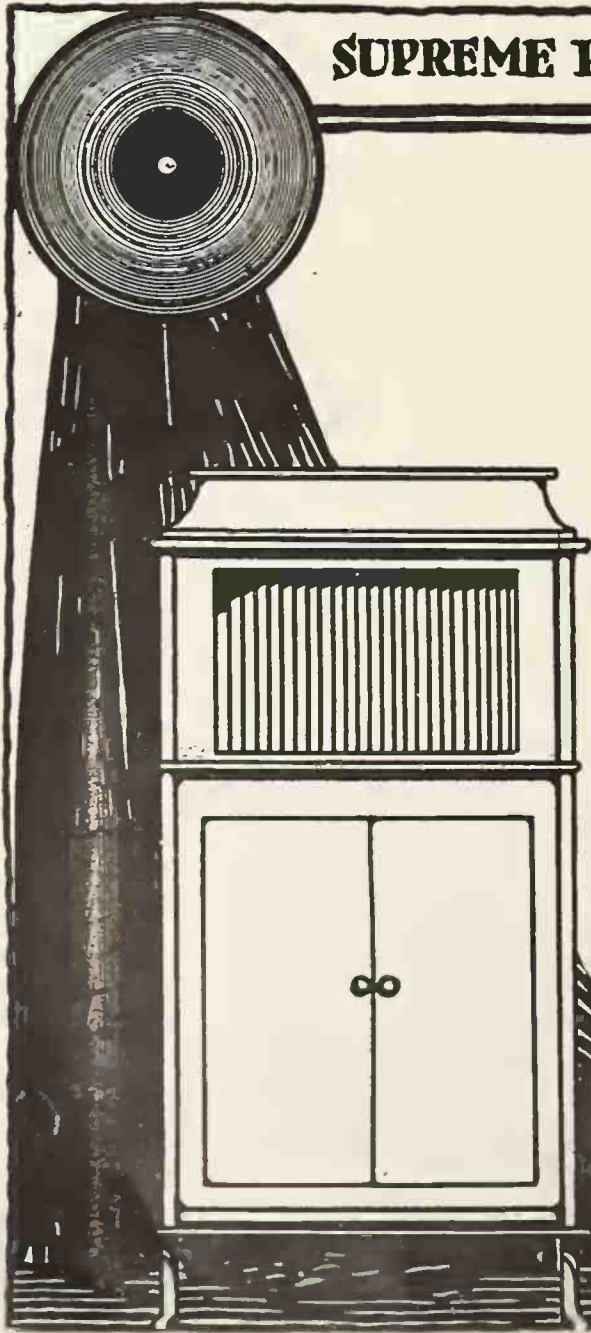

The **VOICE OF THE PATHÉ**
IS ITS BEST SALESMAN

Your big opportunity is here,
Mr. Phonograph Dealer.

If you are not already selling the Pathé Actuelle and Actuelle (lateral cut) Records, it is high time that you ask us for full particulars.



Let our representative explain our plan for financing dealers.

PATHÉ DISTRIBUTORS

Commonwealth Phonograph Co.
21-23 LYMAN ST., Springfield, Mass.

THE TRADE IN BOSTON AND NEW ENGLAND—(Continued from page 102)

name of the E. B. Shiddell Co. with Mr. Shiddell, formerly the local manager of the Musical Products Co., at the head of the new concern which now handles the Okeh records with all of New England as its field. This new arrangement is now only two or three weeks old, but in that time Mr. Shiddell has been able to interest a large number of New England dealers in the Okeh proposition which means a very large distribution of this line of goods. Associated with Mr. Shiddell is W. S. Townsend, who has had a long experience in the talking machine field, and for some time before entering service was with the Columbia. Mr. Townsend spends most of his time traveling through New England.

To Distribute the Regina

The Musical Sales Corporation in Bromfield street has made arrangements for the New England distribution of the Regina and already fifteen accounts have been opened up in the six States composing this territory. The Regina has many points of excellence and dealers have been quick to see its worth as a musical instrument. The Musical Sales Corporation has been able to make an advantageous financial arrangement, and it plans to do considerable advertising throughout New England.

Some Personals

E. B. Shiddell, of the E. B. Shiddell Co., and Mrs. Shiddell spent a week the latter part of October on a hunting expedition up in Maine, whither they went by automobile. They made their headquarters for a part of the time at Carrabasset.

W. S. Townsend, with the E. B. Shiddell Co., returned the end of October from his honeymoon, having married earlier in the month Miss Katherine Leary, who is not unknown to the talking machine trade as she was at one time with the Columbia Co. Mr. Townsend and his bride spent their honeymoon in New Hampshire.

E. B. Holmes, formerly local manager of the Pathé at the Hallet & Davis warerooms, has opened a store of his own out in Roslindale, which is a part of Boston.

A New Incorporation

The Baxt Phonograph, Inc., is the name of a concern that has just been incorporated under

the laws of Massachusetts. The capital is named at \$50,000 and the incorporators are Oscar Sterman and Celia Sterman, of Cambridge; Morris Shapiro, William Baxt, Alexander Shapiro, Maurice Gordon, Morris Levinson, Louis Kalis, Pauline Shapiro and Abraham Adler, of Dorchester, and Harry Tarlow, of Brockton.

BOSTON LIKES JACK NORWORTH

Pathé Headquarters Had Attractive Display Featuring His Record of "Ten Little Bottles"

BOSTON, MASS., October 30.—Here is a reproduction of a window display at the Boylston street headquarters of the Pathé which has attracted a great deal of attention, and, as someone has said, with no offense to anyone. Jack Norworth is a great favorite in this city and this particular song, "Ten Little Bottles," has found instant favor here, and the records of this exclusive Pathé artist have been selling very well.

This novelty song is proving an im-

LARGER QUARTERS IN HAVERHILL

F. W. Peabody Obligated to Secure More Space to Handle His Growing Business

HAVERHILL, MASS., November 3.—After a long career, as a piano and talking machine dealer, F. W. Peabody has developed so large a business that he was obliged to find larger quarters and now he is able to greet his patrons in more commodious and better equipped quarters than ever before. Mr. Peabody, whose name is a household word in town, has moved from Washington square, where he was located for a number of years, to 77 Merrimack street, where two large



Window Display of "Ten Little Bottles"

mense favorite with theatregoers this season and the demand for records of this song is growing among the talking machine trade—at least, so it is reported.

show windows give him ample opportunity for the more adequate display of his lines. Within the establishment there are eight

(Continued on page 104)

KRAFT-BATES AND SPENCER INC.

NEW ENGLAND DISTRIBUTORS

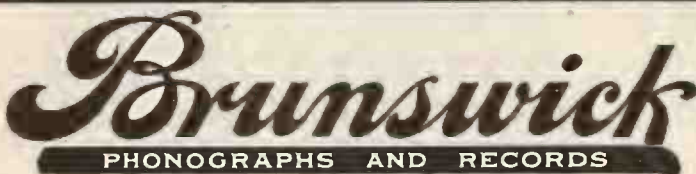

Every Brunswick Sold Sells Others

A REAL customer is not one who buys a thing once, but one who would buy it again, if he had to do it over.

All Brunswick buyers belong to this class. Brunswick owners become enthusiastic about The Brunswick. They take delight in explaining its various features, particularly the Ultona.

Naturally they take pride in having something new, exclusive and different from the rest.

The Brunswick has created an army of recommenders who work unconsciously to make more sales. And they really feel that they are doing others a favor in praising it. Thus Brunswick satisfies the real test of worth—the product stays sold.

KRAFT-BATES & SPENCER, Inc., 156 Boylston Street, BOSTON, MASS.

NEW ENGLAND DISTRIBUTORS

TONOFONE, VICTROLENE, MOTROLAS, RECORD FLASHER

Steel Needles Jewel Points Albums Record Brushes Khaki Covers

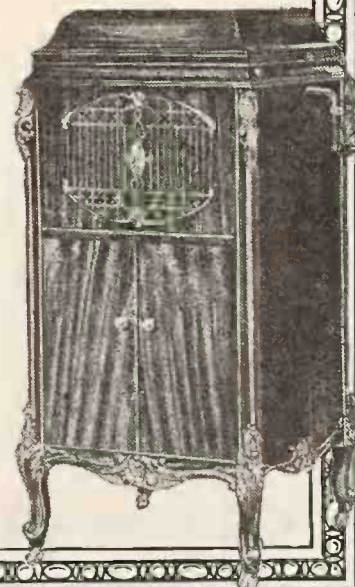

THE TRADE IN BOSTON AND NEW ENGLAND—(Continued from page 103)

Your Guarantee, Mr. Dealer

LANSING KHAKI COVERS

For All Phonographs

Unqualified Endorsement of Biggest Manufacturers and Dealers

Slip
and Rubber
Covers
for
Phonographs



Slip
and Rubber
Covers
for
Pianos

Distributors of the
"LANSING KHAKI MOVING COVER"

- ATLANTA, GA.
Elyea Talking Machine Co., 11 No. Pryor St.
Southern Paramount Co., 23 Peter St.
- BALTIMORE, MO.
E. F. Droop & Sons Co., 231 No. Howard St.
- BIRMINGHAM, ALA.
Talking Machine Co., 1618 Third Ave.
- BOSTON, MASS.
Hallet & Davis Piano Co., 146 Boylston St.
Kraft-Bates & Spencer, 156 Boylston St.
Oliver Ditson Co., 178 Tremont St.
- BROOKLYN, N. Y.
American Talking Machine Co., 358 Livingston St.
G. T. Williams Co., 217-222 Duffield St.
- BUFFALO, N. Y.
Buffalo Talking Machine Co., 776-778 Washington St.
Buffalo Wholesale Hardware Co.
- CEGAR RAPIDS, IOWA
Churchill Drug Co.
- CHICAGO, ILL.
Brunswick-Balke-Collender Co., 623-633 So. Wabash Ave.
Fuller-Morrison Co., 540-552 West Randolph St.
W. W. Kimball Co., Jackson Blvd. & Wabash Ave.
Wade Talking Machine Co., 14 No. Michigan Ave.
- CINCINNATI, OHIO
The Ohio Talking Machine Co.
- EL PASO, TEXAS
W. G. Walz Co.
- INDIANAPOLIS, IND.
Stewart Talking Machine Co.
- JACKSONVILLE, FLA.
Florida T. M. Co., 226 E. Forsyth St.
- KANSAS CITY, MO.
Schmelzer Co.
- MEMPHIS, TENN.
O. K. Houck Piano Co., 103 So. Main St.
- MILWAUKEE, WIS.
Waltham Piano Co.
- MINNEAPOLIS, MINN.
McDonald Bros. Co.
- MOBILE, ALA.
W. R. Reynolds
- NEWARK, N. J.
Collings & Co., Plum Bldg.
- NEW YORK CITY, N. Y.
Columbia Graphophone Co., Woolworth Bldg.
New York Talking Machine Co., 119 W. 40th St.
Knekerbocker T. M. Co., 133-140 W. 124th St.
Blackman T. M. Co., 81 Reade St.
Ormes, Inc., 26 E. 125th St.
- OMAHA, NEBR.
Wright & Wilhelm Co., 10th & Jackson Sts.
- OKLAHOMA CITY, OKLA.
H. A. Mottier Sales Organization.
- PEORIA, ILL.
Putnam-Page Co.
- PHILADELPHIA, PA.
Interstate Phonograph Co., 1026 Chestnut St.
Philadelphia Show Case Co., 127 No. 13th St.
- PITTSBURGH, PA.
W. F. Frederick Piano Co., 635-637 Smithfield St.
- PORTLAND, ME.
Cressey & Allen, 534 Congress St.
- RICHMOND, VA.
Rountree Corp., 111-115 West Broad St.
- ROCHESTER, N. Y.
Rochester Phonograph Co., 44 Clinton Ave., North
- SALT LAKE CITY, UTAH
Salt Lake Hardware Co.
- ST. LOUIS, MO.
Koerber-Brenner Co.
- TOLEDO, OHIO
The Toledo Talking Machine Co., 425 Superior St.
- WASHINGTON, D. C.
O. J. DeMoll & Co., 12th & G Sts., N. W.
F. P. May Hardware Co., 469-477 C St.
- YORK, PA.
Weaver Piano Co.



ELIOT and WARRENTON STS.
BOSTON 11, MASS.

record booths and five player-piano booths. E. H. Stone, who is in charge of the talking machine department, is a man thoroughly experienced in the business and his long association has brought him in touch with many discriminating music lovers. Mr. Peabody's store is one of the largest retail music houses in New England.

RAGTIME RASTUS IN THE MOVIES

Popular Dancing Darcy Talking Machine Toy Now Immortalized Through the Motion Picture Screen—Featured by Viola Dana

BOSTON, MASS., November 3.—Ragtime Rastus, the dancing darcy talking machine toy, has lately been accorded much publicity through the medium of the motion picture screen. This toy, manufactured by the National Co. of this city, was featured in a large moving picture production, Viola Dana in "Dangerous to Men." Ragtime Rastus was given a "Close-up" and received much applause for his work. Ragtime Rastus always attracted much attention in the windows of the talking machine dealers and his entrance into the moving picture field will doubtlessly provide additional impetus to the sale of this toy.

NEW PATHE DEALERS ESTABLISHED

SPRINGFIELD, MASS., November 1.—The Commonwealth Phonograph Co., of this city, Pathé distributor, although in business less than six months, has made rapid progress in the furthering of the interests of the well-known line it represents. Among recent dealers whom it has given the Pathé franchise are the following: Harmony Shop, Springfield, Mass.; Felix Jajuga, Ware, Mass.; B. J. Chase, Waterbury, Vt.; Kahan & Marcy, Chatham, N. Y.; Newell Furniture Co., Newport, N. H.; John F. Lamb, Hinsdale, N. H.; Joseph F. March, Norwich, Conn.;

MICA DIAPHRAGMS

Watson Brothers, Inc.
170 PURCHASE ST.
BOSTON - - - MASS.

Carey & Molloy, Scuyville, N. Y.; Frank A. Garrett, Greenwich, N. Y.; Joseph Mularczyk, Indian Orchard, Mass.; Peter Garjewski, Chicopee, Mass. The greater part of these new dealers have taken on the Pathé line exclusively.

NEW HALIFAX DEPARTMENT OPENS

Nova Scotia Furnishing Co. Displays Magnavox and Pathé Actuelle at Opening

HALIFAX, N. S., November 6.—The formal opening of the Nova Scotia Furnishing Co.'s new remodeled store at 448-450 Barrington street, this city, took place lately. The phonograph department, which contains four sound-proof demonstration rooms, is located on the third floor of the building. At the opening, both the Magnavox, the new instrument for increasing the volume of phonograph music or the human voice, for which I. Montagnes & Co., of Toronto, have the Canadian distribution, and the Pathé Actuelle came in for special demonstration. E. A. Wilson, president of the company, is a phonograph enthusiast and as a result his department is a live branch of the business. Mr. Wilson has on different occasions held phonograph recitals in connection with the phonograph department, believing them to be a

PERFECTION BALL-BEARING TONE ARMS

PERFECTION FLEXI-TONE REPRODUCERS

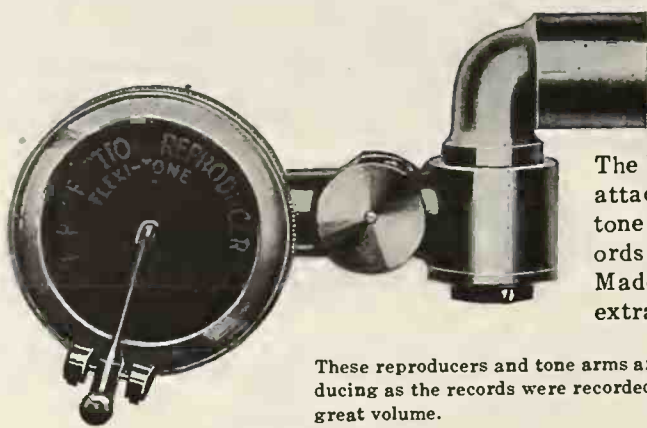

**Manufacturers—
Jobbers—
Dealers—**

The Perfection Flexitone reproducer No. 7 attached to the Perfection ball-bearing tone arm No. 4 plays all lateral cut records on all types of Edison Disc Machines. Made in nickel and 24 carat gold finish, extra fine quality disc.

These reproducers and tone arms are the very finest made, mechanically—reproducing as the records were recorded in the recording room—clarity of sound with great volume.

WRITE FOR DESCRIPTIVE CATALOG AND PRICES

Manufactured by

New England Talking Machine Co.

16-18 BEACH STREET BOSTON, MASS.

DISTRIBUTORS:

- CALIFORNIA
San Francisco—Walter S. Gray Co.
- MISSOURI
St. Louis—Silverstone Music Co.
- OHIO
Cleveland—The Phonograph Co.
- COLORADO
Denver—Denver Dry Goods Co.
- NEBRASKA
Omaha—Shultz Bros.
- PENNSYLVANIA
Pittsburgh—Buehn Phono. Co.
Philadelphia—Girard Phono. Co.
- IOWA
Des Moines—Harger & Blish
- NEW YORK
Albany—American Phonograph Co.
New York—The Phonograph Corp. of Manhattan
- UTAH
Ogden—Proudit Sporting Goods Co.
- MASSACHUSETTS
Boston—Pardee-Ellenberger Co.
- VIRGINIA
Richmond—C. B. Haynes Co., Inc.

Factory Representative—LOUIS A. SCHWARZ
1265 BROADWAY, NEW YORK, N. Y.

It's sweeping the Country!
HONOLULU EYES
 The most beautiful Waltz Melody
 in years Published by LEO FEIST INC
 FEIST BLDG. NEW YORK

"You can't go wrong with any Feist Song."

splendid means of creating amongst the public a greater interest in phonographs and records. As a special inducement to visit the store during the opening days, a return railway fare from any point in Nova Scotia was given to the purchaser of \$100 or more worth of goods.

SOME BOSTON TRADE BRIEFLETS

C. E. Osgood Co. Expands—Welcome for W. W. Longfellow—Some Recent Visitors—Condon in Charge at Berry's—Other Items

BOSTON, MASS., November 4.—The talking machine department of the C. E. Osgood Co., of which Chester J. Sylvester is manager, has been undergoing considerable changes and improvements lately. The large salon at the rear of the department has been entirely redecorated and refurnished and is now most attractive. This department carries the Columbia and Victor lines.

W. W. Longfellow With Barite Co.

Wilbur W. Longfellow, some years ago identified with the local talking machine industry, but subsequently located at New Haven, Conn., and more recently in Providence, is back in town again, having accepted the post of manager of the Barite Co. in Boylston street. His friends are glad to welcome him on his return to the scene of his early successes.

Attend Sessions of Advertising Clubs

Mr. Bacon, of the Chamberlain Huntress Co.; Fred Reed, of Goodman, Pearson & Co.; G. H. White, of Nichols & Frost, all of Fitchburg, were in town during the sessions of the New England Advertising Clubs held the latter part of October.

Attended Vocalion Salesmen's Conference

H. G. Sheldon and H. G. Stoehr, of the traveling staff of the Vocalion, were over in New York the latter part of the month attending the company's salesmen's conference. Manager Wheatley also was over in New York in conference with the home office.

Brunswick Records Grow in Favor

The new records of the Brunswick are finding a ready market throughout the New England territory handled by Kraft, Bates & Spencer, and Wholesale Manager Fred H. Walter reports that there is a large demand for the Brunswick product.

Some Claims Set Forth

The Vocello is the name of a new instrument that is soon to be launched on the market. The present offices are in Dartmouth street and on the windows one reads these words of inducement: "The Wonder of the Musical World" and "A Marvelous New Phonograph."

Raymond W. Sheldon, of the Arinola, is on the Pacific Coast and will be away two or three weeks.

Condon in Charge at Berry's

William Condon has been appointed manager of the Victor department of the Henry W. Berry Co., of Cambridge and Somerville. Mr.

Condon, who comes from the American Supply Co. at Worcester, will assume his new duties November 8.

Studied New York's Famous Dam

W. E. Crary, of the Edison department of the George Lincoln Parker warerooms, spent his vacation at his home in Delaware County, N. Y., and especially enjoyed studying the new big dam which is a part of the New York water supply.

SCRANTON SHOP REDECORATED

The Reisman Song Shop, Scranton, Pa., has reopened for business in its redecorated building. This company has the Columbia agency and on the opening day several concerts were held to demonstrate the new records. In the afternoon and evening additional concerts were given by Siren's orchestra.

NEW QUARTERS IN SAC CITY, IA.

A. C. Neal Now Occupies Three-story Building for His Large Columbia Business

SAC CITY, IA., November 1.—A. C. Neal, Columbia dealer of this city, has recently moved into a new three-story building. The outstanding feature of the new store is the talking machine department, said to be among the finest in the State. Three most artistic hearing rooms of Col-van construction, as well as the latest in record departments, go to make up this branch of the business. Mr. Neal is a Columbia enthusiast and backs up his belief by keeping three trucks in operation in covering a radius of surrounding territory of twenty-five miles.

The man who neglects to wind the clock misses the right train. The Lucky Man gets it. Be careful.

Victor
 "HIS MASTER'S VOICE"

CRESSEY & ALLEN

Built on those same sterling policies that characterized the early pioneer industries of New England, the firm of Cressey & Allen stands ready at all times to offer whatever possible service it can to Victor dealers located in New England.

PORTLAND MAINE

THREE HITS

Bubble Books

"that Sing"

a line that has no competition.

Now being backed by the manufacturers with a national advertising campaign which will send you many buyers. And nearly every buyer of a Bubble Book comes back for more.

Bubble Books are not a one sale proposition. It is a "repeat" line, one that will sell twelve months in a year.

BOOK NO. 10
BOOK NO. 11

Now ready for delivery. Write for our special introductory offer.

MEL-O-DEE MUSIC-ROLLS

The demand for a high grade music roll will be larger this season than ever before.

Owners of player-pianos want a roll that is well made and well played.

Mel-O-Dee has more good features than any roll made. It is "The World's Finest Music Roll."

The dealers who have been handling it showed an increase in sales last month that made two new factories necessary—and there is some real advertising coming to make more sales for Mel-O-Dee Dealers.

Okeh Records

The fastest growing line in the Talking Machine industry to-day. An Okeh Record agency is increasing in value every twenty-four hours.

The policy of quality first; quantity second; has brought a healthy and permanent growth.

We want a few more dealers who will take advantage of the money-making possibilities of an Okeh agency.

4167—Whispering
Dreaming Blues

4168—Japanese Sandman
In the Land of Rice
and Tea

NOW READY FOR
DELIVERY

Our SERVICE means more than prompt shipments. It means a continuous effort on our part to secure for our dealers merchandise so made and advertised as to insure quick sales and real profits. It means that we are constantly working to make each one of our dealers a bigger dealer.

PHILADELPHIA SHOW CASE COMPANY

DISTRIBUTORS OF SONORA PHONOGRAPHS

127 North 13th Street

PHILADELPHIA, PA.

PITTSBURGH BRANCH: 2002 Jenkins Arcade Building

The Trade in PHILADELPHIA and LOCALITY

PHILADELPHIA, Pa., November 4.—The talking machine business in Philadelphia enters the Winter months in very good shape. It has seemed apparent right along that the anticipated slump was not going to strike this trade, as some of the "weak-kneed" had expected. The more farsighted dealers have gone right along and have been advertising extensively and have gotten results. One thing has been apparent for the past month, and that is, those who have secured results are those who advertise—in other words, results were brought about through a more liberal outlay of money.

The machine and record situation has been clearing up gradually, and to-day, aside from the Victor dealers exclusively, all the firms here are very well stocked, and they will have done a very good business, even if they should not make any more purchases before the new year, if they are able to sell the present stocks on hand. But they are going right along and are getting in goods as fast as possible, for they believe that the good business is going to continue throughout the Winter.

Louis Buehn & Co. Improvements

The Louis Buehn Co. has commenced the improvements on its building, and if everything works out according to schedule, before The Talking Machine World appears, the Buehn firm will have finished the work, and will have the finest jobbing establishment in Philadelphia. The first floor offices have been moved more to the rear and have given place to a most attractive reception room. The doorway has been arranged to enter the store direct instead of from the side, and the show window has been considerably changed. To the right, back of the reception room, are the desks of

the sales force, and then come three private offices, attractively partitioned off, the first one being occupied by Frank Reinick, the second by Charles Miller and the third by Louis Buehn himself. The walls have been tastefully decorated, with the wainscoting reaching more than half way up the sides. All new electric fixtures have replaced the old, indirect lighting system.

The second floor front has been turned into a very handsome showroom for the new period models of the Victor Co. Some of these models have already arrived. The idea that the Buehn firm had in giving such prominent space to these models, and with such admirable surroundings, is that it realized that it would not be possible for all its dealers to handle a full line of these models, so it has made a place for them to which they can bring their customers to see these models under the very best circumstances. The rear of this floor will be devoted to records as at present, and the third and fourth floors will be given over to stock, accessories and supplies.

Among the recent Buehn visitors were: J. J. Kneis, of Mahanoy City, Pa.; Mr. and Mrs. W. Christine, of Christine Brothers, Bangor, Pa.; Joseph H. Lester, Williamstown, Pa.; Charles Womelsdorf, of the Toledo Talking Machine Co., of Toledo, Ohio; E. J. Youngjohns, of Norristown, Pa.; T. E. Brown, of Oxford, Pa., and J. H. Voorhees, of Kennett Square, Pa.

Recently Mr. Buehn made a visit in his automobile to all the dealers who purchase from him, and he says that he was amazed to find what very fine stores they all had, especially so in regard to the new Linton Co. store at 4721 Frankford avenue. Charles Miller suffered a

bereavement in the death of his mother during the month.

Great Activity With Penn Co.

T. W. Barnhill, the head of the Penn Phonograph Co., who was ill early in the month and was compelled to go to Atlantic City for a week to recuperate, is in the best of health again. His mother, Sarah A. S. Barnhill, died during the month. She resided at 1320 North Wanamaker street.

The Penn Co. reports that its business has been limited only by the receipt of goods, and that it has been receiving more goods than it did during October of last year. The company is making special arrangements for the display of the new Victor period models, some of which have already been received.

Recently Mr. Barnhill received a letter that interested him very much from the Kranz-Fink Talking Machine Co. of Baltimore. In it it was stated that the firm had had a Fall opening which was the most remarkable in point of attendance and sales that it had ever enjoyed. A feature of this opening was the presentation of a Penn Victor Dog to every adult visitor who was present at the opening. In order to do this the firm ordered 5,000 Penn Victor Dogs, which were secured through H. G. Vosee, a salesman for the Cohen & Hughes firm, who are Baltimore distributors of the Penn dogs. The Kranz-Fink Co. has one of the finest talking machine departments south of the Mason and Dixon line. To call proper attention to the Penn dogs it arranged a window in the form of a baseball diamond, with the opposing teams composed of dogs painted in various colors, with a grandstand built in

(Continued on page 108)

The only phonograph with a round horn— The Emerson Music Master Horn!

IN one vital particular the new Emerson Phonograph differs from all other phonographs: It has a *round* sound chamber or horn—and this horn is built *into* the machine.

Your customers may be curious to know *why* the Emerson Music Master Horn is *round*.

Tell them. Explain to them the law of acoustics* which ordains that sound waves shall expand in widening circles, like the ever widening concentric circles caused by throwing a stone into still water.

Your argument is con-

vincing—because it is founded on a scientific truth which compels universal recognition.

The scientific principle of the round Emerson Music Master Horn is set forth briefly in the loose-leaf catalog showing the various models in the new line of Emerson Phonographs. Send for a copy. Ask about representation.

*From a text-book on "Practical Physics," by N. Henry Black, A. M., and Harvey N. Davis, Ph.D., pages 382-3.

"... sound waves are longitudinal or compression waves, made up of alternate condensations and rarefactions. Just as a stone thrown into a pool makes waves which spread out in ever widening concentric circles, so we think of a bell as sending out soherical waves. These are made up of spherical shells of compressed and rarefied air, traveling out in every direction through space."



MODEL No. 20



Emerson Philadelphia Co.

810 Arch Street

PHILADELPHIA, PA.

Distributors of EMERSON RECORDS

THE TRADE IN PHILADELPHIA AND LOCALITY—(Continued from page 107)

units. in which hundreds of dogs acted as fans.

The Penn Co. has also been doing a very excellent business on its Penn Victor operatic figures, and all the leading dealers here have secured sets and have made elaborate window displays with them. Recent Penn visitors were: Mr. Block, of Block Brothers, Norristown; Robert Bartley, of the Victor factory; A. R. Boone, manager of the Talking Machine Co., Birmingham, Ala.; H. C. Bachman, Hanover, Pa.; L. L. Purchase, Hammonton, N. J.; Robert Shaffers, of Shaffers Sporting Goods Store, Phoenixville, Pa., and Mr. Curtice, Jr., of the Ross-Curtice Co., Lincoln, Neb.

Brown Succeeds Duffy

P. M. Brown, who for a considerable time was connected with the Columbia at its factory at Bridgeport, Conn., has come to Philadelphia to take the place of W. T. Duffy, who was transferred to Buffalo, to become the assistant in the Dealer Service department.

New Stores Opened

The Beddow Co., of 1530 Oxford avenue, in the Frankford section, has just opened a very fine talking machine shop, which is decorated in white and cream furnishings.

B. B. Todd has just opened his new and his third talking machine store at 1623 Chestnut street. It is one of the handsomest stores along Chestnut street, and in a neighborhood now growing very much in favor for business of this character.

Columbia Gathering in Scranton

The Columbia Graphophone Co. reports that it enjoyed a very good business during the entire month of October, in spite of the unseasonable weather. Manager Cummin spent considerable time in visiting the firm's dealers through the State and New Jersey. During his New Jersey visit he was accompanied by F. D. Connelly, who is the sales manager of this territory. He was also in Wilmington visiting the firm's trade in that section. He was present at an important meeting held in Scranton

Established 1864
Manufacturers and
Wholesale Distributors
WEYMANN
1108 Chestnut Street
Philadelphia, Pa.

H. A. Weymann & Son, Inc.

FOR EXTRA PROFITS

to the dealer we heartily recommend a Musical Instrument Department.

Success is practically assured dealers who specialize in quality goods of known merit for which a demand has been created.

Write for catalogue and trade discounts

World famous
Weymann
"Keystone State"
String Instruments
and "W & S" brand
Musical Merchandise.

given by the advertising men of that section. This meeting was also attended by G. W. Hopkins, the general sales manager of the company; C. E. Sheppard, the Columbia's sales manager in that section, and other Columbia representatives there were: Louis Oettinger, Mr. Graef, Mr. Theis and Mr. Keegan, of the Economy Furniture Co.; Charles Reisman, of

Reisman's Song Shop; Max Zoller, of the Scranton Talking Machine Co.; P. C. Penser and Ralph Mack, of the Penser firm, all of Scranton, Pa.; Fred Price, of Fowler, Dick & Walker, and G. Neuberger, of the C. & S. Furniture Co., Wilkes-Barre, both members of the firm of Lewis & Kuschel, of Pittston, Pa.; S. S. Lowry, of S. S. Lowry & Co., Berwick, and J. H.

THIS IS OUR WORK

Fulfilling the vision of its head and founder, this organization serves and will continue to serve its double function in acting as a dependable distributor for The Victor Talking Machine Company and assisting personally the dealers we do business with to make money through the constructive sale of Victor Merchandise.

Distributing fairly our allotment of Victor goods—aiding our dealers in developing bigger and better methods, thereby creating a greater musical interest and a still greater Victor Demand. *This is our work.*

The Louis Buehn Company

OF PHILADELPHIA

Powers and Jack Heater, of the Prince Furniture & Carpet Co., Hazleton, Pa.

Open New Department

During the month J. D. Callahan, the general sales manager here, was in Scranton assisting in the opening of a fine new exclusive Columbia department in Reiseman's Song Shop in that city. It is located at 413 Spruce street, and Mr. Callahan says it is one of the finest stores in Scranton. It contains six new booths which were erected by the Van Veen Co., of this city. He also assisted at the opening of the new Columbia store in this city of M. Klaidman, who trades under the name of the Philadelphia Phonograph Co. It is located at 623 South street, where he has taken over the entire building.

Among the recent Columbia visitors were: H. Hageman, of the Yards Co., Trenton, N. J.; Mr. Felix, of the Felix Department Store, Schuylkill Haven, Pa.; Mr. Williams, of Howard, Pa.; Mr. Schwartz, of Schwartz Brothers, Mauch Chunk, Pa.; Mr. Urkin, of Urkin & Cohan, of Trenton, N. J.; E. Markowitz, South Bethlehem, and N. L. Kaplan, of Bethlehem, Pa.

"Note the Notes Club" Organized

The girl employes of the Columbia Co. have recently organized a girls' club and have named it the "Note the Notes Club." The organization was effected on the 18th. The large reception corridor of the building was turned over to them, through the courtesy of Manager Cummin. The furniture was removed for dancing. A business meeting was held in the Model Shop at which the following were elected officers: Miss M. Bernhart, president; Miss E. McCauley, treasurer; Miss P. Martin, secretary, and Miss A. B. Luttin, chairman of the social committee, who will be assisted by the Misses Tagert, Wager, Rayfield, Dorgan, Eisentrager and Mangan. Miss McGinnis of the dictaphone department was elected chairman of the welfare committee. The object of the club is to promote co-operation, good fellowship and sociability.

Emerson Philadelphia Co. Expansion

The Emerson Philadelphia Co., who recently moved to the third floor of the building at 810 Arch street, has been able to take over almost the entire three-story building, upon which improvements are now being made. It has already taken over the entire second floor, and a considerable portion of the first floor. This shows the wonderful growth of the Emerson in Philadelphia under the direction and able management of Harry Fox.

Ten days ago an important meeting was held at the office of Mr. Fox, which was attended by Harry E. Morrison, of the New York sales department; J. I. Bernat, advertising manager, and Charles F. Usher, of the executive office of the Emerson Co. They were here to discuss various plans about the future of the new machine gotten out by the Emerson.

Mr. Fox is conducting a spirited contest for
(Continued on page 110)

5000 PENN-VICTOR DOGS

GIVEN AWAY

By the **KRANZ-FINK TALKING MACHINE CO.**
of **BALTIMORE, MD.**

They used full page advertisements announcing their offer to give the dogs away.

A large crowd was awaiting the opening of the store at 8 a. m.

All day long there was a continuous line of people passing through the store receiving Penn-Victor dogs.

The sales of the first three days of this event were more than during the whole month of October, 1919.

It is the opinion of the management of the Kranz-Fink Talking Machine Co., and also of merchants handling other lines of business that it was the greatest advertising stunt they had ever seen pulled off.

You may not be warranted in ordering 5000 Penn-Victor dogs, but you are warranted in their use as a business stimulator.



H. T. Bose of the Cohen & Hughes Co., Baltimore, Md., who secured the order for 5,000 Penn Victor Dogs from the Kranz-Fink Co.

**The Penn-Victor Dog
as a
Holiday Souvenir**

is exceptionally valuable and specially appreciated by your customers at that time.

**TRY 500 WITH YOUR NAME
ON THE PEDESTAL**



The Penn Victor Dog, of which there have been sold nearly 500,000 in the United States, Great Britain, Canada, Australia, Bermuda, Brazil, Argentine, Hawaiian Islands and Central America.

DISTRIBUTORS:

- | | | |
|---|--|---|
| Atlanta, Ga. ... Elyea Talking Machine Co. | Indianapolis, Ind. Stewart Talking Machine Co. | Omaha, Neb. ... Mickel Bros. |
| Baltimore, Md. ... Cohen & Hughes. | Jacksonville, Fla. Florida Talking Machine Co. | Philadelphia, Pa. H. A. Weymann & Son |
| Birmingham, Ala. E. F. Droop & Sons Co., Inc. | Memphis, Tenn. Houck Piano Co. | Pittsburgh, Pa. W. F. Frederick Piano Co. |
| Boston, Mass. ... Oliver Ditson Co. | Kansas City, Mo. J. W. Jenkins Music Co. | Portland, Me. ... Cressey & Allen, Inc. |
| Buffalo, N. Y. ... Eastern Talking Machine Co. | Milwaukee, Wis. Badger Talking Machine Co. | Rochester, N.Y. E. J. Chapman |
| Burlington, Vt. ... The M. Steiner & Sons Co. | Minneapolis, Minn. Beckwith-O'Neill Co. | St. Louis, Mo. ... Koerber-Brenner Co. |
| Butte, Mont. ... Orton Bros. | Mobile, Ala. ... Wm. H. Reynolds. | Toledo, Ohio ... The Toledo Talking Machine Co. |
| Chicago, Ill. ... Chicago Talking Machine Co. | New Haven, Conn. The Horton-Gallo-Creamer Co. | Washington, D.C. Cohen & Hughes. |
| Cleveland, Ohio ... Cleveland Talking Machine Co. | Newark, N. J. ... Collings & Co. | E. F. Droop & Sons Co. |
| Denver, Colo. ... The Eclipse Music Co. | New Orleans, La. Philip Werlein, Ltd. | Robt. C. Rogers Co. |
| El Paso, Tex. ... W. G. Walz Co. | New York City. Emanuel Blout | |
| Honolulu, T. H. ... Bergstrom Music Co., Ltd. | New York City. C. Bruno & Son | |
| | New York City. Knickerbocker Talking Machine Co. | |
| | New York Talking Machine Co. | |
| | Ormes, Inc. | |
| | Silas E. Pearsall Co. | |

Dealers not served by any of these distributors will be sold direct by us or we will charge through your preferred distributor if so requested.

DECALCOMANIA

Name Plates for Talking Machines, Pianos, etc.

High Class Workmanship

Write us for further information

National Decalcomania Co.
220-230 N. 60th St., Philadelphia, Pa.

Keystone Die-Casting Co.
Norristown, Pa.

ALFRED C. RANTSCH
Pres. and Gen. Sales Mgr.

E. J. W. RAGSDALE
Treas. and Gen. Mgr.

PENN PHONOGRAPH CO.

Victor Distributors
Wholesale Only

913 Arch Street, Philadelphia

THE TRADE IN PHILADELPHIA AND LOCALITY—(Continued from page 109)

the best dressed Emerson window in his territory, which will not close until November 25.

Building Up a Big Business

The Philadelphia Show Case Co. has been doing a splendid business all through October. Its business on the Melodee rolls, which it recently started to handle, has been way beyond expectation. The company states that the shipments of the whole catalog are coming through in a very satisfactory way, and it is now able to make deliveries to the extent of 100 per cent. and in remarkably quick time after the order is received.

Among the recent visitors to the Philadelphia Co. were: Oscar W. Ray, sales manager of the Melodee; Mr. Furlong, of the Vocalstyle Music Co.; F. J. Coupe, general manager of the Sonora, and W. C. Fuhri, representing the Okeh records.

As to Sonora, the Philadelphia Co. is getting things into very good shape. It has been able to make more prompt shipments upon

which it has been held up for some time. A couple of new salesmen have been added to the Sonora force, including A. George Funke, who is covering New Jersey territory, and Mr. Zepp, who will cover Maryland territory.

H. W. Weymann on Trade Conditions

Harry W. Weymann, of H. A. Weymann & Son, says he believes that early in November the Victor Co. will be able to greatly increase its Victor record business, and likewise he expects to be in a position to supply his trade with every requirement in Victrolas to meet the increased demand during the remainder of the Fall and Christmas season.

Mr. Weymann says: "Our dealers report increased sales on Victrolas, and are well pleased with the shipments in Victor records. Most of our dealers are now concentrating their entire efforts in their talking machine department on Victor product exclusively, and are well pleased with the future prospects. Last week we had one of the biggest weeks we have ever had in

**WE REPAIR
Talking Machine Motors**

Send Them To Us!

Work Guaranteed. Reasonable.

Make Big Money Selling the

Mobley Tone Reproducer

Will increase the tone of any talking machine at least 50 per cent. A demonstration sells it. Send for a sample today—mention make of machine.

E. BAUER

723 N. 26th Street Philadelphia, Pa.

our talking machine department. Among recent Weymann visitors were: Mr. Holland, of the Roebelin Piano Co., and George Gewehr, of Wilmington, Del.; C. M. Ware, of Millville, N. J.; Mr. Voight, of Voight & Ludlow, of Vineland, and J. H. Christman, of Salem, N. J.

Gathering of Pathé Men

The Pathé Co. reports excellent progress all through October. Last Wednesday an important meeting of the Pathé men was held here at the Hotel Adelphi. In the morning there was open house at 1126 Chestnut street, the Pathé headquarters here, at which almost all of the dealers in the territory were present. Luncheon was served at 12:30 to all the delegates at the Adelphi. This was followed by a business session which was continued all afternoon and addressed by several prominent Pathé men from the New York headquarters, including President Eugene Widmann. This business session was followed by a banquet, also held at the Adelphi at 7 o'clock in the evening in the gold room, and the evening was given over to a general jollification, at which a number of eminent Pathé artists assisted.

Mr. Radcliffe and Mr. Wilkinson, of the Vocalion Co., were recent Philadelphia visitors.

F. Connelly, of 2633 West Girard avenue, has just finished the remodeling of his store by the addition of eight hearing rooms. At his opening large crowds were in attendance.

Doing a Big Supply Trade

Everybody's Talking Machine Co. at 38 North Eighth street has been having a splendid business all Fall. It has increased its stock recently to the extent that a full line of everything in the way of talking machine accessories, repair, parts, etc., is covered. This company is also a large distributor of the Heineman products, Brilliantone needles, etc. It has just placed a contract for mainsprings of such a size that it is now able to offer them to the trade at a price lower than at any time since before the war.

This same gentleman says: "We carry a general line of merchandise. We have gone after the accessories business and have achieved such wonderful results that our business has grown to be nation-wide, our orders going out as far South as Florida and as far West as the Coast. Among the recent visitors was A. B. Schector, sales manager of the General Phonograph Corporation.

E. Bauer Opens for Himself

E. Bauer, who has been connected with the talking machine industry for many years and has been most recently identified with the Domestic Talking Machine Corp., is now in business in his own name, conducting a complete repair business for talking machines of every make. Mr. Bauer's many years of experience in the field are of particular value to him in the business which he now conducts and he has opened a well-equipped shop at 723 North Twenty-sixth street, this city.

Recent Change at Ludwig's

Walter Whiteley Hubbard, recently advertising sales manager for the Ludwig Piano Co.'s chain of talking machines and piano stores, now heads the advertising and editorial departments of the Bayonne, N. J., Evening News. He will be assisted by Bernard Kramer, secretary of the new organization, who will have charge of a section for talking machine and piano stores.

(Continued on page 114)

We have moved

to 27-29 South Seventh street, in the heart of the wholesale talking machine district, in order to render more efficient service than ever to our constantly-growing clientele. Increased floor space will enable us to take better care of our dealers' needs.

Okeh Records

which we have always available for immediate delivery, helped us more than anything else to grow. You will grow, also, if you tie up with this sterling line and

C I R O L A



portable phonographs, which we handle exclusively in Eastern Pennsylvania, Southern New Jersey, Delaware, Maryland and the District of Columbia.

Prompt action now means bigger profits later. Stock up now for the fall and holiday season.

"First-run" hits, CIROLA portable phonographs and a complete accessory line always on hand.

VISIT OUR NEW HEADQUARTERS

A. J. Heath & Co., Inc.

(Successors to Heath & Gorham)

27-29 S. Seventh Street

Philadelphia, Pa.

Telephone: Market 1364



INTERSTATE Service like Pathé superiority aims to sell the Dealer solidly to his public, and hence the Pathé Retailer who is "sold" to his community, must be wise enough to anticipate shrewdly what they want.

The organization of the Interstate Phonograph Company, Inc., is prepared not only to stock a retail Pathé Phonograph merchant acceptably but also to teach his sales people the most approved selling practice applied to successful Phonograph and Record placement. Let us tell you what we can do for you.

INTERSTATE PHONOGRAPH CO. ^{Inc}

1026 CHESTNUT ST., PHILADELPHIA, PA.
1018-1024 WABASH AVE., CHICAGO, ILL.



VITANOLA SEVENTEEN



Dealers' Interest

LARGE STOCK
ALL FINISHES
LIBERAL DISCOUNTS
IMMEDIATE SHIPMENTS

VITANOLA DISTRIBUTORS CO.
Eastern Penna., Delaware, New Jersey, Maryland
1025 Arch Street PHILADELPHIA

TRADE NEWS FROM PHILADELPHIA
(Continued from page 110)

James Aaron Manning now heads the talking machine department at the Ludwig Co.'s Philadelphia store, being assisted by Edwin Martin, who replaced C. R. Norman, who has gone abroad to study music.

PHILADELPHIA PATHE DEALERS ENTERTAINED

Interstate Phonograph Co., Inc., Acts as Host at Delightful Entertainment and Banquet to Pathé Dealers Who Attended the Convention Recently Held in the Quaker City

PHILADELPHIA, PA., November 4.—The Interstate Phonograph Co., Inc., Pathé distributor of this city and Chicago, played host to its many Pathé dealers in a lavish manner at the Pathé Dealers' Convention, held at the Adelphia Hotel Oct. 20.

From ten to twelve in the morning the dealers arrived, many coming from far-distant points in Pennsylvania. This period of time was devoted to the registration of the guests and open house at the showrooms of the Interstate Phonograph Co., at 1026 Chestnut street. This model Pathé shop has become the source of inspiration to many of the Interstate Pathé dealers and a thorough inspection was made of the shop. In addition to the dealers, a large delegation, headed by President Eugene A. Widmann, arrived from the New York headquarters of the Pathé Frères Phonograph Co., together with a number of famous Pathé record artists. C. S. Tay, formerly general manager of the company in Philadelphia and now in charge of the Chicago branch, came East for the occasion and was given a hearty welcome.

At 12.30 all adjourned to the Adelphia Roof, where a luncheon was served. Immediately following this luncheon the business session was convened at the south end of the roof and a session of marked enthusiasm was entered into. Following an address of welcome by Walter L. Eckhardt, president of the Interstate Phonograph Co., Eugene A. Widmann, president of the Pathé Frères Phonograph Co., delivered an inspiring address, in which he told of the remarkable success that Pathé was achieving everywhere and disclosed the energetic plans for future achievements. Russell Hunting, recording expert on Pathé records, was introduced by Mr. Eckhardt as one of the oldest men in the recording business and as one who had produced the first commercial talking machine record ever sold. His address on recording Pathé records was much appreciated by the many dealers present. Charles W. Flood, sales manager of the Interstate Phonograph Co., described to the dealers the many sales helps available to the Pathé dealer. C. H. Murray, advertising manager of the Pathé Frères Phonograph Co., was scheduled to speak on the matter of Pathé pub-

Do You Dominate Your Phonograph Field?



The dealer who sells this phonograph will be a leader in your city. His competition will be formidable to rivals because

The Franklin Line

Brings lasting satisfaction to customers. The tone is pure and clear; extra loud and natural. The cabinets are large and luxurious.

For turnover, profit, satisfaction

The Franklin is easy to sell, because it instantly delights both eye and ear. Modern in every way, it has all the advantages of others, and many exclusive improvements and refinements of its own. Franklins last. Their exquisite hand-finish lasts. There are

no "comebacks". This superb instrument can be sold at a price that makes any potential buyer a prospect, yet there's plenty of gain for you in each sale.

Your territory may be open.

Write to-day for full details.

FRANKLIN PHONOGRAPH CO., INC.
PHILADELPHIA, PA.

THE TRADE IN PHILADELPHIA AND LOCALITY—(Continued from page 112)

licity, but due to the tremendous advertising campaign which has been entered into by the Pathé Co. and its dealers alike, Mr. Murray was detained at Pathé headquarters by pressure of business and telegraphed his regrets. The concluding address of the session was by Walter L. Eckhardt, who fairly radiated his intense enthusiasm over Pathé products and gave an excellent demonstration on the proper way to sell Pathé merchandise. A general discussion which was entered into heartily by many of the dealers immediately preceded the adjournment.

In the evening the Interstate Phonograph Co. entertained about 170 at a banquet held in the

risburg, Pa.; Wm. H. Kieser and Mrs. Kieser, Milton, Pa.; B. Mays, Sanford, N. C.; J. Wardell, Wilmington, N. C.; J. Downes, Dover, Del.; C. F. Jacoby, Sellersville, Pa.

Philadelphia dealers present were: E. L. Goldman and Miss A. Goldman, Mrs. J. Gorin, J. Steinbrecker, J. Stavios, Mr. and Mrs. J. McCarthy, Mr. and Mrs. W. Carmine, J. Wurtle, A. Rowbotham, Mr. and Mrs. L. Stern, Mr. and Mrs. David Lentz, Mr. and Mrs. S. K. Slesinger, Miss F. Eastburn, Mr. and Mrs. J. Conway, Mr. and Mrs. S. McIntosh, M. Gottlieb, Sr., M. Gottlieb, Jr., Wm. Keich, Mr. and Mrs. T. M. Kenney, Mr. and Mrs. J. Born, W. J. McCor-

Morsbach, Mr. and Mrs. J. A. Youngblood, Mrs. C. Mays, C. Troxell, George Brennan, W. H. Davies, E. Poole Davies, Mr. and Mrs. J. H. Davies, Mrs. Wm. Davies, J. F. Marcer, E. McClenaghan, F. Shoppe, G. Bergmeister, D. Stauffer, E. A. Boon, A. V. Adams, W. Hainbach, C. Cowden, J. T. Jordan, Mr. and Mrs. J. T. Snyder, Mr. and Mrs. L. M. Baer, J. C. Foust, Miss H. K. Hollar, Mrs. J. Murphy, H. W. Stockinger, Thomas Harron, F. Eisenhart, A. Weir, G. Larett, M. Boughman, A. Nelson, J. Keller, S. Hern, A. Harkins, Miss A. Harkins, W. Harkins, A. Baum, Arthur Judson, Mr. and Mrs. J. Hoffman, W. Myers, C. Kulp, M. Klos-

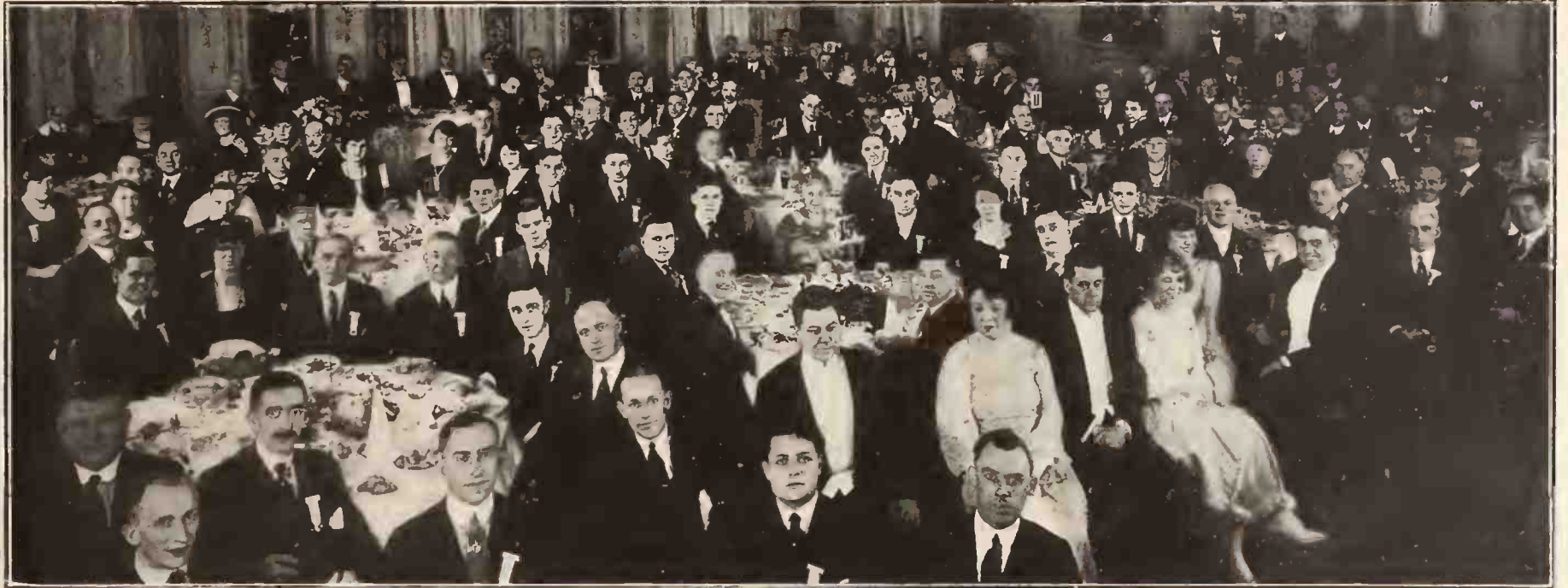

Banquet of Pathé Dealers, Under Auspices of the Interstate Phonograph Co., Inc., in the Gold Room of Adelpia Hotel

Gold Room of the Adelpia. President Widmann again addressed those assembled and Walter L. Eckhardt as toastmaster generously gave credit for the success of the day, as well as the success of the business of Interstate Phonograph Co., to his associates. M. Max, head of the Pathé department of Gimbels' New York store, was present and also spoke. The music for the evening was furnished by the "Melody Makers' Jazz Band." Many of the Pathé artists were present and entertained the guests. Among them were Percy Hemus, with his accompanist, Gladys Craven; Lewis James, Florence Mulholland and Wells Clary, also the famous Lada, "who will teach the world to dance through the medium of Pathé and Actuelle records." The center of the floor was cleared and to music furnished by the Actuelle, Lada, amidst a battery of spotlights trained upon her, danced fairly into the hearts of the many dealers present. The affair was a huge success from every angle and received much comment in the Philadelphia newspapers.

Among the dealers present were: S. Feldman, Salisbury, Md.; H. Klapper, Hazleton, Pa.; J. M. Hough, Shenandoah, Pa.; C. Goodenough and Mrs. Goodenough, Bethlehem, Pa.; B. Alshoutz, Shenandoah, Pa.; M. Kowitz, Easton, Pa.; O. K. Fink, Pottstown, Pa.; W. J. Robertson, Haddon Heights, N. J.; G. Troxells, Allentown, Pa.; O. Hartman, Lehighton, Pa.; N. Rapperport and R. Tait, Allentown, Pa.; F. Young and Mrs. Young and Mrs. N. G. Bergmeister, Reading, Pa.; Howard I. Paul, Pottsville, Pa.; A. Klindworth, Camden, N. J.; A. Monks, Chester, Pa.; C. S. Marley, Siler City, N. C.; A. L. De Turk, Allentown, Pa.; C. F. Wheeler, North Wales, Pa.; Miller Piano Co., Parkesburg, Pa.; S. Chertok, Coatesville, Pa.; C. Casper, Wilmington, Del.; Miss M. Worrall, Oxford, Pa.; Ralph Lanz, Norristown, Pa.; L. Nelson and Mrs. Nelson and E. Emmett, Camden, N. J.; G. Troxell, Jr., Allentown, Pa.; C. Steer, Baltimore, Md.; M. Housel, Montgomery, Pa.; J. S. Alford, Wilmington, Del.; J. W. Helbling, Chicago, Ill.; J. Bowman and Mrs. Bowman, Lewistown, Pa.; G. Henderson, Bristol, Tenn.; W. Heinitsh and W. Heinitsh, Jr., Lancaster, Pa.; L. Troup, Har-

mack, H. A. McCormack, B. B. Shuster, Mr. and Mrs. Harry Derbyshire, Miss Kathryn Kastner, H. A. Pope, E. Whitehill, J. Sanberg, W. F. Stierhem, N. C. Stierhem, Miss W. F. Stierhem, A. Rodgers, M. G. Fleisher, J. F. Spangler, L.

terman, J. T. Brown, T. J. Phelam, H. Slough, David Jacobs, Mrs. G. Weil, Miss M. Politz, L. Jacobs, J. Jacobs, L. Shuman, Miss C. Kohen, H. B. Tyson, J. H. Keller, G. Ross, G. Susselman, I. S. Reice, C. W. Flood, T. F. Pohlig.

GRAND OPERA ARTISTS FOR WINDOW

Lifelike Figures Produced by Penn Co. Win Large Measure of Trade Favor

PHILADELPHIA, PA., November 1.—The life-like figures of various grand opera characters produced by the Penn Phonograph Co., Victor wholesaler of this city, have been very favorably received by the Victor trade. These various figures are startling in their exact portrayal of the characters they represent. Not only the figures themselves, but the costumes are perfect to the minutest detail. They are designed by one of the most prominent costumers of Philadelphia and are made of the richest of materials. Orders for these figures are being received from all sections of the country and dealers are already featuring the display in their windows. These figures are said to be one of the most ingenious devices for the featuring of Red Seal records that have been produced.

Officer—Have you any organic trouble?
Recruit—No, sir. I ain't a bit musical—Tit-Bits.

GRANBY WITH A. J. HEATH & CO.

Prominent Distributors of Philadelphia Add Granby to Cirola and Okeh Lines Handled—Open Branch in Baltimore to Meet Demands

PHILADELPHIA, PA., November 1.—A. J. Heath & Co., of this city, distributors of the Cirola phonograph and Okeh records, have recently also been appointed distributors for the Granby line of phonographs. New quarters at 27 South Seventh street, this city, have been efficiently laid out and contain the executive headquarters of the company, as well as the storerooms and record filing department. A. J. Heath is president of the company and C. A. Malliet, formerly with the Columbia Graphophone Co., has become associated with the company as vice-president. The territory covered by this company includes eastern Pennsylvania, southern New Jersey, Delaware, Maryland and Baltimore. A branch office of the company has been opened in Baltimore in order to render the maximum of service to dealers in that locality. The present sales staff now numbers four men and at an early date it is planned to double this number.

H. J. SMITH LABORATORIES

Jewel Manufacturer

EXECUTIVE OFFICES,
FINISHING and
RECORDING
LABORATORY JEWELS

Plant No. 1
833 Broad Street
Tel. 2896 Market
NEWARK, N. J.

SAWING
GRINDING
ROUGHING
ROLLING and
EXPERIMENTAL
LABORATORY

Plant No. 2
54½ Franklin St.
NEWARK, N. J.

MANUFACTURER OF

Phonograph Diamond and Sapphire Reproducing Points—Recording Laboratory Jewels—Rough Diamond—Diamond Powder—Experimental Work. Jewels manufactured for all talking machine records. Consulting Specialist on all experiments relating to any new recording grooves. Recording problems satisfactorily worked out.

More Distributors Needed—Output of Grey Gull Records Now Tripled

Now that our new factory equipment is installed we want some more good distributors and are willing to make it profitable for them to carry Grey Gull Records, Lateral.

You won't have to wait for your shipments, you will have a good margin of profit, and you will be thoroughly protected against broken or defective records.

A letter will bring you full particulars, our catalogue, and sample records if you ask for them.

Best Selling Grey Gull Records

LATERAL

		Played By	
CHILI BEAN	Sung by Billy Murray		L-2018
MARIELLA	Sung by Patricola		10 in. \$1.00
LET THE REST OF THE WORLD GO BY,	Sung by Henry Burr		L-2017
WOND'RING	Sung by Charles Hart		10 in. \$1.00
JINGA-BULA-JING-JING	Sung by Billy Jones		L-2030
THE MOON SHINES ON THE MOONSHINE,	Sung by Ernest Hare		10 in. \$1.00
I'D LOVE TO FALL ASLEEP AND WAKE UP			
IN MY MAMMY'S ARMS.....	Sung by Billy Jones		L-2029
DOWN IN CHINA TOWN,	Sung by Harmonizer Quartet		10 in. \$1.00
I'LL BE WITH YOU IN APPLE BLOSSOM			
TIME	Sung by Henry Burr		L-2020
LITTLE TOWN IN THE OULD COUNTY			10 in. \$1.00
DOWN	Sung by Henry Burr		
HENRY JONES (Your Honeymoon Is Over),	Sung by Bernard and Hare		L-2031
CHANGE YOUR NAME, MALINDA LEE,	Sung by Bernard and Hare		10 in. \$1.00
MY DIXIE ROSARY.....	Sung by Henry Burr		L-2027
DADDY, YOU'VE BEEN A MOTHER TO ME,	Sung by Charles Hart		10 in. \$1.00
OH, BY, JINGO.....	Sung by Billy Murray		L-2013
THERE'S A TYPICAL TIPPERARY OVER HERE,	Sung by Mel Eastman		10 in. \$1.00
VENETIAN MOON	Sung by Sterling Trio		L-2014
GOLDEN GATE	Sung by Campbell and Burr		10 in. \$1.00
I LOVE THE LAND OF OLD BLACK JOE,	Sung by American Quartet		L-2011
SWANEE	Sung by Peerless Quartet		10 in. \$1.00
THE LOVE NEST—Fox-trot,	Grey Gull Dance Orchestra		L-1020
TYPHOON—Fox-trot.....	Grey Gull Dance Orchestra		10 in. \$1.00
IN SWEET SEPTEMBER..	Grey Gull Dance Orchestra		L-1026
SAXOPATION.....	Krueger's Melody Syncopators		10 in. \$1.00
KAHOLA-HONOLULU—Hawaiian One-step,	Starita Serenaders		L1017
KILAMA-WAILANA—Hawaiian Waltz,	Starita Serenaders		10 in. \$1.00
AVALON—Fox-trot	Starita Saxophone Sextet		L-1027
CUBAN MOON—Fox-trot,	Krueger's Melody Syncopators		10 in. \$1.00
VENETIAN MOON—Fox-trot.....	Gilt Edge Four		L-1014
BEALE STREET BLUES—Fox-trot...Gilt Edge Four			10 in. \$1.00
DARDANELLA—Fox-trot..	Grey Gull Dance Orchestra		L-1022
OSTRICH WALK—Fox-trot...Bostonian Syncopators			10 in. \$1.00
MY LITTLE BIMBO DOWN ON THE BAM-			L-1023
BOO ISLE—One-step.Krueger's Melody Syncopators			10 in. \$1.00
IN THE DUSK—Fox-trot...Grey Gull Dance Orchestra			
ALOHA OE—Hawaiian.....	Starita Serenaders		L-4004
WILIWILI WAI and HAWAIKINI—Popular Hawai-	ian Melodies	Starita Serenaders	10 in. \$1.00
REEVES MARCH	Grey Gull Military Band		L-4005
FATHER OF VICTORY MARCH,	Grey Gull Military Band		10 in. \$1.00
FLANAGAN'S SECOND HAND MOTOR CAR—	Comic Monologue	By Steve Porter	L-7003
HY AND SI AND THE LINE FENCE—Character	Dialogue	By Porter and Jones	10 in. \$1.00



INCORPORATED

295 HUNTINGTON AVENUE, BOSTON, MASS.

MANY IMPORTANT HAPPENINGS IN THE CLEVELAND TRADE

Concert of Famous Victor Artists—Columbia Dealers Hold Important Meeting—May Co.'s Demonstration Plan—Music Appreciation Development—Edison Tone-Test Popular—Other News

CLEVELAND, O., November 6.—The most important musical event for the talking machine industry and followers of the popular music in this section is being planned by the Talking Machine Dealers' Association of Northern Ohio for November 16-17. The event is to mark the second appearance here of Eight Famous Victor Artists, presenting a new program different from that of last year, at Masonic Hall. The affair is being managed by Ed B. Lyons, Eclipse Musieal Co., and secretary of the Association; Dan E. Baumbaugh, the May Co. talking machine department, and Louis Meier, the L. Meier & Sons Co. It is expected that the hall will be crowded to capacity for this second concert, judging from enthusiasm of the talking machine owners and other musical folk over the previous engagement.

A testimonial to the artists is to be a feature of the concert, the October-November meeting being held on the evening of November 16, following the concert, in Shriners' Hall in the Masonic Building. Here, at dinner, members of the trade and their associates are to listen to the artists in explanations of record making, why they make records for the Victor and other useful information designed to increase the distribution of talking machines and records.

Some Distinguished Visitors

Distinguished visitors to Cleveland have been directors of the Victor Talking Machine Co. and representatives of the Gramophone Co. of London, who were here for a few days in connection with a tour of the large cities of the country. The party is traveling in a private car. While here the visitors were guests of officials of the Eclipse Musieal Co. and the Cleveland Talking Machine Co., Victor jobbers. They expressed keen appreciation of the manner in which the industry has been developed alike by jobbers and retailers. Several of the leading stores were visited by the directors during their stay here. In the delegation were J. S. McDonald, sales manager; Walter J. Staats, treasurer; R. L. Freeman, director of distribution; Ernest John, advertising manager of the Victor Co., and Alfred Clark, managing director of the Gramophone Co., Ltd., London, and associates, Messrs. Cooper and Laek.

Trade to Hear Victor Artists

A plan to aid talking machine dealers and their sales staffs in increasing their musical discrimination is being put into effect by the Cleveland Talking Machine Co. Tickets to concerts at which Victor artists will appear during the season here will be purchased and distributed among the trade. The first try-out of this plan, meeting with much enthusiasm, was during the appearance here of the San Carlos Opera Co., which was attended by two persons from each store in the Cleveland district. Representatives from Dale's, Akron, also were present.

Arthur Shepherd, assistant conductor of the Cleveland Symphony Orchestra, will co-operate with the music appreciation development, under direction of Miss Grazella Puliver, educational director of the Cleveland Talking Machine Co. Lectures will be given at schools by Mr. Shepherd. The object will be to give technical information on music to those who plan to attend concerts. Mr. Shepherd will use Victor material in illustrating his lectures.

Music memory contests are expected to be developed locally as a result of meetings being held by Mrs. Adela Prentiss Hughes, concert manager, with music supervisors of the city. It is planned to work up this feature locally, as outlined in a national way by C. M. Tremaine, head of the National Bureau for the Advancement of Music.

Hallowe'en Party for Columbia Staff

A Hallowe'en party for employes of the Cleveland headquarters of Columbia Graphophone Co. was a feature recently planned by J. L. Du Breuil, general manager, and other Columbia officials here. The event was held in the company's warerooms, East Thirtieth street, near Euclid avenue. Special "stunts" were arranged by H. C. Cooley, assistant manager. Dinner, dancing and all the things that go with Hallowe'en were on the program.

More Music Advancement Work

More music advancement work is being done here in several novel ways, conspicuous among them being the lectures arranged by Miss Nina Legge, educational director of the Columbia Co. for the Cleveland district; Louis Mareus Lohler, social professor, Teachers' College, Columbia University, lectured at the Cleveland Normal School on two occasions during the month. Columbia Patty-Smith-Hill records on kindergarten music were used by the professor to illustrate his lectures.

Some Important Tone-tests

Dan Thomas, of Barberton, who wears the crown of tone-test king in these parts, surpassed even his own record in a tone-test in which Collins and Harlan appeared late in October. More than 3,000 persons attended the event and about 1,000 more were turned away. There is no hall large enough in Barberton to hold the crowds that want to attend these Thomas festivities, according to Harry Tucker, sales manager of the Phonograph Co., Cleveland, who was present. E. E. Hirschberger, advertising manager, and Bert Holme, office manager, of the Phonograph Co., also were present. A similar event, though not quite so large, was put on by George Lang, prominent West Side Edison retailer, 1,000 persons being entertained in the store, which was cleared for the affair. Collins and Harlan were the attraction again.

Pathé Progress

Impetus to the sale of Pathé phonographs in

Cleveland has been given through the announcement that \$25 worth of records would be given away with every machine purchased. The reason for the free distribution, the celebration of the twenty-fifth anniversary of the Pathé Frères, is being explained to purchasers by A. R. Saunders, assistant sales manager of the Fischer Co., Pathé distributor in Ohio and adjacent territory. While the people are appreciating the sentiment behind this move, they are equally appreciative of the good business to purchase machines at this time, and an increased result, reports the pleased Mr. Saunders.

Educational Meeting of Columbia Dealers

First of a series of educational meetings for Cleveland Columbia dealers was held this month by J. L. Du Breuil, general manager of the Columbia Co. in this territory. The meeting was at Hotel Winton, forty dealers being present. A sales demonstration was a feature, William G. Bowie, of the B. Dreher's Sons Co. taking the part of the prospective purchaser and Miss Rose Mandelkorn, the Mayer-Marks Co., the seller. All the possible questions that a buyer could ask were asked by the gifted Mr. Bowie and parried by Miss Mandelkorn. The "sale" followed. Miss Nina Legge outlined the educational work and the value of educational records to dealers. Miss Ethel Volk, the Wolfe Music Co., told how to make the most of demonstration rooms. George H. Strief, service manager, explained the operation of his department as an asset to retailers. E. I. Heaton, record department manager, gave suggestions on increasing record sales. Similar helps are planned for future meetings, which are expected to be attended by persons prominent in and out of the talking machine industry, who can give the members pertinent tips on business conditions.

The A. B. Smith Piano Co. has been appointed jobber in the northern Ohio territory for the W. W. Kimball Co. phonographs. The distribution will be under direction of A. B. Bender, from the Cleveland branch of the Smith Co.

Phonographs in Coal Regions

That the coal regions need music is proved by the experience of A. R. Saunders, assistant sales manager of the Fischer Co., Pathé distributor, who recently returned from southern Ohio, where a good-sized order for machines was placed by the general storekeeper of Saltpeter, a town of 112 inhabitants. This tiny community is a town without streets, paving or sidewalks. A platform at the general store alone proclaims its existence to the outsider. When the talking machine was started much of the population crowded around to hear. The interest shown proved to the storekeeper that he had to add them to his stock, which appeared to contain everything one would need, says Mr. Saunders.

Using Outdoor Advertising

Billboards or large electric signs are becoming the correct thing in retail talking machine selling circles. The Muehlhauser Bros. Piano Co. is placing large electric signs at prominent (Continued on page 116)

OKEH RECORDS The Record with the built-in tone quality plus Z. B. J. Service, try it. Ready

- 4171 Don't You Remember the Time. (Waltz) Rega Dance Orchestra
4172 Take Me. (Fox-trot) . . . Waldorf-Astoria Orchestra
4173 Will You Remember or Will You Forget. (Fox-trot) Waldorf-Astoria Dance Orchestra
4174 Romance. (Waltz) Waldorf-Astoria Dance Orchestra
4175 When I Looked in Your Wonderful Eyes, Crescent Trio
4176 I'd Be Good, Yes, for Good for a Good Girl, Shannon Four
4177 That Old Irish Mother of Mine. Sterling Trio
4178 Ev'ry Thing About You Tells Me That You're Irish. (Contralto) Ada Jones
4175 Just Like a Gypsy. (From musical play, "Ladies First") Sterling Trio
4176 Goodbye Sunshine, Hello Moon (From "Ed. Wynn's Carnival" Sam Ash
4177 Norah Acushla. (Tenor) Will Oakland
4178 Little Town in the Ould County Down. (Tenor) Henry Burr
4179 Mauna Kea O Hawaii (The High Peaks of Hawaii) (Ukulele acc.) Prince Lei Lani
4180 Mahina Malamalamala (Hawaiian Guitar Duet) Ferera and Franchini
4181 That Cat Step. (A Modern Polonaise) Rega Dance Orchestra
4182 I'm a Jazz Vampire. (Saxophone Solo) Bennie Krueger, with Rega Dance Orchestra

ZIEGLER, BAKER & JOHNSON, Inc. - 100 Chambers Street, New York City



Freshen up your record hearing rooms with Columbia Idico Deodorant. It's delightfully pleasant. With its delicate perfume it's just another festive note of Christmas cheer.

Columbia Graphophone Co. NEW YORK

TRADE HAPPENINGS IN CLEVELAND (Continued from page 115)

points about the city to extol the merits of the Sonora phonograph. A similar campaign is being started by T. A. Davies, manager of the talking machine department of William Taylor, Son & Co. in the interest of the Columbia models.

Join the Local Association

Unaffiliated members of the talking machine industry in this section may become identified with the Cleveland Music Trades Association, according to a plan being put into effect. A committee including A. B. Smith, the A. B. Smith Piano Co.; C. H. Randolph, Randolph House of Good Music; J. W. Kegel, the Harmony Music Shoppe, and Rexford C. Hyre, assistant secretary, will plan a campaign. Already two members of the talking machine branch of the music industry have joined the organization, including C. H. Kennedy, the Kennedy-Green Co., and the Tiffany Phonograph Sales Co.

An Ambitious Demonstration Plan

The turn of the month marks the completion of the enlargement and improvement of the May Co. talking machine department, under direction of Dan E. Baumbaugh, manager. The outstanding feature is a group of five rooms. In two of these Victor machines, one for mahogany and the other for different shades of oak, will be demonstrated. Another is for Cheney machines and the fourth for Brunswicks. The fifth and largest room is for comparisons, which will be made by the customer. One machine of each make is placed in a group. Each group of machines is differently priced. Records are contained in each machine to facilitate comparative demonstrations. After the customer has

made a selection further demonstrations are made in the room set aside for the particular machine selected. The record demonstration division of this department has been enlarged to thirty-five rooms, which contain machines equipped with motrolas.

Recent callers in the trade here have been R. L. Lemburg, general representative of the Columbia Graphophone Co.; James Watters, secretary of the Pathé Frères Phonograph Co.; A. H. Krapp, of the Witt Music Co., Lorain, and M. G. Vernon, of the Vernon Piano Co., Alliance.

Some Interesting Personals

Mrs. M. D. Kelsey has been appointed manager of the record department of the Starr Piano Co.

Mrs. M. M. Smith, formerly manager of the Brunswick department, the Vincent-Barstow Co., and well known in the trade in this section, has been appointed in charge of record service at the Cleveland Talking Machine Co.

J. L. Du Breuil, general manager, and H. C. Schultz, sales manager of the Columbia Graphophone Co., have left for Pittsburgh to attend a conference of district managers to be presided over by George W. Hopkins, general manager of the Columbia Co.

C. H. Randolph, the Randolph House of Good Music, has been made a member of the Business Exchange Club of Cleveland. Representatives from all lines of business are members. The first comer in each field has the privilege of naming others in his particular business as members of the Club.

TEXAS HOUSE INCREASES CAPITAL

Pierce-Goodell Piano Co. Now a \$100,000 Concern—Has Had Steady Growth

BEAUMONT, TEX., November 1.—An increase from \$30,000 to \$100,000 in the capital stock of the Pierce-Goodell Piano Co. has recently been announced by the president of that company.

The local music house has grown from a consolidation of the K. B. Pierce Co., which was incorporated in 1900 and the Goodell Piano Co., incorporated in 1909. The consolidation took place in 1912 when the business became known as Pierce-Goodell Piano Co., under which name it has continued until the present. At the time of the consolidation Mr. Pierce retired from business and Mr. Goodell purchased the entire stock, and was made president of the company.

The steady growth of the firm has made necessary the increase in their capital stock. There will be no change in the management. The offices are filled as follows: E. S. Goodell, president; Ed. Paggi, vice-president; L. U. Bagarry, secretary and treasurer. E. S. Goodell, Ed. Paggi, W. M. Crook, L. U. Bagarry and Dr. Bruce Richardson form the board of directors. Mr. Goodell states that he attributes the unusual success and growth of the business to the fact that he had been fortunate in securing competent and dependable assistants resulting in an organization which had been loyal in the extreme.

BRUNO logo at the top. Text: 'If the Victor was not giving universal satisfaction, you would not be a Victor dealer.' BRUNO logo at the bottom.

YAZOO RIVER RED GUM
Specials for prompt shipment:
1 carload 1 1/2" 1st and 2nd Qrtd. White Oak.
4 carloads 3" Common and Better Qrtd. White Oak.
1 carload 4" Common and Better Qrtd. White Oak.
8 carloads 1" 1st and 2nd Qrtd. Red Oak.
1 carload 1 1/4" 1st and 2nd Qrtd. Red Oak.
4 carloads 1 1/2" 1st and 2nd Qrtd. Red Oak.
9 carloads 1" No. 1 Common Qrtd. Red Oak.
4 carloads 1 1/2" No. 1 Common Qrtd. Red Oak
2 carloads 1 1/4" 1st and 2nd Qrtd. Red Gum.
4 carloads 2 1/2" 1st and 2nd Qrtd. Red Gum.
2 carloads 3" 1st and 2nd Qrtd. Red Gum.
3 carloads 1 1/4" No. 1 Common Qrtd. Red Gum.
7 carloads 2" No. 1 Common Qrtd. Red Gum.
5 carloads 2 1/2" No. 1 Common Qrtd. Red Gum.
3 carloads 3" No. 1 Common Qrtd. Red Gum.
10 carloads 1 1/2" No. 1 Common Sap Gum.
Our Red Gum is of soft texture and rich, dark color. Specially manufactured and seasoned.
Send us your inquiries for all kinds of cabinet woods.
THOMAS & PROETZ LUMBER CO.
3400 Hall St., St. Louis, Mo.

The MODERNOLA

A Home Delight to Ear and Eye

More Eye Appeal

And that means greater sales appeal—the creating of increased desire for ownership—a distinct preference when choice of a phonograph is to be made.

The Modernola is more beautiful!

Prospective buyers turn away from instruments of conventional design to admire The Modernola—and they buy it.

It is unique in design and rich in finish. The lamp shade feature adds to its individuality and enhances the impression of Modernola rendered music in a home setting of color and cheerfulness. The Modernola brings atmosphere as well as music into a home.

Increased production is enabling us to extend our distribution. We have open territory for individual dealers and for the jobbing trade in certain sections. Now's the time to get real money-value information regarding this exceptional phonograph.

Write Us—Now!

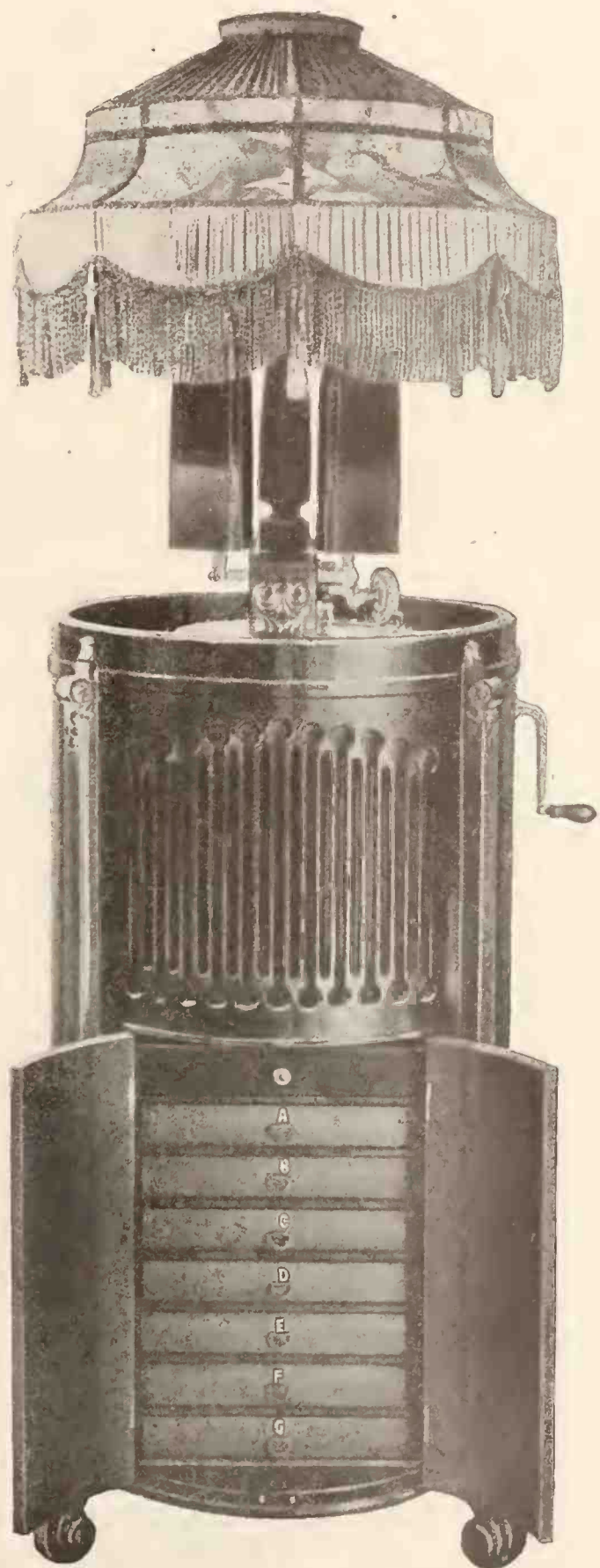

THE MODERNOLA COMPANY

JOHNSTOWN, PA.

Eastern Distributors:

Eastern Phonograph Corporation, 100 West 21st Street, New York

Edison Message No. 83

A Before-the-War Value at an After-the-War Price

Today, Edison Phonographs, in spite of the increased cost of manufacture, are selling at a figure only 15% (including War Tax) greater than in 1914.

“Edison Stood the Gaff”

THOMAS A. EDISON, Inc.
ORANGE, N. J.

HAPPENINGS IN THE DOMINION OF CANADA

MANY NOTED RECORD ARTISTS TO APPEAR IN MONTREAL

Concerts Already Booked Promise Remarkable Winter Season With Caruso, Galli-Curci, Rachmaninoff, Kubelik and Others Featured—Trade in Records Active—News of the Month

MONTREAL, CAN., November 5.—The unusually good weather which has prevailed here for some time has had a bad effect on the talking machine and record business, for when people find it mild enough to spend most of their time out of doors, the stores do not draw much of their patronage. At this time of year much colder weather is the general rule and dealers believe that with cooler weather business will pick up. A noticeable fact is that while buyers are looking for a drop in prices in most commodities, they do not ask this question in regard to talking machines and records.

The musical editor of the Montreal Herald says that it has been amply demonstrated that music, good music, music engaging the services of the foremost stars of the musical world, can be presented in Montreal and not only be enjoyed but understood. In reviewing the inauguration of the musical events which this city has been fortunate enough to secure through the instrumentality of local impresarios, especial stress may be laid upon the fact that the regular season in New York was anticipated by the engagement of the services of two of the most noted artists in the world—Caruso and Galli-Curci. Both these artists attracted audiences numerically and in proportion equal to any concerts ever witnessed in New York, Paris or London. And certainly there is no gainsaying the fact that the engagements matched in enthusiasm any former appearance of the most sensational stars of opera and concert.

There are many outstanding events to look forward to in the near future. The Scotti Grand Opera Co. will undoubtedly be one of the great musical events of the season here. M. Scotti and his company of Metropolitan artists will be heard at the St. Denis at the end of the month in a most ambitious operatic program. Then Jan Kubelik, the eminent violinist, will play at His Majesty's Theatre under M. Bourdon's management on November 8, Alma Gluck and Zimbalist in a joint recital; Rachmaninoff, the Russian pianist; Pablo Casals, the master of the 'cello—all these splendid artists are promised.

During the appearance of Lazaro, the eminent Columbia artist, in Montreal, the Columbia Co. ran full-page copy in all the French and English dailies featuring this artist's selections, together with the names of dealers handling Grafonolas and Columbia records. This advertising was linked up to individual dealer copy, window displays, show cards and photos of the artist, all of which produced increased interest in his repertoire.

The receipts from the Caruso concert held recently in Montreal were stated to be \$28,000, constituting a record for a single entertainment in Montreal. The public was made well acquainted with the fact that Caruso is an exclusive Victor artist. Needless to say His Master's Voice dealers one and all shared in the prosperity.

The Windsor Phonograph Co. is utilizing big space on prominent billboards located in conspicuous places in and around Montreal featuring the Windsor phonograph.

Hughes Macklin, who came from England recently to the Montreal recording laboratories of the Berliner Gramophone Co., Ltd., to record songs for His Master's Voice records, has returned home.

Layton Bros. quite recently sold a new Edison and a large number of Re-creations to St. Stephen's Hospital, Fort Yukon, Alaska. St. Stephen's is the only hospital within the Arctic Circle. Layton Bros. have taken on the Brunswick representation and recently ran a full-page

advertisement to announce to the public their taking the Brunswick agency and to call attention to their sixteen ground floor demonstration rooms.

Record of sales of Columbia Grafonolas, Starr phonographs, Columbia records and Gennett records with Beaudry Freres, Reg., Quebec City, for the three first months since the opening of their talking machine department has proved this a winning venture which gives promise of making this store one of the most frequented in Quebec. The clientele represents mostly English speaking people.

Mr. Atwood, of the E. Nesbitt Drug Co., Win-

nipeg, Man., while attending the druggists' convention at Montreal, paid a visit to the factory of the Berliner Gramophone Co., and was particularly struck by the large proportions of the new factory now being built. Mr. Atwood carried the glad news that it was going to be a bumper year in the West and was looking forward to a tremendous increase in the sale of His Master's Voice products. The E. Nesbitt Drug Co. is at present one of the largest exclusive His Master's Voice dealers in Winnipeg.

Geo. O. Hill, druggist, of Winnipeg, also attended the convention and took the opportunity of visiting the Berliner Gramophone Co.'s factory.

Yerkes Jazarimba Orchestra, now playing at Montreal's newest cabaret, the Blue Bird Cafe, made its initial entry at the Berliner Gramophone recording laboratory quite recently.

TORONTO MUSIC DEALERS LOOK FOR BIG WINTER SEASON

Coming of Prominent Artists Sure to Boom Record Sales—W. H. Hanley New Manager of Ottawa Phonograph Shop—H. R. Braid Joins Musical Merchandise Sales Co.—Other News

TORONTO, ONT., November 5.—After five years' service with Ottawa's Phonograph Shop, W. H. Hanley has been appointed manager of the establishment in succession to E. P. Burns, who was transferred to Ottawa from Hamilton a few months ago after having been the manager of the Ottawa store several years ago. What is popularly known as the Phonograph Shop is the Ottawa branch of the R. S. Williams Sons & Co., the direct connection with the Williams Co. having been indicated last Spring by the adoption of the company's name for the business. Intimation has been made that Mr. Burns has gone to the Canadian West to undertake further activeness for the Williams Co. Mr. Hanley took complete charge of the Ottawa branch a few days ago after having officiated in various capacities during the past five years.

Concert-goers will have a treat in store for them this Fall when Florence Easton, Maurice Dambois, Marguerite D'Alvarez and Marie Sundelius—all exclusive Aeolian-Vocalion artists—will appear in concert before Canadian audiences. Florence Easton, a former Toronto girl and now one of the leading sopranos with the Metropolitan Opera Co., appeared here on November 2. She was assisted by Maurice Dambois, the celebrated Belgian 'cellist and pianist, who made a deep impression on his audience at the time of his former appearance in Toronto under the auspices of the Women's Musical Club.

Harry R. Braid, of Toronto, with an extensive experience in the trade, has joined the Musical Merchandise Sales Co.'s selling organization. He will represent the firm in Ontario territory. G. R. Dring, with headquarters at Calgary, will cover the Alberta and British Columbia territory, succeeding Carl Fulcher, who has been transferred to Manitoba and Saskatchewan. F. V. Wells, a former traveling representative, and who has been in charge of the firm's service

department for the past year, again joins the selling staff, working Western Ontario. With headquarters at Montreal, W. M. Harris will look after Brunswick interests in the Maritime Provinces. Verne A. Boddy, the junior member of the sales force, continues to operate in Ontario and is still going strong.

Hammill & Morgan have opened up a music store at Lindsay, Ont., where they are featuring the Brunswick line. Hammill & Morgan have the local Heintzman agency.

A. R. Patterson, of Allandale, Ont., is a new music dealer, featuring the Brunswick in conjunction with Heintzman pianos.

Columbia Grafonolas and records are being featured in the new store opened up by Lonsdale Piano Co. on Danforth avenue.

Sudbury, Ont., boasts of a new music store owned by Maurice Cohen, formerly of Toronto. The business is conducted by Mr. Cohen's son, and His Master's Voice products are handled.

The Brunswick phonograph has been especially selected for exclusive use in May Anderson's presentation of the big New York success, "On the Firing Line," which appeared in Toronto recently.

Ratepayers of Wingham, Ont., have approved of a by-law granting a loan of \$10,000 and a fixed assessment of \$10,000 for seven years to the William Gunn Co., of Saginaw, Mich., which is to operate a talking machine factory in that municipality.

TORONTO FAVORS "RECORD WEEK"

Dealers Indorse Move to Promote Sale of Records by Country-wide Action

TORONTO, ONT., November 5.—The Toronto Retail Phonograph Dealers' Association held a business meeting recently in the warerooms of the R. S. Williams & Sons Co., Ltd. The vice-presi-

(Continued on page 121)

Talking Machine Supplies and Repair Parts

SPRINGS, SOUND BOX PARTS, NEEDLES

THE RENÉ MANUFACTURING CO. MONTVALE, NEW JERSEY

Immediate Delivery!

NO HEAVY INVESTMENT in machines to protect yourself—no loss of sales during the busy season because of shortages. You can order as many ARIETTAS as you need now and get IMMEDIATE DELIVERY on future orders, as you need them. In other words—

*The Machines You Want,
When You Want Them!*



Arietta
Model IV



Arietta
Model III



PHONOGRAPH



Arietta
Model II

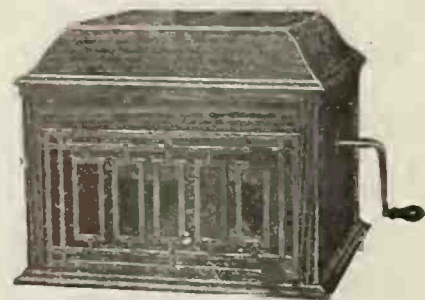

Arietta—Model I

Emerson Records

We are wholesale distributors. Write for list of latest releases. Quick service!

ARIETTA

And ARIETTA Prices Are RIGHT!

ARIETTA HAS EVERYTHING your most exacting customer can ask for—sweetness of tone, beauty of design, quality of materials and workmanship—and the prices are right!

That's the reason ARIETTA is putting new life in dormant phonograph departments—it represents the kind of value people are demanding nowadays—and it nets you a satisfying profit.

At least, investigate the ARIETTA proposition. Fill in and mail the coupon and get our exclusive agency offer by return mail. Do it NOW!

ROUNTREE CORP., Richmond, Va.
Gentlemen:
Kindly send me details about the ARIETTA PHONOGRAPH and your agency proposition, without obligating me.

Name
Address
Post Office
IV-11-20

Rountree Corporation

Manufacturers
Richmond, Va.

NEWS FROM DOMINION OF CANADA

(Continued from page 119)

dent, J. D. Ford, occupied the chair in the absence of the president, H. Ruthven McDonald. The question of records on approval came up, but was held over for another time, the main object of this meeting being to discuss the matter arising out of the minutes of the meeting previous, viz.: the co-operation of the Toronto dealers in putting on a "Record Week."

It was outlined by Mr. Ford that the "Record Week" would, according to the plan recommended by the executive committee, consist of a uniform show card in the windows and a series of advertisements running in all the local papers concentrating the public's attention on record buying.

After examining the rough sketches of the ads suggested, and the estimated cost of running them on a schedule submitted, and with the names of those dealers contributing to the cost appearing at the bottom of the ad in alphabetical order, a motion was passed unanimously, indorsing the idea of "Record Week," as early as possible in November.

FORMAL OPENING IN WINNIPEG

J. J. H. McLean & Co., Ltd., to Handle His Master's Voice Lines in Canadian City

WINNIPEG, MAN., November 3.—One of the best known talking machine and piano firms in the West, the J. J. H. McLean & Co., Ltd., of 329 Portage avenue, established in 1883, held the formal opening of their new talking machine and piano salons recently. The store has been remodeled and is now one of which the management can feel rightly proud. It contains beautiful display and record demonstrating rooms equipped in modern fashion, a novel "island counter" arrangement for the instant selection of His Master's Voice records and accessories. A large number of people visited the store during the day.

CANADIAN PLANT FOR THE EDISON

Canadian Edison Phonograph, Ltd., Just Organized, Purchases Large Cabinet Factory Building in St. Thomas, Ont., for Cabinet Manufacturing and Assembling Purposes

Edison dealers throughout Canada have expressed keen satisfaction as the result of an announcement, made by the Edison Laboratories, to the effect that the manufacture of Edison phonographs in Canada will soon be a reality.

A newly organized concern, known as the Canadian Edison Phonograph, Ltd., has concluded the purchase of a large factory building in St. Thomas, Ontario, known as the Thomas Bros. plant and occupied by the St. Thomas Cabinets, Ltd. It has arranged to purchase also the entire equipment of the latter concern and to install additional machinery with the expectation of making deliveries of some phonograph models as early as June 1.

For the present, the new plant will be devoted entirely to the manufacture of phonograph cabinets and to assembling cabinets and phonograph mechanisms for the Canadian trade and possibly, at some future time, for the export trade for all parts of the British Empire.

According to a statement made by the Edison Laboratories, it is not as yet possible to state what reductions in prices can be accomplished, and it is probable that it will be several months after production has begun before a new schedule of prices can be established, based on Canadian manufacture.

The new branch gave the members of the St. Thomas City Council, the Executive Committee of the Board of Trade and a number of prominent city and country citizens a banquet recently in the auditorium of the Engineers' Building.

Charles Edison, son of Thomas A. Edison, chairman of the Board of Directors of the Canadian corporation; William Maxwell, of Orange, N. J., vice-president of the local concern and head of all the Edison phonograph industries,

and several other officials presided as hosts. About one hundred guests were entertained. A feature of the evening was the singing by Mme. Marie Rappold, soprano soloist of the Metropolitan Opera Co., New York City, who broke an engagement to visit this city and sing in conjunction with her recorded music at the function.

Addresses were delivered by several of the visitors, the outstanding speeches being made by Mr. Edison and Mr. Maxwell, both of whom expressed themselves as seeing Canada one of the most important sections of the globe. "It is because we believe in the future development of Canada and desire to get in on the ground floor that we have established our Canadian plant here," said Mr. Edison. "We are not intending to launch out blindly at the outset, but will feel our way." Mr. Maxwell predicted a mighty immigration of agriculturists to Canada in the near future, not only from the old countries of Europe, but from the United States. The splendid crops this year and the general prosperity that has visited the Dominion will allure thousands, he said. At the present time the new corporation is giving first consideration to the Canadian trade, but eventually will make vigorous efforts to develop all the British Empire trade that they can handle adequately, giving special attention to Australia. Mr. Maxwell looks for the time when preferential trade will be in force among all the Empire's colonies on a co-operative basis.

Addresses of welcome were delivered by Mayor Brinkman, ex-Mayor Horton, president of the St. Thomas Board of Trade; ex-Mayor Geddes, vice-president; City Solicitor W. B. Doherty and others. The other members of the Edison party were: Delos Holden, general counsel; Charles Luher, superintendent of the Orange, N. J., phonograph plant; John Constable, chief engineer; Major Sumner Williams, extension manager, and O. J. Haarlander, manager of the local plant.

Original thinking is the scarcest product entering into any constructive effort.

THIS IS YOUR GUIDE TO A BETTER NEEDLE

Plays All Records

PLAYS 100 to 200 RECORDS



Saves All Records

PLAYS 100 to 200 RECORDS

Announcing a **LOUD** tone needle in the Superb Stylus Semi-Permanent. To meet the demand for a needle that is especially adapted for the popular Jazz and Band Records, we have perfected a **LOUD** tone in the **SUPERB STYLUS SEMI-PERMANENT**.

Plays from 100 to 200 Records without change. The **SUPERB STYLUS** IS NOW MADE IN THREE TONES.

LOUD

MEDIUM

SOFT

Mr. Distributor:—We have among our selling helps a very beautiful display card and booklets to hand out to the trade. You will need this Superb Stylus. Write at once for samples and circulars as well as discounts.



Mr. Retailer:—If your distributor does not handle the Superb Stylus send to us for samples and discounts and we will attend to your wants and co-operate with you in every detail.

No Scratching

4 NEEDLES ON CARD

No Hissing

25c PER CARD

THE TALKING MACHINE NEEDLE SUPERB

Made by **MELLOW-TONE NEEDLE COMPANY, INCORPORATED, Ansonia, Conn.**

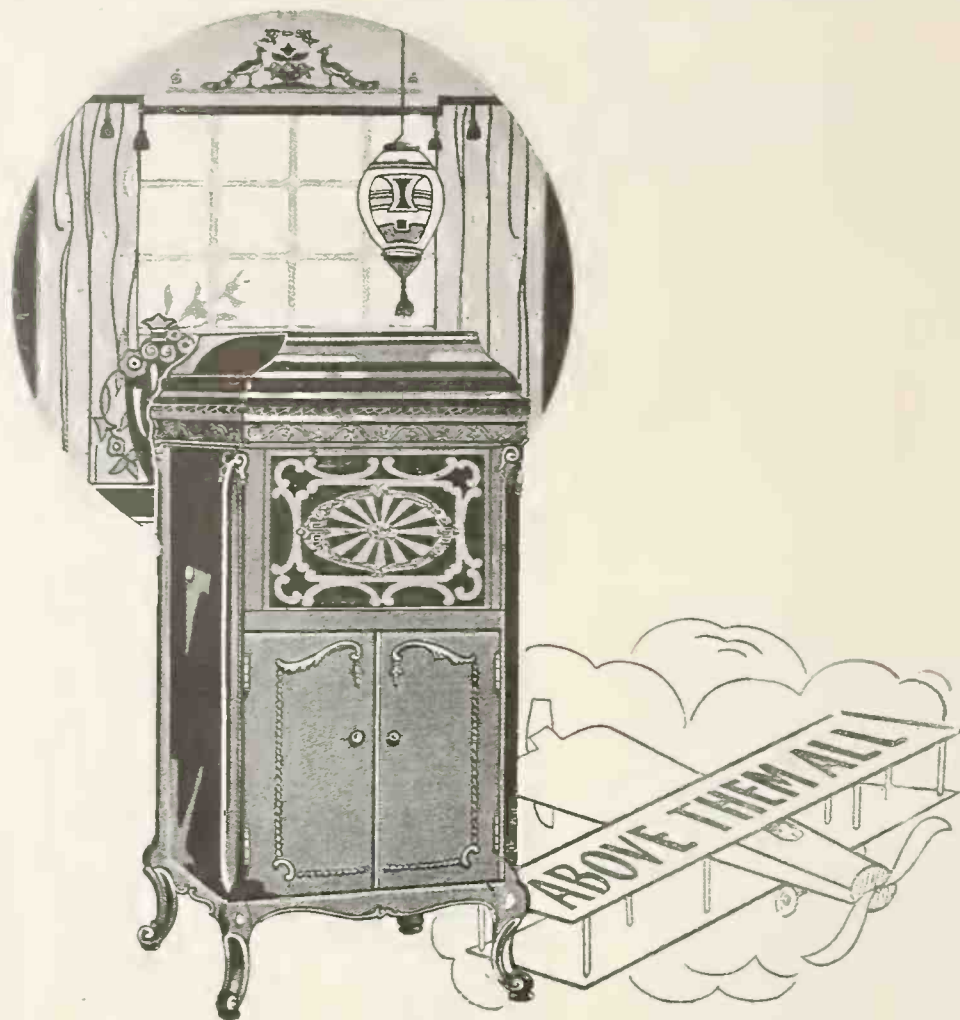

THE PHONOGRAPH DE LUXE

Made for the progressive merchant who has foresight enough to realize that if he wants his business to grow he must handle a product which will advertise him through its owner.

More Sales and Profits will be yours if you handle this line.

Distinctive Designs
Highest Grade Equipment
Beautiful Quality of Tone
Prompt Deliveries.

The
EXCEL
Talking Machine

TO EXCEL DEALERS WE
OFFER AN AMPLE SUPPLY
OF RECORDS OF WELL
KNOWN STANDARD MAKES.

We Invite Comparisons—Read Our Offer

TO ANY RELIABLE MERCHANT

We will send one or more on approval. If satisfactory, you will honor invoice on maturity. If not, return the machine at our expense. Have you ever received a fairer offer? Take advantage of it today and become an Excel dealer.



EXECUTIVE OFFICES: 136 West 23d Street, New York

FACTORIES: Holland, Mich.; Jamestown, N. Y.; Chicago, Ill.

Write for catalog and full particulars

THE VICTOR ARTISTS SUCCESSFUL

Eight Famous Victor Artists Make Strong Impression on Tour—What the Milwaukee Papers Had to Say of the Concert

An idea of the success the eight Victor artists are making on their Fall and Winter tour can be gathered from the following review which appeared in the Milwaukee Evening Wisconsin the day after the artists had made their appearance in Pabst Theatre, that city. The review said, in part:

"It was Victor night at the Pabst Theatre—and such a night!

"On the stage, melody, humor and high spirits; in the audience, laughter, enthusiasm and good will—an occasion memorable for the perfect, warm accord between performers and their patrons. It was really like a big family affair.

"Every person in that great assemblage, which taxed the capacity of the playhouse, knew these artists through their Victor records, was there to greet them in the flesh because of the many happy hours created by their merriment and song.

"If any doubt remained of the mighty factor which the talking machine has become in the domestic and cultural economy of the nation—making for happier home life and finer interests—that doubt would be dispelled by the splendid, representative audience that welcomed these Victor stars Thursday night.

"It was not only a rich, but a remarkably well-balanced program, thoroughly popular in the best sense of the word.

"Henry Burr, Albert Campbell, John Meyer and Frank Croxton were heard in solos, duets, trios and quartets, largely of the sentimental type for which their records are famous; Billy Murray contributed topical dialogue and rapid-fire comic songs; Fred Van Eps produced his magical banjo; Monroe Silver did his inimitable Cohen specialties and Frank Banta presided at the piano.

"After hearing these artists in actual concert, one can understand why they make such remarkably clear and melodious records.

"Take the members of the Peerless Quartet, just mentioned, and not only have they voices of unusual purity and sweetness, but their enunciation and diction is such as to bring every word and phrase into its own.

"Their singing of 'Somebody's Waiting for Someone,' one of their popular records given as an encore, was a thing of sheer beauty. It held the audience spellbound with its rare delivery and subtle charm. In a different vein, but of equal artistry in execution, were 'Swanee' and 'Swing Along.'

"Henry Burr, the tenor, with scores of popular records to his credit, has a mellow organ and an ease of delivery that exceptionally fit him for the tender, sentimental ballad, and the enthusiasm of the audience over his 'Blue Diamonds' and 'In the Castle of Dreams' was in every way justified."

After describing in detail the balance of the program the review ended:

"Altogether, Milwaukee Victor dealers, who brought this aggregation of artists to the city, are to be congratulated upon the success of their effort. Few entertainments within recent memory have given such thorough enjoyment. Let us have more of them."

NEWARK STORE ADDS VOCALION

The Newark store of Jacob Doll & Sons, Inc., has taken on the agency for the Aeolian-Vocalion and Aeolian records, according to an announcement made by L. J. Reinhardt, manager. The new line is featured in specially designed window displays and is being made a specialty of by the company. Generous newspaper space informed the public of the acquisition.

The man who is full of courage and can smile when everything is against him is the man who is going to win, and win big.

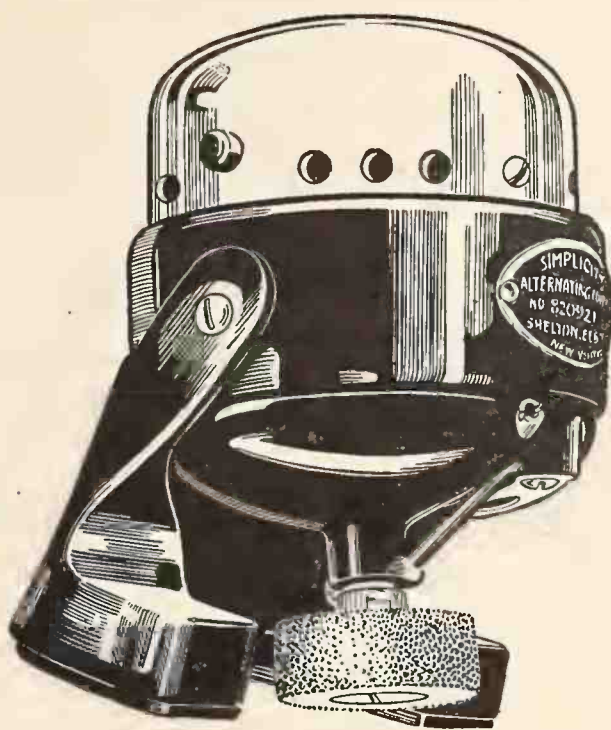

Mr. EDISON

AND

Mr. VICTOR

DEALERS

The Simplicity Electric Motor

is now ready for distribution

Have you suggested it to your customers as a **CHRISTMAS GIFT?**

It can be carried home like a record and installed by the user.

It is operated by a self-contained automatic switch and is absolutely guaranteed.

There is a **HANDSOME PROFIT** for you.

Order From Our Nearest Distributor:

- | | | |
|---|--|---|
| CALIFORNIA
Los Angeles — Edison Phonographs, Ltd.
San Francisco — Edison Phonographs, Ltd. | IOWA
Des Moines — Harger & Blish.
Sioux City—Harger & Blish. | NEW YORK
Albany—American Phonograph Co.
New York — Phonograph Corp. of Manhattan.
Central Talking Machine Co.
Syracuse—Frank E. Bolway & Son, Inc. |
| COLORADO
Denver—Denver Dry Goods Co. | LOUISIANA
New Orleans — Diamond Music Co., Inc. | OHIO
Cincinnati — The Phonograph Co. |
| CONNECTICUT
New Haven—Pardee-Ellenberger Co., Inc. | MASSACHUSETTS
Boston — Pardee-Ellenberger Co. M. Steinert & Sons Co. | OREGON
Portland — Edison Phonographs, Ltd. |
| GEORGIA
Atlanta—Phonographs, Inc. | MICHIGAN
Detroit—Phonograph Co. of Detroit. | PENNSYLVANIA
Philadelphia — Girard Phonograph Co.
Pittsburgh—Standard Talking Machine Co. |
| ILLINOIS
Chicago—The Phonograph Co. | MISSOURI
Kansas City—The Phonograph Co. of Kansas City.
St. Louis—Silverstone Music Co. | |
| INDIANA
Indianapolis—Kipp Phonograph Co. | NEBRASKA
Omaha—Shultz Bros. | |

Manufactured by

SHELTON ELECTRIC COMPANY

16 East 42d Street
New York City



CABLE ADDRESS REG'D
"FILASSE—PHILA."

THE MARK OF

LONG DISTANCE 'PHONE
BARING 535

ANY { Size
Quantity
Quality

SERVICE AND
Phonographically Speaking



SATISFACTION
They Talk For Themselves

Quotation
Delivery } **RIGHT**
Product }

IMICO INDIA RUBY MICA DIAPHRAGMS

INTERNATIONAL MICA COMPANY PHILADELPHIA, PA.
U. S. A.

INTERNATIONAL MICA CO., 106-110 W. Lake St., Chicago, Illinois

FACTORY AND SALES DEPT.,
37TH AND BRANDYWINE STS.,
WEST PHILA., PA.

MOORE & WHITESIDE
MONTREAL, CANADA

FEDERAL PHONO SUPPLY CO.
3009 JENKINS ARCADE
PITTSBURGH, PA.

WALTER S. GRAY
SAN FRANCISCO, CAL.

LAKESIDE SUPPLY CO.
416 SOUTH DEARBORN ST.
CHICAGO, ILLINOIS

"IMICO" and "SERVICE" are SYNONYMOUS

OPENS BRUNSWICK DEPARTMENT

C. A. Dorney Furniture Co. Finds Growth of Business Justifies Separate Section

ALLENTOWN, PA., November 5.—To facilitate the handling of its increasing business in talking machines, records and accessories, the C. A. Dorney Furniture Co., 612 Hamilton street, has set aside a separate department. Although the company has been handling talking machines, featuring the Brunswick, for the past several years, it has not been until now that it was found necessary to have that portion of the business grouped together. The innovation has added greatly to the ease with which this portion of the business is handled and is meeting with the approval of the store's large following.

There have been erected three sound-proof booths in the center of the store. There is one large booth containing six large machines and two smaller booths, the latter erected expressly for the demonstration of records, while the big booth will be used to demonstrate the machines.

The booths are all glass, encased with a framework of wood finished in ivory. Carpets of a

deep blue adorn the floors of the booths, forming a pretty contrast to the ivory wood finish. Pictures of such well-known Brunswick record artists as Max Rosen, the celebrated violinist, and Theodore Karle, the noted tenor, who will be seen here in the series of concerts by Miss Elloda Kemmerer during the Fall and Winter, adorn the walls of the booths. The record department has compartments capable of accommodating several thousand records.

The department is in charge of Arthur Peters, who has been with the firm for the past three years.

BUSINESS CHANGE IN ELWOOD, IND.

Ivan C. Dunlap, of Elwood, Ind., has sold his jewelry store to the Elwood Talking Machine Co., which is composed of a group of Noblesville men. The store was taken over the middle of October and is now under the management of Frank Kaiser. It is carrying an exclusive line of Victor machines. A year ago Mr. Dunlap added a room for his phonograph department and made improvements that made the shop one of the finest in the State.

INAUGURATE VICTOR TRUCK SERVICE

Collings & Co. to Run Big Truck Between Victor Factory and Newark Store

As announced in these columns last month, Collings & Co., the well-known Victor distributors in Newark, N. J., have just inaugurated a truck service between the factory of the Victor Talking Machine Co., Camden, N. J., and



Collings & Co.'s New Truck their home in Newark, thus assuring dependable delivery regardless of traffic conditions.

We herewith reproduce a photograph of this new large van with Pullman body, White machine. It has a capacity of forty-eight Victor XI's, which compares favorably with the capacity of the average freight car.

NEW DEPARTMENT IN SIOUX CITY

Columbia Grafonolas and records have been added as a new department in the large furniture store of Levich & Hersoff at Sioux City, Iowa. Three Col-van hearing rooms and a fine record department are among the features which are located on the main floor.

EXPANSION IN CHEROKEE, IA.

Harry Lamoreaux, of Cherokee, Iowa, is said to be the liveliest druggist handling talking machines in the State. He has just completed the installation of four artistic hearing rooms on a large balcony built to take care of the Columbia trade, and to better display the Columbia product. His truck, with the tandem notes, may be seen daily on the streets in and around Cherokee.

R. F. PERRY TO SALT LAKE CITY

Robert F. Perry, who for some time past has been with the Brunswick Shop at Mt. Sterling, Ill., has accepted a position with the John Elliott Clark Co., Victor distributors of Salt Lake City, Utah. Mr. Perry is well acquainted in the trade and is widely known throughout central Illinois. His host of friends wish him great success in his new location.

STONE IMPROVEMENT

MANUFACTURERS: IMPROVE THE TONE OF YOUR INSTRUMENT BY USING THIS ONE-PIECE AMPLIFIER

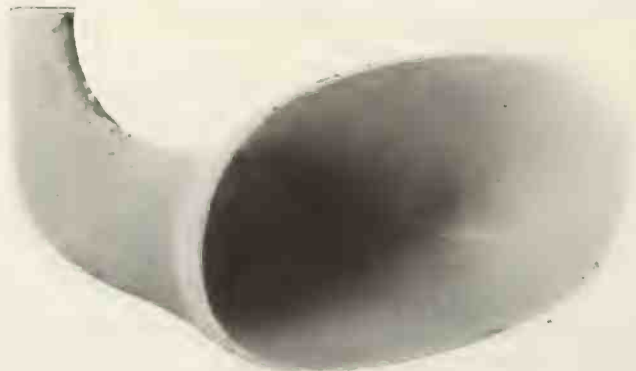

(Patents Pending)

Our amplifiers are guaranteed not to crack—they are unbreakable.
Our amplifiers are guaranteed not to warp—they are damp-proof.
Made to order, any size or shape, from our own composition and by our own processes.

Light in weight. Handsome in appearance.
They are endorsed by large manufacturers who are using them today.
Finished in any color.

For further information address

FRANK WINTERRATH 405 EVERGREEN AVE.
BROOKLYN, N. Y.

VITANOLA

The Phonograph of Marvelous Tone

When a Business Organization founded on Faith—faith that the spirit of true service must and will attract a large and loyal body of dealers and attain all of those things which make business a pleasure and a pride—when such an organization is tossed by a gale on the high seas of Commerce, and it founders not, but emerges strengthened where before was weakness undiscovered, then it may confidently face the future in the knowledge that the same principles and the same ideals assure enduring success.

Thus, the Vitanola Talking Machine Company, temporarily operating under a Receivership, is carrying on as before. The Receiver was appointed not in bankruptcy, but in a chancery action, for the purpose of conserving the vast assets of the corporation, including the invaluable good will of the trade.

The tangible assets of the Company show a very liberal margin in excess of its liabilities, but much of its working capital was tied up in its new plants just at the time when the banks commenced restricting

credit. As a result, it found itself in the same predicament that has beset so many concerns during the period of business depression from which the country now is happily emerging.

Preparations are being made to effect a readjustment of the Company's finances that will result in an organization Bigger, Better and Stronger than ever.

The volume of orders being received is a splendid tribute to the high ideals that govern Vitanola production. And because of unusual facilities, these orders are being shipped with unusual promptness. Vitanolas are loaded directly into cars on private sidings at both the Cicero, Illinois, and the Saginaw, Michigan, plants.

Under the same sales and liberal service policies with which all present Vitanola dealers are familiar, the Vitanola organization is now, as always, bending every effort to serve well. These policies have been, and will remain, the bulwark of success to Vitanola dealers.

Many valuable business building hints and suggestions are contained in our booklet, entitled, "Making A Phonograph Department Pay." It is free for the asking. Send for it—also our interesting proposition to dealers.

Vitanola Talking Machine Company
 1918 SOUTH 52nd AVENUE : : CICERO, ILLINOIS



KNOWN FOR STYLE AND TONE

**BABY GRAND
DESIGN
PHONOGRAPH**

*The most distinctive type of
phonograph on the market.*

*Provides the dealer with un-
limited sales possibilities. A
welcome addition to any high
class lines.*



Model B—The quaint Queen Anne. One of the most desirable designs. In keeping with the furnishings of many music rooms in modern American homes.

List Price \$230.00
Made in Mahogany and American Walnut.



Model C—The Hexagon design fits in with almost any character of home furnishing. Its solid and artistic appearance is in keeping with the best of periods.

List Price \$235.00
Made in Mahogany and American Walnut.

Protect your trade and stimulate your phonograph business by having this Exclusive Period Line on your floor

The Baby Grand Design Phonograph

is the best constructed and finished instrument on the market today. Order Now.

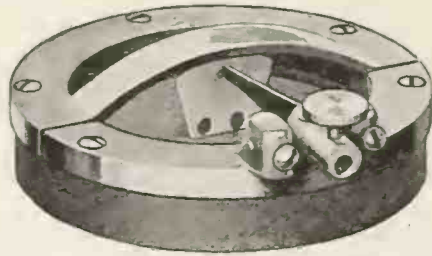

Our Reproducer
(Guaranteed for Twenty Years)

1. Its light weight will always keep your records new.
2. Plays all makes of records without any extra attachments.
3. Diaphragm is insulated from all metal parts, assuring natural tone without the metallic phonograph tones.
4. By off-setting the bridge connection to the diaphragm provides a short and long area over which the high and low notes respectively must travel for best results.
5. Oval har provides ample protection for bridge connection.



Model D—The ever-popular Louis XVI., an especially favored design which finds its place in the drawing rooms of prosperous Americans all over the land.

List Price \$240.00
Made in Mahogany and American Walnut.



Model E—For the Chippendale room. Delicate carvings, perfect design and the last word in arts and crafts workmanship. Study the perfection of this design.

List Price \$250.00
Made in Mahogany and American Walnut.

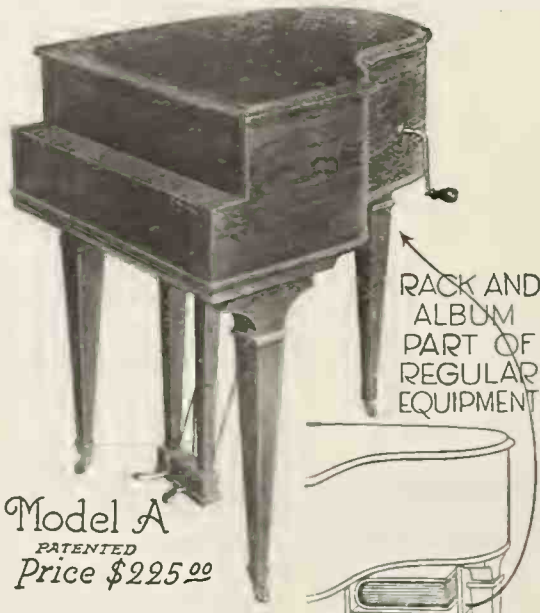

Model A
PATENTED
Price \$225.00

Model A—Baby Grand in Adam period design. The marvelous simplicity and beauty of the period faultlessly carried out. Much favored by the critical buyer.
List Price \$225.00
Made in Mahogany and American Walnut.

The Dimensions of The Amplifying Chamber are 24" in width and 10" in height. Think of that. The Cabinet is 36" high, 27" wide and 34" in depth—Shipped K. D. which assures lowest freight rates.

**The Fern-O-Grand
Company**

212-220 West Canal Street
Cincinnati : : Ohio

FULLY PROTECTED BY PATENTS, DEALERS' DISCOUNTS PROMPTLY FOLLOW YOUR APPLICATION

INDIANAPOLIS DEALERS PUSHING BUSINESS THIS WINTER

Indianapolis Talking Machine Co.'s New Store—Pathé Dealers Meet—Reception for Mrs. Frances E. Clark—Baldwin Record Business Grows—Leading Dealers Tell of Increasing Business

INDIANAPOLIS, IND., November 4.—Indianapolis talking machine dealers express satisfaction over the showing for the first ten months of 1920, and they are working with a determination to make the holiday trade the best in the talking machine history of the city. All admit there have been slack months during the year, just as there have been in previous years, and the consensus of opinion is that more work is the order of the day, but the one most encouraging feature of the situation, as most dealers see it, is the fact that they are no longer handicapped by a shortage of goods.

The largest exclusive Victor shop, as well as one of the most elaborately appointed talking machine shops in the State of Indiana, is being planned by William S. Cooke, general manager of the Indianapolis Talking Machine Co. The new store will be located at 134 North Pennsylvania street, or less than one block north of the present store at 110 North Pennsylvania street. It is expected the store will be opened about the first of the year.

Present plans for the store call for period furniture in mahogany. Ten or twelve booths will be built in on two sides of the main floor. There will be an electric elevator connecting with a mezzanine floor, where the finer period models will be displayed, and with the basement which will be used as a warehouse and for repair work. Facilities will be provided for handling between 18,000 and 20,000 records. The store will have a large educational department. The dimensions of the store will be 22x155 feet.

Mr. Cooke, who recently was appointed manager in the place of C. R. Anderson, who resigned, was made a director of the company at the last meeting of the board of directors.

Fred J. Shelby is now manager of the sales department of Widener's Grafonola Shops. Mr. Shelby was connected with the Indianapolis store of the Baldwin Piano Co. for several years.

The first annual meeting of the Red Roosters organization of Pathé dealers in Indiana, Kentucky, eastern Illinois and western Ohio will be held November 17 at the Claypool Hotel. A representative of the Pathé company will be present at the meeting to discuss with the dealers the problems arising from the general trade conditions and the policy to be followed in

carrying forward Pathé activities during the coming year.

Sales of the Pathé machine have increased 50 per cent in Indianapolis as a result of the offer of \$25 worth of records with each instrument, according to Edgar Eskew, of the Pathé shop. Mr. Eskew has taken full advantage of the nation-wide advertising campaign and his sales force is working overtime with the many prospects. An effective bit of local advertising was a full page in the leading newspaper of the city in which the ads of the six Pathé retailers of the city were coupled with that of the State distributors, the Mooney-Mueller-Ward Co.

G. J. Luebben and C. C. Carter have been added to the sales force of the Edison Shop. Miss Agnes Cullivan and Miss Mabel Chamberlain have been engaged as additional clerks in the record department. Miss Cullivan takes the place of Miss Helen McArthur, who recently went to New York for the study of vocal music.

Miss Dorothy Rybolt, formerly with the Wurlitzer branch at Cleveland and more recently with L. S. Ayers & Co., of this city, has been placed in charge of the record division of the Sonora department of Charles Mayer & Co.

Ernest Arthur, manager of the department, says his one chief worry now is to obtain enough machines to meet the demands of the trade. The difficulty he is experiencing in keeping a large stock on hand, he asserts, is resulting in his tightening up considerably on his payment plan. The bulk of his business now, he says, is cash business with the more expensive period models moving steadily.

The appearance of the Eight Famous Victor Artists at the English Opera House, October 10, for two concerts, drew large crowds and has resulted in a largely increased sale of records made by those particular men. Concerts were given by the artists also at South Bend and Richmond.

The Stewart Talking Machine Co. has started something by publishing in its house organ a story to the effect that the Imfeld Music Store, Victor dealer at Hamilton, Ohio, is proudly exhibiting two Victor records of venerable age but unimpaired faculties. They are records that were issued in 1905 before the cabinet style Victrola was placed on the market.

Stewart

Talking Machine Company

JOBBER
for the
Victor
Talking
Machine
Company



Indianapolis

Now comes Sheet's Music House, of Auburn, Ind., with a duly attested statement setting forth that the Imfeld records of 1905 must take a back seat in favor of three records owned by that store that were bought in 1904 to be used on the small Victor "O" and are still in excellent playing condition.

"Make America a Musical Nation" was the subject of an appeal made by Mrs. Frances E. Clark, of the Victor educational department, to Indiana teachers in attendance at the annual meeting of the State Teachers' Association. Among other marks of appreciation and respect tendered Mrs. Clark during her stay in Indianapolis was a dinner given at the Severin Hotel by the Stewart Talking Machine Co. The seven Indianapolis Victor dealers also were guests at the dinner.

C. P. Herdman, manager of the phonograph department of the Baldwin Piano Co., reports that his record business has grown to such an extent that he has found it necessary to do away with his original method of handling the records from cases in the rear of the store and to open a special counter service well up toward the front of the store, where, he says, it belongs. He says he is handling a larger volume of business now with much greater ease than formerly. The department can be shut off from the rest of the store and locked by means of iron gates.

Miss Vivian Dougherty, formerly of the Brunswick Shop, has been added to the sales force of the record department of the Baldwin piano store. A. G. Gresham, who was with the Columbia Graphophone Co., wholesale distributors of this city, has been employed in the sales department.

As proof that the talking machine is popular in Indianapolis one needs only to tell the story of a man who appeared at the back door of an Indianapolis home and asked for a bite to eat. While the lady of the house was busily engaged in preparing a meal for him she happened to turn around just in time to see the man running toward the street with her phonograph tucked under his arm.

Miss Caroline Hobson, head of the educational work of the Stewart Talking Machine Co., has been placed in charge of a music course added to the curriculum of the Indiana University extension work. The class is made up largely of school teachers and meets once a week in the auditorium of the Shortridge High School. The Victor school machine and Victor records are used in the class work.

W. S. Barringer, who has been established for little more than one month as Victor dealer at Kokomo, Ind., is displaying the blue ribbon first prize for an exhibit of a 42-inch Victor dog at the Kokomo industrial exposition. Mr. Bar-

(Continued on page 129)

"TONAR"

TRADE MARK

RECORD BRUSHES ARE PROFITABLE



They pay JOBBER and RETAILER each a good working profit

They earn your support

Write to-day for sample and prices

PARKS & PARKS, Inc. TROY, N. Y.

New York Office, C. E. Peabody & Co., 186 Greenwich St.

Southern Representatives: I. W. Becker & Co., 226½ Peachtree St., Atlanta, Ga.

The fastest-selling phonograph in the world

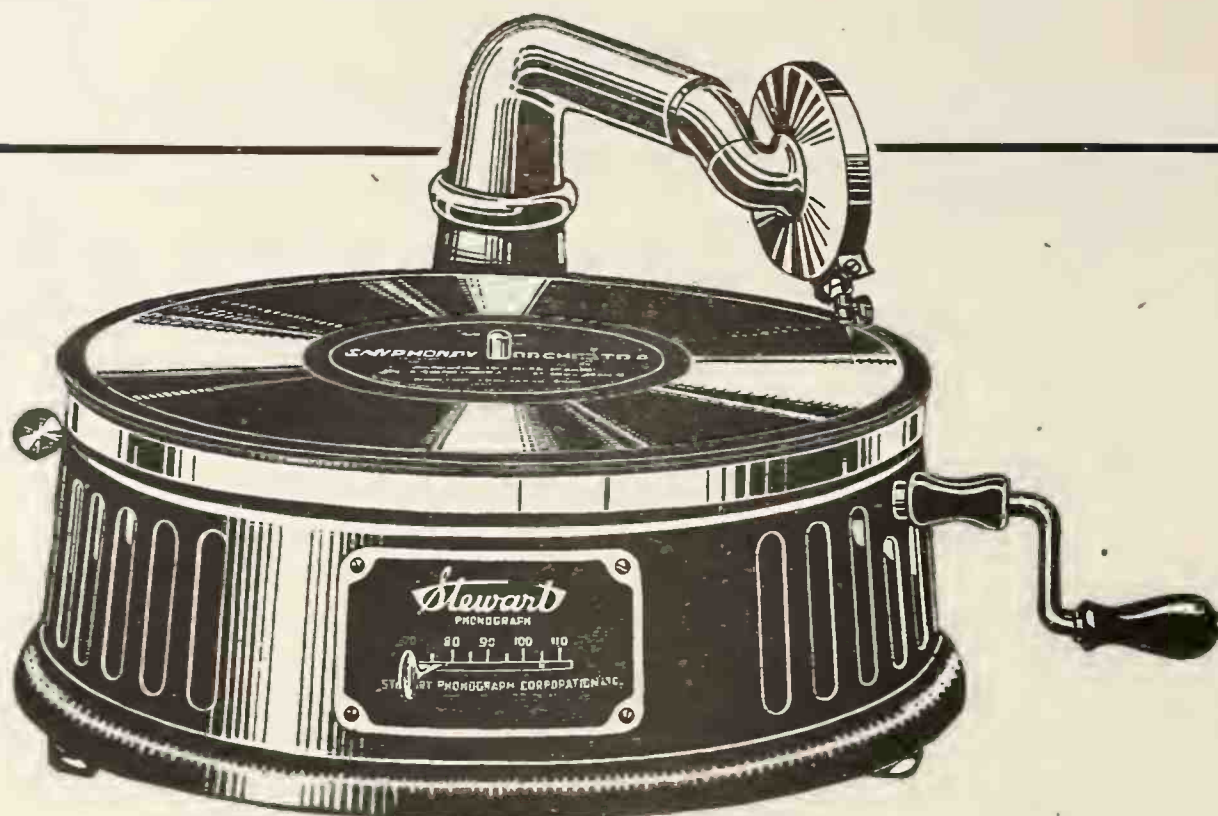

You can have this sensational phonograph in stock for Christmas selling **IF YOU ORDER NOW.** Its wonderful volume of rich, pure tone—its fine mahogany finish—its portability—all coupled with its amazingly low price will make it sell “like hot cakes” this Christmas. Don’t let delay rob you of the generous profits the Stewart offers. Wire at once.

Remember—PRICE is not the index of Stewart quality but the result of Stewart quantity production—over 500 phonographs a day!

STEWART PHONOGRAPH CORPORATION, Inc., Lincoln Bldg., Buffalo

Stewart

PHONOGRAPH

PLAYS EVERY RECORD—ANY MAKE, ANY SIZE

RELIABLE ACCESSORIES

Means Additional Service to Your Customers

BE PREPARED BY ORDERING NOW!

Portophones	Brilliantone Needles	Velvet Record Cleaners
Cabinets for Victrola No. 9	Sheffield Needles	Dustoffs
Albums	Reflexo Needles	Cleanrite Brushes
Jones Motrolas	Wall-Kane Needles	Stock Envelopes
Universal Display Fixtures	Fibre Needles	Reflexo Polish
Record Flashers	Edison & Pathé Sapphires	3 in 1 Oil
Dancing Figures	Fibre Cutters	Graphite

LET US QUOTE YOU PRICES

ESCO MUSIC & ACCESSORIES CO.

137 Lawrence Street,
Oscar Zepernick

Brooklyn, N. Y.
Joseph A. Kerr

REVIEW OF INDIANAPOLIS TRADE

(Continued from page 127)

ringer is conducting his business in temporary quarters in Meyer Brothers' drugstore. He formerly was with the Stewart Talking Machine Co., Indianapolis.

E. H. Jarrard, who has had charge of the Amberola department of the Kipp Phonograph Co., has resigned his position with that company to become manager of the Kimball phonograph department of the Capital Paper Co. H. G. Anderson, manager of the record department of the Kipp company, has taken charge of the Amberola department.

Mr. Anderson talks enthusiastically of the Summer's business and of the prospects for the Winter. He says Edison dealers in this territory have experienced remarkably steady business in the face of disturbing influences, and he credits this business prosperity to the assistance gained through the sales policy inaugurated by the Edison company last Spring.

Walter E. Kipp, president of the company, says he is fully satisfied with the outlook for the phonograph business. He keeps his dealers awake to their opportunities by weekly letters in which he emphasizes the need for consistent, hard work as the best insurance against lean months.

C. A. Grossart, formerly sales manager of the Brunswick Shop, has been appointed manager to succeed George Standke, who recently resigned to become president of an artificial ice machine company. John Hoenig, credit manager, has been given the added duties of assistant manager.

"We are prepared for a large holiday business," says Mr. Grossart. "We have had a few weeks of slack business, due to a period of unusually warm weather, but with the cold weather now coming business is showing signs of picking up. I expect we will have the best holiday business in our history."

Phonograph Horns or Amplifiers

Cast metal base in three different designs, round and rectangular, for metal or wood extensions. Scientifically constructed to give best tone. Musical critics have pronounced our tone unsurpassed by any machine on the market.

Shaped Phonograph Cabinet Legs, Any Quantity, At Reasonable Prices

Buy Your Cabinets Knocked Down

We can supply five different sizes and designs.

Write today for full description and prices, stating quantity wanted.

INDIANA PHONOGRAPH SUPPLY CO.

321 Baldwin Block,
Indianapolis, Ind.

A. G. Burr, a salesman out of the St. Louis office of the Brunswick-Balke-Collender Co., has been appointed manager of the phonograph division of the Indianapolis branch of the company. He relieves Frank Buttweiler, who has been attending to the work of the division in connection with his other duties as general manager. Mr. Buttweiler has added two salesmen to the phonograph division. They are C. E. Saylor and H. G. Parker.

"If the factory would ship us only the machines we order we would hardly have one in the place now," said Mr. Buttweiler in reference to the trade conditions. "Phonographs are going like a house afire and our only difficulty in supplying the trade is in getting just what we want from the factory."

REMODEL TALKER DEPARTMENT

The Victor department of the Coover-Shierling Store at Union City, Ind., has been remodeled in such manner as to win many favorable comments from the trade.

E. W. BARLOW DIES IN PORTLAND

Manager of Stradivara Phonograph Co. Fails to Recover After Operation

PORTLAND, ORE., November 1.—The many friends of E. W. Barlow, manager of the Stradivara Phonograph Co., were grieved and shocked to hear of his death on Wednesday, October 20, at the Portland Surgical Hospital, where an operation for cancer of the stomach proved unsuccessful. Mr. Barlow, who so admirably conducted the affairs of the Stradivara Co., was fifty-three years old and up to the time of his leaving for the hospital remained at his office working up to the very last minute. An estimable citizen, a model husband and father, his passing is deeply regretted by all his friends, who sincerely sympathize with his widow and family. Mrs. Barlow and daughter Ruth reside in Portland. His son, Howard Barlow, is a well-known musician of New York City.

ARTISTIC FOLDER FROM BIRMINGHAM

From Thomas Large, "Advertisement Consultant and Business Creator," 49-50 George street, Basall Heath, Birmingham, England, we are in receipt of a very artistically designed and handsomely printed folder devoted to illustrations and descriptions of Mead cabinet gramophones. The typographical work is of an unusually fine character, and the entire production reflects credit on the Mead Co. and on all interested in the creation of this publicity.

Preliminary announcement has just been made by Thomas A. Edison, Inc., that the Edison phonograph magazine advertisement and window displays for December will be illustrated by a striking photograph of Sergei Rachmaninoff, the celebrated composer-pianist, taken while he was playing the "Second Hungarian Rhapsodie" in unison with the Re-creation of the same composition played by him on the new Edison.



In each community are great possibilities with Victor.

Behind the dealer working to realize those possibilities, is our whole strength.

Elyea Talking Machine Co.

Atlanta, Georgia

Exclusively Victor

Strictly Wholesale

New Comfort Talking Machine

"Supreme in durability, beauty and tone"



Designs that are the products of genius, a delightful sweetness of tone, and an unexcelled service have combined to boost New Comfort sales over 1000% since December, 1919.

The New Comfort possesses lines that are extraordinary for their simplicity, yet perfect gracefulness. Nineteen models—to fit every taste, and pocket book, give New Comfort dealers opportunities for unlimited expansion through our direct-from-the-factory selling plan.



MODEL E



MODEL 80



MODEL D17

"Known for Tone"

Two of our most popular models sent to you upon request, without any cash outlay on your part.

A beautiful Illustrated Catalogue with our proposition to Dealers sent upon request.

New Comfort Phonograph Records will be announced shortly.

The New Comfort Talking Machine Company

General Offices: Cedar Rapids, Iowa

EASTERN OFFICES: 106 Bakewell Bldg., Pittsburgh, Penna.

The
"Caviness"
 Phonographs
 De Luxe

*
QUALITY
FIRST
 *

This Means
Tone,
Material and
Workmanship
 *

Made in the
Finest Grades of
Mahogany and
Walnut

PRICES REASONABLE
 Correspondence Solicited



Patents applied for on designs

THE CAVINESS TALKING MACHINE CO., Inc.
 BATTLE CREEK, MICHIGAN

Not an experiment.
 We have been building phonographs for a particular class of people for several years.

These instruments are equipped with Electric or High-Grade Spring Motors.

Several beautiful designs.

They have the conveniences that make them the most complete phonographs possible.

Write for complete information, booklets, circulars and prices.

REINCKE-ELLIS CO. TO SELL BINGER WINDOW DISPLAYS

Has Arranged to Act as Sales Representative for the Binger Window Displays for Victor Dealers—Various Display Features Now Being Sent Out and Others Being Prepared

On Friday, October 22, in the private office of L. C. Crone, president of the Binger Co., located at 45 West Thirteenth street, New York City, Arno B. Reincke, president of the Reincke-Ellis Co., of Chicago, and Mr. Crone entered into an agreement whereby the Reincke-Ellis Co. will hereafter act as sales representative of the Binger Window Display for Victor dealers.

This Binger display consists of twenty-six different complete displays for the Victor dealer's window. These productions are essentially Victor in atmosphere and are made up in such a way as to be most attractive and timely. They will cover such subjects as the exterior and interior of the Metropolitan Opera House, the Victor Co.'s plant in relief, a timely Christmas window, and a number of other subjects which will appeal directly and successfully to all who have occasion to pass the stores and windows of talking machine dealers.

The Binger Co., under the personal supervision of Mr. Crone, has, for many years past, produced window displays in many varied lines

of endeavor. It is at present producing window display material for the leading manufacturers of several lines of merchandise.

The Reincke-Ellis Co. has long been well and



Arno B. Reincke and L. C. Crone Closing Arrangements in Latter's Office

favorably known as a modern, up-to-date concern producing many forms of sales stimulants for Victor dealers which are conceived along original lines, and which make a strong appeal to progressive dealers.

AEOLIAN SHOP OPENED IN ST. PAUL

Leavitt Music Co. Featuring the Vocalion in Most Elaborate Quarters

ST. PAUL, MINN., November 1.—The Leavitt Music Co., which opened for business in the Hamlin Building, this city, early in September, has already made its presence known in the local trade. The company has most elaborate quarters known as the Aeolian Shop, which are arranged with special attention to the requirements of the business. The main floor is used for the demonstration and display of Vocalions and records, and is equipped with several hearing booths done in ivory and finished with blue drapings and rugs. French windows add to the general effect. The balcony is finished in ivory and mahogany, Colonial style, and has room for a large display booth and the offices.

T. S. Leavitt, formerly manager of a talking machine department in one of St. Paul's large stores, is manager of the Leavitt Music Co., and associated with him are Jules Frankel and George N. Allagher.

OPENS STORE IN CHRISTOPHER

The Southern Illinois Music Co. has opened a store in Christopher, Ill., at 110 Market street. This is the third store opened by this company in the last few years. Miss Harrison is manager of the new store and will devote her entire time to the selling of the New Edison phonographs for which this firm has the agency.

A. H. WILLIAMS MARRIED

On October 24 Abe H. Williams, of Williams Music House, Birmingham, Ala., married Miss Frances Adell Selkowitz, of Norwich, N. Y. The wedding took place in one of the private suites of the Onondaga Hotel, Syracuse, N. Y. Besides the relatives of the bride and groom, many of Mr. Williams' business associates were present.

LYON & HEALY**Everything Known in Music**

Don't Let Statistics Retard Your Efforts

It is said that every fourth baby is a Chinaman and that every other old man is far from robust, but this should hinder no one from establishing his own Vine and Fig Tree.

It is true that many music stores in the past have met with small success, but this has not much bearing on the matter, because a music store dealing in first-class goods and conducted with first-class ability has few peers as a life's enterprise.

Any local merchant can aspire to be the most prosperous small musical instrument dealer of his town.

Music is becoming more and more of a necessity. Music in the home is almost universal. The time is here when the dealer can handle small musical instruments most successfully.

Suppose you write to us in a general way about improving your profits on small goods. Give us an idea of your present stock and tell us frankly what obstacles you find in the way of building up your business.

This season we are arranging to supply the best advertising cuts that money can buy, free of charge to merchants handling our small goods. Also our Advertising department will send a regular monthly service to dealers who appreciate that the newspaper can and should be made the merchant's biggest salesman.

Wabash Ave. at Jackson Blvd.
Chicago



FOUNDED 1864

STIMULATING INTEREST IN MUSIC IN SAN FRANCISCO

Musical Season Brings With It Demand for High-Class Records—Columbia Co. Arranges for Appearance of Singers—New Stores Being Opened—Many Stocks Still Low

SAN FRANCISCO, CAL., October 30.—The general business aspect of San Francisco and vicinity is very lively, yet the music dealers report that demand for musical instruments is not up to expectations. The public is buying most conservatively in the expectation of lower prices. It is the hope of many to see a general reduction in all lines following the November elections. On the average there is a good volume of business with the leading phonograph departments, however, so apparently there is no danger of a slump. Stocks are too low as a rule to cause the dealers much apprehension for the future. The demand for high-class records has materially increased in San Francisco as the result of the recent engagement of the Scotti Grand Opera Company. The several record manufacturers have been featuring records by the principal singers of the company, and as most of these singers were unfamiliar to the Pacific Coast music lovers there was naturally a desire to have the records. The demand for popular song records and jazz pieces is still brisk, and the sale of high-class machines is holding up. Instead of being cut, the price of some machines has been raised—the Brunswick, for example.

Columbia Co. Will Supply Singers

The Columbia Graphophone Co. is carrying on a splendid educational campaign on the Coast in co-operation with Columbia dealers. The company supplies singers to dealers who wish to give tone tests at phonograph concerts and also stage settings and attractive advertising matter. The concert programs are usually arranged by J. Longfeather, who has charge of the recital work of the Columbia company in this territory. Mr. Longfeather is at present traveling about the State in the interest of the Columbia concert bureau.

Andrew C. Love Married

The trade is interested to learn this month of the marriage of Andrew C. Love, formerly located with the San Francisco branch of the Columbia Co., and Miss Hazel Leighton, who was recently connected with the talking machine department of the Fresno store of the Wiley B. Allen Co. Mr. Love is now covering territory in the San Joaquin Valley for the Columbia.

"Whispering" Wins Great Favor Here

"Whispering," one of the recent song hits published by the sheet music department of Sherman, Clay & Co., has just come out as a Victor record and is having a lively sale in California. The talking machine department of Sherman, Clay & Co. is normally busy, and the wholesale Victrola department is handling the Coast business with more facility than for some time. Dealers may hope for normal conditions in regard to Victor merchandise in the near future.

Sees No Reduction in Price

The Wiley B. Allen Co. does not expect any price reductions on talking machines this Fall. Prices have been raised somewhat on Brunswick machines and there are rumors that other goods will be advanced a little before the holidays.

Alice Verlet to Give Tone Test Recital

San Francisco music lovers will have the opportunity early next month to hear some fine Edison tone-test recitals by Mlle. Alice Verlet, the well-known soprano from Belgium, whose selections in the Edison records are growing so popular out this way. The first recitals will be under the direction of G. A. Einselen, one of the leading phonograph dealers in the San Francisco Mission district.

A Visitor From Honolulu

William D. Adams, of the Bergstrom Music Co., Honolulu, is visiting the mainland buying supplies for the company's talking machine department. The concern has a large market for machines among the employes of the sugar plantations. Fred L. Christianer has just been in San Francisco again, this time to arrange for placing his line of "Blue Bird" phonographs in the new

talking machine department of Heine Piano Co. W. F. Anthony, of the Seattle office of the Columbia Graphophone Co., and W. W. Stadin, manager of the Los Angeles branch, visited the Coast headquarters in San Francisco this month.

Cremona to Enlarge Plant

L. E. Gilham, manager of Cremona Phonograph Co., of Albany, Ore., has made announcement of plans for enlarging the manufacturing plant next year. It is expected that the capacity of the factory will be doubled. The present output is seventy phonographs daily. The Cremona line is very attractive and the demand for the machines is growing fast.

H. C. Russell Opens in Fillmore

H. C. Russell, a well-known music dealer of California, has just opened a new establishment at Fillmore. He is featuring the Brunswick phonograph. Before coming to Fillmore Mr. Russell was in the music business at Santa Paula for four years.

Promise Twelve-inch Okeh Records

The General Phonograph Corp. is to put on the market a complete line of twelve-inch records shortly, says J. M. Abrams, manager of the wholesale and retail talking machine departments of Kohler & Chase. The new records will be used principally for the longer classical selections. The Okeh records enjoy a steady and growing demand on the Coast. The Kohler & Chase Co. have on the floor some new period models of Burnham phonographs. The instrument is in the form of a William-and-Mary table of exquisite design.

Various Items of Interest

Gus. A. Einselen, Jr., recently celebrated the opening of his new store at Mission and Twenty-second streets. He has added two more salespeople to his force and also has purchased another delivery truck. The store at Mission

Well Rated Dealers
Can Discount Their

PHONOGRAPH INSTALLMENT CONTRACTS

WITH US

Thereby Turning Their Accounts
INTO WORKING CAPITAL



and Twenty-ninth streets, where he began business eleven years ago, is being remodeled. With both stores in first-class shape Mr. Einselen expects to be in a position to adequately care for his growing trade in the Victor and Columbia lines.

Popularity of the Magnavox

Byron Mauzy is making good use of his Magnavox agency. When lending phonographs for public or charitable functions he has found that by supplying also a Magnavox the results are wonderfully satisfactory.

Makes Successful Tour of the Trade

Horace Hull, who has charge of the Aeolian Vocalion destinies on the Coast, has just been making a tour of his territory in the Northwest for the purpose of placing his line with high-class dealers.

N. F. Milner, who was San Francisco manager for the Columbia Co. just before N. J. Wilcox, has returned to this city from a trip to Honolulu. He has not yet actually started on his proposed tour of the world.

M O D E R N O L A

The instrument unique

M O D E R N O L A

A home delight to Ear and Eye

M O D E R N O L A

Beauty—Tone—Utility

M O D E R N O L A

Satisfaction for dealer and customer

Send your orders now for holiday trade. Apply immediately for agency.

Exclusive Eastern Distributors

**EASTERN PHONOGRAPH
CORPORATION**

**GEO. SEIFFERT
PRESIDENT**

Office and Showrooms:

101 West 20th Street
100 West 21st Street

Corner Sixth Avenue, New York

Telephone Chelsea 2044



OUR TURN NOW

Mr. Victor Dealer

Generally speaking, Victor distributors and dealers, during the past few years, have concerned themselves chiefly with a shortage of production on the part of the factory. The trade's obligations were treated lightly. Initiative, progressiveness, loyalty and responsibility marked time in some cases, or even ceased to function, the excuse being that the Victor trade must first have adequate factory production.

Regardless of mushroom competition, the Victor factory has been loyal to its distributors, and they in turn have avoided the establishment of new accounts during the great shortage.

Victor production today is greatly increased in Victrolas, and the record shortage will be speedily relieved, if not overcome.

It's our turn now, Mr. Victor Dealer. It's time for the factory to question *our* production if we are not measuring up to our responsibilities and opportunities. We must be "on our mark"—ready, fit and worthy representatives to maintain Victor Supremacy.

We, as distributors, feel it our obligation to create and maintain among our Victor dealers quality rather than quantity.

It is our turn now, to handle so intelligently the greatly increased Victor production, that competition will be the worry of the other fellow.

Consider seriously, Mr. Victor Dealer, the present character of your Victor representation. Does it deserve the fullest support, or is it inviting competition? The show-down period is here.

It's our turn now to show the Victor factory that the present Victor representatives will meet all their obligations.

Write or consult us, Mr. Victor Dealer, for it will be a part of our service to help you and advise you in every way possible.

J. NEWCOMB BLACKMAN.

Blackman
TALKING MACHINE CO.
81 READE ST. NEW YORK N.Y.
VICTOR DISTRIBUTORS - WHOLESALE ONLY

ELECTION AND LATE FALL AFFECT TRADE IN MILWAUKEE

Cooler Weather Will Be Much Appreciated by Dealers—Sales Campaigns Getting Results—Wholesalers Now in Good Position to Furnish Stock to Dealers—General News

MILWAUKEE, Wis., November 8.—With the intense strain imposed by the Presidential election relieved, and the public consciousness of the rapid approach of the holidays thoroughly awakened by the strenuous efforts of the trade, talking machine dealers find that there is a perceptible betterment in business in comparison with a month ago. The month of October, at least until the final days of the period, was wholly unseasonable in climatic conditions, temperatures ranging up to 90 degrees being common. A turn to a more accustomed Fall season came as October drew to a close, and it was immediately noticeable that business was infected with a better spirit.

One outstanding feature of the recent past which is worthy of special comment is the fact that in Milwaukee the talking machine trade did not make a grand rush to follow the lead set by automobile dealers in depressing selling prices sharply. There were one or two instances where some local houses advertised reduced prices, but these were isolated cases. The rank and file of dealers is standing pat on the price question in order that they may continue to do business at a reasonable profit margin over costs. There has been no call for selling instruments at cost or below cost as in some other lines where financial considerations or other angles of the situation have made it necessary or desirable to liquidate stocks even at a sacrifice.

Stocks in the hands of talking machine dealers here average higher than a year ago, but a comparison is hardly fair when it is considered that a year ago the manufacturers were still struggling to get back to a peace basis and also to overcome an avalanche of unfilled orders. The wholesale trade, however, reports that buying by dealers has been improving right along, as a reflection of a better demand from the public. Jobbers feel that before Christmas there

will be a rather determined rush for instruments because the present margin of stocks seems hardly adequate to meet the expected demand from this time forward.

"Our business is very satisfactory and we look for a marked increase in requirements during the coming four or five weeks," said Harry A. Goldsmith, secretary of the Badger Talking Machine Co., Victor jobber. "Trade in Victor records has been remarkably good, considering conditions. We have not been able to fill all orders promptly, but we are hoping that we will be able to overcome this shortage. Our record department will show a very material increase in volume this year, compared with any previous year. So far as the Victrola itself is concerned, we have no complaint to make. We have made gains every month over corresponding periods last year."

Charles J. Orth, distributor of the Puritan in Wisconsin and Upper Michigan, is well fortified to take care of his growing trade, having accumulated stocks since last Spring in anticipation of a brisk demand during the Fall and holiday seasons. To handle his stocks of Puritans as well as merchandise for his large retail piano store, Mr. Orth took over an additional warehouse, making three in all, located at 112 Huron street, 152 Fifth street and 233-239 East Water street.

The Yahr & Lange Drug Co. expresses the utmost confidence over good business for the rest of the year, which is based on a constant increase effected during the first ten and a half months. This house distributes the Sonora in the Wisconsin and Upper Peninsula territory and its diligent efforts have resulted in making the name Sonora virtually a household word in all parts of the State. Milwaukee retail Sonora dealers are enthusiastic over past business as well as prospects for holiday trade.

The Columbia dealers are continuing a noteworthy campaign to popularize the Grafonola to the same extent as the Columbia record. The dealer trade in Wisconsin has been built up to a most imposing size in the last six months and now embraces some of the largest and best known merchants of this territory.

H. M. Hahn, manager of the Paramount department of the E. R. Godfrey Co., says that both the Paramount instrument and Paramount records are gaining larger hosts of friends in Wisconsin, the State which produces this line, as well as in Illinois, Michigan, Indiana and Iowa, the other four States in which the Godfrey Co. has exclusive distributing rights. The factory at Port Washington, as well as the recording laboratories in Grafton, Wis., have been enlarged steadily to meet constantly increasing trade requirements and for the present the shortage has been largely overcome. It is expected, however, that the holiday season will bring some demands that will stretch production to its utmost limits.

The Singer Talking Machine Co., of this city, has effected a material increase in its production facilities, following the reorganization of the business into a corporation during the past month. C. A. Kitz, founder of the business, continues in control of the ownership and management. The adoption of a corporate form and other measures to facilitate the expansion of the business promise to make this one of the most important talking machine manufacturing interests in Wisconsin.

The Badger Music Shop, Fond du Lac, Wis., recently held its formal opening. The concern was formed in May to take over the old-established business of the W. E. Fox Music Co., and spent several months in rebuilding, enlarging and equipping its store. It now features the Victor line and also carries a complete stock of pianos. E. R. Sweeney, one of the best known men in the Wisconsin jobbing trade, is vice-president and general manager. L. C. Parker, head of the Badger Victrola Shop in Milwaukee. (Continued on page 136)

What is the DEALER'S Profit?

A question which every dealer asks and one which has been carefully considered in the producing of

**WESER
PHONOGRAPHS**

Not only is the dealer assured that mechanical perfection, workmanship and finish which musical instrument makers of forty years' experience alone know how to produce, but also a liberal profit.

WE ARE SURE OUR PROPOSITION WILL INTEREST YOU

WESER



BROS., Inc.

520-530 WEST 43rd STREET

::: ::: ::: ::: :::

NEW YORK



THE TRADE OUTLOOK IN MILWAUKEE
(Continued from page 135)

kee, is president of the Fond du Lac company. The A. J. Farnham Co., of Milwaukee, was incorporated recently with \$10,000 capital by A. J. Farnham, Albert S. Frank and G. B. Hancock to deal in the Ediphone dictating equipment. The store and offices are located at 373 Broadway.

Twelmeyer Bros. Co., of Milwaukee, is the name of a new corporation organized with \$10,000 capital stock to take over the Edison business conducted for several years by Otto A. Twelmeyer, jeweler, 3409 North avenue. Herman C. Twelmeyer is associated with him in the new enterprise.

Edward Kupper, a leading North Side jeweler in this city, has established a Columbia department incident to the removal of his business to new and larger quarters at 1071 Teutonia avenue.

The Aeolian-Vocalion line, represented in this city and vicinity by Edmund Gram, has become one of the best known among the higher-class talking machines, under the energetic direction of Miss Julia Wolff, manager of the department. The Aeolian record is having an especially good call locally.

Mrs. A. G. Kunde, wife of the pioneer Columbia dealer at 516 Grand avenue, Milwaukee, recently "mothered" a party of Columbia representatives on a trip of inspection to the Bridgeport factories and later to New York City to visit some of the metropolitan Columbia stores and witness recording in the laboratories.

The George H. Eichholz Co., a leading Victor and Edison dealer, reports one of the best Fall seasons in its long history and expresses the confidence that the business during November and December will break all past holiday season records. One of the activities to which is attributed considerable of the success of the store is street car advertising, which the company is continuing with striking "copy" at this time.

Among the exhibits at the recent Milwaukee Food, Household and Electrical Show at the Auditorium were talking machines exhibited by

Personal Service

- G. F. RUEZ
Pres. and Treas.
- H. A. GOLDSMITH
Secretary
- S. W. GOLDSMITH
Vice-Pres. and General Mgr.

The members of our company are always available and will gladly see you personally or write you at any time we can possibly serve you. Get acquainted with the Badger brand of personal service.

Badger Talking Machine Company
Exclusive Victor Distributor
135 SECOND STREET MILWAUKEE, WIS.

the following: United Phonographs Corp., Sheboygan, Puritan; Paramount Phonograph Co., Port Washington, Paramount; Colonial Phonograph Co., Sheboygan, Colonial; Plymouth Phonograph Co., Plymouth; Kesselman-O'Driscoll Co., Edison and Victor; Frank Preuss Co., Edison; Lyric Music Co., Kimball; Luebtow Music Shop, Sonora; Fischer Furniture Co., Cheney; Cooper Music Shop, Emerson.

CLEVER NEW HOUSE ORGAN ISSUED

"Melodie" Is Title of New Monthly Booklet Issued by Granby Phonograph Co. to Be Distributed by the Company's Dealers

The first issue of "Melodie" has just come off the press. It is an attractive eight-page booklet which will be issued each month by the Granby Phonograph Co. of Norfolk, Va., and, as its name implies, is devoted to things musical. This booklet will be supplied to Granby dealers in quantities each month for their mailing lists and will serve to keep the Granby phonograph and its features ever before the attention of the music loving public.

From a typographical standpoint this new booklet is in entire keeping with the high quality of other Granby literature. It is printed on super-quality stock and a careful selection of type with a harmonious blending of colors makes it attractive to a high degree. The opening

article is devoted to Antonio Stradivari and his great accomplishments. Other equally entertaining articles treat on "Folk Songs," "Modern Musical Instruments," and "The Power of Music." The booklet concludes with a list headed "Recent Records Worth While," and contains a varied selection of orchestral, dance, instrumental, operatic, classic and popular song records selected from the monthly lists of a number of the well-known records. It is planned to publish this list each month as a suggestion to Granby owners.

ROEMMELE BROS.' NEW QUARTERS

Roemmele Bros., who have done a successful Victrola and sporting goods business for six years at the southeast corner of Jamaica avenue and 109th street, Richmond Hill, New York, have moved into their own building, diagonally across the avenue, where floors have been fitted up for the business. Ten modern sound-proof booths have been provided and all conveniences for customers installed. Roemmele Bros. declare the new store is one of the most completely stocked and best equipped Victor agencies on Long Island. The opening of the new warerooms occurred on November 6.

The best things in life are not handed down; they are pulled down by the man who goes after them.

OKeh Records

MAMIE SMITH

Exclusive
OKeh Artist

OKeh Records

It's Mamie Smith's blues songs that are creating an unheard-of demand.



MAMIE SMITH AND HER JAZZ HOUNDS

The desire of a nation backs them. Give them the best blues songs ever recorded.

We give immediate delivery upon receipt of order. Don't regret lost opportunities. Mamie Smith is the biggest one of the day. Fill your shelves and the demand.

IT'S BIG

4113 ^{10 in.} \$1.00 { **That Thing Called Love**—Mamie Smith with Orchestra.
You Can't Keep a Good Man Down—Mamie Smith with Orchestra.

4169 ^{10 in.} \$1.00 { **Crazy Blues**—Mamie Smith and Her Jazz Hounds.
It's Right Here For You (If You Don't Get It —'Taint No Fault O'Mine)—Mamie Smith and Her Jazz Hounds.

Kennedy-Green Company
1865 PROSPECT AVENUE
Cleveland, Ohio

WADE

OFFERS A BETTER VALUE TO THE DEALER—TO THE CUSTOMER



SHOWING THE BEAUTIFUL FLUSH TOP

Two Sizes—No. 225—Height, 51", Width, 23", Depth, 25"
No. 175—Height, 48", Width, 21", Depth, 23"

Highest grade double spring motor. Will play 4 to 5 records with one winding. Equipped with electric light, enabling the user to see the edge of record at all times. Fletcher-Wickes tone arm and reproducer with adjustment to play all records at their best. Double braced all wood tone chamber. Perfection in quality, design and finish.

LIST PRICE

No. 175—\$175.00. Our price to you only \$ 87.50
No. 225—\$225.00. Our price to you only \$112.50

*Order at this price at once for your Holiday Trade.
Don't miss this liberal offer.*

Wade Talking Machine Co
WHOLESALE DISTRIBUTORS.

12-20 NORTH MICHIGAN AVE.

**50% DISCOUNT
ON SAMPLES**

REALIZING from our own experience the position in which the dealer is placed—the fact that the busy season is about here and many other reasons preventing your visiting our warerooms at this time—we make this unprecedented offer on a machine which comparison will show to list for a great deal less. Take into consideration the high class equipment, workmanship, style and finish. Order at this price immediately.

**TWO SIZES ONLY IN THIS LINE
THE BEST SELLERS MADE**



Perfection in Design, Quality and Finish. Oak and Mahogany.

CHICAGO, ILL.

THE MID-WEST

WESTERN DIVISION OF THE WORLD, CHICAGO, NOVEMBER 8, 1920.

WE do not always agree with our Eastern friends, but sometimes the busy boys down on Manhattan Isle and adjacent suburbs do something wise. One of the wisest things any of them ever did was to pass that resolution the other day about the excessive use of what is called "jazz" in popular music-rolls and records. Of course, some will say that the Music Merchants' Association of New York are simply hurting themselves by interfering in the public's demands. Others more wisely will hold that when a certain fad goes past a certain point, it is always likely to meet with a very sudden check which will have the result of leaving the trade overstocked with unsalable goods. The fact is, of course, that too much of a good thing is just as bad as too little of it. We have had too much of an insistence upon one certain kind of popular music and in consequence have been running the risk of losing the good-will built up by previous years of careful attention to the better kinds of music. The talking machine trade has in the past been distinguished for its wonderful work in bringing great music to the people, and there has always been considerable regret among the well-wishers of that trade in that the last year or so should have witnessed so marked a degradation of taste amongst dealers and salesmen. Of course, the jazz craze was natural enough as a war-product, but it cannot permanently survive. If it should continue to grow in popularity it must in time destroy the art of music, and to destroy the art of music would be to destroy the talking machine business. It is a perfect circle, whichever way one traces it. It would be much better to take time by the forelock and intelligently anticipate the change in popular taste which is already clearly foreshadowed. Jazz is passing, let us be prepared.

A Fad
Is
Passing

THOSE who are alert to discern the signs of the times note with interest that there appears to exist quite a determination on the part of inventors and researchers to develop new ideas in the way of soundbox manufacture. No one has yet invented what may be termed a perfect soundbox. In fact, there would be much reason for sorrow if one could be sure that the end of improvement in respect of the soundbox were in sight. It would be a pity if one could not feel sure that there would be steady and constant improvement. That is why we are always glad to observe the progress of new ideas and new researches. It looks as if during the next year or so we are going to see on the market some quite revolutionary devices for transmitting the motions of the stylus to the air column connecting with the atmosphere. There is no doubt that one definite defect in all sound-reproducing devices is to be found in their tendency to produce definite tones of their own, owing to the stiffness of their material or for other constructional reasons. One of the directions in which future research must work its way is here. We must eliminate the auto-period, if so it may be called, of the diaphragm, and it may be that the solution to this problem will be found in the adoption of some entirely new material. This, of course, is not at all certain. It is not even especially probable. What is likely, however, is the gradual discovery and development of a method for transmitting the motions of a stylus without auto-period or intruding mechanical process-sounds direct from record to atmosphere. Some good work along these lines is already being done and the future holds very much of promise.

Need
Research
Direction

WHICH reminds us. The world do move indeed. A few years ago it would have been rather a poor joke to suggest that the talking machine trade needed or ever would need salesmen or merchants technically or even artistically acquainted with the nature of tone. Yet to-day those who can see below the surface of things recognize that the day has come when this knowledge is to be decisive. Whatever salesmen may have thought in the past, to-day those who can observe and draw correct conclusions from their observations

Quality
Is
Tone!

know well that the people are asking for quality in a way never before heard of. Now in this talking machine trade of ours we have come to something like a crucial point. The flurry of two years ago, when anything and everything that would make a noise was being offered as a talking machine, has completely died down. Competition is strenuous and growing more so each day. It is not a question of price, but of quality. A good deal of inquiry amongst merchants in Chicago and the Middle West leads us to believe that the people are not worrying about prices. Those who, instead of whining, are going strenuously after business are undoubtedly getting business. What is needed is not lower prices, which in any case cannot properly come down, but higher quality. That is why the merchant of to-day ought to learn something about tone. For, in the end, what else than tone is he selling when he sells a talking machine? He is not selling furniture. He is not selling prices and terms. He may imagine that these two latter incidents to a talking machine represent the matter of sale, but in that case he is wrong. In the end and at the bottom of all the feeling in the mind of the purchaser lies this feeling for tone. The purchaser wants music and music is measured, in a talking machine, by tone. That is why the merchant who wants to build a permanent business must build it on quality and not on price.

THE further one goes down the line, as it were, the stronger becomes the conviction that the basis of our business for the present Winter and the next year must be sought in improved workmanship, finer tone and better quality all around. The future of the talking machine rests upon its ability to maintain the claims that have been made for it. If those claims turn out to have been ill-founded, there is no doubt whatever that the talking machine business will decline. It will decline because the public desire for and interest in the talking machine will not have been founded upon the rock of quality and truth. There has been a very great wave of temporary enthusiasm for the talking machine, and under cover of this many machines have been made and sold under doubtful conditions and with the complete certainty that their inherent defects would sooner or later come to the surface, with resulting dissatisfaction and bad feeling all around. To-day we have to overcome the unfavorable after-effect of all that sort of thing; and we can only do so by setting out resolutely towards the goal of quality, quality ever higher and ever more accessible to the masses. Those who expect to succeed in the talking machine business of the future must be those who can make and sell to the masses of the people a reliable talking machine of high quality and fine tone at moderate price. That is the machine of the future. But it must be genuine. It must be built on honor. It must have been developed through real knowledge of sound-reproduction and not through the dreams of half-educated enthusiasts who have never taken the trouble to study the subject. Invention is never made through dreams or enthusiasm alone. The dreams and the enthusiasm are doubtless necessary, but they are merely the background. The vague thought must be realized in practical fact, must be manifested in tangible form; and this can only be when the dreams and the enthusiasm are backed up by patient research based on patiently acquired knowledge. That is why we need a school of tone-students in the trade.

The
Quality
Year!

THERE is something rather amusing sometimes in watching the barometer and thermometer in the vicinity of the large and hustling city in which these words are written. When we say "amusing" we mean just what we say. Not because the weather has been pleasant, for it most decidedly has not, but because the inspection of the recording instruments aforesaid has disclosed to our critical faculties the interesting fact that the dear people are guided in their buying very largely by the antics of the needles, mercury columns and other mysterious dinguses (or is it dingi?) which attach to weather glasses in general. In a word, as long as the astonishing

Breezes
and
Biz!

POINT OF VIEW

prolongation of Summer weather which we have been witnessing continued to prevail, the dear public resolutely stayed away from the shops and refused to put out its coin for talking machines or for anything else. Even the dear girls stopped buying expensive lingerie. But as soon as the weather took a turn for (from our point of view) the decidedly better, when, in short, Jack Frost sent forth advance signals of his approach, buying began to start up again everywhere, and especially in the music industries. Which perhaps is another way of saying that the dear people are much more sweetly inclined to the talking machine than they usually are supposed to be during these latter days, but that they like to choose their own weather. Which again may cheer up our pessimists.

SOME of our friends will note, we hope, with much satisfaction that various of the Western manufacturers are taking the opportunity this month to present their claims even more strongly than usual through the columns of the Talking Machine World. This will be seen at once by anyone who will take the trouble to look through the Chicago pages adjacent to the columns in which this paragraph appears. Such manufacturers are simply showing that they realize with the greatest clearness the secret of good business in the midst of doubt and even pessimism. Instead of lying down and crying, they are standing up and shouting. They are shouting louder than ever and they are determined to place themselves at the top of the heap. In fact, from our observations we may say pretty definitely that those who are steadily plugging for business are steadily gaining business. That is just what we like to see.

WE noticed our good friend, E. C. Howard, who represents the Granby lines these days, permeating the local trade with his perennial smile. E. C. is a bright boy any way you take him, and one of the brightest of his qualities is his good taste. He has never been connected with a talking machine enterprise which has not from the start reflected the best of taste in design, architecture and general appearance as well as in workmanship and material. We have been looking at the Granby line and find that our old friend has not changed his methods. He is going to do fine work, we believe, in the new enterprise and we hope that he found all the Chicago dealers as kind to him in a business way as they certainly were from a more personal point of view.

HERE is a point worth considering, even if it has nothing directly to do with the talking machine trade. We say "nothing directly," but indirectly a good deal. At the Piano Club the other day the members were addressed informally by Master-in-Chancery Behan, who is a very well-known Chicago attorney and a very well-informed man. The Master made a witty and withal pungent little speech. Among other things he spoke about jury duty. He said that the weakest point in the administration of criminal justice (and for that matter in civil causes where jury trial is provided for) is to be found in the character of the jurymen themselves. Business men, said he, usually seem to do their utmost to escape jury duty, considering themselves lucky when they can satisfy the bench that they have a good excuse. But, said Mr. Behan, what is the result? Simply that the administration of justice becomes farcical when juries are composed of the least intelligent elements in the community. The speaker mentioned that during a recent trial of a damage suit against a local corporation it was discovered that the average weekly income per member of the jury was approximately eighteen dollars. Now, what sort of a jury could that have been in these days in point of intelligence? And why then should business men express annoyance when they find that they are treated to absurd verdicts in civil causes? A business house may at any time find itself the defendant in a suit for damages, or for what is technically called a "negligence" suit, brought by a customer, an em-

ploye or some other person, wherein the plaintiff alleges injuries physical or otherwise. When eighteen-dollar-a-week juries in this day and age (eighteen dollars to-day being worth nine dollars of, say, 1900) are rendering verdicts in negligence cases, the business man who finds that justice is denied has himself to blame.

WHICH again reminds us that the Piano Club of Chicago is to-day becoming a very hefty institution. It is not content to number amongst its members piano salesmen, merchants and manufacturers, but is now reaching out for the talking machine men as well. At a recent weekly luncheon we noticed the fair features of the Only William Wade, of the Wade Talking Machine Co., who, it appears, is a member in good standing and a hustler in all Club matters. At the annual meeting and dinner last month we had the pleasure of beholding also the classic features of L. C. Wiswell, of Lyon & Healy, whilst, if memory mistakes not, we have seen other talking machine men at various times sitting around the luncheon table. Now that the Piano Club has taken permanent station each Monday at the Illinois Athletic Club its meetings are better attended each time, and talking machine men who would like to join the very best bunch of fellows in the music industries of Chicago should not fail to get in touch with the energetic Jim Bristol (of Price & Teeple Piano Co., 218 South Wabash avenue), secretary of the Piano Club of Chicago. Dues, ten dollars a year, weekly luncheon meetings, daily luncheon table at the Stratford Hotel, monthly meetings and dinners with big program each time, six free seats in the best part of Orchestra Hall each week for the Saturday symphony concert: what more can you ask for the money? And the nicest lot of boys you ever met. Get in line, gentlemen, the Club wants all the live talking machine men it can get hold of.

SPEAKING of the Piano Club reminds us once more of Ray Miller, he of the six melody boys (the term "melody" being used in what might be called a Jazzwickian sense). It was Ray Miller who supplied the "noise" at the annual meeting of the Piano Club last month. And when we thought of the one the other just naturally done come to mind. What we find to say about the gentleman and his five colleagues just at present is based on a remark we heard him make the other day. He was saying that although jazz had made success for him he had concluded that the whole thing had pretty nearly gone far enough. Music, in a word, thinks R. M., will have to be "dejazzified" gradually. To this end the six are playing their music now so that not more than one instrument at a time is jazzing a melody, whilst the others carry the tune and the harmony in the legitimate manner. This is a step in the right direction and we hope our friend will carry it out further. But this is not all. We propose to say a word here about this matter of presenting the personality of performers to the buyers of records. The Millers have been giving concerts in the stores of dealers who sell Pathé, Okeh and Gennett records. The idea is good. Now, on the artistic plane, the Victor Co. takes a very good deal of trouble to keep its dealers informed of the concert-tour routes through the country of all the singers and instrumentalists who make Victor records. The intention, of course, is to bring before dealers the opportunities they have to put on special sales of Victor records made by some artist when the latter comes to town to sing or play. All this sort of work tends, of course, to associate the otherwise cold and lifeless record with the living thought of the artist whose creation it is. Naturally our buoyant friends, the Millers, are not being thrust into a class with the Carusos and the Galli-Curcis and the Florence Macbeths, Elmans or Kreislers, but in their way they are doing a work of considerable value to the trade. Let the people see the men and women who make the records which the people buy, and if possible let them see and hear those men and women in the music which they have previously engraved on the wax of the recording machine. It is a great scheme. May it be more and more taken up.

"It's Dogged As Does It"

E. C. the Inimitable

De Jure, and De Facto

The Merry Clubmen

Getting Close to the Musicmakers



STEGER

The finest reproducing
phonograph in the world



Model 506 \$295.00

BUILT along artistic, harmonious lines, a distinct creation of the wood-crafter's highest art, the Steger makes an eloquent appeal to every lover of the beautiful.

It is an exquisite adornment of the home—and more. It is the soul of music.

The masterful artistry of living genius finds in the Steger its most faithful medium of expression. Every beauty of score, every delicate shading of sound is as exact in its rich quality as if emanating direct from artist or instrument. It plays all records *correctly*.

This marvelous fidelity to original tone value is chiefly attributable to the patented Steger tone-arm and tone-chamber, triumphs of human ingenuity and skill.

Active dealers have found that the interest and appreciation of critically inclined buyers eventually center on the Steger.

You can make it a big asset of your business because of the quick turn-over—and because we can ship at once upon receipt of order.

**Desirable territory open. Write for
the Steger proposition
today.**

STEGER & SONS PIANO MFG. COMPANY

Steger Building, Chicago, Ill.



Model 505 \$220.00



Model 502 \$145.00



Model 504 \$200.00



Model 503 \$165.00



Model 501 \$115.00



Model 509 \$235.00



Model 500
\$95.00



Model 510 \$290.00

From our **CHICAGO** HEADQUARTERS
 REPUBLIC BLDG., 209 SOUTH STATE ST TELEPHONE WABASH 5774

EDWARD VAN HARLINGEN

WILLIAM BRAID WHITE

EUGENE F. CAREY

ARTHUR E. NEALY

A. SNYDER

CHICAGO, ILL., November 8.—The long-awaited change of conditions in the retail talking machine field has come at last and there is a steady increase in the sale of instruments throughout the mid-West. The predominant characteristic of present-day trade in retail stores is expressed in the one word—value. The demand for talking machines has again returned, but it is a demand created by a discriminating public, who wants dollar-for-dollar value in everything it buys.

The surplus stocks that marked the trade thirty or sixty days ago are fast being eaten up. The special sales have accomplished much in the way of absorbing the cheaply made instruments which drugged the market a short time ago. To-day the manufacturer and dealer with a good, honest, legitimate line need fear nothing on the score of a diminishing market if the sales organization is functioning properly.

The attitude of the public all along the line has changed, and while the change has not been marked by any sudden resumption of the wild buying of a year ago, it has, nevertheless, been noticeable throughout the mid-West trade.

State street is Chicago's great retail trade barometer. Here October showed a steady increase—in fact, it has been one of the largest months in the year. While the talking machine business has not shown the decided changes noticed in other lines of merchandise, still the effect has been felt in a small way, and if we are to judge by the other commodities sold by State street retail stores, the sale of talking machines points toward a steady increase.

The consuming public, which went on a purchasing "strike," so to speak, when prices were at the peak, is now buying more generously. The trade reports much discrimination on the part of customers—they are after good goods at good prices, and it is value above everything else that they are seeking.

As to prices. The wide variations that exist in other lines have succeeded in bringing the public to greater buying. Although the price of talking machines has not gone down and probably will not, at least for some time to come, the fact that prices have gone down in other lines of merchandise is having its effect on talking machine sales. The public is commencing

to get the impression that prices in all lines are being reduced. Of course, the public is not very familiar with talking machine costs, nor does it know that the materials entering into the manufacture of talking machines have not gone down appreciably in cost.

It is to be hoped that there will not be the disorderly deflation in the talking machine industry that has been evidenced in other lines of merchandise. Price deflation so far has been jumpy and jolty for the retailer. One of the head executives in Marshall Field's makes the following statement: "We have all heard much of orderly deflation. As a matter of actual fact, there is no such thing as orderly deflation, and we are to-day going through a period of very disorderly deflation in many lines of merchandise. For example, in the desire to realize cash with which to pay their bills and to pay their banking indebtedness many retail merchants throughout the country are selling merchandise at less than cost to produce and at less than its replacement value. This is what I call disorderly deflation, because the immediate result of such action is to frighten the manufacturer into reducing or curtailing his production at a most inopportune time."

Columbia Artists Here

The Chicago office of the Columbia Graphophone Co. during the past few weeks has been honored by the presence of a number of record artists who have had occasion to be in Chicago of late. The office was visited by Al Jolson, who played in "Sinbad"; Margaret Romaine, who came in from Lafayette, Ind.; Hulda Lashanska and her accompanist, Miss Rose Borne; Max Bradford, manager of Yerkes "Happy Six," playing in George White's "Scandals," and Art Hickman, who stopped long enough to say hello while en route for San Francisco.

Wyman Buys Out Babb

Wyman, Babb & Co., retail talking machine merchants, with offices in the Republic Building, Chicago, have dissolved partnership and Mr. Wyman has bought out the interests of his partner, Mr. Babb. This concern maintains branches in Austin, Ill., and Hammond, Ind., and for a number of years has done an excellent business in talking machines. Mr. Wyman will continue in business in the three above-named

locations, under the name of the Wyman Piano Co. Mr. Babb has announced no plans for the future as yet.

Newspaper Co-operation

Chicago newspapers of late have been carrying quite a number of classified talking machine advertisements. Some of the papers have been calling attention to the classified pages by small articles run on the feature page of the paper. One of these is entitled "Phonograph Nights" and reads as follows: "Phonograph nights are here; get pleasure insurance by having a phonograph ready to cheer, amuse or instruct you. See to-day's display classified ads."

This sort of thing is getting results in Chicago, and if the newspapers in other cities are not giving similar co-operation it's up to the dealers to suggest the above little stunts.

New Music Rolls on Market

The Columbia Music Roll Co., 16 South Peoria street, this city, is out with an initial announcement and a first-of-the-month bulletin of Columbia player rolls. The November bulletin lists a large number of word rolls and also a fine selection of instrumental dance hits, instrumental marches and instrumental blues. At the present time the catalog is made up almost entirely of popular musical comedy hits and no doubt a great deal of attention will be given to the higher types of music in the near future.

Woodard With the Paramount

C. J. Woodard, who for the past year and a half has covered the Central Western States as special representative for the Emerson Phonograph Co., has resigned his position and is now connected with the firm of E. R. Godfrey & Sons, of Milwaukee. Godfrey & Sons are jobbers for both the Paramount records and talking machines and represent this company in Iowa, Wisconsin, Illinois and Michigan. It is the intention of Mr. Woodard to open an office for Godfrey & Sons in Chicago and establish local warerooms. In his new connection Mr. Woodard will cover Indiana, Illinois and Michigan. He will also carry a stock of from 10,000 to 20,000 records, as well as a full line of phonographs, in order to accommodate emergency business that may arise as time goes on.

(Continued on page 143)

FIRST AND BEST

Sometimes the first in the field does not maintain the position of first in quality and prestige.

Such is not the case with the *Wade Fibre Needle Cutter*.

It was the first on the market but has been steadily improved and maintains today the dominant place it occupied years ago.

The Wade is made in our own factory, a fact insuring uniformity of product. It is literally the cutter of no regrets.

WADE & WADE

3807 LAKE PARK AVENUE

CHICAGO, ILL.

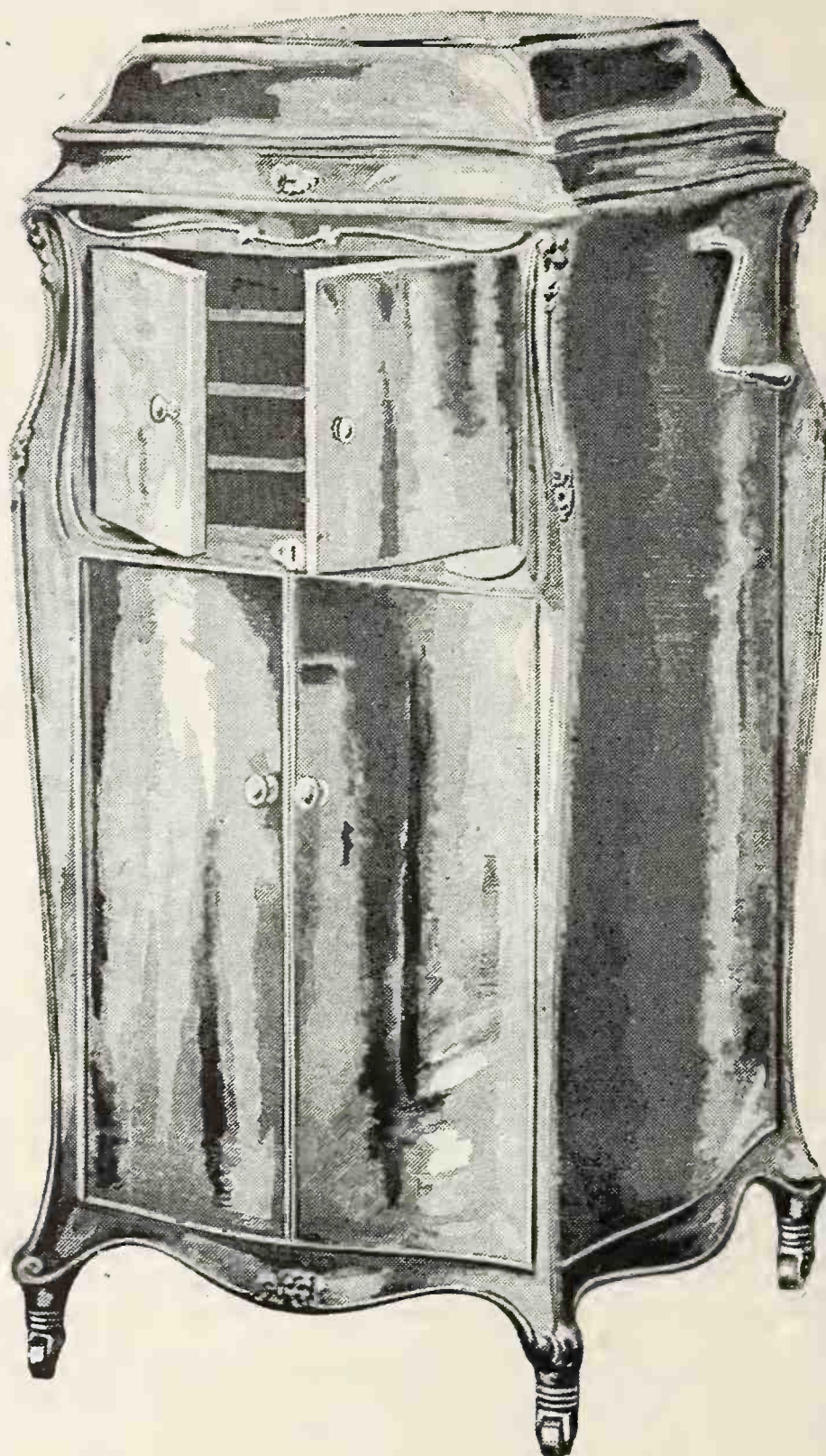

The Supremacy of the Victrola

Victor supremacy is a recognized and long established fact. So well recognized that to some the Victrola is synonymous with all makes of talking machines. There is no stronger evidence of this truth than the frequency with which customers enter a store other than that of a Victor dealer and ask to be shown Victrolas.

This exalted position in the public esteem has been won solely upon the merits of the Victrola as a superfine musical instrument.

The success enjoyed by Victor retailers eloquently testifies that the Victrola is supreme.

Lyon & Healy service to Victor dealers is worthy of the Victrola. It is of the same high quality, the same integrity, the same versatility. It, too, gives complete satisfaction.

LYON & HEALY

VICTROLA DISTRIBUTORS

CHICAGO

The Only *Non-Set* Automatic Stop

Based on the Pneumatic Principle

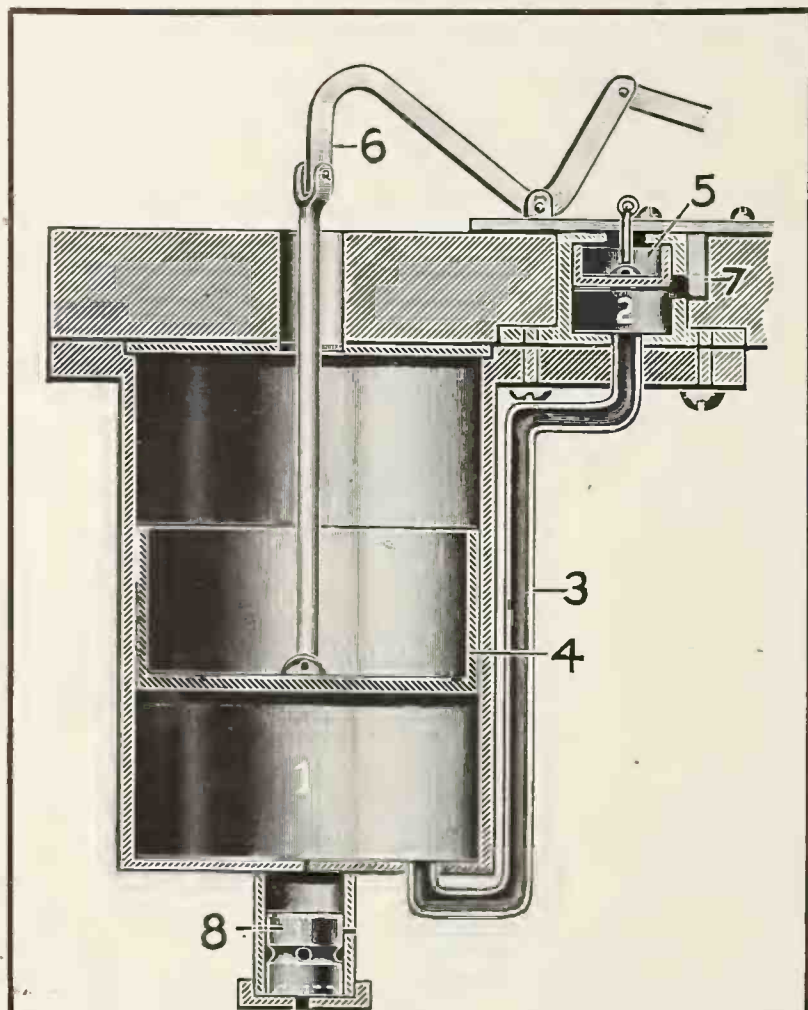

Method of Operation for Automatic Stop

Lever 6 is connected with tone arm and through connecting rod with piston 4. When tone arm moves in, piston 4 is pushed downward, and air in cylinder 1 is pushed through the tube 3 into cylinder 2, which in turn moves piston 5 upwards, and, being connected with brake, either opens brake or keeps it open, as long as piston 4 moves downward. Whenever tone arm stops moving inward, no additional air being supplied to cylinder 2, piston 5, on account of leakage of air between cylinder and piston, starts to move downward, and, being connected with brake, closes same, and thereby stops the motor. Any excessive amount of air can escape through port 7, which makes it possible to play any record, irrespective of its size, or its number of grooves, per inch. Figure 8 designates the intake valve, which lets the air come in. When the tone arm is swung outwardly, piston 4 in turn is moved upwardly. The pistons must fit loosely as a certain amount of air has to escape between the walls of the pistons and the cylinders.

The stop operates with air, at atmospheric pressure, and derives no power from the grooves of the record. It needs no attention after it is once installed; it need not, in fact, should not, be oiled.

which **starts** and **stops** the motor without previously setting it. It can be used on any machine except the Edison, and with any records, and is so simple to operate that no instructions are necessary.

This pneumatic principle, used here for the first time in an automatic stop for phonographs, has made it possible to design a stop at once simple in construction, and yet very sensitive and reliable in operation.

Patents have been allowed in the United States and foreign countries, and since this is the first automatic stop based on the pneumatic principle, it is well protected by basic claims.

An Opportunity

This is an exceptional opportunity for a big manufacturing organization which has the facilities and financial strength to handle a proposition of this size.

The demand for phonographs which can be automatically started and stopped will become universal as soon as the public is acquainted with this feature and no progressive phonograph organization can then afford to expend its efforts in attempts to sell an out-of-date machine.

Why manufacture against competition, when monopoly on a scale like this awaits you?

Patents for Sale Outright, or on a Royalty Basis

For further particulars, address **J. BRANDSTETTER**

4100 Lincoln Avenue

Chicago, Ill.

A Better Fibre Needle Cutter for Less Money

Send for a Sample and Convince Yourself

The ALTO



Retail Price **\$1.00**

ALTO MFG. CO.

3801 ROKEBY STREET

:::

:::

CHICAGO, ILLINOIS

DISTRIBUTORS

- THE AMERICAN SALES CO.
825 Hennepin St., Minneapolis, Minn.
 - I. W. BECKER & CO.
226½ Peachtree St., Atlanta, Ga.
 - MASON & WEIDENSAUL
Care of Daniels & Fisher Stores Co.
Denver, Colo.
 - LOUIS MERKI
150 Post St., San Francisco, Cal.
 - JAMES L. OLD
354 Chapin St., Toledo, Ohio
 - LOUIS A. SCHWARZ
1265 Broadway, New York City
- Territory open for distributors

FROM OUR CHICAGO HEADQUARTERS—(Continued from page 143)

selection. It is adjusted by setting a pointer at a number on the stop which is supposed to correspond with a similar number written on the record. It is quite simple in operation and easily adjusted. Ray Foute, of the General Phonograph Corporation of Illinois, is the inventor and is to be given the credit for having produced one of the best automatic stops of the day. Production has only recently been obtained, but a large number of orders has already been received. The stop seems destined to score considerable popularity.

Favorite Songs

The Chicago Tribune has a department called "The Inquiring Reporter," wherein every day a single question is asked on some subject of general interest. Last week the Tribune put the question, "What Is Your Favorite Song?" One would suppose that the answers to this question would include popular songs of the day, but this was not so. The majority of answers were old standard selections.

Club Activities Outlined

The Chicago Piano Club, which now contains in its membership list quite a number of talking machine men, has outlined an ambitious program of activities for the coming year. The club has taken a number of season tickets for the Chicago Symphony Orchestra concerts and every Saturday night a group of the piano men can be seen at Orchestra Hall. The dues have been raised from two to ten dollars per year. Most of the members have already sent

in their checks. Those who have not, or who wish to, become members of the club should mail their applications to R. E. Davis, 1200 Kimball Building, Chicago, Ill.

The Talking Machine in Americanization

L. L. Sebok, of the foreign record department of the Columbia Co., has some decided opinions on the possibilities offered to the talking machine dealer in cultivating foreign trade. Last month he had an article in these columns which went into detail on the subject of increasing sales of foreign records. His ideas are sound, for the reason that he has himself made good in this work, and we now take this opportunity of giving his further views on the interesting subject of the part the talking machine can be made to play in Americanization. "It may seem absurd," he says, "that talking machine dealers possess opportunity greater than any other one set of people to help powerfully the idea of Americanization. There are dealers who claim that the foreigner should learn our language and listen to our music and that it is unpatriotic to sell him records in foreign languages. These arguments are hypocritical. It is true that America is considered the melting pot of all nationalities, but does the melting pot melt automatically? Can we expect that foreigners should be Americanized by the very act of living here? As a rule, they are living isolated where they are compelled to speak their own language and are surrounded by their foreign customs and habits like a Chinese wall. We let them be exploited

by industrial parasites and send them to the deepest mines to work. Certainly they are entitled to whatever pleasure they can obtain from music in the home, whether it be American or otherwise. We despise and ridicule them and never appreciate that from far distances they brought their own music, their own culture, which, added to ours, would give new impulse to our own ideas. Can we blame the foreigners, if, disappointed by our indifference, they continue to dream their own dreams, follow their own ideas, and speak their own language? Americanization is a slow process which cannot be hastened. Is there any weapon more powerful than music to make them understand our ideas? If the dealer is tolerant and attempts to sell him his own music he will be surprised to see how fast the foreigner switches over to the American melodies.

Edison Attachment Popular

The Jewel Phonoparts Co. states that its Edison and Victor universal attachments are increasing in popularity throughout the trade. There seems to be quite a demand for the playing of lateral-cut records on the Edison machines and for playing Edison records on machines made for lateral-cut records only. The Jewel Phonoparts Co. recently issued a folder to its dealers throughout the country describing the Blood mute in the Universal attachments.

Victor Men Here

A number of men from the factory of the
(Continued on page 147)

TRANSFER NAME-PLATES

We make the Transfer Name-Plates and Trade-Marks for the largest talking machine manufacturers in this country and for dealers in every state.

YOUR NAME, Mr. Dealer, on every machine brings the owner back to you or records and his friends to you for a machine.

Samples, Suggestions and Sketches Furnished Free

THE MEYERCORD COMPANY, CHICAGO

Largest Manufacturers of **DECALCOMANIA** Transfer Name-Plates

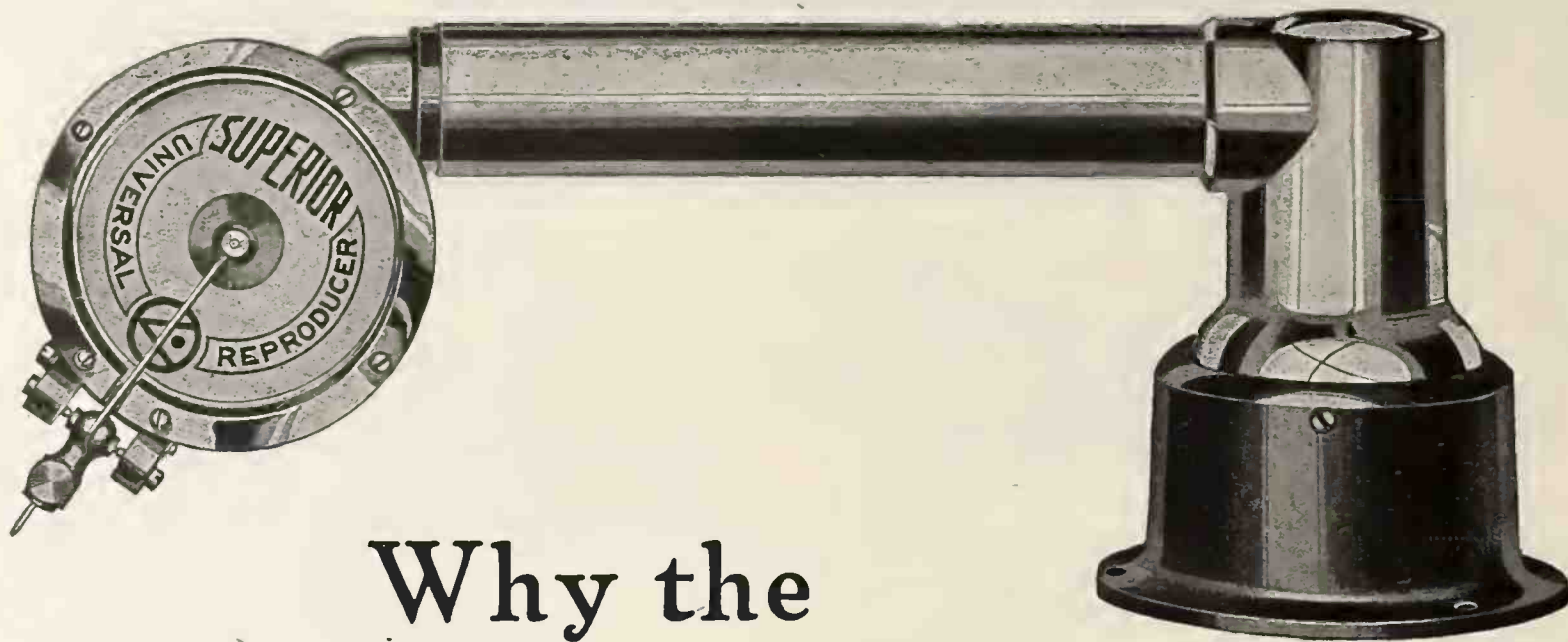

Why the Scotford Tonearm is Different

The straight tube of the flute, the oboe or the clarinet gives a sweeter, purer tone than the blaring notes of the curving cornet, the trumpet or the trombone. In the straight Scotford Tonearm the sound waves travel in the straightest, most direct line possible in a tonearm.

The square turn of the Scotford Tonearm offers less resistance to the passing of the sound waves than is met with around the curving turns of the traditional tonearm design, which imitates the shape of the larger wind instruments, ignoring the fact that in a phonograph tonearm there is no air pressure to force the sound around the curves.

Upsetting pet theories to the contrary, the straight tube and the square turn of the Scotford Tonearm give tone results of superior quality. The proof is in the playing. None of the overtones are lost in the passage, but the tones are delivered outward in full power and clarity. None of the usual phonographic sharpness and thinness of tones—but rich, warm tones of genuine musical quality.

Plays All Makes of Records

and in turning the Reproducer from one position to the other, the needle remains on exactly the same point, at the same and only correct angle. Get a sample and test the Scotford in comparison with others. Decide for yourself, if you know music—but if you are not sure of your own judgment—call in someone on whose authoritative opinion you may safely rely. The average phonograph man has heard the other kind—the thin metallic tone—so much that nothing else may sound quite right to him. Remember "The familiar tone is the best-liked tone." He may like his old familiar out-of-tune piano, but in the language of Goldberg this "Doesn't mean anything." The trained ear would condemn it, and the unprejudiced public will not choose the phonograph of the sharp metallic tone when a comparison is made on the dealer's floor.

You May Safely Use the Scotford Tonearm

Your cabinets will sell readily and bring repeat orders galore if you will build the amplifying chamber to harmonize with the distinctive shape of the tonearm. We are prepared to furnish specifications for building an inexpensive amplifier which exhaustive tests have shown to give ideal results. We can help you to make yours a phonograph which will get the decision in any contest.

It Need Not Cost You Anything to Test the Scotford Inventions

Samples of the Tonearm and Reproducer will be submitted on the following conditions: If you are not rated, send remittance with order to cover the sample prices stated below, which include postage. We refund the full price if the samples are returned within a reasonable time. If you keep the samples and order a quantity, the sample price will then be readjusted at the rate of your quantity order. Quantity prices will be named to quantity users. We suggest that orders for samples specify one Tonearm and Reproducer with Mica and one extra Reproducer with Micompo, so as to compare the two diaphragms. State whether Reproducers should have the regular "Superior" nameplate or plain gilt face.

	With MICA Diaphragm	With MICOMPO Diaphragm
Sample Nickel Scotford Tonearm and Superior Reproducer	\$9.25	\$8.50—Gold \$2.00 Extra
Sample Nickel Extra Superior Reproducer	5.75	5.00—Gold 1.00 Extra

Exclusive Designs for Large Users

We have Design Patents pending on several variations of the Scotford Tonearm standard model illustrated above. These new designs are distinctive and artistic in appearance, and afford attractive ornamental effects pleasingly in harmony with the best cabinet styles. All embody the patented mechanical and acoustic principles of the regular Scotford Tonearm. Our Die Casting department is prepared to produce the necessary special dies, and we can arrange to manufacture as finished products for the licensed exclusive use of large concerns. Particulars may be had on request



Barnhart Brothers & Spindler

Monroe and Throop Streets
CHICAGO, ILL.

Makers of Superior Specialties for Phonographs

FROM OUR CHICAGO HEADQUARTERS—(Continued from page 145)

Victor Talking Machine Co., of Camden, N. J., were visitors to Chicago last week. Messrs. Royal, Staats, Freeman, McDonald, John, Cooper, Clarke and Lack made up the party. The first-named five were from the Victor factory and the last three were from England, where they represent the interests of the Victor Talking Machine Co. in Great Britain. The party was entertained here by the Chicago Talking Machine Co. and Lyon & Healy, Victor jobbers in this territory. They stopped off at a number of cities on the way to Chicago and went on from here to the Coast. The party is making an analysis of general conditions in the country.

Dealers Aid Stars

The Central Concert Co., which started in last season putting on concerts, featuring well-known stars of the musical world at Orchestra Hall, is co-operating with the Rudolph Wurlitzer Co. and other dealers to bring about increased attendance of talking machine owners at the Orchestra Hall concerts. Rosa Ponselle, Nicola Zerola, Giovanni Martinelli, Kittie Beale, Anna Case and Sascha Jacobson are some of the opera stars who appeared. L. E. Noble, manager of the talking machine department of the Rudolph Wurlitzer Co., reports that dealers are selling quite a number of tickets for the concerts and are finding as a result that their sales of operatic records are increasing.

New Columbia Representative

R. M. Reilly, who has been for many months with the Columbia department of the Central Piano Co., recently succeeded Harry Schoenwald as Columbia's loop representative in Chicago. Mr. Reilly is one of the most enthusiastic Columbia workers connected with the Chicago branch of that company, and much credit is due him for the masterful way in which he has helped to build up the talking machine business of the Central Piano Co., which, by the way, is one of the largest talking machine accounts in Chicago and is said for its size to do more

talking machine business than any other store in Chicago.

Mr. Schoenwald, whose position is now being filled by Mr. Reilly, has gone over to the Melodee Roll Co.'s Chicago branch and is looking after Chicago and Milwaukee territories for that company.

They Make Hiawathas

The accompanying two illustrations show the superintendent and foreman of the cabinet room



Joel Lindholm, Sup't
Foreman of Cabinet Department

in the Hiawatha Talking Machine Co.'s plant at Geneva, Ill. Joel Lindholm, superintendent, has been successful in attaining a remarkable output during the past year and has simplified a number of manufacturing operations in the plant. The Hiawatha factory is at present working at capacity producing machines for the holiday trade.

Sell World Co. Business

An order was issued in the United States Dis-

trict Court in the middle part of October for the sale of the assets of the World Phonograph Co., recently petitioned into bankruptcy. A. H. Kraus & Co., Inc., were the purchasers at the receiver's sale and are now in possession of the stock in the building at 4925 South Halsted street. Kraus & Co. will establish an assembling plant in Chicago and will maintain a factory at Princeton, Ill.

Ysaye at Bloomington Store

Eugene Ysaye, director of the Cincinnati Symphony Orchestra, recently appeared at the W. H. Roland Music Salons on a day when he appeared at the Amateur Musical Club of Bloomington. Before a large audience Ysaye listened to a talking machine reproduction of his old exclusive Columbia records, together with several recorded by the Cincinnati Symphony Orchestra.

New Store in Nakomis

The M. E. Rubinowitz Music House is opening a music store in Nakomis, Ill. Homer Fraley will be in charge of the new store. The location in Nakomis had been leased for some weeks past, but the opening was delayed until recently. Mr. Fraley was previously connected with a Detroit music concern.

Meet on License Matter

The matter of licensing retail music establishments of the city was taken up at a meeting of the License Committee of the Chicago Piano & Organ Association and a committee from the City Council which is looking after this matter. The representatives of the Association were called together by Adam Schneider, of Julius Bauer & Co., and a conference with the city officials was entered into. The matter was discussed at length but nothing definite regarding schedule was decided on at this meeting.

James I. Lyons Opens New Store

James I. Lyons, who quite recently turned over his wholesale Amberola business to his

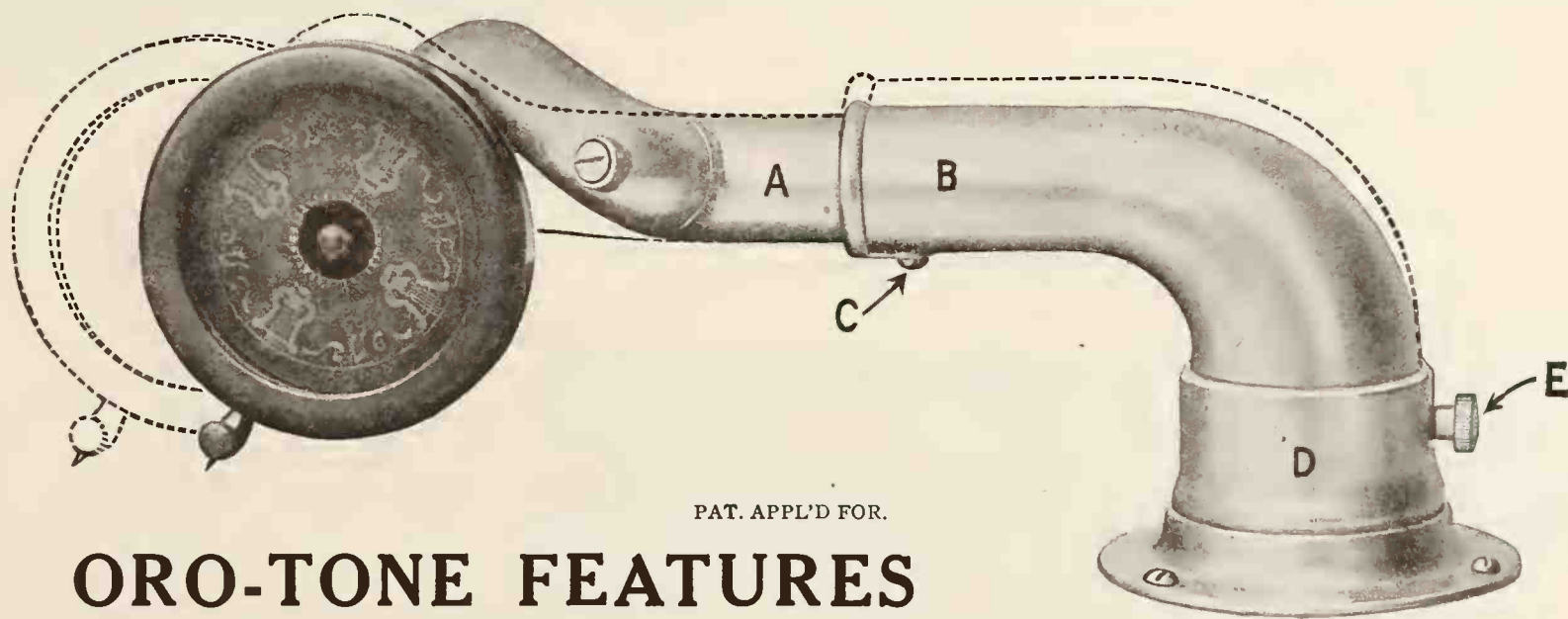

PAT. APPL'D FOR.

ORO-TONE FEATURES

Extension A telescopes into large elbow B, giving a length adjustment from 7¾ to 9½ inches. Adjustment screw C engages an indexed channel in extension A, assuring perfect alignment. Slightly releasing locking thumb screw E permits fractional height adjustment of large elbow in base ring D. Releasing locking screw E entirely, permits tone arm to be removed from base ring D for packing separately before shipping if desired.

Ask for illustrated and descriptive catalog which will acquaint you with the excellent features incorporated in Oro-Tone Tone Arms and Reproducers, which make the Oro-Tone the most scientific and highest grade combination offered.

The Oro-Tone Co. 1000 to 1010 GEORGE ST. CHICAGO, ILLINOIS
QUALITY FIRST

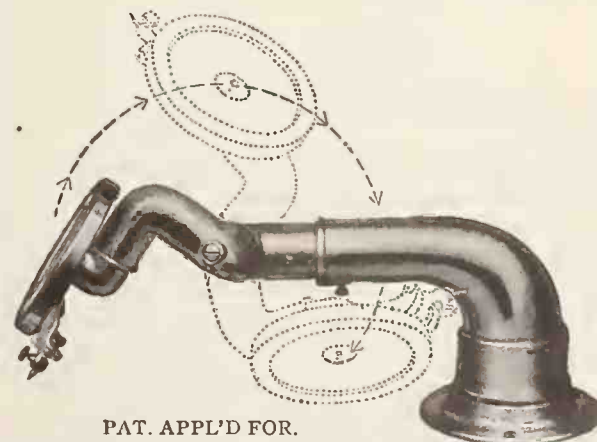

PAT. APPL'D FOR.

Illustrating Angle Throw Back Improvement. Permits reproducer to clear tone arm when thrown back regardless of whether it is in position for playing Hill and Dale or Lateral-cut records.

Phonograph Motors

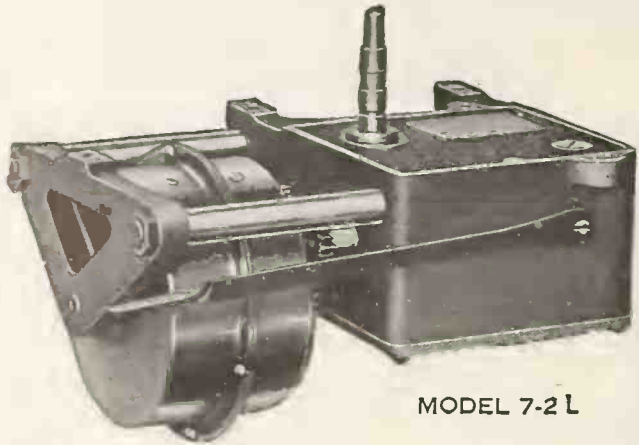

MODEL 7-2 L

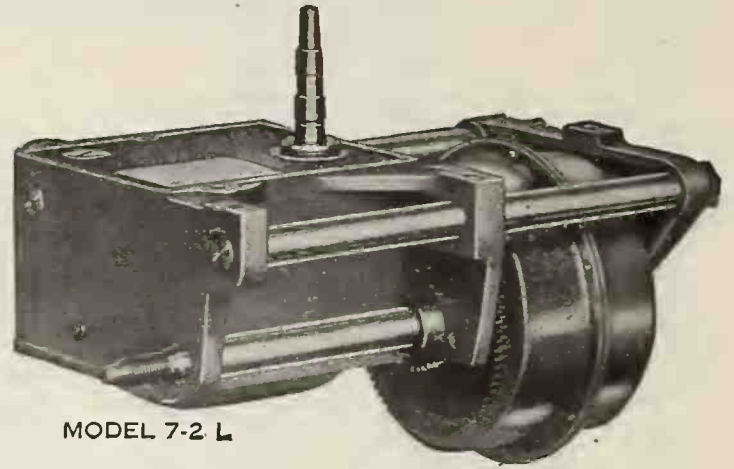

MODEL 7-2 L

Silent—Self-Lubricating—Enclosed No Tuning is Necessary

Think of what this means to you. Think of the time and money you have spent in past years, are spending now, tuning and adjusting noisy motors. Think of the business and money you have lost and realize that now it is unnecessary for you to do any tuning if these ENCLOSED MOTORS are used.

If you have to correct a motor when it reaches you, someone will have to correct it after it leaves you. If it didn't stand shipping shock once, it won't stand it again.

The basis of all motor trouble is faulty design. Even perfect workmanship will not offset it. Our Engineers knew by experience the weaknesses of the open type motor, and overcame them in the design of this ENCLOSED MOTOR.

All delicate parts are housed in a rigid rectangular casting. This keeps out dust and dirt, and makes it possible to use a capillary oiling system which is automatic. The enclosed casting protects the mechanism in handling, besides being so rigid that motors can be shipped any distance without getting

out of adjustment. It insures your finished instruments reaching your jobbers, dealers, and customers in good condition. And although the driving mechanism is in the cabinet, out of sight, mechanical excellence does help make sales to the customer. The smooth, easy winding, the absolute uniformity of speed and the utter absence of noise or vibration are eloquent of quality—finesse.

Excepting only springs, castings, felts, etc., we make every part of this motor in our own factory, where we can and do control its accuracy. We are in real quantity production, and making as we do just one thing—PHONOGRAPH MOTORS—enables us to make better motors. This is a highly specialized business—it takes concentration, experience, capital, and fine equipment—We have all of them.

We are now supplying many of the large Talking Machine manufacturers with these motors, and their motor troubles are over. If you want to see the end of **YOUR** motor difficulties, we will show you.

Supplied in 2, 3 and 4 Spring Models
Felt and Velour Table Coverings, Nickel and Gold Finish
Write us for full information, details of design, models, prices, etc.

UNITED MANUFACTURING & DISTRIBUTING Co.

LAKE SHORE DRIVE AND OHIO ST. CHICAGO, ILL.

FROM OUR CHICAGO HEADQUARTERS—(Continued from page 147)

son, William H. Lyons, announces that on November 15th he will open a retail store at 4813 Kedzie avenue. This will be an exclusive Edison shop, handling both the Edison diamond disc and the Amberola models as well as records. The new location is in Albany Park, where a large number of new dwellings are being built, and there is a good market for talking machines and records. Mr. Lyons has been in the business for over twenty years and is well equipped to make the new venture a success.

Issues New Catalog

The Cole & Dumas Music Co., jobber in supplies and accessories as well as in machines for the dealer, has issued a new wholesale catalog in which appear many new items as well as quite a number of price changes. This is a new merchandise issue and the company calls it a pre-war catalog, claiming that it gives pre-war prices.

W. P. White With Brunswick

W. P. White, formerly with the Victor Talk-



W. P. White

ing Machine Co. as traveling representative, and more recently with the Paramount Talking Ma-

EXCELSIOR PADS

The most satisfactory packing material for packing phonographs for shipment. Used to advantage by the largest manufacturers. Send for prices and samples.

H. W. SELLE & COMPANY

Manufacturers

1000-1016 N. Halsted St., Chicago, Ill.



Automatic Cabinet

THE PERFECT FILE

Records easily seen

Safe and accessible

Use with Table Models or as Auxiliary Cabinet

Two Styles—100 and 200 Records

Dealers and Jobbers order now for the Holiday Trade

AUTOMATIC CONTAINER CO.

437 N. Dearborn St., Chicago

Manufacturers: Equip your Talking Machines with this pleasing sales feature

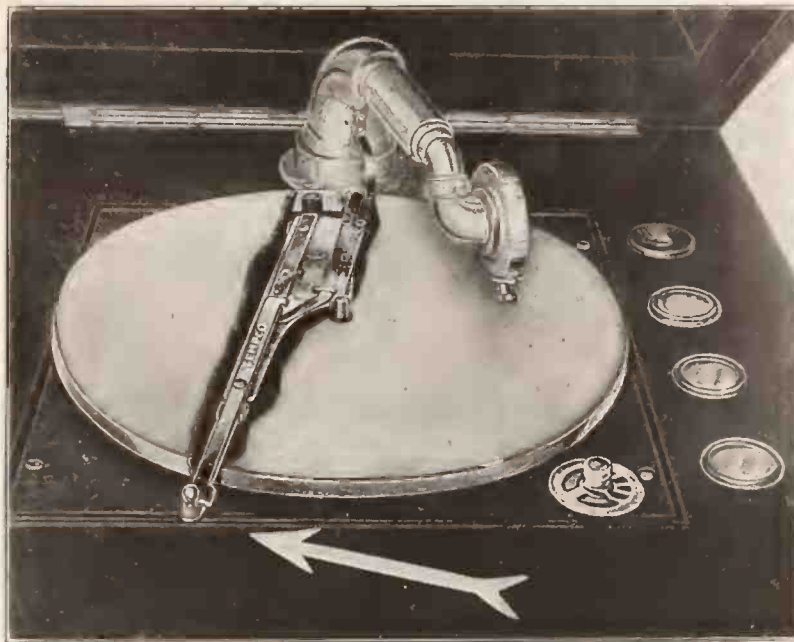

TEMPCO

the perfect phono stop solves your stop problems. Simple to attach. Simple to operate.

SETS STARTS STOPS

From same point as indicated by arrow

The Tempco auto stop meets a long-felt want for a simple and efficient stop. Try the Tempco and be convinced.

WRITE FOR PRICES Sample \$1.50 postpaid. Special Quantity Discounts to Dealers and Jobbers.

Manufactured by the

TEMPCO MANUFACTURING CO.

2227 OGDEN AVE.

CHICAGO, ILL.

chine Co. as sales manager, is now connected with the Brunswick-Balke-Collender Co. and will have charge of the accessory department, dealer record service and sales promotion in connection with the record department. He will also have something to do with the publicity end of the phonograph division and will make his headquarters at the Chicago offices of the company. In Mr. White the Brunswick-Balke people secure a live promotion and publicity man who has created quite a reputation for himself during the years he has been connected with the phonograph business.

Six Best Sellers

The six best Victor sellers are "Love Nest," "Lullaby from Erminie," "Thank God for a Garden," "That Naughty Waltz," "Whispering," "Japanese Sandman," played by Paul Whiteman and his Ambassador Orchestra.

The six best Columbia sellers are "That Naughty Waltz" and "Your Eyes Have Told

Me So"; "Avalon" and "Old Pal, Why Don't You Answer Me?"; "Save a Little Dram for Me" and "Lonesome Alimony Blues"; "My Little Bimbo Down on the Bamboo Isle" and "She Gives Them All the Ha-Ha"; "Idol Eyes" and "In the Land of Rice and Tea"; "Cuban Moon" and "In Old Manila."

The six best Edison sellers are "Shade of the Palm" and "Tell Me, Pretty Maiden"; "Lassie Waltz" and "Young Man's Fancy"; "La Veeda" and "Stop It"; "Karzan" and "My Sahara Rose Medley"; "Daddy, You've Been a Mother to Me" and "Hiawatha's Melody of Love"; "Close to Your Heart" and "Good-bye, Sunshine; Hello, Moon!"

The six best Brunswick sellers are "Broadway Blues" and "Chili Bean"; "Japanese Sandman" and "Koolemoff"; "Avalon" and "Wishing"; "Fair One" and "Sultan"; "Bring Back the Golden Days" and "When You and I Were

(Continued on page 151)

VARNISH DRYROOMS

VARNISH DRYING EQUIPMENT

MODERN PHONOGRAPH CABINET INSTALLATION

MAKE EVERY DAY A PERFECT DRYING DAY

DRYING SYSTEMS, INC. 11-17 So. Desplaines St. CHICAGO.

UNIVERSAL

MASTER MOTOR No. 20

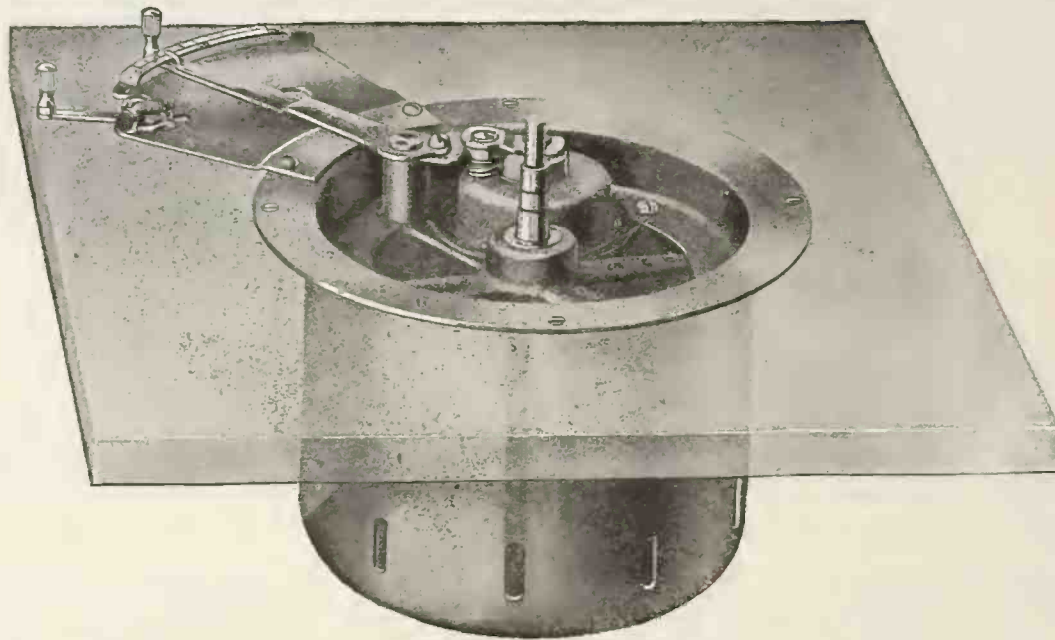

MR. MANUFACTURER:--

During these critical times in the phonograph industry, the phonograph manufacturer must have real talking points and must inject real "pep" into his arguments if he expects to make a success.

There are many tired bank rolls among the dealers in your territory at this time which would hail with joy the wonderful **Universal** Enclosed Master Motor if you installed it in your machines. We know there are some manufacturers who are so infatuated with the Ingersoll type of motor that they overlook the golden opportunity afforded them by this latest achievement in phonograph engineering—the only real enclosed motor being manufactured today.

When comparison is made with other motors, one is impressed with the correct lines, the simple construction and the almost uncannily silent operation of this wonderful power plant.

Have you stopped to realize that if you placed your line of phonographs (equipped with Enclosed Master Motors No. 20) in a dealer's window alongside of any standard make of machine, with an Enclosed Master Motor mounted on a stand to demonstrate its superior features, that 95% of the sales would be machines equipped with this motor?

You may have the best cabinet in the world and a wonderful tone arm and tone chamber, but you must remember this: In order that the dealer may become an asset to you, he must have a motor that will not only bring back the first three payments, but the last nine.

The phonograph business of today is exactly what the individual manufacturer makes it. By installing the **Universal** Enclosed Master Motor No. 20 and telling the world about it, your machines will take on an atmosphere of class and distinction that will simplify your selling problem.

Let us send you a sample of this motor and let us quote you on your requirements for the balance of 1920 and 1921.

Send for Illustrated Folder

Universal Stamping & Mfg. Co.

1917-1925 S. Western Ave., Chicago

FROM OUR CHICAGO HEADQUARTERS—(Continued from page 149)

Young, Maggie"; "I Cannot Sleep Without Dreaming of You" and "Songs of Long Ago."

The six best Okeh sellers are "Whispering" and "Dreaming Blues"; "Japanese Sandman" and "In the Land of Rice and Tea"; "Cuban Moon" and "Granada"; "Crazy Blues" and "It's Right Here for You"; "Chili Bean" and "My Little Bimbo Down on the Bamboo Isle"; "June" and "Hold Me."

BRUNSWICK ART MODELS

Brunswick-Balke-Collender Co. Announces Five Beautiful Consoles in Period Design

CHICAGO, ILL., November 4.—Realizing the necessity and importance of period console types of



The Beaux Arts

talking machines, the Brunswick-Balke-Collender Co. some months ago started preparations



The Stratford

for the issuance of a complete line of period styles. The work has been completed and constitutes a beautiful example of the cabinet mak-

LAKESIDE "F & L" AUTOMATIC STOP

100% EFFICIENT

Number each record once (which takes only a 1/4 minute), thereafter it needs no setting, and works equivalent to a non-set stop.

Without a doubt the best automatic stop on the market.

Use it on any machine, electric or manual.

Sample with full instructions \$1.75.

Add 50 cents for electric machines.

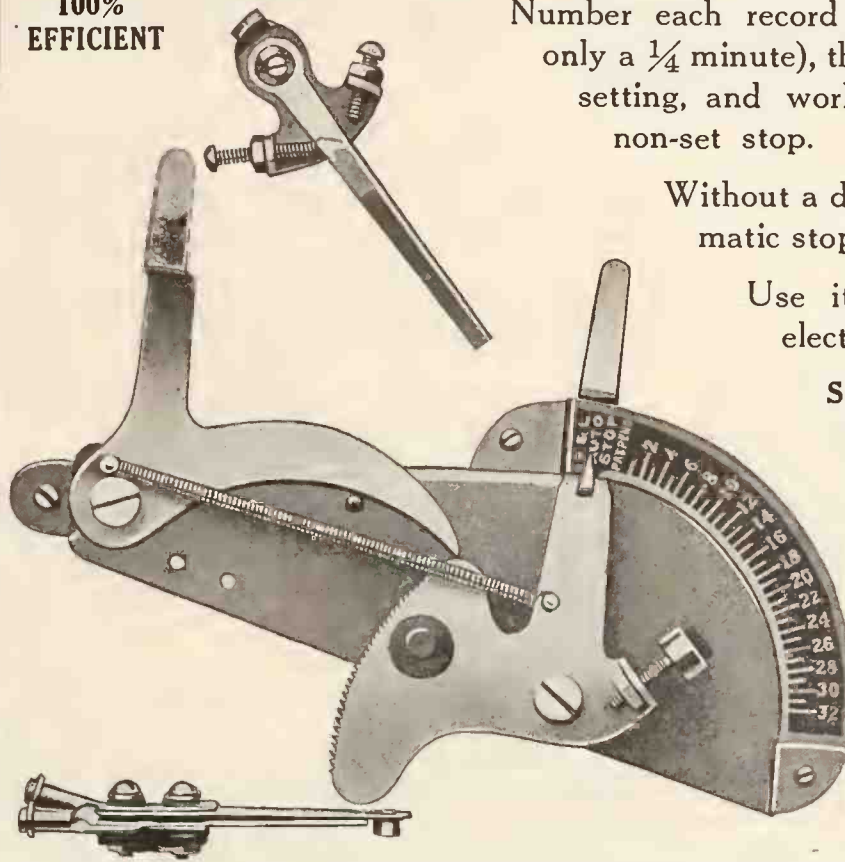

LAKESIDE SUPPLY CO.

416 So. Dearborn Street CHICAGO, ILL.

Phone Harrison 3840

PACIFIC COAST BRANCH WILLIAMS BLDG. SAN FRANCISCO, CAL.

er's art, as set forth in the five new period styles: "Beaux Arts," "Oxford," "Georgian," "Gotham" and "Stratford."

The five models have a wide range of appeal.

mending to their trade and to interior decorators these hand-wrought models. A few homes demand the lavish treatment of palaces. Yet there is a great number who can acquire the simple elegance of the smaller chateaux of France and a still greater number who demand the plain refinement of the manor houses of England. Aside from their classic richness there are other noteworthy and advantageous features.



The Oxford

They will undoubtedly take their places as ready sellers in the warerooms of Brunswick dealers during the holidays and the coming year. They



The Gotham

In each the phonograph is concealed and equipped with a new and improved electric motor, the top is stationary, permitting the use of art garniture. The finishes are of a rich and antique walnut color which will harmonize with either
(Continued on page 155)

Magnifies Sound 50 Times

ACME SOUND AMPLIFIER

Enables the repairman to locate the precise point of origin of unnecessary noise in the motor without loss of time or useless disorganization of the mechanism which results from guessing or the sense of hearing alone.

MAKES EVERY MOVING PART IMMEDIATELY ACCESSIBLE

"Guesswork Won't Do"

The ACME allows a test with the drag of the needle throughout the length of the record.

A
C
M
E

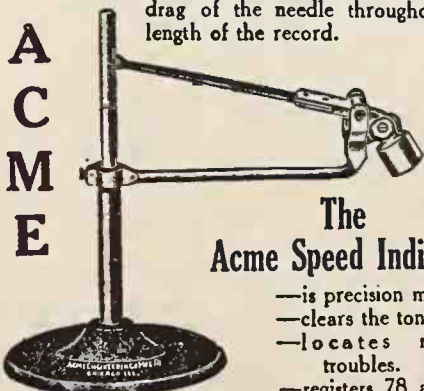

The Acme Speed Indicator

- is precision made.
- clears the tone arm.
- locates motor troubles.
- registers 78 and 80 revolutions.

"The repairman's stethoscope."

Made by

Acme Engineering & Mfg. Co. CHICAGO
1622 Fulton Street



The Georgian

have been issued at a most opportune time, when the period console is coming into its greatest popularity.

Brunswick dealers can take pride in recom-



**Edison Diamond
Amberolas--Plus Service**

You know the quality of Edison instruments. Until you have placed a trial order with us, you are unfamiliar with SERVICE.

A TRIAL CONVINCES

Our Service Covers the Country
William H. Lyons
Formerly Jas. I. Lyons
17 W. Lake St. Chicago

Blood Of Interest to Every

TONE ARM & REPRODUCER

A NEW NON-TAPER NON-THROWBACK TONE ARM

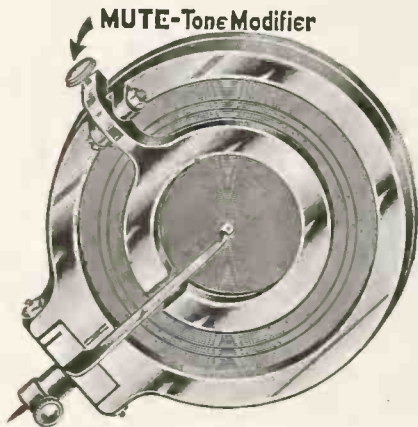

Regulates volume to meet individual taste of audience and character of music.

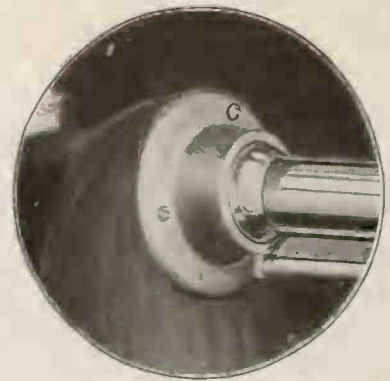
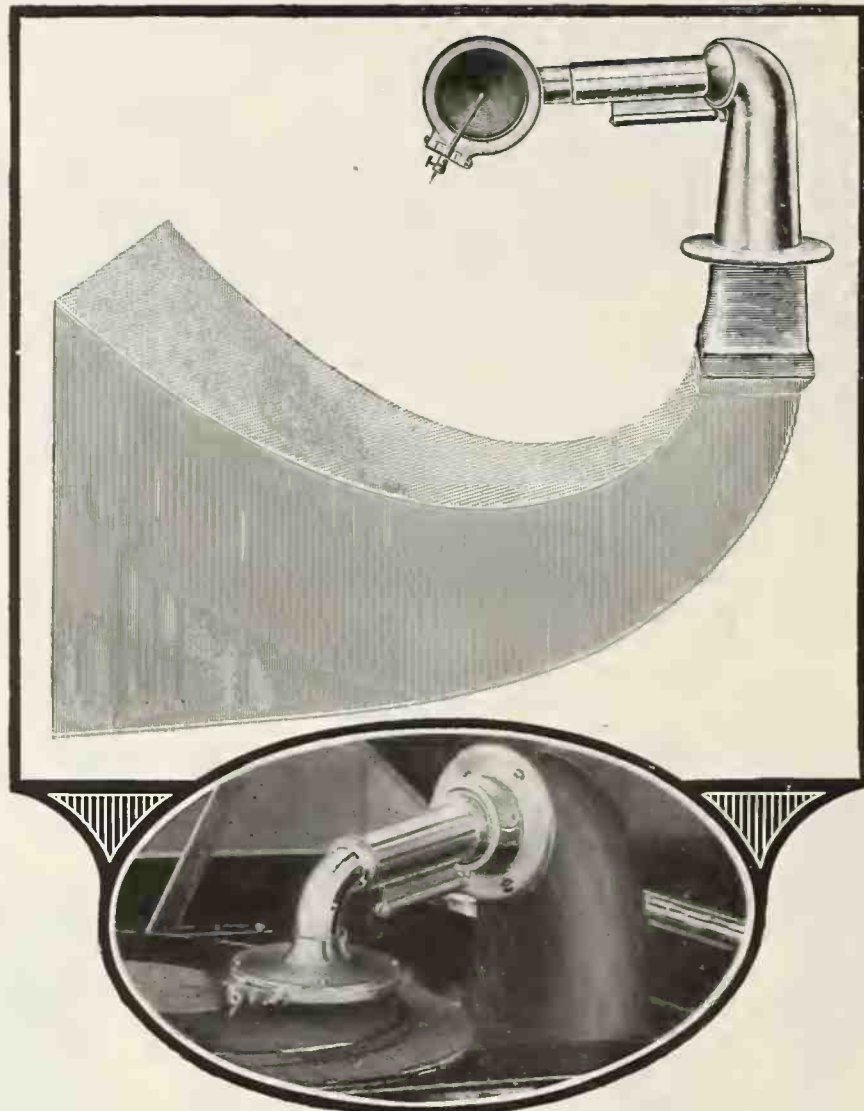

Insures perfect freedom of movement in horizontal and vertical directions.

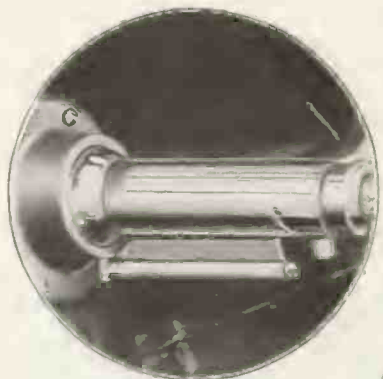

A slight turn of the set screw automatically adjusts the weight for the proper playing of all makes of records.



Shows application of new Blood Tone Arm to both the metal and wood tone chamber throat. Wood throat can be artistically finished to harmonize with the cabinet design.



Note position of reproducer. This is the correct EDISON position for playing all hill and dale records.

Acknowledged as the greatest musical instrument of all time, the phonograph plays an important role in our daily life. But a few years ago the phonograph was looked upon as being merely a "talking machine," a novelty, because of the unnaturalness and imitative quality of the tone produced. Today it has been developed to the point where it is no longer referred to as a "talking machine," but as a musical instrument of the highest order, reproducing every note, vocal and instrumental, in all its original clearness and beauty. The quality of this reproduced tone at times is so natural and life-like that it is impossible to distinguish it from that of the living artist.

These results have been brought about through the development and perfection of recording and reproducing instruments. In the past year we have perfected several features that have proven a big boon to the industry. The most important of these is the NOMIKA DIAPHRAGM, which will not blast, crack, split or warp, and is practically indestructible even under the most severe conditions. In addition, it is not affected by atmospheric conditions and is acknowledged by musical critics as being the greatest advance yet made in phonographic sound reproduction.

Another innovation that is acclaimed by every lover of good music is the MUTE-TONE MODIFIER, which makes possible accurate volume regulation to the individual taste of the audience and character of music. In principle it is the same as the mute as used on the bridge of a violin, in that the length of the vibrations is accurately controlled and the volume regulated to the minutest degree without in any way changing the character of tone.

The crowning feature of all is the Non-Taper, Non-Throwback Tone Arm Combination pictured above. Built along entirely new lines, perfect reproduction and maximum volume are insured because of the positively air-tight construction from needle point to front of tone chamber. Adjustable in length and weight on records, with a free, pivoted, ball-joint movement and centering in lateral and vertical positions, it plays every make of record and does it better than any universal tone arm on the market today. It will give your phonograph an enviable standing in the world of music and DEFIES COMPETITION.

Delay is your loss—Act quickly

Jewel Phonoparts Company

670 W. Washington Boulevard : : Chicago, Illinois

Phonograph Manufacturer **Blood** TONE ARM & REPRODUCER

Tone Arms and Reproducers For Every Need and the new Blood Automatic Stop

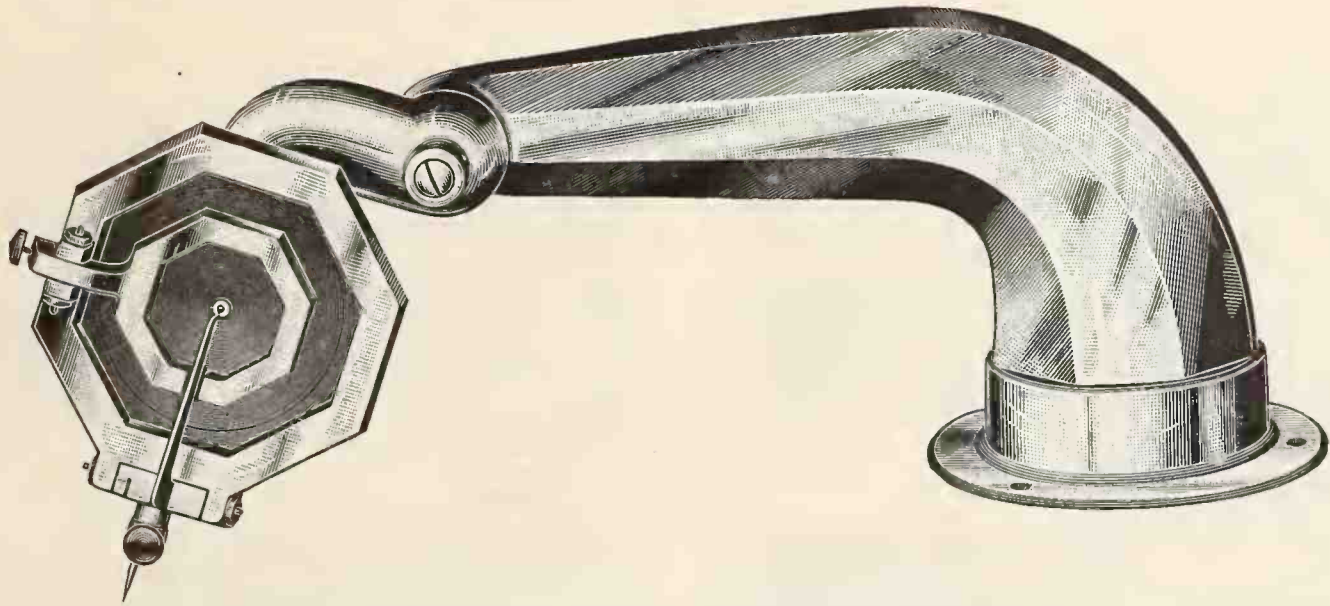

9 1/2" OCTAGON DESIGN BLOOD TONE ARM

This new Blood Tone Arm is without a doubt the most attractive design on the market to-day. Designed especially for manufacturers of high-grade phonographs.

Has the same general characteristics as the product that has won such an enviable reputation for its soft, mellow tone and natural, life-like reproduction.

Made only in the 9 1/2" length. Can be furnished with or without Mute-Tone Modifier, and with Plain or Octagon Design Reproducer.

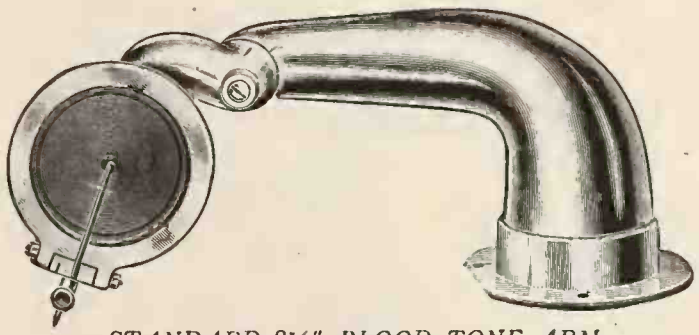

STANDARD 8 1/2" BLOOD TONE ARM

Known the country over for its excellent quality of tone and natural, life-like reproduction of all musical tones. This tone arm on your machine spells Success, because of its high standing in the phonograph world. Made only in the 8 1/2" length. Can be furnished with or without Mute-Tone Modifier, and with Plain or Octagon Design Reproducer.

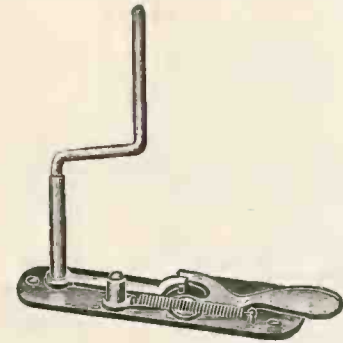
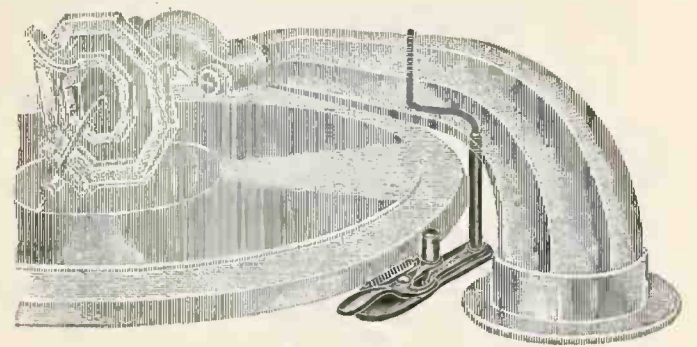

NEW BLOOD AUTOMATIC STOP

Simplest and most effective Automatic Stop made. Watch-like in its accuracy, yet of the most substantial construction, perfect results are insured.

Can be installed in a moment, and on any make of phonograph.

No parts to get out of order.

Prepare for the Holiday Demand—Immediate Deliveries

Jewel Phonoparts Company

670 W. Washington Boulevard : : Chicago, Illinois

MR. DEALER:-

Here's a Rapid-Fire Sales Combination

You Benefit In

- Increased Profits
- Retaining Old Customers
- Winning New Customers
- Increased Record Sales



With Attachments for Edison and Victor Phonographs

Your Customer Benefits

- Better Music
- Less Wear on Records
- Makes Phonograph Like New
- Complete Satisfaction

EDISON UNIVERSAL ATTACHMENT



Showing Blood Reproducer in position for playing Lateral Cut records on the Edison Phonograph. Note the simple construction and pivoted ball joint.



Showing Blood Reproducer in position for playing Vertical Cut records on the Edison Phonograph. Note the CORRECT Edison position, which insures perfect reproduction.

Retail Selling Price

Edison Universal Attachment complete with Blood Reproducer, Nomika Diaphragm and Mute.....\$14.00

VICTOR UNIVERSAL ATTACHMENT



Showing Blood Reproducer in position for playing Vertical Cut records on the Victor Phonograph. Note simple design and correct Edison position. No adjustments necessary.



Showing Blood Reproducer in position for playing Lateral Cut records on the Victor Phonograph. Large diaphragm insures natural, lifelike reproduction.

Retail Selling Price

Victor Universal Attachment complete with Blood Reproducer, Nomika Diaphragm and Mute.....\$12.00

LIBERAL QUANTITY DISCOUNTS TO DEALERS

FEATURES

1. Blood Mute, Tone Modifier, regulates volume to meet the individual taste of audience and character of music.
2. Indestructible NOMIKA diaphragm does not blast, crack, split or warp. It is acknowledged to be the greatest development in phonographic sound reproduction in recent years.
3. Plays ALL hill-and-dale records in the proper EDISON position. See illustration.
4. Air-tight construction and absence of complicated movable joints insure perfect reproduction and maximum volume of tone.
5. Pivoted ball-joint of Edison attachment insures perfect freedom of movement both vertical and horizontal.
6. Needle centers properly on record when playing either lateral or hill-and-dale records. This feature is not found in any other attachment.
7. No adjustments necessary when changing from lateral to hill-and-dale records. Merely reverse position of reproducer and change needle.

Write for Full Particulars.

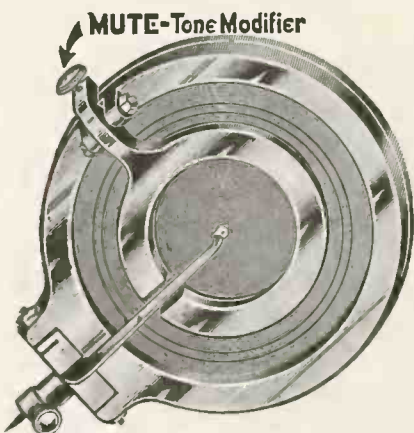

Front View, Blood Reproducer (Half Actual Size)

The Mute-Tone Modifier regulates volume to individual taste of audience and character of music.

Nomika Diaphragm does not blast, crack, split or warp.

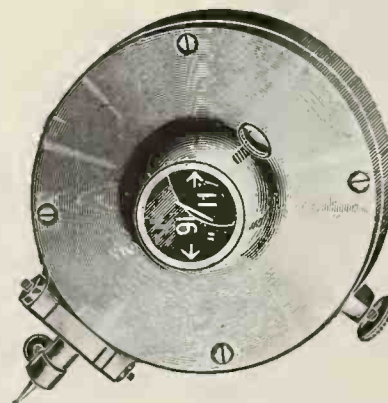

Rear View, Blood Reproducer (Half Actual Size)

Standard construction adopted for back of Blood Reproducer, Center opening measures 11/16" in diameter, which permits of its application to many different makes of phonographs.

Jewel Phonoparts Company

670 W. Washington Blvd.

Chicago

FROM OUR CHICAGO HEADQUARTERS—(Continued from page 151)

brown mahogany or walnut furniture. All moldings in the carvings have been treated in subdued polychrome and antique gold.

The Beaux Arts is a Louis Seize design and can be used with furniture of any of the French periods. The Oxford is an early English design and can be used in connection with English furniture of the early and late eighteenth century. The Georgian has been specially de-

signed to match with furniture after the able Georgian masters such as Chippendale, Hepplewhite, Sheraton and so forth. The Gotham will interest those who are anxious to secure a cabinet that is individual in itself and that can also be used in combination with various styles and types of furniture. The Stratford is a Queen Anne console, particularly appealing to those who like the lower style period cabinet.

MANDEL BROS. VOCALION SALON

Big Chicago Department Store Gives Much Attention to Featuring Vocalion Phonographs and Records in a Most Energetic Manner

CHICAGO, ILL., November 4.—The house of Mandel Bros., which is the Chicago retail headquarters of the Aeolian-Vocalion, ranks among the foremost merchandising institutions of America.

DEMAND FOR PERIOD MODELS GROWS

Campaigns Carried On by Furniture Dealers Educating Public to the Period Idea

(By R. J. Waters, of R. J. Waters, Inc.)

CHICAGO, ILL., November 6.—The talking machine dealer who does not now and then feature period types in large display advertising in his local newspapers is making a big mistake in futures. The trend is largely toward this style of instrument, and a few years hence it will be the period style that goes to make up the average sale, rather than the exception. People are commencing to buy their furniture by periods and are demanding talking machines to match. The demand is still comparatively small, but is increasing steadily. For the foresighted dealer who bases his business on future conditions there is nothing better than the period type of talking machine.

The larger and better furniture manufacturers are advertising the period idea in home furnishing in national campaigns. These are taking effect and more and more homes are seen with furniture of certain definite styles prevailing throughout the rooms. This sort of educational advertising is, of course, having its effect in creating greater demand for period talking machines. The retailer can turn the national advertising of the furniture houses to his advantage if he proceeds to emphasize the idea of period talking machines in his local

newspapers. The idea is first sold in the newspapers. Advertising of this sort serves two purposes. It draws people to your store directly for the period types and has the effect of impressing every person who reads it with the high quality of the goods you sell. There is nothing better calculated to enhance the prestige of the retail talking machine dealer than extensive publicity given to high-class period style instruments.

The public wants the period types, but refuses to pay exceptionally high prices merely because they are period types. They look at the period models and then look at the others, comparing prices, and they form their own conclusions as to what fair prices must be on the former. In the past these styles have been far higher priced than the regular models. Now that the large furniture houses are putting out period furniture at prices within the means of the many, the same thing is happening in the talking machine field. The period talking machine business is one of the dealer's best bets.

"He wouldn't kill a fly" used to be a laudatory phrase. At present most people know that he to whom the phrase can be applied with literal truth is not an admirable person, but a public enemy, rather worse, if anything, than a pirate or a profiteer. For flies and the so-called filth diseases go together, and the former, though not exactly the causes, are the ever-busy distributors of the latter.



Mandel Bros.' Establishment in Chicago

Founded in 1855, and consistently holding to the highest standards of merchandise and service, the institution to-day occupies a magnificent modern, block-long building at State and Madison.

(Continued on page 157)



QUALITY

Okeh Records



The season's most popular dance numbers.

Music that is a marvel of rhythm.

Artists that are the talk of the day.

Vocals that excel in brilliancy of tone.

These are the qualities of Okeh Records

These are the reasons why Okeh Records sell as soon as they are received.

Become a dealer—Write us for particulars.

C. J. VAN HOUTEN & ZOON, 140 Dearborn (South) St. Chicago, Ill.

An Advertising Service That Brings Results!

Here is a real service—the kind that puts pep and ginger into your sales department. MANDEL sales helps create an intensive interest in MANDEL Phonographs. Good sales helps coupled with good salesmanship bring business to the aggressive phonograph dealer. The ad reproduced here is a specimen of a local newspaper ad used by MANDEL dealers. It is one of a large number of ads we have prepared and furnished free to all MANDEL dealers. Road signs, window display cards, descriptive booklets in colors, slides for movie theatres—all these sales stimulators are for the use of dealers in MANDEL Phonographs.

But good advertising must be backed by good merchandise. No sale is complete until the ultimate owner is satisfied. That's where the MANDEL comes in. Every claim of quality is based on facts founded upon our own experience as phonograph makers. For you, Mr. Dealer, the MANDEL is a "Safety First" line. It enables you to say to the prospect—

"We guarantee satisfaction. The MANDEL factories back up this guarantee."

If you are interested in developing your phonograph department

Write at once

**Mandel
Manufacturing
Company**

1455 West Congress Street
Chicago :: :: Illinois

A Christmas Gift for the Family



WHAT gift could be more wonderful—more welcome—more sincerely appreciated, than one which every member of the household will truly enjoy? And it's not a gift for a day—but one that will strengthen the home ties for many, many years.

No home is complete without a phonograph. Make yours complete this Christmas morning. A MANDEL Phonograph will bring added pleasure into your home, thru its marvelous powers of reproducing music and sound. With it the world's most talented artists will perform for you, rendering instrumental and vocal music in a lifelike manner.

Terms to Suit Your Convenience

Don't let a lack of ready cash stand in your way. A small cash payment is all you need. Liberal, long time payment terms may be arranged. There will be a shortage of phonographs this year. Call early and make your selection!

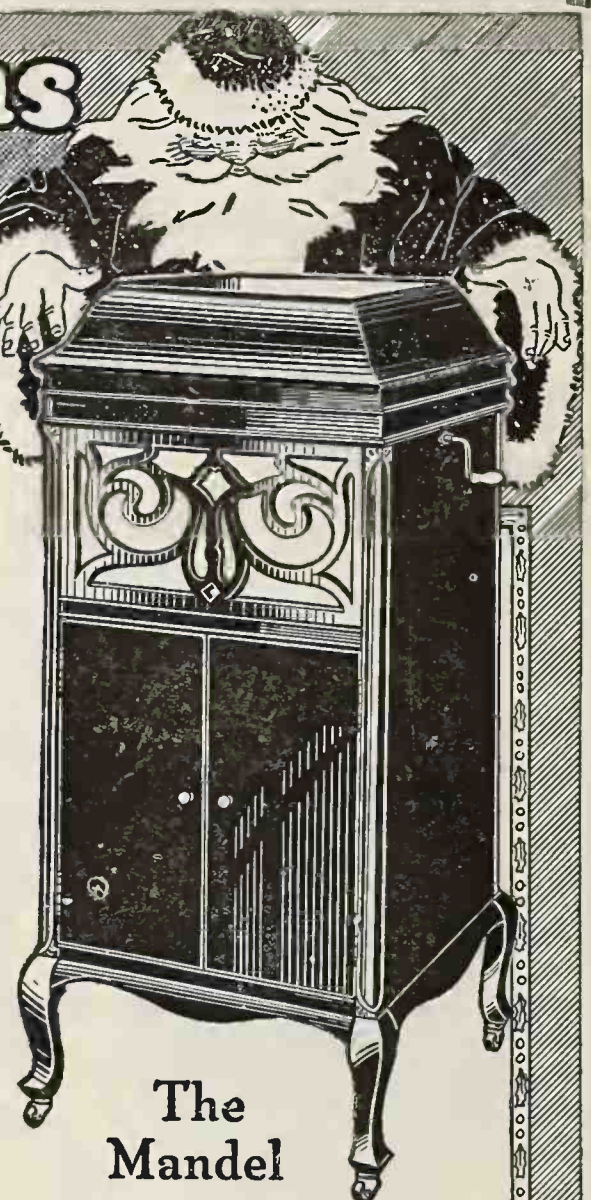

**The
Mandel**

is more than just a talking machine. It is a wonderful musical instrument, playing all makes of records perfectly. Equipped with powerful double spring motor; indexed record files and two extra shelves for albums. The factory stands behind our guarantee of absolute satisfaction to the purchaser.

Hear The MANDEL Play—Today!

(Dealer's Name)

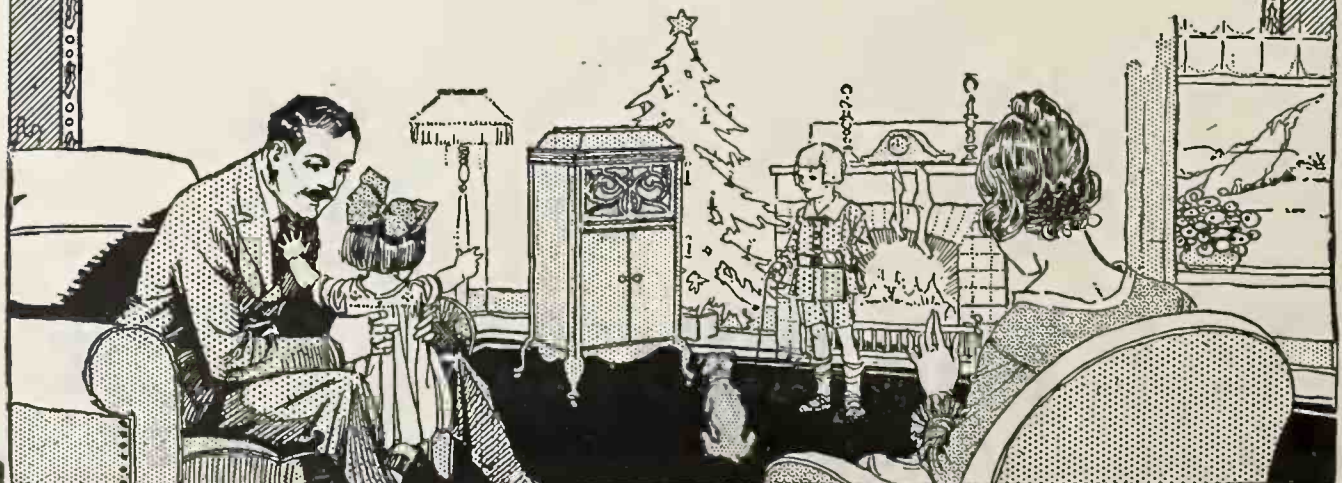

FROM OUR CHICAGO HEADQUARTERS—(Continued from page 155)

son streets—"the heart of Chicago"—the busiest corner in the world.

The Aeolian-Vocalion salon is delightfully situated on the ninth floor of the State street building. The appointments are ideal and rep-

and an opportunity given for the free discussion of timely topics—all of which have proved invaluable.

Mandel Bros. indeed, through the Aeolian-Vocalion, are contributing significantly to the

intellectual activity of conscious and deliberate energy. It is self-centered and independent, and



Window Display of Vocalion Period Models—Mandel Bros., Chicago

resent the utmost in artistic design and equipment for service. The atmosphere here is one of hospitality and good taste and thoroughly conducive to the proper display and demonstration of musical instruments of the high caliber of the Vocalion. There are twelve individual hearing rooms, each decorated in Grecian mode.

The new Vocalion records are also prominently featured and are finding favor with an ever increasing number of Mandel patrons.

The sales organization numbers twelve young men and women all of whom have had the advantage of the course of instruction in selling instituted by Manager T. W. Hindley. On Monday mornings—just at the threshold of each business week—conferences are held at which comparative sales methods are demonstrated

intellectual and artistic life of Chicago—that great mid-Western metropolis of which Sir Philip Gibbs says, in his recent book: "There seemed to me in that great city an intense in-



Thomas W. Hindley, Manager

out of its immense population there are many minds emerging to make it a center of musical, artistic and educational life, apart from the business dynamics."

PLACE BUSINESS ON SOUNDER BASIS

Vitanola Talking Machine Co. Is Put Into Receivership in a Friendly Suit Filed in U. S. District Court on October 16

CHICAGO, ILL., November 4.—The Vitanola Talking Machine Co. has been made the party of a friendly suit filed by Arthur Henderson & Co., manufacturers of phonograph parts. The suit, it is said, has been filed in order to conserve the assets through the appointment of a re-

ceiver. The court acting in the case appointed W. W. Wheelock, a Chicago attorney, as receiver in charge of the company's affairs. Gesas, Epstein and Leonard are attorneys for the petitioner, with Newman, Popperhausen, Stern and Johnson acting for the receiver.

It is the hope and belief of the larger creditors that through the appointment of a receiver it will be possible to bring about a reorganization of the company and a continuation of the business on a sounder basis. The assets of the

(Continued on page 158)

DEALERS—Your Chance for a Clean-up is Here NOW

There is no other, more desirable, acceptable or practical holiday gift than a REPEATER-STOP

THE BIGGEST SELLER ON THE MARKET

COLUMBIA DEALERS:

We have just developed a special model for operation on the Columbia. Thousands of present Columbia owners have been looking for it. Nine out of every ten will buy one upon demonstration. Order a stock now.

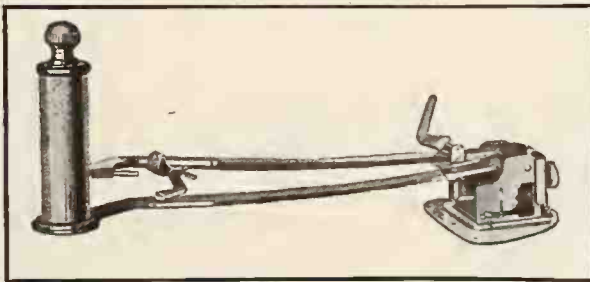

PATHE DEALERS:

It will be interesting to you to learn that we have just developed and are ready to put out a special Repeater-stop for the Pathé. Every live wire Pathé dealer realizes the opportunity for big turn-overs for this remarkable instrument. The sale of ten or more a day is easy—the profits derived more than doubly cover your overhead. Place your order for future delivery early.

Our Standard Victor Type gives perfect satisfaction upon such makes as the Aeolian, Sonora, Emerson, Paramount and hundred others which come equipped with the standard tone arm and reproducer.

At our present list price of \$7.50 for the nickel-plated instrument, it will practically sell itself.—Every jobber of consequence handles it.—If not, order direct. In ordering, specify make of machine you handle.

REPEATER-STOP COMPANY

New York Office
1170 BROADWAY

115 So. Dearborn Street
CHICAGO, ILL.

Export Distributors
CHARMEL TRADING CO., Inc.
1170 Broadway, New York, N. Y., U. S. A.

FROM OUR CHICAGO HEADQUARTERS—(Continued from page 157)

Vitanola Talking Machine Co. are considerably over the known liabilities. Those familiar with the affairs of the company state that the present assets are ample to cover indebtedness but that due to the general conditions which have prevailed in the trade during the past few months it has been found impossible to liquidate all indebtedness at this time.

ESSENTIALS VITAL IN MAKING REPRODUCER

By BARR BLOOD,
of the Jewel Phonoparts Co., Chicago

Much time and money have been spent in an effort to find a suitable material for diaphragms for phonographs. I have made it a matter of considerable study for a good many years and have arrived at certain definite conclusions which our experiments have borne out, and I thought we might add a word that would be of interest to the talking machine industry in general.

What I believe to be vital in reproducer construction is the following:

1. A diaphragm should be of a substance as nonresonant as possible, so that when it is caused to vibrate by the stylus transmission it will not set up counter vibrations of its own.
2. It must be extremely light in weight to permit of a ready response without undue strain on the stylus.
3. It must be very resilient so that it will center properly. Another important feature in this connection is that a properly resilient material does not need the aid of springs in the stylus base to aid the proper functioning of the diaphragm.
4. The diaphragm must not absorb moisture to any perceptible degree or be affected by atmospheric conditions.
5. I have read many theories regarding the action of diaphragms which do not prove out in actual practice—such as the theory that certain tones are produced by certain areas on the diaphragm. This seems ridiculous, since all the vibrations transmitted by the stylus are carried to the centre of the disc in a composite vibra-

tion or sound wave in the air space back of the diaphragm. Now, if the diaphragm is of uniform thickness, the stylus acting on the center will move the disc a greater distance in the center than at or near the circumference; whereas, if the "bending point" of the diaphragm is near the circumference, the whole area will move, giving a uniform compression of air back of the diaphragm. Theoretically, the greater the displacement of air, the wider the sound wave; in like manner, the wider the sound wave, of equal frequency, the louder the tone and the freer it is from intense, contracted tones so common to reproducers. We feel that we have amply proved this theory to be true because our reproducers are constructed with this sort of a diaphragm. Musical critics all over the country have acclaimed it and large phonograph manufacturers have adopted it in preference to others.

We have found that while good results can be obtained with mica, diaphragms composed of a material that can be shaped, as described above, appear to reproduce more accurately and

with greater volume—this has been demonstrated.

The best results are obtained by a complete tonal equipment that is non-vibratory and has a hard, smooth surface from the reproducer through the arm and at least to a point far enough into the tone chamber to develop a substantial sound wave,—one that is not distorted by the vibrations set in motion in this part of the equipment. And above all, as the diaphragm is the part that receives the vibrations in their inception, it should be of a material that responds to those vibrations without any resonance of its own. Mica, being highly resonant, has this one fault in particular. Besides this, it is of uniform thickness and cannot be molded or machined into the proper dimensions. Being composed of minute layers, it has a tendency to separate under strain, causing what is termed a "blast" in reproducers.

There are very many important features in a reproducer other than the diaphragm, such as the stylus, its proportions, length and material; the stylus base and its relative weight; the opening into the arm, its size in proportion to the area of the diaphragm, etc.

So vital are all of these points that a first-class equipment cannot be made without a knowledge of all these and their relation to one another.

STAFFORD CABINETS

Attractively designed, are well made and finished, and produced by an organization of over thirty years' standing. We will be glad to tell you of our low prices either on the cabinet unequipped or the complete phonograph.

Write or call upon us for prices covering your needs this fall

E. H. STAFFORD MFG. CO.
218 SO. WABASH AVE. CHICAGO

THE FERRO SPRING-BALANCE COVER SUPPORT is the latest thing in phonograph cover supports.

It is an innovation that will surely enhance the value of YOUR talking machine.

It is a convenience, as with it the cover can be kept in any position.

And last, but not least, it is a "safety-first" device. A child can operate it without the danger of the lid dropping down and injuring the hands.

Send for a sample and quantity prices

FERRO PHONOGRAPH PARTS CO.
1455 W. Congress Street, Chicago, Ill.

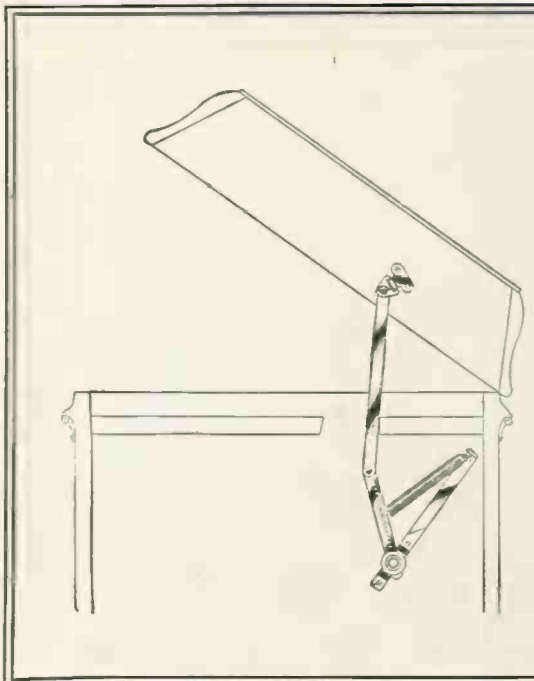

All Steel and Iron

Will absolutely square cases and will not wear out.

Labor Saving and Indestructible

Gives Speed and Accuracy



WE ILLUSTRATE THE **"HANDY" REVOLVING CASE CLAMP**

WE ALSO MAKE IT STATIONARY

Nothing better made for Clamping and Squaring Talking Machine Cabinets.

Write for Catalogue of Clamping Machines for "Domes" and for all purposes.

VENEER PRESSES AND CLAMPS

HANDY MFG. CO.
27 E. Madison St., Chicago, Ill.

Equip Your Phonographs With Perfect Automatic Brakes

Samples \$1.00 Each
Cash with order
State make of tone arm used



Also made with long brake shoe for 1 inch offset

Patented Aug. 28, '17

Simple construction and easily attached. Made in four styles to fit any make of tone arm.

Write for attractive quantity prices

PERFECT AUTOMATIC BRAKE CO.
Room 400, 425 S. Wabash Ave., Chicago

¶ When the Eight Famous Victor Artists made their first tour of Illinois, the Putnam-Page Company booked the concerts through its dealers. The tour was a triumph.

¶ We point the way to Dealers' success and then work out the plan to the dealers' satisfaction.

¶ We lead in Victor Service in Central Illinois and its environs. And our dealers lead.

Putnam-Page Company, Inc.

Exclusive Victor Distributors

Peoria, Illinois

STONE MFG. CO. INCREASES CAPITAL

Talking Machine Manufacturers of St. Louis Expand Capital From \$20,000 to \$175,000—Lease Building to Meet Increased Demands

St. Louis, Mo., November 4.—The reorganization of the Stone Mfg. Co., maker of Supreme phonographs, which has just taken place, will enable the company to go into production heavily on its specialty, and to pursue a nation-wide selling campaign. The company has increased its capital from \$20,000 to \$175,000, of which \$150,000 is paid up. It has a lease for a term of years of a large four-story building at 2621-23 Olive street, adjoining the present quarters. The upper floors will be used entirely for manufacturing and the main floor will be converted into beautifully fitted up wholesale and retail warerooms.

The Supreme phonograph has a number of unique features. The grill is of illuminated art glass, furnished in several attractive designs. Underneath the horn is a shallow velvet-lined drawer, which serves as a shelf for records while being operated, or can be used to make instantly available three or four of the owner's "pet" records. A touch of a button on the motor board illuminates the entire machine. One incandescent lamp floods the top of the machine, enabling the changing of records in the dark. Another lamp located in the horn illuminates the art glass grill and also lights the record drawer before mentioned. A third lamp located in the cabinet in the lower part of the machine lights the record shelves and the record index. M. J. Stone, the president of the company, to whom it is indebted for the patented features of the Supreme, is the inventor and manufacturer of the Stone airplane propellers and is a cabinetmaker and designer of experience. H. C. Edelman, vice-president of the company, who comes in under the reorganization and assumes the general management, is an experienced talking machine man. The other officers are J. J. Stone, secretary, and A. J. Kahn, treasurer. The company is already waging an aggressive advertising campaign in St. Louis through the dailies and street cars.

ISSUES NOTICE TO TRADE

The Geo. A. Long Cabinet Co., manufacturer of Long record cabinets, has advised the trade that it has taken an appeal from the decision which was handed down recently in the United States District Court in the suit of Beecroft & Blackman vs. The L. J. Rooney Co., a talking machine dealer in New York. The Geo. A. Long Cabinet Co. defended this suit for this dealer, and has advised its trade that it will protect all purchasers of Long cabinets from any litigation.

There are times when the most eloquent spokesman is silence.

MAGNAVOX HEARD IN NEW ROCHELLE

Announces Election Returns and Gives Concert at Evening Standard Office in That City—Campaign Records by Candidates Interest

The White-Moorey Music Co., New Rochelle, N. Y., secured some excellent publicity for the Magnavox on election night. The election returns were displayed on a screen at the Evening Standard office and to entertain the crowds musical selections were played and made audible many blocks away by means of the Magnavox. An interesting feature were the campaign records of the Nation's Forum and speeches by both candidates were given as the returns came in for each. In spite of the rain the crowd was kept in a happy mood by the concert and speeches, and many compliments were heard for both the Magnavox and the enterprising music house.

INSTALLING MODEL DISPLAY ROOMS

Van Veen & Co., Inc., are completing the installation of the model warerooms at the headquarters of the New York distributors of the Columbia at 121 West Twentieth street. Similar installations are also being made at the headquarters of all other distributors of the Columbia line throughout the country. This new equipment should prove extremely popular and valuable.

REPEATER-STOP EXECUTIVE IN EAST

Sales Manager Hartenstein Tells of Expanding Business—Bringing Out Repeater-Stop to Fit Pathé—Visits New York Headquarters

R. P. Hartenstein, sales manager of the Repeater-Stop Co., Chicago, Ill., was a visitor to New York recently, making his headquarters at the Eastern offices of the company, 1170 Broadway. Mr. Hartenstein conferred with the Eastern division regarding general conditions in this territory, and was instrumental in closing several important distributing contracts.

In a chat with The World he stated that the demand for the Repeater-Stop is steadily increasing, with the dealers reporting that this repeater and automatic stop is giving splendid service and satisfaction. The Repeater-Stop is now being handled by dealers from coast to coast and Mr. Hartenstein has made plans whereby these representatives will receive maximum service and co-operation during the coming year. Mr. Hartenstein made the important announcement that his company will have a Repeater-Stop to fit the Pathé machine ready for the holiday trade. This means a broadening market for this interesting and invaluable device.

The man who comes to the office too late misses the big chance. The Lucky Man gets it. Be prompt.

A Big Profit in Musical Instruments

Order Right From This Ad

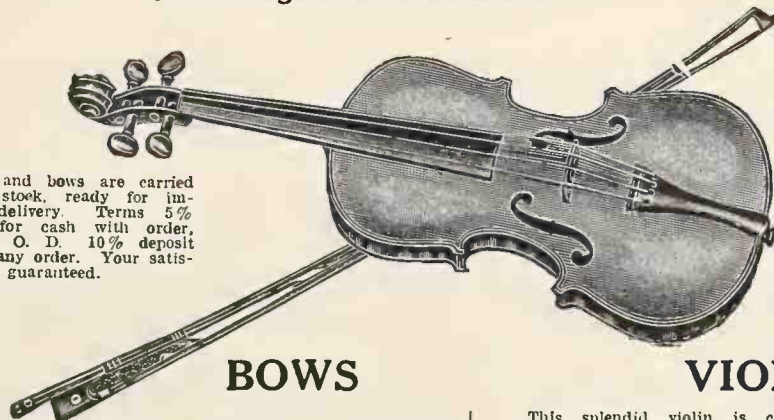

Violins and bows are carried right in stock, ready for immediate delivery. Terms 5% discount for cash with order, or net C. O. D. 10% deposit to accompany order. Your satisfaction is guaranteed.

Cash in on the unusual demand for musical instruments. Progressive dealers, even those that never handled them before, are reaping a handsome profit from our special offerings. They practically sell themselves. A small window display, a little advertising and you are bringing entirely new faces to your store and new profits to your cash register. Here are some special values for quick sale—that you cannot afford to pass by.

BOWS

Round stick, rosewood finished, mother of pearl slide and eye, nickel silver ferrule and slide. Nickel silver mounted button with mother of pearl eye. Leatherette grip. Retail Value, \$2.00

95c

No. 707G—Price each \$1.25
No. 708G—Lots of 6 to 11, each..... 1.10
No. 709G—Lots of 12 or more, each..... .95

An unusual value in a violin bow, made of Brazilian Tource wood; octagon stick; ebony frog; pearl inlaid eye; pearl slide; full lined; silveroid buttons.

\$150 up

Retail value, \$3.00.

No. 704G—Price each \$1.65
No. 705G—Lots of 6 to 11, each..... 1.60
No. 706G—Lots of 12 or more, each..... 1.50

Write for 24 Page Bulletin

Our new 24 page bulletin shows everything in Phonographs, string instruments and supplies. Many items listed at pre-war prices. It is FREE. Write for a copy Today, NOW.

VIOLINS

This splendid violin is copied from a genuine Cremona Stradivarius model; made with back and sides of selected grained maple; back beautifully flamed. Top is straight grained spruce; edges inlaid with black wood; ebony fittings. It is an instrument for professional or student.

\$595 up

Retail Value \$14.00

No. 700G—Price each \$6.60
No. 701G—Lots of 6 to 11, each..... 6.40
No. 702G—Lots of 12 to 23, each..... 6.20
No. 703G—Lots of 24 or more, each..... 5.95

Cole & Dunas Music Co.

52 W. Lake St.

Chicago, Ill.

BRITISH SAILORS WANT VOCALION

Choose This Instrument to Furnish Music to Cheer the Long Evenings in the North

The following interesting tribute appeared in the September 8 issue of the London Sketch and shows how much two sea dogs cared for their Vocalion:

"Do go to the Acolian Co., New Bond street, and choose us a Vocalion—we are so dull in the evenings." Who do you think the commission came from? A house full of young people wanting to dance? No; a couple of matured captains in the "King's Navee" who are partners in a small shooting far away North. If it had been a hard task I'd gladly have undertaken it for two of the men who saved us. Far from this, it was sheer delight to hear those wonderful instruments play glorious music gloriously. Not a hint of hardness or mechanism in the tone; soft, full, and sweet it is; and the Graduola device gives the player a delicate control and produces real artistry. My naval friends are now quite happy, and they, being generous like all sailor men, give an outdoor concert in fine weather. They say the people just love it, and walk miles to listen.

E. W. MILLER GOES WITH HAYNES CO.

Joins Staff of Richmond Edison Jobber as Traveling Representative

E. Weston Miller, until recently manager of the Edison Department of the Stoll Blank Book and Stationery Co., Edison dealers in Trenton, N. J., has joined the staff of the C. B. Haynes Co., Inc., Edison jobbers in Richmond, Va., and will act in the capacity of traveling representative.

Mr. Miller recently spent a week at the Edison Laboratories, acquainting himself more closely with the Edison products and with



E. W. Miller

Edison policies. He has traveled extensively, in addition to having spent some years as an instructor in several well-known colleges, and enters the Richmond jobbing organization well equipped to assume his new responsibilities.

VICTOR ACTIVITIES IN SOUTH

Philip Werlein, Ltd., Making Shipments as Fast as Goods Are Received From Factory

NEW ORLEANS, LA., November 5.—In a recent chat with The World, J. D. Moore, manager of the Victor division of Philip Werlein, Ltd., Victor distributor, stated that business conditions seem to be very good throughout the South, with the exception of some sections in the rice and cotton districts. The rice farmers are somewhat pessimistic, and although the cotton crop was somewhat of a disappointment, there is a feeling of optimism regarding the future.

The company is shipping all of the goods that it receives from the Victor factory, and at the present time is many thousand dollars behind orders. There has been such a rapid development of the Victor industry in the South that Philip Werlein, Ltd., has advised the factory that it can very easily use substantial quantities of Victor product in its territory.

ATTRACTIVE STORES IN BROOKLYN

Baim Bros. & Friedberg Now Have Three Victor Establishments in That City

The newly equipped store of Baim Bros. & Friedberg, at 1525 Pitkin avenue, Brooklyn, is one of the most attractive Victor stores on the further side of the river. Some time ago these three young men purchased the building and built an extension which permitted an enlargement of ten demonstration rooms, together with self service and quick service counters, office and foyer. The windows have been entirely rebuilt. Three stores in the Brownsville section of Brooklyn are now run by these enterprising young men who deserve great credit for the way in which they have built up a substantial business.

STODART

PHONOGRAPH

The sign of a quality phonograph

**A high grade instrument appealing to high grade prospects
Exemplifies its superiority—in Case Design, Tone and Equipment**

Five handsome and distinctive models in mahogany.

*Stephenson Precision-made motor with velour turn-table.
Universal Tone Arm.*

*Its remarkable reproducing device creates extraordinary
tonal volume and tonal beauty. Tone modifying rod.*

The Stodart Phonograph is distinguished for the identical quality which has made the Stodart Piano famous for a century.

A constantly growing demand is reported by our enthusiastic chain of nationally distributed Dealers.

Find out *how* and *why* this Leader can *make money* for you.

Write right now.

STODART PHONOGRAPH CO., Inc.

"PHONOGRAPHS WITH A PEDIGREE"

GEORGE H. BEVERLY, General Manager

Bush Terminal Sales Building

130-132 West 42nd Street

NEW YORK



STYLE
AA



STYLE
D

FOR VICTOR JOBBERS AND DEALERS

The HUGHES Safety Sound Box Controller

Manufactured by the HUSTYLUS CORP., Philadelphia, Pa.

Designed Exclusively for VICTROLAS

THREE MODELS TO FIT ALL TYPES

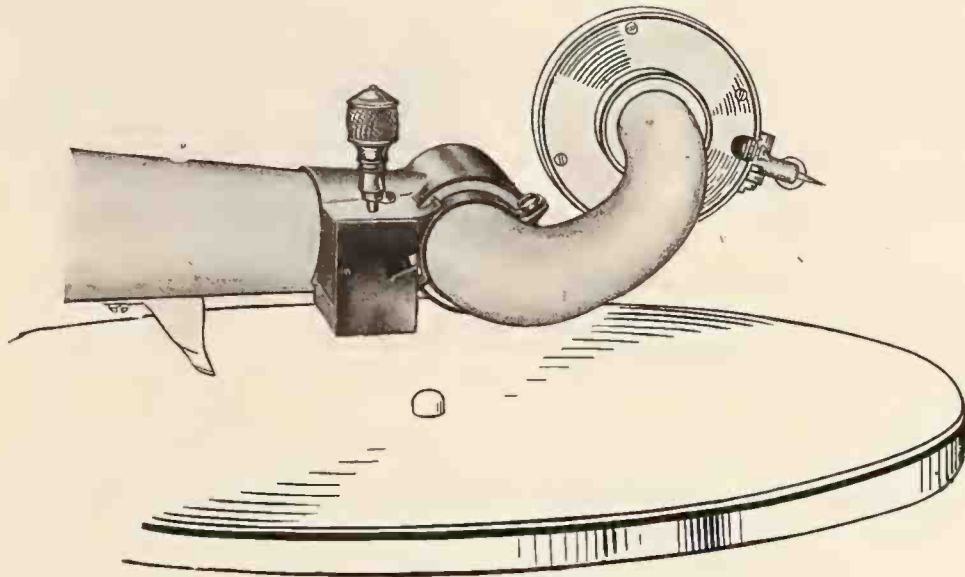

It Holds the Sound Box in Any Position and Cannot Be Dropped

Saves Records
Saves Tungs-Tone Needles
Sound Box **CANNOT**
Be Dropped

Simple
Fool Proof
Durable
Guaranteed

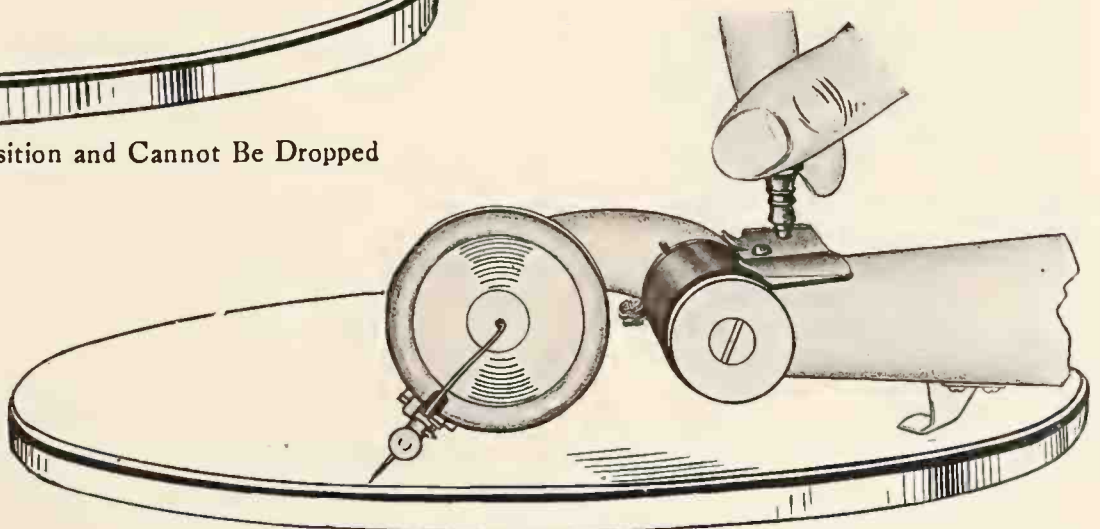

By a Turn of the Knob, It Is Gently Lowered, and is Free to Float When Needle Touches Record

Very Liberal Jobber and Dealer Propositions

AN IDEAL CHRISTMAS GIFT

HERBERT & HUESGEN CO. :: 18 E. 42nd St., New York
SOLE SALES AGENTS

THE VISION

Devoted to the Interest of the Educational Work Being Conducted by the Talking Machine Dealers and Jobbers

The State of New York, Special Classes for Exceptional Children, has adopted Victrolas and Victor records for use in the training of these little ones and has purchased through Landay Brothers, New York City, a complete working library of records for the whole State system.

Columbia Graphophone Co., Educational Department has had Mrs. J. M. Dorey as its representative at several State educational meetings. Mrs. Dorey was formerly head of the English Department, Trenton (N. J.) High School, and is an authority on the Correlation of Music and Literature.

Princess Watahaso, Indian mezzo-soprano, so well known to Victor folk in this country, is making a tour of New York State cities in November and Northern New Jersey cities in December before beginning her nation-wide trip to start after the Christmas holidays. Her bookings are in charge of Franklin G. Dur-

ham, Metropolitan representative of the Victor Educational Department at 4 West 43rd street, New York City.

Vocalion records as produced by the Aeolian Co. are receiving special attention in regard to interesting demonstrations on Sound-Wave Lengths being given before Vocalion dealers by Thos. E. Ratcliff.

James K. O'Dea, progressive Victor dealer of Passaic and Paterson, N. J., has just supplied two M-XXV Victor school instruments for use in the Physical Training Department of the schools in the latter city.

The current issue of the "Musical Monitor" is devoted to school music. Mrs. Frances E. Clark, chairman of the Education Committee, National Federation of Music Clubs and for successive terms president of the National Music Supervisors' Conference, now Educational Director, Victor Talking Machine Co., appears on the full-page frontispiece as Mother of School Music in the United States.

Jobbers' Service Departments in the trade of various talking machine companies are in charge of educational directors, trained to give service not only to dealers but also to schools, libraries and all institutions of learning.

BOLWAY REPORTS ACTIVITY

Frank E. Bolway & Son, Inc., exclusive jobbers of the New Edison, located in Syracuse, N. Y., report the very best of conditions existing among the dealers that they serve. A few weeks ago the firm sent to its many dealers throughout its territory a chart giving each dealer a quota for the month which was one hundred per cent increase over the previous quota allowed him. At the end of the month nearly 50 per cent of the dealers exceeded their 100 per cent increased quota by a very wide margin, and practically every dealer exceeded the quota given him earlier in the year.

ORIGINALITY IN WINDOW DISPLAY

There is always a great amount of material available to dealers for display purposes and this year more than ever the chances for novel and original treatment for the holiday time are legion. Given a good window and attractive display material the clever dealer can work wonders in a short time. The effectiveness of the display can be judged from the sales made. Remember that the manufacturer gives you the opportunity but it is up to you to carry the thing through to its logical end. Suit the needs of your community by your arrangement of your store windows.

The PIKNIK, A Gift Phonograph



Size 9x13x15 Patented in U. S.

If you hope to handle the PIKNIK for holidays write for particulars now.

Western Distributions through
James H. Cumming, Willmette, Ill.
New York State and Metropolitan District
M. M. Roemer Sales Corp., 1123 B'way,
N. Y.

New Jersey
Ziegler, Baker & Johnson, 100 Chambers
St., N. Y. City
Export Distributors
Delphon Sales Co., 25 Church St., N. Y.



Melchior, Armstrong & Dessau, 116 Broad
St., N. Y.
Charmel Trading Co., 1170 B'way, N. Y.

PIKNIK PORTABLE PHONOGRAPH, Inc.

Lakewood, New Jersey

JOHNSON OFFERS CAMDEN \$100,000

President of Victor Talking Machine Co. Wants Civic Center for City and Makes Offer to Chamber of Commerce at Its Last Meeting

PHILADELPHIA, PA., November 5.—The offer of a gift of \$100,000 as the nucleus of a fund to establish a civic center for Camden, made by Eldridge R. Johnson, president of the Victor Talking Machine Co., at the last meeting of the Camden Chamber of Commerce, has aroused the members of this body to energetic action. Mr. Johnson has already given Camden a \$350,000 free library building in Johnson Park and in outlining the purposes for which his new gift is intended he laid out a tentative program which the chamber will promptly take up with vim. President William J. Strandwitz announced that a committee will be named at once to formulate the plans, of which nothing definite will be determined until further consultation with the donor.

Mr. Johnson made no specific suggestion accompanying his offer, which carried the members almost by storm, except that he would like to see organized a civic body as an auxiliary to the chamber to take up purely civic matters and to arouse the interest and co-operation of all the citizens in projects for the general betterment and beautification of the municipality. He believed it might be possible to purchase from the Pennsylvania Railroad Co. the triangular plot at the terminal, between Market and Federal streets, now in some dispute because of the traffic congestion, upon which might be erected an imposing and commodious building for the use of the Chamber of Commerce and other civic bodies as a community center. He said visitors to Camden are now far from favorably impressed by the first view they get of the town as they enter from the ferries, and many decline to make return calls. None of the other approaches to the city have been embellished with a view to making them attractive and all the beauty is confined to sections removed from these approaches.

of Music in piano, and who has on several occasions accompanied Galli-Curci and other famous artists. N. R. Williams, well-known pipe organist of Racine, is also a stockholder.

The Blandin phonograph is being handled by representative dealers throughout the country, who are taking advantage of the general sales co-operation that is being extended by the manufacturers. One of the unique features of this co-operation consists of a patented shipping case for the Blandin machine which enables the dealer to unpack the instrument in two minutes and display it on his floor without a scratch or mar of any kind. This case also protects the talking machine from dust and dampness.

CHINESE LIKE THE NOISY RECORDS

According to the testimony of a member of the Department of Commerce who has recently returned from China, that country would be a fine place for some of these loud records often relegated to the ash can. Chinese buyers like cheapness and seem to enjoy the scratching of the needle. They do not care for foreign records except those of laughing songs and instrumental selections featuring the bugle and drum.

"Does It Play All Records?"

Certainly MAGNOLA does; and without any extra attachments, too. This is only one feature, albeit a most important one, in the thoroughly up-to-date equipment of the MARVELOUS MAGNOLA.

MAGNOLA "Built by Tone Specialists"



Watching the Music Come Out

May we send you our handsome illustrated catalog chock full of information concerning the wonderful construction system of Magnola and the beauties of its musical results, its artistic appearance and its moderate price?

Send your name and let us tell you more!

MAGNOLA TALKING MACHINE COMPANY
OTTO SCHULZ, President

General Offices
711 MILWAUKEE AVENUE
CHICAGO

Southern Wholesale Branch
1830 CANDLER BLDG.
ATLANTA, GA.

HEADED BY STRONG EXECUTIVES

Racine Phonograph Co. Establishing Dealers Throughout Country—Executives of Company Well Known in Industrial Circles

RACINE, Wis., November 5.—The Racine Phonograph Co. of this city, manufacturer of the Blandin talking machine, is meeting with pleasing success in the marketing of its product. The executives of the company are all well known in this section of the country and include Senator Geo. L. Buck, vice-president of the American Trades and Savings Bank and president of the Racine Iron & Wire Works. Milton W. Jones, vice-president of the Racine Phonograph Co., is treasurer of the Belle City Manufacturing Co.

F. F. Blandin, president and general manager of the Racine Phonograph Co., was also responsible for the development of the Racine Manufacturing Co., and H. M. Thomas, assistant sales manager, is connected with the J. I. Case Threshing Machine Co. S. W. Blandin, secretary and treasurer, is the owner of the Worko Co. L. J. Breylinger, cashier of the Farmers and Merchants Bank, is also interested in this talking machine company, as is P. J. Myers, of the firm of Thompson, Myers & Kearney, attorneys.

One of the leading stockholders of the Racine Phonograph Co. who is also an acknowledged musical authority, is Roy A. Goppelsroeder of Chicago, graduate of the Chicago Conservatory



FULTON (Model 35)

Mahogany, 16x16x10 in., double spring motor, universal tone arm. Back casting and metal horn. Discount according to quantities.

True-tone, Cleartone, Brilliantone and Puretone Needles in metal boxes or packages at 50 cents per M. Discount in large quantities. Truetone Needles come 200 to a metal box.

Double and triple spring Motors, Tone-arm, Auto Stops, Repeater Stops, etc. Phono parts and accessories, as Motors, Tone-arms, Sound Boxes, Cabinets and Cabinet hardware. Repair parts for all makes.

Distributors of the Arto Music Rolls and Arto Phonograph Records.

Cash with order

FULTON TALKING MACHINE CO.

253-255 Third Ave., New York City
Between 20th and 21st Streets

Introducing

U-SAV-YOUR

(Reg. U. S. Patent Office)

CLEANSER and DRESSING

Especially Made for the

VICTROLA

Restores the original finish like when the instrument was new—U-SAV-YOUR removes *all* marks and blemishes that result from continued use and maintains a finish equal to the original.

It contains no *wax* or paraffin to build a false finish.

SOLD ONLY BY VICTOR DEALERS



COLLINGS & COMPANY
 DISTRIBUTORS FOR THE
Victor Talking Machine Company
 PLUM BUILDING
 CLINTON & BEAVER STS.
 NEWARK, N. J. October 18th, 1920.

U-Sav-Your Mfg. Company,
Warren, Mass.

Gentlemen:— Attention Mr. B. D. Perkins.

There is no question that your product is the best of its kind on the market. We are pleased to say that we have developed a splendid repeat business in U-SAV-YOUR-DRESSING, which tells us that it is going to be a great success with the Victor dealers.

We have a number of letters on file from our dealers, who say it is the finest dressing they have ever used and they find it a very profitable necessity.

We are confident that the advertising you are undertaking, will be the means of developing a big trade for you.

Yours very truly,

COLLINGS & COMPANY

LWC/V.

Read What Collings & Co., Victor Wholesalers, Say

Dealers:—

You owe it to your customers as well as yourselves to learn all about this "highest grade dressing in the market". Write to your jobber.

YOUR NAME ON LABEL IF ORDERED IN LARGE QUANTITIES, LIKE THIS—



LABEL MEASURES 7 1/2" x 4"

Discounts attractive, clean policy and repeat business guaranteed

Retail price offer: 4 oz. 30c., 8 oz. 50c., 16 oz. 85c., 32 oz. \$1.25

Slightly higher West of Mississippi River

Carried in stock by the following Victor Distributors:

- Florida Talking Machine Co., Jacksonville, Fla.
- Collings & Co., Newark, N. J.
- Ross P. Curtice Co., Omaha, Neb.
- Talking Machine Co., Birmingham, Ala.
- Wm. H. Reynolds, Mobile, Ala.
- Horton-Gallo-Creamer Co., New Haven, Conn.
- Emanuel Blout, 108th St. & Broadway, New York City
- Silas E. Pearsall Co., 10 East 39th St., New York City
- Mickel Bros. Co., Des Moines, Iowa
- Schmelzer Arms Co., Kansas City, Mo.

U-SAV-YOUR MFG. CO.

33 PERKINS AVENUE

WARREN MASS.



Experienced Operators of Talking Machines Use Fibre Needles.

The B & H Fibre Needle owes its present widespread popularity to the fact that it has recruited thousands upon thousands of enthusiasts upon its own merits, discovered by talking machine owners in their own homes through actual tests.

Find the dyed-in-the-wool talking machine owner and you will find a user of B & H Fibre Needles.

Need more be said?

Your success as a merchant depends upon your ability to *sell satisfaction*. Failure to recommend the only needle that will not injure the record—no matter how many times played—weakens your position in the eyes of a customer who later finds it out.

B & H FIBRE MFG. CO.

33-35 W. Kinzie Street, Chicago, Ill.

UNEVEN CONDITIONS PREVAIL IN THE CINCINNATI TRADE

Purchases of Machines Stacking Up Due to Unseasonable Period—New Roll Concern Opens Up —Aeolianites Pleased at Record Production—Ohio Talking Machine Co. Reports Progress

CINCINNATI, O., November 4.—For the first time since Armistice Day in 1918 local jobbers of phonographs whose territories reach outside of the State proper have been receiving cancellation of orders from dealers, mainly in the larger towns, where there were sudden increases in population due to the world war.

The situation, however, at this time, is not in the least alarming, for there are other merchants who have been shy on stock and it can be stated with authority that these have been taking up goods rejected by their competitors in other towns.

Some of the jobbers believe that the unusual fall in the Middle West has had something to do with the cancellation situation. It certainly was not favorable to the coal baron and the clothing artist. So far as the weather was concerned it was just one series of days each more pleasant than the other. It was only during the past week that rain has set in with a tendency towards cooler weather. This condition, some of the jobbers believe, will have a beneficial effect on the general market, including records.

Three salesmen will shortly be traveling out of Cincinnati for the Sterling Roll & Record Co., incorporated during October with a capitalization of \$50,000. It starts in, from a talking machine standpoint, with the Okch record as well as one of the principal agencies for the Motrola with side lines such as the Brilliantone and Wall-Kane needles and record envelopes. F. F. Dawson is the active principal in the new concern, which has secured quarters in the Willis Building, 137 West Fourth street. He was until recently manager of the Cincinnati branch of the Columbia Graphophone Co.

Cincinnati's streets, for a short time in October, sounded like a miniature midway, due to some of the enterprising merchants in the talking machine field stationing machines, equipped with amplifiers, near their doors. These played continuously and across the street the tune of the largest machine could not be identified. Energy of this kind became a nuisance and caused one of the leading newspapers to indulge in an editorial protest. Since then the free "concerts" have been eliminated.

Ben Brown, manager of the Indianapolis branch of the Columbia Graphophone Co., and his traveling representatives were in Cincinnati the latter part of October, consulting with G. W. Hopkins, general sales manager, who was looking over the local territory.

Manager T. Sigman, of the Victor department of the Rudolph Wurlitzer Co., is happy over the October showing of his department. In speaking of this he said:

"The month of October proved to be the best wholesale month that we have had for a long time. Many dealers, realizing the fact that Christmas is only a few months off, have stocked up and will be in better shape this year to take care of the demand which there will be for Victrolas and records than ever before.

"Record sales showed somewhat of an increase, but not what we had anticipated, for our October shipment did not arrive until late in the month. We look for exceptional record business during the month of November.

"We received a few of the latest period model Victrolas, and they are now on display in special rooms we have provided for them. By the time the holiday season rolls around we feel sure that a number of these models will have been sold to people of discriminating taste."

The pleasant news from the factory, announcing the addition of twenty-five new record presses, was received during the past week by the Cincinnati branch of the Aeolian Co. The increasing demand for the new Red record has made it necessary to install these additional presses. This, said Dan Stephens, manager, will be a message of unusual satisfaction to dealers in the territory. The Graul Piano Co., Cincinnati,

is among the recent dealers added to the Vocalion list in the district.

The Aeolianites are very optimistic regarding the Fall and Winter business and feel that the Vocalion dealers will enjoy a larger amount of business this season than heretofore. One aid to this is a continuous advertising program in the better motion picture houses of the city.

By the way, Geo. P. Gross, operator of several stores in Cincinnati, is running a catchy advertisement in theatrical programs, one that covers phonographs, records, player-pianos as well as rolls. Just now he is urging Thanksgiving buying.

The Ohio Talking Machine Co. is now able to make satisfactory shipments, being in a position to supply the pressing wants of its followers. W. T. Haddon, president, who went East last week to bring his family to Cincinnati, is due to-morrow. C. H. North, secretary, is in New

York City on a business mission, leaving A. H. Bates, vice-president, on the job. During the past week he entertained Wayne Wright, dealer at Maricetta, as well as Renato Zanelli, a Victor artist.

The Phonograph Co., handling the Edison, is reaching a point where it is giving the old-time satisfactory service to its dealers, due to improved shipping facilities from the East. Manager Oelman is well satisfied with reports from different parts of his district.

A NEW VOCALION TRAVELER

The Aeolian Co. announces that Mr. H. G. Sheldon has joined the ranks of Vocalion travelers. He is already on the road and is traveling in Massachusetts. Mr. Sheldon is most enthusiastic about the merchandising possibilities of the Vocalion and he knows Massachusetts from end to end.

Legs often make up for brains in getting orders but each is an asset to the other and both are required to accomplish the best result.

Built Upon 25 Years' Phonograph Experience

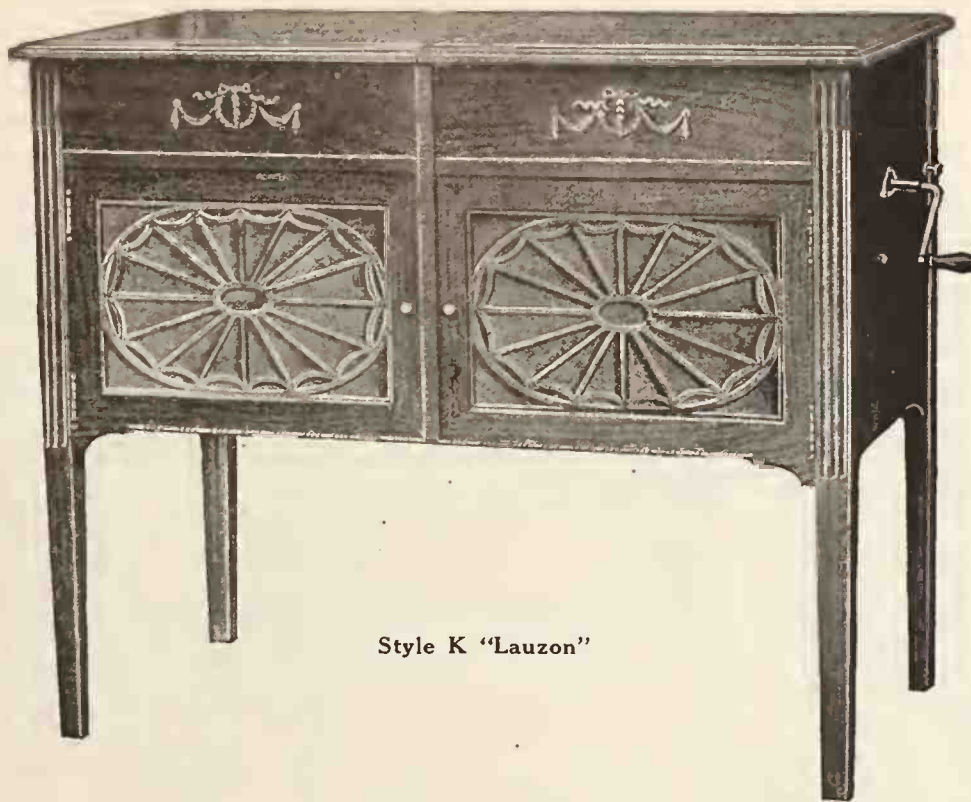

Style K "Lauzon"

Men who make Lauzon have been selling talking machines from the very birth of the industry.

They know jobbers' problems; they know dealers' problems.

They have stressed the strong points of quality phonograph manufacture and avoided the weak spots.

A priceless heritage of talking machine merchandising experience comes to you with the well-made Lauzon.

Line up with a leader—link up to Lauzon!

Seven upright and two console models. For available territories address

Michigan Phonograph Co.

Office Address : National City Bank Building
Factory Address : Monroe Ave. and Sixth St.

GRAND RAPIDS : : : MICHIGAN

Cleartone

PHONOGRAPH

SPEAKS FOR ITSELF

MICA DIAPHRAGMS

We are now cutting our own Mica Diaphragms and can take orders in any quantity. We can furnish you first quality clear Ruby India Mica. Sizes $1\frac{23}{32}$ " to $2\frac{9}{16}$ ". Also occasionally some second quality.

SUNDRY DEPARTMENT

MOTORS

Swiss A. B.—Double-spring, 10-inch turntable, plays 2 10-inch records, \$4.75.

Swiss F. V. B. — Double-spring, \$6.85.

No. 2—Double-spring, 10-inch turntable, plays 3 10-inch records. \$5.50; with 12-inch turntable, \$5.75.

No. 6—Double-spring, \$6.85.

No. 9—Double-spring, 12-inch turntable, plays 3 10-inch records; cast-iron frame, \$7.85.

No. 11—Double-spring, 12-inch turntable, plays 7 10-inch records; cast-iron frame, bevel gear wind, \$9.75.

STONE ARMS AND REPRODUCERS

Play All Records

No. 1—\$1.95 per set.
No. 4—\$4.50 per set.

No. 6—\$4.25 per set.
No. 7—\$3.75 per set.
No. 9—\$2.95 per set.

MAIN SPRINGS

No. 00— $\frac{5}{8}$ in., 9 ft., 29c.
No. 01— $\frac{7}{8}$ in., 7 ft., 29c.
No. 02— $\frac{3}{4}$ in., 7 ft., 29c.
No. 1— $\frac{3}{4}$ in., 9 ft., 39c.
No. 1A— $\frac{3}{4}$ in., 10 ft., 49c.
No. 2— $\frac{1}{2}$ in., 10 ft., 39c.
No. 3— $\frac{7}{8}$ in., 11 ft., 49c.
No. 4—1 in., 10 ft., 49c.
No. 5—1 in., 11 ft., heavy, 69c.
No. 6— $1\frac{1}{4}$ in., 11 ft., 99c.
No. 7—1 in., 25 gauge, 15 ft., 89c.

We also carry other size main springs to fit Victor, Columbia and all other motors.

Special prices on springs in quantity.

RECORDS—10-inch double disc records, 42c each; 12-inch, 60c each.

GOVERNOR SPRINGS—To fit VICTOR, COLUMBIA and all other motors. Special prices on large quantities to Motor Manufacturers.

We also manufacture special machine parts, such as worm gears, stampings, or any screw machine parts for motor; reproducer and part manufacturers.

Special quotations given to quantity buyers in Canada and other export points.

Write for our 84-page catalog, the only one of its kind in America, illustrating 33 different styles of talking machines and over 500 different phonographic parts.



No. 135—Price \$135



Model 105—Price \$105

SAPPHIRE, DIAMOND AND STEEL NEEDLES

STEEL NEEDLES

10,000 Lots.....39c per M
100,000 Lots.....35c per M
1,000,000 Lots.....30c per M
5,000,000 Lots.....29c per M

SAPPHIRE BALLS

	Each
Dozen Lots	11c
Hundred Lots	9c
Thousand Lots	8c
5-Thousand Lots	7c

SAPPHIRE POINTS

	Each
Dozen Lots	12c
Hundred Lots	10c
Thousand Lots	9c
5-Thousand Lots	8c

GENUINE DIAMONDS

	Each
Dozen Lots	\$1.00
Hundred Lots90
Thousand Lots75



Model 175—Price \$175

The CLEARSTONE has become very popular because of its quality, splendid value and the advertising sales campaign that now stands back of it. DEALERS! Watch us grow—write for our agency and grow with us. Keep our 84-page catalog of phonographs and all accessories handy.—Sent free on request.

LUCKY 13 PHONOGRAPH COMPANY

503 East 19th Street

310-312-314 Avenue A

New York, N. Y.

HANDSOME MUSIC SUPPLEMENT

Dallas Music Dealers Fill Fourteen Page Section of Daily Paper With Notable Ads—Many Lines of Musical Instruments Carried

One of the best music supplements we have seen in some time is that which appeared in the Dallas Daily Times Herald in its Sunday edition of October 10. The Texas State Fair, which opened on October 10 and lasted until October 24, was the occasion for which this supplement was issued. Fourteen full pages were devoted exclusively to things musical, a goodly part being advertisements of the various talking machine and piano houses in the city. The front page of the supplement contained a handsome illustration similar to those used by the New York papers during their special music sections at the time of the National Music Show and Music Week last February. A glance through the pages of this supplement is sufficient to make it easy to see why Dallas has won such a prominent place in the musical world. The music merchants of that Texas city are awake to the possibilities of their industry and lose no opportunity to spread their message to the public at large.

The lines advertised in this supplement are many and include the best in musical instruments. Although the majority of the advertisements are devoted to talking machines, pianos and players are also much in evidence.

As for the talking machine side of this supplement, the Victor line was advertised by the Bush & Gerts Piano Co. of Texas, the W. A. Green Co., the Lester Gunst Co., the Field-Lippman Piano Stores, Sanger Bros. and Will A. Watkin Co. The New Edison is to be found at the Edison Shop and Texas-Oklahoma Phonograph Co., wholesale distributors. Among the houses advertising the Columbia were the Riddle Phonograph Co. and the Leyhe Piano Co. The Brunswick phonograph is carried by the Riddle

Phonograph Co. and Thos. Goggan & Bros. A full page was given by Sonora Distributing Co. of Texas, wholesale and retail distributors of Sonoras and Okeh records, to the merits of their product. The Sonora Shop advertised notable musical events arranged for in the near future. G. H. Jackson, wholesale distributor for the Starr Piano Co., displayed Starr phonographs and Gennett records. The Vitrola Distributing Agency of Texas also took a full page for the Vitrola. The D. L. Whittle Music Co. took a page in advertising a sale of player-pianos and musical instruments.

The reading matter in this supplement was devoted entirely to musical topics and a feature was made of the growing realization of the value of music in industry.

HARMONY SHOPPE, INC., IS OPENED

A. Raoul Silber Head of New Corporation Which Will Feature the Vocalion

SPRINGFIELD, MASS., November 1.—The Harmony Shoppe, Inc., 10 Harrison avenue, this city, has just opened for business. A. Raoul Silber, president of this corporation, was formerly connected with the L. M. Pierce Co. of Springfield. Since the early part of last Fall he conducted a phonograph shop on Worthington street and it has been his ambition to become a Vocalion dealer ever since he severed his connection with the Pierce Co. Several months ago he joined hands with Max Bassin, a local man, and they formed a company resulting in the opening of the Shoppe. These people will also handle pianos, sheet music, etc.

One of the leading motion picture houses of Ottawa, Ont., is seriously considering the use of a phonograph to provide music for all performances in place of the piano soloist now employed. This has been tried elsewhere with great success.

RECORDS SOUND ON METAL THREAD

New Invention Displaces Usual Disc or Cylinder Record by Filament of Metal

A few years from now a Presidential inaugural address or an entire opera may be carried in the vest pocket if the inventive claims of E. Steiger are substantiated. His invention consists of a process whereby sound is recorded upon a metal thread instead of the usual disc or cylinder. In the present model of the new recording instrument, the thread is wound on a reel from which it passes under the tube into which the speaker talks. Here the sound waves are recorded upon the wire by a sapphire point in a manner similar to that now employed in making ordinary records. When it is desired to reproduce what is recorded the wire is passed through the machine in a similar way. Among the advantages claimed for this system of recording is economy, for 50,000 feet of wire could be obtained for a moderate sum and would be long enough to record important trials or speeches. The records could be sent by mail in an ordinary envelope and would be practically unbreakable. The inventor claims that his recording machine can be made to sell for from \$60 to \$70.

QUALIFIES AS VOCALION DEALER

Chas. Cagan, Well-known Violin Maker of Beverly, Mass., to Handle That Line

Charles Cagan, the well-known violin maker of Beverly, Mass., and who maintains a shop in an excellent location in that city, has just qualified as a Vocalion dealer and has installed a line of machines and records. Mr. Cagan opened a small shop about nine years ago, and in addition to making violins carried a line of small goods. He won a wide reputation for his cleverness as a workman, and his success in repairing a Strad violin was the subject of articles in the trade papers.

The **HOWE**



Tone — RICH
CLEAR · MELLOW
it does not Blast



BALL BEARING
No obstruction
in the base

C.W. Howe & Company
21 East Van Buren St. Chicago Ill.

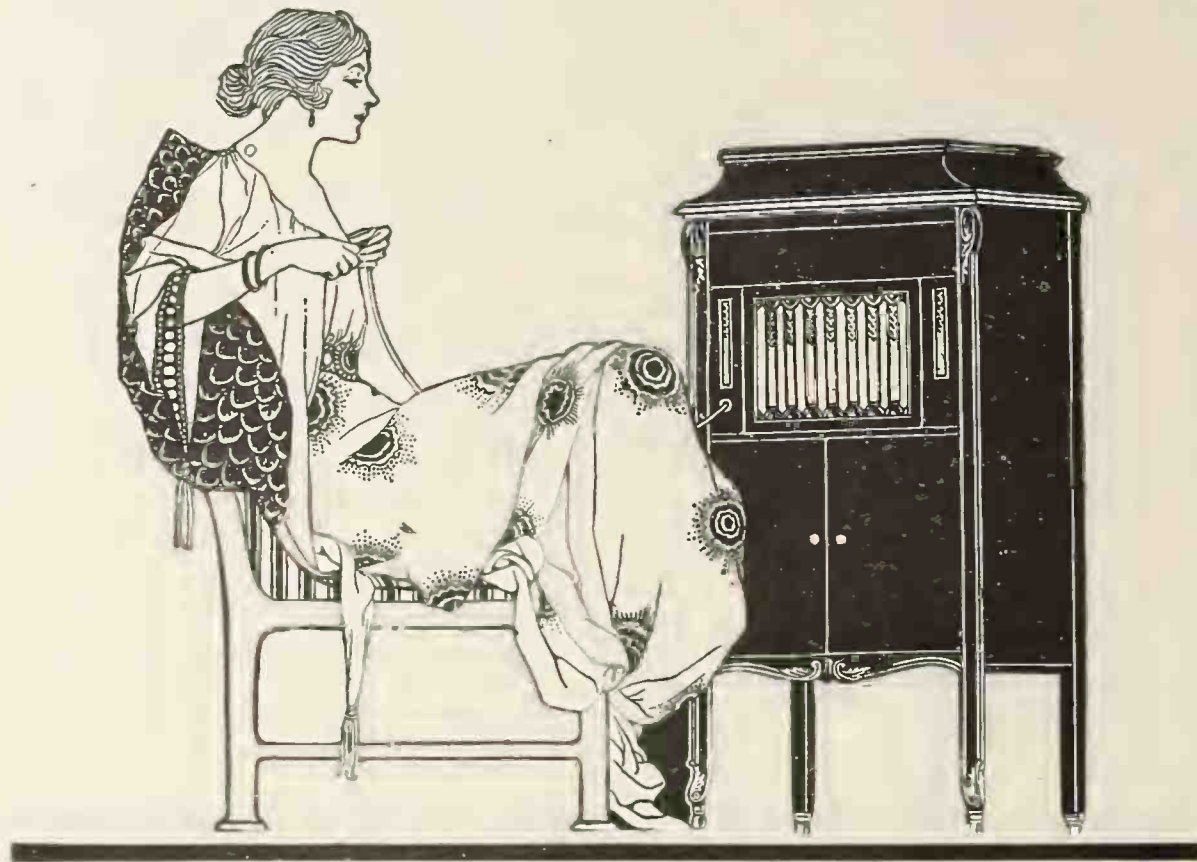

"You can vary the tone-color of each record, giving the music a freshness and spontaneity possible to no other phonograph"

You are not getting the maximum RESULTS
from your phonograph department if you are
not selling the

AEOLIAN-VOCALION

Rosa Raisa, the leading soprano of the Chicago Grand Opera and other famous artists, speaking of the fascinating expression device—the GRADUOLA—says: "With the GRADUOLA I not only can shade the tones to the most delicate pianissimo, but can introduce the subtle tone-gradations with which a singer always varies his or her actual performances."

Write today for Exceptional Agency Proposition

STONE PIANO COMPANY

MINNEAPOLIS, MINN. :: FARGO, NORTH DAKOTA

Aeolian-Vocalion and Mel-O-dee Player-Roll Distributors

E. A. GEISSLER NOW HEADS LOS ANGELES ASSOCIATION

Prominent Talking Machine and Piano Man Succeeds G. S. Marygold—New Victrola Period Models Admired—Columbia Managers Meet—New Stores Make Their Debut—Other News

LOS ANGELES, CAL., November 3.—A banquet was held early in October on the occasion of the annual meeting for the election of officers of the Music Trades Association of Southern California. The new officers elected were E. A. Geissler, vice-president and general manager of the Geo. J. Birkel Co., as president; W. H. Richardson, president of Richardson's, Inc., as first vice-president; Irving Andrews, of the Andrews Talking Machine Co., as second vice-president; Harold Jackson, of the Wiley B. Allen Co., as treasurer. A. G. Farquharson was re-elected secretary.

G. S. Marygold, retiring president, who nominated E. A. Geissler as his successor, said that he appreciated the loyal support which had been given him by the members. He believed that this Association was in many ways in the lead among music trades associations. A number of very important resolutions had been adopted during the past year which had proved of the greatest value, and although many of these seemed of advantage primarily to those who were engaged in the retail business, they were also of value—in many cases of equal value—to the wholesalers and manufacturers who, as members, had lent their loyal support and cooperation on all occasions. E. A. Geissler, in assuming his position as president, thanked the members for the honor which they had paid him in electing him president. He looked forward to the same loyal support which his predecessor had received. The year 1921 doubtless holds many problems which it will be necessary to face, and the usefulness of the Association would be appreciated more than ever.

Barker Bros.' New Store in San Diego

Under the management of Earl Dible, Barker Bros. have leased new and elegant quarters at 1165 Fifth street, San Diego. The Aeolian-Vocalion line has recently been added. Business has been excellent, both with the sale of Sonoras and Aeolian-Vocalions.

Emerson Wins Prize at Fresno

A very attractive exhibit was made of Emerson phonographs and records under the direction of I. Lessor, special representative of the Western Jobbing & Trading Co., at the Fresno Exposition, which was held early last month. Mr. Lessor returned to Los Angeles the proud recipient of a first prize, which was awarded to Emerson phonographs and records for quality, tone and superior finish and design.

Famous Film Folk Favor Period Models

Columbia period models were recently sold by Richardson's, Inc., to Reginald Barker and Tom Moore, of the Goldwyn Studios. Both of the

instruments were purchased to adorn the interiors of these gentlemen's beautiful homes in Beverley Hills. Mr. Parker is the famous Goldwyn director who was responsible for Geraldine Farrar's screen pictures while she was in the West. Tom Moore is the well-known Goldwyn star whose recent pictures, "Officer 666" and "The Poor Simp," have proved so popular.

Columbia Representative in Hospital

Charles Mack, the popular Columbia representative and city salesman, has been laid up in the hospital for the last two or three weeks after an operation which he was obliged to undergo. Latest accounts indicate that he will soon be back again on the job and helping to swell Columbia sales in his territory.

Starr Has New Phonograph Manager

H. L. Nolder, general manager of the Starr Piano Co. for the Pacific Coast, has appointed F. L. Valentine as retail phonograph manager of the Los Angeles store. Mr. Valentine was well known in the talking machine business in San Francisco and was already known by many Los Angeles people, who are pleased to see him locate in this city.

First Arrival of Victor Period Model

The first Victor Victrola of period model design to reach Los Angeles is on exhibition at Sherman, Clay & Co.'s wholesale showrooms. It is of Gothic design and has been admired very much by the favored few who have had the opportunity of viewing it, not only for its beautiful finish and workmanship, but on account of its remarkable tonal qualities and extraordinary reproduction of records. Charles Ruggles, manager for Sherman, Clay & Co., will have some difficulty in allotting this instrument and others, which are expected very shortly, among the many dealers who have orders on file.

Columbia Managers Hold Convention

A convention of Pacific Coast managers of the Columbia Graphophone Co. was held in San Francisco early last month. Los Angeles Branch Manager Win. F. Stidham attended, and while there was the recipient of a telegram from the general sales manager, Geo. W. Hopkins, congratulating him on the business of his branch for the month of September.

Sonora Sales Manager in Los Angeles

James L. Loder, sales manager of the Sonora phonograph division of the Magnavox Co., San Francisco, Pacific Coast distributor of the Sonora phonograph, visited Los Angeles last week and spent some time at Barker Bros., the Los Angeles representatives.

Victor Representative Here

O. L. May, of the Victor Talking Machine Co., has been making his headquarters in Los Angeles for some time. He finds conditions here in excellent shape and looks forward to a much improved record service and supply.

New Dealer in Bakersfield

Arrangements were recently made by E. R. Darvill with the Hochheimer Co. for the installation of an exclusive Aeolian-Vocalion department in its big store. F. F. Stricklin has been appointed manager of the department. Mr. Stricklin is well known in San Diego, where he managed the phonograph department of the Bledsoe Co.

Albert D. Wayne Returns to Los Angeles

Albert D. Wayne, who was very well known in Los Angeles and one of the former proprietors of the Talking Machine Shop, has arrived in Los Angeles from Chicago and is taking up a position with Barker Bros. in their music department, probably as assistant to General Manager Boothe.

"Nameplates With a Personality"

For Manufacturers and Dealers of Talking Machines, Phonographs, Musical Instruments, etc.

E. V. YUELL CO., Malden, Mass.

When You'll Think of Nameplates You'll Think of Yuell.

MICA DIAPHRAGMS

Absolutely Guaranteed Perfect
We get the best India Mica directly.
We supply the largest Phonograph Manufacturers.
Ask for our quotations and samples before placing your order.

American Mica Works
47 West St. New York

MARKETS NEW CABINET DRESSING

U-Sav-Your Mfg. Co. Introduces Cleanser Designed for Talking Machines

WARREN, MASS., November 3.—The U-Sav-Your Mfg. Co. of this city has recently introduced to the talking machine trade a specially prepared cleanser and dressing for talking machines. Although only recently marketed an excellent distribution of the product has already been made. Many of the leading talking machine distributors are handling the polish with remarkable results and the U-Sav-Your bottle is rapidly taking its place in the accessories departments of the dealers. B. D. Perkins, president of the company, has devoted much of his personal time to the perfection of the product and is backing his faith in it by a guarantee to take back unsold stock from dealers—provided this unexpected condition should prevail.

VOCALION IN HAVERHILL, MASS.

The Atherton-Peoples Furniture Co., Haverhill, Mass., are new Vocalion dealers and this makes two connections at this point for the Aeolian Co., the other being Fred W. Peabody. These people have opened an attractive department on their first floor and are looking forward to a good volume of business being closed before January 1.

HAS NEW AMPLIFYING HORN

Frank Winterrath, 405 Evergreen avenue, Brooklyn, N. Y., recently announced to the trade a new amplifying horn. This product has great resiliency and is light in weight. It can be designed to meet the plans of any manufacturer and its cost in large quantities is under the usual figures for similar products. It is understood that several large firms are investigating the merits of this product and during the past season it has been used exclusively by a Southern concern.

MAIN-SPRINGS

For any Phonograph Motor
Best Tempered Steel

1	in. x 10 ft. for Columbia.....	Each	\$0.50
1	in. x 13 ft. for Victor.....	Each	0.50
1 1/4	in. x 18 ft. for Victor.....	Each	0.75
1	in. x 12 ft. for Heineman.....	Each	0.60
7/8	in. x 10 ft. for Col. Pathé-Heineman	Each	0.50
1 1/8	in. x 16 ft. for Heineman.....	Each	1.20
1	x 16 ft. for Saal or Silvertone....	Each	0.90
1	in. x 10 ft. for Saal or Silvertone..	Each	0.60
1	in. x 16 ft. for Sonora or Brunswick	Each	0.90
3/4	in. x 10 ft. for all small type machines	Each	0.45
1 1/2	in. full size for Edison Disc.....	Each	2.10

SAPPHIRES—Genuine

Pathé very best loud tone genuine, each 15c;
100 lots, \$11.50.
Edison very best loud tone, 15c each or \$12.00 in
100 lots.

MOTORS

Special price on Krasberg motors.
Order right from this ad.
Send for price list of other repair parts.

The Val's Accessory House
1000-1002 Pine St. St. Louis, Mo.

BRUNO

People say there is a limit to everything. Not so. Sales of Victor records have no limit.

BRUNO



When Rosa Ponselle sings "Kiss Me Again," the waltz song, you feel the yearning emotion of this wonderful song. Order big. Columbia 49869.

Columbia Graphophone Co.
NEW YORK

LOOK FOR A BIG HOLIDAY BUSINESS IN NEW ORLEANS

City Trade Keeps Large in Volume, but Recent Slump in Cotton, Rice and Sugar Has Hurt Country Business—New Edison Dealers—Grunewald Opens New Store—News of Month

NEW ORLEANS, LA., November 3.—Nothing seems to affect the talking machine business in New Orleans itself, but a recent slump in cotton and the menacing of rice and sugar has hurt the country business. Every New Orleans talking machine retailer says business is much better than at the same time last year and that the holiday business promises to break all records.

An entirely different tale is heard from those merchants or wholesalers doing business in the country surrounding New Orleans. Not in years has money been held onto so tightly. The price of cotton has dropped below what is claimed to be production cost and rice and sugar men are also worrying.

The Diamond Music Co., managed by L. T. Donnelly, reports its business better than the same time last year due solely to the sales promotion work begun the first of the year. The firm does not deny that the volume of business would be something enormous if it was not for the cotton, rice and sugar condition.

Capt. John J. Callahan, sales supervisor of the Edison Co., is in New Orleans for two weeks. He has been in Texas.

New dealers reported by the Diamond Disc Co. are: L. L. Denson, Bay Springs, Miss.; R. A. Felder, Liberty, Miss.; L. E. Lide, Columbus, Miss.; G. C. McKinnon, DeFuniac Springs, Fla.; D. W. Ruff & Son, East Point, La., and Teche Music Co., Franklin, La.

The Diamond Disc Shop, the retail department of the Diamond Music Co., reports its business good, with "Love Nest," "Barcarolle," from "Tales of Hoffman," and "So Long, Oo Long" as the best record sellers.

Grunewald talking machine saleswomen are proud of themselves and declare they can qualify as interpreters. A negress went into the store last week and said to a clerk:

"I want to hear that phonograph piece called 'You Need Rest.'"

Instead of turning to the index of religious records and hunting for the record misnamed by the negress, the clerk looked up the number of "Humoresque," played it for the negress and had guessed it the first time. The negress bought it. It was what she had meant to ask for. Her mistress had it and she had heard it while working about the house.

Grunewalds will open a branch store soon and will have five talking machine hearing rooms in it. This is the first firm to open a branch music store in New Orleans.

E. L. Estes, salesman for the Columbia branch in New Orleans, recently talked before a meeting of the Calcasieu Parish Teachers' Institute and gave a demonstration of how to teach music in school with the aid of a Columbia. There were 175 teachers at the meeting.

A. B. Creal, manager of the Columbia branch, recently returned from a trip to the executive offices in New York.

PARHAM WERLEIN A BENEDICT

NEW ORLEANS, LA., November 3.—Parham Werlein, president of Philip Werlein, Ltd., was married to-night at 8 o'clock to Miss Isabel Orme, a beautiful and talented descendant of one of New Orleans' oldest families. The wedding was at Trinity church, followed by a reception at the home of the bride's parents, Mr. and Mrs. Gordon S. Orme. Mr. Orme is one of the largest rice millers in the South. Mr. and Mrs. Werlein left on a tour which will include Hot Springs, Ark., and Pinehurst, N. C.

Utilize your trade association and make the most of its advantages.

ATTRACTS THE PASSING CROWDS

"Ragtime Rastus" in Window of Chamberlain-Johnson-DuBoise Co., Atlanta, Proves Big Attraction to the General Buying Public

ATLANTA, GA., November 3.—The subject of attractive window display has always been given careful attention by the Chamberlain-Johnson-DuBoise Co., Victor dealers of this city. As a result, their windows usually cause passersby to pause. One of the most recent displays, and



"Ragtime Rastus" in Window Display which is shown herewith, created considerable interest. In the midst of an unusually attractive setting, "Ragtime Rastus," one of the phonograph toys made by the National Co. of Boston, danced continuously upon the turntable of a Victrola. This dancing figure drew large crowds and stimulated not only the sales of the toy itself, but the entire line. The continuous dance was made possible by the Jones-Motrola electrical winding device which was attached to the Victrola.

August Anderson, manager of Jones Piano House, Fort Dodge, Iowa, reports exceptionally good Columbia record business along with an ever-increasing sale of Grafonolas.

Victor Service to the South

PHILIP WERLEIN, Ltd.

VICTROLAS VICTOR RECORDS-TUNGS-TONE NEEDLES
NEW ORLEANS

Elected!

25,000 music dealers throughout the
United States unanimously pronounce
the

GRETSCH

musical instrument line the best
and most profitable in the world.

*For quick action, write for
our up-to-date price list*

FRED GRETSCH MFG. CO.

60 Broadway

Brooklyn, New York



DOEHLER

Is DIE-CASTING HEADQUARTERS

When a manufacturer of a talking machine is seeking to cut the cost of production, in the face of rising costs for labor and material, and wishes to still maintain the quality of his goods, he comes to Doehler to die-cast parts for him.

When a manufacturer of small motors is seeking to speed production, by finding a substitute for sand-cast frames and kindred parts, to keep down the cost and yet produce a better motor, he comes to Doehler to die-cast them for him.

When manufacturers of hundreds of other things are hunting a solution for many of their problems related to economy, quality and quantity of production, they come to Doehler to die-cast for them.

For Doehler

IS DIE-CASTING HEADQUARTERS

for America's most discriminating manufacturers.

Perhaps you have a problem which we can help to solve.

THE WORLD'S LARGEST MANUFACTURERS OF DIE CASTINGS

DOEHLER DIE-CASTING CO.

MAIN OFFICE AND EASTERN PLANT: BROOKLYN, N.Y. CENTRAL PLANT: TOLEDO, OHIO. WESTERN PLANT: CHICAGO, ILL.
SALES OFFICES IN ALL PRINCIPAL CITIES



NEWS FROM THE TRADE IN ST. LOUIS

(Continued from page 173)

manager of the Artophone Corp. Mr. Peters was formerly in another line of work.

James Dick, for the past two-years Columbia traveler for Arkansas, Kentucky and Tennessee, has resigned to travel all over the country for the Fern-o-Grand Co., manufacturers of Cincinnati, O. Lawrence Bauer has been assigned to the Arkansas territory for the Columbia and R. O. Pierce to the Mississippi territory.

The J. S. Rudy Co., Paducah, Ky., has discontinued the two lines of talking machines that it has been carrying and is now handling the Columbia.

Oliver H. Smith and Miss Grace Judlin have been added to the sales staff of the Silverstone Music Co. Mr. Smith is a well-known St. Louis tenor. Miss Judlin was until recently with the Edison shop at Chicago. Thomas J. Brannell, formerly with the Columbia Co., also has joined the Silverstone forces.

"The Japanese Sandman" and "Whispering" have been having a big run in St. Louis. It is claimed that the Okch records of those hits were the first to arrive in the city. C. R. Salmon, in charge of the Okch distribution for the Artophone Corp., reports opening agencies in St. Louis and in Memphis and Little Rock and other Southern cities.

The appearance of the eight Victor artists at the Odeon in October was a complete success. There was a large attendance and the audience demanded many encores. The appearance of the artists, Henry Burr, Fred Van Eps, Albert Campbell, John Meyer, Billy Murray, Frank Banta, Frank Croxton and Monroe Silver, greatly stimulated the sales of their records. The downtown and West End Victor dealers joined in a page announcement of the event.

Princess Watahwaso, Victor artist, appeared at the Scruggs, Vandervoort & Barney auditorium during October in a series of twelve concerts. Miss Blanche S. Rosebrugh, director of the Victor educational department, was accom-

panist. Many of the schools sent pupils and teachers. A request program was given also at the Webster Groves Armory, which was attended by about 2,000 children of the high schools and the upper grades of the grammar schools. Concerts were also given at the Maplewood High School and the Principia Academy. The sale of the Princess records was greatly stimulated, some of them being sold out.

Renato Zanelli, famous Metropolitan star, while appearing in concert in St. Louis recently, visited the service department of Koerber-Brenner and there met and talked to the Victor sales people of the city.

Mr. Zanelli proved an entertaining talker, telling of his experiences in South America and details of his record making at Camden.

Some expenses produce profits; some reduce them. If you are to consider a large reduction of expense, beware how you cut into the former class!

VICTOR CONCERT BY WIRELESS

Wurlitzer Co., in Cincinnati, Gives an Election Night Treat to Wireless Operators

CINCINNATI, O., November 3.—Last night the Rudolph Wurlitzer Co. took the opportunity for giving a free concert for amateur wireless operators, using a Victor talking machine for the purpose. Notice of the concert was given several days in advance in order that those who wanted music with their election returns might be prepared to enjoy it. The election returns were flashed from the Westinghouse plant in Pittsburgh and those who tuned their receivers to hear the returns also heard the music, which they greatly enjoyed.

"Mamma, what's that little rack on papa's cornet for?"

"Oh, that's to help your father to carry a tune, my son."—Yonkers Statesman.

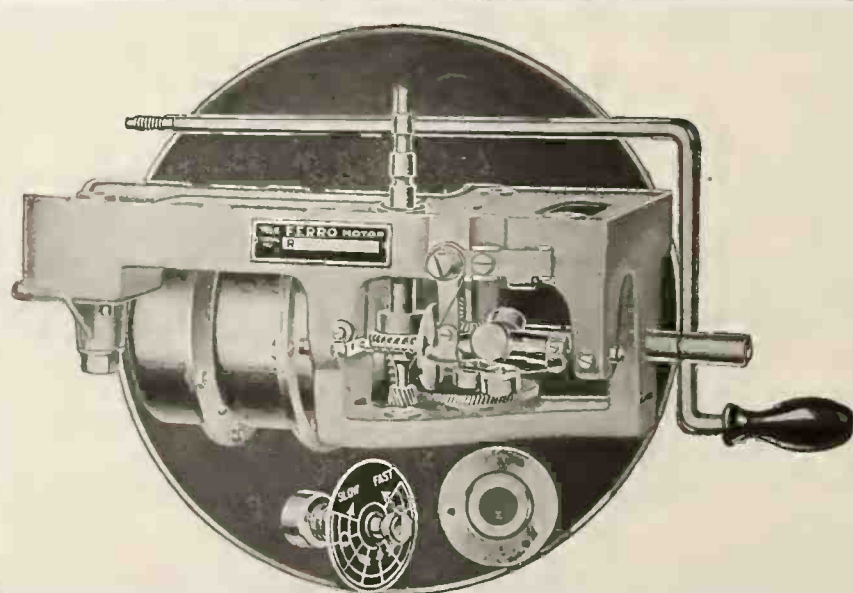

The Powerful, Durable, Noiseless Ferro Motor

The FERRO motor is in a class by itself. It is a quality product from start to finish. It will eliminate YOUR motor troubles and enhance the value of YOUR phonographs. A sample will convince you.

FERRO PHONOGRAPH PARTS CO. 1455 W. Congress St., Chicago, Ill.

Are You Looking Ahead!

Retail floor stock is going to be comparatively plentiful from now on—in fact is already so in many cases. Retail sales totals are going to move up and down at short intervals, the declines being caused principally by sensational price smashes in other fields where inflation and profiteering have been the rule.

The retail merchant who is going to make good from now on is the one who makes an intelligent effort to *sell* goods and who keeps up this effort without any relaxing.

The retailer, to succeed during the coming year, must spend money for good salespeople, and for good sales ideas. He must advertise. His representatives must make calls at the homes of his prospects and customers. He must write letters. He must use his windows. He must give up-to-date service. The retail merchant in the talking machine industry who doesn't do all these things is not going to win out.

So when we recommend your securing the franchise for the *Talking Machine World Service* in your city, we are offering you an opportunity to purchase the kind of brains and ideas for which you will have urgent need during the coming months. Our large staff of experts will prove a powerful help in enabling you to sell your goods intelligently through result-producing advertising, through a properly oper-

ating sales force, through appealing windows, and through letters that secure action.

The cost of our Service for a full year, you as a retail merchant, will pay many times during the coming year for just one good sales idea that will move stock for you on a profitable basis. For this same small investment, however, we will give you hundreds of tested ideas that will positively sell machines, records and accessories.

Perhaps you will not be wise enough to take our advice seriously and to act immediately upon our suggestion. All right—but as a favor, please clip this ad, put it in your files, and refer to it three months from now and again three months after that. You will find our prediction has come true. You will find you'll be glad to buy our Service at a very much higher price than we ask.

ONLY you probably will not be able to get it then. It is a strictly exclusive franchise proposition, one dealer in each city, and the truth of our prediction is going to dawn upon some merchant in your territory before many months are up. *You* had better be the live one.

This may sound like "strong talk," but when you *know* what you are talking about, you can't help being frank and energetic in what you say.

Look over your present inventory of machines and records—your stock is pretty large, isn't it? And there's plenty more goods in sight, isn't there? Your sales aren't entirely satisfactory, are they? The answer is—you've got to *plug* for sales from now on.

Fill out the attached coupon and we'll tell you why our Service is just what you need, and why it will give you the kind of help you cannot buy at any price from any other source.

Talking Machine World Service

For Retail Merchants

373 Fourth Avenue

New York City

----- MAIL THIS COUPON -----

TALKING MACHINE WORLD SERVICE

373 Fourth Avenue, New York

Without obligation to me, send me a sample copy of your Service with full explanation of your proposition, which you say is making a big profit for retail merchants. Tell me the price per month for exclusive use in my territory.

Population of my city is.....

I handle these instruments.....

Firm Name

By

Address

(W-13, 8-15-20)

The
SERENADO
TRADE MARK
SERENADO MFG. CO.

CEDAR RAPIDS, IOWA

ORGANIZATIONS ARE BUILT ON SERVICE

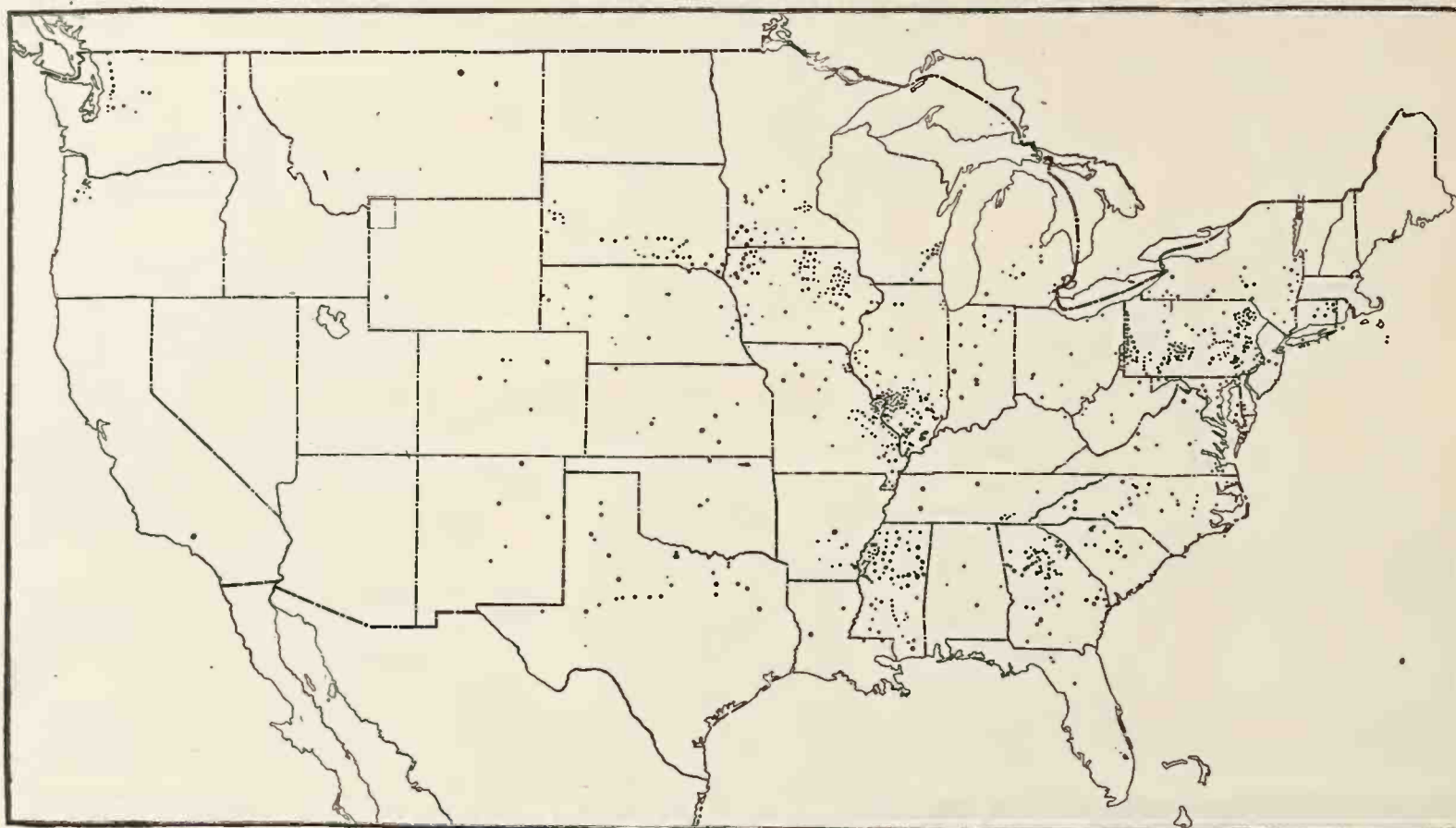

THE PROOF OF SERVICE IS AN ORGANIZATION

There is a dealer under contract for the sale of The Serenado at each point shown on the map.

Some of those dealers are large, some of them are operating in a small way but each and every one of them contracted with us because The Serenado was recognized as standard and of high quality and our effective co-operation and the low prices made possible by our merchandising methods were desired.

They are continuing with us for the same reasons.

As states are opened the better class of dealers are taking on the line—isn't that a guarantee of service rendered?

SERENADO MFG. CO.
CEDAR RAPIDS, IOWA

All the World's Artists play and sing their best
for the Audience of **The Serenado**

SATISFACTORY OUTLOOK IN THE DETROIT TRADE

Business Holding Up Well—Brunswick Line With J. L. Hudson Co.—Important Adora Changes—"Talker" Men Interested in Merchants' Bureau—Other News of Interest

DETROIT, MICH., November 5.—Talking machine business is holding up splendidly this month and dealers look forward to a whopper business all through November and December. It was a little off in October, although collections were very good. There were few repossessions. Dealers often remark that the talking machine business as a whole would not be so good if it were not for the sales of records which are steady month in and month out.

The J. L. Hudson music store has just completed a deal with Manager P. J. Gordon, of the Brunswick-Balke Co., whereby it adds the Brunswick phonograph to its talking machine department. Not only is it adding the phonograph but also the Brunswick line of records, which gives the Hudson store five different brands of talking machines, as follows: Victrola, Cheney, Sonora, Widdicomb and Brunswick. And in records, the Victor, Emerson and Brunswick. The original order placed with Mr. Gordon was a whopper.

The Adora Phonograph Co. is disposing of its ten individual shops to individual owners, thus passing out of the retail field. The store in the Orchestra Hall has been taken over by Mr. Curry, who has renamed it Curry's Music Shoppe. He has taken on the Brunswick line, both machines and records, and has already inaugurated a big advertising campaign.

The Retail Merchants' Bureau of the Board of Commerce has divided its members into groups, and among those talking machine dealers represented in the music group are: Max Strasburg, F. P. Sadowski, Henry S. Doran, H. E. Gardiner, the new manager of the Columbia wholesale branch; J. H. Goldberg, Jay Grinnell, George D. Maddock, E. P. Andrew, R. D. Janney, Edward H. Jeffery, J. Henry Ling, R. B. Alling, Walter Moon and Bernard Hallis. The Bureau has many big and important plans under way for the betterment of retail conditions, such as an early Christmas shopping campaign, uniform weeks for displays, employment bureau, and dozens of other plans which will take time, of course, to work out. Right now the Bureau is anxious for new members.

W. H. Huttie, of the Starr Phonograph Co., and Frank Bayley, Edison dealer, are both still on the lookout for new stores to take the place of their present establishments, as both must

SOSS

INVISIBLE HINGES



Soss Invisible Hinges

are essential to preserve the beauty of design, particularly when it is desired to disguise the talking machine cabinet. In many of the better cabinets of today Soss Hinges are used. They are mechanically accurate and can be installed quickly and easily.

Write for Catalogue T.

SOSS MANUFACTURING COMPANY
Grand Avenue and Bergen Street, Brooklyn, N. Y.



move on or about the first of next May. Mr. Huttie recently leased property on the West Side for storage and repair work.

The Starr Co. of Canada is planning the erection of a large factory at London, Ont. This is the second American company to locate a factory in London, the other being the Edison Co., who moved there from St. Thomas.

Falling off of business attributed to the present depression has caused a receivership for the Saginaw Cabinet Co., of Saginaw, which manufactured phonograph cabinets for a Chicago company. The Security Trust Co., of Detroit, has been appointed receiver. Assets are approximately \$650,000 and liabilities about \$430,000. The receiver will carry on the business governed by the present demands upon it.

A. J. Kendrick, general sales manager of the phonograph department of the Brunswick Co., was a recent Detroit visitor. While here he held a sales conference, outlining the company's sales policy for the balance of the year. P. J. Gordon, Detroit manager for the phonograph division of the Brunswick, has recently added two new salesmen to his list. R. G. Dundore,

formerly with the Pathé Co. in Chicago, and W. C. Zabriskie, who was transferred here from the Brunswick wholesale branch in Omaha.

Detroit jobbers say that goods are coming in in large quantities but that there are still some styles on which there is a shortage, especially the larger models—priced around \$200 retail. As for period models, the retailers are not setting the world afire. True, they are selling, but owing to their cost they are a little slow in moving, although dealers believe they will all be gone by the time Christmas arrives. Practically all of the local dealers in the downtown section are showing period models.

Thomas McGuigan, Gratiot avenue, piano and talking machine dealer, is opening a branch store at 701 Oakland avenue, and will put in the Brunswick line exclusively. It will be attractively equipped.

W. M. Brown has opened a Detroit office at 83 East Woodbridge street to handle the Jones-Motrola motor.

WANTS NAME FOR HIS INVENTION

Eugene F. O'Neill's Device for Demonstrating Several Records at Once All Ready for Christening—Shown at Foster & Waldo Co.

MINNEAPOLIS, MINN., November 6.—A snappy, catchy name for a phonograph selling device, which for lack of a better name is called "the quick service," is desired by the inventor. Eugene F. O'Neill, the globe-trotting phonograph man. His invention was described in the October issue of the Talking Machine World. It is already installed in the store of the Foster & Waldo Co., and arrangements are being made to place a similar counter in the new Cable Piano Co. store. By this device a small store counter is equipped with five or six sound proof boxes in which an equal number of phonographs may be placed. All can be played at once and the respective auditors will hear only the one to which they are connected by the ear phones. It is expected that one bright clerk may wait on several record customers, demonstrating the records all at the same time.

The quick service counter has been inspected by C. Alfred Wagner, of the American Piano Co.; L. M. Willis, of the Unit Construction Co.; George P. Bent, the big piano manufacturer, and others, and all agree that it is a winner. Mr. O'Neill has conveyed his patent rights to the Beckwith-O'Neill Co.

Superior Workmanship
Superior Finish
Superior Service

Trade
"SUPERCAST"
Mark
DIE CASTINGS

THE SUPERIOR DIE CASTING CO.
411 FRANKFORT AVE. CLEVELAND, OHIO

"MAGNET" DECALCOMANIE NAMEPLATES





FOR TALKING MACHINE CABINETS ETC.

Pamphlets with fac-simile illustrations and prices mailed on request.

SMITH-SCHIFFLIN CO.
149 Church Street New York City



SOLD BY
WALTER D. MOSES & CO.
103 E. BROAD STREET RICHMOND, VA.

SOLD BY
J. E. STRATFORD
AUGUSTA, GA.

Universal Displayors—Talking Machine and Music Trades



No. 550

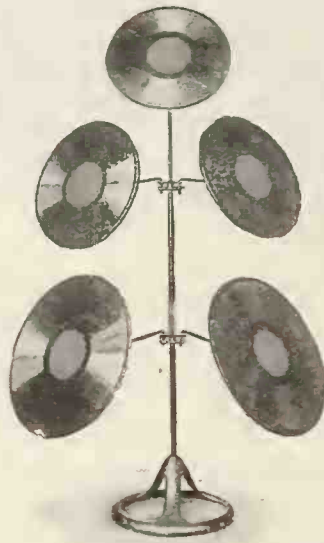

No. 501



No. 553



No. 502



No. 558



No. 560



No. 581

WE MANUFACTURE OVER FORTY DIFFERENT MODELS
Order Through Your Distributors

Now is the time to increase your sales and cut out your overhead.

Make every bit of your store, booth or window space produce more business.

Universal Displayors are effective salesmen—they earn their cost in a week but they keep on earning profits for years.

We can make immediate shipment on all our models so that they will reach you in time to take care of your holiday business.

Dealers who find they have on hand a slow moving stock of records, rolls and sheet music will find Universal Displayors the means of boosting sales of all numbers of this kind. Every title is visible at a glance.



No. 563



No. 559

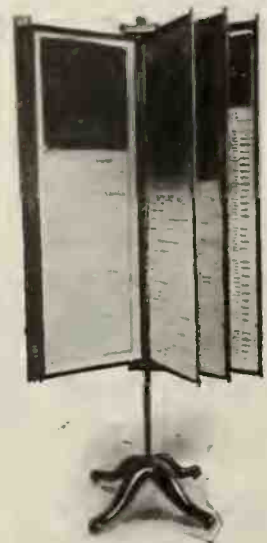

No. 505

Universal Fixture Corporation 133 WEST 23rd STREET
NEW YORK CITY

DECISION IN CABINET SUIT

U. S. District Court Upholds Beecroft Patent Covering Special Moulding on Record Cabinet—Court Orders Injunction and Accounting

A decision of interest to the talking machine trade was handed down by Judge Hand in the United States District Court, Southern District, recently, in the suit of Beecroft & Blackman, Inc., 81 Reade street, New York, against the L. J. Rooney Co., a talking machine dealer of New York, and the Geo. A. Long Cabinet Co., for infringement of Beecroft Patent No. 1,244,944, dated October 30, 1917, covering a moulding for the top of record cabinets used mostly in connection with the Victrola IX.

This suit was defended by the Geo. A. Long Cabinet Co., Hanover, Pa., who claimed to have an irrevocable license to manufacture and sell cabinets with this patented moulding. The existence of any such license was denied by Beecroft & Blackman, Inc., and suit was brought, asking infringement damages and injunction.

Judge Hand in his decision upheld the validity of the Beecroft patent on all the grounds set forth by the plaintiffs, and gave an order for an injunction and accounting. He also denied the existence of any license privilege affecting the Beecroft patent.

W. H. C. Clarke and Geo. P. Luca, 2 Rector street, New York, were counsel for Beecroft & Blackman, Inc., and G. G. Siggers, Washington, D. C., and J. H. Griffen, 277 Broadway, New York, were counsel for the defendants.

WARSAW DEALER IN NEW LOCATION

Brewer & Burge, talking machine dealers of Warsaw, N. Y., have removed from the second floor of the Whitlock-Snow Building in that city and are now located in larger quarters at 16 North Main street.

Success is by no means a matter of luck. It is rather a measure of a man's ability.

THE MODERNOLA FOR JAPAN

Mitsui & Co. Introduce That Machine in the Flowery Kingdom Through Arrangements With Eastern Phonograph Corp.

The Modernola talking machine has invaded the Flowery Kingdom, George Seiffert, president of the Eastern Phonograph Corp., Modernola distributor, New York City, has announced that trade connections have been established with the well-known exporting house of Mitsui & Co. and that the first Modernola was recently shipped to Kobe, Japan. It is expected that the beauty of design of the Modernola will appeal strongly to the Japanese and that the volume of business with that country will grow rapidly. The Eastern Phonograph Corp., besides representing the Modernola in the Eastern territory, also has the export rights and reports that increased orders are being received for the Modernola from South America. Mr. Seiffert reports that the demand for the Modernola from all sections of the country has reached such a point that production will probably be one or two thousand machines behind in the month of December.

DINNER DANCE TO STOCKHOLDERS

SAN FRANCISCO, CAL., November 5.—The Mercantile Finance Co., of this city, recently gave its third dinner and dance to its stockholders in the ballroom of the Palace Hotel. Over 400 guests attended and Frederick Stern, president of the company, gave a brief but interesting talk on the affairs of the company, calling attention to the very satisfactory showing which had been made. The company is now moving into its new home at 459-465 Montgomery street at the corner of Sacramento, and at the present time the most modern banking fixtures are being installed. This new home is located in the heart of the financial district in San Francisco and offers maximum conveniences to the company's patrons.

TO HANDLE VICTOR EXCLUSIVELY

Cleveland Talking Machine Co. Gets Advices to This End From Imfeld Music Store, Hamilton, Ohio—Pays High Tribute to Product

CLEVELAND, O., November 5.—The Cleveland Talking Machine Co., of this city, Victor wholesalers, received recently an interesting letter from the Imfeld Music Store, Hamilton, O., stating that this company had decided to concentrate its activities in the future on Victor products exclusively. This letter, which constitutes a signal tribute to Victrolas and Victor records, stated in part as follows:

"While we have anticipated this move for some time, we hesitated in taking the final step because of the shortage of Victrolas and Victor records, but now this obstacle is swiftly being removed, and we are sure that we can better ourselves in no other way."

JOINS EXECUTIVE ORGANIZATION

A. W. Fritsch, formerly sales manager of the Michigan branch of the General Phonograph Corp., with headquarters at Grand Rapids, Mich., has joined the executive organization at 25 West Forty-fifth street, New York, as an assistant to W. C. Fuhri, general sales manager of the Okeh record division. Mr. Fritsch will concentrate his activities on Okeh records and Dean steel needles, and his previous experience will undoubtedly enable him to co-operate to advantage with the clientele of the General Phonograph Corp., which now covers every section of the United States.

SOLOTONE ENTERS FIELD

The Solotone Phonograph Co. has secured a Delaware charter and will manufacture talking machines. The capital of the new company is given as \$200,000 and the incorporators are F. R. Hansell, J. Vernon Pimm and E. M. MacFarland, Philadelphia.

File Your Records so you can find them and it's easy to sell them.

This System pays for itself by increasing Sales through better service and Automatic ordering of "Sold-Out" Records

OGDEN'S PATENTED RECORD FILING CABINETS AND VISIBLE TAB INDEXES ARE GUARANTEED

MODEL No 2150 D.D.
2 UNITS ILLUSTRATED

LOCKING ROLL TOP PREVENTS DUST AND THEFT, ALSO SUPPLIED WITH SPANISH LEATHER CURTAIN

350 10" OR 10 1/4" RECORDS ON EACH SHELF, FILED IN SALES SYSTEM COVERS AND WITH INDEX GUIDES.

350 10" OR 10 1/2" RECORDS ON THIS SHELF, ALSO 3 SHELVES ABOVE.

SOFT FLAT SUPPORTING SPRINGS PREVENTS WARPING (PATENTED), HOLDS 350 10" OR 12" RECORDS.

10" AND 12" RECORDS FILED ON SAME SHELF, HELD FLUSH AT THE FRONT BY PATENTED ADJUSTERS.

93 inches

48 inches

15 inches

2150 THIN RECORDS IN EACH UNIT. STOCK FINISHES: 4300 RECORDS IN 2 UNITS. WHITE IVORY & PEARL GRAY MAHOGANY & OAK

OGDEN SECTIONAL CABINET CO., INC., LYNCHBURG, VA.

Immediate Shipments

on all models in standard finishes. Light and Golden Oak, Red and Brown Mahogany, Enamels, White, Old Ivory and French Grey.

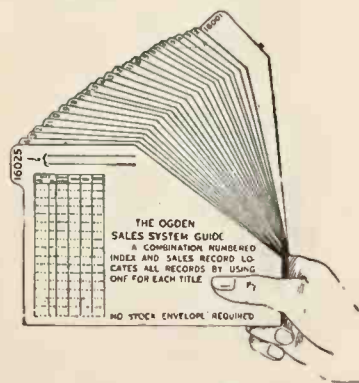

Visible Tab Paperoid Index

The Tab extends in front of the record with numbers always visible. Used the same as a stock envelope, one for each title, leaving all records in their envelopes. Is used to re-order by and keeps "Sold-out" numbers continually before you. Shows quick and slow sellers. The best and simplest "Sales and Ordering" index ever devised and rapidly replacing the stock cover because of its many advantages. Fits any filing system, shelving or racks. Printed both sides for right or left hand flat or upright filing.

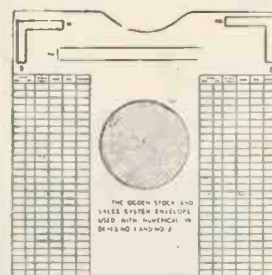

SALES SYSTEM ENVELOPES keep track of what you sell and what you need—an automatic inventory, showing profitable and slow sellers. Arranged for upright or flat filing and will fit any system.

Sectional Models Fit Any Size Stock and Help You Grow.



THE OGDEN SALES SYSTEM IS EQUIVALENT TO AN EXTRA CLERK AND INCREASES SALES



Style 87, shown with top moulding which covers open base of Victrola IX. Note the fine "floor type" effect produced.



Style 87, shown with doors open. Note the attractive shelf arrangement.



Style 87, shown with "flat top" and without top moulding, with "old style" Columbia machine. Note the "floor type" effect produced.

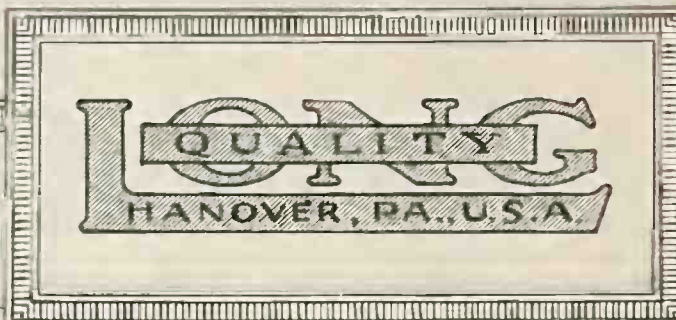

Cabinets As Sales Builders

The progressive talking machine dealer realizes that every record cabinet sale means increased record business, for the purchaser of a record cabinet is a "live" prospect for regular record business.

LONG CABINETS

Represent the last word in cabinet perfection. They are the recognized leaders of the cabinet industry and are sold with an absolute guarantee as to quality and satisfaction.

Write for a copy of our new catalog.

**The Geo. A. Long
Cabinet Company**
HANOVER, PA.

PITTSBURGH FACES HOLIDAY SEASON WITH CONFIDENCE

Optimism Prevails—Dealers Feel Extra Effort Must Be Made to Get Business—A. C. Mayer Talks With Dealers—Victor Dealers Visit Jones Store—Edison Tone-Test Interests—Other News

PITTSBURGH, Pa., November 5.—Talking machine dealers in the Steel City and vicinity are facing the holiday season with supreme confidence in the assurance that the business ahead will show a marked increase over the same period a year ago. The various Pittsburgh dealers are in friendly and wholesome rivalry when it comes to displaying the various makes of talking machines that they handle and a visit to the various stores and a view of the different show windows revealed the fact that the public will have ample opportunity to inspect the various lines before they decide to make a selection.

The general sentiment among the trade is that the "business is here," but that it will require the use of good salesmanship to secure the desired results. All indications point to the fact that it is a "buyer's market" and that the wise talking machine dealer will so arrange his business plans as to get in touch with the "buyer." The search after holiday business is on, a number of the prominent advertisers of talking machines in the local newspapers having a sentence or a paragraph so arranged as to call attention to the utility of the talking machine as a Christmas holiday factor.

Wages still continue high in the Pittsburgh district and there is little chance for a revision downward of the wage scales for months to come. The iron and steel mills and coal mines are working steadily and have plenty of contracts booked ahead. As an instance of the high wages earned in some of the industries that have made the Pittsburgh district famous, it is pointed out that two miners in the mines near Avella, Pa., a short distance from Pittsburgh, for twenty-four days' work, together drew a pay check for \$1,042.36. There are instances on record of laborers drawing as high as \$80 to \$90 for two weeks' pay. The general air of prosperity was never so pronounced in the Pittsburgh district and there is assured plenty of business ahead for the talking machine fraternity.

George W. Hopkins, general sales manager of the Columbia Graphophone Co., with headquarters in New York, was a Pittsburgh visitor the past week and held a conference with Manager S. H. Nichols, manager of the Pittsburgh branch, and T. B. Niles, the assistant manager, and the sales staff. There was a frank interchange of views and the outlook for increased business as a result of the conference was said to be bright. The October business, according to Mr. Nichols, was quite flattering. O. F. Benz, sales manager of the Columbia organization, also spent a day in the Pittsburgh offices in conference with Manager Nichols.

John F. Henk, manager of the Columbia Music Co., exclusive Columbia dealer, stated to The Talking Machine World representative that business was increasing so rapidly that he was compelled to add a number of demonstra-

tion booths for the accommodation of his many patrons. Mr. Henk feels that the Christmas trade will be one of the best that he has ever experienced.

At the October meeting of the Talking Machine Dealers' Association of Pittsburgh an interesting talk was made by A. C. Mayer, Eastern sales manager of the Unit Construction Co. Mr. Mayer had with him a number of photographs of unit equipment installed in various talking machine shops in different sections of the country. Mr. Mayer gave a very forceful and interesting talk, emphasizing the fact that modern equipment in a talking machine shop or department will stimulate business to an unlimited degree. He showed by a number of illustrations that people will invariably patronize a clean and up-to-date music shop in preference to one that is slipshod and run on easy-going policies. Mr. Mayer stated that it was the modern-day dealer who "dressed up" his store who was bound to get the business. He said: "The time has come when the talking machine dealer must go out after business. For the past two or more years you were not selling goods, you merely took orders and delivered goods. Now a change is dawning and the live dealer who goes after business in the right manner is bound to win."

Under the guidance of Thomas T. Evans, manager of the wholesale Victrola department of the C. C. Mellor Co., a party of Victor dealers, including P. S. Schrage, of Klein & Heffelman Co., and George C. Willie, of the George C. Willie Music Co., of Canton, O.; Wood Brown, of the Brown Music Co., of Kittanning, Pa., and J. H. Phillips, president of the Talking Machine Dealers' Association, of Pittsburgh, went to Washington, Pa., on October 28 to inspect the new establishment of the G. W. P. Jones Music Co.

The new structure is three stories in height and is given over to the exclusive use of music. The talking machine department is located on the first floor. It is a model department, the equipment being installed by the Unit Construction Co. The firm handles the Edison, the Victrola and the Columbia Grafonola.

Mr. Jones and his associates received most hearty congratulations from the trade and the Victor Talking Machine Co. sent a handsome floral offering, which was displayed in the department. It was estimated that during the three-day opening festivities fully 25,000 persons passed through the talking machine section. Miss Ethel Blose Barr is the efficient manager of the record department, which is most admirably arranged for speedy service. F. H. Burbick and S. G. Elliott, of the Mellor staff, were also with the party, as was The Talking Machine World representative. The day following W. C. Dierks and H. H. Fleer, of the Mellor Co.,

visited the Jones establishment and extended their congratulations.

On Tuesday evening, November 16, the sales staffs of the various talking machine shops and departments connected with the Pittsburgh Association will participate in a dinner at the Hotel Chatham. Following the dinner there will be a series of salesmanship talks.

T. E. Shortell, manager of the talking machine department of the S. Hamilton Co., is much pleased with the sales that are developing of the Columbia period models and he anticipates a brisk sale for the holiday trade.

C. R. Parsons, manager of the Rosenbaum Co. talking machine department, Victor and Columbia dealer, has been made a member of the Pittsburgh Chamber of Commerce Quartet. Mr. Parsons, in addition to being a progressive talking machine department manager, is a talented singer.

H. J. Brennan, manager of the Pittsburgh Talking Machine Co., Pathé distributor, said to The World representative: "There is every indi-

(Continued on page 182)

A List of Good Things to Stock for the Holiday Trade

Bubble Books
Cirolas
Record Cabinets
Record Albums
Record Envelopes
Stock Envelopes
Supplement Envelopes
Motrolas
Attachments
Phonograph Lights
Oils and Polishes
Motors
Tone Arms
Converto Cabinets
Music Roll Cabinets
Sectional Cabinets
Needles
Record Cleaners
Moving Covers
Name Plates
Stewart Phonographs
Badger Cabinets for Victrolas

The Cabinet & Accessories Co., Inc.

OTTO GOLDSMITH, President

145 East 34th St., New York

The FERRO Tone Arm and Reproducer is the ideal sound reproducing unit. Its reproduction is true to life—its construction symmetrical—its appearance artistic, beautiful.

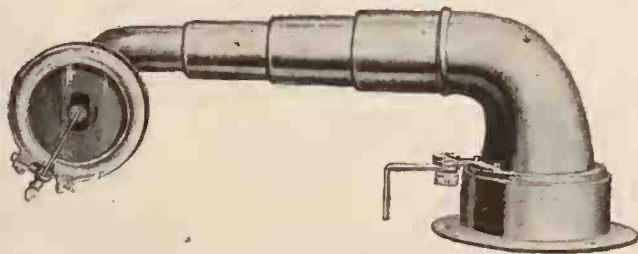

The FERRO Tone Arm is not a die-casting. It is made of the highest grade bell metal and drawn into shape by hydraulic pressure.

In short, the FERRO Tone Arm and Reproducer is just the thing for the high grade talking machine. Let us send you a sample.

FERRO PHONOGRAPH PARTS CO. 1455 W. Congress St., Chicago, Ill.

NEWS FROM THE PITTSBURGH TRADE

(Continued from page 181)

cation that the sales of Pathé machines and Pathé records this month and the next will surpass all previous business done by this house during the same period a year ago. Our roadmen are sending in good-sized orders and I feel that the Pathé line will be a record breaker this year."

George S. Hards, the Dormont Victor dealer, reports trade for the Victor line in the busy little suburb of the Steel City as most encouraging. Mr. Hards is a great believer in the use of printers' ink to promote business and his various methods to attract trade are both novel and productive of the results he seeks.

The Buehn Phonograph Co., distributor of the Edison Phonograph, reports trade conditions as exceptionally brisk and announces that business handled during October in the Edison line was the largest in the history of the company. The outlook for the holiday trade, according to A. A. Buehn, treasurer of the company, is exceedingly bright. During the past week Mr. Buehn, H. M. Swartz, assistant manager of the company, and J. K. Nichol, of the staff of traveling salesmen, were at Washington, Pa., and attended an Edison tone-test given under the auspices of the G. W. P. Jones Music Co. The singer was Madame Odette Le Fontenay, with Roger Barry at the piano. The test was held in the high school auditorium and was heard by a large audience. Madame Le Fontenay has been touring this section, giving a series of tone-tests, under the direction of the Buehn Co. and locally fostered by the Edison representatives. The list of engagements for the week of November 15 is as follows: November 15, Home Furniture Co., Braddock; 16th, W. F. Dufford Co., New Castle; 17th, Wilson Music and Art Shop, Ellwood City; 18th, Patterson Music Store, Beaver Falls; 19th, Purity Drug Co., Coraopolis, Pa.

President Goldsmith, of the Player-Tone Talk-

ing Machine Co., has made arrangements for a complete line of Player-Tone talking machines to be exhibited at the Jamestown Furniture Exhibition, Jamestown, N. Y., November 8 to 21. Mr. Goldsmith stated that the trend of business for the Player-Tone was very good and indicated that the holiday sales would be large.

Manager Scanlan, of the Pittsburgh offices of the Brunswick-Balke-Collender Co., manufacturer of the Brunswick phonographs, states that the demand for the Brunswick line was brisk and he was inclined to think that new sales records would be made as far as the Pittsburgh territory was concerned. Dealers, he stated, were eager to have certain styles of the Brunswick line and this alone, he declared, showed a decided boom for the Brunswick. Sales of Brunswick records are also large.

FINE PATHE EXHIBIT AT FAIR

VINTON, IA., November 5.—Ralph R. Lent, the enterprising Pathé dealer of this city, drew much attention to the Pathé line at the recent county fair. He had a very attractive exhibit in the art hall of the fair from which he conducted a contest for which the award was one of the most attractive models of the Pathé line. The contest created much interest and received considerable comment in the local press. As a result of this contest, Mr. Lent secured the names of more than 3,000 prospects.

RECENT VISITORS TO BRUNO'S

Among the recent visitors at the headquarters of C. Bruno & Son, Victor distributors, was Harry Michlosky of the firm of Landau's, Victor retailers. Mr. Michlosky reports that both their Wilkes-Barre and Hazleton stores are receiving excellent patronage and the outlook for the holiday trade is very bright. This visit was a sort of a return of compliments; as Jerome Harris and E. G. Evans of the Bruno staff had previously visited Mr. Michlosky.

SAFETY SOUND BOX CONTROLLER

New Device Introduced for Use on Victrolas Exclusively—Sold by Herbert & Huesgen Co.

The Herbert & Huesgen Co., New York, has been appointed sole sales agent for the Hughes safety sound box controller, manufactured by the Hustylus Corp., Philadelphia. The company has started an energetic sales campaign in behalf of this device and the results to date have been very satisfactory.

The Hughes safety sound box controller is manufactured exclusively for use on Victrolas and it has many distinctive features that have met with a ready welcome from Victor dealers. According to the inventors, this sound box controller saves the records and also prolongs the lifetime of tungs-tone and semi-permanent needles. It accomplishes these results by reason of the fact that when in use the sound box cannot be dropped on the record. It is simple and fool-proof and does its work under all conditions.

Chas. H. Huesgen, of the Herbert & Huesgen Co., left a few days ago for an extensive trip which will include a visit to Victor jobbers and Victor dealers between here and Chicago. The company plans to merchandise the Hughes safety sound box controller through the Victor trade exclusively, and three models have been prepared so that there is a model available for all types of Victrolas.

CAPITAL INCREASED TO \$300,000

The American Talking Machine Co., Inc., of Bloomsburg, Pa., manufacturer of the Lyrolian talking machines and distributor of Lyric records, needles and other accessories, has recently increased its cash capital to \$300,000. The business of the company has grown far beyond expectations, and with this increased capital it expects to greatly enlarge its activities along important lines.



BY THE WAY

Christmas is fast approaching and the usual Holiday rush of Victor business is going to commence shortly.

If we can be of service to you in helping you plan your campaign for this year's Yuletide business, do not hesitate to call on us. Our Service Department is maintained in order to help you, and we want you to feel that at all times you are at liberty to call on it.

W. D. & C. N. ANDREWS
BUFFALO, N. Y.



These reproductions show the Unico installations as made for Kaufmann & Baer Company of Pittsburgh. We are pardonably proud that they consider their Unico department "beautiful and all that could be desired in arrangement and appearance."

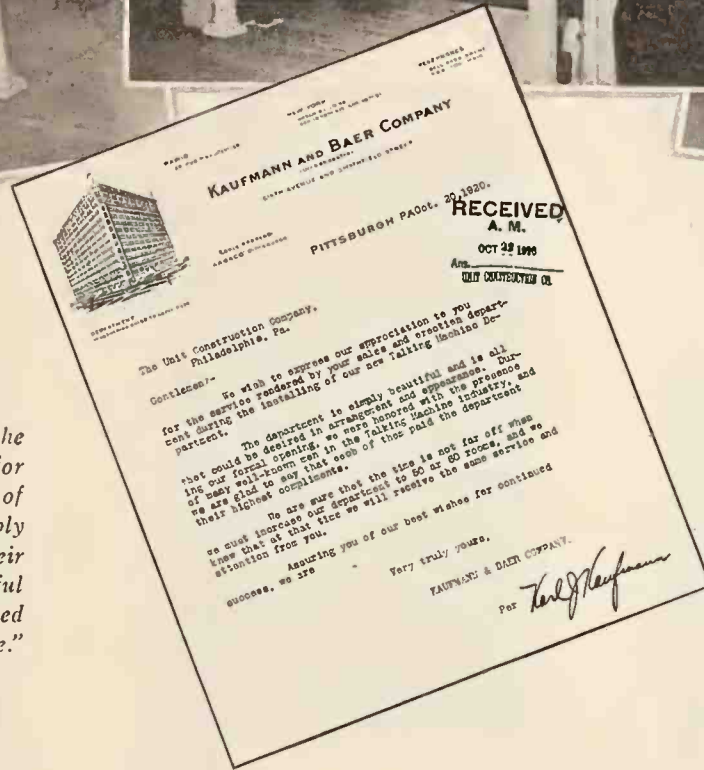

We are now on a normal basis of production and, therefore, guarantee shipment of any of the standard Unico designs within 10 days from receipt of order.

Sales Value of Environment

"There's music in all things if men had ears," said Byron in his immortal Don Juan.... It is not alone the life-like reproduction of the human voice or the naturalness of the violin solo that attracts the casual hearer and transforms him into an actual customer.

Charm of environment and atmosphere directly influence the sale of musical merchandise. Perfect harmony in decoration as well as utmost efficiency in arrangement is achieved through the use of Unico Equipment. It is a proven fact that increased business follows the installation of the Unico System. Unico designs and constructions are patented; their flexibility allows of re-location and additions.

Unico Demonstrating Rooms, Record Racks, Counters and Decorative Treatment in standard designs and finish are now available for prompt shipment from stock. Unico Service with the correction of transportation and labor conditions is again operating on a normal basis of speed and dependability.

We suggest that you send us at once a rough floor plan and dimensions. We will submit recommendations. No obligations are incurred.

Unico Construction
is patented.



Unico Designs
are patented.

UNIT CONSTRUCTION COMPANY

NEW YORK
299 Madison Ave.
Corner 41st St.

Rayburn Clark Smith, President
58th Street and Grays Avenue
PHILADELPHIA

CHICAGO
Willoughby
Building

ANNOUNCING NEW ART MODELS

The "Natural Voice" Line has ever been noted for its quality. At the same time profits for the dealers have always been most liberal. Perfect, guaranteed machines with instant appeal and of quick salability.

Therefore the announcement of the addition of art models to this line should command your attention.



ST50
H37W40D23



ST51
H37W40D23



ST52
H37W40D23



ST53
H37W40D23

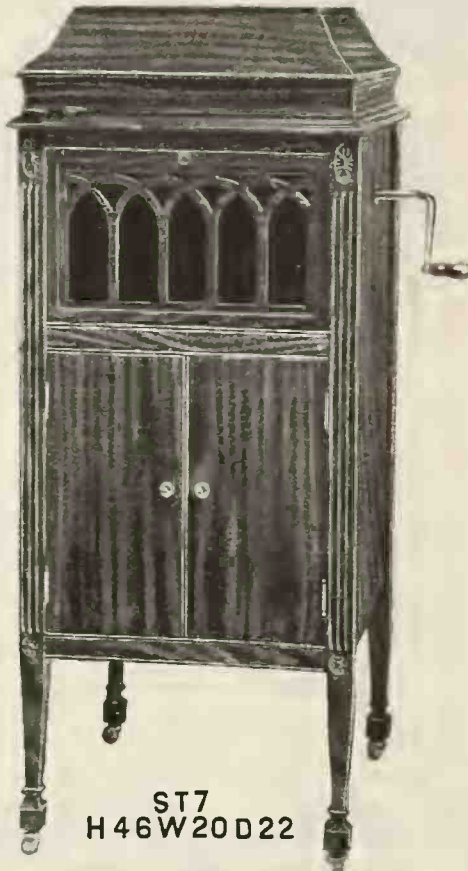

ST7
H46W20D22



ST8
H48W21D24



ST6
H45W18D20

Art models of most original design and of the highest quality throughout; all meeting the high standards set by our products in the past.

To the trade desiring to place such goods on their floors we offer an arrangement of most liberal proportions.

Natural Voice is the most remarkable musical instrument now before the public. For a full line of machines and price list, write today.

NATURAL VOICE PHONOGRAPH CO.

ONEIDA, NEW YORK

Distributors of This Line Wanted in Every State

THE TALKING MACHINE WORLD SERVICE

Robert Gordon's Page

A DEPARTMENT DEVOTED TO PROMOTING RETAIL SALES



Christmas Is Coming! Are You?

If you're not "up and coming," business will be "going"

THE best advertising is not always that which offers attractive prices or terms. There is a sentiment which is held for or against certain stores, which is a more powerful influence than any other consideration. If you can build up good will, friendship and loyalty for your store you will have a foundation for sales that cannot be broken into by competitors. Therefore such items as Christmas cards or Christmas letters to all customers, expressing your good wishes for a Merry Christmas, and your thanks for the business with which they have favored you during the year, may do you more good in the long run than many an ad of strict merchandising character.

Make your Christmas card as elaborate or as simple as you wish, or, if you prefer, write a letter instead of using a printed card. The main thing is to express your appreciation for the patronage of your customers and make them feel that their business is valued by you. It is human nature to desire personal attention, and this little means of expressing it should not be overlooked. It is not a "frill" or a waste. It is sound advertising.

DECORATIVE borders for your ads unquestionably improve their appearance, but the expense of having these specially made by the artists is considerable. The usual result is that ads are set up with plain rules.

You probably do not realize that your local newspapers can supply you with borders from their own typographical equipment. The human tendency for the compositors on the newspapers is to follow the line of least resistance. To set up special borders for your ads requires an extra effort on their part. The rules are handy, are easy, and therefore are used.

Get from your newspaper a type book showing samples of the border designs which they keep in stock, then specify on the layout the border you want. Practically all newspapers have in stock the standard holly border which is used for Christmas ads, and this will help a great deal in giving the right atmosphere to the copy you send to the papers during December. A little attention to this detail will make your advertising pay better, look better and bring more business.

A WORD of warning—Do not at this time advertise prices on talking machines, pianos or records in such a way as to give the impression that "prices are coming down." You will find that this appeal will not create sales, but will cause the public to wait still longer, with the hope that prices will drop to lower levels. Under present conditions it is extremely doubtful that the prices can come down. To foster the mistaken idea that they will be reduced injures your business and the business of all in the trade.

THE general opinion among the business men is that the Republican victory is going to mean an increase in business activity. Against this favorable tendency is the undeniable fact that a buyers' market is here. The old conditions where there was one machine to supply the demand of three customers have entirely disappeared. Stock is more plentiful, and the public is not buying as carelessly and extravagantly as formerly. The reaction from the period of extrava-

gance is in full force. People do not buy now without carefully considering the price they pay, and they are disposed to question high prices with a feeling akin to annoyance and irritation.

The newspapers have been full of talk of profiteering; the public feels that labor has been demanding an exorbitant return for its services, and is awake to the fact that the increase comes out of the public's own pocket. Under these conditions every retail talking machine merchant must realize that it is up to him to go after business with all the aggressiveness he can muster. He must advertise regularly and liberally. He must send out form letters, he must keep his windows as bright and attractive as possible. He must inject new vitality into his sales organization, and use every good merchandising idea with which to improve the service of his store.

Of all times of the year, now is the time to exert every sales effort. Christmas, 1920, should be as profitable as any in the history of your business. But unless you do everything you can to create this business and to draw it to your store and away from your competitors, you will fail to get all you could have.

In other words, you can't get business unless you go after it.

YOU can work up a lot of Christmas atmosphere by placing small signs at points of vantage through your store and also in each talking machine booth, bearing an appropriate Christmas message. These should all be the same in color scheme. White, green, red, gold and black are suitable for Christmas purposes. In each booth there should be a sign reading: "Give Records for Christmas," and this same suggestion should be displayed on your counters and in your windows. Another sign which always brings the best results is "Christmas Isn't Christmas Without a (Name of Your Machine)." Another slogan is "A Talking Machine Makes Every Day as Merry as Christmas"—another, "Make This a Musical Christmas."

THE new piece "Whispering" has taken most of the country by storm. A release of this number has been made by practically all of the record companies. Here is a little window display to give prominence to this number:

On the floor of your window, in the center, place a piece of velvet, preferably a dark color. Underneath the velvet make a slight rise. On top of the rise, place two Kewpie dolls, in such a position that it looks as if one of them is whispering to the other.

Place a large card in the back of the window just bearing a single word, "Whispering," with an exclamation mark after it. On a long, narrow strip, print the words "Whispering, a Splendid Sympathetic Strain, Executed by the Famous Orchestra of ____" (Change name to suit the maker of record handled.) This strip should be placed in the very front of the window, lying flat. Make two other cards, one bearing the word "Incomparable" and the other "Hear It." These should be placed flat, one on either side of the two Kewpie dolls.

Two records of this number should be placed on the floor of the window or on mounts either side of the central display.

You will be surprised the way this very simple window will draw attention—first, because of its novelty, and second, because of its inquisitive power.

EDITOR'S NOTE—Mr. Gordon, who writes this monthly page, is also director of "The Talking Machine World Service." Mr. Gordon will publish on this page any good ideas submitted by you for the benefit of the trade, and also answer any questions you ask him concerning merchandising problems. Use this department as much as you like. It is intended to serve you.

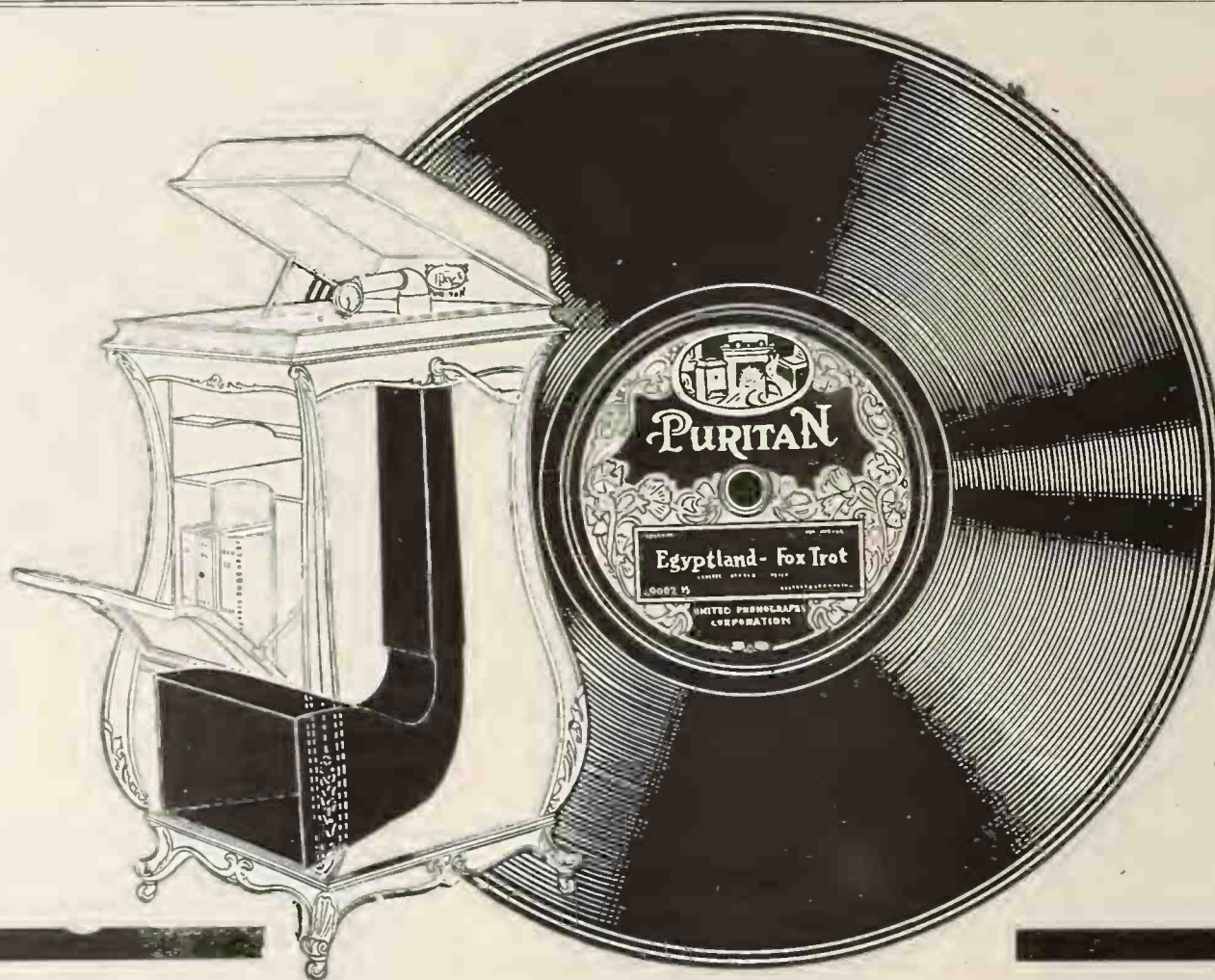

The Puritan

AN OPPORTUNITY FOR DEALERS—The PURITAN Phonograph literally "speaks for itself." There is a richness and purity in the reproduction, quite different from other instruments, that invariably pleases the listener. The most critical music-lovers declare that such smoothness, clearness and volume of tone have never been produced by ordinary phonographs.

THE REPRODUCER—A new type of sound-box and tone arm give absolutely free horizontal and vertical movement, enabling the needle to receive ALL THE IMPULSES from the corrugations of the record. The faintest recorded sounds are faithfully transmitted to the ear. The mechanism is very sensitive to record vibrations, and is the result of long experiment.

The great clearness of tone in the PURITAN is produced by the

Eight beautiful models now ready for immediate shipment.

The Puritan Phonograph plays all makes of Disc Records, with all the distinctness and volume of which the record is capable.

LONG WOOD HORN—This is an exclusive, patented feature, and CANNOT BE USED BY ANY OTHER MANUFACTURER.

The PURITAN HORN is a rectangular channel representing an organ-pipe, extending from the tone arm to the bottom of cabinet. It has only one bend (see illustration).

THIS IS THE MOST EFFECTIVE AMPLIFIER EVER PRODUCED

The PURITAN HORN magnifies and mellows the vibrations from the diaphragm. At the same time it absorbs all hissing and grinding sounds, delivering the MUSIC ONLY in a wonderfully realistic way.

The entire instrument, including motor, sound-box and cabinet, is made in our own factory, and we guarantee every part.

Puritan Lateral-cut Records are brilliant and contain the latest popular numbers.

Write for Catalog and dealership proposition.

United Phonographs Corporation

Factory and General Offices: Sheboygan, Wisconsin

RECORD RECITAL FOR DEALERS

Large Crowd of Retailers Attend Advance Recital of December Victor Releases Given by Knickerbocker Talking Machine Co.

On Friday, October 29, the Knickerbocker Talking Machine Co., Victor wholesalers, entertained a representative gathering of Victor retailers at an advance recital of the December releases of Victor records which was followed by an elaborate luncheon. Practically all responded to the invitations mailed and by 10 a. m. every seat in the large concert hall at Knickerbocker headquarters, 138-140 West 124th street, New York, was occupied. The stage

the many dealers present the Victor Talking Machine Co. was represented by Richard H. Nolan and J. J. Davin and O. H. Williams were present from the Reinecke-Ellis Co.

At the close of the recital the Knickerbocker Talking Machine Co. played host to those present at a luncheon held at the Hotel Theresa. A rising vote of thanks was given to the Knickerbocker staff for their entertainment and accepted by Abram Davega for the company.

PATHE MUSIC VIA WIRELESS

BURLINGTON, IA., November 5.—The Churchill Drug Co., Pathé distributor of this city, Cedar Rapids and Peoria, Ill., is featuring the Pathé

NEWS ITEMS FROM PORTLAND, ME.

Eight Victor Artists Meet With Enthusiastic Reception—Municipal Concert Series Opens—Andrews Music House, of Bangor, Remodeling

PORTLAND, ME., November 6.—The Eight Famous Victor Artists gave their unique entertainment of music and mirth at the City Hall on Friday evening, October 29, before a large, enthusiastic and attentive audience. Hundreds of people who were disappointed at not hearing them upon their first appearance here last Spring took this opportunity of hearing these artists, who were brought to Portland through the efforts of Cressey & Allen, wholesale distributors; M. Steinert & Sons Co., of Portland, and Geary & Johnson, Westbrook, all of whom handled this enterprise in a most creditable manner. Much of the success of the concert was due to the energetic and conscientious work put forth by C. B. Snow, wholesale manager of the Victor department of Cressey & Allen, and J. Frank Conner, manager of M. Steinert & Sons Co.

G. L. Richardson, representative of the Victor Talking Machine Co., recently spent a few days calling on the dealers in Portland and vicinity.

Andrews Music House, Bangor, Me., has been making extensive remodeling on the entire front of the store, which when completed will present a very attractive appearance. They are now planning on a big installation of booths.

Music lovers of Portland had the opportunity of hearing another Victor artist, Emilio De Gogorza, who appeared on the program of the opening of the municipal concert series, October 28, at the City Hall. The unprecedented demand for his records, following this concert, leaves no doubt in the minds of the Victor dealers of his popularity.

C. B. Snow has just returned after spending several days at the Victor factory at Camden, N. J.



Retailers Snapped at Knickerbocker Concert Hall

was attractively set with a complete group of the new grand opera figures produced by the Penn Phonograph Co., of Philadelphia.

During the course of the recital, Abram Davega, vice-president of the company, set forth a number of progressive suggestions on the subject of Victor merchandising. In addition to

Actuelle in an entirely novel manner. Every Thursday evening from 8 to 9 o'clock the amateur wireless operators within a radius of 100 miles of Rock Island, Ill., can listen in on a Pathé Actuelle concert by wireless telephone given by Young & McCombs, of Rock Island. The Churchill Drug Co. is spreading the news.



*The New
Portable
CIROLA*



ALL YEAR ROUND

Dealers who carry the Cirola find that the demand continues through Fall and Winter. There is always a demand for a portable machine.

Ideal for the Holiday Trade

The Cirola measures 12½" x 11½" x 6½", is attractive in appearance. It is without sound chamber, has remarkable tonal volume and many exclusive features. Covers may be had if desired.

*Territory is open for distributors.
Write today.*

Cirola Phonograph Corporation

Executive Offices:

1 West 34th Street : New York City

AT LAST A

(For all Table Type



CABINET

Machines)

Which becomes a "Unit" with the Machine. Fits so the open space or Dust Trap is closed. All You-Nit cabinets are in harmony with the construction of the machine they are made for.

Matches in material and finish and fastens to the machine, making a one-piece Unit of superior appearance, greater convenience, and increases the value and salability of every Table Type Machine.



Model A-E
Fitted to Edison Chalet
Files 56 Edison Records
Price \$18.50
Rouge and Natural Finish

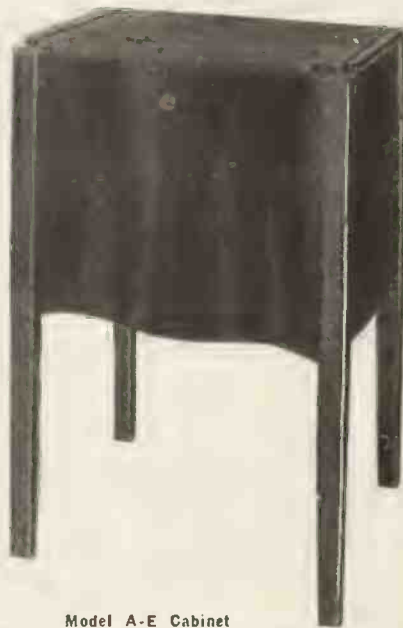

Model A-E Cabinet
Note: Fitting design for fastening to Edison
Big value. Big record capacity

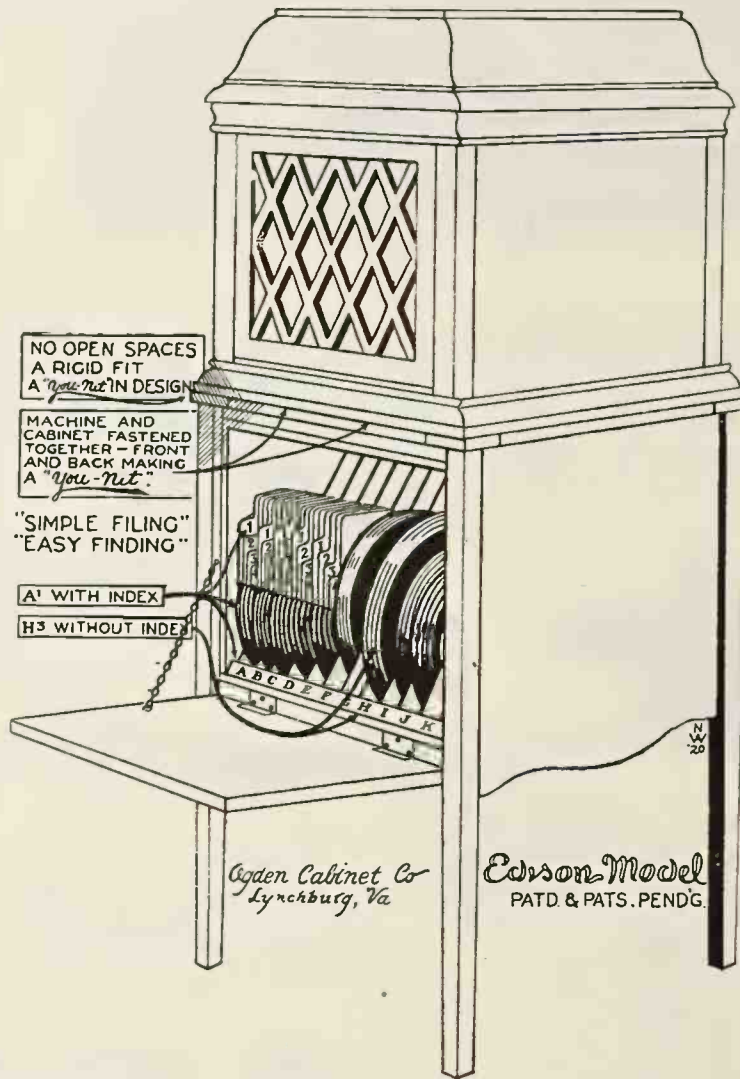

Model B-E
Fitted to Edison Chalet
Files 112 Edison Records
Rouge and Natural Finish
Price \$24.00



Model B-E Cabinet
Note how it is made to fit and fasten together
A You-Nit or fitting cabinet made for all makes of machines

BETTER CABINETS, LOWER PRICE, MORE PROFIT

A Model for Every Table Type.

Edison Disc and Amberolas. Victrola VIII & IXA, Grafonola C & D, Pathé 3 & 6.

Write for list of jobbers carrying this stock and prices of all models.

Prepare now to supply the increasing demand for lower priced outfits.

We can ship you now.

OGDEN CABINET CO.

Lynchburg, Va.

TENDENCY TOWARD HIGH-GRADE PRODUCTS IN PORTLAND

Great Activity in Musical World—Well-known Talking Machines Exhibited at Prominent Fairs—Leading Concerns Pleased With General Trend of Business in Talkers and Records

PORTLAND, ORE., November 6.—Operas and concerts, of which there will be many of a high order given this season in Portland, will give an impetus to the music trade in all lines. Especially is this true of the talking machine and records. The Scotti Grand Opera Company, the Royal English Opera Company, and the Minneapolis Symphony Orchestra have already been here this season and music and musical wants are being discussed not only by musicians, but by all music lovers.

The tendency towards high priced Victrolas continues, said B. Hunt, local manager of the Sherman, Clay & Co.'s Victor department, and new period models will be well received. Record stock is coming in faster and dealers are correspondingly much better satisfied. "Whispering" is a wonderful record and sales are surprisingly large. Other records making big hits this month are "Japanese Sandman," "Best Ever" and "Avalon."

Arthur C. Garbett, the well-known Victor representative, who is now covering the coast for Sherman, Clay & Co., giving talks on record analysis to Victor dealers and their salesmen is being enthusiastically received. Victor salesmen all know that Mr. Garbett is one of the foremost authorities in music, being well acquainted with his descriptions of records and sketches of prominent artists published in the Victor catalog.

The Cheney phonograph was attractively displayed in the handsome exhibit made by the G. F. Johnson Piano Co. at the Salem State Fair this Fall. This entire display was considered the best of any kind made at the fair. Concerts were given every afternoon and large audiences were in attendance. Souvenirs and advertising matter formed a fine part of the display, which was arranged by J. F. Matthews, H. L. Stoner and Dolph Taylor, all of the G. F. Johnson Co.

Swan Neilson, formerly with the Consolidated Music House of Salt Lake, Utah, is now one of the efficient salesmen, under Mr. Peyton, manager of the talking machine department of the Meier & Frank Co. Mr. Peyton hopes to secure more salesmen of the same kind—full of energy, practical ideas and fond of the work.

The Pacific Exchange Co., which has been located on Tenth street, has joined forces with the Perry Music Co. at 427 Washington street and indications are that a prosperous business will be done by both companies. The Pacific Exchange deals exclusively in records and has one of the largest and most complete stocks in the city.

Miss Madeline Larson has joined the Bush & Lane force. H. A. Raynor, manager of the phonograph department of this company, is very enthusiastic over the work accomplished.

The Victor, the Brunswick, the Stradivara and the Heywood all found on the floors of the pleasant music department of Powers Furniture Store,

are selling well, greatly to the satisfaction of W. B. Maxwell, manager of the department. The Heywood, a reed cabinet machine, was selected by the Baker stock company, which is playing "Parlor, Bedroom and Bath," as part of the furniture in the parlor scene and the record "O, By Jingo," which is played during the performance, made a big hit.

J. M. Howard, late of the Foley & Van Dyke Co., is now general manager of Oregon Eilers Music House. As assistant to Hy Eilers, important changes and improvements are contemplated. Mr. Howard was formerly in business in Butte, Mont., and is well known to the trade.

A \$500 Edison period design was sold by Miss Jessie Meighen of the Reed, French Piano Co. during the last week. Last month Reed, French had the best exhibit at the Multnomah County Fair, which was held at Gresham. M. C. Collins and Miss Meighen were in charge of the exhibit and they received a blue ribbon for having the most attractive display on the grounds. They showed Edison, Columbia and Victor instruments and the business in the department has increased largely since the exhibit.

Business is very good all the way from Kansas to Oregon is the opinion of Clyde Wilson, of Jenkins Music House, of Kansas City, Mo. Mr. Wilson is spending a week in Portland. He visited music houses in Kansas, Colorado, Utah, Idaho and Washington on his way from Kansas City and reports prosperity grand throughout the country.

A. J. Kendrick, general manager of the Brunswick-Balke-Collender Co., visited all the dealers handling the Brunswick in Portland the latter part of October.

W. G. Gaston, Jr., Victor field representative of Oregon and Washington, has spent the part of two weeks in this city.

Business in the talking machine department of Edwards' furniture store is quite active. M. L. Youngbar is now in charge. Mrs. C. Carroll, since the resignation of Mrs. Owen Moore, assists in the record department. Chamlee's Brunswick record, "Your Eyes Have Told Me So," is one of the favorite records since Chamlee's appearance here recently with the Scotti Grand Opera Co.

The Monte Wax Co. had a very good exhibit at the State Fair. The Modernola, Portola, Flax-a polish for cabinets and Tone Clear was displayed.

The American Legion post of Portland asks for contributions to its record shelves. It has a new phonograph in one of the new Legion club rooms in the Flatiron Building at Sixth and Ankeny streets, but the shelves are almost bare of records. Here is an opportunity to contribute to a good cause.

Herbert Bach is now in charge of the talking machine department of Lipman, Wolfe &

Co. H. W. Green is also a new member of the department. Six makes of machines are carried and the department is one of the most popular talking machine places in the city. A complete stock of Sonoras is now on hand. A \$405 Circassian walnut model is very much admired.

Mr. Fleming, of the Bush & Lane Piano Co., sells Victors from catalogs. He finds business all right if you go after it. If people are too busy to come to the store, get busy yourself and show them what they want, said Mr. Fleming, who is always alert and on the spot when he hears of a prospective customer.

Business is picking up rapidly in the talking machine department of the Seiberling-Lucas music house. A big country trade is being done. Miss F. L. Cowing, now with the record department, comes from San Francisco, where she was with the Sherman, Clay & Co.

The display of Victor goods, at the State Fair held at Salem, by Seiberling-Lucas Music Co. resulted in a number of good sales. Four Victor machines were sold right on the grounds and eight Victrolas were sold right after the fair to customers who had noticed the exhibit at the fair grounds, became interested, visited the Portland store and bought the instruments they had admired at the fair.

EDISON ARTISTS COMPLETE TOUR

The well-known Edison artists, George Wilson Ballard, soloist; Mr. Rand, violinist, and Mr. Gaylord, pianist and conductor, are finishing up their tone-test tour through Central New York. During this tour, which has lasted for several weeks, they have given matinee tone-tests of the New Edison before the school children in a public school in each city. In the evening the performance was given for the benefit of the adult population. This tour has been one of the most successful tone-test bookings that has been made.

CLOSES IMPORTANT CONTRACTS

WILLIAMSPORT, PA., November 8.—The Eastern sales and export office of the Universal Stamping & Mfg. Co., of Chicago, which makes its headquarters in this city, recently signed contracts whereby it will handle the sale of H. G. Saal motors and Sterling tone arms and devices for the Eastern States and export trade. The company is also maintaining a sales office for the Villinger Mfg. Co., which manufactures talking machine hardware.

A. A. KIDDER'S NEW POST

The Cabinet & Accessories Co., Inc., New York City, reports continuous growth in the distribution of the various lines of accessories which it handles and is steadily increasing the territory which it covers. A. A. Kidder, who has been connected with the talking machine trade for several years, is now covering New York State in the interest of this company.

Quality

Distinction

The "VICSONIA" Reproducer



Recognized for its Perfect interpretation of Edison Disc Records on Victrolas and Grafonolas.

Fitted with permanent jewel point. No loose parts.

Note: The Vicsonia is made of **Bronze**, sand casted and machined to measurement. Finished in heavy Nickel or Gold plate. Flexible stylus.

Meet the demand—Serve your customers

Sample Model "A" or "B" Vicsonia will be sent on receipt of \$4.50. Retail price \$7.50.

Note: Model "B" Vicsonia plays both Edison and Pathe records

VICSONIA MFG. CO., Inc.

313 E. 134th STREET

NEW YORK, N. Y.

OKeh

enters the foreign language record field

We have pleasure in announcing that we have secured the following wonderful repertoires of foreign records:

FONOTIPIA ODEON BEKA FAVORITE
PARLOPHON DACAPO LYROPHON

Thousands of songs and instrumental selections in more than twenty languages, recorded by artists in their native countries, are now offered to the American trade.

There is a market of over thirty million foreigners that can be reached by these repertoires.

The first list of *OKeh* foreign records is in preparation and will be ready shortly.

New releases of *OKeh* foreign records will hereafter be made monthly.

IMPORTATION OF FOREIGN RECORDS

Plans have been worked out whereby dealers can import records of those languages which will not be pressed in America for the time being. These records will be sold with the original foreign labels. Write us for particulars and name of your nearest jobber.

GENERAL PHONOGRAPH CORPORATION

OTTO HEINEMAN, *President*

25 West 45th Street, New York City, N. Y.

Factories: Newark, N. J. Elyria, Ohio Putnam, Conn. Springfield, Mass. Kitchener, Ont.
Branch Offices: Chicago, Ill. Toronto, Can. London, Eng.

CONDITIONS SOUND IN NORTHWEST

Trade Conditions Reviewed—New Brunswick Shop—Large Beckwith-O'Neill Shipments—Pathé Officer a Visitor—Columbia Prospects Excellent—30 Per Cent Increase in Edison Sales—Other News From the Northwest

MINNEAPOLIS and ST. PAUL, MINN., November 6.—Dealers in this part of the United States, accepting the results of the election as a mandate from the people, are settled down to a situation which they believe will prove advantageous. They realize that the Northwest basically is sound and that with the election flurry out of the way normal commercial and industrial activity may be expected. It is possible that the holidays will not produce quite the volume of coin for the local dealers that was garnered in 1919, but they feel right down in their bones that there will be enough doing to satisfy their hopes.

A new Brunswick Shop was opened last week at 22 West Sixth street, St. Paul. A 6 x 17 foot electric sign with 160 lights will proclaim the Brunswick phonographs to the world and the interior will house everything Brunswickian. Ray Swanstrom, late of the phonograph department of the Golden Rule store, will be in active charge of the shop. George M. Nye, in charge of the distribution of the Brunswick in the Northwest, states that some excellent accounts have been opened in this territory and the prospects are bright. As Leopold Godowsky, the eminent pianist, is now an exclusive Brunswick star, the company is capitalizing his recent visit to Minneapolis, at which he sustained his high reputation.

The Beckwith-O'Neill Co. shipped a greater number of Victrolas in October than in any previous month in 1920 and in a measure are somewhat at ease over the Fall prospects as they are receiving larger and more regular shipments than has been their fortune to obtain in several years. F. M. Hoyt, of the company, is on a thirty-day tour of the larger towns of

Minnesota, North Dakota and Montana and his daily reports are very cheering.

James Watters secretary of the Pathé Co., spent two days last week visiting with Jay H. Wheeler, manager of the Pathé department of G. Sommers & Co. His survey of the conditions in the Northwest was pleasing to him and he said so. The Pathé stock, both as to instruments and records, is ample for any ordinary run of business this Fall.

Columbia prospects in the Northwest are reported by Manager W. L. Sprague to be excellent. The warerooms are filled, the demand is keen and things are moving at a lively rate. Robert Porter, New York, field sales manager, has been on a tour of the territory, occupying his time mainly with standardizing the branch organizations. O. F. Benz, the Columbia's record sales manager, also was a visitor to the Minneapolis headquarters.

October showed an increase of 30 per cent in Edison sales over its comparable month of last year, according to Laurence H. Lucker, Northwestern distributor. The volume of shipments exceeded that of September, which was an exceptionally good month. The Minnesota Phonograph Co., handling the retail trade in Minneapolis, shows an increase of 40 per cent in sales as compared with the last previous October.

SOUTHERN DEALERS' ACTIVITIES

The Serenado Mfg. Co., Cedar Rapids, Ia., received recently interesting literature from A. D. Elder & Sons, Coldwater, Miss., Serenado representatives in that territory. This enterprising dealer has instituted an aggressive sales and advertising campaign in behalf of this line, and the results have been satisfactory.

Although general conditions in Mississippi have not been very satisfactory the past few months, A. D. Elder & Sons believe that there is more money in the territory than appeared on the surface, and therefore, inaugurated plans which verified their belief and which produced gratifying sales totals.

BUY BINGHAMTON PHONOGRAPH CO.

Weeks & Dickinson Now Have Two Modern Music Stores in Business Section of City

BINGHAMTON, N. Y., November 5.—Announcement was made recently that Weeks & Dickinson have purchased the business of the Binghamton Phonograph Co., located in the Y. M. C. A. building in Washington street.

The store, which in the past has been known as the Sonora Shop, featuring Sonora phonographs, will, in the future, be known as "The Music Shop." Other lines of talking machines and records and pianos, player-pianos and other musical instruments will be sold there.

This will give the Weeks & Dickinson music house two stores in the business section of the city and is regarded as an indication that this firm has faith in Binghamton's future.

The members of the firm are Edwin R. Weeks and Giles H. Dickinson. They took over the Barrett music store in Collier street and will continue it with the new store in Washington street. The increased business of the firm is given as the cause for the enlargement of musical facilities by the opening of this new shop.

BEQUEATHS MONEY FOR VOCALION

Unusual Provision of Australian's Will Provides Sum to Buy Instrument

From Australia comes the story of a strange bequest. Among other provisions in the will of a late client of a large house was one that "gave, devised and bequeathed the sum of £75 to be spent in the purchase of a Model 'K' Vocalion." Of course the money had to be applied in this direction only, and as the price had risen in the meantime to £85, the fortunate legatee paid the extra £10 himself and the instrument was accordingly delivered. The writer hopes that some day he may have a similar stroke of luck. He is advising his wealthy clients that he adores pipe organs.

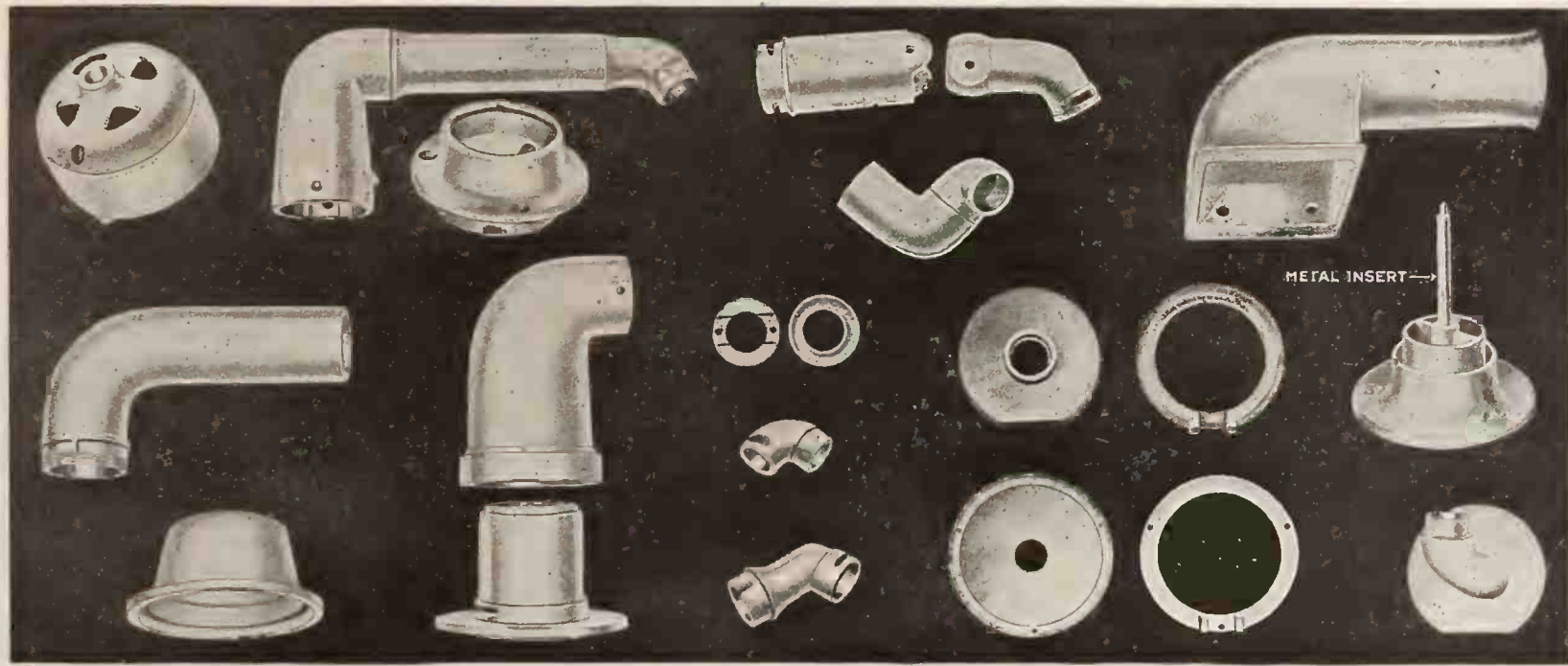

Superior Die Castings for the Music Trades

Castings from finely made Dies—Castings of precision and smoothness. Metals to meet any requirement—from the Standard White Metal of 15,000 pounds tensile strength per square inch to an Alloy of 45,000 pounds plus.



THE IDEAL METAL for Soundbox and Tonearm Castings

A Die Casting Alloy that is Double the Tensile Strength of Cast Iron—200% Stronger, 15% Harder, 30% Lighter in Weight than Ordinary White Metal Die Castings

A Tonearm of this metal is acoustically better even than brass, because a brass Tonearm would necessarily be thin and would have the tendency of blasting and imparting to the tones a thin and "brassy" effect. If your Tonearm and Soundbox of ordinary die castings or brass are too thin or too weak, or too heavy on the record, let us make the parts right with our special metal. Improve the tone by correcting the weight and balance of your equipment. Make the parts stronger and more durable. Ornamental details and shapes of beauty not possible by other processes and with other metals because of manufacturing or weight limitations are made practicable by our method of manufacture. Superior Die Castings plate perfectly in Nickel, Copper, Brass, Silver, Gold, etc., and will take a durable Japan finish, the metal withstanding the necessary high baking heat.

BARNHART BROTHERS & SPINDLER
Die Casting Division • Monroe and Throop Streets • CHICAGO

Henry Ford Says:

"The war is over and it is time war prices were over. There is no sense or wisdom in trying to maintain an artificial standard of values. For the best interests of all concerned it is time a real practical effort was made to bring the business of the country and the life of the country down to pre-war standards."

We Agree With Mr. Ford, but Desire to Add

that we religiously maintained a fixed price all during the war that undersold the market and gave the trade

An Exceptionally Good Product in

Prima-Donna

"The Instrument Inspired"

From a standpoint of value—before the war—during the war and even today—PRIMA DONNA STILL REMAINS the best phonograph value at the price on the market. The reason for this is the manufacturers of Prima Donna saw further than their competitors and put the standard high and the prices right before the war and thus set a policy that has withstood throughout the price-changing period, and it stands today as the most substantial value because—

WHEN VALUE AND PRICE ARE CONSIDERED IT SELLS ITSELF

Can You Beat This?

Prima Donna truly is the instrument inspired, for it is all one could ask for in construction, tone and fine craftsmanship.

Its tone value is enhanced by the scientific-ly constructed all wood amplifier.

All panels are five-ply and inserted in a continuous frame, either genuine mahogany or quartered oak. The mahogany cabinets are hand-rubbed to a high-class piano finish.

In short *Prima Donna* is constructed as well as any machine on the market and very much better than a great many.



Bungalow Model \$95.

Can You Do Without This?

As an up-to-date dealer you must realize the importance of co-operation between manufacturer and dealer in present-day selling methods. This every *Prima Donna* dealer is assured, as our special local advertising and unique window slides have proven a wonderful sales booster. We not only expect to sell to you *but help you sell the consumer*, as our profit is so small we **MUST** have re-orders, and the only way to get them is to help you move the goods.

Will You, Mr. Dealer, Show Enough Interest and Sound Business Judgment to Ask for a Catalog?

The only Phonograph unreservedly guaranteed for one year.

Our output from three big factories guarantees you immediate deliveries.

SIX MODELS

Bungalow....\$ 95	Astoria.....\$160
Stratford..... 115	Majestic.....200
Blackstone... 135	Parlor Grand.225

WE PAY THE WAR TAX

Guarantee Immediate Delivery—F. O. B. New York

If you are a good buyer and a buyer of good phonographs and want a phonograph built by one organization from lumber to finished product (not an assembled proposition) with the factory standing behind its product and behind the dealer, write for our Catalog and selling proposition today. Yes, we give exclusive territory if available.

Frederick P. Altschul
PRIMA DONNA
Distributor

112 WEST 23rd STREET

NEW YORK



Parlor Grand \$225



Blackstone Model \$135.

Featuring the MUSICAL POSSIBILITIES of the TALKING MACHINE

[Editor's Note:—This is the first of a new series of articles by William Braid White, devoted to the various interesting opportunities which prevail in the domain of education for the retailer of talking machines. The subject is one of great interest and we commend these articles to the consideration of all who are devoting attention to the featuring and developing of the musical possibilities of the talking machine.]

PREPARING THE EDUCATIONAL FIELD

Everybody knows in a general sort of way that the talking machine has assumed a position of some importance in the educational system of this country. That is to say, the average man in our industry is aware that the leading talking machine companies have for some years operated educational departments and have produced not only a special type of machine, but a whole equipment designed to link up that machine with musical, patriotic, linguistic and other educational activities in the schools. But even with all this general understanding, knowledge of details is very imperfect; nor is there a general understanding throughout the trade as to the principles which must govern the adaptation of the talking machine to the cause of education. It will be worth while therefore to consider these briefly.

Why Cultivate?

First, however, why exactly should it be worth our while to consider this branch of the possibilities—the musical possibilities of the talking machine? Because the talking machine surpasses all other means for the compact and comprehensive rendering of music. It is a compendium of all musical instruments in one. By its means, indeed, not alone music, but any sound whatever may be at once reproduced; to a degree of fidelity quite astonishing. If there be any virtue at all in bringing to the young mind of the scholar the riches of the world of music, languages, oratory or poetry, then plainly the talking machine is the weapon par excellence for rapid results in educational processes, for putting before the youthful mind the beauties of speech and of music in the only practical and effective way. No educational authority doubts that, in principle, this statement represents the facts. How much less should a talking machine man doubt it!

It may be laid down as an axiom that the retailers, not the manufacturers, are in need of enlightenment in respect of the use of the talking machine for educational purposes. After all, the use which any given community makes of the possibilities of the talking machine, whether privately or publicly, whether in the homes or in the schools, or in both, depends upon the enthusiasm of the local retail dealers. There will always be, of course, a quantity of small and not very strong men, content to sell what they can along lines of least resistance and caring nothing for those possibilities of expansion which are at once the admiration and the despair of every keen thinker, who always clearly sees how much more he might do than he actually does.

A Keen Man's Job

It is not of much use to talk to men of any other kind in cases like this. We have a great field before us. But like all fields, no matter how rich, it must be cultivated. Cultivation in this case means exactly what it is supposed to mean. The field must be carefully prepared and tended, watched and watered. Results do not begin to flow from the first day, but they are certain and their volume is proportionate always to the amount of care and time given to preparing for them.

Educational authorities are not always or often very acute-minded of themselves, at least in respect of new ideas. The political system of the country does not tend to put into public office men of the keenest mental character, and members of school boards are usually more inclined to look at the external than at the in-

ternal. They have to be educated to new ideas. Here the keen merchant can get in work of the most fruitful kind.

Atmosphere

For instance, it will be admitted at once by any one who thinks for a moment that the atmosphere of a talking machine store ought to suggest something else than noise and jazz. It ought to have its appeal to those who love good music, to the student who wishes to study foreign languages, to the vocal music student who wishes to study style and phrasing, to the student of elocution who wishes to study delivery and clarity of speech. It ought to have its special appeal to every school teacher as well as to every music teacher in the com-

munity. It cannot have this unless its proprietor is a man of some imagination who can understand these subtle appeals and make place for them. Thus, if in a given community there be one merchant who is wise enough to link up the talking machine with the musical, the educational and in general with the intellectual leadership of that community, that merchant will certainly influence, and even dominate, the whole feeling of the community towards music in the schools and especially towards the use of the talking machine in the school buildings as regular equipment.

The "Small-Man" Error

Or, to put the matter in another way, if the
(Continued on page 194)

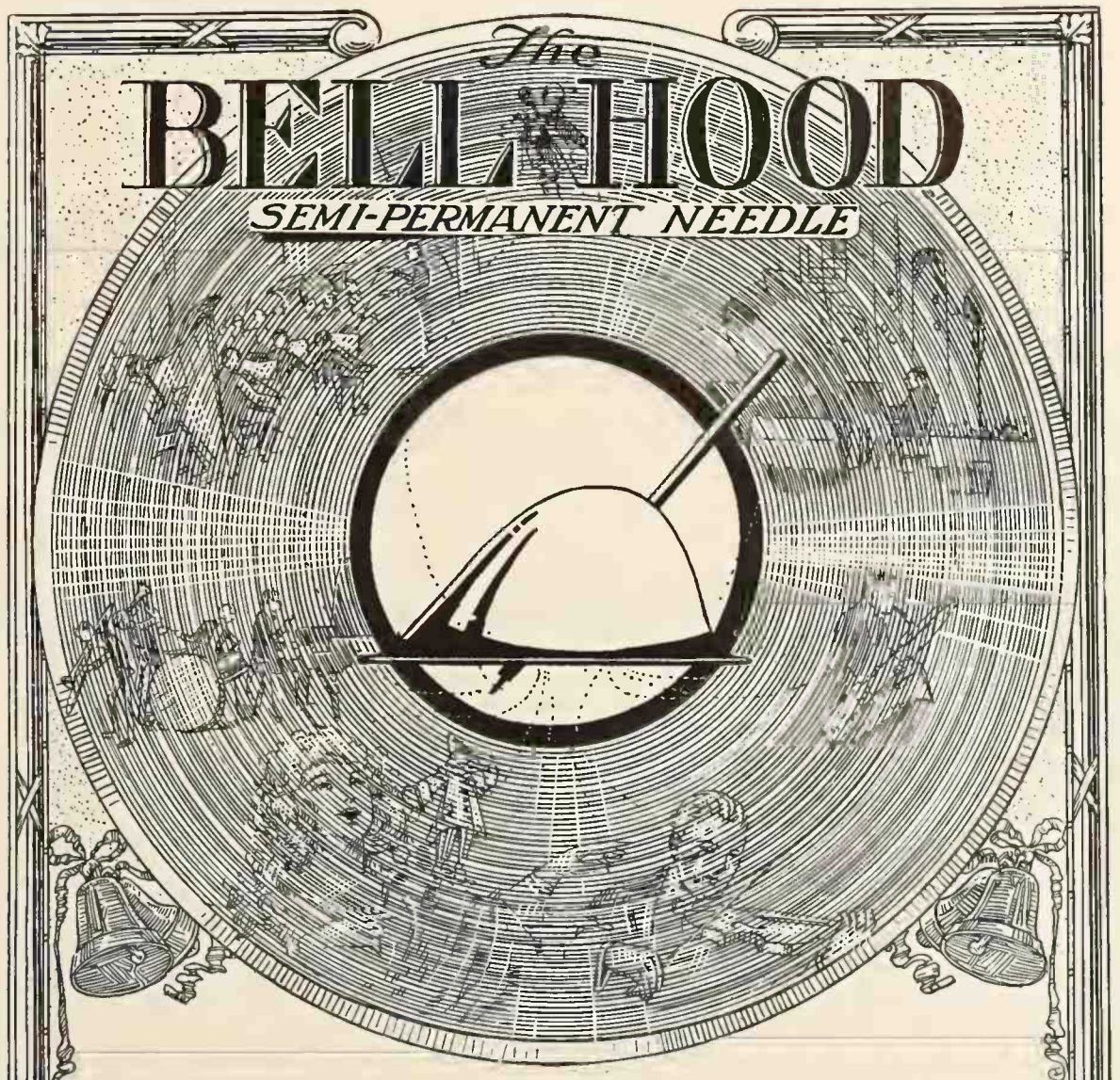

The Bell-Hood Surrounding the Needle Clarifies the Tone of Objectionable Surface and Mechanical Noise

A scientifically perfect needle designed after long experiment to better the tone quality of needles

SEMI - PERMANENT POINT LOUD - MEDIUM - SOFT

A profitable needle for dealers to sell. More than 2000 Dealers are now selling them with splendid success. Order from the nearest branch.

The BELL HOOD NEEDLE CO.

183 Church St., New Haven, Conn.

807 The Arcade, Cleveland

N. E. M. I. T. CO.,

89 10th St., South

3901 Sheridan Road
Chicago, Ill.

127 E. 23rd St.
New York City

Minneapolis

Distributors for all states west of
Mississippi River and Wisconsin

Our agreement for time of shipment is of as much importance to us as the quality and efficiency of our product. We rigidly maintain the integrity of both factors.

Average time for shipment two weeks after date of order.

Plans and Estimates promptly submitted.

VANVEEN & COMPANY INC.

12 YEARS OF STUDY AND EXPERIENCE IN
BUILDING AND PLANNING MUSIC STORES

HEARING ROOMS · RECORD RACKS · COUNTERS ·

EXECUTIVE OFFICE
47-49 WEST 34th STREET
NEW YORK CITY

SALES OFFICE
1711 CHESTNUT STREET
PHILADELPHIA

ROOM 706
7 WEST MADISON STREET
CHICAGO

PREPARING THE EDUCATIONAL FIELD *(Continued from page 193)*

merchant is going to be a big merchant in the talking machine line, that is to say, if he is determined to exert a real influence in his community to his own pecuniary profit and also to his social and popular advantage, he can work in no other way so effectively towards these ends as by working up community feeling for the use of the talking machine in the schools, for the purposes of assisting the teaching of music appreciation, as well as in language study, elocution, English-for-foreigners, and the many other departments in which its many merits can be put to the best of use. But in order to do this he must not be selfish. The small man at just this point will spoil everything. He will forget the big idea in trying to push his own personality. He will almost certainly try to sell to the school board in his community a lot of machines and other equipment which will look to that school board merely like so much money, and not at all like so much value. Here the small man will make his mistake.

Ways and Means

The big man, on the contrary, will never make a mistake like this. Whatever else he realizes, he will realize this: that the only way in which a new and even startling thing can be impressed effectively on the consciousness of the community is by making the idea behind it tremendously interesting. He will begin by getting the community interested in music through the talking machine by means of concerts and special advertising. He will interest the school teachers and the school children. He will have a corner of his store where those who are interested in educational, elocutionary, oratorical and linguistic records can come and get what they want. He will take special care to see that all this is done in the open and that the community knows what he is doing. He will approach the schools through the people; and he will reap a great reward.

It does not mean so much in the way of money to get a few machines and the educational course which goes with them in the schools of one's community. But the indirect results are sure to be very great indeed. The prestige of the dealer who makes the sale is vastly enhanced, whilst so long as there is a single talking machine in use in the schools the children are salesmen for the merchant who has placed the machines there. Every kid wants a talking machine at home.

There are many other possibilities which may be considered later. At present it is enough to make these preliminary considerations of the principles involved in putting the talking machine into the educational life of one's community.

"The hours I spend with thee, dear heart," he sang while visiting his best girl.

"Yes," she murmured to herself, "that's all he does spend."—Judge.

"PHONO-MOVIES" SELLING WELL

Dealers Speak Very Highly of the Selling Possibilities of These Products

The Commercial Art Shop, of Covington, Ky., manufacturers of "Phono-Movies," has instituted an aggressive campaign in behalf of these novelties and the results to date have been very satisfactory. The dealers have placed large orders for "Phono-Movies" in recognition of the fact that these novelties have a distinct appeal to holiday trade.

At the present time "Phono-Movies" are marketed in four standard designs called the "Scare Crow," "Ballet Dancer," "Band Leader" and "Dancing Ducky." Quite a number of the dealers are featuring them extensively in their advertising, and the Commercial Art Shop is doing everything possible to co-operate with the trade in the sale of these novelties which make such a strong appeal.

THE FERRO AUTOMATIC STOP is the best, most accurate automatic stop on the market.

Its operation is positive. There is no guesswork about its stopping the motor at the right moment, all the time.

It is a combination automatic stop and hand brake—will work properly either way.

Order a sample NOW

FERRO PHONOGRAPH PARTS CO. 1455 W. Congress St., Chicago, Ill.

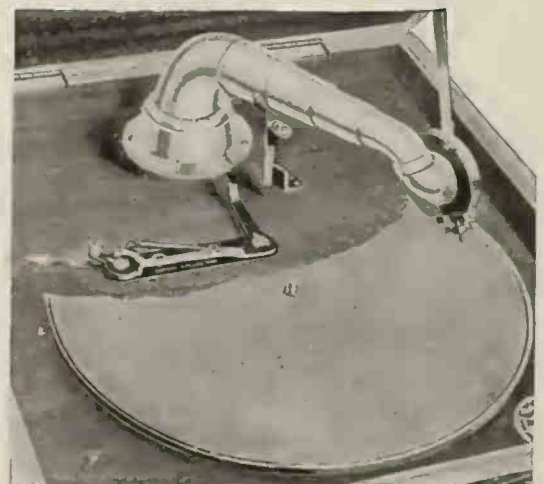

H. C. NAILL VISITS NEW YORK

Executive of Geo. A. Long Cabinet Co. Visits Trade in New York—Was Recently Elected a Director of Furniture Realty Associates

H. C. Naill, of the Geo. A. Long Cabinet Co., Hanover, Pa., was a recent visitor to New York in connection with his activities in the New York Furniture Exchange. Mr. Naill, who is one of the most prominent members of the furniture industry in the East, has been elected a director of the New York Furniture Realty Associates, which has in charge the building of a new home for the New York Furniture Exchange.

According to present plans, the Furniture Exchange will have one of the most pretentious buildings of its kind in the country, and furniture men everywhere are taking a keen interest in the activities of the directors who are responsible for the selection of the site and the erection of the building. Mr. Naill will spend the greater part of this month at Jamestown, N. Y., where the annual furniture exposition is being held.

PATHE ARTISTS IN CONCERT

The popular Pathé record artists are very active in the concert fields throughout the country. Mme. Margarete Matzenauer had the honor of opening the New York Hippodrome's season of concerts on September 19th, to be followed at later concerts by Rosa Raisa, the brilliant coloratura soprano, and by Claudia Muzio. The latter also appeared recently at an immense concert given at Madison Square Garden. The National Symphony Orchestra, whose recordings on the Pathé list are always in much demand, are scheduled for five appearances during the Hippodrome's concert series. For the Lexington Opera House, Mme. Matzenauer and Helen Yorke, both record-makers for Pathé, have been engaged.

The Fall and Winter season of Hans Kronold.

said to be America's most gifted 'cellist and whose wonderful and charming art has been faithfully duplicated on the Pathé record, was opened on Sunday, October 3rd, in Jersey City. Mr. Kronold's engagements will keep him busy during the concert season. Paul Althouse, Percy Hemus and George Jessel have also been featured recently in important recitals.

CALL FOR TRADE MEETING ISSUED

Bankers and Business Men to Meet in Chicago December 10 to Perfect Plans for the New \$100,000,000 Foreign Trade Corporation

SAN FRANCISCO, CAL., November 5.—A call for a meeting of bankers, producers, importers and exporters from all parts of the United States for the purpose of perfecting organization of a \$100,000,000 foreign trade financing corporation, to be held at Chicago on December 10 and 11, was issued to-day by John S. Drum, president of the American Bankers' Association.

The corporation was provided for at the recent convention of the association.

Mr. Drum has requested the following to serve with him as a committee of arrangements:

United States Senator Walter E. Edge, New Jersey; John McHugh, Charles H. Sabin, Lewis E. Pierson, Fred I. Kent, E. P. Thomas, O. K. Davis, George Ed. Smith, New York; John W. Staley, Detroit, and John H. Fahey, Boston.

TO HANDLE VOCALION IN FT. WORTH

Poindexter Carpet & Furniture Co. to Feature That Instrument Exclusively

The Poindexter Carpet & Furniture Co., which recently opened a most elaborate store in Ft. Worth, Tex., has incorporated therein a handsome phonograph department with the Aeolian-Vocalion and Vocalion records as the exclusive line. The company arranged the department before selecting the line of instruments, and after considering the market chose the Vocalion.

J. F. TOLLESON AN EDISON DEALER

Well-known Traveler for Atlanta Jobber Buys Interest in Tolleson & Co., Gaffney, S. C.

Announcement has just been made that J. F. Tolleson, for a number of years traveling representative for Phonographs, Inc., Edison jobbers in Atlanta, Ga., has purchased an interest in the firm of J. R. Tolleson & Co., Edison dealers in Gaffney, S. C., with whom his father has been associated for many years. Mr. Tolleson's experiences, while visiting Edison dealers throughout the South, have afforded him every opportunity to acquaint himself with the proper management of an Edison dealer's establishment and will no doubt be reflected in the success which is expected to attend his latest venture.

VICTOR ARTISTS IN WASHINGTON

Eight Local Dealers Co-operate in Bringing Record Makers to National Capital

WASHINGTON, -D. C., November 7.—The Eight Famous Victor Artists appeared in concert at Poli's Theatre here to-night before an audience that filled the playhouse to capacity. Eight of the local Victor dealers, including the S. Kann Sons Co., K. C. Sexton Co., E. F. Droop & Sons Co., Worch's, Van Wickle Piano Co., Ansell, Bishop & Turner, Inc., Rogers & Fischer and Jordan's, co-operated in bringing the artists to Washington and took occasion to call attention to the fact in the program. Henry Burr, Billy Murray, John Meyer, Frank Cröxton, Monroe Silver, Albert Campbell, Fred Van Eps and Frank Banta participated in the usual excellent program.

GROVE HAS NEW DELIVERY TRUCK

Harry C. Grove, the well-known Columbia distributor of Washington, D. C., has added one more auto delivery truck to his fleet and can now cover additional territory.

The Blue Bird



THE BLUE BIRD *sells on sight*. It satisfies your customers. There is charm in its beautiful lines and artistic construction. It possesses *the tone that thrills*. The mechanism functions perfectly and does not call for repairs.

A satisfied customer brings you other customers.

This brings satisfaction to you as a dealer and merchant—especially when the margin of profit allows you a satisfactory *net* profit above your overhead expenses.

The BLUE BIRD TALKING MACHINE CO.

MANUFACTURERS

LOS ANGELES, CALIFORNIA

Write today for catalogs and discounts.

Some choice territory open for jobbers.





No. 21
Mahogany or Oak



No. 24
Mahogany



No. 20
Mahogany or Oak

Rishell

THE MIRROR OF TONE

Made in the famous works of the J. K. Rishel Furniture Company, more than 55 years leaders of American thought and production in the finest bedroom and dining-room furniture—an absolute guaranty of quality in design, material, assembly and finish that has no parallel in the phonograph industry.

Now Open to Contracts with Jobbers

Heretofore sold directly by our own representatives, Rishell has become so popular and the demand for it so general that a change of business policy has become necessary. The many great selling features of the Rishell—among them the most exquisite cabinet work in upright and console designs; its wonderful motor; its exclusively developed Tone Throat; its sensitive Tone Arm and universal Sound Box—



No. 23
Mahogany



No. 16
Mahogany

Will Increase Your Business and Prove a Stone Wall to Competition

Send **today** for new catalogue and circulars describing in detail this supreme musical instrument—and get our jobber's terms.

RISHELL PHONOGRAPH CO., Williamsport, Pa.

New York Distributor: GRAND TALKING MACHINE COMPANY

270 Flatbush Avenue Extension, Brooklyn, N. Y.

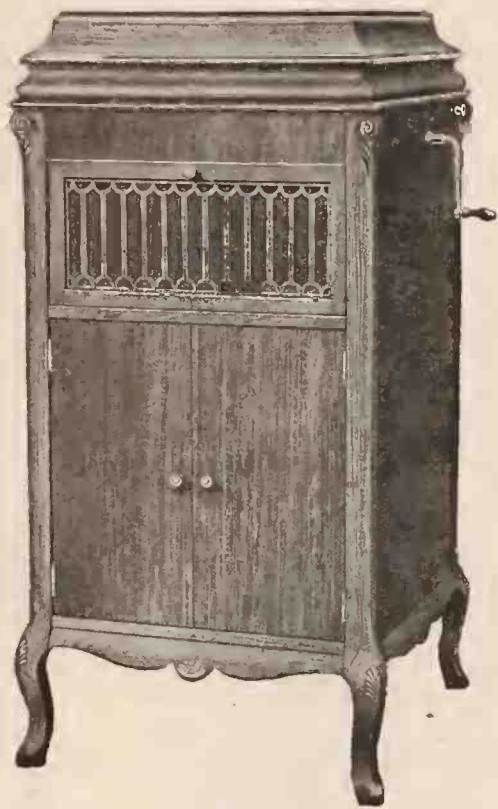

No. 17
Mahogany



No. 25
Mahogany



No. 22
Mahogany or Oak

Rishell

THE MIRROR OF TONE

Nearly five years on the market. A great hit in the critical musical atmosphere of Boston—a positive success everywhere it is represented, especially when sold in the severest competition with the finer productions of the oldest makers. The one phonograph that plays all records—and plays them better than the “machine” for which they were made.

RISHELL Is Quality Merchandise

The whole world is turning away from cheapness and bargaining. High prices and limited supply have taught it the economy of buying the good thing. Cheap phonographs will eventually be forced off the market. Rishell's high quality will command immediate sales and make future sales. We are in a buyer's market—a market of thoughtful choosing and careful examination. Give your trade the merchandise it demands.

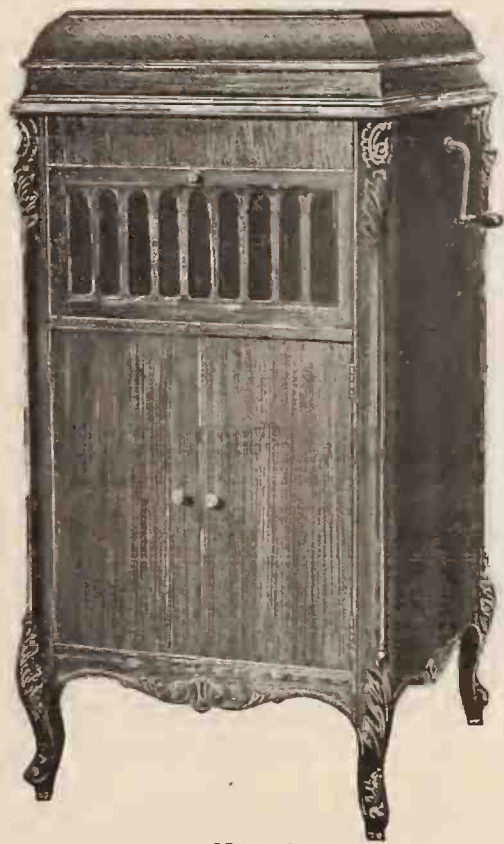

No. 19
Mahogany or English Brown Mahogany

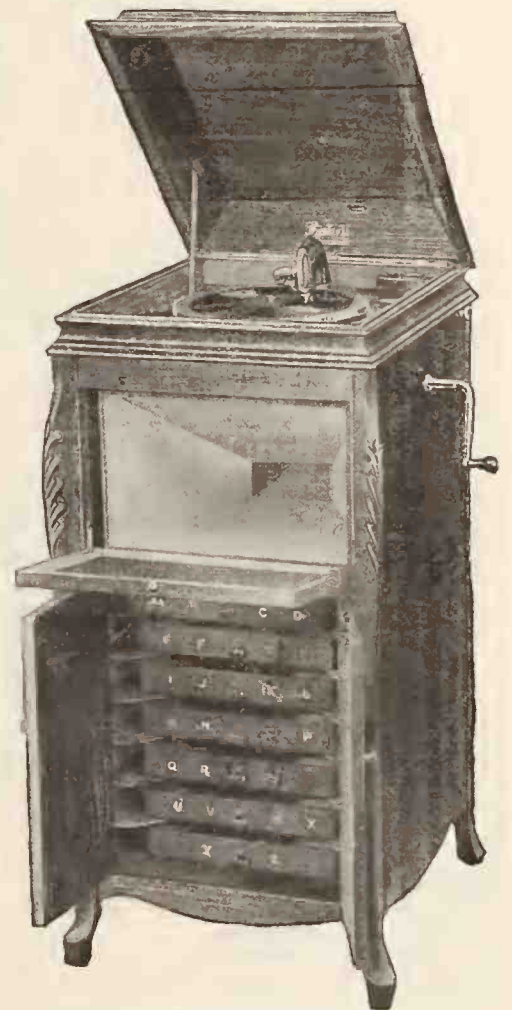

No. 23—Open
Showing Disposition of Records

RISHELL is the Remedy If your sales are slow, or your competition strong

Art catalogue and circular price lists on request. The season for big sales is here—write today. Every Rishell sale makes another. We have a most interesting proposition for jobbers.

RISHELL PHONOGRAPH CO., Williamsport, Pa.

New York Distributor: GRAND TALKING MACHINE COMPANY

270 Flatbush Avenue Extension, Brooklyn, N. Y.

Slides for Talking Machines



Have you ever considered the use of

DOMES OF SILENCE

for the Talking Machine models you carry? Certain well-known Talking Machine manufacturers already use them for they find in addition to the fact that they save strain on Cabinet legs, save floors and rugs and that customers are therefore better satisfied, that they make the "set" of the machine better looking in that they permit of the cabinet setting closer to the floor.

They are nationally advertised. Your customers know their value and your salesman has an additional talking point.

HENRY W. PEABODY & CO.

Domes of Silence Division

17 STATE STREET

NEW YORK

SPECIFY DOMES of SILENCE

AN IDEAL ARRANGEMENT OF TALKING MACHINE SHOP

EXHIBITS AT GEORGIA STATE FAIR



New Quarters of the Freeport Music Shop, on Merrick Road, Freeport, L. I.

OKEH FOREIGN LANGUAGE RECORDS

General Phonograph Corp. Will Issue Records From Many Famous Foreign Libraries—Important Deal Closed Recently in Europe

The General Phonograph Corp., New York, recently made a very important announcement to its jobbers to the effect that arrangements have been completed whereby this company will bring out on Okeh records the foreign language repertoires of the following famous record makers put out by prominent European record manufacturers: Fonotipia, Odeon, Beka, Favorite, Parlophon, Dacapo and Lyrophon. This deal was closed recently in Europe by the president of the company and Okeh jobbers and dealers will undoubtedly appreciate the import of this announcement.

Included in this record library are thousands of songs and instrumental selections in the following languages: Bohemian, Danish, Dutch, French, German, Greek, Hungarian, Italian, Jewish, Norwegian, Polish, Portuguese, Russian, Serbian-Croatian, Swedish, Spanish and Turkish. Artists who are essentially national (most of them have never left their home countries) have recorded their native music for these record libraries and even distinctive Asiatic languages, such as Arabian, Hindustan, Syrian, Chinese, etc., are represented in the foreign language repertoires which will be offered to record buyers through the Okeh library.

The Okeh dealer will be particularly interested in the fact that native artists are making these foreign records, for the foreigner in this country who loves the music of his native tongue is thoroughly familiar with the standing and prestige of the native artists. Okeh dealers will, therefore, have a powerful sales appeal that will undoubtedly stimulate the sales of these records tremendously.

The mother shells of these original recordings have been imported by the General Phonograph Corp. The first list of foreign Okeh records is now being prepared and will be ready shortly, and further monthly releases will be made hereafter.

Okeh dealers will also have an opportunity to import records in such languages for the time being will not be pressed in America. Samples of stocks of such records can be imported for the dealer and records in all languages will soon be available from which importation orders can be compiled. A detailed plan for these orders has been worked out and will be presented to Okeh dealers by the general sales department.

The sales organization necessary to properly handle this very important division of the Okeh business has now been perfected, and Okeh jobbers will have the assistance and co-opera-

tion of the foreign record and import department in making this branch of their business as successful as the domestic end. Extensive sales plans have been completed by this department which will reach the foreign record dealers all over the country, and a detailed plan of cooperation will also be offered the trade.

BEGIN WORKING NOW FOR XMAS

Dealers Should Prepare Their 'Trade Well in Advance of Actual Holiday Season

December is a busy month in the talking machine field. See that you have made a thorough canvass of your customers and prospects and then go after their trade with a vim. This will assure you of a bountiful crop of Yuletide sales. Records especially are becoming more and more an appropriate Christmas gift and dealers should cash in on this proposition. Don't wait until the last minute but prepare your ground by proper publicity. Create your demand well in advance. Then if your stocks are adequate, you need not fear as to the result. The time to act is now, for pre-holiday activity is already apparent.

J. B. White & Co. Have Attractive Display of Victor and Brunswick Machines, Emerson Records and the Magnavox

AUGUSTA, GA., November 6.—J. B. White & Co., the big general store of this city, had a most elaborate display at the State Fair held here last week, much of the exhibit space being turned over to the company's talking machine and record department. There were twelve demonstrators in constant attendance at the company's display space and the talking machine booths, in which both Victor and Brunswick machines were shown, together with Emerson records, were crowded with people all the time. M. H. Wheat, factory representative of the Brunswick, was in attendance during the period of the Fair.

A novel feature of the exhibit was the demonstration of the Magnavox which was used to harangue the crowds and to draw their attention to the booth. The exhibit resulted in a number of excellent sales and a large prospect list.

ISSUES MOST ARTISTIC FOLDER

The Binger Victor Sales Promotion Service Subject of Very Artistic Booklet Just Issued

The Reincke-Ellis Co., of New York and Chicago, has just issued a very impressive folder in which is described in detail the Binger Victor Sales Promotion Service, which this enterprising institution is now bringing to the attention of the talking machine trade. There is a letter above the name of Arno B. Reincke, the president of the company, in which he talks in a colloquial and interesting way about the special value of this window service, which is designed to bring a new display for each two weeks in the year, as well as capitalizing every special holiday event. Two large color illustrations of the window displays showing how these displays will appear form part of the folder and innumerable other details should undoubtedly win the consideration of dealers who desire to rank among the progressives of the industry.

The cover of this folder is printed in red, green and white on a black paper stock, with the caption, "Now Your Window Display Problem Is Solved." In other parts of The World this month Victor talking machine jobbers are announcing the Binger Service referred to in this impressive letter press.



HENRY BURR



ALBERT CAMPBELL



JOHN MEYERS

EIGHT FAMOUS VICTOR ARTISTS

In Concert and Entertainment [Personal Appearance of Eight Popular Victor Favorites on One Program

A live attraction for live dealers and jobbers

Bookings now for season 1920-1921

Sample program and particulars upon request

P. W. SIMON, Manager

1604 Broadway

New York City



BILLY MURRAY



FRED VAN EPS



FRANK CROXTON



MONROE SILVER



FRANK BANTA

Famous Ensembles including Campbell & Burr - Sterling Trio - Peerless Quartet

Edison Amberola Message No. 11

Mr. Phonograph Dealer:

This message is directed to
YOU.

The return to a "buyer's market" does not mean that folks have put padlocks on their pocketbooks.

It means that the prospective buyer demands full value for his money.

The Diamond Amberola line, not having the handicaps of war-time prices, or war-time quality, is meeting the buyer's demand by giving full value.

THOMAS A. EDISON, Inc.

AMBEROLA DEPARTMENT

ORANGE, N. J.

For Christmas don't miss "Ye Olden Yuletide Hymns" arranged by Robert Hood Bowers. A-2993.

Columbia Graphophone Co.
NEW YORK



KANAREK TALKS ON CONDITIONS IN WESTERN TERRITORY

President of Independent Talking Machine Co. Makes Keen Analysis of Business Situation as Gleaned on a Recent Visit—Dealers Who Have Courage and Vision Are Winning Out

Rudolph Kanarek, president of the Independent Talking Machine Co., New York, recently returned to the New York offices of the concern following a several weeks' trade trip throughout the Middle West territory. Mr. Kanarek purposely made visits to the larger trade centers as far Northwest as Minneapolis in order to get first-hand knowledge of retail conditions.

In speaking to a representative of The World upon his return he said: "The purchasing power of the public is slightly curtailed throughout the country. The desire to purchase where the ability to do so exists, is reduced to quite a marked extent. The points where conditions can be considered bad are only to be found in a few cities such as Akron and Toledo, Ohio, and Detroit, Mich., owing, of course, to a great extent to the depression in the automotive indus-

tries which naturally has its effect on the population in those centers. In Detroit I found one department store had laid off over 150 girls on one floor, while in cities 200 miles distant similar stores were still advertising for help.

"Outside of these mentioned cities there will be without doubt more musical instruments sold during 1920 than were sold during 1919. The situation, however, is different inasmuch as there is an abundance this year, whereas there was an extensive shortage last season.

"To a surprising extent I found that because sales were poor with several dealers in one locality such a condition was not general. I found that where live men are in charge of departments or stores sales will undoubtedly be doubled and tripled this year against those of last, while a neighboring store with an easily

discouraged manager is evidently ready to quit owing to the lessened demand.

"As an illustration, which was by no means confined to this one city, I wish to relate a conversation I had with the manager of the musical department of the Famous & Barr Co., of St. Louis, Mo., who said:

"Conditions in our place are more than satisfactory. We have tripled our sales of last year, have put in the Brunswick line a few weeks ago and are going after it quite extensively, and are doing all the business we really could want. I received your card on the second of October and had the usual sale of your machines for two days and sold ninety machines. I had to stop sale as the Brunswick line came in and I had a very successful sale with this line also. It seems to me that conditions are hourly improving, and sales are really to be had if you go after them."

"After bidding Mr. Ditzell of the above department store adieu, I ventured into another downtown store. I had a conversation with the manager of the music department who felt as blue as a fish out of water and assured me that in the last six weeks the bottom of the business fell out, and that for some weeks the total income did not cover the expenses of his department. He seemed utterly discouraged and said that it was a pity to spend more money for advertising purposes and that he would not permit his concern, in a dull time such as the present, to appropriate money to stimulate sales. I, therefore, formed the opinion that the poor success of the department, in no small way, was due to the easily discouraged manager.

"This condition is not only confined to St. Louis, the same situation was met with elsewhere—lack of courage and lack of vision.

"Much of the depression in trade circles, as far as sales are concerned, has been caused by the propaganda maintained by newspapers throughout the country regarding the expectation of tumbling prices, money stringency and the collapse of important industries. Money stringency is a detriment to the trade because the retailers are curtailing sales in places where they are to be had in abundance, owing to lack of capital or the desire to get out from under the thumb of the local money institutions. Of course, where industries are affected, there is an actual crippling of business that is hard to remedy. Regarding the propaganda maintained by newspapers, it is my opinion that what is needed is very extensive counter-propaganda, or at least sufficient publicity to the effect that prices on phonographs have never been artificially inflated and therefore expectations of a drop in prices are very remote. The public must be shown that a decline of the demand will only serve to curtail production instead of reducing prices, which might in turn bring the cost of production to higher figures than at present owing to the very curtailment."

Mr. Kanarek made a minute study of situations everywhere, for it was not his object to sell goods while on the trip. Of course, like any other business man, he expects to benefit by the knowledge he has acquired. Most of this will be realized on in the months to come.



EASTERN PHONOGRAPH CORPORATION

GEO. SEIFFERT, Pres.

WHOLESALE DISTRIBUTORS

OFFICES AND SHOWROOMS

101 West Twentieth St. 100 West Twenty-first St.

Telephone: Chelsea 2044 Cor. Sixth Avenue NEW YORK



THE REPEATOGRAPH

Automatically Repeats Phonograph Records

**RETAIL PRICE NOW
REDUCED TO \$5.00**

THIS new price means a big holiday trade. A splendid chance for the dealer to make a drive on the one really necessary and practical talking machine accessory. Every one of our 10,000,000 instrument owners needs one. A demonstration means a sure sale, now that the dancing season is here.

The HOLIDAY "HAPPY THOUGHT"

An apt and appropriate gift to any one who owns a phonograph.

Inexpensive and impersonal. Just the thing to fill in that blank in a Christmas gift list.

The Repeatograph is a practical perfected device that has met with instant favor. Masterfully simple, so sturdy as to be fool proof. A child can attach it. Will endear the giver to the whole household. Enlarges the use of the phonograph and protects the records.

Order Now—Immediate Delivery

Take advantage of the remarkable demand for Repeatographs. Orders can be filled immediately while our stock lasts.



The Repeatograph Company

NEW YORK
Van Alst & 14th Street
Long Island City

CHICAGO
664 W. Randolph Street

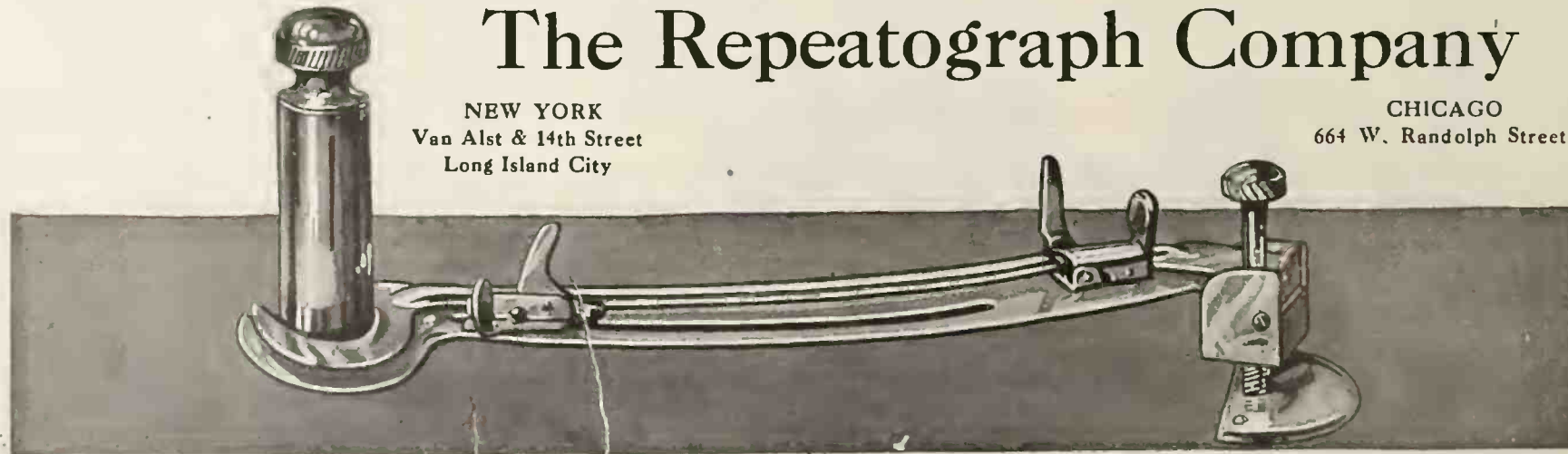

UNIQUE LECTURE RECITAL ATTRACTS

Branson M. De Cou's Dream Pictures With "Dream Music" Charm Audience at Academy of Music in Brooklyn—A Musical Novelty

Two thousand people crowded into the music hall at the Academy of Music, Brooklyn, N. Y., on the evening of November 3 to see "Dream Pictures," a musical visualization of our own Pacific Coast, by Branson M. De Cou, with Victrola accompaniment. An excerpt from the program says, "With the aid of the dissolving shutter and double stereopticon, beautifully colored lantern views are projected in this recital, perfectly synchronized to the music of the Masters reproduced on the Victrola.

The pictures, which include views wonderfully



B. M. De Cou at Mt. Assiniboine, Canada colored by Miss Grace Nichols, of Chicago, and Miss Augusta Heyder, of Newark, consisted of close-ups and vistas from Southern California, Yosemite Valley, Lake Tahoe, "the Lake in the Clouds," Mount Rainier, Tacoma, Blackfoot Indian studies and the supreme spectacle—the Grand Canyon of Colorado.

Mr. De Cou, who was for many years connected with the Educational Department of the Victor Talking Machine Co. and who is now manager of the Landay Bros., Newark (N. J.) Victrola Shop, began his exploits into this field through amateur photography. He soon became an expert, and taking advantage of his opportunities in travel built up a reputation second only to professionals like Holmes, Elmendorf and Newman, for his wonderful set of "American Travelogs." He has just returned from the Canadian Rockies, where he accompanied the Appalachian Mountain Club on their famous

"The Music Without the Blur!"

This ideal of talking machine manufacture is attained more nearly than by any other, in the construction of the

MARVELOUS MAGNOLA
"Built by Tone Specialists"

"Magnola's Tone Deflector eliminates the scratch"



Watching the Music Come Out

We want to show you how to make money with MAGNOLA; and how MAGNOLA is the best buy on the Talking Machine Market to-day. Send us your name and let us send you some real Talker Tips.

MAGNOLA TALKING MACHINE COMPANY
OTTO SCHULZ, President
General Offices: 711 MILWAUKEE AVENUE, CHICAGO
Southern Wholesale Branch: 1530 CANDLER BLDG., ATLANTA, GA.

climb of Mount Assiniboine. His program on this occasion was:

- | | |
|--|---|
| <p><i>Pictures</i></p> <ol style="list-style-type: none"> 1. The Charms of Southern California. 2. Beginning California's History. The Franciscan Missions. 3. Moods of the Pacific. 4. Loveliest of Valleys—Yosemite. 5. The Lake of the Sky Blue Water—Lake Tahoe. 6. The Cathedrals of the Woods. 7. The Mountain that was God. Mt. Rainier—Tacoma. 8. Wildflowers of the Mountains. 9. The End of the Trail. Studies of the Blackfoot Indians. 10. Nature's Supreme Spectacle. The Grand Canyon of the Colorado. | <p><i>Music</i></p> <p>"Knowest Thou the Land" from Mignon
Geraldine Farrar, Fritz Kreisler</p> <p>In a Monastery Garden—Orchestra</p> <p>William Tell Overture
The Storm and the Calm
Prelude to Lohengrin
Symphony Orchestra
From the Land of the Sky
Blue Water
Alma Gluck
Orpheus Ballet (Gluck)
Philadelphia Symphony Orchestra</p> <p>On Wings of Song (Mendelssohn) Jascha Heifetz</p> <p>Quartet in G Major (Dittersdorf)
Elman String Quartet
Indian Lament (Dvorak)
Fritz Kreisler</p> <p>Prelude in C Sharp Minor (Rachmaninoff)
Orchestra</p> |
|--|---|

The instrument used in the great music hall was an M-XXV Victor with a resonant wooden horn, filling the room with a rich vibrant tone, worthy of a great symphony.

DALLAS BETTER BUSINESS BUREAU

Music Dealers Form Important Part of New Organization to Keep Standards High

DALLAS, TEX., November 8.—Great things are expected of the recently organized Better Business Bureau, which is made up of the leading business houses of the city. In the sphere of musical activity the piano men are united for better advertising and better, cleaner business methods. The reputation which Dallas has won and its high place in the world of music are due to the efforts of these dealers who have spared no effort to raise the standards of the industry and keep them high. The music firms which are charter members of the Better Business Bureau of Dallas are: The Edison Shop, the Field-Lippman Piano Stores, G. H. Jackson, the Leyhe Piano Co., Sanger Bros., the Will A. Watkin Co. and the D. L. Whittle Music Co.

Dealers! Get busy on your Christmas campaign.

CHARMAPHONE PHONOGRAPHS

A QUICK SELLER AND A PROFIT-MAKER FOR YOU

Make this Charmaphone Model No. 4 Your LEADER

Its Tone, Equipment, Finish and Construction are of High Standard

Profits for You Value for Your Customers

Priced so They Create Sales

Exclusive Territory to Live Dealers

Write at once for Prices and Catalog



MODEL No. 4
Height 42 inches.
Width 18 inches.
Depth 23 inches.

Five album shelves. Nickel-plated leg sockets and casters

Retail Price \$75.00

CHARMAPHONE COMPANY

39 West 32nd St., New York

Factory: Pulaski, N. Y.

THE SUPREME

A Master Phonograph with Sensational but Sane features that make it a wonderful seller.

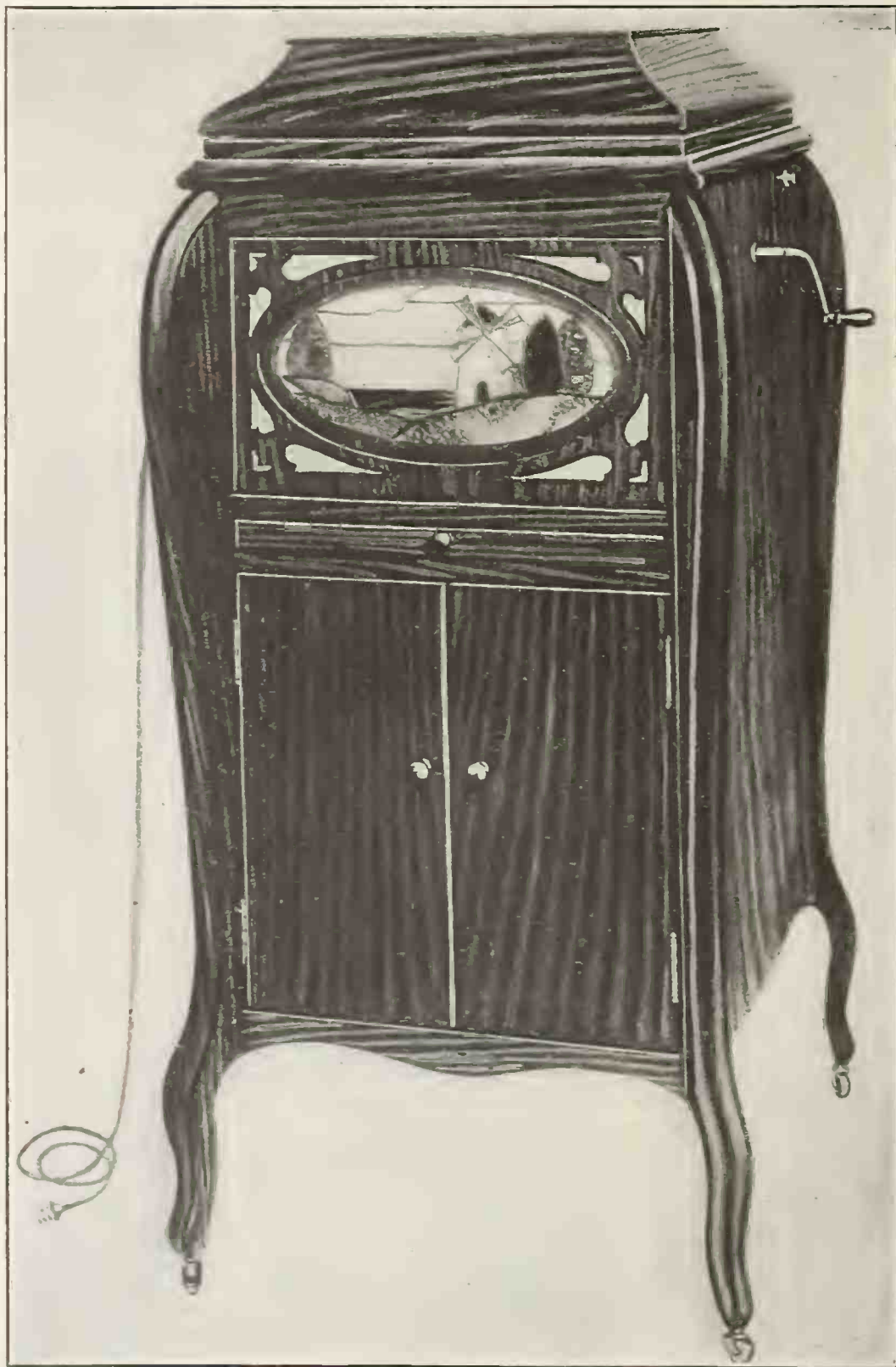

MODEL S

Retail price \$250. Dimensions: 48" high, 23" wide, 25" deep. Made in Mahogany, Oak and Walnut. Furnished with art glass grill shown in cut or new attractive fleur de lis design.

Three Great Supreme Features

1. Beautiful illuminated art glass grill.
2. Pull out velvet lined record drawer, under horn, for holding "pet" records.
3. The Supreme patented lighting system. Touching a button simultaneously lights the top of the machine, so you can place records on in the dark; illuminates the art grill, and record drawer, and also lights up the record shelves in the base of the cabinet.

The Supreme is the biggest novelty seller on the market today.

It will create sales for you while you sleep, as it makes the most attractive night-window display imaginable.

Desirable Territory is Being Rapidly Taken Up.

Better Act Quickly.

STONE MANUFACTURING CO.

FACTORY and SALES OFFICES:

2621 OLIVE STREET :: :: :: :: :: ST. LOUIS, MISSOURI

ENJOY GOOD SPORT IN TEXAS

C. H. Tracy and J. H. Sheldon Report Some Excellent Fishing and Shooting

Believing in the adage that "all work and no play makes Jack a dull boy," Charles H. Tracy, of the wholesale Vocalion department of the Aeolian Co., and J. H. Sheldon, manager of the San Antonio store of the D. L. Whittle Co., Vocalion representatives, took a few days off dur-



Messrs. Tracy and Sheldon in the Native Wilds ing Mr. Tracy's recent visit to Texas, and with rod and gun endeavored to reduce the supply of fish and birds. The accompanying photograph shows Messrs. Tracy and Whittle bound for the happy hunting grounds. Applying all possible discounts to the story of the trip, the fact would seem to remain that there was some game to be had. Dove shooting had an especial appeal for Mr. Tracy.

INTRODUCING MISS OLIVER

Fred P. Oliver, vice-president of the Blackman Talking Machine Co., New York, Victor wholesalers, is receiving the congratulations of his many friends in the trade upon the arrival of a baby girl at the Oliver residence in Brooklyn on Election Day. Miss Oliver has been christened Elizabeth and Mr. and Mrs. Oliver now have two heiresses.

The Yahrling-Raynor Co., Youngstown, O., announces that it has arranged to handle the Victor line exclusively in that city.

DO YOU LACK THE SAND?

The man who quits has a brain and hand
As good as the next; but he lacks the sand
That would make him stick with a courage stout
To whatever he tackles and fight it out.

He starts with a rush and a solemn vow
That he'll soon be showing the others how;
Then something new strikes his roving eye,
And his task is left for the bye and bye.

It's up to each man what becomes of him;
He must find in himself the grit and vim
That brings success; he can get the skill,
If he brings to the task a steadfast will.

No man is beaten till he gives in;
Hard luck can't stand for a cheerful grin;
The man who fails needs a better excuse
Than the quitter's whining, "What's the use?"

For the man who quits lets his chances slip,
Just because he's too lazy to keep his grip,
The man who sticks goes ahead with a shout,
While the man who quits joins the "Down and Out."

NEW HAVEN COLUMBIA NEWS

**Manager H. B. Haring Returns From Trip—
Marion Harris Visits City**

NEW HAVEN, CONN., November 8.—Manager H. B. Haring, of the Columbia Graphophone Co., of this city, has returned from visiting dealers in the northwestern part of his territory, bringing with him a large Grafonola order from Widener's Grafonola Shops, Inc.

On Monday, November 1, a very interesting sales-meeting was held at this branch, at which E. O. Rockwood, general credit manager, Columbia Graphophone Co., Woolworth Building, New York, was present.

Marion Harris, exclusive Columbia artist, is appearing in this city this week and has visited this branch and several of the dealers, many of whom had special window displays on her records.

Brodrib & Blair, proprietors of the Grafonola Store, Waterbury, Conn., have opened up another exclusive Columbia store at Bristol, Conn.

COLUMBIA DIVIDENDS DECLARED

**Dividend on Preferred and Common Stock, Plus
Common Stock Bonus**

The board of directors of the Columbia Graphophone Mfg. Co., at a meeting held a few days ago, declared the following quarterly dividend on the preferred and common stock of the company, payable on January 1, 1921, to stockholders of record at the close of business on December 10, 1920: (a) A dividend of \$1.75 on each share of preferred stock; (b) a dividend of 25 cents on each share of common stock; (c) a dividend at the rate of five shares of common stock on every one hundred shares of common stock outstanding.

The transfer books will not be closed. The above dividends on common stock are payable only on common stock authorized and outstanding on December 10, 1920, under the certificate of incorporation as amended August 20, 1919.

MEETS WITH FAVORABLE RECEPTION

CEDAR RAPIDS, IA., November 6.—The New Comfort Talking Machine Co., of this city, manufacturer of the New Comfort talking machine, has received letters from its dealers in various trade centers commenting upon the favorable reception accorded this line. Several of these letters have referred particularly to the attractive cabinet designs and the co-operation which the company has extended its dealers.

In circulars which were recently prepared for its dealers, the New Comfort Talking Machine Co. emphasized the fact that all of its models are equipped with a violin shape sound chamber, constructed of violin wood and designed to give absolute satisfaction to the most critical music lover. This sales argument has been used to advantage by the dealers who have featured it in their advertising.

Alexander Robinson, Illion, N. Y., has moved his talking machine store to 20 Union street.

Watch Your Lists
For These, Mr.
Dealer

**SONG
HITS**

Stock Up
The Sheet Music
The Records
The Music Rolls

The Overnight
Novelty Hit

PALESTEENA

By Conrad and
Robinson

The Melody
Beautiful

CARESSES

Society's Favorite Fox Trot
By James V. Monaco

Hit of the "Greenwich Village Follies, 1920"
I'm a Lonesome Little Raindrop

That Southern Rag, Ballad Novelty
KENTUCKY

The Hawaiian Waltz Craze
ISLE OF PARADISE
A Terrific Seller

Song Hits From John Corts' New Musical Comedy
"JIM JAM JEMS"
"Sweet Little Stranger", "When the Right Little Girl Comes
Along", "Raggedy Ann"

THERE'S A VACANT CHAIR AT HOME SWEET HOME
The Ballad Success of the Year by the writer of "Rose of Washington Square".

Mary Earl's Latest **IN OLD MANILA** Tango Fox Trot

SHAPIRO, BERNSTEIN & CO., Inc., *MUSIC PUBLISHERS*
BROADWAY & 47th ST., NEW YORK

GLEANINGS *from the* WORLD *of* MUSIC

KEEPING IN TOUCH WITH THE MUSICAL COMEDY HITS

Success of the Talking Machine Record in Carrying Musical Comedy Melodies to All Sections of the Country Makes It Necessary for Dealers to Be Familiar With the Music of Broadway

Some few years ago it was considered absolutely necessary for the live talking machine jobbers in the larger cities, particularly New York and Chicago, or those who could get to such towns easily, to keep in close touch with the new musical comedies and other musical productions as they were presented to the public in order that the song successes might be studied and the proper proportion of records ordered.

Up to a season or so ago the full demand for the song hits of a musical comedy in record form was not realized until that particular production happened to play in or near the city in which the talking machine dealer was located. Certain numbers, of course, such as "Poor Butterfly," from the New York Hippodrome show, gained countrywide popularity while the production was still in New York, but for the most part the flood tide of production number demand was not in evidence until the show had gone on tour.

At the present time the vogue of the talking machine record appears to have changed its mode of procedure, and it is no unusual thing to find musical comedy hits worn ragged in far distant sections of the country before the show has even left New York. An instance in point is "The Love Nest," from "Mary," which was a countrywide sensation before the show had fin-

ished its preliminary engagement in Boston; had become a habit by the time "Mary" played Philadelphia, and had reached the point where it was almost an obsession by the time this production finally got to Broadway.

The secret seems to be that in the case of "The Love Nest," for instance, it was really a snappy little dance number, and was recorded in a manner that made a strong appeal to the public. The fact that it happened to be from the score of "Mary" had nothing whatever to do with the situation. In view of these circumstances it would seem that the day of waiting for a musical production to go on the road before the public in distant sections of the country become acquainted with its music is past, due to the ability of the talking machine record to present the best of such music to the public as far distant as the Pacific Coast, while the show is still enjoying its premiere season in the effete East.

This condition is brought about through the capable efforts of the "scouts" for the talking machine companies, assisted in no small measure by the representatives of the music publishing houses who control the musical comedy scores. Long training has given these men the ability to judge most accurately just what numbers in the score of a new production are likely to have a popular appeal, and they proceed immediately

to offer these numbers in record and music roll form. The selections are not made because they happen to be in this or that show, but because the songs or dances in themselves represent good music, or at least the sort of music that the public is likely to want.

Of course, among all the production numbers recorded there are some that would prove more popular in one section of the country than another, and there are a certain proportion also that are likely to prove poor sellers. The talking machine dealer can make the most of his opportunities in the handling of these records by keeping in touch with the sheet music dealers in his locality and, if possible, with one of the branch offices of the music publishing house handling the music. If a production number shows any signs of life the publisher is quick to place the number with as many orchestras as possible throughout the country, for that means familiarizing the public with the melody and developing sales for the sheet music for home use. Much of this work is done through the medium of local dealers, and if the talking machine man keeps in touch with the situation he will be able to hook up with the publisher's campaign and at the same time enjoy the benefits of the publicity provided by the talking machine company.

To sum up the situation, so far as the musical hits of the season's musical comedies and operettas are concerned, talking machine records have spread Broadway all over the country. While the New Yorker may enjoy the scenic
(Continued on page 208)

The Event of the Season —

AL JOLSON

Sings his great Success

AVALON

for the Columbia
RECORD NO -A-2995

Published by
JEROME H. REMICK & CO.
DETROIT NEW YORK CHICAGO

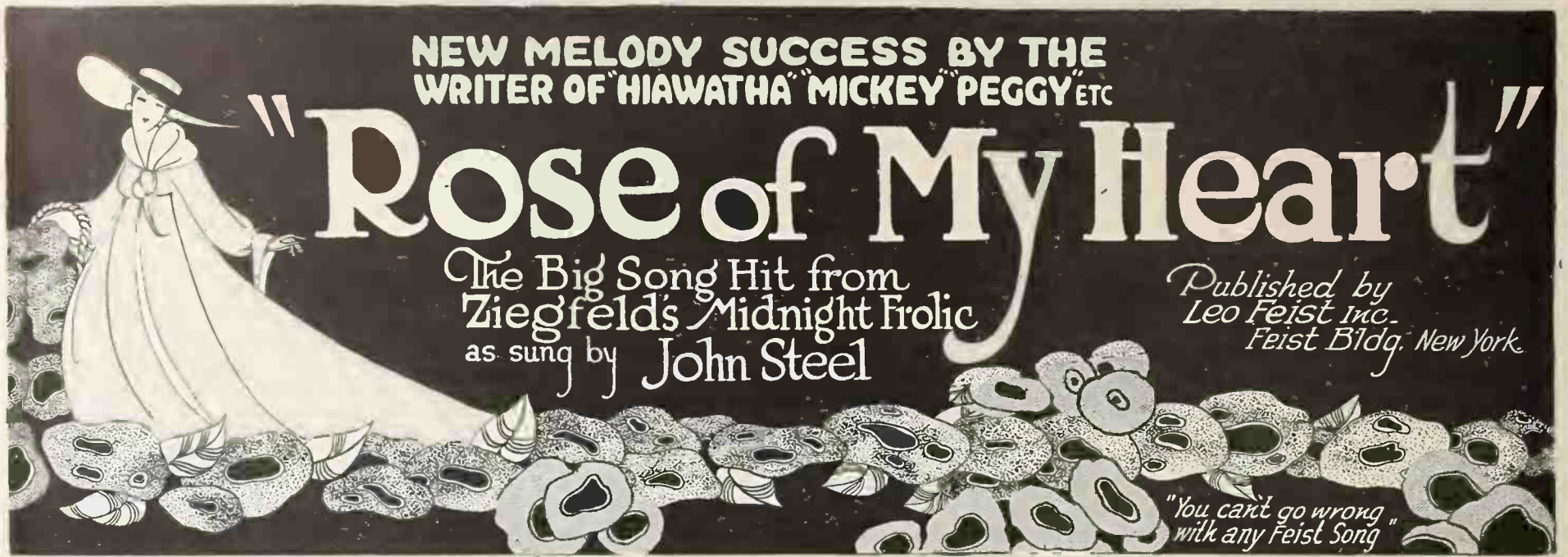

NEW MELODY SUCCESS BY THE WRITER OF "HIAWATHA" "MICKEY" "PEGGY" ETC

"Rose of My Heart"

The Big Song Hit from Ziegfeld's Midnight Frolic as sung by John Steel

Published by Leo Feist Inc. Feist Bldg. New York

"You can't go wrong with any Feist Song"

KEEPING TOUCH WITH MUSICAL HITS
(Continued from page 207)

effects of the "Follies," for instance, at close range in his home city, the gems of the "Follies" music, "Hold Me," for instance, from this year's show can be enjoyed at home by the humblest talking machine owner in Kankakee or in Berkeley, Cal.

If the talking machine dealer handles sheet music, or if he makes an effort to keep in touch with the sheet music trade, he is in a position to keep in touch with the cream of the Broadway music hits, or with the featured concert numbers, and plan his record selling campaign accordingly.

With high traveling costs keeping theatrical companies off the road, people in many sections must now depend for their musical comedy entertainment upon the talking machine record.

HOOKING UP RECORD PUBLICITY WITH VAUDEVILLE

Record Sales Helped Materially if Talking Machine Dealers Are Able to Feature the Local Appearances of Prominent Vaudeville Singers and Concert Artists Using the Numbers

The vaudeville and the concert stages offer the two principal avenues through which most of the popular songs of the day are brought to the attention of the public at large. That is, of course, not considering the featuring of the songs in instrumental form by orchestra. Conditions are such just now that there are being heard on the vaudeville stage an increasing number of songs in the regular catalogs of publishers—numbers that are offered in sheet music, as well as in record and music roll form, owing to the steady elimination of the special song writer for vaudeville artists and the inclination of those artists to fall back on the regular numbers in the catalog.

By keeping in touch with the trade papers the talking machine dealer can keep himself informed regarding the songs that are being featured by the various leading vaudeville singers, and the weeks during which those singers are scheduled to appear in the theatres in his vicinity. Dealers, and jobbers particularly, in talking machine records can do much to keep in touch with the progress of the popular songs of the day by making connections with the leading music publishers and getting the literature sent out by those publishers. This literature gives much information relative to what singers are using the various hits, and when those singers will appear at various times.

THE INIMITABLE

Nora Bayes

Achieves a triumph of Artistry in her new Columbia Records

THE JAPANESE SANDMAN

COLUMBIA RECORD NO — A-2997



and

JUST LIKE A GIPSY

COLUMBIA RECORD NO — A-6138

Published by

JEROME H. REMICK & CO.

DETROIT NEW YORK CHICAGO

Waltz Lullaby Success! On All Records and Rolls

PICKANINNY BLUES

Chicago McKINLEY MUSIC CO. New York

The talking machine dealers who have made a business of keeping in touch with the concert appearances of the great singers of the day know what effective results can be realized by hooking up their window displays and advertising with the appearances of those artists in their own town. By securing the co-operation of the publishers and by a little personal effort the same plan can be worked out in connection with the appearance of vaudeville singers so that similar results in record sales may be obtained.

Just now music publishers are to be classed among the really progressive advertisers, and a number of them have taken particular pains to prepare advertising literature of various sorts

and window displays and store cards of a nature that should appeal to the talking machine dealer and help his record sales. Much of this material is obtainable by the dealer without charge, either direct or through his jobber.

In handling popular music the talking machine dealer must realize that when he sells his records on arguments offered in the record supplement he is presenting the same selling talk as a dozen other dealers in his vicinity, but when he digs up his own information regarding the popular songs, who are singing them and where they may be heard, in vaudeville or concert, he is able to give his customer information that is worth while and helps business.

NORWAY PROTESTS JAZZING GRIEG

Records of Peer Gynt Suite in Ragtime Shock Music Lovers There—Forward Request to Washington in Effort to Abolish Evil

According to a cable from London a Norwegian correspondent of The Morning Post writes:

"All art lovers in Norway have been filled with horror by the incredible fact that three Americans have had the audacity to adapt Grieg's famous 'Peer Gynt Suite' to ragtime, and have put their profanation of the great music on a talking machine to be spread abroad through the United States. They have not spared a single movement of the suite, and the exquisite 'Morning Voices,' 'Anitra's Dance' and even 'Asa's Death' itself have been reduced to syncopated vulgarity. So deep is the indignation felt in Norway that a memorial protesting against this insult to the great composer has been widely signed by representatives of Norwegian culture and has been forwarded to Washington in the hope the authorities may put a stop to this gratuitous desecration of genius." Who's guilty, we wonder!

Men Who Make Popular Songs

No. 18—Chas. K. Harris

There are very few composers who wrote popular successes in the generation almost gone who are still regularly turning out numbers that meet with popular approval. There are, however, one or two such instances. Charles K. Harris, who in the old days was an acknowledged master, is one of them. Among his old songs which will never be forgotten, and which, despite their age, still have a large sale, are "After the Ball," "Break the News to Mother" and "Always in the Way."

Charles K. Harris has always been primarily a ballad writer, and each season he adds at least



Chas. K. Harris

one or more such numbers to his list. Invariably they have a good measure of success, and often they are conceded hits. This season he has released two numbers from his pen. They are "A Little Brook, A Little Girl, A Little Love" and "Somebody Thinks of You." The former has already shown popularity and the latter has indications that it has good possibilities. Mr. Harris' career has been marked by the fact that he has always been his own publisher. From the earliest days he issued his works from his own house, and later he branched out into the publishing field and took in the work of other writers, particularly for some seasons as a production publisher. He has never deviated from his rule of publishing his own songs. There is probably no other writer, at least none that has been as prolific, that has published his own numbers from the days of his earliest songs.

Mr. Harris still carries much of his youthful enthusiasm and promises to continue giving the public Harris songs for a long time to come.

Richard Mayer has opened a talking machine and jewelry store at 569 Broadway, Kingston, N. Y. He was formerly with Tiffany & Co., of New York City.

LARGE DELAWARE CORPORATION

Incorporated under the laws of Delaware, at Dover, the United Phonograph Stores have been organized to manufacture talking machines and phonographs. Work is to be begun on a large scale and the capital is \$5,000,000. The incorporators are Fred A. Hirschfeld, Joseph D. Englesber and Adolph O. Moss, Brooklyn, N. Y. Full details regarding the company's plans will be announced at an early date.

SAM FOX HITS

"ALABAMA MOON" OUR SHINING EXAMPLE OF A NATIONAL HIT, IS BEING CLOSELY FOLLOWED BY EIGHT OF THE BEST POPULAR HITS WE EVER PUBLISHED

SWEET LUANA

A WONDERFUL DREAMY HAWAIIAN SONG

STOP IT!

A NEW ONE-STEP SENSATION
By authors of "M.E. OW & TAY"

AMORITA

THE EXTRAORDINARY SPANISH FOX TROT SONG

DEAR OLD DIXIE MOON

A COOKING SOUTHERN SONG BY GEO. J. HAYES
YOU'LL NEED THIS HIT

TOODLES

A NEW ONE-STEP BY JOE GREEN of the famous GREEN BROTHERS. It's a pecker!

DO ANOTHER BREAK

THE GREATEST NOVELTY FOX TROT SONG OF THE SEASON

MY CUBAN ROSE

A NEW OVERCASTYLE SONG
AROUND IN EVERY BAR AND COUNTRY

BIDDY

A CAPTIVATING IRISH FOX TROT SONG
AN OVERNIGHT HIT IN NEW YORK

Alabama Moon

SONG and WALTZ
A tremendous success

SAM FOX PUB. CO.
CLEVELAND, O. U.S.A.

IMPORTANT NOTICE

TO THE

AMERICAN TRADE

The Sterno Manufacturing Company
 19 CITY ROAD LONDON, E. C. ENGLAND

Manufacturers of the world known COMPACTOPHONE—the most complete portable gramophone extant—beg to announce the conclusion of arrangements for the EXCLUSIVE SELLING RIGHTS IN THE UNITED STATES OF THE

High Grade Motors Manufactured By **Mermod Freres** St. Croix Switzerland

WONDERFUL MECHANISM

These motors represent the acme of workmanship and quality. Each part is made to the finest gauge limits and assembled to run with the precision of a watch—silent and true. Messrs. Mermod Freres is an old established Swiss manufacturer. Back of their motors are years of hard practical experience. The experimental stage was left behind a decade or more ago. Reliability and quality are therefore assured.

DIFFERENT MODELS

Mermod Freres motors comprise several types—single and double spring worm and pinion-gear drive, the very latest and scientific method of construction.

CONSULT US

Before placing your orders elsewhere consult us as to prices and terms of trading. We are out for quick shipments and prompt delivery direct from the factory to the buyer.

SPECIAL TERMS TO JOBBERS

Within the near future it is proposed to establish
A CENTRAL DISTRIBUTING DEPOT IN NEW YORK
 Meanwhile trade inquiries should be directed to

THE STERNO MANUFACTURING CO.
 19 CITY ROAD LONDON, E. C., ENGLAND



Hoffay Phonographs
Resurrectone Reproducers
Airtight Tone-Arms
Famous the World Over.
HOFFAY PHONOGRAPH CO.
59 4th Ave. New York City

NEW EMERSON JOBBERS

Emerson Sales Department Announces Appointment of Jobbers in Columbus and Indianapolis—Well Known in Commercial Circles

The sales division of the Emerson Phonograph Co., New York, announced this week the appointment of S. W. Goldsmith & Co., Columbus, O., and the Lathrop-McFarland Co., Indianapolis, Ind., as distributors for Emerson phonographs and Emerson records. The first-named company will operate as the Emerson-Ohio Co., and both of these jobbers have already organized efficient sales staffs which will extend practical service and co-operation to the dealers in their respective territories. The Lathrop-McFarland Co. is well known in commercial circles in Indianapolis, as it has the agency for Cole and Liberty automobiles.

During the past few weeks the Emerson sales department has received gratifying reports from its jobbers throughout the country, indicating that the Emerson phonograph is steadily increasing in popularity. Jobbers and dealers are taking advantage of the national advertising campaigns sponsored by the Emerson Phonograph Co., and there is every reason to believe they will enjoy a large holiday trade.

INCORPORATED FOR \$5,000,000

The United Phonograph Stores, New York, has been incorporated with capital stock of \$5,000,000 to manufacture and deal in talking machines and records. The incorporators are: Fred A. Hirschfield, J. D. Englesber and A. O. Moss.

GRAMOPHONE OFFICIALS ON VISIT

Executives of Gramophone Co. of England Make Tour of Inspection of Victor Establishments in Large Cities of Country and Are Much Impressed With Character of Trade

CAMDEN, N. J., November 8.—Several officials of the Gramophone Co., of London, Eng., recently made an extensive tour of the East and Middle West sections of the United States, accompanied by and as guests of the officials of the Victor Co., for the purpose of studying at first hand the wholesale and retail talking machine business in this country and how it is conducted. The party visited a number of the larger cities of the country and spent a number of days inspecting various leading establishments devoted to the sale of Victor machines and records.

Eldridge R. Johnson, president of the Victor Co., was in Europe for a considerable part of the Summer studying the business of the Gramophone Co., with which organization the Victor Co. is now associated through acquisition of stock. While there Mr. Johnson invited the officials of the Gramophone Co. to come to the United States with him to survey the industry as carried on here.

Mr. Johnson's guests were Alfred Clark, managing director; A. T. Lack, sales manager, and Colin Cooper, also a director of the Gramophone Co. who was already in this country, and these three gentlemen, together with certain officials of the Victor Co., visited a number of our larger cities, including Boston, Buffalo, Cleveland, Chicago, St. Louis, Indianapolis and Pittsburgh. Only two weeks could be devoted to the tour, and in order that the journey might be made with the least possible delay a private car was chartered for the use of the party.

The tour was made under the direction of Ralph L. Freeman, and the party consisted of Alfred Clark, Colin Cooper and A. T. Lack, of the Gramophone Co.; B. G. Royal, Walter J. Staats, Ralph L. Freeman, J. S. Macdonald and

The Symphony Reproducer

for those who want perfect tone reproduction



The symphony reproducer is designed to operate satisfactorily on either lateral Cut or Hill and Dale records. It is neat in appearance and can be adapted to practically any tone arm on the market.

Sample price, each, \$4.50.

Quantity prices on application.

Manufactured and guaranteed by

FUEHR & STEMMER PIANO CO.

2701 S. WELLS STREET CHICAGO, ILL.

Ernest John, of the Victor Talking Machine Co.

The features of the trip which most impressed the English visitors were the remarkable development of the stores devoted exclusively to Victor product and the enthusiastic cordiality of the trade towards the Victor Co. Their conclusion, voiced by Mr. Cooper, of the Gramophone Co., was to the effect that "the Victor Co. must have been extraordinarily considerate of its trade."

The party reached Philadelphia on its return trip on Friday, October 29, and the overseas visitors are due to sail for England shortly.

The Liberty Music Shop, under the direction of Manager Goldfinger, has moved into a new location at 2369 Broadway, New York.

The New Jewett Phonograph

AS its name indicates, the Jewett Phonograph is the product of the Jewett Brothers, long identified with the Paige-Detroit Motor Car Company, builders of the automobile which is known far and wide as "The Most Beautiful Car in America" and which is sold by more than 1,600 dealers throughout the world.

We are now placing on the market a new product—the Jewett Phonograph—a musical instrument which represents the same standard of perfection in phonographs that Paige Motor Cars represent in the field of automobiles. It is not a machine assembled from parts manufactured elsewhere, but is the product of our factories.

The Jewett Phonograph is the invention of a mechanical genius of twenty years' experience in phonograph designing and differs in several important particulars from any talking machine ever before con-

ceived. It reproduces music just as it was originally recorded on the phonograph record—free from metallic sound, nasal whine and harsh surface noises so common heretofore.

Our company is backed by ample capital and is carrying out advertising and merchandising plans of such wide scope that the success of our new product is already assured. Through extensive advertising throughout the country, the Jewett Phonograph will become as well known to the American public as Paige Motor Cars are at the present time.

The marketing possibilities of the Jewett Phonograph offer, therefore, a most attractive opportunity to distributors and dealers. Those who secure an agency franchise at this time will assure themselves an enviable future in the field of phonograph agencies.

We invite correspondence from reliable distributors and dealers.

E. H. JEWETT, *President,*
Jewett Phonograph Company,
1730 Penobscot Building,
Detroit, Michigan.

VICTOR-CHENEY LITIGATION

Hearing of Argument for Reopening of Injunction Decision Against Cheney Co. Comes Up in Grand Rapids on November 15

GRAND RAPIDS, MICH., November 10.—The case of the Victor Talking Machine Co. against the Cheney Talking Machine Co. will be reopened in the Federal District Court here on November 15. Judge C. W. Sessions has set that date for a hearing of an argument by the attorneys for the Cheney Co. on a motion to reopen the patent case in which the Victor Co. was awarded an injunction and accounting for alleged infringement of various features of the Johnson tone arm and sound amplifier patents controlled by the Victor Co. The Cheney Co. contends that it has discovered new evidence bearing upon the issue in dispute, and sets forth a reference to the Canneval French patent upon continuously tapering sound conveyors in its claim to reopen proceedings.

WILL HANDLE MAGNAVOX IN EAST

J. O. Morris Co. to Represent Magnavox Co. in New York and New England—Sales Campaign Already Under Way

J. O. Morris Co., Inc., has been appointed distributor for the Magnavox for New York and New England territory. The company has started an aggressive campaign in behalf of its product, and dealers have already been appointed in several of the important trade centers in this territory.

J. O. Morris, who is the head of this company, is enthusiastic regarding the possibilities for developing business, and this enthusiasm is based on the fact that the Magnavox has attained signal success in the comparatively short while that it has been on the market. Within a period of a few months it has established nation-wide distribution, and talking machine dealers, realizing the value of the Magnavox, have co-operated with the manufacturers and the jobbers in the introduction of timely and effective publicity.

OPEN A NEW SERVICE DEPARTMENT

New Activities of Schmelzer Co. to Be in Charge of D. R. Walsh

KANSAS CITY, Mo., November 8.—The Schmelzer Co., Victor wholesaler of this city, has just opened a new Victor Educational and Service Department which will be in charge of D. R. Walsh, formerly connected with the educational department of the Victor Co. in Camden. Mr. Walsh traveled through the Kansas City territory for some time as a factory representative and is, therefore, quite familiar with conditions in that section.

The Schmelzer Co. is now engaged in perfecting plans for the organization of a Victor Retail Dealers' Association to take in all the dealers in this territory.

FAMOUS-BARR CO.'S STRIKING BRUNSWICK ADVERTISING

CHICAGO, ILL., November 4. —The Brunswick-Balke-Collender Co.'s advertising department is one of the finest of its kind in the country. When that department becomes enthusiastic over certain advertisements by its dealer clientele one can be pretty sure that said advertisements are distinctive. Such a series of advertisements are those recently run in St. Louis papers by the Famous-Barr Co., retailer of that city. It is putting on a big campaign there in the interests of Brunswick phonographs, which are having immediate effects in the increased sale of Brunswick instruments.

Illustrations of some of the advertisements are shown herewith. They all make the "home" appeal in illustration and copy matter in a most pointed way. Here is a little example of the copy which we think unusually good: "If only mother and father could go to the opera, too! I have it! We'll bring the opera to them! Let's send them a Brunswick! Then they can enjoy operatic arias and every other kind of music without leaving their cozy fireside. We'll do it tomorrow—and then we won't feel so badly about leaving them."



"If only mother and father could go to the opera, too! I have it! We'll bring the opera to them! Let's send them a Brunswick! Then they can enjoy operatic arias and every other kind of music without leaving their cozy fireside. We'll do it tomorrow—and then we won't feel so badly about leaving them to attend affairs which they no longer care for."

No One Is Ever Too Old to Enjoy Good Music

—and here is a thought. Why not surprise the old folks with a Brunswick and some well-chosen Records? The gift would bring them pleasure every hour in every day of the year.

Brunswick Phonographs and Records Have Been Added to Our Music Service

Here is service supreme for Talking Machines, Phonographs and Records. Stocks are at the height of completeness, service facilities are the latest improved—everything that will enable you to choose with greatest satisfaction. The logical place to buy and now is the opportune time.

There is a Brunswick of a Type and Price to Meet Every Requirement

We can make immediate delivery of the Brunswick Phonograph and Records you choose, and you can pay on our convenient monthly payment plan, if you wish.

Record Service Counter

You will especially appreciate the efficiency of this Service Counter when you are in a hurry and have certain Records in mind which you want to obtain without waiting to hear them. You will also find the assistance of our Record Specialists very helpful, should you care to have them offer suggestions. In addition to this unsurpassed service, here you have the advantage of SEALED RECORDS.

Three Exclusive Brunswick Features

The Brunswick "Ultona" Reproducer plays all records at their best—a turn of the hand adapts it to any make of Record.

The Brunswick Oval All-Wood Tone Amplifier—a reliable aid to perfect tone reproduction.

The Brunswick Record File System, with convenient arrangement of drawers and records.

Fresh-Air Demonstration Parlors

We have an unusually large number of Demonstration Parlors, with outside windows—a feature of special importance. Here you can really enjoy selecting Records leisurely—bright daylight and perfect ventilation, which makes selection a pleasure instead of a task. It is another way we have of giving better service.

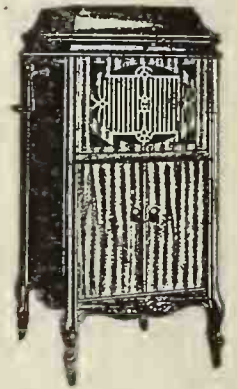

FAMOUS-BARR CO. St. Louis Home of the Ampico in the Chickering Piano

SLIDES FEATURE GRETSCH LINE

Dealers Making Good Use of Colored Slides for Motion Picture Houses Featuring the Various Instruments in the Gretsch Line

Music merchants who were visitors to the music trade convention in New York last February will remember Fred Gretsch as the live wire who devised a system of free taxi-cab transportation to the Gretsch plant in the Williamsburg section of Brooklyn. Appreciating the fact that the out-of-town visitors are sometimes confused by New York's intricate subway system, he offered taxi tickets that enabled them to visit his factory by a convenient and comfortable method. This little bit of service stamped him in the minds of the visiting music merchants as one of the live wires of the trade. Fred Gretsch is now busy living up to his reputation as a live wire. His latest innovation is a set of colored slides for use in motion picture theatres which he is furnishing free of charge to

his dealers. These beautifully colored slides are demonstrating their usefulness as business builders for dealers who are using them.

These slides have been made with painstaking



Two of the Gretsch Slides care and cost the Gretsch firm \$1.50 a set, and because of this fact dealers are requested to be sure to use them if they are desired. Each slide bears the name and address of the indi-

A Question and an Answer: Delivery Troubles? Lansing Khaki Moving Cover!



HERE ARE THE FACTS:

- Outside cover of government khaki. Inside lining of cotton flannel. Finely quilted for uniform evenness and durability. Straps of heavy three-ply webbing, not riveted to the cover. Equipped with loop handles. Patent buckle will not slip or cut the webbing.

RESULTS:

- Insures perfect protection, perfect delivery. Saves cost of paper, twine and time used preparing machine for delivery. Your customer is satisfied, which means future business in records or supplies.

PHOENIX TRADING CO. :: 1265 Broadway, New York City

vidual dealer. A circular has been prepared giving instructions for securing the co-operation of the theatre managers and is sent upon request. Mr. Gretsck declares that the reason these slides have been so successful is the fact that the person who attends moving picture shows is a logical purchaser of an instrument.

MAP VISUALIZES SERENADO GROWTH

CEDAR RAPIDS, IA., November 8.—The Serenado Mfg. Co., of this city, manufacturer of the Serenado talking machine, has just prepared an interesting map which visualizes the success attained by this company in establishing dealers throughout the country. The Serenado factories have been manufacturing quality merchandise for more than forty years and have been manufacturing talking machines for several years past. It has, however, been less than two years since it began the general distribution of the Serenado, and, as indicated on the map, it has established dealers in forty States.

According to the map, the distribution of the Serenado is particularly strong in the most important trade centers in the country, for the company has made contracts with dealers in many of the leading cities in Pennsylvania, Illinois, Missouri, Iowa, Mississippi, Georgia and South Carolina. All of these dealers are under contract for the sale of Serenado and have placed good-sized orders covering their requirements for the coming year.

The company is now concentrating a considerable part of its activities on developing business in Kentucky, Ohio, Oklahoma, Kansas, Nebraska and the New England States, and is adding many names to the roster of Serenado representatives.

DALION REPRESENTATIVES BUSY

The Johndrew Sales Corp., Hamburg, Pa., New York and western Pennsylvania distributor for the Dalion phonograph, has opened up several new accounts in that territory. The business of the Milwaukee Talking Machine Co., makers of the Dalion, is moving along splendidly.

SAILING FOR EUROPE
WILL ATTEND TO YOUR BUYING

Are you interested in FOREIGN RECORDS, PHONOGRAPH parts or MACHINERY?

Advertiser knows the Manufacturers of Phonographs, Accessories and Makers of Records. State your requirements. Act at once.

Address: Frankel, Box 874, Talking Machine World, 373 Fourth Avenue, New York City

NEW VOCALION RECORD PLANT

Aeolian Co. Buys Part of Colt Plant in Meriden for Electroplating Department

MERIDEN, CONN., November 8.—The Aeolian Co. recently purchased a large section of the plant of the Colt's Mfg. Co., on North Colony street, this city, and will utilize the premises for housing the Vocalion record electroplating department. The securing and equipping of this new plant is expected to prove a factor in still further increasing the production of Vocalion records on a quantity basis.

The building acquired by the Aeolian Co. is a one-story structure of brick, on a plot of ground fronting 100 feet on North Colony street and with a depth of 200 feet. There is a railroad siding in the rear of the property convenient for shipping purposes. The acquisition of the new electroplating plant follows closely upon the opening of a new addition to the Vocalion record factory here recently and referred to elsewhere in this issue.

Through Sanger Bros., Victor wholesalers of Dallas, Tex., arrangements have been made whereby the Eight Famous Victor Artists will give fifteen concerts in Texas and Oklahoma beginning February 15 and ending March 5. This is the second time that the artists have visited Texas under the auspices of Sanger Bros.

WASHINGTON DEALERS ORGANIZE

H. C. Groves Heads Association of Columbia Retailers in Capital—M. Philips Secretary

WASHINGTON, D. C., November 10.—The Columbia dealers of the District of Columbia are at last organized and are known as the Columbia Grafonola Retail Dealers' Association of Washington. Columbia dealers of the city without exception have signified their willingness to co-operate with the association and the trade in general is on a more friendly basis than it has been known in a long time. Four years ago an attempt was made to form an association but this did not mature.

H. C. Groves is president of the new association and M. Philips is secretary and treasurer. Mr. Groves assures all sister organizations the support of the Washington association and asks their friendship and good will.

THE STORY OF G. E. BRIGHTSON

The story of George E. Brightson and the Sonora phonograph is told in the November issue of Printers' Ink Monthly by C. P. Russell, who says of the head of the Sonora Phonograph Co: "He ignored competition and gave his attention to the manufacture of the best possible product—then advertised it."

ODEON

AND

FONOTIPIA RECORDS

AMERICAN and INTERNATIONAL REPERTOIRES RECORDED IN THE COUNTRIES OF THEIR ORIGINAL LANGUAGES

WELL KNOWN ALL OVER THE WORLD

WILL BE READY FOR YOU SHORTLY IN THIS MARKET

ONLY THE VERY BEST SELECTED FROM OUR VAST REPERTOIRES

THE ARTISTIC REPERTOIRES COMPRISE SELECTIONS BY THE MOST FAMOUS ARTISTS

ENGLISH—FRENCH—ITALIAN—SPANISH—GERMAN—DUTCH—SCANDINAVIAN—RUSSIAN—POLISH—BOHEMIAN—SERBIAN—HUNGARIAN—TURKISH—ARABIC—CHINESE—GRECIAN—HEBREW—YIDDISH—SLOVENISH—ROUMANIAN—SYRIAN

DISTRIBUTORS APPLY TO US

AMERICAN ODEON CORPORATION

Care of Talking Machine World, 373 Fourth Ave., New York

Watch Our Next Advertisements



4 WINNERS

For Holiday Business, Supreme In

TONE — FINISH — DESIGN

Federal Phonographs

are built up to a standard of art. The cabinets are unexcelled for beauty, the Federal design tone arm is unique, and the distinction of the name FEDERAL stands back of all our console and upright phonographs.

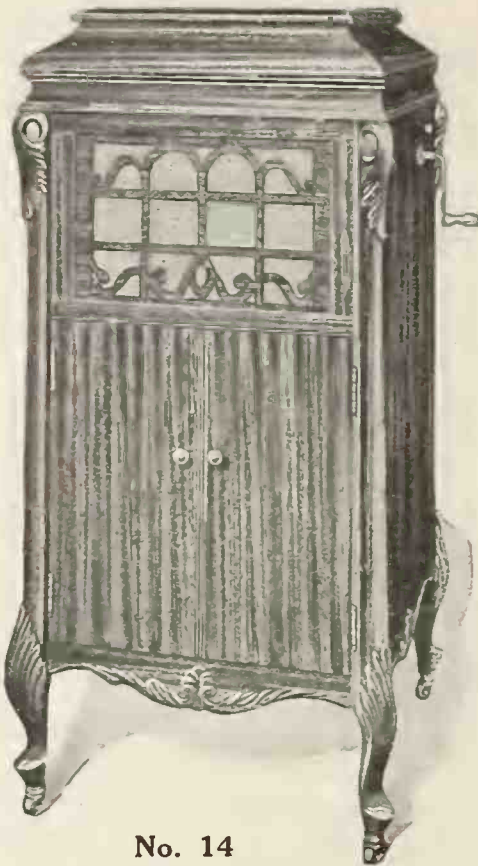

No. 14

Style—Queen Anne.
Wood—Selected figured mahogany with all hand-carved mahogany trimmings.
Dimensions—Height 51 inches. Width, 23½ inches. Depth, 24 inches.
Finish—Red, brown and satin.
Motor—Heineman No. 44 or Meisselbach No. 17, with plush turntable.
Tone Arm—Federal Own Design.
Record Accommodations—Sufficient room for 6 twelve-inch albums.
Trimmings—Best quality gold or nickel plated.
Price—Nickel Plated \$250.00. Gold Plated, \$275.00.

Federal Phonographs

are made in our own factory, which has been famous for over 25 years in the production of high grade furniture. The material used is of the very best selected wood, and the equipment throughout is designed to please the most discriminating buyers.



No. 18

Style—Sheraton inlaid on doors and legs.
Wood—Selected figured mahogany.
Dimensions—Height, 36 inches. Width, 39½ inches. Depth, 23½ inches.
Finish—Red, brown and satin.
Motor—Heineman No. 44 or Meisselbach No. 17, with plush turntable.
Tone Arm—Federal Own Design.
Record Accommodations—Sufficient room for 6 twelve-inch albums.
Trimmings—Best quality gold or nickel plated.
Price—Nickel Plated, \$350.00. Gold Plated, \$375.00.

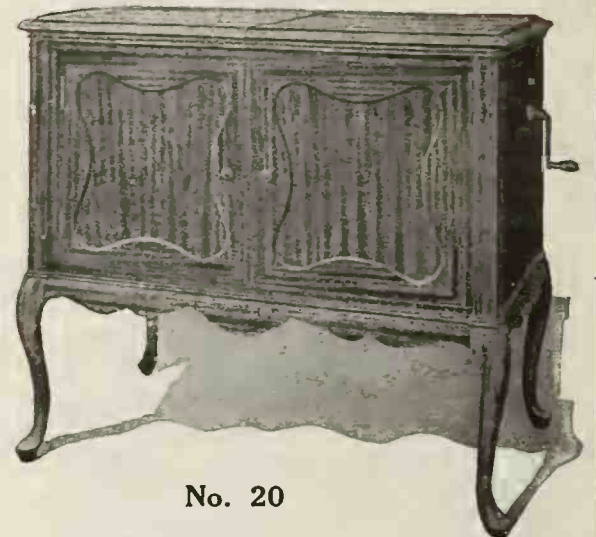

No. 20

Style—Queen Anne.
Wood—Selected figured mahogany.
Dimensions—Height 36 inches. Width, 39½ inches. Depth, 23½ inches.
Finish—Red, brown and satin.
Motor—Heineman No. 44 or Meisselbach No. 17, with plush turntable.
Tone Arm—Federal Own Design.
Record Accommodations—Sufficient room for 6 twelve-inch albums.
Trimmings—Best quality gold or nickel plated.
Price—Nickel Plated, \$325.00. Gold Plated, \$350.00. Walnut, \$10 extra.



No. 16

Style—Adam.
Wood—Selected figured mahogany. All solid mahogany hand carvings.
Dimensions—Height, 36 inches. Width, 39½ inches. Depth, 23½ inches.
Finish—Red, brown and satin.
Motor—Heineman No. 44 or Meisselbach No. 17, with plush turntable.
Tone Arm—Federal Own Design.
Record Accommodations—Sufficient room for 6 twelve-inch albums.
Trimmings—Best quality gold or nickel plated.
Price—Nickel Plated, \$325.00. Gold Plated, \$350.00. Walnut, \$10 extra.

Federal Phonograph Corp.

1458-1464 W. Kinzie St.
CHICAGO, ILL.

Michigan and Pennsylvania
Representatives:

Federal Sales and Supplies Corporation

34 FARMER STREET
DETROIT, MICH.

TALKING MACHINE JOBBERS PLAN ANNUAL CONVENTION

Executive Committee of Association at Meeting in New York Last Week Decides Upon Colorado Springs as 1921 Convention City—Spring Meetings to Be Held in St. Louis and Boston

At an important meeting of the Executive Committee of the National Association of Talking Machine Jobbers, held at the Hotel Commodore, New York, on Monday, November 8, with 100 per cent attendance registered, preliminary plans were made for the holding of two general meetings of the Executive Committee and membership at large in St. Louis and Boston during the Spring, and the annual convention of the Association to be held at the Hotel Broadmore, Colorado Springs, Colo., on July 11, 12 and 13.

The business meeting of the committee was devoted to the discussion of a large number of important matters that had developed since the last convention, and to consideration of the general business situation and of conditions in the Victor trade.

Gilbert H. Montague, counsel for the Association, delivered an extended address in the course of which he reviewed various matters of legislation calculated to affect the interests of the jobbers. Special attention was called to the efforts being made to have Congress lift some of the war tax burdens now carried by business in general, and the jobbers were strongly in favor of the complete elimination of the War Excise tax of 5 per cent which is now placed on talking machines and records even though they are classed as educational works in a large measure.

Plans were discussed whereby the members of the Association might co-operate more closely with each other throughout the year for the benefit of the trade as a whole, particularly in the development of distributing and sales methods.

The decision to hold the annual convention at Colorado Springs was welcomed by most of the jobbers who felt it would not only provide a change from the seashore, but would give to the Western jobbers a convention in their own territory. The plans for the annual convention are in charge of an arrangements committee appointed by President L. C. Wiswell, and including Percy Ware, Lloyd Spencer, V. W. Moody and Fred P. Oliver, with Charles K. Bennett as chairman. The committee will arrange not only for the convention proper, but for a number of side trips to Pike's Peak and other points. A golf tournament will also be held during the convention period, the details being in charge of

the regular committee headed by J. C. Roush.

The open meetings to be held by the Executive Committee and to which all members of the Association will be invited, will be along the lines of the meetings held in Chicago and New York last Winter. The first of the meetings will be held in St. Louis on March 7 and 8, and the members of the committee will then travel to Boston, where the second meeting will be held for the benefit of Eastern jobbers on March 10 and 11.

On Tuesday following the meeting at the Commodore, a number of the jobbers were escorted by A. B. Reincke, president, and J. J. Davin, Eastern managing director of the Reincke-Ellis Co., through the plant of the Binger Co., prominent advertising specialists. The jobbers were welcomed at the Binger building by C. L. Crone, president of the company, who gave the details of the window display service for Victor dealers which the Binger concern is preparing, and which will be distributed by the Reincke-Ellis Co. The tour of inspection was followed by an informal luncheon.

Those who attended the session were: L. C. Wiswell, president, Lyon & Healy, Chicago; Louis Buehn, vice-president, the Louis Buehn Co., Inc., Philadelphia; Arthur A. Trostler, secretary, the Schmelzer Co., Kansas City; W. H. Reynolds, treasurer, Reynolds Music House, Mobile, Ala.; C. K. Bennett, Eclipse Musical Co., Cleveland; J. N. Blackman, Blackman Talking Machine Co., New York; Lester Burchfield, Sanger Bros., Dallas, Tex.; Dan Creed, Chicago Talking Machine Co., Chicago; W. F. Davisson, Perry B. Whitsit Co., Columbus; Thomas F. Green, Silas E. Pearsall Co., New York; George E. Mickel, Mickel Bros. Co., Omaha, Neb.; Fred Putnam, Putnam-Page Co., Inc., Peoria, Ill.; E. C. Rauth, Koerber-Brenner Co., St. Louis; J. C. Roush, Standard Talking Machine Co., Pittsburgh; Henry Winkelman, Oliver Ditson Co., Boston, and French Nestor, national councilor, Standard Talking Machine Co., Pittsburgh.

VICTOR SHOP IN OTTAWA

Ray Bannon, of Morris, Ill., will open a Victrola Shop in Ottawa on the main floor of the Piergue Building. The name of the store will be Bannon's Victrola Shop.

WARNING

WALL KANE STEEL NEEDLES are the standard trade-marked needles of the phonograph industry. Like any article that is a proven success, WALL KANE STEEL NEEDLES are being imitated.

The genuine WALL KANE NEEDLES are manufactured by intricate, chemical processes, by which the point is improved to such an extent that we guarantee them to possess the quality of playing ten records perfectly, the last one as well as the first.

WE GUARANTEE THAT EVERY WALL KANE NEEDLE HAS BEEN, AND WILL BE IN THE FUTURE, THE HIGHEST GRADE ORDINARY STEEL NEEDLE OF DOMESTIC MANUFACTURE.

BEWARE OF IMITATIONS

A package of 50 WALL KANE NEEDLES is superior to 500 ordinary steel needles.

WALL KANE NEEDLES improve the tone and preserve the life of your records.

A package retails at 15c.—costs the dealer 7½c.—8c. in the Far West.

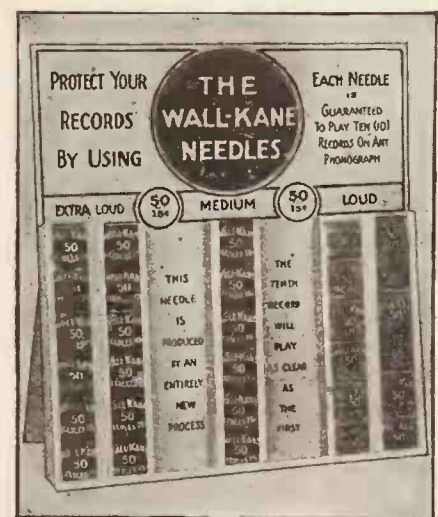

This handsome metal enamel display stand holds 60 packages, 2 doz. extra loud, 1 doz. medium, and 2 doz. loud; each package containing 50 WALL KANE NEEDLES, retailing for 15c. Price of Stand to dealers, \$4.60; \$4.90 Far West. Single packages, 7½c; 8c in the Far West.

Attractive display containers, each holding 100 packages of a tone of WALL KANE Needles, cost the dealer \$7.50; \$8.00 in the Far West.

SOME JOBBING TERRITORY STILL OPEN

Progressive Phonographic Supply Co., Inc.

145 West 45th Street, New York

Olympian Model 60, The Big Trade Winner Pre-War Quality at a Pre-War Price

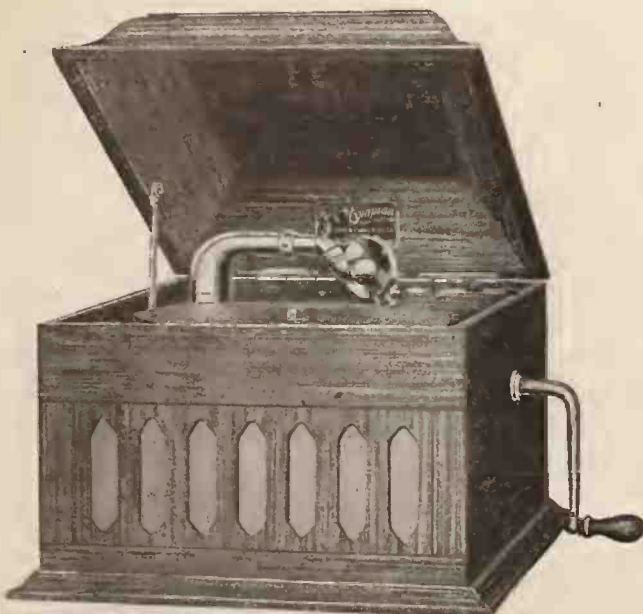

Model 60 is just another example of Olympian guaranteed quality at a special low price. With this instrument you can offer the last word in value and make an unusual profit besides. Act quickly, as we can hold this introductory offer open to dealers for a limited time only.

HAS TONE OF A \$100 PHONOGRAPH

Plays as loud and clear as the large cabinet phonographs. Has an all-wood tone-chamber, universal tone-arm, cast iron frame, double spring motor. Plays all makes of records.

Size: 13 inches high, 19½ inches deep, 17 inches wide. Finished in genuine mahogany or golden oak.

Limit of 6 of Model 60 to any one dealer.

No. 60 AG-Wholesale Price each . . . \$24.50

No. 61 AG-Wholesale Price 6 or more, each \$23.75

Write for 24-page Bulletin

Our new 24-page bulletin shows everything in phonographs, string instruments and supplies. Many other items listed at Pre-War prices. It is FREE. Write for a copy today—Now.

COLE & DUNAS MUSIC CO.

52 W. Lake Street

CHICAGO, ILL.

1918—JONES BOUGHT A LINE OF "WARBREAD SUBSTITUTE" PHONOGRAPHS

Smith stood by the Victor

1919—JONES SOLD VICTORS AND BAR-SINISTER ORPHANS

Smith stood by the Victor

1920—JONES SAID, "BUSINESS IS NOT AS GOOD AS IN 1919"

Smith stood by the Victor—and smiled

1921—JONES SAID, "I WISH I HAD BEEN BORN LUCKY—LIKE SMITH"

Smith stood by the Victor—and laughed out loud!

Pattern after Smith—be the *Victor man of your town—and prosper*

Buffalo Talking Machine Company, Inc.

Victor only

BUFFALO, N. Y.

Wholesale only

BANQUET OF REMINGTON FORCES

Managerial Heads and Assistants Entertained by the Remington Phonograph Corp. at Café Boulevard, New York, on October 27

The Remington Phonograph Corp., New York City, tendered a banquet to the managerial heads of the organization and their assistants at the Café Boulevard on October 27. This, the first banquet of the kind given by this firm, was held with the aim in view of cementing the loyalty and stimulating the enthusiasm of those responsible for the production of the Remington line.



Managerial Heads and Assistants Entertained at Café Boulevard by Remington Phonograph Corp.

Philo E. Remington, president of the company; James S. Holmes, vice-president and general manager, and Everett H. Holmes, sales man-

ager, addressed the gathering. James S. Holmes told interestingly of the history of the Remington family and described the value of the name when attached to the best that can be produced. It is planned to issue a house organ in the near future to further keep the many employees informed of the company's activities and progress.

ISSUE AN INTERESTING NUMBER

The November issue of Pathé News reminds the dealer of the importance of making each minute of the next six weeks count in order

new departure from the usual features of this paper is to be found in the printing of a story entitled "The Deserter," described as a romantic story of filial devotion and love and in which the Pathé phonograph plays an important but entirely unobtrusive part. Although this story is copyrighted by the Pathé Frères Phonograph Co., permission has generously been given for its use by all Pathé dealers in any newspaper. In addition to the publishing of helpful suggestions and experiences which various Pathé dealers have sent to Pathé headquarters, a number of newspaper advertising suggestions are given the dealer, which may be set into type by the local newspaper without the use of matrices.

POLICY OF VALUES WINS OUT

Steger & Sons Piano Mfg. Co.'s Policy as Applied to Phonographs Wins Appreciation

CHICAGO, ILL., November 9.—The Steger & Sons Piano Mfg. Co. report a very satisfactory volume of business in their phonograph department. These instruments have been steadily winning favor with discriminating dealers who, without flourish of trumpets, are bringing their merits to the attention of the public in a manner sufficiently convincing to greatly enlarge their sales.

The Steger & Sons Co. have developed the phonograph business on the same substantial basis that have made the Steger pianos known and appreciated throughout the nation. The basis of this policy is the production of values—values so apparent that they cannot fail to be acknowledged by anyone who has occasion to investigate the instruments manufactured by this prominent institution.

The Steger phonographs are presented in a wide range of styles, including period models, and should make a wide appeal to those competent to differentiate in the matter of art as applied to designs.

For years we have specialized in the production of LITHOGRAPHED WINDOW DISPLAYS

Posters, Hangers, Counter Displays, Cut-Outs, Car Cards, etc., rendering a complete service in our own Art Department and Lithograph Plant.

Some of the largest national advertisers have expressed their satisfaction with the thoroughgoing manner in which we have handled their dealer display problems.

EINSON LITHO INCORPORATED

Executive Offices and Art Studios
71 W. 23rd St., N. Y.

Western Office
Chicago, Ill.

Factory & Plant
327 East 29th St.
New York, N. Y.

Big Savings on Banjo-Ukeleles



This new Olympian Banjo Ukelele breaks all value giving records priced at nearly 50 per cent less than its equal anywhere. It's a leader that will net a good profit for you and a good value for your customer. Solid two-ply wood rim, no brackets, new process for tightening drum head, nothing to get out of order. Retail Value, \$6.00 to \$9.00. Your price for No. 555GM Banjo-Ukelele is only \$3.15.

Everything points to a good old fashioned Christmas trade on string instruments. Prepare and you'll cash in: Our Olympian Banjo Ukeleles will be a good Christmas leader. Order liberally, for our guarantee stands back of every instrument.

Order right from this Ad. Terms 5% discount for cash with order.

Cole & Dunas Music Co.
54 W. Lake St. Chicago, Ill.

It takes Bert Williams to put a rib-shaking laugh into a song. Here are two ten-strikes—"I Want to Know Where Tosti Went When He Said Good-Bye," and "Get Up." Get them. A-3305.

Columbia Graphophone Co.
NEW YORK



VOCALION AT TEXAS STATE FAIR

Elaborate Exhibit Made at Important Texas Fair During the Past Month

One of the interesting musical instrument exhibits at the Texas State Fair, held last month in Dallas, was the display of the Aeolian-Vocalion, made under the direct auspices of the Aeolian



Striking Vocalion Display at Fair

Co. and in charge of H. D. Gupton, Vocalion wholesale representative in Texas territory.

The exhibit was of an elaborate character, as will be seen by the accompanying illustration. A number of popular models of the Vocalion were on display, and two soundproof booths were provided to enable Fair visitors to hear the musical quality of the Vocalion and Vocalion records to the best advantage.

JOINS PATHE STAFF IN BROOKLYN

Earl B. Dryden, formerly in charge of the Pathé department of the Buffalo Wholesale Hardware Co., Pathé distributors, Buffalo, N. Y., has now joined the sales staff of the Pathé Frères Phonograph Co., of Brooklyn, N. Y. Mr. Dryden is an ardent Pathé enthusiast and his many years of experience with the Pathé line in his former connection have proven of great value to him in the new work he has undertaken.

Your Opportunity to Buy at the Right Price

We manufacture 3 and 5-ply panel stock in all thicknesses and woods. Also 3-ply shelf stock for Talking Machine Cases.

Ask for quotations on our Talking Machine Crating Boxes. They are built of solid woods.

THE BRANDTS FURN. CO.
CELINA, OHIO

A. THALLMAYER WITH OKEH

Well-known Talking Machine Man Appointed Manager of Okeh Foreign Language Department—Thoroughly Qualified for New Post

W. C. Fuhri, general sales manager of the Okeh record division of the General Phonograph Corp., New York, announced this week the appointment of A. Thallmayer as manager of the company's foreign record department, with headquarters at the executive offices, 25 West Forty-fifth street, New York City.

Mr. Thallmayer is one of the best-known members of the foreign language record field in the country, having been associated with the Columbia Graphophone Co. for over eighteen years. He served in important executive positions with this company, both in Europe and America, and is thoroughly familiar with every phase of the foreign language record field. Mr. Thallmayer numbers among his personal friends dealers from Coast to Coast, who will be glad to know that he will direct the destinies of the Okeh foreign record division.

VICTOR DEALERS TO MEET

Formation of Dealers' Association in Chicago Territory to Be Discussed

CHICAGO, ILL., November 8.—On Tuesday, November 16, there will be held in this city a get-together meeting which has in view the organizing of a Victor Dealers' Association, composed of Victor retailers located in Chicago and surrounding territory. For some time a desire has been manifested on the part of Victor dealers located in this territory to form such a body, and the first step, which will be made on Tuesday, has come about largely through the personal efforts of L. C. Wiswell, head of the wholesale Victor department of Lyon & Healy, and president of the National Association of Talking Machine Jobbers.

S. H. JACOBS WITH REMINGTON

Samuel H. Jacobs has been appointed advertising manager of the Remington Phonograph Corp., New York City. Mr. Jacobs will devote his attention to a vigorous dealer campaign as well as to taking charge of the factory publicity. He is well experienced, having had fourteen years active work in the preparation of advertising, including a thorough knowledge of printing, art work and lithography.

A VISITOR FROM PITTSBURGH

Wallace Russell, of the Standard Talking Machine Co., Pittsburgh, was a recent visitor to New York, and in a chat with The World spoke optimistically about the general trend of business and conditions generally. Mr. Russell is an optimist, and this is the attitude that is bound to win out these days when so many light-

weights are courting the shadows rather than the sunshine.

THIS Special Price Cabinet Will Interest You



309½

MATCHES VICTROLA NO. IX A

309½—Mahogany, golden oak, fumed oak, weathered oak, nickel-plated trimmings, lock and key, shelves interior, casters. Height, 33 inches. Top, 18¼x21¾ inches. Matches New Victrola IX A. Patented rimmed moulding with removable back piece, so machine can easily slide in, giving a perfect "Cabinet-match" appearance. Average weight, crated, 70 pounds.

Immediate Deliveries

MANUFACTURED BY

SCHLOSS BROS.

801 E. 135th St., New York

Cabinets of all descriptions and finishes

You need our catalog! Have you one?

McLAUGHLIN BUYS OUT GIBSON CO.

Kentucky Music Man Now Operates Two Modern Stores in Paducah—Talking Machine Department Now Handles the Victor Line Exclusively—Continues Piano Line

PADUCAH, KY., November 8.—O. D. McLaughlin, the Music Man, has purchased the Gibson Piano Co., at 518 Broadway, and will operate both the Gibson place and the McLaughlin store at 317 Broadway, under the firm name of O. D. McLaughlin. Announcement of the deal, which is one of the most important business changes made on Broadway in some time, was given out to-day.

Mr. McLaughlin will handle Victor machines and records exclusively. The Columbia record, formerly sold by McLaughlin's, will be handled in the future by J. A. Rudy & Sons. Mr. McLaughlin's complete stock of pianos will be added to the excellent stock of instruments held by the Gibson Co.

Mr. McLaughlin stated that patrons of the Gibson Co. may expect the same efficient and courteous service under the new management that they were accorded by Mr. Gibson. Each store will have a complete stock of Victor machines and records and will also carry the full piano stock.

W. E. Gibson will leave the city in a short time and will reside elsewhere. Mr. McLaughlin has been engaged in the music business in Paducah for a number of years and has been notably successful.

THE NEW MODERNOLA PLANT

Work at Ferndale Is Progressing Rapidly—Dry Kilns Principle Wins Approval

JOHNSTOWN, PA., November 9.—Work on the new plant of the Modernola Co. at Ferndale is progressing rapidly, and it is expected that it will not be long before the company will be able to take advantage of the increased facili-

ties offered by this new plant. As was previously announced, a remarkable system of dry kilns has been installed and the subject of the drying of woods will be given very careful attention.

The Modernola Co. is sending the head of this department to the United States Government Testing School of Lumber at Washington. This representative will take the full course on the drying of woods. Realizing the importance of having the wood under proper atmospheric conditions at all times, the new plant of the Modernola Co. will have a humidifying system throughout the entire plant in addition to the large dry kilns. This system will keep the proper degree of humidity in all rooms at all times, and will permit the construction of cabinets under the right atmospheric conditions from start to finish.

RESIGNATION OF C. A. BRIGGS

Severs Connection With Cathedral Phonograph Co.—Succeeded by W. R. Morrison

OMAHA, NEBR., November 9.—C. A. Briggs has resigned as vice-president and sales manager of the Cathedral Phonograph Co., this city, and has been succeeded in those offices by W. R. Morrison, formerly production manager. Mr. Briggs, who has sold his stock in the company, has not completed his plans for the future, but expects to engage in the wholesale talking machine business, with lines to be selected later.

RUSKIN UP TO DATE

The Remington Phonograph Corp., New York City, has issued an attractive card containing a quotation from Ruskin which is particularly apropos at this time and from which we quote:

"All works of quality must bear a price in proportion to the skill, time, expense and risk attending their invention and manufacture. Those things called dear are, when justly estimated, the cheapest; they are attended with

Record Racks

These racks can be used for records or rolls, exclusively, or for both at the same time. They will not warp or swell. Made of thoroughly seasoned lumber, smoothed and sanded. Delivered to you in the white, so that you can finish them to match your interior decorations.

BETTER SERVICE

Start with one and add others as you need them. When set side by side looks like a single unit. Has a total capacity of 1,250 records. Size 6 ft. high, 32½ inches wide and 13½ inches deep.

No. 875-MG Price \$49.50

Order from this Ad

Your satisfaction is guaranteed. Terms 5% discount for cash with order or net C. O. D. 10% deposit to accompany order.

**Cole & Dunas
Music Co.**

54 W. Lake St., Chicago, Ill.



much less profit to the builder than those which everybody calls cheap.

"Beautiful forms and compositions are not made by chance, nor can they ever, in any material, be made at a small expense. A composition for cheapness and not for excellence of workmanship is the most frequent and certain cause of rapid decay and entire destruction of arts and manufactures."

STATEMENT OF THE OWNERSHIP, MANAGEMENT, CIRCULATION, ETC., REQUIRED BY THE ACT OF CONGRESS OF AUGUST 24, 1912, OF THE TALKING MACHINE WORLD, published monthly at New York, N. Y., October 1, 1920.

State of New York }
County of New York } ss.

Before me, a Notary Public in and for the State and county aforesaid, personally appeared J. B. Spillane, who, having been duly sworn according to law, deposes and says that he is the Editor of The Talking Machine World and that the following is, to the best of his knowledge and belief, a true statement of the ownership, management (and if a daily paper, the circulation), etc., of the aforesaid publication for the date shown in the above caption, required by the Act of August 24, 1912, embodied in section 443, Postal Laws and Regulations, printed on the reverse of this form, to wit:

1. That the names and addresses of the publisher, and editor are: Publisher, Edward Lyman Bill, Inc., 373 Fourth Ave., New York City; Editor, J. B. Spillane, 373 Fourth Ave., N. Y. City.

2. That the owners are: (Give names and addresses of individual owners, or, if a corporation, give its name and the names and addresses of stockholders owning or holding 1 per cent or more of the total amount of stock.) Edward Lyman Bill, Inc., 373 Fourth Ave., N. Y. City; Caroline L. Bill, New Rochelle, N. Y.; J. B. Spillane, 373 Fourth Ave., N. Y. City; J. Raymond Bill, 373 Fourth Ave., N. Y. City; B. B. Wilson, 373 Fourth Ave., N. Y. City; Carleton Chace, 373 Fourth Ave., N. Y. City; E. P. Van Harlingen, 209 So. State St., Chicago, Ill.

3. That the known stockholders, mortgagees, and other holders owning or holding 1 per cent or more of total amount of bonds, mortgages, or other securities are: (If there are none, so state.) None.

4. That the two paragraphs next above, giving the names of the owners, stockholders, and security holders, if any, contain not only the list of stockholders and security holders as they appear upon the books of the company but also, in cases where the stockholder or security holder appears upon the books of the company as trustee or in any other fiduciary relation, the name of the person or corporation for whom such trustee is acting, is given; also that the said two paragraphs contain statements embracing affiant's full knowledge and belief as to the circumstances and conditions under which stockholders and security holders who do not appear upon the books of the company as trustees, hold stock and securities in a capacity other than that of a bona fide owner; and this affiant has no reason to believe that any other person, association, or corporation has any interest direct or indirect in the said stock, bonds, or other securities than as so stated by him.

5. That the average number of copies of each issue of this publication sold or distributed, through the mails or otherwise, to paid subscribers during the six months preceding the date shown above is — (This information is required from daily publications only.)

(Signed) J. B. SPILLANE.

Sworn to and subscribed before me this 1st day of October, 1920.

(Seal) Eugene R. Falck, Notary Public No. 6, N. Y. Co.
(My commission expires March 30, 1922.)

MR. DEALER:

You can sell Adora Phonographs

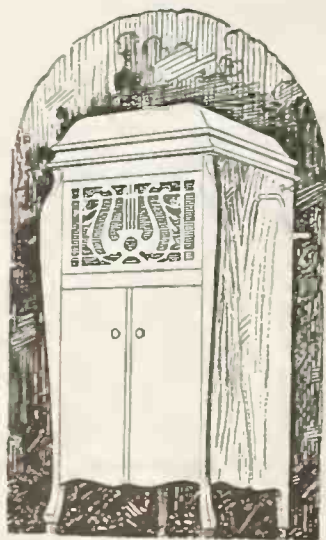

This model is 48 in. high
Retail price, \$135

The Adora plays all records.

It is guaranteed for Five Years.

The cabinets are exquisitely designed and made in all finishes.

WE DISTRIBUTE:

United States Player Rolls

Puritan Records and Supplies

Adora Phonograph Co.

242 E. Jefferson Ave.

DETROIT, MICH.

REPAIRS

24 Hour Service

Largest and best equipped shop in New York

We call for and deliver in New York

Outside of New York, Send by Express
or Parcel Post

W. BAHR

336 East 87th Street New York

Tel. Lenox 7156

WORLD'S CLASSIFIED ADVERTISING

Any member of the trade may forward to this office a "Situation" advertisement intended for this Department to occupy a space of four lines, agate measure, and it will be inserted free. Replies will also be forwarded without cost. Additional space will be at the rate of 25c. per line. If bold faced type is desired the cost of same will be 25c. per line. Rates for all other classes of advertising on application.

WHOLESALE RECORD SALESMAN.—A record salesman with long experience, particularly of recent years, in the metropolitan district, is open for a position as salesman with standard house. His relationship with the New York trade, together with his long experience in the record field, places him in a position to render excellent work for a progressive house. Address "Box 872," care The Talking Machine World, 373 Fourth Ave., N. Y. C.

SUPERINTENDENT of a large phonograph factory located in Chicago desires the services of an ambitious, competent man to act as superintendent. Must be fully experienced in every angle of phonograph construction, a producer of merit and a man of good executive ability. Unless you can comply please do not respond. Replies shall be treated in strict confidence and qualifications must be stated in detail. Address "N. V. 8," care The Talking Machine World, 209 South State St., Chicago, Ill.

RECORDING expert, with 25 years' experience with up-to-date methods, is open for engagement. Address "Box 867," care The Talking Machine World, 373 Fourth Ave., New York City.

RETAIL sales manager, capable executive, who is now in charge of one of the largest exclusive Edison agencies, wishing to make a change, would be pleased to hear from a firm desiring the services of a man of proven ability. "Box 868," care The Talking Machine World, 373 Fourth Ave., New York City.

SALESMANAGER and executive, now employed, desires to make change January 1, 1921. Prefer position as sales manager with manufacturer or as manager of jobbing house. Experience American and foreign records, phonographs, rolls and general musical merchandise. My hobby—service to the dealer. Understand credits, collections, advertising, etc. If you are looking for a competent, experienced, loyal executive, get in touch with me. Remuneration must be good. Salary and commission. I can prove my worth. "Box 864," care The Talking Machine World, 373 Fourth Ave., New York City.

OPENING for experienced repairman. We have a good year-around job for a steady, experienced Victrola repairman in wholesale house, Pittsburgh, Pa. Address "Repairman," care The Talking Machine World, 373 Fourth Ave., New York City.

SALESMEN traveling in the Middle West to sell our line of records and accessories. Good proposition for those who can get orders. Wade Talking Machine Co., 12-20 North Michigan Ave., Chicago, Ill.

AVAILABLE—A man of energy, integrity and ten years' experience in the Victor business. Thorough knowledge of records. At present assistant general manager of one of the largest exclusive Victor retail establishments in the East. Would like position as manager of Victor department. Address "Box 865," care The Talking Machine World, 373 Fourth Ave., New York City.

MASTER RECORDER, with thorough technical training, conversant with best modern methods of lateral recording solicits engagement. Clear balanced recording full of detail with minimum surface noise. Is familiar with every phase of phonograph business and competent to design, organize and manage recording and plating laboratory. "Box 863," care The Talking Machine World, 373 Fourth Ave., New York City.

YOUNG man, age 23, desires position in some retail phonograph store. Has had experience in executive and branch office of large phonograph company. Salary second consideration. "Box 869," care The Talking Machine World, 373 Fourth Ave., New York City.

SUPERINTENDENT wishes to get in with a reliable concern in manufacturing phonographs. Have fifteen years' experience in this line. Address "Box 871," care The Talking Machine World, 373 Fourth Ave., New York City.

OPPORTUNITY FOR EXTRA COMMISSION. Men now selling phonographs or benches will find it entirely profitable to sell our popular line of pianos and players. Fine as side line. Address Opportunity, "Box 848," care The Talking Machine World, 373 Fourth Ave., New York City.

SALESMEN WANTED, to handle popular-priced talking machines on commission basis as a side line. See our advertisement in this issue. The Charmaphone Co., 39 West 32nd St., New York City.

A DANDY side line for talking machine salesmen. Entirely new. Popular price. Liberal commission. Vest pocket sample. Correspondence confidential. J. A. Coates & Sons, Ltd., 589 Main St., East Orange, N. J.

WANTED—Furniture and phonograph salesmen to handle our line on commission basis. American Talking Machine Co., Inc., Bloomsburg, Pa.

TRAVELING SALESMAN with 25 years' road experience wants to sell phonographs and records to trade on commission basis in South Texas. S. S. Steiner, Tuleta, Texas.

RECORDING EXPERT, familiar with every detail of laboratory equipment from the making of wax to the finished record. Will furnish up-to-date recording and shaving machines. Several years of practical experience. "Box 870," care of The Talking Machine World, 373 Fourth Ave., New York City.

YOUNG business woman with thorough knowledge of the Victor, Columbia and Brunswick lines, capable, ability to buy, sell and take entire management of a large talking machine department. Have held the management of present department for ten years. Would consider making a change after January 1st. Can furnish best of references, and nothing but a real live permanent proposition would be considered. For details address Confidential "A-B-C," care of The Talking Machine World, 373 Fourth Ave., New York City.

YOUNG MAN of excellent ability, with best reference, wishes to connect with some phonograph concern. Now manager of music department, wishes place either manager or assistant. Address Manager, care of The Talking Machine World, 373 Fourth Ave., New York City.

POSITION WANTED by salesman, 29 years of age. Thoroughly experienced in selling and buying in all branches of the music business. Excellent references. Box 859, care The Talking Machine World, 373 Fourth Ave., New York City.

CABINETS

Prices are right and deliveries will be prompt. We have a large stock for fall trade in mahogany, walnut and oak. Send for circular. Everett Hunter Mfg. Co., McHenry, Ill.

FOR SALE

On account of other business, good will and small stock in high-class town of 6,000. Good agency of popular machines. Can be transferred if necessary. A. Stein, Cranford, N. J.

LUMBER FOR SALE

Black Walnut Squares. Several car-loads clear and dry black walnut squares and small dimension.

2 1/4 x 2 1/4 — 40	2 1/2 x 2 1/2 — 30
2 1/2 x 2 1/2 — 19	2 x 2 — 46
3/4 x 2 1/2 — 24	3/4 x 2 1/2 — 12
	1/2 x 2 — 46

J. Richard Jackson & Bro., 16th & Chestnut Sts., Philadelphia, Pa.

FOR SALE

Fifteen sound-proof phonograph record and showrooms. All 9 ft. wide and 6 ft. to 18 ft. long. Finished in mahogany, with double glass partitions and doors. All are in good condition. We are disposing of them because we have installed a new and larger phonograph department on our eighth floor. Can be seen any time on our seventh floor. Write or apply to Karl Kaufmann, care of Kaufmann & Baer Co., 6th Ave. & Smithfield St., Pittsburgh, Pa.

Cabinet Bargains

Splendid new cabinets, mahogany finish, beautiful lines. You can buy one, or ten, or all—now—at a big saving. 50 Model A, with cover, 20 1/2 in. wide, 22 1/2 in. deep, 15 1/2 in. high, \$16 each; 50 Model B, with cover, 18 1/2 in. wide, 20 3/4 in. deep, 13 1/2 in. high, \$14.50 each; 100 Model C, without cover, 15 1/2 in. wide, 17 3/4 in. deep, 8 3/4 in. high, \$8 each. Offered for immediate shipment, subject to prior sale. The Phonograph Supply Co., 27 Court Sq., Boston, Mass.

FOUNDRY FOR SALE

PONTIAC, MICH.

within twenty-five miles of Detroit on good concrete road—good rail facilities. Fully equipped for aluminum, brass and bronze casting work and could readily be converted to grey iron. Fifteen thousand square feet of floor space. One-story concrete block construction built about two years ago. Four acres of land. Plant is centrally located and labor conditions are good. Will sell with or without equipment. For particulars and price, write:

DRAWER 47, SYRACUSE, N. Y.



JOBBER'S ATTENTION

This phonograph, 50 inches high, 21 inches wide, 21 1/2 inches deep. Fully equipped with guaranteed motor and tonearm.

\$66.50 Net

F. O. B. Cedar Rapids, Iowa. War Tax paid. Securely crated. 5-ply mahogany veneer. 3/4 inch panels. Piano finish. Immediate delivery.

JOS. BARNETT & CO., Cedar Rapids, Iowa.

RECORD Delivery ENVELOPES \$4.75 Per M

CALENDARS, 1921

For Columbia dealers, 4 cents each

Write for samples

RAIGOR ART & MUSIC CO., St. Louis, Mo.

WHAT DO YOU NEED?

Get in touch with us. We have everything in the phonograph line—needles, tone arms, motors, all kinds of accessories and repair parts. We specialize on main springs. Cash with order. Send for catalog. Fiffer Phonograph Co., 180 Moore St., Brooklyn, N. Y.

(Continued on page 220)

Monthly Price List of Main Springs

2 in. x .022 x 16 ft., Meisselbach No. 18..	Each	\$1.50
1 1/2 in. x .027 x 21 ft., for Edison Disc....	Each	1.50
1 1/4 in. x .022 x 17 ft., reg. Victor.....	Each	0.75
1 1/4 in. x .022 x 17 ft., Victor new style....	Each	0.75
1 3/16 in. x .025 x 16 ft., Heineman No. 44....	Each	0.90
1 in. x .025 x 12 ft., Heineman No. 33 & 77...	Each	0.50
1 in. x .028 x 10 ft., for Columbia.....	Each	0.50
1 in. x .020 x 13 ft., Victor	Each	0.50
1 in. x .020 x 13 ft., Victor new style....	Each	0.50
3/4 in. x .023 x 10 ft.....	Each	0.38
3/4 in. x .023 x 10 ft., oval hole	Each	0.35
3/4 in. x .022 x 8 ft., for Swiss motor....	Each	0.30
5/8 in. x .025 x 11 ft., for Edison	Each	0.30

MICA DIAPHRAGMS

1 23/32 in. Victor Ex. Box, first grade..	Each	0.15
1 1/4 in., new Victor No. 2, very best..	Each	0.18
1 31/32 in., for Sonora.....	Each	0.20
2 3/16 in., for Columbia No. 6.....	Each	0.25
2 9/16 in., for Pathé or Brunswick....	Each	0.45

SAPPHIRES AND STEEL NEEDLES

Pathé, very best loud tone, genuine....	Each	0.15
Pathé, soft tone	Each	0.18
Edison, very best, medium tone.....	Each	0.18
Edison, very best, loud tone.....	Each	0.15
Edison, genuine diamond.....	Each	1.90
Steel needles, all tones.....	Per 1,000	0.50

ATTACHMENTS in Gold or Nickel-plated

Kent attachments for Victor arm.....	Each	0.25
Kent attachments for Edison with C box	Each	2.50
Kent attachments without box for Edi- son	Each	1.60
Victor, Universal old style.....	Each	1.15

MOTORS

No. 1 Single Spring with 10-inch turntable	2.75
No. 2 Double Spring with 12-inch turntable	6.00
No. 3 Double Spring with 12-inch turntable	9.00

TONE ARMS

No. K with sound box.....	Each	\$3.25
No. E with sound box, very loud.....	Each	6.00
No. M with sound box, very loud.....	Each	4.90

SOUND BOXES

No. B 1 Bliss Sound Box, fit Victor....	Each	\$1.75
No. B Balance, fit Victor.....	Each	0.75
No. C Balance, fit Victor.....	Each	1.00
No. F Favorite, fit Victor.....	Each	1.90
No. F Favorite, fit Columbia.....	Each	1.90
No. P Favorite, fit Victor.....	Each	2.00
No. G Glory, fit Victor.....	Each	3.25

CABINET HARDWARE

Automatic, nickel-plated lid support..	Each	0.30
Highly nickel-plated needle cups....	Per 100	1.50
Covers for cups	Per 100	0.75
Highly gold-plated	Per 100	7.00
Cover gold-plated	Per 100	5.00
Piano Hinges, 15 1/2-in. long, nickel-plated.	Each	0.25

REPAIR PARTS

Columbia driving shaft, No. 11778....	Each	0.50
Columbia bevel pinion, No. 12333.....	Each	0.90
Columbia bevel pinion, latest style....	Each	0.90
Columbia bevel pinion, No. 3189.....	Each	0.35
Columbia worm gear No. 6409.....	Each	0.30
Columbia Stylus bar.....	Each	0.50
Columbia driving gear ratchet No. 2152	Each	0.20
Columbia cranks	Each	0.45
Columbia governor weights.....	Each	0.10
Columbia governor shaft, No. 3004....	Each	0.40
Columbia governor bearing, No. 11923..	Each	0.25
Columbia governor springs.....	Per 100	1.00
Columbia governor screws.....	Per 100	1.00
Columbia barrel screws, No. 2621....	Per 100	1.00
Columbia so'dbox thumb screws....	Per 100	1.50
Victor cranks, short or long.....	Each	0.45
Victor Stylus bar (needle arm).....	Each	0.35
Victor governor springs	Per 100	1.00
Victor governor screws	Per 100	1.00
Victor governor balls, new style.....	Each	0.10
Turntable felts, 10 in., round.....	Each	0.15
Turntable felts, 12 in., round.....	Each	0.20
Motor bottom gear for Triton motor..	Each	0.20

Terms, Net Cash—Mail Remittance With Order

FAVORITE MFG. CO.
1506 DeKalb Ave., Brooklyn, N. Y.

RECORDS PRESSED

With or without your stock.

STOCK ROLLED or BLANKED or BOTH

Brooklyn, N. Y. Plant now prepared to accept additional contracts, large or small. Address Box 873, care of The Talking Machine World, 373 Fourth Ave., New York City.

FOR SALE

Phonograph motors, cheap, about 800 Heineman type, double spring motors, cast iron frame. Also the tools, dies, jigs for the same. Will sell only motors, or all. F. Toth & Co., 12 S. Jefferson St., Chicago, Ill.

HUNTOPHONE

Just out, best designs, ready to ship. Equipped with best standard motor and tone arm. Salesmen and dealers wanted everywhere. Prices are right. Chicago Phonograph Mfg. Co., 5127-29 S. State St., Chicago, Ill.

FOR SALE

Beautifully equipped music shop with authorized Columbia Graphophone agency. Good reason for selling. No agents. Address in confidence. P. O. Box 85, Hoboken, N. J.

FOR SALE

Small phonographs at \$10. Record cleaners 8c. Anything required in the phonograph line at reduced prices. Will also buy anything you have to sell in the phonograph line. Extra loud tonearm for \$3.25. Mandell & Co., 88 Rivington St., New York City.

WALDMAN LEAVES FOR EUROPE

Will Secure Contracts With Prominent Foreign Artists—Extensive Itinerary

P. Waldman, of the Standard Phonograph Co., Inc., 146 East Thirty-fourth street, New York City, left early this month for London, England. He will also visit the capitals of Europe for the purpose of securing contracts with a number of continental artists to record exclusively for his concern. He will also arrange recording laboratories in a number of countries and will bring back with him some of his Invicta masters, made by the Invicta Record Co., with whom he was formerly associated.

It is Mr. Waldman's intention to secure very close relationship not only with the record artists but with the European talking machine trade proper. Among the countries besides England which he will visit are France, Germany, Austria, Belgium, Italy, Rumania and Russia.

RECORD DELIVERY ENVELOPES

10 in. only \$4.75 per 1000, lots of 5000 \$4.50 per thousand; lots of 10,000, \$4.25 per thousand. The prices quoted are net cash F. O. B. St. Louis. Samples mailed on request. Tower Talking Machine Shop, 1919 East Grand Ave., St. Louis, Mo.

Big Bargain

We are closing out phonograph cabinets at half factory cost. Write for particulars. Box 866, care of The Talking Machine World, 373 Fourth Ave., New York City.

FOR SALE

Cabinets or complete machines. Designs very attractive. Cabinets well built. Prices low. Prompt delivery. Let us quote you on your fall requirements. Chicago Phonograph Mfg. Co., 5127-29 S. State St., Chicago, Ill.

Exceptional Offer

Five hundred Repeat-O-Graphs at \$3.25 each. Latest style, all in original boxes as received from factory. How many can you use? Write quick. Iver Johnson Sporting Goods Co., Boston, Mass.

Cabinets For Sale

We have several hundred large mahogany phonograph cabinets in three sizes at an attractive price for immediate sale in any quantities for cash. United Distributing Co., 10 W. Forsyth St., Atlanta, Ga.

WANTED

Victor and Columbia records for spot cash. Any quantity. Seminole Co., Westchester, N. Y.

NEW YORK DEALERS VISIT CAMDEN

Officials of the Victor Talking Machine Co. entertained the following members of the New York retail trade at Camden, N. J., one day last week when they were taken on a tour of the plant and afterward entertained at a midday luncheon: Sol Lazarus, William Berdy, Henry Mielka, Joseph Bryant, George Lake, Myer Goransky, Ben Roth and Morris Gingluck. These gentlemen were delighted with their visit and were impressed with the enormity of the preparations being made by the Victor Co. to supply the trade with sufficient talking machines and records to meet the holiday demand.

OLYMPIAN Ukulele

Special!

A Small Investment
A Big Profit
A Quick Turnover

A Big New
Field for Sure-
Fire Extra
Profits for Live
Phonograph
Dealers.



The Olympian Ukulele possesses a beauty of tone and case that this price never before bought. It is made of birchwood, Koa wood finish, hand rubbed and polished. Has maple neck, plain pegs; two imprinted rings around sound hole; brass fret wire. Accurately adjusted. Priced at a startling price-cut for this introductory offer.

Retail value, \$4.00 **\$2.15**
your profit, \$1.85 ..

No. 549G—Price for sample.....\$2.45
No. 550G—Price 1/2 doz. lots, each.....2.25
No. 551G—Price lots of 25, each.....2.15

Write for
PRE-WAR
BULLETIN

Our new 24-page bulletin shows everything in Phonographs, string instruments and supplies. Many items listed at pre-war prices. It is FREE.
WRITE FOR COPY TO-DAY—
NOW

Cole & Dunas Music Co.
DEPT M

54 W. Lake St.

Chicago, Ill.



EUROPEAN HEADQUARTERS

2 GRESHAM BLDG., BASINGHALL ST., E.C. LONDON

W. LIONEL STURDY, MANAGER

Some Tendency Towards Price Reduction in Gramophone and Record Field—Some Slackening Off in Buying—Coal Strike Has Bad Effect—Emphasizing Value of Talking Machine Records in Educational Work—Retail Gramophone Dealers Perfect Strong Organization—Gramophone Co. Announces Price Reductions—New Things to Be Found Among the Records—"Imperial" Record Makes Its Bow—French Import Duty Increased—Some Paragraphs of General Interest to the Trade

LONDON, ENGLAND, October 29.—For some time past there has been an air of expectancy in trade circles that the high level of prices maintained for so long would sooner or later break. It must be admitted that economic conditions hardly warrant such expectations. They were more likely the outcome of encouragement by reason of small price reductions here and there, as much as trade slackness combined with ever-increasing competition. Keen, healthy competition is more often than not the final arbiter of market values, and if it be to this that recent price reductions in the gramophone trade may be ascribed, then it is the best reflection towards the normal since 1914 trading. I do not say it is general, but there is little question that in one or two directions gramophone prices have been somewhat too high; the same may apply to most businesses, with this result, that the public has been forced to reflect before making purchases of goods not absolutely necessary. Each of us, individually, must recognize the fundamental truth. There will be no return to the happy monetary values of 1914, but

in almost every direction other than food the present tendency is certainly towards price reductions. People hesitate to buy at present rates goods they can do without. Of course, I shall be told that the reason of trade slackness is not so much price values as unsettlement produced by constant labor troubles unemployment, and such like. Naturally, it all has something to do with it. But as each industry is in part responsible for a share in the heavy, so-called, cost of living, the effect of any action of a particular trade towards the easement of such conditions must result beneficially over a wide circle. For instance, if by reduced gramophone prices public sales expanded to twice as much as the present average, see how thousands interested in and even outside the trade would have good occasion to rejoice.

As it is, unemployment in every section of the music trades is about as bad as it can be, due to the fact that the public is forced by high prices for everything to protect its pocket by economizing where possible. At this time of year gramophone trade should be on the boom. It is not, unfortunately, though it can be said there are good signs of an early improvement.

By all the laws of average this improvement will be brought to fruition earlier by coaxing the great gramophone public with price concessions. The "His Master's Voice," and the British Zonophone Co. have announced substantial reductions in the prices of their instruments, as elsewhere fully reported.

Record prices in general have not so far moved though in one case, that of the "Popular" record, the change has fallen from 3/- to 2/6.

Miners' Strike Curtails Gramophone Trade

Since writing the foregoing lines the trade position has reached an acute stage by reason of the mine strike. This strike of the sustainers of the life-blood of commerce is greatly to be deplored and is as unpopular with the people as are extreme actions of this nature always. Here we cannot be concerned with the political side—the rights and wrongs of the case, so much as the effect of such a strike upon the industrial life of the nation. Coming on top of existing general trade depression and consequent unemployment, the situation is rendered doubly serious for the gramophone industry, particularly during this, the opening month, of the season. Everybody is trusting to common sense to find a "way out" acceptable to all parties, and business men will carry on as long as possible. All realize the gravity of the situation. In some gramophone quarters we hear pessimistic utterances and have been notified of orders being canceled. This, however, is by no means general, at least, at the time of writing. It is very necessary for every section of the trade to pull together and minimize as far as may be possible the trade restrictive influence of the miners' action. And in this crisis it must not be overlooked that the prevalence of music will help to sustain the good spirit of the people and exert untold influence towards easement of many little difficulties arising out of unusual conditions. The Instructive Value of Gramophone Records

It has been repeatedly demonstrated that the gramophone is becoming of serious educational benefit to students of voice culture, the piano-

(Continued on page 222)



"His Master's Voice"

Copyright

This intensely human picture stands for all that is best in music

—it is the "His Master's Voice" trade-mark, and it brings to you, no matter where you are, the very best music of every kind, sung and played by the world's greatest artists—the greatest singers, pianists, violinists, orchestras and bands—all enshrined in the unequalled "His Master's Voice" records

'His Master's Voice'

—the trade-mark that is recognized throughout the world as the

HALL-MARK OF QUALITY

DENMARK: Skaudluavlsk Grammophon-Aktielselskab, Frihavnen, Copenhagen.

FRANCE: Cie. Française du Gramophone, 115 Boulevard Richard Lenoir, Place de la République, Paris.

SPAIN: Compañía del Gramófono, 56-58 Balmes, Barcelona.

SWEDEN: Skaudluavlska Grammophon-Aktiebolaget, Drottning Gatan No. 47, Stockholm.

RUSSIA: The Gramophone Co., Ltd., 45, Nevsky Prospect, Petrograd (Petersburg); No. 1 Solyanka, Solyanov Dvor, Moscow; 9, Golovinsky Prospect, Tiflis; Nowy-Swiat 30, Warsaw; 11 Michallovskaya Ulltsa, Baku.

INDIA: The Gramophone Co., Ltd., 139, Bal-laghatta Road, Calcutta; 7, Bell Lane, Fort, Bombay.

Great Britain:

The Gramophone Company, Ltd.

HAYES - MIDDLESEX - ENGLAND

AUSTRALIA: S. Hoffmann & Co., Ltd., Sole Concessionaries of The Gramophone Company, Limited, 163, Pitt Street, Sydney.

NEW ZEALAND: Gramophonum, Ltd., 118-120 Victoria Street, Wellington.

SOUTH AFRICA: Darter & Sons, Post Box 174, Capetown; Mackay Bros., Post Box 251; Johannesburg; Mackay Bros. & McMahon, Post Box 419; Durban; Ivan H. Haarburger, Post Box 105, Bloemfontein; Frauz Moeller, Post Box 108, East London; B. J. Ewus & Co., Post Box 86, Queens-town; Handel House, Kimberley; Laurence & Cope, Post Box 132, Bulawayo; The Argus Co., Salisbury.

EAST AFRICA: Bayley & Co., Lourenço Marques.

HOLLAND: Americau Import Co., 22a, Amsterd Veerkade, The Hague.

ITALY: A. Bossi & Co., Via Orefici 2, Milan.

EGYPT (Also for the Sudan, Greece and the Ottoman Empire): K. Fr. Vogel, Post Box 414, Alexandria.

The VULCAN MAIN SPRINGS

J. STEAD & CO LTD

MANOR WORKS SHEFFIELD.

SEND *to-day for* **SAMPLES & PRICES**

The VULCAN Mainspring for TALKING MACHINES
 MANUFACTURED by J. Stead & Co Ltd Sheffield.
BRITISH MADE

FROM OUR LONDON HEADQUARTERS—(Continued from page 221)

forte and of music and of singing generally.

A well-known West London professor of singing recently approached the writer with a request for information respecting a recording apparatus, his idea being that half the battle of teaching would be gained by giving the students an actual demonstration of their vocal efforts. He desired to "picture" to them actually where they went wrong. I was able to put the professor in touch with the makers of a recording apparatus and hope at some later date to receive a report of the results of this new departure.

Apropos this subject, Messrs. J. E. Hough, Ltd., were recently in receipt of a letter from Harold Jeboult, examiner at Taunton for scholarships for the Royal Academy of Music and the Royal College of Music, London. As a professional teacher of music Mr. Jeboult wrote to express appreciation of two "Winner" piano records played by Fred'k Dawson and Marie Novello. "For some time past I have been using the gramophone in my teaching, with most useful results, and whilst I know that manufacturers of records have to cater to the general taste of the public, yet as this taste is improving, I, with many others, am grateful to obtain a well-played reproduction of a worthy composition. . . ."

Another case in point is that at an orchestral contest in Wales the conductor of the winning

band had taken the precaution of listening to some Columbia records as recorded by Sir Henry J. Wood. He spent considerable time in noting particular phrases of the recorded interpretation of the "Unfinished Symphony," and by this close study of a master musician was able to carry off the first prize!

And particularly important in relation to this subject is the development of the "His Master's Voice" education department. The results of some of its activities are mentioned in this month's "Voice." We read, for instance, that for the first time in the history of the gramophone, "His Master's Voice" has been officially received and welcomed at Balliol College, Oxford. The occasion was a lecture on the plan of music in the school curriculum, with special reference to the use of the gramophone in the schools. J. C. Hobart, one of His Majesty's inspectors of schools, presided, and the lecture was a complete success.

A member of the staff of "His Master's Voice" education department recently visited Bingley Training College in Yorkshire, where the education committee held a teachers' vacation course, a special feature of which was the music section directed by Dr. J. E. Borland, musical adviser to the London County Council, who gave six lectures on the "Appreciation of Music," all of which were illustrated with gramophone records. This eminent musician

told his audience of 200 Yorkshire teachers that if he were posted to a country school he would not be there a month without a gramophone, as he considered this instrument indispensable in the schools to-day.

"His Master's Voice" figured also at a board of education vacation course in music for music teachers recently held at the Royal College of Music, London, under the direction of Robert McLeod, music master of a teachers' training college, Edinburgh.

Gramophone Retail Dealers' Association Meet

It is decidedly good news for the retail gramophone traders of this country that at last a strong association has got going in protection of their interests. There is much urgent work and propaganda demanding attention and from personal knowledge of the duly elected officials they are men of long experience in the trade, keen and businesslike and withal enthusiastic.

The first general meeting of the association was held last month, President E. Rasin Jones, being in the chair. His speech was of an historical and interesting nature, evoking particular approval when he urged the necessity of speeding up and encouraging the gramophone dealers to become members of the association.

Elections were as follows: President, E. Rasin Jones; vice-president, E. Marshall; committee, Gerald Forty, S. E. Moon, C. J. Price, J. H. Riley and F. E. Stokes; honorary secretary, S. H. Shand. A number of items on the agenda were fully debated and decisions arrived at. A distinctive badge or monogram for members was suggested and the committee empowered to obtain designs. Members will investigate in their district all cases of alleged bogus advertisements and report in detail to the secretary. A personal campaign to augment membership is another undertaking of each member. The annual subscription rate of membership is 21/.

"His Master's Voice" Big Price Reductions!

The Gramophone Co. has made a very welcome announcement to the trade of substantial reduction in the prices of all models. In some cases these reductions amount to as much as 25 per cent! Outside members of the trade are inclined to put forward their own reasons for such a sweeping price revision, pointing out that only in January last the company found it necessary on the grounds of increasing costs of materials and labor to raise their charges for instruments. It is as well to point out that this was at a period of reconstruction when factory organization and costs had not been brought down to the present-day specialized standard. As to which "His Master's Voice" people state that "the whole of the machinery devoted to the manufacture of motors, cabinets, sound boxes and machine fittings being now fully working, has enabled us to effect savings in many directions, with the result that we are in a position to announce very substantial price reductions."

"PERFECT POINTS"

BRITAIN'S BEST

Gramophone Needle

(Guaranteed made from High Carbon Steel)

IS MADE BY

W. R. STEEL, of REDDITCH,

Head Office and Works—QUEEN ST.

Scientifically pointed, Hardened and Tempered on the latest up-to-date machinery and plant by skilled craftsmen only.

RESULT:

A FIRST QUALITY NEEDLE far ahead of anything of pre-war quality

INQUIRIES SOLICITED

Special Quotations for Quantities

Manufacturer of all Kinds of Sewing Needles

FROM OUR LONDON HEADQUARTERS—(Continued from page 223)

gramophone records is being revived by the Sound Recording Co., Ltd. At least a decade ago a record of this name was handled by Gilbert Kimpton & Co., who, I believe, received their supplies from the States. Be that as it may, the Imperial, as now issued, can have little relation to its namesake of the past. The company plans to issue proved standard sellers only. Price maintenance is an important part of their trading policy and in this regard distributors will be retained, as it were, one to each district.

Miscellaneous Paragraphs of Interest

Due to the increase in the world's shipping tonnage and the general scarcity of goods for export, it is said, there is a slump in freights. Since the beginning of the year there has been an average decrease in rates of about 50 per cent. United States shipping competition is being increasingly felt. On the other hand, the reduction in freight rates allows of a corresponding reduction in the price of imported raw materials. It's an ill wind, etc.

British Gramophone Motors, Ltd., is in liquidation. The company was formed about eighteen months ago to manufacture motors. Its officials put up a big fight, but found prevalent conditions—depressed trade, high bank rate, and financial difficulties—too much. Fortunately, there is some prospect of a reconstruction.

At a recent meeting of the rates advisory committee, the railway companies made proposals for the abolition of the maximum rates schedule. They want recognition of the principle that fares and rates should yield 5 per cent on capital, among other proposals.

It is reported that Ignace Paderewski will be appointed Polish Ambassador in London. We hope the dignity of this office will not preclude the possibility of further recording by this genius of the pianoforte.

British Industries Fair propaganda includes the distribution abroad of an illustrated booklet printed in seven languages. The Fair takes place next February-March at the White City, London, and at Glasgow and Birmingham.

Half of a house was more or less destroyed recently by the explosion of a war curio, but a zonophone, then playing, continued right through the record!

Exclusive Prize Band Record on Zonophone

An item of special interest is found in the announcement that the British Zonophone Co. has secured the exclusive recording rights of the St. Hilda Colliery Band—winners of the grand championship of England at the recent contest at the Crystal Palace, London. The first of a series of records by this premier organization has already been issued and others will follow at regular intervals. Zonophone dealers have naturally placed heavy orders for these discs, which are recorded to the usual Zono standard of merit.

The ordinary supplemental list of record

issues for October represents a variety sufficient to make an appeal to most, if not all, musical tastes. The following examples are typical: "Eulalie Waltz" and "That Haughty Waltz," by Black Diamond's Band; "Swanee" and "Oh, by Jingo," Black Diamond's Band; "El Relicario" and "Fireflies," Picture Palace Orchestra; "The Cobbler's Song" and "My Desert Flower," George Parker; "Rose of No Man's Land" and "When the Harvest Moon Is Shining," Herbert Payne, and "Monterey" and "When They Got to Dixieland," Herbert Payne.

A New Disc Record

For the first time in over a period of several years a new record has made its appearance on the British market. It is of 10-inch diameter, double-sided and sells at the more or less standard price of 3/-. A recent demonstration of vocals and instrumentals showed the Tower, as the record is called, to be of quite good tonal quality. It is marketed by the Sterno Manufacturing Co., of City Road, London.

It's All in the Sound Box!

There is so much truth in the above caption that few would be disposed to split hairs over it. Without any reflection on established products there are a great number of machines on sale equipped in most respects satisfactorily bar one thing and that undoubtedly of pre-eminent importance—the sound box! Apart from this aspect, there are many other reasons why the manufacturer of a good reproducer is always sure of a splendid market here, though (perhaps fortunately) we are not so overflowed with gramophone accessory lines as they are in the States.

One of the leaders in the British field of sound box manufacture is the Pelham Surgical Instruments Co., Ltd., of London and Nottingham. Surgical instruments and sound boxes may fulfill widely different missions in life, but in their manufacture they call for a like craftsmanship, amounting almost to a fine art. Starting from that standard, much would naturally be expected of the Pelham Concert Sound Box, all-British made, by the way. Were one to judge solely from the standpoint of trader's and user's opinions, it is certain that the Pelham has made good right up to the hilt, so to speak.

But, for the satisfaction of World readers, a special test was recently given. It embraced the reproducing of band, orchestral, solo-instrumental and vocal records—all to a standard of fidelity that evoked high praise from your representative. The Pelham Concert Sound Box is undoubtedly of very exceptional tone-quality and as a vehicle of sound second to none. Its construction and general finish are of equal merit.

American readers will be glad to learn that negotiations are well advanced for marketing the Pelham in the States within the near future.

Early Closing for Shops

The board of management of the Early Closing Association have passed an important resolution which closely interests their huge mem-

**Horn, Hornless and Table-Grand
GRAMOPHONES**FOR
EXPORT

Please State Your Requirements

**REX GRAMOPHONE CO. 2 Elizabeth Place
Rivington Street, LONDON, E.C. 2, England**
Cable Address "Lyrecodisc, London"

bership. It is to the effect that retail establishments maintain the present arrangement for the weekly half-day holiday, viz.: Saturday closing for West End and other firms whose trade is not a Saturday afternoon trade, and the mid-week closing for the thousands of shops who cater to the public paid on Fridays and Saturdays, and who have little opportunity during the week of making their purchases. The board also resolves to support the Government in its intention to secure an extension to December of the present 8 per cent closing order, with 9 per cent on Saturdays, a measure which has proved of incalculable benefit to one and three-quarter million shopkeepers and their assistants.

The foregoing is in relation to the present compulsory early closing order which the Government will have under review after next December.

French Import Duty Increased

A presidential decree published in the official Journal (Paris) announces a modification of the import duty rates on musical instruments imported into France and Algeria. Ad valorem rates of duty replace the specific duties formerly in force. According to the new schedule talking machines, parts and accessories, records, etc., will be dutiable at 25 per cent.

THE BROKEN SPRING

'Tis sad, indeed, and casts a gloom,
Our home is like an empty tomb;
The music, once to us so dear,
Has vanished from the listener's ear.
The Phonograph still holds its place,
With silence written on its face,
And strange, as it may seem to be,
It will not sing, "Abide With Me."
The spring is broken, I presume,
If not, why won't it play a tune?
If you can't fix that busted spring,
And make our home with music ring,
I'll take it out in our back yard
And get some rocks,—that's good and hard.
I'll make it play, or sing, or yell,
Or make it look unfit for,—any place.

—The Puritan.

Harry Lamoreaux, Columbia dealer of Cherokee, Ia., has recently enlarged his store equipment by adding four artistic sound-proof demonstration booths. His truck with the familiar Columbia trade-mark is kept busy these days.

AUSTRALIA.Herbert G. Polyblank,
SYDNEY,
N.S.W.**BELGIUM.**P. Carton,
Rue Karel Ooms, 11,
ANVERS.**ITALY.**G. Menaboni,
Via S. Sebastiano 2,
LIVORNO.**SPAIN.**Ernesto Verdu,
ALICANTE.**ENGLAND.**A. Waite & Co., Ltd.,
15-17 Figtree Lane,
SHEFFIELD.**Songster
Talking
Machine
Needles**Manufactured by **J. STEAD & CO. LTD.**
MANOR WORKS. SHEFFIELD ENGLAND.

LATEST PATENTS RELATING TO TALKING MACHINES AND RECORDS

WASHINGTON, D. C., November 8.—Gramophone Drive. Frederick Myers, New York, assignor to Myers Phonograph Corp., same place. Patent No. 1,343,640.

This invention relates to improvements in means for utilizing electric motive power for actuating and properly reproducing sounds from sound records and to means for controlling and regulating the speed of the same.

The principal object of the invention is to provide a simple, reliable electric drive, easily removed from its position for inspection or repairs, and as readily replaced.

A further object is to provide a starting device, operative automatically or manually, and to provide a simple frictional drive mechanism, eliminating gearing, belts, and the like, thereby avoiding noise consequent to their use.

Fig. 1 is a vertical sectional view, showing the motor and allied driving parts as attached within the cabinet. Fig. 2 is a horizontal sectional view taken on line 2—2 of Fig. 1, the motor, governor, lamp and disk support being re-

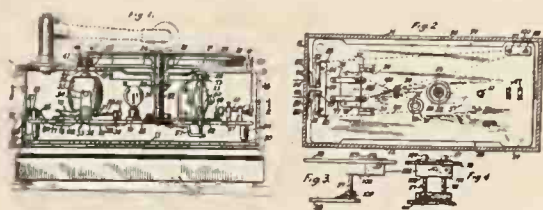

moved. Fig. 3 is a partial side elevational view showing a fragment of the cover and electrical contacts, and Fig. 4 is a front elevational view of the same.

Talking Machine Stylus Arm. Frederick Adams, Philadelphia, Pa., assignor to Perfek-tone Corp., same place. Patent No. 1,341,625.

The principal objects of the present invention are, first, to provide a reproducer for successfully, acceptably and satisfactorily reproducing music and sound from either lateral-wave or hill-and-dale records such as are to be found upon the market; and second, to facilitate and simplify the operation of using the reproducer for different kinds of records. The invention relates principally to improvements in the stylus arm.

Fig. 1 is a side elevation of a reproducer embodying features of the invention and Fig. 2 is a view of a part of a stylus arm, drawn to

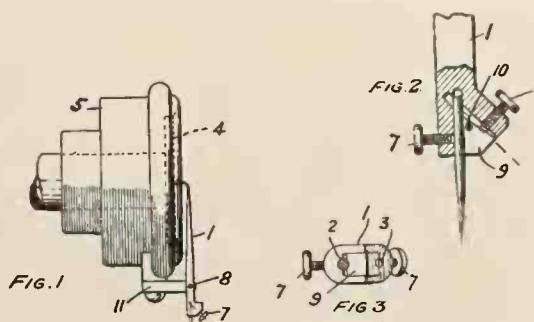

an enlarged scale, and showing in section features of the invention. Fig. 3 is an end view partly in section of Fig. 2.

Sound Tubes for Talking Machines. Lloyd Y. Squibbs, Camden, N. J., assignor to the Victor Talking Machine Co., same place. Patent No. 1,341,522.

This invention relates to certain improvements in talking machines, and more particularly to the sound tube or sound conduit comprising the tone arm proper, the gooseneck or other sound box tube and the connection between the same by means of which the sound box of a talking machine is operatively connected with the amplifying device and through which sound vibrations from the sound box are transmitted to the amplifier.

The objects of the invention are to provide a sound conduit or sound tube which is attractive in appearance, is provided with a generally smooth contour and is without objectionable

parts; is of few parts; is readily assembled; is easily manufactured; in which exact machine work is, to a great extent, obviated; and in which the resistance to the free movement of the same, due to friction between the articulated portions thereof, is materially reduced, and in which the likelihood of wear, rattle, and looseness occasioned by wear, are also lessened.

In the drawings, forming a part of this specification and in which the same reference characters are employed throughout the various views to designate the same parts, Fig. 1 shows in elevation a sound conduit or sound tube, of a talking machine, composed of articulated parts, and showing the relation of the said parts to the sound box, the motor cabinet, and the turn table; Fig. 2 is a plan view, partly in section, showing the connection between the tone arm proper and the gooseneck or other sound box tube; and Fig. 3 is an enlarged view, partly in section, showing on an enlarged scale the two connected and movable elements of

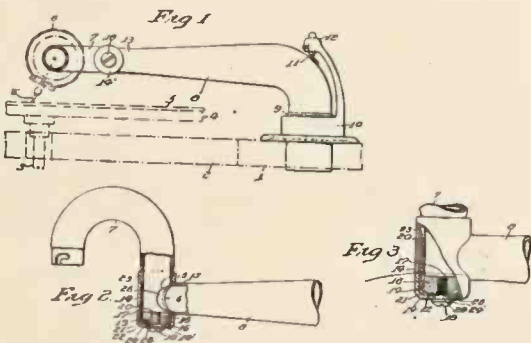

the sound tube, their operative relation, and the bearings, between the same, the larger bearing being a smooth cylindrical bearing at the point where the gooseneck or other sound box tube enters the tone arm, and the smaller bearing constituting a pivotal bearing in axial alignment with the large cylindrical bearing.

Sound Recording and Reproducing Machine. Alfonso Cortella, Philadelphia, Pa. Patent No. 1,341,011.

This invention relates to talking machines. The invention aims to provide an improved machine of that nature for recording and reproducing a plurality of sound records successively and in repeated cycles. By this means an opera or any long musical or other record may be rendered with no break in the reproduction occasioned by the substitution of one record for another.

Fig. 1 is a front elevation; Fig. 2 a partial plan of the record shifting mechanism on an

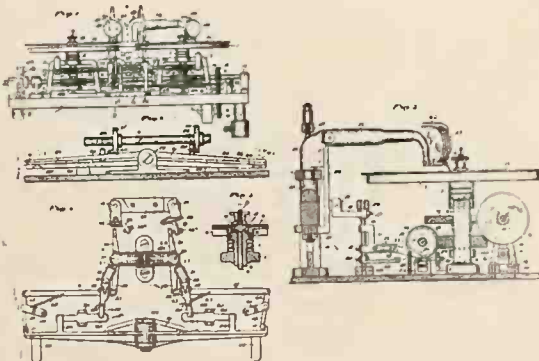

enlarged scale; Fig. 3, a partial vertical cross-section on an enlarged scale on the line 3—3, Fig. 1; Fig. 4, a detail front elevation of a part of the record shifting mechanism on an enlarged scale, and Fig. 5, a detail of the clutch or record locking means.

Sound Box for Sound-recording and Reproducing Machines. Isaac F. Burton, Philadelphia, Pa., assignor to the Victor Talking Machine Co., Camden, N. J. Patent No. 1,350,590.

This invention relates particularly to the providing of means for positively varying and fixing when varied the pitch or note of a diaphragm when mounted in a sound box for

sound-reproducing apparatus and particularly in such sound boxes where the inherent resiliency of the diaphragm is relied upon to control the action of the stylus bar of the sound box as modified and assisted by the co-operative control and adjustment of a co-acting spring member.

In such sound boxes it is an object of the invention to provide a ready adjustment of the spring member which may be positively fixed in position after the necessary or desired relation and adjustments of the spring control to the diaphragm have been ascertained and imparted to the spring member.

In the drawing accompanying this specification and relating thereto, Figure 1 shows a side view, partly broken away, of a sound box. Fig. 2 shows a front elevation of the sound box, Fig. 3 shows an enlarged bottom plan

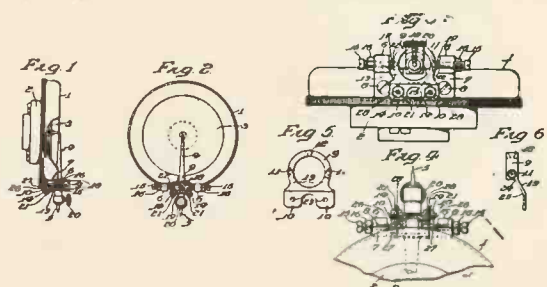

view of the sound box; Fig. 4 is an enlarged rear elevation of the sound box showing the mounting and adjacent parts, Fig. 5 shows in detail the mounting by itself, Fig. 6 shows a side view of mounting shown in Fig. 5.

Sound Box for Sound-reproducing and Sound-recording machines and Sound Box for Talking Machines. Patents Nos. 1,350,595 and 1,350,596. Albert C. Diehl, Pensauken, N. J., assignor to the Victor Talking Machine Co., Camden, N. J.

The first-named invention relates to sound boxes for sound-reproducing and sound-recording machines and particularly to the supporting mechanism upon which the stylus bar is mounted to oscillate in transmitting vibrations to and from the diaphragm through the stylus bar, and has for its objects, among others, to provide a construction in which the stylus bar may be put under tension, and in which the degree to which such tension is applied may be adjusted, regulated and controlled to a nicety and accuracy heretofore unattained, without substantially increasing the friction resistance to the free vibration of the stylus bar; to prevent the compression or tension member from vibrating independently of its vibration by and with the stylus bar about the oscillatory axis of the stylus bar; to so arrange the compression or tension member that its mass is disposed substantially equal on opposite sides of the axis of oscillation of the stylus bar and thus position it in a balanced relation with respect to the axis of oscillation of the stylus bar; to improve the quality of the sound reproduced and to more truly record sound by avoiding any liability of chatter or vibration in the parts of the sound box construction, and to permit the stylus bar to move with the least restraint possible in recording or reproducing sound.

Figure 1 is a side elevational view, partly in section, of a sound box having a stylus mounted in accordance with the invention of this application; Fig. 2 is a front elevational view of the construction shown in Fig. 1; Fig. 3 is a bottom view of the construction shown in Fig. 1; Fig. 4 is an enlarged longitudinal sectional view of a portion of the stylus bar and a longitudinal view of the mounting therefor, said section being taken on the line 4—4 in Fig. 3; Fig. 5 is a longitudinal sectional view enlarged similarly to Fig. 4, of a portion of the stylus bar and the mounting therefor, said section being taken on line 5—5 of Fig. 2; Fig. 6 is a further detailed

(Continued on page 226)

LATEST PATENTS RELATING TO TALKING MACHINES AND RECORDS—(Continued from page 225)

view showing the surface on the end of the adjustable screw stud and the surface at the bottom of the recess in the resilient member as having radii of curvatures greater than the radius of the curvature of the bearing ball cooperating therewith and interposed between said surfaces. Fig. 7 is an enlarged side elevational view of a portion of the stylus bar prior to the attachment thereto of the spring member; Figs. 8, 9 and 10 are detailed views illustrative of the way in which the spring member is made, and Fig. 11 is a view similar to Fig. 6, but showing a modified construction in which the bottom of the recess in the spring member is conical in shape as distinguished from spherical.

Mr. Diehl's second invention (Patent No. 1,350,596) relates to that type of sound boxes comprising a diaphragm and stylus, adapted more especially to reproduce recorded sounds from a disc record whereon such sounds have been recorded as laterally undulating sound grooves; such disc record being operatively rotated, for reproduction purposes, in a horizontal plane, while the sound box, including its stylus, is operatively positioned relatively thereto in a vertical plane.

The improvements in such a sound box have for their object the provision of means to adjust the relative tensioning of the diaphragm and the spring mounting of the stylus bar co-acting therewith; and then to fixedly lock such mounting, when such adjustment has been obtained, to the end that the tonal quality of the sound produced thereby may be regulated and controlled; and these objects are attained by substantially fixedly positioning the tensioning spring members on the stylus bar mounting and

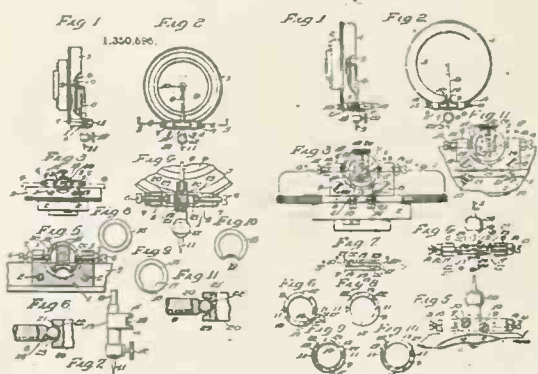

avoiding the usual sliding contact between said spring members and the parts co-acting therewith; reducing such contacting surface to a minimum; providing facility of adjustment of the elements which regulate the spring-controlled stylus bar, and locking the combined and co-acting elements in fixed operative position after the proper adjustment has been effected.

In the accompanying drawings illustrating the invention, Figure 1 is a side elevation of the improved sound box; Fig. 2 is a front elevation thereof; Fig. 3 is an enlarged bottom plan view, illustrating the mounting of the stylus bar and the means to adjust it; Fig. 4 is a section of line 4-4 of Fig. 3, showing the spring under action of the regulating member; Fig. 5 is a side elevation of part of the sound box broken away; Fig. 6 is a side elevation partly in section of a form of mounting encircling the stylus bar; Fig. 7 is a plan view thereof, and Fig. 8 is a like view of Fig. 6, showing the reverse side of the ring member of the mounting;

Fig. 9 is a section on line 9-9 of Fig. 7, and Fig. 10 is another section of Fig. 7 on line 10-10 thereof, and Fig. 11 is a bottom plan view of the stylus bar mounting in a slightly modified form from that shown in Fig. 3.

Phonograph.—Walter H. Miller, Orange, N. J. Patent No. 1,350,616.

This invention relates to an improved phonographic record device. In the cutting of the sound record groove in making a phonograph record the recording stylus removes the material of the record tablet in the form of light, thin, long shavings. These shavings are easily dispersed and ordinarily soon gather on the various parts of the recording device. Sooner or later the shavings are very apt to clog the operating mechanism of the device and to interfere with its proper operation, thus preventing satisfactory records from being obtained. Moreover, the scattering of the shavings is objectionable from the standpoint of cleanliness, especially so in the case of home recording.

The principal object of the invention is to prevent the material removed from sound record tablets in forming records thereon from being dispersed or scattered about so as to obviate the foregoing objections. This result is accomplished by providing the phonographic recording device with means of a novel character for breaking up the shavings as they are cut from the record tablet by the recording stylus into small



pieces or chips which will fall and gather only on the record tablet itself or the holder or support for the latter.

Figure 1 is a view in side elevation, partly in section and partly broken away, of a phonographic recording device embodying the invention, showing the parts in operative position with respect to a record tablet; Fig. 2 is a top plan view of the device shown in Fig. 1, and Fig. 3 is a sectional view on line 3-3 of Fig. 1 looking toward the right.

Tone Arm for Talking Machines. Anthony Vasselli, Newark, N. J., assignor to Harriman National Bank, New York. Patent No. 1,350,753.

This invention relates to tone arms for talking machines and more particularly to tone arms which are provided with joints whereby the position of the sound box may be changed from playing position in order to facilitate inserting or removing the reproducer point, and wherein the sound box will be locked in the latter position. It has been suggested to lock the sound box

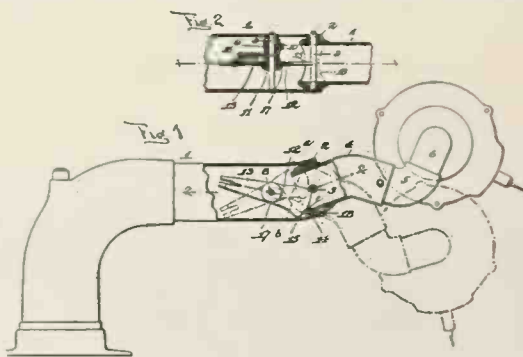

in raised position, but in all of such devices, should the operator neglect to lower the sound box before the lid or cover of the cabinet is closed, the inner side of the lid will be marred and scratched by coming in contact with the sound box, and if considerable force be applied to the cover the tone arm or sound box, or

both, may be broken or very seriously injured.

The object of the invention is to provide means whereby the sound box will be locked in raised position in such a manner that when engaged by the cover it will be moved from such raised position.

A further object is to provide means whereby when in lowered position the sound box, while being free to move vertically relatively to the record disc, will be prevented from being accidentally moved into engagement with the cover when the latter is in closed position.

Figure 1 is a side elevation partly in section of a tone arm provided with the invention, the section being taken on the line 1-1 of Fig. 2, and Fig. 2 is a fragmentary sectional view taken on the line 2-2 of Fig. 1.

Talking Machine. Percy A. Horswell, Cleveland, Ohio, assignor to the Cleveland Talking Machine Co., same place. Patent No. 1,354,301.

This invention relates to talking machines or phonographs and especially to a type or form wherein there is a cabinet having a hinged lid or cover which when closed is designed to cover and inclose the sound reproducer and horn or sound conducting means, and when elevated is designed to act as a reflector to reflect the sound forwardly, the horn or sound conducting means which for convenience will be termed the "horn" extending rearwardly so as to direct the sound into the cover when the latter is elevated.

One of the objects of the present invention is to provide in a machine of the character above stated, means whereby, when the cover is elevated, the horn and sound reproducer may be swung upwardly and readily retained in inoperative position with the needle off the record, so that it will be convenient to change the record or needle. A further object is to provide certain improvements in the shape of the horn which enable the horn to be readily swung upwardly and rearwardly to inoperative position and also prevent or minimize the reflection of the sound

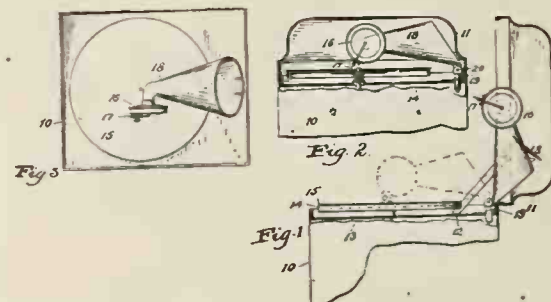

waves back into the horn and additionally permit the cover to be lowered to closed position without engaging the horn and without requiring a cover of very considerable depth.

A still further object is to arrange certain parts of the machine, particularly the rotating platform which receives the record, so that a metal cabinet may be used without a serious or noticeable metallic sound or tone being produced during the reproduction of a record.

In the drawings, Figure 1 is a side view of the upper or main portion of the talking machine, parts being in section, and the sound reproducer and horn being shown in full lines in inoperative position and by dotted lines in normal operating position; Fig. 2 is a side elevation, with parts in section, showing the cover closed; Fig. 3 is a top plan view with the cover removed and with the sound amplifier and horn in normal position for operation.

LESLEY'S PATCHING VARNISH

dries in 10 seconds, flows without showing the lap. With it damaged varnish can be repaired invisibly and permanently. Complete Repair Outfit, \$3.50; 1 quart, \$1.90; 1 pint, \$1.00.

LESLEY'S CHEMICAL CO., MFR.

10 So. New Jersey Street, Indianapolis, Ind.

DISTRIBUTORS:

MOONEY-MUELLER-WARD CO. Indianapolis, Ind.
BALDWIN-MILLER CO. Indianapolis, Ind.
SONORA DISTRIBUTING CO. Dallas, Texas
LANSING SALES CO. Boston 11, Mass.

REPAIRS

All Makes of Talking Machines Repaired Promptly and Efficiently

ANDREW H. DODIN

28 Sixth Avenue New York

TELEPHONE, SPRING 1194

PATENTS

Hand Books on Patents, Trade Marks, etc., sent free. Our 74 years of experience, efficient service, and fair dealing, assure fullest value and protection to the applicant. The Scientific American should be read by all inventors.

MUNN & CO., 617 Woolworth Bldg., N. Y.
Tower Bldg., Chicago, 625 F St., Washington, D. C.
Hobart Bldg., 582 Market St., San Francisco, Cal.

Advance RECORD BULLETINS for December, 1920

VICTOR TALKING MACHINE CO.

- VOCAL RECORDS**
- 45201 The Japanese Sandman.....Olive Kline 10
The Old Fashioned Garden.....Olive Kline 10
35702 Gems from "Mary".....Victor Light Opera Co. 12
Gems from "The Night Boat,"
Victor Light Opera Co. 12
- 18695 Whispering.....John Steel 10
The Love Boat.....John Steel 10
18696 That Old Irish Mother of Mine.....Sterling Trio 10
Just Like a Gypsy.....Sterling Trio 10

- DANCE RECORDS**
- 18697 Fair One. Fox-trot,
The Benson Orchestra of Chicago 10
I'd Love to Fall Asleep and Wake Up in My
Mammy's Arms. Fox-trot,
The Benson Orchestra of Chicago 10
18698 Chili Bean. Fox-trot. (Intro. "I Told You
So").....The Benson Orchestra of Chicago 10
My Little Bimbo. One-step. (Intro. "I
Love the Land of Old Black Joe")
The Benson Orchestra of Chicago 10
18694 Anytime, Anyday, Anywhere. Fox-trot,
Paul Whiteman and his Ambassador Orchestra 10
Wang-Wang Blues. Fox-trot,
Paul Whiteman and his Ambassador Orchestra 10
18699 Dance-O-Mania. Fox-trot,
Selvin's Novelty Orchestra 10
Old Man Jazz. Fox-trot.....All Star Trio 10

- MONOLOGUES**
- 45202 Virginian Judge—Second Session (Part 1),
Walter C. Kelly 10
Virginian Judge—Second Session (Part 2)
Walter C. Kelly 10
35679 Santa Claus Tells About His Toy Shop,
Gilbert Girard 12
Santa Claus Gives Away His Toys. Gilbert Girard 12

- RED SEAL RECORDS**
- ENRICO CARUSO—Tenor—In French
88625 La Juive—Rachel quand du Seigneur la
grâce tutélaire. (The Jewess—Rachel,
When the Grace of the Lord Entrusted
Thee to Me).....Halévy 12

- 64910 Tarantelle.....Chopin 10
EMILIO DE GOGORZA—Baritone
64911 The Garden of Memory.....Curzon-Phillips 10
GIUSEPPE DE LUCA—Baritone—in Neapolitan
64912 Oï Luna.....Cordiferro-Cardillo 10
GERALDINE FARRAR—Soprano
87319 At Parting.....Peterson-Rogers 10
MABEL GARRISON—Soprano
64808 When I Was Seventeen.....Swedish Folk Tune 10
JASCHA HEIFETZ—Violinist
74646 Symphonie Espagnole—Andante. (Fourth
Movement).....Lalo 12
MME. HOMER—Contralto and MISS LOUISE HOMER—Soprano
89159 My Sweet Repose.....Schubert 12
JOHN McCORMACK—Tenor
64913 When You and I Were Young, Maggie,
Johnson-Butterfield 10
PHILADELPHIA ORCHESTRA
(LEOPOLD STOKOWSKI, Conductor)
74647 Hungarian Rhapsody, No. 2.....Liszt 12
ERNESTINE SCHUMANN-HEINK—Contralto
87320 The Home Road.....Carpenter 10

COLUMBIA GRAPHOPHONE CO.

- 49734 Aida. O Terra Addio,
Rosa Ponselle and Charles Hackett 12
79373 Holy Night, Peaceful Night (Silent Night,
Hallowed Night).....Jeanne Gordon 10
78747 Polish Dance.....Toscha Seidel 10
79114 Lullaby.....Hulda Lashanska 10
49869 Kiss Me Again.....Rosa Ponselle 12
A2990 Roses of Memory.....Barbara Maurel 10
Dreaming Alone in the Twilight,
Barbara Maurel 10

- A6167 Faust Selections, Part I,
Metropolitan Opera House Orchestra 12
Faust Selections, Part II,
Metropolitan Opera House Orchestra 12

- A6169 Nazareth,
Oscar Seagle and Columbia Stellar Quartette 12
The Voice of the Chimes,
Oscar Seagle and Columbia Stellar Quartette 12
A2993 Ye Olden Yuletide Hymns, Part I. Orch.
Accom.....Columbia Stellar Quartette 10
Ye Olden Yuletide Hymns, Part II. Orch.
Accom.....Columbia Stellar Quartette 10
A2996 Children's Toy March.....Prince's Orchestra 10
Children's Symphony.....Prince's Orchestra 10
A2991 Uncle Josh at the Dentist's,
Cal Stewart and Harry C. Browne 10
Uncle Josh and Aunt Nancy Put Up the
Kitchen Stove..Cal Stewart and Ade Jones 10
A2992 Meet Me on de Golden Shore. Banjo and
Orch. Accom.,
Harry C. Browne and Peerless Quartette 10
Keep Those Golden Gates Wide Open.
Banjo and Orch. Accom.,
Harry C. Browne and Peerless Quartette 10
A3305 I Want to Know Where Tosti Went When
He Said Good-bye.....Bert Williams 10
Get Up.....Bert Williams 10

- POPULAR HITS**
- A3303 Jinga-Bula-Jing-Jing.....Frank Crumit 10
Nobody to Love.....Frank Crumit 10
A3302 Driftin' Along on a Blue Lagoon,
Campbell and Burr 10
On-Miami Shore.....Campbell and Burr 10

- DANCE RECORDS**
- A3301 Whispering. Fox-trot. Art Hickman's Orchestra 10
If a Wish Could Make It So. Fox-trot.
Intro. "We've Got Something" from
"Tickle Me".....Art Hickman's Orchestra 10
A3304 Je Ne Sais Pa Pa. Song. Fox-trot,
The Happy Six 10
My Little Bimbo Down on the Bamboo Isle.
Intro. "I Love the Land of Old Black
Joe".....The Happy Six 10
A2994 Think of Me, Little Daddy. One-step.
Intro. "I'm Going Back to My Used to
Be".....Wilbur Sweatman's Jazz Band 10
"But" Fox-trot. Intro. "Tiddle-Dee Winks,"
Wilbur Sweatman's Jazz Band 10

- NOVELTY RECORD**
- E4772 The Cbimes. Fox-trot. Columbia Spanish Band 10
Three O'Clock in the Morning,
Columbia Spanish Orchestra 10
- EDUCATIONAL RECORDS**
- A3101 The Music Box..Columbia Miniature Orchestra 10
Dialog for Four. Oboe, Clarinet, Horn and
Flute.....Columbia Miniature Orchestra 10

- A3102 Etude. Opus 424, No. 3 (Behr),
Columbia Miniature Orchestra 10
Waltz in E Flat (Schubert) and
Waltz No. 5 (Koschat),
Columbia Miniature Orchestra 10
A2997 The Japanese Sandman.....Nora Bayes 10
You're Just as Beautiful at Sixty as You
Were at Sweet Sixteen.....Nora Bayes 10
A2995 Avalon, from "Sinbad".....Al Jolson 10
Old Pal, Why Don't You Answer Me,
Henry Burr 10
A3300 Sweet Mamma (Papa's Getting Mad),
Marion Harris 10
I Told You So.....Marion Harris 10
A2989 That Naughty Waltz. Violin Solo. Eddie Brown 10
Your Eyes Have Told Me So. Violin Solo,
Eddie Brown 10

- DANCE RECORDS**
- A2998 Fair One. Fox-trot.....Ted Lewis Jazz Band 10
Gipsy Moon. Fox-trot.....Ted Lewis Jazz Band 10
A2999 That Moanin' Melody. Fox-trot. Paul Biese Trio 10
Rose of Babylon. Fox-trot.....Paul Biese Trio 10
A6168 Hawaiian Twilight. Waltz, Intro. "Myra,
"Home Again".....Columbia Orchestra 12
On Pensacola Bay. Medley Waltz. Intro.
"The Last Waltz I Had With You,"
"Cuddling Arms".....Columbia Orchestra 12

AEOLIAN CO.

- OPERATIC SELECTIONS**
- 52000 Samson and Delilah—Mon coeur s'ouvre à ta
voix (My heart at thy sweet voice) (Charpen-
tier). Contralto, in French. Vocalion orch.
accomp.....Marguerite D'Alvarez 12

- STANDARD SELECTIONS**
- 30112 Songs My Mother Taught Me (Dvorak). So-
prano, Vocalion orch. accomp., May Peterson 10

- INSTRUMENTAL SELECTIONS**
- 24010 Sur le Lao (Dambois). 'Cello, piano accomp.,
Maurice Dambois 10
Elégie (Wagner). 'Cello, piano accomp.,
Maurice Dambois 10

- CHRISTMAS SELECTIONS**
- 14110 Silent Night, Holy Night (Gruber). Contralto,
Vocalion orch. accomp., Nevada Van Der Veer
O, Holy Night (Adam). Vocalion orch. accomp.,
Charles Harrison and Quartet 10
14111 Joy to the World (Traditional Hymn),
Stellar Quartet 10
Hark, the Herald Angels Sing (Anon),
Stellar Quartet 10

- POPULAR SELECTIONS**
- 14109 Avalon (Jolson-Rose). Orch. accomp.,
Ernest Hare 10
Kentucky (Fier). Orch. accomp.....Ernest Hare 10
14112 Believe Me, Beloved, from "Honey Dew" (Zim-
balist). Orch. accomp.....Sam Ash 10
Jinga-Bula-Jing-Jing (Jerome). Orch. accomp.,
Billy Jones 10
14113 You're the Only Girl That Made Me Cry
(Fischer). Orch. accomp.....Crescent Trio 10
Like We Used to Be (Kortlander). Orch.
accomp.....Charles Hart and Elliott Shaw 10
14114 Cohen at the Telephone (Anon).....Monroe Silver 10
Cohen, the Politician (Silver).....Monroe Silver 10

- DANCE SELECTIONS**
- 14115 Bow Wow (Wadsworth). One-step,
(Arden, Green & Wadsworth) All Star Trio 10
A Mouthful of Kisses. Fox-trot, from "Century
Roof" (Bryan & Schwartz),
Wiedoeft-Wadsworth Quartet 10
14116 Avalon (Jolson-Rose). Fox-trot,
Sherbo's Orchestra 10
Fair One (Mallen-Lewis). Fox-trot,
Sherbo's Orchestra 10
14117 On the Shores of Tripoli (Cunningham-Dubin-
Weill). Waltz.....Yerkes' Marimba Band 10
The Bells, introducing "Tell Me, Little Gypsy"
(Berlin). Fox-trot.....Sherbo's Orchestra 10
14118 Feather Your Nest, introducing "Down in China-
town" (Brookman-Johnson). Fox-trot,
Vernon Trio 10
My Midnight Frolic Girl, introducing "Years
Ago" (Black-Hickman). Fox-trot..Vernon Trio 10

EDISON RE-CREATIONS

- 82195 Love's Sorrow (Shelley). Contralto,
Carolina Lazzari 10
Ma Little Sun Flow'r, Good-Night (Vanderpool).
Contralto.....Carolina Lazzari 10
82196 Calm As the Night (Bohm). Baritone,
Mario Laurenti 10
Good-Bye, Beloved, Good-Bye (Arr. from an old
Negro melody by Sampson). Soprano,
Anna Case and Lyric Male Quartet 10

- 82197 Valse in A Flat, Op. 64, No. 3 (Chopin). Piano,
Sergei Rachmaninoff 10
Theme and Variations—Sonata IX (Mozart).
Piano.....Sergei Rachmaninoff 10
82198 Drink to Me Only with Thine Eyes (Old Eng-
lish Air). Bass-baritone.....Arthur Middleton 10
Le Onde del Danubio (Waves of the Danube).
Vocal waltz, soprano, in Italian.....Frieda Hempel 10
80549 Beulah Land (Sweeney). Baritone,
Thomas Chalmers and Mixed Chorus 10
Only a Step to Jesus (Doane). Bass and tenor,
Fred East and Lewis James 10
80550 Berceuse (Fauré). Violin.....Carmine Fabrizio 10
Schwedische Melodie (Ack, Varmeland, du
skona) (Wilhelmj). Violin.....Carmine Fabrizio 10

- 50576 Buck Fanshaw's Funeral (Twain). Recitation,
Harry E. Humphrey 10
Jest 'Fore Christmas (Field); and A Gustatory
Achievement (Riley). Recitation,
Harry E. Humphrey 10
50672 Moon Shines on the Moonshine (Bowers). Negro
duet.....Al Bernard and Ernest Hare 10
Oh, Joe (Please Don't Go) (Briers),
Al Bernard and Frank M. Kamplain 10
50673 Caresse d'Amour—Valse Lente (Love's Caress)
(De Francesco).....Peerless Orchestra 10
Day in Toyland (A Descriptive Tone Picture)
(Hager).....Peerless Orchestra 10
50674 Homeward March (Kimmcl). Accordion,
John J. Kimmel 10
Medley of Southern Airs. Banjo.....Fred J. Bacon 10
Sing Us a Song of Bonnie Scotland (Payne),
Glen Ellison 10
When I Was Twenty-one (H. Lauder)..Glen Ellison 10
50677 Manhattan Beach March (Sousa),
New York Military Band 10

- Windy Willie—Characteristic March (Losey),
New York Military Band 10
82187 Polka de W. R. (Rachmaninoff). Piano,
Sergei Rachmaninoff 10
Prelude in C Sharp Minor, Op. 3 (Rachmani-
noff). Piano.....Sergei Rachmaninoff 10
50683 Pretty Kitty Kelly (Pease-Nelson). Tenor,
William Bonner 10
There's a Typical Tipperary Over Here (Silver).
Male voices.....Premier Quartet 10
50684 La Veeda (Alden). Fox-trot, for dancing,
Max Fells' Della Robbia Orchestra 10
Stop It! (Kaufman). One-step, for dancing,
Green Bros. Novelty Band 10
50685 Karzan (Dulmage). Fox-trot, for dancing,
Green Bros. Novelty Band 10
My Sahara Rose Medley (Clarke-Donaldson).
Fox-trot, for dancing. Two saxophones and
two pianos.....Wiedoeft-Wadsworth Quartet 10
50686 Daddy, You've Been a Mother to Me (Fisher).
Tenor.....George Wilton Ballard 10
Hiawatha's Melody of Love (Meyer). Soprano
and contralto,
Betsy Lane Shepherd and Elizabeth Lennox 10
50687 I've Got the Profiteering Blues (Bibo). Tenor,
Billy Murray 10
Oh! How I Laugh When I Think How I Cried
About You (White). Conversational duet,
Rachel Grant and Billy Murray 10

EDISON AMBEROL RECORDS

- ROYAL PURPLE RECORDS**
- 29064 Dream Faces (Hutchinson). Baritone,
Thomas Chalmers and Chorus 10
29065 Le Rêve (The Dream)—Manon (Massenet). Tenor,
in French.....P. A. Asselin 10

- REGULAR LIST**
- 4126 Sunny Southern Smiles (Gilbert-MacBoyle-Cooper).
Male voices.....Premier Quartet 10
4127 My Garden of Love (Polla). Tenor.....Lewis James 10
4128 Kol Nidrei—Part 1 (Bruch). Violoncello,
Lauri Kennedy 10
4129 Medley of Old-Time Tunes. Accordion..P. Frostini 10
4130 You Can't Trust Nobody (Creamer-Layton),
Ernest Hare 10
4131 Wedding of the Rose—Intermezzo (Jessel),
Conway's Band 10
4132 On the Dreamy Amazon (Hill). Baritone,
Herbert C. Tilley, Jr. 10
4133 I Want a Jazzy Kiss (Milo-Rega),
Arthur Collins and Byron G. Harlan 10
4134 Our Director March (Bigelow).....Conway's Band 10
4135 In Sweet September (Monaco). Fox-trot, for
dancing.....Green Bros. Novelty Band 10
4136 Celestial Chimes (Greene). Celesta.....Robert Gayler 10
4137 Amorita (Zamecnik). Fox-trot, for dancing,
Lenzberg's Riverside Orchestra 10
4138 Hawaiian Twilight (Vandersloot),
Waikiki Hawaiian Orchestra 10
4139 Kingdom Witbin Your Eyes (Nicholls). Tenor,
Talbot O'Farrell 10
4140 Love, Here Is My Heart (Silesu). Tenor,
Reed Miller 10
4141 Love Nest Medley—Mary (Introducing "Mary")
(Hirsch).....Imperial Marimba Band 10
4142 Chautauqua at Pun'kin Center (C. Stewart). Rural
story.....Cal Stewart 10
4143 I'd Like to Take You Away—Betty Be Good (Riesen-
feld). Contralto and baritone,
Helen Clark and Joseph Phillips 10
4144 Two Little Bullfinches Polka (King). Piccolo and
clarinet, Weyert A. Moor and Anthony Giammatteo 10

PATHE FRERES PHONOGRAPH CO.

- POPULAR SUPPLEMENT NO. 39**
- POPULAR VOCAL**
- 20469 There's a Vacant Chair at Home, Sweet Home
(Goodwin-Hanley). Tenor.....Carlton Williams 10
Just for a While (Freedman-Squires). Tenor,
Robert Bruce 10
22448 Sweetie O' Mine (Gillespie-Van Alstyne). Come-
dienne.....Patricola 10
Laughing Vamp ("Hitland" Song Writers).
Comedienne.....Patricola 10
22449 Avalon (Jolson-Rose). Baritone.....Ernest Hare 10
Kentucky (Little-Fier). Baritone.....Ernest Hare 10
22450 Like We Used to Be (Robinson-Kortlander).
Tenor and baritone duet, Chas. Hart & Elliott Shaw 10
Sweetest Lady (Caddigan-Story). Baritone,
Elliott Shaw 10
20470 Affectionate Nan (Sissle-Blake). Tenor,
Noble Sissle 10
Gee, I'm Glad That I'm from Dixie (Sissle-
Blake). Tenor.....Noble Sissle 10
22451 Believe Me, Beloved, from "Honey Dew" (Her-
bert-Zimbalist). Tenor.....Sam Ash 10
Somebody's Eyes (Green-Clair-Goodman). Tenor,
Billy Jones 10
20471 For Every Boy Who's on the Level There's a
Girl Who's on the Square (Pease-Nelson-
Dodge). Tenor.....Fred Whitehouse 10
My Home Town Is a One-Horse Town (Gerber-
Silver). Male quartet.....The Harmonizers 10
22452 Rose of My Heart, from "Midnight Frolic" (Wil-
son-Moret). Tenor.....Lewis James 10
Waiting for the Sun to Come Out, from "Sweet-
heart Shop" (Francis-Gershwin). Male trio,
Crescent Trio 10

- DANCE**
- 22444 Until You Say "Good-Bye," from "Tickle Me"
(Stothart). Waltz,
Hazay Natzy's Orchestra, Hotel Biltmore, New York
Crystal Ball (Cobb). Fox-trot,
Hazay Natzy's Orchestra, Hotel Biltmore, New York 10
20468 April Showers Bring May Flowers, introducing:
"Pip, Pip, Toot Toot, Goodbye-ee" (Robinson).
Fox-trot. Banjo, saxophone, xylophone, piano,
Van Eps Quartet 10
Murder! (Gay). Fox-trot. Banjo, saxophone,
xylophone, piano.....Van Eps Quartet 10
40213 That Certain Something, from "Little Miss Char-
ity" (Henry-Savin). Fox-trot,
Waldorf-Astoria Dance Orch. (Jos. Knecht, Cond)
If a Wish Could Make It So, from "Tickle Me"
(Stothart). Fox-trot,
Waldorf-Astoria Dance Orch. (Jos. Knecht, Cond) 10
22445 Dear Little Rose Girl, from "Rose Girl" (Goetz).
Waltz,
(Continued on page 228)

ADVANCE RECORD BULLETINS FOR DECEMBER—(Continued from page 227)

Waldorf-Astoria Dance Orch. (Jos. Knecht, Cond.) Didn't You, from "Sweetheart Shop." One-step, Waldorf-Astoria Dance Orch. (Jos. Knecht, Cond.) 22446 Honey Dew Medley, introducing: "Drop Me a Line," "My Husband's Dearest Friend" (Zimbalist). Fox-trot.....All Star Trio Biddy (Zamecuk). One-step.....All Star Trio 22447 Feather Your Nest (Kendis-Brockman). Fox-trot.....Bennie Krueger and His Orchestra I'm a Lonesome Little Raindrop (Hanley). Fox-trot.....Bennie Krueger and His Orchestra HAWAIIAN 22453 Isle of Paradise (Earl-Fiorito). Waltz. Hawaiian guitars.....Ferera and Franchini Naughty Waltz (Levy). Waltz. Hawaiian guitars.....Ferera and Franchini

Regular Pathé December List NEW OPERATIC RECORDS

54055 Elégie (Massenet). Soprano, in French, Yvonne Gall 12 54056 Don Pasquale (Donizetti) "Cerchero lontana terra" (In Distant Lands). Tenor, in Italian, Tito Schipa 12 54057 Baciarmi (Buzzi-Peccia). Soprano, in Italian, Claudia Muzio 12

STANDARD SONGS SUNG IN ENGLISH

25046 Marguerite (White). Baritone.....Percy Hemus Afterwards (Lemon-Mullen). Baritone, Percy Hemus 10 22429 Song of the Chimes (Worrell). Soprano, Rosalie Miller 10 Dance the Romaika (Moore-Ware). Soprano, Rosalie Miller 10 25047 Loch Lomond (Old Scotch Air). Contralto, Florence Mulholland 10 The Mother Heart (Merriam-Stickles). Contralto, Florence Mulholland 10 22432 Excelsior (Balfe). Tenor and baritone duet, Lewis James and Elliott Shaw 10 The Voice of the Chimes (Deacy-Hahn), Acme Male Quartet 10 22433 Christians Awake, Salute the Happy Morn (Wainwright). Male quartet...Shannon Four 10 God Rest Ye Merrie, Gentlemen (Traditional Melody). Male quartet...Shannon Four 10 22431 Shepherd, Show Me How to Go (Eddy-Johnson), Tenor.....Robert Bruce O'er Waiting Harpstrings (Eddy-Brackett). Tenor.....Robert Bruce 10

NEW INSTRUMENTAL RECORDS

22434 The Flower of Italy (de Stefano). Concert waltz, accordion duet.....Peppino and Perry 10 The Gossip, "Intermezzo Polka." Accordion duet.....Peppino and Perry 10 20465 Parsiflage (Francis). Saxophone, banjo and piano.....Van Eps-Banta Trio 10 I'Infanta (Gregory). Saxophone, banjo and piano.....Van Eps-Banta Trio 10 22430 The Postman (Porter). Humorous duolog, Russell Hunting & Steve Porter 10 Hi and Si on the Line Fence (Porter). Humorous duolog...Russell Hunting & Steve Porter 10 NEW BAND AND ORCHESTRA SELECTIONS 40209 March of the Toys, from "Babes in Toyland" (Herbert). March, Joseph Knecht, Cond., Waldorf-Astoria Concert Orchestra 12 Habanera (Chabrier). Joseph Knecht, Cond., Waldorf-Astoria Concert Orchestra 12 40210 Bohemian Girl, Part 1 (Balfe). Overture, Versailles Military Band 12 Bohemian Girl, Part 2 (Balfe). Overture, Versailles Military Band 12

EMERSON PHONOGRAPH CO.

SONG HITS

10263 When I See All the Loving They Waste on Bahies I Long for the Cradle Again (De-Rob-Ward-Johnston). Comedy Song, Accom. by Plantation Dance Orch.....Eddie Cantor Dixie Made Us Jazz Band Mad (Johnson-Wells-Dash). Comedy Song, Accom. by Plantation Dance Orch.....Eddie Cantor 10264 The A. B. C. D. Blues (Kershaw-Von Tilzer). Novelty Song, Orch. Accom.....Irving Kaufman Jinga-Bula-Jing-Jing (Lewis-Young-Jerome). Comedy Song, Orch. Accom.....George Jessel 10265 That Oriental Girl of Mine (Brown-Von Tilzer). Baritone Solo, Orch. Accom.....Arthur Fields Nobody to Love (Kahn-Meyer). Baritone Solo, Orch. Accom.....Arthur Fields 10266 Soldiers of Erin (Robert F. O'Reilly). Tenor Solo, Orch. Accom.....Walter Scanlan When Ireland Comes Into Her Own (Brannen-Stanley). Baritone Solo, Orch. Accom, Padric O'Brien

DANCE HITS

10267 The Japanese Sandman (Richard A. Whiting). Fox-trot.....Plantation Dance Orchestra Dancing Eyes. Medley. Intro. "Shuffling Along" (Jay Morden). One-step, Sanford's Famous Dance Orchestra 10268 When the Harvest Moon Is Shining (Harry Von Tilzer). Waltz, Joseph Samuels' Music Masters Pretty Miss Virginia (Ring-Hager). Waltz, Green Brothers' Novelty Band 10269 In Babyland (Ray Perkins). Fox-trot, Merry Melody Men Toodles (Joseph Green). One-step, Green Brothers' Novelty Band

STANDARD AND NOVELTY SELECTIONS

10270 Hark! the Herald Angels Sing (Mendelssohn). Male Quartet.....Stellar Quartet Joy to the World (Handel). Male Quartet, Stellar Quartet 10271 I Need Thee Every Hour (Lowry). Tenor and Contralto Duet, Orch. Accom, Reed Miller and Nevada Van Der Veer I Love to Tell the Story (Hanker-Fisher). Tenor and Contralto Duet, Orch. Accom, Monroe Silver Reed Miller and Nevada Van Der Veer 10272 Cohen at the Telephone. Comedy Monologue, Cohen's New Auto. Comedy Monologue, Monroe Silver 11273 Hawaiian Nights (Lee S. Roberts). Hawaiian Guitars.....Ferari and Franchini Kawaha. Hawaiian Guitars.....Ferari and Franchini

PARAMOUNT RECORDS

20029 Read 'Em and Weep.....Al Bernard My Little Bimbo Down on the Bamboo Isle. Vocal solo.....Al Bernard 20031 Just Like a Gypsy. Medley introducing "I'm Always Falling in Love with the Other Fellow's Girl." Accordion solo.....Frosini Down in Chinatown. Fox-trot, accordion solo, Frosini

20030 Japanese Sandman. Fox-trot, Selvin's Novelty Orchestra Fair One. Fox-trot.....Newport Society Orchestra 33043 Kiddies Dance.....Paramount Band Kiddies Patrol.....Paramount Band 33045 Adeste Fideles.....Cardinal Quartet Christmas Chimes. Duet, Inez Barbour-Elizabeth Lennox 33045 Joy to the World.....Cardinal Quartet Adeste Fideles. Piano solo.....Clifford Murray 33068 Kawaha.....Ferera and Franchini Hawaiian Twilight.....Ferera and Franchini 33069 Holy Night. Violin, 'cello and piano, Hackel Berge Trio Silent Night, Holy Night. Violin, 'cello and piano, Hackel Berge Trio 33070 O' Come, All Ye Faithful.....Reed Miller's Quartet Voice of the Chimes.....Reed Miller's Quartet 50035 Poet and Peasant. Overture, Part 1, Creatore and his Band Poet and Peasant. Overture, Part 2, Creatore and his Band

ARTO CO.

VOCAL RECORDS

9026 Feather Your Nest (Johnson-Brockman-Kendis). Tenor solo, orch. accomp.....Arthur Hall Broadway Rose (West-Fried-Spencer). Tenor solo, orch. accomp.....James Price 9027 Old Pal, Why Don't You Answer Me (Lewis-Young-Jerome). Tenor solo, orch. accomp, Charles Harrison All She'd Say Was Umh-Hum (MacEmery-King Zany). Baritone solo, orch. accomp...Ernest Hare 9028 Profiteering Blues (A. Wilson-I. Bibo). Tenor solo, orch. accomp.....Billy Murray Hiawatha's Melody of Love (G. H. Meyer). Duet, orch. accomp...Charles Hart and Elliott Shaw

DANCE RECORDS

9024 Bring Back My Love Dreams (J. Grandei). Fox-trot.....Selvin's Novelty Orchestra 9025 The Japanese Sandman (R. A. Whiting). Fox-trot.....ARTO Dance Orchestra Darling (C. Schonberg). Fox-trot, Selvin's Novelty Orchestra 9029 La Veeda (C. Alden). Castilian Fox-trot, ARTO Dance Orchestra Railroad Blues (C. L. Roberts). Fox-trot, ARTO Dance Orchestra

STANDARD INSTRUMENTAL AND VOCAL RECORDS

3050 Adeste Fideles. Christmas Hymn, Henry Burr and Peerless Quartet Agnes Dei. Soprano solo, orch. accomp., Mme. Del Sarto 3009 The Sweetest Story Ever Told (R. M. Stults). Soprano solo, orch. accomp.....Louise Patterson Beautiful Isle of Somewhere (J. B. Pounds-J. S. Fearis). Tenor solo.....Henry Burr 3047 Little Grey Home in the West (H. Lohr). Soprano solo, orch. accomp.....Ida Height In the Gloaming (A. F. Harrison). Soprano solo, orch. accomp.....Louise Patterson 3048 Sbuvenir (F. Drdle). Violin solo, piano accomp., Vera Barstow Berceuse, from "Jocelyn" (B. Godard). Violin solo.....Vera Barstow

OKEH RECORDS

4183 The Love Nest (Intro, Chorus of "Mary," from musical play, "Mary"). Tenor, with orch., Lewis James I Would Like to Have a Girl Like You Like Me. Tenor, with orch.....Sam Ash 4134 A Picture of Mother. Tenor, with orch., Henry Burr Wait'n For Me. Male trio, with orch., Sterling Trio 4185 Feather Your Nest. Tenor duet, with orch., Campbell-Burr When I Found You (From musical comedy, "Poor Little Ritz Girl"). Contralto-baritone duet, with orch.....Helen Clark-Joseph Phillips 4186 Moonlight in Mandalay. Tenor-baritone duet, with orch.....James-Shaw Sweet Luana. Vocal duet, with Hawaiian guitar accomp.Jane Neilson-Lewis James 4187 Kentucky. Baritone, with orch.....Ernest Hare Honolulu Eyes. Vocal duet, with orch., Jane Neilson-Lewis James 4188 Whisting. Tenor, with orch.....Henry Burr When Your Ship Comes In. Tenor duet, with orch.....Campbell-Burr 4189 Rock of Ages. Contralto-baritone duet, with orch.....Helen Clark-Joseph Phillips I Need Thee Every Hour. Vocal duet, with orch., Charles Henry-James Jordan 4190 Lead Kindly Light. Vocal quartet, Peerless Quartet Jesus, Saviour, Pilot Me. Tenor, with orch., Henry Burr 4191 When You and I Were Young, Maggie. Tenor, with orch.....Henry Burr with Peerless Quartet The Old Oaken Bucket. Vocal quartet, Shannon Four 4192 Along the Way to Waikiki. Hawaiian guitar duet.....Ferera-Franchini Hapa Haole Hula Girl. Hawaiian guitar duet, Ferera-Franchini 4193 The Teddy Bears' Picnic. Characteristic, Conway's Band March of the Toys (From musical show, "Babes in Toyland").....Conway's Band 4179 Laughing Vamp. Fox-trot, Rega Dance Orchestra, with Incidental Saxophone by Nathan Glantz Kamel-Land. Fox-trot, Green Brothers' Novelty Band 4180 The Blacksmith Rag (With the "Anvil Chorus") Fox-trot.....Green Brothers' Novelty Band Bow-Wow (Puppy Love). One-step, All Star Trio 4181 Silver Water. Fox-trot...Rega Dance Orchestra, with Incidental Saxophone by Bennie Krueger In Old Manila. Fox-trot, Green Brothers' Novelty Band 4182 Tell Me, Little Gypsy (From "Ziegfeld Follies of 1920"). Medley Fox-trot, Rega Dance Orchestra Rock Me in a Cradle of Love. Fox-trot, Ray Miller's Black and White Melody Boys 10

OPERAPHONE CO.

POPULAR VOCAL

21189 In Babyland (Perkins). Baritone, orch. accomp., Ernest Hare Old Pal (Why Don't You Answer) (Lewis-Young-Jerome). Tenor, orch. accomp., William Prescott

21190 Jinga-Bula-Jing-Jing (Lewis-Young-Jerome). Tenor, orch. accomp.....Billy Jones I Know the Reason Why (Porter). Male quartet, unaccompanied.....The Harmonizers 21191 What Cha Gonna Do When There Ain't No Jazz? (Leslie-Wendling). Soprano, orch. accomp.Stella Jasper Read 'Em and Weep, from "Come Seven" (Bernard-Haenschen). Tenor, orch. accomp., Al Bernard

21192 My Dear Old Rose (Rohe-Winne). Baritone, orch. accomp.Elliott Shaw Let Your Sadness Turn to Gladness (Creamer-Layton). Tenor duet, orch. accomp., Lewis James and Charles Hart DANCE 31167 Avalon (Jolson). Fox-trot, Ted Gilbert's Dance Orchestra Sudan (Pollack). Fox-trot, Joe Johnson's Novelty Dance Orchestra 31168 When I Found You (Romberg). Waltz, Joe Johnson's Novelty Dance Orchestra Didn't You, from "Sweetheart Shop" (Felix). One-step.....Ted Gilbert's Dance Orchestra 31169 Rose of Spain, from Ed. Wynn's "Carnival" (Brown-Fazioli-Miller). Fox-trot...Melody Band In Old Manila (Mary Earl). Fox-trot, Ted Gilbert's Dance Orchestra HAWAIIAN 61113 Malanai Anu Ka Makani (Hawaiian Melody) "Lana's Cold Winds".....Hawaiian Guitars Kawaha (Hawaiian Melody).....Hawaiian Guitars INSTRUMENTAL 51145 Medley of Country Reels, introducing "Kelton's Reel," "The Devil's Dream," "Arkansas Traveler," "Old Zip Coon," "Chicken Reel," "Fairy Fancy Reel," "Half-Penny Reel." Violin, piano accomp.Michael Donovan Medley of Country Jigs, introducing "St. Patrick's Day in the Morning," "Mysteries of Knock," "Moll in the Wad," "Tivoli," "Jackson Fancy," "Garry Owens," "Haste to the Wedding." Violin, piano accomp...Michael Donovan 51143 Under the Leaves (Sous les Feuilles) (Francis Thome). Cello solo, Emanuel Balaban at piano.....Bernard Altschuler Melody in "F." (Anton Rubinstein). Cello solo, Emanuel Balaban at piano.....Bernard Altschuler 51144 Souvenir (Franz Drdle). Violin solo, pianoforte by Daniel Lieberfeld.....Irving Weiss Humoresque (Dvorak, Op. 101, No. 7). Violin solo, pianoforte by Daniel Lieberfeld, Irving Weiss

COMIC

19101 No News; or, What Killed the Dog (Willis). Comic monologue.....Victor Fletcher The Three Trees. Descriptive story, Victor Fletcher

LYRIC RECORDS

DANCE RECORDS

4232 Darling. Intro. "Up to the Moon" (Medley Fox-trot).....Nicholas Orland's Orchestra Grieving for You (Fox-trot). Selvin's Novelty Orchestra 4233 Snap Your Fingers at Care. Intro. "The Love Flower" (Medley Fox-trot), Nicholas Orland's Orchestra Good Times. Intro. "Hello Imagination" and "Just Like a Rose" (Medley One-step from N. Y. Hippodrome Success). Yerkes Jazzarimba Orchestra 4234 In Old Manila (Fox-trot). Nicholas Orland's Orchestra When I Found You. Intro. "Land of Yesterday" (Medley Waltz), Nicholas Orland's Orchestra 4235 Hop, Skip and Jump (Fox-trot), Geo. Green's Novelty Orchestra Show Me How (Fox-trot), Geo. Green's Novelty Orchestra POPULAR SONG HITS 5228 I Told You So ("Blues" Song).....Aileen Stanley Singing the Blues ("Blues" Song).....Aileen Stanley 5229 I've Got the Blues for My Kentucky Home, Helen Bell Rush My Home Town Is a One-Horse Town...Arthur Hall Palestinea (Comedy Song).....Fred Whitehouse She Gives Them All the Ha! Ha! Ha! Fred Whitehouse, assisted by Lew Brown 5231 All She Says Is Umh Umh..Billy Jones and Ed Smalley 'Get Up!.....Ernest Hare INSTRUMENTAL RECORDS 4704 Aloha Land (Hawaiian).....Ferera and Franchini On the Beach of Waikiki (Hawaiian), Ferera and Franchini 4807 Light Cavalry (Overture).....Lyric Military Band The Thunderer (March) (Souza).Lyric Military Band CHRISTMAS HYMNS AND SONGS 5904 Adeste Fideles (O Come, All Ye Faithful), Lyric Mixed Quartet Hark the Herald Angels Sing...Lyric Mixed Quartet Cantique de Noel (Soprano Solo).....Helen Davis Silent Night (Traditional Carol).....Marion Swan

STEADY DEMAND FOR VICSONIA

Both Domestic and Foreign Orders Increasing in Volume Is the Report

The Vicsonia Mfg. Co., New York, maker of the Vicsonia reproducer for playing Edison records on machines of the lateral-cut type, reports that a substantial demand for its products from not only the various sections of the United States, but also from foreign countries. Largely as a result of persistent advertising in The Talking Machine World the Vicsonia Co. has received inquiries from many foreign countries as far away as Japan, and only recently received a trial order from South Africa.

At the present time the Vicsonia Co. is carrying on a campaign of advertising in several of the New York papers, including the Sunday World and the New York Globe, with results that are distinctly satisfactory.

Through its New England jobbers the Phonograph Supply Co., Boston, the Vicsonia Co. reports a steadily growing volume of orders from that section of the country, and particularly through Massachusetts.

Some Leading Jobbers of Talking Machines in America

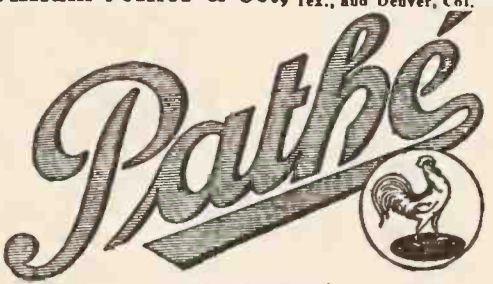

TEST IT. 
 OUR VICTOR
Record Service
 has a reputation for efficiency.
 Suppose you try it.
E. F. DROOP & SONS CO.
 1300 G. STREET, WASHINGTON, D. C.
 231 N. HOWARD STREET, BALTIMORE, MD

William Volker & Co., Kansas City, Mo.; Houston, Tex., and Denver, Col.

DISTRIBUTORS
 Complete Pathephone and Pathe Record Stocks.
 The best proposition for the progressive dealer.

Sherman, Clay & Co.

 San Francisco, Los Angeles, Portland, Seattle, Spokane
 PACIFIC COAST DISTRIBUTORS OF
 VICTOR PRODUCTS

The PERRY B. WHITSIT CO.
 Distributors of
Victrolas and Victor Records
 COLUMBUS, OHIO



Where Dealers May Secure
COLUMBIA
 Product

Ready, Full Stocks, and Prompt Deliveries from Convenient Shipping Centers all over the United States

Distributors

Atlanta, Ga., Columbia Graphophone Co., 63 N. Pryor St.
 Baltimore, Md., Columbia Graphophone Co., 16 South Howard St.
 Boston, Columbia Graphophone Co., 1000 Washington St.
 Buffalo, N. Y., Columbia Graphophone Co., 737 Main St.
 Chicago, Ill., Columbia Graphophone Co., 325 W. Jackson Blvd.
 Cincinnati, O., Columbia Graphophone Co., 317-321 East 8th Street.
 Cleveland, O., Columbia Graphophone Co., 1812 East 30th St.
 Dallas, Tex., Columbia Graphophone Co., 316 North Preston St.
 Denver, Colo., Columbia Stores Co., 1608 Glenarm Ave.
 Detroit, Mich., Columbia Graphophone Co., 115 State St.
 Indianapolis, Ind., Columbia Graphophone Co., 209 W. Washington St.
 Kansas City, Mo., Columbia Graphophone Co., 2006 Wyandotte St.
 Los Angeles, Cal., Columbia Graphophone Co., 809 S. Los Angeles St.
 Minneapolis, Minn., Columbia Graphophone Co., 18 N. 3rd St.
 New Haven, Conn., Columbia Graphophone Co., 206 Meadow St.
 New Orleans, La., Columbia Graphophone Co., 517-525 Canal St.
 New York City, Columbia Graphophone Co., 121 West 20th St.
 Omaha, Neb., Columbia Graphophone Co., Eighth and Jackson Sts.
 Philadelphia, Pa., Columbia Graphophone Co., 40 N. 6th St.
 Pittsburgh, Columbia Graphophone Co., 632-640 Duquesne Way.
 Salt Lake City, Utah, Columbia Stores Co., 221 South West Temple.
 San Francisco, Cal., Columbia Graphophone Co., 130-150 Sutter St.
 Seattle, Wash., Columbia Graphophone Co., 911 Western Ave.
 Spokane, Wash., Columbia Stores Co., 161 South Post St.
 St. Louis, Mo., Columbia Graphophone Co., 1127 Pine St.
 Tampa, Fla., Tampa Hardware Co.

Headquarters for Canada:
 Columbia Graphophone Co., 54-56 Wellington St., West, Toronto Ont.

Executive Office
COLUMBIA GRAPHOPHONE CO.
 Woolworth Building New York

W. J. DYER & BRO.
 DYER B'LD'G, ST. PAUL, MINN.
 NORTHWESTERN DISTRIBUTORS
 OF THE
VICTOR
 Machines, Records and Supplies

 Shipped Promptly to all Points in the Northwest

Mickel Bros. Co.
 Omaha, Nebraska
 Des Moines, Iowa
Victor Distributors

Wholesale Exclusively
EASTERN TALKING MACHINE CO.
 85 Essex Street, Boston
VICTOR DISTRIBUTORS

Every talking machine jobber in this country should be represented in this department, no matter what kind he handles or where he is located. The cost is slight and the advantage is great.

ARTICLES OF INTEREST IN THIS ISSUE OF THE WORLD

Ready Reference for Salesmen, Dealers and Department Heads

Increasing Sales by Developing a Live Prospect List	4	Some Foolish Questions Asked in Salesmanship	32
Shaping the Future of the Industry—Keep Standards High	8	Electric Signs as Business Assets Prove Their Value	34
Prices—Why They Can Not Be Lowered at the Present Time	8	Catering Intelligently to the "Particular" Customer	39
What About Business After Christmas?—Plan for 1921	8	Putting Record Selling on a Scientific Basis	55
Dancing Masters Favor Talking Machine for Dancing	8	The Talking Machine a Vital Aid in Americanization	77
Industry Fights for Readjustment of War-time Taxation	9	Mid-West Commends Condemnation of Jazz by New York Dealers	138
Daily Press Recognizes Music Is of Interest to Public	9	Search for the Perfect Soundbox Still Goes On	138
Holding the Trade of Your Home Town—If Not, Why Not?	10	Quality Standards of Industry Must Be Maintained in 1921	138
How to Combine Art and Utility in Selling	11	Furniture Interests Boost Demand for Period Models	155
Single Idea Window Display Most Effective in Making Sales	15	Essentials in the Making of a Reproducer	158
Sheet Music Sales Result From Record Demonstrations	18	Use Attractive Borders in Your Newspaper Ads	185
Four Fundamentals of Successful Business Practice	21	Creating Christmas Atmosphere in the Music Store	185
How Four Dealers Increased Their Sales	27	A Typical Window Display for "Whispering" Suggested	185
Importance of the First Word in Addressing a Customer	29	Keeping in Touch with Musical Comedy Hits	207
		Hooking up Record Publicity with Vaudeville	208

A C B Z A C O F H K L N P Q S U A X V B D F G I J L N P Q S U V X Z V C E F H J K W O P R T A C E M
 G F J K W
 H M J O U
 P Q N
 T
 S R Q O M K V H F E C V B C E F H J K W O P R T U V W Y Z B D F G I J K L M N O P Q R S T U V W X Y Z
INDEX TO ADVERTISERS

A

Acme Die Casting Corp. 42
 Acme Engineering & Mfg. Co. 151
 Adora Phono. Co. 218
 Aeolian Co., Chicago 41
 Aeolian Co., San Francisco 98
 Alto Mfg. Co. 145
 Altschul, Frederick P. 192
 American Mica Works 169
 American Odeon Corp. 213
 American Talking Machine Co. 86
 American Walnut Mfrs. Ass'n 56
 Andrews, W. D., & C. N. 182
 Armstrong Furn. Co. 71
 Arto Co. 68, 69
 Astoria Mahogany Co. 82
 Automatic Container Co. 149

B

B & H Fibre Co. 164
 Badger Talking Machine Co. 136
 Bagshaw Co., W. H. 100
 Bahr, W. 218
 Barnhardt Bros. & Spindler 146, 191
 Bauer, E. 110
 Beecroft, Clement 97
 Bell Hood Needle Co. 193
 Blackman Talking Machine Co. 134
 Blue Bird T. M. Co. 195
 Bond's Graphophone Shop 43
 Booth Felt Co., Inc. 67
 Brandstetter, J. 144
 Brilliantone Steel Needle Co. 33
 Brandts Furn. Co. 217
 Bruno & Son, Inc. 59, 64, 81, 88, 116, 169
 Brunswick-Balke-Collender Co. Insert following page 34
 Buegeleisen & Jacobson 96
 Buchn Co., Louis 108
 Buffalo T. M. Co. 216

C

Cabinet & Accessories Co. 181
 Carpenter Paper Co. 23
 Cathedral Phono. Corp. 78
 Caviness T. M. Co. 131
 Celina Spec. Co. 69
 Charmaphone Co. 203
 Cheney Talking Machine Co. 30, 31, 97
 Chicago Talking Machine Co. 84, 85
 Cirola Phono. Co. 187
 Classified Want Ads 219, 220
 Cleveland T. M. Co. 95
 Cole & Dunas 159, 215, 216, 218, 220
 Collings & Co. 11
 Columbia Graphophone Co. 12, 13, 16, 23, 32, 43, 53, 62, 71, 91, 116, 170, 201, 216
 Commonwealth Phono. Co. 102
 Consolidated Talking Machine Co. 87
 Cressy & Allen 105
 Curry, Frank B. 101

D

Dalton Talking Machine 90
 DeMoll & Co., O. J. 28
 Deterling Mfg. Co. 173
 Ditson Co., Oliver 15
 Doctorow, D. R. 42
 Dodin, Andrew H. 226
 Doehler Die-Casting Co. 174
 Droop & Sons Co., E. F. 229
 Drying Systems, Inc. 149
 Duo-Tone Co. 53
 Dyer & Bro., W. J. 229

E

Eastern Phono. Corp. 133, 201
 Eastern Sales & Export Office 173
 Eastern Talking Machine Co. 99, 229
 Eclipse Musical Co. 6
 Edison, Inc., Thos. Back Cover, 22, 118, 200
 Efficiency Electric Co. 52
 Eight Famous Victor Artists 199
 Einson Litho, Inc. 216
 Electric Phono. Co. 67
 Elyea T. M. Co. 129
 Emerson Philadelphia Co. 107
 Emerson Phonograph Co. 70
 Emerson Record Sales Co. 10
 Esco Music & Accessories Co. 129
 Everybody's Talking Machine Co. 74
 Excel Cabinet Co. 122

F

Faultless Caster Co. 34
 Favorite Mfg. Co. 220
 Federal Electric Co. 50
 Federal Phono. Co. 214
 Feist, Leo 66, 81, 105, 208
 Ferro Phono Parts Co. 158, 174, 181, 194
 Fern-O-Grand Co. 126
 Fletcher All Tones Needle Co. 42
 Fletcher-Wickes Co. 39
 Fox Pub. Co., Sam. 209
 Franklin Phono. Co. 112
 Fuchr & Stemmer Piano Co. 66, 211
 Fulton Talking Machine Co. 162

G

Geier & Bluhm 61
 General Phonograph Corp. Insert following pages 18, 50, 58, 82 and page 190
 General Phonograph Mfg. Co. 26, 92
 Gibson-Snow Co. 37
 Globe Decalcomanic Co. 32
 Glynn, W. B., Distributing Co. 37
 Gramophone Co., Ltd. 221
 Granby Phono. Corp. 72
 Grand Rapids Brass Co. 45
 Gray Co., Walter S. 93
 Gray & Dudley Co. 21
 Gretsch Mfg. Co., Fred. 171

Grey Gull Records 114
 Griffith Piano Co. 37

H

Hallet & Davis Piano Co. 101
 Handy Mfg. Co. 158
 Harponola Co. 59
 Heath Co., A. J. 110
 Herbert & Huesgen 161
 Hessig-Ellis Drug Co. 37
 Heywood Bros. & Wakefield Co. 17
 Hillman & Son Phonograph Co. 37
 Hoffay Phono. Co. 211
 Horton-Gallo-Creamer Co. 102
 Hough, J. E., Ltd. 223
 Hough, L. W. 101
 Howe & Co., C. W. 167
 Hunt, J. D., Mfg. Co. 94

I

Isley, Doubleday & Co. 79
 Independent T. M. Co. 172
 Indiana Phono. & Supply Co. 129
 International Mica Co. 124
 Interstate Phono. Co. 111

J

Jewel Phonoparts Co. 152, 153, 154
 Jewett Phono. Co. 211
 Jones-Motrola, Inc. 51

K

Kennedy-Green Co. 136
 Kent Co., F. C. 73
 Keystone Die Casting Co. 109
 Keystone Minerals Co. 58
 Kiefer-Stewart Co. 37
 Kirkman Engineering Corp. 19
 Knickerbocker T. M. Co. 27
 Kraft, Bates & Spencer, Inc. 103

L

Lakeside Supply Co., Inc. 151
 Lampagraph Co. insert following page 26
 Lansing Co. 104
 Lawson Piano & Phono. Corp. 35
 Lee-Coit-Andresen Hdwe. Co. 37
 Lesley's 226
 Long Cabinet Co., Geo. 180
 Lorentzen, H. K. 50
 Lucky 13 Phonograph Co. 166
 Lundstrom Mfg. Co., C. J. 89
 Lyon & Healy 132, 142
 Lyons, W. H. 151
 Lyrphone Co. of America 80

M

McKinley Music Co. 209
 Magnavox Co. 37, 54
 Magnola Talking Machine Co. 34, 82, 143, 162, 203
 Mandel Mfg. Co. 156
 Marshall Co., Inc., C. L. 37
 Mellor's 46
 Mellowtone Needle Co. 121
 Mercantile Finance Co. 133
 Mermod & Co. 75
 Meyercord Co. 145
 Michigan Phono. Co. 165
 Mickel Bros. Co. 229
 Milwaukee T. M. Mfg. Co. 90
 Minneapolis Drug Co. 37
 Modernola Co. 117
 Montagnes, I., & Co. 37
 Morris Co., J. O. 76
 M. S. & E. 37
 Munn & Co. 226

N

National Co. 19
 National Decalcomania Co. 109
 National Publishing Co. 6
 Natural Voice Phono. Co. 184
 Neu & Co., H. G. 65
 New Comfort T. M. Co. 130
 New England Piano & Phono. Co. 101
 New England Talking Machine Co. 104
 New York Album & Card Co. 4
 New York Talking Machine Co. 84, 85
 Nye, William F. 61

O

Ogden Sectional Cabinet Co., Inc. 179, 188
 Ohio Sales Co. 37
 Operaphone Co. 93
 Ormes, Inc. 77
 Oro-Tone Co. 147

P

Paramount Talking Machine Co. Inside Back Cover
 Parks & Parks 127
 Pathé Frères Phonograph Co. 24, 25
 Peabody & Co., Henry W. 198
 Pearsall Co., Silas E. 9
 Peckham Mfg. Co. 74
 Peerless Album Co. 40
 Penn Phonograph Co. 109
 Perfect Automatic Brake Co. 158
 Philadelphia Show Case Co. 106
 Philwey Mfg. Co. 46
 Phoenix Trading Co. 212
 Phonograph Appliance Co. 82
 Pisknik Portable Phonograph, Inc. 162
 Plywood Corp. 173

Prescott, F. M. 48
 Progressive Phonographic Supply Co. 215
 Putnam-Page Co. 159

R

Racine Phono. Co. 65
 Reed Co. 29
 Reflexo Products Co. 14
 Regina Co. 63
 Remick Co., Jerome 207, 208
 Renington Phono. Corp. 60
 Rene Manufacturing Co. 58, 119
 Repeatograph Co. 202
 Repeater Stop Co. 157
 Rex Gramophone Co. 224
 Reynolds, Wm. H. 61
 Rishell Phono. Co. 196, 197
 Robinson, Pettit Co., Inc. 37
 Rose Valley Music Co. 75
 Rountree Corp. 120

S

Schloss Bros. 217
 Schmelzer Co. 35
 Seaburg Mfg. Co. 43
 Selle & Co., H. W. 149
 Serenado Mfg. Co. 176
 Shapiro, Bernstein Co. 206
 Shelton Elec. Co. 123
 Sherman, Clay & Co. 229
 Smith Drug Co., C. D. 37
 Smith, Kline & French Co. 37
 Smith Laboratories, H. J. 113
 Smith-Schiffin Co. 177
 Sonora Distr. Co. of Texas 37
 Sonora Phonograph Co., Inc. Inside Front Cover, 36, 37, 45

Soss Mfg. Co. 177
 Sound Recording Co., Ltd. 223
 Southern Cal. Music Co. 205
 Southern Drug Co. 37
 Southern Sonora Co. 37
 Southwestern Drug Co. 37
 Sphinx Gramophone Motors. Insert following page 66
 Stafford Mfg. Co., E. H. 158
 Standard Accessory Corp. 16
 Standard Talking Machine Co. 20, 229
 Starr Piano Co. 44
 Stead & Co., J. 222, 224
 Steel, W. R. 222
 Steger & Sons Piano Mfg. Co. 140
 Steinert & Sons Co., M. 99
 Stephenson, Inc. 38
 Sterno Manufacturing Co. 210
 Stewart Phonograph Corp. 128
 Stewart T. M. Co. 74, 127—Insert following page 10
 Stodart Phonograph Co. 160
 Stone Mfg. Co. 204
 Stone Piano Co. 168
 Stratford Phono. Co. 18
 Strevell-Paterson Hardware Co. 37
 Superior Die Casting Co. 177

T

Talking Machine Co., B'ham, Ala. 79
 Talking Machine World Dealer Service. 175
 Talking Photo Corp. 83
 Temco Mfg. Co. 149
 Thomas & Proetz Lumber Co. 116
 Toledo Talking Machine Co. 91

U

Udell Works 32
 Unit Construction Co. 183
 United Mfrs. & Dist. Co. 148
 United Phonograph Corp. 186
 Universal Fixture Corp. 178
 Universal Stamping & Mfg. Co. 150
 U-Sav-Your Mfg. Co. 163
 Usoskin Litho 50

V

Val Accessory House 169
 Van Houten, C. J., & Zoon. 37, 155
 Van Veen & Co. 194
 Victoria Mfg. Co., Inc. 190
 Victor Talking Machine Co. Front cover, 5, 7
 Vitanola Distributors Co. 112
 Vitanola T. M. Co. 125
 Volker & Co. 229

W

Wade Co., R. C. 57
 Wade & Wade 141
 Wade Talking Machine Co. 137
 Wade, W. H. 62
 Walters & Barry 37
 Walthall Music Co. 55
 Ward Co., C. E. 58
 Watson Bros. & Co. 104
 Weber-Knapp Co. 88
 Werlein, Ltd., Philip 170
 Weser Bros. 135
 Weymann & Son, H. A. 108
 Whitsit Co., Perry B. 229
 Widdicomb Furniture Co. 49
 Wimpfheimer & Bro., A. 48
 Windsor Furniture Co. 47
 Winterrath, Frank 125
 Wonder T. M. Co. 94

Y

Yahr & Lange Drug Co. 37
 Yeuell Co., E. V. 169

Z

Ziegler, Bakcr & Johnson. 115



CONSIDER THIS: Behind The Paramount are resources of \$2,000,000; three great plants manufacturing a complete line of phonographs, records, needles and accessories; production that insures prompt deliveries; Saturday Evening Post Advertising; a complete plan of dealer co-operation

—and most important, the Paramount is a phonograph which builds sales in every neighborhood through its own merit.

The big selling season has started—get in touch with the jobber in your territory now.

The Paramount Company
Port Washington, Wis.

Paramount Releases for December

- | | | | |
|-------|--|-------|--|
| 20029 | READ 'EM AND WEEP.....Al. Bernard | 33044 | ADESTE FIDELISCardinal Quartet |
| | MY LITTLE BIMBO DOWN ON THE BAMBOO | | CHRISTMAS CHIMES—Duet, |
| | ISLE—Vocal SoloAl. Bernard | | Inez Barbour-Elizabeth Lennox |
| 20031 | JUST LIKE A GYPSY—Medley Intro.: "I'm Always | 33068 | KAWAHAFerera & Franchini |
| | Falling in Love With the Other Fellow's Girl"— | | HAWAIIAN TWILIGHTFerera & Franchini |
| | Accordion SoloFrosini | | HOLY NIGHT—Violin, 'Cello and Piano, |
| | DOWN IN CHINATOWN—Fox-trot. Accordion | 33069 | Hackel Berge Trio |
| | SoloFrosini | | SILENT NIGHT, HOLY NIGHT—Violin, 'Cello and |
| 20030 | JAPANESE SANDMAN—Fox-trot, | | PianoHackel Berge Trio |
| | Selvin's Novelty Orch. | 33070 | O COME ALL YE FAITHFUL...Reed Miller's Quartet |
| | FAIR ONE—Fox-trotNewport Society Orch. | | VOICE OF THE CHIMES.....Reed Miller's Quartet |
| 33043 | KIDDIES' DANCEParamount Band | | POET AND PEASANT OVERTURE—Part 1, |
| | KIDDIES' PATROLParamount Band | | Creator and His Band |
| 33045 | JOY TO THE WORLD.....Cardinal Quartet | 50035 | POET AND PEASANT OVERTURE—Part 2, |
| | ADESTE FIDELIS—Piano Solo.....Clifford Murray | | Creator and His Band |

Distributors

SHIPLEY-MASSINGHAM CO.,
Pittsburgh, Pa.,
For Western Penn. and West Virginia.

JOERNS BROS. MFG. CO.,
St. Paul, Minn.,
For Minn., So. Dak., No. Dak.
Eastern Montana.

E. R. GODFREY & SONS CO.,
Milwaukee, Wis.,
For Iowa, Illinois, Michigan, Indiana
and Wisconsin.

PETER-NEAT-RICHARDSON CO.,
Louisville, Ky.
For Kentucky.

THE OHIO PARAMOUNT CO.,
6101 Euclid Ave., Cleveland, O.,
For Ohio.

BREWER & CO.,
Boston, Mass.,
For New England States.

RICHMOND HARDWARE CO.,
Richmond, Va.,
For Virginia.

WITTE HARDWARE CO.,
St. Louis, Mo.
For Missouri.

P. C. DOERR CO.,
New Orleans, La.,
For Mississippi and Louisiana.

SOUTHERN PARAMOUNT CO.,
Atlanta, Ga.,
For Georgia, No. Carolina, So. Carolina
and Florida

PEDEN IRON & STEEL CO.,
Houston, Texas,
For Texas.

BRANDON & TURNER,
Little Rock, Ark.,
For Arkansas.

H. D. TAYLOR CO.,
Buffalo, N. Y.,
For West New York.

A. J. HARWI HARDWARE CO.,
Atchison, Kans.,
For Kansas.

OKLAHOMA PHONOGRAPH CO.,
Oklahoma City, Okla.,
For Oklahoma.

PARAMOUNT SALES CO.,
Denver, Colo.,
For Colorado, Wyoming, New Mexico,
Utah, Arizona, Eastern Nevada, South-
ern Idaho, Southern Montana.

Paramount

Phonographs *and* Records

Edison Phonographs

A Before-the-War Value
at an After-the-War Price

“Edison Stood the Gaff”

THOMAS A. EDISON, Inc.

ORANGE, NEW JERSEY

**JOBBER OF THE NEW EDISON, EDISON RE-CREATIONS, THE NEW EDISON DIAMOND AMBEROLA
AND BLUE AMBEROL RECORDS**

CALIFORNIA
Los Angeles—Edison Phonographs,
Ltd.
San Francisco—Edison Phonographs,
Ltd.

COLORADO
Denver—Denver Dry Goods Co.

CONNECTICUT
New Haven — Pardee-Elleherger
Co., Inc.

GEORGIA
Atlanta—Phonographs, Inc.

ILLINOIS
Chicago — The Phonograph Co.
Wm. H. Lyons (Amberola only).

INDIANA
Indianapolis—Kipp Phonograph Co.

IOWA
Des Moines—Harger & Blish.
Sioux City—Harger & Blish.

LOUISIANA
New Orleans—Diamond Music Co.,
Inc.

MASSACHUSETTS
Boston—Pardee-Elleherger Co.
Iver Johnson Sporting Goods
Co. (Amberola only).

MICHIGAN
Detroit—Phonograph Co. of
Detroit

MINNESOTA
Minneapolis—Laurence H.
Lucker

MISSOURI
Kansas City—The Phonograph Co.
of Kansas City.
St. Louis—Silverstone Music
Co.

MONTANA
Helena—Montana Phonograph
Co.

NEBRASKA
Omaha—Shultz Bros.

NEW YORK
Albany—American Phonograph
Co.
New York—The Phonograph
Corp. of Manhattan.
Syracuse—Frank E. Bolway & Son,
Inc. W. D. Andrews Co.
(Amberola only).

OHIO
Cincinnati—The Phonograph Co.
Cleveland—The Phonograph Co.

OREGON
Portland—Edison Phonographs,
Ltd.

PENNSYLVANIA
Philadelphia—Girard Phono-
graph Co.
Pittsburgh—Buehn Phonograph
Co.
Williamsport—W. A. Myers.

RHODE ISLAND
Providence—J. A. Foster Co.
(Amberola only).

TEXAS
Dallas—Texas-Oklahoma Phono-
graph Co.

UTAH
Ogden—Proudfit Sporting Goods
Co.

VIRGINIA
Richmond—The C. B. Haynes
Co., Inc.

WISCONSIN
Milwaukee—The Phonograph Co.
of Milwaukee.

CANADA
Montreal—R. S. Williams &
Sons Co., Ltd.
St. John—W. H. Thorne & Co.,
Ltd.
Toronto—R. S. Williams & Sons
Co., Ltd.
Vancouver—Kent Piano Co., Ltd.
Winnipeg—R. S. Williams & Sons
Co., Ltd.
Babson Bros. (Amberola only).
Calgary—R. S. Williams & Sons
Co., Ltd.