

SHORT WAVE & TELEVISION

The Popular Radio Magazine

"THE WORLD LISTENS"



**HUGO
GERNSBACK**
EDITOR



**BEST SHORT-WAVE STATION LIST
HOW TO GET OVERSEAS STATIONS
NEWEST RADIO EXPERIMENTS
RADIO QUESTIONS AND ANSWERS**



25c
IN U.S. AND
CANADA

**APRIL
1938**

For Practical Television Training

WHICH WOULD YOU CHOOSE

As The Best Value For The Money?

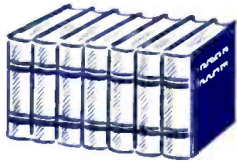

Why be satisfied with just a set of books and perhaps a small dab of instruction equipment? Why attempt to develop a career with the above when for the same price you can get all the equipment shown at the right? We are not condemning or belittling others . . . we just offer you **MORE** for your money . . . this comparison gives you an idea of how *much* more you get from American Television Institute. You be the judge!

OR

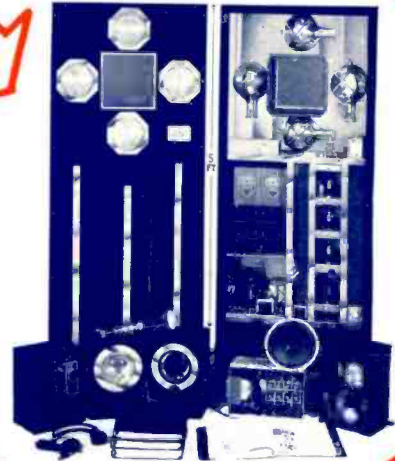

BE YOUR OWN JUDGE

Illustrated above is the equipment you receive from the American Television Institute. A remarkable offer, not equalled anywhere in Radio-Television today! In addition to a superior course of Television-Radio Training with all necessary text books, you get, **AT NO EXTRA COST**, this full sized professional Television Transmitter and Receiver, regularly used for public exhibitions, with a steel rack nearly six feet high and two feet wide; R.C.A. Amplifier and Modulator Tubes throughout; 50 Watt Radio Transmitter; Superheterodyne Receiver; Speaker; Meters; Phones. Four of A.T.I.'s Giant Photo-Electric Cells; a 7" x 21" Cathode Ray Receiving Tube; together with all other parts too numerous to list here, to make a complete Television Transmitter and Receiver that will receive any modern 441 line signal.

AMERICAN TELEVISION *Definitely* OFFERS YOU MORE!

YOU CAN MAKE OVER 350 DIFFERENT EXPERIMENTS WITH A. T. I. EQUIPMENT!

With this A.T.I. Television Equipment you can make over 350 amazing, interesting experiments right in your own home. You can produce your own Television program for a local audience . . . transmitting and receiving the faces of your friends. You can build complete Television Transmission and Reception Systems. Television Amplifiers. Radio Transmitters, Television Pick-ups, Photo-electric Relays, Radio and Television Receivers. Projection System. Light Beam Telephone. Magic Lantern. Grid-Glow Alarms. Scanning Systems. Sound Amplifiers. Current-Levers. Photo-electric Photometers. You can make hundreds of experiments and comparison tests that show you the phenomena of Television and Radio in a quick, simple way . . . much easier to understand than just mere words in a book. Get all the facts about this amazing offer . . . **SEND THE COUPON NOW!**

There is no doubt as to which of the above is the best value for the money. The American Television Institute offers you the most complete Television Training Course in the world, today. The A.T.I. system of teaching Television, Radio and Electronic Engineering is as new and advanced as Television itself. Not mere theory from texts, not experimental work performed by an instructor with you looking on, not the wiring of a few panel boards or the construction of a small dab of equipment. The A.T.I. method is thorough . . . you learn with **ACTUAL TELEVISION EQUIPMENT** that *really* works . . . all training is under the exacting supervision of Mr. U. A. Sanabria, one of the world's foremost Television authorities. *American Television Institute is now training more Television Engineers than all other organizations combined.* There's a definite reason for this . . . the above comparison shows it very simply.

TELEVISION COMMERCIAL IN ENGLAND! ARE YOU PREPARED?

Television Engineering will be the next high salaried profession. Get in on the ground floor and cash in on the great profit possibilities of this fascinating new industry. Trained Television men will command from \$2,500 to \$25,000 a year. A.T.I. gives you complete recognized training in Television and Radio Engineering . . . qualifies you during the first few months to take your **RADIO TELEPHONE FIRST CLASS GOVERNMENT LICENSE EXAMINATION** and get into a good paying job in radio while completing your Television instruction. Write for complete details and further information. *Entire Training and Equipment available on amazingly low, easy payments.* **SEND COUPON NOW . . . NO OBLIGATION WHATEVER!**

FREE BOOKLETS! INSIDE FACTS!

We have compiled, what we believe is, the most interesting and authentic data on Television you've ever read. It's yours **FREE** for the asking. Gives you real **INSIDE FACTS** . . . Technical details . . . diagrams . . . illustrations . . . cathode ray tube construction . . . Television operation . . . and hundreds of other important, interesting **FACTS**. We will send *this data without cost or obligation* so you may determine how to qualify for entrance into the American Television Institute and how A.T.I. training will benefit you and equip you for a future in Television. Clip coupon and mail it to us, **NOW!**

AMERICAN TELEVISION INSTITUTE

433 E. Erie St., Dept. SW438, Chicago, Ill.
Gentlemen: Please send me your Free Television Lessons and literature described on this page. No obligation.

Name Age
Street
City State

4 Free LESSONS in TELEVISION
THIS OFFER GOOD FOR A LIMITED TIME ONLY!
DON'T DELAY! SEND THE COUPON NOW!



J. E. SMITH, President
NATIONAL RADIO INSTITUTE
 Established 1914

The man who has directed the home study training of more men for the Radio Industry than any other man in America.

I will send you a Lesson Free to show how I train you at home in spare time for Good Jobs in Radio



Broadcasting Stations

Employ managers, engineers, operators, installation and maintenance men for fascinating jobs and pay up to \$5,000 a year.



Set Servicing

Spare time set servicing pays many \$5, \$10, \$15 a week extra while learning. Full time servicing pays as much as \$30, \$50, \$75 a week.



Loud Speaker Systems

Building, installing, servicing and operating public address systems is another growing field for men well trained in Radio.

Lesson on Radio Servicing Tips FREE

I'll prove my Training gives practical, money-making information, is easy to understand—just what you need to master Radio. My sample lesson text, "Radio Receiver Troubles—Their Cause and Remedy" covers a long list of Radio receiver troubles in A.C., D.C., battery, universal, auto, T.R.F., superheterodyne, allwave, and other types of sets. A cross reference gives you the probable cause and a quick way to locate and remedy these set troubles. A special section is devoted to receiver check-up, alignment, balancing, neutralizing and testing. You can get this lesson Free. No obligation.



MAIL COUPON NOW

Do you want to make more money? I'm sure I can train you at home in your spare time for a good Radio Job. I'll send you a lesson absolutely FREE. Examine it, read it, see for yourself how practical it is to learn Radio at home, how easy it is to understand—even if you've never had Radio experience or training.

Many Radio Experts Make \$30, \$50, \$75 a Week

Radio broadcasting stations employ engineers, operators, station managers and pay up to \$5,000 a year. Spare time Radio set servicing pays as much as \$200 to \$500 a year—full time jobs with Radio jobbers, manufacturers and dealers pay as much as \$30, \$50, \$75 a week. Many Radio Experts operate their own full time or part time Radio sales and service businesses. Radio manufacturers and jobbers employ testers, inspectors, foremen, engineers, servicemen, paying up to \$6,000 a year. Automobile, police, aviation, commercial Radio, loud speaker systems are newer fields offering good opportunities now and for the future. Television promises to open many good jobs soon. Men I trained are holding good jobs in these branches of Radio. Read their letters in my 64-Page Book. Mail the coupon.

There's a Real Future in Radio for Well Trained Men

Radio already gives good jobs to more than 300,000 people. And in 1936, Radio enjoyed one of its most prosperous years. More than \$500,000,000 worth of sets, tubes and parts were sold—an increase of more than 60% over 1935. Over a million Auto Radios were sold, a big increase over 1935. 24,000,000 homes now have one or more Radio sets, and more than 4,000,000 autos are Radio equipped. Every year millions of these sets go out of date and are replaced with newer models. More millions need servicing, new tubes, repairs, etc. A few hundred \$30, \$50, \$75 a week jobs have grown to thousands in 20 years. And Radio is still a new industry—growing fast!

Many Make \$5, \$10, \$15 a Week Extra In Spare Time While Learning

Almost every neighborhood needs a good spare time serviceman. The day you enroll I start sending you Extra Money Job Sheets. They show you how to do Radio repair jobs, how to cash in quickly. Throughout your training I send you plans and ideas that have made good spare time money—from \$200 to \$500 a year—for hundreds of fellows. I send you special Radio equipment and show you how to conduct experiments and build circuits which illustrate important Radio principles. My training gives you PRACTICAL EXPERIENCE while learning.

I Give You A Professional Servicing Instrument

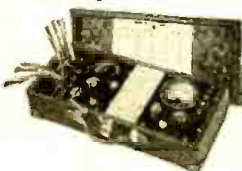

Here is the instrument every Radio expert needs and wants—an All-Wave, All-Purpose, Set Servicing Instrument. It contains everything necessary to measure A.C. and D.C. voltages and current; test tubes, resistance; adjust and align any set, old or new. It satisfies your needs for professional servicing after you graduate—can help you make extra money servicing sets while learning.

Find Out What Radio Offers You Get My 64 Page Book Free Now

Act Today. Mail the coupon now for my Free Lesson and my book, "Rich Rewards in Radio." Both are free to anyone over 16 years old. My book points out Radio's spare time and full time opportunities and those coming in Television; tells about my Training in Radio and Television; shows you letters from men I have trained, telling what they are doing and earning; shows my Money Back Agreement. Find out what Radio offers YOU! MAIL THE COUPON in an envelope, or paste it on a penny post card—NOW!

J. E. Smith, President
National Radio Institute,
Dept. 8DB3, Washington, D. C.

HERE'S PROOF



\$10 Week In Spare Time

"My work has consisted of Radio set servicing, with some Public Address Systems work—all in my spare time. My earnings in Radio amount to about \$10 a week."—WILLIAM MEYER, 705 Ridge Road, Hobart, Ind.



Earnings Tripled by N. R. I. Training

"I have been doing nicely, thanks to N. R. I. Training. My present earnings are about three times what they were before I took the Course. I consider N. R. I. Training the finest in the world."—BERNARD COSTA, 201 Kent St., Brooklyn, N. Y.

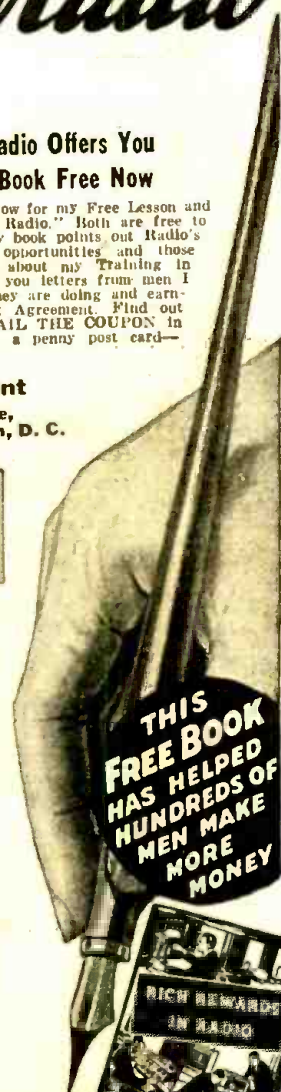

Good for FREE SAMPLE LESSON and BOOK on RADIO'S OPPORTUNITIES

J. E. SMITH, President
 National Radio Institute, Dept. 8DB3
 Washington, D. C.

Dear Mr. Smith: Without obligation send me free the Sample Lesson and your 64-Page Book "Rich Rewards in Radio," telling about spare time and full time Radio opportunities, and how I can train for them at home in spare time. (Please write plainly)

NameAge

Address

CityState14X-1

The Tested Way to BETTER PAY



Globe Photo

Frederick Lanaway, of London, winner of the 45th Short Wave Scout Trophy, in his listening den.

Feature Authors this Month

Dr. D. M. Morandini, Ph. D.
C. W. Palmer, E.E.
George W. Shuart, W2AMN
Edward Peil, Jr.
John Stewart
Pierre Delaunay

In the May Issue

- How to Build a "Lie Detector," with photos and diagrams, by George F. Huether.
- The 1938 Beginner's Station, George B. Hart
- 2-Tube 5-Meter Receiver, George W. Brooks, WIJNO.
- 5-Tube Battery Superhet, Raymond P. Adams.
- Build Your Own Television Receiver, Part 3; C. W. Palmer, E.E.
- 250 Watt R.F. Amplifier using 808's, Art Gregor.
- Latest Short-Wave and Television Foto News.



Certified Circuits

When you see this seal on a set it is a guarantee that it has been tested and certified in our laboratories, as well as privately in different parts of the country. Only constructional—experimental sets are certified. You need not hesitate to spend money on parts because the set and circuit are bona fide. This is the only magazine that renders such a service.

SHORT WAVE & TELEVISION

APRIL — 1938

Vol. VIII No. 12

HUGO GERNSBACK, Editor
H. WINFIELD SECOR, Manag. Editor
M. HARVEY GERNSBACK, Assoc. Editor

The Next issue comes out
April 1st

In This Issue

NEW DEVELOPMENTS

New Avenues for Television, Dr. D. M. Morandini	661
What Sun-Spots Do to Short Waves, H. W. Secor	662
Short Wave Foto News	664
Short-Wave Propaganda, M. Harvey Gernsback	666
Short-Wave Broadcasting In India	668
4-Inch Waves Turn Science <i>Topsy-Turvy</i>	669
Short Waves Land Planes in New Army System	674

S-W STATIONS—HOW TO FIND THEM

Short Wavers' Yardstick	673
How to Identify S-W Stations	675
World S-W Stations	676
Let's Listen In with Joe Miller	677

TELEVISION

News Bulletins Via Wired Television	674
Build Your Own Television Receiver, Part 2, C. W. Palmer, E.E.	690
The "Polaroid Kinescope" for Large Television Images, E. W. Leaver ..	703

LATEST SHORT WAVE APPARATUS

696

CONSTRUCTOR

Model Ship Guided By Radio Waves, Pierre Delaunay	670
New Experiments With Radio Apparatus	681
Any Beginner Can Build This I-Tuber, G. W. Shuart, W2AMN	686
A "3 for 5" Receiver—range 4.5-11 meters, Ed Peil, Jr.	688
How To Build a 441-Line C-R Tube Receiver, C. W. Palmer, E. E.	690
5 and 10 Meter Crystal-Control Transmitter, John Stewart	692

MISCELLANEOUS

Short Wave FOTO NEWS	664
What Do You Think?	671
Short Wave <i>Kinks</i>	672
Can You Answer These Radio Questions?	675
Question Box	683
The S-W Listener Asks	685
Short Wave Scout Trophy Award	693
Short Wave League—"When to Listen In," M. Harvey Gernsback	711
How I Became A Telegraph and Radio Operator, C. R. McDonald, W8CW, Ex-W8AZC	715
Book Review	720

Cover photo composition by H. Gernsback and Arthur Maclean. Maxine, popular NBC songstress is featured. Tower is that of Columbia Broadcasting System station WABC.

SHORT WAVE & TELEVISION—Published monthly on the first of the month, 12 numbers per year. Entered as second-class matter Feb. 15, 1938, at the post office at Springfield, Mass., under the act of March 3, 1879. Trademarks and copyrights by permission of H. Gernsback, 99-101 Hudson St., N. Y. C. Text and illustrations are copyright and may not be reproduced without permission. Address all contributions to Editor, SHORT WAVE & TELEVISION, 99 Hudson St., N. Y. C. We are not responsible for lost manuscripts. Contributions cannot be returned unless authors remit full postage. Subscription price \$2.50 a year in the United States and possessions and Canada. \$3.00 in foreign countries. Single copies 25c, on sale at principal newsstands in the United States and Canada. Make all subscription checks payable to Popular Book Corporation. Printed in U. S. A.

SHORT WAVE & TELEVISION

Copyright 1938, by H. Gernsback
Published by Popular Book Corporation
Publication Office—29 Worthington St., Springfield, Mass. Editorial and Executive Offices—99 Hudson St., New York, N.Y.
HUGO GERNSBACK, President; H. W. SECOR, Vice President; EMIL GROSSMAN, Director of Advertising. European Agents: Goringe's American News Agency, 9A Green St., Leicester Square, London W.C. 2; Brentano's—London and Paris. Australian Agents: McGill's Agency, 179 Elizabeth St., Melbourne.

TRAIN FOR RADIO IN 12 WEEKS

BY MY QUICK, EASY "LEARN BY DOING" METHOD



Prepare today to enter a real money-making field by my quick, easy way to learn Radio. Here in my school you are trained in **12 weeks** for your start for a better job and a real future. You do actual work on a great outlay of Radio equipment. The remarkable "**Learn-By-Doing**" methods used in the great Coyne Shops train you in **Radio, Television** and sound equipment servicing. Not by books . . . Not by Correspondence . . . But all under the individual guidance of skilled instructors, and only on similar kind of work you will meet out on a real job. My methods make it **easy to learn**—First you are **told** how to do a thing—then you are **shown** how to do it—then you **do the work yourself**. **WHERE ELSE CAN YOU FIND SO QUICK AND EASY A WAY TO GET PRACTICAL TRAINING IN THIS GIANT INDUSTRY?**

I'LL FINANCE YOUR TRAINING

DON'T LET LACK OF MONEY keep you from sending in the Coupon TODAY. Learn how you can get training first and take more than a year to pay for it after graduation. Make your first payment 60 days after your regular 12 weeks' training period ends. Then take over a year to pay the balance of your tuition in easy monthly payments. Hundreds of ambitious fellows have used this method to get Coyne Training. **FILL IN THE COUPON AND MAIL IT TODAY.** It will bring you the details of this amazingly quick and easy way to get your start towards a good pay job.



H. C. Lewis

Radio—Television—Sound Equipment

Your training at Coyne is in wonderful, modern daylight shops on the finest kind of **RADIO, TELEVISION** and **SOUND EQUIPMENT**. Television is sure to come as a commercial industry, whether this year or next. Talking Picture and Public Address Systems offer opportunities for the trained man. Everything possible has been done to make your stay at Coyne happy and healthful as well as profitable.

Electric Refrigeration Training Included at No Extra Cost

This combination Training (Radio and Refrigeration) can be of great value to you. Whether you go into business for yourself or get a job working for a Radio Sales and Service organization, the fact that you are trained in servicing Electric Refrigerators should be profitable to you. Many Radio Manufacturers also make Electric Refrigerators and men with this combination training are much more valuable to these employers. You can **NOW** get this training without extra cost.

No Advanced Education or Previous Experience Needed

If you can read and write simple English and are ambitious you can be trained the Coyne way—by actual experience on a wide variety of up-to-date Superheterodyne sets, oscillators, analyzers, and test instruments. You learn how to operate television receiving and transmitting equipment and how to install, test and service public address systems and sound picture equipment. Coyne training also helps prepare you to qualify for a government license examination as Amateur Broadcast or Telegraph Radio Operator and to know Code and Department of Commerce rules. Send coupon for all details.

Part Time Work While Learning Employment Service after Graduation

If you need part time work to help pay living expenses while training, my Employment Department will help you get it. They will also give you Life-time Employment Service after you graduate.

Mail Coupon Today I'll Send You All the Facts

Get the new "Coyne Opportunity Catalog," giving all facts about Coyne Training. Photographs of Shops showing students at work on modern radio equipment under the personal supervision of Coyne Expert Instructors. Also details of my Part Time Employment Offer, Pay After Graduation Plan and Graduate Employment Service. Yours without cost. Simply Mail the Coupon.



H. C. LEWIS, President,
Radio Division, Coyne Electrical School,
500 S. Paulina St., Dept. 48-2K, Chicago, Ill.

Send me your big **FREE** Book about Coyne Training and give me all details regarding your "Part Time Employment Offer" and "Pay After Graduation Plan" of easy, monthly payments.

NAME.....AGE.....
ADDRESS.....
CITY.....STATE.....

H. C. LEWIS, President RADIO DIVISION Founded 1899
COYNE ELECTRICAL SCHOOL
500 S. Paulina St., Dept. 48-2K Chicago, Ill.

Please mention **SHORT WAVE & TELEVISION** when writing advertisers

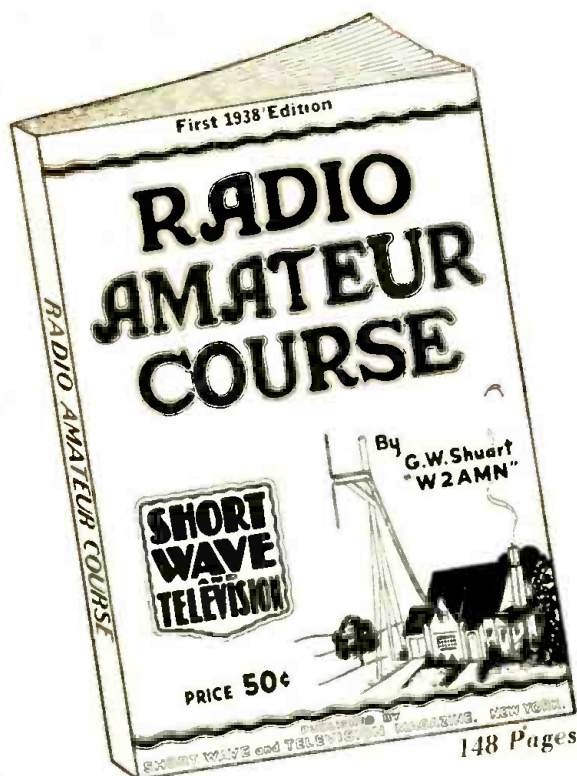

SEE this remarkable book at your dealer

Glance over its 148 pages containing over 150 diagrams and halftone cuts. Read step by step how you can obtain the foundation of a short wave radio education

This book represents the biggest value you ever received for 50c

Written by Geo. W. Shuart, W2AMN—
the authority on short waves

Your library is not complete without it

A new book that will appeal to tens of thousands—
An essential book for all beginners—

ON SALE AT THE FOLLOWING DEALERS

ARIZONA

Sam's Cigar Store,
127 N. First Ave.,
Phoenix.

CALIFORNIA

Scott Wholesale Radio Co.,
344 E. Fourth Street,
Long Beach.
Offenbach Electric Co., Ltd.,
1452 Market Street,
San Francisco.
Zack Radio Supply Co.,
1426 Market Street,
San Francisco.

COLORADO

Auto Equipment Co.,
14th at Lawrence,
Denver.

CONNECTICUT

Radio Inspection Service Co.,
227 Asylum Street,
Hartford.
Stern Wholesale Parts, Inc.,
Stern Bldg., 210 Chapel St.,
Hartford.

GEORGIA

Wholesale Radio Service Co., Inc.,
430 W. Peachtree St., N.W.,
Atlanta.

ILLINOIS

Allied Radio Corporation,
833 West Jackson Blvd.,
Chicago.
Newark Electric Company,
226 W. Madison Street,
Chicago.
Wholesale Radio Service Co., Inc.,
901 W. Jackson Blvd.,
Chicago.

INDIANA

Van Sickle Radio, Inc.,
34 West Ohio Street,
Indianapolis.

MASSACHUSETTS

Greater Boston Distributors,
40 Waltham St.,
Boston.
H. Jappe Co., 46 Cornhill,
Boston.
Wholesale Radio Service Co., Inc.,
110 Federal Street,
Boston.
Springfield Radio Co.,
397 Dwight Street,
Springfield.
H. Jappe Co., 37 Mechanic Street,
Worcester.

MICHIGAN

Rigel Brothers, Inc.,
5027 Hamilton Ave.,
Detroit.

MISSOURI

Modern Radio Company,
409 No. Third Street,
Hannibal.
Hurstel-Applebee Co.,
1012-14 McTee Street,
Kansas City.
Van Sickle Radio Co.,
1113 Pine Street,
St. Louis.

NEBRASKA

Radio Accessories Company,
2-66 Farnam Street,
Omaha.

NEW HAMPSHIRE

Radio Service Laboratory,
1187 Elm Street,
Manchester.

NEW JERSEY

Aero Radio Co.,
227 Central Avenue,
Newark.
Wholesale Radio Service Co., Inc.,
219 Central Avenue,
Newark.

NEW YORK

Wholesale Radio Service Co., Inc.,
542 E. Fordham Rd.,
Bronx.
Wholesale Radio Service Co., Inc.,
90-08 166th Street,
Jamaica, L. I.
Blau, The Radio Man, Inc.,
64 Dey Street,
New York City.
Eagle Radio Co.,
84 Cortlandt Street,
New York City.
Federated Purchaser, Inc.,
23-25 Park Place,
New York City.
Harrison Radio Co.,
12 West Broadway,
New York City.
Sun Radio Co.,
227 Fulton Street,
New York City.
Terminal Radio Corp.,
80 Cortlandt Street,
New York City.
Thor Radio Corp.,
65 Cortlandt St.,
New York City.
Try-Mo Radio Co., Inc.,
85 Cortlandt Street,
New York City.
Wholesale Radio Service Co., Inc.,
100 Sixth Avenue,
New York City.
Radio Parts & Equipment Co.,
244 Clinton Avenue No.,
Rochester.
M. Schwartz & Son,
710-712 Broadway,
Schueneady.

OHIO

News Exchange,
51 So. Main Street,
Akron.

CANTON RADIO & SUPPLY CO.

1140 Tuscarawas Street, W.,
Canton.
United Radio, Inc.,
1103 Vine Street,
Cincinnati.
The Hughes-Peters Electric Corp.,
178-180 N. Third Street,
Columbus.
Standard Radio Parts Co.,
135 East Second Street,
Dayton.

OREGON

Portland Radio Supply Co.,
1300 W. Burnside Street,
Portland.

PENNSYLVANIA

Radio Distributing Co.,
1124-26 Market Street,
Harrisburg.
M. & H. Sporting Goods Co.,
512 Market Street,
Philadelphia.
Cameradio Co.,
963 Liberty Ave.,
Pittsburgh.

RHODE ISLAND

W. H. Edwards Co.,
32 Broadway,
Providence, R. I.

UTAH

O'Loughlin's Wholesale Radio Supply,
315 South Main Street,
Salt Lake City.
Radio Supply, Inc.,
46 Exchange Place,
Salt Lake City.

WASHINGTON

Spokane Radio Co., Inc.,
611 First Avenue,
Spokane.

WISCONSIN

Radio Parts Co., Inc.,
530-528 W. State Street,
Milwaukee.

TEXAS

Amarillo Electric Co.,
111 East 8th Avenue,
Amarillo.

AUSTRALIA

McGill's Agency,
183-184 Elizabeth Street,
Melbourne.

CANADA

The T. Eaton Co., Ltd.,
Winnipeg.
Manitoba.
Canadian Electrical Supply Co., Limited,
285 Craig Street W.,
Montreal, Que.
Metropolitan News Agency,
1248 Peel Street,
Montreal, Que.

CUBA

The Diamond News Co.,
Palacio Asturiano, Por San Jose,
Habana.

ENGLAND

Gorrings's American News Agency,
9a, Green Street, Leicester Square,
London, W.C.2.

INDIA

Empire Book Mart,
Box 631,
Bombay.

MEXICO

American Book Store, S. A.,
Avenida Madero 25,
Mexico City.
Central De Publicaciones,
Avenida Juarez, 4, Apartado 2430,
Mexico, D. F.

NEW ZEALAND

Te Aro Book Depot, Ltd.,
64 Courtenay Place,
Wellington.

SOUTH AFRICA

Technical Book Co.,
147 Longmarket Street,
Cape Town.

IF NOT AT YOUR DEALER'S, PLEASE SEND HIS NAME AND ADDRESS AND WE WILL CREDIT HIM WITH YOUR ORDER. PLEASE FILL OUT COUPON BELOW.

SHORT WAVE AND TELEVISION, SW-4-38
99 Hudson Street, New York City.

Gentlemen: I enclose herewith my remittance for 50c, for which please send me my copy of the "RADIO AMATEUR COURSE" postpaid.

Name

Address

City State

Dealer's Name and Address.....
(Send remittance in form of check or money order. If letter contains cash or unused U. S. postage stamps, register it.)

Be sure to see future copies of Short Wave & Television for additional names of dealers handling this book.
SHORT WAVE & TELEVISION, 99 HUDSON ST., NEW YORK CITY

Please mention SHORT WAVE & TELEVISION when writing advertisers

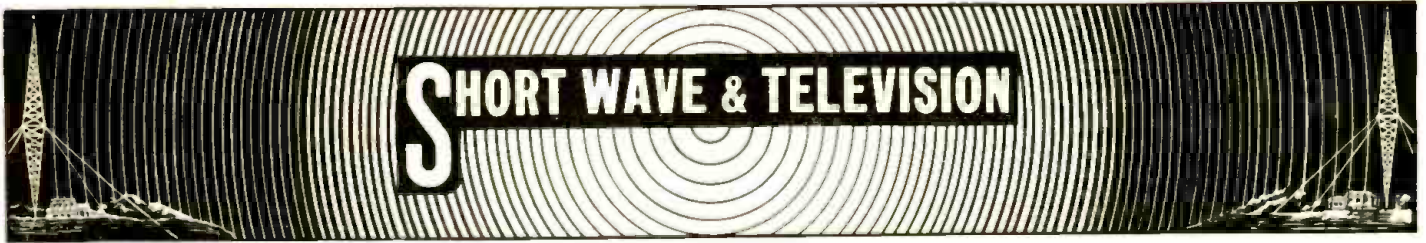

HUGO GERNSBACK, EDITOR

H. WINFIELD SECOR, MANAGING EDITOR

New Avenues for TELEVISION

Dr. D. M. Morandini, Ph.D.

● RECENTLY radio and television underwent changes of minute elaboration and coordinative complexity. The unique behavior of electron-emitting devices, such as radio tubes, cathode-ray tubes and photoelectric cells, is responsible first of all for the rapid development of the radio and television arts during the past two decades. The quick rate of advance, and the precision in detail and in coordination of parts brought forth highly sensitive and dependable sending and receiving apparatus in the field of communication by means of high frequency electrical radiations. In television, for instance, 441 line scanning is contemplated with 30 pictures to be sent per second, establishing—theoretically—the necessity of sending, in case of a square picture, 5,834,430 picture impulses in the same short time. And although the actual number of changes in unit time may be taken to be much less, nevertheless the high number of impulses still remaining demands a precision and cooperation (synchronization) between sender and receiver, which ten years ago was not even thought of, and which renders the art of television, by means of short waves and scanning, highly complex.

Today we have an elaborate electrical system with monitors, modulators, video amplifiers, master oscillators, transfer circuits, transmission lines, coaxial cables, synchronizing generators, cathode-ray oscillographs, and photo-cells (with various trade-names), etc., and a correspondingly elaborate system of electron-optics. Disturbances, such as interference, drifting of the picture, fading, etc., will, under these circumstances, make the introduction of practical television in this country a very difficult matter even without considering the economic difficulties which almost prohibit the sale of cheap television receivers.

I often wonder whether this orientation of the television art, toward which we are all working, will really supply the solution that will have as permanent an effect on television practice as the present radio



Dr. D. M. Morandini

Mechanical and electrical engineer, lecturer in mathematical physics, instructor of television at University College, University of Southern California. Director of research at the Television Research Society, Los Angeles, California.

design principles have on aural radio. The composition of television images from an enormous number of electronically generated picture mosaics, which follow one another in a synchronized time order of extremely short intervals, may seem to us a technically most expedient solution at the present time. However, its feasibility and the inventive ingenuity applied to it by our best technical brains should not, I believe, divert all our inventive readiness into a single groove. It appears to me that any other method than a transmission involving electron-scanning is not even thought of any more. All other possibilities seem to be simply considered as impossible of solution. This is not to say that our present elaborations of high precision, detail and complexity are not appreciated. The author has occupied himself along these lines for many years now. It simply means we should heed the warning that there may

be other avenues of approaching the solution, so as to encourage the imaginative faculties of those who dream along other lines and, at the same time, have the necessary technical preparation to pursue their dreams and check them by their engineering talents.

Although, at the present time, I am not able to point out definitely any direction which would serve as an additional basis for development and would furnish us with dependable alternatives, yet I can not acquiesce complacently in the unconditional acceptance of a *single-track* method of attack. It may easily be that the transmission of television communication through cables accommodating wide frequency ranges will be adopted for the development of a trans-American television network, when and if conditions will permit its introduction; the problems of transmission and redistribution, however, will still welcome, I think, new methods if such are made available.

Let me point to at least one path offering such an assisting possibility. Our attention in dealing with electronic devices in television has been concentrated thus far around the electron (cathodic) beam which is utilized in picture analysis and synthesis. At the transmitting end we expose the picture elements, upon a light-sensitive surface, one by one, in quick succession and in a definite order, to such beams in order to transmit them, one after the other, and we reassemble them at the receiving end by a cooperating or "synchronized" cathode beam operating on a sensitive luminescent screen surface. Not much attention has been paid to the possibility of utilizing positive (canal, mass) rays for picture transmission, and there seem to be very good reasons for this. First of all, the heavy atom or molecule parts of which such a positive beam consists involve, supposedly, the employment of high accelerating voltages; secondly, their thousand times greater masses than those of the electrons introduce high inertias and high kinetic energies to be
(Continued on page 713)

Sixteenth of a Series of
"Guest" Editorials.

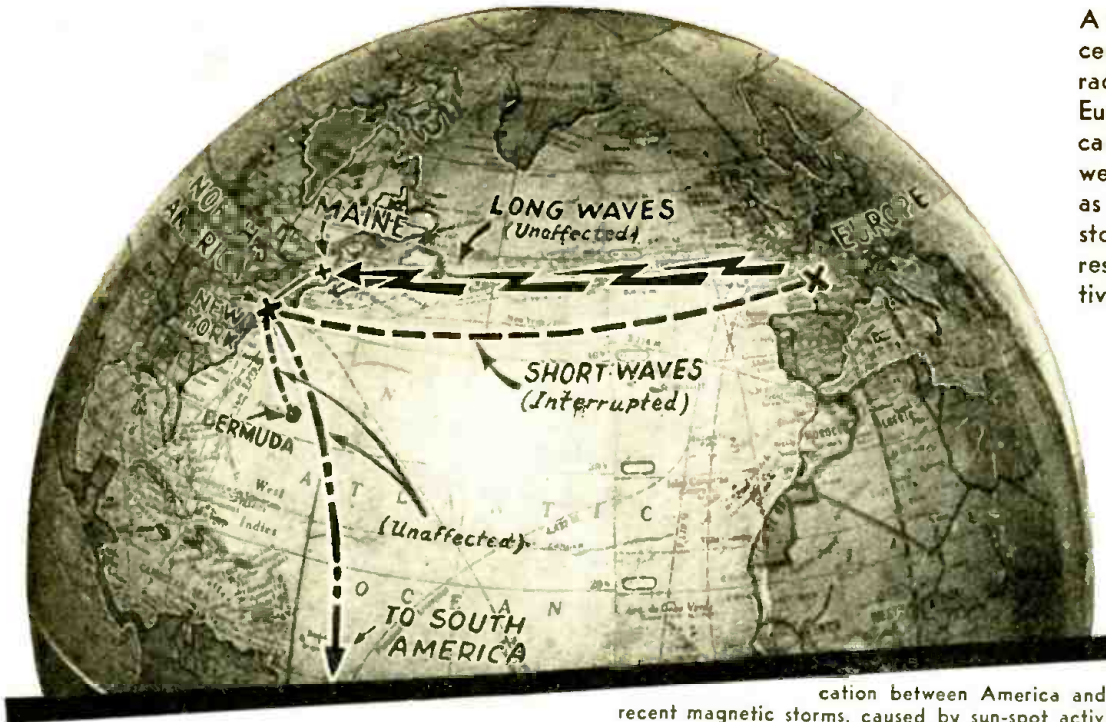

A severe magnetic storm recently disrupted short-wave radio transmission between Europe and America and caused auroral displays which were observed as far south as Bermuda. These magnetic storms are believed to be the result of unusual sun-spot activity. While such unusual sun-spot activity causes a decrease in short-wave transmission in certain directions, long-wave transmission does not appear to be affected.

How short-wave communication between America and Europe was interrupted by recent magnetic storms, caused by sun-spot activity is indicated on the map.

● HELLO. London . . . ? ? ? Short-wave communication between America and Europe stopped as abruptly as the foregoing sentence indicates, due to a severe magnetic storm which recently swept over the earth as a result of unusual sun-spot activity. Telephone traffic across the Atlantic was shifted to the longer wavelengths, in the 5,000 meter region, which paradoxically are more effective than usual during periods of magnetic storm activity.

The earth acts as a gigantic spherical magnet and is surrounded by a powerful magnetic field, and the strength of this field varies throughout constantly. We all know that if a wire connected in a sensitive recording circuit is moved across the field of a magnet, that a current is induced in this wire. In the same way if any outside influence, such as a stream of electrified particles emanating from a large sun-spot (or prominence) strikes this magnetic field surrounding the earth, we will have an upset condition in this field. Such an effect as this is believed by scientists today to

be the cause of the aurora borealis observed in the North Polar regions (and the complementary auroral effect observed in the South Polar regions, known as the aurora australis).

These magnetic storms react in a peculiar manner—certain high frequencies or short-waves on certain paths are not affected, while others are completely "wiped out," sometimes for a short period and at other times for a long period. Signals develop a

What Sun-

Rocky Point, L. I. station which carried A.T.&T. Co. long-wave traffic to Europe when short waves failed.

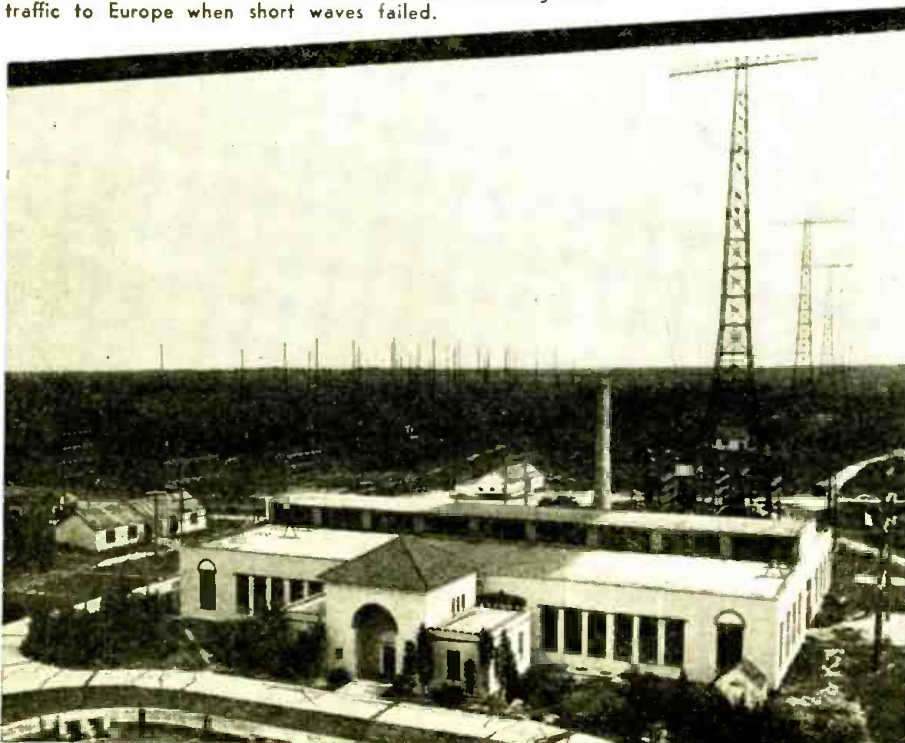

flutter several days (and even weeks, in some cases) before the effect becomes sufficiently strong to blot out short-wave communication over long distances.

The short-wave channels in operation nearest to the North Pole were the most affected, as might be expected, owing to the greater magnetic activity in this region. As a result, short-wave communication on the usual trans-Atlantic frequencies in the neighborhood of 16-19 meters was interrupted several times, while short-wave channels in operation farther south, across the Pacific Ocean, experienced but little interference from the recent magnetic storm. A surprising and very important fact was that short-wave transmission from New York to Buenos Aires, or in a north and south direction, was practically not affected at all. Likewise, short-wave communication between New York and Bermuda remained about the same throughout the magnetic storm.

The RCA Communications had a remarkable experience during the magnetic storm, when short-wave communication between America and Europe directly across the Atlantic failed. They re-routed their European traffic by short wave via Buenos Aires. The messages now traveled over a greatly increased length of circuit or about 5,000 miles to Buenos Aires and approximately 7,000

miles from there to London, or 12,000 miles. Compare this with the ordinary distance of 3,000 miles between New York and London!

An interesting sidelight of the effect of these magnetic storms on short-wave transmission is that the resulting *blanketing effect* on short-waves seems to spread down the coast from Maine to Florida like a fog. First the effect will be noticed at the more northern receiving stations, and gradually works down to New York and New Jersey. The reduction in transmission efficiency has been noticed in Maine several hours before New York is affected.

The general effect of sun-spot activity which passes through regular cycles is to degrade short-wave communication. During the past few years sun-spot activity has been relatively low and transmission conditions have been correspondingly good. During the next two years short-wave transmission is expected to become increasingly poorer.

Some of the freak transmission conditions which have occurred during the past year or two, due to the effect of the sun-spots, may be judged from the fact that the six meter television signals from London have been picked up quite regularly at the RCA experimental receiving station at Riverhead, Long Island, a distance of roughly 3,000 miles. As the sun-spot activity subsides during the next few years, it is believed.

One of the best photos taken of the recent sun-spot activity. These sun-spots are thought by scientists to be the principal cause of the severe magnetic storms which sweep over the earth at times. Sun-spots are frequently made visible by observing the sun through a piece of smoked glass or an old photo negative.

—Photo courtesy U. S. Naval Observatory.

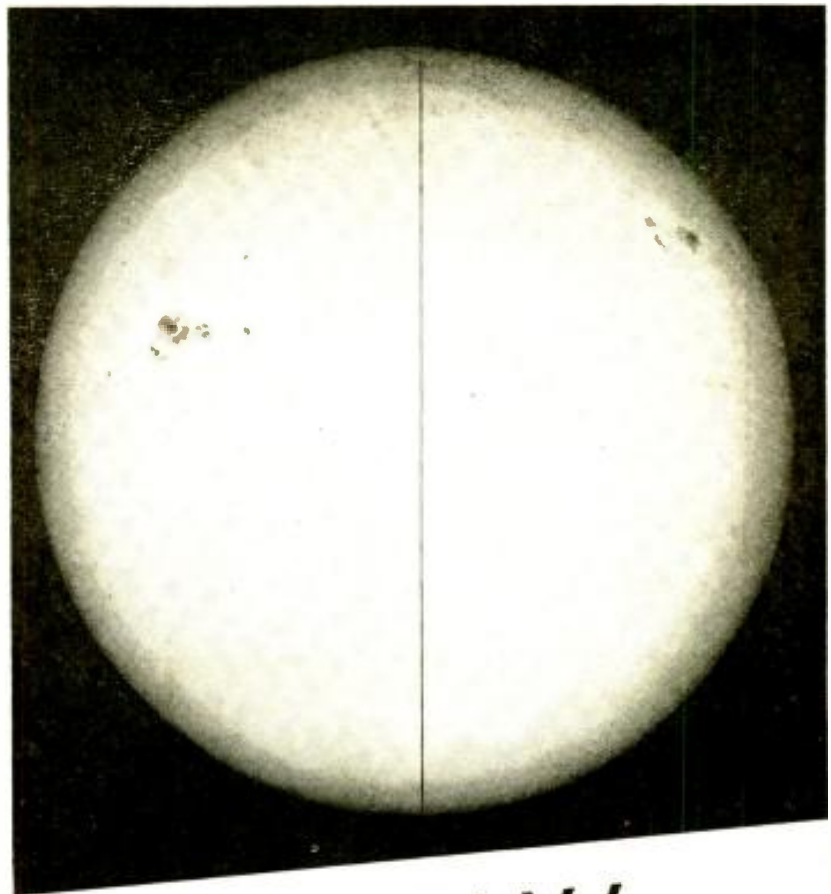

Spots Do to Short Waves

that we will slowly go back to normal. Ordinarily wavelengths as short as 5 or 6 meters will not bridge the distance across the Atlantic Ocean between New York and London, and the all-around operating radius for such waves is approximately that circumscribed by the horizon visible from the tower on which the transmitting aerial is erected (or a few hundred miles at best).

All sorts of odd things happen during one of these magnetic storm outbursts. For instance, one RCA report was to the effect that the day wavelength of 16 meters proved excellent for traffic between America and Europe during one whole night this winter, while ordinarily this wavelength fades out completely on a winter night as darkness spreads over the ocean.

Telegraph Circuits Affected, Too

The effect of the magnetic storms on the long east and west (wire) telegraph circuits, especially in the northern part of the United States and Western Canada, is to induce abnormal currents in these circuits, which frequently burn out apparatus at certain points and in general interfere with regular service.

The wave-reflecting layers of the upper atmosphere are affected by variations in their ionization and by changes in the height of the layers above the earth. The results of these changes is to cause variations in the distances that can be spanned by certain frequencies or wavelengths.

An interesting report which shows how the recent magnetic storm affected short-wave service on A. T. & T. Co. channels is reproduced here. For the magnetic storm beginning on Sunday, January 16, the effect became noticeable between 6 and 7 a.m., and affected all short-wave channels operating across the Atlantic. Practically no effect was noticed on the South American or Bermuda circuits and only a slight effect on ship-to-shore short-wave communication over short distances.

Sometimes these magnetic storms are preceded by a period of improved conditions and then, suddenly, the short-wave channel

goes bad! Operations at the A. T. & T. Co. plant show that the magnetic storm effects on short-wave transmission are quite severe for about a week, but, of course, other slight effects are noticeable over a period of several weeks altogether. It was observed that the lower frequencies seem to last the longest, before the circuit is put out of commission.

(Continued on page 701)

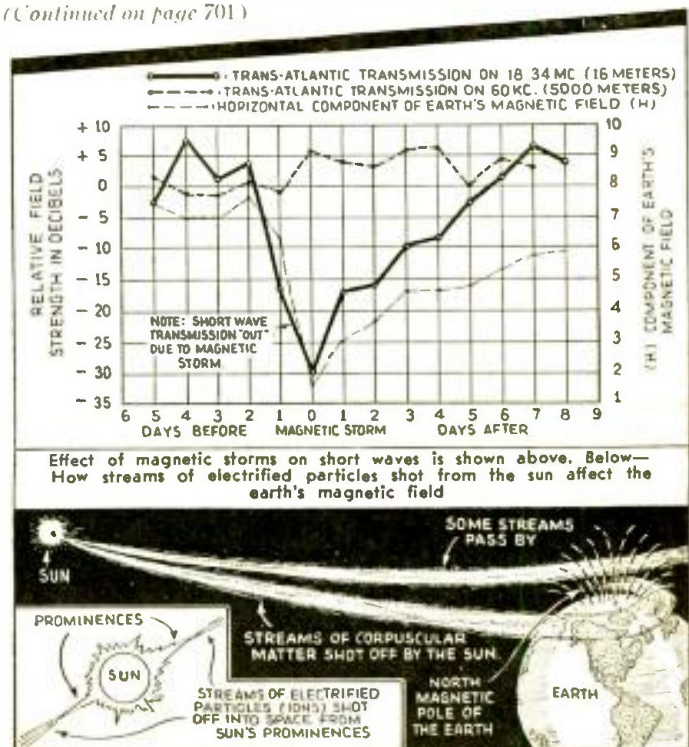

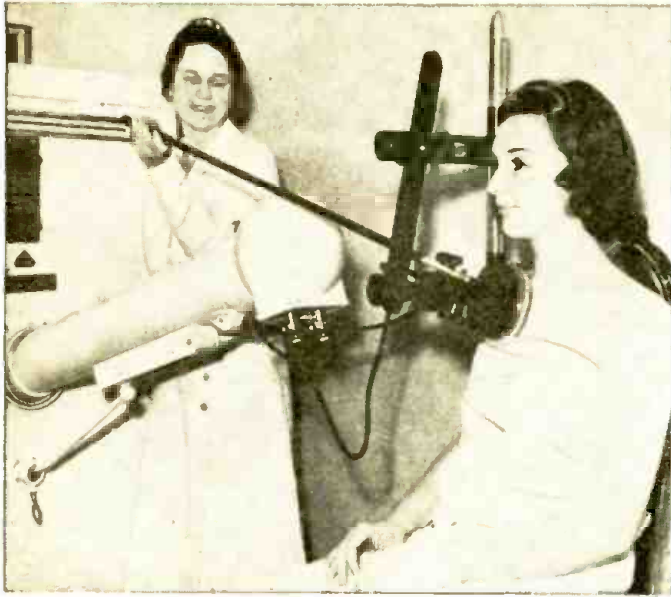

Left — Short-wave therapy is the latest weapon used by science in the continual fight against the common cold. Elizabeth Totman, R. N., is shown administering short-wave treatment to a patient at the Boston Dispensary, first American hospital to use this new treatment.

Copyright International News Photos.



Right — This granite column was recently erected at Poldhu, England, to mark the site of the first wireless station constructed by Marconi. From this station the first wireless signals were transmitted across the Atlantic in 1901.



Short Wave

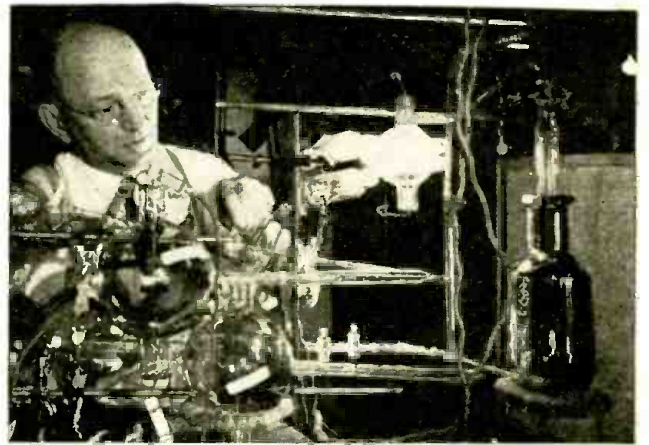

Above — A group of radio actors broadcasting a play over one of the Australian short-wave broadcasting stations. The "Aussies" are heard regularly by thousands of American short-wave fans.



Above—Ultra short-waves help in filming photoplays. The engineer is transmitting directions to a boat from a 5 meter set during the filming of "Lovers and Luggers."



Wanted—A perfect vacuum! W. A. Ruggles worked twenty-five years "trying to make nothing" in the research laboratory of the G. E. Co. He is now able to remove nearly all the air from a glass bulb, or 99.99999999%. When more perfect vacuums are obtained, Ruggles will make them!

Left—5 meter waves help movie producers—sound engineer receiving instructions from land during filming of "Lovers and Luggers" at Sydney, Australia.



FOTO NEWS

Beauty and short wave radio combine to make this picture—the hoop is a new tubular shielded antenna now being tested by United Air Lines to eliminate static from the ground station reception of airplane signals. An airline stewardess posed in the picture to show the relative size of the loop, developed in the United's experimental laboratory.



▲ Above—The two horn-shaped members represent the newest idea in ultra-short-wave antennas being tested experimentally by RCA engineers at Camden, N. J. The conical shape helps to direct the waves in a specific direction.

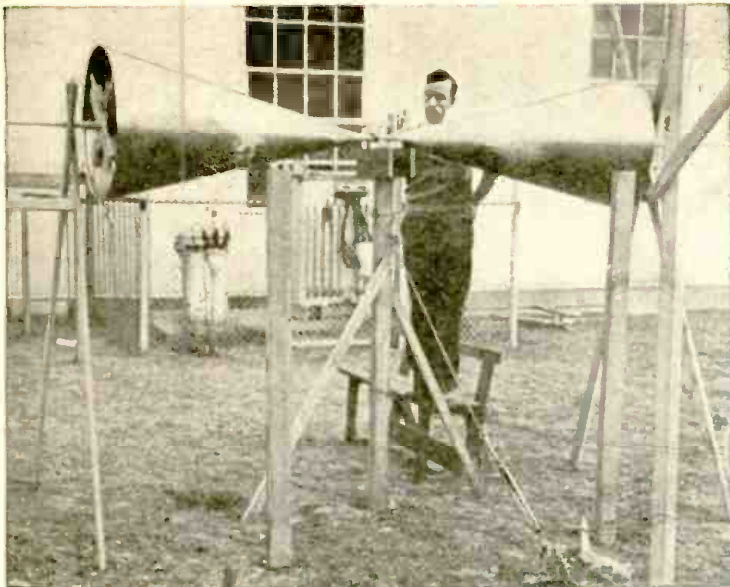

← Photos above and at left show new portable S-W sets used by U. S. forest rangers. In five years the number of short-wave radio sets in use in the woods and mountains of the United States National forests has increased from 300 to 2,300. Some of the portable sending and receiving sets weigh only 8 pounds, yet have ranges of 10 to 50 miles.



The picture above shows an interesting flash of British television. The television camera at the left is picking up a scene from the play "Midsummer Madness." The performers are Marie Burke, Frederick Ranalow, Joan Collier and Henry Wendon.

—Photo Courtesy B.B.C.



A Real Menace

● SPIN the dial of your radio across the short-wave bands. From Russia a voice tells the world in Oxford English—"Hitler is a degenerate pervert—a ruthless murderer of helpless women and children".—Turn the dial a little further and another English voice, this time with a trace of a German accent, is giving the latest "news" in English.—"The filthy Bolshevik government forces in Spain are responsible for the latest torpedoing of a neutral nation's steamship." "50,000 women and children are starving in the streets of Cleveland; Communists are over-running the U.S." A slight shift of the receiver's dial brings in Rome, a voice is

M. Harvey Gernsback

In a world filled with unrest and threats of war on all sides, a powerful new weapon for the spread of hate and dissension has been forged by the perversion of short-wave broadcasting to the purposes of power-seeking dictators.

heard describing the "holy work" done by Mussolini in bringing about "the emancipation and civilization of the benighted people of Ethiopia." (The excerpts from the Moscow and Rome broadcasts were reported in an article appearing in the *New York World Telegram* of Dec. 21, 1937.)

Any day's tuning will strengthen the belief that the world has gone mad. Challenges, denunciations and hymns of hate hurtling through space testify to the fact.

Every large nation in the world now has its short-wave voice. The Germans operate eight powerful stations which can beam programs to any part of the world. Twenty-three hours a day German announcers speaking in English, Dutch, Portuguese, Spanish or German, dependent on whether the program is for Australia, Asia, Africa or the Americas, punctuate musical items with undisguised propaganda. Italy boasts but one station at present. It is kept busy fourteen hours a day, however, broadcasting news in 17 languages. A more elaborate plant is under construction. The Russians have several short-wave voices, none of which are heard very well in this country. They, too, are constantly active, exhorting listeners to rise up and secure the benefits of state socialism.

Japan tells honorable listeners that she is waging a defensive war in China against "the onslaught of Communist imperialism." Nippon speaks through two powerful short-wave voices operating 6 hours daily and broadcasting in seven languages.

In these dictator countries the radio and the press have long been potent allies of government in cramming down the public's collective throat all the misinformation deemed necessary for keeping unrest down. The Charlie McCarthys who pose as radio news commentators in these countries were well trained in their art before the advent of international short-wave broadcasting. It was a simple matter for them to adopt their tactics to the larger sphere of world broadcasting.

The formula of *propagating* is simple. It involves the denunciation of the foreign press as a group of lying charlatans. The emphatic denial of all news items tending to expose the activities

The shaded areas of the map show the seven different beams employed by the German short-wave station when broadcasting to different parts of the world.





Propaganda

To World Peace

of the speaker's country, scornful comments about democratic governments and a stirring description of what a dandy place dear old *Dictatoria* is in which to live. All mention of bloody purges, concentration camps, religious and racial persecution and terror campaigns is carefully avoided by these cheery purveyors of misinformation.

Democracy's Reaction

The democratic nations have long been active in the field of international broadcasting but they have confined their activities to general news broadcasts and entertainment represented by American radio programs.

France broadcasts news in many languages and when we say *news*, it is in the sense familiar to all Americans.

England, whose short-wave equipment is on a par with Germany's, has, until recently, been mainly concerned with keeping her vast Empire in close touch with the homeland. The fact that the short-wave programs from London were heard in foreign countries as well as in the Empire was only incidental. English was the only language heard from Daventry, the British short-wave transmitting center.

The unceasing blasts of hostile propaganda sent out by the dictator states, and particularly the anti-British programs sent out by one Italian station to stir up trouble in British-controlled Palestine and Arabia, compelled England to retaliate; special programs for Arabian listeners were made a daily feature at the beginning of this year. An important item in the programs is the news bulletin in Arabic. By giving a factual survey of the world picture, the British hope to nullify the effects of Italian propagating.

An interesting commentary on the workings of dictatorships is the reaction in Italy to these broadcasts. The government is quite incensed and an official spokesman has said that he considers them "definitely hostile to Italy"!

The Arabs are having the time of their lives as a result. The Italians supply free radios to all and now the British are doing the same. The Italian radios are set to the Italian station and *locked* so that no other stations may be heard. The English sets are locked in similar fashion to the channel of the British station. And Hadji Ben Arab sits back and enjoys his free radio! Moral: When two big sluggers mess each other up the onlooker is sure

of a good free show. Nice work, if you can get it.

Holland, Czechoslovakia and Denmark maintain sizeable short-wave broadcast stations but they are concerned only with broadcasting to their overseas possessions or with creating good will in foreign lands, so they do not enter the picture of organized propagating.

Program Technique

The broadcasts from Dictatorland contain more entertaining fare interspersed with attacks. If they did not, listeners would soon tune in a more diverting station.

Native music, sketches and educational talks play an important part in all programs except those from Russia. The Russians have not yet learned the virtue of a *balanced diet* in entertainment.

Announcers familiar with the customs and idiom of the
(Continued on page 708)

The English station at Daventry has beams pointed in eleven different directions, so as to assure complete coverage of all of the important parts of the world.

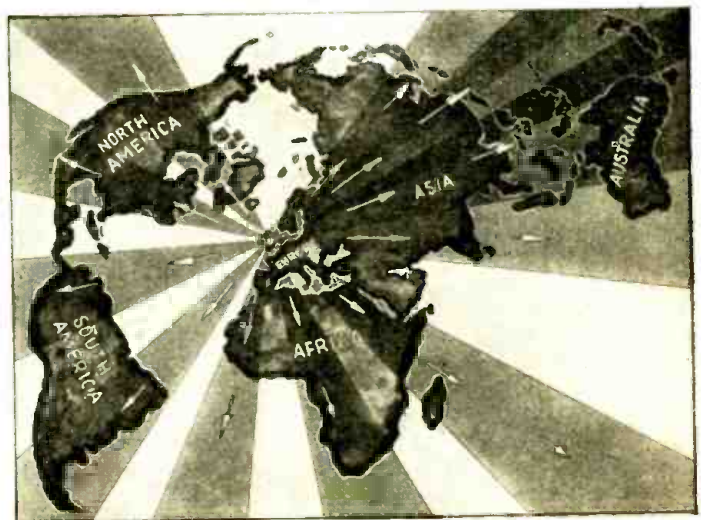

Duplex Phone on German Guard Boats



Left—Captain of German Coast Guard cutter using new type duplex radio phone.

Right—A new collapsible antenna, which greatly extends the range of short waves, is used on the new cutter installations.

● AN especially interesting detail to be found aboard the new German coast guard cutters is the new transmitter. This unit operates in the range from 50-100 and 500-1000 meters with an output of 40 watts on short waves and 70



on long waves.

The transmitter has extremely small overall dimensions and permits duplex telephone conversation, using a French type phone, as well as code transmission. The receiver section of the

(Continued on page 702)

Short - Wave Broadcasting In India

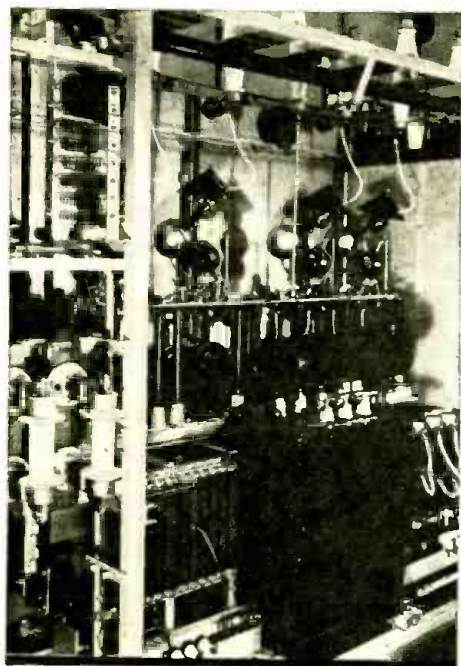

Above—Rear view of a group of rectifier tubes and high voltage transformers.

● IN the development of broadcasting in India it has been accepted by All-India Radio as a fundamental precept that a satisfactory broadcasting system must provide a measure of service to the whole country. This immediately determines the principle of operating transmitting stations on the *short* wavelengths. At the same time it is admitted that this is not, in itself, a final solution. Simultaneously with the provision of a short-wave or "second-grade" service to the whole area, a medium-wave "first-grade" service is necessary for the large towns. The basic principle of broadcasting development in India, therefore, is to provide a *short-wave* service to the whole country and to support this by a continual expansion of the area served by medium-wave stations as funds become available.

To this end ten transmitters have been ordered. Four short-wave "key" stations will be established at Delhi, Bombay, Calcutta and Madras, and will be of 10 kw.

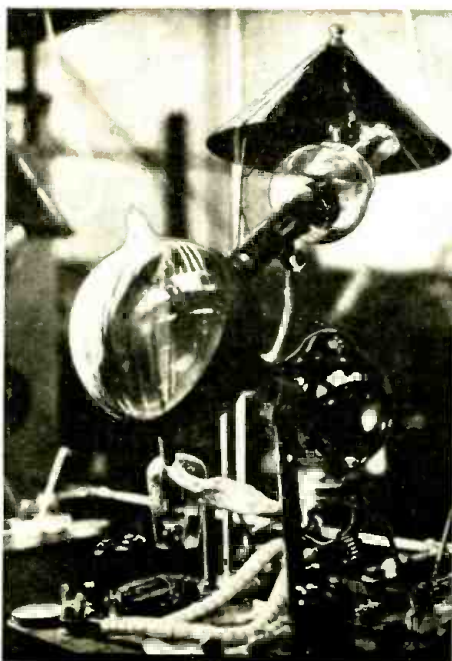

Close-up of one of the new Philips rectifier tubes used in the new Indian S-W transmitters.

Right—New water-cooled power tubes, tuning inductances and condensers.

aerial power. A second short-wave transmitter of 5 kw. power is also to be provided at Delhi for special purposes. The development program does not envisage any future increase in the number of short-wave stations. These short-wave stations will provide a "second-grade" service to the whole of India.

At the same time five medium-wave stations have been ordered, and will be situ-

ated at Lahore, Lucknow, Trichinopoly, Dacca and Madras, the first four stations having a power of 5 kw. The Madras medium-wave station will have a power of 250 watts, and will give a service to the city only, as Madras will also be provided with a 10 kw. short-wave transmitter. With these stations, and the existing medium-wave stations at Delhi, Bombay, Calcutta, and Peshawar, All-India Radio will have in operation five short-wave stations and nine medium-wave stations.

Choice of Short Wavelengths

It is expected that the Indian short-wave stations will normally operate in the daytime on the 30-meter and 49-meter bands and at night principally on the new 60-

(Continued on page 716)

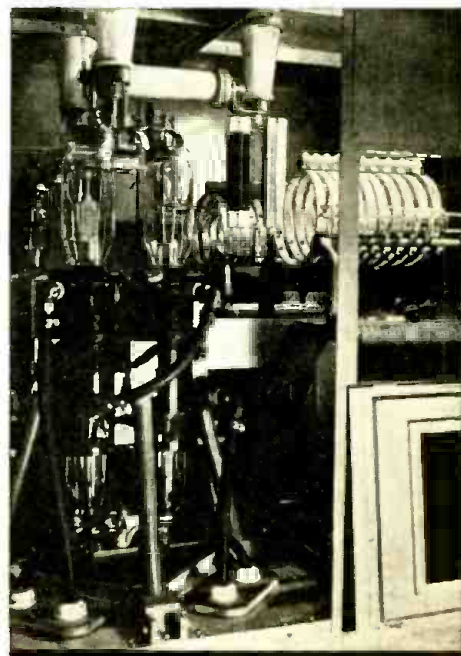

4-Inch Waves Turn Science Topsy-Turvy

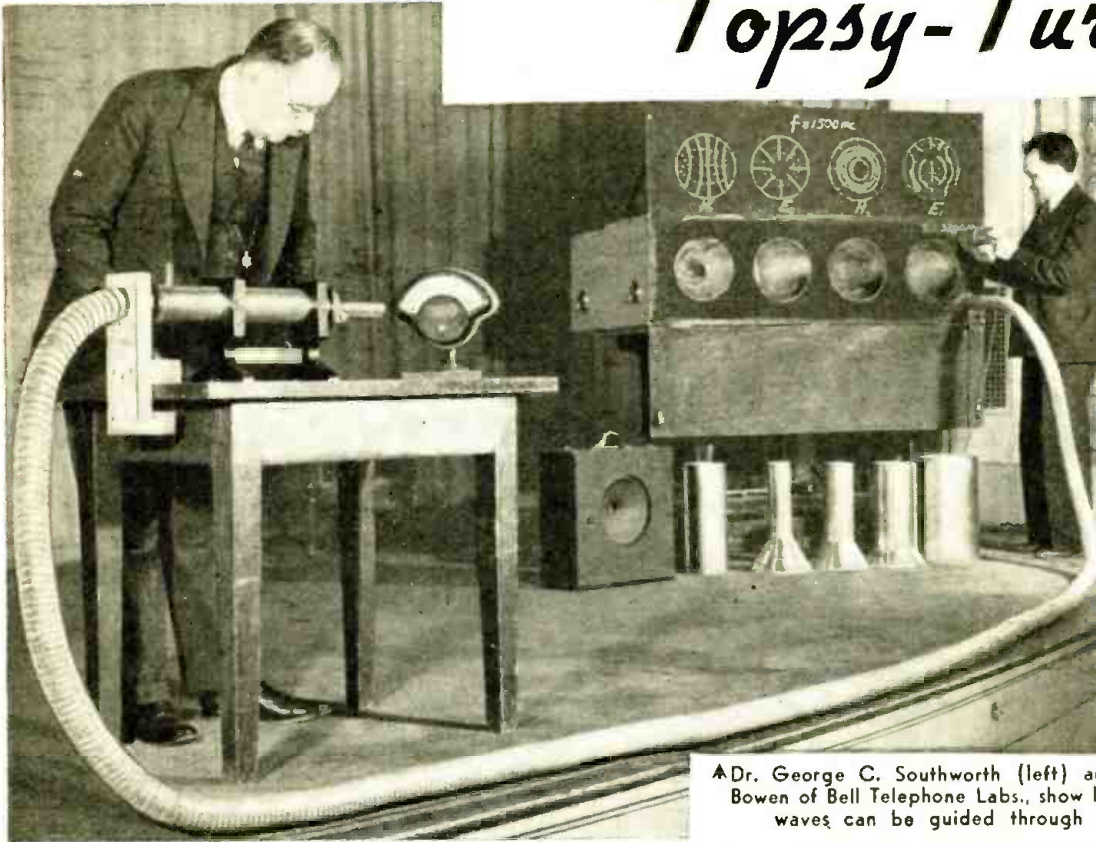

▲ Dr. George C. Southworth (left) and his assistant Mr. A. E. Bowen of Bell Telephone Labs., show how extremely short electric waves can be guided through a flexible metal pipe.

A recent demonstration of microwaves by Dr. George C. Southworth of the Bell Telephone Labs., had the apparent effect of turning some of our best scientific theories upside down. Signals were transmitted over a rubber rod and many strange effects noted.

● **ELECTRIC** waves that flow through pipes were demonstrated before the Institute of Radio Engineers recently, by Dr. George C. Southworth, research engineer of the Bell Telephone Laboratories. Holding a receiver at the end of a long flexible tube, Dr. Southworth showed that energy was flowing, regardless of how the tube was bent. But when the tube was interrupted, the tone from the receiver stopped, showing that the signal came through the tube and not through free space.

Standing in front of a blackboard, Dr. Southworth demonstrated by an electric probe that energy was coming through the blackboard at four different points. By moving the probe, he was able to delimit the energy areas, and by holding up a reflector a foot or so away from the blackboard, he was able to set up standing waves. Measurements made on the spot showed that the wave length was about 20 centimeters (8 inches), corresponding to a frequency of fifteen hundred million cycles per second (1500 megacycles).

That the waves coming through the four different areas were not all alike was shown by two distinct methods. In the first of these, it was shown that certain of the waves would pass through relatively small pipes, whereas others could be transmitted only through relatively large pipes. In the other method, the probe was held close to the blackboard and oriented into various positions to give maximum signal. A plot of these positions drawn with chalk on the blackboard showed patterns of distinguishing characteristics. From one of these, for example, it could be deduced that if the wave were visible to the eye, it would look like a series of smoke rings blown from a pipe.

A striking demonstration was that in which Dr. Southworth held in front of one of the areas a brass grating perhaps an inch deep, made of sheet brass strips on edge and spaced about an inch apart. In one position, this grating offered no barrier to the waves, but if given a quarter-turn it would almost completely suppress them.

Drawings at right show some of the mystical effects performed by Dr. Southworth's 4-inch waves. These waves can be piped, reflected, deflected, and polarized.

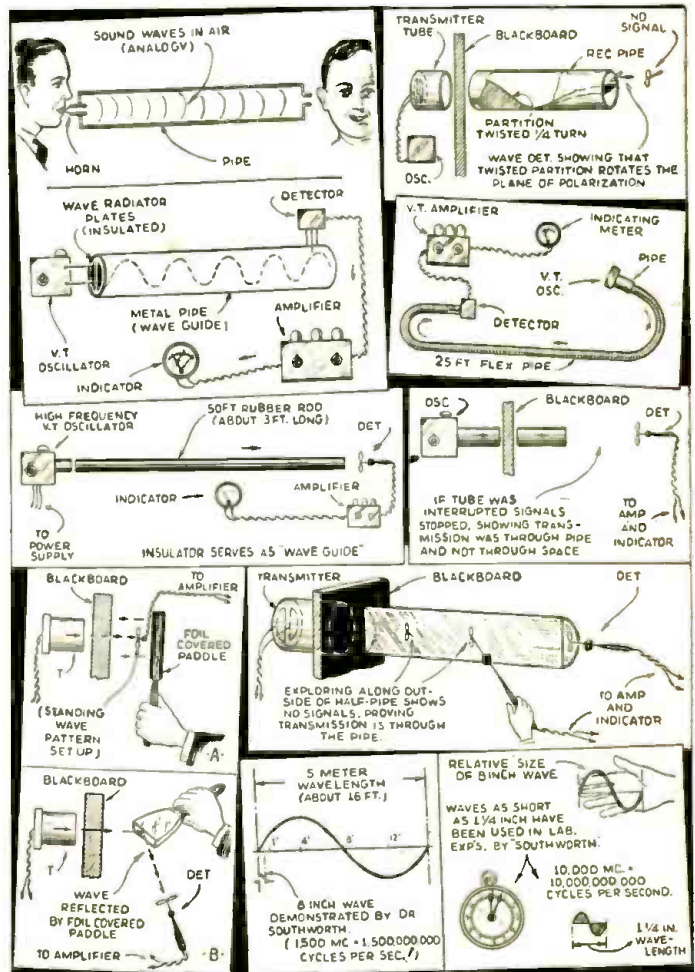

(Continued on page 706)



This photo shows model warship "Terrible" arranged for short-wave control. It was demonstrated on the River Marne by Mr. Casel, its builder. The control transmitter is shown on the pier.

MODEL SHIP Guided by Radio Waves

Pierre Delaunay

● A MODEL of the torpedo boat, "Le Terrible," has executed maneuvers on the river Marne (France), directed from the banks by means of radio waves. This use of *telautomatics* has, owing to the ingenious way in which it was done, attracted great attention.

Many experiments have been made in this field. The applications to which the Army and Navy could apply such a device have not escaped the attention of military and naval experts.

Those opposed to remote control point out that radio transmission is never sure, that a code system is only relatively safe, and that, above all, interfering stations

which are stronger than the controlling station could at least jam the transmission.

This article will deal with these objections. As *telautomatics* has many supporters, we think it worthwhile to study the latest device which Mr. R. Casel has worked out.

About twelve years ago, Mr. Casel obtained excellent results with a very small model. His most recent researches have necessitated the construction of a larger model. He has been quite willing to give public demonstrations which have shown the safety of his system and its workability.

The model is a reproduction, of astonish-

ingly exact workmanship, of the French torpedo boat, "Le Terrible." The hull, built by Mr. Casel himself, is 11.4 ft. long and 1.14 ft. wide. With full sailing equipment, the ship has a draft of 4.4 inches and a weight of 176 to 220 lbs.

The effective speed is 7.2 miles per hour, a speed which is not according to scale,

The editors have received numerous inquiries for data on a radio-control system adaptable to model boats or planes. Those looking for this information will undoubtedly be pleased to read the present article by Mr. Delaunay. Of course, amateur transmitters and receivers of any desired frequency may be used to put the system into operation. Some experimenters may wish to try ultra short-waves for the purpose; a good transmitter and receiver suited to operation on $\frac{1}{2}$ to 1 meter wavelength was described in the Jan. 1936 issue.

but much higher. It is not necessary to point out that in the case of propeller-driven ships, the increase in effective speed is not in direct proportion to the increase in power applied. There are two reasons for this, one the law of energy, and one mechanical. The law of energy is that the force necessary for the propulsion of a definite mobile entity must be *squared* when the velocity is to be doubled. This is to say that the energy increases in geometric progression (logarithmic) and the velocity in arithmetic (linear). Furthermore, the resistance to advance in the water varies with the speed for defined forms according to laws whose different factors enter successively into play. (Resistance, suction, current, instability of the mobile unit and so forth, modify the result.)

The mechanical reason is that up to a certain point the "relation force" exerted

(Continued on page 697)

Sectional view of the model cruiser "Terrible," showing arrangement of various radio control apparatus in different sections of the ship.

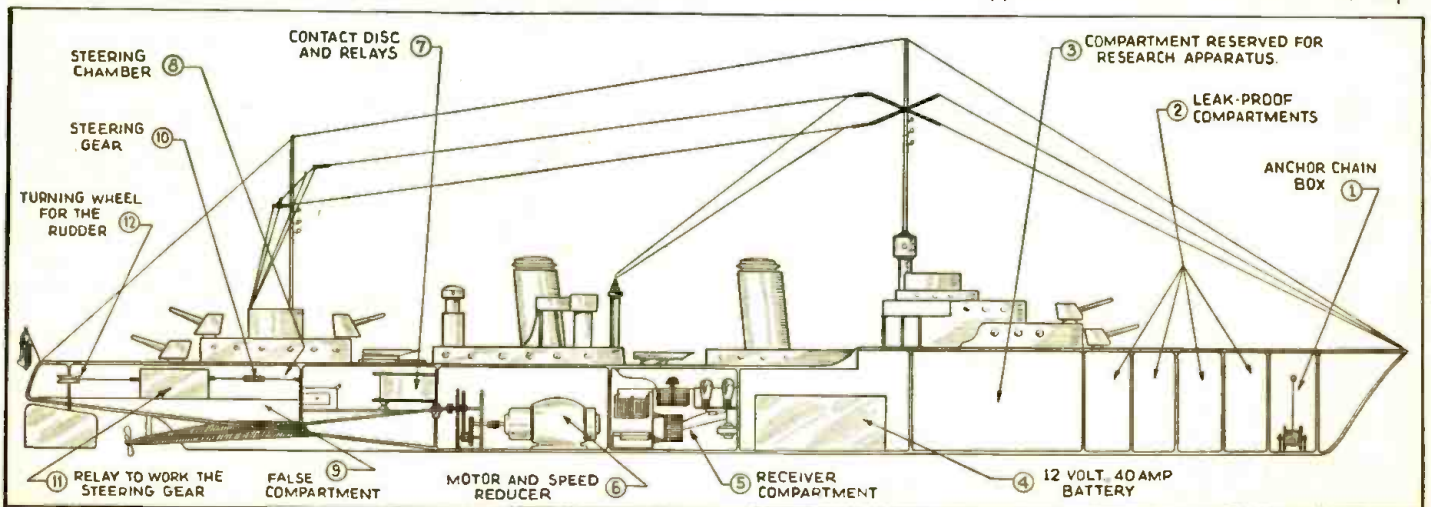

What Do You Think?

Wants More "Amateur Course"

Editor,

For many years I have been an uncomplaining reader of your publications, which is equivalent to saying "I like them."

There is no one who knows better than the editor of this magazine just how much radio owes to the amateur, though he be dubbed a "ham."

The particular brick, hot from the kiln, that I want to throw into your editorial sanctum is this one.

Aside from all the valuable articles, hookups and other aids, there is so little that will help the prospective amateur to qualify himself and get into the field. There are many aids which, though of value, all leave the prospect to figure out or do without explanations which he does not fully understand. My suggestion would be a department of the magazine devoted to helping the untrained novice who is just "itching" to enter the field, and maybe in a short time become something more than merely an amateur. Such a department should begin with the simplest fundamentals going through training for learning the code and the essential technical information which he must acquire before. This should go step-by-step through the fundamentals with detailed explanations, theories, reasons and experimental layouts which the coming amateur can use in acquiring a practical knowledge of the fundamentals, demonstrating the theories and their application, and also a depart-

One Year's Subscription to SHORT WAVE & TELEVISION Awarded for the Best S-W Den Photo

Closing date for each contest—75 days preceding date of issue: March 15th for June issue, etc. The editors will act as the judges and their opinions will be final. In the event of a tie a subscription will be given to each contestant so tying.

ment in which the "prospect" could have his practical problems answered would lead him on instead of leaving him "stumped" when he runs onto something he doesn't understand. In a certain S-W Ham Manual many things are admirable, with laws, regulations, etc., but in the theory of radio, such as self-excited oscillation, and the functions of the vacuum tube as an amplifier, both R.F. and A.F. things are not so clear for many students. They have no source of further information, no "daddy" to go to for a simplified explanation. In this event the student has to do one of two things: either he has to give up in disappointment, or go on with an *imperfect understanding* of the essential fundamentals which only too often block his progress.

At the end of the series such information could be published in pamphlet form and offered as a premium with a subscription, etc. If the department were continued year after year it could be improved, and you would be able to place in the hands of the prospective amateur a mass of tested and tried information, the like of which does not exist today.

The difficulty that the prospective amateur gets into without knowing a way out, suggests an old proverb that the "litter fruit kills the tree that grows it."

GEO. B. THOMPSON, M. D.
1611½ S. Arlington,
Los Angeles, California.

(Continued on page 709)



1—Prize-winning listening post photo. of Caleb Wilkinson, c/o Gen. Del., Texarkana, Ark. Note the "Super-Skyrider." 2—Mel Wentz, WBEEQ and his Ham station at Rawson, Ohio. 3—Jose Morales Hernandez, San Carlos No. 109 (altos), Cienfuegos, Cuba. 4—Edwin E. Hatch, 5508 N. Mascher St., Phila., Pa.

Short Wave Kinks

Each month the Editor will award a 2 year subscription for the best short-wave kink submitted. All other kinks published will be awarded eight months' subscription to **SHORT WAVE & TELEVISION**. Look over these kinks; they will give you some idea of what is wanted. Send a typewritten or ink description, with sketch, of your favorite to the "Kink" Editor.

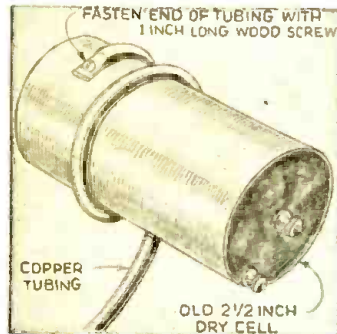

COIL WINDING

An aid in winding coils of copper tubing is shown. An old dry cell 2 1/2" in diameter serves as a coil-winding form. Thread a hole in the end of the tubing and place a wood-screw through it, which is then turned into the casing of the dry cell to secure the tubing during the winding process. Sweet and simple, we call it.—*Bob Pratt*.

NOISE ELIMINATOR

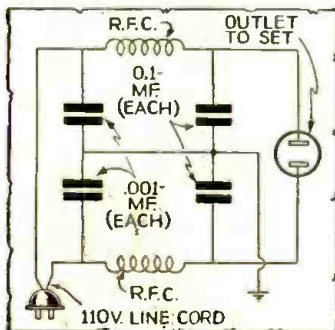

A filter for reducing electrical interference brought into a receiver from the powerlines is shown in the sketch. It consists of 2 R.F. chokes and several by-pass condensers. The R.F. chokes consist of 47 turns of No. 14 enameled wire wound on 1/2" diameter forms. The common returns of the by-pass condensers should be grounded to an external point. Another use for a filter of this type is to connect it between electrical apparatus generating electrical interference and the powerline to stop the noise at its source. In this case care must be taken to see that the amount of current drawn by the apparatus can be safely passed by the No. 14 wire. In this case, can safely handle about 15 amperes.—*Ralph D. Scott*.

A NEON OSCILLATOR

An oscillator which can be attached to a receiver for code practice purposes is shown. It is a variation of the ordinary neon tube oscillator. The proper connections to a receiver are clearly shown. Varying the 3 megohm resistor changes the pitch. If the receiver uses a diode detector it will be necessary to connect one end of the neon tube to the plate prong of the first audio tube instead of the detector.—*R. Willoughby*.

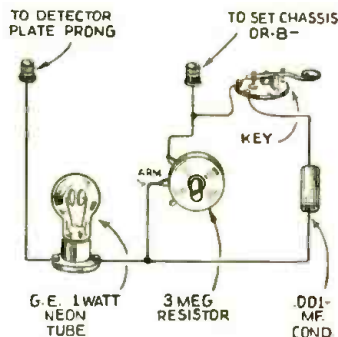

REGENERATION AID

When experimenting with new circuits it is frequently found after wiring up a circuit that a regenerative detector cannot be made to oscillate. Then it is necessary to reverse the wires to the tickler coil. To eliminate the necessity for this, have 2 plug-in coils, identical except that in one the connections from the tickler winding to the base pins are reversed, as shown in the drawing. If the set will not work with one coil it will generally be found to perform satisfactorily with the other. Once it has been determined which arrangement is proper for a given set, it is a simple matter to make any changes necessary in the wiring.—*Kenwood Truesdale*.

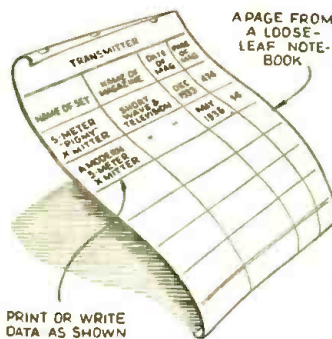
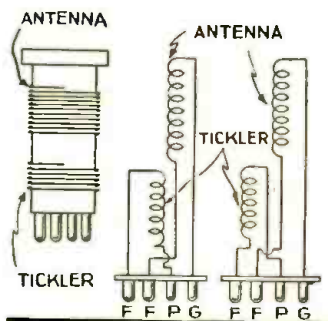

INDEX

A simple indexing system which should prove a great time saver to the experimenter is shown. It is simply a page from a notebook which has been ruled off into several classifications for making a quick-reading rough chart for locating the whereabouts of articles which have appeared in various periodicals.—*John E. Harley*.

CONDENSER TESTER

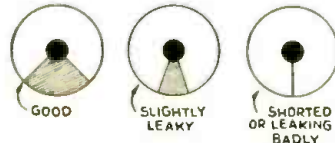
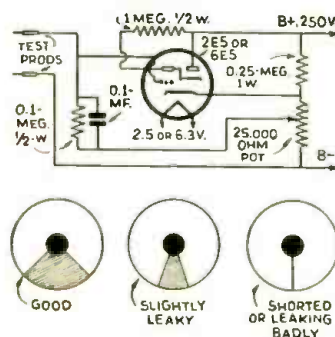

Here is another use for the magic eye tube. In this case it is used as a testing device for paper condensers. The diagram shows how to connect the tube for this use and also the indications for different condenser tests. In addition to testing a condenser for leakiness or shorting, the device can be used to give a rough check on the relative capacity of a condenser by observing the length of time it takes for the eye pattern to open after the condenser has been connected to the test prods. When connecting a condenser the eye shadow will close momentarily until the condenser is charged. This charging period varies from a fraction of a second to several seconds, depending upon the capacity of the condenser.—*Harold Brower*.

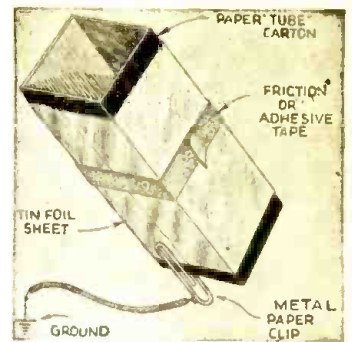

TEMPORARY TUBE SHIELD

1st PRIZE WINNER

How often have you needed a tube shield to complete an experimental circuit, only to find none around? A temporary one is easily made from a tube carton and tinfoil. Wrap several layers of tinfoil around the carton and secure it with cellophane or friction tape as indicated in the drawing. Grounding contact is made with a paper clip at the bottom of the carton.—*Clarence Illk*.

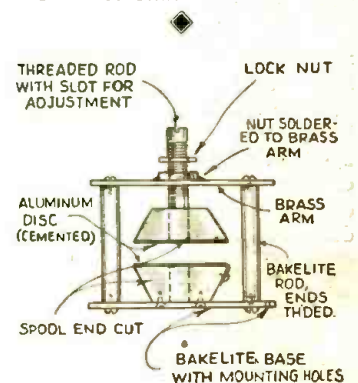

SPOOL CONDENSER

A novel neutralizing condenser may be made from an old thread spool and other odds and ends. The sketch is self-explanatory. This condenser can also be used as an antenna coupling unit or for that matter for any other application requiring a low-capacity condenser.—*Hoy Mah*.

SOLDERING AID

A modification of a soldering iron tip is shown. The large flat surface made by cutting off part of the tip is useful when soldering heavy wires and also when soldering directly to a chassis. The tapering point of the new tip enables ordinary light soldering to be handled nicely.—*Harry W. Crowder*.

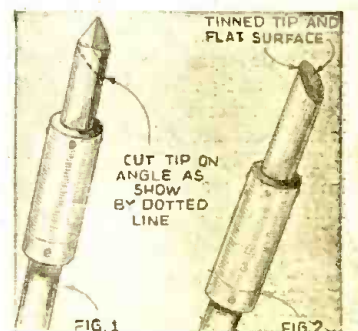

Short Wavers' Yardstick

A quick reference chart showing where short-wave broadcasts come in on an all-wave receiver's dial. For operating schedules of stations, refer to the Station List on page 676.



S-W's Land Planes In New Army System

By using a series of short-wave vertical beacons and ingenious automatic altitude control devices, Army planes can be landed automatically in any weather.



Left—Army plane fitted with new automatic short-wave landing system. A series of vertical short-wave radio-guide beacons, one form of which is shown at the right, are used.



Mobile type of short-wave guide-beacon station.

● TWO U. S. Army Air Corps experts, Captain Carl J. Crane and Captain George V. Holloman, have designed and flight-tested a new system of landing planes automatically by means of short-waves and some of the highlights of this ingenious method are here illustrated.

For over a year Air Corps test planes have been flown automatically over distances that have demonstrated the thorough reliability of the devices now employed. Automatic landing of a plane involves other factors besides control of direction; these factors are—control of altitude, engine control, glide control and

further engine control after landing.

Fig. 1 represents the path of flight and landing made by an army plane with new apparatus. Fig. 2 illustrates a vertical view of the plane's flight path, and also the landing path followed by the plane in making a full automatic landing. Note that in making an automatic landing that the pilot places his plane at a pre-selected altitude before he closes the master landing switch. The plane then flies along at a fixed altitude until a certain number of vertical short-wave beacons have been passed, as the

(Continued on page 710)

The diagrams show how short-waves guide the plane automatically to a landing.

Plane's cockpit with control switches and gyro-pilot.

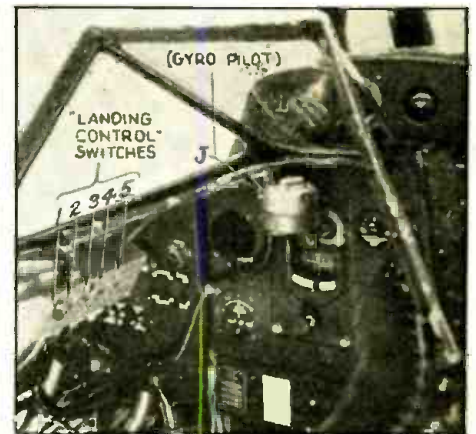
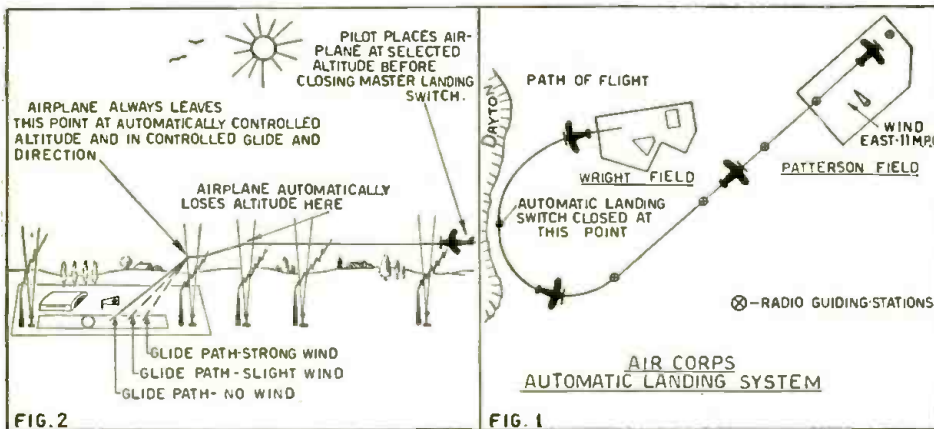

Television news cabinet in Jack Dempsey's restaurant, New York.

● JACK DEMPSEY'S restaurant in New York City was recently the scene of the first commercial television demonstration in America. News bulletins were flashed from the Hotel Lincoln, about five blocks away, over a leased telephone circuit.

This television news bulletin system is the invention of William Hoyt Peck, a leading American television inventor, and a strong proponent of optical and mechanical scanning. Mr. Peck's inven-

News Bulletins Via Wired Television

tion uses mechanical scanning and the results obtained have been surprisingly fine. The messages were typed on a transparent ribbon at the Hotel Lincoln by means of a special automatic-feed typewriter, and one of the photos shows Jack Dempsey preparing the first message to be sent over the circuit.

After the letters composing the message have been typed on the transparent ribbon (Continued on page 705)



Jack Dempsey operating the transmitter.

FREQ. CALL TYPE LOCATION

- 6.077 OAX4Z—B—Lima, Peru.
"Radio Nacionales." Dual call "OAX4A y OAX4Z." Pronounces Z as "Zeta."
- 6.075 VP3MR—B—Georgetown, British Guiana.
Slogan "The voice of British Guiana."
Signs off with "God Save the King."
- 6.073 HJ3ABF—B—Bogota, Colombia.
"La voz de Bogota." Lately announces as HKF, instead of HJ3ABF.
- 6.072 OER2—B—Vienna, Austria.
See OER2, 11.778 mc. (Sept. issue).
- 6.065 SBO—B—Motala, Sweden.
Announces "Radio Motala, relaying programs of Oslo."
- 6.06 FIQA—B—Tananarive, Madagascar.
See FIQA, 11.81 mc. FIQA no longer on 11.81 mc., but is now broadcasting simultaneously on 6.06, 9.38, 10.95 mc., 3:30-4:30 a.m. daily, 2:30-4 a.m. Suns.
- 6.053 HJ6ABA—B—Pereira, Colombia.
Announces—"Achey hota seis ah bay ah —Pereira."
- 6.045 XETW—B—Tampico, Mexico.
Announces—"Eckees ay tay duple-vey."
- 6.042 HJ1ABG—B—Barranquilla, Colombia.
Slogan "Emisora Atlantico."
- 6.033 HP5B—B—Panama City, Panama.
Slogan "Estacion Miramar." Signs off with the march "Panama."
- 6.03 XEBQ—B—Mazatlan, Mexico.
Announces—"Eckees ay bay Coo."
- 6.03 OLR2B—B—Prague, Czecho-Slovakia.
See OLR6A, 21.45 mc.
- 6.023 XEUW—B—Vera Cruz, Mexico.
Slogan "El Eco de Solavento desde Vera Cruz." Signs off with "La Golondrina," waltz.
- 6.017 HI3U—B—Santiago, Dom. Rep.
Slogan "La voz de Comercio." Signs off with organ solo "Maria My Own."
- 6.015 PRA8—B—Pernambuco, Brazil.
Slogan "A voz do Norte en Pernambuco."
- 6.015 RADIO PHILCO—B—Saigon, French Indo-China.
See R. P., 11.705 mc. Frequency varies from 6.015 up to 6.055.
- 6.013 HJ3ABX—B—Bogota, Colombia.
Slogan "La voz de Colombia, Bogota."

How To Identify Short Wave Stations

Keep These Lists for Future Reference

- 6.01 OLR2A—B—Prague, Czecho-Slovakia.
Same as OLR2B, 6.03 mc.
- 6.01 COCO—B—Havana, Cuba.
Announces—Freq. in Spanish and English. Spanish "Say oh, say oh, Habana de Cuba."
- 6.01 9MI—B—"S. S. Kanimbla",
Out of Melbourne, Australia. Program begins with ship's bells, and blast on ship's whistles, followed by music. All programs are broadcast for relay by some Australian BCB station. Miss Arlene Foley announces; call given after every selection "Marine station 9MI calling—, from the motor vessel Kanimbla at sea—(location)". Closes with ship's bells, concluding announcement, and "God Save the King."
- 6.007 RANGOON—B—Rangoon, Burma.
Call given after every second selection Government Radio Station, Rangoon, Burma. Signs off with "God Save the King."
- 6.005 HP5K—B—Colon, Panama.
Slogan "La voz de la Victor"; dual call "HP5O y HP5K."
- 6.004 RV59—B—Moscow, U.S.S.R.
See RAN, 9.60 mc.
- 6.002 CXA2—B—Montevideo, Uruguay.
Announces—"Say eckees ah das", signs off with "Good Night Melody."
- 6.00 XEBT—B—Mexico, D. F., Mexico.
Uses various identifying signals, as auto horns, sirens, etc. Uses dual call "XEB y XEBT."
- 5.997 CS2WD—B—Lisbon, Portugal.
Announced as "Radio Renascena."
- 5.975 OAX4P—B—Huancayo, Peru.
Slogan "La voz de Huancayo, Radio Andina Jienin."
- 5.947 PJCI—B—Curacao, N. W. Indies.
Announced as—"Radio CUROM." Signs off with Dutch National Anthem.
- 5.94 TG2X—B—Guatemala City, Guatemala.
Slogan "La voz de la Policia Nacional." Not used when relaying TGW, and often when relaying TGW, forgets to use own call, announcing simply as "TGW, Radio Nacional."
- 5.935 YVIRL—B—Maracaibo, Venezuela.
Slogan "Radio Popular." Opens and signs off with "National Emblem March." Will soon relay YV1RK, so will use both calls in announcements.
- 5.913 YV4RH—B—Valencia, Venezuela.
Slogan "Radio Valencia." This is old YV15RV.
- 5.905 TILS—B—San Jose, Costa Rica.
Slogan "Radio Parati."
- 5.895 YV3RA—B—Barquisimeto, Venezuela.
"La voz de Lara"; dual calls "YV3RA y YV3RB."
- 5.89 JIC—C&B—Taihoku, Taiwan. (Formosa.)
Identifies in Japanese at start of phone Xsns with Tokio. Inverted speech used thereafter.
- 5.89 HH2S—B—Port-au-Prince, Haiti.
Speaks French; announces in English and French, and occasionally in Spanish.
- 5.885 HI9B—Santiago De Los Caballeros, Dom. Republic.
Slogan "Broadcasting Hotel Mercedes" (rarely heard).
(To be continued)

Can You Answer These Radio Questions?

1. Do sun-spots improve short-wave transmission? See page 662.
2. Where was the play "Midsummer Madness" broadcast by television? See page 665.
3. Why do foreign countries spend large sums of money on short-wave broadcasting? See page 666.
4. Is it possible to transmit short-wave signals through a rubber rod? See page 669.
5. Where are the principal short-wave broadcast stations located on your all-wave dial? See page 673.
6. How do short-wave beacons now make it possible to land airplanes blind? See page 674.
7. What two foreign short-wave stations will transmit special programs for "S.W.&T." readers? See page 677.
8. How can radio parts be used to build a "buried pipe" or faulty circuit locator? See page 681.
9. How may 5-prong band-spread coils be adapted for use in a receiver wired for 4-prong coils? See page 683.
10. Is it possible to build a receiver using but one coil which will have a range of 4.5-11 meters? See page 688.
11. Is it practical to use only one oscillator for combination vision and sound superhets? See page 690.
12. Where is the frequency stabilizing crystal usually connected in a Ham transmitter? See page 692.

World Short Wave Stations

Revised Monthly

Broadcasters' Calls in bold type
Phones' in light type

Reports on station changes are appreciated.

Mc.	Call	Mc.	Call	Mc.	Call
31.600	W3XEY	BALTIMORE, MD., 9.494 m., Relays WFBR 4 pm-12 m.	19.620	VOG4	NAIROBI, KENYA, 15.28 m., Addr. Cable and Wireless, Ltd. Calls London 7.30-8 am.
31.600	W2XDY	NEW YORK CITY, 9.494 m., Addr. Col. Broad. System, 485 Madison Ave. Daily 6-11 pm.; Sat. and Sun. 1.30-6. 7-10 pm.	19.600	LSF	BUENOS AIRES, ARG., 15.31 m., Addr. (See 20.700 mc.) Tests irregularly.
31.600	W9XHW	MINNEAPOLIS, MINN., 9.494 m. Relays WCCO 9 am.-12 m.	19.480	GAD	RUGBY, ENG., 15.4 m. Calls VOG4 7.30-8 am.
31.600	W3XKA	PHILADELPHIA, PA., 9.494 m., Addr. NBC. Relays KYW 12 n-10 pm.	19.355	FTM	ST. ASSISE, FRANCE, 15.5 m. Calls S. America mornings.
31.600	W5XAU	OKLAHOMA CITY, 9.494 m., Sun 12 n-1 pm., 6-7 pm. Irregular other times.	19.345	PMA	BANDOENG, JAVA, 15.51 m. Works Holland 5.30-11 am.
31.600	W4XCA	MEMPHIS, TENN., 9.494 m. Addr. Memphis Commercial Appeal. Relays WMC.	19.260	PPU	RIO DE JANEIRO, BRAZ., 15.58 m., Addr. Cia. Radiotel. Brasileira. Works France mornings.
31.600	W8XAI	ROCHESTER, N. Y., 9.494 m., Addr. Stromberg Carlson Co. Relays WHAM 7.30-12.05 am.	19.220	WKF	LAWRENCEVILLE, N. J., 15.6 m., Addr. A.T.&T. Co. Calls London and Paris daytime.
31.600	W8XWJ	DETROIT, MICH., 9.494 m., Addr. Evening News Ass'n. Relays WWJ 6-12.30 am., Sun. 8 am-12 m.	19.200	ORG	RUYSELEDE, BELGIUM, 15.62 m. Calls OPL mornings.
31.600	W9XPD	ST. LOUIS, MO., 9.494 m., Addr. Pulitzer Pub. Co. Relays KSD.	19.160	GAP	RUGBY, ENG., 15.66 m. Calls Australia 1-8 am.
26.400	W9XAZ	MILWAUKEE, WIS., 11.36 m., Addr. The Journal Co. Relays WTMJ from 1 pm.	19.020	HS8PJ	BANGKOK, SIAM, 15.77 m. Mondays 8-10 am.
26.100	W9XJL	SUPERIOR, WIS., 11.49 m. Relays WEBC daily.	18.970	GAQ	RUGBY, ENG., 15.81 m. Calls S. Africa mornings.
26.100	GSK	DAVENTRY, ENG., 11.49 m., Addr. B.B.C., London. Operates irregularly.	18.890	ZSS	KLIPHEUVEL, S. AFRICA, 15.88 m., Addr. Overseas Comm. of S. Africa, Ltd. Calls GAQ 9-10 am.
25.950	W6XKG	LOS ANGELES, CAL., 11.56 m., Addr. B. S. McGlashan, Wash. Blvd. at Oak St. Relays KGFJ 24 hours daily.	18.830	PLE	BANDOENG, JAVA, 15.93 m. Calls Holland early am.
21.550	GST	DAVENTRY, ENG., 13.92 m., Addr. (See 26.100 mc.) Irregular at present.	18.680	OCI	LIMA, PERU, 16.06 m. Tests with Bogota, Col.
21.540	W8XK	PITTSBURGH, PA., 13.93 m., Addr. Grant Bldg. Relays KDKA 6.45-9 am. Exc. Sun.	18.620	GAU	RUGBY, ENG., 16.11 m. Calls N.Y. daytime.
21.530	GSJ	DAVENTRY, ENG., 13.93 m., Addr. (See 26.100 mc.) 5.45-10.30 am.	18.450	HBF	GENEVA, SWITZERLAND, 16.26 m., Addr. Radio Nations. Tests irregularly.
21.520	W2XE	NEW YORK CITY, 13.94 m., Addr. Col. Broad. Syst., 485 Madison Ave. 7.30-10 am., Sat. and Sun. 8 am.-1 pm.	18.345	FZS	SAIGON, INDO-CHINA, 16.35 m. Works Paris early morning.
21.470	GSH	DAVENTRY, ENG., 13.97 m. (See 26.100 mc.) 5.45 am.-12 n.	18.340	WLA	LAWRENCEVILLE, N. J., 16.36 m., Addr. A.T.&T. Co. Calls England daytime.
21.420	WKK	LAWRENCEVILLE, N. J., 14.01 m., Addr. Amer. Tel. & Tel. Co. Calls S. Amer. 7 am.-7 pm.	18.310	GAS	RUGBY, ENG., 16.38 m. Calls N.Y. daytime.
21.080	PSA	RIO DE JANEIRO, BRAZ., 14.23 m., Calls WKK daytime.	18.299	YVR	MARACAY, VENEZ., 16.39 m. Works Germany mornings.
21.060	WKA	LAWRENCEVILLE, N. J., 14.25 m., Addr. (See 21.420 mc.) Calls England morning and afternoon.	18.250	FTO	ST. ASSISE, FRANCE, 16.43 m. Works S. America daytime.
21.020	LSN6	BUENOS AIRES, ARG., 14.27 m., Addr. Cia. Internacional de Radio. Works N.Y.C. 7 am.-7 pm.	18.200	GAW	RUGBY, ENG., 16.48 m. Works N.Y.C. daytime.
20.860	EHY-EDM	MADRID, SPAIN, 14.38 m., Addr. Cia Tel. Nacional de Espana. Works S. Amer. mornings.	18.135	PMC	BANDOENG, JAVA, 16.54 m. Works Holland mornings.
20.700	LSY	BUENOS AIRES, ARG., 14.49 m., Addr. Transradio Internatl. Tests irregularly.	18.115	LSY3	BUENOS AIRES, ARG., 16.56 m., Addr. (See 20.700 mc.) Tests irregularly. Broadcasts 5-6 pm. Friday.
20.380	GAA	RUGBY, ENG., 14.72 m. Calls Arg. Brazil mornings.	18.040	GAB	RUGBY, ENG., 16.83 m. Works Canada morning and afternoon.
20.040	OPL	LEOPOLDVILLE, BELGIAN CONGO, 14.97 m. Works ORG morn.	17.810	PCV	KOOTWIJK, HOLLAND, 16.84 m. Works Java 6-8 am.
20.020	DHO	NAUEN, GERMANY, 14.99 m., Addr. Reichspostzentralamt. Works S. Am. mornings.	16 Met. Broadcast Band		
19.900	LSG	BUENOS AIRES, ARG., 15.08 m., Addr. (See 20.700 mc.) Tests irregularly.	17,800	TGWA	GUATEMALA CITY, GUAT., 16.84 m., Addr. Ministre De Fomento. Irregular.
19.820	WKN	LAWRENCEVILLE, N. J., 15.14 m., Addr. A. T. & T. Co. Calls England daytime.	17.790	GSG	DAVENTRY, ENG., 16.86 m., Addr. B.B.C., London. 3.15-5.30 am., 5.45 am.-12 n., 12.20-4 pm.
19.680	CEC	SANTIAGO, CHILE, 15.24 m., Addr. Cia. Internacional de Radio. Calls Col. and Arg. daytime.	17.785	JZL	TOKIO, JAPAN, 16.87 m. Tests irregularly.
19.650	LSN5	BUENOS AIRES, ARG., 15.27 m., Addr. (See 21.020 mc.) Calls Europe daytime.	17.780	W3XAL	BOUND BROOK, N. J., 16.87 m., Addr. Natl. Broad. Co. 8.55 am.-6.45 pm.
			17.770	PHI	HUIZEN, HOLLAND, 16.88 m., Addr. (See PHI, 11.730 mc.) Daily except Wednesday, 8.25-10 am., Sun. 7.25-10.25 am.
			17.760	DJE	BERLIN, GERMANY, 16.89 m., Addr. Broadcasting House, 12.05-10 am.; also Sun. 11.10 am-12.25 pm.
17.760	W2XE	NEW YORK, N. Y., 16.89 m., Addr. Col. Broad. System, 485 Madison Ave. Daily 6.20 pm.-12 m.	17.755	ZBWS	HONGKONG, CHINA, 16.9 m., Addr. P.O. Box 200. 4-10 am. irregular.
End of Broadcast Band					
17.741	HSP	BANGKOK, SIAM, 16.91 m. Works Germany 3-5 am., 8-9 pm. Works JVE 11 pm.-6 am.	17.650	XGM	SHANGHAI, CHINA, 17 m. Works London 7-9 am.
17.650	DFB	NAUEN, GERMANY, 17.12 m. Works S. America, near 9.15 am. Works Siam 3-5 am., 8-9 pm.	17.520	VWY2	KIRKEE, INDIA, 17.16 m. Works London 7.30-8.15 am.
17.480	WVY2	HICKSVILLE, L. I., N. Y., 17.33 m., Addr. Press Wireless, Box 296. Tests 9.30-11.30 am. except Sat. and Sun.	17.310	W2XG8	HICKSVILLE, L. I., N. Y., 17.33 m., Addr. Press Wireless, Box 296. Tests 9.30-11.30 am. except Sat. and Sun.
17.120	WOO	OCEAN GATE, N. J., 17.52 m., Addr. A.T.&T.Co. Works ships irregularly.	17.080	GBC	RUGBY, ENG., 17.56 m. Works ships irregularly.
17.080	GBC	RUGBY, ENG., 17.56 m. Works ships irregularly.	16.835	ITK	MOGADISCIO, ITAL. SOMALILAND, 18.32 m. Calls IAC around 9.30 am.
16.835	ITK	MOGADISCIO, ITAL. SOMALILAND, 18.32 m. Calls IAC around 9.30 am.	16.270	WLK	LAWRENCEVILLE, N. J., 18.44 m., Addr. A.T.&T. Co. Works S. Amer. daytime.
16.270	WOG	OCEAN GATE, N. J., 18.44 m., Addr. A.T.&T. Co. Works England late afternoon.	16.240	KTO	MANILA, P. I., 18.47 m., Addr. RCA Comm. Works Japan and U. S. 5-9 pm. irregularly.
16.240	KTO	MANILA, P. I., 18.47 m., Addr. RCA Comm. Works Japan and U. S. 5-9 pm. irregularly.	16.233	FZR3	SAIGON, INDO-CHINA, 18.48 m. Calls Paris early morning.
16.233	FZR3	SAIGON, INDO-CHINA, 18.48 m. Calls Paris early morning.	16.030	KKP	KAHUKU, HAWAII, 18.71 m., Addr. RCA Comm. Works Dixon 3-10 pm.
15.880	FTK	ST. ASSISE, FRANCE, 18.9 m. Works Saigon 8-11 am.	15.865	CEC	SANTIAGO, CHILE, 18.91 m. Calls Peru daytime irregular.
15.865	CEC	SANTIAGO, CHILE, 18.91 m. Calls Peru daytime irregular.	15.810	LSL	BUENOS AIRES, ARG., 18.98 m., Addr. (See 21.020 mc.) Works London mornings and Paris afternoons.
15.810	LSL	BUENOS AIRES, ARG., 18.98 m., Addr. (See 21.020 mc.) Works London mornings and Paris afternoons.	15.660	JVE	NAZAKI, JAPAN, 19.16 m. Works Java and Siam 3-5 am.
15.660	JVE	NAZAKI, JAPAN, 19.16 m. Works Java and Siam 3-5 am.	15.620	JVF	NAZAKI, JAPAN, 19.2 m. Works Cal. near 5 am. and 8 pm.
15.620	JVF	NAZAKI, JAPAN, 19.2 m. Works Cal. near 5 am. and 8 pm.	15.550	CO9XX	TUINICU, ORIENTE, CUBA, 19.29 m., Addr. Frank Jones, Central Tuinicu, Tuinicu, Santa Clara. Broadcasts irregularly evenings.
15.550	CO9XX	TUINICU, ORIENTE, CUBA, 19.29 m., Addr. Frank Jones, Central Tuinicu, Tuinicu, Santa Clara. Broadcasts irregularly evenings.	15.440	XEBM	MAZATLAN, SIN., MEX., 19.43 m., Addr. Flores 103 Alto. "El Pregonero del Pacifico." Irregularly 7 am.-10 pm.
15.440	XEBM	MAZATLAN, SIN., MEX., 19.43 m., Addr. Flores 103 Alto. "El Pregonero del Pacifico." Irregularly 7 am.-10 pm.	15.430	IUD	ADDIS ABABA, ETHIOPIA, 19.44 m. Works Rome 9.15-10.30 am.
15.430	IUD	ADDIS ABABA, ETHIOPIA, 19.44 m. Works Rome 9.15-10.30 am.	15.415	KWO	DIXON, CAL., 19.46 m., Addr. A. T. & T. Co. Works Hawaii 2-7 pm.
15.415	KWO	DIXON, CAL., 19.46 m., Addr. A. T. & T. Co. Works Hawaii 2-7 pm.	15.370	HAS3	BUDAPEST, HUNGAR., 19.52 m., Addr. Radiolabor, Gyali Ut 22. Sun. 9-10 am.
15.370	HAS3	BUDAPEST, HUNGAR., 19.52 m., Addr. Radiolabor, Gyali Ut 22. Sun. 9-10 am.	15.360	DZG	ZEESEN, GERMANY, 19.53 m., Addr. Reichspostzentralamt. Tests irregularly.
15.360	DZG	ZEESEN, GERMANY, 19.53 m., Addr. Reichspostzentralamt. Tests irregularly.	15.355	KWU	DIXON, CALIF., 19.53 m., Addr. A.T.&T. Co. Phones Pacific Isles and Japan.
15.355	KWU	DIXON, CALIF., 19.53 m., Addr. A.T.&T. Co. Phones Pacific Isles and Japan.	19 Met. Broadcast Band		
15.340	DJR	BERLIN, GERMANY, 19.56 m., Addr. Broadcast'g House, 8-9 am.	15,330	W2XAD	SCHENECTADY, N. Y., 19.56 m., Addr. General Electric Co. Relays WGY 11 am. to 9 pm.

(Continued on page 678)

All Schedules Eastern Standard Time

Let's Listen

In With

Joe Miller

● ANOTHER month has passed and here we are almost at the threshold of Spring, with its greatly increased activity on the amateur bands, and a general pick-up in signals from all parts of the world.

The past month has been quiet in so far as DX in general is concerned, but one or two developments of late have kept the month from being too lacking in DX interest.

With the on-coming *International Amateur DX Contest* in March, DXers will have a wonderful chance to enrich their "logs" with many good catches from remote corners of our little globe, with the awakening of interest for many amateurs, who will find the "Contest" a means by which to add new countries to their logs, and for many, an opportunity to earn the coveted "W.A.C." certificate.

As the "Contest" will demand most of the DXer's attention during March, we will give particulars of this *World-Wide Amateur Competition*.

The Contest is to be divided into 2 sections; one, for *C.W.* or *code only*, from

SPECIAL BROADCAST from Reunion Island!

● FR8VX, Reunion Island, will transmit a broadcast for readers of "S.W.&T." sponsored by Joe Miller, on March 19, 20 and 21, from 3-3:30 p.m., E.S.T. Frequency will be 14,340 kc., phone, and Prince Vinh San, the operator, who is a regular reader of our columns, will use a beam antenna toward North America; power used will be 25 watts.

All reports should include a "reply coupon," and all writing should thank the Prince for his courtesy.

Special thanks to Tom Jordan of Seranton, Pa., for his aid in arranging this "FB" Special. Good luck to all of you dial-twisters!

March 4, at 7:01 p.m. to March 13, 6:59 p.m., and the second half of Contest will be for *phone only*, from March 18, 7:01 p.m. to March 27, 6:59 p.m. (all times E.S.T.). Of course, our attention is to be concentrated in the *phone* contest, as will be the case for all of you OM's.

In preparation for this event, we are erecting a W8JK Flat-top Beam here, for 20 meter reception, and as results are said to be a substantial gain of about 3Rs in signal strength over a conventional half wave doublet, the one we now have, we look forward to making a real DX success of this contest. Upon ascertaining the results of this antenna's operation, if it is as good as claimed, we will have full data published in the following issue.

While on the subject of the all-important angle of good skywires, we wish to add a note or two concerning the effectiveness of the diamond rhombic beam we have used, for our reception of South African and other African amateurs on 20 meter phone.

This antenna was directed at a point crossing through the center of the Union of South Africa.

When listening to a South African ham while having our doublet switched in, we

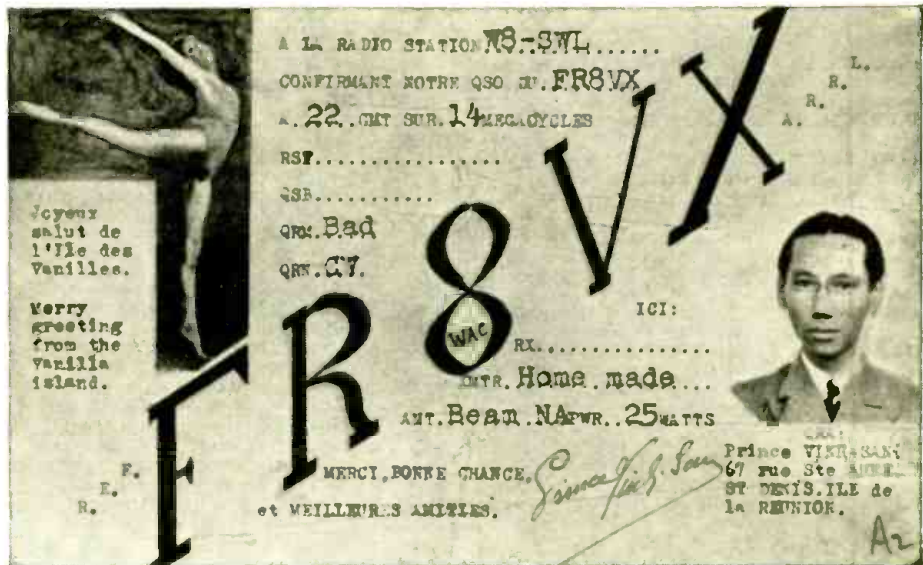

FR8VX—Reunion Island—Breaking a precedent, we print this QSL of Tom Jordan's. If you hear the "special" S-W broadcast, you'll earn one of these!

would have some difficulty if the signal was weak, as the bi-directional properties of the doublet picked up much extraneous noise, and QRM from other stations near the same frequency.

Upon throwing the antenna switch over to the rhombic, a surprising effect was noticed, namely, that the extraneous noise dropped to a negligible value, and that the signal was usually clarified to a remarkable degree, often making the difference between a readable, and an unreadable signal! The QRM situation was also greatly aided by the use of this fine beam, as the pick-up was concentrated in one direction, and stations not located inside of the beam's radius, and which were interfering with the desired signal, were usually attenuated sufficiently

by the beam's selective properties, resulting in but a negligible degree of QRM.

Naturally, everyone has not the opportunity to erect such beams, with their accompanying requisite of the large area necessary for such layouts, but experimentation in this all-important respect will usually help the DXer to improve upon his reception, no matter where his location, nor under what conditions he may labor.

Regarding this Flat-top beam, designed by our world-famous amateur friend, John Kraus, we will add the interesting data that, though its pick-up may reasonably be compared with a diamond rhombic, its requirements of space are no more than that of a half-wave doublet! This should enable

(Turn to page 679)

ZT6AK—South Africa—A very handsome QSL with blue letters on rainbow tinted card.



Mc.	Call		Mc.	Call		Mc.	Call	
15.320	OLR5B	PRAGUE, CZECHOSLOVAKIA, 19.58 m. Addr. (See 11.875 mc.) Daily ex. Sun. 6.30-7.30 am., Sun. 6-7.30 am.	14.730	IQA	ROME, ITALY, 20.37 m. Broadcasts 6-9 pm. irregular.	12.290	GBU	RUGBY, ENG., 24.41 m. Works N. Y. C. evenings.
15.310	GSP	DAVENTRY, ENG., 19.6 m., Addr. (See 26.100 mc.) 1.45-4 pm.	14.653	GBL	RUGBY, ITALY, 20.47 m. Works JVH 1-7 am.	12.250	TYB	PARIS, FRANCE, 24.49 m. Irregular.
15.290	LRU	BUENOS AIRES, ARG., 19.62 m., Addr. El Mundo. 6-8 am.	14.640	TYF	PARIS, FRANCE, 20.49 m. Works Saigon and Cairo 3-7 am, 12 n.-2.30 pm.	12.235	TFJ	REYKJAVIK, ICELAND, 24.52 m. Works Europe mornings. Broadcasts Sun. 1.40-2.30 pm.
15.280	HI3X	CIUDAD TRUJILLO, D. R., 19.63 m. Relays HIX Sun. 7.40-10.40 am. Weekdays 12.10-1.10 pm.	14.600	JVH	NAZAKI, JAPAN, 20.55 m. Broadcasts irregularly 5-11.30 pm. Works Europe 4-8 am.	12.215	TYA	PARIS, FRANCE, 24.56 m. Works French ships in morning and afternoon.
15.280	DJQ	BERLIN, GERMANY, 19.63 m., Addr. Broadcasting House. 12.05-10 am., 4.50-10.45 pm. Also Sun. 11.10 am.-12.25 pm.	14.590	WMN	LAWRENCEVILLE, N. J., 20.56 m., Addr. A.T.&T. Co. Works England morning and afternoon.	12.150	GBS	RUGBY, ENG., 24.69 m. Works N. Y. C. evenings.
15.270	W2XE	NEW YORK CITY, 19.65 m., Addr. (See 21.520 mc.) Daily except Sat. and Sun., 1-2.15 pm.	14.535	HBJ	GENEVA, SWITZERLAND, 20.64 m., Addr. Radio Nations. Broadcasts Sat. 6.45-8 pm.	12.130	DZE	ZEESEN, GERMANY, 24.73 m., Addr. (See 15.360 mc.) Tests irregularly.
15.260	GSI	DAVENTRY, ENG., 19.66 m., Addr. (See 26.100 mc.) 12.20-4 pm.	14.530	LSN	BUENOS AIRES, ARG., 20.65 m. Addr. (See 20.020 mc.) Works N. Y. C. afternoons.	12.120	TPZ2	ALGIERS, ALGERIA, 24.75 m. Calls Paris 12 m.-6.30 am.
15.252	RIM	TASHKENT, U.S.S.R., 19.67 m. Works RKL near 7 am.	14.500	—	ASMARA, ERITREA, AFRICA, 20.69 m. Works Rome and Addis Ababa 6.30-7.30 am.	12.060	PDV	KOOTWIJK, HOLLAND, 24.88 m. Tests irregularly.
15.250	WIXAL	BOSTON, MASS., 19.67 m., Addr. University Club. Daily 2.15-4 pm., Sun. 10.15 am.-12 n.	14.500	LSM2	BUENOS AIRES, ARG., 20.69 m., Addr. (See 21.020 mc.) Works RIO and Europe daytime.	12.060	RNE	MOSCOW, U.S.S.R., 24.88 m. Daily 6-7 am., 12.15-1 pm., 8-9.15, 10-11 pm., also Sun. 6 am.-1 pm.
15.245	TPA2	PARIS, FRANCE, 19.68 m., Addr. 98 bis, Blvd. Haussmann. "Radio Colonial." 6-11 am.	14.485	TIR	CARTAGO, COSTA RICA, 20.71 m. Works Central America and U. S. A. daytime.	11.991	FZS2	SAIGON, INDO-CHINA, 25.02 m. Phones Paris mornings.
15.230	HS8PJ	BANGKOK, SIAM, 19.7 m. Irregularly Mon. 8-10 am.	14.485	YSL	SAN SALVADOR, SALVADOR, 20.71 m. Irregular.	11.970	HI2X	CIUDAD TRUJILLO, D. R., 25.07 m., Addr. La Voz de Hispaniola. Relays HIX Tue. and Fri. 8.10-10.10 pm.
15.230	OLR5A	PRAGUE, CZECHOSLOVAKIA, 19.7 m., 6.30-7.30 am. Sun. 6-7.30 am.	14.485	HPF	PANAMA CITY, PANAMA, 20.71 m. Works WNC daytime.	11.955	IUC	ADDIS ABABA, ETHIOPIA, 25.09 m. Works IAC around 12 m.
15.220	PCJ	HUIZEN, HOLLAND, 19.71 m., Addr. N. V. Philips' Radio Hilversum. Tues. 3.30-5 am., Wed. 9 am.-12 n.	14.485	TGF	GUATEMALA CITY, GUATEMALA, 20.71 m. Works WNC daytime.	11.950	KKQ	BOLINAS, CALIF., 25.1 m. Tests irregularly evenings.
15.210	W8XK	PITTSBURGH, PA., 19.72 m., Addr. (See 21.540 mc.) 9 am.-7 pm.	14.485	YNA	MANAGUA, NICARAGUA, 20.71 m. Works WNC daytime.	11.940	FTA	STE. ASSISE, FRANCE, 25.13 m. Works Morocco mornings and Argentina late afternoon.
15.200	DJB	BERLIN, GERMANY, 19.74 m., Addr. (See 15.280 mc.) 12.05-11 am., 4.50-10.45 pm. Also Sun. 11.10 am.-12.15 pm.	14.485	HRL5	NACAOME, HONDURAS, 20.71 m. Works WNC daytime.	25 Met. Broadcast Band		
15.190	ZBW4	HONGKONG, CHINA, 19.75 m., Addr. P. O. Box 200. Irregular. 11.30 pm. to 1.15 am., 4-10 am., Sat. 9.15 pm.-1 am., Sun. 3-9.30 am.	14.485	HRF	TEGUCIGALPA, HONDURAS, 20.71 m. Works WNC daytime.	11.910	CD1190	VALDIVIA, CHILE, 25.2 m., P. O. Box 642. Relays CB69 10 am.-1 pm., 3-6 pm., 7-10 pm.
15.180	GSO	DAVENTRY, ENG., 19.76 m., Addr. (See 26.100 mc.) 3.15-5.30, 5.45-10 am., 4.15-6 pm.	14.470	WMF	LAWRENCEVILLE, N. J., 20.73 m., Addr. A.T.&T. Co. Works London and Paris daytime.	11.900	XEW1	MEXICO CITY, MEXICO, 25.21 m., Addr. P. O. Box 2874. Tues. and Thurs. 7.30 pm.-12 m., Fri. 9 pm.-12 m. Sun. 12.30-2 pm.
15.170	TGWA	GUATEMALA CITY, GUAT., 19.77 m., Addr. (See 17.8 mc.) Irregular 11.30 am.-2 pm.	14.460	DZH	ZEESEN, GERMANY, 20.75 m., Addr. (See 15.360 mc.) Irregular. Relays Salamanca. Irreg. afternoons.	11.895	HP51	AGUADULCE, PANAMA, 25.22 m. Addr. La Voz del Interior. 7.30-9.30 pm.
15.160	XEWW	MEXICO CITY, MEXICO, 19.79 m., 12 n.-12 m., irregular.	14.440	—	RADIO MALAGA, SPAIN, 20.78 m. Relays Salamanca. Irreg. afternoons.	11.880	TPA3	PARIS, FRANCE, 25.23 m., Addr. (See 15.245 mc.) 2-5 am., 12.15-6 pm.
15.160	JZK	TOKIO, JAPAN, 19.79 m. Irregular.	14.166	PIIJ	RUGBY, ENG., 20.78 m. Works U.S.A. afternoons.	11.870	W8XK	PITTSBURGH, PA., 25.26 m., Addr. (See 21.540 mc.) 7-11 pm.
15.155	SM5SX	STOCKHOLM, SWEDEN, 19.79 m., Daily 11 am.-5 pm., Sun. 9 am.-5 pm.	14.030	EA9AH	DORDRECHT, HOLLAND, 21.15 m., Addr. (See 7.088 mc.) Sat. 12 n.-12.30 pm.	11.860	YDB	SOERABAJA, JAVA, 25.29 m., Addr. N. I. R. O. M. Sat. 7.30 pm. to 2.30 am., daily 10.30 pm. to 2 am.
15.150	YDC	BANDOENG, JAVA, 19.8 m., Addr. N. I. R. O. M. 6-7.30 pm., 10.30 pm.-2 am., Sat. 7.30 pm.-2 am., 5.30-10.30 am.	13.990	GBA	TETUAN, SPANISH MOROCCO, 21.4 m. Daily except Sun. 2.15-5.7 and 9 pm.	11.860	GSE	DAVENTRY, ENG., 25.29 m., Addr. (See 26.100 mc.) Irregular.
15.140	GSF	DAVENTRY, ENG., 19.82 m., Addr. (See 26.100 mc.) 5.45 am.-12 n.	13.820	SUZ	RUGBY, ENG., 21.44 m. Works Buenos Aires late afternoon.	11.855	DJP	BERLIN, GERMANY, 25.31 m., Addr. (See 15.280 mc.) Irregular 11.35 am.-4.7-10.45 pm.
15.120	HVJ	VATICAN CITY, 19.83 m., 10.30-10.45 am., except Sun., Sat. 10-10.45 am.	13.690	KKZ	ABOU ZABAL, EGYPT, 21.71 m. Works with Europe 11 am.-2 pm.	11.845	—	ESSARTS, FRANCE, 25.34 m. Radio Coloniale. Testing.
15.110	DJL	BERLIN, GERMANY, 19.85 m., Addr. (See 15.280 mc.) 12 m.-2.8-9 am., 10.40 am. to 4.30 pm. Sun. also 6-8 am.	13.635	SPW	BOLINAS, CALIF., 21.91 m., Addr. RCA Comm. Irregularly.	11.840	KZRM	MANILA, P. I., 25.35 m. Addr. Erlanger & Gallinger, Box 283. 9 pm.-10 am. Irregular.
15.080	RK1	MOSCOW, U.S.S.R., 19.87 m. Works Tashkent near 7 am. Broadcasts Sun. 12.15-2.30 pm.	13.415	GCJ	WARSAW, POLAND, 22 m., Mon., Wed., Fri. 12.30-1.30 pm. Daily 6-8 pm. Sun. 6-9 pm.	11.840	CSW	LISBON, PORT., 25.35 m. Nat'l Broad. Station. 11.30 am.-1.30 pm. Irregular.
End of Broadcast Band			13.410	YSJ	RUGBY, ENG., 22.36 m. Works Japan and China early morning.	11.840	OLR4A	PRAGUE CZECHOSLOVAKIA, 25.35 m., Addr. Czech Shortwave Sta., Praha XII, Fochova 16.
15.055	WNC	HIALEAH, FLORIDA, 19.92 m., Addr. A.T.&T. Co. Calls Central America daytime.	13.390	WMA	SAN SALVADOR, SALVADOR, 22.37 m. Works WNC daytime.	11.830	W9XAA	CHICAGO, ILL., 25.36 m., Addr. Chicago Federation of Labor. Irregular 7 am.-6 pm.
14.980	KAY	MANILA, P. I., 20.03 m., Addr. RCA Comm. Works Pacific Is.	13.380	IDU	LAWRENCEVILLE, N. J., 22.4 m., Addr. A.T.&T. Co. Works England morning and afternoon.	11.830	W2XE	NEW YORK CITY, 25.36 m., Addr. Col. Broad. System, 485 Madison Av., N.Y.C. 1-6, 6.30 pm.-12 m.
14.960	PSF	RIO DE JANEIRO, BRAZIL, 20.05 m., Works with Buenos Aires daytime.	13.345	YVQ	ASMARA, ERITREA, AFRICA, 22.42 m. Works Rome daytime.	11.826	XEBR	HERMOSILLA, SON., MEX., 25.37 m., Addr. Box 68. Relays XEBH. 2-4 pm., 9 pm.-12 m.
14.950	HJB	BOGOTA, COL., 20.07 m. Calls WNC daytime.	13.285	CGA3	MARACAY, VENEZUELA, 22.48 m. Works WNC daytime.	11.820	GSN	DAVENTRY, ENG., 25.38 m., Addr. (See 26.100 mc.) Irregular.
14.940	H11	CIUDAD TRUJILLO, D. R., 20.08 m. Phones WNC daytime.	13.285	CNR	DRUMMONDVILLE, QUE., CAN., 22.58 m. Works London and ships afternoons.	11.810	2RO	ROME, ITALY, 25.4 m., Addr. E.I.A.R., Via Montello 5. Daily 5-8.30 am., 10.30 am.-12.20 pm.
14.940	HJA3	BARRANQUILLA, COL., 20.08 m. Works WNC daytime.	12.825	CNR	ROME, ITALY, 22.69 m. Works Tokio 5-9 am. irregularly.	11.805	COGF	MATANZAS, CUBA, 25.41 m., Addr. Gen. Betancourt 51. Relays CMGF. 2-3, 4-5, 6-11 pm.
14.920	LZA	SOPHIA, BULGARIA, 20.10 m., Addr. Radio Gareta. Mon., Tues., Thurs., Fri. 11.30 am.-2.45 pm., Wed. 11.30 am.-4.45 pm., Sat. 11.30 am.-5 pm., Sun. 2 am.-5 pm. Daily except Sun. 5-6.30 am.	12.800	IAC	SUVA, FIJI ISLANDS, 22.94 m. Irregularly.	11.805	OZG	SKAMLEBOAEK, DENMARK, 25.41 m., Addr. Statsradionfönnen. Irreg.
14.845	OCJ2	LIMA, PERU, 20.21 m. Works South America stations daytime.	12.780	GBC	ELGIN, ILL., 23.25 m. Press Wireless, Tests 2-5 pm.	11.800	JZJ	TOKIO, JAPAN, 25.42 m., Addr. Broadcasting Co. of Japan, Overseas Division. 12.30-1.30, 7-7.30, 8-9.30 am., 2.30-4, 4.30-5.30, 6-6.30 pm.
14.790	ROU	OMSK, SIBERIA, U.S.S.R., 20.28 m. Works Moscow irregularly 7-9 am.	12.325	DAF	OCEAN GATE, N. J., 23.36 m., Addr. A.T.&T. Co. Works with ships irregularly.	11.795	DJO	BERLIN, GERMANY, 25.43 m., Addr. (See 15.280 mc.) Irregular.
								(Continued on page 680)

All Schedules Eastern Standard Time

many readers, limited as to antenna space, to erect such a beam, with its accepted excellency of results!

More in the next issue regarding this Flat-top beam antenna.

And now, regarding DX:

DELHI, INDIA

VUD, 9.59 mc., approximately, located at Delhi, is being heard here in the East with a surprisingly strong signal, rating R8-9 daily when it pounds in at 9.30 p.m., at which time the program begins.

Just commencing to be heard lately, this station is causing quite a sensation in DXing ranks, what with such a strong signal at this time of night, for the East Coast! Many DXers who were informed of this station, upon hearing it, could scarcely believe they were hearing a station in distant India!

VUD has its strongest peak just as it opens its programs, and about 11:30 p.m., the signal dies out. To receive this station one will experience little difficulty, as one merely has to tune in GSC on 9.58 mc., and tune just a hair off GSC towards the higher frequencies, and at once will be noticed another signal, which will usually be slightly QRM'd by London's strong carrier. However, using the '38 Skyriders, we can hear VUD with no interference whatever from GSC, when using the crystal, and with VUD still a good R6!

VUD transmits a typically Oriental program, consisting of chantings and native songs, with a chorus and orchestra frequently interspersed. Station opens at 9:30 p.m., with the familiar Westminster Chimes played by a clock, the clock chiming eight times, for 8 a.m. At 10:40 p.m., English news and station announcements are made, but at this time the signals are so much poorer that most of the announcement is lost.

An air-mail letter from an Indian DXer, Ahmed Nawaz, of Lahore, gives us more authentic data on VUD. This station also operates on 6.085 mc., and 3.49 mc.! On 6.085 mc., VUD is heard from 10:30 p.m.-midnight, and again from midnight-4 a.m., E.S.T. On 3.49 mc., signal is scheduled from 7:30 a.m.-12:30 p.m., E.S.T. This is very helpful data, and we thank Mr. Nawaz for his aid in giving full data on this rare scoop! The address is Station Manager, Station VUD, New Delhi, India.

Mr. Nawaz also sends a newspaper clipping from a native paper, showing the

ZBIL — Malta—
This is the first veri of a Maltese amateur in the U. S. Coloring blue.

AMATEUR RADIO STATION

QRA. 14, DEPIRO STREET,
SLEIEMA
MALTA.

Z B I L

R. S. G. B. B. E. R. U.

TO RADIO **W2XJM.**

Confirming QSO *20m. 7mc. Confirmed* at *12-36* GMT.

Your signals were RST *cnf/10/37* on *14* Mc.

TRANSMITTER *47 46 P.P.46 25* WATTS RX *Hallen 1115*

PSE QSL direct of via R.S.G.B. 73 or DY. A. R. Vella Operator.

Just one for us kept on my 7mc.

daily program of VUC, 6.11 mc., Calcutta, India, and the schedule, as Mr. Nawaz states, is quite different from that listed for VUC. VUC broadcasts daily from 3:29-5:59 a.m., and from 7:59 a.m.-1:14 p.m., E.S.T.

In Burma, we have VVS, 12.87 mc., Mingaladon, heard phoning in inverted speech at 7 a.m. Good signal, as always.

JAVA

YDB, 4.47 mc., Soerabaja, is being heard with a fair signal most mornings, on this unusually low frequency, for an Asiatic. YDB has 1 kw. power.

"SPECIAL" FROM SIAM!

● HSIBJ, 14,070 kc, Bangkok, Siam, operated by our friend Sangiem Powtongsook, Ass't Engineer at HS8PJ, Siamese National Station, will again Broadcast a program for our readers, and this time we feel conditions will be better than for the last Special. Times will be: March 31, April 1 and 2, from 6-8 a.m., 2 solid hours daily!! HSIBJ should be heard with good strength this time. Power is 25 watts, phone. Address reports, with a reply coupon to Sangiem Powtongsook, HSIBJ, Royal Siamese Post and Tel. Dept., Saladeng, Bangkok, Siam. Good luck to all!

YDA, 3.04 mc., Tandjongpriok, is occasionally heard, but usually with a poorly modulated carrier, making logging difficult.

PMY, 5.145 mc., Bandoeng, also is heard well, being audible every a.m., and this station sends a neat QSL. PLP, 11.00 mc., Bandoeng, is almost inaudible now, strangely, while PMX, 10.26 mc., Bandoeng, is heard better than PLP, the reverse of what

will be true this summer, as always, when PLP is heard with a powerful signal.

To any DXers needing Asiatic veris, these stations present an opportunity to add several good catches, and also to garner some attractive QSLs, as all but PMY are verified by N.I.R.O.M., with the beautiful QSL shown in Feb. issue. All above signals should be very well heard by the first of March, when this article is published.

ST. KITTS, B.W.I.

VP2LO, 6.38 mc., at Basseterre, was logged one Saturday at 5 p.m., when they were heard testing this new broadcaster, contacting VP2CD, an amateur.

This station will enable all DXers to add still another country to their logs, and with ease.

As yet VP2LO has no regular schedule, heard occasionally at 5 p.m., and reported by Eli Powers, W2, at 4 a.m., several Sundays. Constant watching on this frequency should reward the DXer with a new country, so go to it! QRA: Ica Radio Sales & Service, P.O. Box 88, Basseterre, St. Kitts, B.W.I.

MANCHUKUO

JDY, 9.925 mc., Dairen, is sending letter veris to many DXers of our acquaintance, and this nice Asiatic catch, a new country for all DXers, and a very easy signal to log, should be tuned for by all of our readers, as the station cannot be missed, being all alone on that frequency, consequently being very simple to "spot."

Station schedule is listed as from 7:10-8 a.m., daily, but heard here beginning at 7 a.m. sharp. A very strong signal, and they do verify! What more can any DXer ask of an Asiatic catch such as this? On their commercial transmissions, when phoning JVO, 10.37 mc., Nazaki, we have been unable to solicit a veri in 3 tries, but everyone, it seems, has received a veri of their broadcast period.

Address reports to: Manchuria Tel. and Tel. Co., 7, Oyamagori, Dairen, Kwantung Peninsula, Manchukuo. A handsome photo of the station bldg. is often included in the veri.

Harry Honda, W6, reports JDY, phoning JVO at 4 a.m., using inverted speech.

(Continued on page 717)

TO RADIO **W2XJM**
Mr. JOE MILLER

SP 1 DC POLAND

Ur *CRD* wkd recd on *14* mcb at *MEZ 20 Jun 1938*

XMR C. C. Input *30* watts RCVE 1-V-2 ANT L 37

DX wkd W A C *70* countr Remarks *By use of 16 CRD*

Letter and very fine Magnat. SHORT

WAVE and TELEVISION

PSE QSL via *Edward*

The Polish QSL Bureau 73 or Coogon

LWOW, Bielewskiego 4 Edward Kowczyński

Lodz, Przemyslowa 45

SPIDC — Pola
—A rare veri from a Polish amateur. Blue printing on white card.

Mc.	Call		Mc.	Call		Mc.	Call	
11.790	OER3	VIENNA, AUSTRIA, 25.45 m. Daily 10 am.-5 pm. Sat. until 5:30 pm.	10.600	ZIK2	BELIZE, BRIT. HONDURAS, 28.25 m., Tues., Thurs., Sat. 7:30-7:45 pm.	9.790	GCW	RUGBY, ENGLAND, 30.64 m., Works N.Y.C. evenings.
11.790	WIXAL	BOSTON, MASS., 25.45 m., Addr. (See 15.250 mc.) Daily 4.45-6.30 pm., Sat. 1.45-5.15, 6-6.30 pm., Sun. 3-6.30 pm.	10.550	WOK	LAWRENCEVILLE, N. J., 28.44 m., Addr. A.T.&T. Co. Works S. A. nights.	9.760	VLJ-VLZ2	SYDNEY, AUSTRALIA, 30.74 m., Addr. Amalgamated Wireless of Australasia Ltd. Works Java and New Zealand early morning.
11.770	DJD	BERLIN, GERMANY, 25.49 m., Addr. (See 15.280 mc.) 10.40 am.-4.30 pm., 4.50-11 pm.	10.535	JIB	TAIHOKU, TAIWAN, 28.48 m. Works Japan around 6.25 am. Broadcasts, relaying JFAK 9-10.25 am., 1-2.30 am. Sun. to 10.15 am.	9.750	WOF	LAWRENCEVILLE, N. J., 30.77 m., Addr. A.T.&T. Co. Works London and Paris night time.
11.760	TGWA	GUATEMALA CITY, GUAT., 25.51 m. (See 17.8 mc.) Sun., Tues. and Thurs. 8 pm.-12 m.	10.520	VLK	SYDNEY, AUSTRALIA, 28.51 m., Addr. Amalgamated Wireless of Australasia Ltd. Works England 1-6 am.	9.745	COCQ	HAYANA, CUBA, 30.78 m. Addr. 25 No. 445, Vedado, Havana. 6.55 am.-1 am. Sun. till 12 m.
11.760	OLR4B	PRAGUE, CZECHOSLOVAKIA, 25.51 m., Addr. (See 11.875 mc.) Irregular.	10.430	YBG	MEDAN, SUMATRA, 28.76 m. 5.30-6.30 am., 7.30-8.30 pm.	9.710	GCA	RUGBY, ENGLAND, 30.9 m. Works S. A. evenings.
11.750	GSD	DAVENTRY, ENG., 25.53 m., Addr. B.B.C., London. 3.15-5.30, 10.45 am.-12 n., 12.20-6.00 pm., 6.20-8.30, 9.15-11.15 pm.	10.420	XGW	SHANGHAI, CHINA, 28.79 m. Works Japan 12 m.-3 am.	9.698	T14NRH	HEREDIA, COSTA RICA, 30.91 m., Addr. Amando C. Marin, Apartado 40, Sun. 7-8.30 am., Irregular evenings.
11.740	HVJ	VATICAN CITY, 25.55 m. Testing irregular.	10.410	PKD	KOOTWIJK, HOLLAND, 28.8 m. Works Java 7.30-9.40 am.	9.685	TGWA	GUATEMALA CITY, GUAT., 30.96 m. Irregular.
11.730	—	SAIGON, INDO CHINA, 25.57 m., Addr. Radio Philco. 11 pm.-1 am., 5.30-9.30 am.	10.410	KES	BOLINAS, CALIF., 28.8 m., Addr. RCA Communications. Irregular.	9.680	FZF6	FORT DE FRANCE, MARTINIQUE, 30.97 m., Addr. P. O. Box 136. 11.30 am.-12.30 pm., 6.15-7.50 pm.
11.730	PHI	HUIZEN, HOLLAND, 25.57 m., Addr. N. V. Philips' Radio.	10.370	JVO	NAZAKI, JAPAN, 28.93 m. Broadcasts around 5 am.	9.675	DZA	ZEESEN, GERMANY, 31.01 m., Addr. (See 10.042 mc.) Irregular.
11.720	CJRX	WINNIPEG, CANADA, 25.6 m., Addr. James Richardson & Sons, Ltd. Daily 6 pm.-12 m., Sun. 5-10 pm.	10.370	EAJ43	TENERIFFE, CANARY ISLANDS, 28.93 m. Relays Salamanca, Spain, 2.15-3.15, 6.15-10 pm.	9.660	LRX	BUENOS AIRES, ARG., 31.06 m., Addr. El Mundo. 8.30 am.-10.30 pm.
11.718	CR7BH	LAURENÇO MARQUES, PORTUGUESE E. AFRICA, 25.6 m. Daily 12.05-1, 4.30-6.30, 9.30-11 am., 12.05-4 pm., Sun. 5-7 am., 10 am.-2 pm.	10.350	LSX	BUENOS AIRES, ARG., 28.98 m., Addr. Transradio International. Tests irregularly.	9.650	CS2WA	LISBON, PORTUGAL, 31.09 m., Addr. Radio Colonial. Tues., Thurs. and Sat. 4.30-7 pm.
11.715	TPA4	PARIS, FRANCE, 25.61 m., (See 15.245 mc.) 6.15-8.15 pm., 10 pm.-1 am.	10.330	ORK	RUYSSELEDE, BELGIUM, 29.04 m. 2.30-4 pm.	9.650	DGU	NAUEN, GERMANY, 31.09 m., Addr. (See 20.020 mc.) Works Egypt afternoons.
11.710	SBP	MOTALA, SWEDEN, 25.63 m., 1.20-2.05, 6-9 am., 11 am.-1 pm., Sat. 1.20-2 am., 6 am.-1.30 pm., Sun. 3 am.-1.30 pm.	10.300	LSL2	BUENOS AIRES, ARG., 29.13 m., Addr. Cia. Internacional de Radio. Works Europe evenings.	9.645	HH3W	PORT-AU-PRINCE, HAITI, 31.1 m., Addr. P. O. Box A117. 1-2, 7-8 pm.
11.710	YSM	SAN SALVADOR, EL SALVADOR, 25.63 m., Addr. (See 7.894 mc.) Irregular 1.30-2.30 pm.	10.290	DZC	ZEESEN, GERMANY, 29.16 m., Addr. (See 15.360 mc.) Irregular.	9.640	CXA8	COLONIA, URUGUAY, 31.12 m., Addr. Belgrano 1841, Buenos Aires, Argentina, Relays LR3, Buenos Aires 6 am.-11 pm.
11.700	HP5A	PANAMA CITY, PAN., 25.65 m. Addr. Radio Teatro, Apartado 954. 10 am.-10 pm.	10.260	PMN	BANDOENG, JAVA, 29.24 m. Relays YDB 5.30-10.30 or 11 am., Sat to 11.30 am.	9.635	2RO	ROME, ITALY, 31.13 m., Addr. (See 11.810 mc.) Daily 12.30-9 pm.
11.700	CB1170	SANTIAGO, CHILE, 25.65 m. Relays CB89 6 pm.-12 m.	10.250	LSK3	BUENOS AIRES, ARG., 29.27 m., Addr. (See 10.310 mc.) Works Europe and U.S.A. afternoons and evenings.	9.630	HJ7ABD	BUCARAMANGA, COL., 31.14 m. 10 am.-12 n., 4-11 pm.
11.680	KIO	KAHUKU, HAWAII, 25.68 m., Addr. RCA Comm. Irregularly.	10.230	CED	ANTOFAGASTAN, CHILE, 29.33 m. Tesis 7-9.30 pm.	9.625	JFO	TAIHOKU, TAIWAN, 31.16 m. Relays JFAK irreg. 8-10.25 am., 1-2.30 am., Sun. 8-10.15 am.
11.595	VRR4	STONY HILL, JAMAICA, B. W. I., 25.87 m. Works WNC daytime.	10.220	PSH	RIO DE JANEIRO, BRAZIL, 29.35 m., Addr. Box 709. Broadcasts 6-9 pm.	9.617	HJ1ABP	CARTAGENA, COL., 31.20 m., Addr. P. O. Box 37. 11 am.-1 pm., 5-11 pm., Sun. 10 am.-1 pm., 3-6 pm.
11.560	VIZ3	FISKDALE, AUSTRALIA, 25.95 m., Addr. Amalgamated Wireless of Australasia Ltd. Tests irregularly.	10.160	RIO	BAKOU, U.S.S.R., 29.5 m. Works Moscow 10 pm.-5 am.	9.615	ZRK	KLIPHEUVAL, SOUTH AFRICA, 31.2 m., Addr. P. O. Box 4559, Johannesburg. Daily, exc. Sat. 11.45 pm.-12.40 am. Daily exc. Sun. 3.20-7.20, 9-11.40 am., Sun. 4-5.30, 8-11.40 am.
11.530	SPD	WARSAW, POLAND, 26 m., Addr. 5 Mazowiecka St. Testing daily 6-8 pm., Sun. 6-9 pm.	10.140	OPM	LEOPOLDVILLE, BELGIAN CONGO, 29.59 m. Works Belgium around 3 am. and from 1-4 pm.	9.607	HP5J	PANAMA CITY, PANAMA, 31.23 m. Addr. Apartado 867. 12 n. to 1.30 pm., 6-10.30 pm.
11.500	XAM	MERIDA, YUCATAN, 26.09 m. Irregular 1-7.30 pm.	10.080	RIR	TIFLIS, U.S.S.R., 29.76 m. Works Moscow early morning.	31 Met. Broadcast Band		
11.500	PMK	BANDOENG, JAVA, 26.09 m. Tests irregularly.	10.070	EDM-EHY	MADRID, SPAIN, 29.79 m. Works S. A. evenings.	9.600	RAN	MOSCOW, U.S.S.R., 31.25 m. Daily 7-9.15 pm.
11.420	COCX	HAVANA, CUBA, 26.25 m. P. O. Box 32. 6.55 am.-1 am. Sun. till 12 m. Relays CMX.	10.065	JZB-TDB	SHINKYO, MANCHUKUO, 29.81 m. Works Tokio 6.30-7 am.	9.595	HBL	GENEVA, SWITZERLAND, 31.27 m., Addr. Radio Nations. Irregular.
11.413	CJA4	DRUMMONDVILLE, QUE., CAN., 26.28 m. Tests irregularly.	10.055	ZFB	HAMILTON, BERMUDEA, 29.84 m. Works N.Y.C. irregular.	9.590	PCJ	HUIZEN, HOLLAND, 31.28 m., Addr. (See 15.220 mc.) Sun. 2-3, 7-9.15 pm., Tues. 5.30-8 am., 2-3.30 pm., Thurs. 7-8.30, 9-10.30 pm.
11.402	HBO	GENEVA, SWITZERLAND, 26.31 m., Addr. Radio Nations. Sat. 6.45-8 pm.	10.055	SUV	ABOU ZABAL, EGYPT, 29.84 m. Works Europe 1-6 pm.	9.590	VK6ME	PERTH, W. AUSTRALIA, 31.28 m., Addr. Amalgamated Wireless of Australasia, Ltd. 6-8 am, exc. Sun.
11.040	CSW	LISBON, PORTUGAL, 27.17 m., Addr. Nat. Broad. Sta. 1.30-5 pm.	10.042	DZB	ZEESEN, GERMANY, 29.87 m., Addr. Reichspostzentramt. Irregular.	9.590	VK2ME	SYDNEY, AUSTRALIA, 31.28 m., Addr. Amalgamated Wireless of Australasia, Ltd., 47 York St., Sun. 1-3 am., 5-9, 9.30-11.30 am.
11.005	ZLT4	WELLINGTON, NEW ZEALAND, 27.28 m. Works Australia and England early morning.	9.990	KAZ	MANILA, P. I., 30.03 m., Addr. RCA Communications. Works Java early morning.	9.580	GSC	DAVENTRY, ENGLAND, 31.32 m., Addr. B. B. C., Portland Pl., London, W. I., 6.20-8.30, 9.15-11.15 pm.
11.000	PLP	BANDOENG, JAVA, 27.27 m. Relays YDB. 6-7.30 p.m., 5.30-10.30 or 11 am. Sat. until 11.30 am.	9.980	COBC	HAVANA, CUBA, 30.04 m., Addr. P. O. Box 132. Relays CM8C 6.55 a.m.-12.30 a.m.	9.580	VLR	MELBOURNE, AUSTRALIA, 31.32 m. Addr. Box 1686, G. P. O. Daily 3.30-8.30 am. (Sat. till 9 am.) Sun. 3-7.30 am. Daily exc. Sat. 9.35 pm.-2.15 am.
10.970	OCI	LIMA, PERU, 27.35 m. Works Bogota, Col. evenings.	9.950	GCU	RUGBY, ENGLAND, 30.15 m. Works N.Y.C. night time.	9.580	OAX5C	ICA, PERU, 31.32 m. Radio Universal 6-10 pm.
10.960	—	TANANARIVE, MADAGASCAR, 27.36 m., Addr. (See 9.53 mc.) 12.30-45, 3.30-4.30, 10-11 am.	9.940	CSW	LISBON, PORTUGAL, 30.18 m. Addr. Nat. Broad. Sta. 5-7 pm.	9.570	KZRM	MANILA, P. I., 31.35 m., Addr. Erlanger & Galinger, Box 283. 4.30-6 pm., 5-9 am., Sun 4-10 am.
10.840	KWV	DIXON, CALIF., 27.68 m., Addr. A.T.&T. Co. Works with Hawaii evenings.	9.940	JDY	DAIREN, MANCHUKUO, 30.18 m. Relays JQAK daily 6.50-8 am.	<i>(Continued on page 682)</i>		
10.770	GBP	RUGBY, ENGLAND, 27.85 m. Works Australia early morning.	9.930	HKB	BOGOTA, COL., 30.21 m. Works Rio evenings.			
10.740	JVM	NAZAKI, JAPAN, 27.93 m. Works U.S.A. 2-7 am.	9.890	LSN	BUENOS AIRES, ARG., 30.33 m., Addr. (See 10.300 mc.) Works N.Y.C. evenings.			
10.675	WNB	LAWRENCEVILLE, N. J., 28.1 m., Addr. A.T.&T. Co. Works with Bermuda irregularly.	9.870	WON	LAWRENCEVILLE, N. J., 30.4 m., Addr. A.T.&T. Co. Works England nights.			
10.670	CEC	SANTIAGO, CHILE, 28.12 m. Irregular.	9.865	COCM	HAVANA, CUBA, 30.41 m., Addr. Transradio Columbia, P. O. Box 33. 7 am.-12 m. Relays CMCM.			
10.660	JVN	NAZAKI, JAPAN, 28.14 m. Broadcasts daily 2-8 am. Works Europe irregularly at other times.	9.860	EAQ	MADRID, SPAIN, 30.43 m., Addr. Post Office Box 951. Irregular.			
			9.830	IRF	ROME, ITALY, 30.52 m. Works Egypt afternoons. Relays 2RO, 6-9 pm.			
			9.800	XGOX	NANKING, CHINA, 30.61 m., Reported off the air.			
			9.800	LSI	BUENOS AIRES, ARG., 30.61 m., Addr. (See 10.350 mc.) Tests irregularly.			

All Schedules Eastern Standard Time

New Experiments With Radio Apparatus

MONEY FOR YOUR IDEAS!

Each month we will award 2 prizes, the first of \$10, the second \$5, for the best NON-RADIO uses of ordinary radio parts and radio instrumentalities.

First Prize -- \$10.00

Faulty Circuit Locator

I AM pleased to submit a brief description of the construction and use of an instrument which has saved us many hours of labor, and shortened the time required

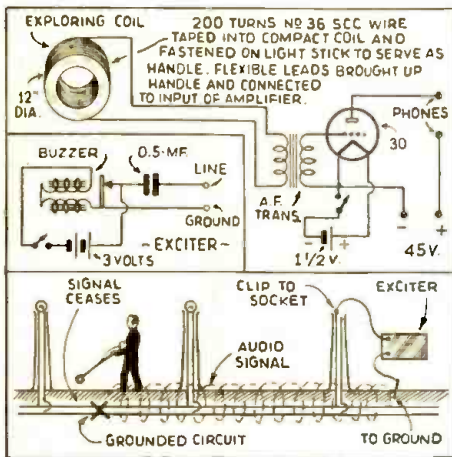

This simple device locates faults in lighting or other circuits and is easily and cheaply made.

to locate and repair outages of our multiple low-voltage underground street-lighting circuits.

In practically every case of trouble, whether an open- or short-circuit, these circuits show grounded. Therefore, an instrument that will show the spot where the circuit is grounded, without digging, is certainly of great benefit to the troubleshooter.

I devised a system, using two units, an exciter and an exploring coil connected through a small amplifier to a headset.

As shown by the accompanying sketch, the exciter consists simply of a buzzer
(Continued on page 689)

Inter-Office Carrier Phone System

INTER-OFFICE telephone systems are being widely adopted, the instruments used for both talking and listening utilizing radio parts such as tubes, resistors, loudspeakers, etc. The accompanying diagram shows one form of carrier type inter-phone using four tubes and an additional so-called tube containing a ballast resistor.

A dynamic speaker of the permanent magnet type and about 5" in diameter serves very well as both transmitter and receiver, a simple gang-switch being turned to send or receive. (Marked "S" or "R" in diagram.) The power-supply uses a 25Z6 tube and a 300 ohm A.C.-D.C. choke, shunted by two 8 mf. electrolytic condensers. A jack is provided for headphone reception, which is sometimes quite desirable; pilot lights indicate the send and receive conditions. A gain control is also provided, and the whole affair fits into a 5" x 6" x 9" cabinet, which should be of metal to prevent R.F. radiation.

A 25A6, triode-connected, is used as the detector-oscillator as the diagram shows. I.F.T.1. may be most anything; for example, a broadcast R.F. transformer capable of being tuned to a point below or above the regular B.C. channels. Again it may be an I.F. transformer or a single layer homemade coil, tuned by a small condenser to any desired operating frequency.

The 25A6 tube is used as the modulator power-amplifier and a 6F5 is the voltage amplifier for the loudspeaker when used as a microphone. The ganged "send to receive" changeover switch is a 4-pole double-throw type. The coil used at T1 is a universal output transformer, the voice-coil of which remains unused. Note that the chassis is connected to B- only through the condenser C16. The return connections for the electrolytic filter condensers and also the by-pass condensers are joined to B-.

When the switch is turned to the send position the 10,000 ohm resistor is connected to ground. In case difficulty is had with the 25A6 tube as det.-osc., so far as

oscillation is concerned, the recommended substitute is a 6J7. When different tubes are substituted, care must be taken to make any required change in the value of the ballast resistor.

For further details on this carrier type inter-phone system, refer to the June 1937 issue of *Radio-Craft*.

Second Prize -- \$5.00

Automobile Theft Alarm

HERE is a simple motor-car theft alarm which I have constructed from an old tube socket. I turned a piece of metal in a lathe in the shape of a cone as shown in the drawing; then I machined out a slight depression at the top of the cone in which a brass or steel ball would rest when carefully placed thereon.

The diagram shows how this auxiliary

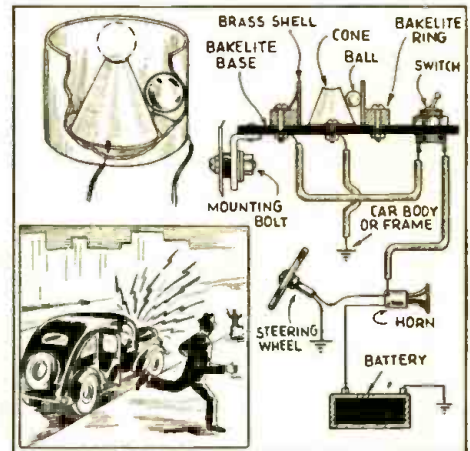

One of the simplest and yet most sensitive electric theft alarms for attachment to automobiles is that shown here. It is made from an old tube socket.

alarm circuit for the horn is wired. If anyone jars the car, such as would be the case when trying to remove a tire or break open
(Continued on page 707)

Diagram below shows how to build an inter-office carrier phone system, using odd radio parts

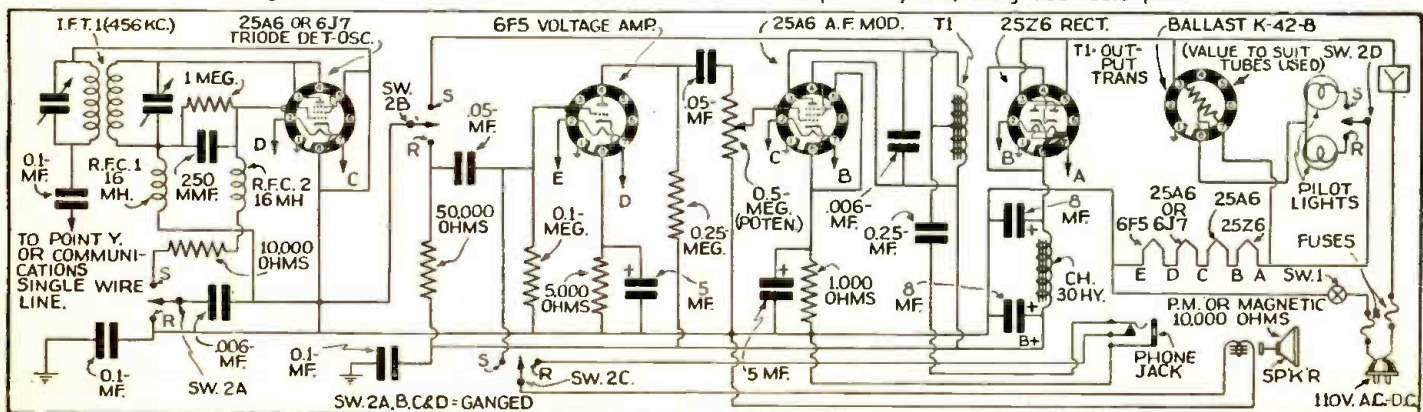

Mc. Call		Mc. Call		Mc. Call	
9.570 WIXK	SPRINGFIELD, MASS., 31.35 m., Addr. Westinghouse Electric & Mfg. Co. Relays WBZ 7 am. to 1 am. Sun. 8 am. to 1 am.	9.345 HBL	GENEVA, SWITZERLAND, 32.08 m., Addr. Radio Nations Fri. 7:15- 8:30 p.m., 6:45-8 p.m.	7.854 HC2J5B	GUAYAQUIL, ECUADOR, 38.2 m. Evenings to 11 pm.
9.560 DJA	BERLIN, GERMANY, 31.38 m., Addr. Broadcasting House, 12.05- 11 am., 4.50-10.45 pm.	9.330 CGA4	DRUMMONDVILLE, CANADA, 32.15 m. Works England irreg.	7.797 HBP	GENEVA, SWITZERLAND, 38.48 m., Addr. Radio-Nations. Sat. 5.30- 6.30 pm.
9.550 OLR3A	PRAGUE, CZECHOSLOVAKIA, 31.41 m. (See 11.840 mc.) Daily exc. Sun. 10.05-11 am., daily 12.55-4.40 pm. Sun. 6.15-8.55 pm. Irregular Mon., Wed., Fri. 8- 10.35 pm.	9.330 OAX4J	LIMA, PERU, 32.15 m., Addr. Box 1166, "Radio Universal." 12 n.- 3 pm., 5 pm.-1 am.	7.715 KEE	BOLINAS, CAL., 38.89 m. Relays NBC and CBS programs in even- ing irregularly.
9.550 —	FRANCE, 31.41 m. Radio Coloniale. Testing evenings.	9.290 HIG	CIUDAD TRUJILLO, D. R., 32.29 m. 7.10-8.40 am., 11.40 am.-2.10 pm., 3.40-8.40 pm.	7.626 RIM	TACHKENT, U.S.S.R., 39.34 m. Works with Moscow in early morning.
9.550 XEFT	VERA CRUZ, MEX., 31.41 m. 11.30 am.-4 pm., 7 pm.-12 m.	9.280 HC2CW	GUAYAQUIL, ECUADOR, 32.31 m., 11.30 am.-12.30 p.m., 8-11 pm.	7.610 KWX	DIXON, CAL., 39.42 m. Works with Hawaii, Philippines, Java and Japan, nights.
9.550 YDB	SOERABAJA, JAVA, 31.41 m., Addr. N.I.R.O.M. Daily exc. Sat. 6-7.30 pm., 5.30 to 10.30 or 11 pm. Sat. 5.30-11.30 am.	9.280 GCB	RUGBY, ENGLAND, 32.33 m. Works Canada and Egypt even- ings and afternoons.	7.540 RKI	MOSCOW, U.S.S.R., 39.76 m. Re- lays RAN 7-9.15 pm. Works RIM early am.
9.540 DJN	BERLIN, GERMANY, 31.45 m., Addr. (See 9.560 mc.) 12.05-10 am., 4.50-10.45 pm.	9.200 COBX	HAVANA, CUBA, 32.59 m. Addr. San Miguel 194. Altos. Relays CM8X 7 am.-12 m.	7.520 KKH	KAHUKU, HAWAII, 39.87 m. Works with Dixon and broadcasts irregularly nights.
9.540 VPD2	SUVA, FIJI ISLANDS, 31.45 m., Addr. Amalgamated Wireless of Australasia, Ltd. 5.30-7 am.	9.170 WNA	LAWRENCEVILLE, N. J., 32.72 m. Works England evenings.	7.510 JVP	NAZAKI, JAPAN, 39.95 m. Irreg.
9.535 JZI	TOKIO, JAPAN, 31.46 m., Addr. (See 11.800, JZJ) 12.30-1.30 am., 2.30-4, 4.30-5.30 pm.	9.150 YVR	MARACAY, VENEZUELA, 32.79 m. Works with Europe afternoons.	7.410 HCJB4	QUITO, ECUADOR, 40.46 m., 7- 9.30 pm. irregularly.
9.535 HB9D	ZURICH, SWITZERLAND, 31.46 m., Addr. Radio Club of Zurich, Post Box Zurich 2. Sun. 9-11 am., Thur. 1-3 pm.	9.125 HAT4	BUDAPEST, HUNGARY, 32.88 m., Addr. "Radiolabor," Gyali-ut, 22. Sun. and Wed. 7-8 pm., Sat. 6-7 pm.	7.390 ZLT2	WELLINGTON, N. Z., 40.6 m. Works with Sydney, 3-7 am.
9.530 W2XAF	SCHENECTADY, N. Y., 31.48 m., Addr. General Electric Co. 4 pm.-1 am.	9.100 COCA	HAVANA, CUBA, 32.95 m., Addr. Galiano No. 102. Relays CMCA 9 am.-12 m.	7.38 XECR	MEXICO CITY, MEX., 40.65 m., Addr. Foreign Office. Sun. 6-7 pm.
9.530 —	TANANARIVE, MADAGASCAR, 31.48 m., Addr. Le Directeur des PTT, Radio Tananarive, Adminis- tration PTT. 12.30-12.45, 3.30-4.30, 10.11 am.	9.060 TFK	REYKJAVIK, ICELAND, 33.11 m. Works London afternoons.	7.220 HKE	BOGOTA, COL., S. A., 41.55 m. Tues. and Sat. 8-9 pm. Mon. and Thurs. 6.30-7 pm.
9.526 XEDQ	GUADALAJARA, GAL., MEXICO, 31.49 m. Irregular 7.30 pm. to 12.30 am.	9.020 COBZ	HAVANA, CUBA, 33.26 m., Radio Salas Addr. P. O. Box 866 7:45 am.-12.10 am. Irreg. 12.30-2 am. Relays CM8Z.	7.200 YNAM	MANAGUA, NICARAGUA, 41.67 m. Irregular at 9 pm.
9.525 ZBW3	HONGKONG, CHINA, 31.49 m., Addr. P. O. Box 200. 11.30 pm. to 1 am., 4-10 am., Sat. 9 pm.- 1 am., Sun. 3-9.30 am.	9.020 GCS	RUGBY, ENG., 33.26 m. Works N. Y. C. evenings.	7.100 FO8AA	PAPEETE, TAHITI, 42.25 m., Addr. Radio Club Oceanic. Tues. and Fri. 11 pm.-12.30 am.
9.525 LKJI	JELOY, NORWAY, 31.49 m. 5-8 am.	9.010 KEJ	BOLINAS, CAL., 33.3 m. Relays NBC and CBS programs in even- ing irregularly.	7.090 —	GUADALAJARA, JALISCO, MEX., 42.29 m., Addr. Madero 210, La Radiodifusora del Pueblo. 9-11 pm.
9.523 ZRH	ROBERTS HEIGHTS, S. AFRICA, 31.5 m., Addr. (See ZRK, 9.606 mc.) Daily exc. Sat. 11.45 pm.- 12.45 am.; Daily exc. Sun. 5-7.30 am.; Sun. 3 or 3.30 to 4.30 or 5 am.	8.967 VWY	KIRKEE, INDIA, 33.43 m. Works with England in morning.	7.088 PIJ	DORDRECHT, HOLLAND, 42.3 m., Addr. Dr. M. Hellingman, Techni- cal College. Sat. 11.10-11.50 am.
9.520 HJ6ABH	ARMENIA, COLOMBIA, 31.51 m. 8-11 am., 6-10 pm.	8.965 COKG	SANTIAGO, CUBA, 33.44 m. Addr. Box 137. 9-10 am., 11.30 am.-1.30 pm., 3-4.30, 5-6, 10-11 pm., 12 m.-2 am.	6.990 XEME	MERIDA, YUCATAN, 42.89 m., Addr. Calle 59, No. 517, "La Voz de Yucatan desde Merida." Irregular.
9.520 OZF	SKAMLEBOAEK, DENMARK, 31.51 m., Addr. Statsradiofonien, Co- penhagen., 2-6.40 PM.	8.960 TPZ	ALGIERS, ALGERIA, 33.48 m. Works Paris afternoons.	6.977 X8A	TACUBAYA, D. F., MEX., 43 m. 9.30 am.-1 pm., 7-8.30 pm.
9.520 YSH	SAN SALVADOR, EL SALVADOR 31.51 m., Addr. (See 7.894 mc.) Irregular 6-10 pm.	8.841 HCJB	QUITO, ECUADOR, 33.5 m. 7-8.30 am., 11.45 am.-2.30 pm., 5-10 pm., except Mon. Sun. 12 n.- 1.30 pm., 5.30-10 pm.	6.905 GDS	RUGBY, ENG., 43.45 m. Works N.Y.C. evenings irregularly.
9.510 GSB	DAVENTRY, ENGLAND, 31.55 m., Addr. (See 9.580 mc.—GSC) 3.15-5.30 am., 12.20-6 pm., 6.20- 8.30, 9-11 pm.	8.775 PNI	MAKASSER, CELEBES, N. I., 34.19 m. Works Java around 4 am.	6.860 KEL	BOLINAS, CALIF., 43.70 m. Tests irregularly. 11 am.-12n., 6-9 pm.
9.510 HS8PJ	BANGKOK, SIAM, 31.55 m. Thurs- day, 8-10 am.	8.765 DAF	NORDDEICH, GERMANY, 34.23 m. Works German ships irregularly.	6.850 XGOX	NANKING, CHINA, 43.8 m. Daily 6.40-8.40 am., Sun. 4.40-6.05 am.
9.510 HJU	BUENAVENTURA, COLOMBIA, 31.55 m., Addr. National Rail- ways. Mon., Wed. and Fri. 8- 11 pm.	8.760 GCQ	RUGBY, ENG., 34.25 m. Works Africa afternoons.	6.805 HI7P	CIUDAD TRUJILLO, DOM. REP., 44.06 m., Addr. Emisoría Diaria de Comercio. Daily exc. Sat. and Sun. 12.40-1.40, 6.40-8.40 pm. Sat. 12.40-1.40 pm. Sun. 10.40 am.- 11.40 am.
9.500 VK3ME	MELBOURNE, AUSTRALIA, 31.58 m., Addr. Amalgamated Wireless of Australasia, 167 Queen St. Daily except Sun. 4-7 am.	8.750 FZEB	DJIBOUTI, FR. SOMALILAND, AFRICA 34.29 m. Works Paris around 2.30 am.	6.790 PZH	PARAMIRABO, DUTCH GUIANA, 44.16 m., Addr. P. O. Box 18. Daily 6.06-8.36 am., Sun. 9.36- 11.36 am. Daily 5.36-8.36 pm.
9.500 XEWW	MEXICO CITY, MEX., 31.58 m. Addr. Apart. 2516. Relays XEW. 6 pm.-12 m.	8.730 GCI	RUGBY, ENG., 34.36 m. Works India 8 am.	6.775 HIH	SAN PEDRO DE MACORIS, DOM. REP., 44.26 m. 12.10-1.40 pm., 7:30-9 pm. Sun. 3-4 am., 4.15-6 pm., 4.40-7.40 pm.
9.500 PRF5	RIO DE JANEIRO, BRAZ., 31.58 m. Irregularly 4.45 to 5.45 pm.	8.720 VPD3	SUVA, FIJI ISLES, 34 m., Addr. (See 9.540 mc., VPD2). Irregular.	6.755 WOA	LAWRENCEVILLE, N. J., 44.41 m., Addr. A.T.&T. Co. Works Eng. evenings.
9.488 EAR	MADRID, SPAIN, 31.6 m., Addr. (See 9.860 mc.) 7.30-8.30 pm. Mon., Tues., Thur., Sat. at 9.30 pm. also.	8.700 HKV	BOGOTA, COLOMBIA, 34.46 m. Tues. and Fri. 7-7.20 pm.	6.750 JVT	NAZAKI, JAPAN, 44.44 m., Addr. Kokusai-Denwa Kaisha, Ltd., Tokio. Irregular.
— End of Broadcast Band —		8.860 GBC	RUGBY, ENG., 34.56 m. Works ships irregularly.	6.730 HI3C	LA ROMANA, DOM. REP., 44.58 m., Addr. "La Voz de la Feria." 12.30-2 pm., 5-6 pm.
9.460 ICK	TRIPOLI, N. AFRICA, 31.71 m. Works Rome. 5.30-7 am.	8.665 COJK	CAMAGUEY, CUBA, 34.64 m., Addr. Finlay No. 3 Altos. 5.30- 6.30, 8-11 pm., daily except Sat. and Sun.	6.720 PMH	BANDOENG, JAVA, 44.64 m. Re- lays NIROM programs. 5.30-9 am.
9.445 HCODA	GUAYAQUIL, ECUADOR, 31.77 m. Irregularly till 10.40 pm.	8.665 W2XGB	HICKSVILLE, N. Y., 34.64 m., Addr. Press Wireless, Mon. to Fri. News at 9 am. and 5 pm.	6.690 TIEP	SAN JOSE COSTA RICA, 44.82 m. Addr. Apartado 257, La Voz del Tropico. Daily 7-10 pm.
9.428 COCH	HAVANA, CUBA, 31.8 m., Addr. 2 B St., Vedado. 7 am.-1 am.	8.580 YNPR	MANAGUA, NICARAGUA, 34.92 m. Radiodifusora Pilot.	6.672 —	44:94 m., relays Salamanca, Spain, evenings.
9.415 PLV	BANDOENG, JAVA, 31.87 m. Works Holland around 9.45 am. Broadcasts 5.30-9.30 am., 6-6.30 pm.	8.560 WOO	OCEAN GATE, N. J., 35.05 m. Works ships irregularly.	6.672 YVQ	MARACAY, VENEZUELA, 44.95 m. Irregular.
9.355 HCIETC	QUITO, ECUADOR, 32.05 m., Addr. Teatro Bolivar, Thurs. un- til 9:30 p.m.	8.380 IAC	PISA, ITALY, 35.8 m. Works Italian ships irregularly.	6.650 IAC	PISA, ITALY, 45.11 m. Works ships irregularly.
		8.185 PSK	RIO DE JANEIRO, BRAZIL, 36.65 m. Irregularly.	6.635 HC2RL	GUAYAQUIL, ECUADOR, S. A., 45.18 m., Addr. P. O. Box 759. Sun. 5.45-7.45 pm., Tues. 9.15- 11.15 pm.
		8.036 CNR	RABAT, MOROCCO, 37.33 m. Sun. 2.30-5 pm. Irregular.	6.630 HIT	CIUDAD TRUJILLO, D. R., 45.25 m., Addr. "La Voz de la RCA Victor." Apartado 1105. Daily exc. Sun. 12.10-1.40 pm., 5.40-8.40 pm.; also Sat. 10.40 pm.-12.40 am.
		7.901 LSL	BUENOS AIRES, ARGENTINA, 37.97 m. Works Brazil at night.	6.625 PRADO	RIOBAMBA, ECUADOR, 45.28 m. Thurs. 9-11.45 pm.
		7.894 YSD	SAN SALVADOR, EL SALVADOR, 37.99 m., Addr. Dir. Genl. Tel. & Tel. 7-11 pm.		
		7.870 HCIRB	QUITO, ECUADOR, 38.1 m. La Voz de Quito. 9-11 pm.		
		7.860 SUX	ABOU ZABAL, EGYPT, 38.17 m. Works with Europe, 4-6 pm.		

(Continued on page 684)

All Schedules Eastern Standard Time

Question Box

A fee of 25c (stamps, coin or money order) is charged for letters that are answered by mail. This fee includes only hand-drawn schematics. We cannot furnish full-size working drawings or picture layouts. Letters not accompanied by 25c will be answered on this page. Questions involving considerable research will be quoted upon request. Names and addresses should be clearly printed on each letter.

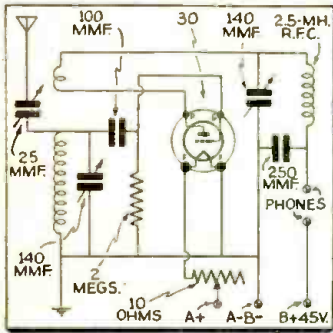

Set for Battery Use—1116

be advisable to try shorting out the antenna coupling condenser completely. Signal pick-up will not be very great with a small antenna.

BANDSPREAD COILS

I have a 2-tube receiver using 4-prong plug-in coils. How can I connect 5-prong bandspread coils in it?—Marc Molynoux, Jr., Saraland, Ala.

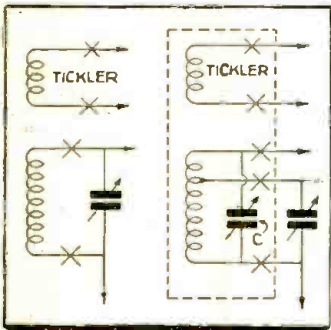

Using Bandsread Coils—1117

We have drawn the diagram of a universal type power supply. The value of the high voltage winding has not been shown because this would depend upon the output voltage desired by the user. The rectifier tube is an 80. The power transformer should be capable of supplying the required voltages at the required current drain. The current drain, of course, depends upon the number and type of tubes in the receiver with which the unit is used. The bleeder should have a value of 20,000 ohms—20 watts, for output voltages ranging from 200 to 300 volts. The chokes should have the specified inductance at the current drain at which they will be operated. For example, a 10 henry choke designed for operation with a current of 65 ma. will have a much higher inductance at a lower current drain and a much lower inductance at a higher current drain. For an output voltage of 250 at a current drain of about 50 ma., the high voltage winding should be approximately 300 volts each side of center-tap.

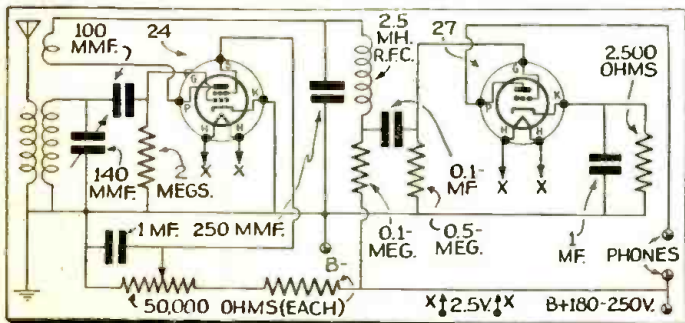

Set with a 24 and a 27 Tube—1120

BATTERY SET

Please print a diagram of a 1-tube battery receiver using a 30 type tube, 4-prong plug-in coils and a 140 mmf. condenser to control regeneration. I intend to use a short piece of copper tubing for the antenna.—Edward H. Nagel, Buffalo, N. Y.

We have reproduced the diagram you requested. This receiver can be used with any type of antenna, but when using the short piece of copper tubing it would probably

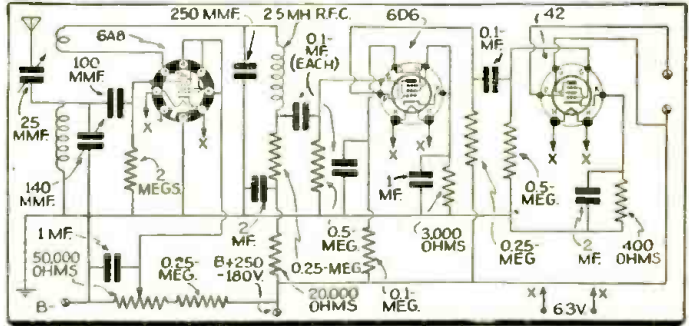

3-Tube Receiver—1119

3-TUBE RECEIVER

Please print a circuit with a 6A8 as a detector, 6D6 as a first A.F. and 42 for the output.—Gerald Pipin, Farnham, P. Q.

Although we do not recommend the use of a 6A8 as a regenerative detector, we have drawn a diagram as you requested. Note particularly the way the extra grids of the 6A8 are connected. It would be better to use a 6C6 or 6D6 as the detector.

The combination of the 6D6 and 42 for the audio stages should result in a quite high-gain audio system. The output of the 42 should be fed to a loudspeaker through a coupling transformer.

2-TUBE RECEIVER USING A 24 AND A 27

Please publish the circuit of a 2-tube set using a 24 and a 27.—James Sutera, Brooklyn, N. Y.

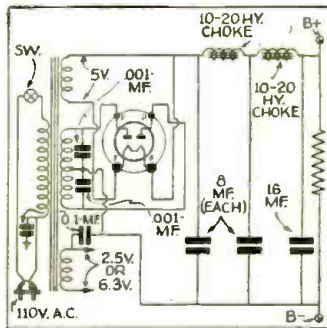

Low Hum Power Supply—1118

The circuit you request is reproduced on this page. A 24 tube is used as a regenerative detector employing a screen grid potentiometer for regeneration control and a 27 tube as an A.F. amplifier. Ordinary 6-prong plug-in coils can be used. (1120)

PORTABLE 2

Please diagram a receiver employing a 30 and a 19 type tube for portable use.—Raymond Chandler, Springfield, Mo.

A circuit employing these tubes is shown. The 30 is used as a regenerative detector and the 19 as a 2-stage A.F. amplifier. Four-prong plug-in coils may be used for the set, which can very easily be made into a portable unit.

Regeneration is controlled by a 250 mmf. variable condenser in the plate circuit of the 30. For a saving in filament current consumption, the 19 tube might be replaced by a 1J6G, an octal based tube identical to the 19, except that it consumes less filament current.

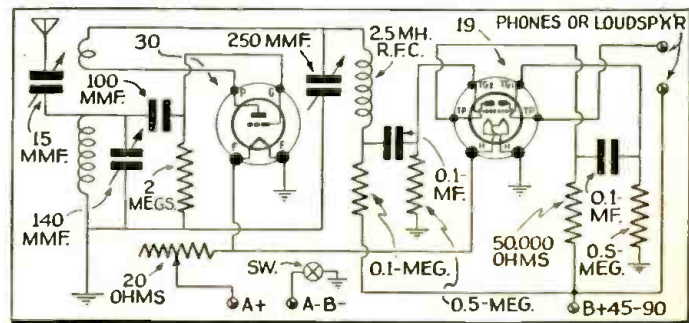

Portable 2-Tube Circuit—1121

Mc. Call
 6.558 HI4D CIUDAD TRUJILLO, D. R., 45.74 m. Except Sun. 11.55 am.-1.40 pm.
 6.550 XBC VERA CRUZ, MEX., 45.8 m. 8.15-9 am.
 6.550 TIRCC SAN JOSE, COSTA RICA, 45.8 m., Addr. Radioemisora Catolica Costarricense. Sun. 11 am.-2 pm., 6-7, 8-9 pm. Daily 12 n.-2 pm., 6-7 pm., Thurs. 6-11 pm.
 6.545 YV6RB BOLIVAR, VENEZUELA, 45.84 m., Addr. "Ecos de Orinoco." 6-10.30 pm.
 6.520 YV4RB VALENCIA, VENEZUELA, 45.98 m. 11 am.-2 pm., 5-10 pm.
 6.516 YNIGG MANAGUA, NICARAGUA, 46.02 m., Addr. "La Voz de los Lagos." 8-9 pm.
 6.500 HIL CIUDAD TRUJILLO, D. R., 46.13 m. Addr. Apartado 623. 12.10-1.40 pm., 5.40-7.40 pm.
 6.490 HIIL SANTIAGO DE LOS CABALLEROS, D. R., 46.2 m., Addr. Pres., Trujillo 97, Altos., 5.40-7 pm.
 6.470 YNLAT GRANADA, NICARAGUA, 46.36 m., Addr. Leonidas Tenoria, "La Voz del Mombacho." Irregular.
 6.465 YV3RD BARQUISIMETO, VENEZUELA, 46.37 m. Radio Barquisimeto, Irregular.
 6.450 HI4V SAN FRANCISCO DE MACORIS, D. R., 46.48 m., 11.40 am.-1.40 pm., 5.10-9.40 pm.
 6.440 TGQA QUETZALTENANGO, GUATEMALA, 46.56 m., Irregular eve.
 6.420 HIIS SANTIAGO, D. R., 46.73 m. 11.40 am.-1.40 pm., 5.40-7.40, 9.40-11.40 pm.
 6.416 YV6RC BOLIVAR, VENEZUELA, 46.73 m. Radio Bolivar.
 6.410 TIPG SAN JOSE, COSTA RICA, 46.8 m., Addr. Apartado 225, "La Voz de la Victoria." 12 n.-2 pm., 6-11.30 pm.
 6.400 YV5RH CARACAS, VENEZUELA, 46.88 m. 7-11 pm.
 6.388 HI8J LAS VEGAS, D. R., 46.92 m., Irreg.
 6.384 VP2LO STE. KITTS, LEEWARD ISLANDS, B.W.I. 46.96 m. Irregular around 5 pm.
 6.380 YV5RF CARACAS, VENEZUELA, 46.92 m., Addr. Box 983. 6-10.30 pm.
 6.370 TIBWS PUNTARENAS, COSTA RICA, 47.07 m., Addr. "Ecos Del Pacifico", P. O. Box 75. 6 pm.-12 m.
 6.365 YVIRH MARACAIBO, VENEZUELA, 47.18 m., Addr. "Ondas Del Lago." Apartado de Correos 261. 6-7.30 am., 11 am.-2 pm., 5-11 pm.
 6.360 HRPI SAN PEDRO SULA, HONDURAS, 47.19 m. 7.30-9.30 pm.
 6.340 HIIX CIUDAD TRUJILLO, D. R., 47.32 m. Sun. 7.40-10.40 am., daily 12.10-1.10 pm., Tues. and Fri. 8.10-10.10 pm.
 6.335 OAXIA ICA, PERU, 47.33 m., Addr. La Voz de Chiclayo, Casilla No. 9. 8-11 pm.
 6.324 COCW HAVANA, CUBA, 47.4 m., Addr. La Voz de las Antillas, P. O. Box 130. 6.55 am.-1 am. Sun. 10 am.-10 pm.
 6.310 HIZ CIUDAD TRUJILLO, D. R., 47.52 m. Daily except Sat. and Sun. 11.10 am.-2.25 pm., 5.10-8.40 pm. Sat. 5.10-11.10 pm. Sun. 11.40 am.-1.40 pm.
 6.300 YV4RD MARACAY, VENEZUELA, 47.62 m. 6.30-9.30 pm. exc. Sun.
 6.295 OAX4G LIMA, PERU, 47.63 m., Addr. Apartado 1242. Daily 7-10.30 pm.
 6.290 HIG TRUJILLO CITY, D. R., 47.67 m. 7.10-8.40 am., 11.40 am.-2.10 pm., 3.40-8.40 pm.
 6.280 COH8 SANCTI SPIRITUS, CUBA, 47.77 m., Addr. P. O. Box 85. 9-11.30 am., 12.30-1.30, 4-7, 8-11 pm.
 6.270 YV5RP CARACAS, VENEZUELA, 47.79 m., Addr. "La Voz de la Philco." Daily to 10.30 pm.
 6.255 YV5RJ CARACAS, VENEZUELA, 47.18 m.
 6.243 HIN CIUDAD TRUJILLO, D. R., 48 m., Addr. "La Voz del Partido Dominicano." 12 n.-2 pm., 6-10 pm.
 6.235 HRD LA CEIBA, HONDURAS, 48.12 m., Addr. "La Voz de Atlantida." 8-11 pm.; Sat. 8 pm.-1 am.; Sun. 4-6 pm.
 6.225 YVIRG VALERA, VENEZUELA, 48.15 m. 6-9.30 pm.

Mc. Call
 6.220 — SAIGON, INDO-CHINA, 48.2 m., Addr. Radio Philco. 4.30 or 5.30-9.30 am.
 6.210 TG2 GUATEMALA CITY, GUAT., 48.28 m., Addr. Secretaria de Fomento. Relays TGI 11 pm.-2 am.
 6.205 YV5RI CORO, VENEZUELA, 48.32 m., Addr. Roger Leyba, care A. Urbina y Cia. Irregular.
 6.200 HI8Q CIUDAD TRUJILLO, D. R., 48.36 m. Irregular.
 6.185 HI1A SANTIAGO, D. R., 48.5 m., Addr. P. O. Box 423. 7 am.-5 pm.
 6.171 XEXA MEXICO CITY, MEX., 48.61 m., Addr. Dept. of Education. 7-11 pm.
 6.160 VPB COLOMBO, CEYLON, 48.7 m. Daily exc. Thurs. and Fri., 6.30 am.-12.30 pm.; Sun. 7-11.30 am.
 6.156 YV5RD CARACAS, VENEZUELA, 48.71 m. 11 am.-2 pm., 4-10.40 pm.
 6.153 HI5N MOCA CITY, D. R., 48.75 m. 6.40-9.10 pm.

49 Met. Broadcast Band

6.150 ZRD DURBAN, SOUTH AFRICA, 48.78 m., Addr. (See ZRK, 9.606 mc.) Daily exc. Sat. 11.45 pm.-12.45 am.; Daily exc. Sun. 3.30-7.30 am., 9 am.-3.45 pm.; Sun. 8-11.30 am., 12 n.-3.20 pm.
 6.150 CJRO WINNIPEG, MAN., CANADA, 48.78 m., Addr. (See 11.720 mc.) Daily 6 pm.-12 m., Sun. 5-10 pm.
 6.147 ZEB BULAWAYO, RHODESIA, S. AFRICA, 48.8 m. Mon., Wed., and Fri. 1.15-3.15 pm.; Tues. 11 am.-12 n.; Thurs. 10 am.-12 n.
 6.145 HJ4ABE MEDELLIN, COL., 48.79 m. 11 am.-12 n., 6-10.30 pm.
 6.140 W8XK PITTSBURGH, PA., 48.86 m., Addr. Westinghouse Electric & Mig. Co. Relays KDKA 11 pm.-1 am.
 6.137 CR7AA LAURENCO MARQUES, PORT. E. AFRICA, 48.87 m. Daily 12.05-1.40-6.30, 9.30-11 am., 12.05-4 pm., Sun. 5-7 am., 10 am.-2 pm.
 6.130 VP38G GEORGETOWN, BRIT. GUIANA, 48.94 m. From 5 pm. on.
 6.130 COCD HAVANA, CUBA, 48.94 m., Addr. Box 2294. Relays CMCD 7 am.-1 am.
 6.130 VE9HX HALIFAX, N. S. CAN., 48.94 m., Addr. P. O. Box 998. Mon.-Fri. 7 am.-11.15 pm., Sat. 11 am.-11 pm., Sun. 12 n.-11.15 pm. Relays CHNS.
 6.130 ZGE KUALA LUMPUR, FED. MALAY ST., 48.94 m. Sun., Tue. and Fri. 6.40-8.40 am.
 6.130 LKL JELOY, NORWAY, 48.94 m. 11 am.-6 pm.
 6.125 CX44 MONTEVIDEO, URUGUAY, 48.98 m., Addr. Radio Electrico de Montevideo., Mercedes 823. 10 am.-12 n., 2-8 pm.
 6.122 HP5H PANAMA CITY, PAN., 49 m., Addr. Box 58. 12 n.-1 pm., 8-10 pm.
 6.120 W2XE NEW YORK CITY, 49.02 m., Addr. Col. B'cast. System, 485 Madison Ave. Irregular.
 6.117 XEUZ MEXICO CITY, MEX., 49.03 m., Addr. 5 de Mayo 21. Relays XEFO 1-3 am.
 6.115 HJ3ABX BOGOTA, COL., 49.05 m., Addr. La Voz de Col., Apartado 2665. 12 n.-2 pm., 5.30-11 pm.; Sun. 6-11 pm.
 6.115 OLR2C PRAGUE, CZECHOSLOVAKIA, 49.05 m. (See 11.40 mc.)
 6.110 XEPW MEXICO CITY, MEX., 49.1 m., Addr. La Voz de Aguila Azteca desde Mex., Apartado 8403. Relays XEJW 11 pm.-1 am.
 6.110 VUC CALCUTTA, INDIA, 49.1 m. Daily 3-5.30 am., 9.30 am.-12 n.; Sun. 7.30 am.-12 n.
 6.110 GSL DAVENTRY, ENG., 49.1 m., Addr. (See 26.1 mc.) 6.20-8.30, 9.15-11.15 pm., irregular.
 6.108 HJ6AB8 MANIZALES, COL., 49.14 m., Addr. P. O. Box 175. Mon.-Fri. 12.15-1 pm.; Tue. and Fri. 7.30-10 pm.; Sun. 2.30-5 pm.
 6.100 YUA BELGRADE, JUGOSLAVIA, 49.18 m. 12.45-2.30, 4-8 am., 1-6 pm.
 6.100 W3XAL BOUND BROOK, N. J., 49.18 m., Addr. Natl. Broad. Co. 7 pm.-1 am. Sun. 6 pm.-1 am.

Mc. Call
 6.100 W9XF CHICAGO, ILL., 49.18 m., Addr. N.B.C. 4-6.50 pm., 1.05-2 am. Sun. 1-5.50 pm.
 6.097 ZRK KLIPHEUVEL, S. AFRICA, 49.2 m., Daily 12 n.-4 pm., Sun. 12 n.-3.20 pm.
 6.097 ZRJ JOHANNESBURG, S. AFRICA, 49.2 m., Addr. African Broad. Co. Daily exc. Sat. 11.45 pm.-12.40 am.; Daily exc. Sun. 3.15-7.30, 9-11.30 am.
 6.095 JZH TOKIO, JAPAN, 49.22 m., Addr. (See 11.800 mc., JZJ.) Irregular.
 6.090 CRCX TORONTO, CAN., 49.26 m., Addr. Can. Broadcasting Corp. Daily 7.45 am.-5 pm., Sun. 10.30 am.-12 n.
 6.090 ZBW2 HONGKONG, CHINA, 49.26 m., Addr. P. O. Box 200. Irregular.
 6.085 HJ5ABD CALI, COLOMBIA, 49.3 m., Addr. La Voz de Valle. 12 n.-1.30 pm., 5.10-9.40 pm.
 6.083 VQ7LO NAIROBI, KENYA, AFRICA, 49.31 m., Addr. Cable and Wireless, Ltd. Mon., Fri. 5.30-6 am., 11-15 am.-2.15 pm., also Tues. and Thurs. 8.15-9.15 am.; Sat. 11.15 am.-3.15 pm.; Sun. 10.45 am.-1.45 pm.
 6.081 YVIRD MARACAIBO, VEN., 49.32 m. 6-11 pm.
 6.080 ZHJ PENANG, FED. MALAY STATES, 49.34 m. 6.40-8.40 am., except Sun., also Sat. 11 pm.-1 am.
 6.080 W9XAA CHICAGO, ILL., 49.34 m., Addr. Chicago Fed. of Labor. Relays WCFL Irregular.
 6.079 DJM BERLIN, GERMANY, 49.34 m., Addr., Broadcasting House. Irregular.
 6.077 OAX4Z LIMA, PERU, 49.35 m. Radio Nacional 7-11 pm.
 6.075 VP3MR GEORGETOWN, BRI. GUIANA, 49.35 m. Sun. 7.45-10.15 am.; Daily 4.45-8.45 pm.
 6.073 HJ3ABF BOGOTA, COL., 49.41 m. 7-11.15 pm.
 6.070 CFRX TORONTO, CAN., 49.42 m. Relays CFRB 7.30 am.-12 m., Sun. 10 am.-12 m.
 6.070 VE9CS VANCOUVER, B. C., CAN., 49.42 m. Sun. 1.45-9 pm., 10.30 pm. 1 am.; Tues. 6-7.30 pm., 11.30 pm.-1.30 am. Daily 6-7.30 pm.
 6.069 — TANANARIVE, MADAGASCAR, 49.42 m., Addr. (See 9.53 mc.) 12.30-12.45, 3.30-4.30, 10-11 am., Sun. 2.30-4.30 am.
 6.065 S80 MOTALA, SWEDEN, 49.46 m. Relays Stockholm 1.30-5 pm.
 6.060 W8XAL CINCINNATI, OHIO, 49.5 m., Addr. Crosley Radio Corp. Relays WLW 6.30 am.-8 pm., 11 pm.-2 am.
 6.060 W3XAU PHILADELPHIA, PA., 49.5 m. Relays WCAU 8-11 pm.
 6.054 HJ6ABA PEREIRA, COL., 49.52 m. 9.30 am.-12 n., 6.30-10 pm.
 6.050 HP5F COLON, PAN., 49.59 m., Addr. Carlton Hotel. Irregular.
 6.050 GSA DAVENTRY, ENGLAND, 49.59 m., Addr. (See 26.1 mc.) Irregular.
 6.045 XETW TAMPICO, MEXICO, 49.6 m. Irregular 7-11 pm.
 6.042 HJ1ABG BARRANQUILLA, COL., 49.65 m., Addr. Emisoras Atlantico. 11 am.-11 pm.; Sun. 11 am.-8 pm.
 6.040 W4XB MIAMI BEACH, FLA., 49.65 m. Off the air temporarily.
 6.040 W1XAL BOSTON, MASS., 49.65 m., Addr. University Club. Exc. Sat. 7-9 pm.
 6.040 YDA TANDJONGPRIOK, JAVA, 49.65 m., Addr. N.I.R.O.M., Batavia, 10.30 pm.-2 am.; Sat. 7.30 pm.-2 am.
 6.033 HP58 PANAMA CITY, PAN., 49.75 m., Addr. P. O. Box 910. 12 n.-1 pm., 7-10.30 pm.
 6.030 VE9CA CALGARY, ALTA, CAN., 49.75 m. Thur. 9 am.-1 am.; Sun. 12 n.-12 m.
 6.030 OLR2B PRAGUE, CZECHOSLOVAKIA, 49.75 m. (See 11.875 mc.) Daily 12.45-4.40 pm. Mon., Wed. and Fri. 8-10.35 pm.
 6.023 XEUW VERA CRUZ, MEX., 49.82 m., Addr. Av. Independencia 98. 8 pm.-12.30 am.

(Continued on page 702)

The Listener *Asks*

Questions asked by not-so-technically inclined listeners are answered in this department.

WHISTLING

Q. When operating my receiver on the short-wave bands, I notice that certain stations have a whistling sound mixed in with the program. Why is this and what can I do about it?

A. Since you say that only certain stations are affected by this phenomenon, it is probable that the trouble is not your receiver. In the congested short-wave broadcast bands there are a great many stations operating on relatively few channels. It frequently happens that two or more stations may be operating on the same channel simultaneously. When this occurs, a whistle is heard when the receiver is tuned to this channel. The pitch of the whistle is an indication of the difference in frequency between the interfering stations. There is nothing that can be done to remedy this situation except by international agreement to restrict the use of channels to one station at a time. A good many South American stations have settled down on various channels which have been assigned by international agreement to other countries and are causing a great deal of interference of this type. The broadcasting authorities of various countries are trying to eliminate this situation which is especially bad in the 6 and 9 mc. short-wave broadcast bands.

A very selective receiver will frequently permit reception without hearing the whistle, but, at the same time, the quality of reproduction of the station will be seriously impaired, so that enjoyable entertainment is not possible.

LIFE OF TUBES

Q. My radio is about two years old and none of the tubes have been replaced. They all light up, but I have been wondering whether it would be advisable to replace them?

A. After two years' use it is quite possible that one or more of the tubes in your receiver have lost their efficiency. The average life of a tube is generally considered to be 1,000 hours. In actual practice, however, tubes last much longer. No general rule about their life can be laid down. It is a good practice to have tubes tested about once a year and to replace any which are not in good condition. It is not necessary to make complete replacement of tubes periodically.

The mere fact that a tube lights up is not an indication of its condition. Modern tubes used in electrically operated receivers do not burn out readily; in most cases they wear out before they burn out. If certain tubes in a receiver wear out quickly, it is

wise to have the receiver examined because there may be a defective part in the set which is shortening the tubes' life.

TYPES OF S-W STATIONS

Q. The dial of my all-wave receiver indicates "amateur" stations, "broadcast" stations and "telephone" stations. Just what is the difference between these various stations?

A. An amateur station is one operated by an experimenter for his own pleasure or education. Amateur stations may send out either voice or dots and dashes (code). The various governments of the world have set aside certain frequencies for the exclusive use of amateur stations. Amateurs generally use their stations for the purpose of communicating with other amateurs. It is for this reason that if you pick up one of these stations you generally hear one end of a conversation. They do not broadcast entertainment of any sort, as they are forbidden by law to do this in most countries.

Short-wave broadcast stations send out regular programs of entertainment in a manner similar to the ordinary long-wave broadcast station. Special frequency bands have been allotted for the exclusive use of short-wave "broadcasting" stations by international agreement, as is the case with amateur stations. However, a good many countries do not abide by these international agreements and operate short-wave broad-

Behind the scenes of a "short-wave rebroadcast" from abroad—next month. Don't miss it!

casting stations on frequencies which are not within the limits of the prescribed bands. But by far the greater number of short-wave broadcasters are to be found in these various broadcast bands. On page 673 there is a "tuning yardstick" which shows just where these "broadcast" bands are located on the short-wave tuning dial.

The third class of stations are the "commercial" stations. These are operated by commercial communication companies for the purpose of maintaining communication lines between various parts of the world. These stations either send out telephony or dots and dashes. The telephony stations are used to carry telephone conversations overseas and to ships-at-sea and are connected with the regular wire telephone circuits in each country. To insure privacy of conversations being carried on these stations, special devices are employed at the transmitters to render all speech transmitted unintelligible to anyone listening in on an ordinary receiver.

METERS VERSUS MEGACYCLES

Q. Some stations announce that they operate on a wavelength of so many meters; others announce that they operate on a frequency of so many megacycles; and still others say they operate on a frequency of so many kilocycles. Please explain the meaning of these terms.

A. A radio station sends out invisible waves. These waves have a definite length. It would be quite possible to measure these different wavelengths in feet or inches, but it has become customary to measure the waves by the metric system in meters. So if a station operates with a wavelength of 30 meters it means that the waves sent out by that station have a length of 30 meters (or 98.4 ft.).

The speed at which these waves travel is approximately equal to the speed of light—186,000 miles (or 300,000,000 meters) per second, regardless of the length of the wave. At any given point a certain fixed number of these waves will pass in one second. Since the speed at which they travel is constant but the length of the waves is variable, the number of waves passing the given point per second will vary as the length of the wave is varied.

For example, if a station transmits a wave having a length of 30 meters, a little simple arithmetic (dividing the speed of the waves, 300,000,000 meters/sec., by the length of the waves, 30 meters) will show that ten million of these waves will pass a given point in a second, or, stated otherwise, the wave has a frequency of ten million cycles per second. However, in radio the use of such large numbers to express the frequency is cumbersome so instead of saying ten million cycles the term kilocycle (kc.) is used—meaning 1,000 cycles. Therefore, ten million cycles is the same as 10,000 kilocycles, so a wave having a length of 30 meters has a frequency of 10,000 kilocycles. Even this is a rather cumbersome figure to handle, especially when dealing with short waves or higher frequencies; therefore, it has become customary to further abbreviate and use the term megacycles (mc.). One megacycle is equal to one million cycles or 1,000 kc. So ten million cycles is equal to 10,000 kc., which is equal to 10 mc. This is not difficult to follow if you just remember that you can call a mile 5,280 ft. or 63,360 inches. In the United States it has become customary to use the frequency terms as a means of stating the channel on which a station operates; while in Europe until recently it was customary to use the wavelength method to state a station's operating channel.



Any Beginner Can Build This 1-TUBER

George W. Shuart, W2AMN



Changing bands on this single-tube receiver is a simple matter—just plug-in a different coil

● WE have had many "dual purpose" tubes, but never one quite like the 6F8G. All of the dual tubes in the past have had a common cathode. This tube has two separate cathodes and is, in the true sense of the word, a twin triode. This tube makes it possible for us to build a real two-tube set using only one tube, paradoxical as it may seem.

This receiver is intended for the beginner who wants a good one-tube set that is simple to build and easy to operate, and does not cost a fortune to construct.

Naturally we have selected the time-tried regenerative circuit with one stage of audio amplification. While there have been many "one-tube wonders," most of them have been, to put it mildly, quite tricky. This set offers no "wonders." It is a straight 2-tuber, with no tricks in it. It will provide plenty of entertainment, and is really the set with which the newcomer should start.

Our original intention was to construct this receiver on a bread-board, but we recalled one of our young friends having had no end of trouble with such a set. Now, we don't claim that all bread-board sets are taboo, but the chassis type of construction leads to much less trouble.

The chassis on which this set is built is made of 1/16" aluminum and measures 1x4x7-inches. The panel is 5x7-inches and supports the two variable condensers. One of these condensers is the main tuning control, while the other controls regeneration. The only other control on the set is the antenna series condenser. This condenser, while adjustable, does not require continual adjustment. Once set for optimum results it needs no further attention unless the coil is changed or the antenna is altered. It can be adjusted so that it requires no changing, even though the coils are changed. This latter setting is convenient but does not provide maximum sensitivity or signal strength. Better results can be obtained if this condenser is frequently adjusted as the set is tuned over a fairly wide frequency range.

Referring to the circuit diagram, we find that resistance coupling is employed in the audio stage. Transformer coupling might

just as well have been used with a slight increase in volume. However, the choice is up to the builder.

As mentioned before, a condenser is used to control the regeneration. An alternative would be the use of a potentiometer to vary the plate voltage, thus controlling the amount of feed-back in the circuit. However, we find that where low plate voltage is employed, the condenser method of controlling regeneration works out much better than the potentiometer method. We mention low voltage because this receiver

will operate with as low as 45 volts on the plates of the tube. Slightly higher voltage will result in an increased signal strength. This does not mean that we can increase the plate voltage to a couple of hundred volts. If we do, the regeneration control will become "sticky" and result in uncomfortable tuning. If, however, the plate voltage of the detector tube is fed separately with only 45 to 67.5 volts, then the voltage of the amplifier section may be increased to 135 or more in order to obtain greater audio amplification and louder signals. The main purpose of this receiver was low cost of operation and the use of a single 45 volt "B" battery. Therefore, we have shown both tubes, or both sections of the tube, tied together and going to a common B terminal.

One triode section

of the tube has its grid terminal coming out the top of the glass envelope. We have used this section of the tube as the detector in order to reduce losses as much as possible. Also, this arrangement provides easier construction insofar as wiring is concerned.

While the wiring diagram does not indicate it, the B negatives (or common grounds) are all connected to a single soldering lug. The metal chassis is not depended upon to carry current or serve

(Continued on opposite page)

The wiring diagram for this 1-tube receiver is extremely simple to follow and the author reports excellent reception and smooth tuning with this set

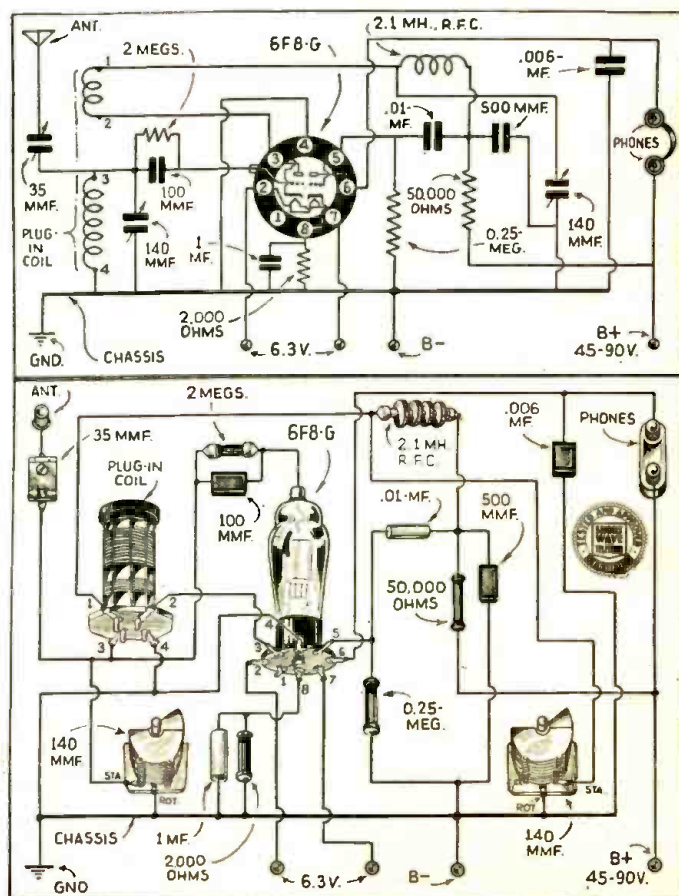

THE NEW 1938 ULTRA STRATOSPHERE "10"

2½ to 4000 METER TRANS-RECEIVER (RECEIVES 2½ to 4000 METERS) (TRANSMITS 2½ and 5 METERS)

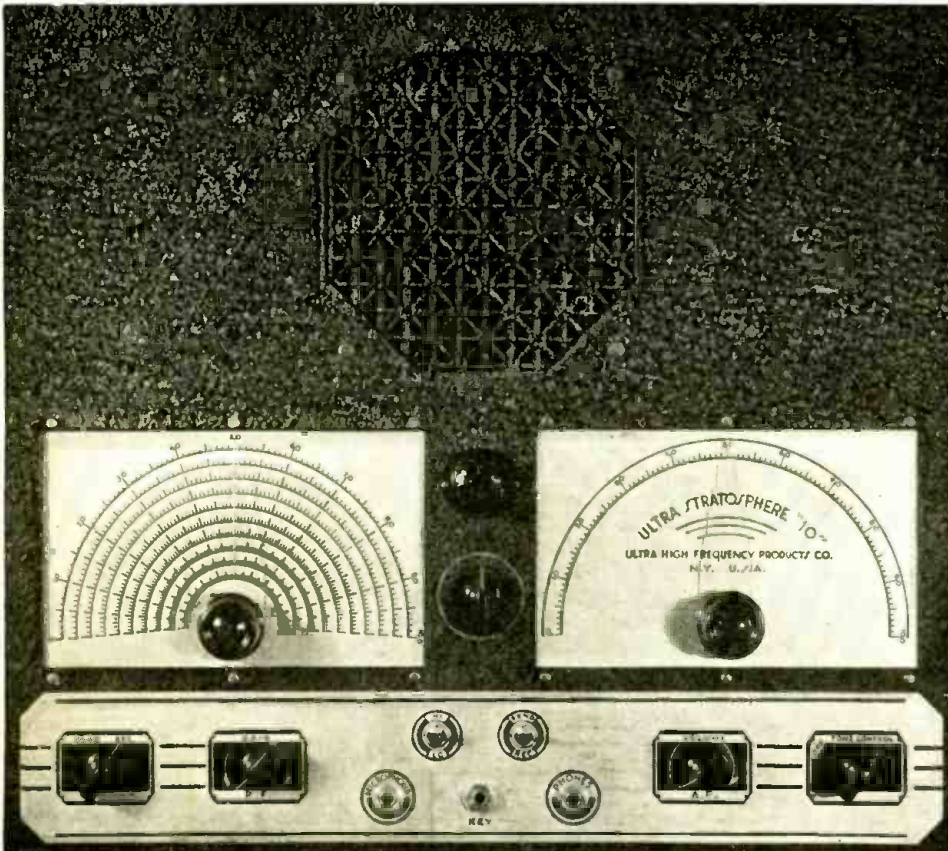

- *Ten tubes.
- 1—6K7 Regenerative Tuned R.F. Amplifier.
- 1—6J7 Regenerative Detector.
- 1—6J5G Super Regenerative Detector & Transmitting Osc.
- 2—6C5 P.P. 1st Audio Stage.
- 2—25L6 P.P. Beam power output stage & modulators.
- 2—25Z6 Parallel Rectifiers.
- 1—6G5 Electronic tuning indicator & R meter.
- *Receives from 2½ to 4000 meters.
- *Transmits on 2½ & 5 meters.
- *8" Dynamic Speaker.
- *Calibrated R.F. Gain Control.
- *A.F. Gain Control.
- *Size—17½" x 19½"—16 gauge metal.
- *Tone control.
- *R.F. Resonator control.
- *Separate electrical bandspread.
- *Vernier planetary drives on tuning Cond.
- *Large 8" tuning dials.
- *May be used for I.C.W. and phone transmission and as a code practice oscillator. Only a key required.
- *Standby switch.
- *Automatic Phone Jack.
- *Built-in A.C. & D.C. Power supply.

Complete kit of parts, including 8" Dynamic Speaker, unwired, less tubes and accessories **\$18.95**

- 1 Kit of 10 matched Sylvania tubes.....\$6.95
- Set of 4 coils—2½ to 15 meters..... .30
- Set of 8 coils—15 to 550 meters..... 2.20
- Set of 4 coils—550 to 4000 meters..... 2.00
- American S. B. Hand-mike..... 2.95
- Wired and tested extra..... 4.50

SENSATIONAL ULTRA A. C. + D. C. 2-TUBE TRANS-RECEIVERS 2½ to 4000 Meters

TRULY A SENSATION

Uses the new 6J5G super triode tube which is the equivalent of acorn types

Never before was a unit of this type available at any price. This compact and self-contained unit will receive from 2½ to 4000 meters with a high degree of excellence. Will receive foreign stations, amateurs, police calls, broadcast, press, airplane and weather reports, time signals, and all ultra high frequency stations. As a 2½ and 5 meter transmitter surprising results will be obtained when calling friends from afar.

- FEATURES**
- Transmits from 2½ to 5 meters
 - Receives from 2½ to 4000 meters (12 bands)
 - Separate electrical and mechanical bandspread
 - Loud speaker volume
 - Automatic super-regeneration, 2½ to 15 meters
 - House to house communication
 - Plate modulation
 - Built-in A.C. & D.C. power supply (any cycle)

Complete kit unwired less tubes, coil, cabinet, microphone.....	\$7.15
Cabinet.....	.95
Matched set of tubes (12A7-6J5G).....	1.65
Wired and tested.....	2.00
Set of 4 coils (2½ to 15 meters).....	.30
Set of 4 coils (15 to 200 meters).....	.95
Set of 5 coils (200 to 4000 meters).....	1.75
American 5B Hand-mike.....	2.95
5" Magnetic Speaker.....	1.25

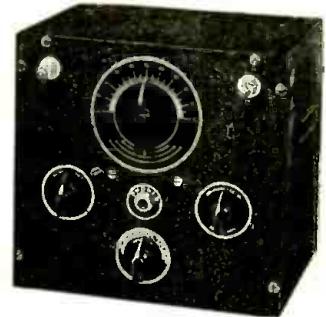

SPECIAL HEAVY DUTY POWER SUPPLY

OUTSTANDING FEATURES

- 6.3 volts at 6 amps.
- 400 volts D.C. at 250 mils.
- Encased in handsome black crackle metal finish cabinet 12¾"x7¼"x3¾" overall dimensions.
- Tapped extremely heavy duty power transformer allows operation on any line voltage from 95 to 250 volts, 25 or 60 cycles.
- Ideal for medium powered transmitter or P.P. 6L6 amplifier or modulator.

Complete, wired and tested with Sylvania 523 rectifier tube and cabinet **\$4.95**

ULTRA HIGH FREQUENCY PRODUCTS CO., 123 Liberty St. New York, N.Y.

Act now as quantity is limited

as a connecting link between circuits.

Since the rotors of the condenser are connected to the chassis, they must in turn be used in the cold part of the circuit. The panel connects the two rotors together and if they are then connected to the wrong part of the circuit they will be short-circuited and not only become inoperative but the B battery will be run down, due to the short-circuit across it. Make sure that the stator of the grid tuning condenser connects to the grid side of the coil, and the stator of the regenerative condenser to the tickler.

Proper placement of the parts on the chassis is quite important. If the parts are placed properly with respect to one another, the leads will be short and the receiver will be more efficient and stable in operation.

As viewed from the front, the coil is on the left, and the tube is on the right. The coil socket has its large holes facing the tube, while the tube socket is mounted with the key-slot facing the right.

The midget condenser on the left (in front of the coil) is the tuning condenser and that on the right is for controlling regeneration.

The antenna condenser is a 35 mmf. compression type padder and is supported by a ½-inch stand-off insulator, which also serves as the antenna binding post.

Tuning and adjustment of this receiver is the same as with any other regenerative set, the technique of which can only be developed by experience.

Best results are obtained with the proper adjustment of the antenna condenser and the regeneration control. Once the "feel"

of the receiver is obtained there will be no difficulty in tuning in even the weakest stations.

As for results, this receiver will pull in even the most remote stations with good earphone volume, provided a fairly efficient antenna is used. The author has found that a 75-foot over-all single wire, mounted clear of all objects and as high as possible, is about the best for this type of receiver.

Parts List

HAMMARLUND

- 2—H.F. 140 mmf. condensers.
- 1—4-prong socket, Isolantite.
- 1—8-prong socket, Isolantite.
- 1—35 mmf. Trimmer.
- 1—2.1 mh. R.F. choke.
- 1—Set SWK Coils—17-260 meters range.

(Continued on page 696)

Please mention SHORT WAVE & TELEVISION when writing advertisers

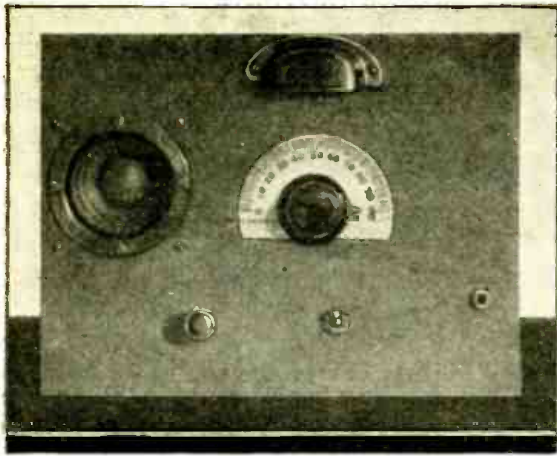

Front view of the 5-meter, 3-tube receiver (Fig. 3)

A "3 for 5" Receiver

Ed. Peil, Jr.

The author calls this his "surprise" high frequency receiver and states that very fine reception results have been obtained with it. The circuit employs a super-regenerative self-quenching detector, one stage of A.F. and a half-wave rectifier. Coverage is 4.5 to 11 meters.

● THIS "Five-Meter Three-Tuber" gave me a real surprise, for in dressing it up, so to speak, for this article I made a few changes, wound a new coil of 9 turns, $\frac{3}{4}$ " outside diameter, and spaced it so that in conjunction with a 15-plate Hammarlund condenser (15-plate per section, 2-gang), it not only worked below five meters, but also took in television on 6 meters, police cars on $7\frac{1}{2}$ meters, police and Hi. Freq. stations on 9 meters, such as W9XPD, etc. The 10 meter band brought in Hams from all districts—Canadian, Mexican, etc. The "top of the dial" brought in W9XAD, W6XKG, etc.—all on the same coil.

A sketch is included of the dial and log. These and many, many more stations wait to be tuned in by those that build this set, built of parts taken from half a dozen old or "junked" sets.

The chassis is an old converter chassis, $7\frac{1}{2}$ "x10" and 3" deep. The panel is not metal but is made of tempered Masonite, 11 "x $8\frac{1}{2}$ ", and there are no hand capacity effects.

The speaker is a 3" dia. P.M. type. A dial flange is used to frame the speaker on the panel. A drawer pull reflects the panel or dial light; the dial consists of a pointed knob that is set over a silver and black

lettered dial taken from a midget set. The "stand-by" switch which turns the speaker on and off is from my old "Super-Wasp" receiver. The other on and off switch is from the "junk box." A single-circuit jack makes up the remainder of the panel equipment.

The circuit? Well, maybe I should have mentioned it first. It's novel, yet simple. A super-regenerative, self-quenching detector, one-stage of A.F. and a half-wave rectifier (56 Det. 56 A.F. 27 rect.) as simple a line-up as possible, yet efficient.

I got tired of building Hi-Freq. sets in which I had to use a yard or so of insulated shafts and bushings and sit across the room from the set while tuning. So I simply decided to use a two-gang variable condenser, with the shaft grounded to eliminate this. The coil is tapped 5 turns from the plate-end, or 4 turns from the grid-end; the exact placement of this tap is most essential. Experiment until you get it where there are no dead-spots over the entire dial. The antenna is not connected during this operation. The detector R.F. choke, too, has to be just about right; 75 to 100 turns wound on a burned-out fuse taken from an auto set, with pig-tail connections soldered to the ends, before you

start to wind the choke. The choke in the power-supply can be any one you have handy.

Two marked improvements may be added

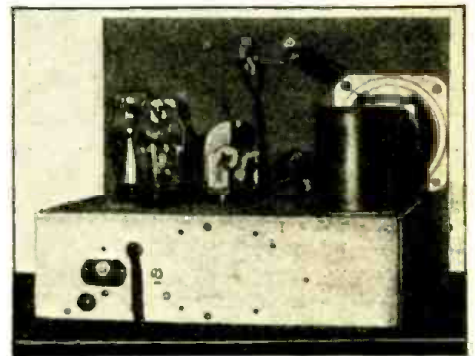

Rear view of the receiver.

to the original set. First by putting a 50,000 to 75,000 ohm resistance in series with the detector "B" positive lead, and connecting a suitable condenser from "B+" on the transformer to ground.

Second improvement is to connect a .01 mf. condenser in series with a variable re-
(Continued on opposite page)

How to wire the simple but very efficient 5-meter receiver, described by Mr. Peil

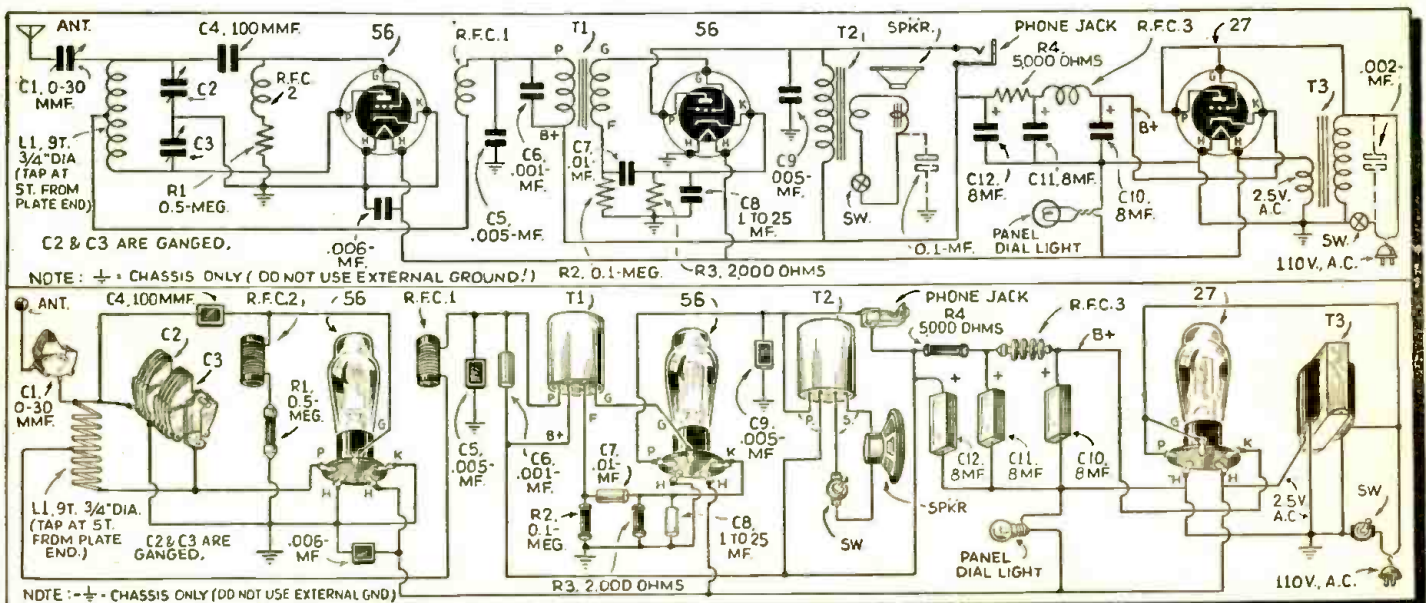

sistance (pot.) from the 56 A.F. plate to ground. This not only acts as a tone control; it also cuts down noise and filters out the high pitched whistle common in super-regenerative sets, and amplified through the A.F. stage. This control practically eliminates it altogether.

These two controls were left off this set for simplicity's sake. It might be interesting to note that a 110v. to 2½v. step-down transformer is used in the power-supply; the same filament voltage of 2½v. supplies all three tubes.

Either single or double 8 mf. condensers are used in the filter and do a good job of filtering. A 5,000 ohm resistor takes the place of the more common type iron-core choke.

The P.M. speaker is insulated from the metal chassis, but is connected to the chassis through a by-pass condenser to tie it down to as near ground potential as possible.

The A.F. transformer used has a 5-to-1 turns ratio. I would even recommend a 10-to-1. The A.F. stage is of good design and will give a high gam. No "fringe howl" was noticed in the set, so it will not be necessary to use a resistor across the secondary of the A.F. transformer. This only tends to cut down volume.

Here is a point up to the prospective builder of this set. If you have a step-down transformer of 110 to 6 volts, and you wish to use a type 76 tube instead of a 56, F.B.—go ahead—but I would suggest the following tube line-up—76 Det., 38 A.F., while the rectifier could be a 76—1V, or an 84. Whichever tubes you use, experiment, get that old super-detector to *suping*. Try winding several kinds of R.F. chokes; try different condenser and resistance combinations. Try to better the receiver—I dare you!

I'll guarantee that a real thrill awaits you when you build this surprise high frequency receiver, and now "good luck" and 73.

Parts List

L1—9 turn coil ¾" outside diam. Tapped approximately 5 turns from plate end or 4 turns from grid end of coil.

HAMMARLUND

C1—30 mmf. Trimmer condenser.
C2-C3—Two-gang, 15-plate per section. (Cap. per section 100 mmf.)

MISCELLANEOUS*

C4—0001 mf. Mica condenser.
C5—005 mf. Mica condenser.
C6—001 mf. Mica condenser.
C7—01 to .1 mf. tubular condenser.
C8—1. to 25 mf. tubular condenser.
C9—005 mf. Mica or tubular.
C10-C11—8 mf. condensers.

T1—5 to 1 A.F. transformer.
T2—6 ohm output to P.M. speaker.
T3—110 to 2½ V. step-down transformer.

R1—500,000 ohm grid resistor.
R2—100,000 ohm resistor.
R3—2,000 ohm resistor.
R4—5,000 ohm resistor, 5 watt.

R.F.C.1-2—As specified in article.
R.F.C.3—2½ mh. R.F. choke.

Magnetic or permanent magnet Loud-speaker.
3 five-prong sockets.
Chassis. panel. single-pole switches, knobs, jack, nuts, bolts, etc.

Drawer-pull used as reflector for panel light; one dial light and socket.

*Most radio mail order houses can supply this item. If properly identified as to title of article, issue (month) of **SHORT WAVE & TELEVISION** and year.

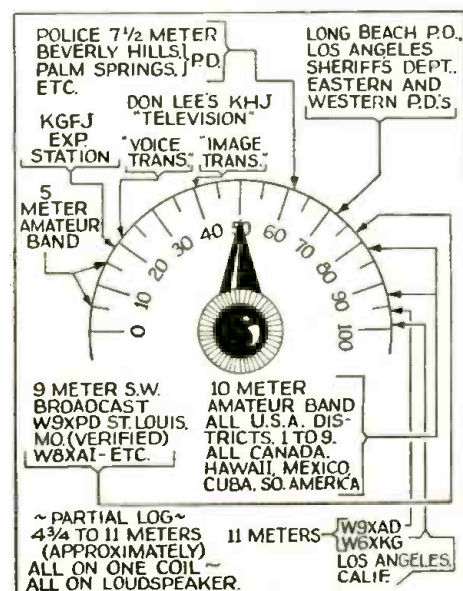

Some of the stations the author picked up on the "3 for 5" receiver.

Faulty Circuit Locator

(Continued from page 681)

driven by two dry-cells. Output binding-posts connect across the contacts through a blocking condenser, which prevents a short across the output from putting the buzzer out of commission.

One side of the output is connected to the circuit in trouble at any convenient point, which may be at the socket of any street lamp near where the trouble might be expected. The other side is connected to ground through an iron stake or in any way convenient.

In operation this causes an audio frequency note to travel along the underground circuit to the point where the ground has occurred, thence back through the ground to the exciter.

The locator unit consists of an exploring coil wound with approximately 200 turns of No. 36 S.C.C. wire into a twelve-inch ring, the turns being tightly taped together and then fastened by tape or otherwise to a light wooden handle about three feet long, for convenience.

Flexible leads are brought from the ends of the coil up the handle and connected to the small portable amplifier. By using two flashlight cells connected in parallel for the filament supply and the smallest size 45 volt "B" battery, the whole thing is not much larger and weighs about as much as a box camera.

Signals from the exciter may be picked up for surprising distances but when the coil has passed over the grounded point in the underground circuit, the signal stops at once, indicating that you have found, or are very close to the point of trouble.

Needless to say, the regular lighting supply current should be cut out during this procedure.

For tracing underground circuits in service, the pick-up coil amplifier and phones do a good job, without the exciter.

When tracing any line keep the plane of the pick-up coil in a line with the wire to be followed.—G. C. WILKINS, W8HIG.

THESE BEAM POWER TUBES...

THEY LOOK ALIKE
THEY'RE PRICED ALIKE



BUT...

NO ONE CAN IMITATE RAYTHEON PERFORMANCE!

... No "SOFTIES"
in the RK LINE

None of us can resist that urge to crowd the plate 'way past its normal rating. So RAYTHEON tubes are built with an extra margin of safety. Just look inside an RK-47. Here's what you'll find:

1. **A HARD GLASS BULB.** Prolongs tube life. No pin pricks when operated at high temperatures. Also enables us to produce a tube that is much more gas-free.
2. **MOLYBDENUM PLATE**—not iron. "Moly" costs 10 times more, but it assures gas-free operation.
3. **CERAMIC INSULATION**—no mica. Mica is a gas supplier. It is not used in RK-47 tubes.

BEAM POWER TUBES

RK-47—Hard Glass Bulb. 10 Volt. 3.25 Amp. Filament. 1250 Volts Plate. Driving Power. 1 Watt. Output Power. 120 Watts. Amateur Net Price

\$17.50

RK-48—Hard Glass Bulb. 10 Volt. 5 Amp. Filament. 2000 Volts Plate. Driving Power 1.2 Watts. Output Power. 250 Watts. Amateur Net Price

\$27.50

RK-39—6.3 Volt. 0.9 Amp. Filament. 500 Volts Plate. Driving Power. 0.3 Watts. 35 Watts Output. Amateur Net Price

\$3.50

Even RK tubes should not be overloaded. But they will stand more abuse, they will last a longer time than any other tube you can buy. You will always get the most for your money if you will always ask for RAYTHEON!

See your RAYTHEON jobber or write for FREE technical data.

RAYTHEON RK AMATEUR TUBES

420 Lexington Ave., New York 445 Lake Shore Drive, Chicago
55 Chapel St., Newton, Mass. 555 Howard St., San Francisco
415 Peachtree St. N. E., Atlanta

WORLD'S LARGEST EXCLUSIVE TUBE MANUFACTURERS

Build Your Own Television

The 441-Line "S.W. & T." Sight and Sound Receiver

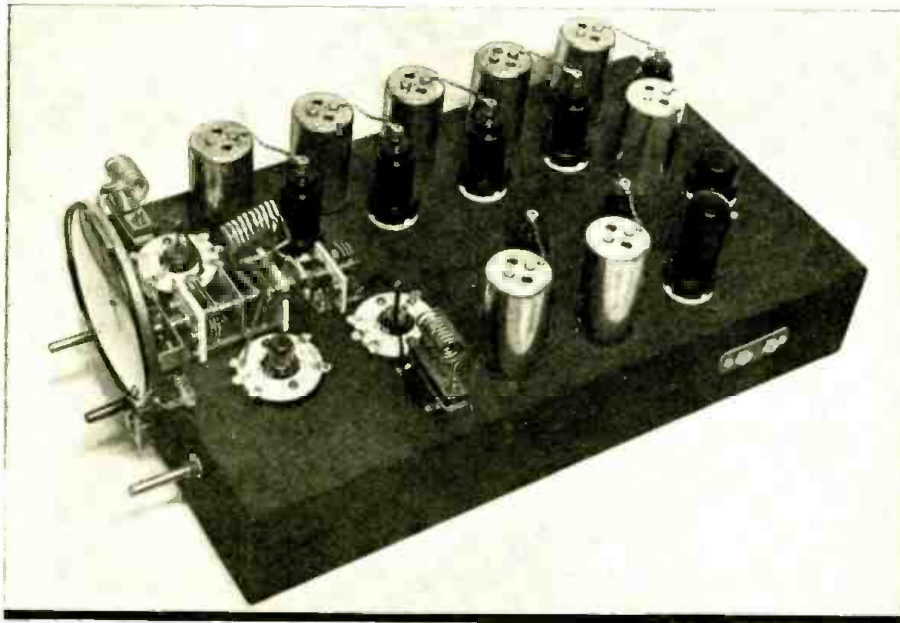

lator and first detector. The 5 stages are needed because a very high I.F. is necessary in order to pass a band of frequencies more than 2 megacycles wide. With 441-line images a band width of 2,000,000 cycles is required to reproduce clear, undistorted images. This compares with 5,000 to 10,000 cycles needed for music reproduction—which explains some of the difficulties en-

General view of the "S.W.&T." cathode-ray Sight and Sound receiver. Power-supply unit is not shown as this is built as a separate unit.

countered in the design of a high quality television receiver.

Special I.F. transformers are used, designed for the purpose of amplifying video signals. These transformers have very small inductances and comparatively large trimming capacities. It is well known that a large C and small L in a tuned circuit will produce a lower value of selectivity than a high L to C ratio. In addition, close coupling—commonly called "over coupling" is used to further widen the pass band. A slight misalignment of the I.F. transformers, thus staggering the I.F., further widens the band. But all these broadening effects are accompanied with a reduced amplification which, combined with the very high frequency used for the I.F. amplifier, explains why so many amplifying stages are needed.

A single oscillator beats against the incoming signals in the first detectors of both sound and video receivers. This combination permits simultaneous tuning of both receivers with a single dial and also eliminates the need for excessive shielding between receivers that would be needed if

● IN Part I of this series we pointed out that the modern cathode-ray television receiver consists of three essential parts: (1) a radio receiver which will tune to the transmission frequency and have certain characteristics which will be outlined later; (2) a special type of power-supply system, and (3) a "television type" cathode-ray tube with suitable circuits for "sweeping" the spot of fluorescent light across the end of the tube and keeping this motion synchronized with the scanning which takes place at the television transmitter.

The particular part of the television receiving system which we are building in this part is the radio receiver. For convenience

in operation, two distinct receivers are included on the chassis shown in the photos. One of these receivers picks up the sound accompaniment of the pictures or images and reproduces these sounds through a loudspeaker. This receiver which we will call the *sound receiver* is a normal U.S.W. superhet type set with a pentode second-detector and a 6V6 beam-power output stage.

The "Image" Receiver

The second receiver is the actual television or image receiver which we will call the video receiver. This is also a superhet type receiver with 5 stages of intermediate-frequency amplification following the oscil-

Wiring diagram of the Sight and Sound superhet receivers, not including the power-supply, which will be described later.

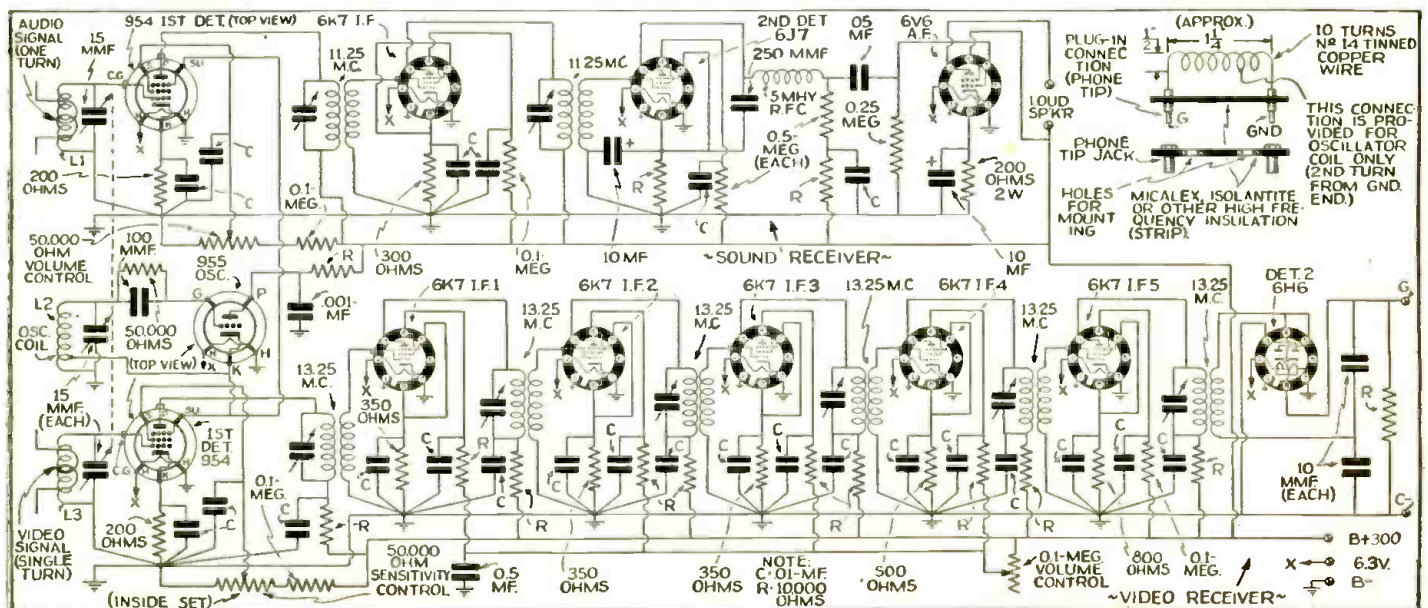

Receiver

Part II

C. W. Palmer, E.E.

two separate oscillators and first detectors were used.

Acorn tubes are employed in both the detector and oscillator circuits of the two receivers, to keep the noise level and tube noise to a minimum and to permit high efficiency on the high frequencies used for television transmissions.

An unusual second detector is used in the video set. An examination of the schematic circuit shows that this detector is an adaptation of the *voltage-doubling*

novice to tackle. Hams and experimenters who have used high voltage equipment and know something of the operation and characteristics of cathode-ray tubes—and who live near one of the experimental transmitters now in operation in several of our large cities—will get a great kick out of building and operating an image and sound receiver and will learn a lot about television, at the same time. For this class of reader, this receiver has been designed and constructed.



Top view of the "S.W.&T." television receiver.

scheme used in some power supply-systems, which is applied to high-frequency work. This detector was developed in England by W. T. Cocking and was described in *Wireless World* (London) some time ago. With this detector and the 5 stages of I.F. amplification it is possible to eliminate the need for a video frequency amplifier (the same as an audio-frequency amplifier in ordinary receivers, but having a flat response from 20 or 30 cycles to at least 1,500,000 cycles), thus greatly simplifying the construction and adjustment of the set. A peak voltage swing of well over 60 volts from the detector is possible with this arrangement within reasonable distances from the transmitter when an I.F. of higher than 3 or 4 mc. is used. At lower I.F.'s the need for extremely low load-impedance limits the output—but this does not apply to our receiver which employs an I.F. of 13.25 mc.

So much for the design considerations. This discussion of the many problems encountered could be continued indefinitely—but we must turn to the actual construction of our set.

First, however, it may be well to point out once more that the construction of a television receiver is not a problem for the

Construction

The first thing to do after obtaining the parts listed in the parts list at the end of this article is to lay out the chassis, placing the parts as shown in the photographs. No drilling details are given as the parts are best laid out and scaled right on the chassis. The left-hand side of the chassis looking from the front is the video side. Directly behind the dial on the left side is the 954 first detector of the video set. This is tuned by the front section of the 3-section tuning condenser. Behind this is the first I.F. coil of the *video* amplifier. The 6 transformers are situated as shown, in a row down the side and across the back. The tube sockets are located in a line, and are set diagonally between the transformers—to keep the leads short.

On the right-hand side of the chassis, looking back from the dial are: first, the oscillator, type 955, tube which is tuned by the second condenser section of the tuning condenser. This is followed by the first detector, type 954, tube of the *sound* receiver and the I.F. amplifier, second detector and beam-power amplifier of the *sound* receiver.

(Continued on page 699)

Please mention SHORT WAVE & TELEVISION when writing advertisers



New Amplifier for Direct Current Circuits

Added to the long list of amplifier circuits developed in the radio research laboratories of the Jefferson Electric Company is the Jefferson 10 Watt 25L6 Amplifier.

This may be connected to the usual 110-115 Volt direct current source of supply found in many sections—and makes unnecessary the use and expense of a converter.

Metal tubes are used throughout, including four 25L6's in the final stage. The extremely high gain of 139 decibels is attained with perfect stability of operation. . . Mikes of the lowest output levels swing the amplifier to full output of 10 Watts.

Bulletin PA-15—FREE

This describes all parts, including chassis and complete large circuit diagram. . . Use the coupon below. . . JEFFERSON ELECTRIC COMPANY, Bellwood (Suburb of Chicago), Illinois. Canadian Factory: 535 College St., Toronto, Ont.

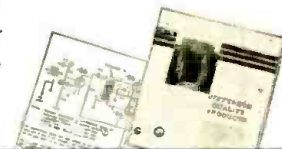

JEFFERSON RADIO TRANSFORMERS

JEFFERSON ELECTRIC COMPANY, (S) Bellwood, Ill.

Please send new Radio Catalog 372-R, Bull. PA-15 and Manual of Amplifier Circuit Diagrams.

Name

Address

City and State

5 and 10 Meter Crystal-Control Transmitter

John Stewart

• OUR five-meter transmitters have always been quite a problem. To make them truly modern has, in the past, meant considerable complication. We have all looked forward to a simple five-meter rig which should have all the advantages of our lower frequency transmitters. We know that it is possible to build a very efficient two-stage transmitter for our other bands, but until recently this has not held true with our five-meter gear.

It seems that the manufacturers of crystals have been giving this problem considerable thought, for their research and experimentation have now produced a good 10 meter crystal and its cost is no greater than an ordinary low-frequency crystal. These new 10 meter crystals open a vast field for improvement in the present-day ultra-high frequency transmitters. It is now possible to build a crystal-controlled rig for 5 meters which is very simple and not the least costly. Those who have been complaining that a crystal-controlled rig was too complicated and far too costly, especially for short-haul contacts such as we have on five meters, have an answer to all their alibis in this new crystal. Why the whole problem is so simplified that it is now possible to build an efficient one-tube 5-meter crystal-controlled transmitter. (Not including the modulator and the power-supply.) To illustrate what can be done to this end we have shown a diagram of just such a rig. This is so simple that there is no excuse for modulated oscillators remaining in the 5 meter

band. Those of the "five meter gang" now using the famous 61.6 MO'PA can convert it to crystal-control in a few moments' time by replacing the oscillator tube and adding the crystal.

It has long been established that 40 or 50 watts output from a five-meter transmitter is sufficient to work anything heard on that band. The really important item is not the power output of the transmitter, but the efficient radiation of that power, whatever the amount. But we are not discussing antennas in this article; plenty has been said in these pages in the past about good antennas.

The main idea in building the transmitter shown in the photos was to introduce the 10-meter crystal in a rig which had an output of around 40 or 50 watts—one that could work anything heard on the band, and one that was complete and compact enough to take its place permanently beside our other equipment.

A transmitter for 5 and 10 meter operation. Crystal-control provides high stability; power supply data is included. Set uses new 10 meter crystal.

Lineup of R.F. Section

The lineup of the R.F. section is simplicity itself. An RK-34 is used as the oscillator and frequency-doubler. The doubler section drives a pair of 807's in push-pull as the final amplifier. The measured output with 400 volts on the plates of the 807's was 40 watts. If the plate voltage is increased to 450 the output will increase to 50 watts. Returning to the oscillator stage the reader will probably

(Continued on page 694)

Below—Wiring diagram of the 5 and 10 meter crystal-controlled transmitter.

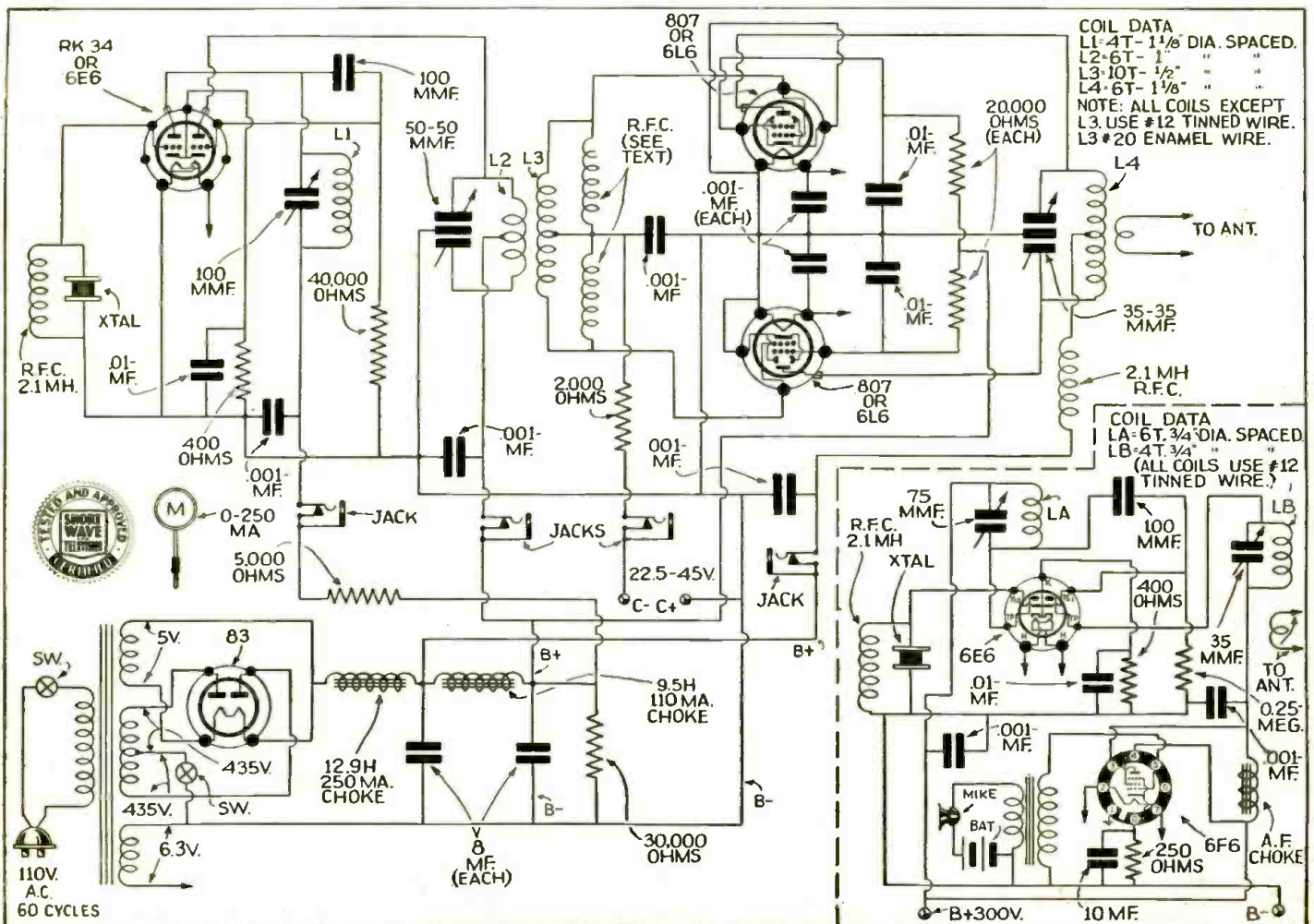

Short Wave Scouts

The Forty-Eighth Trophy
Presented to
SHORT WAVE SCOUT

JOHN PAWLUK

1081 N. Hazard Street
Los Angeles, Calif.

For his contribution toward the advancement
of the art of Radio

by

SHORT WAVE and
TELEVISION

Honorable Mention

JOHN SZLUCHA
R. D. No. 1, Owego, N. Y.

78 Veris Win the April Contest

● MR. PAWLUK, one of the runners-up in two previous contests, submitted a list of 102 stations. Only 78 of these came within the contest regulations, however, and they won the trophy for him.

There were four entrants each submitting more than 50 stations. The runner-up was Mr. John Szlucha, who submitted a list totaling 82 stations. However, upon examination of his entry, less than 75 cards came within the contest rules, so he was given honorable mention.

Mr. Pawluk used a 1937 model Silvertone radio with a ¼-wave 25-meter doublet. His list of cards contained entries from 31 countries and five continents. Mr. Pawluk deserves special commendation for the large list of stations which he submitted.

TROPHY AWARD TO BE DISCONTINUED

Because the Editors believe the original purpose of these contests (that is, the popularizing of long-distance short-wave reception) has been fulfilled, we have decided to discontinue the award effective with the May contest, which closed February 24.

However, the editors would welcome comments on this step from readers. If sufficient and widespread interest in the trophy award seems evident it is possible that the contests will be resumed.

GET YOUR NEW GUIDE TO RADIO! SEE EVERY NEW DEVELOPMENT

ALLIED'S NEW CATALOG

for Spring and Summer



PACKED WITH NEWS FOR EVERY RADIO MAN!

Now Ready!

164
PAGES

NEW KITS!
NEW TESTERS!
NEW PARTS!



NEW SETS!



NEW SOUND SYSTEMS!



NEW HAM GEAR!

Everything New in Radio!

Just off the press! ALLIED'S new Spring and Summer Catalog, 164 pages packed with everything new in radio. Whatever your radio interests, you'll want this new book. It's the outstanding Radio Buying Guide with comprehensive listings of Radio sets, parts, sound systems, kits, test equipment, Amateur gear, tools, books, etc., for every purpose. All leading lines of highest quality—arranged for easy reference.

Volume sales and economical merchandising mean that ALLIED can buy in huge quantities and pass the savings on to you. Everything regularly stocked under one roof. A speed-minded organization ready to serve you. That's why you get more for your dollar at ALLIED—why you save time, money, and effort on every order from ALLIED'S Catalog. Send coupon now for new Spring and Summer edition.

Dealers! See "America's" Greatest set values! 62 new Knights, Electric Push-Button-Tuning at \$19.95—auto radios \$14.95! —sets under \$10—new Phono-radios, Portables, Farm, Hush-a-Tone, Remote Control, models for every purpose; 5-16 tubes, AC, AC-DC, 6-volt, 32-volt, Battery, Auto—big profits for you. See them!

Service Men! See the latest tube-checkers, set-testers, analyzers, oscillographs, meters! All standard lines—new Hickok, Triumph equipment—at lowest prices! Over 12,000 parts, books, tools, etc.—every service need—send Coupon!

Sound Men! See amazing new P.A.—new features, styling, convenience—Knight Integrated systems, 10 to 80 watts—new power stage units, portable cases, mobile units, phono-players, etc.—send Coupon!

Amateurs! See the new transmitters, receivers, transceivers—all standard lines—new Hallcrafters, Howard Communications Receivers, HTL Hi-Frequency, RCA Television Tubes, new Transmitter Kits—send Coupon!

Set Builders! See Radio's largest Kit selection—many new types, Electric Fence-Control kit, Transmitter Kits, etc. We supply matched kits for any circuit in any magazine—write for Free Parts Lists.

ALLIED RADIO CORP.

833 W. JACKSON BLVD., CHICAGO, ILL.

FREE SEND COUPON

Allied Radio Corporation, Dept. 3-D-8
833 W. Jackson Blvd., Chicago, Ill.

Send me your new Spring-and-Summer Catalog FREE.

Name

Address

City State

FREE Books with your Subscription to Short Wave & Television
SEE PAGE 714

CRYSTAL HEAD PHONES

"TRANSFILTER"

Information on request

THE BRUSH DEVELOPMENT CO.
3325 PERKINS AVE., CLEVELAND, OHIO

SHORT WAVE CONVERTERS FOR CAR RADIOS



Can be attached to any car radio. Has on and off switch and does not affect the reception on the standard broadcast band.

MODEL 600 covers 40-31-25-20-19 and 16 meter bands. Designed for American and Foreign short wave broadcast. Distance range 5000 to 10000 miles. List Price \$24.95

MODEL 700 long wave covers 135 to 410 KC. Receiver Nov. weather reports, etc. List Price \$24.95

POLICE UNITS

MODEL 100 with fixed condenser, covers 1600 to 2600 kilocycles. List Price \$11.95

MODEL 200 with variable condenser, covers 1550 to 6000 kilocycles. List Price \$17.95

MODEL 400 with fixed condenser, covers 5 to 10 meters. List Price \$13.95

MODEL 500 with variable condenser and illuminated dial. Very sensitive, has two metal tubes. Exceptional distance range. List Price \$21.95

Jobbers and Dealers wanted

ABC RADIO LABORATORIES 3534 N. New Jersey St., Dept. 3-4, Indianapolis, Ind., U.S.A.

Please mention SHORT WAVE & TELEVISION when writing advertisers

Further Details on 5 and 10 Meter Crystal-Control Transmitter



(Continued from page 692)

wonder why some of the latest circuits were not used. This requires a little explaining. It seems that these new crystals give best results in a *simple triode oscillator* circuit using such tubes as the RK-34, 6E6, 6J5-G, the 955 or the newer 6F8G type. It is not advisable to attempt to use another type of tube with the 10 meter crystal. All experimental work has been done and the above listed tubes prove most satisfactory. The last mentioned tube should work out well in modernizing the 6L6 MOPA. Its output is sufficient to drive one beam tube as a modulated amplifier. This tube is a twin-triode and has two separate cathodes and one of the grid terminals comes out of the top of the glass bulb, thus reducing the feed-back from the other triode into the crystal circuit.

807 Tube Superior Performer

The final amplifier is of conventional pattern. However, all of the glass-type beam tubes will not give satisfaction in the circuit shown. The 807 works perfectly and also the 6L6 metal tube gives good results. Other types require *neutralizing* which is not easily accomplished, with the beam type tube at 56 mc. (5 meters). Experience proves the 807 to be the best performer. The new type 807 will work well with 500 volts on the plate, while the 6L6 metal tube should be run at 400 volts for maximum tube life.

The ten-meter crystals are not a bit fussy about operating properly if the correct circuit values are employed. It is possible to make the crystal oscillate at about 30 meters, if the values in the circuit are not correct. But if the reader follows the details given there will be danger of this occurring.

No grid-leak is used in the oscillator circuit. Bias is obtained with a 400 ohm cathode resistor. The crystal is shunted with an R.F. choke. This arrangement must be used if proper results are to be expected. Other arrangements reduce the output to a point where there is not sufficient to drive the final amplifier tubes. The doubler section employs 40,000 ohm grid-leak. This is a one watt metallized type and no R.F. choke was found necessary.

"Series-Feed" Used

In order to evenly excite the two amplifier tubes the plate coil of the double-driver was center-tapped and tuned with a split-stator condenser. The tap on the coil must be by-passed and the rotor of the condenser grounded. Coupling between the oscillator and the doubler is accomplished with a .0001 mf. mica condenser and *series-feed* is used in all circuits associated with the RK-34 tube, because of the complications which are liable to exist with shunt-feed.

Coupling between the doubler and the final stage is *inductive* and consists of a large number of turns of small diameter mounted inside the doubler plate coil. The two coils comprise a single plug-in unit with five plugs mounted on a victron strip one-half inch in width. The base has a similar number of midget jacks and is of the same construction. A National five-prong plug and base assembly can also be used. One of the photos provides details of the plug-in unit.

Shunt-feed is used in the amplifier grid circuit to eliminate a sixth plug and jack. The choke has two windings each $\frac{3}{4}$ of an inch long and close-wound with No. 36 cotton-covered wire—later given a coat of victron coil dope.

All leads associated with the final amplifier that go to B-minus are connected to a single buss lead. This is done to avoid closed loops in the ground circuit. These loops can cause a lot of trouble and care should be taken in making the ground connections in both the oscillator-doubler portion as well as the final amplifier. The diagram shows that no plate by-pass condenser connects to the center tap of the final amplifier plate coil. A choke is used here instead and
(Continued on opposite page)

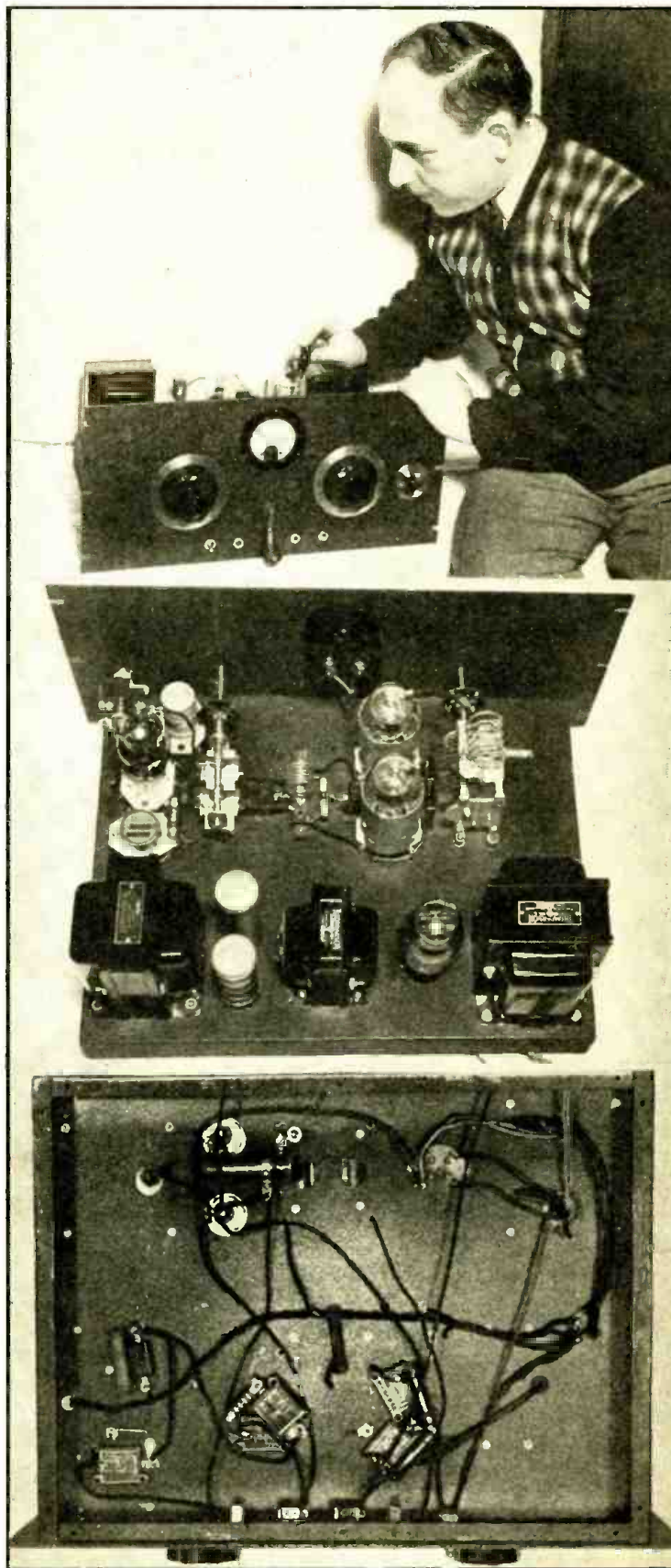

Top—General appearance of the transmitter; center—rear view of the set, and lower picture—a bottom view of the transmitter.

5 and 10 Meter Crystal-Control Transmitter

(Continued from preceding page)

the condenser is on the B plus side of the choke, greater amplifier efficiency was obtained in this manner.

Fixed Bias Used in Amplifier

Fixed bias is used in the amplifier in order to improve stability. A single 22½ volt battery of the midget variety proved sufficient. If for any reason, the grid current of the final amplifier permits it, 45 volts bias may be used. In all cases the grid current should be 5 ma. for the two tubes. For a single-ended amplifier the grid current would be 2.5 ma.

This transmitter is intended for five- and ten-meter operation, both phone and CW. Only the five-meter information will be given here. The entire transmitter may be housed in a cabinet designed to accommodate two 8¾ inch panels. This portion which we are discussing is mounted on a chassis 17 by 13 by 2 inches; the panel is 8¾ by 19 inches.

Adjustment, Antenna and Power Supply

Adjustment of the transmitter is the same as with all similar arrangements. As a guide the various current readings are as follows—oscillator plate -30 ma., doubler plate -30 ma., amplifier grid as we said before -5 ma. and the final amplifier plate may be loaded up to 200 ma. although from 150 to 175 ma. is about optimum.

No antenna data will be given because it is felt that the individual reader will prefer the one he is now using. Our only suggestion is the use of untuned feeders. The number of coupling turns should be adjusted to permit proper loading of the final amplifier.

The voltage to the oscillator should not exceed 325 volts; otherwise undue crystal heating will result. The screen voltage is 250 and the final amplifier plate voltage is just 400. The latter can be increased for greater output as we pointed out before.

Parts List

HAMMARLUND

- 1—100 mmf. var. cond. MC-100-S
- 1—50-50 mmf. var. cond. MCD-50-S
- 1—35-35 mmf. var. cond. MTC-35-R
- 1—4 prong socket
- 4—5 prong sockets
- 1—7 prong socket
- 2—2.1 MH RF chokes—CHX

I.R.C. RESISTORS

- 1—400 ohm 10 watt resistor
- 1—2000 ohm 10 watt resistor
- 1—30,000 ohm 20 watt resistor
- 1—40,000 ohm 1 watt resistor metalized
- 1—5000 ohm 20 watt resistor
- 2—20,000 ohm 10 watt resistors

CORNELL DUBILIER

- 3—.01 mf. mica condensers 600 V.
- 6—.001 mf. mica condensers 1,000 V.
- 1—.0001 mf. mica condenser rec. type
- 2—8 mf. electrolytic condensers 500 V.

THORDARSON

- 1—plate transformer—870V. ct., 6.3 V.-5 V. (T75R50)
- 1—filter choke 12.9 H., 250 ma.—(T75C51)
- 1—filter choke 9.5 H., 110 ma.—(T57C54)

BLILEY

- 1—11F2-10 meter crystal

TRIPLETT

- 1—0-250 ma. large bak. case meter

PAR-METAL

- 1—8¾x19 in. panel
- 1—17x13x2 in. chassis

TUBES

- 1—RK34 twin triode (Raytheon)
- 2—807 beam tetrodes (RCA)
- 1—83 rectifier (RCA)

New 1938 SUPER-CLIPPER!



New 7 Tube, 7 Band Receiver With BUILT-IN SIGNAL BOOSTER and PRESELECTOR!

UNUSUAL DX RECEPTION ASSURED

THE SUPER-CLIPPER has been designed for DX hunters—it has all the features you have ever asked for built into a single, big receiver with every useful control at your finger-tips.

The SUPER-CLIPPER guarantees you consistent foreign reception, and goes further; you can expect the unusual in long-distance reception with this *big record-breaking receiver*. Big?—Yes, big in size and bigger in performance—19 inches wide, 10 inches high and 9 inches deep! No crowding of parts on its large, well-designed chassis. Efficiency dictated the mechanical and electrical layout

of this superb set.

The SUPER-CLIPPER circuit utilizes both regeneration and super-regeneration combined with radio frequency amplification. The tube line-up is: 6K7 R.F. Booster; 6K7 R.F.; 6K7 Ultra-high R.F. (separate channel); 6J5G Detector; 6J5G 1st Audio; 6L6G Power output; 80 Rectifier.

A Few of the Many Features

- Built-in Signal Booster and Preselector which permits foreign stations to be separated and weak ones built up to loudspeaker volume. Covers same range as main tuner, and is tuned automatically with it but may be switched out of circuit for stand-by tuning and local high fidelity reception.
- Calibrated reduction drive tuning dial covering from 22 to .54 megacycles (13 to 555 meters) in four overlapping bands controlled by handswitch (NOT plug-in coils).
- Both electrical and mechanical handspread entirely eliminating critical tuning on weakest foreign stations. A separate handspread and ultra-high frequency condenser is used.
- Two stages of powerful audio amplification with 6L6 beam power output.
- Separate ultra-high Frequency R.F. channel (3 to 12 meters) using air-wound coils and 6K7 R.F. amplifier. (Separate antenna connection is provided for maximum efficiency.)
- Six one-half inch dynamic speaker; Noise and Tone Control; Earphone jack, etc. The SUPER-CLIPPER has every worthwhile feature that you would like to have in your personal receiver.

The New 1938 Super-Clipper

complete with 7 tubes, ready to plug into AC 110 v. line and operate. Guaranteed for one year

Shipping weight 30 lbs. **\$29.75**
NOT SOLD IN KIT FORM

RACO RADIO CONSTRUCTORS LABORATORIES
136 LIBERTY ST. Dept. S-4 NEW YORK, N. Y.

WHERE can you Buy the RADIO AMATEUR COURSE? See page 660.

THE NATIONAL NC80X AND NC81X

**SUPERHET RECEIVERS
NOW IN STOCK FOR
IMMEDIATE SHIPMENT**

Either above receiver complete with tubes, crystal and speaker chassis.

NET PRICE \$99.00 COMPLETE

CAMERADIO

963 LIBERTY AVE. 30 TWELFTH ST.
PITTSBURGH, PA. • WHEELING, W. VA.
Established 1919



The New "Clipper" Dynamic

Another American Moving-Coil Microphone. Featuring

HIGH OUTPUT
—SMALL SIZE
RUGGEDNESS
—FIDELITY

TRIM
—EFFICIENT DESIGN
LONG LIFE

—STABILITY

D7T — High Impedance 10,000

List Price **\$22.50**

D7 — Low Impedance

30 to 50 Ohms

List Price **\$20.00**

Request Catalogue No. 27 for Complete Details.

American Microphone Co., Inc., Los Angeles, Calif.

Please mention SHORT WAVE & TELEVISION when writing advertisers.

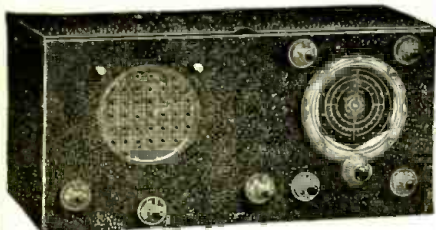

DOERLE MODEL D-38

A. C. 17 1/2 x 8 1/2 x 8 1/2

8 Tubes 4 1/2 to 3000 Meters

The last word in short wave receivers. Before you buy send for circular D-38, an eight-page booklet containing schematic and picture diagrams, instructions, and sketches.

Read this booklet and compare with the other models you have in mind. Then send your order to the concern who in your opinion is giving you the best for your money.

Complete, with all coils, and tubes **\$32.50**
no extras.....

Kit, factory assembled, but unwired, less tubes, with all coils.... **\$22.50**

7C 5-Tube

Short Wave Receiver 8 1/4 to 625 Meters

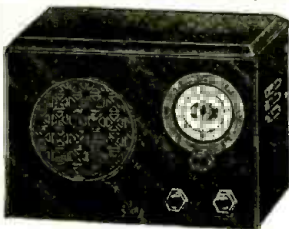

Bigger and More Powerful Than Ever
A Giant in Performance

Uses a 6K7 radio-frequency stage, a 6F7, twin 2 in 1 tube, as regenerative detector and first audio, one 6C5, one 12A7, twin 2 in 1 tube, and one K92A. Earphone pack has been incorporated to permit the use of phone when loudspeaker operation is not desired. Operates from regular house current.

Size: 10x7 1/2 x 7 1/2

Complete with all coils, 9 1/2 to 600 meters, and all tubes, ready to use, nothing else to buy..... **\$16.50**

In Kit form, but factory assembled, including all coils and tubes, but unwired..... **\$12.95**

*Available in battery model upon special order at same price.

**Also available in ham model with special tuning circuit to provide additional bandsread at \$1.00 additional.

2-Tube Electric Set

Complete with 5 coils, 2 tubes, wired and tested, 12 to 600 meters, which includes the broadcast band..... **\$4.00**

In kit form, factory assembled with coils, but less tubes and tinned..... **\$2.50**

Available for battery operation at the same price, if specified.

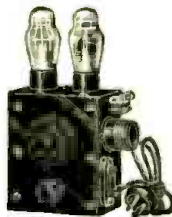

FLASH!

JUST OFF THE PRESS!

SEND FOR OUR NEW CATALOG containing CIRCUIT DIAGRAMS, and complete information on over 25 different types of short wave receivers and transmitters from \$2.50 and up.

This catalog is chock full of schematic and picture diagrams, hook ups and short wave information. A book in itself. Well worth the dime, which is refunded when you send your order.

OSCAR B. KUSTERMAN

68 Barclay Street, New York City

Any Beginner Can Build This I-TUBER

(Continued from page 687)

I. R. C. (Resistors)

- 1—2 meg. resistor 1/2 w.
- 1—1/4 meg. resistor 1/2
- 1—2,000 ohm resistor 1/2
- 1—50,000 ohm resistor 1/2

AEROVOX (Condensers)

- 1—.0001 mf. mica
- 1—.0005 mf. mica
- 1—.006 mf. mica
- 1—.01 mf. paper
- 1—1 mf. paper

TUBES (Raytheon)

- 1—6-F8-G tube.

MISCELLANEOUS

- 1—1x4x7-inch chassis.
- 1—5x7-inch panel.

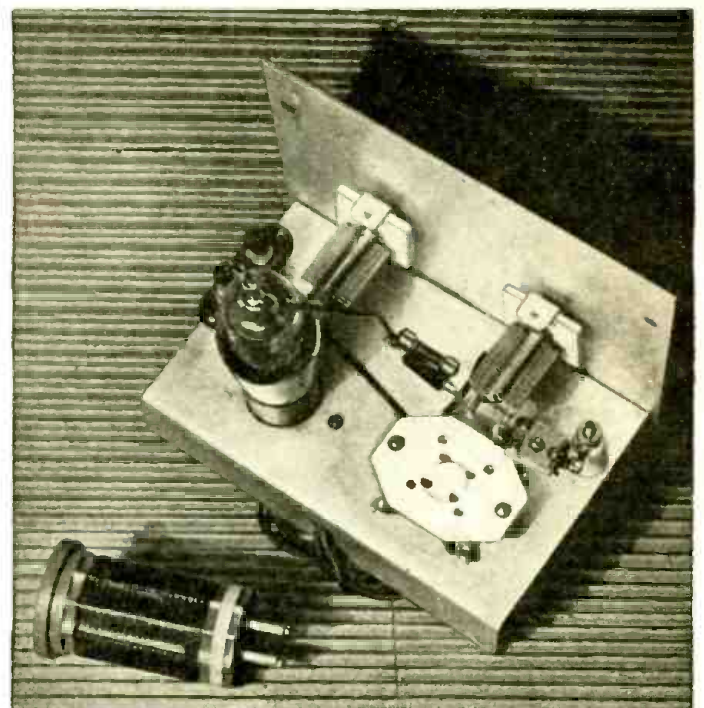

Coil Data for I-Tube Beginner's Receiver

Range Meters	Grid Turns	Tickler	Winding Space	Size Wire
135-270	82	16	1 1/2"	No. 28
66-150	38	11	1 1/2"	No. 26
33-75	18	6	1 1/2"	No. 24
17-41	9	5	1 1/4"	No. 16
9-20	3 1/2	3	1"	No. 14

Rear view of the I-tube receiver—the coil socket is the one on the right.

All coils wound on 1/2" diameter ribbed forms. Space between grid coil and tickler 1/4". Winding space is length of winding. Primary is wound between turns of grid coil. All ticklers wound with No. 30 D.S.C. wire.

Neutralizing Condenser



● THE accompanying picture shows a new version of the National NC-800 neutralizing condenser for use with transmitting tubes. The frame of the condenser is substantial and long bearings insure accurate adjustments of the electrodes. A micrometer lock

is provided and thus the condenser can be set and locked without the aid of a screwdriver or other tool. The threaded adjustment screw is accurately machined and the moving plate cannot wobble. (No. 693.)

This article prepared from data supplied by courtesy of the National Company.

Tiny Dynamic Mike



● ONE of the smallest true dynamic microphones ever built. The diameter of the instrument is only 1 1/2"; the net weight 8 1/2 ounces. This tiny mike has an excellent frequency response with an output level of -55 db. when used in connection with an efficient transformer. The mike is built in both high and low impedance types. Several different styles of mounting attachments are available for use with it, including a regular pedestal base, a handle for supporting the mike when gripped in one hand, an overhead cable support, etc. The handle supports are fitted with switches. It may be used for communi-

cations purposes, airplanes, marine installations, police broadcasting, amateur stations, public address, etc. (No. 694.)

ations purposes, airplanes, marine installations, police broadcasting, amateur stations, public address, etc. (No. 694.)

This article has been prepared from data supplied by courtesy of the American Microphone Lab'y, Inc.

New Filament Transformers

● TO more completely meet the requirements for all types of transmitter, receiver and rectifier tubes, the Jefferson company has added three more filament transformers to their line. They are all insulated with ample factor of safety to withstand dependably the high voltages encountered in this service. Of the three new transformers, the 464-461 has a secondary of 5V/CT at 12A and is insulated for 3,000 volts. The 464-451 is similar, except that it has a secondary of 5V/CT at 20 A. The 464-441 has a secondary of 10V/CT at 4 A and is insulated to stand 2500 volts.

This article has been prepared from data supplied by courtesy of the Jefferson Electric Co.

"CQ's"

Some "Hams" sure have their troubles in getting the R.F. into their antenna. But one day when I was pounding the key to see who I could raise, checking the xmitter all over and the "soup" showing strong in the R.F. meter CQ—CQ— I got a station and started a chat when all of a sudden the R.F. meter "went west" and trouble began. After a short check-up on the xmitter, without finding my trouble, I went outside to take a peep at the antenna, and imagine my surprise. Some yard man had tied a couple of mules to the antenna pole! The mules finding no grass around, decided there was more grass down in the next block and had proceeded to take antenna—wire, pole and all!

—H. FISHER, W5AMJ

Watts a "Ham"? Is he sugar-cured? More important than that is this: Watts a "Ham" without watts?—GEO. B. THOMPSON, M.D.

Model Ship Guided by Radio Waves

(Continued from page 670)

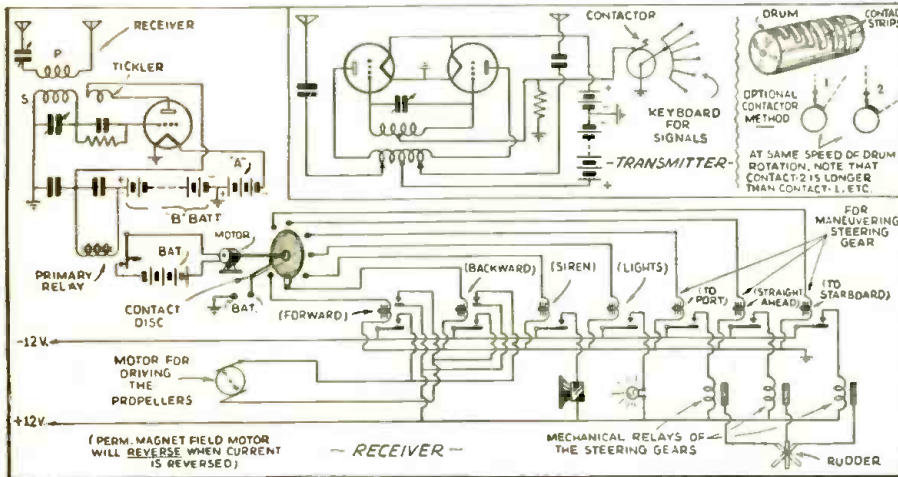

The receiving circuit used aboard the model cruiser "Terrible" is reproduced above. A simplified diagram of the transmitter used in France is also shown; one method of obtaining timing impulses of various lengths is illustrated in the upper right-hand picture.

upon the dead weight of the motor grows; at a certain moment the relation reverses itself; the "relation force" exerted upon the volume is then in constant progress, exerting power on the dead weight of the carrier itself increasingly. Just this reason makes the result appear very interesting. A battery furnishes the required energy. It is constructed specially so as not to shift the center of gravity of the ship. The battery weighs 88 lbs., rating is 12 volts, 40 amperes.

This battery is sufficient to put the ship through its maneuvers for three hours; the current used is about 12 amperes. In the

present state of experimentation, with the wave lengths and power of transmission in use, the remote control works up to a distance of about 2 miles.

The transmitter has an output of 9 watts, at a wavelength of 42 meters. In order to facilitate transportation, its power-supply consists of batteries, but any other power-supply adapted to these requirements could be used.

The signals are sent out by means of a keyboard; the board has twenty keys and a circuit-breaking bar (see Fig. above). It can give signals of a duration corresponding to that required by the various maneuvers. The mechanism of the remote control proper corresponds to the working of the Breguet telegraph (which is still in use in many European railway systems).

In the interior of the boat, a very simple receiver works upon a relay, which is arranged in series. This relay closes the circuit of the contact disc.

This contact disc, under the action of the current circulating in the circuit closed in this way, always turns in the same direction, until the circuit becomes the carrier of a current, i.e., during the whole duration of the signal.

But the rotation stops at the very moment when the signal stops, and as the current starts to vary the intermediate relay breaks the circuit.

Twenty contacts are placed on the circumference of the contact disc. Each contact corresponds with a signal of a duration equal to that necessary for the contact disc to go from zero to the position of the contact in question.

The contact thus established serves to feed a relay transforming the electric energy into either light, mechanical energy or sound.

Let us take some examples which the figure above will help us to understand better:

The pilot on shore wants the boat to leave its moorings. It is only necessary to press the key marked AV (Forward) in order to transmit a signal of a given length.

This signal is received on board the model ship and by means of the radio receiver causes a current to flow in the circuit, which works upon the primary relay connected in this circuit.

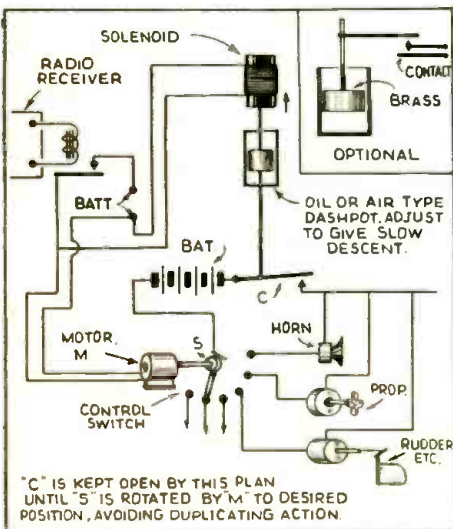

Optional receiving control method suggested by the editor, which incorporates a time-delay switch C. The solenoid and dashpot keep the switch C open, until the selector switch S has been rotated to the desired point. Otherwise, the successive apparatus must be momentarily switched into action as the selector is rotated, which is, of course, undesirable. By using a magnet fitted with ratchet and pawl to rotate the selector switch, this switch may be rotated by simply transmitting a sequence of "dot" signals.

How would YOU Like to SAVE up to 40% on Nationally Advertised RADIOS

Selling Nationally advertised Radios, such as Stromberg-Carlson—HCA—Philo—Zenith—G. E.—Grinow—Emerson—Fada—Gard—Kadette—Crosley—DeLoe and many other makes, is as easy as "rolling off a log."

With our new and enlarged 1938 Radio Catalog (Spring and Summer Edition) you have over 400 different models of Radio sets for home, farm and auto to offer, at prices ranging from \$7.95 to \$1,500.

In addition to all the Standard Radios made by the leading manufacturers, this new spring and summer edition Giant Catalog contains many electrical conveniences for the home and gift items. Special savings on Electric Refrigerators, Vacuum Cleaners, Electric Clocks, Toasters, Food Mixers, Electric Razors, Air Conditioners and hundreds of other items that we know you'll be interested in. Send AT ONCE for your copy FREE OF CHARGE before the supply is exhausted.

Get This New 1938 Catalog FREE

Also our plan on how you may make big weekly commissions in spare or full time. Experience is not necessary as our catalog describes fully each set and the instructions we furnish will help you make sales more readily. The discounts our salesmen make are as high as 40% off the list price and every set is shipped in a factory sealed carton, with a 3-year written guarantee.

Here is an offer open to you NOW. Pick the set you want and we will give you the salesman's big discount. This special inducement is offered so that you may have at least one set in your home or shop for display and demonstration purposes.

MODELL'S is the only Radio organization in the U. S. selling Standard make, Nationally known Radio Sets in every hamlet, town, farm. We have been in business for almost 50 years and have been selling radios for about 20 years, so you see you are doing business with a concern of responsibility and reputation.

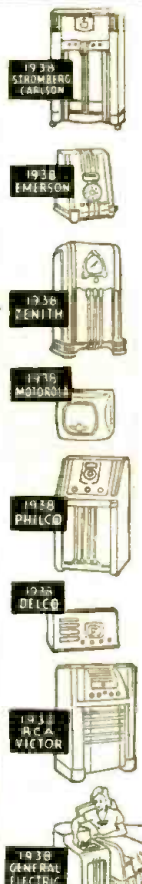

and over 400 other models

MAIL COUPON OR SEND POSTCARD TODAY TO ADDRESS NEAREST YOU

Modell's

Since 1889

NEW YORK, N. Y.
58 Cortlandt St.

CHICAGO, ILL.
56 W. Washington St.

ATLANTA, GA.
57 Forsyth St.



MODELL'S, Dept. L-6
58 Cortlandt St., New York City, N. Y.

- Send me your New Spring and Summer 1938 Catalog.
- How may I increase my income.
- I wish to purchase a Radio for myself.

NAME

ADDRESS

CITY STATE

PASTE COUPON ON PENNY POSTCARD

Please mention SHORT WAVE & TELEVISION when writing advertisers

The BIGGEST Sensation of the Year! 27 Instruments in One!

The Allmeter, a 1,000-ohms-per-volt d'Arsonval instrument, instead of being just a volt-ohm-ammeter, is such an instrument plus a.c. readings for voltages and currents, also accurately measuring very low resistance, from below one ohm, also high resistance, capacity, henries and decibels, comprising 27 instruments in one. For a.c.-d.c. use.
0-15-150-750 volts and milliamperes, a.c. and d.c.
-12 to +30 decibels .03-500 ohms 500-500,000 ohms 5-1,000 henries.
.01-50 m.f.d.
© on t i n u i t y Tester



GENEMETER

WITH VARIABLE AUDIO FREQUENCIES

1. Direct reading in frequencies, 100 kc-22 mc. in five bands, all fundamentals, by front-panel switching. Ultra band by harmonics to 105 mc. also direct-reading.
2. Direct reading in frequencies, 25-10,000 cycles, in three bands, all fundamentals, by front-panel switching.
3. R.F. and A.F. outputs independently obtainable alone, or with A.F. (any frequency) modulating R.F.
4. Output meter.
5. R.F. attenuation.
6. Condenser and other leakages to 100 megohms.
7. Main dial constructed on 7 1/2" diameter, precision pointer 4-to-1 vernier planetary drive.
8. All serviles on 90-130 volts a.c. or d.c.

PRICE
14.40

When You Buy
SUPERIOR
TEST EQUIPMENT
YOU GET
SUPERIOR
VALUE!



SUPERIOR INSTRUMENT COMPANY
136 LIBERTY STREET Dept. SW-4 NEW YORK, N. Y.

During the whole time the signal lasts, the contact disc turns. For instance, let us say that Contact No. 1 corresponds to AV (Forward); as soon as the contact disc has arrived at Contact No. 1 the signal stops because the signal must have only the duration which is absolutely necessary.

This contact closes a secondary circuit containing a relay which applies a tension of 12 volts to the motor driving the propellers, and the ship moves forward.

If we give a new signal, for instance the siren, for which Contact No. 3 is reserved, this signal will last longer than the preceding one, and the contact disc will turn correspondingly longer. At this moment there will be two closed circuits.

The opening of circuits is effected by a signal of a duration corresponding to the time which was necessary for the establishing of the contact, or the establishing of such a circuit, or a combination of circuits.

It should be noted that the transmission is not continuous; it is only in force when a signal is given.

At the present stage, the contact disc has twenty combinations, of which only ten are used.

The principal maneuvers are:

- Forward.
- Backward.
- Starboard.
- Port.
- Position O.
- Siren.

Firing of guns.
Explosion of a charge of powder placed in the ship.

The constructor has mounted on the masts, in addition to the position lamps, ten other lamps which by lighting show that the desired order has been received. As each lamp indicates the reception of a command, even before the ship makes the corresponding maneuver, the spectators can see that the mechanism is functioning.

The whole equipment is placed in the hull, in watertight compartments, which may be reached by lifting off the superstructures. These superstructures are movable, and cover the openings through which the operator can pass his hand or even remove a piece of the equipment.

Diagram shows how the various compartments are situated. There are several empty compartments (2) which have been placed there as stabilizers.

Then comes a large space (3) which is reserved for the experiments for which the ship was built.

The following compartment (4) contains the battery, and in (5) the receiver and its power source are placed. Through an opening placed between the two torpedo tubes right on top of this compartment, the receiver is regulated.

In (6) the motor for the propellers, its coupling, and other gears are placed.

Behind this in (7) are installed the contact disc and the relays. If it is necessary to get at them, it can be easily done by lifting the torpedo tube which is situated on top of them.

The last chamber (8) contains the steering gear and the three plunger magnets which control the rudder.

The large case in which the transmitter is mounted usually has enough space for any attachment for keeping the transmission secret.

An apparatus which assures *secret* communication is provided nearly always by the frequency modulation of the carrier wave, which places an interfering signal near the real control signal, or by modulation of the carrier wave itself.

30 WATT 5-10 METER CW or PHONE TRANSMITTER

Simplified circuit—easy to assemble (power supply is already wired)—high gain speech input—driving modulators—class A into pair of R.F. tubes using 8 ft. aerial—well filtered and regulated—(humless)—1,000 volt power supply can be wired in one hour with our large pictorial Blue Print.

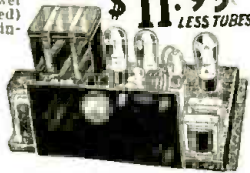

Kit of tubes \$2.99 extra
Transmitter complete wired with tubes.....**\$19.95** No C.O.D. shipments

13 WATT BEAM POWER AMPLIFIER KIT

A beautifully designed amplifier conservatively rated at 13 watts (in push pull) 2 stages, one 6J7G high gain stage and a pair of the Beam Power 6V6G tubes using a 82 type rectifier for AD-110-125 v., 60 cy. may be used for crystal, velocity or ribbon mike and magnetic or crystal phono pick-up—complete kit with all necessary parts (less tubes) with pictorial wiring diagram and drilled chassis size 10 1/2 x 7 1/2—shipping weight, 10 lbs.

AD-112-A. 10 watt amplifier kit complete less tubes. Wiring and testing. **\$4.49** extra.

AD-112-B. 13 watt amplifier kit complete less tubes. Wiring and testing. **\$4.95** extra. No C.O.D. shipments.

KIT OF TUBES, 1-82, 1-6J7G, 2-6V6G, \$2.75

KOLSTER 7 1/2-20 WATT

Public Address Amplifier Transmitter Power Supply

This 210 or 250 tube amplifier unit with 12 1/2" 25 Watt speaker, brand new in factory sealed cases, costing over \$100.00, ready to use as amplifier and tapped power supply. Conversion diagram for making 20 Watt High Gain amplifier furnished free. Shipping wgt 80 lbs. No C.O.D. shipments.

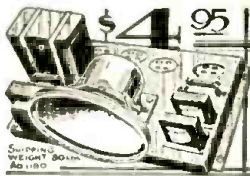

Send for our new money saving catalogue. Containing over 1000 red hot radio items at bargain prices.

UNITED RADIO CO.

Dept. S NEWARK, N. J.

Ask your **JOBBER**
for the NEW

STANCOR

"HAMANUAL"

New Tubes . . . New Circuits

16 NEW TRANSMITTERS
5 WATTS TO 1000 WATTS

STANDARD TRANSFORMER CORPORATION
850 BLACKHAWK STREET, CHICAGO

RADIO as you like it PRIVATELY with Cannon-Ball Headsets



Cannon-Ball Adaptor
permits using headsets on all radios. Get diagram and complete details.

without disturbing others. When loudness is annoying. Proven reliable radio friends over 20 years. Folder S-4 illustrates complete line. Write Headset Headquarters—

C. F. CANNON COMPANY
SPRINGWATER, N. Y.

You need our 1938 Catalog

It illustrates and describes our complete line of

RACKS • PANELS • CABINETS

Write for your Free Copy Today!

PAR-METAL PRODUCTS CORP.
3529 41st St., Long Island City, N. Y.

Outstanding Short Wave Books at your Dealer! See Page 712.

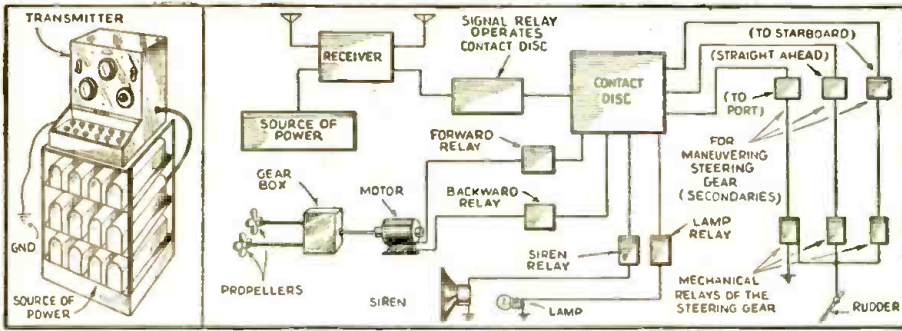

Appearance of the transmitter and the keyboard control is shown at the left, while the diagram at the right shows in simplified form the receiver control circuits on the model ship.

It is clear that the choice of wavelengths is at present unimportant. However for certain special cases, Mr. Casel studies apparatuses tuned for different frequencies, either for insuring a superior transmission under circumstances where the wavelength of 42 meters doesn't work well, or in order to effect simultaneous control of several units within the same district.

He also experiments with groups of two wavelengths for giving alternative commands on one or the other wavelength by means of a synchronizing key, which can be changed according to a code; or by means of identical cam wheels placed in transmitter and receiver.

On the high seas the interception of a coded signal by an enemy ship is not a cause for worry, as it is not easy to find the key, especially as the decoding requires a code expert with special knowledge not only of codes, but also of the special technique of communication employed. It is very rare to find some one who is expert in both these lines. But admitted that a ship piloted by remote control is exposed to such a hazard, an observer who finds the key, in order to jam the radio commands,

must have at his disposal a transmitter with the wavelengths in question, and apparatus which within record time can be adapted to the code.

By the time this is accomplished, the ship under remote control has completed its task and has perhaps even sent the marauder to the bottom of the sea.

At the present state of the technical development of radio communication it is easy to give the receiver a selectivity so precise, and a sensitivity so delicate that successful interference is nearly impossible.

Finally it must be mentioned that there exist already a number of sets for protection against jamming (interference) which are in general use, especially by coast stations for the automatic reception of S.O.S. calls.

After rejecting the argument that the transmission cannot be kept secret, one can easily appreciate the interest with which these experiments are followed. Mr. Casel has given them such a pleasant form that his boats seem to be only toys for amusing grown-up children.—*Courtesy L'industrie Française Radioélectrique.*

Build Your Own Television Receiver

(Continued from page 691)

It will be noticed in the photos that the two 954 tubes are inserted in their sockets "upside down". In other words, instead of the long end (plate) being on top, the short end (control-grid) is at the top. This permits the leads to the grids and plates to be short and places the plate leads below the chassis where they belong. In making this reversal it must be remembered that the screen-grid and suppressor-grid contacts on the sockets are now reversed from the manufacturer's instructions for socket connections, and must be wired in reverse.

The output of the sound receiver is on the right side, near the 6V6 tube. The output of the video side is on the rear, near the 6H6 tube while the power supply leads are located on the back also.

The various condensers, resistors and choke coils are located in such positions that the leads are as short as possible. A word at this point will avoid some trouble later. It is advisable to have a single grounding point for each stage, returning all bypass condensers grounded resistors, grid returns and other R.F. leads to this point for the stage. A terminal on one of the socket supports is a good point at which to locate the grounding for the stage as it furnishes a support for the condensers, etc., as well as providing the single point ground.

This individual chassis ground is especially important for the two first detectors (video and sound) and for the oscillator.

One filament lead on each tube is connected to the chassis and the other lead is connected in parallel with the other filaments. This is a little different than the usual twisted lead filament supply method, but it has been found that grounding the filament to the chassis in this way keeps the tube noise low—an important point.

It will be noticed that no power-supply equipment is included on the receiver chassis. This has been done deliberately—for several very good reasons. First, all magnetic circuits must be kept far away from the cathode-ray tube if clear, undistorted images are to be obtained. Second, hum and induction pickup in the receiver tends to be lower when power-supply parts are removed from the receiver.

The coil winding details are shown in Fig. 2. These coils are best wound at home as they can be changed and adjusted as desired to provide the desired characteristics, as explained later under adjustment data. The coupling to the aerial is provided by a single turn of insulated wire wound around the grid coil and connected to the two halves of a dipole aerial or one side grounded and the other connected to a half-wave resonant rod—or any other form of U.S.W. aerial that the builder prefers from experience. Two aerials are needed—one for the video receiver and the other for the sound receiver.

The oscillator coil is provided with a
(Continued on page 700)

Please mention SHORT WAVE & TELEVISION when writing advertisers



BY MY AMAZINGLY QUICK, EASY WAY

PREPARE Today for a Real future

Whether you are 16 or 40 years old Electricity offers you many opportunities for a well paying job or a business of your own. Here in the Coyne Shops you can get a training in 12 weeks that will qualify you for your start in this fascinating opportunity field. Coyne training is practical "Learn by doing" shop training. You don't need advanced education or previous electrical experience.



Students at COYNE operating a switchboard that controls power and light enough for a small town



No Correspondence
Students testing actual converter

Work on Actual Dynamos, Motors, etc.—Only 12 Weeks—in the Great COYNE Shops

Coyne training is not given by home study. You must come to the Coyne shops to get this training, on real actual electrical machinery and apparatus. You are trained on real Dynamos, Motors, Generators, etc., all in full operation.

I'll Finance Your Training



Get your training first. Then take 18 months to pay for it in easy monthly payments starting 5 months after you start school. Send coupon today for all details of this plan. *H. C. Lewis*

Earn While Learning Here is Proof of EMPLOYMENT HELP AFTER GRADUATION

If you are short of money and need part-time work to help pay living expenses while training, my Employment Department will help you get a part-time job. After graduation they will give you Free Lifetime Employment Service.

"Two weeks after leaving school I took wiring job," says E. D. Berndt, "profits paid for entire course" I You would be amazed at the number of such enthusiastic letters we receive from graduates praising COYNE results.

Included NOW — Diesel Engines Refrigeration, Air Conditioning

This extra Training without extra cost is included with your regular training if you enroll now.

FREE! Send today for the Big Free Coyne book. With it I'll send you all the facts of Coyne training and special features.



FILL OUT THE COUPON and SEND it before another day of your life slips away from you!

RUSH COUPON FOR FULL FACTS

H. C. LEWIS, Preside SCHOOL, Chicago, Ill.
COYNE ELECTRICAL SCHOOL, Chicago, Ill.
Dept. 48-87, 500 S. Paulina St.

Dear Mr. Lewis: Send me your Big Illustrated Catalog and details of your "Pay-After-Graduation" Offer.

Name..... Age.....
Street..... City..... State.....

20 SECONDS THAT MAY BE THE TURNING POINT IN YOUR LIFE

ULTRA MODEL 1A1 Precision Signal Generator

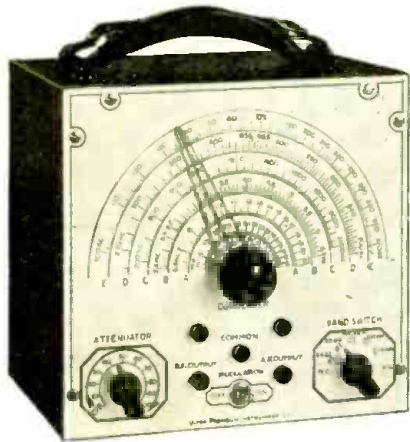

- Wide range 100 K.C. to 66 M.C. (3000 to 4.5 meters).
- Direct reading dial accurately calibrated for entire range.
- Accuracy of calibration 1/2 of 1% on I.F. and broadcast bands, 1% on short wave bands.
- High ratio vernier dial drive with hair splitting pointer.
- Separate outputs for both R.F. and audio.
- Attenuator for both R.F. and audio channels.
- Modulated or unmodulated R.F.
- Pure sine wave audio output.
- Due to pure wave form of both R.F. and audio outputs the unit may be used in conjunction with an oscillograph.
- Tests condensers for opens and shorts by pitch method.
- Outstanding appearance. Unit has beautifully etched metal panel.
- A.C. and D.C. operation. Any cycle.
- Supplied for 110 volt A.C. and D.C. operation. May be supplied for any operating voltage from 110 volts up, on request at no extra charge.

Model 1A1 Precision signal generator supplied complete with tubes, cabinet, and operating instructions as illustrated and described.

\$1250

IF YOUR DEALER CANNOT SUPPLY YOU, ORDER DIRECT.

ULTRA PRECISION INSTRUMENTS CO., Inc.
 123 Liberty St., Dept. S-4 New York City

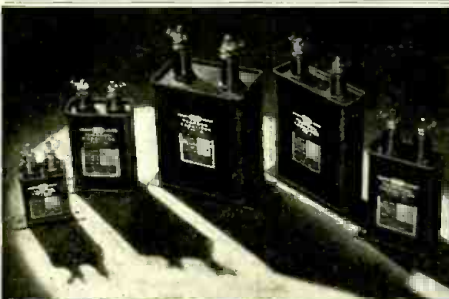

TRANSOIL

for transmitting

HIGHEST QUALITY OIL CAPACITORS

Ask for new complete Transmitting Catalog describing

TRANSOIL—SOLAREX—TRANSMICA

SOLAR MFG. CORP.  599 BROADWAY, NEW YORK CITY

Elgin V 15-550 Meter 5-Tube Receiver



Entirely new in design. Operates from 110 volts A.C. or D.C. Features: Five Tubes... Dynamic Speaker... 4 Band Switch Coil... Band Spread Tuning... Beam Power Output.

A receiver that any "ham" or experimenter will be proud to own. Pulls in signals from all parts of the world with ease.

Elgin AR5 Complete with 5 tubes, ready for operation **\$17.25**

TRY-MO RADIO CO., Inc.
 85-S Cortlandt St., N. Y. C., N. Y.

Build Your Own Television Receiver

(Continued from page 699)

tap on the second turn from the ground end. This is for the cathode connection of the "electron-coupled" oscillator circuit. A clip can be made to slip on this tap, to facilitate circuit changing. The coils can be either soldered to the socket contacts, or micalex or isolantite strips can be obtained to provide plug-in facilities for changing coils when desired. This latter method was used in the experimental model in arriving at the coil constants given in Fig. 2.

Testing and Adjustments

After the set has been completely wired it can be tested, using a temporary power supply providing 250 to 300 V. at about 100 ma. and 6.3 V. for the filaments. Any good power-supply unit or the power-supply of another receiver can be used.

A signal generator covering the signal frequencies of the second or third harmonics of these frequencies as well as the intermediate frequencies of 11.25 and 13.25 mc. used in the two sets is an essential part of the adjusting equipment. First, the I.F. should be adjusted to 13.25 mc. for the video I.F. amplifier and 11.25 for the sound I.F.

Top and bottom views of the "S.W.&T." Television Receiver.

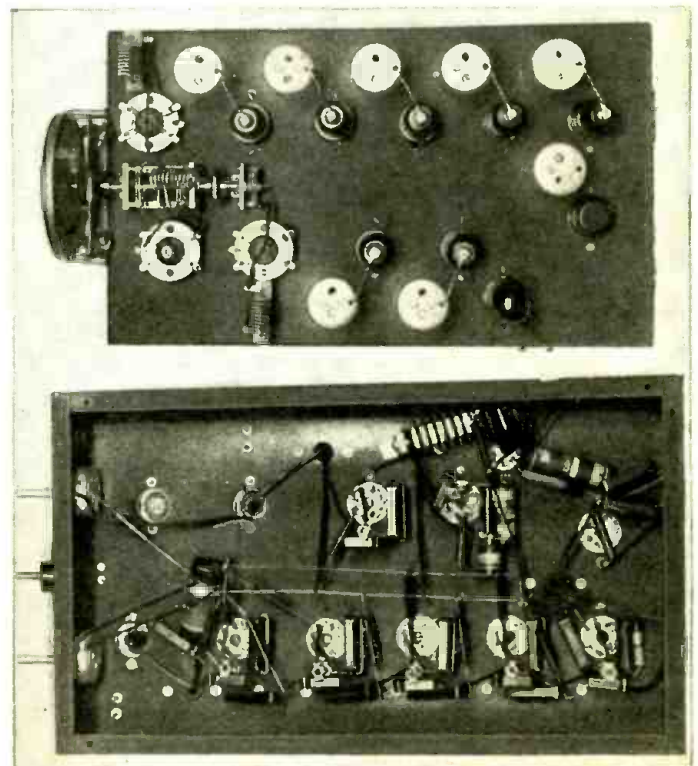

amplifier, by coupling the signal generator to the grid of the first detector of each receiver, after disconnecting the regular grid connection. The Aladdin I.F. transformers are only tuned on one side (single tuned) so this job is not difficult with a reliable signal generator and output indicator—especially since these I.F. transformers are unusually broad in tuning as mentioned earlier in this article.

Next, the signal generator should be coupled to the sound receiver and tuned to the frequency of the local sound transmissions accompanying the television broadcasts. This will have to be determined by contacting the station in question. Then the tuning condenser should be turned back and forth across the band until signals are heard. The volume control of the sound receiver should be at its maximum position. Adjust the spacing between turns on the coils (aerial and oscillator) until the signals are loudest and come in near the center of the tuning band on the dial. Finally, the signal generator should be coupled to the video receiver and tuned to the frequency of the local television transmitter. The first detector coil of the video receiver should then be adjusted until the strongest signal is recorded. The sensitivity adjustment and volume controls of the video receiver should be at maximum position. This may necessitate changing the settings of the I.F. transformers slightly. If so, all of the I.F.'s must be changed to keep the pass band sufficiently broad.

Then the set is ready for an aerial and actual test on the air. Slight readjustments of coils and I.F. settings may be made, depending on how reliable the oscillator is that is used for adjustment. Once the condenser is set at the point of greatest signal strength for either video or sound signals, the condenser should not be touched again all through the adjustments—all corrections being done with the coils and I.F. settings. As a last resort, the plates of the two detector tuning condensers may be bent to permit alignment, taking care to avoid shifting the rotor position.

Next month we will describe the complete power-supply for the set, the cathode-ray tube and the sweep circuits. In the

meantime, the sound accompaniments to the television broadcasts can be enjoyed, using the temporary power-supply set-up.

List of Parts

- ALADDIN (Coils)**
 7—U-100 I.F. transformers (2 of which are resonated at 11.25 mc. and 5 at 13.25 mc.).
 1—U-200 I.F. transformer (resonated at 13.25 mc.).
- PAR-METAL (Chassis)**
 1—Black crackled finished steel chassis—10"x17"x3".
 1—No. 153 dial.
- CARDWELL Condensers**
 1—ER-15-AD 15 mmf. variable condenser.
 1—ER-15-AS 15 mmf. variable condenser.
 1—Type "A" flexible coupling.
- HAMMARLUND**
 3—Insulantite Acorn tube sockets.
 1—CII-500 R.F. choke.
- SOCKETS***
 9—RNS8 octal tube sockets (steatite).
- CORNELL-DUBILIER (Condensers)**
 22—.01 mf. mica condensers, type 4-6S1.
 1—.250 mmf. mica condenser, type 4-6T25.
 1—100 mmf. mica condenser, type 4-6T1.
 1—.001 mf. mica condenser, type 4-6D1.
 1—.05 mf. mica condenser, type 9-6S5.
 2—.00001 mf. mica condensers, type 4-6Q1.
- SPRAGUE**
 2—10 mf. 25 V. electrolytic condensers, type HC10
 2—.1mf. 400 V. paper condensers, type TC-5.
 1—.5mf. 400 V. paper condenser, type TC-1.
- I.R.C.**
 1—200 ohm 2 W. resistor, type BW2.
 1—.25 meg. 1 W. resistor, type BT1.
 2—.5 meg. 1 W. resistors, type BT1.
 16—10,000 ohm 1 W. resistors, type BT1.
 3—.1 meg. 1 W. resistors, type BT1.
 1—300 ohm 1 W. resistor, type BW1.
 2—200 ohm 1 W. resistor, type BW1.
 1—50,000 ohm 1 W. resistor, type BT1.
 3—350 ohm 1 W. resistor, type BW1.
 1—500 ohm 1 W. resistor, type BT1.
 1—800 ohm 1 W. resistor, type BT1.
- RCA**
 2—954 Acorn tubes.
 1—955 Acorn tube.
- RAYTHEON**
 6—6K7 metal tubes.
 1—6J7 metal tube.

MARINERS—Here Is Your Radio!



SARGENT MODEL 50. AC-DC

SPECIFICATIONS—

Tunes 13 to 550, 750 to 2000 meters
 AC DC circuit equivalent to 11 tubes. Actually uses 8 tubes, 3 being combination. Full A.C. operation with power trans. and rectifier. Metal case insulated from power circuits, both lines completely filtered. Circuit has 1 stake tuned r.f. panel trimmer, 2 stakes high gain I.F. push pull 43s output into 8" Jensen PM speaker. Trouble-proof parts throughout, nothing deteriorates except the tubes. Tone control, phone Jack, 6 tuning bands. Latest glass tubes used throughout. Illuminated, communication type dial. Rugged, rust-proof cabinet and chassis.

Net Price, Complete \$127.00
IMMEDIATE DELIVERY

- 1 6V6 metal tube.
- 1 6H6 metal tube.

MISCELL.*

- 2—Potentiometers, 50,000 ohms.
 - 1—Potentiometer, 10,000 ohms.
 - 2—Bindingpost strips, 2 terminal type.
 - 1—Bindingpost strip, 3 terminal type.
 - 7—metal tube grid caps.
 - 20 ft. No. 14 tinned copper wire.
 - 1 roll No. 20 push-back hookup wire.
- Miscellaneous rubber grommets, insulated wiring terminals, screws, nuts, washers, etc.
- *Most radio mail order houses can supply this item, if properly identified as to title of article, issue (month) of *SHORT WAVE & TELEVISION* and year.

A "SEA-GOING" RADIO SET, built by designers who know the requirements at sea! Model 50 is a set for the short wave listener, peaked to maximum efficiency at all short wave broadcast bands. Vibration-proof. Filters to eliminate line noise, 4 short wave tuning bands, broadcast and "X" band, 6 bands in all. Complete tuning range 13 to 550, 750 to 2000 meters.

Heavy rust-proof steel cabinet. Built to communication standards. Lifetime paper filter condensers—no electrolytics to replace. Bypass condensers moisture-proof, shielded, and bolted to chassis. Resistors, insulated moisture-proof. Power transformer, 80 rectifier used for A.C. Push-pull output, Jensen speaker. Pleasing tone, world-wide range. Easy running, commercial type, vernier tuning dial. Visual tuning. Sensitivity, volume, tone controls, automatic volume. A receiver, designed against giving trouble, that should last for years. Equally good at sea or ashore. A powerful receiver that should keep you in daily touch with Europe, the Americas or the Orient from any sea location in the world. Especially designed for the marine trade.

Model 11 Goes to Pitcairn Island

The new station being erected at Pitcairn Island, in the middle of the south Pacific, will use a Model 11. Model 11 has the ruggedness and dependability for installations of this type. Regenerative tuned R.F. communication receiver, built to modern selectivity standards but preserving traditional sensitivity and quietness. Band switching, band spread, everything the experienced operator demands. Many operators prefer them to larger receivers. Write for details.

A.C. Prices, Complete
 Model 11-AA, 9.5-550 mtrs, net \$52.00
 Model 11-MA, 9.5-750 mtrs, net \$57.00
 Model 11-UA, 9.5-20,000 mtrs, net \$77.00
 Available also for D.C. and battery operation.

E. M. SARGENT CO., 212 9th St., Oakland, Calif.

What Sun-Spots Do to Short Waves

(Continued from page 663)

Eighteen mc. is normally used when it is daylight over the Atlantic—as twilight creeps over the ocean the frequency shifts to 12 mc. and then to 9 mc. at night and then finally to 7 and 5 mc. When a magnetic storm arises and the 18 mc. channel goes out, it is frequently found that 12 mc. will still carry the traffic, and when 12 mc. is no longer effective, 9 mc. can still be used in many cases.

Short-wave commercial circuits operated out of San Francisco, California, or Miami, Florida, experienced little effect from the magnetic storms. Over a period of several days the time that the usual short-wave channels were made ineffective due to magnetic storm effects varied from 15% to 65%. More spots have recently been noted on the surface of the sun than have been observed in many years.

The engineers of the A. T. & T. Co. have developed new systems and apparatus to offset the bad magnetic storm years and the results obtained during the recent severe magnetic storm proved that *single side-band* transmission helped to keep short-wave transmission effective over a longer period. Likewise the newest idea in aerials—the *multiple-unit steerable-antenna*, which will be put into service in another year, will help a great deal. The effect of this antenna is to improve or focus the receiving activity in a certain direction and for a

certain frequency, and also to enable waves of different frequencies to be received with maximum efficiency. In other words, waves arriving at a receiving station at different angles can be compensated for and the maximum strength of signal realized. The *Musa* steerable-antenna, as it is called by the engineers who developed it, selects the most effective signals coming in and combines them in phase, so that they thus add up to give a signal of greater combined power.

The sun-spots move across the surface of the sun by virtue of its rotation, and successive photos have been taken, showing the movement of a spot or a group of spots across the surface of the sun as it rotates. A strong sun-spot disturbance, which resembles a veritable whirlpool of incandescent gases in the sun's surface, causes streamers to be shot forth from the sun in the region surrounding these sun-spots, some of the streamers extending more than a million miles in length, as recorded by the camera. These streamers can be likened to the jets of water caused by a revolving lawn spray, and it will be seen that as the sun rotates, and providing the streamers are pointed at the right angle to intercept the earth, the earth will be swept by one of these streamers and the speed of the sun's rotation is such that the streamer would sweep across the earth's disc in about thirty seconds.

ASTATIC
Grip-to-Talk Stand

New Type G, Grip-To-Talk Desk Stand. Made with relay operating switch for remote control of amplifiers and transmitters through suitable relay systems. Interchangeable socket connector to accommodate microphones illustrated. See your jobber for prices or write for literature.

ASTATIC MICROPHONE LABORATORY, INC.
 Dept. J-6 YOUNGSTOWN, OHIO
 Licensed under Brush Development Co. Patents

5 METER **5 METER**

CRYSTAL CONTROL

The new HF2 10-meter crystal unit now makes possible high stability 5-meter transmitters of greatly simplified construction. Price, at all Bliley Dealers, \$5.75.

Write for Engineering Bulletin E-5.
BLILEY ELECTRIC COMPANY
 200 UNION STATION BLDG. ERIE, PA.

Please mention SHORT WAVE & TELEVISION when writing advertisers

TECO TEST EQUIPMENT *Sold with a* **GUARANTEE**

10 DAYS FREE TRIAL!

You can buy TECO Instruments direct from the factory on a 10-Day Free Trial. If the instrument you buy does not meet your specific needs you may return it to us for full credit on any other TECO equipment which we make! Buy TECO and SAVE the difference!

NEW TECO TUBE TESTER



Model T-10
A genuine achievement! And rapid work. Has d'Arsonval moving coil meter. Tests all types of receiving tubes. For use on 110v., 60 cycle AC.

Features
• Tests all 4, 5, 6, 7, 7L and octal base tubes. • Tests by the well established emission method for tube quality, directly on the Good? Bad? scale of the meter. • Affords separate neon test for leakage and shorts between elements. • All serv-
ices performed with 5 controls at maximum—many tests not requiring all controls. • Rugged, foot-proof construction; black, wrinkle-finish shield cabinet with attractive etched metal panel. • Works on 90-120 volts, 60 cycle AC. • Supplied with instructions and reference table covering all tubes which you will commonly encounter in servicing. Size 11 1/2 x 9 1/2 x 5 1/2". With removable hinge cover. Shpg. wt. 11 lbs. Net price.....

\$1175

TECO POCK-O-METER

A.C. and D.C.



A new pocket size volt-ohm-milliammeter that includes AC measurements and is the lowest priced, full-service instrument ever offered! Has 3" d'Arsonval movement 0-1 milliammeter. Comes with etched panel.

SPECIFICATIONS

5 linear DC ranges: 0/1.5/15/25/75/500 volts.
5 linear AC ranges: 0/1/10/100/500/2,500 volts.
2 DC current ranges: 0/1/10/100/500 M.A.
2 resistance ranges: 0/500/500,000 ohms (low ohms read to 1 ohm.)
Pock-O-Meter, test leads and instructions. Size 6 1/2 x 3 1/2 x 2 1/2"; shpg. wt. 5 lbs. Our net price.....

\$845

TEST EQUIPMENT CO. of America
139 CEDAR STREET • Dept. SW-438 • NEW YORK, N. Y.

- Mc. Call 6.010 CJCX SYDNEY, NOVA SCOTIA, 49.92 m. Relays CJCX 7 am.-1 pm., 4-8 pm.
- 6.007 ZRH ROBERTS HEIGHTS, S. AFRICA, 49.94 m., Addr. (See ZRK, 9.606 mc.) Daily exc. Sun. 10 am.-4 pm., Sat. till 4.45 pm.; Sun. 8 am.-12 n., 12.15-3.15 pm.
- 6.005 HP5K COLON, PAN., 49.96 m., Addr. Box 33. 7-9 am., 11.30 am.-1 pm., 6-11 pm.
- 6.005 CFCX MONTREAL, CAN., 49.96 m., Can. Marconi Co. Relays CFCX 7.45 am.-1 am.; Sun. 9 am.-11.15 pm.
- 6.005 VE9DN DRUMMONDVILLE, QUE., CAN., 49.96 m., Addr. Canadian Marconi Co. Sat. 11.30 pm.-2 am.
- 6.004 RV59 MOSCOW, U.S.S.R., 49.77 m. Irregular. 3-6 pm.
- 6.002 CXA2 MONTEVIDEO, URUGUAY, 49.98 m. Addr. Rio Negro 1631. Relays LS2, Radio Prieto, Buenos Aires. 10.30 am.-10.30 pm.
- 6.000 ZEA SALISBURY, RHODESIA, S. AFRICA, 50 m. (See 6.147 mc., ZEB.) Also Sun. 3.30-5 am.
- 6.000 XEBT MEXICO CITY, MEX., 50 m., Addr. P. O. Box 79.44. 8 am.-1 am.

End of Broadcast Band

- 5.977 CS2WD LISBON, PORTUGAL, 50.15 m., Addr. Rua Capelo 5. 3.30-6 pm.
- 5.975 OAX4P HUANCAYO, PERU, 50.16 m. La Voz del Centro del Peru. 8 pm. on.
- 5.968 HVJ VATICAN CITY, 50.27 m. 2-2.15 pm. daily; Sun. 5-5.30 am.
- 5.940 TG2X GUATEMALA CITY, GUAT., 50.47 m. 4-6, 9-11 pm.; Sun. 2-5 am.
- 5.940 PJCI CURACAO, DUTCH W. INDIES, 50.47 m., 6.36-8.36 pm.
- 5.935 YVIRL MARACAIBO, VEN., 50.52 m., Addr. Radio Popular, Jose A. Higuera M. P. O. Box 247. Daily 11.43 am.-1.43 pm., 5.13-10.13 pm.; Sun. 9.13 am.-3.13 pm.
- 5.913 YV4RP VALENCIA, VEN., 50.71 m. Irreg.
- 5.900 ZNB MAFEKING, BRI. BECHUANALAND S. AFRICA, 50.84 m. Addr. The Govt. Engineer, P. O. Box 106. 6-7 am. 1-2.30 pm.
- 5.900 TILS SAN JOSE, COSTA RICA, 50.85 m. 6-10 pm.
- 5.898 YV3RA BARQUISIMETO, VEN., 50.86 m., Addr. La Voz de Lara, 12 n.-1 pm., 6-10 pm.
- 5.892 HH2S PORT-AU-PRINCE, HAITI, 50.89 m., Addr. P. O. Box A103. 7-9.45 pm.
- 5.890 JIC TAIHOKU FORMOSA, 50.9 m. Works Tokio 6-9 am.
- 5.885 H19B SANTIAGO, D. R., 50.95 m. Irregular 6-11 pm.
- 5.875 HRN TEGUCIGALPA, HONDURAS, 51.06 m. 1.15-2.16, 8.30-10 pm.; Sun 3.30-5.30, 8.30-9.30 pm.
- 5.855 H11J SAN PEDRO DE MACORIS, D. R., 51.25 m., Addr. Box 204. 12 n.-2 pm., 6.30-9 pm.
- 5.853 WOB LAWRENCEVILLE, N. J., 51.26 m., Addr. A.T.&T. Co. Works Bermuda nights.
- 5.845 YVIRB MARACAIBO, VEN., 51.3 m., Addr. Apartado 214. 8.45-9.45 am., 11.15 am.-12.15 pm., 4.45-9.45 pm.; Sun. 11.45 am.-12.45 pm.

DATAPRINTS

Only 33 1/3c each
At New Low Price—3 for \$1
BUILD YOUR OWN—SAVE MONEY!



RADIO CONTROL FOR MODEL BOATS, PLANES, ETC.
Circuit data50c

20 **ELECTRIC LODGE & PARTY TRICKS. Fun Galure!**
"How to Do 'Em" Data 50c



S-W DIATHERMY (Artificial Fever)
Dataprint giving Constructional data for Small, Medium and Large size ADD. (All 3).....50c

Induction PIPE & ORE LOCATOR
Construction Data.....50c



RECORD PROGRAMS on Steel Wire!
Telegraphone Data, for Voice or Code.....50c

TESLA COIL DATA:
Data print—drawings and data for building 36-inch spark Tesla. 50c
Exciter—1 K.W. 20,000 Vt. Transf. 50c
3" Sp'k. Tesla Coil. Works on Ford Coil 50c
3" Sp'k. Oudin Coil. Works on 110 A.C. 50c
20 "Tricks" with Teslas & Oudins 50c
8" Sp'k. Tesla Coil. 15,000 Volt Exciter—1/4 K.W. 50c
Violetta—1" Sp'k. Oudin. Vibrator type 50c
How to Operate Oudins from V. T. Osc. 50c



More DATAPRINTS You Need!
100 Mechanical Movements Electric Pipe Thawer
Water Turbines "Re-winding" Armatures
Water Wheels Induction Balance
Motor Circuits (20) Telautograph
Telephone Hookups (20) Eintunon String Galva-
Polarized Relay. Ultra- nometer
sensitizing Magnets and Solenoids—
Ring 4 bells on 2 wires Get our list
20 Simple Bell Hook-ups Wheatstone Bridge
Electric Chime Ringer fits Induction Coils—1 to 12
any clock Inch Sp'k data
Welding Trf. 2 K.W. 110 V. Prim. 18 V. Sec.50c
Any 5 prints \$1.50 or 10 for \$2.00

The DATAPRINT Co.
Lock Box 322 RAMSEY, N. J.

HOTEL DRAKE

SOUTH CAROLINA AVENUE
AT PACIFIC
ATLANTIC CITY,
NEW JERSEY

European Plan Hotel — Moderate Rates • 150 Outside Rooms Beautifully Furnished • Convenient to Piers, Theaters and Churches • Also Bus and Railroad Depot • Garage Accommodations.

For Literature and Rates, Address
W. GRAHAM FERRY, Mgr.

World S-W Stations

(Continued from page 684)

- Mc. Call 6.020 DJC BERLIN, GERMANY, 49.83 m., Addr. (See 6.079 mc.) 10.40 am.-4.30 pm.
- 6.018 ZHI SINGAPORE, MALAYA, 49.84 m., Addr. Radio Service Co., 2 Orchard Rd. Mon., Wed. and Thurs. 5.40-8 am., Sat. 10.40 pm.-1.10 am.
- 6.017 H13U SANTIAGO DE LOS CABALLEROS D. R., 49.85 m. 7.30-9 am., 12 n.-2 pm., 5-7 pm., 8-9.30 pm.; Sun. 12.30-2, 5-6 pm.
- 6.015 PRA8 PERNAMBUCO, BRAZIL, 49.84 m., Radio Club of Pernambuco, 6-9 pm.
- 6.010 COCO HAVANA, CUBA, 49.92 m., Addr. P. O. Box 98. Daily 7.55 am.-12 m., Sun. til 11 pm.
- 6.010 9MI S. S. KANIMBLA, 49.92 m. (Travels between Australia and New Zealand). Sun. around 7 am.

Duplex Phone on German Guard Boats

(Continued from page 668)

unit shown is constantly connected with a speaker; lifting the French phone from the hook disconnects the speaker and starts the transmitter.

The new antenna consists of a metal disk of square form (the center of which is partly cut out). This disk has been fastened atop a collapsible telescopic mast which in its maximum extended position reaches about 15 feet above the boat's deck. The S-W range has been increased 100 per cent.

This antenna, which has a surprisingly effective height and a sufficiently great capacity to insure excellent pickup and radiation, has extended the customary range of installations of this type one hundred per cent.

Please mention SHORT WAVE & TELEVISION when writing advertisers

The "Polaroid Kinescope" for Large Television Images

Erie W. Leaver

● THE continual search for some means of producing large and brilliant television pictures has occupied the time, money, and brains of most of the leading figures in television for many years. Many devices have been invented, and at the present time, quite satisfactory pictures are obtained. However, as the entertainment value of a television picture depends so much upon its size, brilliancy, and contrast, then any device which shows promise of a great stride toward improving these factors can profitably engage the attention of everyone directly concerned or interested in television. We believe that the device described in this article is such an invention.

Within the past year, the supersonic light valve and the projection type cathode ray tube have shown remarkable advances. This new device which we tentatively call "The Polaroid Kinescope," for descriptive purposes, promises to eclipse these developments. This invention may produce pictures approaching regular cinema quality.

The cathode ray tube in itself is quite an efficient instrument, and it has numerous

that light from portions of the picture falls upon a photo cell successively, then, one can readily see that as the definition becomes higher and the corresponding number of elements increases, the signal output from the photo cell will decrease in proportion. The signal output with high definition television using this method, may be only a few electrons. If some means were available to store the energy over a picture frame period, then obviously, the output would be tremendously increased. This arrangement has been embodied in the television camera tube known as the iconoscope. It is one of the objects and purposes of the "polaroid kinescope" to perform the same storing action at the receiver as the iconoscope performs at the transmitting end.

The apparent brilliancy of a television picture element depends not only upon the amount of light emanating from each element, but also upon the time during which the light is given off. This is due to the integrating action of the human eye. It has been found by actual experiment that the apparent brilliancy increases up to a

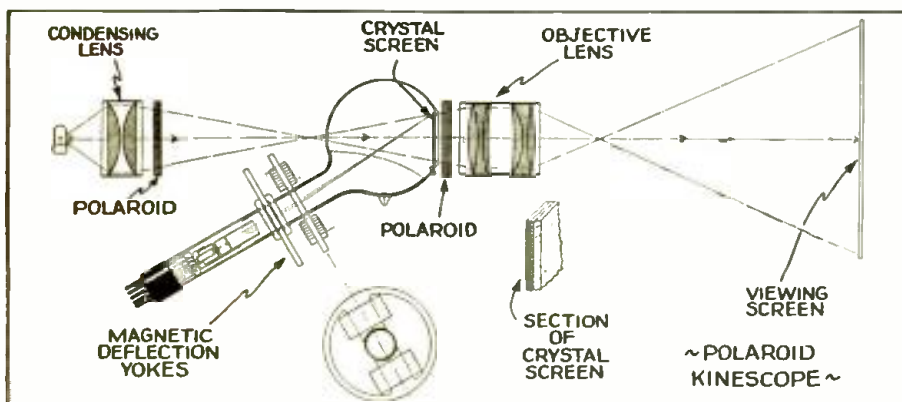

A new system for producing large television images is shown above.

advantages over most mechanical systems. The usual limiting factor to enlarging the picture from a cathode ray tube to any desired size greater than the end of the tube itself is usually the amount of light available. Thus, if we can greatly increase the amount of light, we have solved many of our problems, for we can project the picture on a larger screen. The incandescent light source is known for its high brilliancy, its ruggedness, and its cheapness. Therefore, if we can efficiently combine and utilize an incandescent light source with a cathode ray modulation and scanning system, we would pretty well have the omega of television reproducers.

All present day television systems use scanning. That is, they break the picture up into elements and send signals corresponding to these elements, one after the other to the receiver, where they are re-assembled. In most receiving systems, each element only appears for a very small fraction of a second, and as they appear successively, the persistence of vision of the eye is relied upon to give the impression that all the elements are there all the time. As each element has such a small duration, it must be many times more brilliant than if it were present all the time to give the same impression. A somewhat similar situation exists at a transmitting end. If the picture is scanned in the usual manner so

time limit of approximately 1/20 of a second. The actual value of the time depends upon the real brilliancy of the picture element.

This new invention takes advantage of the increasing apparent brilliancy with time as well as several other factors which will be described later. In effect the new reproducing device consists of a screen, the opacity of which is varied by a modulated electron beam. Further, after the beam has caused any part of the screen to have a certain translucency the screen continues to have a proportional translucency until the next frame scan when the beam strikes the element again. There have been several attempts to use this principle directly by using a material the transparency of which can be directly changed by a change in an electric field across it. Many experiments in the laboratories of the American Television Institute have tended to show that the direct variation of transparency does not offer a practical solution to the problem, and we have therefore resorted to a device which depends upon the rotation of the plane of polarization of light. The broad idea of the new device was conceived by Mr. U. A. Sanabria quite some time ago. Briefly, it consists of a cathode ray tube, the screen of which possesses the ability to rotate the plane of polarization of light passing through it proportional



You can get out from under that QRM with The **MEISSNER** Signal Shifter

It's a variable-frequency electron-coupled exciter unit that makes it easy to slide your signal into "holes" in the band for 100% QSO's—by remote control if you wish. Single dial control, too, with oscillator and buffer stages ganged together.

It has unbelievable frequency stability (superior to many crystals) with uniform output over entire tuning range. Plenty of sock to drive your medium power final or RF Amplifier.

Operates on 10, 20, 40, 80 and 160 meter bands with just 5 sets of coils, three to a set. Has built-in power supply for 110 volts 60 cycles, and uses one each 6F6, 6L6 and 80 tubes.

It's COMPLETE (including one set of coils). Coils are \$2.50 NET each set. And it's YOURS for

\$39⁹⁵
NET

ANOTHER *Meissner* IDEA!

See it at your Jobber's store. New 1938 catalog ready soon. Reserve your copy now.

MEISSNER MANUFACTURING CO.
120 BELLMONT AVENUE, MT. CARMEL, ILL.

SOMETHING NEW!

New C.D. type BR dry electrolytics are the last word in compact filter capacitors. Write for catalog No. 154A, TODAY!

CORNELL-DUBILIER ELECTRIC CORP.
1027 Hamilton Blvd., So. Plainfield, N. J.

RADIO IN IT'S ENTIRETY!

"B-A" serves the trade with every need in radio—complete 160-page catalog of nationally known radio receivers, public address, parts, supplies and equipment. Orders shipped same day received.

COMPLETE CATALOG AVAILABLE

BURSTEIN-APPLEBEE CO. 1022-24 McGEE ST. KANSAS CITY, MO.

Please mention SHORT WAVE & TELEVISION when writing advertisers

RADIO INSTRUCTION

TAKE THE *Easy* WAY TO LEARN RADIO

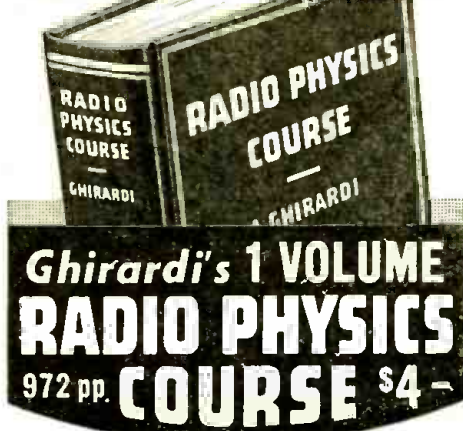

YOU, too, can pick up RADIO quickly—if you will let Ghirardi help you. In almost no time at all you'll completely master the subject, because Ghirardi's 972-page home-study RADIO PHYSICS COURSE is such easy reading, so simple, so absorbing, and so exciting that you won't lay it down from the time you start with simple electrical theory to where you wind up with television under your belt! Ghirardi makes everything about RADIO, ELECTRICITY, SOUND—and even TELEVISION—as simple as A. B. C! That's why more radio schools and students use it than any other radio book printed. They say it's the best there is—at any price!

What You Will Learn From This Book!

Sound, Speech and Music . . . Electric Current . . . Ohm's Law . . . Batteries . . . Magnetism . . . Electromagnetism . . . Transformers . . . Inductance . . . Condensers . . . Alternating Current Circuits . . . Filters . . . Electrical Measuring Instruments . . . Radio Waves and Radiations . . . Broadcast Stations . . . Receiving Equipment . . . Vacuum Tubes . . . Radio and Audio Frequency Amplification . . . Superheterodynes . . . Loud Speakers . . . Battery Operated Receivers . . . Power Supply Units . . . Electric Receivers . . . Automobile and Aircraft Receivers . . . Phonograph Pickups . . . P. A. Systems . . . Short-wave Receivers . . . Piezo-electric Cells . . . Television . . . Antennas and Grounds . . . Texting and Servicing Receivers . . . Sound Motion Pictures . . . Appendixes . . . 856 Review Questions for Self-Study . . . AND LOTS MORE!
The 506 illustrations alone are worth much more than the amazingly low price of only \$4 for the entire book! When are you going to start? Don't put it off—get going —learn RADIO NOW. Books sent postpaid anywhere!

Snip this Coupon out!
-MAIL IT NOW!

A. RADIO & TECHNICAL PUBL. CO.
 Dept. SW-48 45 Astor Place, New York
 City, N.Y. Enclosed find my \$4.50 for my RADIO
 PHYSICS COURSE at once, postpaid.
 B. Send me a free circular describing this
 book.
 Name _____ State _____
 Street & City _____
**MONEY-BACK
 GUARANTEE!**

LEARN CODE RIGHT

It's easy and practical to learn or improve your radio or Morse Code, any speed. Senior model with 10 tapes and book of instructions—\$20.25. (limited at low cost.) Junior model with 5 tapes and book of instructions—\$12.00. (Not netted). Complete oscillator equipment, less battery, \$8.50. Send for details today to—

INSTRUCTOGRAPH CO.
 Dept. SW-4
 912 Lakeside Place
 Chicago.

Canadian Represent.
 Active: Radio College of
 Canada, 863 Bay
 St., Toronto

BUY ON CASH OR TERMS: HALLICRAFTER and R. M. E.
 SHORT-WAVE RECEIVERS, SPEED-X and VIBROPLEXES

RADIO ENGINEERING,
 broadcasting, aviation and police radio, servicing, marine radio telegraphy and telephony, Morse telegraphy and railway accounting taught thoroughly. Engineering course of nine months' duration equivalent to three years of college radio work. All expenses low. Catalog free. School established 1874.
Dodge's Institute, Turner St., Valparaiso, Ind.

to the intensity of the scanning cathode ray beam. Most of us no doubt will be familiar with what plane polarized light is and how it differs from ordinary light, but for those who are not familiar, we can explain as follows:—

Light is known to be a transverse wave motion, and if a beam of light is made up of rays which are all vibrating in the same plane, the beam is said to be "plane polarized." Many substances are known to have the property of separating ordinary light (which consists of light vibrating in practically every plane) into two light beams vibrating in planes at right angles to one another. One of these rays is called the ordinary, while the other is called the extraordinary ray. In polarizers, as they are called, one of these rays is usually absorbed in some manner so that only light vibrating in one plane emerges from the other side. If two of these polarizers are placed in succession with one another, they will pass a great deal of light if they tend to polarize the light in the same direction; while if one is rotated with respect to the other so that they tend to polarize light planes at right angles to one another, then no light at all will pass through the system. Intermediate positions of the analyzer will allow various amounts of light to pass through. Various types of polarizers have been invented. One of the older types is known as the Nicol prism, while of much more recent origin is polaroid, the invention of E. H. Land.

Many substances possess the property of rotating the plane of polarization so that if one of these substances were placed between two sheets of polaroid which were originally set to cut off the light completely, some light would now pass through it. The greater the rotatability of the substance, the greater the amount of light which would pass through the combination. It was discovered that substances which normally had no effect upon polarized light would rotate the plane of polarization when under the influence of a strong magnetic field. It was found that the rotation was proportional to the magnetic field and thus, we could use this arrangement as a primitive type of light valve. It was then discovered by Kerr that the glass dielectric in a condenser possessed optical rotatability, and that the rotation was proportional to the square of the applied potential. The electrostatic ability of many substances has been determined and nitrobenzene has been found to be the most suitable for use in light valves such as the Kerr cell.

Some time later it was found that a quartz crystal could be used as a dielectric in a type of Kerr cell, and much more recently it was discovered by Pockels, that the plane of polarization of light was rotated if the light was sent through the condenser along the lines of force. This effect, named after the discoverer, is directly proportional to the applied voltage, and in some salts like Rochelle salts, the effect is quite large. One of the fundamental possibilities is to apply this effect by having a transparent plate inside the cathode ray tube in which these crystals are embedded. A beam of light from a Mazda projection lamp passes through a sheet of polaroid through the crystal sheet to another sheet of polaroid where it is completely cut off. When the electron beam scans the crystal sheet, however, a field is applied across each little crystal which causes it to twist the plane of polarization of the light passing through it, and thus, when the light strikes the second sheet of polaroid, some

RADIO ENGINEERING

TRI-STATE COLLEGE
DEGREE IN 2 YEARS.

Complete Radio Engineering Course in 96 weeks. Bachelor of Science Degree. Radio (telephony, talking pictures and the vast electronic field) offers unusual opportunities for trained radio engineers. Courses also in Civil, Electrical, Mechanical, Chemical, Aeronautical Engineering; Business Administration and Accounting. Low tuition, low living costs. World famous for technical two-year courses. Those who lack high school may make up work. Students from all parts of the world. Enter September, January, March, June. Write for catalog, 2548 College Ave., Angola, Ind.

MATH TABLES

\$1.25

Only \$1.25 for a complete set of practical, widely used mathematical tables containing four and five place logarithms, squares, cubes, roots of numbers, differentials, integrals, algebraic and trigonometric formulae, trigonometric functions and their logarithms, interest tables, areas and circumferences of circles, and many others. Convenient pocket size, 5 1/4 by 7 3/4 inches, 320 pages bound in flexible Fabrikoid. For students, teachers, engineers, draftsmen and others. Moneyback guarantee.

CHEMICAL RUBBER PUBLISHING CO.
 1534 W. 112th St., Cleveland, Ohio

EXPERT RADIO SERVICE COURSE

Speed tough service jobs. Make more profit. The C-B Visual Service Course gives you "know how." Designed for service men by famous Midland Television School and C-B engineers. For details, see your C-B jobber or write us. Make your time pay more. Don't delay. Write TODAY.

FREE WITH ANY INSTRUMENT

The CLOUGH-BREngle CO.
 2813-E W. 19th St. Chicago, Ill.

will pass through it onto a screen. The greater the intensity of the electron beam, the greater will be the rotation of the plane of polarization and the more light will pass through the polaroid onto the screen. To impress a field on the crystals, it will be obvious that a screen or a transparent layer of metal must be on the opposite side of the crystals from that of the electron beam.

When many crystals are subjected to an electrostatic field, they tend to twist, and therefore, their optical rotatability is changed. In other words, the piezo electric rather than the Pockel's effect can be utilized. In such a case, the crystals would be needle-shaped in form, and have their ends only embedded in the glass. Thus, there are two slightly different forms of the "polaroid kinescope."

In order that the crystals may be charged and then slowly discharged over a frame period, they may be coated with a thin transparent layer of some photo-sensitive substance such as potassium. The intense light falling on the screen causes it to become positively charged, the electrons from it having been emitted from the potassium coating and been taken up by the anode of the tube. The polaroid is adjusted so that when the screen is positively charged no light passes through it. When the electron beam strikes a portion of the screen, the positive charge on that portion becomes neutralized to an extent determined by the intensity of the beam. Thus, the rotation of the plane of polarization of the light becomes less. Therefore, the amount of light passing through the combination will

Please mention SHORT WAVE & TELEVISION when writing advertisers

RADIO INSTRUCTION

YOUR CODE LICENSE IN 1/2 THE TIME with CANDLER TRAINING



If you are sincere in your desire to be a skilled amateur or radio operator don't let a penny postcard stand between you and achieving your ambition. That post card will bring you the most amazing opportunity in all code history.

World's Champion McElroy says: You can't learn code by practice alone with any kind of practice set. Automatic Sound Consciousness is POSITIVELY ESSENTIAL to speedy code.

FREE 1938 Book of Facts VALUABLE CODE BOOK for Beginners and Radio Operators. . . . WRITE TODAY!

CANDLER SYSTEM CO.

Dept. SW4 Asheville, N. C. U. S. A.

RADIO COURSES

RADIO OPERATING: Prepare for Gov't License Exam. RADIO SERVICING: Including Short Wave AMATEUR CODE ELECTRONICS TELEVISION:

New York YMCA Schools 6 W. 64th Street, New York City

JOBS in RADIO-TELEVISION

If you are seriously ambitious to make this fascinating, well-paying field your life work—if you have fair ability and are willing to train for success—write us.

RADIO ENGINEERING

RCA Institutes offer an intensive course of high standard embracing all phases of Radio and Television. Practical training with modern equipment at New York and Chicago schools.

RCA INSTITUTES, Inc.

A Radio Corporation of America Service 75 Varick St., New York, 1154 Merchandise Mart, Chicago

DO YOU LIKE

RADIO & TELEVISION

If you want to know employment opportunities and requirements in radio and related industries, get National's book of facts.

NATIONAL SCHOOLS Los Angeles

BE A RADIO SERVICE EXPERT

TRAIN WITH R.T.A. NOW

Modern receivers require men with modern training for service work. LEARN AT HOME. Our home instruction method and service equipment offer starts you earning money almost at once.

vary accordingly, and light will continue to pass until the crystal has again been positively charged. Other methods can be devised of dissipating the charge, but the one described above has proven the most satisfactory to date.

We might state here that we make no claim to the name "polaroid kinescope" for our new device. We realize that both the name "polaroid" and "kinescope" are trade names, and have merely used the combination for descriptive purposes.

Laboratory experiments are continuing to determine the practicability of this invention as well as to iron out the various technical difficulties which are bound to occur in any new development.

Courtesy American Television Institute, Inc.

News Bulletins Via Wired Television

(Continued from page 674)

it is fed through a small transmitting cabinet; as the ribbon moves along, a beam of light is caused to scan the ribbon and the letters by means of a revolving lens disc.

At Dempsey's restaurant where the receiving cabinet was set up, the letters move along on a ground glass screen measuring 3 ft. long and about 6" high. The news bulletins are received by a television process, including a mechanical scanning system and a light modulating cell.

The general plan of the television news service is to install a number of the receiving cabinets in prominent public places such as hotels, restaurants, etc. These news bulletin receivers are to be connected to a central office where trained operators will prepare and transmit the latest spot news to the outlying stations.

"CQ"

The other day I was over to a friend Ham's shack, chewing the fat over some changes in his set. when his wife came in and said that she would like to go out that evening.

"You think more of that old radio set than you do of me!" To which remark my friend replied—"Well, I get less interference from it." (Hi, hi!)—Richard Dawson.

MAKE MORE MONEY in RADIO

CASH IN ON MY SENSATIONAL HOME TRAINING PLAN

Actually Sets You Up For a PROFITABLE BUSINESS



Be your own Boss! Get into the fast moving Radio industry. If you are an ambitious fellow, I can train you for a good paying full time or part time job.

No Experience Needed . . . Earn While You Learn Sprayberry Training not only covers thoroughly all phases and branches of Radio.

BIG PROFESSIONAL OUTFIT GIVEN! Consists of All-Wave, All-Purpose Analyzer, Rider Manual, 17,076 pieces, Tool Kit, Electric Eye Outfit, Experimental Apparatus.

A. H. Lanoie, Northbridge, Mass., writes: "Since enrolling I have cleared a net profit of more than \$150. in spare time alone."

SPECIAL SERVICEMAN'S COURSE Advanced Training for those already in Radio—teaches the easiest way to do the hardest jobs.



Mail Coupon Now

SPRAYBERRY ACADEMY OF RADIO F. L. Sprayberry, Pres. 145-D University Place, N.W., Washington, D. C.

Please send me FREE copy of "More Money in Radio."

Name Age Address City State Mail in envelope or paste coupon on postcard.

FASTEST WAY TO LEARN CODE

Easy, Fascinating, LEARN by EAR To Be a GOOD OP.



The New All Electric Mobile Teleplex (Code Teaching Machine) is exactly what thousands are looking for.

with Master Teleplex, because it records your sending in visible dots and dashes. You SEE and HEAR exactly how you are making your signals.

TELEPLEX CO. 72-76 Cortlandt St. New York, N. Y.

Announcing THE FOURTH EDITION of EXPERIMENTAL RADIO

(198 p. 6x9 cloth, 136 experiments, 167 figures). By Professor R. R. Ramsey, Ind. Univ. A revision of the original book for experimenters and students.

FUNDAMENTALS of RADIO Second, 1935 Edition. By the same author. A modern text book with a minimum of mathematics giving fundamental theory of radio.

Ramsey Publishing Co., Bloomington, Indiana

Please mention SHORT WAVE & TELEVISION when writing advertisers

AMERICA'S MOST POPULAR RADIO BOOKS

We herewith present a selected collection of recent important radio books. We have selected these volumes because they represent the foremost radio books of their kind in print today. We publish no catalog. Order direct from this page. Prompt shipments will be made to you. Remit by money order or certified check. Register all letters containing cash.

RADIO ENGINEERING HAND BOOK , 850 pages, latest.....	\$4.90
PRACTICAL TELEVISION , 223 pages, 127 illus.....	\$3.69
ELEMENTS OF RADIO COMMUNICATION , 286 pages, 241 illus.....	\$2.98
RADIO PHYSICS COURSE , 992 pages, 510 illus.....	\$4.00
THE RADIO AMATEUR'S HANDBOOK , 448 pages, 126 illus.....	\$1.97
MODERN RADIO ESSENTIALS , over 200 pages, and over 100 illus.....	\$1.95
FOUNDATIONS OF RADIO , 246 pages, 145 illus.....	\$2.47
PHOTOCELLS AND THEIR APPLICATION , 332 pages, 180 illus.....	\$2.88
ELECTRONICS , 134 pages, 45 illus.....	\$1.95
SHORT WAVE RADIO HANDBOOK , 128 pages, 150 illus.....	\$1.00
PRINCIPLES OF RADIO , 478 pages, 306 illus.....	\$3.46
EXPERIMENTAL RADIO , 256 pages, 168 illus. Prepaid.....	\$2.69
MODERN RADIO SERVICING , 1000 pages, over 700 illus.....	\$4.00
FIELD SERVICE DATA AND ANSWER BOOK , 436 pages.....	\$2.50
Both Books	\$6.00
DRAKE'S CYCLOPEDIA OF RADIO AND ELECTRONICS , 1050 pages, 1178 illus.....	\$4.88

FUNDAMENTALS OF RADIO , 426 pages, illustrated. Prepaid.....	\$3.46
ELECTRICITY AT HIGH PRESSURES AND FREQUENCIES , 248 pages, 141 illus. Prepaid.....	\$1.89
RADIO CONSTRUCTION AND REPAIRING , 444 pages, illustrated.....	\$2.50
THEORY OF VACUUM TUBE CIRCUITS , 226 pages, 226 illus.....	\$3.00
PRINCIPLES OF RADIO COMMUNICATION , 988 pages, Profusely illus.....	\$7.35
RADIO ENGINEERING , 813 pages, 475 illus.....	\$5.50
EXPERIMENTAL RADIO ENGINEERING , 346 pages, 250 illus.....	\$3.46
RADIO OPERATING QUESTIONS AND ANSWERS , 427 pages, 106 illus.....	\$2.50
OFFICIAL RADIO SERVICE HANDBOOK , over 1,000 pages, 1,000 illus. Prepaid.....	\$3.92
OFFICIAL SHORT-WAVE RADIO MANUAL , 240 pages, many illustrations. Vol. 1 (1934) Prepaid.....	\$2.00
Vol. 2 (1935) Prepaid	\$2.50
OFFICIAL RADIO SERVICE MANUAL , Volume 4, 2,000 illus., over 400 pages Prepaid.....	\$3.43
OFFICIAL RADIO SERVICE MANUAL , Volume 5, over 3,000 illus., over 1,000 pages, Prepaid.....	\$6.86
OFFICIAL RADIO SERVICE MANUAL , Volume 6, over 1,200 pages, over 2,500 illus. Prepaid.....	\$6.86

15 HANDY—POCKET-SIZE RADIO BOOKS

Here are 15 up-to-date books on radio and air conditioning. Modern in every sense. ALL BOOKS UNIFORM—they contain 64 pages; 50 to 120 illustrations. All books written by well-known authors. Order by Number.

2. MODERN VACUUM TUBES
3. THE SUPERHETERODYNE BOOK
5. HOW TO BECOME A SERVICE MAN
6. BRINGING ELECTRIC SETS UP TO DATE
8. RADIO QUESTIONS AND ANSWERS
9. AUTOMOBILE RADIO AND SERVICING
10. HOME RECORDING AND ALL ABOUT IT
12. PUBLIC ADDRESS INSTALLATION AND SERVICE
13. ABC OF AIR CONDITIONING
14. POCKET RADIO GUIDE
15. ABC OF REFRIGERATION
16. PRACTICAL RADIO CIRCUITS
17. SERVICING WITH SET ANALYZERS
18. POINT-TO-POINT RESISTANCE ANALYSIS
19. PRACTICAL RADIO KINKS AND SHORT CUTS

PRICE PREPAID EACH BOOK..... **50c**

HOW TO ORDER

No C.O.D. orders. Our prices are net, as shown. Some of the books sent prepaid (in U.S. only). Those that are not thus listed are shipped collect if sufficient postage is not included. Add 7% of price for postage.

4-Inch Waves Turn Science Topsy-Turvy

(Continued from page 669)

To show how the waves could be transmitted over appreciable distances, Dr. Southworth had a flexible metal pipe some 25 ft. long leading to a receiver on the opposite side of the platform. When the other end was plugged into the transmitter, a strong tone was given off by the receiver.

To make the point that the waves, while they originate with high frequency electric currents, are decidedly different from radio waves, Dr. Southworth showed that radio waves move with the velocity of light through free space. His "guided" waves, however, are restrained by a surface where the dielectric constant of a material differs from that of the surrounding air. Such a discontinuity would be found at the surface of glass, rubber or other insulating material, or it would be created by enclosing an insulator in a conducting tube. The insulator in this case *might even be air*.

These demonstrations by Dr. Southworth, may, in the editor's opinion, point the way toward the radio transmission of tomorrow. In other words, it would seem that instead of having metal pipes or tubes to guide these waves but a few inches in length, we may in the future see such waves guided by rods or tubes made of a non-metallic substance.

In the first place any loss in transmission is caused by the absorption of the energy from the waves by a metal or other tube (or rod) along which the waves travel. If an insulating material such as rubber of the proper chemical make-up, could be devised having a very small absorption factor, so far as this ultra-high frequency wave transmission is concerned, it probably would serve the purpose even better than a metal rod or tube. At the recent demonstrations the actual transmission of these ultra-high frequency waves along a soft rubber rod a few feet in length took place, much to the surprise of the audience who witnessed the experiments.

The accompanying drawings show, in simplified form, how the high frequency waves are guided along the inside of the pipe, similar to sound waves in the air column enclosed within an ordinary speaking tube. In the case of Dr. Southworth's micro-waves, the metal pipe simply acts as a guide to prevent the waves from spreading out and being dissipated in all directions.

The oscillators were placed behind a blackboard and the lecturer then explored the field in front of these transmitter tubes by moving a sensitive detecting instrument across the face of the blackboard. Each time the tiny pick-up antenna was in the proper position and parallel to one of the tiny waves constituting the field, a 1,000 cycle note was heard at maximum strength on the auditorium loudspeaker. The diagram shows how the energy picked up from the H.F. field was rectified by a crystal detector (silicon) and the rectified signal sent through a suitable amplifier.

In some of the other demonstrations a large indicating meter was connected to the amplifier and the changes indicated on the meter. Metal pipes of different diameters were placed in front of one of the fields, as shown in the accompanying picture, and only when a certain size pipe was placed in front of the field was there a response on the loudspeaker. The definite relation between the diameter of the wave guide pipe and the frequency or wavelength was thus demonstrated.

Another experiment was performed with

RADIO PUBLICATIONS, 97 HUDSON ST., NEW YORK, N. Y.

SHORT WAVE COIL DATA BOOK

COMPLETE COIL DATA AND CIRCUITS FOR ALL TYPES OF RECEIVERS AND TRANSMITTERS

Price 25 Cents

RADIO PUBLICATIONS
97 Hudson Street
NEW YORK

FOR RECEIVERS AND TRANSMITTERS

The 1 and ONLY

SHORT WAVE COIL DATA BOOK

Every experimenter knows that the difference between a good and a poor radio set is usually found in the construction of short-wave coils. Coil winding information is vitally important and in the new coil book all "dope" appears. There are illustrations which give instructions on how to wind coils, dimensions, sizes of wire, curves and how to plot them. Every experimenter needs this book—it also contains complete data on all types of receiving coils, together with many suitable circuits using these coils. Also complete data on various types of transmitting coils with many transmitting circuits such as exciters and amplifiers using the various coils described.

Contents Briefly Outlined

S-W Tuning Inductance Charts • Coil Data for T. R. F. Receivers • One Tube Oscillodyne • Two Tube Bandspreeder • The Mono-Coil • 2-Tube Oil Reliable • 2-Tube Globe Trotter • 2 Winding Coils—10-500 Meters • Dierke 3-Tube "Signal Gripper" Electrified • 3-Tube Bandspreeder for the Ham • General Coverage Coils on Ribbed Forms • Coil Data for Superhet or S-W Converter • Ultra S-W Coils • Switch Coils for S-W Superhets • Experimental Coils • S-W Antenna Tuner • Most Popular S-W Tuning Circuits • Self-Supporting Transmitting Circuits Employing Coils Described • All Band Antenna Tuner for Transmitting • Plug-in Coils for Exciters • Frequency-Wavelength Conversion Chart.

PRICE 25c PREPAID

For a copy of this handy book, send 25c in U.S. Coin or stamps to

RADIO PUBLICATIONS

97 HUDSON STREET NEW YORK, N. Y.

Vest Pocket Adding Machine

Sturdy Steel Construction. Lifetime Pocket Companion. Adds, subtracts, Aids in Multiplication. Capacity, 999-999.99. A real machine—guaranteed 5 years. Send name and address. We ship immediately. On delivery, pay postman \$2.50 (plus few cents postage). (Foreign countries send cash.) Your money back after 10 days' trial if not satisfied. Thousands of satisfied users.

Free Trial **\$2.50** Total Cost

Mascot Slide Rule

It fits the pocket and your pocket in multiplication, division, proportion. Gives the square, the square root, logarithm and reciprocals of all numbers. Trig scale. Flies scales and tangents of numbers. Fine black graduations on white celluloid. Price in fabricoid case \$1.00, in leather case \$1.25. Money back if not satisfied. Special offer to agents on both items.

R. Tavella Sales Co., 25 West Broadway, New York, N. Y.

KEEP your home ORDERLY

Don't leave magazines scattered all over the house. Gold Shield Holder will keep them CLEAN.

12 3/4" x 9 1/2" 3 1/4" x 9 1/16"

Made of heavy cardboard, covered with Genuine DuPont fabricoid—holds 24 magazines.

Holder, 50c each, 10 for \$2.50 prepaid. Nickel silver Autogram initial, illustrated above, 10c each. Two or three initials look swell on the bottom right hand corner of the holder.

GOLD SHIELD PRODUCTS

Dept. S-4 98 Morningside Ave., New York City

Please mention SHORT WAVE & TELEVISION when writing advertisers

a copper pipe which had a partition passing through the center, this partition being twisted through 90°; when a detector unit was placed in front of this tube and parallel to the edge of the partition a response was noted; at right angles, there was no response, indicating that the H.F. wave field had been rotated while passing through the twisted pipe.

Another startling demonstration—the waves were guided through a 25 ft. length of flexible pipe as shown in the picture. An oscillator was connected at one end of the pipe and a detector unit at the other end connected with an amplifier and an indicating meter. The flexible pipe could be twisted to different positions and the response noted just the same.

In still other demonstrations, the effect of grids or gratings was shown. These had to be made in different patterns for the different types of wave fields demonstrated. For one simple type field, a filter or grid having straight slots in it, passed the wave successfully; when this grid was turned 90° the waves were cut off or stopped.

The fact that transmission of these waves took place along a soft rubber rod is due to the fact that as long as a substance having a different dielectric constant than air is provided, the waves will be guided along this substance. Some sort of tube can be used, too, one made from an insulating material or metal. If the tube is interrupt-

ed, transmission is stopped, proving that the waves are carried through the pipe and not through space.

Experiments in deflecting or reflecting the waves were made by means of a tin-foil-covered paddle as shown. If the paddle was placed between the transmitter and the detector, the signals stopped. When the paddle was carefully placed at a certain angle as shown, the waves were deflected onto the detector unit, demonstrating to the audience that the waves acted the same as light and other waves and could be deflected as well as reflected.

Another picture shows how two half-pipes made of copper were demonstrated to the audience. When a suitable detector was placed on the outer end of the two half pipes placed with their flat sides together, transmission was carried on successfully. As proof that the transmission was through the pipe, and not through space, one of the half-pipes was removed and when the space along the flat side of this half pipe was explored with a suitable detecting instrument, no response was noted. However, when the detector was placed at the open end of the half-pipe as shown in the picture, a signal response was at once obtained.

It was pointed out by Dr. Southworth that in some of the experiments in the laboratory these ultra short waves, which were really electro-magnetic in character, had been sent through tubes nearly a mile long. He stated that when properly extended and developed, such a system should prove excellent for television.

The small vacuum tubes used to produce the high frequency oscillations for these demonstrations furnished about .9 watt of power.

Automobile Theft Alarm

(Continued from page 681)

a door, or when stepping on the running board, the delicately poised metal ball falls off the top of the cone and closes the circuit between the large supporting cone and the metal shell of the socket.

Not only is this device very simple but it operates with the slightest vibration or jarring of the object on which it is mounted. It can also be used for protecting trailers, tents, boats or what have you?

The smaller the top of the cone on which the ball is to rest, the more sensitive the device will be. Naturally, the owner of the car equipped with this device should look around just before setting the ball-switch so that so far as he knows no one is watching him set the ball in place. Probably one of the best locations for the device is just inside the car door so that it can be set while reaching inside the car. It could be mounted just below the cowl or instrument board.—F. J. FAULKNER.

BOOK REVIEW

THE LOW VOLTAGE CATHODE RAY TUBE, G. Parr. Stiff cloth covers; 6"x8 3/4", 178 pages, Chapman Hall Ltd., London, England. (Allen B. DuMont Labs., Montclair, N. J.)

This is a very excellent book which every student of television should study carefully. The first part of the book deals with low and medium voltage cathode ray tubes and goes into the construction of the tubes, with a discussion of the function of the individual parts such as the anode, screen, etc. The physics of the electro-static and electro-magnetic beam deflection systems are covered at length. Focusing of the cathode beam is explained in detail. A chapter is devoted to Lissajous' figures. Next we come to the subject of linear time bases, followed by a chapter on other types of time bases, with plenty of diagrams and photos of these important parts of television receivers (known in this country as sweep circuits).

A valuable section is devoted to the application of the cathode ray tube to radio engineering and industry. Chapter 8 deals with television reproduction with the cathode ray tube; scanning circuits are shown with the values of the parts.

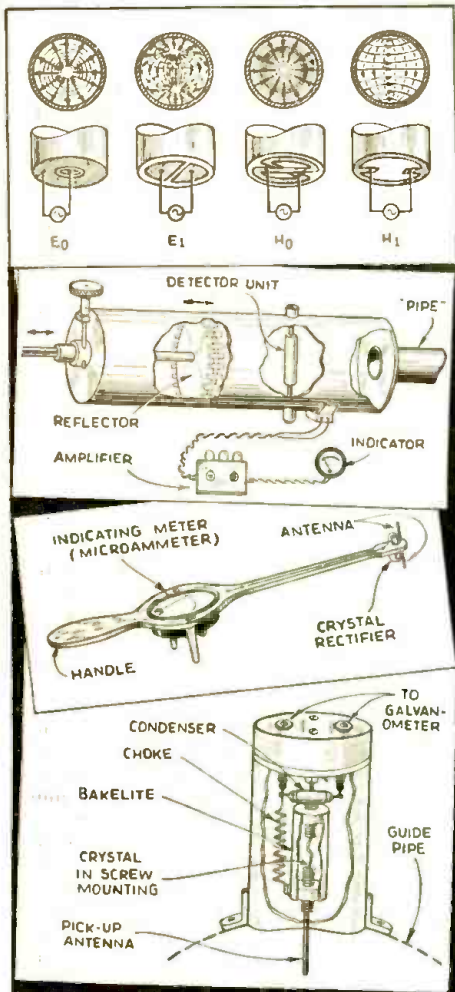

Top figures show four types of micro-waves produced by Dr. Southworth and various methods of connecting the oscillator to the end of the tube. The other drawings show method of detecting wave with adjustable tuner or reflector; an exploring detector, and at bottom—crystal detector and antenna unit which may be mounted wherever desired along the wave-guide pipe.

WANTED... YOUR TOUGHEST RESISTOR JOBS!

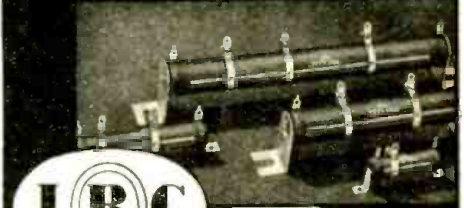

TRANSMITTING WIRE WOUNDS

They'll stand the overloads. No breakdowns, "opens" or coating cracks. No damage by moisture.

For more than five years, IRC Cement Coated Power Wire Wounds have been proving their superiority. Today you'll find them specified for the most difficult industrial, aircraft, naval and communications applications—jobs where there must be no resistor failures. Write for IRC Catalog No.42.

INTERNATIONAL RESISTANCE COMPANY

401 N. Broad St., Philadelphia, Pa.



TIME and MONEY

SAVE BOTH WITH THIS GREAT CATALOG

HERE'S the book that shows you how to save! 180 pages crammed full of the greatest "Buys" in radio today—parts, tubes, test instruments, ham rigs, and public address equipment, plus the famous Lafayette "line of 70" radio models for '38. In all, over 50,000 items completely described at prices you cannot beat. Write for FREE parts lists for any circuit described in this magazine. Send for your FREE copy of this catalog NOW!



FREE

WHOLESALE RADIO SERVICE CO. INC.

NEW YORK, N.Y. • CHICAGO, ILL. • ATLANTA, GA.
100 BIRTH AVENUE • 401 W. JACKSON BLVD. • 245 PEACHTREE STREET
BOSTON, MASS. • BRONX, N.Y. • NEWARK, N.J. • JAMAICA, L.I.

WHOLESALE RADIO SERVICE CO., INC.
401 W. JACKSON BLVD., CHICAGO, ILL. • 100 SIXTH AVENUE, NEW YORK, N.Y.
(Mail to nearest warehouse)

Rush FREE general Catalog No. 69-4DB Reserve NEW SPRING Catalog No. 71-4DB Send FREE parts lists for.....

Name.....
Address.....
City..... State.....

PASTE COUPON ON PENNY POST CARD

Please mention SHORT WAVE & TELEVISION when writing advertisers



BRINGS YOU ANY ONE OF THESE 4 FAMOUS RADIO BOOKS

RADIO FANS! Help yourselves to a radio education for the price of the per book. These books give you a good foundation towards the study of radio. You'll be amazed at the wealth of information contained in them. They are especially written for beginners but are useful review and reference books for all

Each book contains 32 pages, profusely illustrated with clear, self-explanatory diagrams. They contain over 15,000 words of clear legible type. They are an education in themselves and lay the groundwork for a complete study of radio and electricity.

HOW TO BUILD FOUR DOERLE SHORT WAVE SETS

Due to a special arrangement with the publishers of SHORT WAVE CRAFT, we present in this book complete details for building the Doerle sets, also an excellent power pack if you plan to electrify any of the sets. Contains EVERYTHING that has ever been printed on these famous receivers. These are the famous sets that appeared in SHORT WAVE CRAFT: "A 2-Tube Receiver that Reaches the 12,500 Mile Mark," by Walter C. Doerle, "A 3-Tube 'Signal Gripper,'" by Walter C. Doerle, "The Doerle

HOW TO MAKE THE MOST POPULAR ALL-WAVE 1- AND 2-TUBE RECEIVERS

This book contains a number of excellent 1- and 2-tube sets, some of which have appeared in past issues of RADIO-CRAFT. These sets are not toys, but have been carefully engineered. They are not experiments. To mention only a few of the sets the following will give you an idea. The Megadyne 1-Tube Pentode Loudspeaker Set, by Hugo Gernsback—Electrifying The Megadyne—How to Make a 1-Tube Loudspeaker set, by W. P. Chesney—How to Make a Simple 1-Tube All-Wave Electric Set, by F. W. Harpiss—How to Build A Four-to-Two All-Wave Electric Set, by J. T. Borsley, and others. Each set is fully described in simple language so that anyone can build with limited means and with practically no experience a worth-while all-wave radio set. Has 30 illustrations. 10c postpaid

ALTERNATING CURRENT FOR BEGINNERS

This book gives the beginner a foothold in electricity and radio. Electric circuits are explained. This includes Ohm's Law, alternating current, sine waves, volts, amperes, watts, condensers, transformers, motors and generators, A.C. instruments, house-wiring systems, electrical appliances and electric lamps. Here are some of the practical experiments which you can perform. Simple tests for differentiating between A.C. and D.C.; how to light a lamp by induction; making a simple electric horn; demagnetizing a watch testing motor armatures; charging storage batteries from A.C. outlet; testing condensors with A.C. making A.C. electromagnets; frying eggs on a cake of ice; making simple A.C. motors and many others. Has 42 illustrations. 10c postpaid

ALL ABOUT AERIALS

In simple, understandable language this book explains the theory underlying the various types of aerials; the inverted "L," the Doublet, the Doublet Doublet, etc. It explains how noise-free reception can be obtained, how low-impedance transmission lines work; why transposed lead-ins are used. It gives in detail the construction of aerials suitable for long-wave broadcast receivers, for

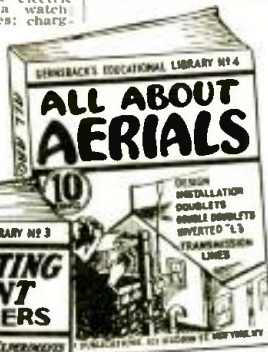

"2-Tube" Adapted to A.C. Operation, "The Doerle 3-Tube 'Signal Gripper' Electrified," and "The Doerle Goes 'Band Spread.'" Has 30 illustrations. 10c postpaid

short-wave receivers, and for all-wave receivers. The book is written in simple style. Various types of aerials for the amateur transmitting station are explained, so you can understand them. Has 68 illustrations. 10c postpaid

RADIO PUBLICATIONS SWT-4-38
 101 Hudson Street, New York, N. Y.
 Please send immediately POSTPAID the books checked:

No. 1—How to Build 4 Doerle Short Wave Sets.10c
 No. 2—How to Make the Most Popular All-Wave 1- and 2-Tube Receivers.10c
 No. 3—Alternating Current for Beginners.10c
 No. 4—All About Aerials.10c

I am enclosing; the price of each book is 10c

Send me FREE circular listing 48 new 10c publications

Name
 Address
 City State
 (U. S. coin or U. S. Stamps acceptable.) Books are sent postpaid.

Remember that each book has 32 pages and contains over 15,000 words. Each book has from 30 to 66 fine illustrations. **POSITIVELY THE GREATEST 10c VALUE IN RADIO BOOKS EVER OFFERED TO THE PUBLIC.**

If you do not think that these books are worth the money asked for them, return them within 24 hours and your money will be instantly refunded.

Send for our FREE circular listing 48 new 10c Publications

RADIO PUBLICATIONS
101 Hudson St., New York, N. Y.



HEY FELLOWS! 6 BACK NUMBERS OF SHORT WAVE AND TELEVISION SENT ANYWHERE IN U.S. FOR 70¢

For a limited time only, and as long as they last, we will send you six back numbers of SHORT WAVE & TELEVISION assorted, your choice, for 70 cents.

The usual price for six copies would be \$1.50, and most publishers charge a higher price for back numbers over one year old.

We can supply only the following back numbers: Dec. 1930; Feb., April, June, Oct., 1931; Oct., Dec., 1933; Jan., Feb., Mar., April, May, June, Aug., Sept., 1934; 1935—All issues except January and February; 1936—All issues; 1937—All issues; 1938—All issues to date.

If you do not specify copies, we will send assorted numbers to fill your order. Note, we cannot exchange the copies for ones that have been sent to you.

Every copy of SHORT WAVE & TELEVISION contains information which you should have. Here is a chance to get those copies.

As only a small supply of back numbers on hand, this offer will be withdrawn as soon as they have been sold. We accept U. S. stamps, U. S. coin, or money order. Rush your order today.

SHORTWAVE & TELEVISION, 4-38
 99-101 Hudson Street, New York, N. Y.

Gentlemen: I enclose herewith 70c, for which you are to send me six back number copies of SHORT WAVE & TELEVISION as follows:.....

Name

Address

City

State

Please mention SHORT WAVE & TELEVISION when writing advertisers

Short Wave Propaganda

(Continued from page 667)

countries to which they broadcast adopt an easy informality to secure listeners' good will. A favorite device is to request listeners to write to the station, read their letters over the air, and send friendly personal greetings via the microphone. Of course the listener in Oshkosh is tickled to hear his name announced over the air from some faraway land. Such letters are a daily special in the German radio bill of fare.

Monthly or weekly program booklets printed in many languages are mailed free to all foreign listeners. Some of these have program schedules printed in the local time of the foreign country. Germany's program sheet for North America is listed in Eastern Standard Time.

The British charge \$2.50 a year for their programs, which are issued weekly. The illustration across the top of the first page of this article is a photograph of program sheets from the principal countries of the world.

Broadcasts to South America

Russia, Germany and Italy, and especially the latter two nations, are engaged in a concerted effort to win public favor in South America.

Broadcasting to South America plays an important part in their propaganda activities. Every day from 4:50 to 10:45 p.m. Germany sends forth programs in Spanish and Portuguese for the ears of South Americans. Italy performs a similar daily service from 6-7:30 p.m. News bulletins attack the United States government's foreign and domestic policies and seek to paint democracies as the villains in international affairs. Fascism is extolled as the salvation of the world. Complaints have been received by American stations indicating that European stations interfere with their news broadcasts to prevent South Americans from hearing our point of view.

Washington Concerned

This situation has been causing much annoyance in Washington for it may seriously affect friendly relations with South America. The state department has been making strenuous efforts to improve Pan-American trade by the Good Neighbor policy only to have its efforts nullified by European sniping.

It seems evident the Fascist countries hope to swing South America into their political sphere. This is a direct threat to the traditional policy of keeping the Americas free of European entanglements.

U. S. Stations Now Active

In the United States, radio stations are owned by private capital and are not subject to any government regulation. However, station owners are granted periodic license renewals, only if it can be shown that they are performing a public service. With the growing uneasiness of the United States over the situation abroad, the large operating companies have found it advisable to cooperate with the government in enlarging the scope of their short-wave broadcasting outlets. Since last July, the National Broadcasting Company has operated its powerful short-wave station W3XAL at Bound Brook, N. J., for sixteen hours daily. From 9 a.m. to 6 p.m. programs especially designed for foreign listeners are beamed toward Europe on 17.78 mc. with news and announcements given in French, German, Italian and English.

From 6 p.m. to 1 a.m. programs are beamed to South America on 17.78 or 6.1 mc. with announcements in Spanish and

Portuguese. The General Electric Company's stations W2XAF and W2XAD at Schenectady, N. Y., on 15.23 and 9.53 mc. are performing a similar service as is the Westinghouse station W8XK at Pittsburgh, Pa., which operates 4 different frequencies.

The Columbia Broadcasting System recently enlarged its short-wave broadcasting plant at New York (W2XE) and now beams its broadcasts to Europe and South America on any of 5 different frequencies in a similar way, although foreign-language programs have not been promoted to any great extent to date. The educational station W1XAL operated by the World Wide Broadcasting Foundation at Boston, Mass., on 15.25, 11.79 and 6.04 mc., is also performing noteworthy service in this field.

To date, no effort has been made to counteract the effects of European stations' propaganda by counter propaganda. The American stations have confined themselves to broadcasting what they term *factual news* in various foreign language news bulletins. The theory is that if the listener has to choose between a so-called factual news bulletin and a highly colored one, such as that sent out by European stations, he will tend to discount the latter. Whether this is sound reasoning remains to be seen. Our whole policy at present is merely an extension of the well-known *Good Neighbor* policy. Programs are all designed to create good will among foreign listeners.

Dictatorship countries are disturbed over the entrance of the United States and Great Britain into the foreign language broadcasting field, because up to now their citizens have heard only their own governments' side of the story. In Germany the only information in the German language which could be picked up on the radio, presenting a different point of view from that presented by German radio and press was from the powerful Russian stations, which have long broadcast in various languages for the benefit of Europeans. In Germany it is a criminal offense to be caught listening to a Russian broadcast. No such drastic penalties have been inflicted upon those listening to broadcasts from democratic nations.

The recent broadcast of President Roosevelt's opening message to Congress was sent overseas in several languages, from Bound Brook, N. J., and for the first time, thousands of European S-W listeners heard the democratic point of view enunciated in their own language. Foreign language news broadcasts sent out from this country are now heard in those countries where freedom of the press does not exist and are naturally causing considerable concern to the governments in power.

Future Trends

What effect this powerful tool for molding public opinion will ultimately have on world affairs is anybody's guess.

The results of Italy's ethereal invasion of Palestine and Arabia have been noted. It is difficult to say whether or not the Arab unrest that followed the Italian broadcasts points a parallel for a similar reaction in South America. It is significant that our State Department is concerned over the situation.

Two courses are open to a nation to defend itself against these attacks. One entails the adoption of tactics similar to those used by the propagandists—fight fire with fire! The other is to smother the propaganda stations with a blanket of interfering signals so that no one can hear them. (This method has already been used by certain European nations to prevent reception of Moscow.)

Both courses mean further friction on

the badly frayed cords of international diplomacy, and as long as nations continue to follow their violently nationalistic policies all talk of international regulation of world wide broadcasting is futile.

Schedule of foreign broadcasts to North and South America

- GERMANY
 - 4:50-10:45 pm.
 - North America (Ger., Eng.) 6.02, 11.77, 15.2 mc.
 - Central America (Ger., Eng., Spanish) 9.54, 15.34 mc.
 - South America (Ger., Span., Portuguese) 9.56, 15.28 mc.
 - 8-9 am.
 - North America 15.11 mc.
 - Central America 15.34 mc.
 - 6-8 am.
 - South America 15.28 mc.
- ITALY
 - 7:35-9 pm.
 - North America (Italian) 9.53, 11.9 mc.
 - 6-7:30 pm.
 - South America (Span., Italian, Portuguese) 9.53, 11.9 mc.
- RUSSIA
 - North America (Eng.) 6-9:15 pm.
 - 9.6 mc.
- JAPAN
 - North America (Eng., Jap.) 6-6:30 pm.
 - 11.8 or 15.16 mc.
 - South America (Portuguese, Span., Jap.) 4:30-5:30 pm.
 - 11.8 and 15.16 mc.
- ENGLAND
 - 4:15-6 pm.
 - North and Central America 15.31 and 15.14 mc.
 - South America 15.18 mc.
 - 6:20-8:30 pm.
 - North America 9.58, 11.75 mc.
 - South America 9.51 or 15.18 mc.
 - Central America 9.51 or 15.14 mc.
 - 9:20-11:20 pm.
 - North America 9.58, 9.51, 11.75 mc.
 - Central America 9.51 mc.

What Do You Think?

(Continued from page 671)

(Your suggestions are appreciated, doctor. We have carried out your ideas to some extent, at least, by taking all the lessons published in the *Radio Amateur Course* and reproducing them in book form. The *Radio Amateur Course* by George W. Stuart is now available from most radio dealers. The course contains chapters on "How The Vacuum Tube Works," "Alternating Current," "Resistance, Inductance and Capacity," "Laws Pertaining to Amateurs," etc. We always welcome constructive criticism and again thank you for your valued letter.

It's your magazine, and if enough readers write to the editors asking for more *Amateur Course* lessons, we'll do our darndest to fill the order. A post-card will do; just write on it these three words—"More *Amateur Course*."—Editor.)

Please mention SHORT WAVE & TELEVISION when writing advertisers



BUILT FOR "DX"

HAMMARLUND components built into your receiver means greater "DX." The "MC" midget condensers together with the "SWK" 17-270 meter "XP-53" low-loss coil set, and the type "S" Isolantite socket are matched parts "built for 'DX'".—Send coupon for 1938 catalog.

HAMMARLUND MFG. CO., Inc.
424-438 W. 33 St., N. Y. City
() Please mail me new "38" catalog.

Name

Address

City State

SWT 4-38

HAMMARLUND

NEVER BEFORE

300 TESTED MONEY MAKERS
MAIL ORDER PLANS
BUSINESS SECRETS
SUCCESS SCHEMES

64 PAGES

10¢

has the small sum of 10c brought you so much as we offer in our 1938 edition 64 page book, 300 TESTED MONEY MAKERS.

In this book you will find all the real money makers which have and still are making money for others.—men who have started on the proverbial shoe-string and often with less than \$10 capital. In this book you will find dozens of successful mail-order plans, many confidential business secrets, successful formulas and many profitable schemes that are being used by small business traders who are making a good but honest living either in their full time or spare time.

WE ONLY ASK YOU TO DEPOSIT THE SMALL SUM OF TEN CENTS WITH US. IF THREE DAYS AFTER RECEIPT OF THE BOOK YOU DO NOT THINK IT WORTH TEN TIMES THE AMOUNT, WE WILL CHEERFULLY REFUND YOUR MONEY.

Do not fail to send for this important book—the New 1938 Edition has just been published. It's sent post-paid. Remember, all of these plans are genuine, NOT JUST IDEAS, but every plan has been tried out successfully, you can send either coin or U. S. postage stamps.

NATIONAL PLANS INSTITUTE
246 Fifth Avenue New York City

STOPPANI COMPASS

A Precision Instrument made in Belgium. Purchased by the U. S. Government at more than \$30.00 each. Ideal for Radio Experimenters Laboratory, also may be used as a Galvanometer for detecting electric currents in radio circuits. Ruby jeweled, solid bronze, 4 inches square, fitted in a hardwood case. Also used by hunters and surveyors.

Our price prepaid \$4.50 each



GOLD SHIELD PRODUCTS
Dept. 5-4, 98 Morningside Av.
New York City

All about the SHORT WAVE LEAGUE

A FEW WORDS AS TO THE PURPOSE OF THE LEAGUE

The **SHORT WAVE LEAGUE** was founded in 1930. Honorary Directors are as follows:

Dr. Lee de Forest, John L. Reinartz, D. E. Replogle, Hollis Baird, E. T. Somerset, Baron Manfred von Ardenne, Hugu Gernsback, Executive Secretary.

The **SHORT WAVE LEAGUE** is a scientific membership organization for the promotion of the short wave art. There are no dues, no fees, no initiations, in connection with the **LEAGUE**. No one makes any money from it; no one derives any salary. The only income which the **LEAGUE** has is from its short wave essentials. A pamphlet setting forth the **LEAGUE'S** numerous aspirations and purposes will be sent to anyone on receipt of a 3c stamp to cover postage.

FREE MEMBERSHIP CERTIFICATE

As soon as you are enrolled as a member, a beautiful certificate with the **LEAGUE'S** seal will be sent to you, providing 10c in stamps or coin is sent for mailing charges.

Members are entitled to preferential discounts when buying radio merchandise from numerous firms who have agreed to allow lower prices to all **SHORT WAVE LEAGUE** members.

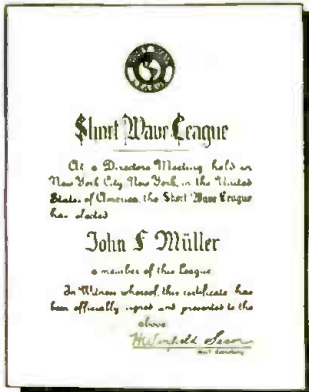

If you wish your name engraved on the Free membership certificate, as illustrated above, please send 25c to cover cost.

SHORT WAVE ESSENTIALS LISTED IN OPPOSITE COLUMN SOLD ONLY TO SHORT WAVE LEAGUE MEMBERS

They cannot be bought by anyone unless he has already enrolled as one of the members of the **SHORT WAVE LEAGUE** or signs the blank below (which automatically enrolls him as a member, always provided that he is a short wave experimenter, a short wave fan, radio engineer, radio student, etc.)

Inasmuch as the **LEAGUE** is international, it makes no difference whether you are a citizen of the United States or any other country. The **LEAGUE** is open to all.

Application for Membership SHORT WAVE LEAGUE

SHORT WAVE LEAGUE. 4-38
99-101 Hudson Street, New York, N. Y.

I, the undersigned, herewith desire to apply for membership in the **SHORT WAVE LEAGUE**. In joining the **LEAGUE** I understand that I am not assessed for membership and that there are no dues and no fees of any kind. I pledge myself to abide by all the rules and regulations of the **SHORT WAVE LEAGUE**, which rules you are to send to me on receipt of this application.

I consider myself belonging to the following class (put an X in correct space): Short Wave Experimenter Short Wave Fan Radio Engineer Student

I own the following radio equipment:

Transmitting

Call Letters

Receiving

Name

Address

City and State

Country

I enclose 10c for postage and handling for my Membership Certificate.

S-W's Land Planes in New Army System

(Continued from page 674)

diagram shows; then the airplane automatically starts to lose altitude and follows a pre-determined glide and direction. The various glide paths for different degrees of wind velocity are indicated in Fig. 2.

In the execution of an automatic landing, using the new Air Corps system, it is necessary for the pilot of the airplane to bring the airplane to a definite altitude, determined by a sensitive altimeter, and to place the airplane within the range of radio reception of the ground radio facilities. It is, of course, desirable to place the airplane generally in the direction in which it is expected to land, but this is not necessary as was determined in flight and can be understood by reference to Fig. 1, in which the airplane was actually placed in a position which headed it 180° away from the direction of final landing. When the pilot has placed the airplane at a selected altitude in the vicinity (20 miles or less) of the landing field, the master landing switch is closed and the airplane proceeds through the following routine in accomplishing the automatic landing:

A. The selected altitude is automatically maintained and the airplane's heading is changed, so that it flies in the direction of the radio guiding station most remotely located from the landing runway.

B. The altitude control device maintains the proper altitude during the initial approach as just noted. A directional relay interlocks the radio compass and the gyro pilot, thereby causing the change in heading of the airplane. The frequency of the radio compass is automatically set by the interaction of the marker beacon receptor, working in conjunction with the frequency selector. The pilot of the airplane is informed as to the correctness of automatic settings by observing a frequency selector indicator. Through the automatic and co-operative action of these devices, the airplane heads to the compass guiding station farthest from the field. Upon reaching that station the frequency is automatically changed to Station No. 3, where it is again automatically changed to the frequency of Station No. 2, where the frequency is again automatically changed to that of Station No. 1; at the same time the engine throttle is automatically operated by a throttle engine. The throttle engine is interconnected with the altitude control in such a manner, that should the airplane reach its minimum altitude prior to reaching radio Station No. 1, the throttle engine will be so actuated to control the airplane in such a manner that it will maintain accurately the minimum altitude required for the operation of the automatic landing system. After passing Station No. 1, the throttle engine is so actuated that the airplane maintains a selected glide angle and rate of descent until ground contact is made. When ground contact is made, the throttle engine is further actuated by the landing gear switches, which in turn causes the engine to be idled and proper brake application made.

At the present writing, the automatic landing system has been flown so that all of the landings made to date, have been made under cross-wind conditions varying in intensity as high as eleven miles per hour. In at least 50% of the automatic landings made, the air conditions have been moderately rough.

The Sperry gyro-pilot has been used throughout as the automatic flight control feature of the airplane. Certain additions to the pilot have been required to provide for the automatic control of direction.

Accessories for Members of the SHORT WAVE LEAGUE

Every member of the **SHORT WAVE LEAGUE** wants to identify himself in some way. For your convenience the League directors have prepared suitable letterheads, label buttons, stickers, etc. In addition there are many short-wave accessories, such as maps, globes, etc., which the League offers only to members at special prices. Take your choice from this advertisement. **THESE ESSENTIALS ARE SOLD ONLY TO LEAGUE MEMBERS.**



A—50c per 100

LEAGUE LETTERHEADS

A beautiful, official letterhead has been designed for members' correspondence. The letterhead is invaluable when it becomes necessary to deal with the radio industry, mail order houses and radio manufacturers, as many houses offer members of the **LEAGUE** preferential discount. The letterhead is also absolutely essential when writing for verification to radio stations either here or abroad. It automatically gives you a professional standing.

A—SHORT WAVE LEAGUE letterheads. **50c**
per 100

WORLD GLOBE

This important essential is an ornament for every den or study. It is a globe, 6 in. in diameter, printed in fifteen colors, glazed in such a way that it can be washed. This globe helps you intelligently log foreign stations. The base is of solid walnut, and the semi-meridian of a nickel-like metal. Entire device substantially made, and will give an attractive appearance to every station, emphasizing the long-distance work of the operator.



D—Globe of the World **89c**

D—89c each

SHORT WAVE MAP OF THE WORLD

This beautiful map, measuring 18x26 in. and printed in 18 colors is indispensable when hung in sight or placed "under the glass" on the table or wall of the short wave enthusiast. It contains a wealth of information such as distances to all parts of the world of the political nature of the country in which a broadcast station is located, etc., and from the manner in which the map is blocked off gives the time in different parts of the world at a glance.



F—SHORT WAVE Map of the World.Prepaid **25c**

F—SHORT WAVE Map of the World.Prepaid **25c**

WORLD RADIO MAP AND STATION FINDER

The finest device of its kind published. The world's map on heavy board is divided into 23 sections, while the rotary disc shows you immediately the exact time in any foreign country. Invaluable in logging foreign stations. Also gives call letters assigned to all nations. Size 11"x22".

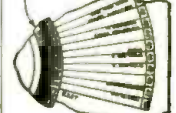

C—25c each

C—Radio Map of the World and Station Finder. **25c**
.....Prepaid

LEAGUE LAPEL BUTTON



E—35c each

This beautiful button is made in hard enamel in four colors, red, white, blue and gold. It measures three quarters of an inch in diameter. By wearing this button, other members will recognize you and it will give you a professional air. Made in bronze, gold filled, not plated. Must be seen to be appreciated.

E—SHORT WAVE LEAGUE lapel button **35c**
.....Prepaid



G—15c for 25

LEAGUE SEALS

These seals or stickers are executed in three colors and measure 1 1/2 in. in diameter, and are gummed on one side. They are used by members to affix to stationery, letterheads, envelopes, postal cards and the like. The seal signifies that you are a member of the **SHORT WAVE LEAGUE**. Sold in 25 lots or multiples only.

G—SHORT WAVE LEAGUE seals, per 25. **15c**
.....Prepaid

EE—SHORT WAVE LEAGUE lapel button, like the one described above but in solid gold. **\$2.00**
.....Prepaid

SHORT WAVE LEAGUE

99-101 Hudson St., New York, N. Y.

SHORT WAVE LEAGUE. 4-38
99-101 Hudson Street, New York, N. Y. Gentlemen.

I am a member of the **SHORT WAVE LEAGUE**
 Please send me application for membership in the **SHORT WAVE LEAGUE**

Please send me the following short wave essentials as listed in this advertisement:

.....

.....

.....

.....

.....

for which I enclose \$..... herewith.

Name

Address

City and State

Country

(The LEAGUE accepts money orders, cash or New U. S. stamps in any denomination. Register cash and stamps.)

Short Wave League

HONORARY MEMBERS

Dr. Lee de Forest Manfred von Ardenne
 D. E. Replogle E. T. Somerset
 John L. Reinartz Hollis Baird
 Hugo Gernsback, Executive Secretary

When to Listen In

M. Harvey Gernsback
 All schedules in Eastern Standard Time

SWEDEN . . . One of our correspondents has sent us the latest schedules of short-wave stations in Garbo Land. SM5SX at Stockholm now broadcasts on 15.155 mc. daily from 11 a.m.-5 p.m. and on Sundays from 9 a.m.-5 p.m. SBP at Motala broadcasts daily on 11.705 mc. from 1:20 to 2 a.m., 6-9 a.m., 11 a.m.-1 p.m. SBO, also at Motala, broadcasts on 6.065 mc. daily from 1:30-5 p.m. On Saturdays SBI' broadcasts from 1:20-2 a.m. and from 6 a.m.-1:30 p.m. SBO broadcasts from 1:30 p.m.-5 p.m. On Sundays and holidays, SBI' is on the air from 3 a.m.-1:30 p.m. and SBO from 1:30-5 p.m.

CANADA . . . A check of the various Canadian short-wave stations has brought the following information. CJRO and CJRX, 11.72 and 6.15 mc. broadcast daily from 6 p.m. to midnight and on Sunday from 5-10 p.m. CFRX at Toronto on 6.07 mc. broadcasts from 7:30 a.m. to 12 midnight daily and 10:30 a.m.-12 midnight on Sunday. CFCX at Montreal on 6.005 mc. is on the air from 7:45 a.m.-1 a.m. daily and on Sunday from 9 a.m.-11:15 p.m. VE9CA at Calgary, Alta., on 6.03 mc. relays station CFCN from 9 a.m.-1 a.m. daily and from 12 noon to 12 midnight on Sundays. VE9HX, Halifax, Nova Scotia, is on 6.13 mc. from 7 a.m. to 11:15 p.m. daily. 11 a.m.-11 p.m. Saturdays and 12 noon-11:15 p.m. Sundays. A letter from CJCX at Sydney, Nova Scotia, on 6.01 mc. informs us that at present the station has no definite schedule but will probably go on a regular schedule some time in March. CRCX at Toronto on 6.09 mc. broadcasts daily, 7:45 a.m.-5 p.m. and Sunday 10:30 a.m.-12 midnight.

ITALY . . . Programs for South and North America on 2RO, Rome, 9.635 mc., are now broadcast simultaneously on IRF, 9.83 and IQY 11.9 mc. in addition to 2RO. Although IQY announces as 11.7, it actually operates on 11.9 mc. Both IRF and IQY are very well heard, although the quality of IQY is not so good.

FRANCE . . . The new Radio Coloniale station mentioned in these columns recently is still experimenting. To date it has been heard testing between 5:30 p.m. to mid-

night on 6.04 and 9.55 mc. It has also been heard at very great strength on 17.78 mc. around 8:30 a.m., and on 15.13 and 11.845 mc. it has been heard several times around 7:30 a.m.

ECUADOR . . . A letter from HCJB at Quito, Ecuador, says that station broadcasts daily except Monday, on 8.841 mc. and 4.107 mc. from 7-8:30 a.m., 11:45 a.m.-2:30 p.m., and 5-10 p.m. The Sunday schedule is 12 noon-1:30 p.m. and 5:30-10 p.m. Address is P. O. Box 691.

JAPAN . . . The Japanese have been operating on a new schedule since the first of January. A program for the west coast and the Hawaiian Islands is broadcast from 12:30-1:30 a.m. on JZJ 11.8 mc. On this same frequency there is a special program for Japanese listeners in the United States from 7-7:30 a.m. and a program for Australian and South Sea listeners from 8-9:30 a.m. From 6-6:30 p.m., JZJ broadcasts a program in English for the east coast of the United States. JZJ and JZL 9.525 operate simultaneously from 2:30-4 p.m. with a program for Europe, and from 4:30-5:30 p.m. with a program for South America. JVN or JVM is active from 2-8 a.m. relaying programs from Tokyo to Manchukuo. JVH on 14.6 mc. broadcasts irregularly from 5-11:30 p.m. for Manchukuo and is frequently heard in New York.

(Continued on page 713)

Additions to Station List

Mc.	Call	Location
9.980	COBC	HAVANA, CUBA
9.550	—	RADIO COLONIALE, FRANCE
9.355	HCITC	QUITO, ECUADOR
9.345	H8L	GENEVA, SWITZERLAND
9.280	HC2CW	GUAYAQUIL, ECUADOR
7.870	HCIRB	QUITO, ECUADOR
7.410	HCJ84	QUITO, ECUADOR
6.465	YV3RD	BARQUISIMETO, VENEZUELA
6.440	TGQA	QUETZALTENANGO, GUATEMALA
6.416	YV6RC	BOLIVAR, VENEZUELA
6.384	VP2LO	STE. KITTS, LEEWARD ISLANDS, B.W.I.
6.290	HIG	TRUJILLO CITY, D.R.
6.255	YV5RJ	CARACAS, VENEZUELA
6.045	XT6W	TAMPICO, MEXICO
5.940	PJCI	CURACAO, DUTCH W. INDIES
4.107	HCJB	QUITO, ECUADOR

TRIPLET Pocket-Volt-Ohm- Milliammeter D.C. and A.C.

Uses large 3" Sq. Triplet Instrument. Has molded case, selector switch and all necessary accessories. A complete instrument for all servicing needs. Can be used for all A.C.-D.C. voltage, current and resistance analyses.

See Your Jobber
 Write for Catalog



Size —
 3-1/16"
 x 5 7/8"
 x 2 1/8"
Model 666
DEALER
PRICE
\$15.00

The Triplet Electrical Instrument Co.
 284 Harmon Drive, Bluffton, Ohio

Please send me more information on Model 666.

Name

Address

City State

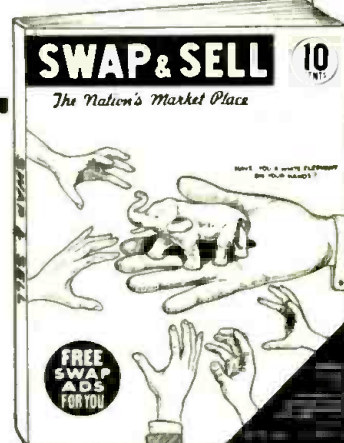

SWAP & SELL

is the great, big, new magazine that shows you how to get more than 1000 different articles, such as cameras, rifles, books, magazines, clothing, tools, pets, etc., "without having to buy them!" It runs YOUR OWN swap ad free! It prints letters from men and women who SEEK NEW FRIENDS! It publishes TRUE EXPERIENCES from real life! It tells you how to swap and HOW TO MAKE MONEY! It helps you get all the things you've always longed for, yet never could afford!

You NEED a copy to help you get more out of life!

NOT SOLD ON NEWSSTANDS

Send only 10c for sample copy, or get all twelve big issues for the coming year—only \$1.00 if you order at once!

SWAP & SELL, 99T Hudson Street, New York, N.Y.

CHASSIS — CABINETS PANELS & CANS

STANDARD SIZES ON HAND
 SPECIAL SIZES MADE TO ORDER
KORROL RADIO PRODUCTS CO.

232 Greenwich St., New York City

Please mention SHORT WAVE & TELEVISION when writing advertisers

.... THESE OUTSTANDING SHORT WAVE BOOKS ARE Now Available AT YOUR DEALER!

YOU buy parts, tubes, kits, accessories from your local radio dealer—that's what countless thousands of short-wave fans do. Now through a nation-wide distribution service our numerous books are available at your favorite radio dealer—right where you buy other radio equipment. It's more convenient, saves time and you can inspect the books before you buy. Ask your dealer to show you all the books advertised on this page—they're always in stock.

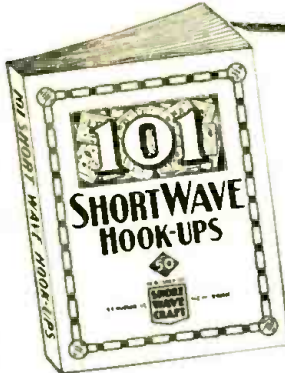

101 SHORT WAVE HOOK-UPS

Compiled by the Editors of SHORT WAVE and TELEVISION

Here is a worthwhile book that every short wave listener, every short wave fan, and every short wave amateur has wanted for a long time. It gives you the 101 best short wave hook-ups which have appeared heretofore.
100 Illustrations
72 Pages **50c**

HOW TO BUILD AND OPERATE SHORT WAVE RECEIVERS

This is the best and most up-to-date book on the subject. It is edited and prepared by the editors of SHORT WAVE and TELEVISION and contains a wealth of material on the building and operation, not only of typical short wave receivers, but short wave converters as well.
150 Illustrations
72 Pages **50c**



HOW TO GET BEST SHORT WAVE RECEPTION

M. HARVEY GERNSBACK tells you everything you have ever wanted to know about short wave reception. The author, a professional radio listener and radio fan for many years, gives you his long experience in radio reception and all that goes with it.
49 Illustrations
72 Pages **50c**

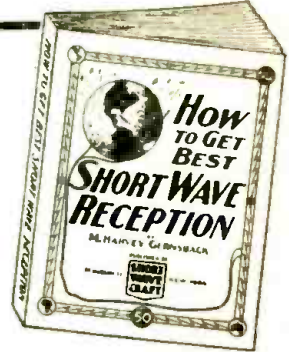

HOW TO BECOME AN AMATEUR RADIO OPERATOR

By Lieut. Myron F. Eddy, whose experience in the amateur field has made him pre-eminent in this line.
If you intend to become a licensed code operator, if you wish to take up phone work eventually—this is the book you must get.
150 Illustrations
72 Pages **50c**

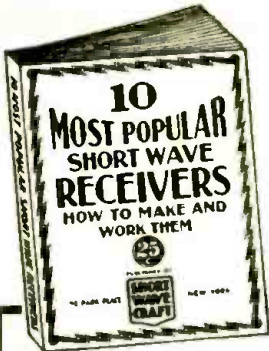

TEN MOST POPULAR SHORT WAVE RECEIVERS

HOW TO MAKE AND WORK THEM
The editors of SHORT WAVE and TELEVISION have selected ten outstanding short wave receivers and these are described in the new volume. Each receiver is fully illustrated with a complete layout, pictorial representation, photographs of the set complete, hook-up and all worthwhile specifications.
75 Illustrations
40 Pages **25c**

THE SHORT WAVE BEGINNER'S BOOK

Here is a book that solves your short wave problems—leading you in easy stages from the simplest fundamentals to the present stage of the art as it is known today. It is the only low-priced reference book on short waves for the beginner.
75 Illustrations
40 Pages **25c**

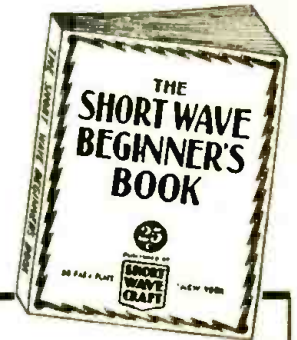

LOOK FOR YOUR NEAREST DEALER

For convenience the publishers list below dealers in all parts of the world where our books are available. On your next shopping trip be certain to examine these volumes. You're sure to want them for your technical library.

- | | | | |
|--|---|---|---|
| <p>ALABAMA
Walthers Bros., Montgomery</p> <p>ARIZONA
Sam's Cigar Store, Phoenix</p> <p>CALIFORNIA
Electric Supply Co., Oakland
Radio Supply Company, Los Angeles
Radio Television Supply Co., Los Angeles
Pacific Radio Exchange, Inc., Los Angeles
Western Auto Supply, Los Angeles
Zack Radio Supply Co., Los Angeles
Vroman's Book Store, Pasadena
Western Radio & Elec. Co., San Diego
Offenbach Electric Co., San Francisco
Technical Book Co., San Francisco
Zack Radio Supply Co., San Francisco
Radio Specialties Co., San Jose</p> <p>COLORADO
Auto Equipment Co., Denver
Interstate Radio Supply, Denver</p> <p>CONNECTICUT
The Edward P. Judd Co., New Haven</p> <p>DELAWARE
Wilmington Elec. Spec. Co., Inc., Wilmington</p> <p>FLORIDA
Radio Accessories Co., Orlando</p> <p>GEORGIA
Wholesale Radio Service Co., Inc., Atlanta</p> <p>ILLINOIS
Allied Radio Corporation, Chicago
Walter C. Braun, Inc., Chicago
Chicago Radio Apparatus Co., Chicago
A. C. McClurg & Co., Chicago
Midwest Radio Mart, Chicago
Newark Electric Co., Chicago
Sears, Roebuck & Co., Chicago
Max Stein & Co., Chicago
Montgomery Ward & Co., Chicago
Wholesale Radio Service Co., Inc., Chicago</p> | <p>INDIANA
Van Sickle Radio, Indianapolis</p> <p>MASSACHUSETTS
DeWolfe & Fluke Co., Boston
The Personal Book Shop, Boston
Wholesale Radio Service Co., Inc., Boston
Library Book House, Springfield
Tremont Elec. Supply Co., Boston</p> <p>MICHIGAN
Rissel Brothers, Detroit</p> <p>MINNESOTA
St. Paul Book & Stat. Co., St. Paul</p> <p>MISSOURI
Hurststein-Applebee Inc., Kansas City
Radio Labs, Kansas City
Walter Ashe Radio Co., St. Louis
Van Sickle Radio Co., St. Louis</p> <p>NEW JERSEY
Radio Apparatus Co., Newark
United Radio Co., Newark
Wholesale Radio Service Co., Inc., Newark</p> <p>NEW YORK
Fort Orange Radio Dist. Co., Albany
Wholesale Radio Service Co., Inc., Bronx
Wholesale Radio Service Co., Inc., Jamaica, L. I.
American News Co., New York City
Baker & Taylor Co., New York City
Hint, the Radio Man, New York City
David Bogen & Co., New York City
Federated Purchaser, Inc., New York City
Harrison Radio Co., New York City
Radio Circular Co., New York City
G. E. Steinhilber & Co., New York City
The Steiner Co., New York City
Sun Radio Co., New York City
Thor Radio Corp., New York City
Try-Mo Radio Co., New York City
Van Richtenbach Book Stores, New York City
Wholesale Radio Service Co., Inc., New York City
H. W. Wilson Co., New York City
Radio Paris & Equipment Co., Rochester
M. Schwartz & Son, Schenectady</p> | <p>OHIO
College Book Exchange, Toledo</p> <p>OREGON
J. K. Gill Co., Portland</p> <p>PENNSYLVANIA
Radio Electric Service Co., Philadelphia
Cameradio Co., Pittsburgh</p> <p>WASHINGTON
Seattle Radio Supply Co., Seattle
Widel Co., Inc., Seattle
Spokane Radio Co., Spokane</p> <p>WISCONSIN
Radio Parts Co., Milwaukee</p> <p>ARGENTINA
Radio Revista, Buenos Aires</p> <p>AUSTRALIA
McGill's Authorized Agency, Melbourne</p> <p>BELGIUM
Emil Areus, Brussels</p> <p>CANADA
T. Eaton & Co., Winnipeg, Man.
Electrical Supplies, Ltd., Winnipeg, Man.
Wholesale Radio Supply, Winnipeg, Man.
Canadian Electrical Supply Co., Ltd., Toronto, Ont.
Radio Trade Supply Co., Ltd., Toronto, Ont.
Canadian Electrical Supply Co., Ltd., Montreal, P. Q.</p> <p>BRAZIL
Agencia Soave, Sao Paulo</p> <p>CHINA
China News Co., Shanghai
International Booksellers, Ltd., Shanghai</p> <p>CUBA
Diamond News Co., Havana</p> <p>ENGLAND
Gorringe's Amer. News Agency, London</p> <p>FRANCE
Toute La Radio, Paris</p> | <p>GERMANY
Rehr G.M.B.H. S.W.15, Berlin NW No. 7</p> <p>INDIA
Empire Book Mart, Bombay</p> <p>MEXICO
American Book Store, Mexico, D. F.
Central De Publicaciones, S. A., Mexico, D. F.
Jaques Salvo, Mexico, D. F.</p> <p>NEW ZEALAND
Johns, Ltd., Auckland
James Johnston, Ltd., Dunedin
Te Aro Book Depot, Ltd., Wellington</p> <p>SOUTH AFRICA
Technical Book Co., Cape Town
Central News Agency, Johannesburg
International House, Johannesburg
South African Radio Publications, Johannesburg</p> |
|--|---|---|---|

IF YOUR DEALER DOES NOT CARRY THESE BOOKS, ORDER DIRECT FROM US. FILL OUT COUPON BELOW. SHIPMENT WILL BE MADE IMMEDIATELY.

POPULAR BOOK CORPORATION SW-4
99 Hudson Street, New York City.

Gentlemen: I enclose herewith my remittance for _____ for which please send me the following books:

.....

Name _____

Address _____

City _____ State _____

(Send remittance in form of check or money order. If letter contains cash or unused U. S. postage stamps, register it.)

Short Wave League

(Continued from page 711)

VATICAN CITY . . . HVJ has been heard testing on a new frequency, 11.74 mc., at various times.

GENEVA . . . The League of Nations station at Geneva, Switzerland, broadcasts on HBL 9.345 mc. on Friday, 7:15-8:30 p.m. and on Saturday, 6:45-8 p.m.

ILLINOIS . . . A new station reported is W9XDH in Elgin, Ill., on 12.882 mc. This station is operated by Press Wireless and is heard testing from 2-5 p.m.

CZECHOSLOVAKIA . . . The Prague station was active on 6.03, 6.01, 15.23, 15.32, 9.55 and 11.84 mc. in the last month. Since they

change their schedule so frequently, we will not attempt to give their schedule. **SEASONAL CHANGES . . .** in frequencies employed by the principal short-wave stations are already noticeable. Daventry, Prague and Tokyo are shifting to the higher frequencies once more with the return of longer days and shorter nights.

After the equinox on the 21st of March, there should be a marked change noticeable in reception on the higher frequency channels.

W2XAF and W2XAD are now using two new frequencies, 21.5 mc. from 8 am.-12 n., and 9.55 mc. from 7:30 pm.-12 m.

See page 714 for late news.

New Avenues for Television

DR. D. M. MORANDINI, PH.D.

(Continued from page 661)

dealt with. And there are other disadvantages.

It is not proposed here, therefore, that inventive effort should be concentrated on the elimination of electronic devices by replacing them with positive ray (or ionic) devices. This, even if it should become possible, would constitute only an equivalent method involving by no means less trouble and circumspection than the previous one. There might be, however, another possible alternative: On account of their great masses and, therefore, their more definite nature as individual units, these positive ray particles might, perhaps, be arranged to follow strictly parallel paths and thereby proceed in space as carriers of the picture impulses in their consecutive order. If such be the case, they could, furthermore, be compressed, possibly by means of an enveloping repelling (positive) force applied upon the surface of a pipe-like envelope, while the positive beam itself would proceed within the isolated walls of this cylindrical tube.

Beside this repelling force—and independently of it—there could be a second (negative) force applied along the cylindrical envelope in such a manner that its intensity would be changed periodically, as if a wave were proceeding along the cylinder envelope and providing thereby the necessary acceleration for the propagation of the positive beam of parallel rays within the cylindrical envelope. This pipe-like "conductor" of the picture impulses would have to be evacuated so that the ray particles would not collide with an exceedingly great number of air particles and lose their character thereby. The cylindrical pipe would remind us of a multiple coaxial cable, around the axis of which the cylindrical vacuum container would run, as the innermost portion of the construction. The pipe would be of a flexible cable type.

This "fantastic" device would then transmit images directly, without scanning and synchronizing, and would carry all picture elements simultaneously (with the velocity of the accelerated positive ray) to the receiving station. At the receiving end the compressed beam could be expanded and create an image on a luminous screen (an actual image, not one which is our interpretation only of short-interval, scanned impulses).

Such a "piped television system" could be arranged for a great number of outlook-

ers, who, at different locations, would want to see the same television program. A bank of positive ray guns would provide for the pick-up. Shifting to other programs could be arranged by means of an automatic switching central station operating like an automatic telephone exchange. At the broadcasting studio each positive ray gun would be equipped with an individual optical focusing device which would focus the scene to be televised upon the gun.

The above brief description of a new televising method not yet invented may seem to be far-fetched. May I point out, however, that all things not yet realized but appearing only in the imagination of some dreamer, look necessarily far-fetched. If I could visualize the actual embodiment of such a system, I would proceed to describe it, instead of giving here visionary hints of its possible realization. I think, nevertheless, that it is worth while to mention such thoughts as this. They may inspire other minds to conceive ideas along similar lines and thus may lead to actual discoveries. It is one of the purposes of technical editorials, I believe, to do just this. This is why I avail myself of this opportunity.

At the *Television Research Society* in Los Angeles, parallel to the present work, we often discuss things that seem to be in the distant future. But even present-day development seemed to be visionary not long ago. I remember well the earlier days of television experimenting, around 1915-1919 in Europe. Instead of radio tubes the inventors then had to depend on selenium cells, etc.; synchronization and scanning was provided for by tiny mirrors rotating on cylindrical drums and minute vibrating mirrors fixed upon galvanometer loops. Time delays caused by the fatigue and sluggishness in reaction of the selenium cells were compensated by circuits coupled so as to operate impulse receivers on a current-difference principle. Such was the method of Professor Korn, for instance, one of the most famous European pioneers. "In that age"—rapid as television developments were considered to be—no one even dreamed of the present-day advance of the art. We were happy and considered ourselves very successful during these first experiments when the televised image of a cross appeared as a sort of a four-sided star, or a triangular something that was nearer to a circle than a three-sided figure!

CLEAR AS A BELL—

with 

CONDENSERS!

Your signals come through clean and clear when you use BUD'S perfected

JUNIOR DUAL ULTRA HIGH FREQUENCY CONDENSER —

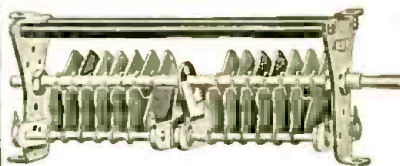

With the purest capacity ever obtained, BUD'S variable tuning condenser unit keeps self-inductance and high frequency resistance at an absolute minimum. It avoids parasitics and self-oscillation!

- 4 point rotor wiping contact is placed at the electrical center of the rotor assembly—practically eliminating standing waves and high frequency resistance.
- 6 brass tie rods are insulated at each end with 1" Isolantite insulators—preventing any possible inductive effect from a closed loop in the frame.
- 2 1/4 rotor plate diameter.
- .040 plate thickness.

See these condensers at your jobbers today

BUD RADIO, INC.
CLEVELAND, OHIO

• ELEMENTARY MATHEMATICS •

For the Technician and Craftsman

CONTENTS OF BOOK

I. ARITHMETIC: Addition, Multiplication, Division. II. Factoring and Cancellation, Fractions, Decimals, Percentages, Ratio, and Proportions. III. The Metric System. IV. How to Measure Surfaces and Capacity (Geometry). V. POWERS: Involution—ROOTS: Evolution. VI. Mathematics for the Manual and Technical Craftsman, Thermometer Conversions, Graphs or Curve-Plotting, Logarithms, Use of the Slide-Rule. VII. Special Mathematics for the Radio Technician. VIII. Commercial Calculations. Shortcut Arithmetic, Interest, Discounts. IX. Weights and Measures, Useful Tables.

PRICE
50c
POSTPAID

TECHNIFAX

Division SWT-4-38

558 W. Washington Blvd.

Chicago, Illinois

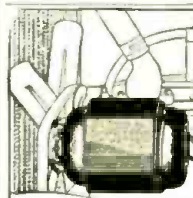

110 VOLTS A. C.

Fan belt generator for sound trucks. Produces constant voltage at various engine speeds. Cannot be burned out. Also good for operating flood lights, car heating, electric drills, neon signs. Sizes: 250 to 1000 watts. Prices from \$25.00 net.

LEJAY MFG. COMPANY
117 LeJay Bldg., Minn., Minn.

FREE TO SERVICEMEN RADIO PROFITS



BUY WHOLESALE—SELL RETAIL
Send for sales data TODAY! See 1938 nationally advertised radio for his profit. ACT AT ONCE! WRITE
RADIO DISTRIBUTING COMPANY
1080 NORTH HALSTED STREET CHICAGO, ILLINOIS

COMPLETE DISCOUNT SALES PLAN SENT

Please mention SHORT WAVE & TELEVISION when writing advertisers

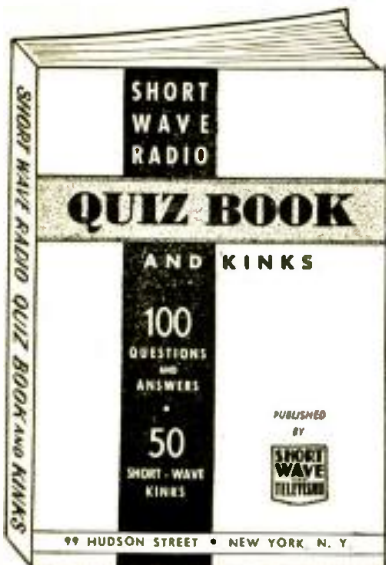

WE HAVE NEVER MADE SUCH AN OUTSTANDING OFFER TO OUR READERS!

HERE is a brand new book—with an unusually interesting content. The text—prepared by the Editorial Staff of SHORT WAVE AND TELEVISION, contains a variety of material which only experts could select and incorporate in such an excellent volume. "SHORT WAVE RADIO QUIZ BOOK AND KINKS" cannot be bought—it is sent to you absolutely FREE with your subscription to SHORT WAVE AND TELEVISION at the Special Rate of Seven Months for One Dollar. (Old subscribers may get this book by extending their subscription.) The book contains 64 pages with a heavy flexible colored cover. It measures 5½x8½ inches, and includes hundreds of photographs and diagrams. The contents are outlined below.

Questions and Answers Covering S-W Transmitters.
 Questions and Answers Covering S-W Receivers.
 Ultra-Short-Wave Transmitters and Receivers.
 S-W "Kinks"—Short-cuts and Practical Wrinkles, Coil Winding Data.
 How to Add an Audio Amplifier to a Small

S-W Receiver.
 How to Connect an R.F. Stage Ahead of Your Present Receiver.
 Dozens of Novel New Hook-Ups for the S-W Experimenter.
 Clear diagrams showing how to connect the latest type tubes in place of your old tubes, so as to obtain greater DX.

HOW TO "HOOK UP"—

S-W Converters Power supplies Beat Oscillators Pre-selectors
 Noise Silencers Modulators Antennas 5-meter receivers

SHORT WAVE AND TELEVISION • 99 Hudson Street • NEW YORK, N. Y.

2 Other FREE Books
ABC OF TELEVISION

Contains latest material on Television developments. It covers theory of scanning; simple television receiver, how the eye sees; the photo-electric cell; neon lamps; need for broad channel width in transmission of high-fidelity television signals; cathode ray tube and television receivers; Farnsworth system of television transmission, and other important features.

SHORT WAVE GUIDE

Covers hundreds of Short-Wave questions and answers; illustrates popular Short-Wave kinks; gives instructions for building a simple Short-Wave receiver; instruction on the best type of antenna to use; diagram and construction details for building a simple "ham" transmitter; practical hints on Short-Wave tuning.

SHORT WAVE AND TELEVISION, 99 Hudson Street, New York, N. Y.

Gentlemen: Enclosed you will find my remittance of \$..... for which enter my subscription to SHORT WAVE AND TELEVISION for

7 months—\$1.00—choice of any one of three (3) books. (Canadian and foreign—\$1.30)

14 months—\$2.00—choice of any two (2) of the three (3) books. (Canadian and foreign—\$3.60)

21 months—\$3.00—all three books (Canadian and foreign—\$3.90)

If you are a subscriber now, we will extend your present subscription. (Books are to be mailed POSTPAID.)

New subscriber Old subscriber

Name Address

City State

Send your remittance by check or money order. If you send cash or unused U.S. postage stamps, please be sure to register your letter for your own protection.

Dept. SWT-134

And what great secrets were the *television sensitizing processes!* They were guarded better than Cerberus watched the entrance of the other world of Greek mythology. Only the *tube-sensitizing secrets* of today seem to be guarded more carefully. Yet, they all become known sooner or later. And I believe it is far better for television inventors without enormous funds to reveal "secrets" in their embryo stage, than to keep them secret in hope of the habitually expected million dollar reward for their perfected invention. This way the "secrets" become public property and are at the free disposal of every capable engineer and experimenter, if not patented within two years after publication.

Infra-red detecting devices—which see objects through fog and darkness—had a similar fate recently. Most of them operate with photo-electric cells or thermocouples sensitive in the infra-red range. They detect and locate objects—airplanes for instance—at great distances, utilizing—as television does—energy of the radiant spectrum. Television itself may be applied to this field, and perhaps to the detection of objects at far greater distances. Invisible signals, in this case, could be sent out as reconnoitering beams to be reflected back to the sender from the surfaces of the object to be detected which are at nearly right-angles to the path of the beam. Prac-

tically every approaching object presents some such surfaces.

Another field, which thus far has been touched upon only by inventive endeavor, is that of large television receiving screens of the square flat neon-tube type, in which two wire-screens parallel with each other, and consisting of parallel wires perpendicular to the wires of the other screen, are employed for picture reception.

A year ago, in the February, 1937, issue of *Short Wave and Television*, the editorial of Dr. Lee de Forest advocated the return to *mechanical scanning systems*, although with new mechanisms. Some of the ideas therein touched upon advocate electro-mechanical transmission principles which would eliminate scanning, electrical or mechanical, altogether. I agree with one of the conclusions of Dr. de Forest:—*the present elaborate "cathode ray" devices do not appear to me as the real solution for the practical application of television.* Yet the advance made along the "cathodic" line is a more than necessary step on our way to a more practical solution. As the experiments and devices of Farnsworth, Zworykin and of the author show (the latter described in 1932 in *Television News*, and further developed in the August, 1937, number of *Short Wave and Television*), cathode ray devices have a great versatility and are applicable to many purposes in

television. But somehow I feel that the "final" practical solution of the television transmission problem will have much less accent placed upon such devices than it has today.

A "synchronization-less and scanning-less" television system would certainly be a most valuable thing. If not along the lines here suggested, it will come by other routes not long after the present highly developed and elaborate transmission methods will have been turned into daily use and made accessible to the average experimenter. Practice will accomplish wonders. Let us, therefore, get television out of the laboratory! The sooner economic and business conditions will permit such a jump, the quicker will unsuspected new avenues of thought and experiment open up before an eagerly waiting army of television fans.

AS WE GO TO PRESS . . .

W3XAU at Philadelphia now operates from 11 pm.—12 m. on 9.59 mc. TGWA operates on 9.685 or 11.76 mc. Sundays 7:15—10 pm.; Monday, Tuesday, Thursday, 9—11 pm.; Wednesday, 9:30—10:15 pm., Saturday 10 pm.—1 am.; on 15.17 or 17.8 mc. daily from 12:45—1:30 pm.; Sunday, 12 n.—2:45 pm. HVJ, Vatican City is reported on 6.07 mc. and Moscow is reported on 6.055 mc.

Please mention SHORT WAVE & TELEVISION when writing advertisers

How I Became a Telegraph and Radio Operator

L. R. McDonald, W8CW, Ex-W8AZC

● SINCE winning a recent contest in copying continental code, I have had many requests for advice about learning the code.

As a young lad I lived with my parents near "GS" tower, on the Wabash and Pennsylvania railroads at Butler, Indiana. I had learned the code and practiced on a homemade key and sounder.

I put in a good many hours of hard practice, and at the age of fourteen found myself a fairly good railroad operator.

After a time I got to working some of the better commercial wires, but not the fast trunks. The wire I remember best was the old Richmond, Indiana, wire. I remember it so well because it was on this wire that I heard my first perfect Morse. The Richmond operator was "Dick" Thomas. I have never met Dick face to face, but ten years after I worked this wire I was visiting the Western Union office in Detroit and heard a man sending. I walked over and said:

"There is only one man in the world who can send like that; your name is Thomas, isn't it?" To which he replied: "Yes, but how do you know? I don't remember you."

I said: "Don't you remember me, Dick, I used to work Richmond wire out of Indianapolis?"

He began to laugh and told me he was Dick Thomas' younger brother, and that Dick had taught him how to send.

Any one may think this incident is exaggerated, but it can be verified by getting in touch with one of the Thomas boys of Richmond, Indiana. I haven't heard from Dick in 19 years, and if he reads this, I hope he will write me. I have always considered his sending as a model for all operators. The reason I mention Dick Thomas is that I always associate him in my mind with Walter Candler. I don't know whether it was Thomas who first told me about Candler, or whether I merely heard about him around the Indianapolis Western Union office, but after a while it seemed that every time a group of top-notch operators got to talking, somebody brought up the name of Candler. I was complaining one day about the rotten wires they always assigned to me, and an old timer suggested I write to Mr. Candler and get him to help me perfect my telegraphing. It seems that he had been doing that very thing for many operators. Candler would take some mediocre operator, who seemed doomed to the slow wires for life, and by showing him the right way, soon had him working the fastest wires. He seemed to put new life into the man.

At this point I want to say the most difficult code work I have ever attempted was on the amateur radio code bands. Every one seems to have a system of his own for sending. I cannot make this statement without mentioning that there are many exceptions. The best amateur radio operators I have worked so far are: Ralph Carpenter (W8AA), Saginaw, Michigan; Roy Gardner (W8RF), Detroit, and John Sincock (W9CSI), Marquette, Michigan.

I find that amateurs generally take pride in a certain "swing" or style. This would do no harm in slow work except that an operator tends to exaggerate his peculiar style all the time, and after a while no one

can read it without guessing! I recognized Thomas' style of sending because of its perfection. This style business probably had its advantages in the old key and stylus days, but has no place in modern code work, where the bug and mill (typewriter) have become indispensable tools. The only style that appeals to me as an operator, is fast, correctly spaced, smooth, rhythmic sending.

I got tired of commercial work and took a job on the L. E. & W. Railroad at Bennetts Switch, Indiana. After I got there I found out I was "station agent" and "operator." The agent part didn't please me very much, but I was still under age and decided to keep the job. I was reading the official magazine of the Order of Railroad Telegraphers one day and saw the announcement by Walter H. Candler, offering to train operators to become better operators. I remembered the old-time commercial operators talking about Candler, so I wrote Mr. Candler a letter, mentioning a certain "old timer" who had recommended the course. It seems the two had worked a fast bonus wire together at one time. In a short time I was studying the Candler method and wondering how long it would be before I would be able to "work" bonus wires, as I had seen them "worked" in Indianapolis. As I studied this course I found the answer to a lot of riddles that had been perplexing me ever since I started learning the code.

Rudolph Haynes (now a Wabash railroad operator), and I built two complete sending and receiving stations in Butler in 1916. Although we couldn't claim much DX with our Ford Spark coils, and E. I. Co. phones and "cat whiskers," we did manage to work each other consistently.

In 1917 I applied for an amateur license, second class. I never lost contact with the wireless men. I also took the Gernsback wireless magazines of that time and tried to keep myself informed.

In September, 1937, I heard there was to be a code contest at the A.R.R.L. Central Division convention here in Detroit. For ten years I had been engaged in other communication work, with practically no telegraphing, and my ham work confined to radiophone communications. I felt the urge to compete in the contest, but decided to attend only as a spectator. Two minutes after I got there I had the "cans" on and was copying in the amateur contest, but not as a contestant. I informed the judges that I held a commercial license and that I did not wish to compete. I copied all through the amateur contest, and my copy was read by spectators, but was not submitted officially to the judges. A special contest for commercial operators was then staged for my benefit, in which I copied 60 words per minute.*

I would like to give a parting word of advice for the young code aspirant. Always try to copy behind. Force yourself to do this, even though it appears to slow you up for a time. Here is something I have told a good many beginners, and no one has ever claimed I was wrong. *The day you start reading and copying words instead of letters, is the day you cease being a beginner, and become a real operator.*

*Due to mechanical difficulties with the tape machine, this was the greatest speed at which the code could be transmitted.

H. G. CISIN'S AIR WAVE Air Scout Jr. Radios THREE-TUBE \$3.20 ALL ELECTRIC AIR WAVE SET MODEL 3A-E WITH PHONE

A well-designed sensitive set. Holds wonderful records for distance reception and MARVELOUS FOREIGN RECEPTION. Owners with practice able to bring in police calls, amateur code, Transatlantic phone and broadcast entertainment. Works from any A.C. or D.C. house current. Easiest set to build. Employs newest metal ballast tube as one of the tubes. Speaker mounts on attractive panel. Range 0 1/2 to 610 meters or to 1500 meters with special long wave coil. Complete Kit includes: Ear-phones, broadcast coil, 70 to 200 meter coil, Panel, Chassis, High Grade Variable Condenser, Potentiometer, Antenna Trimmer, Dial, Sockets, Knobs, Wire, Resistors, Condensers, and all other required parts, including instructions and diagram.



Model 3A-E
Pat. No. 2,086,256

TWO-TUBE BATTERY SET—Model 2B. Complete kit including all parts listed above plus parts for extra audio stage including power tube \$2.95 With Two Tubes & Phone (unwired)

THREE-TUBE DE LUXE BATTERY SET—Model 3B. Complete kit including all parts in the 2-tube model plus parts for two extra audio stages in \$3.45 With Three Tubes including all three tubes. & Phone (unwired) Following Auxiliary Parts are available: 0 1/2 to 20 meter coil (foreign) 25c; 15 to 45 meter coil (foreign) 25c; 40 to 80 meter coil (foreign) 25c; 225' wire battery, 75c; Two flashlight "A" batteries, 10c each; 5" Flnd-All Loud Speaker, \$1; Complete Antenna Kit, 50c; Wood Screw Kit, 10c. Tubes for Model 3A-E, \$1.35. Long Wave Unit and coil for any model, \$1; Double Earphones, \$1.20; Bandspread Attachment, 75c. Any model wired extra, \$1. NOTE: If you already have earphones, two extra foreign coils may be substituted in any model.

WORLD FAMOUS AIR WAVE 1-TUBE AIR SCOUT

Thrilling Short Waves, Police Calls, Broadcast Programs, Amazing Results. Kit is complete except phone and battery. Uses single dry cell tube (50c) or storage bat. tube (25c). Three foreign coils \$25c ea. \$1 Less Tube Un-Wired

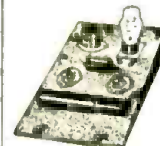

H. G. CISIN, CHIEF ENGINEER
Allied Engineering Institute, Dept. S-46
98 Park Place, New York, N. Y.

An Accurate, Eight Inch White Wood SLIDE RULE with A, B, C, D, CI and K Scales

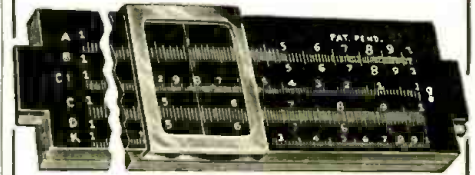

Features
Nickel Silver Framed Indicator with Integral friction springs. Scales calibrated directly on well-seasoned wood will retain accuracy regardless of temperature or humidity changes. Instructions and illustration of primary operations clearly printed on back side of rule for ready reference or teaching. Each rule in a durable pocket carrying case for convenience and protection.
The extremely low price of these slide rules and their absolute accuracy makes them ideal for the student as well as the working man who has always wanted to use a slide rule.

Price postpaid anywhere 50c each
3 for \$1.00, 10 for \$2.50

GOLD SHIELD PRODUCTS

Dept. S4 98 Morningside Ave. New York

EXPERT RADIO SERVICE COURSE

Speed tough service jobs. Make more profit. The C-B Visual Service Course gives you "know how." Designed for service men by famous Midland Television School and C-B engineers. For details, see your O-B jobber or write us. Make your time pay more. Don't delay. Write TODAY.

The CLOUGH-BREngle CO.
2813-E W. 19th St. Chicago, Ill.

METAL SLIDE RULES!

4 inch diameter metal slide rule (with case). Price, prepaid, \$2.00. Equivalent scale length is about 12 inches. Performs all the regular slide rule computations. Roots, logs, sines, etc. Endorsed by colleges. Accurate, handy.
8-inch diameter metal. Special—large scale divisions, easy reading, equivalent scale length about 20 inches. Price, with case, \$3.00.
DATA PRINT CO., Lock Box 322a, Ramsey, N.J.

SPECIAL FOR THIS MONTH

Send \$1.00 (\$1.25 Canada and foreign) and we will send you SHORT WAVE & TELEVISION for Eight months. "DO IT NOW"

SHORT WAVE & TELEVISION
99-101 Hudson Street New York

ZE1JR, ZS1J, 14090, ZT6N, 14100, ZS1B, 14080, FB, Ralph!

Irv. Goodeve, W8, who signs himself the Celery City DXer, being in Kalamazoo, hi. runs in a sweet list also, as: ZU5Z, ZS5M, ZU5M, ZT5S, ZT6AL, ZU6AF, ZS6AJ, ZS5J, ZS1B, ZS2N, ZS2X, ZU6N, ZU6E, and FB8AB, also FB8AF, 14000, last heard 9:15 p.m. F.B. OM! Irv. wants a crack at FR8VX, well, there's the Special, OT, go to it!

Irv. lately logged a new one, VK4HN, at Port Moresby, Papua, the 1st phone from that land. VK4HN was on 14300, QSOing KA1MH at 9:15 a.m. Irv. also reports a batch of 20 meter VK's, as early as 5:20 and as late as 9:40 a.m. unusual to hear these at all during January.

From Europe we have some very FB reports from Bill Edwards, of Bristol, and Ian Jamieson, of Manchester, England.

Ian reports: FB8AF and FB8AH. AH on 14370; FR8VX, 14340; ZE1JA, 14320. So. Rhodesia; ZT1R, ZS1AX, ZS3F. in So. Africa; VQ4CRE, 14300, Kenya; and OQ5AA, all in afternoons E.S.T.

Bill Edwards reports these Africans: SU1RK, 14300 and SU1GP, 14000. Egypt, CN8AR, 14285; CN8MT; CN8MB, 14150; CN8AI, 14285, in French Morocco, FA3JY, 14120 in Algeria, and ZS1AX, So. Africa.

ASIATICS

Chris Jaffe, W4, reports: VS7RF, 14340, VS7GJ, 14130, Ceylon, near 6 a.m., J2M1, 14100, Japan, 3:13 a.m., PK1GL, 14280. Java, 9:22 a.m., HS1BJ, 14070, Siam, 8:25 a.m., all FB DX. OM!

F18AC, PK1BX, GL, TR, MD, MO, MX, PK, RL, VL, VN, VY, ZZ, PK2VD, VM, WL, PK3AL, CD, BD, WI, PK4DG, TD, TE, VG, WS, PK6CI, PK8? All these in Java; VU2LL, India; VS7GT, RA, RF, Ceylon.

Other 20 meter DX: Bill Edwards reports: I1LM, 14120, I1IY, 14320; I1IT, 14355; I1MX, 14150; I1WY, 14285; I1IE, 14390; I1II, 14285, all in Italy.

Also YT7KP, 14185, Jugoslavia; CT2AB, 14350, CT2BC, 14355, Azores; ES5D, 14300, Esthonia; SV1NK, 14020, Greece; SP1DE, 14020, Poland, EA3SI, 14185, Spain.

Ian Jamieson reports: UX5KF, 14380 approx., at 8 a.m., and doesn't know who 'tis, hi! Sounds good, too! Also, Ian reports: YL2CC, LSH.F. Latvia; YT7KP, OK1SZ, 14050, Czechoslovakia; LY1X, LY1HB, both 14135, Lithuania; OZ1I, H.F. end, OZ5BW, L.F. end, in Denmark, SV1RX, 1CA, 1KE, 1NK, all in Greece, alternating on both ends of 20 meter band, except 1RX on L.F. end.

Ian also reports CT2AB and 2BC, ES5C, and ES5D from 11 a.m. on.

Chris Jaffe reports SV1KE, 14275, and SV1NK, 14020, around 4 p.m.

On 75 meters, Ian hears FA3QV, on 3590 kc., Algeria, around 3 p.m. Adds the FA3 also heard FB on 20 & 40. Ian says that ON4HS schedules U.S. & Canadian phones on 75 meters at 6 p.m. Also adds that the following are good "sigs" on 75 meter phones, and that U.S. DXers should look for them in the evenings. Here goes: GM5NW, GM6SR, Scotland; ON4HS, ON4FOR, Belgium; OZ4HF, OZ2D, OZ2EA, OZ7X, in Denmark; F8MG, France; E16F, E18L, E18J, E19D, in Ireland; G2XV, G2PO, G5CJ, England, and GM5IM, besides several North Africans.

Perhaps a few of these might be heard, so let's give it a try, it's a new DX band!

On 10 meters, following DX logged: CN8MA, ZS6T, ZT6AK, CN8AV, I1IT, HR5C, ZE1JR. The band is open, but usually not "hot," as it was last Oct.-Nov. We look forward to increased activity on this most interesting band during March!

Chris Jaffe reports U3FB, Russia, at 9:30 a.m.

Ian Jamieson reports these 10 meter catches: ZE1JR, ZT6J, VU2CQ, FA3JY, CN8AV, CN8AJ, heard between 9-11:30 a.m. Also OK3VA and OK2NB, 9-10 a.m. Ralph Gozen reports ZS6T, ZE1JR, VU2CQ.

A last minute report: W11FK, our friend Ed Murphy, Stamford, Conn., reports FR8VX, Reunion Island, testing 6:45-7 p.m., Suns., several weeks in a row, with a good signal. This on 14440 kc.!

Look for above listed Africans, as Morocco, Egypt, Algeria, in afternoons, 2-6 p.m., and same for above Europeans. Asiatics should be heard in March, beginning at 6:30-7 a.m.

REVIEW OF '38 SKYRIDER

By Our DX Editor, Joe Miller

● THIS excellent all-around communication receiver was tested in our DX shack during the past month, and after putting it through all its paces, we feel that we have here one of the very best DX receivers on the market today, and that the claims made for the Skyrider are certainly no "hunk"!

Concerning sensitivity, this set compared more than favorably against our old reliable T.R.F. Regen, on which we do most of our DX, bringing in weak, distant stations intelligibly, when unintelligible on the T.R.F., and that, OMs, is a recommendation for any DX set!

G.E. PHONOGRAPH MOTOR
Formerly Sold for \$15.00 **Only \$4.95**
VARIABLE speed induction type self-starting, 110 volt, 25 to 60 cycle, AC, with speed control. Plug and cord. Speed range from 5 to 200 RPM. Can be installed in place of old-fashioned, hand-winding speed motor. Also ideal for display turn table, and a hundred other uses. These General Electric Motors are brand new, in original factory cartons. **\$4.95** G.E. Electric Phonograph motor as described. Shipping weight—12 lbs.

Westinghouse Power Generator
Manufactured for U. S. Signal Corps
200 Watt. 110 V. AC

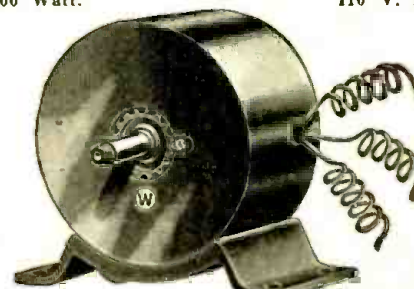

A. C. ELECTRICAL POWER

from a Windmill, from available Waterpower, from your Automobile, from your Motorcycle, from your Bicycle. Foot-pedals or Handcrank (for transportable Radio Transmitters, Strain Floodlights, Advertising Signs); do you want to operate AC Radio sets from 32 V. DC farm light systems; operate two generators in series to get 200 V. AC; obtain two phase and three phase AC, etc., etc.

There Are Over 25 Applications

Some of which are:

A.C. Dynamo lighting from eight to ten 20 Watt 110 Volt lamps. Short Wave Transmitter supplying 110 Volts AC for operating "Hiam" transmitter. Operating 110 V. AC 60 Cycle Radio Receiver in DC districts. Motor Generator. Public Address Systems. Electric Sirens on motor boats, yachts, etc. Camp Lighting. Short Wave artificial "fever" apparatus. Television. Pelton Waterwheel for lighting or other purposes. Airplane: for lighting strong searchlights or electric signs. Laboratory work, etc., etc.

1/4 to 1/2 H.P. needed to run generator.

BLUE-PRINT 22 x 28 in. and Four-Page

8 1/2 x 12 in. INSTRUCTION SHEETS

FREE with Generator.

Generator, as described, including four replacement carbon brushes. Blue-print and instructions **\$7.90**

Send \$2.00 deposit, balance C.O.D.

Shipping weight 18 lbs.

(Replacement carbon brushes bought separate \$1.50 per set of four. Set of instructions bought separate \$1.00.)

MONEY-BACK GUARANTEE

WELLWORTH TRADING COMPANY

560 West Washington Blvd. Dept. SW-438 Chicago, Ill.

50 YEARS OF RADIO PROGRESS
144 PAGES
Highlights of MARCH RADIO-CRAFT — depicting FIFTY YEARS OF RADIO PROGRESS.
• Story of Amateur Radio • Progress of Receivers — Parts of Yesterday • Forecasts and Fulfillments • Reminiscences of Old-timers • Fleming's Valve and Up • Early Circuits • Old Stations • Feature Articles • Sensational Articles to Bring Fond Memories • Cover in Four Colors and Gold • Special Cover and Body Paper • Hundreds of Old-Time Illustrations, Diagrams and Photographs • Every New Advertisement Accompanied by an Old-Greatest Thing You Ever Saw!
50c THE COPY
Look for the GOLD COVER on the JUBILEE SOUVENIR NUMBER MARCH 1938 RADIO-CRAFT -- ON ALL NEWSSTANDS RADIO-CRAFT

Enter this Interesting Contest!
Writing ADVERTISING is not only FASCINATING but PROFITABLE. Many men who showed ability to write FORCEFUL copy were promoted to the position of SALES MANAGER or highly paid EXECUTIVE. To encourage our readers to enter the contest, we offer the following prizes:
For best worded piece of advertising copy submitted, together with layout:
First prize\$5.00
Second prize\$3.00
Third prize\$2.00
You may write as many pieces of copy and for as many firms as you desire. Manufacturers will gladly supply you with catalogs or folders describing their products in order to guide you in writing copy. Illustrations in the MEDIUM are desirable. The names of the winners will be published in SHORT WAVE & TELEVISION in the next issue after the prizes have been won.
All contests close on the 1st of each month for the issue of the 2nd following month.
The judges will be Emil Grossman and the Editors of this magazine and their opinions will be final.
Checks will be promptly mailed to all prize winners by
EMIL GROSSMAN, Director of Advertising
SHORT WAVE & TELEVISION
99 Hudson Street, New York, N. Y.

Ian Jamieson reports: XZ2EZ, Burma, 8 a.m., QSO F8XT, while on 14350; VS7GJ, 14130, 9 a.m., using 25 watts; VU2CQ, 14130, India, 5:30 a.m., using 300 watts now; KA1ME, 14130, Philippines, at 6 a.m., nice lot of DX, Ian!

Irv. Goodeve reports KA1CS "Canada-Shanghai," 14290, Manila, at 9:40 a.m.

Murray Buitkant reports F18AC, on 14050, in French Indo-China, at 8 a.m., a sweet catch. OT! Irv. Goodeve reports a handsome QSL from F18AD.

Harry Honda, W6, relays some data on 20 meter phones, reported to him by Frank Taylor, VK6, West Australia. These are now active, so look for them in the early a.m.'s!

ZL2BI, ZL3NP, L.F. end of 20 metre band, New Zealand.

Inside the American phone band, 14150-14250, the following KA's in the Philippines: KA1AP, AT, CS, DH, DT, EG, EK, FD, HS, ME, MC, MD, MH, MN, KA2OV.

These in L.F. end 14000-14150: VK7CL, KV, RY, YL, in Tasmania. FB8AH,

Please mention SHORT WAVE & TELEVISION when writing advertisers

Takes the Sock!



- ★ Porcelain-case mica capacitor. For those h.f. applications.
- ★ Minimum metal in h.f. field. Units rated in max. current-carrying capacity at 15 mc., 7.5 mc., 3750 kc., and 1875 kc.
- ★ In capacities of .00005 to .1 mfd. 2000 to 12500 volts D.C. test.

Ask your local AEROVOX jobbers, or write us direct, for new catalog on transmitting capacitors and resistors.

AEROVOX CORPORATION
70 Washington St. Brooklyn, N. Y.
IN CANADA: AEROVOX CANADA, Limited, Hamilton, Ont.

SHIPPING LABELS Size 2½ x 4 **\$1.50** per 1000

Printed in RED & BLUE with your name & address. Regular \$3.50 value. SAMPLES.

SAMNICK 305 E. 45th St., New York City
Write for prices on printing.

Experimental Television

INVITES PIONEERS

• Still in its infancy, no one doubts the future of television—and if you would like to be in on the ground floor of a development that's bound to revolutionize American life, here is a course of study that will equip you to go ahead with it. Ask for information.

INTERNATIONAL CORRESPONDENCE SCHOOLS

Box 2879-E, Scranton, Penna.
Send me—free—information on subject checked:
 Experimental Television

Radio Operator Radio Service Man
 Radio Engineer Electrical Engineer

Name.....
Address.....

Selectivity:—Very good, with a total of 3 controls to be used in different variations of selectivity. Signals that are badly QRM'd can be brought in clearly, through the use of the crystal, with a variable phasing control which is invaluable, and a broad-sharp selectivity switch.

Of course, the dial merits special mention. Wheel (inertia) dials are used, and can be spun halfway around by a mere spin of a finger, the ultimate in fatigueless tuning! Band-spread is very fine, and the 20 meter band can actually be stretched from 260-740, or a total of almost 500 degrees, on a 1000 degree dial! The 20 meter band is best covered by setting the main dial at 14.500 on the marker.

Then the tone quality must be mentioned. This is very good, as the receiver is equipped with an excellent 12 inch permanent magnet speaker, and we often prefer the fine music of a local, to "plowing thru" the QRM for DX!

Calibration is good, and one can easily locate most any DX station with ease.

A tone-control, beat oscillator, oscillator pitch control, "S" meter, single or doublet aerial provisions, send and receive switch, 'phone jack on panel, AVC on and off control, and separate R.F. and A.F. gain controls—all combine to make this a really excellent and modern DX receiver, one which we would choose for our own DX shack.

BOOK REVIEW

FUNDAMENTALS OF RADIO, Frederick Emmons Terman. Stiff cloth covers; 6½"x9¼"; 458 pages; 278 illustrations; published by McGraw Hill Book Co., New York City.

The first part of the book deals with radio wave propagation, transmitters, the fundamental elements of radio circuits and includes a valuable section on inductance.

Among the interesting subjects taken up later are—band pass filters, fundamental actions taking place in vacuum tubes, how the grid works, the action occurring in triodes and pentodes, beam tubes, variable mu tubes, etc.

It seems we can never read enough on vacuum tube amplifiers and the author has included a refreshing treatment on this important subject, including the cause of noise, hum and microphonic effects in amplifiers. Power amplifiers are also discussed at length, with tables of representative tubes suited for this purpose.

An important chapter covers vacuum tube oscillators, with fundamental circuits, and the action taking place in these circuits. Crystals and the important part they play in oscillator control circuits are included. Important subjects dealt with in the latter part of the book are—modulation, the vacuum tube detector, radio transmitters and receivers, propagation of radio waves, antennas, radio aids to navigation, television and acoustics.

RADIO AMATEUR COURSE, George W. Shuart, W2AMN; stiff paper covers; 6½"x9¼"; 144 pages; profusely illustrated; published by Short-Wave & Television Magazine, New York City.

Every student of short-wave radio who aspires to become a licensed amateur, should certainly read this Radio Amateur Course book by Mr. Shuart. The lessons are arranged in progressive style and the elements of electricity and the basic actions taking place in vacuum tube detectors and amplifiers are clearly explained.

Not only are these basic subjects described with simple diagrams and clearly written text, but wherever necessary analogs, such as water pump and valve systems, are shown which make the subject of the action in radio circuits so simple that practically anyone can understand them.

As we proceed with the series of lessons or chapters, we come to the study of a vacuum tube as a regenerator and oscillator; How class A, B & C amplifiers work, the MOPA—or master oscillator and power amplifier, etc. Then we come to such important subjects as antennas and feeders for amateur stations; how to select the proper tubes for low-power exciter stages, and the fundamentals of amplitude modulation. Later we find—power supplies for amateur sets, including bridge rectifier circuits; short-wave receivers of different types, including the super-heterodyne. Plenty of diagrams are included so that the student who finishes this course will find himself ready to answer the questions propounded by the license authorities.

Ultra high frequency receivers are described and also U.H.F. transmitters. Several first-class transmitters and receivers are described with complete constructional details, photographs and diagrams, so that the embryo "ham" can build the apparatus for his station.

Index to Advertisers

A	
ABC Radio Laboratories.....	693
Aerovox Corporation.....	720
Allied Engineering Institute.....	715
Allied Radio Corporation.....	693
American Microphone Co., Inc.....	695
American Television Institute, Inside Front Cover	
Astatic Microphone Laboratory, Inc.....	701
B	
Barter & Exchange Free Ads.....	716, 717, 718
Biley Electric Co.....	701
Brush Development Co., The.....	693
Bud Radio, Inc.....	713
Burstein-Applebee Co.....	703
C	
Cameradio Co.....	695
Candler System Co.....	705
Cannon, C. F., Co.....	698
Chemical Rubber Publishing Co.....	704
Classified Advertisements.....	716
Clough-Brengle Co., The.....	704, 715
Cornell-Dubilier Corp.....	703
Coyne Electrical School.....	659, 699
D	
Dataprint Company.....	702, 715
Dodge's Institute.....	704
Drake, Hotel.....	702
G	
Gold Shield Products.....	706, 709, 715
H	
Hallcrafters, Inc., The.....	Back Cover
Hammarlund Manufacturing Co., Inc.....	709
I	
Instructograph Company.....	704
International Correspondence Schools.....	730
International Resistance Company.....	707
J	
Jefferson Electric Company.....	691
K	
Korrol Radio Products Co.....	711
Kusterman, Oscar B.....	696
L	
Lejay Mfg. Co.....	713
M	
Meissner Manufacturing Co.....	703
Midland Television, Inc.....	705
Modell's.....	697
N	
National Company, Inc.....	Inside Back Cover
National Plans Institute.....	709
National Radio Institute.....	657
National Schools.....	705
New York Y.M.C.A. Schools.....	705
P	
Par-Metal Products Corporation.....	698
R	
Radio Amateur Course.....	660
Radio & Technical Publ. Co.....	704
Radio Constructors Laboratories.....	695
Radio-Craft.....	719
Radio Distributing Company.....	713
Radio Publications.....	706, 708
Radio Training Assn. of America.....	705
Ramsey Publishing Co.....	705
Raytheon Production Corporation.....	689
RCA Institutes, Inc.....	705
S	
Samnick.....	720
Sargent, E. M., Co.....	701
Short Wave Coil Data Book.....	706
Short Wave League.....	710
Solar Mfg. Corp.....	700
Sprayberry Academy of Radio.....	705
Standard Transformer Corporation.....	698
Superior Instruments Company.....	698
Swap & Sell.....	711
T	
Tavella Sales Co.....	706
Technifax.....	713
Teleplex Co.....	705
Test Equipment Company of America.....	702
Triplet Electrical Instrument Co.....	711
Tri-State College.....	704
Try-Mo Radio Co., Inc.....	700
U	
Ultra High Frequency Products Co.....	687
Ultra Precision Instruments Co., Inc.....	700
United Radio Co.....	698
W	
Wellworth Trading Company.....	719
Wholesale Radio Service Co., Inc.....	707

(While every precaution is taken to insure accuracy, we cannot guarantee against the possibility of an occasional change or omission in the preparation of this index.)



In these few short months the NC-80X has become part of the National tradition. Their advanced circuit details, including the wide-range crystal filter and high IF frequency for image rejection, have brought a new standard of performance to the low priced field. Their thorbred construction keeps that performance consistently high. And their convenience makes operation swift, accurate, and tireless.

NATIONAL NC-80X

NATIONAL COMPANY, INC.
Malden, Mass.

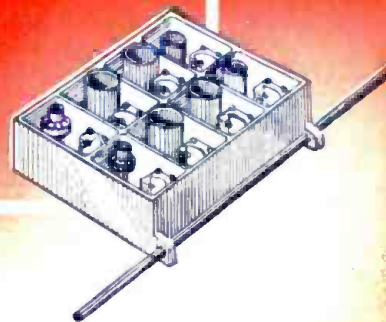



Infinite image rejection
with the **SKY CHALLENGER II**

The INFINITE IMAGE REJECTOR* is just one of the features of the NEW SKY CHALLENGER II that makes it unique among communications receivers. Where ordinary amateur receivers are designed to reduce image ratio to the minimum level, the Hallicrafters have gone a step further, and provided the means to *completely* eliminate image interference. Any amateur can appreciate the value of this new Hallicrafters circuit, especially when working the 10 and 20 meter bands. Combined with the 1000° Spiral Band Spread, its razor-sharp selectivity, and rigid, smooth-operating, mechanical superiority, this feature accounts for the instantaneous popularity and acceptance of the New Sky Challenger II by the amateur radio world. See it at your dealer's or write for complete information.

*Pat. Applied for

- ★ 9 Tubes
- ★ Infinite Image Rejector
- ★ 1000° Spiral Band Spread
- ★ Extreme Selectivity

- ★ 38 MC to 540 KC (7.9 to 545 meters)
- ★ Recessed Main Tuning Dial
- ★ "S" Meter Terminals
- ★ Iron Core IF's

All Hallicrafters Receivers available on Liberal Time Payments

The Super Skyrider



The Super Skyrider is universally accepted as the highest development in communications receivers. Its brilliant performance has made it the most talked of receiver in the entire amateur world. ●

Leading Sports Announcer Uses Super Skyrider
Johnnie O'Hara, W9OP, of KWK, St. Louis, and one of the leading sports announcers of the country, says this of his Super Skyrider: "This is the only receiver on the market that has the rigid, business-like build and the performance of a commercial job."



the hallicrafters inc.

2601 Indiana Ave., Chicago, U. S. A. • Cable Address "Hallicraft" Chicago

"WORLD'S LARGEST BUILDERS OF AMATEUR COMMUNICATIONS RECEIVERS"