

THE RADIO EXPERIMENTER'S MAGAZINE

HUGO GERNSBACK
Editor

SHORT WAVE AND TELEVISION

December

WORLD'S
LARGEST
SHORT WAVE
CIRCULATION

Ultra-Portable S-W
Army Phone Set
See Page 408



25¢
IN U.S. AND
CANADA

The New 1938 Ultra Stratosphere "10"

2½ to 4000 METER TRANS-RECEIVER (RECEIVES 2½ to 4000 METERS TRANSMITS 2½ and 5 METERS)

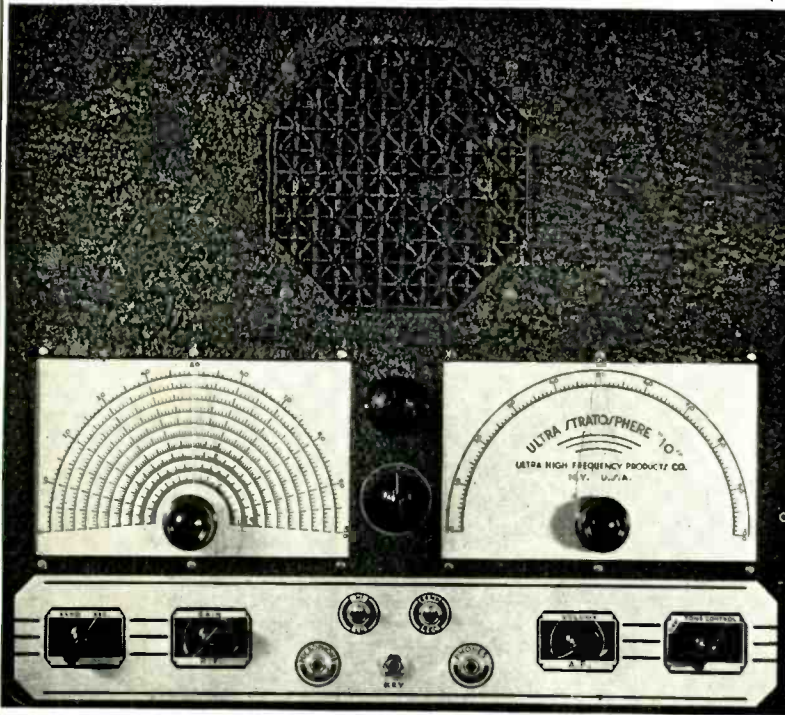

- *Ten tubes.
- 1—6K7 Regenerative Tuned R.F. Amplifier.
- 1—6J7 Regenerative Detector.
- 1—6J5G Super Regenerative Detector & Transmitting Osc.
- 2—6C5 P.P. 1st Audio stage.
- 2—25L6 P.P. Beam power output stage & modulators.
- 2—25Z6 Parallel Rectifiers.
- 1—6G5 Electronic tuning indicator & R meter.
- *Receives from 2½ to 4000 meters.
- *Transmits on 2½ & 5 meters.
- *8" Dynamic Speaker.
- *Calibrated R.F. Gain Control.
- *A.F. Gain Control.
- *Size—17½" x 19½"—16 gauge metal.
- *Tone control.
- *R.F. Resonator control.
- *Separate electrical bandspread.
- *Vernier planetary drives on tuning Cond.
- *Large 8" tuning dials.
- *May be used for I.C.W. and phone transmission and as a code practice oscillator. Only a key required.
- *Standby switch.
- *Automatic Phone jack.
- *Built-in A.C. & D.C. Power supply.

Eager acceptance on the part of its purchasers singles out the Ultra Stratosphere "10" as the value of the year. The number of letters of appreciation was far greater than normally expected to prove that dollar for dollar the many purchasers of the Ultra Stratosphere "10" found it a wise investment. Long lists of verified stations received with this amazing unit will make even the most successful D.X. listener enthusiastic of its performance. Described in detail Page 295, October issue *Short Wave & Television*.

Complete kit of parts, including 6" Dynamic Speaker, unwired, less tubes and accessories.....	\$18.95
1 Kit of 10 matched Sylvania tubes.....	\$6.95
Set of 4 coils—2½ to 15 meters.....	.30
Set of 8 coils—15 to 550 meters.....	2.20
Set of 4 coils—550 to 4000 meters.....	2.00
American S. B. Handmike.....	2.95
Wired and tested extra.....	4.50

SENSATIONAL ULTRA A.C.+D.C.

2-TUBE TRANS-RECEIVERS 2½ to 4000 Meters

TRULY A SENSATION

Uses the new 6J5G super triode tube which is the equivalent of acorn types

Never before was a unit of this type available at any price. This compact and self-contained unit will receive from 2½ to 4000 meters with a high degree of excellence. Will receive foreign stations, amateurs, police calls, broadcast, press, airplane and weather reports, time signals, and all ultra high frequency stations. As a 2½ and 5 meter transmitter surprising results will be obtained when calling friends from afar.



IF YOUR DEALER CAN NOT SUPPLY YOU, ORDER DIRECT FROM

FEATURES

- ★ Transmits from 2½ to 5 meters
- ★ Receives from 2½ to 4000 meters (12 bands)
- ★ Separate electrical and mechanical bandspread
- ★ Loud speaker volume
- ★ Automatic super-regeneration from 2½ to 15 meters
- ★ House to house communication
- ★ Plate modulation
- ★ Built-in A.C. & D.C. power supply (any cycle)

Complete kit unwired less tubes, coils, cabinet, microphone.....	\$7.15
Cabinet.....	.95
Matched set of tubes (12A7-6J5G).....	1.65
Wired and tested.....	2.00
Set of 4 coils (2½ to 15 meters).....	.30
Set of 4 coils (15-200 meters).....	.95
Set of 5 coils (200 to 4000 meters).....	1.75
American SB Handmike.....	2.95
5" Magnetic Speaker.....	1.25

Ultra High Frequency Products Co., 123 Liberty St., New York, N. Y.

How a "Tip" got Tom a Good Job

Panel 1: THERE'S DJC IN BERLIN—THE TENTH FOREIGN STATION TONIGHT. RADIO'S CERTAINLY FUN!

Panel 2: HELLO, TOM, HOW'S EVERYTHING? NOT SO GOOD BILL, BUT I'M STILL PLAYING WITH RADIO. HAD DJC LAST NIGHT. IS RADIO STILL YOUR HOBBY TOO?

Panel 3: YOU'RE SURE LUCKY, BILL. I NOTICED YOUR NEW CLOTHES AND SNAPPY CAR. I THOUGHT YOU HAD INHERITED A MILLION.

Panel 4: YOU HAVE THE SAME CHANCE TOM, ABOUT A YEAR AGO I SHOWED YOU A BOOK FROM NATIONAL RADIO INSTITUTE TELLING ABOUT THE OPPORTUNITIES AND FUTURE IN RADIO, AND NOW OTHERS HAD SUCCEEDED THROUGH THEIR HOME TRAINING, WELL I ENROLLED.

Panel 5: I'M DOING SWELL IN RADIO. MARY AND I ARE TO BE MARRIED NEXT MONTH. RADIO IS MORE THAN A PLAYTHING. IT'S A BIG BUSINESS AND GROWING FAST. TAKE MY TIP AND GET INTO RADIO NOW, TOM!

Panel 6: IF BILL SUCCEEDED, I CAN TOO! THEN I CAN MAKE REAL MONEY SERVICING RADIO SETS.

Panel 7: OR GET A JOB IN A BROADCASTING STATION

Panel 8: OR INSTALL AND SERVICE LOUD SPEAKER SYSTEMS

Panel 9: OR MAKE GOOD MONEY IN ANY ONE OF THE MANY OTHER NEW AND GROWING BRANCHES OF RADIO. I'M GOING TO SEND FOR THAT FREE BOOK RIGHT NOW!

Panel 10: YOU CERTAINLY KNOW RADIO. MINE NEVER SOUNDED BETTER. THANKS! N.R.I TRAINING CERTAINLY PAYS. I JUST STARTED A FEW MONTHS AGO AND I'M ALREADY MAKING GOOD MONEY IN MY SPARE TIME.

OH, TOM, IT'S WONDERFUL HOW FAST YOU'VE GONE AHEAD IN RADIO. WE NEVER COULD HAVE GOTTEN MARRIED ON WHAT YOU WERE GETTING BEFORE.

OUR WORRIES ARE OVER. I'M MAKING GOOD MONEY NOW, AND THERE'S A FUTURE AHEAD FOR US IN RADIO.

... I will train you to start a spare time or full time **Radio service business Without Capital**



J. E. Smith, President National Radio Institute Established 1914

Many Radio Experts Make \$30, \$50, \$75 a Week

Do you want to make more money? The world-wide use of Radio sets has made many opportunities for you to have a spare time or full time Radio service business of your own. Three out of every four homes in the United States have Radio sets which regularly require repairs, servicing, new tubes, etc. Many sets are old and will soon be replaced by new models. I will train you to sell, install, service all types of Radio sets—to start your own Radio service business and build it up on money made in spare time while learning.

Get Ready Now for a Business of Your Own and for Jobs Like These
 Broadcasting stations employ engineers, operators, station managers and pay to \$5,000 a year. Spare time Radio set servicing pays as much as \$200 to \$300 a year—full time Radio servicing jobs as much as \$30, \$50, \$75 a week. Many Radio Experts own and operate full time or part time Radio sales and service businesses. Radio manufacturers and jobbers employ testers, inspectors, foremen, engineers, servicemen, paying up to \$6,000 a year. Radio operators on ships get good pay and see the world besides. Automobile, police, aviation, commercial Radio, and loud speaker systems offer good opportunities now and for the future. Television promises many good jobs soon. Men I trained at home have good jobs in all these branches of Radio. Read their letters in my 64-page book. Mail the coupon.

Many Make \$5, \$10, \$15 a Week Extra in Spare Time While Learning
 Extra Money Job Sheets. They show you how to do Radio repair jobs—how to cash in quickly. Throughout your training, I send you plans and ideas that have made good spare time money for hundreds of fellows. I give you special Radio equipment for conducting experiments and building circuits which illustrate important Radio principles. Your Training gives you practical Radio experience while learning.

Find Out What Radio Offers You—Mail Coupon Now
 Mail the coupon now for my Free Lesson and my book "Rich Rewards in Radio." Both are free to anyone over 16 years old. My book points out Radio's spare time and full time opportunities, and those coming in Television; shows my Training in Radio and Television; tells about my Money Back Agreement; shows you letters from men I trained, telling what they are doing and earning. Find out what Radio offers YOU! MAIL THE COUPON in an envelope, or paste it on a penny postcard—NOW!

J. E. SMITH, President, NATIONAL RADIO INSTITUTE, Dept. 7NB3, Washington, D. C.
 MAIL THIS. Get a Lesson and 64 page book FREE.

HERE'S PROOF THAT MY TRAINING PAYS

\$3,500 a Year in Own Business
 "After completing the N. R. I. Course I became Radio Editor of the Buffalo Courier. Later I started a Radio service business of my own, and average over \$3,500 a year."—T. J. TELAAK, 657 Broadway, Buffalo, N. Y.

\$10 to \$25 a Week in Spare Time
 "I am making from \$10 to \$25 a week in spare time while still holding my regular job as a machinist. I owe my success to N. R. I."—WM. F. RUTP, 203 Front Street, Conshohocken, Pa.



I GIVE YOU A PROFESSIONAL SERVICING INSTRUMENT
 Here is the instrument every Radio expert needs and wants—an All-Wave, All-Purpose, Set Servicing Instrument. It contains everything necessary to measure A.C. and D.C. voltages and current; test tubes, resistance; adjust and align any set, old or new. It satisfies your needs for professional servicing after you graduate—can help you make extra money servicing sets while training.

GET MY FREE LESSON on Radio Servicing Tips

I will prove that my training is practical, money-making information, that it is easy to understand—that it is just what you need to master Radio. My lesson text, "Radio Receiver Troubles—Their Cause and Remedy" covers a long list of Radio receiver troubles in A.C., D.C., battery universal, auto, T. R. F., superheterodyne, all-wave and other types of sets. A cross reference system gives you the probable cause and a quick way to locate and remedy these set troubles. A special section is devoted to receiver checkup, alignment, balancing, neutralizing and testing. Get the lesson Free. No obligation. Just mail coupon.



J. E. SMITH, President, Dept. 7NB3 National Radio Institute, Washington, D.C.

Dear Mr. Smith: I want to take advantage of your offer. Without obligating me, send me your Free Lesson and your book "Rich Rewards in Radio." (Please write plainly.)

NAME..... AGE.....
 ADDRESS.....
 CITY..... STATE..... 14x1

Please mention SHORT WAVE & TELEVISION when writing advertisers

IN THIS ISSUE: PROMINENT SHORT-WAVE AND TELEVISION AUTHORS

Priess • Menzel • DuMont • Shuart • Palmer • Adams • Miller

HUGO GERNSBACK
Editor



H. WINFIELD SECOR
Managing Editor

GEORGE W. SHUART,
W2AMN
Associate Editor

Combined With
Official SHORT WAVE LISTENER

Contents for December, 1937

Editorial—"Home Television—Its Commercial Promise," by William H. Priess.....	405
Can We Signal Mars by Short Wave?, by Dr. Donald H. Menzel.....	406
Associate Prof. of Astronomy, Harvard University.	
Ultra-Portable S-W Army Phone Set.....	408
Elaborate "World-Wide" Program Picked Up on Short Waves and Broadcast Over NBC Network.....	408
Europe Points the Way in Television, An interview with Allen B. DuMont.....	409
Secret S-W Phone Link to U.S.....	410
"Ham" Waves Link Brothers in U.S. and Africa.....	411
High-Frequency Heat Removes Gas from Tube Ele- ments, by E. G. Shower.....	411
Bell Telephone Laboratories.	
Short Waves and Long Raves.....	412
World-Wide S-W Review, edited by C. W. Palmer.....	414
Dr. J. M. B. Hard's Station a "Ham's" Paradise!.....	416
Rectifier D. C. Output Read from Graph.....	416
2-in-1 "Clock-Case" Receiver for the Beginner, by H. G. Cisin, M.E.....	417
A "Fixed-Band" 8-Tube Superhet for S-W "Fans", by Raymond P. Adams.....	418
Crystal Filter Gives RAZOR-SHARP Tuning on "S.W. & T." Communications Receiver, by George W. Shuart, W2AMN.....	420
What's New In Short-Wave Apparatus.....	421
\$5.00 For Best Short Wave "Kink".....	423
Let's Listen In with Joe Miller.....	424
World S-W Station List, Edited by M. Harvey Gerns- back.....	426
Question Box.....	427
Short Wave Scouts—Forty-fourth Trophy.....	429
How To Identify S-W Stations.....	431
A Desk-Type 10-80 Meter Transmitter, by George W. Shuart, W2AMN.....	433
Short Wave League—When To Listen In. by M. Harvey Gernsback.....	436

Certified Circuits



● **SHORT WAVE & TELEVISION** goes to a large expense in verifying new circuits. When you see this seal it is your guarantee that such sets have been tested in our laboratories, as well as privately, in different parts of the country. Only "Constructional-Experimental" circuits are certified by us.

When you see our certified seal on any set described, you need not hesitate to spend money for parts, because you are assured in advance that the set and circuit are bona fide and that this magazine stands behind them.

SHORT WAVE & TELEVISION is the only magazine that certifies circuits and sets.

OUR COVER

● THE ultra-portable short-wave army phone set shown on our cover this month is a product of English military engineering. As the picture shows, this is a complete transmitter and receiver and is operated by batteries self-contained in the radio pack. These portable military sets are of unusual interest today with the many military activities the world over . . . see page 408.

COPYRIGHT, 1937, BY H. GERNSBACK

Published by **POPULAR BOOK CORPORATION**

404 N. Wesley Avenue, Mount Morris, Ill.

Editorial and Executive Offices - - - - 99-101 Hudson St., New York, N. Y.
HUGO GERNSBACK, President - - - - H. W. SECOR, Vice-President
EMIL GROSSMAN - - - - - Director of Advertising
European Agent: Gorrings's American News Agency, 9A Green St.,
Leicester Square, London W. C. 2

Australian Agents: MCGILL'S AGENCY, 179 Elizabeth St., Melbourne

Features in the January Issue

- "Desk-Type, 10-80 meter Transmitter," Part 2, by George W. Shuart, W2AMN.
- Hi-Quality Portable S-W Receiver, by Raymond P. Adams.
- Electrical Uses for Radio Parts.
- Question Box for the S-W Listener, edited by M. Harvey Gernsback.
- Latest Television News.
- 5-Meter Transmitter.
- 9 People Now Talk Over Single Short Wave Circuit.

SHORT WAVE & TELEVISION—Monthly, Entered as second-class matter May 7, 1930, at the post office at Mount Morris, Illinois, under the act of March 3, 1879. Trademarks and copyrights by permission of H. Gernsback, 99-101 Hudson St., N. Y. C. Text and illustrations of this magazine are copyrighted and must not be reproduced without permission. **SHORT WAVE & TELEVISION** is published on the 1st of every month. Twelve numbers per year. Subscription price is \$2.50 a year in the United States and possessions and Canada. Foreign countries, \$3.00 a year. Single copies 25c. Address all contributions for publication to Editor **SHORT WAVE & TELEVISION**, 99-101 Hudson St., New York, N. Y. Publishers are not responsible for lost manuscripts. Contributions cannot be returned unless authors remit full postage. **SHORT WAVE & TELEVISION** is for sale at all principal newsstands in the United States and Canada. European agents: Brentano's, London and Paris. Printed in U. S. A. Make all subscription checks payable to Popular Book Corporation.

MANY OPPORTUNITIES FOR THE COYNE TRAINED RADIO MAN



Are You Ready for a Better Job—More Pay?

Don't be an untrained man. Let me show you how to get your start in Radio — a fast growing, live money-making industry.

Prepare for jobs as Assembler, Inspector and Tester—Radio Sales or Service and Installation Work—Broadcasting Station Operator—Wireless Operator on a Ship or Airplane or Sound Work — HUNDREDS OF OPPORTUNITIES for a real future in radio!

12 Weeks of Shop Training

We don't teach by book study. We train you on a great outlay of Radio, Television and Sound equipment—on scores of modern Radio Receivers, actual Broadcasting equipment, Television apparatus and Sound Reproduction equipment, Code and Telegraph equipment, etc. You don't need advanced education or previous experience. We give you — RIGHT HERE IN THE COYNE SHOPS — the actual practice and experience you'll need for your start in this great field. And because we cut out all useless theory and only give that which is necessary you get a practical training in 12 weeks. Mail coupon for all facts about my school and training methods.

TELEVISION *and* PUBLIC ADDRESS

Television is sure to come as a commercial industry. Rapid progress is now being made in developing this new field. It will offer opportunities to the man who is trained in Radio. Here at Coyne you learn Television principles, and work on actual Television equipment. Public Address Systems offer opportunities to the Trained Radio Man. Here is a great new Radio field which is rapidly expanding. Prepare NOW for these wonderful opportunities! Learn Radio Sound Work at COYNE on actual Sound Reproduction equipment. Not a home study course.

SEND FOR DETAILS OF MY "PAY AFTER GRADUATION" PLAN

Mail the Coupon below and I'll tell you about my "Pay After Graduation" Plan which has enabled hundreds of others to get Coyne training with very little money. On this plan you can get your training first, then take 18 months to complete your small monthly tuition payments starting 5 months after you begin training. Not a home study course.

Mail the coupon for all details of this "Tuition Payment Plan."

PRACTICAL WORK at COYNE in Chicago

ACTUAL, PRACTICAL WORK. You build and service radio sets. You get training on real Broadcasting equipment. You construct Television Receiving Sets and actually transmit your own Television images over our Television equipment. You work on real Sound equipment. You learn Wireless Operating on Actual Code Practice apparatus. We don't waste time on useless theory. We give you the practical training you'll need for your start in Radio—in 12 short weeks. If you desire code, this requires additional time for which there is no extra charge.

Mail Coupon Today for All the Facts

H. C. LEWIS, Pres. RADIO DIVISION Founded 1899

Coyne Electrical School
500 S. Paulina St., Dept. 97-2K, Chicago, Ill.

ELECTRIC REFRIGERATION AIR CONDITIONING AUTOMOBILE ELECTRICAL WORK

Instruction now included at no extra cost. Here is your opportunity to learn these valuable allied lines without extra tuition charge.

PART TIME EMPLOYMENT TO HELP YOU "EARN WHILE LEARNING"

If you are short of money and need part time employment to help pay for your room and board while training, my Employment Department will help you get a part time job.

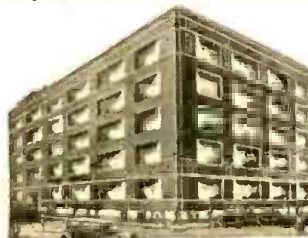

GET THE FACTS

Don't let lack of money prevent your sending in the Coupon. Mail the Coupon today and I Will send you the Big FREE Coyne Book full of FACTS.

H. C. LEWIS, Pres.

Radio Division, Coyne Electrical School

500 S. Paulina St., Dept. 97-2K, Chicago, Ill.

Dear Mr. Lewis:—Send me your Big Free Radio Book, and all details of your "Pay After Graduation" Plan including valuable instruction in Electric Refrigeration, Air Conditioning and Automobile Electrical Work.

Name

Address

City.....State.....

Please mention SHORT WAVE & TELEVISION when writing advertisers

NOW READY!

SEE this remarkable book at your dealer

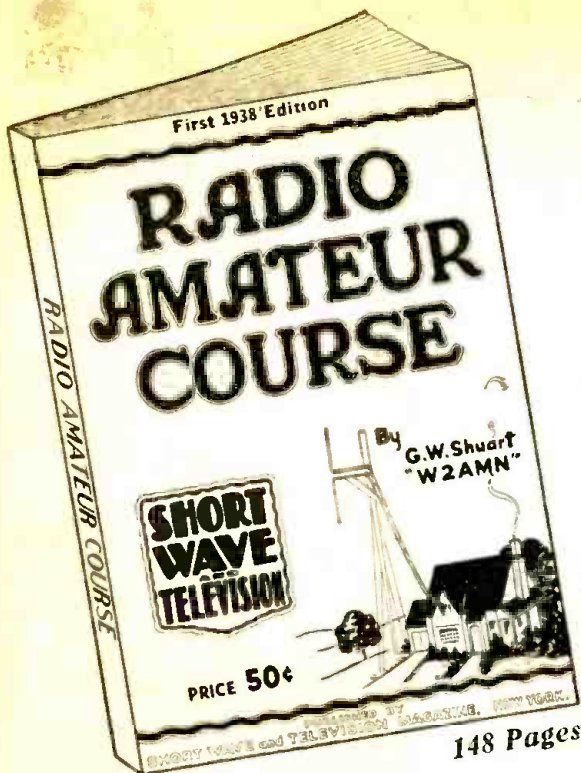

Glance over its 148 pages containing over 100 diagrams and cuts and read *step by step* how you can obtain the foundation of a *short wave radio education*

This book represents the biggest value you ever received for 50c

A new book that will appeal to tens of thousands—
An essential book for all beginners—
The foundation of a radio education.

Written by Geo. W. Shuart, W2AMN—
the authority on short waves

Your library is not complete without it

ON SALE AT THE FOLLOWING DEALERS

ARIZONA
Sam's Clear Store,
127 N. First Ave.,
Phoenix.

CALIFORNIA
Scott Wholesale Radio Co.,
344 E. Fourth Street,
Long Beach.
Offenhach Electric Co., Ltd.,
1452 Market Street,
San Francisco.
Zack Radio Supply Co.,
1426 Market Street,
San Francisco.

COLORADO
Auto Equipment Co.,
14th at Lawrence,
Denver.

CONNECTICUT
Radio Inspection Service Co.,
227 Asylum Street,
Hartford.
Stern Wholesale Parts, Inc.,
Stern Bldg., 210 Chapel St.,
Hartford.

GEORGIA
Wholesale Radio Service Co., Inc.,
430 W. Peachtree St., N.W.,
Atlanta.

ILLINOIS
Allied Radio Corporation,
833 West Jackson Blvd.,
Chicago.
Newark Electric Company,
226 W. Madison St.,
Chicago.
Wholesale Radio Service Co., Inc.,
901 W. Jackson Blvd.,
Chicago.

INDIANA
Van Sickle Radio, Inc.,
34 West Ohio Street,
Indianapolis.

MASSACHUSETTS
Greater Boston Distributors,
40 Waltham St.,
Boston.
H. Jappe Co., 46 Cornhill,
Boston.
Wholesale Radio Service Co., Inc.,
110 Federal Street,
Boston.
Springfield Radio Co.,
397 Dwight St.,
Springfield.
H. Jappe Co., 37 Mechanic St.,
Worcester.

MICHIGAN
Hiss Brothers, Inc.,
5027 Hamilton Ave.,
Detroit

MISSOURI
Modern Radio Company,
408 No. Third St.,
Hamilton.
Bursteln-Applebee Co.,
1012-111 McGee St.,
Kansas City.
Van Sickle Radio Co.,
1113 Pine St.,
St. Louis.

NEBRASKA
Radio Accessories Company,
2566 Farnam Street,
Omaha.

NEW HAMPSHIRE
Radio Service Laboratory,
1187 Elm Street,
Manchester.

NEW JERSEY
Wholesale Radio Service Co., Inc.,
219 Central Avenue,
Newark.

NEW YORK
Wholesale Radio Service Co., Inc.,
542 E. Fordham Rd.,
Bronx.
Wholesale Radio Service Co., Inc.,
90-09 166th Street,
Jamaica, L.I.
Blau, The Radio Man, Inc.,
64 Day Street,
New York City.
Federated Purchaser, Inc.,
23-25 Park Place,
New York City.
Harrison Radio Co., Eagle Radio Co.,
12 West Broadway, 84 Cortlandt Street,
New York City. New York City.
Terminal Radio Corp.,
80 Cortlandt Street,
New York City.
Thor Radio Corp., Sun Radio Co.,
65 Cortlandt St., 227 Fulton Street,
New York City. New York City.
Wholesale Radio Service Co., Inc.,
100 Sixth Avenue,
New York City.
Radio Parts & Equipment Co.,
244 Clinton Avenue No.,
Rochester.
M. Schwartz & Son,
710-712 Broadway,
Schenectady.

OHIO
Canton Radio & Supply Co.,
1140 Tuscarawas St., W.,
Canton.
United Radio, Inc.,
1103 Vine St.,
Cincinnati.
The Hughes-Peters Electric Corp.,
178-180 N. Third Street,
Columbus.

Standard Radio Parts Co.,
135 East Second Street,
Dayton.

OREGON
Portland Radio Supply Co.,
1300 W. Burnside St.,
Portland.

PENNSYLVANIA
Radio Distributing Co.,
1124-26 Market St.,
Harrisburg.
M & H Sporting Goods Co.,
512 Market St.,
Philadelphia.

UTAH
O'Loughlin's Wholesale Radio Supply,
315 South Main Street,
Salt Lake City.

WASHINGTON
Spokane Radio Company, Inc.,
611 First Avenue,
Spokane.

WISCONSIN
Radio Parts Co., Inc.,
536-538 W. State St.,
Milwaukee.

TEXAS
Amarillo Electric Co.,
111 East 8th Ave.,
Amarillo.

AUSTRALIA
McGill's Agency,
183-184 Elizabeth St.,
Melbourne.

CANADA
The T. Eaton Co., Ltd.,
Winnipeg.
Man.

Canadian Electrical Supply Co., Limited,
285 Craig Street W.,
Montreal, Que.
Metropolitan News Agency,
1248 1st Street,
Montreal, Que.

CUBA
The Diamond News Co.,
Palacio Asturiano, Por San Jose,
Habana.

ENGLAND
Gorringe's American News Agency,
9a. Green Street, Leicester Square,
London, W.C.2.

INDIA
Empire Book Mart,
Box 631,
Bombay.

MEXICO
American Book Store, S. A.,
Avenida Madero 25,
Mexico City.
Central De Publicaciones,
Avenida Juarez, 4. Apartado 2430,
Mexico, D. F.

NEW ZEALAND
Te Aro Book Depot Ltd.,
61 Courtenay Place,
Wellington.

SOUTH AFRICA
Technical Book Co.,
147 Longmarket St.,
Cape Town.

IF NOT AT YOUR DEALER'S, PLEASE SEND HIS NAME AND ADDRESS AND WE WILL CREDIT HIM WITH YOUR ORDER. PLEASE FILL OUT COUPON BELOW.

SHORT WAVE & TELEVISION. SW-12
99 Hudson Street, New York City.
Gentlemen: I enclose herewith my remittance for 50c. for which please send me my copy of the "RADIO AMATEUR COURSE" postpaid.

Name

Address

City State

Dealer's Name and Address

(Send remittance in form of check or money order. If letter contains cash or unused U. S. postage stamps, register it.)

Be sure to see future copies of Short Wave & Television for additional names of dealers handling this book.
SHORT WAVE & TELEVISION, 99 HUDSON ST., NEW YORK CITY

Please mention SHORT WAVE & TELEVISION when writing advertisers



HOME TELEVISION —Its Commercial Promise

By William H. Priess

President, International Television Radio Corporation.



Wm. H. Priess, well-known American radio and television engineer.

● VIEWED from the mere base of pure science, television has been an astounding success. Beautiful large action pictures have been sent and received thru space. The equipment employed in these demonstrations was built regardless of expense. Its only purpose was to show what could be accomplished. In it was jelled the product of the thought of many brilliant minds in the various fields of science.

Experience has shown us, however, that there is a very wide gap between an achievement in pure science and the successful commercial utilization of the new knowledge. In the era of the "gay nineties," Blondel, the world's foremost high wire artist, crossed over Niagara Falls on a slender steel cable carrying a man on his back. The feat was widely acclaimed. But it was not until a stout bridge was thrown across the river, that traffic could move commercially over this gap between the two great countries. In a sense the bridge might be called a commercial embodiment of Blondel's perilous pioneer crossing.

We do not need to be convinced that acceptable action pictures can be sent and received through space. This rabbit has long ago been plucked from Nature's hat. The one big problem that faces us is to make home television commercial.

Commercial success of an enterprise is measured by the degree with which the public utilizes the device or service. Apply this test to television. Immediately we are confronted with the all-important questions of cost and performance by which the public judges a product or service. And remember, without general public approval there can be no successful commercial home television. Therefore let us visualize the expressed or dormant mental picture of a television set that lies in the mind of the public—necessarily, of course, a set that the "man in the street" would be willing to buy.

In the first place, we can eliminate questions that affect the transmitter, for our neighbors do not bother to think about such matters. Furthermore, our average public is but mildly interested in the technical "innards" of the receiving set. What he wants is a set that will produce a

picture about the size, quality and brilliancy of a home motion picture and at a cost that will be met comfortably by the average family budget. Naturally he expects to find suitable programs. Programs need not concern us now, for the public is genial and sympathetic to the early efforts of the broadcasters in their cut-and-try attempts to please.

This simple definition of acceptable television erects a rigid narrow doorway through which each system must make a supreme effort to pass. This is the doorway that opens from the limited confines of laboratory curiosities, to the broad limitless vista of commercial utility and success. Place this gauge in the path of many of the highly publicized television projects, and the conclusions reached are devastating.

There are two outstanding systems before the public eye. The older is the Nipkow rotor in miriads of forms. The other is the Braun cathode ray tube system, likewise in many variations. Most of the television engineers, and practically all of the money they have spent on research to date, are in these two schools. It is safe to say that each has achieved the approximate limit of its perfection, that each has had adequate funds for development, and that each can only hope for comparatively minor improvement due to their respective inherent limitations imposed by the basic principles they employ.

The Nipkow system can produce a picture comparable to a home motion picture, but it is being abandoned, for the cost of such a receiving set is so high that it cannot be considered commercially.

The cathode ray system produces either of two types of pictures. The first or less expensive is *painted* on the end of a cathode ray tube by an electron stream. Obviously there is a limit to the size of the tube and its picture imposed by the atmospheric pressure of fifteen pounds an inch on the walls of the evacuated glass vessel. A picture a foot square would have a pressure on the flattened glass end in excess of a ton. The cost of a receiving set to produce a picture this size is beyond the (Continued on page 440)

Twelfth of a Series of "Guest" Editorials

SHORT WAVE & TELEVISION IS PUBLISHED ON THE 1st OF EVERY MONTH

This is the December, 1937 Issue.—Vol. VIII, No. 8. The Next Issue Comes Out December 1

SHORT WAVE & TELEVISION, Published monthly at Mount Morris, Ill.
EDITORIAL and EXECUTIVE Offices, 99 Hudson St., New York City

Can We Signal MARS

The Possibility of Interplanetary

Including the Views of Dr. Lee de Forest and Nikola Tesla

● THE possibility that intelligent life exists somewhere else in the universe than on earth is an intriguing subject. The possibility that we might in some way or other achieve intelligible communication with some other planet is even more exciting. The astronomer, in replying to questions about life in the universe—and scarcely a week passes but that he meets the query in some form—is forced to rely on cold scientific facts. He does not believe in the validity of the argument so frequently advanced: that the earth, being so insignificant, could hardly have been selected as the only place in the universe for the development of life. This argument proves nothing. One might quite as logically reason in the reverse direction, and say that man is so much more insignificant that the presence of life is an improbable accident that could scarcely happen twice in an otherwise well-ordered universe.

When we approach the problem of possible planetary life and interplanetary communication scientifically, we are forced first to study (even if we cannot answer) the question "What is life?" On the earth, we find a multitude of living organism, ranging from minute single-cell organism bacteria to the highly complex *homo sapiens* (man). If we limit the consideration to intelligent life, then the problem becomes still more difficult. There is no simple way of finding an answer, especially for those people for whom "seeing is believing." No telescope yet built or under construction is sufficiently powerful to show the form of even the largest mammal, even if it were located on as near an object as the moon. Meteors and meteorites, our only direct messengers from space, have shown no evidence of the existence of living organism beyond. Our

approach obviously, must be indirect.

What Is Necessary to Support Life?

First of all, we may survey the known planets and regard the relative likelihood of their being inhabited. There is one prime test for the existence of life, as we know it, on the earth; the existence of liquid water. Water, apparently, is the one most important constituent of all cells. Oxygen is not necessary, since plants exist on carbon dioxide. Not even carbon is absolutely necessary, since certain bacteria have been found that are composed chiefly of sulphur. Presumably, however, carbon would be necessary for any higher form of life, owing to the peculiar chemical property of that element in being able to string itself together with atoms of oxygen and hydrogen into long and complex chains to form protoplasm cell-base. But water, in the liquid state, is absolutely necessary. Water, because of its peculiar physical and chemical properties, could not be replaced by any other solvent.

Consequently, when we wish to examine the possibility of the planets' being inhabited, we must first investigate whether liquid water could exist on their surfaces. For that reason, both the moon and Mercury can be dismissed. Both of these bodies are too hot on their sunward side and too cold on the night side. We may also dismiss the smaller planets, the asteroids, which are so small that water would have completely disappeared from their surfaces. Jupiter, Saturn,

liquid air. We could have dismissed these major planets on other grounds, mainly the presence of such gases as ammonia and methane in their atmosphere, which would not be very conducive to the existence of life.

Mars and Venus

In the solar system there remain, aside from the earth, only two possibilities—Mars and Venus. Of these, Mars has been the most publicized concerning the possibility of its being inhabited. We can study Mars much more readily than we can Venus because the atmosphere of Mars is very thin and our telescopes can penetrate to its surface. From the meager observational data at our disposal, we can construct the following picture of the surface of Mars. Most of the planet consists of bare red rock, possibly broken, and possibly red sand. I like to think of this condition as approaching that of our painted desert in Arizona. At either pole of the planet we find water, congealed in the form of hoar frost. These polar caps dwindle in size with the Martian summer and consequently we have reason to suspect that liquid water is present on certain portions of the planet at some time during the year.

There, are,

also, dark markings, most prominent in the neighborhood of the Martian equator. The most surprising fact

is that these dark markings change in size and also in color with the season. Sometimes they are grey-green and at other times brown. The changing form and coloration could, perhaps, be explained as the result of natural causes. It has been suggested, for example, that the changes are due to the presence of dust which, on absorbing water, changes its reflecting power. This explanation is entirely reasonable, but I prefer to account for the changes as the result of vegetation. We can give no picture of Martian vegetation as the Martian himself would view it. We do not know whether the vegetation is in the form of trees, shrubbery, or merely minute organism like algae. Of course, where vegetable life is found, animal life may also occur, but the general consensus of opinion is that no very high degree of intelligent life exists in our solar system.

The planet Venus presents another possibility. It is completely covered with clouds so that our telescopes cannot penetrate to the solid surface—if, indeed, it has a solid surface. It is conceivable that the entire surface of Venus is covered by an ocean. But our conclusions are mere conjectures and based on no rigorous scientific reasoning, save the fact that the terrestrial continents seem to have risen more by

Uranus, Neptune, and Pluto may also be removed from the realm of possibility. These planets, being so far from the sun are all too cold for water to exist in the liquid state. The temperature that has been found for Jupiter, the planet nearest to the sun of this group, is more than a hundred degrees below zero centigrade. The temperatures of the other planets are not far from that of

The picture at the left indicates that a veritable "power-house" would be required in order to transmit a readable short-wave signal to a planet such as Mars. Experts compute that probably 50,000 kw. would be required to send such a signal. A specially designed beam antenna would also be necessary.

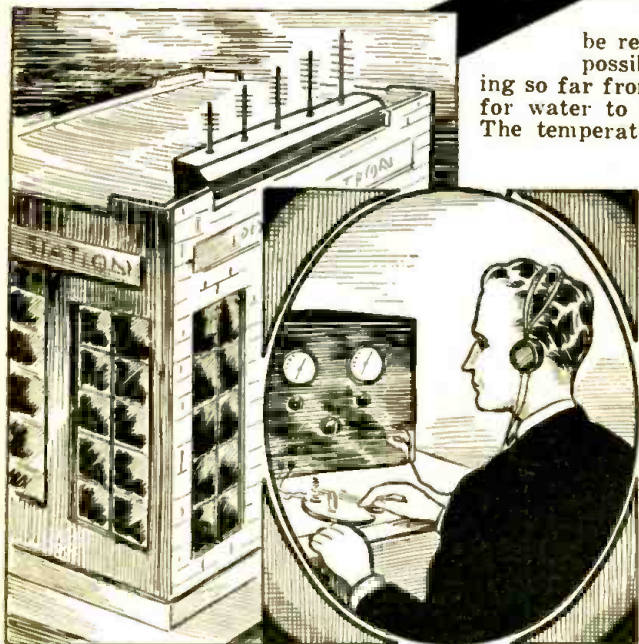

by Short Wave? Communication

By Dr. Donald H. Menzel

Associate Professor of Astronomy, Harvard University.

● The question of radio-communication with distant planets still holds supreme charm for all red-blooded radio experimenters. First, of course, is the question of the possibility of life existing on such planets as Mars, and we have asked the well-known authority, Dr. Menzel to answer this question. The amount of radio power required would probably be about 50,000 kilowatts; the wavelength possibly as low as one centimeter (four-tenths of an inch).

accident than by design. The atmosphere of Venus contains an abundance of carbon dioxide and no traces of oxygen have been found. Since vegetation on earth lives on carbon dioxide and gives off oxygen as a by-product, we might infer that plant life, as we know it here, does not exist on Venus.

As for life elsewhere in the Universe, no scientific data are available. We do not know whether planets are the exception or the rule. If planets are born as the natural genesis, as astronomers once thought, then the Universe might contain many abodes of life. But if the planets are formed as the result of a collision or a near collision of two stars, then planets must be rare, and life, accordingly an even rarer phenomenon.

Dr. Lee de Forest's Opinion on Signalling Mars

● IT has been quite conclusively demonstrated that ultra short radio waves, in the neighborhood of 5 meters or less, are ordinarily not reflected by the Heaviside-Kennelly and other refracting layers of the upper atmosphere but ordinarily traverse these. Especially is this true if the wave is directed vertically.

It is therefore probable that such ultra high frequency waves can be directed by means of a parabolic reflector in the direction of Mars, when that planet is near the zenith. The question then is—how much power would be required to transmit signals from such a source to the distance of Mars from the Earth?

Then comes the question as to whether or not the weak signals arriving could penetrate the very dense atmosphere surrounding Mars. Then admitting that a certain extremely small fraction of all projected energy should penetrate the Martian atmosphere, have the inhabitants of Mars a sufficiently sensitive detector and amplifier system to pick up these Earth signals? A yet more important question is whether or not Mars is inhabited by intelligent beings. Current astronomical evidence and opinion now seem to be overwhelming against the probability of there being any such life on Mars; however, there is sufficient contrary opinion to permit us to indulge, from time to time, in such idle speculation as I have here set down.

It seems certain that if Martians exist and are attempting to signal the Earth, there is not the slightest evidence of this fact.

If Radio Signals from Space Were Received—What Then?

The chances are, that radio messages to outside space can bring in only one reply: "Nobody home." But if we should, at some future date, receive bonafide radio signals from outside the earth, what then? We could absolutely verify their extra-terrestrial character and perhaps even determine the actual source by means of direction finders. But could we hope to read the messages and enter into intelligible communication with beings on a distant planet? The archaeologists who read the Maya inscriptions had the advantage of knowing something of their origin, and especially of seeing drawings associated with the writing to indicate something of the nature of the text.

Don't fail to read Joseph Richey's technical analysis of the probable power required to send a signal to Mars. See page 452.

A message has come to us, to be definite, let us say, from Mars. It consists of dots and dashes. Phone would be of no advantage and interplanetary television unlikely in the early stages of communication, at least. We have recorded the message, have built powerful sending stations with directional antennae. Our own message to them has been repeated, although we know that it is unintelligible to them. But we understand that they hear us. How can we proceed to communicate with beings that have nothing in common with us earth-dwellers?

Nothing in common? That statement is clearly untrue. If we are in communication with one another, both

(Continued on page 450)



Fig. 1, above, shows drawing of Mars as it appeared on August 22, 1934; drawn by R. J. Trumpler of the Lick Observatory. This drawing shows the line-like "canals," the existence of which was suggested by the well-known astronomer, Percival Lowell, as evidence for "Life on Mars." Astronomers have not generally accepted Lowell's conclusions.

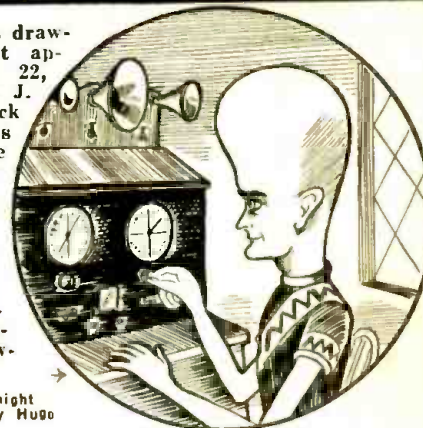

At right—What a Martian might look like, as visualized by Hugo Gernsback.

Nikola Tesla's Opinion On Martian Communication

● NIKOLA TESLA, one of the greatest electrical and radio inventors of all time, recently made the statement that he believed that he had heard signals from a distant planet, nearly forty years ago.

In about the year 1899, he was making a series of careful listening tests on short waves, when he heard a series of signals which had a peculiar measured cadence, and which were repeated many times. Dr. Tesla's interpretation of these signals was that they spelled out—"1-2-3-4," etc. It is his opinion that if these signals had been sent by Martians, they had used numbers in an attempt to establish communication with the earth, for the good reason that numbers constitute a very broad universal language.

Dr. Tesla was one of the earliest investigators of short-wave phenomena, and, about fifty years ago—even before the year 1890—he was producing short-waves in his electrical demonstrations by means of his high-frequency Tesla coil. Without a shade of doubt a great part of the credit of the early establishment of radio should go to Dr. Tesla. His early patents and scientific papers establish a record of the remarkable work he did long before the dawn of the century. His opinion on the possibility of communicating with Mars is, therefore, of more than usual interest.

Ultra-Portable S-W Army Phone Set

This Month's Cover



The latest ultra-portable phone set for military use; it comprises a short-wave transmitter and receiver. H.R.H. The Princess Royal is shown inspecting this new type field radio equipment at Aldershot, England, during an inspection visit.

● SHORT WAVE and ultra-short-wave portable sets are being used to maintain contact between various groups of soldiers in many parts of the world at the present time. The accompanying picture shows an interesting two-way, ultra-portable battery transmitter and receiver being carried pack-aback, as used in the British army. The picture shows H.R.H. The Princess Royal, inspecting this new type of short wave transmitter-receiver at Aldershot, England, when she paid a visit of inspection to the Royal Signal Corps. The battery, tubes, coils and tuning condensers and other apparatus comprising the transmitter and receiver are housed in the small square box carried on the back. The aerial is enclosed in the semi-circular tubes at the top and bottom of the horizontal cabinet. The operation of switching from *transmit* to *receive* is carried out by means of a hand-operated switch-button mounted on the belt.

The American and other armies, have been quick to adapt short-wave sets operating on 60 mc. or 5 meters, and other similar frequencies, these sets being well adapted to the very compact construction necessary, and at the same time provide a range of 5 to 10 miles under good conditions; all with battery-operated tubes.

The previous models of portable army radio sets were generally equipped with hand-operated dynamos and while they were portable, it required several men to operate them, two of the men taking turns at spinning the dynamo with a hand-driven gear.

No matter in what part of the world one happens to inspect military radio equipment today, whether it is with the Japanese, or whether it is with one of the factions fighting in Spain, or again in the great army of the U.S.S.R., these ultra short-wave sets will be found plentifully sprinkled through the signal corps units.

As our front-cover picture shows, officers in advanced positions can today give orders rapidly "right on the spot" and often turn a bad military situation into a victorious one. The type of receiver used for (Continued on page 441)

Elaborate "World-Wide" Program Picked Up on Short Waves and Broadcast Over NBC Network

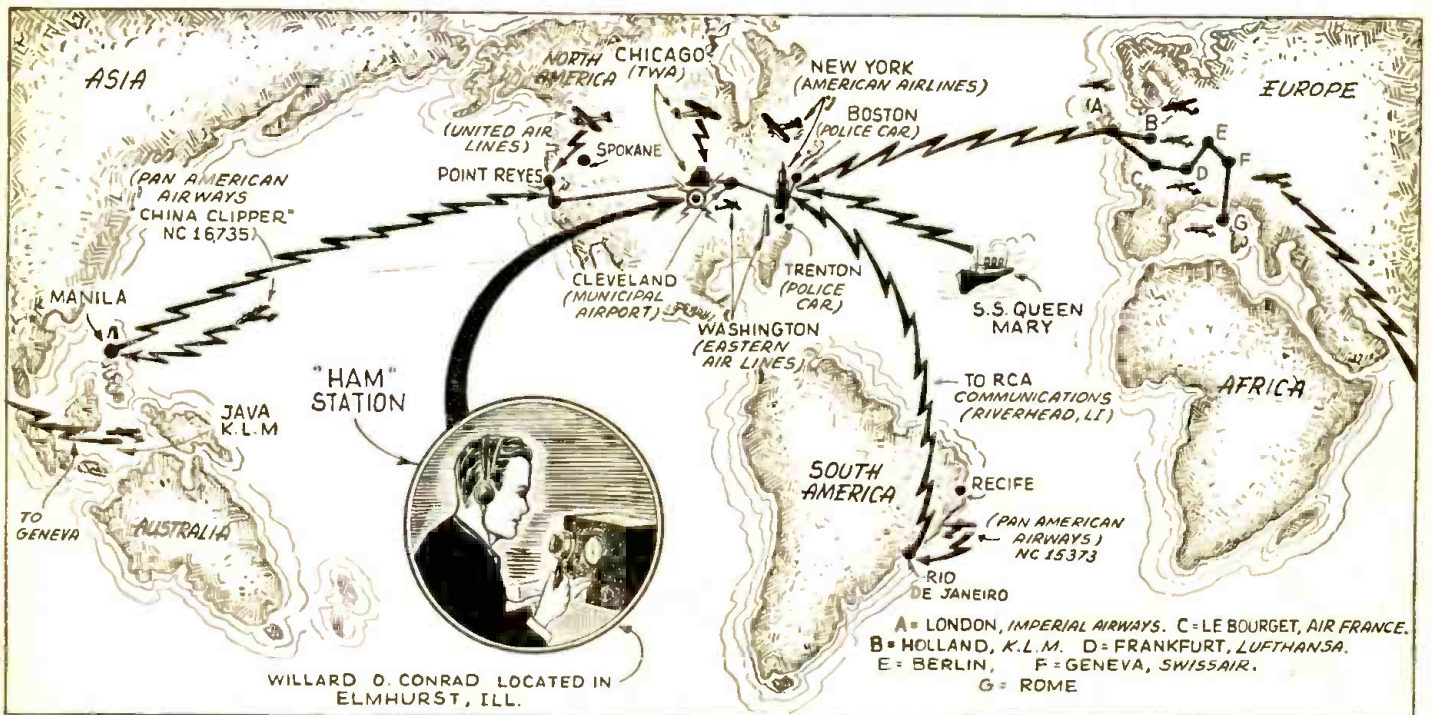

● THE illustration above shows diagram of radio operations performed on a recent occasion when the RCA had a world-wide Magic Key program. A short-wave "Ham" station figured in the broadcast and this station was operated by Willard O. Conrad of Elmhurst, Ill. Other features in the program picked up via short-wave and heard over the NBC network, were conversations from planes of six nations, in

addition to programs from planes of five of the leading airlines of the United States, the police department of Boston, and the police and fire departments of Trenton, New Jersey. Part of the program picked up by short-wave was from the famous steamship *Queen Mary*. As the map shows, other distant points heard by the American listening audience were—Rio de Janeiro, Rome, Berlin, Manila, etc.

EUROPE points the way in TELEVISION

An Interview with Allen B. DuMont

Mr. DuMont, recently returned from Europe, says that Actions, Rather Than Words, Characterize the Status of Television in European Countries

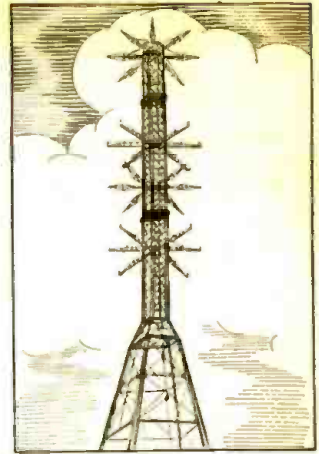

The transmitting antennas for both vision and sound, atop the steel tower on Alexandra Palace, London, now famous as the first commercial television broadcaster on a regular daily schedule.

● Smart people, these Chinese. One of their ancient philosophers once pointed out that *one picture is worth ten thousand words!* He might well be summing up our present television situation. For the tens of thousands of words and statements and promises we have had these past few years do not begin to equal a *single* television picture.

Instead of the hush-hush and tut-tut and the "just around the corner" theme so frequently expressed by those guardians of the closed laboratory doors, an everyday television program would, in a year's time, far surpass the progress which can possibly be made in ten more years of laboratory blind man's buff. After all, nothing takes the place of everyday usage. Ask the automobile industry or telephone or broadcasting and others. They know.

Thus Allen B. DuMont, pioneer worker in the cathode-ray tube and equipment field, with television for the time being as a side line, expressed himself as we faced him after his return home from a study of television in England, France, Belgium and Holland. We sat in his Upper Montclair (N.J.) office, surrounded by the extensive laboratory and plant he has built up these past seven years. We were among cathode-ray tubes and oscillographs in the making, undergoing tests, and being shipped to all parts of the world. In an adjacent darkened room were several television receivers, including the latest *home models* from England, which have been receiving the programs of the Empire State Building's experimental television transmitter with a wealth of detail and entertainment

value that leaves little to be desired. We were impressed by the fact that it is but a step from the serviceman's oscillograph to a television receiver, albeit a mighty difficult step to take by anyone but a specialist in the idiosyncracies of this funnel-shaped glass-ware.

"I can't help being outspoken about our American television situation," stated Mr. DuMont with visible impatience. His youthful appearance clashes with his many achievements in the electric lamp, radio tube

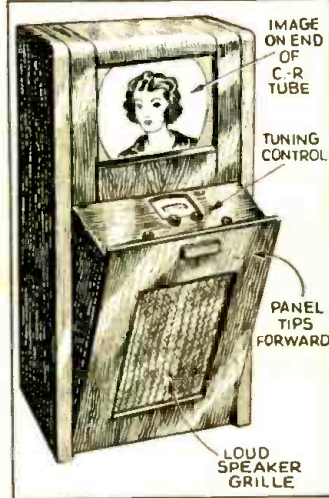

One of the newest models of Baird (British) television receivers. Note that the bottom panel swings out to expose the tuning controls. Images are observed on the end of cathode ray tube.

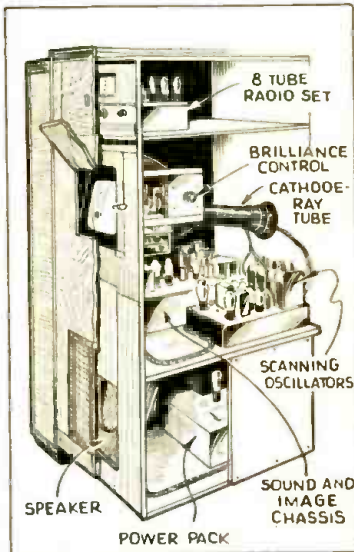

television and other fields.

10,000 Television Sets in London

"After seeing actual programs—real pictures packed with genuine entertainment value—on a daily schedule in England; after learning that some ten thousand television sets are already in daily use there; after talking with British manufacturers about their plans for the mass production of television sets beginning this fall—well, I feel we in America are just dropping by the wayside.

The G.E.C. (British) television receiver which includes an all-wave radio set; a forerunner of what we shall have in the U.S. presently.

A recent Baird model television receiver with phonograph included. With "broadcast" band added; such sets will prove popular.

"Now don't misunderstand me, I'm not jumping at hasty conclusions. No one knows better than I do the tremendous difference between the *tax-supported* broadcasting setup in European countries, and our *commercially-sup-*

ported situation. Nor do I overlook the extreme compactness of European broadcast service areas and audiences, where a 50-kilowatt transmitter can readily serve an entire nation.

"But the fact remains that we have every bit as good television equipment and practice here as have the Europeans. We know as much as they do regarding the technique—and probably more. But while the Europeans have gone ahead and put television over, we still keep on talking and promising and stalling. —I can't see it!"

American Television Should Start Regular Programs

Television, points out this authority—who was responsible for the technical and entertainment phases of our first sight-and-sound station on a regular program basis—Station W2XCD of Passaic, N.J. (which was on the air in the early 'thirties), is an evolution and not a single invention. It is a development that must come out of practical experience. Kept in the laboratory for another few years, our television workers will still lack the *right* answers relative to technique, scanning standards, program preferences, service areas, networks, economics and so on. Those answers can only come out of practical, everyday experience. So the sooner American television goes on a regular program basis, with television sets and programs available to the general public—regardless of how crude and no matter what the immediate obstacles may be—the sooner we are going to realize *practical* television.

"I was pleasantly surprised to see the British Broadcasting Corporation operating a television station in the Alexandra Palace, overlooking London. The Palace is surmounted by a mast about 300 feet high, or a total height of about 600 feet for the aerial. The 17 kw. television transmitter sends out its television (Continued on page 448)

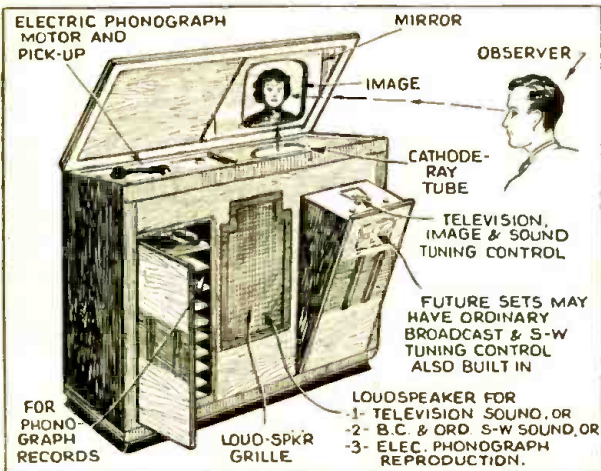

France Inaugurates

Secret S-W Phone Link to U. S.

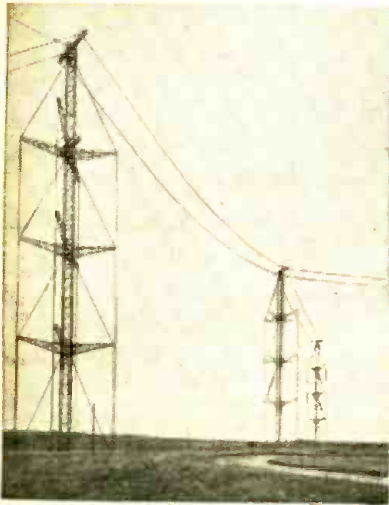

Above—Part of the elaborate antenna system used at the new French S-W station at Pontoise. The station operates with specially beamed directional antennas, which consist of capacity-coupled dipoles operating on one-half wavelength. The wavelength used may be changed according to the time of day and the season, the different wavelengths being available by simply pushing a button. Short-wave contact between France and the United States is practically guaranteed with the aid of this powerful station.

Interesting details of the new French short-wave station at Pontoise, which represents the very latest design. It is rated at 14 kw. on phone and up to 500 words per minute can be transmitted.

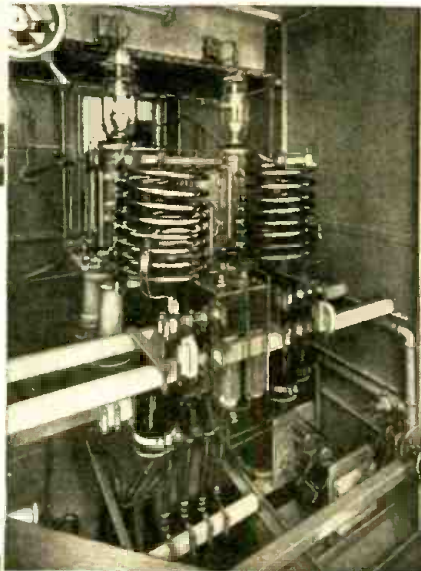

Above—A view of part of the system of elaborate filter circuits, built into panels, which are used to scramble or mix-up the speech frequencies, in order to prevent their being picked up by the average S-W listener.

Left—A close-up of the output stage of the new 14 kw. transmitter at Pontoise. The transmitter is rated up to 20 kw., when C. W. or code is to be used.

Below—In the background of this photo we see the transmitter control panel; at the extreme right and left we see the pre-amplifiers for phone transmission.



The picture at the left shows the "line" amplifiers. Each one of the four amplifiers is connected with cable lines leading to various parts of France. These V.T. amplifiers boost the speech level for incoming or outgoing voice frequencies passing over the lines, thus overcoming losses in the circuits.

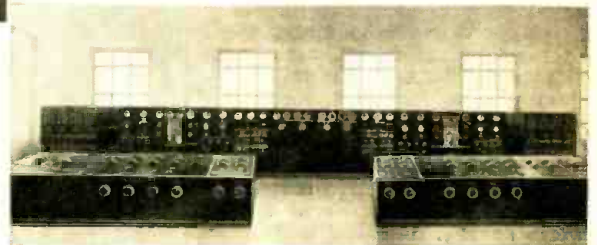

● AN especially interesting short-wave station, which may be considered as the last word in European short-wave transmitter design, has recently been inaugurated in France. The new French station is located at Pontoise (Seine-et-Oise), and has an output power of 14 kilowatts for telephony, or 20 kilowatts in case telegraphy is to be transmitted.

The main feature of this new station, which has been designed as a direct radio-telephone link to America, is its extremely flat audio response curve. The French designers (*The société Française Radio-Électrique*) claim that all audio frequencies between 50 and 11,000 cycles are radiated without appreciable attenuation. This faculty places the new station in the class of the few short-wave stations which are actually able to radiate real *high-fidelity* transmissions.

Another interesting detail of design is the control unit applied to keep the frequency of the transmitter constant. Here also the designer has tried to sur-

pass the design of the average short-wave station at present in use. The control crystal has been inserted in an insulated box, which is either electrically heated or cooled.

A thermostat installed in this box controls, through an extremely sensitive relay, the heater unit or respectively the cooler unit. This control apparatus operates so precisely as to guarantee an absolutely uniform transmitter frequency, which will not vary more than 1/100,000th cycle per second.

The transmitter itself is symmetrical-ly designed, and is modulated by means of a push-pull transformer stage. In case telegraphy is to be radiated, this modulator stage is automatically disconnected from the transmitter at the very moment the operator touches the key.

It may be of interest to note that up to 500 words per minute may be transmitted by means of an automatically operated recorder using the system devised by Baud. A very desirable feature for the users of this radio-telephone

link to America is the precaution taken to keep the phone conversation over the Atlantic secret.

In order to do the trick the following principle has been applied. A part of the speech frequencies are "cut out" by means of an ingeniously designed system of filters. These "frequency-cuts" are fed (but in reversed manner) into the modulator stage, and as a result an unintelligible mixup of speech-frequencies is radiated.

Similar filter circuits (respectively inverter units) are applied at the American reception station in order to re-arrange the speech frequencies in their natural sequence. Since the speech frequencies arriving at the French end of the transmission have been previously "mixed-up" in America a similar "clear up" system is used at the French reception station.

Elaborate precautions have been made to prevent accidents in case tubes must be changed or routine check-ups are to be made. The opening of any of the doors leading (Continued on page 461)

"Ham" Waves Link Brothers in U. S. and Africa



● AT the missionary station in Coquilhatville, deep in the Belgian Congo, Africa, the loud speaker thundered, and Dr. Wescott adjusted his short-wave receiver. "Hello, OQ5AA . . . W8FHE . . . Hello, OQ5AA . . . Hello, OQ5AA . . . Have you got me? Have you got me, Doctor?" the speaker kept repeating.

(Rev. Frederick Rowe had come down from remote Tonda with his wife and their daughter; Elizabeth, 4, to spend his vacation with Dr. G. W. Wescott, head of the Baptist Mission Station at Coquilhatville, Belgian Congo. Dr. Rowe is a missionary of the Christian Church. Cleveland is Dr. Rowe's home. Dr. Wescott is the possessor of a short-wave radio transmitter.

Dr. Rowe talked with his brother, John Rowe, who sat in the study of Harold W. Abell in the Abell residence at 14316 Ashwood Road, Shaker Heights, Cleveland, O.)

John Rowe sat at Abell's side as Abell repeated his call letters, sitting at his microphone in Shaker

John Rowe about to talk with his brother in Africa via amateur short-wave station of H. W. Abell (right).

Heights, Cleveland, Ohio. Abell spoke in a matter-of-fact tone and looked out of the window. Presently he stopped sending, and sat awaiting the reply.

For a little the sounds that came from Abell's speaker were indistinguishable, then the voice of Dr. Westcott, sitting at a missionary station in the Belgian Congo, remarked. "I do not get you very well. Change your frequency."

Abell followed instructions. There was more mutual adjusting of frequency. Rowe was fidget-

ing. He had not heard his brother's voice for two years. Abell moved aside and gave Rowe the mike.

"Hello, Fritz," called Rowe somewhat nervously. "I thought I was hard-boiled about this kind of stuff, but when I heard Africa I changed my mind. Well, how are you?"

"I wonder if you could repeat (Continued on page 457)

High-Frequency Heat Removes Gas from Tube Elements

By E. G. SHOWER

Vacuum Tube Development, Bell Telephone Laboratories

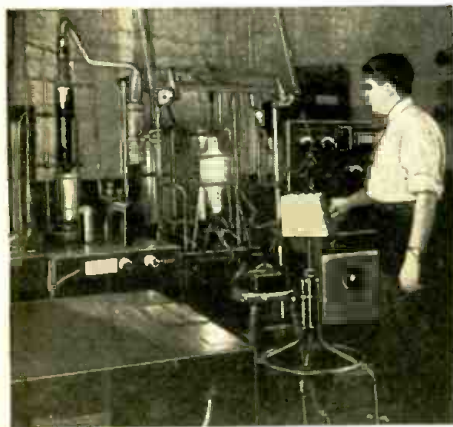

High-frequency heater in use for degassing vacuum tube elements while pumping.

ing the parts before and during the pumping operation.

Materials which go into a tube can be classed roughly into two groups, conductors and insulators. The insulators must be heated by conduction or radiation, as, for example, the glass envelope, which is heated at the beginning of the evacuating process by an electric oven fitted around the outside of the tube. The insulators used inside the envelope are degassed previous to assembly, or during evacuation by conduction or radiation from parts which are adjacent to them.

The conductor class of materials can be heated by two additional methods; namely, *electron bombardment* and *high frequency induction*. As the name of the first process implies, the part is bombarded with high velocity electrons which give up practically all their energy to the bombarded surface, thus heating it to the desired point. However, the bombardment process necessitates, first, a source of electrons sufficient to supply the required amount of energy, and, second, a geometrical arrangement whereby the electrons will travel in essentially straight lines and still be made to strike the surface of the material to be heated. In general, the second condition cannot be fulfilled for all of the internal parts of a vacuum tube. In some cases the filament could not safely emit a sufficiently large electron current to develop the required temperature. In other cases the part to be heated is isolated either electrically or mechanically in such a way as to preclude heating either by conduction, radia-



The fifteen-kilowatt oscillator employs a manually operated tap switch for adjusting the output.

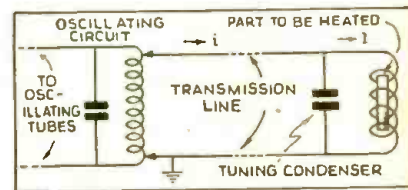

By employing a condenser at the pumping station to tune the heating coil, only a small current is transmitted over the line.

● ALL materials which eventually go inside a vacuum tube will absorb into their mass and absorb onto their surface a considerable amount of gas when they are at atmospheric pressure and temperature. Under the low pressures and high temperatures found in vacuum tubes during operation, the amount of these gasses which can be held bound is much less. If a tube were rapidly pumped without heating, the excess gasses would come out of the elements, slowly while the tube remained cold and rapidly as soon as it was placed in service. So many molecules thus appearing inside the envelope would be ionized by collision with electrons that the tube would not function properly and a destructive arc might strike between the elements. These facts were discovered early in the high vacuum art, and means were provided to drive off the gasses by heat-



An interesting short-wave amateur station in far-off Siam. The author appears at the left.

Did You Hear This HAM Station in Siam?

Editor, SHORT WAVE & TELEVISION:

I am a regular reader of *Short Wave & Television*, which is the most popular radio magazine in Siam, and as I have seen pictures of radio amateur stations in this magazine regularly, I hope that you and your readers may welcome a rare picture of Siamese Ham station in *The Jewel City of Asia*.

The picture here shows the operating room of 3 Siamese amateur stations: HS1BJ, HS1PJ and HS1RJ, at Saladeng, Bangkok. The HS1BJ transmitter is at the extreme left of the operating desk, using a 59 as tri-tet xtal oscillator, a 10 as FD or PA for 14 or 7 mc. respectively and plate voltage of 300. (I first saw the circuit for this kind of oscillator in your magazine and it encouraged me to try this FB circuit later on.) The power in the voltage-fed Hertz antenna (21 m. long Zepp.) does not exceed 5 watts, yet I have successfully contacted many W6. 7 stations with RST 58/99x reports, and some W9, G, F8, with FB results, hi! (A PA unit for this small xmtr, using a 203A, is under construction, and it will increase the power to 50 watts at least. (Continued on page 463)

SHORT WAVES and LONG WAVES

Our Readers Forum

HE HEARD 4,500 AMATEUR STATIONS!

Editor, SHORT WAVE & TELEVISION:

Have been in the DX game for about seven years now, and I am glad to be able to say that I still get a big kick out of hauling in a VK or ZT.

In this period I have yanked in 700 broadcast band stations, 158 short-wave broadcast stations, and about 4,500 amateur phone stations! I have verified over sixty countries.

I wish you would put a paragraph in your very FB magazine asking dxers in all parts of the world to drop me a line, as I sure would like to spill the old blarney with the *faithful*, both at home and abroad. Anyone who desires an SWL card should just drop me a line or send their card along. If a picture is wanted, (to keep the nice out of the cellar!), I will be glad to oblige in return for one of theirs.

I am 21 years old, and say if any SWL or YL comes across this, I sure would like to hear from them—purely in the interests of radio. "Hi!"

Well O.M. I had better cut out this daffy rambling and say 73.

Radiospectfully yours,

STAN ELCHESHEN,
"The Sleepless Knight"
801 Literary Road,
Cleveland, Ohio.

WANTS S-L-O-W-E-R ANNOUNCEMENTS!

Editor, SHORT WAVE & TELEVISION:

Help! Help! Can't something be done about those Spanish-speaking stations. I sit for hours trying to identify them, but no luck. The suggestion in your October issue is very good. They surely could use a record in English, and identify themselves at least every half-hour! What good is a short-wave station if it cannot be identified in foreign countries?

I believe I have another good suggestion. If all stations would identify themselves as the U. S. Stations do, it would be a great help. For example, "This is short-wave station W2XE," etc. Even if you are unable to understand the speech in a foreign language, or if the reception is not clear, as soon as you hear the words *short-wave station*, which might even be understandable in a foreign language, you make a special effort to get the call letters. And then—if they would only give the letters s-l-o-w-l-y! It seems as if all announcers

are in a great hurry; even the U. S. announcers.

I have several friends who have All-Wave sets and they have the same difficulty as I do, and I believe the condition is general throughout the world.

At the present time I have ten Spanish-speaking stations that I cannot identify, and I certainly wish you would try to start a campaign to assist the DX'ers.

Yours very truly,

O. E. OBERBECK,
4933 Mardel Ave.,
St. Louis, Mo.

OUR "1-TUBE SET" HIS STAND-BY!

Editor, SHORT WAVE & TELEVISION:

I have built many sets and have also heard many high-priced receivers, but the set that seems to stand high above the majority of receivers I have heard is the little *1-tube pocket-set* shown in the Question Box, September 1936 issue. This receiver is one of my old *stand-bys* when my big set breaks down.

I have heard PK, VK, six South American countries, Europe and Asia. Africa is the only place from which I have not heard. The 25-16 meter broadcast band is the best. On 20 meters I have heard all the places mentioned above. I would like very much to hear from persons in South America, Africa or, in other words, every place under the sun!

I hope that you will print some data on a simple *transceiver* using low power, of the type that I like to work with. Your magazine is the best "ham" publication I have read!

WILBERT COURTNEY,
Shepard, Alberta,
Canada.

A "FLASH" FROM DELHI, INDIA

Editor, SHORT WAVE & TELEVISION:

I think *Short Wave & Television* is the finest magazine I have seen, and I would not

like to miss a single copy. I have come across many magazines, but none of them has such a *variety* as S.W.&T.

I use a Phillips A.C.-D.C. receiver with an inverted L-antenna, 30 ft., high, and I have had excellent results from this combination. I have heard over 400 phone stations on the loud-speaker, from all six continents. I have heard 47 countries, among them being the U.S.A. (nine districts), Cuba, Peru, Dominican Republic, Hawaii, Alaska, Canada, Chile, Argentine, Brazil, Bolivia, Columbia, Venezuela, Mexico, Bermuda, Japan, Philippines, Fiji, Australia, Java, China, Egypt, South Africa, Kenya, Rabat, Arabia, Ethiopia, Rhodesia, Eritrea and most of the European countries.

Is it possible for people outside America to compete for the Scout Trophy? If it is, some of us here may have a try.

(Continued on page 463)

Short-Wave Echo from French Morocco

● The photo below comes with the best wishes of Lemoille Kléber, CN8AF. The picture shows the operator's charming little daughter and his low-power transmitter with a 59 oscillator and a 46 amplifier. A single-button mike is used at this station and the antenna is of the Zeppelin type. The wavelength used is 21 meters and the feeders are 15 meters long. DX stations in French Morocco are W21XY, VE2DC, LA1G, and many G and F Stations. Address—M. Lemoille Kléber, CN8AF, Controle Civil de Sefrou, Region de FES, Maroc Francais.



More Short Waves and Long Raves



A swell transmitting "rig," not forgetting the snappy-looking receiver.

W1AIQ Has Neat "Ham" Rig

Editor, SHORT WAVE & TELEVISION:

With the permission of Deo Brunette, I am submitting this photograph of his station, W1AIQ. The transmitter consists of a 47 crystal oscillator, 46 doubler, pair of 46's as buffer, and a pair of Taylor 825's in the final amplifier. The speech amplifier consists of a double-button microphone, a 57 and a 56 as speech amplifier, a pair of 45's as a driver, and a pair of 801's as modulator. The transmitter runs at about 100 watts on all bands.

The antenna is a 250 foot Zepp. The receiver is an All-Star Sr. Although the transmitter looks like a commercial job, I assure you it is a homegrown one with frequent changes made.

May I add that Mr. Brunette has been teaching me radio, and that I am soon to go up for my "ticket" (transmitting license) 73.

Norman Bougie
400 Herson St.,
New Bedford, Mass.

Likes His "Globe" Lamp

Editor, SHORT WAVE & TELEVISION:

I received "world globe" lamp, and was very well pleased with it. The lamp was much nicer than described in your magazine, and gave the final touch I needed in my radio setup.

The XYL agrees with me, "hi!"

My receiver is a homemade all-wave (10 to 560 meters) super having one R.F. stage. The hook-up is one similar to the All-Star Jr., super of a few years back, with the exception of the tuned R.F. stage; the hook-up for which I took from your "F.B." magazine, *Short Wave & Television*.

I have received practically all important European, South and Central American, Canadian, and U.S. stations; also Europe, South and Central American phone stations on 10 and 20 meters. One of my best DX on 20 is K6CGK of Hawaiian Islands. I haven't had much success with African phone stations.

Because I work nights and get home about 2 A.M.—M.S.T. I usually listen to Japan (JVN 28.14 M.), China (ZBW3 31.49 M.) Both VK3ME (31.55M.), VK3LR (31.32 M.) Every morning between 2:30 and 4 A.M. I consider this good DX on any set; especially for my location here in Denver, Colorado.

Well, I think I have rambled on long enough, "hi."

Keep up the good work on the magazine!
Sincerely Yours,

James D. Meskey
1226 Marion Street,
Denver, Colorado.

He Hears the World!

Editor, SHORT WAVE & TELEVISION:

Here in my listening corner, I find most of the world at the twist of the dial. England, France, Germany, Japan, China, Australia come in with great volume. Many an evening is spent in the enjoyment of tuning in the short waves.

The receiver is a seven-tube Grunow, which works well on all bands. The Antenna is a double-doublet running from northeast to southwest. These two work well together, which gives me great satisfaction.

The bands that are my favorite are the Amateur bands. Here one finds "friendship" the leader. They speak to each other from opposite ends of the earth. Many new friends are secured via the air. I do hope that I may be one of them in the very near future. The greatest DX heard here in regards to Amateurs are VK4JX in Brisbane, Australia; ZU6P in Johannesburg, South Africa; ON4VK in Brussels, Belgium; EA8AF in Canary Islands; EA2BH in Jaca, Spain, and a host of others.

The first time I ran across *Short Wave & Television* was quite by accident, but a most fortunate one. The first copy was read till the wee small hours of the morning. Your magazine is just "chock-full" of many interesting articles. Cannot do without it now. Your *World S-W Station List* is the most helpful aid in securing those "hard to get" stations. A credit of thanks is due you. Joe Miller's column is "fine business." His short-wave station data is



S-W Listening Post of Theodore Domy

just what the short-wave listener wants. His column is always read first. George W. Shuart, W2AMN, also has fine articles. All in all, your magazine is R9 plus, from cover to cover. Keep up the good work, for your magazine is the best on the market. Wishing you and your staff the very best of luck and success, I remain

Yours very truly,
Theodore Domy,
3816a Wyoming Street,
St. Louis, Missouri.

(Good, Theodore, and we hope you continue to enjoy not only the department you mention, but many new features which we have in store for you.—Editor.)

Thinks We're the "Tops"!

Editor, SHORT WAVE & TELEVISION:

I have quite a collection of Q.S.L. cards received from various stations all over the world. I am using a 1936 Philco, with a 60-foot doublet. I have succeeded in hearing eighteen countries and four continents; I'm hoping to hear the fifth pretty soon. Your *World S-W Station List* has helped me greatly in my DX work. I have been reading your magazine for a long time and think it's the "Tops" in providing first-hand radio information.

WALTER SUSZYLO,
13 Fourth St.,
Passaic, N.J.

Likes the "Beam Tube—3" Transmitter

Editor, SHORT WAVE & TELEVISION:

I am one of the fortunate persons who built Mr. Shuart's "Beam Tube-3" transmitter described in the August, 1936 issue of *Short Wave Craft*.

Since building this transmitter I have been on the lookout for a proper modulator. I observed carefully the 6L6 modulator described by Art Gregor in *Short Wave Craft* for November, but believe a modulator could be designed using fewer tubes, preferably 6L6's, which would do the job equally well and I hope not cost as much. Won't you try to design a modulator (keeping our pocketbook in mind) suitable for modulating the truly remarkable "Beam Tube-3"?

I use only 500 volts on the plates of the amplifiers and have had unusual success.

Yours very truly,

"V E 3 A I G" or
R. A. Shannon,
197 Princess St. W.,
North Bay, Ontario.

(Thanks for the "bouquet," R. A. S. We'll try to provide the data on the modulator shortly.—Editor.)

A "Tip-Top" Home-Built Rig

Editor, SHORT WAVE & TELEVISION:

Here is a photo of the station and the description follows: The rack at the left is entirely home-built and consists of a 47 crystal oscillator working on 1858 kc. and 7,042 kc.; 46 doubler used when working on 3716 kc. and 1484 kc., 46 buffer and a pair of 210's in the final, with about 40 watts input on phone and 60 watts on C.W.

The audio equipment consists of a double-button mike, two stages of 56 transformer coupled speech, driving a pair of 250 modulators in parallel class A. The receiver observed in the center of the desk and used on the above bands (20-40-80-160 meters) is a Hallicrafter "Super-Seven." On the left of the receiver is a monitor used on all bands.

At the right is a five-meter receiver, and at the top center of the desk may be seen part of the short-line oscillator used on five meters, which uses a pair of 45's with about six watts input. The same modulator is used on this set by a simple switching arrangement.

I am a constant reader of *Short Wave & Television* and find it very helpful in building amateur equipment.

Vy 73 and good DX, W1IPS

Fred L. Burgess,
27 Dexter Street
Lynn, Mass.

(Thanks for your letter and photo, Fred. A swell job and it just shows what a little perseverance will do when it comes to building a home-made "rig."—Editor.)

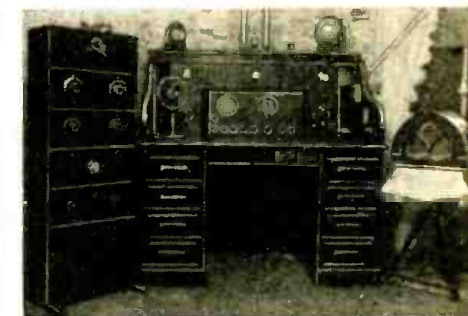

A swell layout, we call it! Yessir! It's a wonder more Hams do not build part of their rig into a desk.

World-Wide Short-Wave REVIEW

-Edited By C. W. PALMER

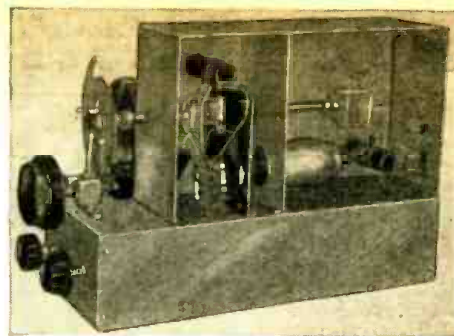

Appearance of ultra-high frequency receiver here described; it is suitable for listening to 6-meter television "sound" channels.

A High-Quality U.H.F. Receiver
 ● Anyone who has listened to the sound accompaniments to the televisions experiments which have emanated from the Empire State transmitter has been amazed

high quality of the transmissions was described in the latest issue of *Wireless World* (London). The set is a tuned R.F. type of set using an R.F. pentode, plate-tuned, followed by a triode detector and a triode A.F. amplifier which is arranged to

sketch, which shows the shield removed from the side of the aerial and R.F. tuned circuits, to show the method of construction.

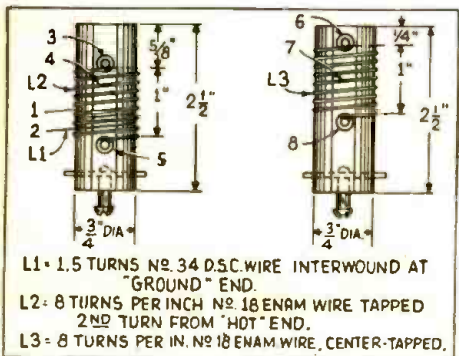

Coil data and "hook-up" for T.R.F. high-frequency receiver.

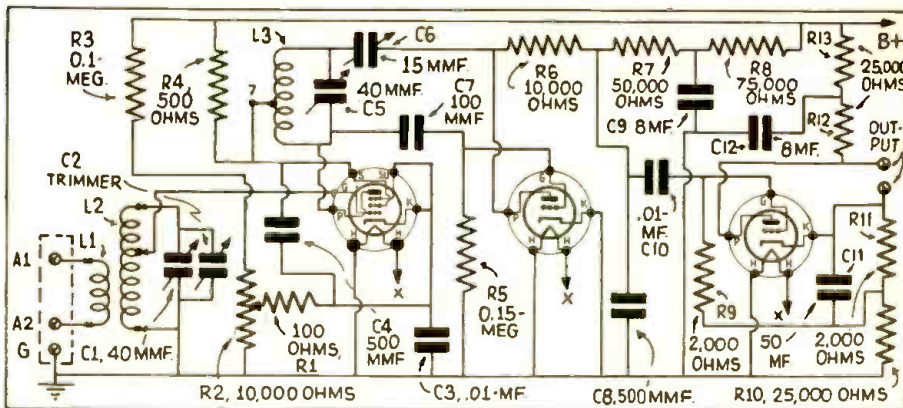

at the fidelity—the reality of the music and the voices. None of the usual "radio" sound is present—the voices and music are real.

A receiver which can do justice to the

feed into a high-quality push-pull A.F. amplifier (not given).

The values of the parts in the tuner are presented in the circuit and the details of the tapped coils are also given. The appearance of the unit is illustrated in the

Anyone who wants a thrill in radio reception should try tuning in the U.H.F. broadcast transmissions from one of the several stations operating on this band in different parts of the country.

A Short-Wave Reflex Receiver

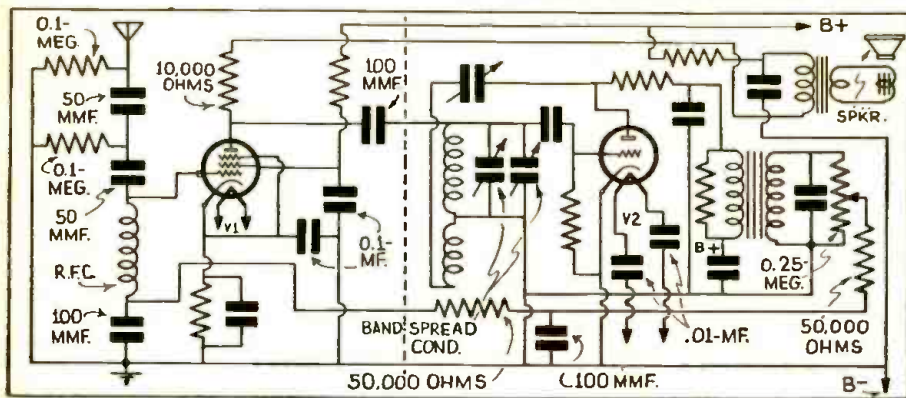

Reflex circuits have seldom been used for short-wave reception. Here is an interesting one to try.

● SOME few years ago, Dr. Lee deForest—the father of modern radio—made a suggestion which, though it has had very little practical application has always stuck in the back of the writer's mind as a most ingenious and logical arrangement.

It consists of using an output pentode tube as an aperiodic aerial coupling tube, by feeding the aerial to the grid of the pentode, and the output of this tube coupled through an R.F. filter to the grid of the detector, the output of which is again fed by means of a low-frequency coupling system to the grid of the pentode. Thus the pentode acts as an aperiodic R.F. tube which provides a certain amount of amplification but, what is more important, acts as a decoupling tube between the detector and the aerial.

A circuit using this arrangement in a practical, workable circuit was described in a late issue of the English weekly radio magazine—*Practical and Amateur Wireless*.

\$25.00 FOR GOOD 1-TUBE SET

● THE editors know that our short-wave set-builders and experimenters must have developed some extra fine 1-tube circuits—possibly for receiving sets, short-wave converters, etc.

We are therefore offering \$25.00 for a good 1-tube set, either in the form of a short-wave receiver or a converter. Please note that there is little use in sending in an ordinary hook-up for a 3-element tube as most of the circuits possible with these tubes have been published.

What the editors want is a new circuit, designed around one of the latest type tubes having a multiplicity of grids. Refer to the March issue, page 675, where a very ingenious 1-tube S-W converter circuit is given. This will give you some idea of what we are after.

As a preliminary, you may send in a diagram and a description of the set and a good clear photo or two of it. A list of parts should accompany the description and the editors, who will act as the judges, and whose opinion will be final, reserve the privilege of requiring the set to be sent to them for inspection and test if they so desire. With the dual purpose tubes now available many ideas will suggest themselves. For example—Receivers with R. F. and Detector stages; Detector and A.F. stage; Detector and Plate-Supply Rectifier; 1-tube Super-het; Reflex set, etc.

VK2NO U.H.F. Superhet

● A WELL designed ultra-short-wave superhet receiver for the advanced amateur was described in the Australian magazine—*The Bulletin*.

This set, surprisingly enough, uses three tuned circuits, R.F. first detector and oscillator, which are ganged together. This R.F. amplifier and oscillator are electron-coupled thus providing a measure of regeneration in the aerial circuit, to increase the gain—the electron coupling increases stability and freedom from drift.

The I.F. is about 5,000 kc. and the I.F. coils are made from standard 456 kc. transformers taken apart. The primary and secondary are in separate cans, to avoid the possibility of self-oscillation in the I.F. circuits. Link circuits couple the two coils.

The I.F. coils are wound on 1-inch tubes and contain 35 turns of 9-38 litz wire. At the "B plus" and ground ends of the coils two turns of push-back wire are wound for the link connection. The I.F. coils are tuned by 35 mmf. air dielectric trimmers. The photo shows the 6 cans which house the three I.F. transformers.

A beat-frequency oscillator is coupled to the triode second detector for the reception of C.W. signals. This B.F.O. has a separate filament winding on the power transformer to prevent the introduction of hum on a signal in case the oscillator is incompletely shielded. A resistance-coupled A.F. stage completes this well-engineered set.

The coil data follows:

Range in Mc.	Aerial	R. F.	Detector	Oscillator
64-48	1 3/4	6 1/2	6 1/2 tap 1 3/4-3 3/4	5 1/2 tap 2 3/4
48-36	2 3/4	10 1/2	9 1/2 tap 1 3/4-4 3/4	7 1/2 tap 3 3/4
36-27	2 3/4	14 1/2	13 1/2 tap 1 3/4-6 3/4	10 1/2 tap 4 3/4

Coils are of 14 enamelled copper wound on a 1/2 in. rod and stretched to occupy about 1 1/2 in. length.

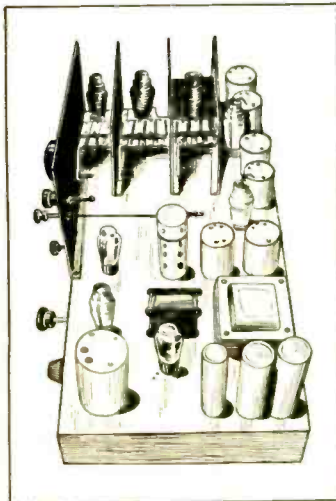

Another short-wave superhet receiver for the advanced amateur is shown above, and the diagram below.

Acorn Tube "Vision" Receiver

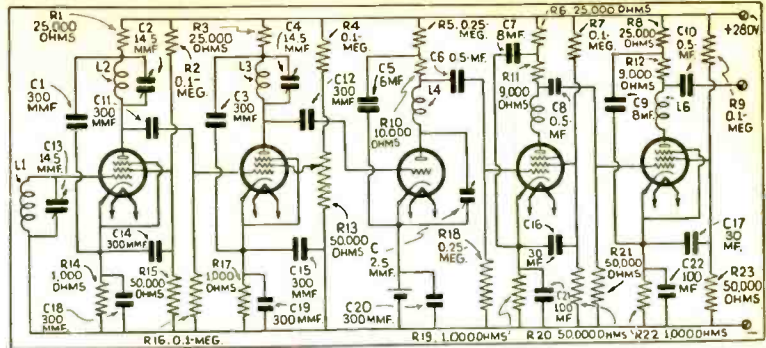

● IN the latest copy of *Television and the Short-Wave World (London)* to be received, an interesting set designed around the acorn-type tubes for the reception of television signals from the London television station was described. This set contains two stages of R.F. amplification, a triode detector and two stages of signal-frequency amplification in a T.R.F. circuit. All the coupling circuits are designed to provide the necessary wide-frequency characteristic necessary for television reception. The set is suitable for reception over the usual service area of the London transmitter, providing a swing of 10 volts to the cathode-ray tube.

The values of the parts for this television tuner are given on the circuit. A part of the set (the A.F. amplifier) is shown in the photo.

The diagram above shows an acorn tube television receiver; the appearance of the receiver is shown in the picture below.

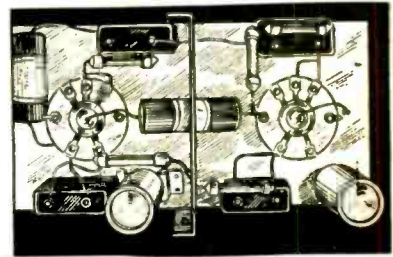

REGENERATION STABILITY

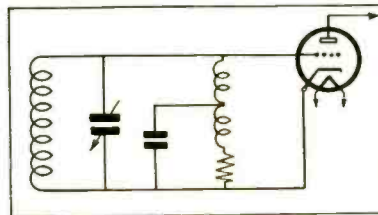

Above—A circuit designed to provide more stable regeneration.

● A RECENT issue of *Radio Welt (Vienna)* contained a circuit worth trying.

The circuit is a part of the detector of a regenerative short-wave set in which the grid-leak is replaced by a network of two R.F. chokes and a resistor with a fixed condenser. The R.F. chokes are of different sizes and the condenser has a very low capacity. The resistance is somewhat lower than the usual value used for grid-leak, having a value of about 50,000 to 100,000 ohms.

With correctly chosen values of the R.F. chokes and the condenser, regeneration is much more stable than usual and the detector will oscillate to much higher frequencies than before.

Choke and condenser values must be determined experimentally.

A TELEVISION PATENT

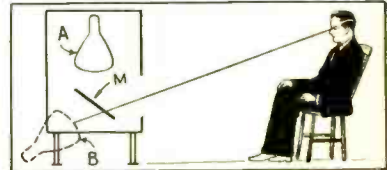
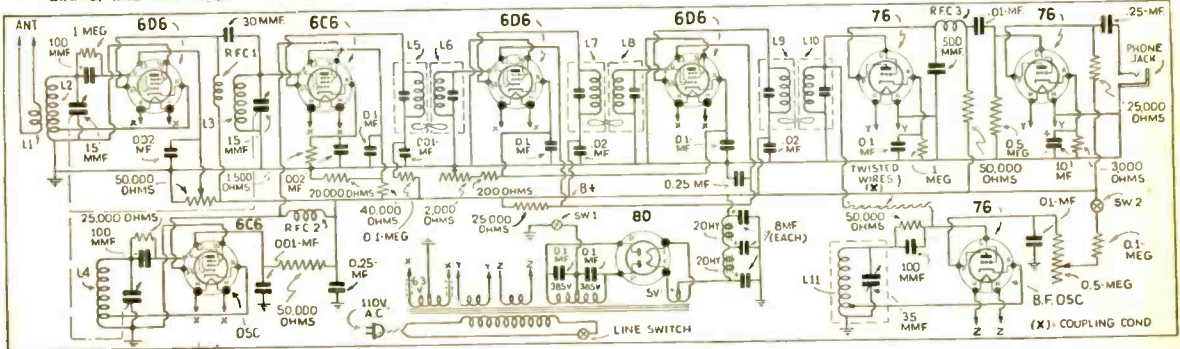

Diagram above shows a clever television idea, the screen pointing downward.

● MOST of the television receivers which have been made experimentally in the U. S. and commercially in England have the cathode-ray tube mounted vertically in the console cabinet, with a mirror mounted on the inside of the top cover, so that the images are seen reflected from the surface of this plane surface.

However, this is not the most convenient position for a person viewing the screen, as it is too high to sit down comfortably while watching the images.

A recent patent issued in England and granted to the British G.E. Co., shows the tube mounted in just the reverse of the usual method, i.e., with the screen pointing downward and with a mirror under the tube. An opening in the lower end of the console cabinet permits viewing. This puts the image in a better position for viewing and permits the C.R. tube and mirror to be in a darkened container.



Dr. J. M. B. Hard's Station a HAM'S Paradise!

● HEREWITH the latest photo of amateur station XE1G, now located on the outskirts of the town of Cuernavaca, State of Morelos, Mexico. The name of the residence is "Quinta Leonor."

The present station was built specially for radio work and has proved a great source of pleasure.

The antenna layout

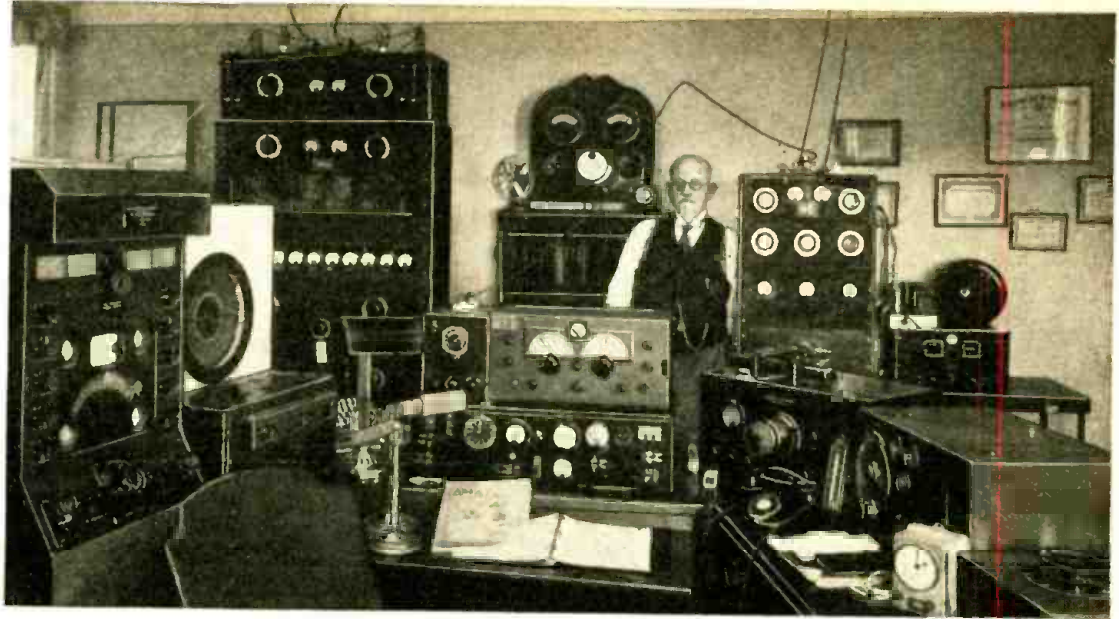

Show us the short-wave "Ham" or "Fan" who would not like to exchange stations with Dr. J. M. B. Hard! This Ham's Paradise is located in Cuernavaca, State of Morelos, Mexico.

consists of three steel masts over 160 feet high. The No. 1 mast is to the west of the radio shack, No. 2 lies to the east of the shack, and No. 3 lies southwest from No. 2. This gives me a wide area for placing the antennas. The distance between the masts is over 200 feet. The antenna between No. 1 and No. 2 is a 33 foot Zepp. with 50 foot leaders, which, like all the antennas, come through glass plates in the roof. The antennas of the other masts, that is between No. 1 and No. 3, as well as between No. 2 and No. 3 are 75 meter antennas, doublets, with E01 twisted lead-ins.

The shack is connected to the house, bungalow style, with a corridor over 150 feet long. The antenna design has been carefully worked out and the system has performed very well. It is as follows: A pulley is fixed at the top of the mast through which a steel cable runs, made endless by having the two free ends fastened to another pulley of like size. The pulley can be raised or lowered at will from the ground. Through this pulley runs another steel cable that is fastened to the antenna proper. By this means any angle can be given to an antenna. By (Continued on page 443)

Rectifier D. C. Output Read from Graph

● MUCH of the design of power packs has been more or less guesswork. Especially in the case of condenser-input filters, the average man has difficulty determining the proper size of the input condenser. There seems to be little known about equations which will enable one to find the d.c. output voltage of a full-wave or half-wave rectifier in terms of the applied a.c. voltage, the load current and the size of the input condenser. Admittedly, such equations only partially solve the problems since the rectifier resistance and the transformer leakage reactance modify the result. However, since the voltage drops in the transformer and the rectifier can be determined experimentally, the presentation of the chart with this article is believed to fill a need.

The chart of Figure 1 applies to rectifier circuits employing a condenser-input filter and is designed assuming the transformer to be ideal and the rectifier perfect. It shows the relation between applied a.c. voltage, d.c. output voltage, current drain and input capacity. Any one of these quantities can be found from the chart when the other three quantities are known. This chart was made for 120 cycles (full-wave rectification of 60 cycles) but it will be shown how it can be used for other frequencies as well.

In the case of condenser-input filters, the rectifier conducts current only during a small part of each half cycle. This is at the peak of the applied voltage.

The charging ends when the peak is reached and the condenser is then charged up to that peak voltage. The condenser then discharges through the load until the voltage across the condenser becomes lower than the rising a.c. voltage of the next half cycle when

the charging begins again. At this time the transformer supplies whatever charge has been lost during the intervening time. It should now be clear that the condenser acts as a large reservoir which is partially emptied and refilled at (Continued on page 449)

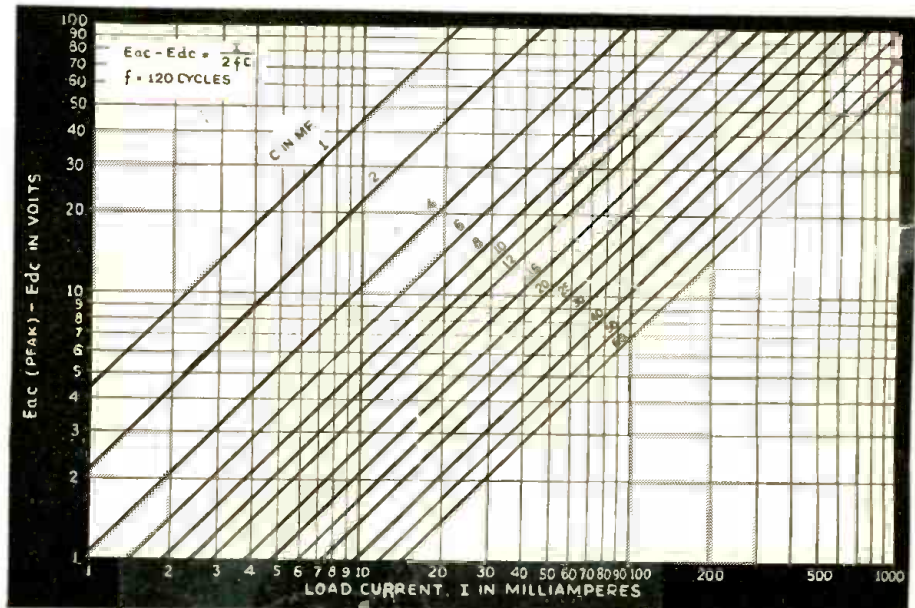

By means of this graphic chart, many problems connected with the design of rectifiers and power-packs can be instantly solved.

2-in-1 CLOCK-CASE Portable

Uses New 1.5 Volt Dual Triode

This ideal beginner's S-W receiver operates on a single dry cell and provides 2-stage results with but a single tube.

By
H. G. Cisin, M.E.

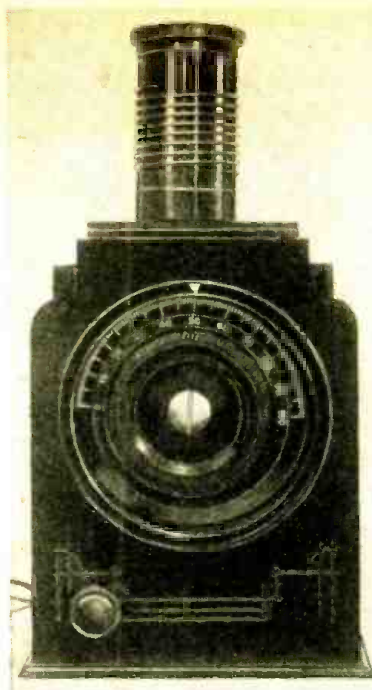

Left—front view of 2-in-1 Clock-Case receiver. Using the 1.5 V. dual purpose tube.

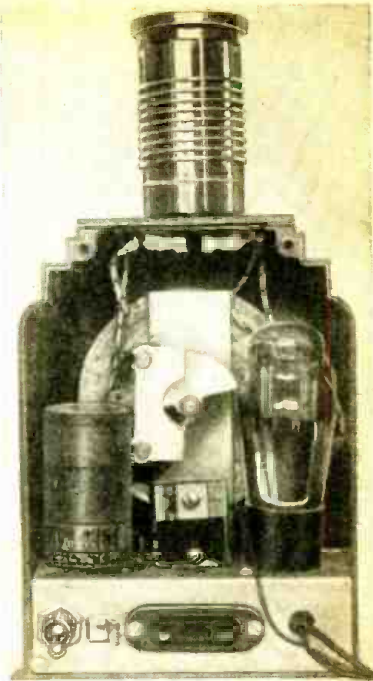

Rear view of the Clock-Case portable receiver. Plug-in coils give all-wave coverage.

● A GREAT deal of interest has been evidenced by radio fans in the new series of radio tubes which can be operated at full efficiency by means of a single 1½ volt dry cell. These tubes were developed for special types of aeronautical work, where high efficiency, compactness and lightness in battery supply were vital considerations. Since they have now been made available commercially to radio amateurs, they are ideal for every type of portable work.

The 2-in-1 Clock-Case Portable is an all wave receiver, designed around the new RK-43 dual triode. This new tube is somewhat similar in characteristics to the dual function 19 tube. Its most important difference, of course, lies in the fact that it operates at full efficiency on 1½ volts instead of 2 volts, as in the case of the 19. Another very important characteristic is the fact that it draws only 120 milliamperes, which is less than one-half the filament current consumed by the 19 tube. This tube is also sim-

ilar in appearance to the 19 tube, but has an over-all height of only four inches. It employs a standard six-pin (small) base.

In the present circuit, one of the triodes of the tube is employed as a *regenerative detector*. The other triode is used in the *audio stage*. Resistance coupling is employed between the stages.

The entire receiver is constructed in a standard bakelite clock-case, 4¾" by 6½" high by 2¼" deep. The coil socket is mounted on top of the case, thus facilitating the removal and interchange of the various coils. These are of the four prong plug-in type and a series of five overlapping coils permit complete coverage of the short wave and broadcast bands from 17 to 560 meters.

Practically all the other parts are mounted on a small metal chassis, 4½" by 2" by 1½" high. The only exception is the midget type 140 mmf. variable condenser, which is mounted on a large

bracket fastened to the front of the chassis. This bracket has a ¾" hole drilled for the variable condenser at the exact center point of the clock face. A novel feature of this set is the fact that the flash-light cell used for the "A" supply can be fastened within the case, directly to the chassis.

The rear view of the receiver shows this clearly. The battery can be seen at the left; the RK-43 tube at the right and between them, the adjustable antenna trimmer. The variable condenser may be observed directly above the antenna trimmer. The twin earphone jack is mounted at the center of the rear chassis wall. To its left is a clip for the ground connection and at the extreme left is the "on-off" switch. The two "B" battery connection wires come out of the rear chassis wall at the right.

Looking at the front of the receiver, one sees the *station selector* dial in the center and the *regeneration control* knob at the (Continued on page 442)

A Novel 2-Tube S-W Reflex Receiver

● TO THOSE of us with limited means, reflex circuits still make an immediate appeal. In the early days, *reflex* receivers—in which one tube was made to perform two or more functions—were highly popular. In recent years, however, as the result of reduced tube prices, such circuits have gone largely into the discard. Lately, however, with the advent of multi-element tubes, the idea of *reflexing* has attained a certain amount of popularity once more.

In the short-waver described in this article, the pentode section of the 6B7 tube is employed as a tuned-radio frequency amplifier (with regeneration) and also as a first audio-frequency amplifier, the diode section of the same tube being utilized for

By B. S. Jones

detection purposes. For the benefit of those who are unfamiliar with the operations involved in a reflex circuit, perhaps it will be just as well to follow the signal right through, from the antenna to the headphones. Signals picked-up by the antenna are applied through aerial condenser (C1) to the primary of the 1st R.F. transformer, the secondary of which is tuned by C3 and its trimmer (C4). Potentials developed across L2 are applied across the grid and cathode of the 6B7 tube. Part of the R.F. energy appearing in the screen circuit of the tube is fed-back through coil L3 and throttle condenser C5 to produce regeneration in this circuit, this R.F. energy being prevented from passing

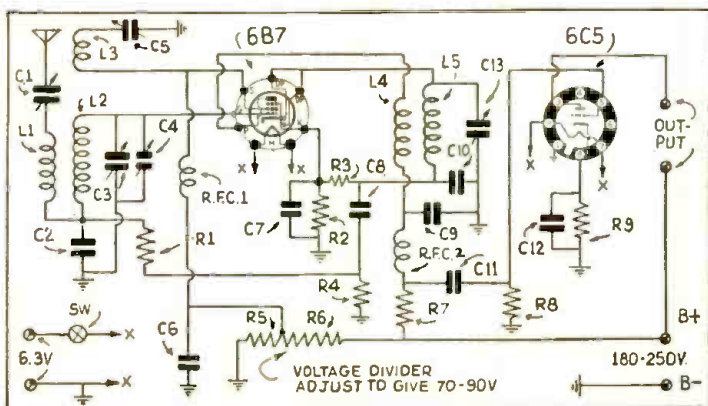

Theoretically, 4-tube results are here obtained with 2-tubes, thanks to reflexing.

(Continued on page 447)

A FIXED-BAND 8-Tube Superhet for S-W FANS

By Raymond P. Adams

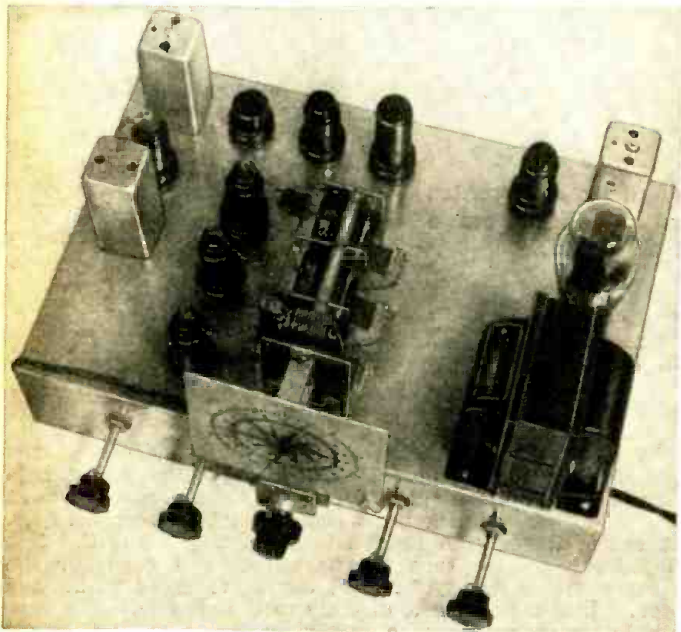

Front view of the "fixed-band" 8-tube superhet.

● WHY a fixed band receiver? To the average *foreign broadcast fan* (and to the more critical short-wave DXer), that portion of the high frequency spectrum which includes the standard 15, 11, 9, and 6 mc. bands is of greatest usefulness and interest, regardless of extremes of range which his receiver may feature. Commercial, low-frequency amateur, and special service phone signals—and certain code—are infrequently listened to (unless the operator is himself an amateur or a commercial phone or code enthusiast, in which case he may or may not be at all impressed by what we say here); so that what we may roughly call the *police-amateur-airways band* remains of relatively less importance, along with any other bands not distinctly open to broadcast transmissions.

All of which implies that nine out of ten listeners might not particularly care if their receivers missed nonbroadcast bands altogether—and all of which, to us, suggests that there might be a definite reader interest in a short-wave job tuning simply and exclusively across the high-frequency broadcast channels. Such a construction might be made to perform with noticeable efficiency; it might be built cheaply (the cost being twenty-five dollars or less), require but a single set of wired-in coils, have maximum selectivity, use a simple, pentode amplifier for A.F. output—and all in all hit our mark satisfactorily, functionally, and certainly with more accuracy than could any but the most expensive all-wave jobs. Such a set might not only appeal to the short-wave fan who takes his DXing seriously—but to owners of *broadcast band* (550-1500 kc.) receivers who do not find it convenient or financially possible to replace their sets (and particularly if such sets are of high-fidelity design) with all-wave and costly supers—but who are nonetheless interested in having on hand means for the reception of *foreign short-wave programs*.

The Author's Design

That said, we'll get on to our receiver, which has been specifically, if somewhat experimentally, built to do the best possible job (while using a minimum of parts wired in a simplified but highly efficient circuit) in *fixed-range* short-wave service. Though it may appeal to the operating *amateur* (Ham) by reason of its 14 and 7 mc. coverage, its *beat-oscillator* stage, its mechanical *band-spreading*, and its practically *single-signal* selectivity—it is nonetheless an essentially *foreign broadcast* job—and as such it is presented here.

This superhet is simplified by the fact that no complicated coil-switching is involved. The set tunes on a fixed-band, which covers all of the important S-W frequencies. The set uses 8 tubes, plus a rectifier, and operates from a 110 volt A.C. 60 cycle circuit. The design incorporates a beat-oscillator and band-spread. A suggestion for simplifying the set to 6 tubes is also given.

Duplication will not involve much cash outlay. None of the coils—R.F. or I.F.—are costly. A good power-transformer is suggested—but even here no unusual investment is implied. The dial may seem expensive at first thought—but isn't so in the long run, as any other suitable means of tuning will call for a separate band-spreading three-gang condenser, *two dials*, and thus a certainly greater parts cost. No filter choke other than a proper speaker field will be required, a single dual 8 mf. electrolytic will afford sufficient filter capacity.

The tuning range is from 18 to 5.9 megacycles—which is to say 16.4 to 51 meters—with sensitivity one microvolt or less over the complete band. As no band-switch is used, R.F., detector, and oscillator coils are wired right into the circuit, with leads short and direct. Switch and long-lead losses "jest ain't."

The I.F. frequency is 456 kc., and the single stage has been made regenerative, so that 4 kc., and almost single-signal selectivity is featured. The *sharp tuning* of high-priced and multituned circuit receivers is accordingly a characteristic of this job. AVC is employed—confined in application to simply the *mixer* stage, so that the R.F. and I.F. will work at maximum efficiency with the gain control and selectivity control open. A 6K7 R.F., 6L7 mixer, 6J7 H.F. oscillator, 6K7 I.F., 6H6 second detector, 6C5 A.F., 6F6 output, 6C5 beat oscillator, and a 5Z3 rectifier complete the nine-tube line-up—which may be simplified down to a practical minimum of *six tubes*, if a 6Q7 is substituted for the 6H6 detector and 6C5 audio (with minor circuit changes) and if the BFO stage is eliminated.

The usual magic eye tuning indicator has been omitted; it may be added if found convenient (*Continued on page 444*)

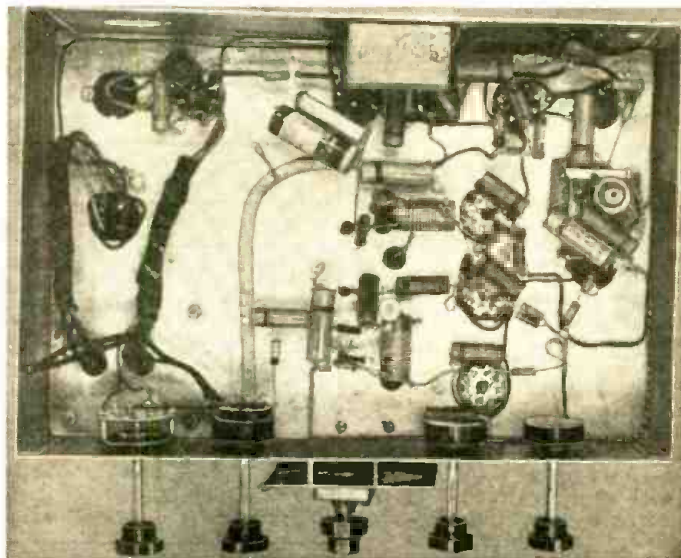

Bottom view of the 8-tube superhet.

The picture wiring diagram makes it easy to build this 8-tube superhet

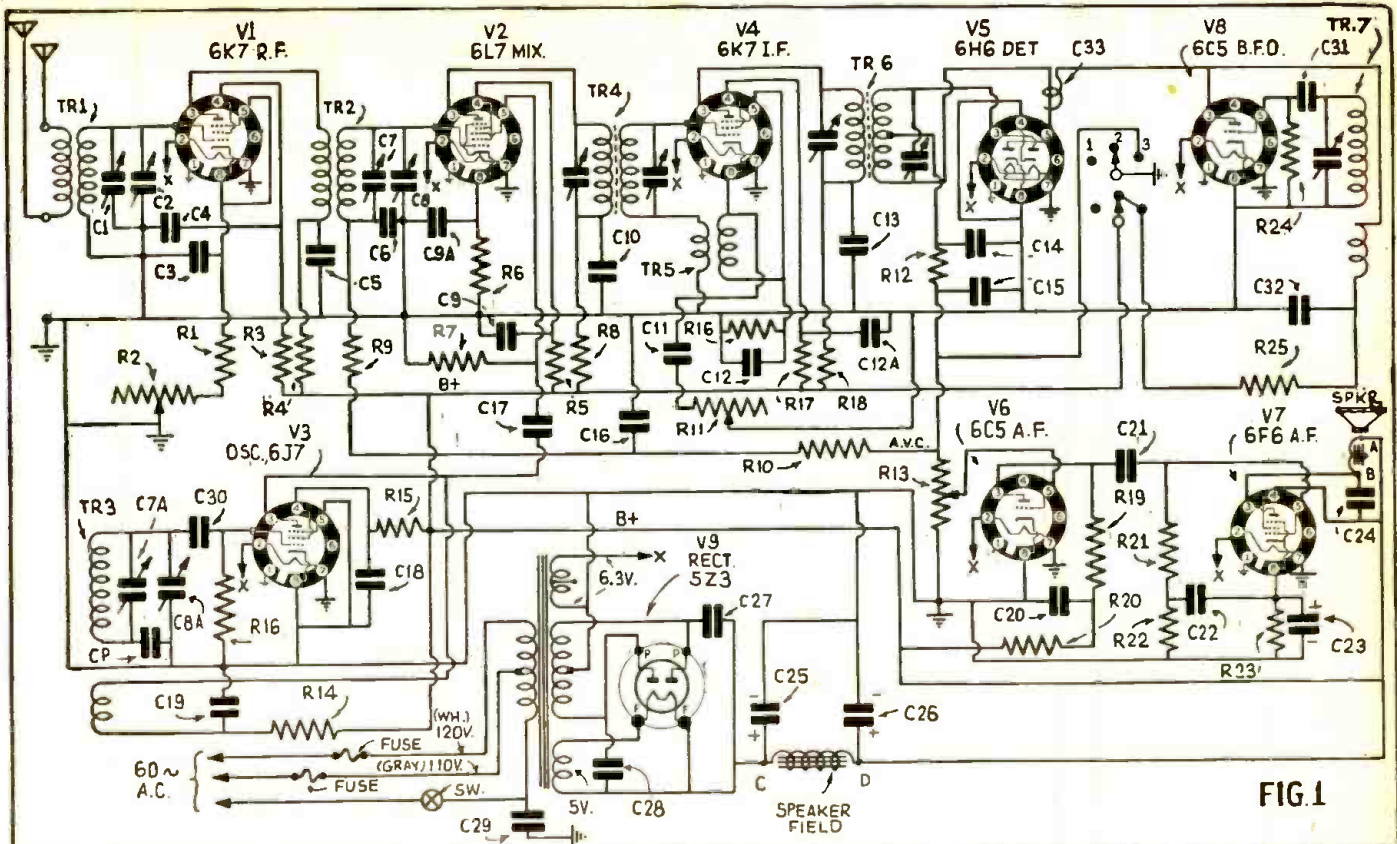

FIG. 1

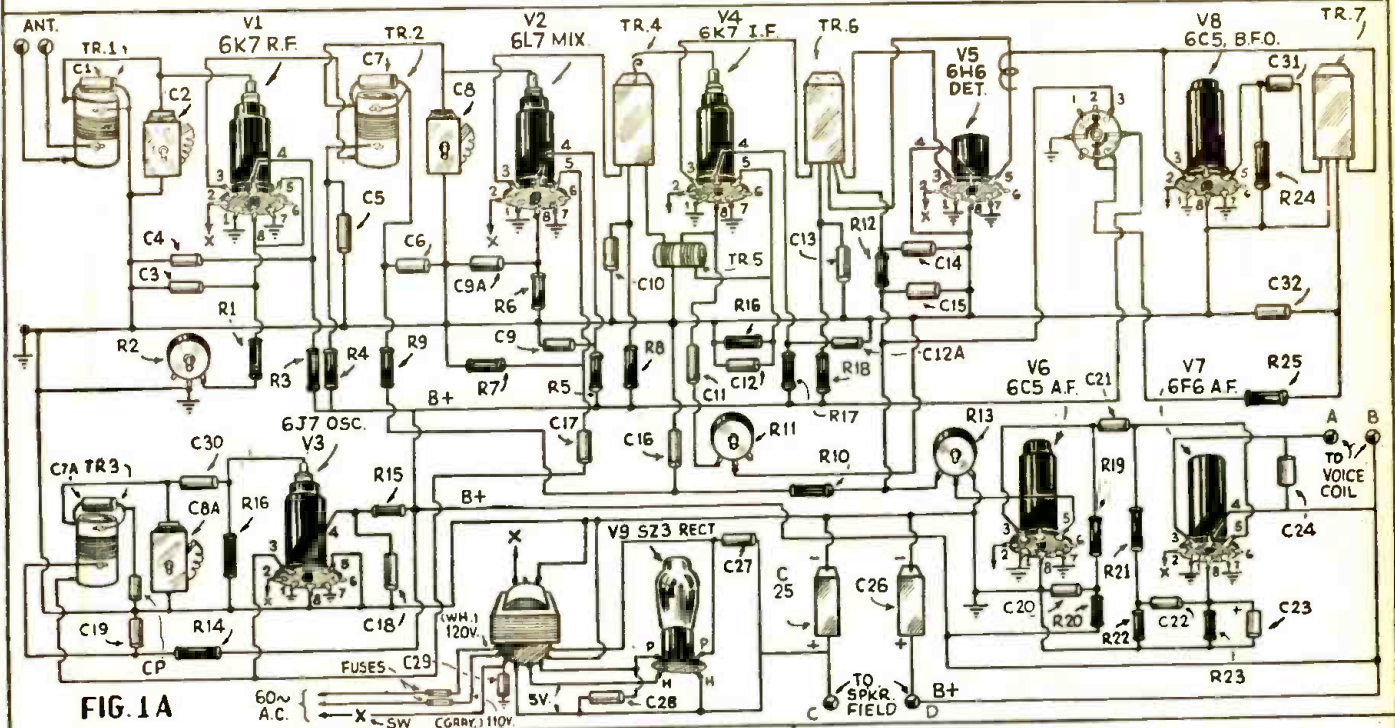

FIG. 1A

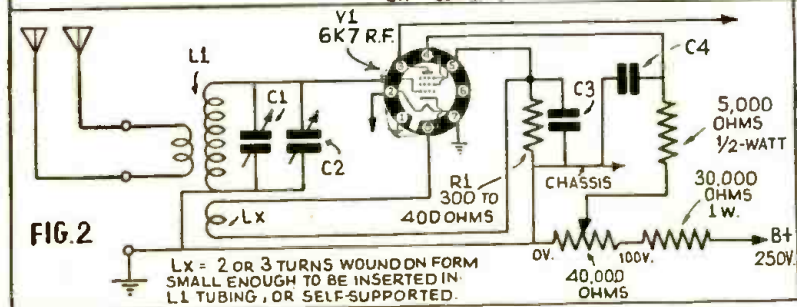

FIG. 2

LX = 2 OR 3 TURNS WOUND ON FORM SMALL ENOUGH TO BE INSERTED IN L1 TUBING, OR SELF-SUPPORTED.

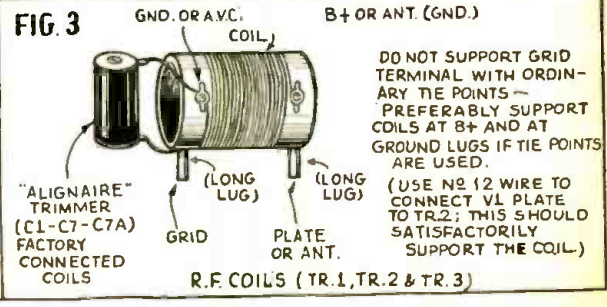

FIG. 3

B+ OR ANT. (GND.)

DO NOT SUPPORT GRID TERMINAL WITH ORDINARY TIE POINTS — PREFERABLY SUPPORT COILS AT B+ AND AT GROUND LUGS IF TIE POINTS ARE USED.

(USE NO. 12 WIRE TO CONNECT V1 PLATE TO TR. 2; THIS SHOULD SATISFACTORILY SUPPORT THE COIL.)

R.F. COILS (TR. 1, TR. 2 & TR. 3)

Schematic and picture wiring diagrams are given above for the 8-tube superhet; it operates on a "fixed-band," covering the European and other S-W broadcast stations. This set can also be used by the "ham" and the beat oscillator helps to locate weak stations very easily.

This "CRYSTAL FILTER"

Gives

Razor-Sharp Tuning

on the

"S.W.&T."

Communications

Receiver

By G. W. SHUART, W2AMN

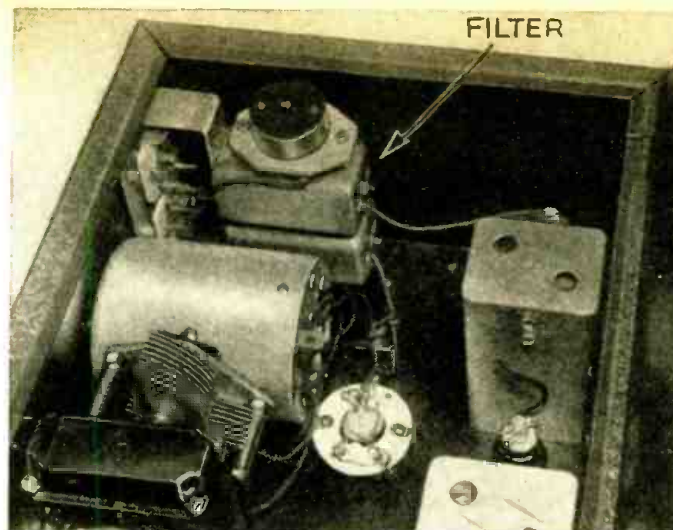

This view shows the crystal unit in place.

● WE have had a number of requests for information regarding a quartz crystal filter for the "S. W. & T." Communications receiver described by the author in the August, 1937, issue. It seems that this receiver has become quite popular due to its excellent sensitivity and many other interesting characteristics. Many who have built it, or are building it would rather use a quartz crystal filter to obtain extremely sharp single-signal action for C.W. operation and also maintain a favorable degree of selectivity for phone operation.

Good for C.W. or Phone

The crystal filter shown in the diagram is capable of excellent performance either for C.W. or phone operation. Our first thought, of course, was to have a switch on the crystal so that it could be taken out of the circuit; however, it is almost impossible to maintain satisfactory communication on any of the phone bands during crowded periods with the ordinary selectivity provided by a receiver without a crystal. With the crystal filter properly constructed and adjusted it is possible to maintain intelligible phone QSO's minus all the hash and heterodynes which would be present without the filter. Once used, you'll never be without it.

For instance, this circuit is variable from 4 kc. to around 1/2 kc. which is broad enough for voice communication and selective enough for real single-signal reception. The unit is constructed around two Hammarlund I.F. trans-

formers, model ST1465-CT. These are intended for coupling between the last I.F. amplifier and the diode detector in the superheterodyne.

How an I.F. Transformer Is Converted for Job

L1 L2 is one complete transformer; however, it is necessary to remove the transformer from the shield can and cut away the tubing which separates the two coils. The spacing between the two coils is too great for proper operation in this circuit. After the tubing has been sawed from between the coils L1 is then fastened to L2 with wax and some pieces of cambric tape or any other type of cloth which will serve the purpose. These coils should be placed as close together as possible. The condenser which was employed for tuning L1 is not used and it should be disconnected.

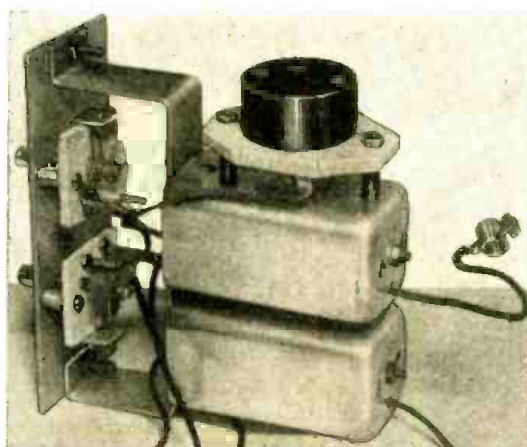

Close-up view, showing the mechanical arrangement.

The other I.F. transformer is used for the input to the first I.F. amplifier. The untapped winding of this transformer is eliminated entirely by disconnecting it from the condenser and sawing it off the mounting. The center tap portion is L4 in the diagram. In this transformer we also have two tuning condensers which are used for adjusting. C4 is the condenser on top of the transformer which was previously used to tune the primary. C5, is of course, left in the same position and serves as the tuning adjustment.

The entire assembly is built on the bracket which is of the proper dimensions to just fit the space available on the left-hand side of the receiver. The photograph clearly shows how this is mounted. The drawing shows the dimensions and actual construction of the unit. A 50 mmf. condenser C2 is connected across C1 which is the trimmer condenser mounted in the transformer and C3 is the phasing or elimination control.

How Filter Is Adjusted

In tuning up the receiver, C1 should be adjusted so that the maximum selectivity required for C.W. reception is obtained with C2, at minimum capacity. Then as the capacity of C2 is increased toward maximum the selectivity response will broaden. Maximum capacity will make the entire circuit resonant with the crystal; this position is used for broadest phone reception. Of course, when set even in the broadest position the crystal filter eliminates a good portion of the higher frequencies and tends to make the voice sound slightly drummy; however, the intelligibility is better because of the lack of the usual background hash and heterodynes caused by stations within a few kilocycles of the station being received. Heterodynes can usually be phased out with condenser C3.

Example of Selectivity

An idea of the phone selectivity obtainable with good understanding can be shown by the (Continued on page 438)

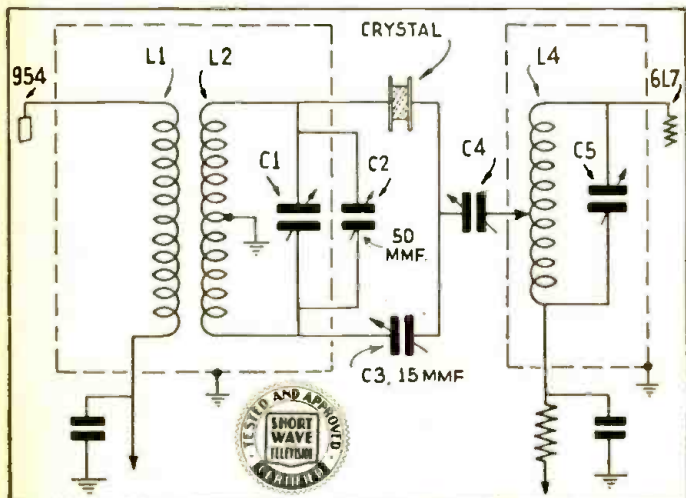

Diagram of the "variable-selectivity" crystal unit.

WHAT'S NEW In Short-Wave Apparatus

The short-wave apparatus here shown has been carefully selected for description by the editors after a rigid investigation of its merits.

The New National NC-80X

● THE average short-wave "fan," as well as the "ham," has been looking a long time for a really reliable short-wave receiver, one which would not tax his pocketbook unduly. These new receivers of the model here illustrated and bearing the number NC80X, for the general coverage receiver, and NC81X for the set covering the Amateur bands, seems to fulfill these requirements.

An efficient 8" permanent-magnet loud-speaker is supplied with the sets and the bands are switched in one after another by simply turning the knob. The frequency coverage is continuous, except for a small gap at 1560 kc., and runs from 550 kc. the upper part of the American broadcast band, down to 30 mc., or 10 meters, in 4 ranges.

The NC81X is a special amateur model and covers the following bands only: 1.7—2.0 mc.; 3.5—4.0 mc.; 7.0—7.3 mc.; 14.0—14.4 mc.; 28—30 mc. The dial is calibrated in megacycles. Automatic plug-in coils are used, controlled by a knob on the front panel, the same as in the NC-100. This arrangement has proven itself to be

thoroughly reliable and efficient.

Ten tubes are used in a high-gain superheterodyne circuit, as follows: 1st detector 6L7; H.F. osc. electron-coupled, 6J7; three I.F. stages, 6K7's; linear 2nd detector, 6C5; amplified and delayed A.V.C., 6B8; panel-controlled beat-frequency oscillator, 6J7; beam power output, 25L6G; and rectifier, 25Z5. The I.F. amplifier is of entirely new design, operating at a frequency of 1560 kc. and providing a high order of image suppression, better in fact than that obtainable in many receivers having elaborate pre-selectors. The crystal filter (2nd I.F. stage) is truly remarkable in its performance, since selectivity is continuously variable between 400 cycles for single-signal CW, and 5 kc. for high quality broadcast. The range of the phasing circuit (heterodyne elimination) has been similarly extended. With such unusual characteristics, the crystal filter remains in the circuit at

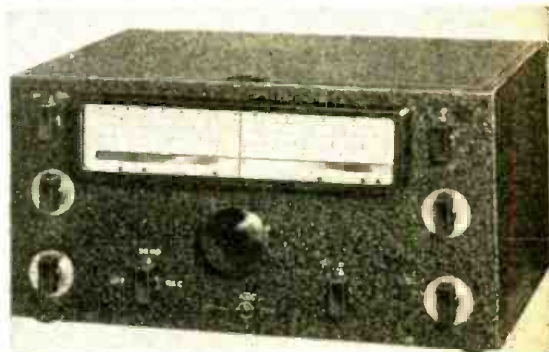

Front view of the new National model 80X receiver, which is furnished with speaker. (No. 668)

all times, simplifying the tuning considerably. With the development of the 25L6G beam power tube, having an undistorted output of 2 watts, it has become possible to design a high performance communication receiver, operating with full efficiency on either A.C. (Continued on page 447)

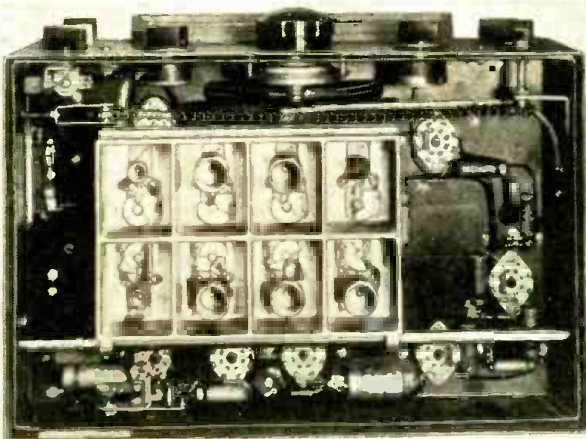
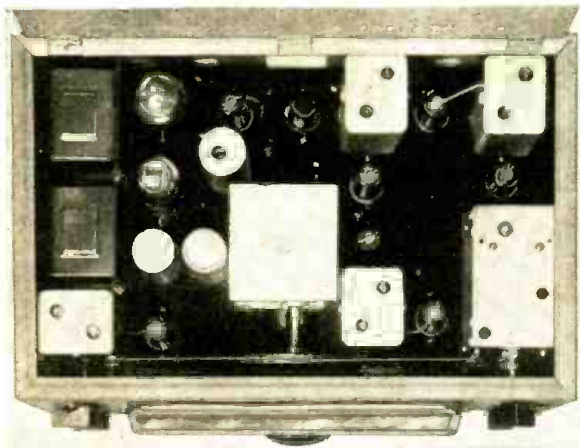

Photos at left show two different views of the NC-80X receiver. It has a tuning range from 550 kc. to 30 mc. in 4 ranges. One model, the 81X, is arranged especially for amateur reception and covers the usual amateur bands: the dial of the set is calibrated in megacycles. A crystal filter gives razor-sharp selectivity and where desired, the set is available for 6 volt battery operation and 135 volt B-supply.

New Short-Wave Apparatus of Interest

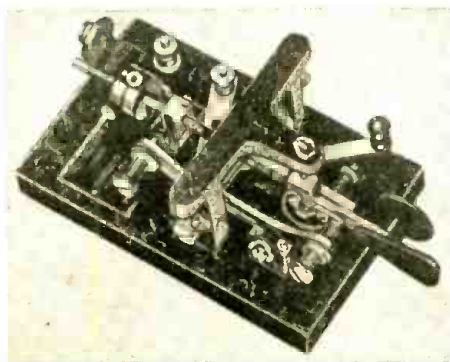

Newest model speed-key "styled" by T. R. McElroy, world-champion operator. (No. 665)

A Real De Luxe Key

● THIS new 1938 model of the Mac-Key is finished in polished black marble effect with white veins. It is highly polished and won't collect dust. The brass and bronze parts above the base are chrome and nickel finished.

The pins and bearing are oversize and case-hardened. Pigtails are used for electrical connection, thus assuring efficient and uniform operation. The insulating bushings and washers, together with a thumb paddle and finger button are of molded bakelite. A circuit-closing switch is also included for telegraph-line operation.

This article has been prepared from data supplied by courtesy of T. R. McElroy.

New 3-Gang Midget Condenser

● AT last a 3-gang midget! In the photograph we see the Bud 3-gang condenser. This instrument should prove of great value to the experimenter, especially in superheterodyne receivers employing 1 stage of R.F. The oscillator, detector and R.F. amplifier can now be operated from a single shaft. The condenser is constructed of brass plates and securely soldered to the supporting shafts.

In the other photo we see a large 2-gang midget of the double-spaced variety. These are available in capacities ranging from 35 mmf. to 75 mmf. per section.

The 3-gang unit is available in capacities from 20 to 140 mmf. Both units are mounted on ceramic bases 1 3/4" wide, by 5 1/4" long.

This article has been prepared from data supplied by courtesy of Bud Radio, Inc.

Below—2-gang midget.

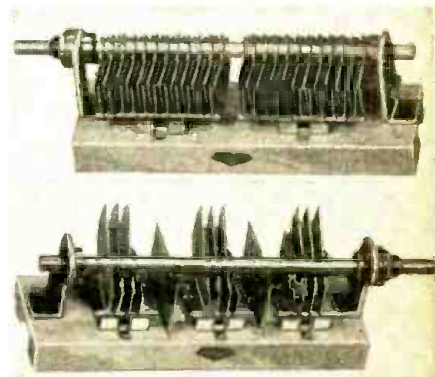

A long-awaited unit—the 3-gang midget condenser. (No. 666)

Names and addresses of manufacturers of apparatus furnished upon receipt of postcard request: mention No. of article.

New Apparatus for S-W HAMS and FANS



Rear view of the new Utah Junior transmitter.

New Junior Transmitter— 25 Watts C.W.

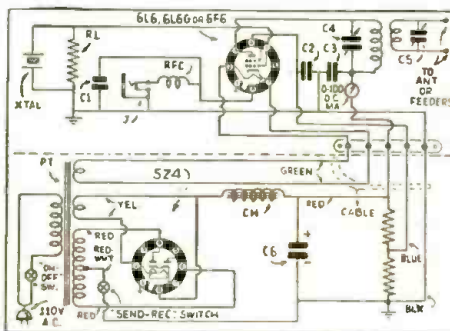

Hook-up of the Junior transmitter.



Front view of the 25-watt C.W. transmitter. No. 659

● THE two photos and diagram above show one of the newest C.W. transmitters designed for the beginner in "Ham" radio. This set, while small in size, has crystal control of the frequency and is rated at 25 watts for C.W. operation. The crystal-control oscillator circuit is such

that it will operate on all amateur bands with only one coil per band to change, and complete coverage is obtained with but two crystals. This transmitter unit will operate on two or more bands with one crystal. A power-supply is included in the transmitter as the diagram shows, a 5Z4

tube being used as a rectifier. For the oscillator a 6L6 or else a 6F6G tube may be used. A keying jack is provided in the cathode circuit.—This data has been supplied by the courtesy of the Utah Radio Products Co.

Clever Fuse Holder



A clever fuse holder which can be mounted on the front panel of a transmitter. No. 660

● THE problem of mounting and changing small fuses in radio apparatus has now been solved by this new compact insulated fuse plug. The housing is made of bakelite and can be fastened directly to metal panels or chassis. The fuse is inserted in the end of a small screw plug which fits into bakelite housing. When a fuse blows it is only necessary to unscrew the small bakelite plug and the fuse which is fastened to it is removed at the same time. It is almost impossible to become shocked with this arrangement.

Our information bureau will gladly supply manufacturers' names and addresses of any items mentioned in Short Wave & Television.

A Novel "Grip-to-Talk" Mike Stand

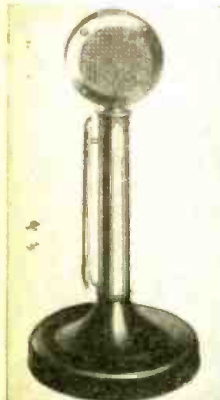

No. 661

This article has data supplied by courtesy of Astatic Microphone Laboratory, Inc.

● THE well-known D-104 crystal microphone widely used by Amateurs is now available with a "grip-to-talk" stand. This stand, as can be seen in the photograph, resembles a telephone stand and it is only necessary to grip the midsection in order to transmit. A very convenient arrangement for duplex break-in operation.

This article has data supplied by courtesy of Astatic Microphone Laboratory, Inc.

Spacing Insulators for Antennas

● THERE are two commonly used methods of matching the impedance of a transmission line to that of an antenna system: the concentrated transformer network and the quarter-wave section. The latter is most popular in amateur installations and is usually either a quarter-wave matching stub (in from one end) or a linear transformer, alias Q-bar. Of the two, the Q-bar type seems to be the most favored by wide usage. It is an extremely effective and practical method, and kits of parts have long been available from practically all dealers.

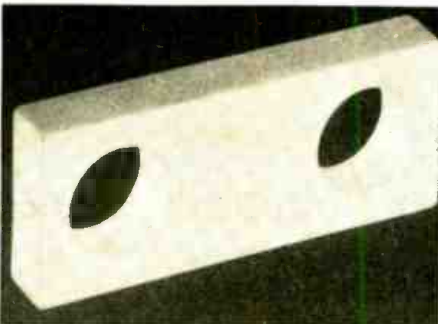

New Spacing Insulator for Ham Antenna Matching Systems. No. 662

Our own objection to the Q-bar system has been a mechanical one. Namely, that the coils of soft tubing and adjustable insulators supplied in the usual kit have been somewhat haywire. It is almost impossible to get the coiled tubing straight, and the feat is scarcely worth the trouble in any case since the tubing is not stiff enough to support its own weight and immediately kinks again. The adjustable insulators are likewise subject to involuntary adjustments.

For use at W1HRX, it was decided to design a rigid, non-adjustable assembly. This has proved so entirely satisfactory that arrangements have been made to supply the parts commercially. Thus does history repeat itself, for the original disk-type neutralizing condensers too were first built as a private folly at W1HRX, using disks left as scrap when socket holes were punched in aluminum chassis. These have

(Continued on page 454)

Television Tubes

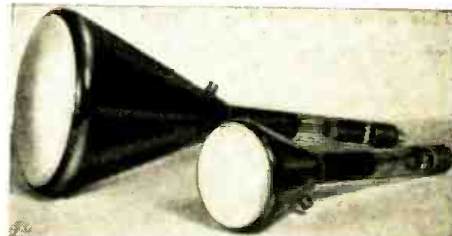

New RCA experimental television cathode-ray tubes. No. 664

● THE American television experimenters have been anxiously waiting for an experimental type cathode ray tube—here's the answer by RCA. The No. 1800 tube is 9" dia., and the No. 1801 kinescope tube measures 5" dia. The 9" tube will take 7,000 V. maximum and the 5" tube 3,000 V. maximum.—This article prepared from data supplied by courtesy of the RCA Mfg. Co.

New 3-in-1 Short-Wave Receiver

● THIS 3-in-1 short-wave receiver is known as the Air-Wave Air-Scout. This new set brings in short waves, local broad-

(Continued on page 454)



Appearance of the 3-in-1 S-W receiver. No. 663

Names and addresses of manufacturers of apparatus furnished upon receipt of postcard request; mention No. of article.

CARRIER HUM INDICATOR

In a radio frequency phone transmitter the amount of hum or other noise on the carrier may be heard directly by the insertion of an ordinary A. F. output transformer, such as used on dynamic speakers, with the voice coil winding connected in series with either the cathode or the lead to the center-tap of the filament transformer used for the tube in the modulated stage. A pair of phones is connected across the high resistance winding. This makes a very efficient monitor for continuous checking of the quality of the emitted signal.—H. F. Beane, Mountain Lakes, N.J.

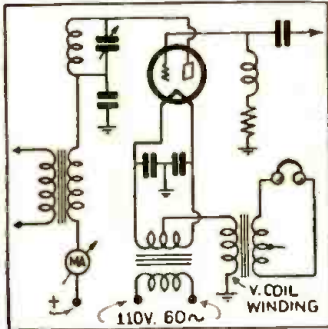

SOCKET PUNCH

Two pieces of iron pipe, sawed squarely across, make a handy socket punch. One piece of pipe must have an outside diameter such as to fit closely inside the other piece. Both sections, which need be only an inch or so long, are fitted with hardwood plugs. The centers are located and a pin fitted in one section, to be centered in a hole in the other. The plugs should be slightly shorter than the pipe. When drilling, the assembly should be together and the holes drilled through the two wood blocks in one operation.—R. Etelberg.

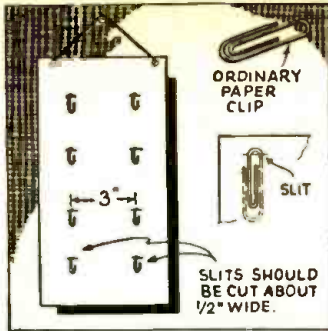
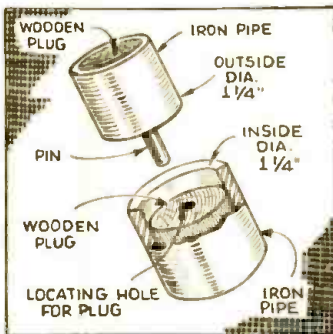

QSL CARD MOUNT

I am submitting this kink to S. W. & T. readers who do not wish to mount their QSL cards permanently. Any suitable size cardboard can be used. Old advertising signs are excellent as the back usually has a smooth white surface. To prepare the cardboard cut two slits about four inches apart and about 1/2-inch wide. Then insert an ordinary paper clip in each slit. The smaller part of the clip should be on the front of the card. Then slip the QSL under these clips.—Robert Lee Nichols.

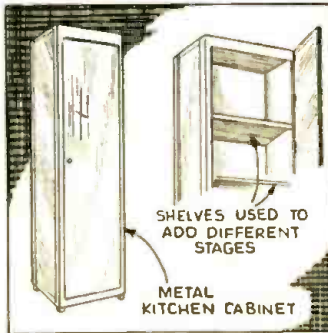

TRANSMITTER RACK

I have found that an excellent transmitter rack can be made by using a kitchen cabinet which is made of solid tin which is used to put dishes into. I made a rack out of such a cabinet and turned it around so the door would be facing the back. The shelves are very useful for putting different stages on and is well shielded from other stages. All ground connections may be soldered directly to the tin chassis.—Eugene Manning, W3FZQ.

CUTTING SLOTS IN PANELS

Here is a kink that I find useful in work-

USING DEFECTIVE CRYSTALS

Few amateurs take advantage of the fact that defective quartz crystals can usually be made to oscillate by introducing a little regeneration into the circuit. If the crystal is merely inactive, it will probably work with this device. If it has been cracked, it should be carefully broken through the fracture and its edges flattened and the corners rounded on a fine carborundum stone, being careful not to scratch the surface. The final shape and size is not important, and it is possible to get several good crystals from an inch square plate in this manner, all of which oscillate on the original frequency. The coil may consist of from 5 to 30 turns of No. 20 wire on a 1 1/2" tube base, for 80 meter crystals, and about half that for 40 meter plates; a little experimenting is necessary for best results.—James K. Oliver, W8C1W.

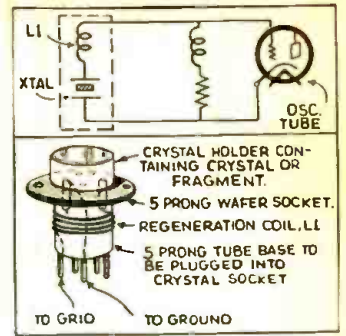

\$5.00 FOR BEST SHORT-WAVE KINK

The Editor will award a five dollar prize each month for the best short-wave kink submitted by our readers. All other kinks accepted and published will be awarded eight months' subscription to **SHORT WAVE & TELEVISION**. Look over these "kinks"; they will give you some idea of what the editors are looking for. Send a typewritten or ink description, with sketch, of your favorite short-wave kink to the "Kink" Editor, **SHORT WAVE & TELEVISION**.

ing large metal panels. In the absence of special tools. The panel to be cut is clamped in a vise with a square piece of steel along the mark, as shown in the drawing. A backsaw blade with taped ends is then used to cut along the mark.—John Metzler.

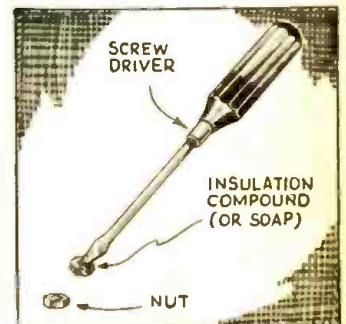
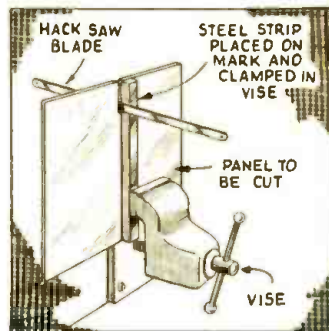

SOAP WORKS ALSO

When nuts have to be put on bolts in difficult places. I place a little insulation compound, beeswax, and resin on the screw driver. I use it in transformers on the end of the screw driver and stick the nut to it.—E. H. Barrow.

HELP! WE NEED MORE AND BETTER "KINKS"! SO SEND YOUR IDEAS ALONG!

"CQ"

It's Always The "Ham"!

As I had been without a receiver and consequently off the air for three weeks, I went to a local radio store to listen to a championship fight. When I returned I found that a B.C.L. (XYL) had complained that I had made so much noise on her set (about a mile away) that she could not listen to the fight!—William F. Rogers, W3GRC.

Static with a Vengeance!

I have an antenna about 100 ft. high and during a dust storm when it is blowing, the antenna generates static-electricity. This causes sparks about 2 inches long to jump across the antenna condenser.—Jack Baxter.

Beep! Beep! A New Call!

Since the license plates on my V-8 have been two letters—just plain "CQ," during 1936 and 1937, I contacted about a dozen "Hams" a week, via the beep-beep horn method, very often pulling over to the curb for a personal meeting with some op. that

"Ham" and "Fan" Set-Building Articles Wanted!

● The Editors are looking for good construction articles on "Ham" and "Fan" sets, including receivers and allied apparatus. Our readers are anxious to know about new circuits which you may have devised. Just because the set may only have 2, 3 or 4 tubes, there is no reason why you should think it unimportant.

Be sure to write the Editors and give them a brief description of your particular circuit; if they are interested, they will inform you promptly, so that you can prepare an article and take photos of the set. Otherwise, the set can be sent to the Editors and they will photograph it.

I've worked on CW or phone.—Ralph C. Folkman, W8COX.

He Knew His Radio

A young man was applying for a job in an electrical concern. "Do you know anything about electricity," asked the boss. "Yes, sir!" answered the young man.

"Well, what is an armature?" asked the employer impatiently.

"An armature is someone who sings for Major Bowes."—Frank Little, Jr.

Not So Dumb!

One cold windy evening the town "dumb-bell" appeared on the public square, complete with new clothes, including a derby. Protruding from under the "iron hat" was a pair of large earmuffs, giving a local "wit" an idea. Calling to the fellow he asked:

"What station have you got, Happy?"

Happy turned slowly, looked the fellow over from head to foot, and said:

"From what I'm hearing right now, I believe I've tuned in station S-K-U-N-K!"—Keith W. Kilton.

SOUTH S.A.R.R.L. AFRICA.

TO RADIO *W 2500* *11/4/1937*

Was sure pseed to meet u wen ur sigs were wkcd in mt shack
 at GMT rattling the cans on mi. *LV* at QSA. *R* es

T. *QSB* *QRN* *QRM* *WX*

Mi Xmtr Xtal Cont only *25* Kcs uses the *6* c. pack wid. *50* watts
 at *500* volts on plate pf. *35* *oh.* feeding. *Doublet* *Ant* aerial

Pse QSL to *B. G. Knott*

Tks QSO es vy 73's *Nottingham - 1/11/37*

Dx: *Shack* for report on my *20* meter *hone*

ZT2G—A nice card received from South Africa, with red letters.

JVO, 10.37 mc. was heard arranging a schedule with JDY at 7 a.m. JZG, 6.33 mc., heard contacting JFZC, 8.84 mc., at 7 a.m., and later, JFZC, the Xmtr aboard the S.S. *Chiehu Maru*, giving its location as 150 miles out of Yokohama, this at 7:30 a.m.

Also, JVE, JVG, which are usually used as commercial Xmtrs, are teamed up with JZJ and JZK in relaying JOAK. at 8:30 a.m. JZI has now shifted to 9.61 mc., moving from 9.535 mc.

JVE, 15.66 mc., was once heard here at 12:40 a.m., 'phoning. JVF, 15.61 mc., was heard at 2:35 a.m.

ITALIAN AFRICANS

IUD, 18.27 mc., Addis Ababa, Ethiopia, is being frequently heard of late, often with a woman doing the 'phoning, near 6 a.m. IUD has a very good signal.

IUG, 15.45 mc., also at Addis Ababa, is heard almost daily, near 8:30-9:30 a.m., and last heard at 8:38 a.m., 'phoning ITK, 16.385 mc., at Mogadiscio, Italian Somaliland. All these stations rate fine signals.

ALGERIA

TPZ, 12.12 mc., at Alger, is being well heard, and last month was tuned in repeatedly, between 2:30-3 a.m., and, in the afternoons, at 2:30-3 p.m. As mentioned before TPZ uses side band secrecy Xmsn. and a voice can only be poorly heard by tuning to the side of the carrier wave. This is all one needs to hear and log. however. to merit a verification. Reports indicate that TPZ occasionally broadcasts near 3:30-4 p.m., in clear speech, of course.

TPZ2, on 8.96 mc., has not been heard for a long time, and we regret this, as TPZ2 was heard all over the U.S. with a powerful signal, and enabled many DXers to add Algeria to their countries heard and verified.

QRA for TPZ-TPZ2 is: L'INGENIEUR EN CHEF. SERVICE ALGERIEN DES. P.T.T., 137, RUE DE CONSTANTINE, ALGER, ALGERIA.

OCEANIA

ZMBJ, 8.84 mc., S.S. *Awatea*, after being unheard here for a few months, was again logged at 2:30 a.m. when heard 'phoning ZLT4, 11.05 mc. at Wellington, New Zealand. As may be known, ZMBJ was barred from broadcasting musical programs, and therefore is heard rather infrequently now, being used only for communication purposes. Reports should be addressed to: Mr. L. H. Jones, Chief Opr., S.S. *Awatea*, Union Line, Wellington, New Zealand. As for ZLT4, they no longer verify reports. A last minute report shows ZMBJ to be heard at 6 a.m. ZMBJ uses inverted speech, except when contacting a station, or signing off. Signal strength excellent.

DUTCH EAST INDIES

YBG, 10.43 mc., at Medan, Sumatra, was heard in contact with PLV, 9.43 mc., Bandoeng, Java, at the beginning of their almost daily contact, 5:30-6:30 a.m.

PLV was the stronger of the two as usual as PLV has 80 k.w., to YBG's 3 kw. Though the D. E. I. commercial phones are no longer supposed to verify, we have obtained several most specific QSL cards by writing to this QRA: The Chief Engineer of the Govt., 6th Telegraph and Telephone District Medan, Sumatra, D. E. Indies. This QRA, of course, for YBG. As we have not received veries for other Javanese Xmtrs, we can't say about other QRAs.

PMC, 18.135 mc., Bandoeng, was once heard at 8:11 a.m., 'phoning inv. speech.

YDH4, Bandoeng, on a frequency of 3.31 mc., has confirmed reception of Ashley Walcott, this FB catch using just 30 watts! That's real DX, OM! Ashley adds that YDH4 has same QRA as PMY, Nillmy-Building, Bandoeng, Java. Also noted is that PMY has increased power from 600 watts to 1 kw. and should

be heard quite well this winter, when any experienced DXer can easily log this DX catch.

ASIATIC JOTTINGS

HSE2, 19.016 mc., was heard fairly well again, at 6:43 a.m., on a Saturday while phoning DFB, 17.52 mc., Nauen, Germany. Look for DFB first, and if DFB is heard phoning, inverted speech, chances are that HSE2 is also on the air. HSE2 usually has a rather poor, unsteady signal when tuned in, but can be brought up to an R7-8, when using the doublet here.

VWY2, 17.48 mc., Poona, India, has been often heard of late, always on schedule with GAU, 18.62 mc., Rugby, England. Inverted speech is used. Try for VWY2 now, as, whenever traffic is to be carried, the regular contact time is 8 a.m., and VWY2 is usually heard several times a week at this hour, with a much improved signal.

JDY, 9.925 mc., Dairen, Manchukuo, is still heard from 7-8 a.m. and gives news in English from 7:45-8 a.m. "JDY" is the only call announced now, "JQAK" being dropped. This from Ashley Walcott, W6, and Jim Lanyon, Vancouver, B.C. Harry Honda, W6, also reports this. JDY has a fine signal here, daily. QRA of JDY given in last issue.

A letter from our Singapore, S. S. correspondent, Mr. A. L. McIntyre, informs us that Singapore is going to have a new S.W. station,

this being announced over the air in a Singapore broadcast. This Xmtr will replace the lately deleted ZHI, famous for a number of years as Singapore's only S.W. station. The new broadcaster will be erected as soon as possible, and will have a wavelength, as yet undecided, between 31-49 meters. Thanks very much, OM, and please write again!

KTR, 10.91 mc., Manila, Philippines, is reported, with KAY, 14.98 mc., also at Manila, at 9:30 a.m., both using clear speech. KTR also heard here at 6:15 a.m., with a good signal.

TDE, 10.065 mc., Shinkyo, Manchukuo, heard at 5:55 a.m. 'phoning in clear speech, and at another time using inv. speech at 2:30 a.m. Although TDE is easily heard, we have yet to elicit a veri from either Tokio or Shinkyo! Yet Shinkyo once confirmed our reception of TDD, 5.83 mc., with a very friendly letter signed "from all members of the Shinkyo Xmitting station"! That report must have gotten into the right hands!

RV15, 4.25 mc., Khabarovsk, Siberia, is reported between 7:30-8 a.m., with a very strong QSA5, R9 plus signal, by Harry Honda, W6. Here's one to go after this winter. A fine catch for any Dxer, especially in the East.

KZRM, 9.57 mc., Manila, which is well heard throughout the U. S., is reported using chimes when announcing QRA, by Harry Honda. Everyone should try for KZRM, the only Philippine station that is easy to get, and sure to verify. QRA given in previous issues.

AFRICAN REVIEW

VQG, 19.62 mc., Nairobi, Kenya Colony, has been reported by Roy Myers, W6, at 6:30 a.m., and by Roger Legge, W2, at 7:35 a.m. VQG usually heard between 7:30-8:30 a.m. Roy Myers also reports ZSS, Klipheuvell, So. Africa, in contact with GAU, 18.62 mc., Rugby, together with VQG at 6:30 a.m. That's cleaning 'em up, Roy!

Roy also reports SUZ, 13.83 mc., Cairo, Egypt, at 11 a.m., and we also heard SUZ 'phoning GBB, 13.58 mc., Rugby, (their usual contact) at 11 a.m. GBB will usually call, exactly at 11 a.m. "Hello Cairo, GBB calling." SUZ will immediately answer and if any traffic is to be carried, both change to inv. speech. Usually, both sign off in clear speech. (Continued on page 456)

TO RADIO *W 2 X J M WKD* FONE *EW* MC *14*
8/24 1937 AT *21* MEZ *R 5 S 9 T P*

H A 8 N

TX: ~~CO~~ *FP* - PA - PA WATTS AER HERTZ DIPOL
 RX: SUPER 5 TUBES PSE TNX QSL BEST 73 ES DX!
 QRA: BUDAPEST, HUNGARY
 L. KÖLTÓ UTCA 8 PETER KADVANY

HA8N—An outstanding QSL with green letters received from Hungary.

A fee of 25c (stamps, coin or money order) is charged for letters that are answered by mail. This fee includes only hand-drawn schematics. We cannot furnish full-sized working drawings or picture layouts. Letters not accompanied by 25c will be answered on this page. Questions involving considerable research will be quoted upon request. Names and addresses should be clearly printed on each letter.

QUESTION BOX

EDITED BY G. W. SHUART, W2AMN

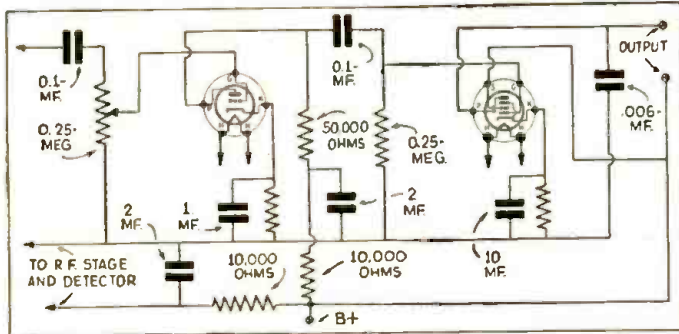

Stabilized A.F. Amplifier—1099

STABILIZING THE AUDIO IN A REGEN. SET

Arthur Paulinson, Sioux City, Ia.

(Q.) I recently added an audio stage, power pentode to my regenerative receiver which also has a T.R.F. stage. Since I have added the second stage of audio amplification, I have had considerable trouble with motor-boating. Will you kindly explain how this might be overcome.

(A.) In the diagram we have shown the two audio amplifier stages of a tuned R.F. regenerative receiver. You notice that the plate circuit of the first audio amplifier has two resistors. The mid-point between the two is by-passed with a large fixed condenser. The resistor marked 50,000 ohms may have to be reduced in size to as low as 20,000 ohms in stubborn cases. Also we have shown that the B+ lead feeding the R.F. and detector stages has a resistor and condenser network connected in it. These changes, together with the proper shielding in your receiver should overcome any feedback trouble you may have.

FOR THE HAM BEGINNER

Richard J. Wright, Philadelphia, Pa.

(Q.) Will you please print a diagram for a 2-tube radio receiver suitable for 40 meter "ham" operation.

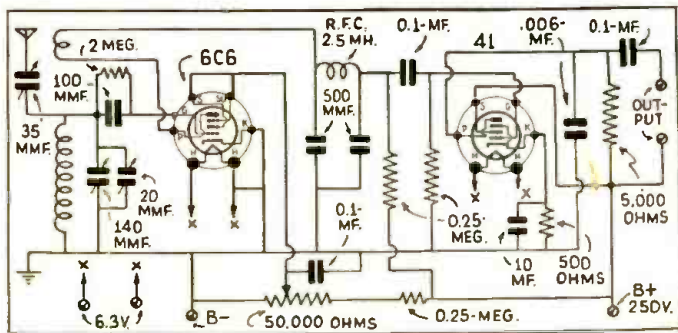

Ham Beginner's Receiver—1100

(A.) The 2-tube regenerative receiver shown in the diagram is one of the best receivers that a "ham" or "fan" beginner could start out with. The detector is a regenerative 6C6. Regeneration is controlled by a 50,000 ohm potentiometer in the plate circuit. This tube is, in turn, resistance coupled to the 41 pentode amplifier. The output circuit is arranged so that a pair of earphones might be connected to the output tube without injury to them, without the heavy plate current of the 41 flowing through them. Band-spread is obtained by connecting the 20 mmf. condenser in parallel with the 140 mmf. main tuning condenser.

1-TUBE "POLICE CALL" RECEIVER

James Oliver, Detroit, Mich.

(Q.) I am interested in listening to police calls and would like to have a receiver to tune in those police calls just below the broadcast band. Would you be kind enough to print a diagram of a 1-tube receiver, all electric, which would serve for receiving such calls.

(A.) We have shown a diagram of a 12A7 which is a combination pentode and rectifier. The circuit is of the A.C.-D.C. variety and should not be connected to an external ground except through a .1mf. condenser as shown in the diagram. The grid coils should have approximately 50 turns of No. 22 double cotton covered wire and

the tickler should have about 10 turns. Each should be wound on a 1 1/4" diameter form. Regeneration is controlled with 100,000 ohm potentiometer connected across the output of the power supply.

3-TUBE T.R.F. RECEIVER

Firmin Lopez, San Francisco, Calif.

(Q.) Will you please print in the Question Box the necessary diagram for a T.R.F. set employing a 58, R.F. stage, 57 regenerative detector and a 2A5 audio output tube. This set should be resistance coupled and employing a potentiometer for regeneration control and also it should use Hammarlund six prong 3-winding coils.

(A.) We have shown the diagram you request. It is conventional in every respect, regeneration is controlled with a potentiometer, the audio output is controlled by a 1/4 meg. potentiometer in the grid circuit of the 2A5. The small coil shown below the grid coil in the

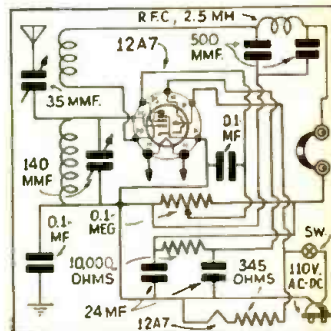

"Police Call" Set—1101

R.F. stage, the one with the 100 mmf. condenser, is used as a trimmer. This is the interwound winding. The antenna coil is the small coil which is equivalent to the tickler coil in the detector stage. It is advisable to build the receiver with two compartments, one containing the R.F. stage including the tuning condensers and coil, and another compartment for the detector and audio.

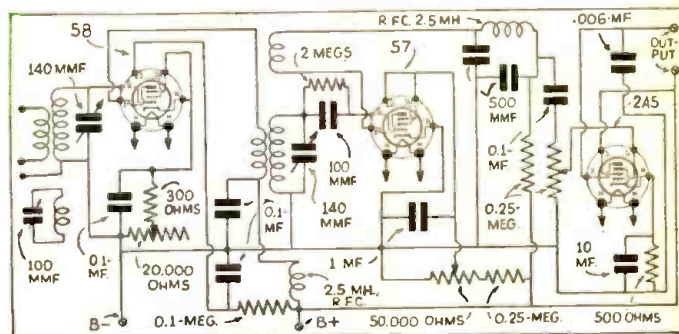

3-Tube T.R.F. Receiver—1102

PROPER ANTENNA NETWORK TUNING

Stanley Harrison, Freeport, L.I.

(Q.) I am using an impedance matching network with a single wire antenna and have difficulty in tuning in. Will you kindly explain the proper procedure.

(A.) In the first place, the transmitter should be tuned up with the clip marked "X" not connected to the final amplifier tank circuit. Condenser C1 in the tank circuit should be adjusted so that the plate current meter shows minimum, indicating that the circuit is resonant with the output frequency. With C3, set at either minimum or maximum capacity, the clip should be attached to the plate coil about midway between the two ends. When the plate voltage is applied C2 should be adjusted to restore resonance in the final amplifier as indicated by a minimum reading of the plate meter. If this is not obtainable, start with C3 at the other end of the scale (minimum, as you started with maximum).

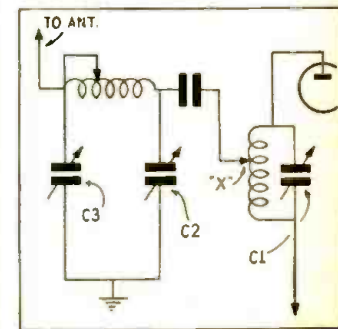

Antenna Tuning—1103

Mc.	Call	Location	Mc.	Call	Location	Mc.	Call	Location
15.280	H13X	CIUDAD TRUJILLO, D. R., 19.63 m. Relays H1X Sun. 7.40-10.40 am. Week-days 12.10-1.10 pm.	14.530	LSN	BUENOS AIRES, ARG., 20.65 m., Addr. (See 20.020 mc.) Works N. Y. C. afternoons.	12.215	TYA	PARIS, FRANCE, 24.56 m. Works French ships in morning and afternoon.
15.280	OJQ	BERLIN, GERMANY, 19.63 m., Addr. Broadcasting House. 12.05-11 am., 4.50-10.45 pm. Also Sun. 11.0 am.-12.25 pm.	14.500	---	ASMARA, ERITREA, AFRICA, 20.69 m. Works Rome and Addis Ababa 6.30-7.30 am.	12.150	GBS	RUGBY, ENG., 24.69 m. Works N. Y. C. evenings.
15.270	W2XE	NEW YORK CITY, 19.65 m., Addr. (See 21.520 mc.) 1-6 pm., 8.30-12 m., Sat. and Sun. 2.30-6, 8.30 pm.-12 m.	15.500	LSM2	BUENOS AIRES, ARG., 20.69 m., Addr. (See 21.020 mc.) Works RIO and Europe daytime.	12.130	DZE	ZEESEN, GERMANY, 24.73 m., Addr. (See 15.360 mc.) Tests irregular.
15.260	GS1	DAVENTRY, ENG., 19.66 m., Addr. (See 26.100 mc.) 12.20-3.45 pm.	14.485	TIR	CARTAGO, COSTA RICA, 20.71 m. Works Central America and U. S. A. daytime.	12.120	TPZ2	ALGIERS, ALGERIA, 24.75 m. Calls Paris 12 m.-6.30 am.
15.252	R1M	TACHKENT, U.S.S.R., 19.67 m. Works RK1 near 7 am.	14.485	YSL	SAN SALVADOR, SALVADOR, 20.71 m. Irregular.	12.060	PDV	KOOTWIJK, HOLLAND, 24.88 m. Tests irregularly.
15.250	W1XAL	BOSTON, MASS., 19.67 m., Addr. University Club. Sun. 11 am.-12 n.	14.485	HPF	PANAMA CITY, PANAMA, 20.71 m. Works WNC daytime.	12.000	RNE	MOSCOW, U.S.S.R., 25 m. Daily except Sun. 3-6 pm., Sat., Sun., Tues., Fri., 10.15-10.45 pm., also Sun. 6-11 am., Wed. 6-7 am.
15.245	TPA2	PARIS, FRANCE, 19.68 m., Addr. 98 bis. Blvd. Haussmann. "Radio Colonial." 6-11 am.	14.485	TGF	GUATEMALA CITY, GUATEMALA, 20.71 m. Works WNC daytime.	11.991	FZS2	SAIGON, INDO-CHINA, 25.02 m. Phones Paris mornings.
15.230	HS8PJ	BANGKOK, SIAM, 19.32 m. Irregularly Mon. 8-10 am.	14.485	YNA	NICARAGUA, MANAGUA, 20.71 m. Works WNC daytime.	11.960	H12X	CIUDAD TRUJILLO, D. R., 25.08 m., Addr. La Voz de Hispaniola. Relays H1X Tue. and Fri. 8.10-10.10 pm.
15.230	OLR5A	PRAGUE, CZECHOSLOVAKIA, 19.32 m., Irregular.	14.485	HRL5	NACAOME, HONDURAS, 20.71 m. Works WNC daytime.	11.955	IUC	ADDIS ABABA, ETHIOPIA, 25.09 m. Works IAC around 12 midnight.
15.220	PCJ	HUIZEN, HOLLAND, 19.71 m., Addr. N. V. Philips' Radio. Hilversum. Tues. 4-6.30 am., Wed. 8-10.30 am.	14.485	HRF	TEGUCIGALPA, HONDURAS, 20.71 m. Works WNC daytime.	11.950	KKQ	BOLINAS, CALIF., 25.1 m. Tests irregularly evenings.
15.210	W8XK	PITTSBURGH, PA., 19.72 m., Addr. (See 21.540 mc.) 9 am.-7 pm.	14.470	WMF	LAWRENCEVILLE, N. J., 20.73 m., Addr. A. T. & T. Co. Works London and Paris daytime.	11.940	FTA	STE. ASSISE, FRANCE, 25.13 m. Works Morocco mornings and Argentina late afternoon.
15.200	DJB	BERLIN, GERMANY, 19.74 m., Addr. (See 15.280 mc.) 12.05-11 am., 4.50-11 pm. Also Sun. 11.10 am. to 12.25 pm.	14.460	DZH	ZEESEN, GERMANY, 20.75 m., Addr. (See 15.360 mc.) Irregular.	↓ S.W. BROADCAST BAND ↓		
15.190	ZBWA	HONGKONG, CHINA, 19.75 m., Addr. P. O. Box 200. 11.30 pm. to 1.15 am., 4-10 am. Sat. 9.15 pm.-1 am. Sun. 3-9.30 am.	14.440	GBW	RUGBY, ENG., 20.78 m. Works U. S. A. afternoons.	11.900	XEW1	MEXICO CITY, MEXICO, 25.21 m. Monday, Wed. and Fri. 3-4 pm., 9 pm. 12 m. Tues. to Thurs. 7.30 pm.-12 m. Sat. 9 pm. to 12 m. Sunday 12.30-2 pm.
15.180	Q8O	DAVENTRY, ENG., 19.76 m., Addr. (See 26.100 mc.) 3.15-5.30, 5.45-8.55 am, 4-6 pm.	14.200	EASAH	TETUAN, SPANISH MOROCCO, 21.13 m. Daily except Sun. 2.15-5.7 and 9 pm.	11.895	HP61	AGUADULCE, PANAMA, 25.22 m., Addr. La Voz del Interior. 7.30-9.30 pm.
15.165	XEWW	MEXICO CITY, MEXICO, 19.78 m. 12 n.-6 pm.	14.164	PI1J	DORDRECHT, HOLLAND, 20.52 m., Addr. (See 7.088 mc.) Sat. 12 n.-12.30 pm.	11.880	TPA3	PARIS, FRANCE, 25.23 m., Addr. (See 15.245 mc.) 2-5 am., 12.15-6 pm.
15.160	JZK	TOKIO, JAPAN, 19.79 m., 3-4 pm., 4.30-5.30 pm., 12.30-1.30, 8-9 am.	13.990	GBA	RUGBY, ENG., 21.44 m., Works Buenos Aires late afternoon.	11.870	W8XK	PITTSBURGH, PA., 25.26 m., Addr. (See 21.540 mc.) 7-9 pm.
15.160	Y00	BANDOENG, JAVA, 19.8 m., Addr. N. I. R. O. M. 6-7.30 pm. 10.30 pm.-2 am., Sat. 7.30 pm.-2 am., 5.30-10.30 am.	13.820	SUZ	ABOU ZABAL, EGYPT, 21.71 m. Works with Europe 11 am. to 2 pm.	11.860	YDB	SOERABAJA, JAVA, 25.29 m., Addr. N. I. R. O. M. Sat. 7.30 pm. to 2.30 am., daily 10.30 pm. to 2 am.
15.140	GSF	DAVENTRY, ENG., 19.82 m., Addr. (See 26.100 mc.) 9.15 am.-12 n., 4-6 pm.	13.890	KKZ	BOLINAS, CALIF., 21.91 m., Addr. RCA Communications. Irregular.	11.860	GSE	DAVENTRY, ENG., 25.29 m., Addr. (See 26.100 mc.) Irregular.
15.120	HVJ	VATICAN CITY, 19.83 m., 10.30-10.45 am., except Sun., Sat. 10-10.45 am.	13.635	SPW	WARSAW, POLAND, 22 m., Mon., Wed. Fri., 12.30-1.30 pm.	11.855	DJP	BERLIN, GERMANY, 25.31 m., Addr. (See 15.280 mc.) Irregular 11.35 am. to 4 pm.
15.110	OJL	BERLIN, GERMANY, 19.85 m., Addr. (See 15.280 mc.) 12 m.-2, 8-9 am., 11.35 am. to 4.30 pm. Sun. also 6-8 am.	13.586	GBB	RUGBY, ENG., 22.08 m. Works Egypt and Canada afternoon.	11.840	KZRM	MANILA, P. I., 25.35 m. Addr. Erlanger & Gallinger, Box 283. 9 pm.-10 am. irregular.
↑ S.W. BROADCAST BAND ↑			13.410	YSJ	SAN SALVADOR, SALVADOR, 22.37 m. Works WNC daytime.	11.840	CSW	LISBON, PORT., 25.35 m. Nat'l Broad. Stat. 11.30 am.-1.30 pm. irreg.
15.055	WNC	HIALEAH, FLORIDA, 19.92 m., Addr. A. T. & T. Co. Calls Central America daytime.	13.390	WMA	LAWRENCEVILLE, N. J., 22.4 m., Addr. A. T. & T. Co. Works England morning and afternoon.	11.840	OLR4A	PRAGUE, CZECHOSLOVAKIA, 25.35 m. Addr. Czech Shortwave Sta. Praha X11, Fechova 16. Daily 2-4.30 pm., Mon. and Thurs. 7-9.10 pm.
15.038	RK1	MOSCOW, U.S.S.R., 19.95 m. Works Tashkent near 7 am.	13.380	IDU	ASMARA, ERITREA, AFRICA, 22.42 m. Works Rome daytime.	11.830	W9XAA	CHICAGO, ILL., 25.36 m., Addr. Chicago Federation of Labor. Irregular.
14.980	KAY	MANILA, P. I., 20.03 m., Addr. RCA Comm. Works Pacific Islands.	13.345	YVQ	MARACAY, VENEZUELA, 22.48 m. Works WNC daytime.	11.830	W2XE	NEW YORK CITY, 25.36 m., Addr. Col. Broad. System, 485 Madison Av., N. Y. C.
14.970	LZA	SOPHIA, BULGARIA, 20.04 m., Addr. Radio Garata. Sun. 12.30-8 am., 10 am. to 4.30 pm. Daily 5-6.30 am., 12 n.-2.45 pm.	13.285	CGA3	DRUMMONDVILLE, QUE., CAN., 22.58 m. Works London and ships afternoons.	11.820	XEBR	HERMOSILLA, SON., MEX., 25.38 m., Addr. Box 68. Relays XEBH. 2-4 pm., 9 pm.-12 m.
14.960	PSF	RIO DE JANEIRO, BRAZIL, 20.43 m., Works with Buenos Aires daytime.	13.330	1RJ	ROME, ITALY, 22.69 m. Works Tokio 5-9 am. irregularly.	11.820	GSN	DAVENTRY, ENG., 25.38 m., Addr. (See 26.100 mc.) Irregular.
14.950	HJB	BOGOTA, COL., 20.07 m. Calls WNC daytime.	13.075	VPD	SUVA, FIJI ISLANDS, 22.94 m. Irregularly.	11.810	ZRO	ROME, ITALY, 25.4 m., Addr. E.I.A.R., Via Montello 5. Daily 6.43-10.30 am, 11.30 am.-5.30 pm., Sun. 6.43-9 am, 11.30 am.-5.30 pm.
14.940	HR1	CIUDAD TRUJILLO, D. R., 20.08 m., Phones WNC daytime.	12.840	WOO	OCEAN GATE, N. J., 23.36 m., Addr. A. T. & T. Co. Works with ships irregularly.	11.805	OZF	SKAMLEBOAEK, DENMARK, 25.41 m. Addr. Statsradiofonien. Irregular.
14.940	HJA3	BARRANQUILLA, COL., 20.08 m. Works WNC daytime.	12.825	CNR	RABAT, MOROCCO, 23.39 m., Addr. Director General Tele. & Teleg. Stations. Works with Paris irregularly.	11.800	JZJ	TOKIO, JAPAN, 25.42 m., Addr. Broadcasting Co. of Japan, Overseas Division, 8-9 am, 3-4, 4.30-5.30 pm.
14.845	OCJ2	LIMA, PERU, 20.21 m. Works South American stations daytime.	12.800	IAC	PISA, ITALY, 23.45 m. Works Italian ships mornings.	11.800	OER3	VIENNA, AUSTRIA, 25.42 m. Daily 10 am.-5 pm. Sat. until 5.30 pm.
14.780	ROU	OMSK, SIBERIA, U.S.S.R., 20.28 m. Works Moscow irregularly 7-9 am.	12.780	GBC	RUGBY, ENG., 23.47. Works ships irregularly.	11.795	DJO	BERLIN, GERMANY, 25.43 m., Addr. (See 15.280 mc.) Irregular.
14.730	IQA	ROME, ITALY, 20.37 m. Tests irregularly.	12.466	HIN	CIUDAD TRUJILLO, D. R., 24 m. "Broadcasting National." 12 n.-2 pm. 6-11 pm. approx.	11.795	OAX5B	ICA, PERU, 25.43 m., Addr. Radio Universal. 11 am.-12 n. 4-11.15 pm.
14.953	GBL	RUGBY, ENG., 20.47 m. Works JVIH1-7 am.	12.325	DAF	NORDDEICH, GERMANY, 24.34 m. Works German ships daytime.	11.790	COGF	MATANZAS, CUBA, 25.45 m., Addr. Gen. Betancourt 51. Relays CMGF. 2-3, 4-5, 6-11 pm.
14.840	TYF	PARIS, FRANCE, 20.49 m. Works Saigon and Cairo 3-7 am, 12 m.-2.30 pm.	12.300	CB816	SANTIAGO, CHILE, 24.39 m., Addr. Louis Desmaras, Casilla, 761. 11 am.-1 pm., 4-8 pm., Sun. 4-10 pm.	11.790	W1XAL	BOSTON, MASS., 25.45 m., Addr. (See 15.250 mc.) Daily 4.45-6.30 pm., Sat. 1.45-5.15, 6-6.30 pm.
14.600	JVH	NAZAKI, JAPAN, 20.55 m. Broadcasts irregularly 5-11.30 pm. Works Europe 4-8 am.	12.250	GBU	RUGBY, ENG., 24.41 m. Works N. Y. C. evenings.	(Continued on page 430)		
14.590	WMN	LAWRENCEVILLE, N. J., 20.56 m., Addr. A. T. & T. Co. Works England morning and afternoon.	12.235	TYB	PARIS, FRANCE, 24.49 m. Irregular.			
14.535	HBJ	GENEVA, SWITZERLAND, 20.64 m., Addr. Radio Nations. Broadcasts Sat. 6.45-8 pm.		TFJ	REYKJAVIK, ICELAND, 24.52 m. Works Europe mornings. Broadcasts Sun. 1.40-2.30 pm.			

(All Schedules Eastern Standard Time)

Short Wave Scouts

FORTY-FOURTH TROPHY

Presented to
SHORT WAVE SCOUT
Stanley La Rue
 309 South Bedford Drive
 Beverly Hills, California
 For his contribution toward the
 advancement of the art of Radio



Magazine

11 Veris—Australia, Africa, Oceania

● THE Australia, Africa, Oceania contest was won by Stanley La Rue with a total of 11 verifications, which all came within the rules of the contest. The receiver employed was a 1934 seven-tube Stromberg-Carlson with a Peak, 2-tube preselector. The antenna was an RCA double-doublet, around 25 ft. above the ground with a length of 50 ft. No ground connection to the set was used. Mr. La Rue heard many other DX stations in the areas designated in the contest rules, however, they were slow in verifying and, of course, could not be entered.

Congratulations, Mr. La Rue, and we hope you like your trophy.

Winning Station List—11 Stations

Station	Frequency	Location
Africa		
CR7BH	11,718 kc.	Lourenco Marques, Mozambique
EA9AH	7,004 kc.	Tetuan, Spanish Morocco
IUC	11,955 kc.	Addis Ababa, Ethiopia
SUZ	13,820 kc.	Cairo, Egypt
ZSS	18,890 kc.	Klippeval, South Africa
Australia & Oceania		
VK3LR	9,580 kc.	Lyndhurst, Australia
VK2ME	9,590 kc.	Sydney, New South Wales, Aus.
VK3ME	9,503 kc.	Melbourne, Victoria, Australia
VPD	13,075 kc.	Suva, Fiji Islands
ZLT4	11,000 kc.	Wellington, New Zealand
ZMBJ	8,840 kc.	"T.S.S. Awatea," New Zealand

● THE last of the special continental contests will be for South American stations, and this contest will close on December 24. Following this, we are planning to return to the original type of contest. That is to say, there will be no restriction on the geographical location of the stations to be entered in any one contest. Each contest will be world-wide. Stations heard and verified during any thirty-day period, regard-

Contest Rules

- THE first of the new contests was for the greatest number of verified stations heard in Asia and the winner was announced in the November issue.
- THE second of the new contests was for Australia, Africa and Oceania and closed Sept. 25th. The winner, Stanley La Rue, of Beverly Hills, Calif., is announced on this page.

A notarized affidavit must be sent with the veri cards and, of course, all of the veris will have to be for the continent assigned for each particular contest. The trophy winner in the next contest will be published in the January issue.

A—By midnight Nov. 24th all entries for the North American (including Central America, West Indies, Canada and Mexico) contest must therefore be in the hands of the Editors, together with the veris and the notarized oath that the contestant personally listened to all of the stations listed.

B—In the event of a tie between two or more contestants, each listing the same number of stations, the judges will award a similar trophy to each contestant so tying.

C—Bear in mind that the veri cards should be absolute verifications, and not simply an acknowledgment that you notified a station that you heard them. Several stations do not verify, but simply send an acknowledgment card. Note that in either contest that only experimental phone or broadcast stations should be entered in your list. No amateur transmitters or commercial code stations can be entered. The contest for the February issue will close in New York City, Nov. 24th, etc.

The judges in each contest will be the Editors of Short Wave & Television and the opinion of the judges will be final.

Send veri cards with your letter and oath certificate all in one package. Use a single line for each station and list them in a regular order, such as: frequency, schedule (all time should be reduced to E.S.T., which is five hours behind Greenwich Meridian Time), name of station, city, country; musical identification signal if any.

less of their location, will be acceptable (providing that 50% of the stations submitted are from countries other than the one in which the contestant resides). The first of these contests will close on January 24, 1938.

The response to the continental contest has not been as great as we had hoped, so, we believe that a return to the old type of contest is desirable in order to encourage more entrants.



● ON this page is illustrated the handsome trophy which was designed by one of New York's leading silversmiths. It is made of metal throughout, except the base, which is made of handsome black Bakelite. The metal itself is quadruple silver-plated, in the usual manner of all trophies today.

It is a most imposing piece of work, and stands from tip to base 22 1/2". The diameter of the base is 7 3/4". The diameter of the globe is 5 1/4". The work throughout is first-class, and no money has been spared in its execution. It will enhance any home, and will be admired by everyone who sees it.

The trophy will be awarded every month, and the winner will be announced in the following issue of SHORT WAVE & TELEVISION. The winner's name will be hand engraved on the trophy.

The purpose of this contest is to advance the art of radio by "logging" as many short-wave phone stations, amateurs excluded, as explained in detail elsewhere. The trophy will be awarded to that SHORT WAVE SCOUT who has logged the greatest number of short-wave stations in each respective contest as explained herewith.

NEXT CONTEST—North America S-W stations, including Central America, West Indies, Canada and Mexico

Closes Nov. 24th, when all veris from these countries must be in the Editor's hands.

Important! Note: the last special "continent" closing date!

Contest closing Dec. 24th—South American stations.

How To

KEEP THESE LISTS OF IDENTIFYING SIGNALS, AS THEY WILL PROVE MOST VALUABLE.

Identify Short-Wave Stations

WORLD-WIDE STATION IDENTIFICATION LIST

Part Six

Freq. Station
Mc. Call Type—Location
9.50 HJ1ABE B—Cartagena, Colombia. Slogan: "La Voz de los Laboratorios Fuentes." Signs off with organ playing "Aloha Oe."



9.492 XEFT B—Vera Cruz, Mexico. "La voz de Vera Cruz." Uses dual calls "X E T F y XEFT."

9.49 XTV C—Canton, China. Announcements in Chinese and English

at start of transmitting, then uses inverted speech. Off the air at present.

9.488 EAR B—Madrid, Spain. Slogan: "La voz de Libertad." Frequently uses slogans: "La voz de Espana," or "La voz de Madrid," instead.

9.475 EAH B—Madrid, Spain. Announces as U.G.T.1. Not heard lately.

9.453 TGWA B—Guatemala City, Guatemala. "Radio Dipusora Nacional." Often announces as "TGW-TGWA."

9.45 XEDQ B—Guadalajara, Mexico. "Radio Fonographica." Announces as "XED y XEDQ." Unstable frequency.

9.44 HCODA B—Guayaquil, Ecuador. "La voz del Alma, Guayaquil, Ecuador."

9.43 COCH B—Havana, Cuba. Mentions "General Electric" a great deal. Plays "Maria La O," Spanish love song, on signing off.

9.415 PLV C—Bandoeng, Java. Announcements at start of transmitting, in Dutch: "Hallo, Palembang. Hier ist Bandoeng oper PL-Victoria." Or, in English when phoning San Francisco, Manila or Tokio: "Here is station PLV, Bandoeng, Java." Scrambled

speech used for all stations but YBZ. 9.365 COBC B—Havana, Cuba. Announcements: "COBC, en Havana, la capital de la Republica de Cuba." Poor modulation, frequency very unstable.

9.33 OAX4J B—Lima, Peru. "Radio Internacionales, la voz de Lima,

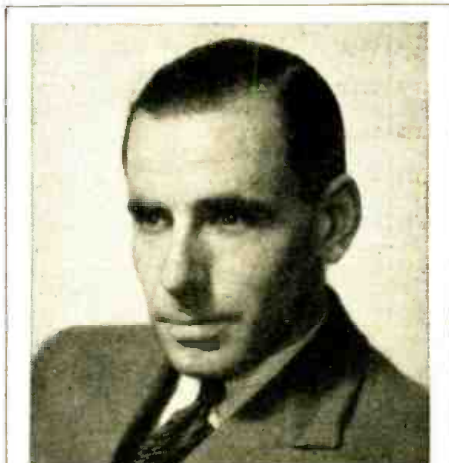

J. B. Clark, director of the British Empire Broadcasting Service.

Peru." Dual call: "OAX4I y OAX4J." 9.31 COBC B—Havana, Cuba. Lately reported on this frequency.

9.30 YNGU B—Managua, Nicaragua. "La voz de los Lagos." Signing off with Blue Danube Waltz, on the organ.

9.285 XTC C—Shanghai, China. See XTV, 9.49 mc.

9.195 COBX B—Havana, Cuba, Relays CMBX, Havana BCB station. English announcements when signing off. Announcements are pre-

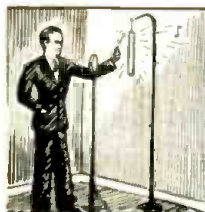

ceded by single stroke of small chime at half hour and hour.

9.125 HAT4 B—Budapest, Hungary. Calls: "Hallo, ist Radio Budapest." Begins transmitting with bells ringing. Uses interval signal of music box. Slogan: "Justice for Hungary." English announcements at beginning and end of programs.

9.120 YCP C—Balikpapan, Borneo. Calls at start of transmitting only: "Hallo Makassar, hier ist Balikpapan." Clear speech always used.

9.08 XTK C Hankow, China. See XTV, 9.49 mc.

9.00 COBZ B—Havana, Cuba. "Radio Sales." Announcements as "COBZ also CO9BZ." Announcements QRA as "Box 866."

8.88 JFZC C—"S.S. Chichibu Maru." See JFZC, 17.70 mc.

8.84 ZMBJ C "S.S. Awatea." Broadcasts no more, used only for radio-phone work. Announcing call at beginning of transmitting.

8.84 HCJB B—Quito, Ecuador. Opens with march. Slogan: "La voz de los Andes." Interval, 4 notes on gong.



8.775 PNI C—Makassar, Celebes. Call given in Dutch at beginning of transmitting only: "Hallo Bandoeng, hier ist Makassar." Inverted speech used when phoning Bandoeng, but never when phoning YBZ or YCP.

8.75 CEM C—Magallanes, Chile. Call and location often announced at beginning of transmitting only. Clear speech used.

8.719 VPD2 B—Fiji Islands. Not used at present, see VPD2, 9.54 mc.

8.71 KBB C—Manila, Philippines. Identifies in English at beginning and end of transmitting. Inverted speech used if station contacted uses it, otherwise clear speech.

Television—Why and How

● RESIDENTS of New Jersey will have front row seats in the "theatre of the air" when television becomes a public service, according to Dr. Alfred N. Goldsmith, former vice president of the Radio Corporation of America and now technical consultant to the company. The statement was made in the course of a talk on television by Dr. Goldsmith before the New Jersey Press Association recently in congress at Rutgers University.

Dr. Goldsmith explained that in the northern part of the state particularly, experimental field tests have shown reception conditions often as good as those met with in many parts of metropolitan New York, where the RCA transmitting station is located, in the Empire State Building. New York presents problems in television transmission that are unique, because of the

By Dr. Alfred N. Goldsmith

effect of tall steel structures on the ultra-short radio waves employed in the new art. However, communities in northern New Jersey are said to be lucky in that so many points are in direct air line with the television transmitting antenna on top of the Empire State Tower, because this is the ideal condition for reception of ultra-short waves.

Points in southern parts of the state may not be able to realize successful reception of television images direct from New York, he said, but it was pointed out that the terrain of that section was generally flat, favoring utmost "horizon" range from a transmitter in the area which might be at Philadelphia or at a point in South Jersey,

where it would be logical to locate an automatic radio relay to connect the two large cities.

Dr. Goldsmith told the press men that successful experiments in the automatic radio relay between New York and Philadelphia were accomplished by RCA several years ago, through a single relay station, located at Arney's Mount, near Trenton. This was done with 180-line images, he said, whereas today's standards call for 441 lines to the picture, but the test was taken to be indicative of future possibilities.

Dr. Goldsmith traced the operation of the RCA electronic television system from pickup to receiver image. "We may call it a 'celestial art,'" he said, "because the higher the transmitting and receiving antennas, the more ideal are the conditions of operation." The problems of (Continued on page 464)

Mc.	Call	Mc.	Call	Mc.	Call			
9.540	DJN	BERLIN, GERMANY, 31.45 m., Addr. (See 9.560 mc.) 12.05-11 am., 4.50-10.45 pm.	9.020	GCS	RUGBY, ENGLAND, 33.26 m. Works N. Y. C. evenings.	7.088	PI1J	DORDRECHT, HOLLAND, 42.3 m., Addr. Dr. M. Hellingman, Technical College. Sat. 11.10-11.50 am.
9.540	VPD2	SUVA, FIJI ISLANDS, 31.45 m., Addr. Amalgamated Wireless of Australasia, Ltd. 5.30-7 am.	9.010	KEJ	BOLINAS, CAL., 33.3 m. Relays NBC and CBS programs in evening irregularly.	6.996	PZH	PARAMIRABO, DUTCH GUIANA, 42.88 m., Addr. P. O. Box 18. Daily 6.06-8.36 am., Sun. 9.36-11.36 am., Daily 5.36-8.36 pm.
9.535	HB9D	ZURICH, SWITZERLAND, 31.46 m., Addr. Radio Club of Zurich, Post Box Zurich 2. Sun. 9-11 am., Thur. 1-3 pm.	9.957	VWY	KIRKEE, INDIA, 33.43 m. Works with England in morning.	6.977	XBA	TACUBAYA, D. F., MEX., 43 m. 9.30 am.-1 pm., 7-8.30 pm.
9.530	W2XAF	SCHENECTADY, N. Y., 31.48 m., Addr. General Electric Co. 4 pm.-1 am.	9.960	TPZ	ALGIERS, ALGERIA, 33.48 m. Works Paris afternoons.	6.976	HCETC	QUITO, ECUADOR, 43m., Addr. Teatro Bolivar. Thurs. till 9.30 pm.
9.525	ZBW3	HONGKONG, CHINA, 31.49 m., Addr. P. O. Box 200. 11.30 pm. to 1.15 am., 4-10 am. Sun. 3-9.30 am.	9.950	HCJB	QUITO, ECUADOR, 33.5 m. 7-10 pm. except Monday.	6.905	GDS	RUGBY, ENG., 43.45 m. Works N.Y.C. evenings irregularly.
9.525	LKJ1	JELOY, NORWAY, 31.49 m. 5-8 am.	9.795	HKV	BOGOTA, COLOMBIA, 34.09 m. Mon. and Thurs. 7-7.30 pm.	6.860	KEL	BOLINAS, CALIF., 43.70 m. Tests irregularly. 11 am.-12 n., 6-9 pm.
9.520	HJ4ABH	ARMENIA, COLOMBIA, 31.51 m. 8-11 am., 6-10 pm.	9.775	PNI	MAKASSER, CELEBES, N. I., 34.19 m. Works Java around 4 am.	6.850	XGOX	NANKING, CHINA, 43.8 m. Daily 6.40-8.40 am., Sun. 4.40-6.05 am.
9.520	OZF	SKAMLEBOAER, DENMARK, 31.51 m., Addr. Stateradiofonen, Copenhagen. 2-6.40 P.M.	9.765	DAF	NORDEICH, GERMANY, 34.23 m. Works German ships irregularly.	6.800	HI7P	CIUDAD TRUJILLO, DOM. REP., 44.12 m., Addr. Emisoría Diaria de Comercio. Daily exe. Sat. and Sun. 12.40-1.40, 6.40-8.40 pm. Sat. 12.40-1.40 pm. Sun. 10.40 am.-11.40 am.
9.520	YSH	SAN SALVADOR, EL SALVADOR, 31.51 m., Addr. (See 7.894 mc.) Irregular 6-10 pm.	9.760	GCQ	RUGBY, ENGLAND, 34.25 m. Works Africa afternoons.	8.770	HIH	SAN PEDRO DE MACORIS, DOM. REP., 44.26 m. 12.10-1.40 pm., 7.30-9 pm. Sun. 3-4 am., 4.15-6 pm., 4.40-7.40 pm.
9.520	XEDQ	GUAOALAJARA, GAL., MEXICO, 31.51 m. Irregular 7.30 pm. to 12.30 am.	9.750	FZE8	DJIBOUTI, FR. SOMALILAND, AFRICA, 34.29 m. Works Paris around 2.30 am.	6.775	WOA	LAWRENCEVILLE, N. J., 44.41 m., Addr. A. T. & T. Co. Works England evenings.
9.510	VK3ME	MELBOURNE, AUSTRALIA, 31.55 m., Addr. Amalgamated Wireless of Australasia, 167 Queen St. Daily except Sun. 4-7 am.	9.730	GCI	RUGBY, ENGLAND, 34.36 m. Works India 8 am.	6.750	JVT	NAZAKI, JAPAN, 44.44 m. Addr. Kokusai-Denwa Kaisha, Ltd., Tokio. Irregular.
9.510	QSB	DAVENTRY, ENGLAND, 31.55 m., Addr. (See 9.580 mc.—GSC) 3.15-5.30 am., 12.20-6 pm., 6.20-8.30, 9-11 pm.	9.720	VPD3	SUVA, FIJI ISLES, 34 m., Addr. (See 9.540 mc., VPD2). 5.30-7 am.	6.730	HI3C	LA ROMANA, DOM. REP., 44.58 m., Addr. "La Voz de la Feria." 12.30-2 pm., 5-6 pm.
9.510	HS8PJ	BANGKOK, SIAM, 31.55 m. Thursday, 8-10 am.	9.680	GBC	RUGBY, ENGLAND, 34.56 m. Works ships irregularly.	6.720	PMH	BANDOENG, JAVA, 44.64 m. Relays NIROM programs. 5.30-9 am.
9.505	HJ1ABE	CARTAGENA, COLOMBIA, 31.57 m. Addr. P. O. Box 31. 5-10.30 pm.	9.665	COJK	CAMAGUEY, CUBA, 34.62 m., Addr. Finlay No. 3 Altos. 5.30-6.30, 8-11 pm., daily except Sat. and Sun.	6.710	TIEP	SAN JOSE, COSTA RICA, 44.71 m., Addr. Apartado 257, La Voz del Tropic. Daily 7-10 pm.
9.500	XEWV	MEXICO CITY, MEX., 31.58 m. Addr. Apart. 2516. Relays XEW. 6 pm.-12 m.	9.650	YNLG	MANAGUA, NICARAGUA, 34.92 m. 7.30-9.30 pm.	6.672	YVQ	MARACAY, VENEZUELA, 44.95 m. Sat. 8-9 pm.
9.500	HJU	BUENAVENTURA, COLOMBIA, 31.58 m., Addr. National Railways. Mon., Wed. and Fri. 8-11 pm.	9.600	WOO	DCEAN GATE, N. J., 35.05 m. Works ships irregularly.	6.670	HC2RL	QUAYAQUIL, ECUADOR, S. A., 44.95 m., Addr. P. O. Box 759. Sun. 5.45-7.45 pm., Tues. 9.15-11.15 pm.
9.500	PRF6	RIO DE JANEIRO, BRAZ., 31.58 m. Irregularly 4.45 to 5.45 pm.	9.400	HC2CW	QUAYAQUIL, ECUADOR, 35.71 m. 11.30 am.-12.30 pm., 8-11 pm.	6.650	IAC	PISA, ITALY, 45.11 m. Works ships irregularly.
9.478	EAR	MADRID, SPAIN, 31.65 m., Addr. (See 9.860 mc.) 7.30-9.30 pm.	9.380	IAC	PISA, ITALY, 35.8 m. Works Italian ships irregularly.	6.630	HIT	CIUDAD TRUJILLO, D. R., 45.25 m., Addr. "La Voz de la RCA Victor." Apartado 1105. Daily exe. Sun. 12.10-1.40 pm., 5.40-8.40 pm.; also Sat. 10.40 pm.-12.40 am.
4 S.W. BROADCAST BAND 4						6.625	PRADO	RIOBAMBA, ECUADOR, 45.28 m. Thurs. 9-11.45 pm.
9.460	ICK	TRIPOLI, N. AFRICA, 31.71 m. Works Rome, 5.30-7 am.	9.180	XEME	MERIDA, YUCATAN, 36.63 m., Addr. Calle 59, No. 517, "La Voz de Yucatan desde Merida." 10 am.-12n., 6 pm.-12 m.	6.590	COCU	HAVANA, CUBA, 45.52 m., Addr. Estrada Palma 25, Vibora, Havana. Relays CMCU 7 am.-12 m.
9.450	TGWA	GUATEMALA CITY, GUATEMALA, 31.75 m., Addr. Ministere de Fomento. Daily 12 n. to 2 pm., 8 pm. to 12 m. Sat. 9 pm. to 5 am. (Sun.)	9.185	PSK	RIO DE JANEIRO, BRAZIL, 36.65 m. Irregularly.	6.558	HI4D	CIUDAD TRUJILLO, D. R., 45.74 m. Except Sun. 11.55 am.-1.40 pm.
9.440	HC2RA	QUAYAQUIL, ECUADOR, 31.78 m. Irregularly till 10.40 pm.	9.038	CNR	RABAT, MOROCCO, 37.33 m. Sun. 2.30-5 pm.	6.550	XBC	VERA CRUZ, MEX., 45.8 m. 8.15-9 am.
9.428	COCH	HAVANA, CUBA, 31.8 m., Addr. 2 B St., Vedado. 7 am.-1 am.	7.978	HC2TC	QUITO, ECUADOR, 37.62 m. Thurs. and Sun. at 8 pm.	6.550	TIRCC	SAN JOSE, COSTA RICA, 45.8 m., Addr. Radioemisora Catolica Costarricense. Sun. 11 am.-2 pm., 6-7, 8-9 pm. Daily 12 n.-2 pm., 6-7 pm., Thurs. 6-11 pm.
9.415	PLV	BANDOENG, JAVA, 31.87 m. Works Holland around 9.45 am. Broadcasts 5.30-9.30 am., 6-6.30 pm.	7.901	LSL	HURLINGHAM, ARGENTINA, 37.97 m. Works Brazil at night.	6.545	YV6RB	BOLIVAR, VENEZUELA, 45.84 m., Addr. "Ecos de Orinoco." 6-10.30 pm.
9.350	COBC	HAVANA, CUBA, 32.09 m. Addr. P.O. Box 132. Relays CMBG. 6.55 am.-12.30 am.	7.894	YSD	SAN SALVADOR, EL SALVADOR, 37.99 m., Addr. Dir. Genl. Tel. & Tel. Irregular 6-10 pm.	6.530	YN1GG	MANAGUA, NICARAGUA, 45.94 m., Addr. "La Voz de los Lagos." 8-9 pm.
9.330	CGA4	DRUMMONDVILLE, CANADA, 32.15 m. Works England irregularly.	7.860	SUX	ABOU ZABAL, EGYPT, 38.17 m. Works with Europe, 4-6 pm.	6.520	YV4RB	VALENCIA, VENEZUELA, 46.01 m. 11 am.-2 pm., 5-10 pm.
9.330	OAX4J	LIMA, PERU, 32.15 m., Addr. Box 1166. "Radio Universal." 12 n.-3 pm., 5 pm.-1 am.	7.854	HC2J8B	QUAYAQUIL, ECUADOR, 38.2 m. Evenings.	6.500	HIL	CIUDAD TRUJILLO, D. R., 46.15 m., Addr. Apartado 623. 12.10-1.40 pm., 5.40-7.40 pm.
9.300	YNQU	MANAGUA, NICARAGUA, 32.26 m. 12 n.-2 pm., 6-7 pm.	7.797	HBP	GENEVA, SWITZERLAND, 38.48 m., Addr. Radio-Nations. Sat. 5.30-6.30 pm.	6.500	TIOW	PUERTO LIMON, COSTA RICA, 46.15 m., Addr. Ondas del Caribe. Daily 12 n.-1.30 pm.
9.280	GCB	RUGBY, ENGLAND, 32.33 m. Works Canada and Egypt evenings and afternoons.	7.715	KEE	BOLINAS, CAL., 38.89 m. Relays NBC and CBS programs in evening irregularly.	6.477	HI4V	SAN FRANCISCO de MACORIS, D. R., 46.32 m. 11.40 am.-1.40 pm., 5.10-9.40 pm.
9.170	WNA	LAWRENCEVILLE, N. J., 32.72 m. Works England evenings.	7.628	RIM	TACKENT, U.S.S.R., 39.34 m. Works with Moscow in early morning.	6.470	YNLAT	GRANADA, NICARAGUA, 46.36 m., Addr. Leonidas Tenorio, "La Voz del Mombacho." Irregular.
9.150	YVR	MARACAY, VENEZUELA, 32.79 m. Works with Europe afternoons.	7.610	KWX	DIXON, CAL., 39.42 m. Works with Hawaii, Philippines, Java and Japan, nights.	9.450	HI8A	CIUDAD TRUJILLO, D. R., 46.51 m. 8.40-10.40 am., 2.40-4.10 pm. Sat. 9.40-10.40 pm. Sun. 2.40-4.40 pm.
9.125	HAT4	BUDAPEST, HUNGARY, 32.88 m., Addr. "Radiolabor," Gyali-ut. 22. Sun. and Wed. 7-8 pm., Sat. 6-7 pm.	7.560	TI8WB	PUNTA ARENAS, COSTA RICA, 39.74 m., Addr. "Ecos Del Pacifico," P. O. Box 75. 6 pm.-12 m.	6.420	HI18	SANTIAGO, D. R., 46.73 m. 11.40 am.-1.40 pm., 5.40-7.40, 9.40-11.40 pm.
9.100	COBX	HAVANA, CUBA, 32.96 m., Addr. San Miguel 146. Relays CMBX 7 am.-12 m.	7.520	KKH	KAHUKU, HAWAII, 39.89 m. Works with Dixon and broadcasts irregularly nights.			
9.080	TFK	REYKJAVIK, ICELAND, 33.11 m. Works London afternoons.	7.510	JVP	NAZAKI, JAPAN, 39.95 m. Irregular.			
9.030	COBZ	HAVANA, CUBA, 33.2 m., Radio Salas Addr. P. O. Box 866. 7:45 am.-12.3 am. Irreg. 12.30-2 am. Relays CMBZ	7.500	RKI	MOSCOW, U.S.S.R., 40 m. Works with RIM early am.			
			7.390	ZLT2	WELLINGTON, N. Z., 40.6 m. Works with Sydney, 3-7 am.			
			7.380	XECR	MEXICO CITY, MEX., 40.65 m., Addr. Foreign Office. Sunday 6-7 pm.			
			7.220	HKE	BOGOTA, COL., S. A., 41.55 m. Tues. and Sat. 8-9 pm. Mon. and Thurs. 6.30-7 pm.			
			7.200	YNAM	MANAGUA, NICARAGUA, 41.67 m. Daily at 9 pm.			
			7.100	FO8AA	PAPEETE, TAHITI, 42.25 m., Addr. Radio Club Papeete. Tues. and Fri. 11 pm.-12 m.			

(All Schedules Eastern Standard Time)

(Continued on page 434)

A Desk-Type 10-80 Meter



TRANSMITTER

By George W. Shuart, W2AMN

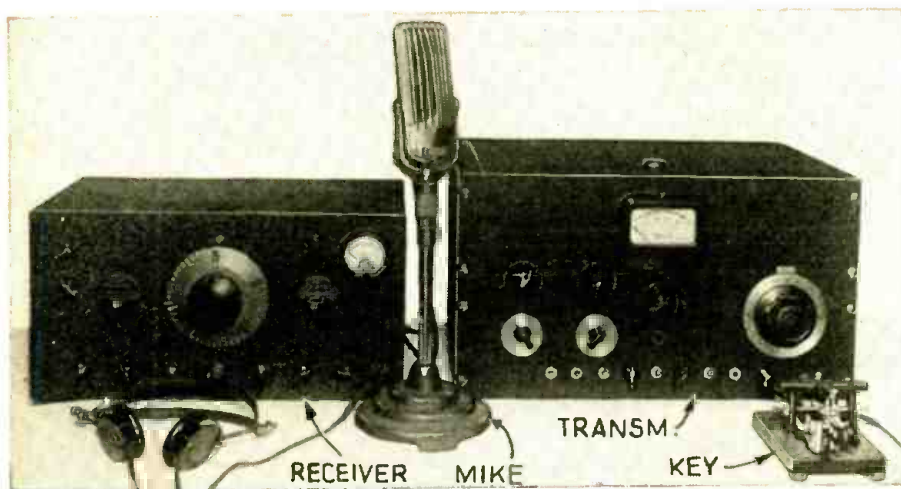

A complete "ham" station, including the new transmitter and the "S.W. & T." communications receiver.

● IT has long been our desire to build a transmitter which would be truly modern in all respects, one that contained all the features for convenience and efficiency we could possibly think of.

At the same time this transmitter should serve the Amateur of modest means who desires simplicity in operation and a compact station layout. In other words, it should be built for the man who enjoys operating and nothing else, experimenting being either beyond his technical ability or not within his spare-time schedule.

Transmitter Extremely Compact

The transmitter shown in the photographs is, we believe, an ideal arrangement. It is most compact because it is complete in one unit and its over-all dimensions are only 19" long, 10½" high and 13" deep. Its size permits it to be placed on the operating desk alongside the receiver; it is no larger than an average commercial receiver. Next, this transmitter should have all controls on the panel and be very flexible, with as few operations as possible for changing from one band to another. In other words, the idea was to eliminate all plug-in coils and still maintain the possibility of operating on the most popular bands from 10 to 80 meters.

"Key-Clicks" Eliminated

Although the latter features are not entirely available in the transmitter, it is only necessary to change the final amplifier plate coil to change from one band to another. This could also have been a tapped coil, with a slight loss in efficiency. The most important part in the operation of this transmitter was

the elimination of key-clicks, and when we say elimination, we mean just that! There should be no signs of clicks in the receiver alongside of it. Also it should permit break-in operation in order to permit a really pleasant QSO on C.W. These features are actually accomplished and just how will be explained later. Also every now and then every "ham" likes to take a flip at phone operation. That meant that this transmitter must be designed for phone service. While the output on C.W. is

This transmitter will provide 100 watts output on C.W. and 30 watts on phone. It is complete in one unit, there are no accessories except the microphone and key. It is built for the man who operates purely for pleasure, is not an experimenter, and really wants a compact job so that the entire station can be located on the operating desk. It has band-switching in all except the final amplifier coil, and meter-switching for all circuits. Additional constructional data will be given in the following issue of this magazine.

over 100 watts, the carrier output for phone operation is around 25-30 watts, because we used grid modulation for simplicity and compactness.

The description of this transmitter has been divided into two parts; the first part will be devoted to the R.F. portion, while complete information and details on the audio power supplies and operation will be given in the second half of the article, to appear next month.

41 Pentode Oscillator

Referring to the diagram we find that we have a 41 pentode oscillator. Many other circuits could have been used, but in this particular line-up a single tuned circuit serves the purpose better than anything else because the oscillator is always operating on the crystal frequency. Three crystals are used in the oscillator circuit. These crystals are changed automatically with a 2-gang rotary switch, which also shorts out sections of the oscillator coil in changing from 80 to 20 meters.

The RK25 serves as a buffer, driver and multiplier and also as the keying tube. The plate coil of this stage is also tapped, but goes from 80 to 10 meters. For 10-meter operation this tube is operated as a frequency doubler; this means that for 80-meter operation one frequency is available. However, on 40 and 20 meters 2 frequencies are (Continued on page 435)

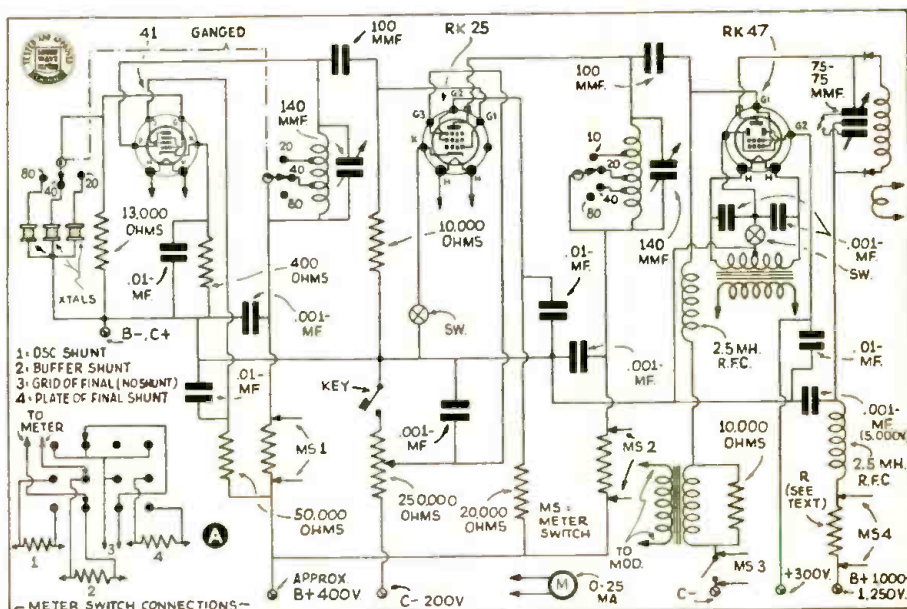

Wiring of the R.F. portion of the new Desk-Type transmitter.

Call	Mc.	Call	Mc.	Call	Mc.
6.410	TIPQ	SAN JOSE, COSTA RICA, 46.8 m., Addr. Apartado 225, "La Vos de la Victor." 12 n.-2 pm., 6-11.30 pm.	6.135	HJ1ABB	BARRANQUILLA, COL., 48.9 m., Addr. P. O. Box 715. 11.30 am.-1 pm., 4.30- 10 pm.
6.400	YV5RH	CARACAS, VENEZUELA, 46.88 m. 7-11 pm.	6.135	H15N	SANTIAGO, D. R., 48.9 m. 6.40-9.10 pm
6.395	COX4S	MARIANAO, CUBA, 46.9 m., Addr. Jefe del Cuerpo de Senales de la Republica de Cuba, Ciudad Militar, Marianao. Tests daytime and evenings.	6.130	TQXA	GUATEMALA CITY, GUAT., 48.94 m., Addr. Giornal Liberal Progressista. Irregularly.
6.380	YV5RF	CARACAS, VENEZUELA, 47.02 m., Addr. Box 983. 6-10.30 pm.	6.130	VP3BQ	GEORGETOWN, BRIT. GUIANA. 48.94 m. From 5 pm. on.
6.350	HRP1	SAN PEDRO SULA, HONDURAS, 47.19 m. 7.30-9.30 pm.	6.130	COCD	HAVANA, CUBA, 48.94 m., Addr. Calle G y 25, Vedado. Relays CMCD 10 am-10 pm.
6.350	YV1RH	MARACAIBO, VENEZUELA, 47.19 m., Addr. "Ondas Del Lago," Apartado de Correos 261. 6-7.30 am., 11 am.-2 pm., 5-11 pm.	6.130	VE9HX	HALIFAX, N. S., CAN., 48.94 m., Addr P. O. Box 998. Mon.-Fri. 9 am.-1 pm., 5-11 pm. Fri.; 1-3 pm., Sat.; Sun. 9 am.- 1 pm., 2-11 pm. Relays CHNS.
6.350	HRY	TEGUCIGALPA, HONDURAS, 47.24 m. 6.30-8.30 pm.	6.130	ZGE	KUALA LUMPUR, FED. MALAY ST., 48.94 m. Sun., Tue. and Fri. 6.40- 8.40 am.
6.340	H11X	CIUDAD TRUJILLO, D. R., 47.32 m. Sun. 7.40-10.40 am., daily 12.10-1.10 pm., Tues. and Fri. 8.10-10.10 pm.	6.130	LKL	JELOY, NORWAY, 48.94 m. 11 am. 6 pm.
6.330	COCW	HAVANA, CUBA, 47.39 m. Addr. LaVoz de las Antillas, P. O. Box 130. 6.55 am.-1 am. Sun. 10 am.-10 pm.	6.125	CXA4	MONTEVIDEO, URUGUAY, 48.98 m., Addr. Radio Electrico de Montevideo., Mercedes 823. 10 am.-12 n., 2-8 pm.
6.318	H1Z	CIUDAD TRUJILLO, D. R., 47.5 m. Daily except Sat. and Sun. 11.10 am.- 2.25 pm., 5.10-8.40 pm. Sat. 5.10- 11.10 pm. Sun. 11.40 am.-1.40 pm.	6.125	OAX1A	CHICLAYO, PERU, 48.98 m., Addr. La Voz de Chivlayo, Casilla No. 9. 8-11 pm.
6.310	TG2	GUATEMALA CITY, GUAT., 47.55 m., Addr. Secretaria de Fomento. Relays TG1 11 pm.-2 am.	6.122	OAX4P	HUANCAYO, PERU, 49 m. La Voz del Centro del Peru. 8 pm. on.
6.300	YV4RG	MARACAY, VENEZUELA, 47.62 m. 8- 10.30 pm.	6.122	HP5A	PANAMA CITY, PAN., 49 m. Addr. Box 58. 12 n-1 pm., 8-10 pm.
6.290	COHB	SANCTI SPIRITUS, CUBA, 47.77 m., Addr. P. O. Box 85. 9-11.30 am., 12.30- 1.30. 4-7, 8-11 pm.	6.122	HJ3ABX	BOGOTA, COL., 49 m. Addr. La Voz de Col., Apartado 2665. 12 n.-2 pm., 5.30- 11 pm.; Sun. 6-11 pm.
6.280	H1G	CIUDAD TRUJILLO, D. R., 47.77 m. 7.10-8.40 am., 12.40-2.10, 8.10-9.40 pm.	6.120	W2XE	NEW YORK CITY, 49.02 m., Addr. Col. B'cast. System, 485 Madison Ave. Irregular.
6.270	YV5RP	CARACAS, VENEZUELA, 47.79 m., Addr. "La Voz de la Philco." Irregular.	6.120	XEUZ	MEXICO CITY, MEX., 49.02 m., Addr. 5 de Mayo 21. Relays XEFO 1-3 am.
6.243	H1N	CIUDAD TRUJILLO, D. R., 48 m., Addr. "La Voz del Partido Dominicano." 12 m.-2 pm., 7.30-9.30 pm., irregularly.	6.115	OLR2C	PRAGUE, CZECHOSLOVAKIA, 49.05 m. (See 11.875 mc.)
6.235	HRO	LA CEIBA, HONDURAS, 48.12 m., Addr. "La Vos de Atlantida." 8-11 pm.; Sat. 8 pm.-1 am.; Sun. 4-6 pm.	6.110	XEPW	MEXICO CITY, MEX., 49.1 m., Addr. La Voz de Aguila Azteca desde Mex., Apartado 8403. Relays XEJW 11 pm.- 1 am.
6.230	YV1RG	VALERA, VENEZUELA, 48.15 m. 6-9.30 pm.	6.110	VUC	CALCUTTA, INDIA, 49.1 m. Daily 3- 5.30 am., 9.30 am.-12 m.; Sun. 7.30 am.- 12 m.
6.230	OAX4Q	LIMA, PERU, 48.15 m., Addr. Apartado 1242. Daily 7-10.30 pm.	6.110	YUA	BELGRADE, JUGOSLAVIA, 49.18 m., 12.45-2.30, 4-8 am., 1-6 pm.
6.210	YV5RI	CORO, VENEZUELA, 48.31 m., Addr. Roger Leyba, care A. Urbina y Cia. Irregular.	6.105	HJ4ABB	MANIZALES, COL., 49.14 m., Addr. P. O. Box 175. Mon.-Fri. 12.15-1 pm.; Tue. and Fri. 7.30-10 pm.; Sun. 2.30- 5 pm.
↓ S.W. BROADCAST BAND ↓					
6.190	H18Q	CIUDAD TRUJILLO, D. R., 48.47 m' 11.45 am.-1 pm., 4.45-6.45 pm.	6.100	W3XAL	BOUND BROOK, N. J., 49.18 m., Addr. Natl. Broad. Co. 9.15 pm.-1 am.
6.185	H11A	SANTIAGO, D. R., 48.5 m., Addr. P. O. Box 423. 11.40 am.-1.40 pm.; 7.40-9.40 pm.; Wed. 6-10.30 pm.	6.100	W3XF	CHICAGO, ILL., 49.18 m., Addr. N.B.C. 8 am.-9.10 pm., 1.05-2 am.
6.171	XEXA	MEXICO CITY, MEX., 48.61 m., Addr. Dept. of Education. 7-11 pm.	6.100	HJ4ABE	MEDELLIN, COL., 49.18 m. 11 am.-12 m., 6-10.30 pm.
6.160	YV5RO	CARACAS, VENEZUELA, 48.7 m. 11 am.-2 pm., 4-10.40 pm.	6.097	ZTJ	JOHANNESBURG, S. AFRICA, 49.2 m., Addr. African Broad. Co. Sun.-Fri. 11.45 pm.-12.30 am.; Mon.-Sat. 3.30-7 am., 9 am.-4 pm.; Sun. 8-10.15 am., 12.30-3 pm.
6.150	VPB	COLOMBO, CEYLON, 48.7 m. Daily exc. Thurs. and Fri., 6.30 am.-12.30 pm.; Sun. 7-11.30 am.	6.095	JZH	TOKIO, JAPAN, 49.22 m., Addr. (See 11.800 mc., JZJ.) Irregular.
6.150	CSL	LISBON, PORTUGAL, 48.78 m. Irregular. 7-8.30 am., 2-7 pm.	6.092	OAX4Z	LIMA, PERU 49.25 m. Radio National 7-11 pm.
6.150	CJRO	WINNIPEG, MAN., CANADA, 48.78 m., Addr. (See 11.720 mc.) 4-10 pm.	6.090	HJ4ABC	IBAGUE, COL., 49.26 m. 7 pm.-12 m.
6.147	ZEB	BULAWAYO, RHODESIA, S. AFRICA, 48.8 m. Sun. 3.30-5 am.; Tues., Fri., 1.15-3.15 pm.; Mon. and Thurs. 11 am.- 12 m.	6.090	CRCX	TORONTO, CAN., 49.26 m., Addr. Can. Broadcasting Corp. Daily 5.30-11.30 pm.; Sun. 5-11.30 pm.
6.147	COKG	SANTIAGO, CUBA, 48.8 m., Addr. Box 137. 9-10 am., 11.30 am.-1.30 pm., 3- 4.30 pm., 10-11 pm., 12 m.-2 am.	6.090	XEBF	JALAPA, MEXICO, 49.26 m., Addr. In- surgentes 34. Testing.
6.145	HJ4ABU	PEREIRA, COL., 48.8 m. 9.30 am.-12 m., 6.30-10 pm.	6.090	ZBW2	HONGKONG, CHINA, 49.26 m., Addr. P. O. Box 200. Irregular.
6.140	W8XK	PITTSBURGH, PA., 48.86 m., Addr. Westinghouse Electric & Mfg. Co. Relays KDKA 10 pm.-1 am.	6.085	HJ5ABD	CALI, COLOMBIA, 49.3 m., Addr. La Voz de Valle. 12m.-1.30 pm., 5.10-9.40 pm.
6.137	CR7AA	LAURENCO MARQUES, PORT. E. 48.87 m. 4-9, 10.30-11 am., 12 m.-3.30 pm., 11.15 pm.-1 am.	6.083	VQ7LO	NAIROBI, KENYA, AFRICA, 49.31 m., Addr. Cable and Wireless, Ltd. Mon.- Fri. 5.45-6.15 am., 11.30 am.-2.30 pm., also Tues. and Thurs. 8.30-9.30 am.; Sat 11.30 am.-3.30 pm.; Sun. 11 am.-2 pm.
			6.080	ZHJ	PENANG, FED. MALAY STATES, 49.34 m. 6.40-8.40 am., except Sun., also Sat. 11 pm.-1 am.
6.080	CP5	LAPAZ, BOLIVA, 49.34 m. 7-10.30 pm.	6.070	W9XAA	CHICAGO, ILL., 49.34 m., Addr. Chicago Fed. of Labor. Relays WCFL irregular
6.080	HP5F	COLON, PAN., 49.34 m., Addr. Carlton Hotel. 11.45 am.-1.15 pm., 7.45-10 pm.	6.079	DJM	BERLIN, GERMANY, 49.34 m., Addr. Broadcasting House. Irregular.
6.070	VP3MR	GEORGETOWN, BRIGUIANA, 49.42 m. Sun. 7.45-10.15 am.; Daily 4.45-8.45 pm.	6.070	HJ3ABF	BOGOTA, COL., 49.42 m. 7-11.15 pm.
6.070	CFRX	TORONTO, CAN., 49.42 m. Relays CFRB 6.30 am.-11 pm. Sun. 9.30 am.- 11 p. m.	6.070	YV1RE	MARACAIBO, VEN., 49.42 m. 6-11 pm.
6.070	VE9CS	VANCOUVER, B. C., CAN., 49.42 m. Sun. 1.45-9 pm., 10.30 pm.-1 am.; Tues. 6-7.30 pm., 11.30 pm.-1.30 am. Daily 6-7.30 pm.	6.065	HJ4ABL	MANIZALES, COL., 49.46 m. Daily 11 am.-12 m., 5.30-7.30 pm.; Sat. 5.30-10.30 pm.
6.065	SBQ	MOTALA, SWEDEN, 49.46 m. Relays Stockholm 1.30-5 pm.	6.065	W8XAL	CINCINNATI, OHIO, 49.6 m., Addr. Crosley Radio Corp. Relays WLW 6.30 am.-8 pm., 11 pm.-2 am.
6.060	W8XAL	CINCINNATI, OHIO, 49.6 m., Addr. Crosley Radio Corp. Relays WLW 6.30 am.-8 pm., 11 pm.-2 am.	6.060	W3XAU	PHILADELPHIA, PA., 49.5 m. Relays WCAU 8-11 pm.
6.060	W3XAU	PHILADELPHIA, PA., 49.5 m. Relays WCAU 8-11 pm.	6.045	H19B	SANTIAGO, D. R., 49.63 m. Irregular 6-11 pm.
6.045	H19B	SANTIAGO, D. R., 49.63 m. Irregular 6-11 pm.	6.042	HJ1ABG	BARRANQUILLA, COL., 49.65 m., Addr. Emisora Atlantico. 11 am.-11 pm.; Sun. 11 am.-8 pm.
6.040	W4XB	MIAMI BEACH, FLA., 49.65 m. Relays WIOD 12m.-2 pm., 5.30-8 pm., 10 pm.-12 m.	6.040	W1XAL	BOSTON, MASS., 49.65 m., Addr. Uni- versity Club. Exc. Sat. 7-9 pm.
6.040	W1XAL	BOSTON, MASS., 49.65 m., Addr. Uni- versity Club. Exc. Sat. 7-9 pm.	6.040	YDA	TANDJONGPRIOK, JAVA, 49.65 m., Addr. N.I.R.O.M., Batavia. 10.30 pm.-2 am.; Sat. 7.30 pm., -2 am.
6.030	HJ4ABP	MEDELLIN, COL., 49.75 m. 8-11 pm.	6.030	HP5B	PANAMA CITY, PAN., 49.75 m., Addr. P. O. Box 910. 12m.-1 pm., 7-10.30 pm.
6.030	HP5B	PANAMA CITY, PAN., 49.75 m., Addr. P. O. Box 910. 12m.-1 pm., 7-10.30 pm.	6.030	VE9CA	CALGARY, ALTA., CAN., 49.75 m. Thur. 9 am.-2 am.; Sun. 12 m.-12 m.
6.030	VE9CA	CALGARY, ALTA., CAN., 49.75 m. Thur. 9 am.-2 am.; Sun. 12 m.-12 m.	6.030	OLR2B	PRAGUE, CZECHOSLOVAKIA, 49.75 m. (See 11.875 mc.)
6.025	HJ1ABJ	SANTA MARTA, COL., 49.79 m. 5.30- 10.30 pm. except Wed.	6.025	HJ1ABJ	SANTA MARTA, COL., 49.79 m. 5.30- 10.30 pm. except Wed.
6.020	DJC	BERLIN, GERMANY, 49.83 m., Addr. (See 6.079 mc.) 11.35 am.-4.30 pm.	6.020	XEUW	VERA CRUZ, MEX., 49.83 m., Addr. Av. Independencia 98. 8 pm.-12.30 am.
6.020	XEUW	VERA CRUZ, MEX., 49.83 m., Addr. Av. Independencia 98. 8 pm.-12.30 am.	6.018	ZHI	SINGAPORE, MALAYA, 49.18 m., Addr. Radio Service Co., 2 Orchard Rd. Mon., Wed. and Thurs. 5.40-8.0 am., Sat. 10.40 pm.-1.10 am.
6.015	H13U	SANTIAGO DE LOS CABALLEROS D. R., 49.88 m. 7.30-9 am., 12m.-2 pm., 5-7 pm., 8-9.30 pm.; Sun. 12.30- 2, 5-6 pm.	6.012	HJ3ABH	BOGOTA, COL., 49.91 m., Addr. Apar- tado 565. 12 n.-2 pm., 6-11 pm.; Sun. 12m.-2 pm., 4-11 pm.
6.010	COCO	HAVANA, CUBA, 49.92 m., Addr. P. O. Box 98. Daily 7.55 am.-12m., Sun. till 11 pm.	6.010	COCO	HAVANA, CUBA, 49.92 m., Addr. P. O. Box 98. Daily 7.55 am.-12m., Sun. till 11 pm.
6.005	HP5K	COLON, PAN., 49.96 m., Addr. Box 33. 7-9 am., 11.30 am.-1 pm., 6-11 pm.	6.005	CFCX	MONTREAL, CAN., 49.96 m., Can. Marconi Co. Relays CFCF 7.45 am.- 1 am.; Sun. 10 am.-12.15 am.
6.005	CFCX	MONTREAL, CAN., 49.96 m., Can. Marconi Co. Relays CFCF 7.45 am.- 1 am.; Sun. 10 am.-12.15 am.	6.005	VE9DN	DRUMMONDVILLE, QUE., CAN., 49.96 m., Addr. Canadian Marconi Co. Sat. 11.30 pm.-2 am.
6.000	CXA2	MONTEVIDEO, URUGUAY, 50 m., Addr. Rio Negro 1631. Relays LS2, Radio Prieto. 10.30 am.-10.30 pm.	6.000	ZEA	SALISBURY, RHODESIA, S. AFRICA, 50 m. (See 6.147 mc., ZEB.)
6.000	ZEA	SALISBURY, RHODESIA, S. AFRICA, 50 m. (See 6.147 mc., ZEB.)	6.000	RV59	MOSCOW, U.S.S.R., 50 m. Irregular
6.000	RV59	MOSCOW, U.S.S.R., 50 m. Irregular	5.990	XEBT	MEXICO CITY, MEX., 50.08 m., Addr. P. O. Box 79-44. 8 am.-1 am.

(Continued on page 455)

(All Schedules Eastern Standard Time)

available, for if the harmonic of the 80-meter crystal does not fall on exactly the same frequency as the 40-meter crystal, we can double the frequency of the 80-meter crystal or use the 40-meter crystal, in the 40-meter band. For 20-meter operation we also have 2 frequencies; one from the 40-meter crystal when the frequency is doubled and another from a 20-meter crystal when the latter is operated as a straight amplifier. For 10-meter operation we must use the 20-meter crystal and we have the choice of only one frequency.

The final amplifier tube is a new Raytheon RK-47 beam tetrode; this tube requires very little driving power and is capable of over 100 watts output under normal operating conditions and will give excellent service on each of the four bands this transmitter covers.

The tuning condenser for the final stage is a split-stator affair with 75 mmf. capacity per section. Only one section is employed for 10-, 20- and 40-meter operation; however, two stators are connected in parallel for 80-meter operation.

Meter-Switching Scheme Employed

Another feature for economy and simplicity is the *meter-switching* arrangement. As can be seen from the photo, we only employ one meter; this has a scale of 0-25 ma. By means of the 3-gang rotary switch and small shunts placed in series with the B+ leads of the various stages, we are able to connect the meter to any one of the 3 stages without breaking the plate circuits. The shunt in the oscillator and buffer stages makes a full-scale reading on the meter of 125 ma., while the shunt in the final amplifier plate circuit makes it 0-250 ma. The reason a 3-gang switch was employed here, rather than a 2-gang switch, was to enable us to read the grid current in the final amplifier stage with the 0-25 scale. In all positions except that where the meter reads *grid* current in this stage, the point marked "X" is *short-circuited*. However, in position *three* this circuit is opened and the meter is connected in it. Details for the meter-switch connections are shown in the drawing.

By a trick arrangement of the power-supply, we are able to furnish all voltages for the plates and screens of the R.F. tubes, C bias for the final amplifier tube negatives, keying bias for the suppressor grid of the RK-25 and plate voltages for the audio section. By running 200 volts negative to the potentiometer in the suppressor grid circuit of the buffer stage, we are able to adjust the excitation for either phone or C.W. operation. Simply by connecting a key in series with this potentiometer, we obtain *clickless* keying; when the key is opened, the 200 volt negative bias on the suppressor removes all excitation from the final amplifier. This arrangement works out so well that it is possible with good station arrangement to work 10 kc. either side of the carrier with excellent break-in performance. Many stations have been contacted in this manner during the past two months since this transmitter has been completed.

Details for the *audio section* and the *power-supply* and also the general switching and tuning operations necessary in operating the transmitter, will be completely described in Part 2, which will be presented next month.

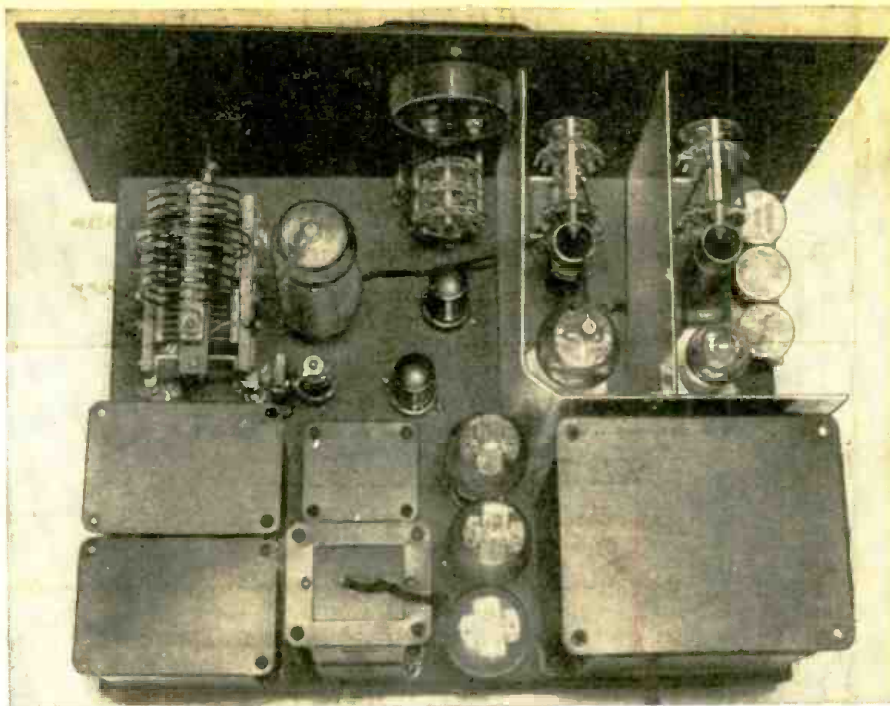

Inside view, showing the arrangement of parts.

PARTS LIST FOR DESK-TYPE TRANSMITTER

Part I

CORNELL-DUBILIER

- 2—.0001 mf. mica condensers
- 4—.01 mf. mica condensers
- 5—.001 mf. mica condensers—1,000 V.
- 1—.001 mf. mica condensers—5,000 V.

I.R.C.

- 1—400 ohm wire-wound resistor—10 watts
- 3—10,000 ohm wire-wound resistor—10 watts
- 1—50,000 ohm wire-wound resistor—20 watts
- 1—20,000 ohm wire-wound resistor—10 watts
- 1—250,000 ohm potentiometer

CARDWELL

- 2—140 mmf. Trim-Air condensers
- 1—split stator, double spaced midway—75 mmf. per section (micalex)

MEISSNER

- 2—2 gang shorting type inductance switches
- 1—3 gang shorting type inductance switches (the long spaces are replaced with shorter ones to make the unit more compact.)

HAMMARLUND

- 1—6-prong isolantite socket
- 1—7-prong isolantite socket
- 1—7-prong isolantite socket
- 2—2½ mh. R.F. chokes

BLILEY

- 1—80 meter crystal
- 1—40 meter crystal
- 1—20 meter crystal

TRIPLETT

- 1—0-25 ma. square case meter

RAYTHEON

- 1—41 pentode
- 1—RK-25 pentode
- 1—RK-47 beam tetrode

PAR-METAL

- 1—19" x 10½" x 13" cabinet
- 1—2" x 17" x 13" chassis

MISCELLANEOUS

The 3-gang crystal holder is home-constructed on a piece of micalex insulation. The resistors marked "R" are home-made shunts; the size will depend upon the meter used and can best be determined by experimental adjustment.

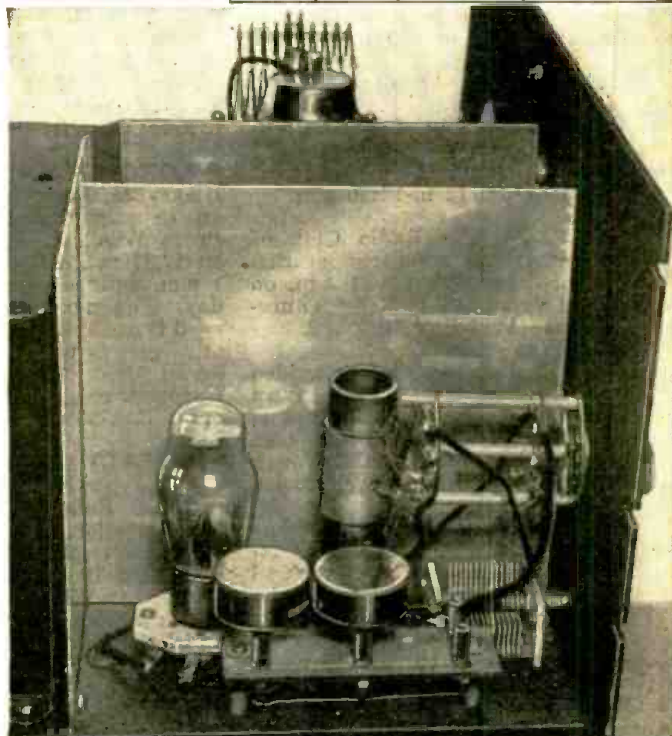
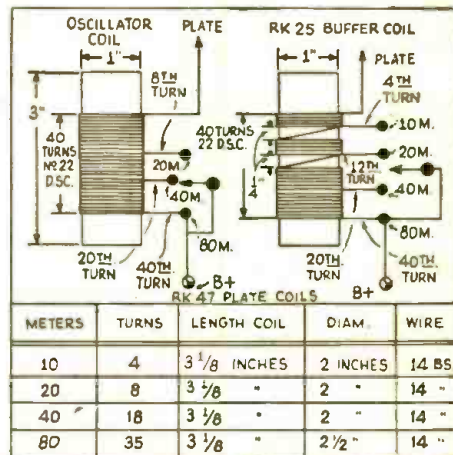

The oscillator compartment, showing the 3 crystals and the "switching" arrangement.



HONORARY MEMBERS

- Dr. Lee de Forest
- John L. Reinartz
- D. E. Replogle
- Hollis Baird
- E. T. Somerset
- Baron Manfred von Ardenne
- Hugo Gernsback
Executive Secretary

Station is now operating on the following schedule:
 Trans. 1-3:15-5:30 a.m.
 GSG—Far East, New Zealand, Australia.
 GSO—New Zealand and Australia.
 GSD—Australia and New Zealand.
 GSB—New Zealand.

Trans. 2-5:45-8:55 a.m.
 GSJ—Malaya, India, West Indies, and Australia.
 GSH—Africa.
 GSG—Malaya, India and Australia.
 GSO—Far East and New Zealand.

WHEN TO LISTEN IN

M. Harvey Gernsback

All Schedules in Eastern Standard Time

❖ **NEW YORK . . .** W2XE now operates on the following schedule: Monday to Friday, 7:30-10 a.m. on 21.520 mc. for Europe; 1-6 p.m. on 15.27 mc. for Europe; 6:30-8 p.m. on 17.76 mc. for South America; 8:30 p.m.-12 midnight on 15.27 mc. for South America. On Saturday and Sunday the schedule is: 8 a.m.-1 p.m. on 21.52 mc. for Europe, 2:30-6 p.m. on 15.27 for Europe; 6:30-8 p.m. on 17.76 mc. for South America, and 8:30 p.m.-12 midnight on 15.27 mc. for South America.

❖ **JAPAN . . .** Several new Japanese broadcasting stations are reported. A station at Taihoku, Taiwan, is operating on 9.625 mc. and also on 10.535. The latter station is JIB, a commercial station. These stations relay JFAK irregularly from 1-2:30 a.m. and from 8-10:25 a.m. (On Sunday from 9:50-10:15 a.m.) Announcements are given in English as well as Japanese. Station JDY on 9.925 mc. at Dairen, Manchukuo, relays JQAK daily from 6:50-8 a.m.

❖ **JAVA . . .** PLV at Bandoeng on 9.415 mc. now broadcasts daily, 5:30-9:30 a.m. and from 6-6:30 p.m.

❖ **HOLLAND . . .** An experimental station in the Netherlands is PI1J, operated by the Technical College at Dordrecht. This station operates on 7.088 mc. on Saturday from 11:10-11:50 a.m. and 14.164 mc from 12 n.-12:30 p.m.

❖ **ZURICH . . .** The Radio Club of Zurich, Switzerland operates station HB9D on 9.535 mc. from 9-11 a.m. on Sunday, and from 1-3 p.m. on Thursday. Address—Post Box Zurich, 2.

❖ **URUGUAY . . .** CXA2 at Montevideo is broadcasting on 6 mc. daily from 10:30 a.m.-10:30 p.m. The address is Rio Negro 1631. This station relays an Argentine broadcast station LS2. Power is 5 kw. so it should be quite well heard.

❖ **CUBA . . .** The island republic has added a few more to its group of short-wave stations, the newest are: COX4S on 6.396 mc. in Marianao. Operated by the Signal Corps of the Cuban army and used to transmit programs to schools throughout Cuba. At present the power is 100 watts but a 15 kw. transmitter is being built. For further details consult the station list. COCU is a newcomer in Havana on 6.59 and 9.95 mc. It relays CMCU from 7 a.m.-

Additions to Station List

Mc.	Call	Location
5.770	YV2RA	SAN CRISTOBAL, VENEZUELA
5.813	TI2H	SAN JOSE, COSTA RICA
6.000	CXA2	MONTEVIDEO, URUGUAY
6.090	XEBF	JALAPA, MEXICO
6.396	COX4S	MARIANAO, CUBA
6.590	COCU	HAVANA, CUBA
7.088	PI1J	DORDRECHT, HOLLAND
7.894	YSD	SAN SALVADOR, EL SALVADOR
9.100	COBX	HAVANA, CUBA
9.520	YSH	SAN SALVADOR, EL SALVADOR
9.535	HB9D	ZURICH, SWITZERLAND
9.625	—	TAIHOKU, TAIWAN, JAPAN
9.925	JDY	DAIREN, MANCHUKUO
9.950	COCU	HAVANA, CUBA
11.710	XEWB	GUADALAJARA, MEX.
11.710	YSM	SAN SALVADOR, EL SALVADOR
15.550	CO9XX	TUINICU, ORIENTE, CUBA
17.310	W2XGB	HICKSVILLE, L. I., N. Y.

12 midnight. The address is Estrada Palma 25, Vibora, Havana. A third station is COBX, also at Havana, on 9.1 mc. This station relays CMBX from 7 a.m. to 12 midnight. Address San Miguel 146. CO9XX, an experimental station on 15.55 mc., is located at Tuinicu and is operated by Frank Jones. It broadcasts irregularly in the evening.

❖ **LONG ISLAND . . .** W2XGB at Hicksville, Long Island, New York, is an experimental station operated by Press Wireless. Generally it operates on 17.31 mc. and tests from 10 a.m. to 1 p.m. daily except Saturday and Sunday. The power used is about 5 kw., and generally an aerial directed to Europe is used. Address Box 296.

❖ **EL SALVADOR . . .** Three stations in San Salvador, El Salvador, are testing irregularly from 6-10 p.m. They are: YSD on 7.894; YSH on 9.52 and YSM on 11.71. Address, Director General Telephones and Telegraphs.

❖ **DAVENTRY . . .** The British Empire

Trans. 3-9:15 a.m.-12 noon.
 GSH—Africa.
 GSG—India, Malaya, and Australia.
 GSF—India, Malaya, and Australia.
 GSJ (until 10:30 a.m.)—India, Malaya, and West Indies.
 GSD (from 10:45 a.m.)—India and Malaya.

Trans. 4A—12:20-3:45 p.m.
 GSG—Africa generally.
 GSI—Africa generally.
 GSD—Africa generally.
 GSB—Near East and East Africa.

Trans. 4B—4-6 p.m.
 GSP—North America.
 GSO—South America.
 GSF—West Indies and Central America.
 GSB—Africa.

Trans. 5-6:20-8:30 p.m.
 GSP—North America.
 GSD—West Indies, Central America, India and Malaya.
 GSO—North America.
 GSB—South America.

Trans. 6-9-11 p.m.
 GSD—Western Canada
 GSC—Western Canada.
 GSC—North America.
 GSB—West Indies, Central America, and India.

Note that in transmissions 5 and 6, two transmitters are used simultaneously on the same wavelength using different aeriels.

The frequencies employed by these stations are as follows:
 GSJ—21.53 mc.
 GSH—21.47 mc.
 GSG—17.79 mc.
 GSP—15.31 mc.
 GSI—15.26 mc.
 GSO—15.18 mc.
 GSF—15.14 mc.
 GSD—11.75 mc.
 GSC—9.58 mc.
 GSB—9.51 mc.

(Continued on page 458)

11 NELSON ST. COVENTRY, ENGLAND.

DATE 1937

METRES. AT

To Radio
Rcvd ur sigs on

R
QSA
QRN
QRN
QSB
Quality

RX 0V2
ANT 66 FT
WX

BS 220

PSE QSL VY BEST 736 Hughes

An Unusual SWL Card from England

The
1938

SUPER-CLIPPER!



A Remarkable New 7 Tube, 7 Band Receiver THREE STAGES OF RADIO FREQUENCY AMPLIFICATION INCLUDING BUILT-IN SIGNAL BOOSTER AND PRESELECTOR!

THE SUPER-CLIPPER HAS BEEN DESIGNED ESPECIALLY FOR THE SHORT WAVE DX HUNTER. IT WILL GIVE YOU HARD-BOILED S.W.L.'s. A THRILL YOU WONT FORGET. HERE IS EVERY FEATURE YOU HAVE EVER ASKED FOR BUILT INTO A SINGLE, BIG HANDSOME RECEIVER WITH EVERY USEFUL CONTROL BROUGHT OUT TO YOUR FINGER-TIPS.

UNUSUAL DX RECEPTION

The SUPER-CLIPPER of course guarantees you consistent foreign reception, but it goes further than that; you can expect the *unusual* in long distance reception with this big record-breaking receiver. Big?—Yes, big in size as well as in performance—19 inches wide, 10 inches high and 9 inches deep! No crowding of parts on its large well-designed chassis. Efficiency, and efficiency only, dictated the mechanical and electrical layout of this superb set.

The SUPER-CLIPPER circuit utilizes both regeneration and super-regeneration combined with radio frequency amplification. The tube line-up is as follows: 6K7 R.F. Rooster; 6K7 R.F.; 6K7 Ultra-high R.F. (separate channel); 6J5G Detector; 6J5G 1st audio; 6L6G Power output; 80 Rectifier.

A Few of Its Many Features:—

- ★ Built-in Signal Booster and Preselector which enables the crowded foreign stations to be separated and even the weak ones built up to loud-speaker volume. Covers same range as main tuner and is tuned automatically with it but may be switched out of circuit for stand-by tuning and local high fidelity reception.
- ★ Calibrated reduction drive tuning dial covering from 22 to .54 megacycles (13 to 555 meters) in four overlapping bands controlled by band-switch (NOT plug-in coils).
- ★ Both electrical and mechanical bandsread entirely eliminating critical tuning on even the weakest foreign stations. A separate bandsread and ultra-high frequency condenser is used.
- ★ Two stages of powerful audio amplification with 6L6 beam power output.
- ★ Separate Ultra-high Frequency R.F. channel (3 to 12 meters) using air-wound coils and 6K7 R.F. amplifier. (Separate antenna connection is provided for maximum efficiency).
- ★ Six inch dynamic speaker; Noise and Tone control; Earphone jack, etc. In fact every worthwhile feature that you have told us you would like to have in your personal receiver.

The New 1938 Super-Clipper

complete with 7 tubes, ready to plug in to any 110 v. line and operate. **\$29⁷⁵**
Shipping weight 30 lbs. NOT SOLD IN KIT FORM.

THE UNIVERSAL CLIPPER

A NEW MODEL OF THE FAMOUS HAYNES R-S-R CLIPPER

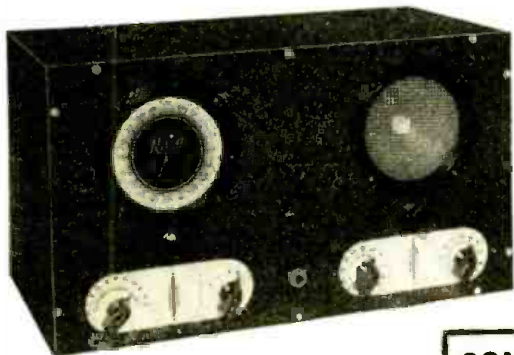

Uses the new 25L6 low voltage beam power tube which has made possible high power output with an inexpensive AC-DC power supply, operating from any type of 110 volt current. Here is the famous CLIPPER circuit, used today by hundreds of short wave fans, incorporated in an inexpensive receiver without sacrificing any of its well known distance getting ability. The same smooth, non-critical tuning; combined regeneration and super-regeneration; separate bandsread and ultra-high frequency tuning condenser; bandswitch control; seven separate tuning bands; noise and tone control; 5 inch dynamic speaker; 3 to 555 meter tuning range; automatic earphone jack; in fact all of the splendid design features which have helped make the CLIPPER circuit such a tremendous success.

ASK THE MAN WHO OWNS A CLIPPER—LOOK AT HIS LOG!

UNIVERSAL CLIPPER; complete with black crackle cabinet (20" x 10" x 9") five tubes; 6K7, 2-6J5G, 25L6, 25Z6G; ready to operate, with one year guarantee. Special **\$19⁵⁰**
Complete Price.....

COMPLETE KIT WITH ALL PARTS
ASSEMBLED and wiring diagram:
less only tubes and cabinet un-
wired.....\$12.40
Black crackle finish cabinet..... 1.80
Matched set of five tube..... 3.20
Wiring..... 2.90

CONTINUED ON NEXT PAGE



RADIO CONSTRUCTORS LABORATORIES

Dept. S-12, 136 LIBERTY ST., NEW YORK, N. Y.



Please mention SHORT WAVE & TELEVISION when writing advertisers

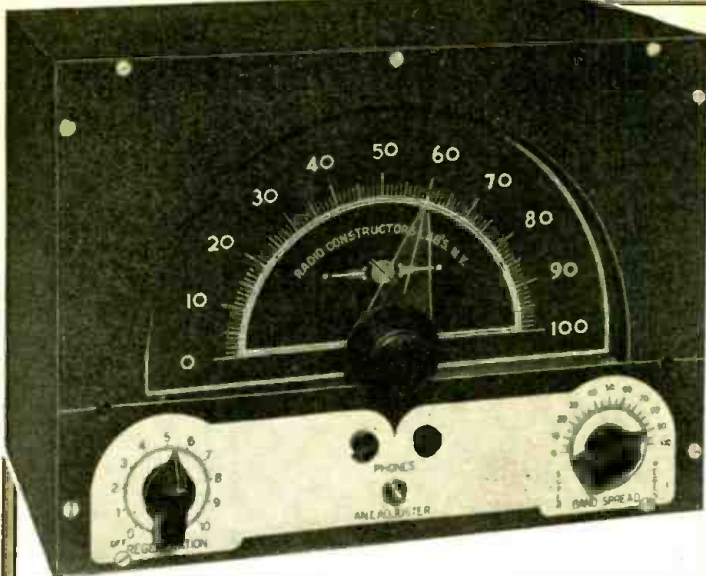

THE NEW RANGER 3 Tube Universal AC-DC

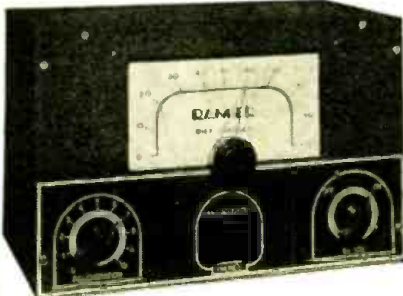

Crystallized metal cabinet..... .90
 Set of three tubes (2-6J5G; 1-6A7)..... 1.35
 Wired and tested..... 1.40
SPECIAL COMPLETE PRICE with all coils, cabinet & tubes wired and tested with one year guarantee..... 8.25

THE NEW RANGER 2 Tube Universal AC-DC

THE GREATEST VALUE IN A REALLY LOW PRICED SET THAT HAS EVER BEEN OFFERED!

Built on the same chassis as the above receiver with the same big tuning dial and the same sensitive circuit. Genuine air dielectric, rotary tuning condenser, etc. We guarantee short wave foreign reception on this receiver.

RANGER 2 TUBE UNIVERSAL AC-DC: complete kit, assembled but not wired, including wiring diagram and broadcast coil but less cabinet and tubes..... **\$3.65**
 3 additional coils (15 to 200 meters)..... 5.00
 Crystallized metal cabinet..... .90
 Set of two tubes (6J5G and 6A7)..... .95
 Wired and tested..... 1.10
SPECIAL COMPLETE PRICE with all coils, cabinet & tubes, wired and tested with one year guarantee..... \$6.90

THE NEW RANGER 3 Tube AC Receiver

AN ABSOLUTELY NEW and Unique Type of All Wave DX Receiver. Nothing like this set has ever been offered before to the short wave fan. Built for long distance earphone reception it uses a 6J5G regenerative detector plus one stage of audio amplification and full AC power supply having a highly efficient filter circuit which positively eliminates line hum.

A Big 7 1/2 Inch Tuning Dial makes this receiver a pleasure to handle on the closely crowded foreign bands. Never before has such a dial been used on any receiver selling within many times the price of this set. Seven plug-in coils cover the tremendous tuning range of from 2 1/2 to 550 meters. Separate bandspread condenser is also used for super-regenerative tuning below 10 meters.

RANGER 3 TUBE AC; complete kit, assembled but not wired, including wiring diagram and broadcast coil, but less cabinet and tubes..... **\$6.95**
 5 additional coils—5 to 200 meters..... .90
 Crystallized metal cabinet..... 1.00
 Kit of three matched tubes; 2 - 6J5G, 1 - 80..... 1.25
 Wired and tested, with one year guarantee..... 2.00

DX-4 4 Tube AC Receiver

An exceptionally fine communication type receiver for the short wave fan or amateur who is interested in serious long distance work. A band-switch receiver combining both regeneration and super-regeneration over a tuning range of 3 to 560 meters. Extreme bandspread, using separate condenser, provides splendid station separation even on the crowded 20 meter amateur band. Powerful two stage amplifier with beam power output to full size dynamic speaker. Uses the original Haynes electron coupled regenerative and super-regenerative circuit which gives perfect control with a minimum of tuning interaction. There is no hand capacity effect on this receiver and it is entirely free of AC hum on even the highest frequencies. Tubes are: 6J5G detector, 6J5G 1st audio, 6V6G output, 80 rectifier. The DX-4 is unquestionably one of the outstanding radio values obtainable today. It is NOT obtainable in kit form. DX-4 Complete with 4 tubes and cabinet ready to operate from any 110 volt AC line; one year guarantee..... **\$17.85**



THE NEW RACO SHORT WAVE CONVERTER

RECEIVES ALL OF THE FOREIGN SHORT WAVE BANDS. Can be used with any AC or battery receiver. This new converter, when connected to your broadcast receiver will enable you to receive all the wavelengths between 15 and 35 meters which includes every one of the foreign short wave stations. The large airplane type dial with reduction tuning drive gives easy, smooth control over this entire range. Extremely selective and sensitive; this new RACO CONVERTER provides a simple, inexpensive means of "tuning in" this fascinating long distance foreign broadcasting. It converts your receiver into a powerful short wave superheterodyne. Sold only complete, ready to connect to your broadcast receiver (not sold in kit form). When ordering specify output tube or tubes used in your receiver. RACO SHORT WAVE CONVERTER, complete with tube and connection adapter..... **\$8.85**



RADIO CONSTRUCTORS LABORATORIES, 136 LIBERTY ST. Dept. S-12 NEW YORK, N. Y.

following example. The present receiver in operation at W2AMN has the padders in the plug-in coils adjusted so that the 20 meter phone band covers 100 degrees on the dial. This is approximately 1 kc. per division. Moderately strong signals separated a division and a half, will not cause interference with each other, with the selectivity control C2 set at optimum. Of course, if we have an R9 signal one and a half divisions from an R4 signal it is quite difficult to separate them. However, in many cases we have carried on a QSO with a R5 or 6 station with an R9+ signal even less than one and one-half divisions from the station being received.

C4 in the diagram should be set for minimum capacity and increased gradually until the performance is normal. If the coupling is too close or the capacity of C4 too great, the filter will be considerably broadened and C.W. reception will not take on the single-signal aspect. The best adjustment of this can be obtained by experimenting. As we said before, there is no shorting-switch to eliminate the crystal. This was contemplated in the beginning, but experiments have proved that since the set was not made for music and we are mainly interested in amateur communica-

This "Crystal Filter" Gives Razor-Sharp Tuning on the "S. W. & T." Communications Receiver

(Continued from page 420)

tion, the maximum band width was entirely sufficient and it was more convenient to leave out the switch, because these switches have to be very low in capacity and its incorporation is not worth the construction effort required.

Probably many readers will want to know whether or not there are any other improvements made in the receiver since its description in the August 1937 issue, but it seems that there are none necessary. The receiver works absolutely perfect and with the addition of the above crystal it leaves practically nothing to be desired.

Parts List—Crystal Filter

- 1—5-prong isolantite socket—Hammarlund
- 2—ST-465-CT I.F. transformers
- 1—HF-50-50 mmf. variable condenser
- 1—465 kc. crystal—Bliley

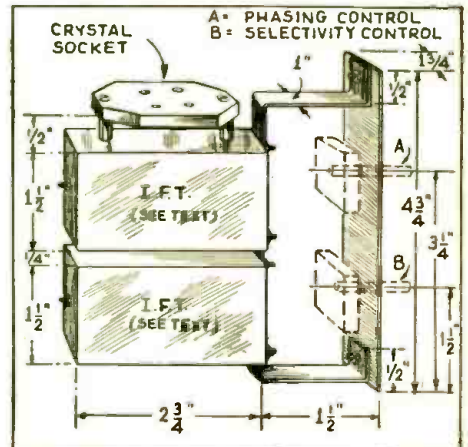

Physical dimensions of the crystal unit.

Please mention SHORT WAVE & TELEVISION when writing advertisers

OFFICIAL
DOERLE
WORLD-WIDE
Receivers

5 TUBES
•
6L6 BEAM
POWER OUTPUT
•
FULL SIZE
DYNAMIC SPEAKER
•
QUALITY +
• FINISH •
BLACK CRYSTAL

110 TO 120 V.A.C.
50 TO 60 CYCLES

9 TO 1000
METERS

HAM BAND SPREAD
COILS AVAILABLE

EFFICIENCY

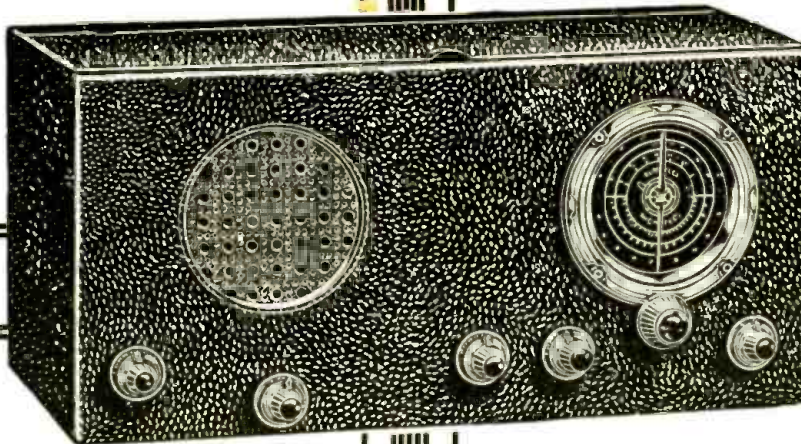

OVERALL DIMENSIONS
17 1/2" x 8 1/2" x 8 1/2"

AS ILLUSTRATED
**COMPLETE
WITH TUBES**
WIRED READY TO USE AND
LABORATORY TESTED
\$2500

... THE KIT ...
FACTORY ASSEMBLED
UNWIRED LESS TUBES
Now \$1950

DOERLE MODEL D-5

SPECIAL FEATURES
CONDENSERS MOUNT-
ED ON RUBBER ELIMI-
NATING FEED BACK.
STAND BY SWITCH A.C.
SWITCH COMPLETELY
SHIELDED CON-
NECTIONS FOR DOUB-
LET AERIAL.

NOTE

This model uses a carefully designed A.C. power supply and an elaborate filter system. Employs a transformer to increase the voltage to over the 300 volts necessary to provide the tubes with their proper operating voltages as specified by the tube manufacturers.

Note: It does not use the A.C. D.C. type of rectifier and power supply as the disadvantage of the maximum of only 100 volts obtainable would require additional tubes to obtain the same output and the voltage regulation would still be poor.

SPECIAL FEATURES
SEPARATE CONTROLS
FOR RF. GAIN
TUNING
TONE
REGENERATION
VOLUME
CONNECTIONS FOR
EXTERNAL SPEAKER

THE DOERLE MODEL D-5

Doerle Model D-5, popular-priced receiver designed to give utmost efficiency with a minimum of parts, with each tube performing a necessary and important function in the circuit.

Uses a tuned screen-grid radio frequency stage, a tuned screen-grid electron-coupled regenerative detector. The output of which is fed into a 6C5, which is used as a first audio stage to supply the necessary excitation to drive the grid of the 6L6 beam power output tube to maximum rating.

A single rectifier, the low internal drop, 5Y3, takes care of the full power requirements of the set. High quality dynamic speaker is used, the tuning condensers are mounted on rubber to eliminate mechanical feed-back.

Additional refinements have been provided, such as connections for a

crystal pick-up allowing victrola records to be played; an automatic phone jack which disconnects the speaker when phones are used.

A socket provided at the rear of the set permits the use of an external speaker if desired. For the amateur model special bandspread coils have been designed which are inter-changeable with the general coverage type, supplied with the regular model.

If you desire the amateur model please specify amateur model, so you will receive the amateur bandspread coils for 20, 40, 80, 160 meters, and the broadcast band instead of general coverage which cover from 9 to 1000 meters.

If you desire both types of coils, please state "Send me both amateur and general coverage coils," and include \$2.50 additional with your remittance.

Note: Do not fail to send for our large, free catalog, mentioned in the bottom of the last column of this page, which describes this and many other models of receivers and transmitters, parts, and supplies.

7C 5-Tube

Short Wave Receiver 8 1/4 to 625 meters

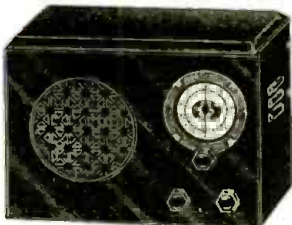

**Bigger and
More
Powerful
Than Ever
A Giant in
Performance**

3 Tube Electric
Model, com-
plete, tested
and ready to
use, with 5
plug-in coils,
12 to 600 me-
ters, at \$6.50.

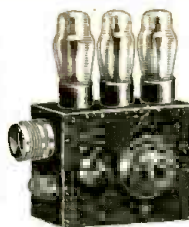

Kit form, factory
assembled, but
unwired, with
coils, less tubes,
\$3.50.

Available in bat-
tery model at
same prices, if
specified.



HF-35, assembled, and ready to
wire (less tubes, power
supply, crystal, holder) **\$21.95**
and additional coils)

Matched Arcturus Tubes (3) \$2.15

Eilen quartz crystal (80 or
160) 1.95

Eilen crystal holder 1.00

Coils for additional bands,
per set 1.45



BS-5 Six tube Bandswitch Receiver, no plug-in-coils, select
the band by a simple flip of the switch.
Loudspeaker Operation
12 to 800 meters, automatic headphone Jack also included.
Complete, ready to use, including tubes, factory wired and
laboratory tested, \$18.50.
Complete kit, factory assembled, ready to wire, including tubes
and cabinet, \$16.50.

Our Model 7C, A Midget in Size—A Giant in
Performance. One of our most popular short
wave receivers.

Our files contain many letters from satisfied lis-
teners from all over the world which testify to the
popularity of this set, and their lists of DX stations
received on the loudspeaker is amazing.

Uses a 6K7 radio-frequency stage, a 6P7, twin 2
in 1 tube, as regenerative detector and first audio,
one 6C5, one 12A7, twin 2 in 1 tube, and one
K92A.

Earphone Jack has been incorporated to permit
the use of phone when loudspeaker operation is not
desired. Operates from regular house current.
Size: 10x7 1/2 x 7 1/2.

Complete with all coils, 9 1/2 to 600 meters, and all
tubes, ready to use, nothing else to buy... \$16.50

In Kit form, but factory assembled, including all
coils and tubes, but unwired... \$12.95

*Available in battery model upon special order at
same price.

**Also available in ham model with special tun-
ing circuit to provide additional bandspread at \$1.00
additional.

**EILEN RADIO LABS., 68 BARCLAY ST. | FREE CATALOGUE
NEW YORK CITY | SEND STAMP TO COVER MAILING**

Please mention SHORT WAVE & TELEVISION when writing advertisers

Now Reduced Prices Bring Brush Mikes within everyone's reach

Just see how much money you can save with these reductions:

Type BR2S microphone now reduced from \$37.50 to \$29.50
Type B-1 microphone now reduced from \$32.50 to \$26.50

The general trend of increase in prices has had a boomerang reaction on these popular Brush mikes—now available to everyone at a price reduction of almost 20%.



BR2S, now \$29.50

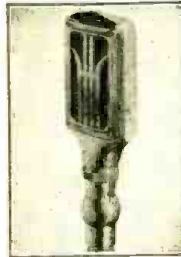

B-1, now \$26.50

This was made possible by the constantly increasing number of users who, accustomed to quality sound equipment, have preferred these Brush mikes that are so FREE FROM hum pickup, frequency discrimination on long lines, response peaks causing feedback.

Both the BR2S and B-1 are ideally adapted for amateur and public address work. Write us today if your jobber can't supply you.

The BRUSH
DEVELOPMENT COMPANY
3326 PERKINS AVE., CLEVELAND, OHIO

Home Television—Its Commercial Promise

By William H. Priess
(Continued from page 405)

average public pocket book. Cheaper sets with pictures less than a foot square will not satisfy the public. The home motion picture industry proved this point. If pictures larger than those that can be made on the end of a tube are required, a method has been devised to obtain them by projection. Here again we have another boost in cost which makes prices fantastic from a universal home angle.

The inescapable conclusion from this state of facts is that neither the cathode ray nor the Nipkow rotor systems are answers to the problem of commercial home television. No amount of publicity and no further expenditure of money can alter this conclusion.

Television engineers and executives who are seriously attempting to devise a commercial home television set, must limit their efforts to a system that will produce a set giving a picture of the approximate size, quality and brilliancy of a home motion picture and at a cost within the limits of the average public pocket book.

The writer is pioneering a system that appears to satisfy these simple but exacting requirements. It uses as its scanning element a small mirror resonantly vibrated simultaneously in two directions. At a distance of six feet from the screen, it will scan a screen three feet on a side, placing down two million picture elements a second with an expenditure of only one half watt of low voltage driving power. Synchrony is achieved by a component of the radio wave. Scanners of this type have been built to lay down as high as eight millions of picture elements a second. Tentatively I would estimate the retail price for such a television receiver at two hundred dollars.

Thus far we have defined the commercial receiving set, and have ignored the commercial effect of an operating television system with a vast audience upon industry. We will now consider this phase.

The logical broadcasters are the present radio stations, which will add a visual channel to their existing sound channel. This can be done at little expense, for the vast investment in buildings and real estate that house the studios need not be duplicated. Since sponsors expend their advertising funds in the media that bring the best results, and since the selling effect of a combined sound and sight presentation is much more attractive than that of sound alone, the broadcasters can charge a higher rate for a television program. In other words, for a small additional investment, the present broadcasters can look forward to a disproportionately larger income.

In a like manner the existing manufacturers and distributors of radio sets will enter the television industry. Their outlook is a rosy one. The advent of the cheap midget radio has driven the average retail price of a radio down from about \$200.00 a set to about \$30.00 a set. Since the fixed charges of a sale are independent of the price, the net profits on a constant gross dollar volume of business have been materially reduced. Likewise the cost of manufacturing of a constant gross dollar volume of business increases as the number of units are increased, due to various fixed charges such as test, supervision, shipping costs, etc. The return to a higher priced unit will restore the margin of profit to both the radio manufacturer and the radio distribution system, without even requiring that the gross volume of business be increased. Since no one doubts that the gross dollar volume of sales will rise materially over the present levels, the advent of commercial home television should prove to be a most profitable event to these organizations.

The hopes of increased profits explains the financial investment that the present radio broadcasting, manufacturing and distributing industries are making in television.

There are two other businesses that will be hurt by the success of television.

LITTLE GIANTS

TYPE JR
ETCHED FOIL DRY ELECTROLYTICS

SMALL in size . . . HIGH IN QUALITY! No wonder Cornell-Dubilier Type JR etched foil electrolytics are in demand everywhere. Compact, efficient and easily mounted in any position, in the tightest corners.

FOR A GOOD JOB STANDARDIZE ON CORNELL-DUBILIER CONDENSERS MICA • DYKANOL • PAPER WET & DRY ELECTROLYTICS

Complete technical data and catalog free on request.

Cornell-Dubilier Electric Corporation
1027 Hamilton Blvd., South Plainfield, N. J.

CORNELL - DUBILIER
ELECTRIC CORPORATION
South Plainfield, New Jersey

MIDWEST MOTORIZED TUNING-

TODAY'S radio sensation! Just touch electric button and corresponding station flashes in! (Tune by hand also.) Save up to 50% by ordering this bigger, better, more powerful 20-tube, 6-band radio direct from factory. Pay as little as \$50 a week. Write for FREE 1938 catalog.

20 TUBES-6 BANDS
\$49.95 NEW LOW BASE PRICE CHASSIS

MIDWEST Radio Corporation
Dept. HH-14 Cincinnati, O.

WHEN LOUDNESS IS ANNOYING, Use Cannon-Ball HEADSETS

for private, clear reception. We supply the best in headsets—in sensitivity, workmanship, and ruggedness of structure. Write for folder S-12.

Cannon-Ball Adaptor permits using headsets on all radios. Get diagram and complete details.

C. F. CANNON COMPANY
SPRINGWATER, N. Y.

BLILEY CRYSTALS

10-20-40-80-160 Meter Bands
Now \$3.35 up.
Bliley Electric Co., Erie, Pa.

Please mention SHORT WAVE & TELEVISION when writing advertisers

If a sponsored television program can effect more sales than a similar sum spent in local newspapers and national magazines, will not the advertiser spend a smaller portion of his advertising dollar appropriation in these media, and a greater portion in television broadcasting?

If the public can see an entertaining talking motion picture in the home with no effort and at a nominal cost, why should it go to the local movie and subject itself to the higher charges, the discomfort of the trip, and the rigors of mass discipline that is required in managed public gatherings?

I do not believe that these two industries will take a "do nothing" attitude. I believe that wisdom calls for any industry that will be modified beneficially or adversely by a new one, to take a part in that new one. For example, the motion picture industry, if related closely to the television industry, would logically make up its film subject matter. The newspaper industry with ownership of television stations would recover their loss in newspaper advertising by their income from sponsored television programs.

From a broad National viewpoint, television should prove a commercial blessing. It should provide a host of new jobs, consume a vast quantity of materials for its products and stimulate the movement of many forms of goods and services. I have not said a word about the improved spiritual well being of our people that operating networks of television will bring about, and yet, I do believe that this contribution alone outweighs in real volume all dollar values irrespective of their size that commercial television will create.

Ultra-Portable S-W Army Phone Set

(Continued from page 408)

these portable extra light-weight military sets is invariably a superheterodyne. Unknown to the average reader, many ultra small size superhet sets have been built and tried out successfully in this country, notably by the New York Police Department. Some of these superhets use as many as six special tubes to work a loud-speaker and have been built in such a small space that they measured only about 2" x 6" x 4" and would fit on a belt similar to a cartridge case. The batteries for operating these miniature superheterodynes are especially made by one of the leading battery manufacturers, and are carried in another small case on the other side of the belt. The antenna consists of a short length of wire sewed in the coat.

Some of the small one-meter and similar high frequency transmitters and receivers used by the broadcast companies for "spot news" pick-ups, have been built around the well-known acorn tube, the sets being operated on batteries, of course. With these ultra light-weight short-wave transmitters and receivers available today, the possibility of a future "lost battalion" episode should be quite remote, as a group of men temporarily lost between the lines will usually have at least one signal corps man with them, equipped with one of these featherweight portable short-wave sets.

Radio and Sound System Data

● A valuable collection of data on radio and sound systems is incorporated in the newest catalog of the Wholesale Radio Service Co. Tubes of all sizes are tabulated and an extraordinary assortment of transformers, relays, condensers and resistors are described. A very useful collection of data of interest to every "Ham," "Fan" and serviceman. Several styles and size of "Ham" transmitters and receivers are described.

For your free copy ask for booklet No. 69, and write to the Reader's Technical Service Department, Short Wave & Television, 99 Hudson St., New York City, N. Y.

ALLIED LEADS AGAIN IN VALUE!



Knight 11-Tube All-Wave with Electric Tuning, Select-O-Matic Dial, 12" speaker, only \$58.95

Knight 7-Tube Chair-Side with Select-o-Dial Tuning, World-Wide Range, only \$41.75

1938 KNIGHT RADIOS OFFER EVERY New FEATURE
ELECTRIC PUSH-BUTTON TUNING • FULL VISION DIALS
STUDIO TONE QUALITY • WORLD-WIDE RANGE
AND MANY OTHER "MONTHS-AHEAD" FEATURES
AT PRICES THAT CHALLENGE THE INDUSTRY!

ALLIED has done it again! Now in the 1938 Knights, ALLIED presents radio's newest thrilling features at sensational, typically-ALLIED prices: *Select-O-Matic Electric Tuning*—a station a second, just press a button! New simplified *Horizontal Dials*—new *Full-voiced Speakers*—Broadcast Studio Tone Quality—Advanced R.C.A. and Hazeltine licensed circuits—Newest Tube types—World-Wide Range—the *Electric Eye*—Automatic Frequency Control—all these features and more, at the season's lowest prices!

Only ALLIED'S tremendous volume, low distribution costs, and low-price policy makes these values possible. KNIGHT Radios offer you greater values and bigger profits than any other line. Choose from 61 great models—for every purpose—from 5 to 16 tubes, for AC, AC-DC, 6 volt, 32 volt, battery and auto operation. See them all in ALLIED'S great 1938 Catalog—if you haven't one, just send coupon.

Everything in Radio at Lowest Prices!



KITS

Radio's largest selection, from Beginners' One-Tube to 14-tube Superhet. Write for Free Parts Lists for any kit described in any radio publication.

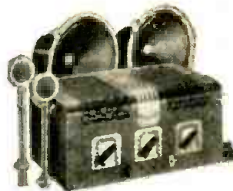

SOUND

Knight Integrated Sound Systems for every P. A. need—8 to 60 watts—and Inter-Com Systems. Selective and Super-Selective.

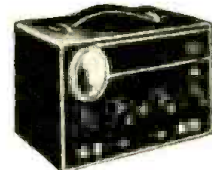

TESTERS

Every type—analyzers, tube-checkers, set-testers, meters, signal generators—all nationally-known brands, at lowest prices.

Whether you're a Dealer, Service man, Sound-Specialist, or Amateur-Experimenter, you need ALLIED'S 1938 Catalog. It brings you everything you need in one book, at lowest prices. Over 12,000 Parts, for building or repairing any circuit. Complete *Amateur Section*—all nationally-known lines of receivers, transceivers, transmitters—factory-built or kit form. *Test Equipment* for every service requirement, including new instrument-kits, *Sound and Inter-Com Systems—Builders' Kits* of every type—*Books, Tools, Tool-Kits*—every radio requirement. ALLIED's high standards and rigorous testing assure you of highest quality. Fast dependable shipment (stocks all under one roof) saves your time. And ALLIED's prices (possible through tremendous volume) save you money. That's why thousands buy from ALLIED! For free catalog, just send coupon.

FREE



SEND COUPON FOR RADIO'S COMPLETE SUPPLY GUIDE

59 other great KNIGHT Radios shown in ALLIED'S Catalog

ALLIED RADIO CORPORATION
833 W. JACKSON BLVD., CHICAGO, ILL.

Allied Radio Corporation
Dept. 3-M8, 833 W. Jackson Blvd., Chicago, Ill.

Send your Free 1938 Catalog
 Send Free Parts Lists for.....

Name _____
Address _____
City _____ State _____

Please mention SHORT WAVE & TELEVISION when writing advertisers

AMERICAN AND FOREIGN RECEPTION

FOR ONLY \$24.95

WITH THESE 2 NEW CROSLLEY FIVERS

FIVER DE LUXE TABLE MODEL



The famous Crosley Fiver with striking advanced cabinet styling and featuring sensational Foreign reception. Incorporates Crosley Mirro-Dial and all other famous features that have made and kept the Fiver "The World's Greatest Radio Value." Dimensions: 12 1/4" high, 10 7/8" wide, 6 1/8" deep.

FIVER DE LUXE COMPACT

The same Crosley Fiver housed in an unusually attractive compact type cabinet. Offers the same outstanding features and brilliant American and Foreign reception found in the regular Fiver. Dimensions: 8 1/4" high, 13 1/8" wide, 6 1/8" deep. 5 tubes superheterodyne; 2 bands, 540-1720 Kc. and 5800-15,400 Kc.; full floating, moving coil electrodynamic speaker; full vision, illuminated, 3-dimensional Mirro-Dial; automatic volume control; power supply noise filter.



(Prices slightly higher in South and West)

THE CROSLLEY RADIO CORPORATION
 POWEL CROSLLEY, Jr., Pres. CINCINNATI
 Home of "the Nation's Station"—WLW—
 500,000 Watts—70 on your dial.

YOU'RE THERE WITH A CROSLLEY

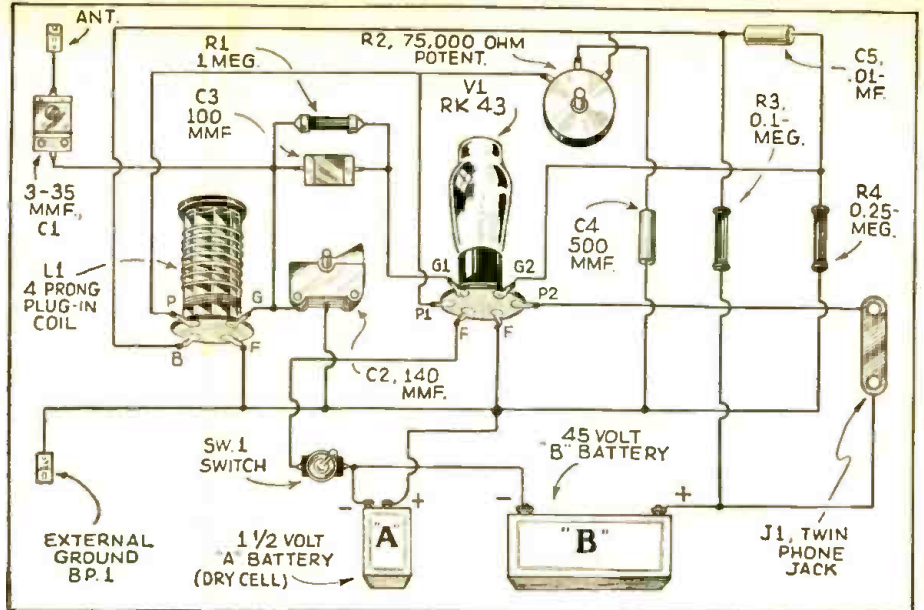

Picture Wiring Diagram of 2-in-1 Clock-case set.

2-in-1 Clock-Case Portable

(Continued from page 417)

lower left of the case. A compact type 75,000 ohm potentiometer mounted on the front chassis wall provides the means of controlling regeneration.

As can be noted from the schematic diagram, the circuit of this receiver is extremely simple. The grid condenser and grid leak, the .0005 mfd. fixed condenser, the two resistors and cartridge condenser of the resistance coupled stage all mount beneath the chassis. It is suggested that half-watt resistors, or even smaller, be used. An interesting side-light is the fact that the complete receiver, including cabinet, coil, tube and "A" supply, weighs only 1 1/2 pounds. It is now possible to obtain a midget 45 volt "B" battery having a rating of 190 milliamperes hours, and occupying a space only 3 inches in length, by 1 1/4 inches in width, by 3 3/4 inches high. A battery of this type can be strapped on the back of the cabinet and the entire outfit will then weigh less than 3 1/4 pounds, since the compact "B" battery adds only 11 ounces to the weight of the outfit.

If any difficulty is experienced in obtaining a suitable clock case, the set can

be built in a small cigar box with plenty of room for batteries and coils. In fact, this powerful little circuit can be adapted to many interesting types of portable cases. It is just the thing for a light pocket radio set.

Due to its extreme simplicity, the wiring of this receiver will present no difficulties and therefore this set is especially recommended for the beginner. While only one tube is used, it gives two tube results and it can even operate a small speaker on strong stations. Another thing about this set is the fact that it is capable of really excellent short wave reception. Of course, where foreign reception is desired, the set should be connected to an efficient aerial. This does not mean that a special type of aerial is necessary, but merely that the antenna consist of a 30 to 50 foot length of single wire, well insulated at each end and as high as possible. The lead-in may be at either end or at the center. A good ground is also essential for best short wave results.

Where the set is to be used only for broadcasting or for local short wave reception such as police calls, amateurs, etc.

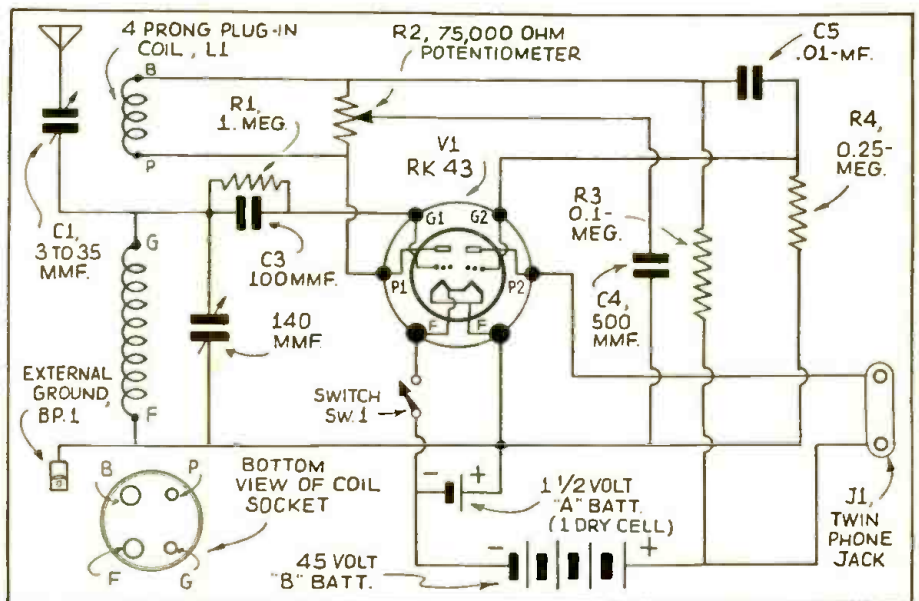

Schematic wiring diagram.

Please mention SHORT WAVE & TELEVISION when writing advertisers

a length of wire strung between two trees will give surprisingly good results.

Complete List of Parts for "Clock-Case" Portable

HAMMARLUND

- C1—Equalizer antenna trimmer, type EC-35 (3 to 35 mmf.)
- C2—Star midget condenser, type SM-140 (140 mmf.)
- L1—Set of four short-wave plug-in coils, 17 to 270 meters, type SWK-4
- L1—One 4-prong broadcast coil, 250 to 560 meters, type BCC-4

CORNELL-DUBILIER

- C3—.0001 mf. mica condenser, type 3L
- C4—.0005 mf. mica condenser, type 1W
- C5—.01 mf. "Cub" tubular condenser, type BA-4S1

RESISTORS—I.R.C.

- R1—1 meg., 1/2 watt metallized resistor
- R2—75,000 ohm potentiometer
- R3—100,000 ohm, 1/2 watt metallized resistor
- R4—250,000 ohm, 1/2 watt metallized resistor
- 1—4-prong coil socket for L1
- 1—6-prong tube socket for V1
- 1—Clock-case—See article
- 1—Chassis—See article
- 1—"On-Off" toggle-switch
- 1—Dial to fit clock face
- 1—Knob for regeneration control
- 1—1 1/2 volt flash-light dry cell
- 1—45-volt compact "B" battery

RAYTHEON

- V1—RK-43 dual triode tube

MISCELLANEOUS

- J1—Twin phone jack
- Hook-up Wire, Hardware

Dr. J. M. B. Hard's Station a HAM'S Paradise

(Continued from page 416)

raising say the antenna pulley to the top of No. 1 mast and lowering the antenna pulley of No. 2 mast an angle of 45° with the high end to the west can be had.

The Radio Shack, interior view. The antennas can be seen coming from the roof through glass plates. The kilowatter (1,000 watter) is to the left, and the 100 watter is to the right, both transmitters are in the background. In the center against the back wall are the meters that show the current coming into the shack. One of them shows the amount of amperes being consumed by the kilowatter when on the air. In the foreground is the hexagonal desk from which all the various apparatus are controlled, without moving from the easy chair seen before the desk.

From left to right the apparatus shown is as follows: the Dual Diversity Receiver designed and built by James J. Lamb and James L. A. McLaughlin, which consists of the receiver proper; next to it, the audio amplifier, which is in front of the loud-speaker with its tweeter, and the power-packs are in the desk below, inside.

In front is the control panel from which all apparatus is manipulated. The only switch used when on the air is the anti-capacity switch that can be distinguished in the center of the panel; when pushed down all transmitters are off the air and either one or both receivers are on, and vice versa.

On top of the control panel is an RME 69 with a Peak pre-selector. Next comes the Oscilloscope, then a frequency-meter graduated for the different amateur bands, a clock for giving an alarm when it is time to call or stand-by for a station, and lastly a variac with a transformer to give 130 volts A.C. or other voltage that may be necessary from the 240 volt A.C. line coming in from outside.

All lines throughout the buildings are in iron conduits embedded in the roof and floors in concrete. The ground for the apparatus is a copper ribbon 2 1/2" wide of No. 20 gauge, buried under the rock foundations of the buildings with a section that runs outside of the buildings alongside of the clay pipe that goes to the septic tank.

This gives a general idea to what trouble Dr. Hard went to get the best reception possible; and, the results have been very satisfactory.

TRADE your AUTOGRAPH for this GOLD-MINE



THAT'S NO ORDINARY HEAD-LINE, MISTER, I KNOW—I TOOK 'EM AT THEIR WORD AND SWAPPED MY NAME FOR WHAT TURNED OUT TO BE THE SWELLEST RADIO CATALOG I'VE EVER SEEN—



PUBLIC ADDRESS EQUIPMENT

Page after page of the world's greatest line of amplifiers and public address systems. There's money in this new field and the FREE catalog shows you how to make it. Whether you rent, sell or install, this is the book for you.

LAFAYETTE RADIOS

35 pages of sets, showing 70 models. Priced so low, that the "extra set" need no longer be just a hope. Study the LAFAYETTE line in the FREE catalog and you'll learn what real radio value is. Prices range from 8.75 to 99.50. 30 day free trial in your own home.

"HAM" RECEIVERS

Every nationally advertised line of amateur equipment—receivers and parts. They're all in this FREE WHOLESALER Catalog and at prices that will astound you. Consult with our engineering staff for special "rigs". No obligation, of course.

TEST INSTRUMENTS

You servicemen will find this part of the catalog particularly valuable. The finest in set testers, tube checkers, oscilloscopes, etc. at prices that will make you sit up and take notice.

EASY TIME PAYMENT PLAN

Get your P.A. equipment, LAFAYETTE radios, "Ham" receivers, Test instruments on Wholesale's Easy Payment Plan, outlined in the FREE Catalog.

TAKE THE GUESSWORK OUT OF XMAS SHOPPING WITH THIS New FREE CATALOG

Do your Xmas shopping from Wholesale's special Xmas catalog. 40 pages of "extra value" gift buys featuring nationally advertised electric trains, home appliances, toys.



CLIP COUPON NOW FOR BOTH CATALOGS — 220 PAGES OF ASTOUNDING VALUES

WHOLESALE RADIO SERVICE CO., INC.
NEW YORK, N.Y. CHICAGO, ILL. ATLANTA, GA.
 100 SIXTH AVENUE 901 W. JACKSON BLVD. 430 W. PEACHTREE ST., N.W.
 BOSTON, MASS. BRONX, N.Y. NEWARK, N.J. JAMAICA, L. I.

WHOLESALE RADIO SERVICE CO., INC.
 100 SIXTH AVENUE, NEW YORK, N.-Y.

Rush FREE 1938 Catalog No. 69-4M7

Rush FREE Xmas Catalog No. 70-4M7

NAME _____

ADDRESS _____

CITY _____ STATE _____

they're
FREE

PASTE COUPON ON PENNY POST CARD

Please mention SHORT WAVE & TELEVISION when writing advertisers

H. G. CISIN'S FAMOUS KITS

WORLD WIDE

DEMAND FOR THE 1938

AIR WAVE AIR SCOUT

1 TUBE 3-IN-1 KIT

THRILLING SHORT WAVE RECEPTION
KEEN BROADCAST RECEPTION
INTERESTING LONG WAVE RECEPTION



1.00
Less Tube Unwired

All three types of reception with this remarkable, low-priced set, merely by interchanging plug-in coils. Coil included in kit brings in Broadcasting, Police Alarms and other interesting short wave programs. Five other coils available to cover 5 different wave bands. FOREIGN RECEPTION under suitable conditions. Three foreign coils 25c ea. extra. Long Wave unit and coil 75c. Designed for earphones, but operates loud speaker on strong stations. Works with any battery type tube. Uses inexpensive batteries. Dry cell tube (50C) requires 1 or 2 flashlight cells and small "B" battery. 5-volt tube (25c) substitutes storage battery for flashlight cells. Kit comes complete with black mounting panel, coil, all necessary parts, detailed instructions and amazing new full sized picture guide which fastens under panel showing exactly where to mount parts and fasten wire.

H. G. CISIN'S All-Wave Air Scout Jr. Radios

THREE-TUBE ALL ELECTRIC ALL WAVE SET

\$3.20
WITH PHONE
Less Tubes Unwired

MODEL 3A-E. A powerful sensitive all-wave set. Holds wonderful records for foreign reception. Also brings in police calls, amateur, code, Transatlantic phone and broadcast entertainment. Excellent volume. Works from any A.C. or D.C. house current. Easiest set to build. Employs newest metal ballast tube as one of the tubes. Speaker mounts on attractive panel. Range 9 1/2 to 810 meters or to 1500 meters with special long wave coil. Complete Kit includes: Earphone, broadcast coil, 70 to 200 meter coil. Panel, Chassis, High Grade Variable Condenser, Potentiometer, Antennas, Condensers, and all other required parts including instructions and diagram. **\$3.20** With Phone (Less ONLY tubes, unwired)



Model 3A-E Pat. No. 2,086,858

ONE-TUBE BATTERY SET—Model 1B. Satisfied owners report MARVELOUS FOREIGN RECEPTION. Also other S.W. and broadcast reception same as model 3A-E. Earphone reception. Complete kit includes parts listed above plus 30 tube and filament rheostat. Uses inexpensive **\$2.45** With Tube and batteries (unwired)

TWO-TUBE BATTERY SETS—Model 2B. Complete kit including all parts in the 1-tube model plus parts for extra audio stage in 2-tube model plus parts for extra audio stage in 2-tube model plus parts for extra audio stage in 2-tube model. **\$2.95** & phone (unwired)

THREE-TUBE DE LUXE BATTERY SET—Model 3B. Complete kit including all parts in the 1-tube model plus parts for two extra audio stages including two 30-type tubes and 33 with three tubes power output tube. **\$3.45** & phone (unwired)

Following Auxiliary Parts are available: 9 1/2 to 20 meter coil 25c; 15 to 45 meter coil (foreign) 25c; 40 to 80 meter coil (foreign) 25c; 22 1/2 volt "B" battery 75c; Two flashlight "A" batteries 10c each; 5" Find-All Loud Speaker \$1; Complete Antenna Kit 50c; Wood Screw Kit 10c. Tubes for Model 3A-E, each 45c. Long Wave Unit and coil for any model \$1. Double Earphones \$1.50. Bandspread Attachment 75c. Any model wired extra 75c.

NOTE: If you already have earphones, two extra foreign coils may be substituted in any model.

30 PIECE RADIO EXPERIMENTAL KIT

A Treasure Trove of Useful Radio Components! Best parts for scores of radio hook-ups. Ideal beginner's outfit. Educational. Will also save money for experienced radio fans. Illustration shows only a portion of kit, which includes Adjustable Trimmer Condenser, 5 four-prong sockets, 2 five-prong sockets, 1 six-prong socket, 1 7-prong socket, 1 lattice-wound Find-All R.F. choke, 1 calibrated Dial, 3 assorted Fixed Condensers, 3 assorted Resistors, 1 Grid Leak, 1 Grid Condenser, 10 Connection Clips, roll hook-up Wire. (Value, if purchased separately, including free gifts approx. \$4.75)

COMPLETE **\$1.00** With 6 FREE GIFTS Add 20c for postage any place in U. S. or Canada

FREE WITH EVERY KIT SIX VALUABLE GIFTS

This unprecedented Gift Offer may never be repeated. Made solely to create new radio enthusiasts. Only one to a customer. None to dealers.

FREE GIFT OFFER NO. 1: A Genuine R.C.A. Radio Tube in its original carton. If ordered separately 50c postpaid.

FREE GIFT OFFER NO. 2: H. G. Cisin's "ELEMENTS OF RADIO". A seven lesson theoretical and practical instruction course. If ordered separately 50c postpaid.

FREE GIFT OFFER NO. 3: Zeh Boucks "HOW TO MAKE MONEY IN RADIO SERVICING." Profusely illustrated 130-page book. Sold separately for 75c postpaid.

FREE GIFT OFFER NO. 4: Full-size picture diagram "How to Build a 1-Tube Broadcast Battery Set." Separately 10c postpaid.

FREE GIFT OFFER NO. 5: Full-size picture diagram "How to Build a 1-Tube All Wave Receiver." Separately 10c postpaid.

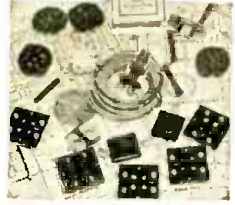

H. G. CISIN, CHIEF ENGINEER
Allied Engineering Institute, Dept. 5-42
98 Park Place, New York, N. Y.

A Fixed-Band 8-Tube Superhet for S-W Fans

(Continued from page 418)

or necessary as the builder may decide.

The R.F., Mixer, and High-Frequency Oscillator Circuits

A three-gang variable condenser of extremely low minimum and 410 mmf. maximum capacity per section, used with the specified coils, will permit the 16.4 to 51 meter coverage. A unit with a higher minimum will limit the high frequency range—and, as is apparent, one of less than the required maximum will limit the low frequency range. It is thoroughly advisable that the particular condenser mentioned in our list of parts be acquired—in any event if lab. model extension is to be duplicated.

Coils are small, high efficiency jobs, matched for proper service with this condenser; they come equipped with air-trimmers and their use will naturally obviate any necessity for coil construction and the separate purchase of aligning capacities.

In our laboratory model we at first employed R.F. stage regeneration with noticeable success, but feedback was finally removed from the front end in an effort to simplify the design as much as possible, and to permit the installation of the R.F. coil above the variable condenser. Regeneration remains more or less optional here—and Fig. 2 should be carefully noted where feedback (which will considerably improve input selectivity, and signal-to-noise and signal-to-image ratios) is to be employed. A somewhat different positioning of the R.F. coil will be necessary; it may have to go under the chassis or at least be mounted so that cathode coil leads to the associated tube socket will be reasonably short. In any event, the Fig. 2 circuit should be precisely followed, as e.c. feedback does not permit the usual direct tie between 6K7 suppressor grid and cathode; any such tie will nullify the shielding effect of the tube's screen and seriously involve R.F. stage stability. Note that the coupling coil is in the cathode lead, and that the return for this lead is made to the suppressor, with the suppressor circuit in turn by-passed and returned to chassis through the bias resistor. The suppressor is free from R.F. potential—but is still effectively connected to the cathode, so that the advantage of having the suppressor is better realized than if we were simply to tie that tube member to ground or screen (the conventional procedure where e.c. feedback is employed with tubes of the 6K7 type).

Where regeneration is desired and used—some means of controlling it is advisable. We may here simply return the tube bias limiting resistor directly to ground instead of through the R.F. fader control—and use the fader as a potentiometer, connected as the 100 volt-to-ground portion of a suitable B plus-to-B minus voltage divider, with the variable tap tied to the screen and properly by-passed.

The mixer circuit is quite conventional, as is the oscillator circuit. Note that the 6L7 is AVC controlled, that the HFO signal is introduced into the mixer through a .0001 mf. mica capacity, tied between oscillator plate and the 6L7 No. 5 or injector terminal, and that the injector circuit is completed to ground through a 50,000 ohm resistor.

The coupling capacity between the mixer and oscillator circuits has been given an optimum value; and values for the oscillator grid condenser and leak and the oscillator and mixer screen and plate resistors, have all been selected to permit a satisfactory mixing or conversion with a minimum of oscillator hiss.

The I.F. Stage

The input I.F. transformer is a Ferrocart (iron core) affair, designed especially for use between converter and I.F. tubes.

Though the single stage has a very excellent gain, due to careful design and the use of this input transformer—we have pushed up amplification to the limit (and pushed up selectivity of course in the bargain) by wiring the I.F. circuit for regeneration. The feedback details are more or less those suggested as optional for the R.F. stage, varying simply in the method of coupling a cathode coil into the tuned circuit. Note that we have used a conventional broadcast-band oscillator coil here, that its primary is wired between cathode and ground and that its smaller pickup winding (generally used as a plate or tickler inductance) is series-connected in the return lead to chassis of the I.F. input transformer secondary. Feedback here is nicely controlled not by a variation of screen-potential, as is suggested for a regenerative R.F. stage, but by a variation of the shorting effect of a rheostat placed in parallel with the cathode coil. The coupling condenser between the cathode and this rheostat prevents any D.C. from flowing directly through the resistance, and yet permits the passing through of the R.F.; while the rheostat itself permits by-passing of this R.F. on to ground, to more or less degree as its variable resistance determines, (as more and more resistance is cut in, less and less R.F. is by-passed and more I.F. regeneration results). Using the values specified for by-pass condenser and variable resistance a very smooth control is possible without much danger of circuit oscillation with the rheostat wide open.

Detector, A.F., and Power Circuits

The output transformer (I.F.) has a center-tapped secondary to permit push-pull feed into the 6H6 second detector, rectification over both alternations (full wave), and the development of power in the diode load impedance, effectively twice that produced with half-wave rectification. Power is not exactly important, however, as we would have plenty of detector output were we to use the conventional single-ended hookup; but what

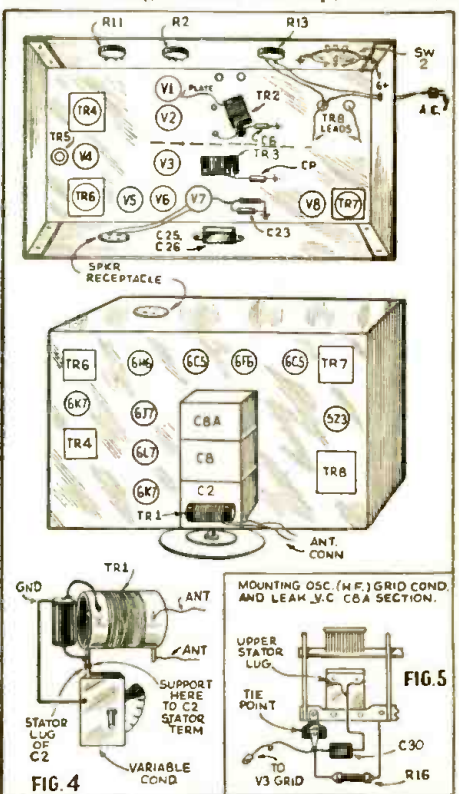

Detail of assembly of Fixed-Band Superhet, also coil mounting arrangement.

Please mention SHORT WAVE & TELEVISION when writing advertisers

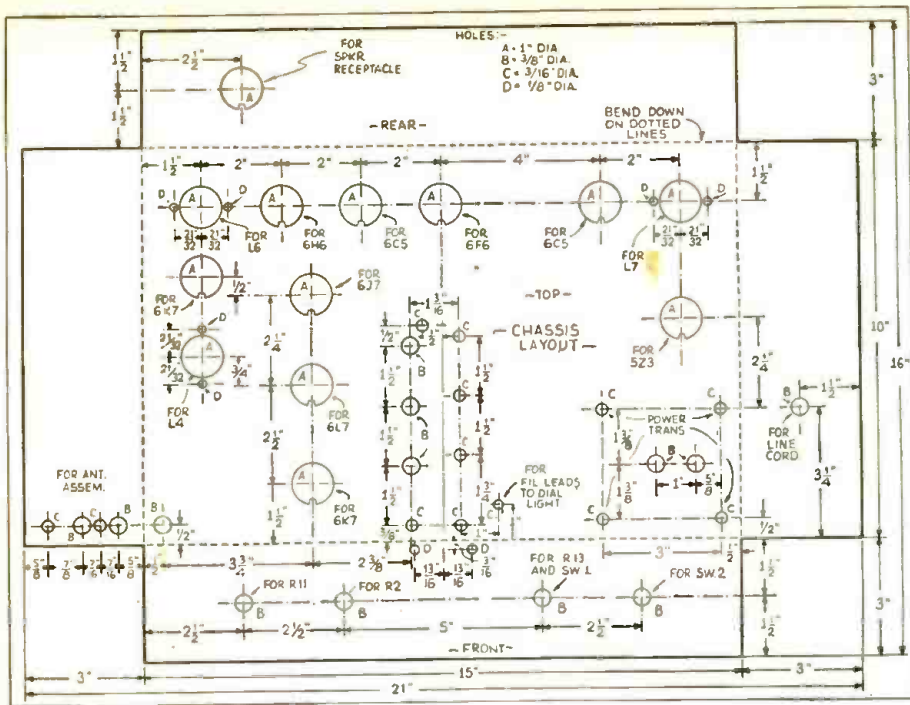

Chassis Drilling Layout

is important is the improved modulation capability which results—that and the more effective elimination of R.F. Note that the load impedance is split up into (1) a limiting resistance—and (2) the paralleled resistance of the rest of the leg and the bridging audio-level potentiometer, and that the available A.F. (and the available AVC) voltage is determined in amount by the value of the limiting resistance. This suggests conventional practice, and though it is not altogether imperative here, largely because we have used the more efficient if less common full-wave rectification, it is nonetheless well worth application due to the additional R.F. filtering which it effects.

The first audio tube is diode biased—eliminating the necessity for a coupling capacity, a separate grid resistor, a cathode resistor, and a cathode bypass electrolytic. The rectified signal, or such portion of it as is selected by an adjustment of the A.F. level-control, is applied both as an A.F. and D.C. voltage to the tube grid; and the D.C. voltage, being negative with respect to ground, biases the triode by its own amount. In other words, the bias for the 6C5 and thus the gain of the tube is directly related to carrier, as the detection action is linear; as the signal-level increases, the output level increases in proportion, and the A.F. tube bias also increases in proportion, so that for strong signals the A.F. gain drops down, while for weak signals this gain opens up to maximum, the limiting bias for the tube being determined solely by noise-level.

The plate circuit for the 6C5 and the grid circuit for the consequent pentode output tube are arranged in network fashion. Coupling between the two stages is capacitive and conventional. The 6F6, of course, delivers a good, healthy signal to the speaker—ample signal, in any event, for our particular purposes.

The power transformer has values functionally related to our particular design and is rated to deliver about 350 volts D.C. at 85 ma., into a filter with electrolytic input. Our receiver actually draws about 80 ma., when all tubes are drawing full current, so that approximately this voltage is measured at the input to the speaker field resistance. At this current pull, a filter resistance of 1,250 ohms is required to provide a 100 volt drop for 250 volt B plus; and anything from 1,000 ohms to 1,400 ohms in

value will be satisfactory. For the laboratory model, a 1,000 ohm speaker field was pressed into service, and this speaker resistance will be found proper where 2,000 ohm decoupling resistors are used, as specified, in R.F. and I.F. plate circuits, and where all voltage dropping resistors have "lab." model value.

The Beat Oscillator Circuit

The beat oscillator stage is optional—useful as a sort of *weak signal beacon* where the DX reception of short wave broadcasters is in order—more or less of an imperative refinement if the receiver is used for communication purposes. *Under no circumstances should the operator depend upon an oscillating I.F. circuit for the development of a beat—however much I.F. regeneration suggests this killing of two birds with one stone.* If facilities for obtaining a beat note are desired, use the separate BFO stage.

Switching and Control

A switch permits three-point selection of: 1—AVC on and BFO off; 2—AVC on and BFO on; 3—AVC off and BFO on. Other controls are for A. F. level, I.F. feedback (receiver selectivity); R.F. regeneration (input sensitivity), and tuning. No other controls will be necessary unless manual R.F. and Mixer circuit trimming is desired.

Layout

The photographs adequately illustrate the placement of parts. Note that the R.F. coil is above the chassis, that the first detector and oscillator coils are below the chassis and positioned at right angles to each other, that the H.F. oscillator grid condenser and resistor are mounted on the variable condenser frame, near the oscillator section stator terminal. Tubes near the variable condenser are those for the R.F. circuits. The 6K7 in the I.F. stage lies between the two I.F. coil components. Second detector, first and second audios, and beat oscillator extend along the rear of the chassis from I.F. output transformer to the BFO coil. The power-supply items—transformer and 5Z3 rectifier tube—are spaced well away from other parts.

Construction

A standard chassis—10x15x3 inch size—will permit laboratory model layout and afford more than ample room for the ad-

The world's largest Exclusive Radio Tube Manufacturers!

ALL the resources of the vast Raytheon organization are concentrated in the development and production of radio tubes! Raytheon is an organization of specialists. All the brains, time and effort are expended toward one end—that you may have better quality, longer-lasting radio tubes.

This unusual policy is responsible for some of the greatest developments in tube design: The universally used auto-set filamentless gaseous rectifier—the OZ4—is one of the fruits of Raytheon concentration. The RK-47 and RK-48 Beam-Power output amateur tubes are another important Raytheon contribution.

There have been many others since the famous Raytheon "BH" and "BA" tubes years ago which began the era of all-electric receivers.

Raytheon service is comparable to Raytheon quality. There is an outstanding Raytheon jobber in every community to supply you promptly. He stocks the most complete line of tubes made today.

Order Raytheon for greater permanent tube profits!

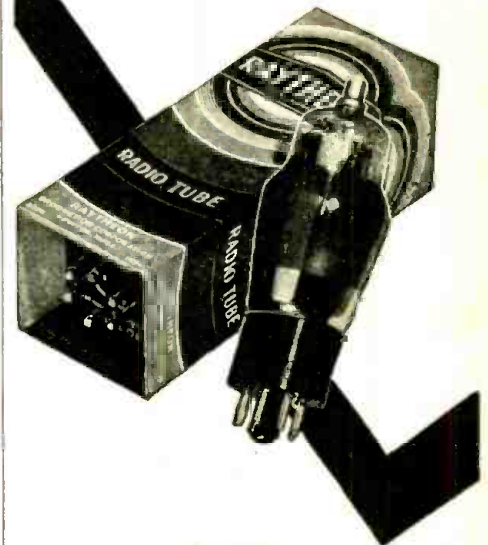

RAYTHEON

445 Lake Shore Drive, Chicago, Illinois
 555 Howard St., San Francisco, Cal.
 420 Lexington Ave., New York, N. Y.
 55 Chapel Street, Newton, Mass.
 6415 Peachtree St., N. E., Atlanta, Ga.

FOR BETTER RECEPTION

Please mention SHORT WAVE & TELEVISION when writing advertisers

AMAZINGLY NEW,
MIDLANDS
GREAT
"COLOR-CODED"
RADIO
TELEVISION
EXTENSION TRAINING

Originated and developed by experienced engineers and educators. Backed by the resources and modern facilities of nationally known, 5000-watt Columbia basic network broadcasting station, KMBC. "Color-Coded" training fits you for better jobs in radio—prepares for future television opportunities. Graduates qualified to take Government operator's license exams. Lifetime employment service. Get the facts without delay.

WE SEND ALL NECESSARY EQUIPMENT FOR YOUR "HOME LABORATORY" EXPERIMENTS



You will build this modern oscilloscope. And it will be yours to keep.

You get 90 modern "color-coded," illustrated lessons. 10 attractive "Home Laboratory" manuals; 10 big shipments of experimental equipment including 3-inch Cathode Ray tube—necessary tools. Then, after completing your "home training," you get a bus ticket to Kansas City and 4 weeks' intensive training in our fine school laboratories. WE ARE NOT CONNECTED WITH ANY OTHER RADIO OR TELEVISION SCHOOL.

MIDLAND TELEVISION, Inc.

29th Floor, Kansas City Power & Light Bldg.
 112 M. 14th St., Kansas City, Mo.

ITS Free
FORTUNES IN FORESIGHT

Get the Facts Before you Act! Send for your copy today.

MAIL COUPON TODAY

■ MIDLAND TELEVISION, Inc. (Mail in 29th Floor, Kansas City envelope or paste Power & Light Bldg. on postcard)
 ■ 112 M. 14th St., Kansas City, Mo.
 ■ Without obligating me, send your new FREE book about the Radio-Television profession, "FORTUNES in FORESIGHT."
 Name..... Age.....
 Address.....
 City..... State.....

dition of such refinements as a push-pull output A.F. stage, a larger transformer, and two-section filter (in the event a P.M. speaker is by any chance to be used). Drilling specifications refer very definitely to the "lab." model, of course, and may or may not be useful to the builder—largely and logically depending upon whether he has acquired listed parts or has substituted parts of different make and consequently of different physical construction.

The tube socket holes may be punched with a die—or simply formed with a circle cutter and to such size that the retainer-ring mounted sockets may be installed with a very close fit.

Mount the R.F. coil above the R.F. section of the condenser, soldering the coil grid lug (see Fig. 4) directly to the top stator terminal and connecting the ground lead to the condenser frame. Run twisted pair leads from the primary for this coil down to and through or along the chassis and to the two A posts of the antenna B.P. assembly. If possible, run this twisted pair through low capacity shield tubing.

Complete the R.F. wiring. Use physically small resistors and by-pass condensers and see to it that these are well away from the fields of the R.F. coils. Return grounds for each stage to one convenient point—preferably the No. 1 terminal of the associated tube socket. Between detector and oscillator coils, install a shield partition—high enough and wide enough so that ample stage isolation is secured. Such a shield may or may not be imperative but is in any event advisable.

Wire up the I.F. circuit, similarly working out a single point ground for the one stage. Mount the cathode coil right over the I.F. socket, so that leads may be short. It might be wise to completely shield this coil—if that can be easily effected.

Complete the wiring of the receiver, using tie points wherever necessary for resistor and condenser support—or relying on available free or unused socket terminals. Run the leads from the second detector load resistor to the parallel volume control through low capacity tubing.

When the wiring is completed, check it over against the circuit diagram at least twice. Then, with sensitivity control opened right, and with selectivity and A.F. level controls closed left, turn on the A.C. supply. The following voltage readings should be taken:

6K7s-R.F. and I.F.: plates 250, screens 100, cathodes—3.

6L7 Mixer: plate 250, screen 150, cathode—6.

6J7 osc.; plate 200, screen 160.

6C5 BFO; plate 90-100.

Output pentode plate and screens at high potential; first A.F. plate reading will vary with the signal, due to shifting bias.

If these values are not indicated—particularly screen and cathode—increase or decrease the size of voltage dropping or limiting resistances until the proper condition obtains.

Open the A.F. level control for visual or audio output reading and align the I.F. to 456 kc. It will be quite advisable to stick close to this frequency—and in any event definitely necessary to bring both transformers into a precise match. But this should not be very difficult—whether or not test equipment is available—as the specified transformer components will have been factory pre-peaked to 456 kc. and as trimmers may simply need a very slight quarter-turn or so readjustment to compensate for capacity effects in the I.F. wiring.

If a test oscillator is on hand, adjust it for an approximately 17 mc. signal, introduce this signal into our front end, and trim up the H.F., R.F., and mixer coil alignaire capacities for maximum output. A similar alignment for the low frequency end of the band might be in order—but will not be definitely imperative if a 456 kc. I.F. "on the nose" line-up has been effected.

Open up the gain control still more and

note if at any point of adjustment an oscillation or periodical beating is introduced which slows up in frequency as the control is advanced, and quickens in frequency and finally disappears as the knob is turned back toward the left again. If any such oscillation is experienced, R.F. filtering in the second detector output load is insufficient; increase the size of the mica capacities in the load leg—or, better still, insert a shielded R.F. choke, effective at 456 kc., in the load and at its high voltage (coil center-tap) end, by-passing both sides to ground with mica condensers of from .00005 to .00025 mf. value, as is required.

Open up the selectivity control and note if at any point of adjustment a dull plop is heard—indicating I.F. circuit oscillation and too much feedback. If such a plop is heard, add resistance (in parallel connection) to the 5,000 ohm selectivity control until evidence of oscillation disappears—or is at least indicated only with the control wide open for minimum R.F. by-passed and maximum regeneration. Or—simply short the pick-up coil in the TR 6 secondary's return lead to ground, using fixed resistance of various trial values. Simpler still, increase the capacity of C11 to twice its specified value or so. If, on the other hand, insufficient regeneration is indicated, reduce the value of C11 until a noticeable increase in signal-level and sharpness of tuning is experienced as the selectivity control is advanced from minimum to maximum.

The beat oscillator is turned on by moving the AVC-BFO switch arms to the No. 2 or center contacts. (This connects B plus to the 6C5-BFO plate, but does not short-out the AVC). Adjust the B.F.O. transformer single trimmer until the beat is obtained and CW signals come in clearly and sharply.

Fixed Band Super—Required Materials and Parts

MEISSNER

One set type 4 short-wave coils, unshielded, complete with Alignaire trimmers (C1, 7, 7A0 and osc. pad (CP)—TR1, 2, 3.
 One type 5740 input I.F. transformer (TR4).
 One type 6211 output I.F. trans. (TR6).
 One type 4034 (unshielded) or 4243 (shielded) coil (TR5).
 One type 6753 BFO transformer (TR7).
 One type 15130 variable cond. (C2, C8, C8A).
 One type 18254 switch (SW2).

JEFFERSON ELECTRIC CO.

One type 463-351 power transformer—350 volts D.C., 85 ma., (TR8).

LOUD SPEAKER

One dynamic speaker, size and model as required, with 1,000 to 1,500 ohms field resistance and transformer for single 6F6.

I. R. C.

One type 13-137 A.F. pot., with switch (R13-SW1); one type 13-123 cathode control (R2); one type 11-114 control (R11).

Half-watt resistors (type M5 or standard): 300 ohms (R1 and R16); 600 ohms (R6); 10,000 ohms (R14, R15); 15,000 ohms (R5); 40,000 ohms (R15); 50,000 ohms (R7, R16, R12, R19, R20, R24); 2,000 ohms (R4, R8, R18); 100,000 ohms (R3, R9, R17, R22); 500,000 ohms (R10, R21).
 Three-watt resistor: 400 ohms (R23).

AEROVOX

Type 284—1 mf.—C3, 4, 9, 9A, 11, 12, 12A, 16, 22, 18.
 Type 484—1 mf.—C5, 10, 13, 20.
 Type 484—.05 mf.—C29, 32, 19, 21.
 Type 284—.05 mf.—C6.
 Type 284—.006 mf.—C24.
 Type 1468 mica—.0001 mf.—C17, C30; .00025 mf.—C14, 15; .002 mf.—C27, 28 (optional); .0005 mf.—C31.
 Type PR25—10 mf.—C23.
 Type PBS-5—8-8 mf.—C25, C26 (one dual unit).

SOCKETS

Two type S4 sockets for rect. and speaker recept.; four type S8 octal sockets; three type RSS8 steatite octal sockets; one (optional) type MEA6, magic eye assembly.

DIAL

One type 317 Micromaster dial, plain 0-100 reading scale; four type 591 knobs.

MISCELLANEOUS

One three-post, "Ant.-Ant.-Ground" Assembly. One 15x10x3 inch chassis; special R.F. and standard push-back hook-up wire; grommets, etc.

(Names and addresses of the manufacturers of the various parts specified above will be furnished upon request.)

Please mention SHORT WAVE & TELEVISION when writing advertisers

The New National NC-80X

(Continued from page 421)

or D.C. 115 volts.

The tuning system, likewise entirely new, employs a multiple scale dial of the full-vision type, accurately calibrated in megacycles. Several unusual features are incorporated, such as the mirror for overcoming parallax, the auxiliary linear scale

(at the bottom), and the adjustable frequency markers, by means of which any particular stations, or frequencies, such as band limits, may be "logged" on the dial itself. Two vernier reduction ratios are available, 16 and 80 to 1, with a separate knob for each.

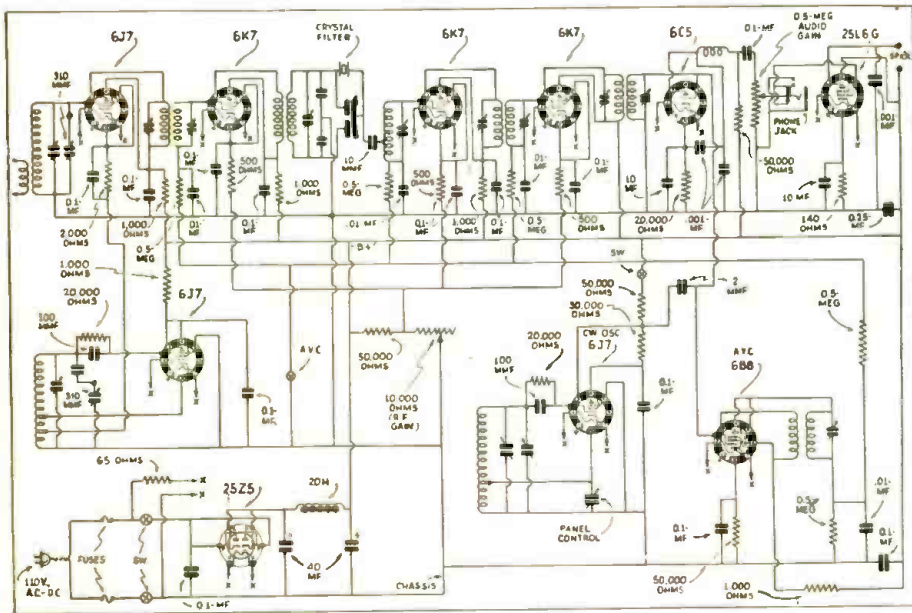

Hook-up of new National NC-80X Receiver.

A Novel 2-Tube S-W Reflex Receiver

(Continued from page 417)

to earth, other than through L3-C5, by the inclusion of the choke in series with the B+ potential to the screen.

The R.F. signal having been amplified by the pentode section of the tube passes through R.F. transformer No. 2 (L4-L5) and is now applied between the diode plates and cathode of the 6B7 tube. It is thus rectified, the load resistance (R3) being tapped to allow the A.F. component to be applied to the pentode control-grid through coupling condenser C8 and resistor R1. (The cathode bias developed across R2 is applied to this control circuit through resistors R4-R1.) The pentode section now amplifies at audio frequency, the potentials developed across its plate resistor (R7), being fed through coupling condenser C11 to the grid of the 6C5 amplifier tube, which grid is biased by the voltage drop across resistor R9 and fed to it by way of grid resistor R8. After amplification by the tube, the output is fed to headphones connected in its plate circuit.

The use of this 6C5 tube is recommended, since this arrangement allows of a more perfect matching for the headphones, the pentode section of the 6B7 offering too high an impedance for the connection of headphones in its plate circuit.

The two R.F. chokes (R.F.C.1, R.F.C.2) should be of a good make of the type suitable for incorporating in S-W receivers.

The construction of this receiver should present little difficulty to the "ham" who has had a little experience along this line. It should be emphasized that the values of capacities and resistance utilized in this circuit are fairly critical and must not be deviated from, to any appreciable degree; for instance, if condensers C2, C10, have values of capacities much larger than those specified, they will by-pass some of the A.F. currents, and the set, in consequence, will lose "punch".

This receiver may be operated from either "A" and "B" batteries, or, an A.C. power-pack. The latter will be found to be the more desirable of the two, since the

upkeep is less and the higher B voltages available will give more volume.

The writer utilizes plug-in coils wound on old UX and UY tube-bases and particulars of the windings are given below. It will be observed that the tickler windings require a slightly greater number of turns than usual—this on account of regeneration being derived from the screen circuit (and not the plate) of the 6B7 tube.

Due care being paid to its construction and operation, this receiver will delight the heart of the builder, its sensitiveness and tonal qualities being perhaps its outstanding features.

Coil Details

Wave Band	Ant.	Grid	Reg.	Det. Pri.	Coil Grid.
20-32 meters	3	8	7	3	8
30-45 meters	4	12	9	5	12
40-70 meters	5	18	11	7	18
60-100 meters	7	25	15	9	25

All coils close wound with 25 D.S.C. wire; separation between L1 and L2 and between L4 and L5 is 1/8"; separation between L2 and L3 is 1/4".

Parts List

- C1—35 mmf. ant. condensers
- C2, C10—.002 mf. mica condensers. Aerovox
- C3, C13—2 gang tuning condensers, 50 mmf. per section
- C4—10 mmf. trimmer condenser
- C5—200 mmf. regen. condenser
- C6, C7—.05 mf. paper condenser, 400 V. Aerovox
- C8, C11—.01 mf. mica condenser. Aerovox
- C9—.001 mf. paper condenser, 400 V. Aerovox
- C12—1 mf. paper condenser, 400 V. Aerovox
- R1—50,000 ohms, 1/2 watt
- R2—400 ohms, 1 watt
- R3, R4, R8—1 megohm, 1/2 watt
- R5, R6—25,000 ohms, voltage divider
- R7—100,000 ohms, 1 watt
- R9—1,000 ohms—1 watt
- L1, L2, L3, L4, L5 (see coil table)
- RFC1, RFC2—radio frequency chokes, 2 1/2 mh.
- 1 chassis—8"x10"x2"
- 1—7 prong socket (isolantite)
- 1—8 prong socket (isolantite)
- 1—Switch filament
- 1—5 prong socket (isolantite) for coil (R.F.)
- 1—4 prong socket (isolantite) for coil (det.)
- 1—Set tubes (6B7, 6C5)
- Knobs, hardware, wire, dial, etc.

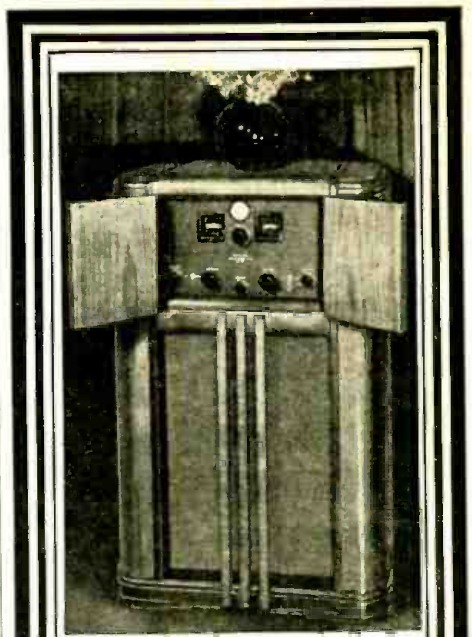

"SUPER-PRO" Console A HIT!

THE new Hammarlund "Super-Pro" professional receiver console model—presenting professional efficiency, stirring acoustical reproduction, and a distinctive console—though announced only a few weeks ago, has already become the talk of the country! The brilliant low and high audio frequencies, characteristic of real high fidelity, are now completely available with this new type console model with its wide range heavy duty 15" speaker, inclosed in a specially developed sealed sound chamber. With this new type sound chamber, the "boominess" or so-called cabinet resonance, is completely eliminated. In addition, the range of the loud speaker is extended approximately an octave.

The receiver itself affords the marked superior efficiency the professional demands for his critical measurement and air patrol work. Among its outstanding features are: 2 stages of R.F. on all bands; fractional micro-volt sensitivity; absolute image rejection on all bands; electrical band spread; exclusive cam operated knife switch (noiseless and trouble-free), models for 7 1/2 to 240, 15 to 560, and 15 to 2000 meters, etc.

For guaranteed superior results install this new Hammarlund "Super-Pro" console model. Mail coupon below for further details!

HAMMARLUND MFG. CO., INC. SWT-12
424-438 W. 33 St., N. Y. City

Please mail me "Super-Pro" console bulletin.

Name _____

Address _____

City _____ State _____



HAMMARLUND

Please mention SHORT WAVE & TELEVISION when writing advertisers

**WHO SAID WE
MODERNS AREN'T
RUGGED!**



WE'VE got polish, sure . . . but it takes more than good looks to *work* for today's modern circuits with precision and micrometer accuracy. Trust **BUD** Variable Condensers! Under that high lustre is the strength of a giant, the stability of the Sphinx.

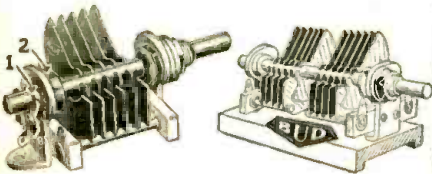

LOOK at those four tie rods holding endplates in place. **FOUR** rods—nickel plated at that! That is what **BUD** means by extreme rigidity of construction. That is the reason why Bud condensers are able to withstand rough treatment, mechanical strain—yes, and downright abuse, without injurious effect or capacity variation.

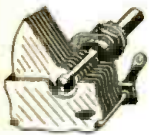

EVEN more than this guarantee of lasting satisfaction, **BUD** condensers sell for less! And for utmost dependability and economy in midsize variable condensers, try **BUD'S** famous brass-isolantite combination!

Want to get acquainted with **BUD'S** versatile line?

Send **TODAY** for **BUD'S** big **FREE** Catalog! Ask for No. **SW-1238!**

BUD RADIO, INC.

5205 CEDAR AVE. CLEVELAND, O.

Ask your **JOBBER**
for the **NEW**

STANCOR

"HAMANUAL"

New Tubes . . . New Circuits

16 NEW TRANSMITTERS
5 WATTS TO 1000 WATTS

STANDARD TRANSFORMER CORPORATION
850 BLACKHAWK STREET, CHICAGO

Europe Points the Way in Television

(Continued from page 409)

programs on 6.9 meters.

"Now here's something we learn about television service areas from this London transmitter. We had assumed right along that on the ultra short waves of television the service range is the *visual* horizon. But the London transmitter is covering a far greater range than that—about a 100 mile radius. On freak occasions the London television programs are being picked up as far away as South Africa—6000 miles! I believe that the sensitivity of the television receiver provides for a greater range than we have been counting on. Also, there is little static interference, although automobile ignition interference is still a problem.

"Another thing to be learned is the practicability of ultra-short-wave links between pick-up source and transmitter. Our London friends have three television pick-up vans or trucks which go out in search of interesting *news* and *sporting events*. Each truck is completely equipped with cathode-ray tube cameras, microphones, amplifiers and low-power transmitters operating on about 3.5 meters. Sight and sound programs are flashed back to Alexandra Palace for rebroadcasting to the audience. We hear a lot about the need for costly *coaxial* cables in order to cover our country by a network of television transmitters. Our British friends indicate what can be done with ultra-short-wave links for a nation-wide network as well as for remote pickup.

No Flicker on English Television Screen

"The British are using a 405-line screen, with 25 pictures per second, interlaced scanning. *There's no flicker discernible!* Nor a screen pattern when viewed at the same relative distance as a theatre screen. By holding one's hand at arm's length, with outstretched palm just masking the screen, we obtain the proper viewing distance for television and movies alike.

"I had the pleasure of following the Wimbledon tennis matches *via television*. The received pictures measured about 10 x 12 inches. The pictorial detail was excellent—fully on a par with *good home movies*. The synchronized sound provides virtually a *radio talking picture*.

"At Kensington Science Museum there are the various makes of British television sets on display. A row of booths provides individual demonstrations. Television programs are received from the Alexandra Palace transmitter, or, in the absence of programs, from a local pick-up and transmitter.

"Home" Television in England Successful

But how about the television sets in homes, we asked Mr. DuMont. It's one thing to have television demonstrations, and quite another to enjoy *home* television.

"There are some fifteen television set manufacturers now operating in Great Britain," replied Mr. DuMont, "of which eight are large and prominent. Something like 10,000 sets have already been sold. The average price for an excellent sight-and-sound receiver is about \$350.00, which is a pile of money for an Englishman. There are cheaper sets, of course, especially those without the dual receiver arrangement for sound as well as sight reception. I fully anticipate British television sets at under \$200.00, just as soon as manufactures tool up and swing into mass production, which they will."

At this point, our host took us to the adjoining room to examine a British television receiver which he had sent over here. A handsome cabinet—not much larger than the usual broadcast receiver. The very rounded end of a huge 12-inch cathode-ray tube is neatly framed by the front panel. The loud-speaker grille is below, together with the many controls. We viewed the smooth screen pattern of black and white

lines. There were no television signals at the moment whereby to test the pictorial qualities, but a glance at the smooth blank screen indicated what might be expected. Mr. DuMont assures us that the results are every bit as good as the usual home movies. And that's plenty good enough.

"Throughout England," Mr. Dumont continued, "one sees television sets on display in radio shops, music stores and department stores. The public is keenly interested—not just a mere look out of sheer curiosity, such as attended the premature television demonstrations in this country some six years ago, but actually the enjoyment of the subject matter. The British public are interested because they are seeing *television programs*, and *not* just experiments.

"And by the way, here's something for your servicemen readers to jot down for future references. One British manufacturer charges the equivalent of \$20.00 for a set installed in the home on a demonstration basis. If the set is purchased, that sum is applied on the payment. If the set is returned, the \$20.00 becomes a rental fee. Thus families wishing to 'wow' their friends with television entertainment have to pay one way or the other. Better jot that down, fellows!

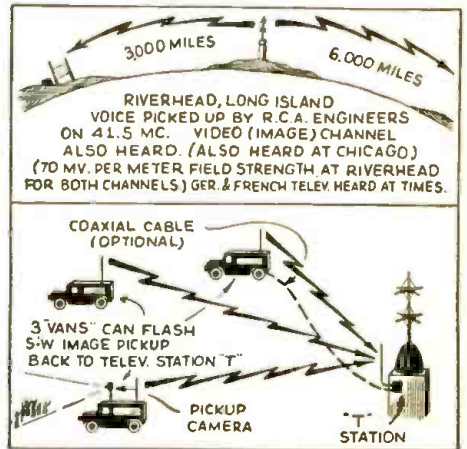

Remarkable television-ranges have been obtained with the B.B.C. Transmitter.

"Television manufacturers are installing and servicing their sets for the present, to insure satisfactory results. Later, of course, they'll turn those functions over to trained servicemen.

French Television

"Going over to France, I found our French friends lagging behind the British, although keyed up to television possibilities. I visited the laboratory of the pioneer worker Barthelmy, outside Paris. There I found a well-equipped laboratory and studio. They will soon have a television transmitter on the lofty Eiffel Tower, for regular television programs. France will probably 'go commercial' on television this fall.

"In Belgium and Holland, television is likewise moving ahead. Those smaller countries follow the lead of Britain and nearby Germany. I saw German television demonstrated at the Paris Exposition. The results were splendid, even though the Germans are using 375 line scanning as compared with the British 405. The Germans plan to go ahead to the American 441-line standard shortly.

What About American Television

So much for what Europeans have and are doing. But what about us? Can television turn that corner and give us everyday television entertainment?

"Well, one guess is as good as another," replied our authority. "I'm sure on this

Please mention **SHORT WAVE & TELEVISION** when writing advertisers

one point; so far as technique goes, we have every bit as much as Europe, and perhaps even more.

"It is for our big radio interests to realize that television cannot be worked to final perfection in the laboratory. It is possible to introduce tried, tested and perfected television sets. Like sound broadcasting, which existed as an experiment for a decade and a half prior to the inauguration of the pioneer Station KDKA in 1920, television must go on the air on a regular schedule basis, with genuine entertainment programs. Television sets will soon be forthcoming after that. The public will buy and support the efforts. The proper kind of programs will be worked out by the trial-and-error method. Servicemen will shortly know how to handle television. The whole structure will be reared out of practical experience.

"Because of the intricacies of television, I don't look forward to the home-made set era which greeted sound broadcasting. Indeed, we have sold several keen radio experts our larger cathode-ray tubes for their television experiments. And thus far I don't know of a single one who has succeeded in obtaining satisfactory pictures. It's quite a stunt to design and build a

satisfactory television receiver. Even if the proper specifications and instructions are provided by experts, the assembly and wiring still admit of failure. In our own studios, we find that the slightest deviation in wiring or components leads to faulty results.

"I believe that television sets will be sold in very large numbers, just as soon as good programs are made available and set manufacturers can swing into volume production on "sight sets." It will give our radio industry a tremendous impetus. Television may be that "shot in the arm" which will spur America to its old-time ambition, throwing overboard the all-to-frequently-heard philosophy that we have too much of everything already.

"It is my sincere hope that our radio leaders, networks, design engineers, set manufacturers, servicemen and others may soon get together for the inauguration of practical television entertainment. We shall then show Europe that we still possess the pioneering instinct to the fullest measure."

To all of which we absolutely agree. Television cannot attain its majority until it disentangles itself from the apron strings of laboratory workers, rolls up its sleeves, and goes to work to make its own living.

Rectifier D. C. Output Read from Graph

(Continued from page 416)

each half cycle. Therefore the smaller the charge and discharge with respect to the total charge of the condenser, the less the fluctuation of pressure or voltage. In other words, the larger the condenser, for a given drain, the less the ripple voltage. Furthermore, if there was no drain, the voltage across the condenser would become equal to the peak a.c. voltage. When there is a drain, the d.c. voltage across the condenser is equal to the peak a.c. voltage minus the average ripple voltage. Consequently, a larger condenser raises the d.c. voltage.

The above can be expressed in a mathematical equation when assuming the discharge to be linear which is the case if a large enough filter choke is used; it is also assumed that the charging period is very short. Under these conditions, the output voltage (d.c.) across the first filter condenser is given by Terman as:

$$E_{dc} = E_{ac} - \pi I X$$

where E_{ac} is the d.c. voltage across the first filter condenser

E_{ac} is the peak of the applied a.c. voltage (each side of center-tap)

X is the reactance of the first filter condenser at the lowest ripple frequency in ohms

I is the load current (d.c.) in amperes

In order to make the equation suitable for the chart it can be modified as follows:

$$E_{dc} = E_{ac} - \pi I \frac{1}{2\pi f C} = E_{ac} - \frac{I}{2fC}$$

$$E_{ac} - E_{dc} = \frac{I}{2fC}$$

where f is the lowest ripple frequency in cycles per second, C is the capacity of the first filter condenser in farads, and the other quantities are the same as in the previous equation. If the load current is to be expressed in milliamperes and the capacity in microfarads, the equation becomes:

$$E_{ac} - E_{dc} = \frac{500I}{fC}$$

This expression gives us the difference between the peak a.c. voltage and the d.c. output voltage. In spite of the required subtraction on the part of the user, this is the most convenient way of making the chart since it permits the use of I and C as the independent variables.

It is interesting to note that $E_{ac} -$

E_{dc} does not depend on the absolute value of E_{ac} . For instance if, for a given drain and condenser size, the d.c. output is 10 volts less than the peak a.c. voltage, it will be so regardless of whether the applied a.c. voltage was 200, 400 or 1000 volts or only 25 volts, as long as the current drain in the load and the condenser capacity remain the same.

Since the assumption was made that the charging period be very short, the chart will become less accurate for cases where the charge takes an appreciable part of the half-cycle. Best results will be obtained when $\frac{X}{R} < 0.25$.

EXAMPLES

A receiver requires a power supply of 300 volts at 100 ma.; the rectifier is of the full wave type connected to a 60 cycle supply. If the input condenser of the filter is 8 mf. what will the required a.c. voltage be? Locate the "100 ma." mark on the load current scale, follow the vertical line upwards until it intersects the oblique line, marked "8 mf." then follow the horizontal line towards the left and find $E_{ac} - E_{dc} = 52$ volts. Then the peak a.c. voltage should be 352 volts and the r.m.s. value is $.71 \times 352 = 250$ volts (each side of center-tap).

Given a transformer with a secondary delivering 350 volts r.m.s. each side of center-tap, what size input condenser is required to obtain a d.c. supply of 480 volts at 5 ma.? 450 volts at 60 ma.?

First determine the peak a.c. voltage which is $1.4 \times 350 = 490$ volts. In order that the d.c. voltage shall be 480, the difference ($E_{ac} - E_{dc}$) must be 10 volts. Turning to the chart, find the intersection of the horizontal line marked "10 volts" with the vertical line marked "5 ma." This intersection is slightly below the 2 mfd. line. By estimation one may find 2.1 mf.

Proceeding in a similar way for the 450 volt supply, we find that the required capacity for a 60 ma. drain is 6.25 mf.

The result obtained in practice will of course be reduced by the voltage drop in the tube and in the transformer secondary. In some cases this is easy to determine: the mercury vapor rectifier, for instance, has a constant voltage drop of about 15 volts.

In case of different frequencies, the chart can be used if all values of C in the chart are divided by the factor $f/120$ where f is the lowest frequency component of the ripple. It can be used both for half-wave and full-wave rectification. —By the Engineering Dept., Aerovox Corporation.

BOB AND MARY FINDAWAY

RADIO! TELEVISION!
THAT'S WHAT JANE'S HUSBAND DOES! THEY'RE GETTING ALONG SWELL!
SURELY BOB CAN DO AS WELL...OR BETTER

LATER

WELL, HONEY, I'LL SOON BE A RADIO EXPERT. THIS FIRST NATIONAL TRAINING IS AS THOROUGH AND PRACTICAL AS GOING AWAY TO SCHOOL

YES, AND LOOK HOW MUCH YOU EARNED WHILE TRAINING

I'VE NEVER WORKED HARDER-NOR EARNED LESS! THINGS'RE TOUGH

OH, BOB, IF YOU COULD ONLY GET IN SOME NEW UNCROWDED FIELD

BOB! LOOK! HERE'S YOUR "POT OF GOLD" YOU CAN QUICKLY TRAIN FOR RADIO-TELEVISION RIGHT HERE AT HOME

S-A-Y! THAT'S SWEET WORK, TOO!

YOU, TOO, CAN NOW GET STARTED RIGHT! TRAIN IN SPARE TIME FOR RADIO-TELEVISION. LEARN OF THE MANY OPPORTUNITIES IN THIS FASCINATING CAREER

SEND FOR "VISION" A FREE BOOK TELLING THE WHOLE STORY

RADIO-TELEVISION PAY YOU BIG

Get in on the ground floor now!

Men with vision who train now for fascinating careers in Radio-Television are destined to become leaders quickly in this fabulous money-making industry.

TRAIN AT HOME! MAKE SPARE TIME PAY YOU RICH REWARDS

Now you can get the same expert training as at resident schools—the advanced knowledge and practical experience available through First National's operation of Radio Station KXBY and Television Station W9XAL—all without leaving your home or casting loose from your present safeguards.

COMPLETE TRAINING LABORATORY SENT YOU —YOURS TO KEEP

All equipment for actual experiments is now furnished you—your final assurance of expert training. Many other progressive new advantages have been instituted for you by First National to make it really possible for you to quickly train for the big paying jobs in Radio-Television. Write me personally today, using coupon below for full facts—FREE

S. Q. Noel
President

First National Television, Inc.
Training Division Dept. 88-12X Kansas City, Mo.

SEND COUPON TODAY! ACT NOW

S. Q. Noel, Pres., First National Television, Inc. Dept. 88-12X, Fidelity Bldg., Kansas City, Mo.

I want to be an outstanding success. Send me your free book "Vision" I am _____ years old.

Name _____

Address _____

Town _____ State _____

Please mention SHORT WAVE & TELEVISION when writing advertisers

can continue with the rest of the alphabet.

Our next message consists of seven points, which are plotted in figure 3. Neither you nor the Martians will have to be told that the *Big Dipper* is meant. The other constellations may be similarly transmitted, for the stars have essentially the same appearance from both planets. Individual stars may be designated and scientific data of all varieties compared with mutual benefit.

Astronomy is not the only science that fits into the Martian picture. The number series 1.008, 4.002, 6.940, 9.02, 10.82, 12.00, etc., for ninety-two consecutive numbers provides a starting point, as the relative atomic weights of the successive chemical elements. The number 1.008 identifies hydrogen (H), 12 carbon (C), 16 oxygen (O), etc. Chemical formulae for compounds, water HOH (H₂O), acetylene HCCH (C₂H₂) can be given, with equations for chemical reactions. The formulae of complex organic compounds might even throw light on the nature of Martian life.

There is no obvious limit to the information that could be exchanged. Most irksome would be the delay between sending off a message and receiving the answer. A radio signal that circles the earth seven times in a second will require at least three minutes and sometimes as long as twenty minutes to reach Mars, according to the position of the planet in its orbit. I am convinced, for the reasons set forth in the foregoing pages, that if radio signals could be exchanged with any planet, intelligent two-way communication would be possible and would lead to valuable advances in many phases of science. It seems too bad that the planets are probably uninhabited.

Editor's note: Professor Menzel (WJEX) who pioneered in short-wave radio as early as 1924, sends the follow-

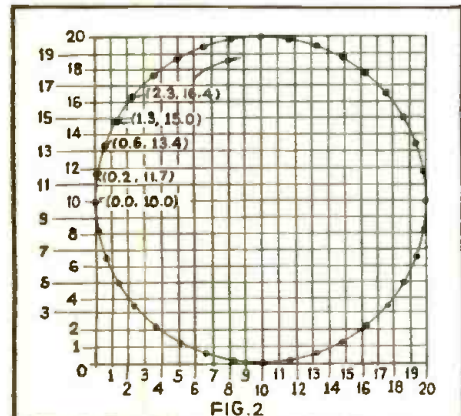

FIG. 2

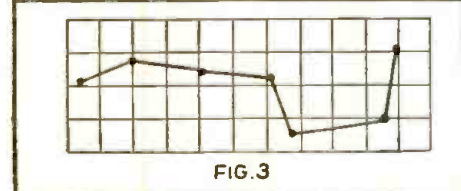

FIG. 3

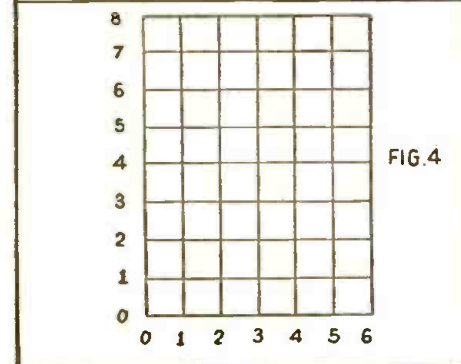

FIG. 4

How "circle" and "dipper" could be transmitted to Mars by Number code. Bottom—puzzle picture—see text.

RADIO INSTRUCTION

LEARN CODE—

and everything necessary to pass your exam with Candler Scientific Code Training

• Code is so easy to learn when you are taught the right way. The famous Candler System always succeeds because it teaches you to read code by sound just as you read print by sight! Your progress will be amazingly rapid. You'll enjoy your easy practice lessons. Candler Training is so marvelously quick and simple, so surprisingly inexpensive—you'll wish you'd started months ago.



• You are sure of getting your license with Candler Training. You'll not only pass your code test with speed to spare, but you'll know your stuff on the technical requirements, too. You acquire code skill PLUS a radio education when you're Candler Trained.

CANDLER SYSTEM CO.

North Carolina, U.S.A.
Asheville, Dept. S-12

CANDLER TRAINED
T. R. McElroy, World's
Champion Radio Operator
teaches Candler System at
Harvard College. Candler
Trained men get places in
radio. Ask any skilled
operator.

Do yourself this favor.
Write for FREE Book of
Facts TODAY!



READ CODE Like an Expert

SEND CODE Like an Expert

Learn Quickly at Home—Get Real SPEED

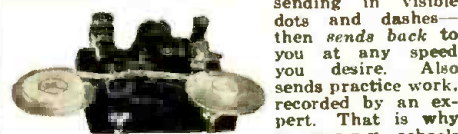

It's easy, fascinating, to become a good op. with the NEW ALL ELECTRIC MASTER TELEPLEX CODE TEACHER to help you. Only instrument ever produced which records your sending in visible dots and dashes—then sends back to you at any speed you desire. Also sends practice work, recorded by an expert. That is why so many schools teaching code prefer Master Teleplex, why thousands agree this method is surest and quickest. We furnish Complete Course, lend you Master Teleplex, give you personal instruction FREE with a MONEY-BACK GUARANTEE. BOOK Low cost. Send today for booklet S12; no obligation.

TELEPLEX CO.
72-76 Cortlandt St. New York City

RADIO ENGINEERING TRI-STATE COLLEGE DEGREE IN 2 YEARS.

Complete Radio Engineering Course in 96 weeks. Bachelor of Science Degree. Radio (television, talking pictures and the vast electronic field) offers unusual opportunities for trained radio engineers. Courses also in Civil, Electrical, Mechanical, Chemical, Aeronautical Engineering; Business Administration and Accounting. Low tuition, low living costs. World famous for technical two-year courses. Those who lack high school may make up work. Students from all parts of the world. Enter September, January, March, June. Write for catalog. 25127 College Ave., Angola, Ind.

RADIO ENGINEERING

RCA Institutes offer an intensive course of high standard embracing all phases of Radio. Practical training with modern equipment at New York and Chicago schools. Also specialized courses and Home Study Courses under "No obligation" plan. Catalog Dept. SW-37.

RCA INSTITUTES, Inc.
A Radio Corporation of America Service
75 Varick St., New York. 1154 Merchandise Mart, Chicago

NOW! the World's Champion Telegrapher Offers You His Radio Key

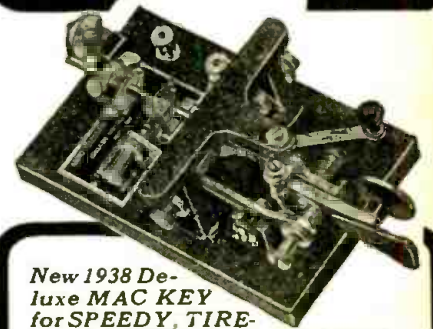

New 1938 De-luxe MAC KEY for SPEEDY, TIRE-LESS RHYTHMIC SENDING

- New dot stabilizer, selected mainspring, heavy Marbrite base "stays put", big silver contacts, large adjustment screws, in every detail the finest ever produced. Worth many times the low net price of \$9.50.
 - Standard model MAC KEY, same as DeLuxo, but with black crackle finish, only \$7.50.
 - MAC STRAIGHT KEY—acclaimed by all the experts. Excellent balance and construction. Heavy base. Now every operator can have one. Only \$1.50 net.
 - MAC OSCILLATOR—1000, 800 or 600 cycle notes with tone control. Amazing value, only \$4.50 net.
 - MAC PRACTICE SET—a practical instrument of commercial caliber. Employs MAC STRAIGHT KEY and MAC HUMMER. Just \$2.95.
 - MAC HUMMER, \$1.50—
 - MAC AUTO, \$69
- Immediate delivery on all MAC items. See your jobber or write for details

T. R. McELROY
175 Congress Street, Boston, Mass.
WORLD'S CHAMPION TELEGRAPHER

See announcement, page 456, about FREE "Barter and Exchange" advertisements.

DON'T KICK AND HOLLER

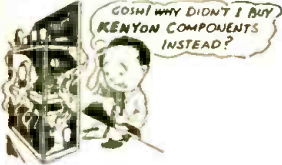

BE WISE—

KENYONIZE

Ask your local jobber to show you the new amateur line of audio and power components. 180 different items ranging from small pre-amplifiers to 1 K.W. audio components.

KENYON TRANSFORMER CO., Inc.

840 Barry St.,

New York, N. Y.



BRINGS YOU ANY ONE OF THESE 4 FAMOUS RADIO BOOKS

RADIO FANS! Help yourselves to a radio education for the price of 10c per book. These books give you a good foundation towards the study of radio. You'll be amazed at the wealth of information contained in them. They are especially written for beginners but are useful review and reference books for all.

Each book contains 32 pages, profusely illustrated with clear, self-explanatory diagrams. They contain over 15,000 words of clear legible type. They are an education in themselves and lay the groundwork for a complete study of radio and electricity.

HOW TO BUILD FOUR DOERLE SHORT WAVE SETS

Due to a special arrangement with the publishers of SHORT WAVE CRAFT, we present in this book complete details for building the Doerle sets, also an excellent power pack if you plan to electrify any of the sets. Contains EVERYTHING that has ever been printed on these famous receivers. These are the famous sets that appeared in SHORT WAVE CRAFT: "A 2-Tube Receiver that Reaches the 12,500 Mile Mark," by Walter C. Doerle. "A 3-Tube 'Signal Gripper,'" by Walter C. Doerle. "The Doerle

HOW TO MAKE THE MOST POPULAR ALL-WAVE 1-AND 2-TUBE RECEIVERS

This book contains a number of excellent 1- and 2-tube sets, some of which have appeared in past issues of RADIO CRAFT. These sets are not toys, but have been carefully engineered. They are not experiments. To mention only a few of the sets the following will give you an idea. The Megadyne 1-Tube Pentode Loudspeaker Set, by Hugo Gernsback—Electrifying The Megadyne—How to Make a 1-Tube Loudspeaker set, by W. P. Chesney—How to Make a Simple 1-Tube All-Wave Electric Set, by F. W. Harris—How To Build A Four-in-Two

ALTERNATING CURRENT FOR BEGINNERS

This book gives the beginner a foothold in electricity and radio. Electric circuits are explained. This includes Ohm's Law, alternating current, sine waves, volts, amperes, watts, condensers, transformers, motors and Generators. A.C. instruments, house-wiring systems, electrical appliances and electric lamps. Here are some of the practical experiments which you can perform. Simple tests for differentiating between A.C. and D.C.; how to light a lamp by induction; making a simple electric horn; demagnetizing a watch; testing motor armatures; charging storage batteries from A.C. outlet; testing condensers with A.C.; making A.C. electromagnets; frying eggs on a cake of ice; making simple A.C. motors and many others. Has 42 illustrations.

ALL ABOUT AERIALS

In simple, understandable language this book explains the theory underlying the various types of aerials; the inverted L, the Doublet, etc. It explains how noise-free reception can be obtained, how low-impedance transmission lines work; why transposed lead-ins are used. It gives in detail the construction of aerials suitable for long-wave broadcast receivers, for

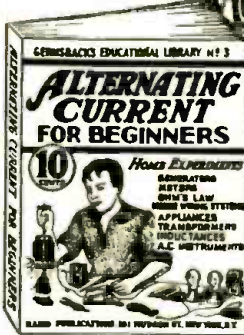
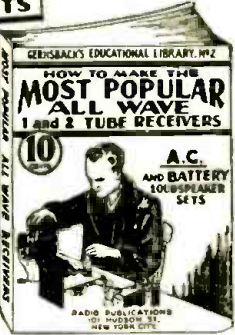
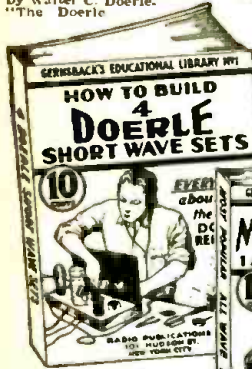

"2-Tuber" Adapted to A. C. Operation. "The Doerle 3-Tube 'Signal Gripper' Electrified" and "The Doerle Goes 'Band-Spread.'" Has 30 illustrations. 10c postpaid

10c postpaid

10c postpaid

short-wave receivers, and for all-wave receivers. The book is written in simple style. Various types of aerials for the amateur transmitting station are explained, so you can understand them. Has 66 illustrations. 10c postpaid

Remember that each book has 32 pages and contains over 15,000 words. Each book has from 30 to 66 fine illustrations. POSITIVELY THE GREATEST 10c VALUE IN RADIO BOOKS EVER OFFERED TO THE PUBLIC.

If you do not think that these books are worth the money asked for them, return them within 24 hours and your money will be instantly refunded.

Send for our FREE circular listing 48 new 10c Publications

RADIO PUBLICATIONS 101 Hudson St., New York, N. Y.

RADIO PUBLICATIONS SWT-1237
 101 Hudson Street, New York, N. Y.
 Please send immediately POSTPAID the books checked:

No. 1—How to Build 4 Doerle Short Wave Sets.....10c
 No. 2—How to Make the Most Popular All-Wave 1- and 2-Tube Receivers.....10c
 No. 3—Alternating Current for Beginners.....10c
 No. 4—All About Aerials.....10c

I am enclosing.....c; the price of each book is 10c

Send me FREE circular listing 48 new 10c publications

Name.....
 Address.....
 City..... State.....
 (U. S. Coin or U. S. Stamps acceptable.) Books are sent postpaid.

ing code message, which he received the other evening on five meters. "If this message came from Mars," he states, "it undoubtedly represents a picture of a Martian." The decipherment is left to the reader, who may chart the points on the cross-section diagram of Figure 4.

(0.80.5.60)	(0.87.5.70)	(1.00.5.80)	(1.40.5.80)	(1.38.6.00)
(1.40.6.40)	(1.58.6.68)	(1.90.6.85)	(1.80.7.23)	(2.00.7.60)
(2.50.7.70)	(2.82.7.50)	(2.97.7.00)	(2.87.6.68)	(2.92.6.57)
(3.30.6.70)	(3.82.6.50)	(3.90.6.00)	(3.50.5.65)	(3.00.5.80)
(2.85.5.45)	(2.60.5.30)	(2.92.5.00)	(3.18.4.50)	(3.32.4.00)
(3.60.3.50)	(3.70.3.30)	(4.00.3.40)	(4.50.3.57)	(5.00.3.68)
(5.50.3.68)	(6.60.3.42)	(6.10.3.00)	(6.00.3.32)	(5.50.3.58)
(5.90.3.38)	(4.50.3.47)	(4.00.3.30)	(3.70.3.20)	(3.70.3.30)
(3.80.2.62)	(3.58.2.50)	(3.60.2.90)	(3.70.1.50)	(3.80.1.00)
(3.72.0.57)	(3.50.0.53)	(3.00.0.40)	(3.70.0.60)	(3.00.1.10)
(3.42.1.02)	(3.35.1.50)	(3.32.2.00)	(3.30.2.40)	(3.02.2.37)
(3.00.2.55)	(2.60.2.60)	(2.50.2.30)	(2.30.2.30)	(2.15.2.00)
(2.10.1.50)	(2.10.1.10)	(2.10.0.68)	(1.50.0.40)	(1.00.0.60)
(0.80.1.00)	(1.00.1.35)	(1.50.1.30)	(1.70.1.05)	(1.70.1.50)
(1.80.2.00)	(1.95.2.37)	(1.70.2.50)	(1.78.3.00)	(1.87.3.50)
(1.90.3.00)	(1.50.3.80)	(1.00.3.53)	(0.83.3.50)	(0.70.3.60)
(0.50.3.65)	(0.82.3.82)	(0.48.3.92)	(0.82.4.10)	(0.76.4.18)
(1.00.4.26)	(1.28.4.20)	(1.40.4.08)	(1.92.4.32)	(2.05.4.62)
(2.20.4.87)	(2.18.5.27)	(1.76.5.12)	(1.81.5.25)	(1.50.5.13)
(1.00.5.30)	(0.92.5.50)			

AS one of the accompanying pictures shows, a very powerful short-wave transmitter, or else a group of transmitters would be required to transmit a worth-while signal to Mars.

The antenna, as suggested by one of the experts of the A. T. & T. Company's Engineering Department, might take the form of a series of di-poles, arranged in a group at different elevations, so as to project a powerful concentrated wave from the earth, the time at which signals are transmitted being selected so that the antenna pointed toward Mars.

Another form of antenna suggested might be in the form of a metal tube, on the interior of which a large number of small di-poles and reflectors would be arranged to radiate a highly-concentrated ultra short-wave signal toward a distant planet. The wavelength finally chosen for this experiment may run as low as one centimeter. (0.4 inch).

Calculation has shown that, allowing for a reasonable amount of absorption in the atmospheres of both the earth and the distant planet, a power of about 50,000 kw., in round numbers, would be necessary in order to establish a readable signal.

Communicating with Mars—A Few Technical Considerations

By Joseph L. Richey
Member Information Dept., American Telephone and Telegraph Company

TO communicate with intelligent beings on the planet Mars is a most romantic idea and one upon which much speculation has been made throughout the years. Assume that there are intelligent beings on Mars, what difficulties would normally present themselves? It is not from the anthropological language and philosophical point of view that consideration is given herein, but from a quantitative and engineering aspect.

There are four major factors to take into account.

First, the only known means by which communication may be physically accomplished is through the instrumentality of something akin to electro-magnetic waves, i.e., light or radio waves. We know that light waves can travel from Mars to the earth in the form of reflected sunlight. Hence by the reciprocity theorem they should be able to travel from the Earth to Mars by the same means. If large quantities of light could be readily controlled, it would present possibilities as a carrier. Radio doesn't look quite so promising.

Second, because of the great distance Mars is away from the Earth, it is expected that large amounts of energy will have to be expended to permit a recognizable signal to be picked up.

Third, both Mars and the Earth rotate around the sun with different speeds. The Earth completes a rotation in 365 1/4 days

and Mars in 687 of our days. Hence it is expected that the distance between the Earth and Mars will change, and will depend upon their position in their orbits. The Earth's distance from the Sun is approximately 93,000,000 miles, and that of Mars is about 142,000,000 miles. The closest distance the Earth and Mars may approach each other is about 34,600,000 miles, and their greatest distance apart is when they are on opposite sides of the sun or 235,000,000 miles.

Fourth, there are absorbing media in both the atmosphere of the Earth and Mars, through which the signaling energy must pass. Based on terrestrial experience, this absorption may be expected to change with the frequency of the electro-magnetic radiation. The ionosphere absorbs and reflects radio waves—reflection becomes a greater factor as the wave-length is made longer. On less than 10 meters the penetration of the ionosphere becomes an easier task. Water vapor and carbon dioxide, present in the troposphere and stratosphere, will absorb considerable of infra-red radiation. The molecular particles of the atmospheric gases absorb considerable of the longer than infra-red radiation (green-house effect). The visible spectrum of light penetrates the earth's atmosphere with about 50% reflection, scattering and absorption. Ultra-violet light will be absorbed to a large extent by the ozonosphere. Shorter wave-lengths than ultra-violet light will ionize the atmospheric gases and its energy will be expended to a large degree in that way. So the best wave-lengths, so far as can be conjectured, lies between the region near 10 meters and the much longer than sub-infra-red radiation, and also of course the visible spectrum.

Having put down these factors, let's explore the radio idea. Assume the ideal frequency is located, one whose losses through the atmosphere of the Earth and Mars and interplanetary space is accomplished without absorption and the only important propagation factor is that of the energy spreading out into space.

Power Required With Half-Wave Radiator

Start with a half-wave radiator, with its best directivity toward Mars. According to Dr. G. C. Southworth of the Bell Telephone Laboratories, the electric field picked up at a distance *d* from a radio transmitter using a half-wave radiator is $e = 851/d$, where *e* is the electric field intensity in volts per meter, and *I* is the current in the center of the antenna. Expressed in microvolts per meter:

$$e = 8.5 \times 10^7 I/d$$

Consider the condition when Mars is closest to the Earth or 34,600,000 miles or 5.54×10^{10} meters,

$$e = 8.5 \times 10^7 I / 5.54 \times 10^{10} = 1.53 \times 10^{-3} I$$

Experience has indicated that a field intensity of 5 microvolts per meter is usually the commercial limit to which a telegraph signal may fall for reliable communication with present facilities. This assumes a quiet receiver location—free from man-made electrical disturbances, a very high-grade selective receiver, and an array of receiving antennas giving a gain of about 15db over a half-wave antenna.

Let's assume a desired minimum field of 5 microvolts per meter.

$$I = 5 / 1.53 \times 10^{-3} = 3.27 \times 10^3 \text{ amperes.}$$

A half-wave antenna has a radiation resistance of 73.2 ohms; the power radiated will be:

$$P = I^2 R = (3.27 \times 10^3)^2 \times 73.2 = 780 \times 10^6 \text{ watts} = 780 \times 10^3 \text{ kilowatts or } 780,000 \text{ kilowatts.}$$

Special Antenna Reduces Power Required

Now assume that we have an array of transmitting antennas available whose directivity and efficiency are 30 db better than a half-wave radiator; this means that we shall require 1/1000 of the power used by a half-wave radiator to produce the same field intensity at the receiver, or a radiated power of 780 kilowatts. Assume the source has an efficiency of 60%; the total input power required will be about 1,300 kilowatts.

As stated earlier the present commercially-used long waves and short waves are reflected back to the earth by the ionosphere, the usable wave-length must lie in the ultra-short, or hyper-short wave lengths, the propagation properties of which are somewhat like that of light waves.

In the present state of the art, powers in the order of 1,300 kilowatts for ultra-short or hyper-short wave lengths is quite beyond the pale of practicability.

For the sake of being liberal, assume we could get an amount of power somewhere in this neighborhood, what would be the power requirements at Mars' greatest distance of 235,000,000 miles? (235,000,000 miles = 3.76×10^{11} meters)

$$e = 8.5 \times 10^7 I / 3.76 \times 10^{11} = 2.23 \times 10^{-4} I$$

For a field intensity of 5 microvolts per meter at the receiver

$$I = 5 / 2.23 \times 10^{-4} = 2.24 \times 10^4 \text{ amperes (approximately).}$$

With a radiation resistance of 73.2 ohms for the half-wave radiator, the power transmitted into space would be:

$$P = I^2 R = (2.24 \times 10^4)^2 \times 73.2 = 364 \times 10^9 \text{ watts or } 364 \times 10^6 \text{ kw.} = 36,400,000 \text{ kilowatts.}$$

Again assume a transmitting radiator array with a gain of 30 db over a half-wave radiator, or a power requirement of 1/1000 of that of a half-wave radiator, or 36,400 kilowatts. Again assume an efficiency in the transmitting equipment of 60%, the power requirements would be 60,660 kilowatts.

This is approximately 46.6 times as much power as required for the closest distance. In fact, the power required varies as the square of the distance.

It certainly does look like too big a job for the present state of the radio art. So we shall have to pass up the idea of communicating with Mars with radio instrumentalities, until something new develops, that will make radiation and power requirements a much easier proposition to realize.

It may be of interest to mention that for radio-telephony the power requirements would be about four times greater, since the minimum field requirements are about 10 microvolts per meter.

Speed of Transmission

Another factor to consider is the speed of transmission. At Mars' closest distance of 34,600,000 miles, and with radio waves traveling at a speed of 186,000 miles a second, it would take a trifle over three minutes for a signal to reach Mars, and a similar time to get back. At the farthest distance of 235,000,000 miles, it would take about 21 minutes to go each way. In the hustle and bustle of our economic existence this would be too slow for radio telephony, and would offer a difficult situation for radio telegraphy.

In the quantitative treatment above, absorption was not considered. Bringing it into the picture may make the power requirements many fold greater. Meteorological considerations of the absorption of light and infra-red rays, and our radio experiences of ionospheric absorption lead us to suspect that it will be quite appreciable.

Moreover the transmission conditions will change as a result of solar activity. During sunspot maximum the condition may require about 20 db stronger fields to permit communication as compared to the sunspot minimum.

The sun spreads energy over areas at our distance from it to the extent of 1.351 kw. per square meter. Since this energy is in electromagnetic form, it corresponds to an electric field strength of 714 volts (714 million microvolts) per meter. One-half of this is returned to space by scattering and reflection; one-twelfth is absorbed by the atmospheric gases, leaving five-twelfths available at the earth's surface. So about 0.56 kw. per square meter (460 million microvolts per meter) is available at the earth's surface, perpendicular to the sun. Allowance for curvature will have to be made for other places. A square 10 kilometers on each side would collect 56,000,000

Increase Transmitter Efficiency

with New



ILLUMINATED THERMO-AMMETERS

Model 446 with Front Illumination

NEW FOUR INCH SQUARE modernistic instrument featuring extra long scale. Available also in ammeters, milliammeters, microammeters, voltmeters, millivoltmeters, etc., A.C. and D.C.

TO ANTENNA

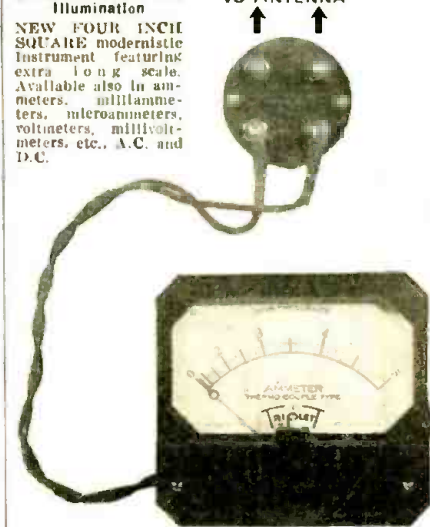

PRICES GREATLY REDUCED

All amateurs know that the sure way to get the most out of your rig is to install a Thermo Ammeter in your antennae circuit. Now you can get a Thermo Ammeter with front illumination. Illumination attachment is extra. Does not affect meter, and light bulb can be easily replaced. Perfect distribution of light.

Triplet Thermo Ammeters are sturdily built to carry high overloads, and to give long life. The thermo couples are external to the meter and connected to it by 2 ft. leads. The thermo couple can be located where convenient while the ammeter is placed on the panel.

All Thermo Couples are designed to work on any size Triplet Thermo Ammeters.

2" Model No. 241 complete with Thermo Couple, not illuminated..... \$5.83

4" Model No. 446 as illustrated with thermo couple, not illuminated..... 7.83

Thermo Couple for all sizes, each..... \$2.67

Thermo Ammeters are available in the following ranges: 0-.5, 0-1, 0-1.5, 0-2.5, 0-5.



The Triplet Electrical Instrument Co., 2812 Harmon Ave., Bluffton, Ohio

Please send me more information on Model 426:

I am also interested in.....

Name.....

Address.....

City..... State.....

Please mention SHORT WAVE & TELEVISION when writing advertisers

AMERICA'S MOST POPULAR RADIO BOOKS

We herewith present a selected collection of recent important radio books. We have selected these volumes because they represent the foremost radio books of their kind in print today. We publish no catalog. Order direct from this page. Prompt shipments will be made to you. Remit by money order or certified check. Register all letters containing cash.

- RADIO ENGINEERING HANDBOOK.** 850 pages, latest \$4.90
- PRACTICAL TELEVISION.** 223 pages. 127 illus. \$3.69
- ELEMENTS OF RADIO COMMUNICATION** 286 pages, 241 illus. \$2.98
- RADIO PHYSICS COURSE.** 992 pages, 510 illus. \$4.00
- THE RADIO AMATEUR'S HANDBOOK,** 448 pages, 126 illus. \$1.97
- MODERN RADIO ESSENTIALS.** over 200 pages, and over 1000 illus. \$1.95
- FOUNDATIONS OF RADIO.** 246 pages, 145 illus. \$2.47
- PHOTOCELLS AND THEIR APPLICATION.** 332 pages, 180 illus. \$2.88
- ELECTRONICS,** 134 pages, 45 illus. \$1.95
- SHORT WAVE RADIO HANDBOOK.** 128 pages, 150 illus. \$1.00
- PRINCIPLES OF RADIO,** 478 pages, 306 illus. \$3.46
- EXPERIMENTAL RADIO,** 256 pages, 168 illus. Prepaid. \$2.69
- MODERN RADIO SERVICING** 1300 pages, over 700 illus. \$4.00
- FIELD SERVICE DATA AND ANSWER BOOK** \$2.50
- 436 pages \$6.00
- Both Books
- DRAKE'S CYCLOPEDIA OF RADIO AND ELECTRONICS,** 1050 pages, 1178 illus. \$4.88

- FUNDAMENTALS OF RADIO** 426 pages, illustrated. Prepaid. \$3.46
- ELECTRICITY AT HIGH PRESSURES AND FREQUENCIES.** 248 pages, 141 illus. Prepaid. \$1.89
- RADIO CONSTRUCTION AND REPAIRING,** 444 pages, illustrated. \$2.50
- THEORY OF VACUUM TUBE CIRCUITS.** 226 pages, 226 illus. \$3.00
- PRINCIPLES OF RADIO COMMUNICATION.** 988 pages, profusely illus. \$7.35
- RADIO ENGINEERING.** 813 pages, 475 illus. \$5.50
- EXPERIMENTAL RADIO ENGINEERING,** 346 pages, 250 illus. \$3.46
- RADIO OPERATING QUESTIONS AND ANSWERS.** 427 pages, 106 illus. \$2.50
- OFFICIAL RADIO SERVICE HANDBOOK,** over 1,000 pages, over 1,000 illus. Prepaid. \$3.92
- OFFICIAL SHORT-WAVE RADIO MANUAL.** 240 pages, many illustrations. Vol. 1 (1934) Prepaid. \$2.00
- Vol. 2 (1935) Prepaid. \$2.50
- OFFICIAL RADIO SERVICE MANUAL, Volume 4.** 2,000 illus., over 400 pages. Prepaid. \$3.43
- OFFICIAL RADIO SERVICE MANUAL, Volume 5,** over 3,000 illus., over 1,000 pages. Prepaid. \$6.86
- OFFICIAL RADIO SERVICE MANUAL, Volume 6,** over 1,200 pages, over 2,500 illus. Prepaid. \$6.86

15 HANDY—POCKET-SIZE RADIO BOOKS

Here are 15 up-to-date books on radio and air conditioning. Modern in every sense. ALL BOOKS UNIFORM—they contain 64 pages; 50 to 120 illustrations. All books written by well-known authors. Order by Number.

2. MODERN VACUUM TUBES
3. THE SUPERHETERODYNE BOOK
5. HOW TO BECOME A SERVICE MAN
6. BRINGING ELECTRIC SETS UP TO DATE
8. RADIO QUESTIONS AND ANSWERS
9. AUTOMOBILE RADIO AND SERVICING
10. HOME RECORDING AND ALL ABOUT IT
12. PUBLIC ADDRESS INSTALLATION AND SERVICE
13. ABC OF AIR CONDITIONING
14. POCKET RADIO GUIDE
15. ABC OF REFRIGERATION
16. PRACTICAL RADIO CIRCUITS
17. SERVICING WITH SET ANALYZERS
18. POINT-TO-POINT RESISTANCE ANALYSIS
19. PRACTICAL RADIO KINKS AND SHORT CUTS

PRICE PREPAID EACH BOOK 50c

HOW TO ORDER

No. C.O.D. orders. Our prices are not, as shown. Some of the books sent prepaid (in U.S. only). Those that are not thus listed are shipped collect. If sufficient postage is not sent, add 7% of price for postage.

RADIO PUBLICATIONS, 97 HUDSON ST., NEW YORK, N. Y.

NEWER than NEW!

NEW IDEAS
for EVERYBODY
A Goldmine of Information
\$5.00 IN PRIZES FOR YOUR IDEAS
See Page 24
This Issue Features -
17 New Ideas for Making Money
35 New Ideas on Health
12 New Ideas on Safety
72 New Ideas for Your Home
8 New Ideas for Careers
51 New Ideas for Your Business
12 New Ideas for Girls
28 New Ideas for Women
21 New Ideas for Boys
43 New Ideas for Men
48 New Ideas of All Sorts
26 New Ideas of Yesterday
373 NEW IDEAS
This Magazine is Scented
Editorial & General Office: 99 HUDSON ST., NEW YORK, N. Y. \$3 A YEAR

At last a new magazine that really is N-E-W! Not only new but revolutionarily NEW! NEW IDEAS is a revelation in magazines—A GOLD MINE OF INFORMATION. Adjectives are no longer sufficient to describe its revolutionary ideas. Just to name a few:

The magazine that can't get dog-eared because it has rounded corners.

The magazine is scented. A brand new idea in magazine publishing. It gives off a most pleasant odor, pleasing to man and woman alike. As for its contents, it is literally worth its weight in gold.

NEW IDEAS supplies a want that has not been satisfactorily filled by any other magazine before.

A veritable mine of information, where a single copy may be the one that will start YOU on the road to success. All ideas are eminently practical and all are NEW.

Over 300 new ideas are put into a single issue every month. Ideas by which everyone may benefit and profit. It is ideas that make the world go 'round and, particularly, new ideas that shape our destinies.

NEW IDEAS has many departments among which are the following N E W IDEAS:

- New Ideas How to Make Money
- New Ideas for the Working Man
- New Ideas for the Working Girl
- New Ideas How to Succeed
- New Ideas in Careers
- New Ideas in Spare-Time—Money Making
- New Ideas for Your Home
- New Ideas for Your Business
- New Ideas for Boys
- New Ideas for Girls
- New Ideas for Your Health

The magazine will be on sale the 25th of the month, and as the magazine is widely advertised, we suggest that you place your order with your news-dealer now. If the news-dealers cannot supply, you, send 25c to

NEW IDEAS, 99-A Hudson Street, New York City

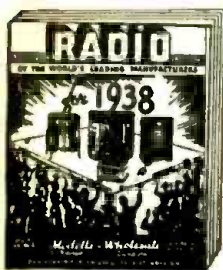

FREE!! New 1938 Radio Catalog

SERVICEMEN—Radio Salesmen and Agents— become a MODELL representative in your community without any investment. Earn up to \$100 a week in commissions selling Nationally Known Radios. Take orders from the largest and most complete catalog ever published, describing and illustrating the following 1938 makes: RCA—Philco—General Electric—Zenith—Motorola—Delco—Grunow—Crosley—Stromberg-Carlson—Kadette—Emerson. Join our nationwide organization. Territory is now being allotted to live wire men who are anxious to earn extra money in their spare time. Write for this big catalog and selling proposition today. No experience necessary.

CHICAGO, ILL. ATLANTA, GA. NEW YORK, N. Y.
56 W. Washington St. 57 Forsyth St. 58 Cortlandt St.

Modell's Since 1889
AGENCY DIVISION, Dept. L-2

Please mention SHORT WAVE & TELEVISION when writing advertisers

kilowatts. If this energy could be readily collected, controlled and converted, it may offer probabilities for an interplanetary communication channel, provided there is someone to communicate with.

Cloudless areas would have to be selected and a series of such places distributed around the equatorial belt to maintain a relay chain for a continuous coverage, during the time when Mars is on our side of the sun. If Mars had a similar setup, it may be found that when it is beyond the sun the receiving conditions would become more difficult, not only because of increasing distance, but because of a closer position in the sky to the sun, would make observation more difficult.

So, summed up, communication with Mars is too difficult for us to consider with radio instrumentalities, and economically and technically not feasible with present-day equipment.

New Spacing Insulators for Antennas

(Continued from page 422)

been widely copied, even to the use of a socket-sized disk.

However, to get back to the Q-bar. The particular dimensions which we chose were designed to match 72 ohms to 600 ohms, or in other words they matched a centered half-wave antenna to a feeder using No. 12 B. & S. gauge wire and 6-inch spreaders (such as National AA-3 spreaders).

Once a system of fixed dimensions is decided on, it becomes very easy to build a rugged assembly. Stiff, thin-walled, seamless duralumin tubing is now available.

The spacers become the simple isolantite blocks pictured here. They are simply slipped over the duralumin tube to the position desired. To hold them in place, a small hole is drilled through the tubing opposite the small hole in the isolantite block and a screw holds both together.

This article has been prepared from data supplied by courtesy of the National Company.

New 3-in-1 Short-Wave Receiver

casting and long waves through the use of plug-in coils, but due to its extreme simplicity, it can be built for a very nominal sum.

This set can be used with several different types of two-volt tubes, such as the 30 or 31, or with a number of different types of five-volt tubes such as the UX-200, the UX-200-A, the UX-201-A, etc. When used with the two-volt type tube, it can be operated on a single flashlight cell as an "A" battery and a 22½ volt dry cell as the "B" battery. If the five-volt type tube is used, a storage battery may be substituted for the flashlight cell, or the set may be operated directly from a 32-volt farm lighting plant without any batteries.

H. G. Cisin, is the designer of the new set. As shown in the illustration, the parts are assembled on a black sloping panel 8½" by 11". The two knobs shown at the center of the panel are for the filament voltage control and the regeneration control respectively. At the upper left is the antenna trimmer with plug-in coil alongside.

Instructions are available showing how to add an extra tube, mounting this on the same panel, so as to permit full loud-speaker operation on all stations.

A full-size guide or template is provided which fits on the underside of the panel. This shows exactly where to mount the various parts and heavy black lines show where to connect the various wires.

The complete set consists of the black mounting panel, two calibrated dials, the regeneration control-potentiometer, metal tube variable condenser, filament rheostat, grid condenser and grid leak, hook-up wire, two knobs, antenna trimmer, mica by-pass condenser, seven connection clips, coil and tube sockets, detailed instructions, picture wiring diagram and a plug-in coil which brings in not only broadcasting, but also police calls, amateurs and other interesting short wave programs. Auxiliary parts include three foreign coils, long wave coil, batteries, etc.

This article has been prepared from data supplied by courtesy of Allied Engineering Institute.

World Short-Wave Stations

(Continued from page 434)

↑ S.W. BROADCAST BAND ↓

5.970	HJ4ABD	MEDELLIN, COL., 50.26 m., Addr. La Voz Catia. 8-11.30 pm.	5.790	JVU	NAZAKI, JAPAN, 51.81 m. Irregular.
5.968	HVJ	VATICAN CITY, 50.27 m. 2-2.15 pm. daily; Sun. 5-5.30 am.	5.780	OAX4D	LIMA, PERU, 51.9 m., Addr. P. O. Box 853. Mon., Wed. and Sat. 9-11.30 pm.
6.950	HJN	BOGOTA, COL., Radiodifusora Nacional. 50.42 m. 6-11 pm.	5.770	YV2RA	SAN CRISTOBAL, VENEZUELA, 51.96 m., Addr. La Voz de Tachira. 11.30 am.-12 n., 5.30-9 pm., Sun. till 10 pm.
6.940	TG2X	GUATEMALA CITY, GUAT., 50.5 m. 4-6, 9-11 pm.; Sun. 2-5 am.	5.758	YNOP	MANAGUA, NICARAGUA, 52.11 m. 8-9.30 pm.
6.930	YV1RL	MARACAIBO, VEN., 50.59 m., Addr. Radio Popular, Jose A. Higuera M., P. O. Box 247. Daily 11.43 am.-1.43 pm., 5.13-10.13 pm.; Sun. 9.13 am.-3.13 pm.	5.740	TGS	GUATEMALA CITY, GUAT., 52.26 m. Wed., Thur. and Sun. 6-9 pm.
6.925	HM2S	PORT-AU-PRINCE, HAYTI, 50.63 m., Addr. P. O. Box A103. 7-9.45 pm.	5.730	HC1PM	QUITO, ECUADOR, 52.36 m. Irregular 10 pm.-12 m.
6.917	YV4RP	VALENCIA, VEN., 50.71 m. Irregular.	5.720	YV2RB	SAN CRISTOBAL, VEN., 52.45 m., Addr. La Voz de Tachira. 6-11.30 pm.
5.900	ZNB	MAFEKING, BRI. BECHUANALAND S. AFRICA, 50.84 m., Addr. The Govt. Engineer, P. O. Box 106., 1-2.30 pm. Irregularly from 1-2 am.	5.500	T15HH	SAN RAMON, COSTA RICA, 54.55 m. Irregular 3.30-4, 8-11.30 pm.
6.900	TJMS	PUNTA RENAS, COSTA RICA, 50.85 m. 6-10 pm.	6.145	PMY	BANDOENG, JAVA, 58.31 m. 5.30-11 am.
6.898	YV3RA	BARQUISIMETO, VEN., 50.86 m., Addr. La Voz de Lara, 12 m.-1 pm., 6-10 pm.	5.077	WCN	LAWRENCEVILLE, N. J., 59.7 m. Addr. A. T. & T. Co. Works England late at night irregularly.
6.890	JIC	TAIHOKU, FORMOSA, 50.93 m. Works Tokio 6-9 am.	5.025	ZFA	HAMILTON, BERMUDA, 59.7 m. Works N. Y. C. irregularly at night.
5.885	HCK	QUITO, ECUADOR, 50.98 m. 8-11 pm.	5.000	TFL	REYKJAVIK, ICELAND, 60 m. Works Europe nighttime irregularly.
5.875	HRN	TEGUCIGALPA, HONDURAS, 51.06 m. 1.15-2.16, 8.30-10 pm.; Sun. 3.30-5.30, 8.30-9.30 pm.	4.975	GBC	RUGBY, ENG., 60.3 m. Works ships irregularly.
5.855	H11J	SAN PEDRO DE MACORIS, D. R., 51.25 m., Addr. Box 204. 12 m.-2 pm., 6.30-9 pm.	4.836	HJ3ABD	BOGOTA, COL., 62 m., Addr. La Nueva Granada, Box 509. 12 m.-2 pm., 7-11 pm., Sun. 5-9 pm.
6.853	WOB	LAWRENCEVILLE, N. J., 51.26 m., Addr. A. T. & T. Co. Works Bermuda nights.	4.820	GDW	RUGBY, ENG., 62.24 m. Works N.Y.C. nighttime irregularly.
6.850	YV1RB	MARACAIBO, VEN., 51.28 m., Addr. Apartado 214. 8.45-9.45 am., 11.15 am.-12.15 pm., 4.45-9.45 pm.; Sun. 11.45 am.-12.45 pm.	4.810	HJ2ABC	CUCUTA, COL., 62.34 m. La Voz de Cucuta, 8 pm. to 12 m.
6.830	TDD	SHINKYO, MANCHUKUO, 51.46 m. Works Tokio 6-9 am.	4.807	HJ1ABB	BARRANQUILLA, COL., 62.39 m., La Voz de Barranquilla, Addr. P. O. Box 715. 11.30 am. to 1 pm., 4.30-6 pm.
6.830	T10PH	SAN JOSE, COSTA RICA, 51.5 m., Addr. Alma Tica, Apartado 800. 11 am.-1 pm., 6-10 pm. Relays TIX 9-10 pm.	4.790	VE9BK	VANCOUVER, B. C., CAN., 62.63 m. Addr. Radio Sales Service, Ltd., 780 Beatty St. Except Sun. 11.30-11.45 am., 3-3.15, 8-8.15 pm.
6.813	T12H	SAN JOSE, COSTA RICA, 51.59 m., Addr. Senor Gonzalo Pinto, H.	4.762	WOO	OCEAN GATE, N. J., 63.1 m., Addr. A. T. & T. Co. Works ships irregularly.
6.800	YV5RC	CARACAS, VEN., 51.72 m., Addr. Radio Caracas. Sun. 8.30 am.-10.30 pm. Daily 7-8 am., 10.30 am.-1.45 pm., 3-4.5-10.30 pm.	4.600	HC2ET	QUAYAQUIL, ECUADOR, 65.22 m., Addr. Apartado 249. Wed. and Sat. 9.15-11 pm.
			4.272	WOO	OCEAN GATE, N. J., 70.22 m., Addr. A. T. & T. Co. Works ships irregularly.
			4.250	RV15	KHABAROVSK SIBERIA, U. S. S. R., 70.42 m. 1-10 am.

Which Cover Do You Like Best?

● HERE is your chance to be the referee in our monthly battle, choosing the type of cover we think the readers prefer. We have found a considerable difference in opinions and have decided to put the problem up to you readers. Here are the styles we usually follow, and from which you may choose the one you like best.

1—We generally follow one of two main themes for our front cover illustration. The first type is the popular cover, showing the latest television or short-wave invention in actual use, etc.

2—The second type of cover is the one

which has been used at times in the past, and shows a new set the construction of which is described in that particular number.

We are very desirous of knowing which style of cover you prefer. If you have any other ideas on the matter, they will be greatly appreciated. Please express your ideas in about 150 words or less and send them along. Now "Hams" and "Fans," do your duty and vote in the box below. Paste on a postcard and mail.

I Prefer Cover Design	
_____	Popular Inventions
_____	Picture of Set
Name _____	Check
Address _____	↓
	HAM _____
	FAN _____

Please mention SHORT WAVE & TELEVISION when writing advertisers

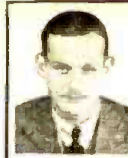

Mr. Raymond P. Adams, well known West Coast radio engineer and designer.

The Designer of the
ORTHOTECH
All-Wave Set Says:
"None but the best for Me"

Hollywood, California
August 24, 1937

JEFFERSON ELECTRIC COMPANY,
Bellwood, Illinois.

Gentlemen:

In my particular line of activity - the design, development, and description of special radio and communications equipment using standard parts - I find it unquestionably imperative to depend upon none but the very best audio and power components.

Over a period of some years in this work, it has been my privilege to become intimately familiar with JEFFERSON transformers and chokes, to employ various JEFFERSON items in the development of better class designs, and to recommend and specify these parts to friends and to readers of my articles and I think it high time that I compliment you on the unusually high quality and efficiency of the line as a whole.

Their very moderate cost notwithstanding, your components are in my estimation among the best in the field. They are durably and ruggedly constructed, cleanly and attractively finished, built to withstand such usage and abuse and to hold ratings in extended and adverse service, and remain certainly consistent in these ratings, unit for unit - implying practice of using ample material in the construction of even the least costly of these items - and your policy of rebate value of input filter capacity. The line is complete, and, if I am any judge, should appeal as such to the critically-minded amateur as to the professional engineer and technician.

Very truly yours,
Raymond P. Adams
RAYMOND P. ADAMS



No. 467-451—Transformer for Class B Driver

Jefferson transformers are all liberally proportioned and combine all the experience, skill and knowledge of transformer engineering gained through the manufacture

of transformers since radio's inception.

The characteristic of each type is accurately set up and proved in laboratory and field operation.

To insure the greatest satisfaction—be sure to insist on "Jefferson". Your Parts Jobber can supply you or get any particular type you require. . . . Send the attached coupon for free complete catalog and set of new amplifier circuit diagrams.

JEFFERSON ELECTRIC COMPANY
BELLWOOD, ILLINOIS
Canadian Factory:
535 College St., Toronto, Ont.

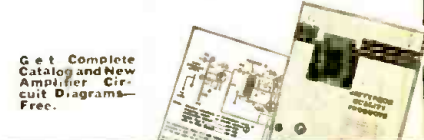

JEFFERSON RADIO TRANSFORMERS

JEFFERSON ELECTRIC COMPANY,
BELLWOOD, ILL.

Mail latest catalog 372-R and your free manual of new amplifier circuit diagrams to:

Name _____
Address _____
City _____ State _____

BARTER AND EXCHANGE FREE ADS

This new department will be inaugurated in the January issue.

Space in this department will not be sold. It is intended solely for the benefit of our readers, who wish to buy, sell or exchange radios, parts, phonographs, cameras, bicycles, sporting goods, books, magazines, etc., without profit.

As we receive no money for these announcements, we cannot accept responsibility for any statements made by the readers.

The following advertisements are printed to give you an idea of the type of advertisement that will be of interest to both buyers and sellers. They do not contain real names or real addresses.

BEST CASH OFFER TAKES 1937 Super-Skyrider, complete with speaker and crystal. Former net price, \$115. Richard Newton, 2105 Ocean Blvd., Bronx, N.Y.

I HAVE \$5,000 U.S. AND FOREIGN postage stamps mounted in album, also 2,000 duplicates. Will exchange for good bicycle or amateur receiver. Write Bryan Collins, 21603 Avenue U, Ypsilanti, Mich.

TRADE HAM EQUIPMENT FOR photographable equipment. Send details. Michael Cahn, 13 Delancey Ave., Omaha, Nebr.

SACRIFICE: COMPLETE 150- watt fone or c.w. transmitter, standard rack type. First \$150.00 takes it. Write or call WA52W, 17 Hempstead St., San Francisco, Calif.

HAMS AND FANS EVERY- where. Wish to correspond with you fellows, especially in far parts of the globe and exchange experiences. Bert Howard, Bordeaux Ave., Denver, Colo.

MUST SELL 700 WATT C.W., 100- watt fone, four-band switching, rack and panel xmitter, modulator and mike, ready to use, 80 m. xtal, 53. 53. RK23; pr. 8013; 150 T final, five pwr. supplies; 80 to 10 meters, change bands in 30 seconds. A buy. Manuel Ozana, Burlington Rd., Cleveland, Ohio.

GOING ON TRIP, MUST SELL MY chemistry outfit, fishing rod and reel, rifle, 75 radio parts, microscope, typewriter and numerous other gadgets. Write for details. Will take best offer for the entire lot or individual offers for separate items. James Finnan, 16 Barto Street, Binghamton, N.Y.

I OWN AN INDIAN MOTORCYCLE in very good condition. What have you to exchange for it? Also will sell—what am I bid? Thomas Ingers, 10 Southern Parkway, Chicago.

FOR SALE—JANETTE ROTARY converter, 32 v. d.c. to 110 v. a.c. 300 watt with filter. Used about 5 hours. Cost \$44.25. First \$23 takes it. WQ932, Portland, Oregon.

WANTED: PORTABLE TYPE- writer, in exchange for floor lamp, head phones, speaker and small bookcase. Peter Dawson, Bridgeport, Conn.

SELL OR SWAP—\$49, 201A, PAIR 600 mill output 866A's, four tantalum 852's. All guaranteed. SW3 with coils & power supply. Reconditioned WE387 carbon mike. All priced for quick disposal. William Pizansko, 19025-201st St., Indianapolis, Ind.

Let's Listen In With Joe Miller

(Continued from page 425)

MISCELLANEOUS

Joe Linehan, Adelaide, So. Australia, writes an interesting letter, and much to our amusement, sends us a clipping from "S.W. & T." of a few months ago, caricaturing us in royal robes and seated on a throne, wearing a crown, and asks us if that is a good likeness, hi! Well, Joe, all we can say is that the big cigar shown in our face is the only correct likeness pictured, hi! Yes, we do go for the ropes in a big way!!

Joe adds that out of 152 reports to American "hams," he got exactly 2 QSLs, so it seems that the U. S. DXers have much the better of the QSLing situation. Joe mentions being a Listening Post Observer for one of the leading broadcast stations in Australia, 5AD, and says he would very much like to be one for S. W. & T. Of course, Joe, as long as you send a monthly report to us on your DX results. Glad to have you, OM! Any DXer in a foreign country can be a Listening Post Observer for "S. W. & T." provided he sends us a monthly report of amateur and BC DX. However, we do not issue any certificates for this position.

Mr. Harry Hawkins of the Universal DX Club asks us to print the following data on the UDXC, which we do with pleasure. The UDXC publishes a bimonthly S. W. bulletin of 7 pages, called "Universal News," and has an annual club fee of \$1.00. Address the UDXC at 345 Maple Ave., Oradell, N.J., for full particulars.

Mr. Carroll H. Weyrich offers data pertaining to membership in the Rueda del Oeste (Western Association) to all who are interested. This offer to all U. S. DXers, and to all in U. S. possessions. For Canadian DXers, write to Peter Dandois, VE2DC, P.O. Box 64, New Carlisle, Quebec. The Rueda del Oeste has been known for years as the leading Radio Association for amateurs in Central and South America, and is now spreading its influence to Europe and Africa, and also in the SWL ranks. Our FB amigo, Mr. Felix Gunther, LU1DA, LU8AB, is President of this famous organization.

.....HAM STARDUST.....

DX in the amateur bands is awakening, on 10 and 20 meters, and many new amateurs are being heard, from all parts of the world. Very little time has been put in here on the ham bands, due to lack of time, but we hope to "clean up" some FB DX from now on. We must rely on reports this month for most of our amateur DX data.

AFRICA

CN8AJ, 14090, and CN8AM, 14080, French Morocco, are being heard throughout the U. S. with fine signals, usually near 5-7 p.m., and near midnight. Many report these two. Others reported are CN8AF, 14090, and CN8AL, 14300, within the same times.

FA3HC, 14350, Algeria, is also well heard, often around 8:30-9:30 p.m. FA3HC is Algerian I.D.A. representative.

FR8VX, 14340, Reunion Island, has a special I.D.A. Broadcast scheduled for Oct. 15-17, at 3-3:30 p.m. We regret having received data too late for publication in "S. W. & T." FR8VX uses 25 watts, and is the exiled former ruler of French Indochina.

SUIGP, 14060, Egypt, reported at 7 p.m. by Roger Legge, W2.

FB8AB, 14348, Tananarive, Madagascar, reported by Roy Myers, W6. Also, FB8AH, 14270, is reported by Ashley Walcott, and John De Myer, by John at 6:45 a.m. Ashley adds that the call letter assignments in Madagascar have been "shaken up," according to word from ZUGN, and that the present calls listed in the Call Book cannot be depended upon. FB8AF, 14275, also reported.

Ashley reports following African hams heard during September: ZS1B, 14060;

Study these ads and mail your typewritten or printed copy before November 1st to appear in the January issue.

CLASSIFIED 15¢ A WORD

Under this heading only advertisements of a commercial nature, such as those shown below, will be accepted. Remittance of 15¢ per word should accompany all orders. Copy should reach us not later than the 5th of the month for the second following month's issue.

INSTRUCTION	QSL—CARDS—SWL	SHORT WAVE RECEIVERS
COMPLETE TRAINING FOR ALL Amateur and Professional Radio Licenses. New York Wireless School, 1123 Broadway, New York.	QSL, SWL CARDS, NEAT, ATTRACTIVE, reasonably priced, samples free. Miller, Printer, Ambler, Pa.	PLANS 36 DISTANCE RECORD Crystal Sets 50c; 18—25c; with "Radio Workbench." Laboratories, 151-A Liberty, San Francisco.

SHORT WAVE and TELEVISION

99 Hudson Street

NEW York City

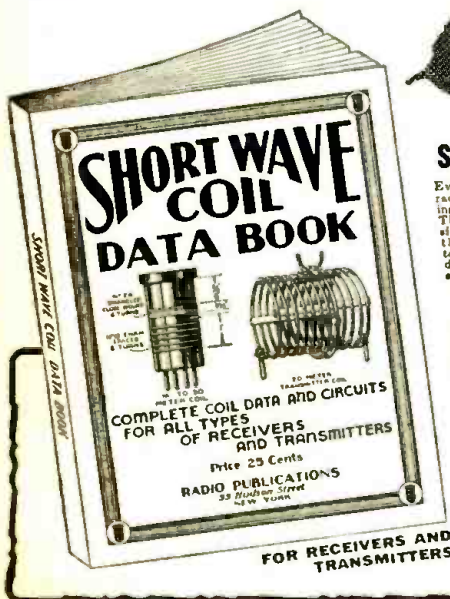

NEW!

SHORT WAVE COIL DATA BOOK

Every experimenter knows that the difference between a good and a poor radio set is usually found in the construction of short-wave coils. Coil winding information is vitally important and in the new coilbook all "dope" appears. There are illustrations which give instructions on how to wind coils, dimensions of wire, curves and how to plot them. Every experimenter needs this book—it also contains complete data on all types of receiving coils, together with many suitable circuits using these coils. Also complete data on various types of transmitting coils with many transmitting circuits such as exciters and amplifiers using the various coils described.

Contents Briefly Outlined

- S-W Tuning Inductance Chart • Coil Data for T. R. F. Receiver • One Tube Oscillidyn • Two Tube Bandspreder • The Mono-Coil • 2-Tube Old Reliable • 2-Tube Globe Troter • 2 Winding Coils—10-500 Meters • Duple 2-Tube "Signal Gripper" • Electrified • 3-Tube Bandspreder for the Ham • General Coverage Coils on 11thed Form • Coil Data for Superhet or S-W Converter • Ultra S-W Coils • Switch Coils for S-W Superhets • Experimental Coils • S-W Antenna Tuner • Most Popular S-W Tuning Circuits • Self-Supporting Transmuting Circuits Employing Coils Described • All Band Antenna Tuner for Transmitting • Plug-In Coils for Exciters • Frequency-Wavelength Conversion Chart.

PRICE 25c PREPAID

For a copy of this handy book, send 25c in U.S. Coin or stamps to

RADIO PUBLICATIONS

97 HUDSON STREET NEW YORK, N. Y.

Please mention SHORT WAVE & TELEVISION when writing advertisers

Formulas and Recipes FOR THE PRACTICAL MAN

CONTENTS OF BOOK

1. Adhesives: Glues, Cements, Gums, Mucilages, Lubricants. 2. Cleansing: Stain Removers, Paint Removers, Bleaches, Cleaning Fluids. 3. Metal Craft: Coloring, Oxidizing, Plating, Repairing, Welding, Polishes, Alloys, Solders, Amalgams. 4. Paints: Colors, Stains, Varnishes, Enamels. Luminous Paint, Washable Paint; Paint-Removing. Water-proofing. Fireproofing. 5. Glass-Working: Cutting, Drilling, Boring, Bonding, Blowing, Etching, Engraving, Frosting, Silvering, etc. 6. Wood-craft: Fillers, Fireproofing, Acid-proofing. Water-proofing; Furniture Polishes, Finishes, etc. 7. Inks: Recipes, Eradicators, Ink Stain Removers; Special Inks Colored, Indelible, Sympathetic, Invisible, Hectograph. 8. Photography: Developers, Emulsions, Fixers, Sensitizing, Toning, Printing, Photographic Paper, Blueprint Paper. 9. Antidotes for Poisons, Remedies for Burns and Scalds, Disinfectants, First-Aid in Accidents, Emergency Remedies, Home Remedies. 10. Preparation, Manipulation, Handling, Mixing, Measuring, Weighing, Filtering, Straining Solutions; List of Technical Substances; Emulsifying; Use of Hydrometer. Use of Thermometer; Tables of Weights and Measures, Decimal System, Useful Tables.

Price 50c Postpaid

TECHNIFAX

Division SWT-1237

558 W. WASHINGTON BLVD. CHICAGO, ILL.



Universal Ribbon MICROPHONES

Self energizing. No polarizing voltage. Plug in and use. Distant pickup. Semi-directional. No feedback. Unconditionally guaranteed. Incl. ten feet 2-conductor cable. Can be used on amplifiers not less than 85 db. gain.

List \$22.50 without plug

List \$24.25 with plug

Microphone Division
UNIVERSAL MICROPHONE CO., LTD.
424 Warren Lane
Inglewood Calif., U.S.A.

RADIOS..SAVE UP TO 50%

DEAL DIRECT...FACTORY PRICES! Many models to select from: AG-DC, All-Wave, armchair models; automatic tuning; car radios; Farmmate that operates like city radio! Send postcard for NEW Bargain Catalog FREE. 30-DAY TRIAL plan and lowest price position! GOLDENTONE RADIO CO. DEPT. C12, DEARBORN, MICHIGAN

Free Catalog

30 DAY TRIAL \$6.98 UP

RADIO TRAINING GIVEN

Investigate NOW the opportunity offered by Clough-Brengle and Midland Television engineers. Free radio instructions. See your C-B distributor or write us today for details. Time is valuable.

FREE Catalog \$200. Ask your parts distributor or write us direct.

The CLOUGH-BRENGLE CO.
2813-E W. 19th St. Chicago, Ill.

CHASSIS—CABINETS PANELS & CANS

STANDARD SIZES ON HAND
SPECIAL SIZES MADE TO ORDER
KORROL RADIO PRODUCTS CO.
Dept. S-12
232 Greenwich St., New York City



ALADDIN Polyiron Improves RECEPTION

New ALADDIN Polyiron I-F's give remarkable improvements in Selectivity, Sensitivity and Gain. Write now for FREE technical booklet and data.

Aladdin Radio Industries, Inc.
466sw W. Superior St., Chicago, Ill.

ZU1T, 14070; ZS2J, 14285; ZS2N, 14030; ZS2X, 14040; ZT2G, 14255; ZS5AB, 14060, 14090, 14140; ZT5P, 14060; ZS6AJ, 14130, 14250, 14340; ZS6S, 14252; ZT6AK, 14030; ZT6J, 14270; ZT6T, 14090; ZT6Y, 14050; ZU6AF, 14350; ZU6K, 14060; ZU6N, 14110; ZU6P, 14120.

Roy Myers reports ZS2A, ZT2G, ZT5P, ZT6AK, ZU6N, ZE1JB, but does not mention frequency.

ASIA

XZ2DY, 14340, Burma, reported by Ashley Walcott, using 9 watts. John De Myer has received a QSL from XZ2EZ, 14340, who also uses 9 watts! These stations may be limited to 10 watts power.

VS3AE, 14350, is mentioned by Roy Myers as the Sultan of Johore's station.

John De Myer also reports a QSL from VS6AB, Hong Kong, with a power of 34.7 watts input. Very FB DX, John!

XU8MC, 14040, Shanghai, is often heard by Ashley Walcott, talking to American hams. Jim Lanyon of Vancouver adds that many messages are handled daily by a relay composed of VE5VO, KA1AP, Manila, and XU8MC. As usual, the hams are turned to in emergencies.

Jim also reports J2NI, 14100, Tokyo, VS1AI, 14060, Singapore, and PK2AA, Java, in the middle of the American fone band!

Roger Legge reports PK1VN, 14100, Java, at 6:40 a.m.

ZC6R, Palestine, reported on 14290, PK3ZU, 14300, PK6HI, 14270, both in Java, and VS7GJ, 14130, in Ceylon. Also reported is VU2BG, 14276, India, this ham is notorious for his failure to QSL reports.

HS1BJ, 14070, operated by our friend Sangiem Powtongsook, of Bangkok, Siam, is at last on 20 meter phone, as W6ITH QSO'd him one morning, and reported HS1BJ's signal as R99 plus!

VS1AM is a new Singapore ham reported by Harry Honda, W6.

Other DX reported is HB9BL, Switzerland, 14020. HA8N, Hungary, QSLs with nice card, requesting mention in our columns, and that we send him a copy of that issue. OK, OM! You'll find your card in this article, where you can't miss it, hi!

HA4A, 14140, Hungary, a new one heard here at 5 p.m.

We gave 10 meters a try today, and snared ZU6P, So. Africa. This is the band to try now for good DX, so go to it, OMs! Best o' DX.

"Ham" Waves Link Brothers in U.S. and Africa

(Continued from page 411)

that." Dr. Wescott came back. "Hello, Fritz, how are you," called Rowe. "I'd like to hear your voice."

A new voice came out of the speaker, and Rowe's eyes enlarged a little. The voice was hard to understand, but it mentioned being glad to be talking, and said, "We're glad we finally got you."

Rowe told his brother, in the Belgian Congo, about Aunt Pett's health, and Uncle Jesse's new car and the death of the Supreme Court bill. He asked what Dr. Rowe's ideas were on current events in general.

"The information we get is very limited," said Dr. Rowe. "Your broadcasts over there are so late at night that we can't afford to stay up for them often."

A woman's voice came in then. It was Mrs. Rowe. "It's about midnight here now," she said. In Cleveland it was not yet 7 p. m.

In Cleveland, Mrs. John Rowe, who was sitting in the room, moved to the mike and talked about family matters for a little. A friend who was also present said "Hello, how are you?" and then Africa was heard again, asking about the weather.

When a reporter who was present left, a conference was being held in an effort to determine what was most important to be talked about. Everybody had become so excited that good subjects were simply refusing to present themselves. It was that way in Africa, too.—Courtesy Cleveland Plain Dealer.

AMAZING VALUE VOLT-OHMMETER

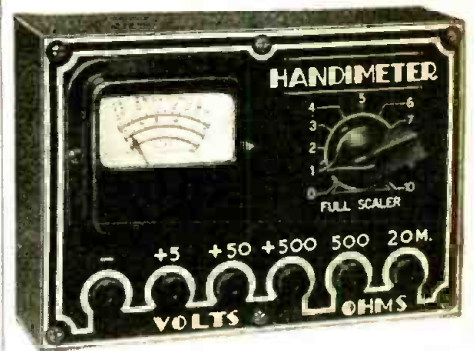

THE HANDIMETER, our new volt-ohmmeter, combines beauty and performance, enabling direct reading of d-c volts 0/5/50/500, also ohms 500/50,000. Likewise direct reading, and d-c current determination to 20 milliamperes. Besides, the device is a perfect continuity tester. The low ohms scale is particularly important, because enabling checking r-f and i-f, as well as a-f coils, for shorts and opens. Low-priced instruments never before included this low-ohms range, reading to one ohm. Nor did they have an adjuster for accuracy of ohms readings. Our HANDIMETER has such adjustment for both ohms ranges. Latest square type meter used, appropriately marked for services performed at individual binding posts, and is etched metal. Complete with test leads and self-contained batteries. Shipping weight, 5 lbs.

Net price..... **\$4.10**

OSCIMETER



LOWEST-PRICED direct frequency-reading all-wave signal generator, this instrument, accurate to 1% on i-f and broadcast bands, 2% on short waves, covers 100 kc. to 22 mc., all on fundamentals, in five bands. It is switch-controlled, has attenuator, and enables also leakage test of condensers, tubes, etc. It has sine-wave r.f., also separate modulator, cut in or out by switching.

This instrument works on 90-150 volts, a.c. or d.c. If a.c. is used it may be of any commercial frequency. Tubes are oscillator, rectifier and modulator. R-f output may be at high or low impedance, from separate posts. Also separate audio output enables testing P.A. systems and other a-f amplifiers.

Housed in black wrinkled finished shield cabinet, with carrying handle, the signal generator, 5 lbs. unpacked, is easily portable. Order Oscimeter Model T-40, complete with tubes (shipping weight **\$10.40** 6 lbs.)

TUBE TESTER



Emission type perfected tube tester for any and all types receiver tubes, including metal and metal-glass. Tests shorts and d leakage. Accurate, simple, sturdy, direct — English — reading (Bad?—Good). Shipping weight, 9 lbs.

\$10.40

SUPERIOR INSTRUMENTS CO.
Dept. SWT-12, 136 Liberty St., New York, N. Y.

All about the SHORT WAVE LEAGUE

A FEW WORDS AS TO THE PURPOSE OF THE LEAGUE

The SHORT WAVE LEAGUE was founded in 1930. Honorary Directors are as follows: Dr. Lee de Forest, John L. Reinartz, D. E. Replogle, Hollis Baird, E. T. Somerset, Baron Manfred von Ardenne, Hugo Gernsback, Executive Secretary.

The SHORT WAVE LEAGUE is a scientific membership organization for the promotion of the short wave art. There are no dues, no fees, no initiations, in connection with the LEAGUE. No one makes any money from it; no one derives any salary. The only income which the LEAGUE has is from its short wave essentials. A pamphlet setting forth the LEAGUE'S numerous aspirations and purposes will be sent to anyone on receipt of a 3c stamp to cover postage.

FREE MEMBERSHIP CERTIFICATE

As soon as you are enrolled as a member, a beautiful certificate with the LEAGUE'S seal will be sent to you, providing 10c in stamps or coin is sent for mailing charges.

Members are entitled to preferential discounts when buying radio merchandise from numerous firms who have agreed to allow lower prices to all SHORT WAVE LEAGUE members.

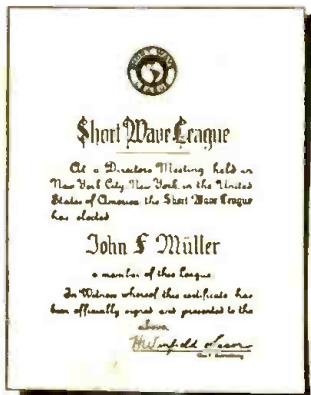

If you wish your name engraved on the Free membership certificate, as illustrated above, please send 25c to cover cost.

SHORT WAVE ESSENTIALS LISTED IN OPPOSITE COLUMN SOLD ONLY TO SHORT WAVE LEAGUE MEMBERS

They cannot be bought by anyone unless he has already enrolled as one of the members of the SHORT WAVE LEAGUE or signs the blank below (which automatically enrolls him as a member, always provided that he is a short wave experimenter, a short wave fan, radio engineer, radio student, etc.).

Inasmuch as the LEAGUE is international, it makes no difference whether you are a citizen of the United States or any other country. The LEAGUE is open to all.

Application for Membership SHORT WAVE LEAGUE

SHORT WAVE LEAGUE 12-37
99-101 Hudson Street, New York, N. Y.

I, the undersigned, herewith desire to apply for membership in the SHORT WAVE LEAGUE. In joining the LEAGUE I understand that I am not assessed for membership and that there are no dues and no fees of any kind. I pledge myself to abide by all the rules and regulations of the SHORT WAVE LEAGUE, which rules you are to send to me on receipt of this application.

I consider myself belonging to the following class (put an X in correct space): Short Wave Experimenter Short Wave Fan Radio Engineer Student I own the following radio equipment:

Transmitting _____

Call Letters _____

Receiving _____

Name _____

Address _____

City and State _____

Country _____

I enclose 10c for postage and handling for my Membership Certificate.

When to Listen In

(Continued from page 436)

❖ RECEPTION NOTES . . . Continuing our discussion of last month about the whys and wherefores of short wave's behavior, it is well to note that solar activity has a great effect on short wave reception. Sunspots, which are gaseous eruptions, frequently appear on the surface of the sun and very frequently have a marked effect on short-wave reception.

In general, it may be said that following a period of sunspot activity, the higher frequencies are improved for long distance reception whereas if there has been a considerable period with no sunspot activity the high frequencies will begin to deteriorate, and the lower frequencies will improve.

Sunspot activity, as is well known, follows an eleven year cycle, that is to say, once every eleven years there is a sunspot maximum period and similarly once every eleven years there is a sunspot minimum period. The last minimum period was about the winter of 1932, and the next maximum period is expected to occur this winter.

So for the last year or so, the frequencies between 15 and 25 mc. have been giving very good reception, whereas the lower frequencies, have not. In the year 1932, on the other hand, frequencies as low as 4 mc. gave very good results for trans-Atlantic reception, while frequencies above 15 mc. were not very effective.

Here's Your Button

The illustration herewith shows the beautiful design of the "Official" Short Wave League button, which is available to everyone who becomes a member of the Short Wave League.

The requirements for joining the League are explained in a booklet, copies of which will be mailed upon request. The button measures 1/2 inch in diameter and is inlaid in enamel—3 colors—red, white, and blue.

Please note that you can order your button AT ONCE—SHORT WAVE LEAGUE supplies it at cost, the price, including the mailing, being 35 cents. A solid gold button is furnished for \$2.00 prepaid. Address all communications to SHORT WAVE LEAGUE, 99-101 Hudson St., New York.



Short Wave League

At a Directors Meeting held in New York City, New York, in the United States of America, the Short Wave League has elected

John F. Müller

a member of this League.

In Witness whereof, this certificate has been officially signed and presented to the above.

H. Winfield Secor
Club Secretary

This is the handsome certificate that is presented FREE to all members of the SHORT WAVE LEAGUE. The full size is 7 1/4"x9 1/2". (See this page.)

Accessories for Members of the SHORT WAVE LEAGUE

Every member of the SHORT WAVE LEAGUE wants to identify himself in some way. For your convenience the League directors have prepared suitable letterheads, label buttons, stickers, etc. In addition there are many short-wave accessories, such as maps, globes, etc., which the League offers only to members at special prices. Take your choice from this advertisement. THESE ESSENTIALS ARE SOLD ONLY TO LEAGUE MEMBERS.



LEAGUE LETTERHEADS

A beautiful, official letterhead has been designed for members' correspondence. The letterhead is invaluable when it becomes necessary to deal with the radio industry, mail order houses and radio manufacturers, as many houses offer members of the LEAGUE preferential discount. The letterhead is also absolutely essential when writing for verification to radio stations either here or abroad. It automatically gives you a professional standing.

A—SHORT WAVE LEAGUE letterheads, per 100..... 50c

A—50c per 100

WORLD GLOBE

This important essential is an ornament for every den or study. It is a globe, 6 in. in diameter, printed in fifteen colors, glazed in such a way that it can be washed. This globe helps you to intelligently log foreign stations. The base is of solid walnut, and the semi-meridian of a nickel-like metal. Entire device substantially made, and will give an attractive appearance to every station, emphasizing the long-distance work of the operator.

D—Globe of the World 89c

D—89c each



SHORT WAVE MAP OF THE WORLD

This beautiful map, measuring 18x26 in. and printed in 18 colors is indispensable when hung in sight or placed "under the glass" on the table or wall of the short wave enthusiast. It contains a wealth of information such as distances to all parts of the world, political nature of the country in which a broadcast station is located, etc., and from the manner in which the map is blocked off gives the time in different parts of the world at a glance.

F—SHORT WAVE Map of the World.....Prepaid 25c



WORLD RADIO MAP AND STATION FINDER

The finest device of its kind published. The world's map on heavy board is divided into 23 sections, while the rotary disc shows you immediately the exact time in any foreign country. Invaluable in logging foreign stations. Also gives call letters assigned to all nations. Size 11"x22"

C—Radio Map of the World and Station Finder.....Prepaid 25c



C—25c each

LEAGUE LABEL BUTTON



E—35c each

This beautiful button is made in hard enamel in four colors, red, white, blue and gold. It measures three quarters of an inch in diameter. By wearing this button, other members will recognize you and it will give you a professional air. Made in bronze, gold filled, not plated. Must be seen to be appreciated.

E—SHORT WAVE LEAGUE label button.....Prepaid 35c

EE—SHORT WAVE LEAGUE label button, like the one described above but in solid gold.....Prepaid \$2.00

SHORT WAVE LEAGUE

99-101 Hudson St., New York, N. Y.

SHORT WAVE LEAGUE, 99-101 Hudson Street, New York, N. Y. 12-37

Gentlemen,

I am a member in the SHORT WAVE LEAGUE

Please send me application for membership in the SHORT WAVE LEAGUE

Please send me the following short wave essentials as listed in this advertisement:

for which I enclose \$_____ herewith.

Name _____

Address _____

City and State _____

Country _____

(The LEAGUE accepts money order, cash or new U. S. Stamps in any denomination. Register cash and stamps.)

Please mention SHORT WAVE & TELEVISION when writing advertisers

DATAPRINT SERVICE

New low price—
Any 3 Prints.....\$1.00

TESLA COIL DATA:

Dataprint—drawings and data for building 36 inch spark Tesla.....50c
Exciter—1 K.W. 25,000 Vt. Transf.....50c
3" Sp'k. Tesla Coil. Works on Ford Coil.....50c
3" Sp'k. Oudin Coil. Works on 110 A.C.....50c
20 "Tricks" with Teslas & Oudins.....50c
8" Sp'k. Tesla Coil.....50c
Exciter—1/4 K.W. 15,000 V. Transf.....50c
Violeta—1/2 Sp'k. Oudin. Vibrator type.....50c
How to Operate Oudins from V. T. Gas.....50c



S-W DIATHERMY (Artificial Fever)

Dataprint Constructional data for Small, Medium and Large size App.....50c



RECORD PROGRAMS on Steel Wire!

Telegraphone Data, for Voice or Code.....50c



Induction PIPE & ORE LOCATOR

Construction Data.....50c



20 ELECTRIC LODGE & PARTY TRICKS. Fun Galore!

"How to Do 'Em" Data 50c



RADIO CONTROL for MODEL BOATS, etc.

Circuit data.....50c
More DATAPRINTS You Need!
50c each..... 3 for \$1.00

Water Turbines
Water Wheels
Motor Circuits (20)
Telephone Hookups (20)
100 Mechanical Movements
Polarized Relay, Ultra-sensitive
Ring 4 bells on 2 wires
20 Simple Bell Hook-ups
Electric Chime Binger fits any clock
Welding Trf. 2 K.W. 110 V. Prim. 18 V. Sec.....50c
4" metal SLIDE RULE \$2.00; 8".....\$5.00

The DATAPRINT Co.
Lock Box 322 RAMSEY, N. J.

High-Frequency Heat Removes Gas from Tube Elements

(Continued from page 411)

tion or bombardment. In such cases, high frequency inductive heating is used. Essentially this process is accomplished by surrounding the tube with an inductance coil through which high frequency current is passed. The resultant eddy currents in the metallic parts of the tube, which act as the secondary of an oscillator transformer, raise the temperature of those parts to a degree dependent upon the coupling, frequency, field strength, and resistivity of the material.

Since the internal geometry of the tube is determined by operating requirements, it frequently happens that the metallic parts are deeply buried in the tube, with a correspondingly low coefficient of coupling with the inductor coil. Energy transfer, however, increases with the square of the frequency and hence high frequencies are invariably used.



The thirty-five-kilowatt oscillator is remote controlled and provides frequencies of 250, 500, or 1000 kc.

The Poulsen arc, the spark oscillator and the high frequency alternator have been used, but the vacuum tube type of generator permits the use of higher frequencies than these other methods and in addition is considerably more flexible.

The simplest form of vacuum tube generator is a portable set and is used for pumping the smaller tubes. It is self-contained, operates on sixty cycles, 208 volts, and consists of a plate-supply rectifier, oscillator, tubes, switches, transformers and condensers. The heating coil serves as the tuning inductance of the oscillating circuit. The frequency at which this set operates depends, of course, upon the heating coil used, since the oscillating condenser is fixed, but is usually in the range of 250 to 500 kc. Tap switches are provided to regulate the oscillator plate voltage, which determines the circulating current in the heating coil and hence the temperature of the parts being treated. All tubes used in this type of equipment are air cooled.

In pumping large tubes or tubes where the contained parts are very small as compared with the glass envelope, hence involving poor coupling, the maximum available power in the portable sets is not sufficient to reach the required outgassing temperatures. It has therefore been necessary to design non-portable oscillators using water-cooled tubes. There are two such sets in use in the Vacuum Tube Development laboratory at the present time, one nominally rated at fifteen kilowatts output and the other at thirty-five kilowatts.

When a fixed set is used, it is, of course, necessary to transmit its power to the pump stations, of which there are about a



MAKE \$40-\$60 a WEEK

get MY
FREE RADIO LESSON

IT ACTUALLY SETS YOU UP FOR BUSINESS!

Here is a new kind of Radio training in theory, practice, and business methods that shows you how to make money fast. Men taking this training are earning \$10, \$15, \$20 a week in spare time—while they learn. Men who have graduated are holding down jobs paying up to \$60 a week and more.

NO EXPERIENCE NEEDED
Old-timers and newcomers are both making money this way, because my course is arranged to give you practical lessons and business instruction right at the start. Quickly you are able to begin Radio Work—simple instructions show you every step. Furthermore, I send you the equipment and parts to handle these jobs properly.

A SPECIAL COURSE FOR SERVICEMEN

If you are already in the business, I have a special 45-lesson service course ready for you. There's nothing else like it in print—shows you how to service the latest circuits—how to get better pay for your work. So, whether you are old or new, send for my FREE BOOK. It gives full details on both courses. . . . And remember, I offer TERMS AS LOW AS \$3 PER MONTH.

\$100 EXTRA

How would you like to put \$100 extra in your pocket every month? My student Merlyn Hansen, a farm boy, is doing that very thing. He has built up a regular business of his own, and attends to it in his spare time. If you are serious about getting a better income, let me give you the facts about my training.

BIG OUTFIT

As a regular part of my training, I send you a Big Outfit, including Trip-lett Tester, complete set of Rider Manuals, Professional Tool Kit, Repair Parts, Work Sheets, and Eby Electric Eye.

BOOKS SENT FREE

Get all the facts about my training and your future in Radio. Send for my FREE BOOK "More Money in Radio"—it's crammed with facts and interesting information. I'll also send you one of my famous "Business Builders."



Mail Coupon Now

Sprayberry Academy of Radio,
F. L. Sprayberry, President,
45-P. University Place, N.W.,
Washington, D.C.

Please send me a free copy of "More Money in Radio" and also a free "BUSINESS BUILDER."

Name.....Age.....

Address.....

City.....State.....

Paste coupon on penny postcard, mail TODAY, if interested in Service Course only, check here

STOPPANI COMPASS

A Precision Instrument made in Belgium. Purchased by the U. S. Government at more than \$30.00 each. Ideal for Radio Experimenters Laboratory, also may be used as a Galvanometer for detecting electric currents in radio circuits. Ruby, jeweled, solid bronze, 4 inches square, fitted in a hardwood case. Also used by hunters and surveyors.

Our price prepaid \$4.50 each



GOLDSHIELD PRODUCTS
99 Hudson St., 11th Floor
New York City

See Page 404 about

RADIO AMATEUR COURSE

50c

At Your Radio Supply Store

Practical electricians

FOR EVERYBODY—PASTIME OR PROFIT

Clearly written, fully illustrated. Check full of ideas. Easily understood—easily made. Write for free circular today.

AUTOPOWER, 414 S. Moyné Ave., Chicago

Print Your Own

Cards, Stationery, Circulars, Advertising, etc. Save money. PRINT for OTHERS, big profit. Junior Outfits \$8.85 up. Senior \$12 and up. Easy rules sent. Write for free catalog with all details. The KELSEY Co., D-28, Meriden, Conn.



SOLAR

announces a complete line of

TRANSMITTING CAPACITORS

OIL - PAPER
and
MICA TYPES

Write for Complete Catalog

SOLAR MANUFACTURING CORP
599-601 Broadway, New York, N. Y.

NEW!

MODEL T9 CRYSTAL MICROPHONE

\$19.50
LIST

With Stand as Shown \$22.50

NEW SHOCK PROOF INTERIOR

Model T9 Ask for Bulletin T9

THE TURNER CO.

Cedar Rapids, Iowa
Licensed Under Patents of The Brush Development Co.



YOU CAN HAVE EITHER OR BOTH OF THESE TWO OUTSTANDING BOOKS FREE

The publishers of *Short Wave & Television* give you the opportunity to add one or two new books to your library. They make the offer even more attractive by giving the books to you absolutely FREE. A subscription to *Short Wave & Television* for seven months at the sensationally small cost of One Dollar brings to you your choice of the books illustrated and described below. For Two dollars you will receive *Short Wave & Television* for fourteen months and BOTH books sent to you absolutely FREE. ANOTHER SAVING FOR YOU—THE PUBLISHERS PAY POSTAGE ON THE BOOK OR BOOKS YOU CHOOSE.



ABC OF TELEVISION

This book contains only the latest material available on Television. It is written by a well-known radio authority, and the book is available with a subscription to *SHORT WAVE & TELEVISION*.

Partial Contents of ABC of Television

- CHAPTER 1**—The simplest television receiver; how the eye sees; its likeness to television equipment.
- CHAPTER 2**—Theory of scanning; the Nipkow disc and its relation to television; the photo-electric cell; neon lamps; brief description of several modern mechanical systems.
- CHAPTER 3**—Need for a large number of picture elements; need for broad channel width in transmission of high-fidelity television signals.
- CHAPTER 4**—The use of the cathode ray tube in television receivers; necessary associated equipment used in cathode-ray systems.
- CHAPTER 5**—How a television station looks and how the various parts are operated.
- CHAPTER 6**—The Ikonoscope as used for television transmission in the RCA system.
- CHAPTER 7**—The Farnsworth system of television transmission.
- CHAPTER 8**—The future of television; probable cost of receivers; some expressions of opinion by prominent men; list of present television transmitters.

64 PAGES—100 ILLUSTRATIONS
Stiff, Flexible Covers. 5 1/2 x 8 1/4 INCHES

SHORT WAVE GUIDE

A few thousand copies of *SHORT WAVE GUIDE* still remain from our subscription campaign earlier in the season. It is an excellent book—recommended by short-wave enthusiasts everywhere. Send for your copy if you have not already received it.

Partial Contents of SHORT WAVE GUIDE

SHORT-WAVE QUESTIONS AND ANSWERS
So many questions and answers were sent to *SHORT WAVE & TELEVISION* space did not permit them to be included. In this book we have printed hundreds of questions and answers, with complete illustrations.

SHORT-WAVE KINKS, Illustrated
In *SHORT-WAVE GUIDE* you'll find dozens of short-wave kinks and wrinkles described and illustrated.

HOW TO BUILD SIMPLE SHORT-WAVE RECEIVERS
Complete constructional plans, including schematic diagrams, lists of parts, are included for building a number of one-, two-, and three-tube receivers.

WHICH IS THE BEST TYPE OF AERIAL TO USE?
The many antenna systems suitable for short-wave receivers are carefully described and illustrated in *SHORT WAVE GUIDE*.

A SIMPLE "HAM" TRANSMITTER
All the details, including list of parts, wiring diagrams and constructional details in building a simple "ham" transmitter will be found in this book.

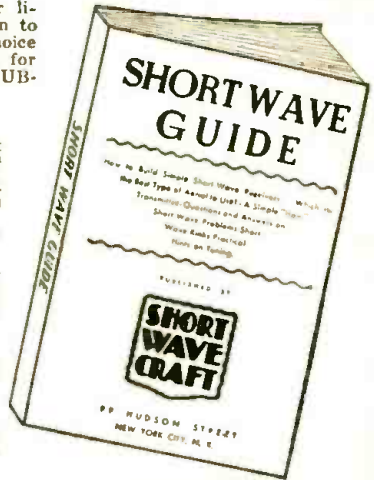

PRACTICAL HINTS ON SHORT-WAVE TUNING

Hundreds of short-wave stations are heard daily by "fans," but if you knew how to tune them in, you could hear more stations and get greater enjoyment and thrills from your receiver. Expert advice on proper short-wave tuning is included in *SHORT WAVE GUIDE*.

64 PAGES—106 ILLUSTRATIONS
Stiff, Flexible Covers. 5 1/2 x 8 1/4 INCHES

SHORT WAVE & TELEVISION, 99G HUDSON STREET, NEW YORK, N. Y.

12-37

Gentlemen: Enclosed you will find my remittance of One Dollar (Canada and Foreign \$1.30) for which enter my subscription to *SHORT WAVE & TELEVISION* for Seven Months. You are also to send me ABSOLUTELY FREE and POSTPAID the book indicated by (x) at the right.
() Two Dollars are enclosed. Send *SHORT WAVE & TELEVISION* for fourteen months and send me BOTH BOOKS ABSOLUTELY FREE. (Canadian and Foreign \$2.60)

- ABC OF TELEVISION
- SHORT WAVE GUIDE
- New Subscriber
- Old Subscriber

Name..... Address.....
City..... State.....

Send remittance in form of check, money order or unused U.S. Postage Stamps. (Foreign: International Postal Money Order.)
Register letter if you send cash.

ADD THESE BOOKS TO YOUR LIBRARY!

When you subscribe to *SHORT WAVE & TELEVISION*, you get these books FREE. If you already are a subscriber, and you send for these books, your present subscription will be extended for another seven or fourteen months. It's easy to add these books to your technical library.

SHORT WAVE & TELEVISION

99 HUDSON STREET, NEW YORK, N. Y.

PYRO PANTAGRAPH



Size of Box:
12 1/2 x 8 1/2
inches

\$2.75

Shipping weight, 3 lbs.

VOGUE

THIS electrical outfit is especially designed for burning designs permanently on materials such as Leather, Wood, Cork, Bakelite, etc. Plug the Pyro-electric pencil in any 110 volt AC or DC outlet and it is ready to be used. Plug and cord furnished.

By the use of the Pantagraph included in the outfit, any design may be reproduced either in original, reduced or enlarged form.

Outfit consists of: one Pyro-electric Pencil; one Pantagraph; three hardwood plaques; one bottle of Varnish; one Brush; one tracing tip and four-page instruction sheet.
Size of box: 12 1/2 x 8 1/2 inches.

Outfit will be forwarded by Express Collect if not sufficient postage included with your order.

WELLWORTH TRADING CO.

558 W. Washington Blvd., Dept. SWT-1237 Chicago, Ill.

dozen in the laboratory. Since the transmission line must be well over a hundred feet long and must transmit substantial amounts of power at frequencies in or near the broadcasting band, precautions were necessary against loss through radiation, either into space or into adjacent metal structures. Accordingly the impedance of the system was made high by tuning the coupling circuits at both ends, thus minimizing the line current while giving a large current through the heating coil. To guard against radiation when a unit is slightly detuned and a considerable current flows in the line, the return (grounded) line is run physically parallel to the high side of the transmission line and about eight inches away from it. The construction of the line follows current high-tension practice, with interlocking switches so that the two generating sets cannot be connected together or to the same pumping station. Safety grounding switches are also provided.

The fifteen-kilowatt oscillator employs two 228A water-cooled tubes in parallel as oscillators, and two 255A mercury-vapor tubes as rectifiers for plate supply. Regulation is accomplished by a manually operated tap switch on the front of the set. With the control at the oscillator itself, it is desirable to transmit the high frequency only to points where the operator at the oscillator can watch the heating process. For this reason the switching system of the transmission line is so arranged that the fifteen-kilowatt oscillator can be connected only to the six pumping stations in the immediate vicinity of the oscillator.

In some cases it is not possible to obtain the desired temperature due to lack of available power or to the fact that the coupling is poor. For these reasons a thirty-five-kilowatt set using four 228A tubes as oscillators was designed and built. This set is provided with a remote-control feature whereby it can be fully controlled

from the point of use. The same transmission line is used for the high frequency as with the fifteen-kilowatt set, interlocking switches being provided for this purpose. Remote control is provided through a six-conductor cable which terminates in a convenient outlet at each point of use. The remote-control apparatus consists of an "on-off" switch, a volt-meter and a "raise-lower" switch. The "on-off" switch controls a magnetic contactor in the primary of the oscillator plate-supply transformer. The voltmeter indicates the voltage across the primary of that transformer and the "raise-lower" switch controls the three-phase motor which operates an induction regulator in the 120-volt, sixty-cycle supply line to the plate transformer. This induction regulator performs the same functions as the tap switches in the other sets, but here there are no perceptible steps.

Although the high frequency is controlled remotely it is necessary to turn on cooling water and filament supplies at the set, but this operation is only performed one or two times in a working day. In order to change the point of use the remote control apparatus is rolled to the new point and plugged into the outlet and the interlocking switches in the transmission line thrown to the proper positions. There is no necessity for going back to the set itself. The plate voltage is turned off when the remote-control unit is disconnected from the convenience outlet, even though the operator may have failed to turn off the plate voltage in the usual manner.

The thirty-five kilowatt set has an additional feature in that it provides for three different frequencies. Adjustable bus bars and heavy terminals accessible from the front of the set (shown through lower right-hand glass panel) serve to connect the four oscillator condensers in parallel, series parallel or in series, giving nominal frequencies 250, 500 or 1000 kc. The higher frequencies are particularly desirable in

Please mention *SHORT WAVE & TELEVISION* when writing advertisers



**THE YEAR'S
OUTSTANDING
SERVICE
BOOK!**

**Over
1,000 Pages**

**Over 1,000
Illustrations**

**OFFICIAL RADIO
SERVICE HANDBOOK**

PUBLISHED only a few months ago, the OFFICIAL RADIO SERVICE HANDBOOK by Bernsey, is the most modern, up-to-the-minute volume on radio servicing. Contains over 1,000 PAGES filled with vitally important service data—over 1,000 ILLUSTRATIONS.

OVER 250 PAGES OF OPERATING NOTES
The section on Operating Notes contains valuable information supplied from personal notes of hundreds of Service Men for over a thousand manufactured receivers.

Other highlights of the OFFICIAL RADIO SERVICE HANDBOOK: **CIRCUIT THEORY AND ANALYSIS**—Circuit Fundamentals, Tuning Circuits and Aligning Data, Volume Control, Tune Control, A.V.C., Resonance Indicator Circuits, A. F. Amplifier Systems and Power Supplies, Speakers, Pickups, Phono-equipment, Commercial Receivers; **SERVICING EQUIPMENT**—Fundamentals of Test Instruments, Commercial Equipment, Cathode-Ray Oscilloscope, Building Test Instruments, Localizing Trouble, Short Cuts, Unusual Servicing Experience; **STANDARD AND SPECIALIZED RECEIVER AND INSTALLATION DATA**—All Wave Receivers, Auto-tunings, Noise Interference; **MODERNIZATION AND CONVERSION DATA**—Receiver Conversion Work; **SOCIAL AND ECONOMIC PROBLEMS OF THE SERVICE MAN**—Improving Knowledge and Technique, Unifying the Profession; **OPERATING NOTES FOR STANDARD RECEIVERS.**

Order your HANDBOOK today—use the coupon below
RADCRAFT PUBLICATIONS, Inc. 99 Hudson St., New York, N. Y.

RADCRAFT PUBLICATIONS, Inc. SWT-1237
99 Hudson Street, New York, N. Y.
Gentlemen: Enclosed please find my remittance of \$3.00 for which send me immediately, POSTPAID, one copy of the OFFICIAL RADIO SERVICE HANDBOOK by Bernsey—just published.
 Please send HANDBOOK to me C. O. D.

Name _____
Address _____
City _____ State _____
 Please send complete literature on HANDBOOK.
(Send remittance by check or money order. Register letter if you send cash or currency.)

KEEP your home ORDERLY
Don't leave magazines scattered all over the house. Gold Shield Holder will keep them CLEAN and in 12 1/2" x 9 1/2" monthly sequence. 5/8" x 9/16"

Made of heavy cardboard, covered with Genuine DuPont fabricoid—holds 24 magazines.

AN IDEAL CHRISTMAS GIFT

Give them to your friends. (\$1.00 value). Holder, 50c each, 10 for \$2.50 prepaid. Nickel silver Autogram initial, illustrated above, 10c each. Two or three initials look swell on the bottom right hand corner of the holder. Write for wholesale prices.

GOLD SHIELD PRODUCTS

99 Hudson St., Dept. SW, 11th Floor, New York City

THE MAGAZINE OF NOVELTIES, SPECIALTIES and **GADGETS** ILLUSTRATED

The world's only magazine on this subject. Contains 150 illustrations of the latest and best gadgets, novelties, and specialties. A veritable gold mine of information which you can not get in any other way. Every month, GADGETS ransacks not only America but the entire world for the newest, most useful articles of this type, including the latest gadget and novelty patents.

Don't fail to read the monthly articles how inventors of well known gadgets have made fortunes from their ideas.

If your newsdealer cannot supply GADGETS MAGAZINE send 25c to Gadgets Magazine, 99-S Hudson Street, New York City

cases where coupling conditions are poor, such as in the case of a tube with small elements and a relatively large glass envelope. The recently developed ultra-high frequency Western Electric 316A tube is an example of a tube heating problem which requires high frequencies. Since for any given material the power consumed by eddy currents is proportional to the square of the frequency, this increase in frequency, where possible, is a definite advantage.

The impedance at the terminals of the resonant circuit at the load end is relatively high as compared with the line impedance. There would be reflection losses at this junction of the transmission line with the heating coil and condenser combination and standing waves would result if the electrical length of the line approached a quarter wavelength. This difficulty could be overcome by the use of impedance-matching networks with the risk of considerably complicating the set and reducing its present flexibility. For these reasons it was not deemed advisable to generate and use frequencies above 1000 kilocycles. In some of the more remote stations the length of transmission line involved makes it necessary to limit the frequency to 500 kilocycles or less.

When large circulating currents are used, the design of adequate heating coils is somewhat complicated. The coils become hot due to resistance and eddy current losses within themselves, with resultant danger to the nearby glass envelope and to insulation and adjacent parts. The problem has been solved satisfactorily by the use of water-cooled coils. The coil shown in one of the photos consists of a partially flattened copper tube wound edgewise and supported by slotted micalex insulators. The flattening of the tube allows the required number of turns to be wound in the available space without danger of arc-over between turns and still permits the passage of an amount of water sufficient for adequate cooling. Rubber hose connections to the water supply and drain provide insulation for the high voltage from ground, the local water supply being pure enough to prevent high current leakage, even at the high voltage used under these conditions.—Courtesy Bell Laboratories Record.

**France Inaugurates
Secret S-W Phone Link
to U. S.**

(Continued from page 410)

to transmitter sections, which carry plate voltages as high as 12,000 volts, puts the entire transmitter automatically out of operation.

Finally a word about the antenna system applied. The station operates of course with directional "beamed" antennas, which consist of capacity-coupled half-wave dipoles. A number of different wavelengths may be used according to the time of day by the management of the station.

The designers made provisions which permit the operator to utilize the following day and night waves simply by pushing a button: 16.58 meters, 21.8 meters, 28.76 meters, and finally—for cases of emergency—the operator has also the 40 meter wavelength at his disposal.

In short this station provides every means to guarantee a constant telephone link between France and America at all times of the day, and under all conditions of the atmosphere. The operation of this station has been simplified to an extent which can be found only in a few other present-day short-wave stations.

Next Issue!

Valuable articles for both HAMS and FANS—Don't miss it! All the regular departments—plus NEW Features.

the **AMPERITE
VELOCITY**
with **NEW DESK STAND**



Ideal for desk, pulpit, footlights, banquets. Leaf spring suspension acts as shock absorber. **STAND ONLY** . . . LIST \$4.00 **NAME PLATE** with call letters . . . LIST \$2.00

MICROPHONES: Model RBHn (High Imped.) or RBMn (200 ohms) with cable connector & switch . . . LIST \$42.00 Models RBSn, RSHn, with switch only . . . LIST \$32.00

NEW "HAM MIKE"

No Peaks! No Splashing! Real Broadcast Quality! RF Choke Circuit included in microphone. Output—68 db. Operates directly into grid. **MODEL HAM (High Imped.)** or **MODEL HAL (200 ohms)** . . . Gunmetal. LIST \$22.00. Chrome LIST \$23.00. Price includes Ham Desk Stand, Call Letters, and 6 feet of cable.



MODEL RAL \$22.00 LIST

A popular Amperite Velocity of very high excellence. Used for both speech and music. No peaks. Flat response over audible range. Output—68 db. Triple shielded. Shock absorber, swivel bracket. **MODEL RAL (200 ohms)**; or **MODEL RAH (2000 ohms)** high impedance . . .

FREE: Window Decal & Window Display

AMPERITE Co. 561 BROADWAY, N. Y.

AMPERITE Velocity **MICROPHONE**

PAR-METAL

**RACKS—PANELS
CABINETS
FOR
TRANSMITTERS
PORTABLES
RECEIVERS**



PAR-METAL offers you a uniform line of standardized products that enables you to build up a job that is professional in construction and appearance.

All parts are available in various sizes—a complete line that will meet every requirement.

Write for our New Catalogue No. 38
PAR-METAL PRODUCTS CORP.
3529 41st ST., LONG ISLAND CITY, N. Y.

DON'T BUY!!

RADIO TUBES, PARTS OR EQUIPMENT UNTIL YOU HAVE SENT FOR OUR NEW CONFIDENTIAL WHOLESALE CATALOG. LOWEST PRICES. TO PROVE THAT, SEND FOR OUR LATEST FALL BULLETIN AND COMPARE PRICES.

"One of America's Fastest Growing Mail Order Houses"
UNITED RADIO CO., 58-B MARKET ST., NEWARK, N. J.

..... THESE OUTSTANDING SHORT WAVE BOOKS ARE Now Available AT YOUR DEALER!

YOU buy parts, tubes, kits, accessories from your local radio dealer—that's what countless thousands of short-wave fans do. Now through a nation-wide distribution service our numerous books are available at your favorite radio dealer—right where you buy other radio equipment. It's more convenient, saves time and you can inspect the books before you buy. Ask your dealer to show you all the books advertised on this page—they're always in stock.

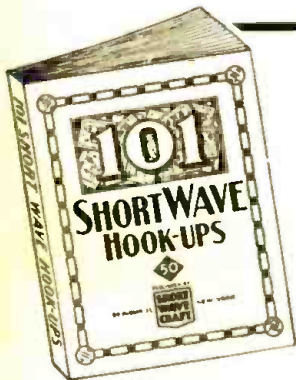

101 SHORT WAVE HOOK-UPS
 Compiled by the Editors of **SHORT WAVE and TELEVISION**
 Here is a worthwhile book that every short wave listener, every short wave fan, and every short wave amateur has wanted for a long time. It gives you the 101 best short wave hook-ups which have appeared heretofore.
 100 Illustrations
 72 Pages **50c**

HOW TO BUILD AND OPERATE SHORT WAVE RECEIVERS

This is the best and most up-to-date book on the subject. It is edited and prepared by the editors of **SHORT WAVE and TELEVISION** and contains a wealth of material on the building and operation, not only of typical short wave receivers, but short wave converters as well.
 150 Illustrations
 72 Pages **50c**

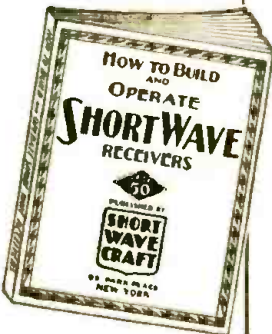

50c

TEN MOST POPULAR SHORT WAVE RECEIVERS

HOW TO MAKE AND WORK THEM
 The editors of **SHORT WAVE and TELEVISION** have selected ten outstanding short wave receivers and these are described in the new volume. Each receiver is fully illustrated with a complete layout, pictorial representation, photographs of the set complete, hook-up and all worthwhile specifications.
 75 Illustrations
 40 Pages **25c**

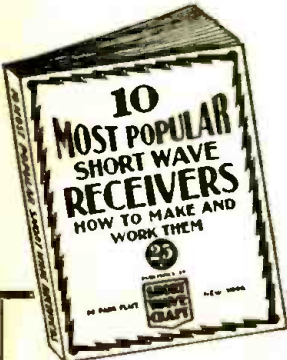

25c

HOW TO GET BEST SHORT WAVE RECEPTION
 M. HARVEY GERNSBACK tells you everything you have ever wanted to know about short wave reception. The author, a professional radio listener and radio fan for many years, gives you his long experience in radio reception and all that goes with it.
 40 Illustrations
 72 Pages **50c**

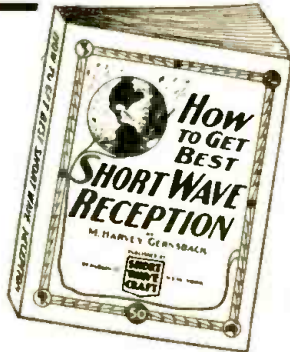

HOW TO BECOME AN AMATEUR RADIO OPERATOR

By Lieut. Myron F. Eddy, whose experience in the amateur field has made him pre-eminent in this line.
 If you intend to become a licensed code operator, if you wish to take up phone work eventually—this is the book you must get.
 150 Illustrations
 72 Pages **50c**

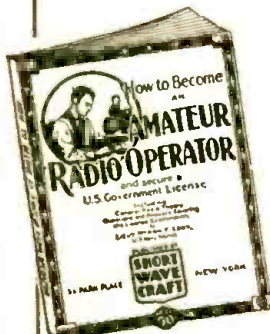

THE SHORT WAVE BEGINNER'S BOOK

Here is a book that solves your short wave problems—leading you in easy stages from the simplest fundamentals to the present stage of the art as it is known today. It is the only low-priced reference book on short waves for the beginner.
 79 Illustrations
 40 Pages **25c**

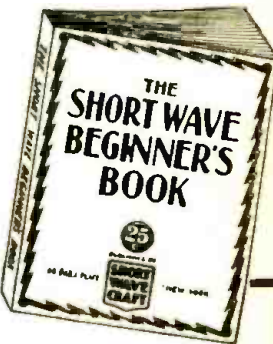

25c

LOOK FOR YOUR NEAREST DEALER
 For convenience the publishers list below dealers in all parts of the world where our books are available. On your next shopping trip be certain to examine these volumes. You're sure to want them for your technical library.

- ALABAMA**
Walther Bros., Montgomery
- ARIZONA**
Sam's Cigar Store, Phoenix
- CALIFORNIA**
Electric Supply Co., Oakland
Radio Supply Company, Los Angeles
Radio Television Supply Co., Los Angeles
Pacific Radio Exchange, Inc., Los Angeles
Western Auto Supply, Los Angeles
Zack Radio Supply Co., Los Angeles
Vroman's Book Store, Pasadena
Western Radio & Elec. Co., San Diego
Offenbach Electric Co., San Francisco
Technical Book Co., San Francisco
Zack Radio Supply Co., San Francisco
Radio Specialties Co., San Jose
- COLORADO**
Auto Equipment Co., Denver
Interstate Radio Supply, Denver
- CONNECTICUT**
The Edward P. Judd Co., New Haven
- DELAWARE**
Wilmington Elec. Spec. Co., Inc., Wilmington
- FLORIDA**
Radio Accessories Co., Orlando
- GEORGIA**
Wholesale Radio Service Co., Inc., Atlanta
- ILLINOIS**
Allied Radio Corporation, Chicago
Walter C. Braun, Inc., Chicago
Chicago Radio Apparatus Co., Chicago
A. C. McClure & Co., Chicago
Midwest Radio Mart, Chicago
Newark Electric Co., Chicago
Sears, Roebuck & Co., Chicago
Max Stein & Co., Chicago
Montgomery Ward & Co., Chicago
Wholesale Radio Service Co., Inc., Chicago

- INDIANA**
Van Sickle Radio, Indianapolis
- MASSACHUSETTS**
DeWelle & Flske Co., Boston
The Personal Book Shop, Boston
Wholesale Radio Service Co., Inc., Boston
Library Book House, Springfield
Tremont Elec. Supply Co., Boston
- MINNESOTA**
St. Paul Book & Stat. Co., St. Paul
- MISSOURI**
Bursteln-Applebee Co., Kansas City
Radio Labs., Kansas City
Waller Awh Radio Co., St. Louis
Van Sickle Radio Co., St. Louis
- NEW JERSEY**
Radio Apparatus Co., Newark
United Radio Co., Newark
Wholesale Radio Service Co., Inc., Newark
- NEW YORK**
Fort Orange Radio Dist. Co., Albany
Wholesale Radio Service Co., Inc., Bronx
Wholesale Radio Service Co., Inc., Jamaica, L. I.
American News Co., New York City
Baker & Taylor Co., New York City
Bian, the Radio Man, New York City
David Bogen & Co., New York City
Federated Purchaser, Inc., New York City
Harrison Radio Co., New York City
Radio Circular Co., New York City
G. E. Stecher & Co., New York City
The Steiger Co., New York City
Sun Radio Co., New York City
Thor Radio Corp., New York City
Try-Mo Radio Co., New York City
Van Riemsdyck Book Stores, New York City
Wholesale Radio Service Co., Inc., New York City
H. W. Wilson Co., New York City
Radio Parts & Equipment Co., Rochester
M. Schwartz & Son, Senenectady

- OHIO**
College Book Exchange, Toledo
- OREGON**
J. K. Gill Co., Portland
- PENNSYLVANIA**
Radio Electric Service Co., Philadelphia
Cameradio Co., Pittsburgh
- WASHINGTON**
Seattle Radio Supply Co., Seattle
Wedel Co., Inc., Seattle
Spokane Radio Co., Spokane
- WISCONSIN**
Radio Parts Co., Milwaukee
- ARGENTINA**
Radio Revlstin, Buenos Aires
- AUSTRALIA**
McGill's Authorized Agency, Melbourne
- BELGIUM**
Emil Arens, Brussels
- CANADA**
T. Eaton & Co., Winnipeg, Man.
Electrical Supplies, Ltd., Winnipeg, Man.
Wholesale Radio Supply, Winnipeg, Man.
Radio Trade Supply Co., Ltd., Toronto, Ont.
Canadian Electrical Supply Co., Montreal, P. Q.
- BRAZIL**
Agencia Soave, Sao Paulo
- CHINA**
China News Co., Shanghai
International Booksellers, Ltd., Shanghai
- CUBA**
Diamond News Co., Havana
- ENGLAND**
Wm. Dawson & Sons, Ltd., London, E. C. 4
Gorringe's Amer. News Agency, London
Cree's of Manchester, Pendleton, Manchester
- FRANCE**
Toule La Radio, Paris

- GERMANY**
Rehr G.M.B.H. SW15, Berlin NW No. 7
- INDIA**
Empire Book Mart, Bombay
- MEXICO**
American Book Store, Mexico, D. F.
Central De Publicaciones, S. A., Mexico, D. F.
Jaques Salvo, Mexico, D. F.
- NEW ZEALAND**
Johns, Ltd., Auckland
James Johnson, Ltd., Dunedin
Te Aro Book Depot, Ltd., Wellington
- SOUTH AFRICA**
Technical Book Co., Cape Town
Central News Agency, Johannesburg
International House, Johannesburg

IF YOUR DEALER DOES NOT CARRY THESE BOOKS, ORDER DIRECT FROM US. FILL OUT COUPON BELOW. SHIPMENT WILL BE MADE IMMEDIATELY.

POPULAR BOOK CORPORATION SW-12
 99 Hudson Street, New York City.
 Gentlemen: I enclose herewith my remittance for _____ for which please send me the following books:

 Name _____
 Address _____
 City _____ State _____
 (Send remittance in form of check or money order. If letter contains cash or unused U. S. postage stamps, register it.)

POPULAR BOOK CORPORATION • Publishers • 99 HUDSON STREET • NEW YORK, N. Y.

Please mention **SHORT WAVE & TELEVISION** when writing advertisers

Short Waves and Long Waves

(Continued from page 412)

A "Flash" from Delhi, India

Under AIR's (All-India Radio) new plans, four 10 kw. short-wave stations, are to be installed at Delhi, Bombay, Calcutta and Madras. The first of these—Delhi, will be working by the beginning of next year. They will work on the 30 and 49 meter bands in the day time, and on the new 60 and 90 meter bands at night. Bombay will not be on the short waves till the new transmitter is ready. Calcutta is on the air every day from 2 a.m., to 4:30 a.m., and 6:30 a.m., to 12 noon E.S.T. on 49.1 meters.

I would like to correspond with anyone about 18 years of age.

Wishing S.W.&T. every success.

Yours faithfully,

MASUD AKHTAR,
Member British Long-Distance Listeners Club, and the Short Wave League,
8 Keeling Road,
New Delhi, India.

(Yes, Masud, any reader is eligible to enter the scout trophy contest, glad to hear from a reader in far away India.—Editor.)

Did You Hear This Ham Station in Siam?

This xmtr will also be used for phone work later. The operating frequency is 14,070 kc.

The RCA 11 tube superhet receiver, ACR 175, is seen in the center of the desk. This is the receiver that brings the world of "dx" to Bangkok. A double-button carbon mike for phone QSO is placed on top of it. A speech amplifier kit is placed between the receiver and the dynamic loud-speaker.

Behind the receiver is another xmtr: HS1RJ. This xmtr is MOPA using 10 and 203A, with a maximum power output of 50 watts, and a centre-fed Hertz antenna. It is also equipped with a plate modulator, using a 211 for phone work. HS1RJ was at one time very popular in the U.S.A. as it had QSOed with many W stations in 1, 2, 4, 6, 7, 8 and 9 districts.

On the wall directly behind this xmtr, you will see an azimuthal map, showing true direction and distances from Bangkok to any point on the globe, and some QSL cards confirming the QSO with amateur stations on all continents.

The other xmtr installed in the next room, not shown in this picture, is HS1PJ, which is CC-FD-PA, using 10-860-861, with an input power of 400 watts to final cascade. Grid modulation is employed for phone work. The working frequency is 14200 kc. The antenna in use is Marconi type or full wave Zepp.

The radio amateur work of Siam had been silent for over 6 years, that was since the closing down of HS1HH. From that time, until this day, we have received lots of false QSL cards reporting and confirming the QSO with HS stations that could not be found in Siam, or had been closed down. Then on May 23, 1936, HS1PJ was born and flashed its very first signal on the air. This enabled DXers to add a rare new country to their list of stations worked or heard. It was then followed by HS1PU on Sept. 27, 1936; HS1RJ on November 11, 1936, and, lastly, HS1BJ on February 13, 1937.

This picture also shows the writer standing beside HS1BJ xmtr, that is, on the left. One of my operators is seen behind the speech-amplifier and speaker.

We are always pleased to send our QSL cards confirming the QSOs with our stations, or confirming the reception of the signals transmitted from our gang xmtrs. All QSL cards and reports should be sent to our QRA, which is:

RADIO TECHNICAL SECTION,
Royal Siamese Post & Telegraph Dept.,
Saladeng, BANGKOK, Siam.

Very 73 and good luck to you and all DX'ers,

SANGIEM POWTONGSOOK.



ELGIN "Air Roamer III"

3-TUBE RECEIVER

Completely outclasses any receiver of similar design. Reaches out and pulls in signals from all parts of the world. Plug-in coils, the most efficient system for shortwave tuning, are employed. The coils furnished with the receiver tune from 15 to 550 meters. Additional coils may be purchased to tune from 9 1/2 to 15 and 550 to 2000 meters. Four tube performance is obtained from the three used. 1-6F7 combination detector and 1st audio feeds into a 43. A 25Z5 is used for rectification. A 5" dynamic speaker capably handles the full output.

Complete Kit of Parts, less tubes, cabinet, extra coils, unwired..... \$2.08
Set of matched tubes..... \$2.98
Wiring, extra..... \$1.50 9 1/2-15 meter coil..... \$.29
Metal Cabinet..... \$1.25 550-2000 meter coils..... \$.89

\$8.12

"Buddy" II S.W. 2-Tube Receiver

Operates on either A.C. or D.C. Makes use of 1-6J7 metal tube and 1-12A7 as a combined rectifier and pentode output tube. Furnished with four plug-in coils which tune from 15 to 200 meters. Additional coils to extend the ranges down to 9 1/2 and up to 2000 meters are available.

Complete kit of parts including pictorial and schematic wiring diagrams, unwired, less tubes, cabinet and additional coils..... \$4.95
Wiring and testing, extra..... 1.25
2 Matched Sylvania tubes..... 1.75
Crystallized metal cabinet..... .95
9 1/2-15, and 200 to 2000 meter coils..... 1.47



Send for New 1938 Catalog

TRY-MO RADIO CO., INC.
85 CORTLANDT ST., N. Y. C.

6 BACK NUMBERS SHORT WAVE & TELEVISION 70c MAILED PREPAID

For a limited time only, and as long as they last, we will send you six back numbers of SHORT WAVE & TELEVISION assorted, your choice, for 70 cents.

The usual price for six copies would be \$1.50 and most publishers charge a higher price for back numbers over one year old.

We can supply only the following back numbers: Dec. 1930; Feb., April, June, Oct. 1931; Oct., Dec. 1933; Jan., Feb., Mar., April, May, June, July, Aug., Sept., Oct., 1934; 1935—All issues except January; 1936—All issues; 1937—All issues to date.

If you do not specify copies we will use our own judgment in sending assorted numbers to fill your order. Note we cannot exchange the copies for ones that have been sent to you.

Practically every copy of SHORT WAVE & TELEVISION contains im-

portant information that you should have. Here is a chance to get those copies.

As we have only a small supply of back numbers on hand, this offer will be withdrawn as soon as they have been sold. We accept U.S. stamps, U.S. coin, or money order. Rush your order today.

SHORT WAVE & TELEVISION

99-101 Hudson Street New York, N.Y.

SHORT WAVE & TELEVISION, 12-37

99-101 Hudson Street, New York, N. Y.

Gentlemen: I enclose herewith 70c, for which you are to send me six back number copies of SHORT

WAVE & TELEVISION as follows:

Name

Address

City

State

CLASSIFIED

Beginning with the January, 1938, issue, the Classified Advertising rate will be 15c per word. See our announcement on page 456. Copy for that number should reach us not later than November 5.

AGENTS WANTED
SIGN LETTERS FOR STORE AND Office Windows; 500% profit. Free Samples. Metallic Co., 446 N. Clark, Chicago.

CODE MACHINES
SPECIAL CODE PRACTICE Oscillator including tube and battery sent postpaid for only \$2.75. Oliver Fretter, 22 Moss St., Westerly, Rhode Island.

ELECTRICAL SUPPLIES
HUNDREDS OF NEW, UNUSUAL, hard-to-get electrical items, replacement parts and supplies. Send for free Wholesale Catalog, Autopower, 414 South Hoyne Ave., Chicago.

"HAM" OFFERS AND WANTS
MANY BARGAINS SUPER-SEVEN Skyrider \$29.50; Chief \$34.50; McMurdo Silver Prof. 5c 8 tube with Xtal \$34.50; Doerle Sr. \$12; W. E. and RCA Condenser Mikes \$15; \$10 Mike-stand with ring \$3.50. Candle Camera Bargains, sell or trade. Wells-Smith Radio Corp., 71 E. Adams Street, Chicago, Ill.

SACRIFICE! 100 Short Wave Radio parts (no junk) only \$1.00. Limited quantity! Order now! Richard Dawson, 1308-P, The Dalles, Oregon.

MASTERPIECE IV, LIKE NEW! cabinet \$95. Owner, 1711 Riverside Ave., Muncie, Ind.

INSTRUCTION
COMPLETE TRAINING FOR ALL

Amateur and Professional Radio Licenses. New York Wireless School, 1123 Broadway, New York.

MISCELLANEOUS
WE ORIGINALLY HAD FIVE thousand Stoppall Compasses for which the U.S. Government paid over \$30.00 each. We sold all but a very few. We cannot obtain more to sell at three times our present price. Send in your order before they are all sold at \$4.50 each, postage paid. Gold Shield Products, Room 14, Eleventh floor, 99 Hudson St., New York City.

COIL INDUCTANCE CHARTS—complete set for any size coil; accurate; \$2.15 prepaid. Slide Rules—4 inch circular metal type \$2.00; 8" dia., 20" scale, \$5.00 prepaid. Dataprint Co., Box 322, Ramsey, N.J.

PATENT ATTORNEYS
INVENTORS, ALL PATENT AND trademark cases submitted given personal attention by members of the firm. Form "Evidence of Conception" and instructions free. Lancaster, Allwine & Kimmel, 436 Bowen Building, Washington, D. C.

QSL—CARDS—SWL
100 NEAT SWL CARDS PRINTED with your name and address sent postpaid for \$1. Bunch of samples and RSP chart for five cent stamp. WIBEF, 16 Stockbridge, Lowell, Mass.

tractive, reasonably priced, samples free. Miller, Printer, Ambler, Pa.

QSL CARDS, 2 COLORS, 75 Cents per 100, postpaid. Radio Press, East Sullivan, N. H.

SHORT WAVE RECEIVERS
SHIPPED ON TEN DAY TRIAL: RME-69s \$99.00, NC100Xs \$99.00, NC-100s \$89.00, AC11-175s \$69.00, SX10 Ultraskyrider \$69.00, S9 Super-Skyriders \$49.00, AC11-155s \$19.00, P11-10s \$39.00, AC11-136a \$39.00, Super-7s \$29.00, Silver 5Bs \$29.00, Sky Buddies \$19.00, P117s \$19.00, All-Stars \$17.50, SW3s \$12.50, other sets, List free. All new sets at wholesale prices on 6% terms to suit you. Henry Radio Shop, Butler, Missouri.

PLANS 18 DISTANCE CRYSTAL Sets—SW record 4,250 miles, with "Radiobuilder" — 25c. Laboratories, 151-A Liberty, San Francisco.

TELEVISION
SIMPLE DIAGRAMS FOR BUILDING and operating a complete experimental television transmitter and receiver, sent for only 25c. Oliver Fretter, 22 Moss Street, Westerly, Rhode Island.

TRANSMITTING EQUIPMENT
CRYSTAL CONTROLLED TRANSMITTER kit with self-contained power supply, \$6.95. Send for particulars, Nance, 6001 E. 10th Street, Kansas City, Missouri.

Please mention SHORT WAVE & TELEVISION when writing advertisers

1938 RADIO PARTS CATALOG
 Showing The Latest **RADIO EQUIPMENT FOR THE DEALER THE SERVICEMAN AND THE AMATEUR**
 Our New Catalog just off the Press Write for your free copy—Now!
CAMERADIO
 963 LIBERTY AVE. PITTSBURGH, PA. 30 TWELFTH ST. WHEELING, W.VA.
 Established 1919

RADIO
 holds great rewards for trained men



The big opportunities in Radio will be enjoyed by trained men. The International Correspondence Schools Radio Course, prepared by leading authorities and constantly revised, will help make you a trained man! A fascinating book—FREE.

ELECTRICAL ENGINEERING
 —A Great Industry with a Great Future

The new I. C. S. Course in Electrical Engineering covers this fascinating field thoroughly. If you are just starting or are on the way to a real paying position in this industry, this course brings the knowledge necessary for advancement.



MECHANICAL ENGINEERING
 —A Field with a Future

This I. C. S. Course has meant advancement to hundreds of ambitious mechanics, draftsmen, blacksmiths, foundrymen, patternmakers, apprentices, and mechanical engineers. You, too, will find that enrolling for an I. C. S. Course is an investment in a Bigger Future. Use the coupon!



AUTOMOBILE EXPERTS
 are always in demand

The rapid progress in manufacture and service of the modern automobile brings new opportunities to thousands of ambitious and forward-looking men. There's always a demand for trained men. The new I. C. S. Automobile Course will make you a trained man! The time to act is now. Use the coupon.



INTERNATIONAL CORRESPONDENCE SCHOOLS
 BOX 2881-D, SCRANTON, PENNA.
 Without obligation, send me full information on subject checked below:
 RADIO AUTOMOBILE COURSE
 ELECTRICAL ENGINEERING
 MECHANICAL ENGINEERING

<input type="checkbox"/> Architecture	<input type="checkbox"/> Drafting	<input type="checkbox"/> Accounting
<input type="checkbox"/> Concrete Construction	<input type="checkbox"/> Good English	
<input type="checkbox"/> Reading Shop Blueprints	<input type="checkbox"/> Salesmanship	
<input type="checkbox"/> Civil Engineering	<input type="checkbox"/> Advertising	
<input type="checkbox"/> Diesel Engines	<input type="checkbox"/> Show Card Lettering	
<input type="checkbox"/> Gas Engine Operating	<input type="checkbox"/> Civil Service	
<input type="checkbox"/> Refrigeration	<input type="checkbox"/> High School Subjects	
<input type="checkbox"/> Chemistry	<input type="checkbox"/> Air Conditioning	
<input type="checkbox"/> Highway Engineering	<input type="checkbox"/> Inventing and Patenting	
<input type="checkbox"/> Poultry Farming	<input type="checkbox"/> Aviation Engines	

Name _____ Age _____
 Address _____

Television—Why and How

(Continued from page 431)

programming television are not the least of its developers' worries, it was said. "It costs Hollywood \$400 to \$30,000 to produce a minute's worth of usable 'feature' film for a total of 600 hours entertainment a year. Present sound broadcasting networks render service for upwards of seventeen hours each day.

"Television must develop its own program technique. If we may summarize the ultimate characteristics of such programs in a word, it should be 'spontaneity.' Television must capture images of the world in action."

"Television networks of stations comparable to those existing in sound broadcasting," Dr. Goldsmith told his audience, "must await the development of either the co-axial cable or automatic radio relay stations. Meanwhile, if public service should be inaugurated, the individual station has recourse to three classifications of program material: local talent, motion picture film, and 'road shows' of live talent travelling from studio to studio." In the instance of the last, it was pointed out that stock companies would face the necessity of developing a new make-up technique, since the television camera does not see its images in the same values of color and tone as does the eye or motion picture camera.

Dr. Goldsmith, who has been actively interested in the development of television for more than a dozen years, said that upwards of ten million dollars, probably had been expended on its development to date, by all experimenters, and that current research appropriations might total between one and two million dollars a year.

Plenty of constructional articles in the next issue—including transmitters and receivers. Also don't forget that the Editors are looking, and will pay, for good "set construction" articles.

STATEMENT OF THE OWNERSHIP. Management, Circulation, Etc. Required by the Acts of Congress of August 24, 1912, and March 3, 1933
 Of Short Wave and Television published monthly at Mount Morris, Illinois, for October 1, 1937.
 State of New York }
 County of New York } ss.

Before me, a Notary Public in and for the State and county aforesaid, personally appeared Hugo Gernsback, who, having been duly sworn according to law, deposes and says that he is the Editor of the Short Wave and Television, and that the following is, to the best of his knowledge and belief, a true statement of the ownership, management (and if a daily paper, the circulation), etc., of the aforesaid publication for the date shown in the above caption, required by the Act of August 24, 1912, as amended by the Act of March 3, 1933, embodied in section 537, Postal Laws and Regulations, printed on the reverse of this form, to wit:

1. That the names and addresses of the publisher, editor, managing editor, and business managers are: Publisher, Popular Book Corp., 99 Hudson Street, N. Y. C.; editor, Hugo Gernsback, 99 Hudson Street, N. Y. C.; managing editor, H. Winfield Secor, 99 Hudson Street, N. Y. C.; business managers, none.

2. That the owner is: (If owned by a corporation, its name and address must be stated and also immediately thereunder the names and addresses of stockholders owning or holding one per cent or more of total amount of stock. If not owned by a corporation, the names and addresses of the individual owners must be given. If owned by a firm, company, or other unincorporated concern, its name and address, as well as those of each individual member, must be given.) Popular Book Corp., 99 Hudson Street, N. Y. C.; D. Gernsback, 99 Hudson Street, N. Y. C.; H. Winfield Secor, 99 Hudson Street, N. Y. C.

3. That the known bondholders, mortgages, and other security holders owning or holding 1 per cent or more of total amount of bonds, mortgages, or other securities are: (If there are none, so state.) None.

4. That the two paragraphs next above, giving the names of the owners, stockholders, and security holders, if any, contain not only the list of stockholders and security holders as they appear upon the books of the company but also, in cases where the stockholder or security holder appears upon the books of the company as trustee or in any other fiduciary relation, the name of the person or corporation for whom such trustee is acting, is given; also that the said two paragraphs contain statements embracing affiant's full knowledge and belief as to the circumstances and conditions under which stockholders and security holders who do not appear upon the books of the company as trustees, hold stock and securities in a capacity other than that of a bona fide owner; and this affiant has no reason to believe that any other person, association, or corporation has any interest direct or indirect in the said stock, bonds, or other securities than as so stated by him.

5. That the average number of copies of each issue of this publication sold or distributed, through the mails or otherwise, to paid subscribers during the twelve months preceding the date shown above is (This information is required from daily publications only.)

(SEAL) II. GERNSBACK, Publisher.
 Sworn to and subscribed before me this 23d day of September, 1937.
 MAURICE COYNE,
 New York County Clerk No. 500.
 (My commission expires March 30, 1938.)

Index to Advertisers

A	
Aladdin Radio Industries.....	457
Allied Engineering Institute.....	444
Allied Radio Corporation.....	441
Amperite Co.....	461
Autopower.....	459
B	
Bliley Electric Co.....	440
Brush Development Co., The.....	440
Bud Radio, Inc.....	448
C	
Cameradio Co.....	464
Candler System Co.....	451
Cannon, C. F., Company.....	440
Classified Advertisements.....	463
Clough-Brengle Co., The.....	450, 457
Cornell-Dubilier Corp.....	440
Coyne Electrical School.....	403
Crosley Radio Corporation, The.....	442
D	
Dataprint Company.....	459
Dodge's Institute.....	450
E	
Eilen Radio Labs.....	439
F	
First National Television, Inc.....	449
G	
Gadgets Magazine.....	461
Goldentone Radio Co.....	457
Gold Shield Products Co.....	459, 461
H	
Hallcrafters, Inc., The.....	Back Cover
Hammarlund Manufacturing Co., Inc.....	447
I	
Instructograph Company.....	450
International Correspondence Schools.....	464
J	
Jefferson Electric Co.....	455
K	
Kelsey Co., The.....	459
Kenyon Transformer Co., Inc.....	452
Korrol Radio Products Co.....	457
M	
McElroy, T. R.....	451
Midland Television, Inc.....	446
Midwest Radio Corporation.....	440
Modell's.....	454
N	
National Company, Inc.....	Inside Back Cover
National Radio Institute.....	401
National Schools.....	450
New Ideas.....	454
P	
Par-Metal Products Corporation.....	461
R	
Radcraft Publications.....	461
Radio Amateur Course.....	404
Radio & Technical Publ. Co.....	450
Radio Constructors Laboratories.....	437, 438
Radio Publications.....	452, 454
Radio Training Assn. of America.....	450
Raytheon Production Corporation.....	445
RCA Institutes, Inc.....	451
S	
Short Wave Coil Book.....	456
Short Wave League.....	458
Solar Mfg. Corp.....	459
Sprayberry Academy of Radio.....	459
Standard Transformer Corporation.....	448
Superior Instruments Company.....	457
T	
Technifax.....	457
Teleplex Co.....	451
Triplett Electrical Instrument Co.....	453
Tri-State College.....	451
Try-Mo Radio Co., Inc.....	463
Turner Co., The.....	459
U	
Ultra High Frequency Products Co.....	Inside Front Cover
United Radio Company.....	461
Universal Microphone Co.....	457
W	
Wellworth Trading Company.....	460
Wholesale Radio Service Co., Inc.....	443

(While every precaution is taken to insure accuracy, we cannot guarantee against the possibility of an occasional change or omission in the preparation of this index.)

Please mention SHORT WAVE & TELEVISION when writing advertisers

KABLE BROS. CO., PRINTERS



Announcing
NATIONAL NC-80X

The new National NC-80X Receiver is ready. It embodies basic new improvements that for the first time make it possible to design a high-performance communication receiver at a low price. A new crystal filter circuit provides continuously variable selectivity from 400 cycles to 5 kilocycles, and wide phasing range. By its use, noise and interfering signals are reduced enormously. A high IF frequency (1560 KC) separates image frequencies by so great a span that they are readily rejected. These features make it practical to eliminate preselector stages. Use of new tubes designed for very low plate voltages allow AC-DC operation without sacrifice in performance. Thanks to such refinements, it has been found possible to engineer this new receiver with the high quality of the NC-100X, including the famous Movable Coil Tuning Unit, and yet achieve the remarkably low price of \$88.00 Net, complete with speaker, tubes, and power supply. Two models are available, the NC-80X with coverage from 550 KC to 30 MC, and the NC-81X Amateur Model (illustrated) covering five amateur bands with extreme bandspread. The new National Catalogue No. 270 describes this fine receiver in detail.



NATIONAL COMPANY, INC., MALDEN, MASS.



W9ARA, winner of the A.R.R.L. DX contest for phone, says he is delighted with the performance of his New Super Skyrider.

W9WVZ of Marshall Pass, Colorado, with his 6 Volt Battery operated Sky Challenger "It's a privilege to own it" says he.

Thousands OF AMATEURS THE WORLD OVER USE HALLICRAFTERS RECEIVERS

If we had a telephoto camera, we could catch pictures of thousands of radio amateurs enjoying the marvelous performance, the razor-sharp selectivity and fine sensitivity of their Hallicrafters Receivers. Here are a few caught in Ninth District. We may show more in the future so why not send us a snapshot of your rig with your Hallicrafters receiver?

World's Largest Manufacturer of Amateur Communications Equipment

the hallicrafters inc.

2601 Indiana Avenue, Chicago, U. S. A.

Cable Address "Hallicraft" Chicago

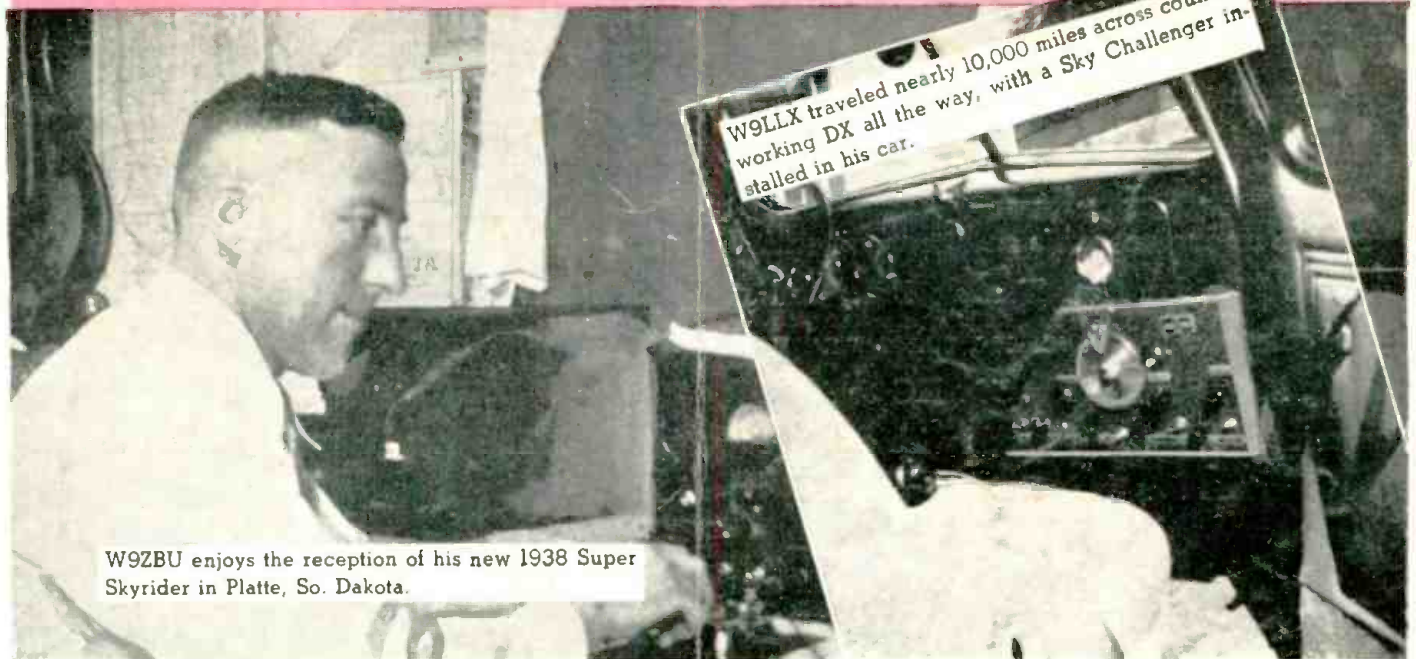

W9LLX traveled nearly 10,000 miles across country, working DX all the way, with a Sky Challenger installed in his car.

W9ZBU enjoys the reception of his new 1938 Super Skyrider in Platte, So. Dakota.