

# THE RADIO EXPERIMENTER'S MAGAZINE

HUGO GERNSBACK  
Editor

# SHORT WAVE CRAFT

January 1936

WORLD'S  
LARGEST  
SHORT WAVE  
CIRCULATION

Pg 538 Transmitter very good  
and easy to build little expense  
Pg 546 coil data for almost all  
SW sets including P.C. Peckle and  
"Merry DX-Mas!"  
a.c. Peckle

Pg 521 is the set which  
I will build and add  
2 stages of IF ahead of  
Pet-

Jan  
1936

Eng 5pm to  
6 pm 1020 on



25c  
IN CANADA  
30c

# Best and lowest priced WORLD GLOBES FOR SHORT WAVE LISTENERS



World  
Globe  
No. P-100

This beautiful floor model globe fills the demand for a globe of this type at a popular price. The 12" standard ball shows 67 prominent international short-wave stations—steamship routes, ocean currents, mountain peaks with heights, principal railroads, Lindbergh's flight and other important data will be found clearly printed on the globe.

The ball is mounted in a fully graduated, semi-meridian. The solid walnut base has been gracefully patterned to harmonize with the interior of home or office. The base is sturdily constructed.

A beautifully illustrated, 32-page book, "The Story of the Globe" is included with this model. It is full of interesting facts, including the Question and answer globe-game. Height of stand, including 12" globe—34". Shipping weight—12 lbs. **\$3.95**  
PRICE

**T**HESE remarkable, new globes printed in a variety of popular colors are indispensable to short-wave fans. Notable among the many features of these world globes, is that they give life-time service.

Short-wave fans are enabled to determine correct time in various centers of the world with the aid of these globes; distances from city to city can be accurately established.

There is a graduated "Meridian" scale on many of the globes. Another feature is the moveable hour scale found at the north pole—this facilitates determining the hour in any part of the world.

You will be thrilled when you put the globe to actual use—measuring distances from New York to Moscow; from Cape Town to Tokio; from Los Angeles to Rio de Janeiro; etc. A flat map is deceptive for measuring, but take a small string and stretch it across the globe, from city to city, and you have the correct distance.

Each globe contains a listing of several thousand cities in nations all over the world—spellings conform to international geographic standards—all globes are of 1935 production. They contain such important features as—places of Admiral Byrd's recent voyage to Little America; Lindbergh's Paris flight; the new Japanese Empire; principal railroads; principal international short-wave radio stations and call letters;

The colors on our fine handmade or Library globe maps are refined and delicate. Nevertheless, the two types have an essential characteristic in common—their rich color harmony, in which each color of equal strength blends into a harmonious color unit.

The map surface of all models is protected by a high, glazed, water and scratch proof finish which can easily be kept fresh and new with a damp cloth. This finish will not fade, crack or become yellow with age. The colors are sun proof.

These globes add dignity to home, office, studio or laboratory—they are globes that everyone will be proud to own.



World Globe No. P-88

This 8" standard globe, which has been the most popular seller, includes many fine features. You will find Manchukuo, the new Japanese empire; thousands of place names; ocean currents; famous ruins; principal railroads; Lindbergh's flight; Little America; and other essential data.

With each of these beautiful globes you receive, FREE, a 16-page globe-game book "Do You Know . . . ?" It contains 146 questions and answers about curious and fascinating geographic facts.

The 8" ball is mounted in a full meridian, carefully graduated. The ring, of unbreakable steel, is finished in statuary bronze and gold. Height—11 1/4". **\$1.75**  
Shipping weight—30 lbs. PRICE

U. S. Army Air Corps,  
Dryden, Texas.

Gentlemen:  
Receipt is acknowledged of the "Short Wave World Globe" which arrived okay today and am very well pleased with same. The writer desires to thank you for attention to this order.

The globe was received at our local express office this morning, in good condition. The agent had never seen one of this type, so upon demonstrating the globe to him, he "fell in love" with it immediately and wrote down your address, saying that he would order one immediately.

(S) S. H. Buelanan,  
Radio Operator.



World  
Globe  
No. P-75

This beautiful 7" Radio Globe, with 55 principal international short-wave stations and call letters, is attractively mounted in a half ring, with a sturdy spun steel base. The stand is finished in statuary bronze.

The highly glazed surface of this ball is scratch-proof as well as water-proof. It shows 2,500 place names; it is printed in seven, rich, beautiful colors. Important geographic information such as: Lindbergh's flight, Byrd's travels through Little America, etc., will be found on the map. Height—10". Shipping weight—2 1/2 lbs. PRICE **85c**

World Globe  
No. P-212

The 12" standard globe was the first to list principal international short-wave stations and call letters. On this map are printed 67 prominent short-wave stations—quickly recognized since they are printed in red. They are accurate and up-to-date.

Such data as: steamship routes, ocean currents, mountain peaks, principal railroads, Lindbergh's flight, and other useful information will be found on the globe. There are over 5,000 place names shown.

This attractive globe is highly suitable for home, studio, school or office. It is extremely low in price when compared to its beauty and utility value.

A 32-page booklet, well illustrated, entitled "The Story of the Globe" is included with this world globe. Height—16 1/4". Shipping weight—6 1/2 lbs. PRICE **\$2.95**



ORDER YOUR GLOBE TODAY!

**SHORT WAVE CRAFT** SWC-1-36  
99 Hudson St., New York, N.Y.

Gentlemen: Enclosed you will find my remittance of \$..... for which please ship me the following:  
World Globe.

World Globe No. P-75 @ \$ .85  
 World Globe No. P-88 @ 1.75  
 World Globe No. P-212 @ 2.95  
 World Globe No. P-100 @ 3.95

Name .....

Address .....

City .....

State .....

Send remittance in check or money order—register letter if it contains cash, stamps or currency. **GLOBES ARE SHIPPED FROM OUR WAREHOUSE IN CHICAGO, P.O.B. FROM THAT CITY.**

All globes are carefully packed in original, corrugated protected, cartons, assuring safe delivery. **ORDER BY NUMBER.** Send check or money order, plus sufficient postage for delivery by parcel post. Globes are shipped from our Chicago warehouse. Register letter if it contains cash, currency or stamps. Specify if shipment is to be sent express collect. **ALL ORDERS ARE FILLED PROMPTLY.**

SHORT WAVE CRAFT

99 HUDSON STREET,  
NEW YORK, N. Y.

# Read what happened

## to these two men

### when I said:



**YES!**

I'll take your training. That's what S. J. Ebert said. He has made good money and found success in Radio.



**NO!**

I'm not interested. That's what this fellow said. Today he would be ashamed if I gave you his real name.

# I will Train You at Home in Spare Time for a GOOD JOB IN RADIO

These two fellows had the same chance. They each clipped and sent me a coupon, like the one in this ad. They got my book on Radio's opportunities.

S. J. Ebert, 104-B Quadrangle, University of Iowa, Iowa City, Iowa, saw that Radio offered him a real chance. He enrolled. The other fellow, whom we will call John Doe, wrote that he wasn't interested. He was just one of those fellows who wants a better job and better pay, but never does anything about it. One of the many who spend their lives in a low-pay, no-future job, because they haven't the ambition, the determination, the action it takes to succeed.

But read what S. J. Ebert wrote me and remember that John Doe had the same chance: "Upon graduation I accepted a job as serviceman, and within three weeks was made Service Manager. This job paid me \$40 to \$50 a week compared with \$18 I earned in a shoe factory before. Eight months later I went with Station KWCR as operator. From there I went to KTNT. Now I am Radio Engineer with WSUI. I certainly recommend the N.R.I. to all interested in the greatest field of all, Radio."

**Get ready for Jobs like these. Many Radio Experts make \$30, \$50, \$75 a week**

Spare time and full time set servicing; installing, operating, maintaining broadcast, aviation, commercial, police, ship and television stations. Opportunities with Radio dealers and jobbers. A service shop or re-



"I want to help you. If you are earning less than \$35 a week I believe I can raise your pay. However, I will let you decide that. Let me show you what I have done for others, what I am prepared to do for you. Get my book, read it over, and decide one way or another." J. E. Smith.

tail Radio business of your own. I'll train you for these and other good jobs in connection with the manufacture, sale and service of Radio sending and receiving sets, auto Radios, loud speaker systems, short wave sets, etc.

**Save Money—Learn at Home. Money Back Agreement Protects You**

Hold your job. I'll train you quickly and inexpensively right at home in your spare time to be a Radio Expert. You don't need a high school or college education. My 50-50 method of training—half with lessons, half with Radio equipment—gives you broad practical experience—makes learning at home easy, fascinating, practical. I will

agree in writing to refund your money if you are not satisfied with my Lesson and Instruction Service when you graduate.

**Many Earn \$5, \$10, \$15 a Week in Spare Time While Learning**

That's what many of my students earn in spare time while taking my course. I send you Extra Money Job Sheets containing tested plans and ideas to help you do it. Many students have made \$200 to \$1,000 in spare time while learning. Nearly every neighborhood offers a spare time serviceman an opportunity to make good money. I'll show you how to "cash in"—show you why my Course is famous as "the Course that pays for itself."

**Find Out What Radio Offers You**

Mail the coupon. My book is free to any ambitious fellow over fifteen years of age. It tells you about Radio's spare time and full time opportunities—about my Course, what I give you, what my students and graduates do and earn. There is no obligation. Act today. Mail coupon in an envelope or paste on a 1c postal card. Do it right now.

**J. E. SMITH, President National Radio Institute, Dept. 6AB3 Washington, D. C.**



**Get my FREE LESSON on Radio Servicing Tips**

I'll prove that my training is practical, money-making information. That it is easy to understand—that it is just what you need to master Radio. My sample lesson text, "Radio Receiving Troubles—the Cause and Remedy" covers a long list of Radio receiver troubles in A.C., D.C., battery, universal, auto, T.R.F., super-heterodyne, all-wave and other types of sets. And a cross reference system gives you the probable cause and a quick way to locate and remedy these set troubles. A special section is devoted to receiver check-up, alignment, balancing, neutralizing and testing. Get this lesson Free. No obligation. Just mail coupon.



**FOR FREE BOOK OF FACTS ABOUT RADIO**

J. E. SMITH, President, Dept. 6AB3 National Radio Institute, Washington, D. C.

Dear Mr. Smith: Without obligation, send me in the Sample Lesson and your free book about spare time and full time Radio opportunities, and how I can train for them at home in spare time. (Please write plainly.)

NAME ..... AGE .....

ADDRESS .....

CITY ..... STATE.....14X1

Please mention SHORT WAVE CRAFT when writing advertisers

## IN THIS ISSUE: PROMINENT SHORT-WAVE AUTHORS

Vette • Cisin • Gregor • Shuart • Palmer

**HUGO GERNSBACK**  
Editor



**H. WINFIELD SECOR**  
Managing Editor  
**GEORGE W. SHUART,**  
W2AMN  
Associate Editor

### Contents for January, 1936

Editorial—The Glories of Short Waves, by Hugo Gernsback .....	517
New S-W Sets at the German Radio Show.....	518
Solar Phenomena and Their Effect on Short Waves.....	519
How Waves Are Propagated from Different Antennas, by H. W. Secor.....	520
Improved 3-Tube DOERLE for Battery Operation.....	521
5-Meter TRANSCEIVER Uses "Midget" Tubes, by Art Gregor .....	522
World-Wide Short-Wave Review, edited by C. W. Palmer .....	524
Talking on One-Half Meter! By George W. Shuart, W2AMN .....	526
Short Waves and Long Raves—Our Readers' Forum.....	528
Short Wave Scouts—"Silver Trophy" Award.....	530
New Circuit Testing Unit, by William J. Vette.....	531
An All-Electric Amplifier and Power Supply, for small S-W Receivers, by H. G. Cisin, M. E.....	532
What's New in S-W Apparatus—2.5 and 5-Meter Super-Het .....	533
11-Tube "Communications" Receiver, with a Range of 1.5 to 25 mc.....	534
Practical 5-Meter Antenna Design, by Arthur H. Lynch.....	535
Radio Amateur Course, by George W. Shuart, W2AMN.....	536
The "SG3" Transmitter—Made from "Receiver" Parts, by George W. Shuart, W2AMN.....	538
\$5.00 for Best Short-Wave "Kink".....	540
Short-Wave Stations of the World, edited by M. Harvey Gernsback .....	541
Short Wave League—Keeping the S-W Club "Alive".....	545
Short Wave QUESTION BOX.....	546
Short Wave Scout "NEWS".....	548
When to Listen in, edited by M. Harvey Gernsback.....	575
Latest Tube Developments.....	564

### Features in the February Issue

- Another S-W Receiver for the Beginner, by Walter C. Doerle.
- Metal Tube T.R.F. Receiver, by M. Harvey Gernsback.
- 5-Meter M. O. P. A. Transmitter using Three 89 Receiver-Type Tubes, by George W. Shuart, W2AMN.
- Universal "Tester" for the Ham and S-W Experimenter—Measures A.C. and D.C. Voltage, Current and Resistance.
- Latest Television News—including a New Mechanical Scanning System.
- Talking on an "Infra-Red" Light Beam.



### Certified Circuits

● **SHORT WAVE CRAFT** goes to a large expense in verifying new circuits. When you see this seal it is your guarantee that such sets have been tested in our laboratories, as well as privately, in different parts of

the country. Only "Constructional-Experimental" circuits are certified by us.

When you see our certified seal on any set described, you need not hesitate to spend money for parts, because you are assured in advance that the set and circuit are bona fide and that this magazine stands behind them.

**SHORT WAVE CRAFT** is the only magazine that certifies circuits and sets.

### OUR COVER

"Merry DX-mas" is the title of this month's cover illustration. It incorporates the two principal Xmas thoughts uppermost in the mind of every short wave fan and Ham—a new radio receiver for Xmas; one that can "step out" and bring in that "DX"!

COPYRIGHT, 1935, BY H. GERNSBACK

Published by **POPULAR BOOK CORPORATION**

**HUGO GERNSBACK**, President - - - - **H. W. SECOR**, Vice-President  
**EMIL GROSSMAN** - - - - - Director of Advertising  
 Chicago Adv. Office - - - - - **L. F. McCLURE**, 919 No. Michigan Ave.  
 Los Angeles Adv. Office - - - - - **J. A. Kendall**, Box 176, Arcade Annex  
 Publication Office - - - - - 404 N. Wesley Avenue, Mount Morris, Ill.  
 Editorial and General Offices - - - - - 99-101 Hudson St., New York, N. Y.  
 European Agent: Goringe's American News Agency, 9A Green St.,  
 Leicester Square, London W. C. 2  
 Australian Agents: **McGILL'S AGENCY**, 179 Elizabeth St., Melbourne

**SHORT WAVE CRAFT**—Monthly. Entered as second class matter May 7, 1930, at the post office at Mount Morris, Illinois, under the act of March 3, 1879. Trademarks and copyrights by permission of H. Gernsback, 99-101 Hudson St., N. Y. C. Text and illustrations of this magazine are copyrighted and must not be reproduced without permission. **SHORT WAVE CRAFT** is published on the 1st of every month. Twelve numbers per year. Subscription price is \$2.50 a year in the United States and possessions. Canada and foreign countries, \$3.00 a year. Single copies 25c. Address all contributions for publication to Editor, **SHORT WAVE CRAFT**, 99-101 Hudson St., New York, N. Y. Publishers are not responsible for lost manuscripts. Contributions cannot be returned unless authors remit full postage. **SHORT WAVE CRAFT** is for sale at all principal newsstands in the United States and Canada. European agents: Brentano's, London and Paris. Printed in U. S. A. Make all subscription checks payable to Popular Book Corporation.



STUDENTS BUSY AT WORK IN LARGE COYNE SHOPS

# Learn RADIO

**SEND TODAY FOR DETAILS OF MY Pay-Tuition-after-Graduation Plan!**

Train for Radio in 90 days, right here in the big Coyne Shops — not by correspondence — but on real Radio, Sound and Television equipment. Mail the coupon below. If you are short of money I'll send you all details of my finance plan and consider your application. If accepted, you won't have to start paying tuition back until five months from the date you start school, and then you'll have over a year to complete your payments.

## Tremendous Developments Ahead in Radio and Television!

HERE is YOUR opportunity to cash in. Every day brings news of new developments in every branch of Radio and Television, with more opportunities, more jobs, and a greater future for the trained man than ever before. I consider the fellow who is ambitious enough to want to get ahead by taking my Training, worthy of my help. MAIL THE COUPON BELOW and you can prove to me that you are willing to spend just 12 weeks in the Coyne Training Shops learning Radio. Then, I'll tell you about my finance plan which has enabled many to get complete Training and pay tuition back later.

## Learn By Doing In 90 Days

I don't care whether you are 16 or 45. It makes no difference to me if you don't know an oscillator from a spark coil. You don't need any previous experience or advanced education to master my Shop Training. Don't let lack of money hold you back from getting all details of my amazing plan.

### MANY EARN While LEARNING

If you need part-time work to help pay your living expenses and will tell us your problems we may be able to help you as we have thousands of others. Then, in 12 brief weeks, in the great Training shops of Coyne, you will learn on a wide variety of modern, up-to-date A. C. Superheterodyne sets, oscillators, analyzers and test instruments. Prepare for Amateur Broadcast, or Telegraph Radio Operator's License and to know all code and Dept. of Commerce rules for a government License Examination.

### TRAINING

#### By Actual Work

No dull books . . . you get individual training . . . real actual work with only the theory you will need. Building real radio sets,



### Auto Radio Instruction Prepare For Jobs Like These

Here are a few of hundreds of positions in the Radio field. My free employment bureau gives you life-time employment service.

- AIRCRAFT RADIO OPERATOR
- SHIP RADIO OPERATOR
- RADIO SERVICING
- PUBLIC ADDRESS SYSTEMS
- BROADCAST STATION OPERATOR
- TALKING PICTURE STUDIOS
- TELEVISION LABORATORY MAN

doing radio wiring and testing, trouble-shooting, repairing and servicing. That's a glimpse of how we help to make you a Radio expert, and fit you to qualify for jobs leading to the biggest pay.

### Jobs - Pay - Future

"I got my present job two days after graduation, at shorter hours, and wages increased 60% over my old job," reports Arne Wiklem of Minnesota. "I have my own shop, own a real car and make fine money in the radio business," writes E. Allen of Montana. "All this is possible because I came to Coyne." And I could go on quoting from hundreds of letters of successful Coyne Trained men. What they have done, you should be able to do.

### Electric Refrigeration Air Conditioning

Right now I'm including my new Electric Refrigeration and Air Conditioning course at no extra cost.

### GET THE FACTS

Coyne is your one great chance to get into Radio. This school is 36 years old—Coyne training is tested—proven beyond all doubt—endorsed by many large concerns. You can find out everything absolutely free. Simply mail the coupon and let me send you the big, free Coyne Book with photographs . . . facts . . . jobs . . . salaries . . . opportunities. Tells you how many earn expenses while training and how we assist our graduates in the field. This does not obligate you. So act at once.

**MAIL Coupon Today for FREE! BOOK!**



*H. C. Lewis*



### Home of Coyne Shops

This is our fireproof modern building wherein is installed thousands of dollars' worth of Radio equipment of all kinds. Every comfort and convenience has been arranged to make you happy and contented during your Training.

**COYNE** H. C. LEWIS, President **Founded 1899**  
**RADIO & ELECTRICAL SCHOOL**  
 500 South Paulina Street Dept. 16-2K Chicago, Ill.

**H. C. LEWIS, President Coyne Radio & Electrical School 500 S. Paulina St. Dept. 16-2K, Chicago**

Dear Mr. Lewis: Without obligation send me your big free catalog and all details; also tell me all about your "Pay-Tuition-After-Graduation" Plan.

Name..... Age.....  
 Address.....  
 City..... State.....

Please mention SHORT WAVE CRAFT when writing advertisers

● IT IS always the well-trained man who wins out over the horde of thousands of superficially trained and incompetent men. You are reading this magazine because you are interested in radio. Sooner or later, the time will come when you will wish to cash in on your knowledge. Your chance may come over night, and then the big and vital question will be, "How well equipped am I to fill the job?" You are in radio because you like it. You also realize that, at the present time, there are many branches of the radio art which you do not know as thoroughly as you should. Knowledge, these days, can be gotten cheaper than ever before. It isn't necessary

# CUT PRICES ON RADIO BOOKS

for you to go to college to become proficient in radio. Start today, to build a REAL radio library and become acquainted with all branches of this great and growing art. In this page are listed the world's best radio books. We have combed the market for the really important books in radio; so that, no matter what branch you are interested in, you can pick out the best books that are now printed. Start, now, to build a complete radio library. You do not have to get all the books at once, but make up your mind to get one book a month; so that, when your chance comes, you will be fully equipped to win out over the others not so well equipped.

**IMPORTANT—All prices have been drastically reduced—many new books.**

**SHORT WAVE WIRELESS COMMUNICATION.** by A. W. Ladner and C. R. Stoner. Cloth covers, size 6 1/2" x 9 1/2". 348 pages, 200 illustrations, 12 plates. 200 illustrations. Price **\$3.46**

Short wave experimenters who have grown out of 1-tube sets will revel in this book, which tells the "how come" of short-wave operation. A good portion of the volume is devoted to the amateur and commercial aspects of S. W. transmission.

**SHORT WAVES.** by C. R. Leutz and R. B. Gable. Cloth covers. Size 6x9". 384 pages, 258 illustrations. Price was formerly \$2.98. **NEW PRICE NOW, \$1.15**

The biggest and most complete book on short waves. Covers every imaginable phase, including S. W. Superheterodynes, Television, Aircraft Radio, Ultra Short Waves, Directional Antennae, etc. The authors are famous short-wave authorities. This is the best book on Short-Waves in print today.

**PRACTICAL TELEVISION.** by E. T. Larner. Cloth covers, size 5 1/2" x 8 1/2". 223 pages, 127 illustrations. Price **\$3.69**

This book explains television in full, including elementary principles, photo-electric cells, and all important types of television sets as well as basic principles of optics, images, mirrors, lenses, etc.

**OFFICIAL SHORT-WAVE RADIO MANUAL, Volume 1.** by Hugo Gernsback and H. W. Secor, with 352 pages, illustrations. Flexible, looseleaf leatherette binder. Size 9x12". Price **\$2.00**

The one and only short-wave manual published. Contains constructional information on the most important Short-Wave Receivers, S.W. Transmitters, Ultra Short Waves, S.W. Beginner's section, coil winding, A.C.-S.W. Power Packs, kinks, etc., for S.W. Experimenters, sections on S.W. Converters, Antennae, Superheterodynes, Amateur Phone Transmitters, Super Regeneration in S.W. Receivers, S.W. Therapy, S.W. Physics, etc.

**ELEMENTS OF RADIO COMMUNICATION (Second Edition).** by John H. Morecroft. Cloth covers, size 6 x 9 1/2". 246 pages, 211 illustrations. Price **\$2.98**

An introductory volume, written in easily understandable style, to the more comprehensive, "Principles of Radio Communication."

**AUDELS RADIOMAN'S GUIDE.** by Frank D. Graham. Cloth covers (flexible), size 5 1/2" x 8 1/2". 220 pages, 500 illustrations. Price **\$ .89**

A practical, concise book presenting the theoretical and practical information for the proper operation, maintenance and service as applied to modern radio practice.

**EXPERIMENTAL RADIO.** by R. R. Ramsey, Prof. of Physics, Indiana University. Cloth covers, size 7 1/2" x 5 1/2". 256 pages, 168 illustrations. Price, **\$2.69**

A marvelous book for the experimenter. Experiments galore in easy comprehensible language.

**FOUNDATIONS OF RADIO.** by Ludolph L. Duncan. Cloth covers, size 5 1/2" x 8 1/2". 246 pages, 145 illustrations. Numerous tables. Price **\$2.47**

This textbook gives you the fundamentals of electricity as applied to radio. It equips you for further study in the field of radio.

**THE RADIO AMATEUR'S HANDBOOK.** (New Revised Edition), by A. Frederick Collins. Cloth covers, size 5 1/2" x 7 1/2". 394 pages, 116 illustrations. Price **\$1.97**

If you wish to become a radio amateur (radio ham) this book tells you how. Everything in receiving and transmitter sets and how to build them.

**RADIO THEORY AND OPERATING.** by M. T. Loomis. 5th revised Edition. Cloth-bound; size 5 1/2" x 8 1/2". thick; 1,000 pages; over 800 illus.; 450 review questions and answers. Price **\$4.38**

Written in textbook style, a tremendous amount of useful information has been crammed into this thin-paper, compact reference work. Radio transmission and reception have been covered, "from soup to nuts." A truly great book.

**THEORY OF VACUUM TUBE CIRCUITS.** by Leo Jaimes Peters. Cloth covers, size 6 1/2" x 9 1/2". 226 illustrations, 226 pages. Price **\$2.98**

It is one thing to "connect green lead No. 1 to pink lead No. 4," but it is another to know why the connections are made. Read this book and learn the design factors in tube circuits.

**PRINCIPLES OF RADIO COMMUNICATION.** by J. H. Morecroft, Prof. of Electrical Engineering, Columbia University. Cloth covers, size 9 1/2" x 6 1/2". 988 pages. Profusely illustrated. Price **\$7.35**

The radio classic by the dean of radio. Covers entire radio art as does no other book.

**SHORT WAVE RADIO HANDBOOK.** by Clifford E. Denton. Paper covers, size 6 1/2" x 8 1/2". 128 pages, 150 illustrations. Price **\$1.00**

Full data, circuit data, testing data, I.F. and A.F. amplifier data—in fact, let us say, "data of every imaginable sort—in connection with short-wave radio reception."

**DRAKE'S CYCLOPEDIA OF RADIO AND ELECTRONICS.** by H. P. Manly. Cloth covers, size 6 1/2" x 9 1/2". 1056 pages, 1080 illustrations. New 1935 Edition. Price **\$4.88**

The latest work of its kind ever put between two covers. New and up-to-date; a standby for every radio man.

**FUNDAMENTALS OF RADIO.** by R. R. Ramsey, Professor of Physics, Indiana University. Cloth covers, size 9 1/2" x 6 1/2". 372 pages, illustrated. Price, prepaid **\$3.46**

The backbone of the radio art. This book gives you the foundation on radio from A to Z.

**OFFICIAL RADIO SERVICE MANUAL, Volume 4.** by Hugo Gernsback and C. Walter Palmer. Flexible, looseleaf leatherette cover, size 9x12". Over 2,000 illustrations, over 400 pages. Price **\$3.00**

Prepaid. Whether for public address work, receiver diagrams or tube data, every conceivable kind of radio set information needed will be found in this great service manual.

**OFFICIAL RADIO SERVICE MANUAL, Volume 5.** by Hugo Gernsback and C. Walter Palmer. Flexible, looseleaf leatherette cover, size 9x12". Over 3,000 illustrations, over 1,000 pages. Printed on thin bible paper. Price Prepaid **\$5.86**

This 1935 Manual is the most authentic and elaborate service guide ever used in the radio field. There has never appeared such a complete radio manual as this one.

**EXPERIMENTAL RADIO ENGINEERING.** by John H. Morecroft. Cloth covers, size 6 1/2" x 9 1/2". 346 pages, 250 illustrations. Price **\$3.46**

A student's book; devoted to the principles of radio apparatus; intended to accompany a course in electricity. The best of its kind.

**RADIO CONSTRUCTION AND REPAIRING.** by James A. Moyer and John F. Wostrel. Cloth covers, size 8 1/2". Well illustrated, new revised fourth edition, containing 444 pages, still remaining at the same price. Price **\$2.50**

A handbook that every radio set tester and general student must have. The diagrams alone are worth the price of the book.

**RADIO ENGINEERING HANDBOOK.** by Keith Henney. Flexible Leatherette, size 4 1/2" x 7", 581 pages, 482 illustrations. Price **\$4.88**

Each of the 23 sections has been written by a specialist! Includes valuable data on talkies and short waves.

**RADIO SERVICE MAN'S HANDBOOK WITH ADDENDA DATA SHEETS.** Flexible covers, size 9 1/2" x 7", 200 pages, 400 illustrations. Price prepaid **\$1.49**

The Service Man's standby. Contains the latest practical information on radio servicing.

**HOW TO PASS U. S. GOVERNMENT RADIO LICENSE EXAMINATIONS.** by R. L. Duncan and C. E. Drew. Flexible covers, size 9 1/2" x 7". 170 pages, 92 illustrations, appendix. Price **\$1.89**

The most important book on the subject ever published. Gives every conceivable angle which will help you to pass a radio license examination successfully.

**RADIO OPERATING QUESTIONS AND ANSWERS.** (Revised Fifth Edition), by Nilson and Hornung. Cloth covers, size 5 1/2" x 8". 390 pages, 96 illustrations. Price **\$2.47**

Contains over 600 questions and answers covering all phases of licensed radio operation. Revised to contain much new material. Nothing better in print.

**RADIO PHYSICS COURSE** (2nd enlarged edition), by Alfred A. Ghirardi. Cloth covers, size 7 1/2" x 9 1/2". 992 pages, 510 illustrations, numerous tables. Price **\$3.89**

The finest and most popular book on electricity and radio. Each subject is clearly discussed, with the aid of dozens of excellent drawings. Chapters on talkies, television, electronics and service work, etc. Highest buy in radio.

**5 METER RADIOTELEPHONY.** by Frank Jones. 52 pages, 49 illustrations. Price, per copy, postpaid **\$.25**

Here you learn to construct a variety of 5 meter transmitters and antennas. Written by the designer of the 5 meter equipment for the San Francisco Bay Bridge.

**PRINCIPLES OF RADIO.** by Keith Henney, M. A. Cloth covers, size 8 1/2" x 6 1/2". 478 pages, 306 illustrations. Price **\$3.46**

A marvellously written textbook with the latest radio principles, including screen grid and pentode, amplifiers, etc.

**PHOTOCELLS AND THEIR APPLICATION.** (Second Edition), by V. K. Zworykin and E. D. Wilson. Cloth covers, size 5 1/2" x 8 1/2". 332 pages, 180 illustrations. Price **\$2.88**

Does this book tell you why and how to use light-sensitive cells? The answer is that the first edition was a "sell out," and the second edition, brought right up to date, is even a better volume. Enough said.

**ELECTRONICS.** by H. C. Hudson. Cloth covers, size 6 1/2" x 9 1/2". 45 pages, 45 illustrations. Price **\$1.95**

"This book is written for the reader who may wish to know something about what is going on and who has not heretofore given the matter much attention," says the author. Read it and learn how dry rectifiers, vacuum tubes, batteries, television tubes, and other apparatus, work; get the "low down" on electrons and atoms.

**MODERN RADIO SERVICING** (2nd Revised and Greatly Enlarged Edition of Radio Servicing Course) by Alfred A. Ghirardi. Cloth covers, size 8 x 6". 1300 pages, over 700 illustrations. Price **\$4.00**

One of the greatest text books on radio servicing. Contains hundreds of facts on up-to-date servicing methods—construction and operation of latest test equipment, auto radios, all-wave receivers, etc.

**RADIO ENGINEERING.** by Frederick Emmons Terman. Cloth covers, size 6 1/2" x 9 1/2". 700 pages, 425 illustrations. Price **\$4.88**

Not a book for the beginner in radio, but a reference volume for the technician who wants modern information on the design and use of hand-selectors, automatic volume control, diode detectors, and the thousand-and-one units and circuit arrangements which have been recently developed.

**NEW LOW PRICE RADIO BOOKS**

Here are 14 new, up-to-date books on every conceivable radio subject, just published. Modern in second sense. ALL BOOKS UNIFORM in size, 6 1/2" x 9 1/2"; 50 to 120 illustrations. All books written by well-known radio authors. Order by Number.

- No. 1 RADIO SET ANALYZERS
  - No. 2 MODERN RADIO VACUUM TUBES
  - No. 3 THE SUPERHETERODYNE BOOK
  - No. 4 MODERN RADIO HOOKUPS.
  - No. 5 HOW TO BECOME A RADIO SERVICE MAN
  - No. 6 BURNING ELECTRIC (RADIO) SETS UP TO DATE.
  - No. 7 RADIO KINKS & WRINKLES (for Experimenters)
  - No. 8 RADIO QUESTIONS & ANSWERS.
  - No. 9 AUTOMOBILE RADIO & SERVICING
  - No. 10 HOME RECORDING AND ALL ABOUT IT.
  - No. 11 POINT-TO-POINT RESISTANCE MEASUREMENTS by C. E. Denton
  - No. 12 PUBLIC ADDRESS INSTALLATION AND SERVICE
  - No. 13 HOW TO BUILD AND OPERATE SHORT WAVE RECEIVERS, by the Editors of SHORT WAVE CRAFT
  - No. 14 HOW TO BECOME AN AMATEUR RADIO OPERATOR.
- PRICE PREPAID **\$ .45**  
EACH BOOK.  
PRICE PREPAID FOR ALL 14 BOOKS **\$6.00**

**HOW TO ORDER** We cannot ship C. O. D. Our prices are net, as shown. Some of the books sent prepaid (in U. S. only). Those that are not thus listed will be shipped by express collect if sufficient postage is not included by you.

**ORDER DIRECT FROM THIS PAGE**

**ELECTRICITY AT HIGH PRESSURES AND FREQUENCIES.** by Henry L. Transtrom. Paper covers, size 7 1/2" x 5 1/2". 248 pages, 131 illustrations. Price Prepaid **\$1.89**

A marvelous book for the student in electricity and radio. General fundamentals lead up to a complete discussion of every type of Tesla and Oudin high-frequency coils, Geissler tubes, etc.; construction details of Tesla coils are given in great profusion. THE ONLY BOOK OF ITS KIND.

**THE RADIO MANUAL.** by George E. Sterling and Robt' M. Kruse, E.E. 2nd enlarged edition. Flexible fabricoid covers. Size 5 1/2" x 8 1/2". 805 pages, 358 illustrations. Price **\$5.88**

A complete Radio Course for the operator, the technician, the amateur, the student and experimenter. Everything imaginable in the whole radio art is covered in this great book—the "radio Bible" of the amateur. DON'T MISS THIS.



# The Glories of Short Waves

An Editorial By HUGO GERNSBACK

● EVER since the beginning of radio, there has been woven about this art a particular romance which has kept increasing as the years went by. The thrills that humanity got when the first important SOS was flashed from mid-ocean and heralded the rescue of many lives, fired the popular imagination as very few events had done heretofore. Then, the very idea of *communication through free space without even wires*, made for romance in itself. Finally, the spoken word hurled across hundreds of miles, and lately over thousands of miles regularly by *short waves*—all this has helped to bring glory to the art of radio and, particularly, to short waves.

But then, it should never be forgotten that we are still at the very beginning of radio in general. Our instruments and apparatus are still very crude. We are still groping around in the dark. Most of the basic facts in radio we do not know.

David Sarnoff, president of the Radio Corporation of America—easily the most dynamic figure in radio today—is one who holds these views.

In mid-ocean last month, while Mr. Sarnoff and the writer were discussing radio, Mr. Sarnoff proposed the question, "What," said he, "is radio's biggest asset?" I ventured the opinion that perhaps radio's greatest asset lay in short waves.

"No," replied Mr. Sarnoff. "RADIO'S GREATEST ASSET LIES IN OUR IGNORANCE OF ITS FUTURE."

You have to let this statement sink into your consciousness for a while, to appreciate its real importance. Mr. Sarnoff, of course, means that, since we are ignorant of what the future holds for radio, we cannot tamper with it and work mischief with something yet unknown. He also means that the future of radio holds much more than the past, a thing on which probably all of us agree with him. Further Mr. Sarnoff believes that some day in the future you will be enabled, by means of a *wrist-watch* short-wave radio, to talk with your wife in China; if she does not answer, it will mean that she is not wearing her wrist-watch radio, or that she is incapacitated.

Mr. Sarnoff is quite serious when he talks in this fashion and, while our present-day radio engineers may not be able to conceive the instrumentalities by which this will all come about, there is no question that we are headed exactly toward this goal.

Consider the fact that, when Marconi in 1901 sent his first letter "S" across the Atlantic, it required 10 kilowatts, or over 13 horsepower to do it. Machines weighing many

tons were necessary to generate this power. In addition to this, it required a fearful array of radio masts, with tons of copper wire, to send the signal across the Atlantic. Then, in Newfoundland, the Marconi operators picked the weak signal from the air on a 400-ft. wire suspended from a kite.

This performance makes any 14-year-old radio experimenter smile today because, with a little transmitter requiring a few dry cells, and an aerial strung around his own living room, he can now call up his friends at the Antipodes and get back an answer in a few seconds. The entire equipment need not weigh more than ten pounds, and the power is less than that of a 60-watt electric light bulb. In other words, in 34 years we have achieved the result whereby instead of using hundreds of tons of equipment, a few pounds give us much better results, so far as radio is concerned.

What will the resulting picture be in the future, when we have Mr. Sarnoff's wrist-watch radio? Here we will have a little instrument, small enough to actually slip onto your wrist, containing a few tubes, the battery perhaps being carried in your pocket. The tiny loudspeaker is also the "microphone." When you wish to talk, you

press one button; when you wish to hear, you press another button. The wavelength adjustment will be done automatically. Yes, and it probably will be crystal-operated too, in order that you shall "stay on your frequency," so that you will not clash with Tom Jones, who a half mile away from you, is talking to *his* wife—who may be in mid-ocean on a pleasure trip. The transmitting and receiving antenna for the wrist-watch radio will be concealed, right on your own person, it being only a strip of flexible wire sewed into your suit—or dress if you are a lady—when the suit or dress is first made by the tailor.

Will you be talking *directly* to your wife in China? Perhaps not at first. You will be sitting in your automobile, talking with the nearest telephone central, who will make the direct connection to China, and thence, by short waves, to your wife. The parallel to this is when you are on a steamship in mid-ocean today, and call up your home in Chicago. You do not talk by short waves *direct* to Chicago. The ship operator makes connection to a receiving station at some point on the Atlantic seaboard, and then your voice impulses go by wire to Chicago.

Perhaps it will be possible some day for all human beings to communicate with each other *directly*, without intervening telephone wires, but that will come much later.

## Radio's Greatest Asset:

"Our ignorance of its  
future."

—David Sarnoff

**SHORT WAVE CRAFT IS PUBLISHED ON THE 1st OF EVERY MONTH**

This is the January 1936 Issue—Vol. VI, No. 9. The Next Issue Comes Out January 1.

Editorial and Advertising Offices, 99-101 Hudson Street, New York City

# New S-W Sets at the German Radio Show

A number of interesting new S-W apparatus, including television sets were exhibited at the German Radio show. An S-W converter, also new tubes with "wing" contacts were exhibited, and a new type of flywheel dial.



German short-wave converter: One of the new short-wave converters, furnished with an autodyne circuit. These converters are to be used for the reception of television signals by means of the regular short-wave receiver.

Below: Newest Telefunken S-W receiver.

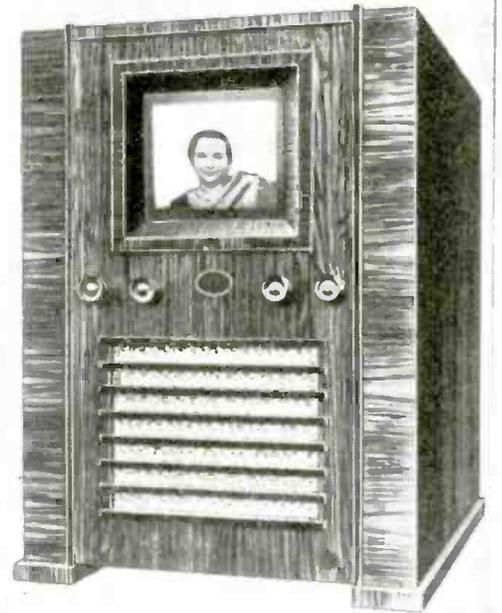

Above: Modern German television set. The new television receiver as produced by C. Lorenz, A.G., operates with a cathode ray tube. The screen size is about 8 inches.

## An Interesting 4-tube German superhet

The tuning knob of this set, a great hit at the recent Berlin Radio Show (see right side of the cabinet below), drives a heavy flywheel, which is connected with a gearing system with the large ratio of 1 to 150. The knob on the left side operates the tone and volume control. In case the radio listener wants to switch over to a station to be found on a distant part of the tuning scale, he puts the flywheel in full swing, and a small blue ball is used as an indicator, the ball moving very fast over the scale.

If the blue ball is near the desired scale division, the flywheel is stopped and the final exact tuning is done by means of the gearing which moves the ball very slowly over the scale. It might be of interest to note that the manufacturer of this 4-tube superhet claims that this set has nine tuned circuits. That means, according to the German advertising custom, not nine tuned circuits in a band-filter manner, but involves all the primary and secondary windings of the I.F. transformers.

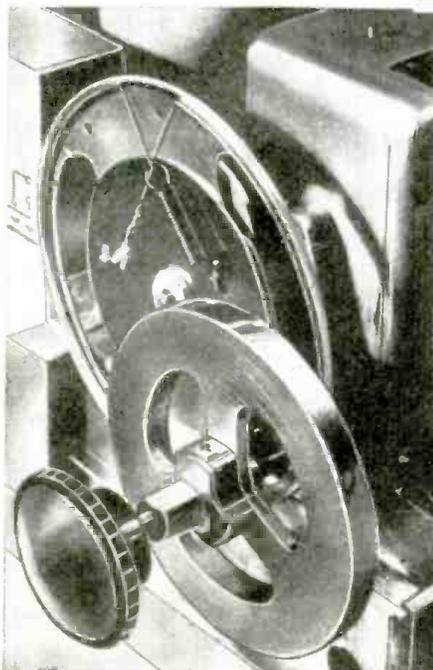
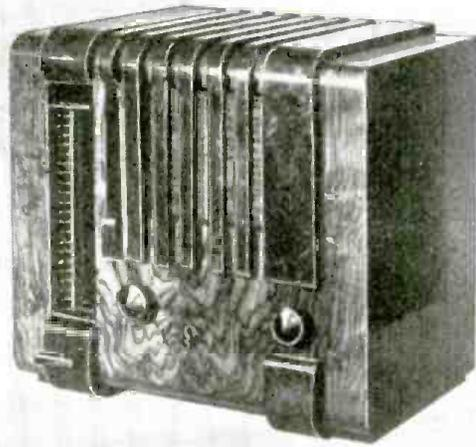

Left: The heavy flywheel in front drives a gear having a ratio of 1 to 150, which in turn is connected with tuning condensers closed by the metal box in the background. The indicator of the tuning scale, which cannot be seen since it is fixed on the left side of the chassis, is operated by a cable drive. This cable lies in a groove around the wheel.

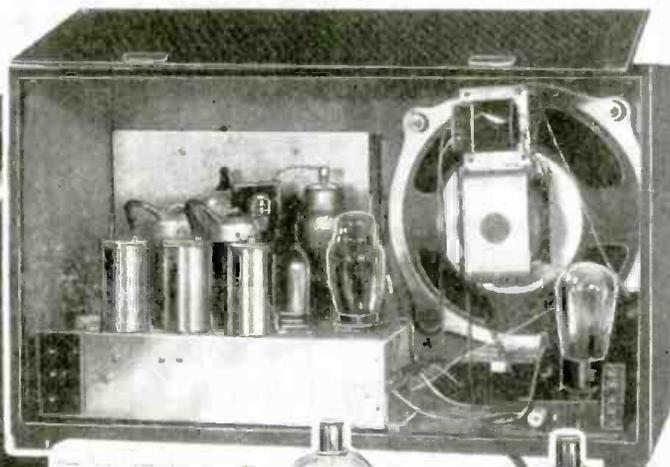

The image shown is not faked as is oftendone, through the incorporation of a photo in the receiver screen window, but is an actual image received by television, showing the announcer of the Berlin television station, Miss Ursula Patzke.

Below: The new German tubes with wing contacts instead of pins.





The tremendous size of a typical "prominence" on the sun is clearly indicated in the above illustration; note relative size of the earth! Some of the streamers extending from the sun are more than a million miles in length; the "prominence" shown above measured 140,000 miles in height, and was photographed from the Mount Wilson Observatory, Pasadena, Calif.

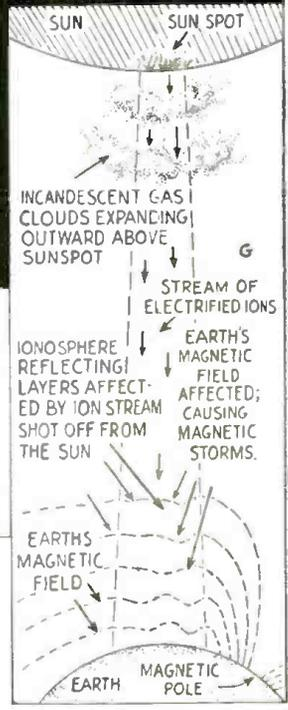
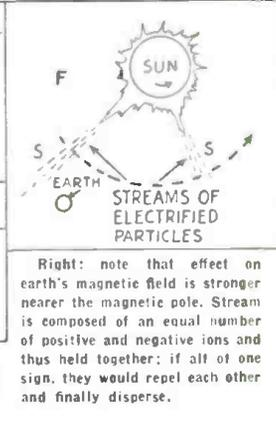
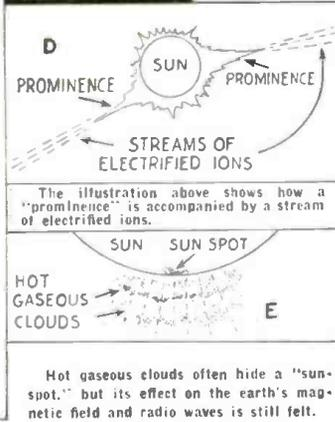
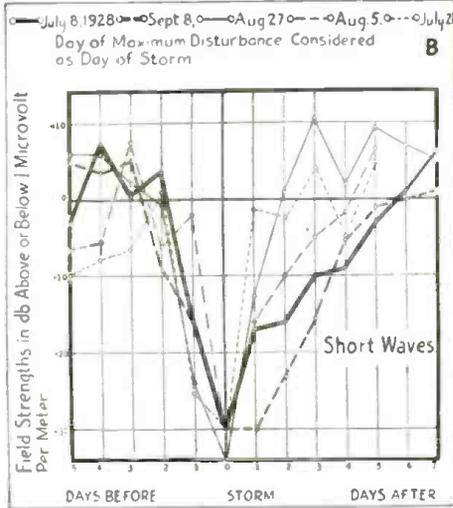
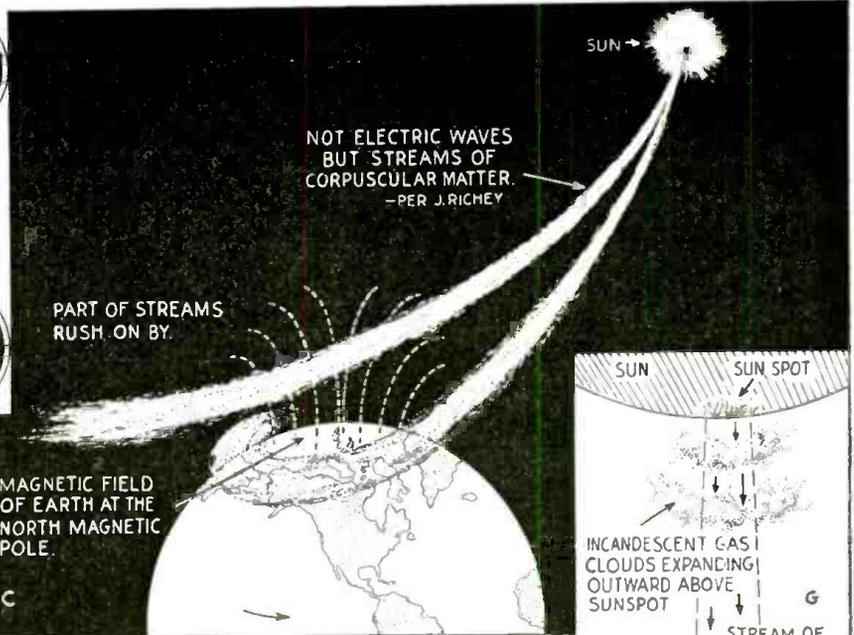

Hot gaseous clouds often hide a "sunspot," but its effect on the earth's magnetic field and radio waves is still felt.

Streams of electrified particles shot off by the sun, in the region of the spots, sweep across the earth and cause "magnetic storms." These storms markedly reduce short-wave transmission ranges.

# Solar Phenomena and Their Effect On Short Waves

● **SUNSPOTS**, which are the most conspicuous of solar phenomena, have a far-reaching influence on radio transmission, especially short-wave propagation, and the technical people in charge of the short-wave telephone circuits in daily operation across the ocean, between the United States and Europe as well as other parts of the world, have made a special study of solar disturbances and their periods of recurrence. It is somewhat difficult to believe that the sun, some 93,000,000 miles distant from the earth, can cause magnetic disturbances on the earth of such magnitude that during periods of strong sunspot activity, short-wave transmission across the Atlantic, for example, may be entirely disrupted. At the same time, long wave transmission, such as that employing 5,000 meter waves, usually improves in the daytime, so far as transmission is concerned. One of the accompanying graphic charts illustrates an actual case of high sunspot activity when the short-wave transmission fell off markedly, while the long-wave transmission actu-

ally improved during this period. What effect do Sunspots have on Short-Wave transmission—and why? Is the range of Long Waves increased? What is the length of the average sunspot cycle? These and other questions are answered in this article.

A great deal of special study regarding the effect of sunspots, their cycle of recurrence, and the probable method whereby they affect short-wave transmission so markedly, has been made by Joseph L. Richey, chief technical operator of the Trans-Atlantic Control Room of the A. T. & T. Co., in New York. Elaborate records of solar activities and their day-to-day effects on short as well as long waves

are kept and studied carefully. The rotation period of that part of the sun in which sunspots most frequently appear, is about 27 days. This rotation frequently causes a variation in short-wave transmission efficiency on the earth, for the reason that the electrified particles radiated from the sun in the region of high sunspot activity, will sweep across the earth every time the sun makes one revolution. If the activity producing a certain spot or spots on the sun should subside while the sun is making one rotation, then the next time the spot comes around into a position where it faces the earth, there may not be much of a terrestrial effect noticed. Another peculiar thing about the effect of sunspots and the radiations of electrified particles shot out from the sun, which cause magnetic disturbances in the earth's field, and markedly affect the transmission of radio waves, particularly the short ones, is the fact that effects of this nature have been observed when apparently very few or no spots have

(Continued on page 559)

# How Waves are Propagated From Different Antennas

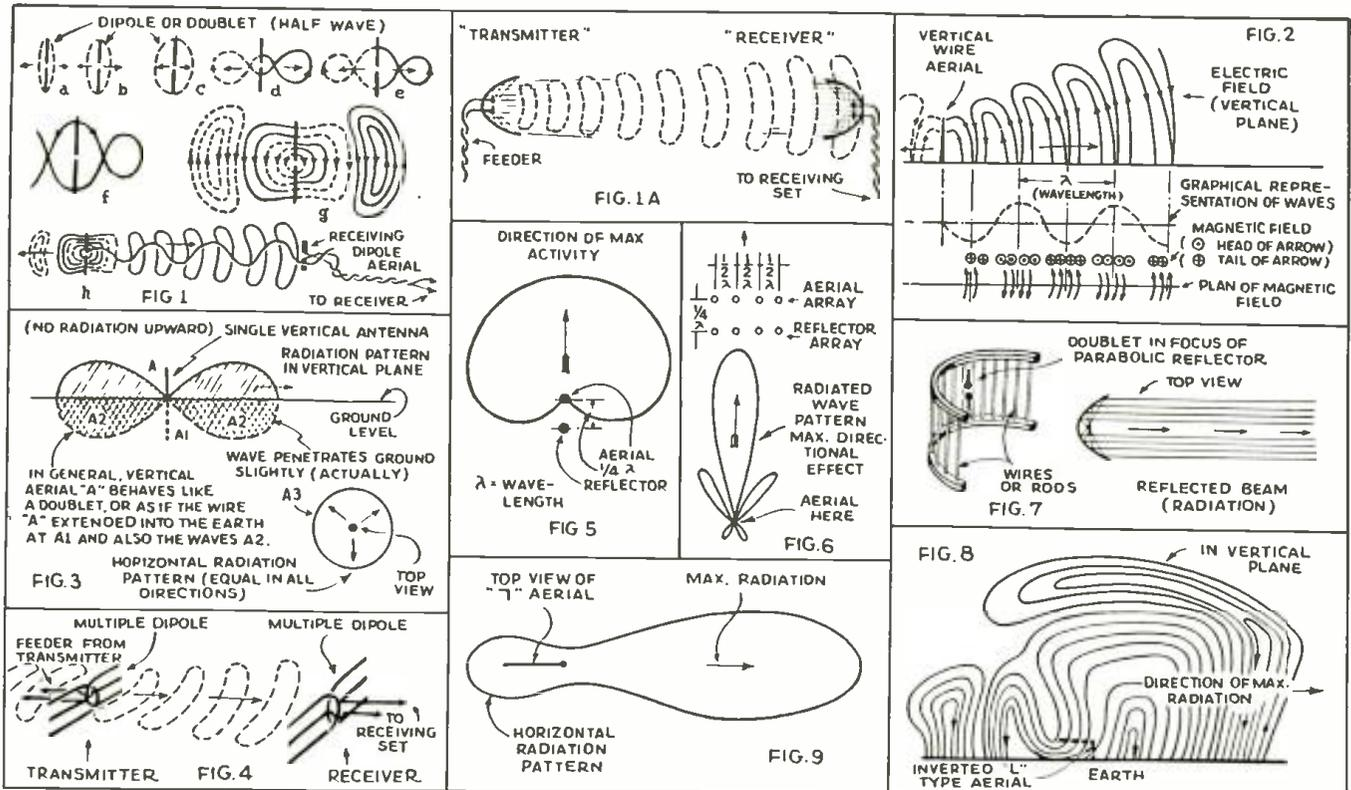

Fig. 1 shows progressive development of electric field about a half-wave doublet. 1A shows waves passing from doublet placed in a reflector to a receiving doublet also mounted in a reflector. Fig. 2 shows formation of waves about a vertical antenna. Fig. 3 shows vertical and horizontal radiation patterns for a vertical grounded antenna. Fig. 4 shows radiation from multiple dipole aerial. Fig. 5 illustrates horizontal radiation from aerial with a reflector one-quarter wave behind it. Fig. 6—Directive horizontal radiation from aerial array with reflector one-quarter wave behind it. Fig. 7—Concentrated beam from a reflector made of wires. Fig. 8—vertical and horizontal radiation patterns about an inverted "L" aerial.

● THE wide popularity of short waves today has caused many students of the subject to ponder the subject of short-wave propagation and the accompanying drawings have been prepared to provide the layman with a possible explanation of the mystery.

While the doublet antenna, commonly comprising two equally balanced arms or radiator elements, as shown in Fig. 1, (a half-wave doublet is illustrated) is mostly used in short-wave work for receiving the signals, (usually each arm is one-fourth wave long) it has also been employed for transmitting purposes, especially in the case of ultra-short waves a fraction of a meter long. In some of these applications, where waves only 1.3 meters long are employed, (a 56-mile link is in daily operation between two islands of the Hawaiian group) the transmitting and receiving aerials used until recently were small dipoles or doublets, placed in the focus of reflectors. The doublets were so-called half-wave units, each half of the doublet being one-fourth wave long. Recently a multiple dipole aerial has been substituted for the dipoles and parabolic reflectors. It is interesting to study the progressive development of a wave, as shown at A, B, C, D, etc., in Fig. 1 and to note how a detached loop or free space wave is finally whipped off the antenna, which phenomena occurs as the electro-static waves and their magnetic components continually form and expand on the doublet, similar to the effect of dropping a pebble into smooth pool of water.

(Refer to the October issue for charts showing simple explanation of how waves are formed.)

In Fig. 2 we see a number of interesting factors concerned with the production of radio waves about a vertical antenna. The first striking thing that will be noted from the diagram is that it has no radiation directly overhead. The waves spread progressively outward from the vertical antenna wire. As explained by several different authorities in a discussion of aerials, it is best to consider the vertical grounded aerial as a doublet, the wave generation and propagation being similar to Fig. 1, excepting that in the case of Figs. 2 and 3 the lower half of the wave, shown by dotted lines at A2, A2 does not penetrate into the ground as shown, but theoretically it can be considered that it does so. In this way a clearer conception of the shape of the wave radiated from the antenna is obtained. The diagram A3 in Fig. 3 shows the horizontal radiation, equal in all directions, looking down at the top of a vertical antenna.

The same rule holds for the vertical antenna where it is employed for reception, i.e., it receives equally well from all directions and manifests no directional characteristics in the horizontal plane.

Looking at Fig. 2 for the moment, we see that the electro-static waves move along horizontally outward from the antenna, the magnetic components of each wave being at right-angles to the electro-static field. The meaning of wavelength is also shown in Fig. 2, and the circles indicating the magnetic field are shown with dots and crosses, the dots within the circles indicating the heads of arrows and the crosses the tails of arrows. Note the changing polarity of the magnetic fields as well as the electro-static waves as we move progressively from one wave to the next. It must be remembered that these waves are circular like the rings or ripples on a pool of water when a pebble is dropped into it, as explained in the first article on antennas in the October issue.

Also, the waves expand spherically or in three dimensions, the same as if you repeatedly deflated and expanded a toy balloon.

One of the newest short-wave aerials is that known as the *multiple-dipole* shown at Fig. 4, The maximum directional activity of this antenna is at rightangles to the array, as shown in the diagram, and unless a set of reflection wires or rods spaced say a quarter of a wavelength from it are

(Continued on page 558)

The next article will cover radiation and wavelength relations of short-wave aerials of the directive type.

# Improved 3-Tube DOERLE For Battery Operation



Front view of the 3-tube battery-operated receiver, which gives 4-tube performance.

Here is a 3-tube receiver that actually gives 4-tube performance! It operates directly from dry batteries and gives the utmost in simplicity, sensitivity and signal strength.



• WHILE electrified receivers, i. e., receivers operated directly from the A. C. house circuit, have become the standard in performance, there are still many short-wave "fans" who either are not equipped to build and operate an A. C. receiver, or prefer battery-operated sets because of their quiet operation.

With the present-day tubes, a very satisfactory battery-operated receiver can be constructed at an extremely low cost. It can be built in the old bread-board fashion, with remodeled broadcast receiver parts. However, if the results obtained with the modern electrified sets are to be duplicated, the battery-operated receiver should be constructed, with the same high-quality parts and using the conventional A.C. receiver design.

The battery-operated receiver, or any receiver for that matter, using more than one or two tubes, should, by all means, employ a tuned *radio frequency* amplifier. This amplifier, while it does not increase the selectivity, does increase the sensitivity tremendously, and allows more efficiency and stable operation of the regenerative detector. The receiver shown in the photographs, and outlined in the accompanying circuit diagram, employs three tubes, although 4-tube performance is obtained. Glancing at the diagram, we find that a type 34 R.F. pentode is used in the T.R.F. stage; inductive coupling is used, to increase gain and stability, between the R.F. stage and the detector. This detector is a type 30 triode. (Continued on page 550)



Rear view showing placement of the various parts.

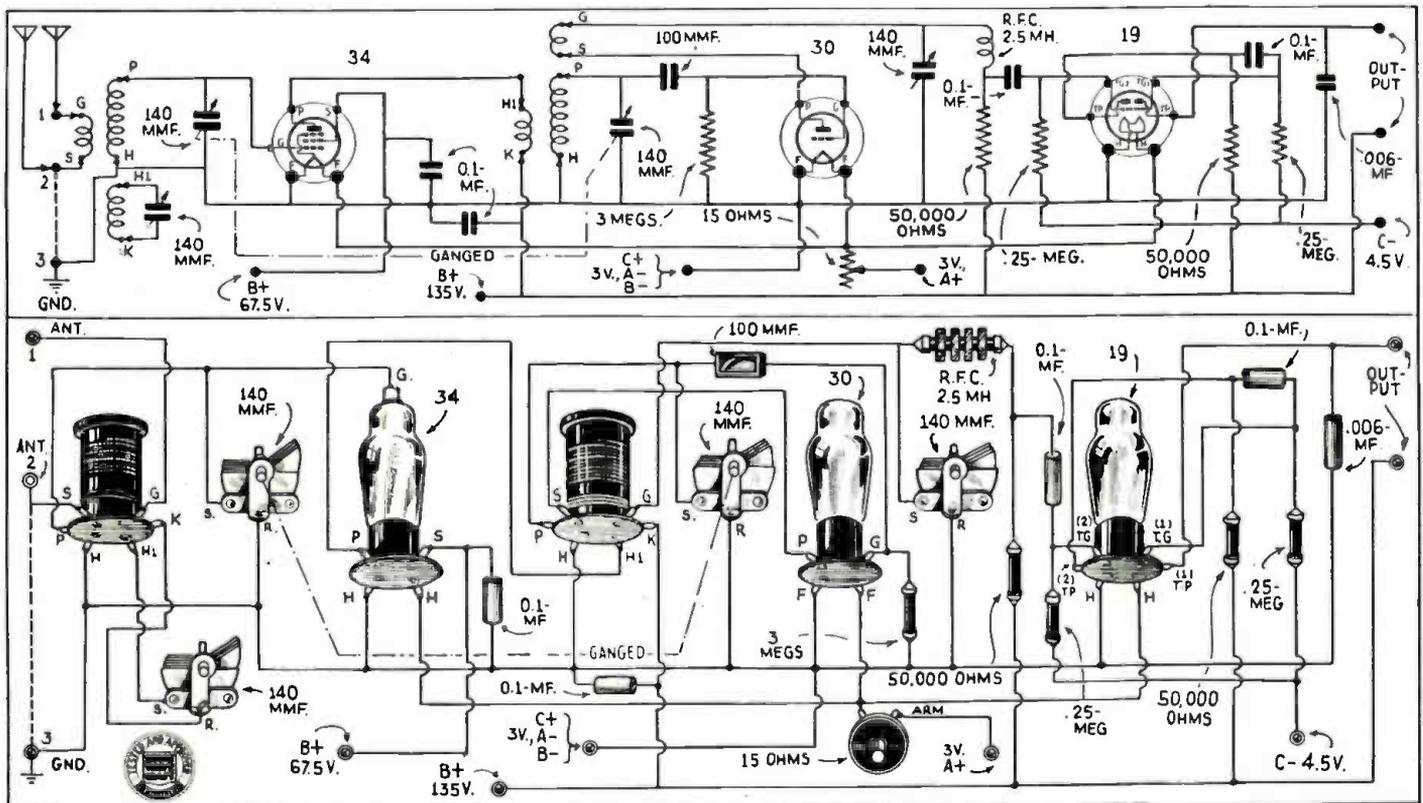

This diagram very clearly shows how to wire the improved battery-operated Doerle receiver described above.



# 5-Meter Transceiver

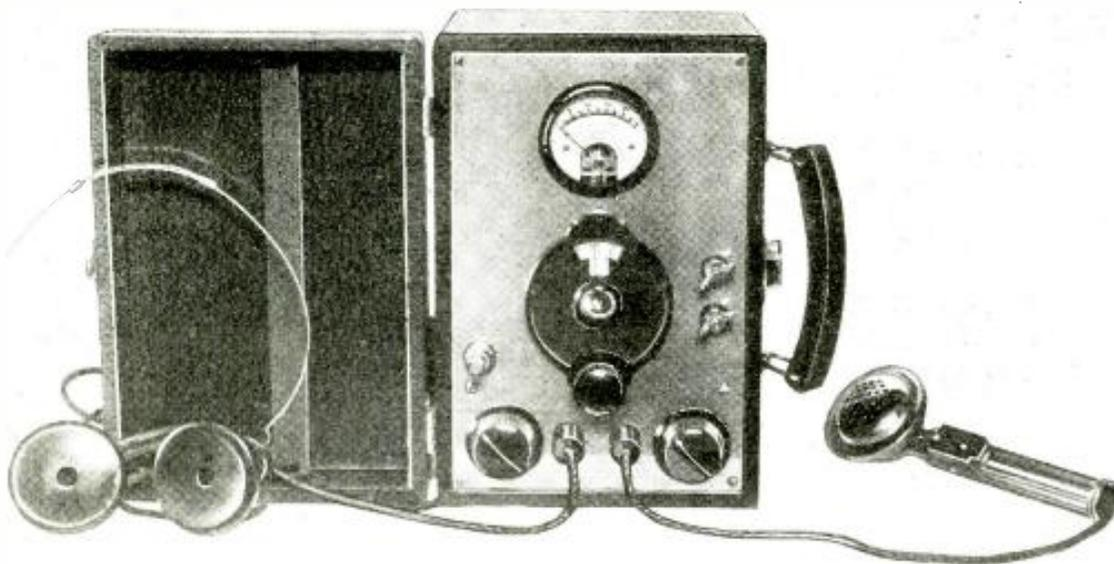

The battery-operated Transceiver ready for a QSO.

● NEARLY every amateur, who is interested in the 5-meter band, has at some time, like ourselves, wanted a really portable transmitter and receiver. The logical solution of course is a *transceiver*. Even considering the few "nasty things" certain people have said of them. We agree that a transceiver, if not in the hands of a discreet person can kick up more noise and fuss than two Model-T Fords. But, there is no reason why the receiving position of the switch should create as much noise as the transmitting position. Most transceivers do not employ separate low-frequency oscillation coils and depend upon very high plate voltage and a small grid-leak to produce super-regeneration. This type of detector will no doubt radiate a strong signal and interfere with other near-by receivers.

In this receiver we use a regular *interruption-frequency*

is not so good for small batteries and for this reason the 30 is the better of the two.

Until just recently the transceiver was handicapped by large batteries. But this past year has seen astounding development in the manufacture of small batteries. The two 45-volt B batteries used in this rig furnish 90 volts and each measures  $2\frac{7}{8} \times 1\frac{3}{16} \times 4\frac{5}{8}$  inches and weighs only  $\frac{3}{4}$  of a pound. Each unit is a full-fledged 45-volt battery with a 22.5-volt tap. The "A" battery is a 3-volt affair and measures  $2\frac{1}{8} \times 3\frac{3}{4} \times 1\frac{1}{8}$  inches and this only weighs  $\frac{1}{2}$  pound. Quite an advantage, these small batteries especially in small portable receivers and transmitters such as this one.

The entire transmitter-receiver unit is built into a wooden box which is covered with black paper, a sort of instrument box readily obtainable from radio stores. The particular box used is  $6\frac{1}{4} \times 9\frac{1}{4} \times 5\frac{3}{4}$  inches, outside dimensions, although any convenient size may be used. The panel is aluminum  $5\frac{5}{8} \times 8\frac{5}{8}$  inches and has a shelf  $5\frac{5}{8} \times 4$  inches.

All of the apparatus is mounted above that shelf excepting the three winding transformer, the modulation choke and a few by-pass condensers.

In the photos of the rig, we have three views, one front, one back, and one of the underneath side of the shelf. In

Here is a 5-meter Transceiver that can be carried on hikes or any similar excursion into areas where no electricity is available. It is extremely light in weight and entirely self-powered; the batteries are contained in the carrying case, and it is capable of working a distance of 15 or 20 miles. It uses midget tubes manufactured in England, but which are available in the United States.

transformer to obtain super-regeneration, thus allowing the detector to be operated at lower plate voltages during reception and consequently causing much less interference. A separate tube could have been used for the low-frequency oscillator, but would not have helped in the least. So much for the arguments against transceivers.

The most important features of any transceiver are the weight, size, and serviceability. We can build transceivers that are much lighter and more compact than this one, but if the "rig" only operates a half hour or so, what good is it?

The tubes used in this set are manufactured in England by the High Vacuum Valve Co., Ltd., and are obtainable in the United States. These tubes are about the size of our American *peanut* tubes, but have the advantages of a type 30 in that the filament only draws .06 ampere at two volts. The 30's may be used if there is space in the box used to house the "rig." The *peanut* tubes require  $\frac{1}{4}$  ampere which

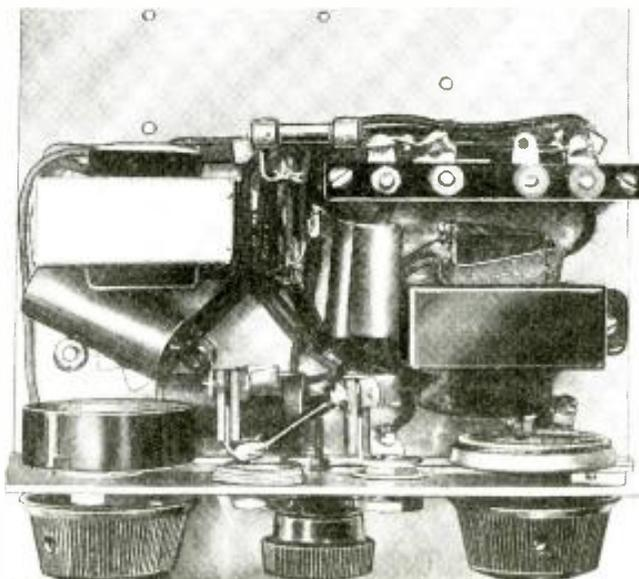

This view clearly shows how the parts are mounted.

# Uses MIDGET TUBES

By Arthur Gregor

the front view we see the 0-25 milliammeter at the top, the main dial in the center, the two antenna posts to the right and the "send-receive" switch at the left. The two knobs are the regeneration control and the filament rheostat. The two jacks are for the earphones and the microphone. These last two items fit in the cover when not in use making it completely self-contained.

The rear view shows the detector tube in the center of the shelf and the audio tube to the left of it. Behind the audio tube is the interruption-frequency transformer. The split coil and the antenna coil are on the right of the detector. The double-pole-double-throw switch is also shown. This switch has an extra single circuit switch which controls the microphone. This switch happens to be an old one used on battery sets of a few years back, however, a modern toggle type would serve.

Referring to the diagram we see that the same battery is used for the filaments, "mike" current, and bias on the audio stage. This was done to preserve space but the builder may use separate units. In switching from receiving to transmitting the grid-leak of the detector is changed, the plate circuit is cut loose from the transformer and connected to the plate of the audio tube, which is then a modulator. This puts the full "B" voltage on the detector which is now the power oscillator and feeds R.F. into the antenna coupling coil. The microphone circuit is also closed.

The transformer is a common transceiver type which has two primaries, one for the mike and another for the output of the detector. The modulation choke is a midget affair designed for A.C.-D.C. radios. There is no change in the plate of the modulator as the choke, together with the .1 mf. condenser, serves as the output filter for the phones.

One warning—do not allow the plate current of the oscillator to exceed 5 or 6 mills (M.A.) or the tube life will be materially shortened; the meter is used for that reason.

In the detector-oscillator circuit we show a 1 meg. grid-leak for receiving. This value may have to be changed to

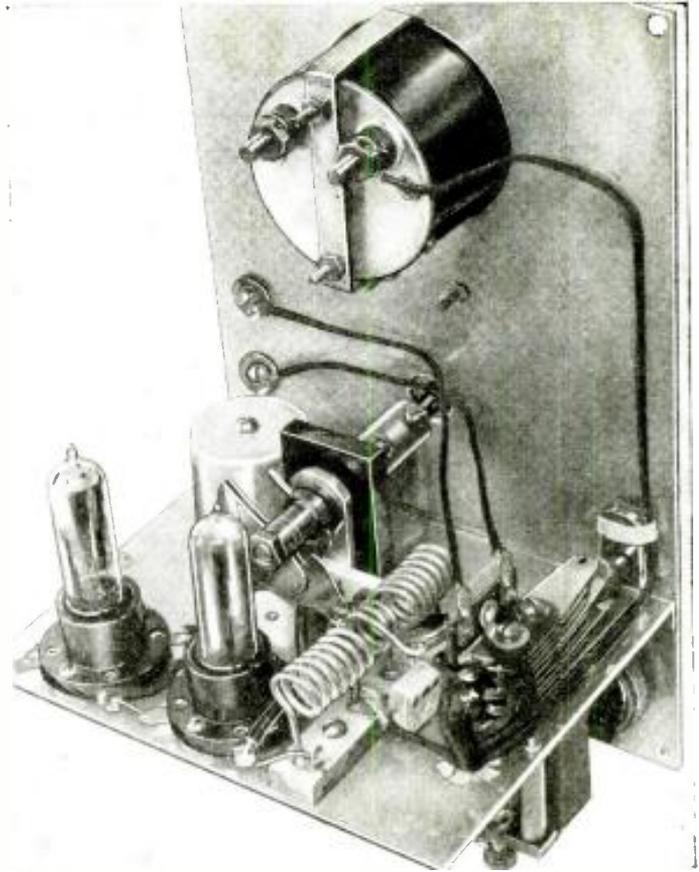

Rear view of the Transceiver; note the small size tubes.

suit different types of tubes. The transmitting grid-leak may also have to be changed although 50,000 ohms seemed to be just right.

In operation, the detector should produce a strong hissing sound as do all super-regenerators. The regeneration control should be adjusted to a point of lowest plate voltage

(Continued on page 562)

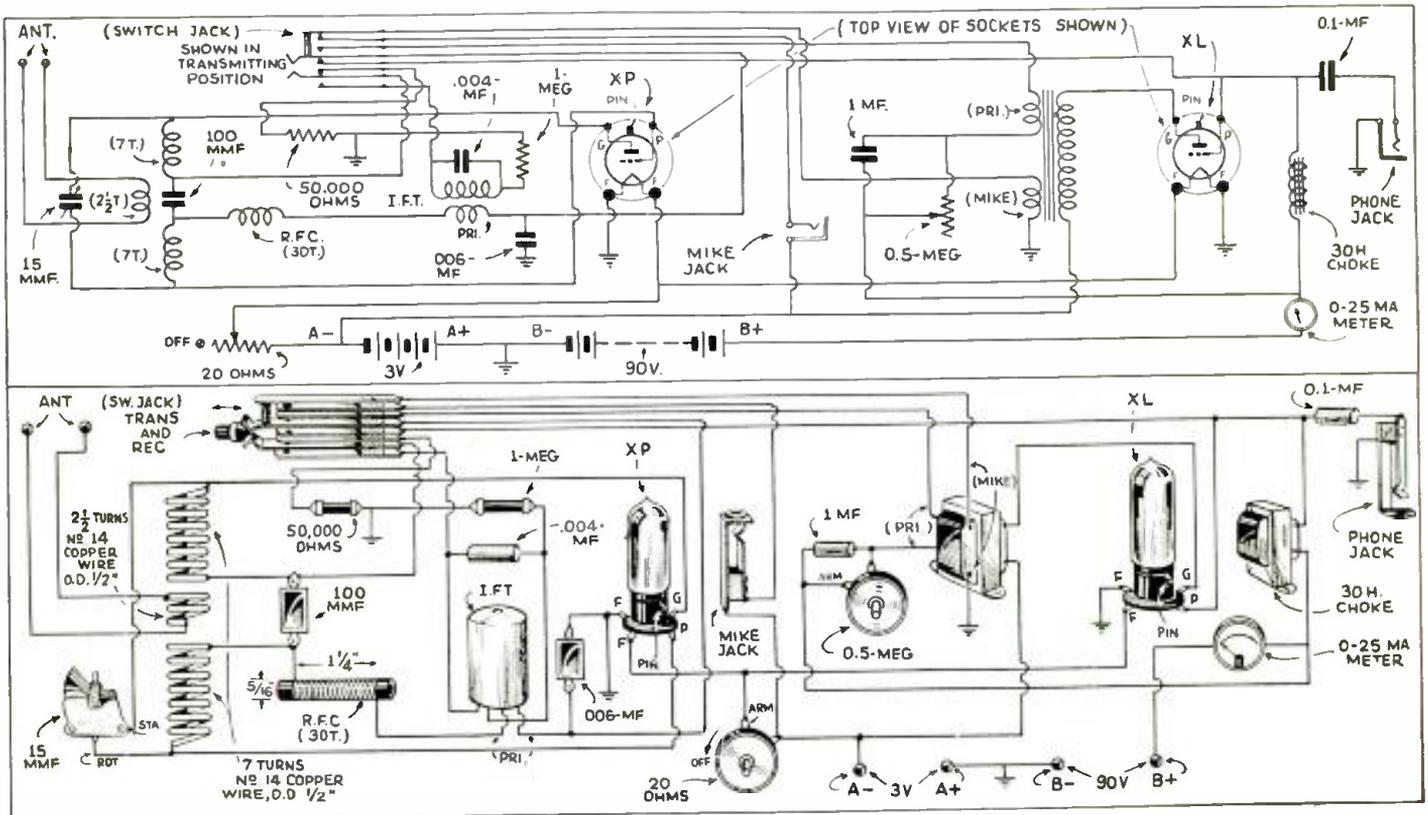

Diagram of the 2-tube battery-operated portable Transceiver.

# WORLD-WIDE SHORT-

## A French Automatic Set

● IN THE new issue of *Documentez-Vous*, a French magazine for the trade, a picture of a new receiver covering both the broadcast and short-waves was shown. This receiver is novel in that small buttons permit stations to be tuned in, without the usual procedure of turning a dial. Forty-eight of these buttons are placed on the



Tripping one of the 48 buttons shown on this French automatic receiver causes the station corresponding to that "tuner setting" to roll in. No dialing is necessary.

panel at the front of the receiver, permitting 48 different stations to be brought in. This novelty in receiver design will, without doubt create much interest, as did the new German receiver which is equipped with a dial similar to the dial telephone, so that it is only necessary to dial a number to tune the set.

It seems that Europe is going in quite strongly for these novelties in receiver design.

## A New Short-Wave Converter

● IN A RECENT issue of *Wireless World*, a description appeared for a short-wave converter of the self-powered type.

It uses a triode-pentode type of frequency changer with a coil arrangement covering the band from 13.5 to 200 meters in three steps.

The dial used for the unit is a two-ratio affair, providing 12-1 or 150-1 reduction.

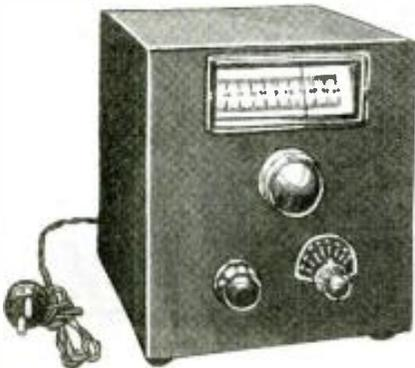

An English short-wave converter which has its own power supply. When used with a "broadcast" band receiver, it permits reception of wavelengths from 13.5 to 200 meters.

● The Editors have endeavored to review the more important foreign magazines covering short-wave developments, for the benefit of the thousands of readers of this magazine who do not have the opportunity of seeing these magazines first-hand. The circuits shown are for the most part self-explanatory to the radio student, and wherever possible the constants or values of various condensers, coils, etc., are given. Please do not write to us asking for further data, picture-diagrams or lists of parts for these foreign circuits, as we do not have any further specific information other than that given. If the reader will remember that wherever a tuned circuit is shown, for instance, he may use any short-wave coil and the appropriate corresponding tuning condenser, data for which are given dozens of times in each issue of this magazine, he will have no difficulty in reconstructing these foreign circuits to try them out.

An A.C.-D.C. type of power supply is included, so that the unit may be self-powered on any type of power line.

The output of the frequency changer is coupled to a tuned coil output, preadjusted to a frequency of 1,800 kc. This makes it possible to track the two tuning condensers in the converter and at the same time allow sufficient I.F. selectivity for use with small broadcast sets, without introducing the annoyance of image or other forms of interference.

A test by the above magazine produced some fine results from so simple a device.

## An English 4-Band Coil Unit

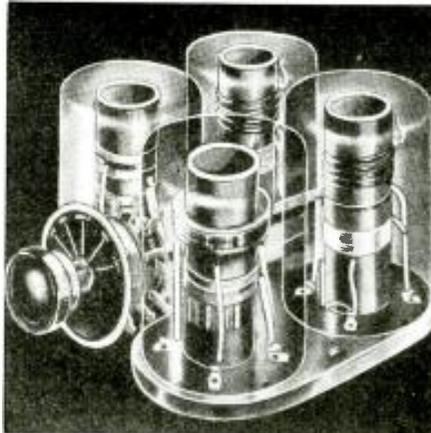

Novel 4-band coil unit recently introduced in England. Both the aerial and the oscillator coils are included in each of the four shield cans.

● A RATHER interesting form of tuner for all-wave superheterodynes was introduced recently, in England, according to *The Broadcaster and Wireless Retailer* (London).

The unit is shown in phantom form in the accompanying illustration. It will be noted that both the aerial and oscillator coils are included in each of the four shield cans. The coils are designed to cover 15 to 35, 35 to 85, 200 to 575 and 1,000 to 2,000 meters, which include the frequencies of practically all European broadcast stations on short, medium, and long waves.

The coils are designed to feed into a 465 kc. intermediate frequency amplifier. The features are high efficiency; ease of installation in new and modernized receivers; and reasonable price. The method of mounting the coils keeps the connecting leads extremely short, and still allows the coils to be completely and effectively shielded.

## Cathode-Ray Frequency Doubler

● CATHODE-RAY tubes have been so closely allied to television scanning and A.C. wave-form analysis that some of the more obscure applications of the cathode-ray principle are apt to be neglected.

For example, a very ingenious frequency doubler for ultra-short-wave communication was described in the latest issue of *Wireless World* (London).

The ordinary fluorescent screen is replaced by an annular electrode, P, formed of a strip of insulating material bounded by inner and outer conducting wires, which are connected respectively to the two arms of a Lecher-wire system coupling to a dipole aerial. Inserted at intervals along the insulating strip are a series of small "targets," connected alternately to the inner and outer conductors, so as to feed intermittent pulses of energy from the cathode-ray stream to the aerial.

The discharge stream through the tube is focused, as usual, by a negatively biased cylinder, C, so as to pass through the center of the accelerator plate, A. Once past the plate, the stream comes under the influence of a pair of deflecting plates which cause it to trace out a circular path over the annular target.

High-frequency oscillations from a source, O, are applied directly to the first pair of deflecting plates. Owing to the distance separating the first pair of deflecting plates from the second it is necessary to introduce a definite phase difference in the voltages applied to the second pair of plates, to cause the stream to follow the required circular track. For this reason, the upper pair of plates is fed from the lower through a Lecher-wire system fitted with a "trombone" section for fine adjustment.

The speed at which the cathode-ray traverses the annular strip is, of course, determined by the frequency of the oscillations from the source, O, while the multiplied frequency fed to the aerial depends upon the number of pairs of "targets" inset in the annular strip. Using eight targets, as shown, the frequency emitted from the tube is four times that fed into it from the source O.

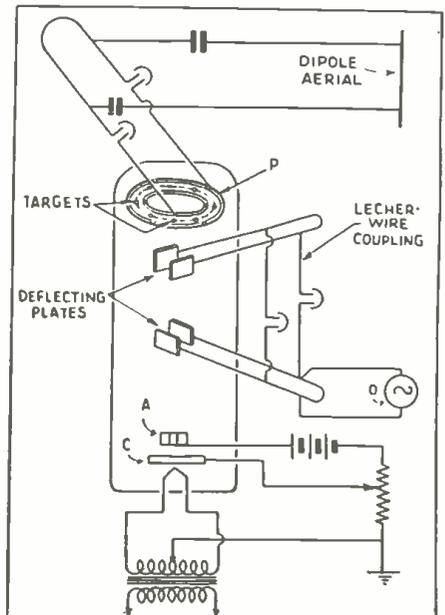

Using eight targets, the frequency emitted from this cathode ray tube is four times that fed into it from source "O."



# Talking On One-Half

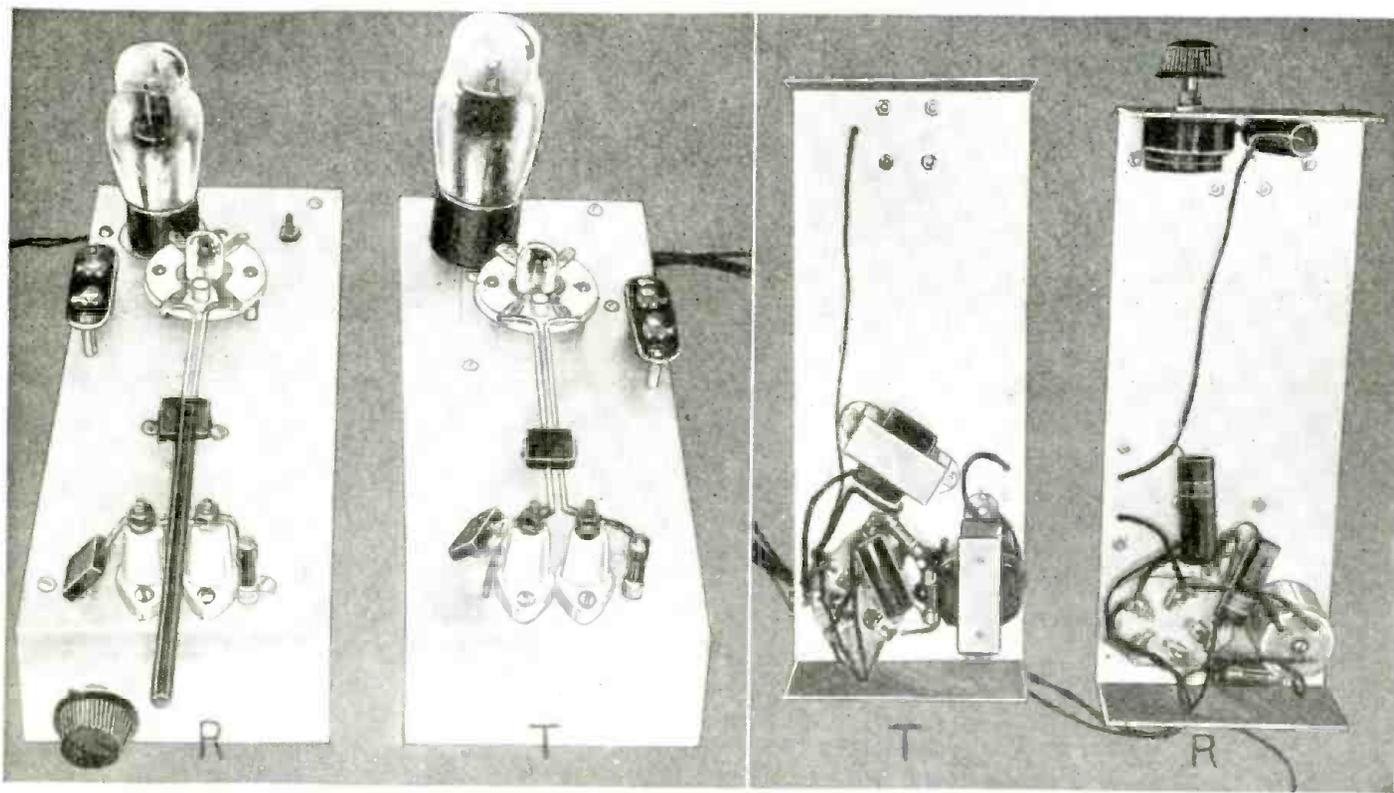

Left—Top views of receiver and transmitter. Right—Bottom views of transmitter and receiver. "T" is the transmitter, and "R" is the receiver.

● MANY times it has been said that in the days of the *crystal set* and the *loose-coupler* there were real thrills and a certain romance to radio. But today this is all gone, because radio has become so fully commercialized, what with the two and three thousand dollar Ham transmitting stations and Ham receivers selling as high as \$500.00! All we can say is—maybe!

Just as mysterious as radio was in the days of the galena detector are these new *ultra-short waves*. Because they are few if any who know more than a little bit about them. Radio in the old days was fascinating because of its newness. Today we have something just as *new and far more mysterious in the waves below one meter!* Some time ago we were told that *ultra-short waves* were quasi-optical. This has been proven false to a con-

siderable extent in many recent instances. Who can say that new discoveries may not prove it true in all? The dyed-in-the-wool experimenter of today, as of old, has a very great opportunity for interesting and valuable experimentation and research. Many weird *ultra-high-frequency* transmitters and receivers have been built and experimented with under the roof of W2AMN's "shack." A good

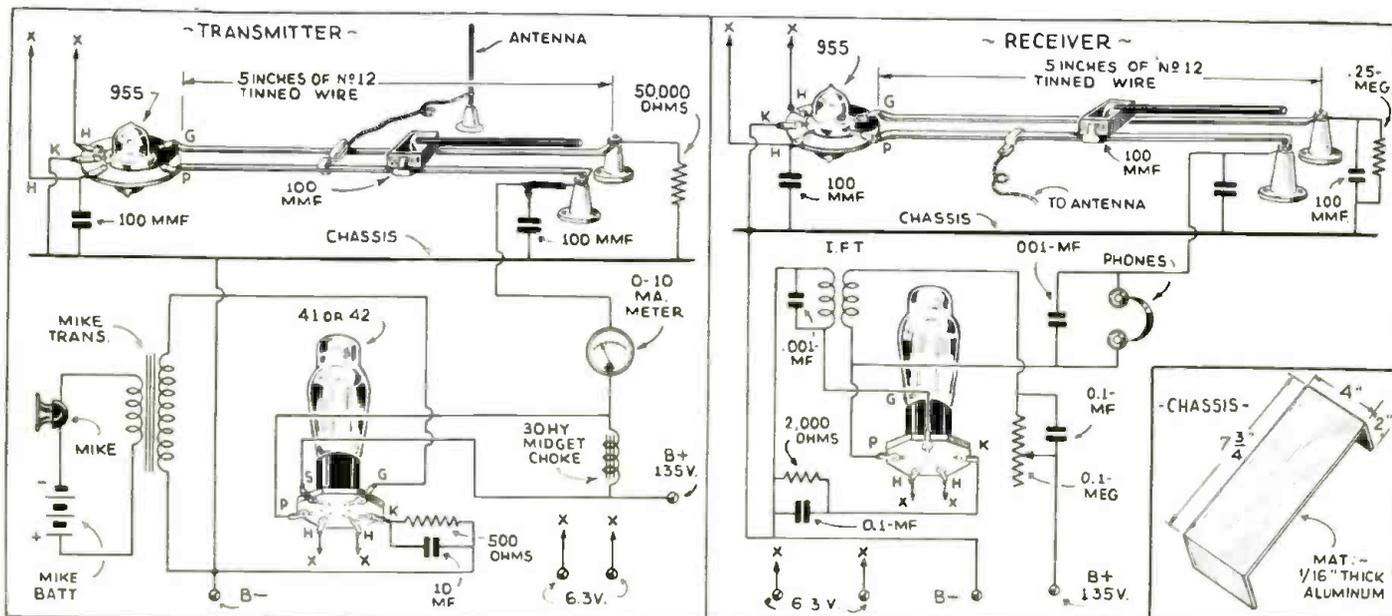

Complete diagrams of the half-meter transmitter and receiver.

# Meter



By George W. Shuart, W2AMN

Fans, Experimenters, and Hams alike have long desired information on a simple and effective transmitter and receiver to operate below one meter. The transmitter and receiver described in this article is built around the Acorn tubes and tunes between one-half and one meter; of course, for transmitting, an amateur license is absolutely essential. The dimensions of the antenna and the low cost of the apparatus offer the experimenter a wonderful opportunity of performing many interesting experiments.

Mr. Shuart demonstrating his half-meter transmitter.

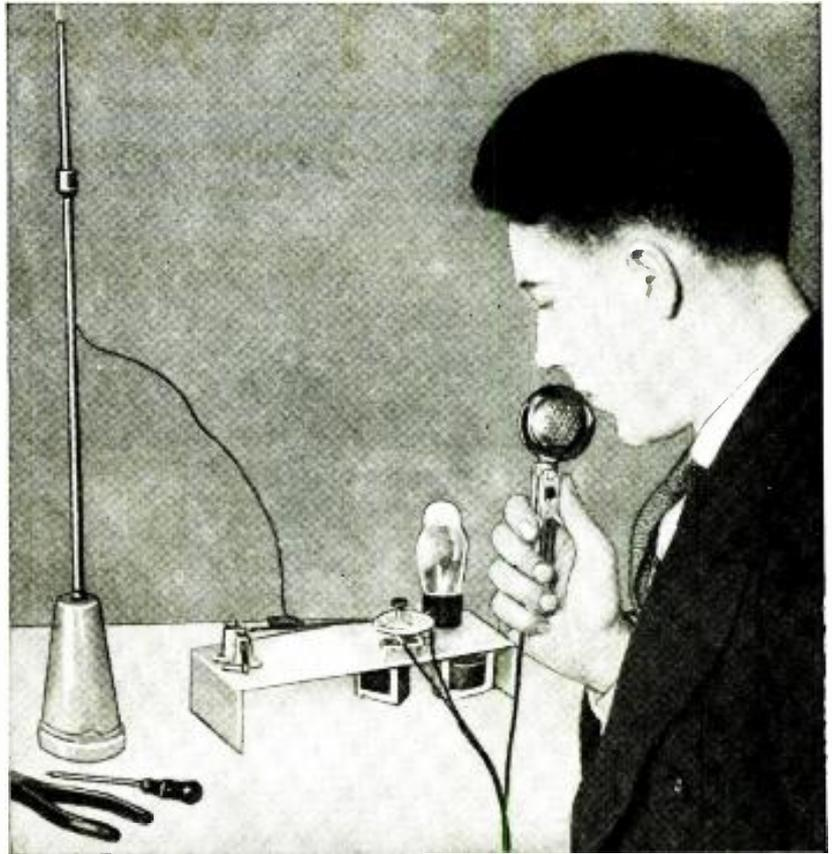

many worked and just as many were failures. But we still say that we had a lot of fun and there's lots of it left for you boys. Probably the most interesting part of it is the comparative small cost of the apparatus used. Most of it is homemade as in the days of old.

## Range 0.5 to 1 Meter

The transmitter and receiver shown in the photos are the acme in low cost and simplicity. They both operate in a range of from less than one-half meter up to slightly less than one meter. Although very low power apparatus they provide plenty of opportunity for experiment. Don't forget that the transmitter must only be operated by or in charge of a licensed operator. Anyone can talk over it as long as the operator is present. The tuned circuits are an adaptation of the now famous "long lines" oscillators previously described by the writer. The detector tube in the receiver and the oscillator tube in the transmitter are 955 "Acorn" tubes, the only ones that can be successfully used on waves below one meter, at this writing.

## Receiver Is a Super-Regenerator

The receiver is a super-regenerator and uses a type 37 as the low frequency oscillator. In the transmitter we have a type 41 connected as a pentode and used to modulate the 955 oscillator. The microphone is connected directly to the pentode and provides plenty of modulation for the 955.

Both sets are alike in construction, therefore it will be necessary to describe only one in detail. The tuning is done by sliding a fixed capacity condenser along the two wires making up the —should we say—"very short lines."

In constructing this very short line, place the wires as close together as possible without danger of "shorting" them by contact with each other. If

these wires were farther apart they would have less length per given wavelength. This is a peculiarity of this type of circuit. If they were placed say an inch apart and gradually brought closer together, the wavelength would become shorter or the frequency higher. This is because even though the capacity increases, the inductance decreases more

the line there is the grid-leak connected between the grid wire and the chassis. At the end of the plate wire is fed the plate voltage for the tube.

## Tuning Adjustments

When the "shorting" condenser is placed at the extreme end of the line, the circuit is resonant at its lowest frequency. As this condenser is pushed nearer to the 955 tube, the frequency becomes higher until it is placed as near to the tube as it will go, when the circuit is resonant at the highest frequency to which it will tune.

On the transmitter the adjustment of the tuning condenser is not changed as often as on the receiver, therefore a handle is attached to the receiver condenser. This is a 1/4-inch bakelite rod which has been filed flat on one side and cemented to the condenser with household cement.

For calibration and aid in tuning, a scale of numbers may be marked on the chassis directly under the two wires. This will serve in returning to a given wavelength.

At the end of the plate wire on both the receiver and transmitter, there is a .0001 mf. by-pass condenser connected between it and the chassis. R.F. (radio frequency) chokes of various sizes were tried and proved of no particular value. Also there is a .0001 mf. condenser bypassing one of the heater leads to the chassis. This aids considerably in obtaining stable operation of both the transmitter and receiver. Cathode R.F. chokes were also tried and were of no benefit. It seems the more gadgets one puts on one of these very short-wave outfits, the poorer they perform.

The grid-leak for the receiver which provided maximum sensitivity with the particular tubes available was 250,000 ohms. The transmitting grid-leak depends a great deal upon the plate voltage applied (Continued on page 557)

## Parts List

- 4—Small stand-off insulators, I.C.A.
- 2—Acorn Tube Isolantite Sockets, Hammarlund.
- 1—6-Prong Isolantite Socket, Hammarlund.
- 1—5-Prong Isolantite Socket, Hammarlund.
- 1—50,000-ohm one-half watt Resistor, I.R.C.
- 1—250,000-ohm one-half watt resistor, I.R.C.
- 1—500-ohm Resistor, I.R.C.
- 7—.0001 mf. Mica Condensers, Aerovox.
- 1—100,000-ohm Potentiometer, Electrad.
- 1—2,000-ohm one-half watt Resistor, I.R.C.
- 1—Interruption Frequency Transformer, I.C.A.
- 2—.001 mf. Condensers, Aerovox.
- 2—.1 mf. Condensers, Aerovox.
- 1—10 mf. Electrolytic Condenser, Aerovox.
- 1—Midget Microphone Transformer, Stancor.
- 1—Midget Filter Choke, A.C.-D.C. type, Stancor.
- 2—Chassis (see drawing), Blan.
- 2—955 Acorn Tubes.
- 1—37 Tube.
- 1—41 Tube.
- 1—Hand-mike—Universal Microphone Co.
- 1—Pair Headphones—Trimm Radio Mfg. Co.

rapidly than the capacity increases. Number 12 tinned bus-bar was used and the spacing between the wires is about equal to the diameter of the conductors.

Each wire is 5 inches long; one connects directly to the grid and the other to the plate of the tube. At the end of

# SHORT WAVES and

**Howard L. Dull Built This High-Quality Amateur Station  
Awarded This Month's Prize**

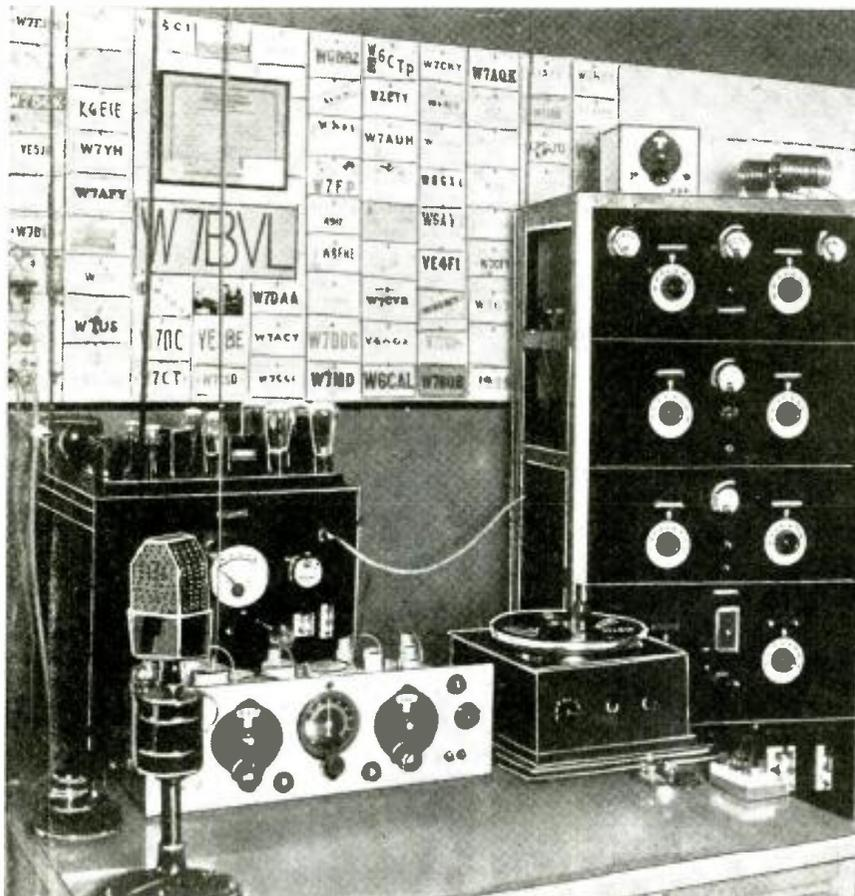

Howard L. Dull of Seattle, Wash., is the lucky winner of this month's prize—one year's subscription to this Magazine, for the photo of his very fine home-built amateur station. The receiver is a 9-tube homemade superhet with A.V.C. and an "R" meter.

Editor, SHORT WAVE CRAFT:

● THIS photograph gives a general view of radio station W7BVL, owned by Howard L. Dull, 7214 Palatine Ave., Seattle, Wash. The station has not been designed for the maximum power, but rather for good quality transmission. Most of the operating is done on 20- and 75-meter 'phone with a power input of 150 watts. W7BVL has been "on the air" since January, 1932.

The rack and panel on the right contains a complete four-stage R.F. unit, consisting of a 59 crystal oscillator, a 59 buffer doubler exciting two type 10's in push-pull which are link-coupled to a single 211 as a final amplifier. Grid-leak bias is used in the final amplifier, and the coils of the R.F. exciting units are shielded to eliminate feed-back. The high-voltage and low-voltage power supplies are at the bottom of the rack; next above are the low-power stages, followed by the final stage and antenna matching network. The antenna used at the present time is a 75-meter current-fed zepp with 45-foot feeders and 120-foot flat-top.

The audio equipment includes an Amperite velocity microphone, with a four-stage resistance-coupled pre-amplifier employing a 75 high-gain triode, a 76, and two 37's. The pre-amplifier is not shown in the picture, but is one completely shielded unit. The output of the pre-amplifier feeds into two 56's in push-pull, which "kick" two 2A3's as push-pull drivers, which in turn excite four type 250's in push-pull parallel as Class-A-Prime modulators—making

a total of seven stages of audio. The modulator and high-level audio equipment are in the rack on the left—the large meter shown in the picture is in the plate circuit of the modulator and provides a check on modulation. The additional equipment includes a vacuum tube voltmeter and a special two-stage amplifier in the phonograph box on the desk. It is utilized for the phonograph pickup, and as an emergency pre-amplifier. A "fading" system is also used, making it possible to mix both voice and music.



Charles B. Cox of York, Pa., sports an "up-and-going" short-wave listening post.

The receiver at W7BVL is a nine tube homemade superheterodyne which incorporates A.V.C. and an "R" meter. A separate matched-impedance "doublet" receiving antenna is used, making possible duplex operation. All districts in the United States and Canada, Cuba, Mexico, and the Hawaiian Islands have been worked on 'phone, and SWL verifications have been received from beyond these limits. This station is operated in the interest of "world-wide friendship."

(We are glad to award this month's prize for the photo of your homemade transmitter and receiver "rig," Howard. You certainly deserve a lot of credit for building up this excellent transmitter and receiver, and anyone who has ever tried to build a 9-tube superhet of the type you have, will quite agree, we are sure.—Editor)

## C. B. COX HAS LIVE LISTENING POST

Editor, SHORT WAVE CRAFT:

My receiver is homemade and A.C. operated. It uses 58 TRF, 57 Detector, 57 and 2A5 audio stages. I have heard a total of 123 stations (no Hams or CW), with stations on all continents. I have received 38 veries, some of which are shown in the photo. My aerial is about 75 feet long. At the highest end it is 30 feet high. The aerial runs east and west, the free end pointing to the west. The ground is made on a radiator pipe.

I am assistant vice-president of the International 6000-to-12500-Mile Short Wave Club, of which Mr. Oliver Amlie is president. How about some more of you DX-ers joining up? It's a fine club to belong to, one must do some work to become a member.

In closing I will say that *Short Wave Craft* is the best magazine I have ever seen for the "SWL." I have been reading it for several years and hope to do so for many more. My receiver was built from plans in *Short Wave Craft*, it has always worked fine.

CHARLES B. COX,  
526 Madison Ave.,  
York, Pa.

One Year's Subscription to  
**SHORT WAVE CRAFT**  
FREE

for the "Best" Station Photo

Closing date for each contest—75 days preceding date of issue; Dec. 15 for March issue, etc. The editors will act as judges and their opinions will be final. In the event of a tie a subscription will be given to each contestant so tying.

# LONG WAVES • • • OUR READERS' FORUM

*(Thanks for your expressions of opinion on Short-Wave Craft, Charles, and also for your courtesy in sending us the very nice photo of your short-wave "listening post." The set-up looks like "real business."—Editor)*

## A "KINK" THAT DID WONDERS!

Editor, SHORT WAVE CRAFT:

I wish to compliment Mr. Seiko Yakahi on his fine "kink" in the October *Short Wave Craft*. He described how to change an ordinary two-circuit detector into an electron-coupled one. I tried his circuit out on my "Doerle A.C. Two," which heretofore had worked fairly well. Within an hour after I had made the required changes I had picked up EAQ, Madrid, with enough volume to be heard all over the upstairs and part of the downstairs rooms of our house. The tonal quality was almost equal to that of any U.S. station. The sensitivity and "pep" were about doubled. It is my opinion that Mr. Yakahi had the best "kink" on the page. Every "fan" who has a set similar to a "Doerle" should at least give Mr. Yakahi's "kink" a trial, as there are only four wires to change.

I hope that the sets in *Short Wave Craft* do not all start using metal tubes, as most of us still have quite a few glass tubes left that are still usable.

Yours truly,

LOUIS E. KELSEY,

420 North Lincoln Avenue,  
Wilmington, Ohio.

*(Will give you plenty of glass-tube sets, O. M.—Editor.)*

## W7AHQ HAS FIVE STATIONS

Editor, SHORT WAVE CRAFT:

Having been a reader of *Short Wave Craft* for quite some time, I have been interested in reading about all the amateur stations which you have published. I used to spend a lot of time during the winter working Eastern stations and I thought this would be a good way to show them what I have.

I have been active in amateur radio ever since 1920 and am about the only "old-timer" left in the northwest I believe.

The receiver is a National FB7 with antenna for BK-1N. The transmitter is a MOPA, using a 210 to drive a pair of 210's. With about 750 volts, a pair of 866's, with a large filter, keep the note clear. Separate filament transformers are used for rectifier and main tubes, and during transmission the tubes are run steady, instead of being turned off after each time.

Your editorials on radio, particularly the last one, have been quite interesting, and

## VE2HM—Corking Station operated by W. C. J. Meredith at 1228 Pine Ave. Montreal, Canada.

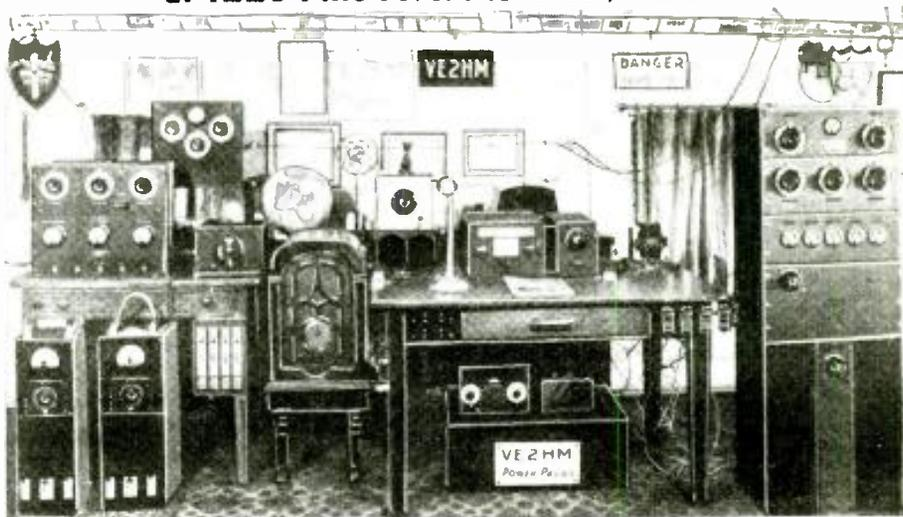

Speaking of short-wave Ham stations—here is a corker, operated by W. C. J. Meredith at Montreal, Canada.

I have been hoping that some editor would write on this subject.

I'll be glad to exchange photos with other amateurs.

R. C. NASER, W7AHQ,  
1119 9th St.,  
Anacortes, Wash.

*(Glad to hear from you, R. C. N., together with the excellent photo of your Ham station, particularly as we have not heard from many of our friends in the state of Washington. You ought to obtain some very fine long-distance contacts with this excellent station, and with the FB7 receiver, your reception should be right up to par. Editor)*

Editor, SHORT WAVE CRAFT:

The transmitter on the left of the photo is capable of a fully modulated carrier output of 25 watts and is used principally on 160-meter phone over medium distances, and on regular schedules, with the OM's shack in the country. On the right is a Collins 30 FXB transmitter, which is run with an average input of 200 watts to the final stage and is employed mostly for 20-meter phone work. Its signals have been reported fairly consistently in many parts of the world, but probably owing to directional effects the best DX reports are usually had

from Europe. Recent successful 2-way phone contacts include EA4AO Spain, CT1BY Portugal, G6XR England, VP3BG British Guiana, LU9PA Argentina, etc. On April 20 and 22 last, under good conditions, reports of QSA 5, R9 "local strength and quality" were obtained from G5VL, Cornwall, England, in 2-way QSO's.

Four transmitting antennas are available: a 268-foot single-wire-fed Hertz for 160-meter work, a 20-meter current-fed antenna, a 40- and a 20-meter Zeppelin. Both transmitters are fitted with the well-known Collins impedance matching system which greatly simplifies a change over from one antenna to another and also reduces harmonic radiation to a minimum.

The principal receiver is a National FBX, with one stage of pre-selection, coupled to a doublet antenna via a variable "all-wave coupler." This receiver is transformer-coupled to a dynamic speaker seen in the background. A National SW3 and a 3-tube battery set (seen under operating table) are available as stand-by receivers and a General Electric K80 is used for broadcast reception. On the left, under the smaller transmitter, are two self-contained portable 56 mc. transceivers used for experimental work on the 5-meter band. On the right of the principal receiver are the keys and key-click filter system—a combination of choke, condenser and resistance.

The station mascot, a black cat, presides over the monitor, wishing DX to every CQ.  
W. C. J. MEREDITH,  
1228 Pine Ave.,  
Montreal, Canada.

*(Some station! And we don't mean maybe! With this elaborate transmitting and receiving station, you should be able to contact stations just about anywhere "round the world," under good operating conditions, of course. The idea of using a series of antennas for the different wave-lengths is a very good one, and we have often wished for a large tract of ground, way out in the open country, away from high-tension lines, railroads, and other electrical or mechanical structures, so that we could erect a veritable "flock" of S-W antennas; then select, by means of switches, the one best suited for the particular transmission or reception frequency in us at the time.—Editor)*

## D.C. 2-TUBE DOERLE WORKS FINE

Editor, SHORT WAVE CRAFT:

Having built the 2-tube Doerle D.C. set,  
*(Continued on page 571)*

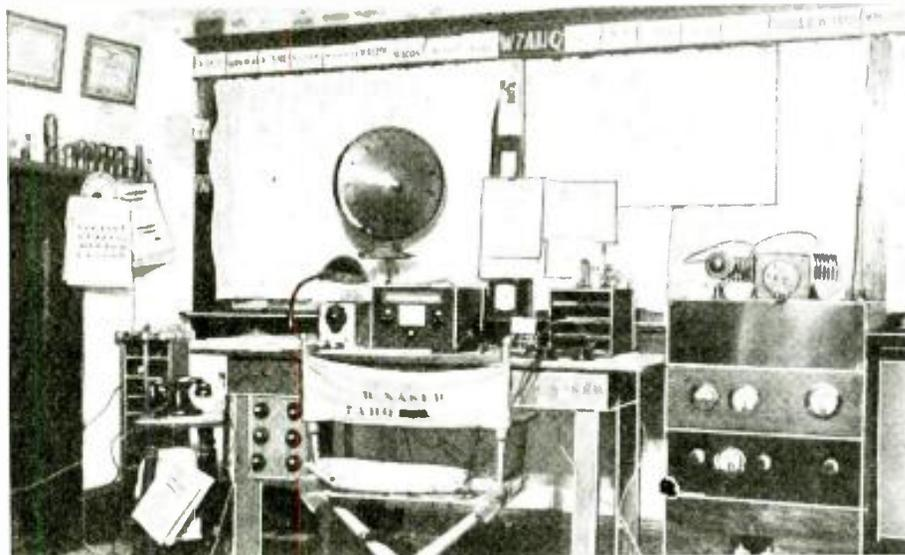

R. C. Naser of Anacortes, Wash., owner and operator of Station W7AHQ.

## TWENTY-SECOND "TROPHY CUP"

Presented to  
SHORT WAVE SCOUT  
FLETCHER W. HARTMAN  
SOUTH AMBOY, N.J.

For his contribution toward the  
advancement of the art of Radio



Magazine

### 22nd TROPHY WINNER

62 veries; 47 foreign

● IT IS with pleasure that we award the 22nd Short Wave Scout Trophy to Fletcher W. Hartman of 365 John St., South Amboy, N.J., for his contribution to the art of short-wave radio. Mr. Hartman had a total of 62 stations, all of which were verified; 15 were located in the United States, and 47 in foreign countries.

Mr. Hartman built his own receiver, and has been using it for the past two years. It is a 6-tube superheterodyne and has a switch arrangement for changing bands, and tunes from 9 meters to 26 meters in one position, 24 to 52 meters in the other, and from 200 to 550 meters in the third position of the switch. The antenna was a 60-foot wire with a 20-foot lead-in and 20 feet high. It seems, from his letter, that he had considerable difficulty with several stations in getting them to send verification cards, which would conform with the rules of our Contest. However, after much correspondence, he was able to win his point and submit the excellent total of 62 stations. You other fellows, who are complaining that the verifications received do not conform with our Contest rules, should take a hint from Mr. Hartman, and you will obtain the right kind of veries.

#### UNITED STATES STATIONS

- W1XK—9,570 kc.—Westinghouse Elec. & Mfg. Co., Boston, Mass.  
W2XAD—15,330 kc.—General Elec. Co., Schenectady, N. Y.  
W2XAF—9,530 kc.—General Elec. Co., Schenectady, N. Y.  
W2XE—6,120 kc.—Atlantic Broadcasting Co., 485 Madison Ave., New York City.  
W3XAL—17,780 kc.—National Broadcasting Co., New York City.  
W3XAL—6,100 kc.—Nat'l Broadcasting Co., N. Y. C.  
W3XAU—6,060 kc.—1622 Chestnut St., Philadelphia, Pa.  
W3XL—6,425 kc.—National Broadcasting Co., New York City.  
W8XAI—6,060 kc.—The Crosley Radio Corp., Cincinnati, Ohio.  
W8XK—15,210 kc.—Westinghouse Elec. & Mfg. Co., Pittsburgh, Pa.  
W8XK—6,140 kc.—Westinghouse Elec. & Mfg. Co., Pittsburgh, Pa.  
W8XK—11,870 kc.—Westinghouse Elec. & Mfg. Co., Pittsburgh, Pa.  
W9XAA—6,080 kc.—Northeast Tower, Navy Pier, Chicago, Ill.  
W9XF—6,100 kc.—National Broadcasting Co., Chicago, Ill.  
W10XV—3,100 kc.—Nat'l Broadcasting Co., N. Y. C., Mobile transmitter testing with Empire State Bldg.

#### FOREIGN STATIONS

- CJRO—6,150 kc.—Jas. Richardson & Sons, Winnipeg, Manitoba.  
C1RX—11,720 kc.—Same as above.  
VE9GW—6,090 kc.—Canadian Radio Comm., R. R. 4, Bowmanville, Ont.

(Continued on page 573)

# SHORT WAVE SCOUTS

## Honorable Mention Awards

Honorable Mention:

Samuel Solito, Leetsdale, Pa.

W. C. Boyce, Ambler, Pa.

P. E. Thompson, New York City, N. Y.

## Trophy Contest Entry Rules

● THE rules for entries in the SHORT WAVE SCOUT Trophy Contest have been amended and 50 per cent of your list of stations submitted must be "foreign." The trophy will be awarded to the SHORT WAVE SCOUT who has logged the greatest number of short-wave stations during any 30 day period; (he must have at least 50 per cent "foreign" stations). This period need not be for the immediate month preceding the closing date. The complete list of rules appeared in the September issue of this magazine.

In the event of a tie between two or more contestants, each logging the same number of stations (each accompanied by the required minimum of 50 per cent "foreigns") the judges will award a similar trophy to each contestant so tying. Each list of stations heard and submitted in the contest must be sworn to before a Notary Public and testify to the fact that the list of stations heard were "logged" over a given 30 day period, that reception was verified and that the contestant personally listened to the station announcements as given in the list.

Only commercial "phone" stations should be entered in your list, no "amateur transmitters" or "commercial code" stations. This contest will close every month on the first day of the month, by which time all entries must be in the editors' hands in New York City. Entries received after this date will be held over for the next month's contest. The next contest will close in New York City, December 31.

The winner each month will be the person sending in the greatest number of verifications. Unverified stations should not be sent in, as they will not count in the selection of the winner. At least 50 percent of the verifications sent in by each listener must be for stations located outside of the country in which he resides! In other words, if the contestant lives in the United States at least 50 percent of his "veries" must be from stations outside of the United States. Letters or cards which do not specifically verify reception, such as those sent by the Daventry stations and, also by commercial telephone stations, will not be accepted as verifications. Only letters or cards which "specifically" verify reception of a "given station," on a given wave length and on a given day, will be accepted! In other words it is useless to send in cards from commercial telephone stations or the Daventry stations, which state that specific verifications will not be given. Therefore do not put such stations on your list for entry in the trophy contest!

SHORT WAVE SCOUTS are allowed the use of any receiving set, from a one-tuber up to one of sixteen tubes or upwards, if they so desire.

When sending in entries, note the following few simple instructions: Type your list, or write in ink, pencilled matter is not allowed. Send verification cards, letters and the list all in one package, either by mail or by express prepaid; do not split up the package. Verification cards and letters will be returned, at the end of the contest, to their owners; the expense to be borne by SHORT WAVE CRAFT magazine.

In order to have uniformity of the entries, when writing or typing your list, observe the following routine: USE A SINGLE LINE FOR EACH STATION; type or write the entries IN THE FOLLOWING ORDER: Station call letters; frequency station transmits at; schedule of transmission, if known (all time should be reduced to Eastern Standard which is five hours behind Greenwich Meridian Time); name of station, city, country; identification signal if any. Sign your name at the bottom of the list and furthermore state the type of set used by you to receive these stations.

(Continued on page 573)

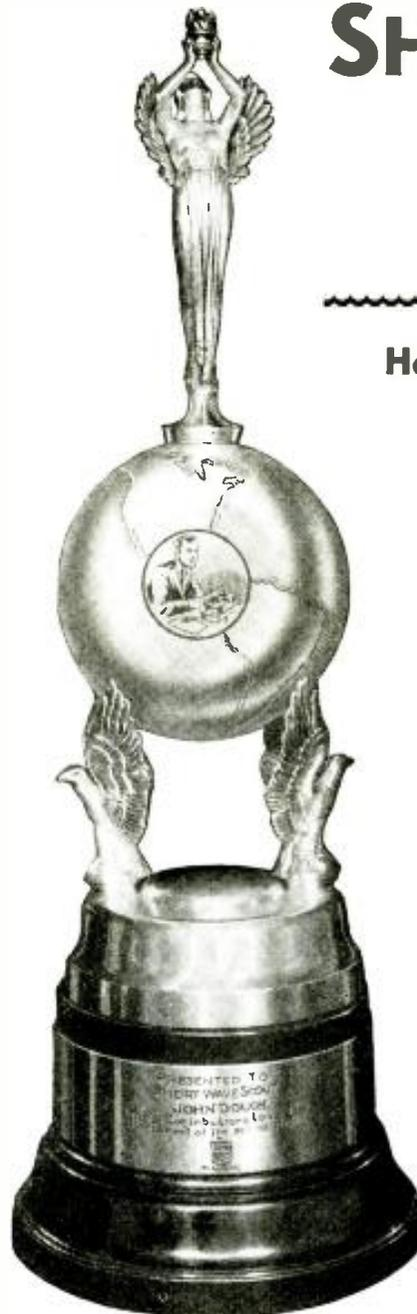

● ON this page is illustrated the handsome trophy which was designed by one of New York's leading silversmiths. It is made of metal throughout, except the base, which is made of handsome black Bakelite. The metal itself is quadruple silver-plated, in the usual manner of all trophies today.

It is a most imposing piece of work, and stands from tip to base 22½". The diameter of the base is 7¾". The diameter of the globe is 5¼". The work throughout is first-class, and no money has been spared in its execution. It will enhance any home, and will be admired by everyone who sees it. The trophy will be awarded every month, and the winner will be announced in the following issue of SHORT WAVE CRAFT. The winner's name will be hand engraved on the trophy.

The purpose of this contest is to advance the art of radio by "logging" as many short-wave phone stations, amateurs excluded, in a period not exceeding 30 days, as possible by any one contestant. The trophy will be awarded to that SHORT WAVE SCOUT who has logged the greatest number of short-wave stations during any 30-day period.

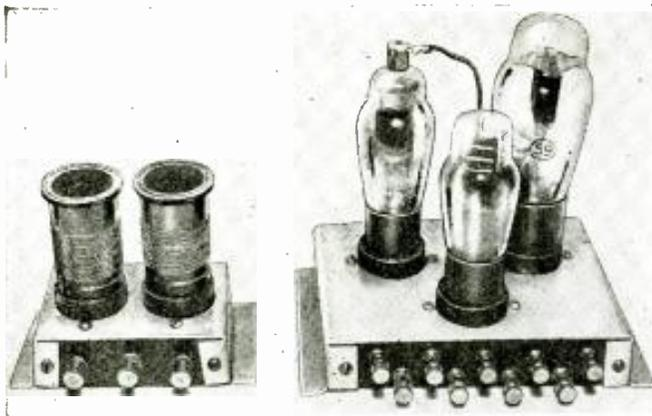

# It's a Cinch to Try Out The NEW CIRCUITS With These Units

By WILLIAM J. VETTE

Here's a simple idea which will make it easy to try out the various new circuits. The author provides "coil" and "tube" units fitted with numbered binding post terminals leading from all the socket contact springs. Connections can be made by means of flexible insulated wire.

In the scheme here described by Mr. Vette, a set of "coil" and "tube" units are provided, the various wires from the socket terminals leading to numbered binding posts, all sorts of connections being quickly arranged.

● HOW many times have hundreds of you readers of SHORT WAVE CRAFT, having good little sets working in tip-top shape, read the praises of hundreds of other experimenters using the "XYZ" circuit, which was a later circuit than yours, and wished that you could try out that circuit, without tearing up the set you already had, and without spending another five to twenty dollars. We all like to try out new circuits and improvements, of which the pages of this magazine are full. But about eight-tenths of us cannot afford a complete new outlay of parts, nor do we wish to spoil the performance of the set already operating so sweetly. Even so, I have found from experience that it doesn't take much soldering, unsoldering, and resoldering, along with unmounting and remounting parts to make them noisy and unfit for use in the modern hi-gain S.W. circuits. Well, it is to the above-mentioned eight-tenths that this article is dedicated. And I'm willing to bet a goodly number of the other twenty per cent will perk up their ears, too.

A few words here about what the two units about to be described will do: You will remember the famous "Doerle" two-tube receiver—you read its praises in every issue of SHORT WAVE CRAFT. And the more recent "Oscillidyne", in all its phases. And the "Pentaflex", another of Worcester's brain-children (or Storms?) And the "Twinflex", also by Worcester. And dozens of other circuits. Just look back over a few issues of SHORT WAVE CRAFT, and see how many circuits strike you as being worth a whirl, due to their novelty, or the writer's claims as to their DX abilities.

And how many more of these circuits are going to appear next month—and each month after that? Super-regenerative circuits by the dozen, and dozens of different regeneration schemes. It would cost a fortune to buy new parts and try them all out—but that's not necessary. You can, for an expenditure of between two and three dollars experiment with each and every one of these experiments, without damaging parts, or destroying the receiver already in use. In fact you may experiment with a dozen or so of them in a day's time; and you don't even need a soldering iron. This latter article, I believe, takes most of the job out of experimenting, if one makes very many changes. But this is not a necessity, after once building the about-to-be described gadgets. You can, by changing a few wires

to various binding posts on the units, try any regeneration control scheme with any coil, and with any ordinary tube on the market. And change from one to half a dozen others in just a few moment's time. It sounds fantastic, and even impossible—yet the two units making it not only absolutely possible, but practical as well, are constructed so simply that anyone without the slightest knowledge of radio can put them together and build them into a workable set in a very short while. These two units consist of merely two chosen groups of sockets, paralleled in such a manner as to receive any coil form in use today, and any common tube now in use by the average experimenter, their terminals brought out to metal binding posts arranged so that any tube may be used in any circuit, merely by connecting associated apparatus to the proper binding posts.

The photograph reproduced elsewhere shows two aluminum shelves, one holding two sockets and six binding posts; the other three sockets and nine binding posts.

These five sockets are of the type that will permit the use of any tube or coil form, due to their novel construction.

Reference to the parts list will show that of these five sockets, two of them are four-prong UX sockets, two of them "Universal" small and large base seven-prong socket. With the exception of the antique and ancient WD, WX and UV bases, these sockets will accommodate any type, size or make of tube, and as tubes will probably run to no more than seven prongs for a short while at least, will accommodate any that will be brought out in months to come. In addition to these five sockets, all else that is necessary is fifteen of the old style metal binding posts, with a hole and clamping screw, three strips of bakelite, dimensions shown in drawings, and two pieces of aluminum, dimensions also shown. The only substitution possible is the binding posts, and as such a substitution would be more expensive than the specified part, such is not advised. For quick and easy change, these binding posts should have a hole in them, and the metal post specified is the cheapest obtainable. There is, however, a similar post having two holes, and this would be an extremely worthy substitution, as will become apparent when you start adapting the E-Z Change units to different circuits. Auxiliary and external apparatus, of

(Continued on page 556)

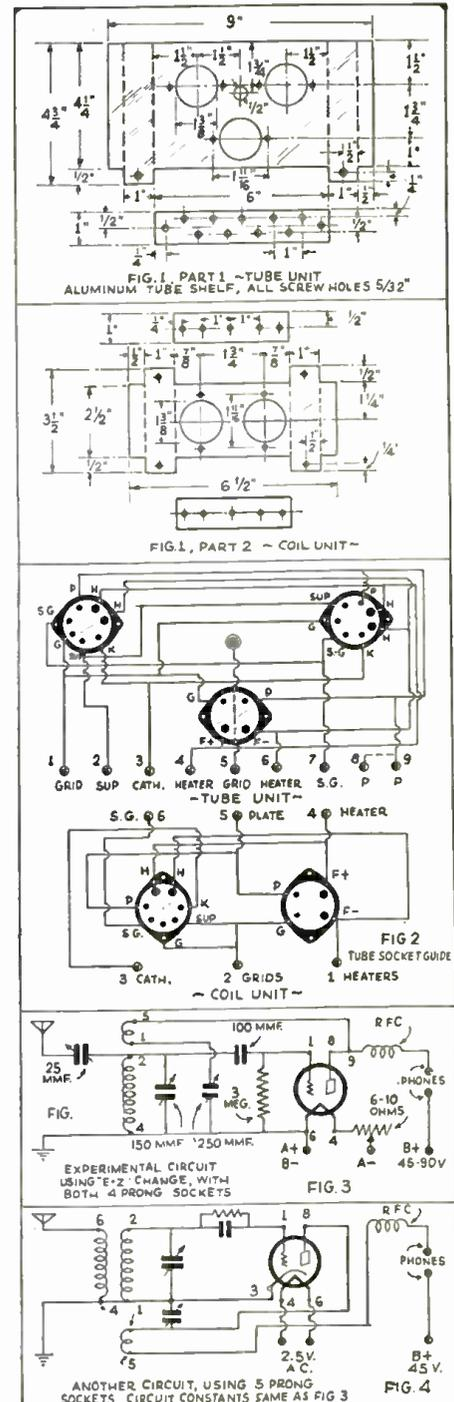

Above: Dimensions for making the "coil" and "tube" units. Also, two hook-ups for "1-tube" receivers are shown, the numbers referring to the binding posts on the units.

# An All-Electric Amplifier and Power Supply

By H. G. Cisin, M.E.

An amplifier for the 1 - 2 and 3 tube All-Electric sets—Part 3 of "standardized radio for the short-wave constructor."

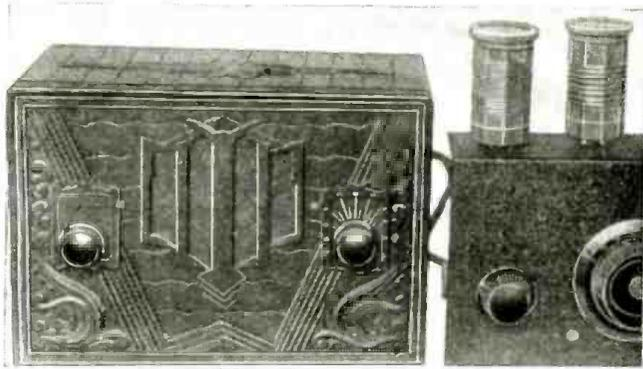

Above—Appearance of the amplifier and power supply unit with built-in speaker, connected to 2-tube S-W receiver. Photo at right shows rear view of amplifier and power supply unit.

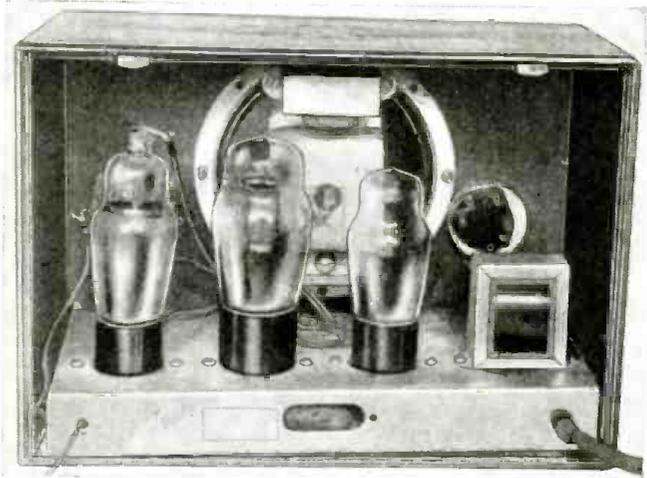

● IN the article in the November issue, a schematic diagram was given showing how to add a second stage to the "two-tube all-electric" receiver. No doubt the reader will recollect that this merely involved the addition of a 38 tube together with a few fixed resistors and fixed condensers. The actual physical appearance of this set is shown in the accompanying illustration.

Actually a set having two audio stages is powerful enough to operate a loudspeaker. In fact, this set is strong enough to operate a dynamic speaker, the only difficulty being that the 37 rectifier cannot pass enough current to supply both the set and the speaker field. Consequently, this set is restricted to magnetic speaker operation, except where a dynamic speaker is available which has a separate source of field supply. Where the set is to be operated on direct current, it is a simple matter to rig up a small filter and thus supply the speaker field independently. On alternating current, however, an A.C. type speaker would be necessary and this would involve an unwarranted expenditure.

In using this receiver on alternating current, the hum may be annoying when earphones are used instead of a speaker, due to the increased amplification. If such trouble manifests itself, the remedy is to increase the filtering action by adding electrolytic condensers on either side of the

choke. The best values can readily be determined by a little experimentation.

Now we come to the description of a device which can be used in conjunction with any of the sets described in this or previous articles. This is an inexpensive all-electric amplifier. The writer has received many requests for information regarding this amplifier (Continued on page 566)

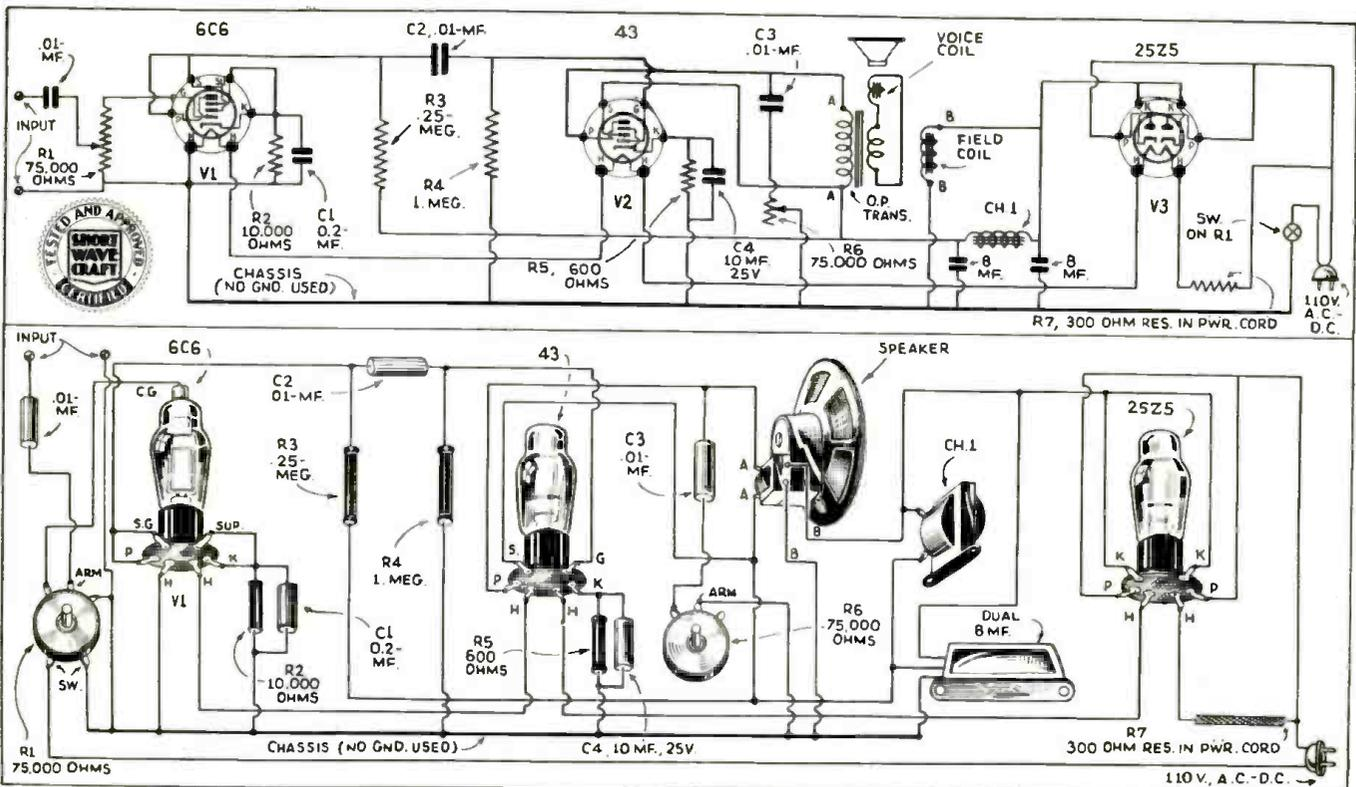

Here we have the wiring diagram for the All-Electric amplifier and power supply unit described by Mr. Cisin. This amplifier will work out of the detector stage of practically any short-wave receiver.

# WHAT'S NEW

The short-wave apparatus here shown has been carefully selected for description by the editors after a rigid investigation of its merits

## In Short-Wave Apparatus

### 2.5 and 5-Meter Superhet.

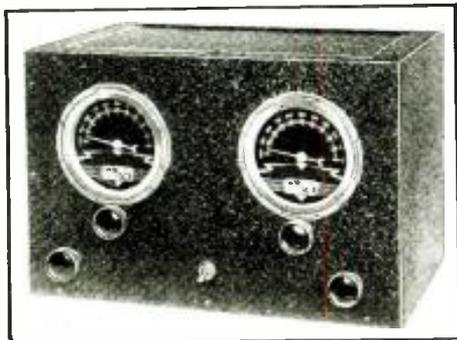

Front view of the Lafayette 2.5 and 5-meter superhet receiver.

● FULL advantage is taken of the excellent characteristics of the type 954 "Acorn" tube in the new two and a half and five-meter "Lafayette" superheterodyne receiver, recently brought out.

Examination of the accompanying diagram reveals that this receiver employs a type 954 "Acorn" pentode in a tuned R.F. stage, followed by another 954 as a tuned autodyne detector. Two 6D6 I.F. stages, a 41 second detector and semi-automatic volume control tube and a 42 output tube com-

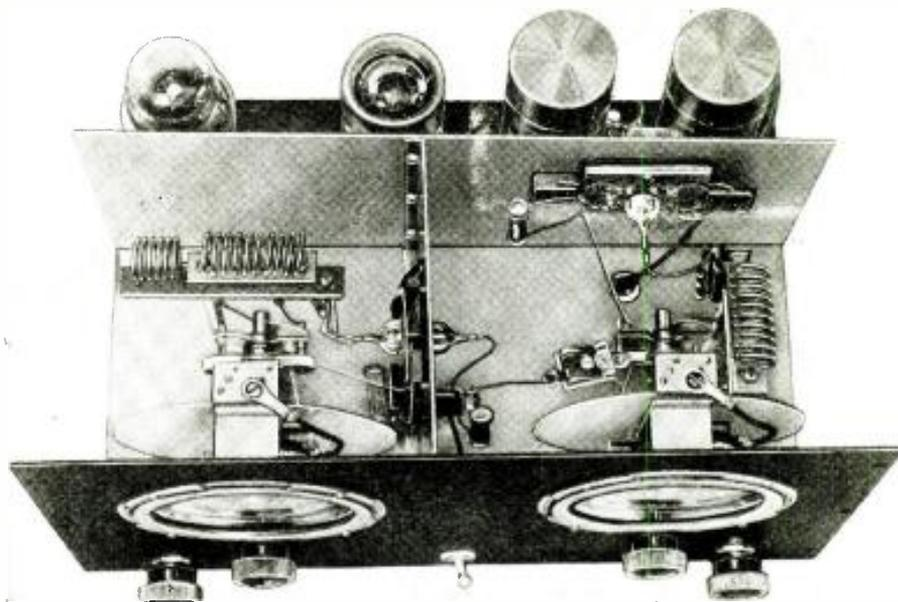
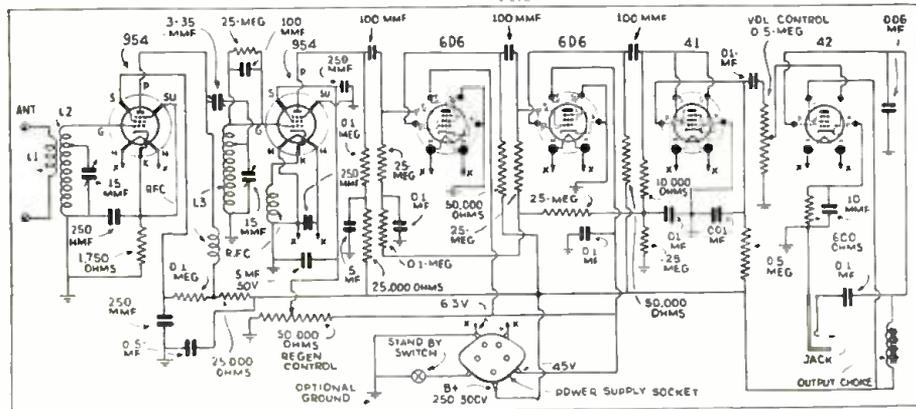

Photo above shows combination front and top view of 2.5 and 5-meter superhet, while diagram of the receiver appears at the left.



plete the circuit. The action of the autodyne detector is controlled by a 50,000-ohm potentiometer in the screen circuit, while audio volume is regulated by a one-half megohm potentiometer between the 41 and 42 tubes.

Due to the internal construction and design of the 954's, very little noise that is due to thermal agitation is heard in this set. Although the overall gain is much higher than in conventional superregenerative receivers, the background noise is at a very much lower level.

Although six tubes are used, the entire (Continued on page 571)

### Noise-Reducing Aerial

● THE All-Wave Aerial shown is a noise-reducing, high-efficiency system for reception of both broadcast and short wave. The system comprises a group of resonant circuits which are responsive to various frequency bands within the short-wave ranges, as well as complete frequency re-

sponse in the broadcast band. For example, the 17-foot section is resonant to a quarter wave length of the 15-megacycle band. The entire length of 60 feet is resonant to a half wave length in the 6-megacycle band. The 43-foot section is resonant to a quarter wave length somewhat below 6 megacycles. The combination of condensers, transformers and transmission line affords various other resonant points throughout the short-wave range. The result is that the antenna system is completely or partially resonant at almost any frequency within the short-wave broadcast transmission band. It likewise affords the high efficiency that a carefully installed antenna of the untuned type would for the other frequencies. When the set switch is placed in the broadcast position instead of the short-wave position, the system is then resonant to all frequencies within the broadcast band.

The set transformer is equipped with a switch having two positions—one for short waves and the other for standard broadcast. By adjusting the antenna system in this way for short-wave reception or for broadcast reception, the utmost efficiency is thus obtained. In the new All-wave An- (Continued on page 558)

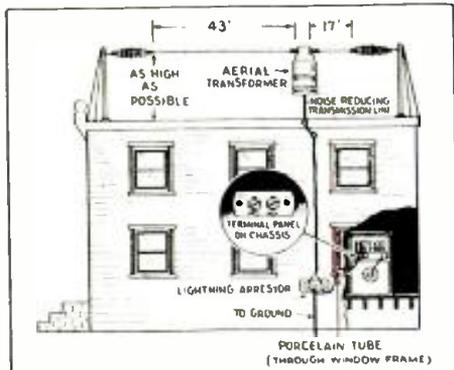

Arrangement of short and broadcast wave aerial supplied by one of the leading set manufacturers. (No. 328.)

### New Line Filter

● THE new service line filter has a brand-new feature, in that it is adjustable for each individual installation, by means of a small set-screw provided on the front of the filter. The filter is very easy to install, the plug from the set being inserted in the outlet on the filter box, while the rubber- (Continued on page 560)



A new "adjustable" Line-Filter or balancer which is connected between the A.C. line and the receiver itself. (No. 513)

Names and addresses of manufacturers of apparatus described on this and following pages furnished upon receipt of 3-cent stamp; mention No. of article.



Front view showing the control panel of the new RCA AR-60-S Communications Receiver.

## 11-Tube Communications Receiver—Range 1.5 to 25 mc.

its associated circuits. A large part of this noise is due to thermal agitation in the first tuned circuit. Being designed for *communication* purposes, the set naturally has *band-spread*, and this is of the type which allows full coverage and band-spread at any frequency within the range of the receiver. It is also equipped with a *crystal filter*, thus allowing extremely high selectivity, together with "single-signal" reception. Band switching is arranged so that all one needs to do, when changing from one band to another, is to "flip the switch," located directly under the tuning dials, to anyone of the six bands which the set takes in. The tuning range incidentally is from 1,500 to 25,000 kilocycles in the following steps: 1.5-2.29 meg., 2.29-3.63 meg., 3.63-5.65 meg., 5.65-9.25 meg., 9.25-15.2 meg., and 15.2-25 meg. As can be seen from the photograph, a great many switches and knobs are located on the panel. Every circuit that needs adjustment has a knob or control on the front panel, greatly simplifying the operation of the receiver.

This receiver can be operated from a 110-volt or 240-volt 60-cycle alternating current supply or from batteries, as explained in the instruction book supplied by its sponsors, the RCA (Continued on page 551)

● In the photo herewith we see the new RCA AR-60-S Communications Receiver which represents the last word in radio design. This receiver uses 11 tubes. The functions of the various tubes are as follows: Two 6D6's are used as R.F. amplifiers ahead of the first detector, which is a 6C6; another 6C6 is used as a high-frequency oscillator, and the voltage of this tube is regulated by an RCA 991 Regulator Tube; two more 6D6's are used as I.F. amplifiers, feeding into a 6B7, which functions as the third stage of I.F. second detector and AVC.

From this, we go into a 6F7 which is used as a combination audio frequency amplifier and CW beat oscillator. The audio output tube is a "41," and the rectifier is an indirectly heated cathode tube, type 84.

Glancing at the diagram it appears that the 11 tubes actually perform the duty of 14. The manufacturers claim that the sensitivity of the receiver is limited only by tube noise originating in the first tube and

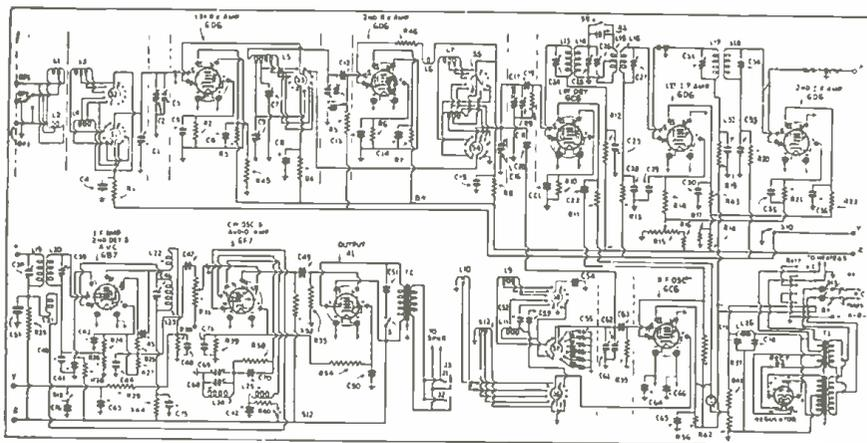

Wiring diagram of the new RCA Receiver.

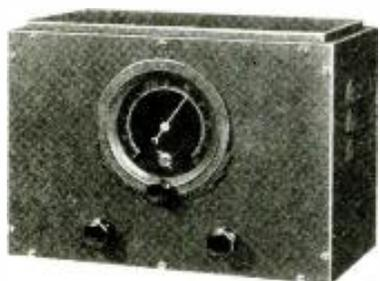

Front view of the Miller preselector.

## A 3-Tube Preselector

● IN all superheterodynes the local oscillator can be tuned to either of two frequencies that are an intermediate frequency higher or lower than the signal frequency. For example, we have an intermediate amplifier of 200 kc. and a signal of 2000 kc., so we must use an oscillator frequency of either 1800 or 2200 kc. The higher frequency setting of the oscillator is usually used. The 2200 kc. oscillator will also beat with any signal at 2400 kc. unless we take precautions against allowing frequencies of 2400 kc. to reach the oscillator. The undesired response is sometimes called the *image*.

In receivers where the signal circuit tuner consists of a single-tuned circuit connected to an antenna, the selectivity of such a setup is very broad and signals far off resonance will be passed. In the above example a signal of 2400 kc. would be heard along with the desired 2000 kc. signal. This is why we hear a lot of interference on signals, that is not due to the supposition that the signals are near each other in frequency but that they are *twice the intermediate frequency* apart. Many listeners suffer along, listening to short-wave broadcasts that are all smeared with code signals, thinking that the code is on the same frequency, when the fault is in their receiver and could be corrected by the use of a *preselector*.

All superheterodynes that have no preselection suffer from this sort of interference, especially on the *short waves*.

It can be seen that no matter how good the selectivity of the intermediate ampli-

fier, the image response will come through, without *preselection*.

Modern receivers have increased the intermediate frequency to a point just outside the broadcast band about 500 kc. and this makes the image response 1000 kc. away from the signal. This improves the situation at comparatively low signal frequencies, but when we tune in signals in the high-frequency spectrum the image is comparatively close to the signal. For instance, with a signal of 20,000 kc., the image, with a 500 kc. intermediate, is 21,000 kc. and the detector circuit cannot eliminate it, so that in modern receivers preselection is absolutely necessary. If the modern receiver did not have to tune continuously through the broadcast band up to the neighborhood of 25,000 or 30,000 kc., a higher intermediate frequency could be used, which would put the image farther away from the signal. Receivers that are made to receive high frequencies, only, take advantage of this point, but an all-wave receiver cannot.

(Continued on page 565)

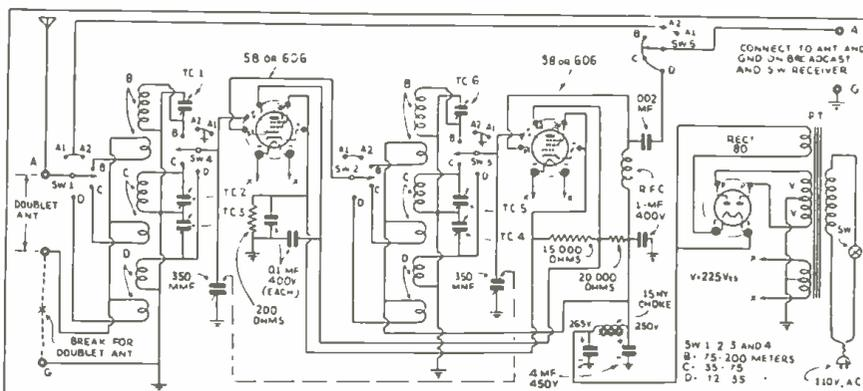

Wiring diagram of the 3-tube preselector.

Names and addresses of manufacturers of apparatus described on this and following pages furnished upon receipt of 3 cent stamp; mention No. of article.

# NEW APPARATUS FOR THE HAM

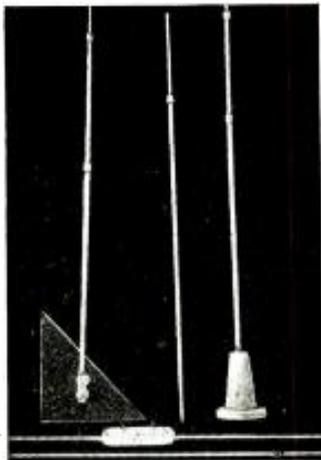

5-Meter Antennas (H-25)

## Adjustable U.H.F. Antennas H-25

Here is a complete set of adjustable ultra high-frequency antennas which should prove very interesting to the amateur. As can be seen in the photograph, several different types are manufactured. They are constructed of aluminum and are telescoped, with a hard metal locking sleeve to insure good contact at the joint. Lying horizontally at the base of the photo is a partial view of a complete doublet with the central insulating block clearly shown.

## Dial and Knob for Ham Set H-26

These dials will beautify any Ham transmitter or similar apparatus. They are of attractive satin finish, with black numbers and graduation marks on a chrome silver background. The knob is a large type with a flange, providing a very comfortable grip. These are available in 2", 3 1/2" and 4" diameters with various scale readings.

The readings are 0 to 100, with a 180-degree swing and 0 to 100 with a 325-degree swing. Bar type bakelite pointer knobs and the usual round finger-grip knob with pointer are also available to take the place of the flange-type knob shown in the photograph.

They are made with several different mounting arrangements.

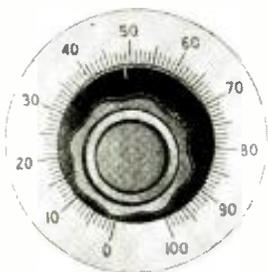

New dial. (H-26)

## Transmitting Condenser H-27

This is a really rugged and well-designed dual-transmitting condenser. The frame is made of heavy cast aluminum with plates of extremely high polish and with rounded edges. This new Hammarlund product can be obtained in capacities ranging from 50 to 500 mmf. per section. With the two sections in series the breakdown voltage is 13,000 volts.

With a split-stator condenser of the type shown, R. F. burns and body-capacity effects are eliminated when the two sections are connected across the coil and the rotor grounded to the "B" negative side of the circuit, thus permitting precise adjustment.

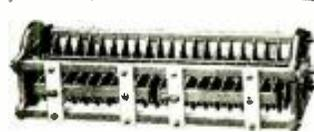

Transmitting condenser. (H-27)

## Flexible Shaft Coupling H-28

This new National flexible shaft coupling unit is ideally suited to cases where the driving adjustment and instrument shafts are offset up to angles of 90 degrees. This virtually eliminates all aligning problems.

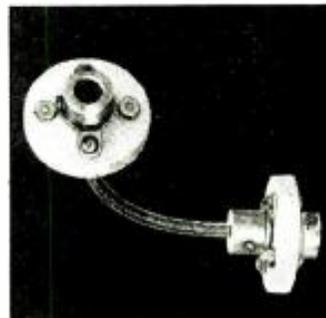

Flexible coupling. (H-28)

## Transceiver Hand-Set H-29

Hand-sets of this type are ideally suited to the present popular transceivers. It provides a microphone and ear-phone combination which is hard to beat where simplicity and convenience are essential.



Transceiver hand-set. (H-29)

# Practical 5-Meter Antenna Design

● IT IS DOUBTFUL that any group of radio amateurs in the country has been more active, during the past year and a half, than the Garden City Radio Club. This organization has made a very definite study of ultra-high-frequency operation and it has gone to considerable expense to prove certain theories by working them out practically. Members of the Club have been very active in arranging ultra-high-frequency tests between ground and aircraft and between fixed and mobile stations.

It has long been recognized by the Club that 5-meter operation in a large city is vastly different from such operation in flat unobstructed areas. The Club's urban activities have been placed in charge of the present author and in order to draw satisfactory conclusions, good and poor 5-meter locations have been chosen and the following interesting results have been obtained, with receiving antennas.

It may be that the work we have done

## Various Types of Aerials Used at W2DLG and W2DKJ and the Results Obtained

By Arthur H. Lynch

will be of some benefit to others who contemplate 5-meter activity. We have discovered no new principles. In fact, a recent rereading of "Below Ten Meters" prepared by James Millen and S. Kruse, some time ago, indicates that nearly all of the present ultra-high-frequency operation is along lines which were fairly well understood many years ago. It is, rather, with the idea of enabling the beginner on five meters to eliminate much of the guesswork, that we recount our own activities.

It has been our belief that fair distances can be covered with moderate power, provided aerials of suitable design were used. We have never looked upon the method of getting long distances by the expedient of using high power as being very intelligent when, with moderate power and careful attention to antenna design, the same result can be accomplished, at a much lower cost. Much cutting and trying will be eliminated if the newcomer to five meters will first read "Below Ten Meters" because there is more real dope packed into that one little publication, than can be dug up from a whole group of texts.

For our receiving antenna, after observing 5-meter performance in various sections of New York City, we realized that for suitable metropolitan coverage, it would be desirable to secure a location having reasonably good altitude.

Through the good offices of Eli M. Lurie, (Continued on page 532)

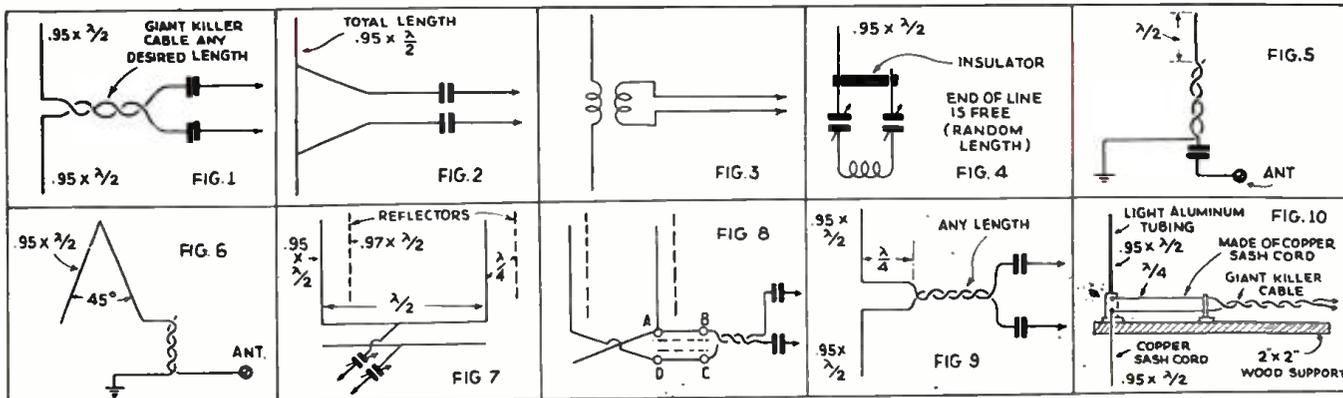

Various 5-meter aerials described by the author.

Names and addresses of manufacturers of apparatus described on this and following pages furnished upon receipt of 3 cent stamp; mention No. of article.

# THE RADIO AMATEUR

*Conducted by Geo. W. Stuart*

## Radio Amateur Course

● THIS is the fifth lesson in our *Radio Amateur Course*, and will deal with radio and audio frequency, class "A" and "B" amplifiers, and radio frequencies, class "B" and "C" amplifiers, together with frequency multipliers. The first type of amplifier that the average radio experimenter comes in contact with is the well-known *Class "A" audio amplifier*. In our previous lessons discussing the vacuum tube action, we clearly explained the functions of the cathode grid and plate, also just how the changes in grid potential effect changes in plate current, thus amplifying the signal.

When reading the following descriptions of amplifiers, it is well to review the previously described actions of the various elements in tubes because these will not be taken up again in detail, and a perusal of the lesson on tubes will greatly aid in obtaining a clear mental picture of various types of amplifiers.

In Figure 1-A, the tube is operated under conditions so that the *output* is an exact replica of the *input* signal. It can, therefore, be said that the tube is operated on the flat portion of its grid-voltage plate-current curve. By examining the drawing at Figure 1-A, we see that the grid never goes sufficiently negative to reduce the plate current to zero, and it is also not allowed to go positive; if it were, the grid would draw current on the positive peaks, and this is not desirable in the usual Class "A" amplifier.

### Class "A" Amplifiers

Class "A" amplifiers are capable of really faithful amplification, but are quite inefficient, insofar as power conservation is concerned. Usually these

In this, the fifth lesson of the Radio Amateur Course, Class "A", "B" and "C" amplifiers are discussed. Also frequency multipliers and modulated Class "C" amplifiers are explained.

amplifiers are about 50 per cent efficient. In Figure 2-A we have in a 1-tube audio frequency Class "A" amplifier circuit. In figure 2-B we have an amplifier of the push-pull variety wherein two tubes are used, each operating on alternate half cycles of the input signal. In Figure 1-B we have a diagram of the characteristics of a Class "B" radio frequency amplifier. The operating characteristics are essentially the same as a Class "B" audio amplifier, only in the R.F. amplifier, as indicated, the frequency is constant and the amplitude of it is varied by modulation. This is said to be a *Linear* amplifier.

In a Class "B" audio amplifier, the frequency would vary. However, the essential functions are the same. We find that the bias is such that it allows the grid to become positive on one-half of the incoming signal, running the plate current way up. On the negative half of the cycle in the R.F. amplifier, we find that the plate current is zero and remains zero through the entire 180 degrees of the negative grid swing, and then it begins to rise as the grid again goes positive. It can thus be seen that plate current flows over the 360 degrees of the grid swing in Class "A" amplifier, and only

180 degrees of the grid swing in a Class "B" amplifier. Now, in an audio system, it is essential that we reproduce an exact replica of the incoming signal; that is why in Class "B" amplifiers intended for audio frequency use, we use push-pull in order to reproduce *both halves* of the incoming signal.

### Class "B" Amplifiers

In R.F. amplifiers wherein the variations in amplitude of a constant frequency carrier constitutes our audio frequency signal, we do not need push-pull, because if we refer to Figure 1-D, we will see that a complete A.F. variation is present on the one-half, although two tubes are often used in the Class "B" R.F. amplifier. This is only done to increase the power output. We can very easily see why only one-half of the modulated R.F. signal is needed; because of the action of our detector, really only one-half of it is used anyway. In Class "B" amplifiers of all descriptions, the grid-bias is adjusted so that the plate current is zero or nearly zero with no signal present in the grid circuit. In the now popular Class "AB" or "A" prime, audio frequency amplifiers, plate current flows throughout more than 180 degrees of the input cycle but less than 360. This means that the plate current may fall to zero and remain zero for just a small portion of the input cycle. In Figures 1-E, F and G, we clearly show how in the Class "A" amplifier, the plate current is continually flowing, and in the Class "B" amplifier, it only flows through 180 degrees of the input cycle, while on Class "C" amplifier, which is next to be discussed, on less than 180 degrees of the input cycle.

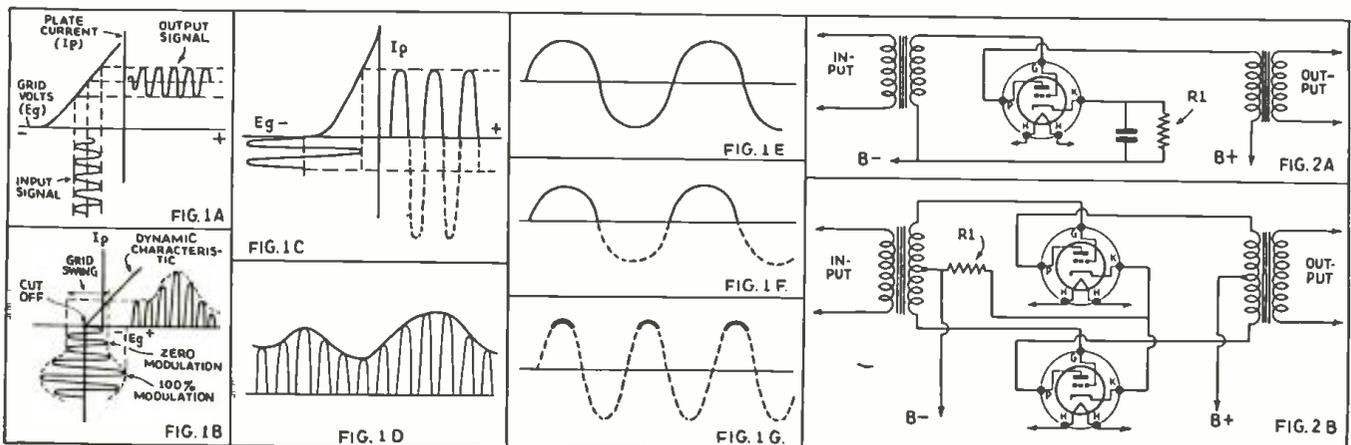

The above drawings show characteristics of Class "A," "B," and "C" amplifiers, together with amplifier diagrams.

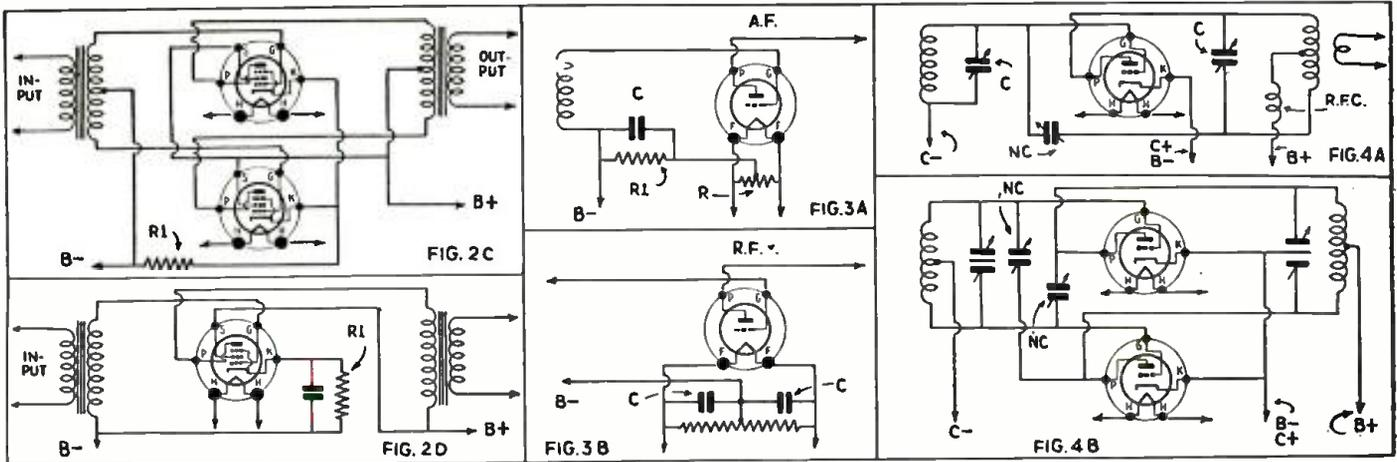

Diagrams of pentode A.F. amplifiers, single and push-pull, together with neutralizing single and push-pull R.F. amplifiers.

**Class "C" Amplifiers**

Class "C" amplifiers are usually used only for *radio frequency* amplification because of the tremendous amount of distortion which is present in the output wave. In Class "C" amplifiers, the bias is increased to about two times the value necessary to bring the plate current to zero. This means that a greater amount of excitation is required in order to make the plate current flow. This requires, of course, that the grid be driven considerably *positive*. Vacuum tubes operated in the Class "C" category are capable of tremendous power output as compared to a Class "A" or "B" amplifier, and are usually quite a bit more efficient, insofar as plate-power conversion is concerned. Efficiencies as high as 85 per cent are quite easily obtained. Of course, the ratio of power amplification is reduced considerably in a Class "C" amplifier, because of the fact that plate current only flows on a small portion of the input cycle and because a Class "C" amplifier requires a good deal more excitation.

A class "C" amplifier in a radio frequency phone transmitter is modulated directly, i.e., a powerful modulator is used to vary the plate input to the tube at audio frequencies, while a Class "B" amplifier used in a phone transmitter is not modulated directly, but a low-power, class "C" amplifier which is modulated at voice frequencies, is used to drive the Class "B" linear R.F. amplifier. While the Class "B" amplifier is not

as efficient as the Class "C" amplifier, it introduces a considerable saving in the cost of modulator equipment, because a fairly low-power stage is modulated, and the Class "B" amplifier is merely used to amplify the modulated output of this low-power stage.

The next lesson will describe a M.O.P.A. (Master Oscillator-Power Amplifier) transmitter—using a crystal oscillator, a frequency multiplier, a buffer and a power amplifier. Thorough outline of the tuning and operative procedure will be given.

times 100. For instance, if we have an amplifier with a power input of 100 watts and an output of 75 watts, we would have an amplifier which was 75 per cent efficient, the output being 75 per cent of the total plate input.

In figures 1-C and 1-G, we have illustrations of the operation of a Class "C" amplifier. To the lay reader, Figure, 1-G would probably be the clearest, because herein we find a clearer picture, showing that the plate current flows on a very small portion of the input cycle. In Figures 2-C and 2-D, we have *pentodes* used as *audio frequency* amplifiers. Bias for these is obtained by inserting the resistor in series with the cathode, or if it is a filament type tube, a center-tap resistor is needed, as shown in Figures 2-A and 3-A. In an R.F. amplifier, usually the center-tapped resistor is *by-passed* with two condensers, as in Figure 3-B. Resistors "R" in Figure 2-C, 2-D, and 3-A, are the *self-biasing* resistors.

**Neutralizing**

With a *triode* used as a radio frequency amplifier and where the input and output circuits are tuned to the same frequency, a method of overcoming *self-oscillation* is required. This is accomplished by *neutralizing* as shown in Figure 4-A. What we have done here is to center-tap the plate coil, making the two ends *out of phase 180 degrees*. Then a small condenser is connected between the grid of the tube and the end (Continued on page 561)

**Efficiency in Power Output**

Efficiencies of around 70 per cent may be secured from a Class "B" amplifier with 100 per cent modulation on the driver stage, although an unmodulated Class "B" amplifier would be only about 35 per cent efficient. Speaking of plate efficiency or power conversion in the plate circuit of the vacuum tube, we mean the "power" output divided by the power input,

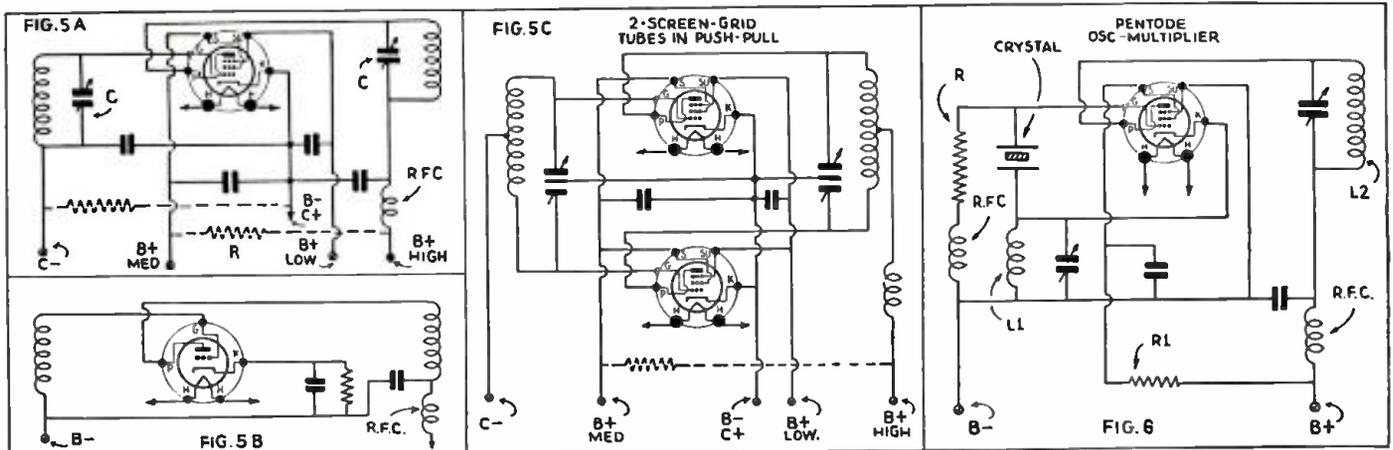

Pentode single and push-pull R.F. amplifiers and crystal oscillator-frequency multiplier diagrams.

# The "SG3"



Front view of 20-watt transmitter using all receiving parts

excitation. The 89 is the berries for tritot oscillators and frequency multipliers!

### Actual Tests Showed Superior Results

It might be well to "take time out" and say that two of these transmitters were built; one to operate on the low-frequency bands and one for the 5-meter band. And with the push-pull amplifier running on 5 meters with 500 volts on the plates and a total of 50 mills plate current, 14 watts output was obtained and the tubes showed no signs of being overloaded. In fact, this is still within the plate dissipation value previously given. This 5-meter transmitter will be described in an early issue.

The low-frequency transmitter here-in described gave an output of approximately 20 watts with 35 watts input—500 volts at 70 mills (M.A.); higher inputs gave little increase in output and would materially shorten the tube life. Neither of the transmitters required any shielding, not even tube shields. By all means do not employ tube shields, because the tubes become very warm in operation and the shield would only hinder heat radiation and cause trouble.

### The Hook-Up

Looking at the circuit diagram, we find a conventional tritot oscillator, inductively coupled to the amplifier. The values of condensers and resistors indicated in the diagram, have proved optimum and should not be changed. The same power supply is used for both the oscillator and amplifier; the oscillator voltage being reduced slightly with a series resistor. There is also a separate voltage-dropping resistor for the screen voltages of the two stages. The screen voltages are kept quite low in order not to shorten the tube life.

● LOW cost and high efficiency is the cry of the young Ham. Still, when building his transmitter he should have a quality piece of apparatus capable of putting out a fairly strong signal of the highest quality—a signal that meets with the present Government requirements. The first thought is toward *receiving* type tubes. Of these we have built plenty of transmitters and obtained excellent results. In most cases though, we have not had the latest in quality and simplicity. Most low-power transmitters use triodes or pentodes which require neutralizing and this makes a messy job of shifting bands.

### The "89" Tube a Daisy!

There is one tube which is comparatively unknown amongst the amateurs and this is the type 89 intended for audio frequency amplification either as a pentode, triode, or class A and B amplifier. The tube is almost an exact duplicate of the type 59, well known as a crystal oscillator and frequency multiplier. The 89 differs from the 59 in that the control-grid connection is brought out the top of the bulb much

the same as screen-grid tubes. The 89 is rated at somewhat lower-power input than the 59, but tests have shown that it will do just about all a 59 will, and besides has many advantages not found in the 59. In the first place the 89 can be used as a screen-grid R.F. amplifier on all frequencies up to 125 megacycles! And by good authority we have been informed that it will stand up to 8 watts plate dissipation and 1.4 watts for the screen-grid! This makes it a rather "husky" tube for low-power transmitters and exciter units.

Three type 89's are used in this transmitter, one as a crystal-controlled "tritot" oscillator and two in push-pull as screen-grid R.F. amplifiers. No neutralizing whatsoever is necessary and the amplifier operates as "stable" as any we have ever come in contact with; there is not the slightest trace of a tendency toward self-oscillation. The transmitter will work on any two bands with one crystal. For 80 and 40 meters an 80-meter crystal is used; on 40, the plate circuit of the oscillator takes care of the frequency doubling and the amplifier is provided with plenty of

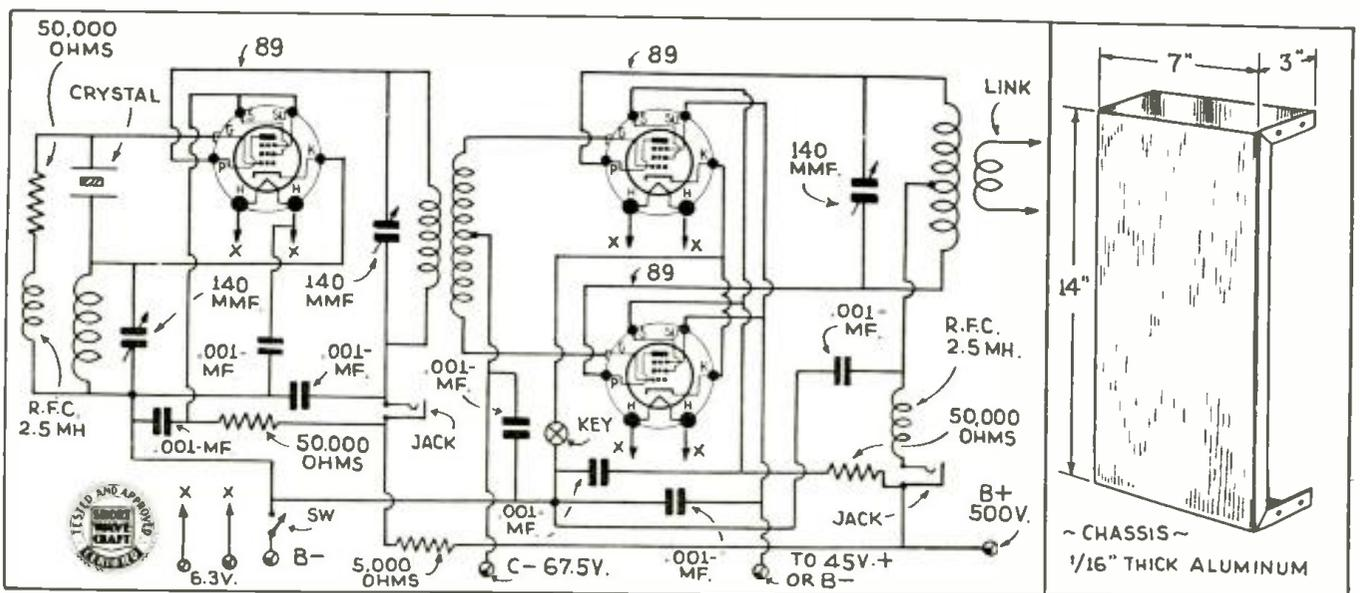

Circuit diagram and chassis details of 20-watt transmitter.

# TRANSMITTER

## Made from Receiver Parts

It is at last possible, thanks to W2AMN, to build a transmitter almost entirely of receiving parts and one which is not really "flea power." This one uses 3 type "89" tubes, one as a crystal-control oscillator, and two in a push-pull, screen-grid amplifier circuit. It is capable of transmitting a high-quality signal, and has an output of 20 watts! It operates on 80, 40 and 20 meters. Believe it or not, it can be built for less than a dollar a watt.

By George W. Shuart,

W2AMN



### Oscillator

In the oscillator we find that the suppressor grid is connected to the screen while in the amplifier the suppressors are either connected to the cathodes (B negative) or a positive potential of from 22.5 to 45 volts. This positive potential gave a slight increase in output but probably not enough to warrant its application.

The three plug-in coils are wound on small National type XR20 isolantite forms, having five prongs. The plate coil of the oscillator is wound on the outside of the form while the grid coil of the amplifier is wound on a short length of one-inch tubing and placed inside of the coil form. This coil is wound with fine wire and is untuned much the same as in TNT circuits. The tuning condensers are all midget receiving condensers, having 140 mmf. capacity.

### Aluminum Chassis Used

The entire transmitter is mounted on an aluminum chassis 7 inches wide, 14 inches long, and 3 inches high; along one side of the chassis is mounted a bakelite strip to accommodate the 0-100 scale milliammeter and the various jacks and power switch. By this plug arrangement only one meter is needed, thus lowering the cost of the parts. All by-pass condensers are mounted under the chassis and the leads feeding it are by-passed right at the point where they come through the chassis.

Looking at the photo of the top view we have the oscillator grid-coil and the crystal on the extreme left, and the os-

illator tube behind the tuning condenser. The oscillator plate coil and its tuning condenser are in the center with the two amplifiers next, and the plate tuning condenser between them and the plate coil. The output link which is supported around the plate coil with standoff insulators, serves to couple the antenna or another amplifier stage. With the plate voltage reduced on the oscillator the plate current will be low. The plate current when operating on the crystal frequency will be around 20 mills (M.A.) and slightly higher when operating on the second harmonic of the crystal fre-

quency. The plate condenser of the oscillator should be adjusted for minimum plate current. The plate condenser of the amplifier should also be tuned for lowest plate current, this will be around 20 or 25 mills, when no antenna load is present. With the antenna coupled, the current will rise. The coupling should not be adjusted to load the plate circuit up to more than 60 mills (M.A.). With this input (30) watts, the output should be around 20 watts. Tuning is very simple especially as there is no neutralizing required. The key jack is in series with the two cathodes of the amplifier

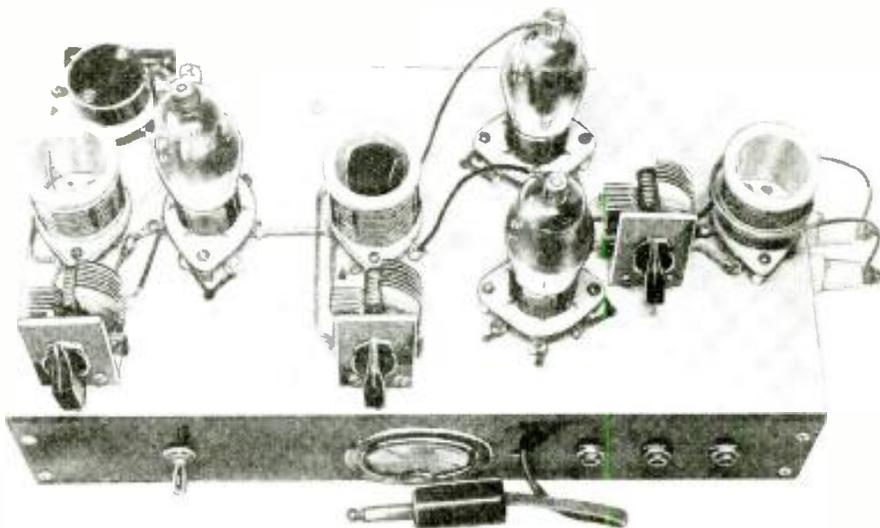

Above: Top view showing the placement of parts; note its extreme simplicity.

Left: Bottom View. Only condensers and resistors are placed underneath.

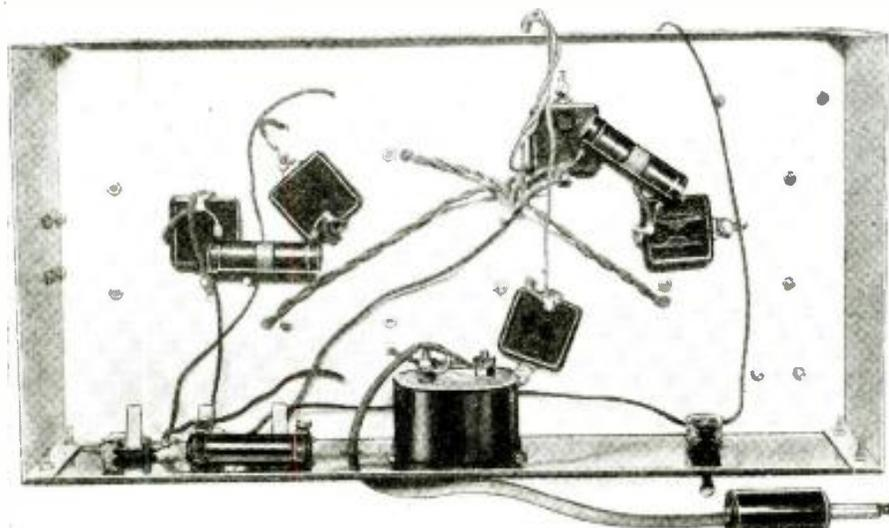

providing very smooth keying.

During a month of operation and testing this little transmitter proved positively practical as a transmitter of *high quality* and also as a very efficient exciter unit for a higher power stage. In the very near future we will describe an amplifier, antenna network, and power supply which will provide a combination hard to beat.

### Parts List for Transmitter

- 1—Aluminum chassis (see drawing), Blan.
- 1—Bakelite panel (see drawing).
- 3—6-prong isolantite sockets: National.
- 4—5-prong isolantite sockets: National.
- 3—140 mmf. condensers, National, type EX.
- 6—.001 mf. 1,000 volt mica condensers: Aero-vox.
- 3—50,000-ohm resistors, 20 watt; Aerovox.
- 1—5,000-ohm resistor, 20-watt; Aerovox.
- 2—R.F. chokes, National R100.

(Continued on page 564)

\$5.00 Prize

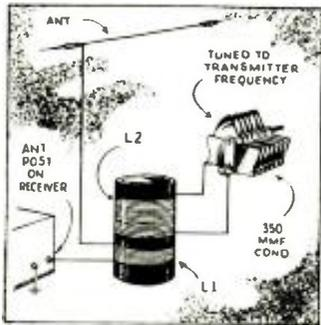

**AID FOR DUPLEX**

Duplex operation may be greatly aided by means of an inductively-coupled wave-trap as shown in the diagram. The coupling between L1 and L2 may be varied to increase the selectivity of the circuit or to increase the effect of the trap, so that the trap will weaken the transmitter signal without seriously affecting the strength of the incoming signal. L1 should generally be about 1/4 the number of turns of L2. Approximate dimensions of L2 are: For 160 meters, 25 turns; for 80 meters, 10 turns; for 40 meters, 5 turns; for 20 meters, 3 turns—all on 3" diameter form and wound with No. 20 or larger wire.—Roger E. Farmer.

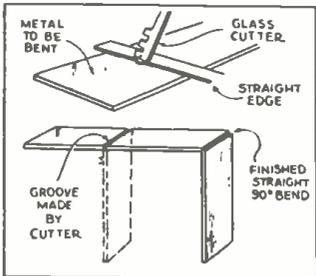

**HOME-MADE SHIELD CANS**

Here's how to use a glass-cutter to very good advantage in making "summer-looking" square shield cans for that sub-herb you're building, or for any other purpose—all from aluminum 1/32" or under. First get a straight edge and place against line to be bent, then glass cutter with plenty of pressure run back and forth against straight edge, until an impression of about one-third the thickness of the aluminum is obtained. Then with the cut side on the outside of the square can, put in vice or in between two blocks of wood and bend as per sketch. You will be surprised to see what a perfectly square and straight corner you have. That will make a fine commercial-looking job.—Geo. Kusnich.

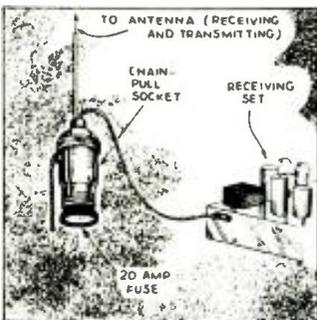

**ANTENNA SWITCH**

My kink is to use an ordinary lamp socket that has a pull chain device for turning on and off the current. Screw a 20 amp. fuse in the socket to complete the circuit when the switch is pulled to the on position. This device may be mounted alongside the feeder where it enters the room, and ordinary strong twine runs from the chain of the socket through eyelets to the receiving position. All the operator has to do, is to pull the twine and he breaks the receiving antenna in order to transmit.—R. S. Krebs-W3ESY.

**EARPHONE AS MIKE**

I have found that by connecting a 2,000-ohm earphone to the input circuit of the

## \$5.00 FOR BEST SHORT-WAVE KINK

The Editor will award a five dollar prize each month for the best short-wave kink submitted by our readers. All other kinks accepted and published will be awarded eight months' subscription to **SHORT WAVE CRAFT**. Look over these "kinks" and they will give you some idea of what the editors are looking for. Send a typewritten or ink description, with sketch, of your favorite short-wave kink to the "Kink" Editor, **SHORT WAVE CRAFT**.

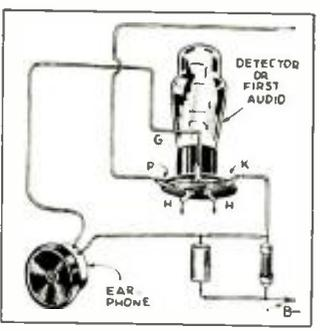

detector or first audio amplifier of my broadcast receiver. It served as an excellent microphone. The diagram clearly shows how it is connected.—Tom Davis.

**PLUG-IN SOLDERING IRON**

Here is a kink which should find favor among the short-wave experimenters and mechanics. I fastened an old tube-base to the handle of my soldering iron. Then connect the terminals of the socket in series

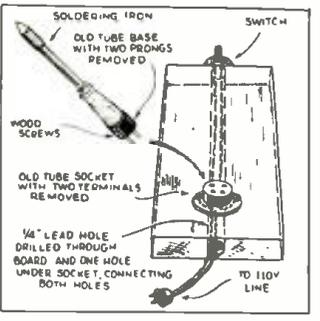

of the A. C. line and a switch. The drawing clearly shows how the job is done. Be sure the socket will carry the current requirements of the iron.—Clarence Teter.

**NOVEL ANTENNA CONDENSER**

As is shown in the drawing, I used two condenser plates from a discarded i-grid condenser as an antenna tuner. One is fastened to a bakelite strip, while the other can be moved, thus varying the capacity. A knob attached to the shaft of the movable plate, will be of considerable aid.—Edward Whages.

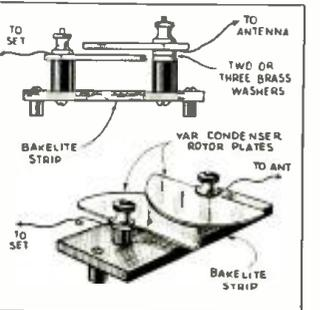

**NEW USE FOR SHADE FIXTURE**

The other day I was visiting a friend of mine who is an amateur radio operator. He was having trouble mounting a couple of "V" type transmitting condensers and I happened to think of curtain holders. We found they worked very efficiently and did the trick. There are many cases when you would like to mount this type of condenser on a bread-board but have no supports. I hope this kink will help many radio experimenters. Enclosed you will find a sketch of the kink.—Francis G. Boudreau.

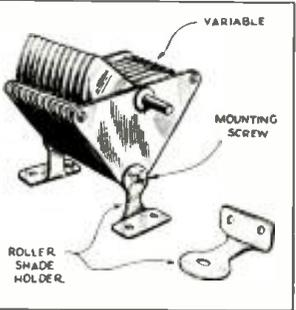

**SIMPLE SOLDERING IRON HOLDER**

During my experiments, I found that a large screw-eye fastened into a baseboard, served as a very convenient soldering iron holder. A number of these can also be fastened directly on to the work-bench, so that soldering can be done on any part of the bench without moving the holder. Several of these may be used.—Fred Fischell.

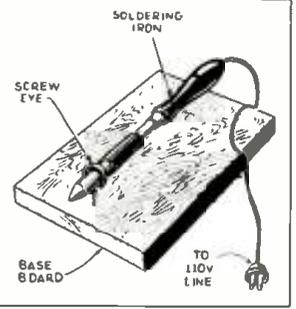

**TUNING KINK**

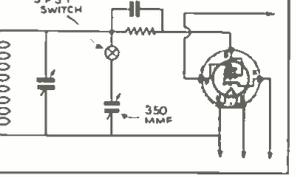

An easy method of receiving the broadcast station is to connect a .00035 mf. tuning condenser in parallel with the one in use in the set. Connect the rotor of the new condenser to the rotor of the old one. Then connect the stator together with a S.P.S.T. switch in the circuit as shown in the diagram. With the switch open the set functions as usual; to receive B.C. stations, close the switch and tune with the new condenser. The largest S-W coil (160 meter coil) should be used.—Viron E. Payne.

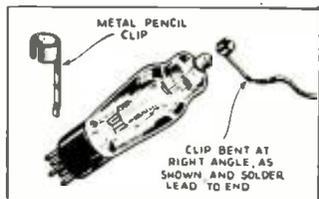

**GRID-CLIP KINK**

I had my set completed except for one grid clip. I noticed a pencil with a pocket clip on it, and found it would fit over the tube cap. I then bent the long end up at right-angles, and soldered the wire to this. In cases where the clips are nickel-plated, it is necessary to file off the plating, because the solder usually will not adhere to the smooth nickel surface.—Thomas H. Lamborn.

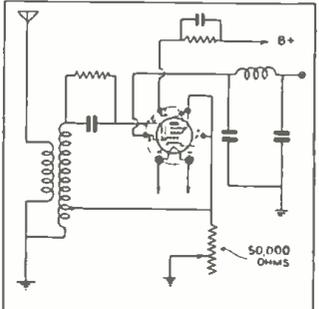

**SMOOTH REGENERATION CONTROL**

I have found that by connecting a potentiometer across the cathode section of an electron-coupled detector, smoother control was effected, of course, the screen voltage must be correct for normal sensitivity. This method of controlling regeneration proved to be smoother than the usual methods.—J. Kent Hogan.

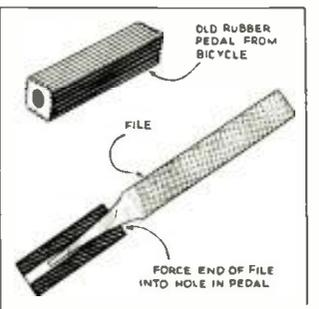

**RUBBER FILE HANDLE**

Using wood file handles for a number of years, and having them break and wear out, I finally decided to hunt around for something more serviceable. A discarded rubber pad from a bicycle pedal was finally selected and proved to be far superior to the wooden handles. The file is merely fastened into one end of the rubber block.—Everett E. Hoard.

**NEW USE FOR CONDENSER PLATE**

Removable plates of an old "HC" condenser may be used as a dial plate, by carefully engraving them. With the aid of a straight edge and a sharp tool, professional appearance is obtained. The new type knob pointers may be used to provide a real swell dial.—E. Abel.

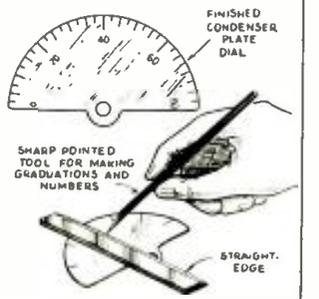



# Short-Wave Stations of the World

## Complete List of Broadcast, Police and Television Stations

We present herewith a revised list of the short-wave broadcasting, experimental and commercial radiophone stations of the world. This is arranged by frequency, but the wavelength figures are also given for the benefit of readers who are more accustomed to working with "meters." All the stations in this list use telephone transmission of one kind or another

and can therefore be identified by the average listener. Herewith is also presented a very fine list of police as well as television stations. Note: Stations marked with a star ★ are the most active and easily heard stations and transmit at fairly regular times. Please write to us about any new stations or other important data that you

learn through announcements over the air or correspondence with the stations themselves. A post card will be sufficient. We will safely return to you any verifications that you send in to us. Communications of this kind are a big help. Stations are classified as follows: C—Commercial phone. B—Broadcast service. X—Experimental transmissions.

### Around-the-Clock Listening Guide

Although short-wave reception is notorious for its irregularity and seeming inconsistency (wherein lies its greatest appeal to the sporting listener), it is a good idea to follow a general schedule as far as wavelength in relation to the time of the day is concerned. The observ-

ance of these simple rules will save time. From daybreak till 3 p.m., and particularly during bright daylight, listen between 13 and 19 meters (21540 to 15800 kc.). To the east of the listener, from about 1 p.m.-8 p.m., the 25-35 meter will be found very pro-

ductive. To the west of the listener this same band is generally found best from about 8 p.m. until 9 a.m. (After dark, results above 35 meters are usually much better than during daylight.) These general rules hold for any location in the Northern Hemisphere.

### Short-Wave Broadcasting, Experimental and Commercial Radiophone Stations

NOTE: To convert kc. to megacycles (mc.) shift decimal point 3 places to left: Thus, read 21540 kc. as 21.540 mc.

<b>21540 kc. W8XK</b> -B- 13.93 meters WESTINGHOUSE ELECTRIC PITTSBURGH, PA. 7-9 a.m.; relays KDKA	<b>19345 kc. ★PMA</b> -B.C- 15.51 meters BANDOENG, JAVA Calls Holland early a.m. Broadcasts Tues., Thur., Sat., 10:00-10:30 a.m.	<b>17790 kc. GSG</b> -B- 16.86 meters DAVENTRY B.B.C. BROADCASTING HOUSE, LONDON, ENGLAND 6-8:45 a.m.	<b>15880 kc. FTK</b> -C- 18.80 meters ST. ASSISE, FRANCE Phones Saison, morning	<b>15250 kc. W1XAL</b> -B- 19.67 meters BOSTON, MASS. Irregular, in morning
<b>21420 kc. WKK</b> -C- 14.01 meters A. T. & T. CO. LAWRENCEVILLE, N. J. Calls Argentina, Brazil and Peru, daytime	<b>19220 kc. WKF</b> -C- 15.60 meters LAWRENCEVILLE, N. J. Calls England, daytime	<b>17780 kc. ★W3XAL</b> -B- 16.87 meters NATIONAL BROAD. CO. BOUND BROOK, N. J. Relays WJZ, Daily exc. Sun. 9 a.m.-1 p.m.	<b>15810 kc. LSL</b> -C- 18.98 meters HURLINGHAM, ARGENTINA Calls Brazil and Europe, daytime	<b>15245 kc. ★</b> -B- 19.68 meters "RADIO COLONIAL" PARIS, FRANCE Service de la Radiodiffusion 103 Rue de Grenelle, Paris 7-11 a.m.
<b>21080 kc. PSA</b> -C- 14.23 meters RIO DE JANEIRO, BRAZIL Works WKK Daytime	<b>19160 kc. GAP</b> -C- 15.68 meters RUGBY, ENGLAND Calls Australia, early a.m.	<b>17775 kc. PHI</b> -B- 16.88 meters HUIZEN, HOLLAND Used irregularly	<b>15760 kc. JYT</b> -X- 19.04 meters KEMIKWA-CHO, CHIBA- KEN, JAPAN Irregular in late afternoon and early morning	<b>15220 kc. ★PCJ</b> -B- 19.71 meters N.V. PHILIPS' RADIO EINDHOVEN, HOLLAND Sun. 8:30-11:30 a.m. Also Tues. 3-6 a.m., Wed. 7-11 a.m.
<b>21060 kc. WKA</b> -C- 14.25 meters LAWRENCEVILLE, N. J. Calls England noon	<b>18970 kc. GAQ</b> -C- 15.81 meters RUGBY, ENGLAND Calls S. Africa, Morning	<b>17760 kc. DJE</b> -B- 16.89 meters BROADCASTING HOUSE BERLIN, GERMANY 8-11:30 a.m.	<b>15660 kc. JVE</b> -C- 19.16 meters NAZAKI, JAPAN Phones Java 3-5 a.m.	<b>15210 kc. ★W8XK</b> -B- 19.72 meters WESTINGHOUSE ELECTRIC & MFG. CO. PITTSBURGH, PA. 9 a.m.-7 p.m. Relays KDKA
<b>21020 kc. LSN6</b> -C- 14.27 meters HURLINGHAM, ARG. Calls N. Y. C. 8 a.m.-5 p.m.	<b>18830 kc. PLE</b> -C- 15.93 meters BANDOENG, JAVA Calls Holland, early a. m.	<b>17760 kc. IAC</b> -C- 16.89 meters PISA, ITALY Calls ships, 6:30-7:30 a. m.	<b>15620 kc. JVF</b> -C- 19.2 meters NAZAKI, JAPAN Phones U.S., 5 a.m. & 4 p.m.	<b>15200 kc. ★DJB</b> -B- 19.74 meters BROADCASTING HOUSE BERLIN, GERMANY 3:45-7:15 a.m., 8-11:30 a.m.
<b>20700 kc. LSY</b> -C- 14.48 meters MONTE GRANDE ARGENTINA Tests irregularly	<b>18620 kc. GAU</b> -C- 16.11 meters RUGBY, ENGLAND Calls N. Y., daytime	<b>17310 kc. W3XL</b> -X- 17.33 meters NATIONAL BROAD. CO. BOUND BROOK, N. J. Tests irregularly	<b>15415 kc. KWO</b> -C- 19.46 meters DIXON, CAL. Phones Hawaii 2-7 p.m.	<b>15140 kc. ★GSF</b> -B- 19.82 meters DAVENTRY. B.B.C. BROADCASTING HOUSE, LONDON, ENGLAND 3:30-5:30, 6-8:45, 9-10:30 a.m.
<b>20380 kc. GAA</b> -C- 14.72 meters RUGBY, ENGLAND Calls Argentina, Brazil, mornings	<b>18435 kc. FZS</b> -C- 16.35 meters BAIGON, INDO-CHINA Phones Paris, early morning	<b>17120 kc. WOO</b> -C- 17.52 meters A. T. & T. CO., OCEAN GATE, N. J. Calls ships	<b>15370 kc. ★HAS3</b> -B- 19.52 meters BUDAPEST, HUNGARY Broadcasts Sundays, 9-10 a.m.	<b>15120 kc. ★HVJ</b> -B- 19.83 meters VATICAN CITY ROME, ITALY 10:30 to 10:45 a.m., except Sunday Sat. 10-10:45 a.m.
<b>19900 kc. LSG</b> -C- 15.08 meters MONTE GRANDE, ARGENTINA Tests irregularly, daytime	<b>18310 kc. GAS</b> -C- 16.38 meters RUGBY, ENGLAND Calls N. Y., daytime	<b>17080 kc. GBC</b> -C- 17.56 meters RUGBY, ENGLAND Calls Ships	<b>15355 kc. KWU</b> -C- 19.53 meters DIXON, CAL. Phones Pacific Isles and Japan	<b>15090 kc. RKI</b> -C- 19.88 meters MOSCOW, U.S.S.R. Phones Tashkent near 7 a.m. and relays RNE on Sundays irregularly
<b>19820 kc. WKN</b> -C- 15.14 meters LAWRENCEVILLE, N. J. Calls England, daytime	<b>18250 kc. FTO</b> -C- 16.43 meters ST. ASSISE, FRANCE Calls S. America, daytime	<b>16270 kc. WLK</b> -C- 16.44 meters LAWRENCEVILLE, N. J. Phones Arg., Braz., Peru, daytime	<b>15330kc.★W2XAD</b> -B- 19.56 meters GENERAL ELECTRIC CO. SCHENECTADY, N. Y. Relays WGY daily, 2-3 p.m. Sun. 10:30 a.m.-4 p.m.	<b>15070 kc. PSD</b> -C- 19.91 meters RIO DE JANEIRO, BRAZIL Calls N.Y., Buenos Aires and Europe, daytime
<b>19650 kc. LSN5</b> -C- 15.27 meters HURLINGHAM, ARGENTINA Calls Europe, daytime	<b>18200 kc. GAW</b> -C- 16.48 meters RUGBY, ENGLAND Calls N. Y., daytime	<b>16270 kc. WOG</b> -C- 16.44 meters OCEAN GATE, N. J. Calls England, morning and early afternoon	<b>15280 kc. DJQ</b> -B- 19.63 meters BROADCASTING HOUSE BERLIN, GERMANY 12:30-2 a.m.	<b>15055 kc. WNC</b> -B- 19.92 meters HIALEAH, FLORIDA Calls Central America, daytime
<b>19600 kc. LSF</b> -C- 15.31 meters MONTE GRANDE, ARGENTINA Tests irregularly, daytime	<b>18135 kc. PMC</b> -C- 16.54 meters BANDOENG, JAVA Phones Holland, early a. m.	<b>16240 kc. KTO</b> -C- 16.47 meters MANILLA, P. I. Calls Cal., Tokio and ships 8-11:30 a.m.	<b>15270 kc. ★W2XE</b> -B- 19.65 meters ATLANTIC BROADCASTING CORP. 485 Madison Av., N.Y.C. Relays WABC daily, 11 a.m.-6 p.m.	<b>14980 kc. KAY</b> -C- 20.03 meters MANILA, P. I. Phones Pacific Isles
<b>19355 kc. FTM</b> -C- 15.50 meters ST. ASSISE, FRANCE Calls Argentine, Morning	<b>18040 kc. GAB</b> -C- 16.63 meters RUGBY, ENGLAND Calls Canada, morn. and early aftn.	<b>16233 kc. FZR3</b> -C- 16.48 meters SAIGON, INDO-CHINA Calls Paris and Pacific Isles	<b>15260 kc. GSI</b> -B- 19.66 meters DAVENTRY. B.B.C. BROADCASTING HOUSE, LONDON, ENGLAND 12:15-2:15 p.m.	<b>14950 kc. HJB</b> -C- 20.07 meters BOGOTA, COL. Calls WNC, daytime

(All Schedules Eastern Standard Time)

**14600 kc. JVH**  
-B.C. 20.55 meters.  
NAZAKI, JAPAN  
Broadcasts Mon. and Thurs.  
4-5 p.m.  
Phones Europe 4-8 a.m.

**14590 kc. WMN**  
-C. 20.56 meters  
LAWRENCEVILLE, N. J.  
Phones England  
morning and afternoon

**14535 kc. HBJ**  
-B. 20.64 meters  
RADIO NATIONS,  
GENEVA, SWITZERLAND  
Broadcasts irregularly

**14530 kc. LSN**  
-C. 20.65 meters  
HURLINGHAM, ARGENTINA  
Calls N.Y.C. afternoons

**14500 kc. LSM2**  
-C. 20.69 meters  
HURLINGHAM, ARGENTINA  
Calls Rio and Europe daytime

**14485 kc. TIR**  
-C. 20.71 meters  
CARTAGO, COSTA RICA  
Phones Cen. Amer. & U.S.A.  
Daytime

**14485 kc. HPF**  
-C. 20.71 meters  
PANAMA CITY, PAN.  
Phones WNC daytime

**14485 kc. TGF**  
-C. 20.71 meters  
GUATEMALA CITY, GUAT.  
Phones WNC daytime

**14485 kc. YNA**  
-C. 20.71 meters  
MANAGUA, NICARAGUA  
Phones WNC daytime

**14470 kc. WMF**  
-C. 20.73 meters  
LAWRENCEVILLE, N. J.  
Phones England  
morning and afternoon

**14440 kc. GBW**  
-C. 20.78 meters  
RUGBY, ENGLAND  
Calls U.S.A., afternoon

**13990 kc. GBA**  
-C. 21.44 meters  
RUGBY, ENGLAND  
Calls  
Buenos Aires, late afternoon

**13635 kc. SPW**  
-B. 22 meters  
WARSAW, POLAND  
Sundays 11:30 a.m.-12:30 p.m.

**13610 kc. JYK**  
-C. 22.04 meters  
KEMIKAWA-CHO, CHIBA-  
KEN, JAPAN  
Phones California till 11 p. m.

**13585 kc. GBB**  
-C. 22.08 meters  
RUGBY, ENGLAND  
Calls  
Egypt & Canada, afternoons

**13415 kc. GCJ**  
-C. 22.36 meters  
RUGBY, ENGLAND  
Calls Japan & China early  
morning

**13390 kc. WMA**  
-C. 22.40 meters  
LAWRENCEVILLE, N. J.  
Phones England  
morning and afternoon

**13345 kc. YVC**  
-C. 22.48 meters  
MARACAY, VENEZUELA  
Calls Hialeah daytime

**13075 kc. VPD**  
-X. 22.94 meters  
SUVA, FIJI ISLANDS  
Daily exc. Sun. 12:30-1:30 a.m.

**12840 kc. WOO**  
-C. 23.36 meters  
OCEAN GATE, N. J.  
Calls ships

**12825 kc. CNR**  
-B. C. 23.39 meters  
DIRECTOR GENERAL  
Telegraph and Telephone  
Stations, Rabat, Morocco  
Broadcasts: Sunday, 7:30-9 a. m.

**12800 kc. IAC**  
-C. 23.45 meters  
PISA, ITALY  
Calls Italian ships, mornings

**12780 kc. GBC**  
-C. 23.47 meters  
RUGBY, ENGLAND  
Calls ships

**12396 kc. CT1GO**  
-B. 24.2 meters  
PAREDE, PORTUGAL  
Sun. 10-11:30 a.m., Tues.,  
Thurs., Fri. 1:00-2:15 p.m.

**12290 kc. GBU**  
-C. 24.41 meters  
RUGBY, ENGLAND  
Calls N.Y.C., afternoon

**12235 kc. TFI**  
-C. 24.52 meters  
REYKJAVIK, ICELAND  
Phones England mornings,  
Broadcasts irregularly

**12150 kc. GBS**  
-C. 24.69 meters  
RUGBY, ENGLAND  
Calls N.Y.C., afternoon

**12000 kc. RNE**  
-B. 25 meters  
MOSCOW, U. S. S. R.  
Sun. 6-9, 10-11 a.m., 12:30 p.m.  
Wed. 5-6 a.m.

**11991 kc. FZS2**  
-C. 25.02 meters  
SAIGON, INDO-CHINA  
Phones Paris, morning

**11950 kc. KKQ**  
-X. 25.10 meters  
BOLINAS, CALIF.  
Tests, irregularly, evenings

**11940 kc. FTA**  
-C. 25.13 meters  
STE. ASSISE, FRANCE  
Phones CNR morning,  
Hurlingham, Arge., nights

**11890 kc. \***  
-B. 25.23 meters  
"RADIO COLONIAL"  
PARIS, FRANCE  
11:50 a.m.-6 p.m.  
3-4 a.m.

**11870 kc. W8XK**  
-B. 25.26 meters  
WESTINGHOUSE ELECTRIC  
& MFG. CO.  
PITTSBURGH, PA.  
5-9 p.m.  
Fri. till 12 m  
Relays KDKA

**11860 kc. GSE**  
-B. 25.29 meters  
DAVENTRY,  
B.B.C., BROADCASTING  
HOUSE, LONDON, ENGLAND

**11830 kc. W2XE**  
-B. 25.36 meters  
ATLANTIC BROADCASTING  
CORP.  
485 MADISON AVE., N. Y. C.  
Relays WABC 6-8 p.m.

**11810 kc. 2RO**  
-B. 25.4 meters  
E.I.A.R.  
Via Montello 5  
ROME, ITALY  
8:15-9 a.m., 9:15-10:15 a.m.,  
12 n.-1 p.m.

**11800 kc. CO9WR**  
-X. 25.42 meters  
P. O. Box 83  
SANCTI SPIRITUS,  
CUBA  
Testing in early evening  
and 9 a.m.-12 n.

**11790 kc. W1XAL**  
-B. 25.45 meters  
BOSTON, MASS.  
Sun. 5-7 p.m.

**11770 kc. DJD**  
-B. 25.49 meters  
BROADCASTING HOUSE,  
BERLIN, GERMANY  
12-4:30 p.m.

**11750 kc. GSD**  
-B. 25.53 meters  
DAVENTRY,  
B.B.C., BROADCASTING  
HOUSE, LONDON, ENGLAND  
3:30-5:30 a.m., 9 a.m.-12n.  
12:15-4 p.m.

**11730 kc. PHI**  
-B. 25.57 meters  
HUIZEN, HOLLAND  
Daily exc. Tues. and Wed. 8:30-  
10:30 a.m., Sun. 8:30-11:30 a.m.

**11720 kc. CJRX**  
-B. 25.6 meters  
WINNIPEG, CANADA  
Daily, 6 p. m.-12 m.

**11715 kc.**  
-B. 25.61 meters  
"RADIO COLONIAL"  
PARIS, FRANCE  
7-10:10 p.m.  
11 p.m.-1 a. m.

**11710 kc. HJ4BA**  
-B. 25.62 meters  
P. O. BOX 50,  
MEDELLIN, COLOMBIA  
11:30 a.m.-1 p.m., 6:30-10:30  
p.m.

**11680 kc. KIO**  
-X. 25.68 meters  
KAHUKU, HAWAII  
Tests in the evening

**11560 kc. VIZ3**  
-X. 25.95 meters  
AMALGAMATED WIRELESS  
OF AUSTRALIA  
FISKVILLE, AUSTRALIA  
Calls Canada evening and early  
a.m.

**11413 kc. CJA4**  
-C. 26.28 meters  
DRUMMONDVILLE,  
QUE., CAN.  
Tests with Australia irregularly  
in evening

**11200 kc. XBJQ**  
-B. 26.79 meters  
BOX 2825,  
MEXICO CITY, MEX.  
Daily 5:30-6:30 p.m., 10 p.m.-  
12 m. Relays XEW.

**11050 kc. ZLT4**  
-C. 27.15 meters  
WELLINGTON, N. ZEALAND  
Phones Australia and England  
early a.m. Also broadcasts ir-  
regularly on Sunday, 9-10 a.m.

**11000 kc. PLP**  
-B. C. 27.27 meters  
BANDONG, JAVA  
Relays NIROM programs 5:30-11  
a.m. irregular on Sundays

**10770 kc. GBP**  
-C. 27.95 meters  
RUGBY, ENGLAND  
Calls  
Sydney, Austral. early a. m.

**10740 kc. JVM**  
-B. C. 27.93 meters  
NAZAKI, JAPAN  
Daily 12 n.-1 a.m., Tues. and  
Fri. 2-3 p.m., Mon. and Thur.  
4-5 p.m.

**10675 kc. WNB**  
-C. 28.1 meters  
LAWRENCEVILLE, N. J.  
Calls Bermuda, daytime

**10670 kc. CEC**  
-C. 28.12 meters  
SANTIAGO, CHILE  
Broadcasts Thurs., Sun.  
8:30-9 p.m.

**10660 kc. JVN**  
-C. 28.14 meters  
NAZAKI, JAPAN  
Phones Europe 3-8 a.m.

**10550 kc. WOK**  
-C. 28.4 meters  
LAWRENCEVILLE, N. J.  
Phones  
Arge., Braz., Peru, nights

**10520 kc. VLK**  
-C. 28.51 meters  
SYDNEY, AUSTRALIA  
Calls Rugby, early a.m.

**10430 kc. YBG**  
-C. 28.76 meters  
MEDAN, SUMATRA  
5:30-6:30 a. m., 7:30-8:30 p. m.

**10420 kc. XGW**  
-C. 28.79 meters  
SHANGHAI, CHINA  
Calls Manila and England, 8-9  
a. m. and California late evening

**10410 kc. PDK**  
-C. 28.80 meters  
KOOTWIJK, HOLLAND  
Calls Java 7:30-9:40 a. m.

**10410 kc. KES**  
-X. 28.80 meters  
BOLINAS, CALIF.  
Tests evenings

**10350 kc. LSX**  
-C. 28.98 meters  
MONTE GRANDE,  
ARGENTINA  
Tests irregularly 8 p.m.-12 mid-  
night.

**10330 kc. ORK**  
-B. C. 29.04 meters  
RUYSSSELEDE, BELGIUM  
Broadcasts 2:30-4 p.m.

**10300 kc. LSL2**  
-C. 29.13 meters  
HURLINGHAM, ARGENTINA  
Calls Europe, evenings

**10290 kc. DIQ**  
-X. 29.16 meters  
KONIGSWATERHAUSEN,  
GERMANY  
Broadcasts irregularly

**10260 kc. PMN**  
-C. 29.24 meters  
BANDONG, JAVA  
Calls Australia 5 a.m.

**10250 kc. LSK3**  
-C. 29.27 meters  
HURLINGHAM, ARGENTINA  
Calls Europe and U. S., after-  
noon and evening

**10220 kc. PSH**  
-C. 29.35 meters  
RIO DE JANEIRO, BRAZIL

**10140 kc. OPM**  
-C. 29.59 meters  
LEDPOLDVILLE, BELGIAN  
CONGO  
Phones around 3 a.m.

**10055 kc. ZFB**  
-C. 29.84 meters  
HAMILTON, BERMUDA  
Phones N. Y. C. daytime

**9950 kc. GCU**  
-C. 30.15 meters  
RUGBY, ENGLAND  
Calls N.Y.C. evening

**9890 kc. LSN**  
-C. 30.33 meters  
HURLINGHAM, ARGENTINA  
Calls New York, evenings

**9870 kc. WON**  
-C. 30.4 meters  
LAWRENCEVILLE, N. J.  
Phones England, evening

**9860 kc. EAQ**  
-B. 30.43 meters  
P. O. Box 951  
MADRID SPAIN  
Daily 5:15-9:30 p.m.;  
Saturday also 12 n.-2 p.m.

**9840 kc. JYS**  
-X. 30.49 meters  
KEMIKAWA-CHO, CHIBA-  
KEN, JAPAN  
Irregular, 4-7 a. m.

**9800 kc. LSE**  
-C. 30.61 meters  
MONTE GRANDE,  
ARGENTINA  
Tests irregularly

**9790 kc. GCW**  
-C. 30.64 meters  
RUGBY, ENGLAND  
Calls N.Y.C., evening

**9760 kc. VLJ-VLZ2**  
-C. 30.74 meters  
AMALGAMATED WIRELESS  
OF AUSTRALIA  
SYDNEY, AUSTRALIA  
Phones Java and N. Zealand  
early a.m.

**9750 kc. WOF**  
-C. 30.77 meters  
LAWRENCEVILLE, N. J.  
Phones England, evening

**9710 kc. GCA**  
-C. 30.89 meters  
RUGBY, ENGLAND  
Calls Arge. & Brazil, evenings

**9635 kc. 2RO**  
-B. 31.13 meters  
E.I.A.R.  
ROME, ITALY  
M., W., F. 7:45-9 p.m.  
Daily 2:30-5 p.m.

**9625 kc. CT1AA**  
-B. 31.17 meters  
LISBON, PORTUGAL  
Tues., Thurs., Sat. 4:30-7 p.m.

**9600 kc. XEFT**  
-B. 31.25 meters  
AVE. INDEPENDENCIA, 28.  
VERA CRUZ, MEXICO  
Daily 11 a.m.-4 p.m., 7:30 p.m.-  
12 m., Sat. 11 a.m.-4 p.m.,  
6:30 p.m.-12 m., Sun. 11 a.m.-  
4 p.m., 9 p.m.-12 m.  
Relays XEFT.

**9595 kc. HBL**  
-B. 31.27 meters  
LEAGUE OF NATIONS  
GENEVA, SWITZERLAND  
Saturdays, 5:30-6:15 p. m.  
Mon. at 1:45 a.m.

**9590 kc. VK2ME**  
-B. 31.28 meters  
AMALGAMATED WIRELESS.  
LTD., 47 YORK ST.  
SYDNEY, AUSTRALIA  
Sun. 1-3, 5-11 a.m.

**9590 kc. HP5J**  
-B. 31.28 meters  
APARTADO 867  
PANAMA CITY, PANAMA  
11:45 a.m.-1 p.m., 7:30-10 p.m.

**9590 kc. W3XAU**  
-B. 31.28 meters  
NEWTOWN SQUARE, PA.  
Relays WCAU  
12 N-7:50 p.m.

**9580 kc. GSC**  
-B. 31.32 meters  
DAVENTRY,  
B.B.C., BROADCASTING  
HOUSE, LONDON, ENGLAND  
4:15-5:45, 6-8, 10-11 p.m.

**9580 kc. VK3LR**  
-B. 31.32 meters  
Research Section,  
Postmaster Gen'l's. Dept.,  
61 Little Collins St.,  
MELBOURNE, AUSTRALIA  
3-7:30 a.m. except Sun.  
also Fri. 10:30 p.m.-2 a.m.

**9570 kc. W1XK**  
-B. 31.35 meters  
WESTINGHOUSE ELECTRIC  
& MFG. CO.  
SPRINGFIELD, MASS.  
Relays WBZ, 7 a.m.-1 a.m.  
Sun. 8 a.m.-1 a.m.

**9568 kc. LKJ1**  
-B. 31.35 meters  
JELOY, NORWAY  
5-8 a.m., 11 a.m.-6 p.m.

**9565 kc. VUB**  
-B. 31.36 meters  
BOMBAY, INDIA  
11 a.m.-12:30 p.m., Wed.,  
Thurs., Sat.

**9560 kc. DJA**  
-B. 31.38 meters  
BROADCASTING HOUSE,  
BERLIN  
5:05-9:15 p.m.  
12:30-2 a.m.,  
8-11:30 a.m.  
5:05-10:45 p.m.

**9540 kc. DJN**  
-B. 31.45 meters  
BROADCASTING HOUSE  
BERLIN, GERMANY  
12:30-2 a.m.  
3:45-7:15 a.m.  
8-11:30 a.m.  
5:05-10:45 p.m.

**9530 kc. W2XAF**  
-B. 31.48 meters  
GENERAL ELECTRIC CO.  
SCHENECTADY, N. Y.  
Relays WGY 4 p.m.-12 m.  
Sun. 4:15 p.m.-12 m.

**9518 kc. VK3ME**  
-B. 31.54 meters  
AMALGAMATED WIRELESS.  
LTD.  
G. P. O. Box 1272L,  
MELBOURNE, AUSTRALIA  
Wed. & Sat.  
5:00-7:00 a. m.

**9510 kc. GSB**  
-B. 31.55 meters  
DAVENTRY,  
B.B.C., BROADCASTING  
HOUSE, LONDON, ENGLAND  
10:30 a.m.-12 n.  
12:15-4, 4:15-5:45 p.m.

**9501 kc. PRF5**  
-B. 31.58 meters  
RIO DE JANEIRO, BRAZIL  
Irregularly 4:45-5:45 p.m.

**9428 kc. COCH**  
-B. 31.8 meters  
2 B. ST. VEDADO,  
HAVANA, CUBA  
10 a.m.-12 n., 4-6:30, 8-10 p.m.  
also 11 a.m.-12 N. Thurs.

**9415 kc. PLV**  
-C. 31.87 meters  
BANDONG, JAVA  
Phones Holland around 9:45 a.m.  
Broadcasts Tues. and Thurs.,  
Sat. 10-10:30 a.m.

**9330 kc. CJA2**  
-C. 32.15 meters  
DRUMMONDVILLE, CANADA  
Phones England irregularly

**9280 kc. GCB**  
-C. 32.33 meters  
RUGBY, ENGLAND  
Calls Can. & Egypt, evenings

**9170 kc. WNA**  
-C. 32.72 meters  
LAWRENCEVILLE, N. J.  
Phones England, evening

**9125 kc. HAT4**  
-B. 32.88 meters  
"RADIOLABOR"  
GYALI-UT, 22  
BUDAPEST, HUNGARY  
Sunday 6-7 p.m.

**9060 kc. TFK**  
-C. 33.11 meters  
REYKJAVIK, ICELAND  
Phones London afternoons,  
Broadcasts irregularly.

**9020 kc. GCS**  
-C. 33.26 meters  
RUGBY, ENGLAND  
Calls N.Y.C., evenings

22 860 meg

**9010 kc. KEJ**  
-C- 33.3 meters  
BOLINAS, CAL.  
Relays NBC & CBS  
Programs in evening irregularly

**8795 kc. HKV**  
-B- 34.09 meters  
BOGOTA, COLOMBIA  
Irregular: 6:30 p.m.-12 m.

**8775 kc. PNI**  
-C- 34.19 meters  
MAKASSER, CELEBES,  
N.I.  
Phones Java around 4 a. m.

**8760 kc. GCQ**  
-C- 34.25 meters  
RUGBY, ENGLAND  
Calls S. Africa, afternoon

**8750 kc. ZEK**  
-B- 34.29 meters  
HONGKONG, CHINA  
Relays ZBW  
Daily 11:30 p.m.-1:15 a.m.  
Mon. and Thurs. 3-7 a.m.  
Tues., Wed., Fri. 6-10 a.m.  
Sat. 6-11 a.m.

**8730 kc. GCI**  
-C- 34.36 meters  
RUGBY, ENGLAND  
Calls India, 8 a. m.

**8680 kc. GBC**  
-C- 34.58 meters  
RUGBY, ENGLAND  
Calls ships

**8560 kc. WOO**  
-C- 35.05 meters  
OCEAN GATE, N. J.  
Calls ships irregular

**8380 kc. IAC**  
-C- 35.8 meters  
Pisa, Italy

**8220 kc. ZP10**  
-B- 36.4 meters  
ASUNCION, PARAGUAY  
7-9 p.m.

**8214 kc. HCJB**  
-B- 36.5 meters  
QUITO, ECUADOR  
7-11 p.m., except Monday  
Sun. 11 a.m.-12 n.; 4-10 p.m.

**8185 kc. PSK**  
-C- 36.65 meters  
RIO DE JANEIRO, BRAZIL  
Irregularly

**8170 kc. CO9JQ**  
-X- 36.72 meters  
CAMAGUEY, CUBA  
Broadcast 8-9 p.m. daily  
except Sat. and Sun.

**8036 kc. CNR**  
-B- 37.33 meters  
RABAT, MOROCCO  
Sunday, 2:30-5 p. m.

**7901 kc. LSL**  
-C- 37.97 meters  
HURLINGHAM, ARGENTINA  
Calls Brazil, night

**7880 kc. JYR**  
-B- 38.07 meters  
KEMIKAWA-CHO, CHIBA-KEN, JAPAN  
4-7:40 a. m.

**7860 kc. HC2JSB**  
-B- 38.17 meters  
GUAYAQUIL, ECUADOR  
8:15-11:15 p. m.

**7799 kc. HBP**  
-B- 38.47 meters  
LEAGUE OF NATIONS,  
GENEVA, SWITZERLAND  
5:30-6:15 p. m., Saturday

**7715 kc. KEE**  
-C- 38.89 meters  
BOLINAS, CAL.  
Relays NBC & CBS  
Programs in evening irregularly

**7630 kc. ZHJ**  
-B- 39.32 meters  
PENANG, MALAYA  
Daily 7-9 a.m.  
also Sat. 11 p.m.-1 A.M. (Sun.)

**7510 kc. JVP**  
-C- 39.95 meters  
NAZAKI, JAPAN  
Heard irregularly

**7400 kc. HJ3ABD**  
-B- 40.54 meters  
P. O. Box 509  
BOGOTA, COLOMBIA  
Daily 12-2 p. m.; 7-11 p. m.  
Sunday, 5-9 p. m.

**7380 kc. XECR**  
-B- 40.65 meters  
FOREIGN OFFICE,  
MEXICO CITY, MEX.  
Sun. 6-7 p. m.

**7281 kc. HJ1ABD**  
-B- 41.04 meters  
CARTAGENA, COLO.  
Irregularly, evenings

**7100 kc. HKE**  
-B- 42.25 meters  
BOGOTA, COL., S. A.  
Tue. and Sat. 8-9 p. m.; Mon.  
& Thurs. 6:30-7 p. m.

**7080 kc. VP3MR**  
-B- 42.68 meters  
GEORGETOWN, BRI. GUI-  
ANA, S.A.  
Sun. 7:45-10:15 a.m.  
Mon. 3:45-4:45, 6:45-7:45 p.m.  
Wed. 6:45-7:45 p.m.  
Thurs. 5-6:45 p.m.  
Sat. 6:45-7:45 p.m.

**7030 kc. HRP1**  
-B- 42.67 meters  
SAN PEDRO SULA,  
HONDURAS  
Reported on this and other waves  
irregularly in evening

**7000 kc. HJ1ABK**  
-B- 42 meters  
CALLE, BOLIVIA,  
PROGRESO-IGUALDAD  
BARRANQUILLA, COLOMBIA  
Testing in evenings

**6996 kc. PZH**  
-B- 42.88 meters  
P. O. BOX 18,  
PARAMARIBO, DUTCH  
GUIANA  
Sun. 9:36-11:36 a.m.  
Mon. and Fri. 5:36-9:36 p.m.  
Tues. and Thurs. 8:36-10:36 a.m.  
2:36-4:36 p.m.  
Wed. 3:36-4:36, 5:36-9:36 p.m.  
Sat. 2:36-4:36 p.m.

**6905 kc. GDS**  
-C- 43.45 meters  
RUGBY, ENGLAND  
Calls N.Y.C. evening

**6860 kc. KEL**  
-X- 43.70 meters  
BOLINAS, CALIF.  
Tests irregularly  
11 a. m.-12 n.; 6-9 p. m.

**6814 kc. HIH**  
-B- 44.03 meters  
SAN PEDRO de MACORIS  
DOMINICAN REP.  
12:10-1:40 p.m.; 7:30-9 p.m.  
Sun. 3-4 a.m.; 4:15-6 p.m.

**6755 kc. WOA**  
-C- 44.41 meters  
LAWRENCEVILLE, N. J.  
Phones England, evening

**6750 kc. JVT**  
-B-C- 44.44 meters  
NAZAKI, JAPAN  
KOKUSAI-DENWA KAISHA,  
LTD., TOKIO  
Broadcasts 12 m.-1 a.m.,  
4-8 a.m.

**6710 kc. TIEP**  
-B- 44.71 meters  
LA-VOZ DEL TROPICO  
SAN JOSE, COSTA RICA  
APARTADO 257, Daily 7-10  
p. m.

**6672 kc. YVQ**  
-C- 44.95 meters  
MARACAY, VENEZUELA  
Broadcasts Sat. 8-9 p.m.

**6660 kc. HC2RL**  
-B- 45.05 meters  
P. O. BOX 759, GUAYAQUIL,  
ECUADOR, S. A.  
Sunday, 5:45-7:45 p. m.  
Tues., 9:15-11:15 p. m.

**6650 kc. IAC**  
-C- 45.11 meters  
PISA, ITALY  
Calls ships, evenings

**6620 kc. PRADO**  
-B- 45.30 meters  
RIOBAMBA, ECUADOR  
Thurs. 9:11:45 p.m.

**6611 kc. RV72**  
-B- 45.38 meters  
MOSCOW, U. S. S. R.  
1-6 p. m.

**6600 kc. YV5AM**  
-B- 45.45 meters  
"ECOS de LLANO"  
SAN JUAN de LOS MORROS,  
VENEZUELA  
Testing in evening

**6550 kc. TIRCC**  
-B- 45.77 meters  
RADIOEMISORA CATOLICA  
COSTARRICENSE  
SAN JOSE, COSTA RICA  
Sun. 12:45-2:30, 6-7, 8-9 p.m.

**6528 kc. HIL**  
-B- 45.95 meters  
SANTO DOMINGO, D.R.  
Sat., 8-10 p.m.

**6520 kc. YV6RV**  
-B- 46.01 meters  
VALENCIA, VENEZUELA  
12 n.-1 p.m., 6-10 p.m.

**6500 kc. HJ5ABD**  
-B- 46.15 meters  
MANIZALES, COL.  
12-1:30 p. m., 7-10 p. m.

**6482 kc. HI4D**  
-B- 46.28 meters  
SANTO DOMINGO, DOMINI-  
CAN REPUBLIC  
Except Sun. 11:55 a.m.-1:40  
p.m.; 4:40-7:40 p.m.

**6450 kc. HJ4ABJ**  
-B- 46.51 meters  
"LA VOZ de CAMBEBE,"  
IBAQUE, COLOMBIA  
6-9 p.m.

**6447 kc. HJ1ABB**  
-B- 46.53 meters  
BARRANQUILLA, COL., S. A.  
P. O. BOX 715,  
11:30 a. m.-1 p. m.; 5-10 p. m.

**6425 kc. W9XB**  
-X- 46.7 meters  
DAILY NEWS BUILDING,  
CHICAGO, ILL.  
Operates irregularly in afternoon

**6410 kc. TIPG**  
-B- 46.8 meters  
APARTADO 225,  
SAN JOSE, COSTA RICA  
"COSTA RICA  
BROADCASTING"  
12 n.-2 p.m.; 6-10 p.m.

**6375 kc. YV4RC**  
-B- 47.06 meters  
CARACAS, VENEZUELA  
4:30-10:30 p.m.

**6316 kc. HIZ**  
-B- 47.5 meters  
SANTO DOMINGO  
DOMINICAN REPUBLIC  
Daily except Sat. and Sun.  
4:40-5:40 p. m.; Sat., 9:40-  
11:40 p. m.; Sun., 11:40 a.  
m.-1:40 p. m.

**6230 kc. OAX4G**  
-B- 48 meters  
Apartado 242  
LIMA, PERU  
Wed. 7-11:30 p.m.

**6198 kc. CT1GO**  
-B- 48.4 meters  
Portuguese Radio Club,  
PAREDE, PORTUGAL  
Sun. 11:30 a.m.-1 p.m.  
Daily exc. Tues. 7:20-8:30 p.m.

**6185 kc. HI1A**  
-B- 48.5 meters  
P. O. BOX 423, SANTIAGO,  
DOMINICAN REP.  
11:40 a. m.-1:40 p. m.  
7:40-9:40 p. m.

**6175 kc. HJ2ABA**  
-B- 48.58 meters  
TUNJA, COLOMBIA  
1-2; 7:30-9:30 p.m.

**6170 kc. HJ3ABF**  
-B- 48.62 meters  
BOGOTA, COLOMBIA  
6-11 p.m.

**6160 kc. YV3RC**  
-B- 48.7 meters  
CARACAS, VENEZUELA  
11 a.m.-2 p.m.; 4-10:30 p.m.

**6155 kc. CO9GC**  
-B- 48.74 meters  
GRAU & CAMERONS LABS,  
BOX 137, SANTIAGO, CUBA  
9-10 a.m., 11:30 a.m.-1:30 p.m.,  
3-4:30 p.m., 10-11 p.m., 12 m.-  
2 a.m.

**6150 kc. CSL**  
-B- 48.78 meters  
LISBON, PORTUGAL  
7-8:30 a.m.; 2-7 p.m.

**6150 kc. CJRO**  
-B- 48.78 meters  
WINNIPEG, MAN., CANADA  
8 p. m.-12 m.  
Sun. 3-10:30 p. m.

**6150 kc. HJ5ABC**  
-B- 48.78 meters  
CALI, COLOMBIA  
M., W., F., 7-10 p.m.

**6140 kc. W8XK**  
-B- 48.88 meters  
WESTINGHOUSE ELECTRIC  
& MFG. CO.  
PITTSBURGH, PA.  
Relays KDKA  
9 p.m.-1 a.m.

**6130 kc. COCD**  
-B- 48.92 meters  
"La Voz del Aire"  
CALLE G y 25, VEDADO,  
HAVANA, CUBA  
Relays CMCD 8 p.m.-12 m.

**6130 kc. HJ1ABE**  
-B- 48.92 meters  
CARTAGENA, COL.  
P. O. Box 31  
Daily 11:15 a. m.-1 p. m.; Sun.  
9-11 a.m.; Mon. 10 p.m.-12 m.  
Wed. 8-11 p.m.

**6130 kc. ZGE**  
-B- 48.92 meters  
KUALA LUMPUR,  
FED. MALAY STATES  
Sun., Tue. and Fri.  
6:40-8:40 a. m.

**6120 kc. W2XE**  
-B- 49.02 meters  
ATLANTIC BROADCASTING  
CORP.  
485 MADISON AVE., N. Y. C.  
Relays WABC, 8-11 p.m.

**6120 kc. XEFT**  
-B- 49.02 meters  
VERA CRUZ, MEX.  
11 a.m.-4 p.m.; 7:30 p.m.-12 m.  
Sat. also 6:30-7:30 p.m.  
Sun. 11 a.m.-4 p.m.; 9 p.m.-12  
p.m.  
Relays XETP

**6110 kc. GSL**  
-B- 49.10 meters  
DAVENTRY,  
B.B.C., BROADCASTING  
HOUSE, LONDON, ENGLAND  
2:15-4, 10-11 p.m.

**6110 kc. VUC**  
-B- 49.1 meters  
CALCUTTA, INDIA  
Daily except Sat., 3-5:30 a. m.,  
9:30 a. m.-noon;  
Sat., 11:45 a. m.-3 p. m.

**6105 kc. HJ4ABB**  
-B- 49.14 meters  
MANIZALES, COL., S. A.  
P. O. Box 175  
Mon. to Fri. 12:15-1 p. m.;  
Tues. & Fri. 7:30-10 p. m.;  
Sun. 2:30-5 p. m.

**6100 kc. W3XAL**  
-B- 49.18 meters  
NATIONAL BROADCASTING  
CO.  
BOUND BROOK, N. J.  
Relays WJZ  
Monday, Wednesday, Saturday,  
5-6 p.m.; Sun. 12 m.-1 a.m.

**6100 kc. W9XF**  
-B- 49.18 meters  
DOWNERS GROVE, ILL.  
Relays WENR, Chicago

**6097 kc. JB**  
-B- 49.2 meters  
AFRICAN BROADCASTING  
CORP.  
JOHANNESBURG, SOUTH  
AFRICA  
Sun.-Fri. 11:45 p.m.  
12:30 a.m. (next day)  
Mon.-Sat. 3:30-7 a.m.  
9 a.m.-4 p.m.  
Sun. 8:10:15 a.m.; 12:30-3 p.m.

**6090 kc. CRCX**  
-B- 49.26 meters  
TORONTO, CANADA  
Daily 6 p.m.-12 m., Sun.  
12 n.-12m

**6090 kc. VE9BJ**  
-B- 49.28 meters  
SAINT JOHN, N. B., CAN.  
7-8:30 p. m.

**6085 kc. 2RO**  
-B- 49.3 meters  
E.I.A.R.  
ROME, ITALY  
Mon., Wed., Fri. 6:15-7:30 p.m.  
Daily 6-6:15 p.m.

**6083 kc. VQ7LO**  
-B- 49.31 meters  
NAIROBI, KENYA, AFRICA  
Mon.-Fri. 5:45-6:15 a.m.; 11:30  
a.m.-2:30 p.m. Also 8:30-9:30  
a.m. on Tues. and Thurs. Sat.  
11:30 a.m.-3:30 p.m. Sun. 11  
a.m.-2 p.m.

**6080 kc. CP5**  
-B- 49.34 meters  
LAPAZ, BOLIVIA  
7-10:30 p. m.

**6080 kc. W9XAA**  
-B- 49.34 meters  
CHICAGO FEDERATION OF  
LABOR  
CHICAGO, ILL.  
Relays WCFL  
Sunday 11:30 a. m.-9 p. m. and  
Tues., Thurs., Sat., 4 p. m.-12 m.

**6072 kc. OER2**  
-B- 49.41 meters  
VIENNA, AUSTRIA  
9 a.m.-5 p.m.

**6070 kc. HP5H**  
-B- 49.42 meters  
COLON PANAMA  
Testing in evening.

**6070 kc. HJ4ABC**  
-B- 49.42 meters  
PERIERA, COL.  
9:30-11:30 a.m., 7-8 or 9 p.m.

**6070 kc. VE9CS**  
-B- 49.42 meters  
VANCOUVER, B. C., CANADA  
Sun. 1:45-9 p. m.; 10:30 p. m.-  
1 a. m.; Tues. 6-7:30 p. m.,  
11:30 p. m.-1:30 a. m. Daily  
6-7:30 p. m.

**6065 kc. HJ4ABL**  
-B- 49.46 meters  
MANIZALES, COL.  
Daily 11 a.m.-12 n., 5:30-7:30  
p.m. Sat. 10:30-11:30 p.m.

**6060 kc. OXY**  
-B- 49.50 meters  
SKAMLEBOAEK, DENMARK  
1-6:30 p. m.; also 11 a. m.-12 n.  
Sunday

**6060 kc. W8XAL**  
-B- 49.50 meters  
CROSLEY RADIO CORP.  
CINCINNATI, OHIO  
6:30 a.m.-8 p.m.; 11 p.m.-1 a.m.  
Relays WLW

**6060 kc. W3XAU**  
-B- 49.50 meters  
NEWTOWN SQUARE, PA.  
Relays WCAU, Philadelphia  
8 p.m.-11 p.m.

**6050 kc. GSA**  
-B- 49.59 meters  
DAVENTRY,  
B.B.C., BROADCASTING  
HOUSE, LONDON, ENGLAND  
10:45 a.m.-12 n.-4-5:45 p.m.,  
6-8 p.m.

**6045 kc. HJ3ABI**  
-B- 49.63 meters  
BOGOTA, COLO.  
Irregular in evening

**6042 kc. HJ1ABG**  
-B- 49.65 meters  
BARRANQUILLA, COLO.  
12 n.-1 p.m.; 6-10 p.m.  
Sun. 1-6 p.m.

**6040 kc. W4XB**  
-B- 49.67 meters  
MIAMI BEACH, FLA.  
Relays WIOD 12 n.-2 p.m.,  
5:30 p.m.-12 m.

**6040 kc. PRA8**  
-B- 49.67 meters  
RADIO CLUB OF  
PERNAMBUCO  
PERNAMBUCO, BRAZIL  
1-3 p.m.; 4-7:30 p.m. daily

**6040 kc. W1XAL**  
-B- 49.67 meters  
BOSTON, MASS.  
Tues., Thurs. 7:15-9:15 p.m.

**6040 kc. YDA**  
-B- 49.67 meters  
N.I.R.O.M.  
TANDJONGPRIK, JAVA  
Testing 5:30-11 a.m.

**6030 kc. HP5B**  
-B- 49.75 meters  
P. O. BOX 910  
PANAMA CITY, PAN.  
12 n.-1 p.m., 8-10:30 p.m.

**6030 kc. VE9CA**  
-B- 49.75 meters  
CALGARY, ALBERTA, CAN.  
Thurs. 9 a.m.-2 a.m. (Fri.);  
Sun. 12 n.-12 m.  
Irregularly on other days from  
9 a.m.-12 m.

**6020 kc. CQN**  
-B- 49.83 meters  
MACAO, CHINA  
Mon. and Fri. 3-5 a.m.

**6020 kc. DJC**  
-B- 49.83 meters  
BROADCASTING HOUSE,  
BERLIN  
12 n.-4:30 p.m.; 5:05-10:45  
p. m.

**6020 kc. HJ3ABH**  
-B- 49.83 meters  
BOGOTA, COLO.  
APARTADO 565  
7-11 p.m.

**6018 kc. ZHI**  
-B- 49.9 meters  
RADIO SERVICE CO.,  
20 ORCHARD RD.,  
SINGAPORE, MALAYA  
Mon., Wed. and Thurs 5:40-8:10  
a.m. Sat. 10:40 p.m.-1:10 a.m.  
(Sun.) Every other Sunday 5:10-  
6:40 a.m.

**6010 kc. COCO**  
-B- 49.92 meters  
P.O. BOX 88  
HAVANA, CUBA  
Daily 9:30-11 a.m., 4-7 p.m.  
and 8-10 p.m.  
Sat. also 11:30 p.m.-1:30 a.m.

<p><b>6000 kc. TGWA</b> -B- 50 meters GUATEMALA CITY, GUAT. 12 n-1 p.m., 6:30-7:30 p.m. 16-11 p.m. Sat. also from 12 m. 6 a.m. (Sun.)</p>	<p><b>5950 kc. HJ1ABJ</b> -B- 50.42 meters SANTA MARTA, COLO. 11 a.m.-1 p.m., 7-9 p.m.</p>	<p><b>5800 kc. ★YV2RC</b> -B- 51.72 meters BROADCASTING CARACAS CARACAS, VENEZUELA Sun. 9:30 a.m.-10:30 p.m. Daily 11 a.m.-1:30 p.m., 9:30 p.m.</p>	<p><b>5077 kc. WCN</b> -C- 59.08 meters LAWRENCEVILLE, N. J. Phones England irregularly</p>	<p><b>4320 kc. GDB</b> -C- 69.44 meters RUGBY, ENGLAND Tests, 8-11 p. m.</p>
<p><b>6000 kc. RV59</b> -B- 50 meters MOSCOW, U. S. S. R. Daily 3-6 p.m.</p>	<p><b>5950 kc. HJ4ABE</b> -B- 50.42 meters MEDELLIN, COLO. Daily 11 a.m.-12 n., 6-10:30 p.m.</p>	<p><b>5790 kc. JVV</b> -C- 51.81 meters NAZAKI, JAPAN Broadcasts 2-7:45 a.m.</p>	<p><b>5025 kc. ZFA</b> -C- 59.7 meters HAMILTON, BERMUDA Calls U.S.A., nights</p>	<p><b>4273 kc. RV15</b> -B- 70.20 meters KHABAROVSK, SIBERIA. D. S. S. R. Daily, 3-9 a.m.</p>
<p><b>5990 kc. ★XEPT</b> -B- 50.08 meters MEXICO CITY, MEX. P. O. Box 79-44 8 a.m.-11 a.m.</p>	<p><b>5940 kc. TG2X</b> -B- 50.5 meters GUATEMALA CITY, GUAT. 4-6, 9-11 p.m.</p>	<p><b>5780 kc. HI1J</b> -B- 51.9 meters SAN PEDRO DE MACORIS, DOM. REP. 7-9:30 p.m.</p>	<p><b>5000 kc. TFL</b> -C- 60 meters REYKJAVIK, ICELAND Calls London at night. Also broadcasts irregularly</p>	<p><b>4272 kc. WOO</b> -C- 70.22 meters OCEAN GATE, N. J. Calls ships irregularly</p>
<p><b>5985 kc. HJ2ABC</b> -B- 50.13 meters CUCUTA, COLOMBIA Irreg. in evening</p>	<p><b>5880 kc. YV8RB</b> -B- 51.02 meters "LA VOZ DE LARA" BARQUISIMETO, COLOMBIA 6-10 p.m.</p>	<p><b>5780 kc. OAX4D</b> -B- 51.9 meters P.O. Box 853 LIMA, PERU Mon., Wed. &amp; Sat. 9-11:30 a.m.</p>	<p><b>4975 kc. GBC</b> -C- 60.30 meters RUGBY, ENGLAND Calls Ships, late at night</p>	<p><b>4098 kc. WND</b> -C- 73.21 meters HIALEAH, FLORIDA Calls Bahama Isles</p>
<p><b>5980 kc. XECW</b> -B- 50.17 meters CALLE del BAJO 120 MEXICO CITY, MEX. 4-4:30 p.m., 10:30 p.m., 12 m.</p>	<p><b>5875 kc. HRN</b> -B- 51.06 meters TEGUCIGALPA, HONDURAS 7-9 p.m.</p>	<p><b>5720 kc. YV10RSC</b> -B- 52.45 meters "LA VOZ DE TACHIRA." SAN CRISTOBAL, COLOMBIA Testing near 12 m.</p>	<p><b>4820 kc. GDW</b> -C- 62.24 meters RUGBY, ENGLAND Calls N.Y.C., late at night</p>	<p><b>4002 kc. CT2AJ</b> -B- 74.95 meters PONTA DELGADA, SAO MIGUEL, AZORES Wed. and Sat. 5-7 p. m.</p>
<p><b>5980 kc. HIX</b> -B- 50.17 meters SANTO DOMINGO, DOMINI- CAN REP. Sun. 7:10 a.m.; Tues. and Fri. 11:10 a.m., 4:40 and 8:10 p.m.; Mon., Wed., Thurs. and Sat. 11:10 a.m. and 4:40 p.m.</p>	<p><b>5853 kc. WOB</b> -C- 51.26 meters LAWRENCEVILLE, N. J. Calls Bermuda, nights</p>	<p><b>5714 kc. HCK</b> -B- 52.5 meters QUITO, ECUADOR, S. A.</p>	<p><b>4752 kc. WOO</b> -C- 63.1 meters OCEAN GATE, N. J. Calls ships irregularly</p>	<p><b>3543 kc. CR7AA</b> -B- 84.67 meters P. O. BOX 594 LOURENCO MARQUES, MO- ZAMBIQUE, E. AFRICA 1-30-3:30 p.m., Mon., Thurs., and Sat.</p>
<p><b>5980 kc. HVJ</b> -B- 50.27 meters VATICAN CITY (ROME) 2-2:15 p. m., daily, Sun., 5-5:30 a. m.</p>	<p><b>5850 kc. ★YV5RMO</b> -B- 51.28 meters CALLE REGISTRO, LAS DE- LICIAS APARTADO DE COR- RES 214 MARACAIBO, VENEZUELA 11 a.m.-1 p.m., 5:30-10 p.m.</p>	<p><b>5713 kc. TGS</b> -B- 52.51 meters GAUTEMALA CITY, GUAT. Tues., Thurs., and Sun. 6-8 p.m.</p>	<p><b>4600 kc. HC2ET</b> -B- 65.22 meters Apartado 249 GUAYAQUIL, ECUADOR Wed., Sat. 9-11:30 p.m.</p>	<p><b>3490 kc. YDH3</b> -B- 85.96 meters BANDONG, JAVA Daily except Fri., 4:30-5:30 a. m.</p>
<p><b>5968 kc. HVJ</b> -B- 50.27 meters VATICAN CITY (ROME) 2-2:15 p. m., daily, Sun., 5-5:30 a. m.</p>	<p><b>5825 kc. TIGPH</b> -B- 51.5 meters SAN JOSE, COSTA RICA 6:15-11 p.m.</p>	<p><b>5500 kc. T15HH</b> -B- 54.55 meters SAN RAMON, COSTA RICA Irregularly around 9:45 p.m.</p>	<p><b>4470 kc. YDB</b> -B- 67.11 meters N.I.R.O.M. SOERABAJA, JAVA 10:30 p.m.-1:30 a.m., 5:30- 11 a.m., 5:45-6:45 p.m.</p>	<p><b>3040 kc. YDA</b> -B- 98.68 meters N.I.R.O.M. TANDJONGPRIOK, JAVA 10:30 p.m.-1:30 a.m., 5:30-11 a.m.</p>

(All Schedules Eastern Standard Time)

# Police Radio Alarm Stations

CGZ	Vancouver, B.C.	2342 kc	KGZT	Santa Cruz, Cal.	1674 kc.	KSW	Berkeley, Cal.	1658 kc.
CJW	St. Johns, N.B.	2390 kc.	KGZU	Lincoln, Neb.	2490 kc.	KVP	Dallas, Tex.	1712 kc.
CJZ	Verdeon, Que.	2390 kc.	KGZV	Aberdeen, Wash.	2414 kc.	VDM	Halifax, N.S.	1690 kc.
KGHA	Portable-Mobile		KGZW	Lubbock, Tex.	2458 kc.	VYR	Montreal, Can.	1706 kc.
KGHB	In State of Wash.	2490 kc.	KGZY	Albuquerque, N.Mex.	2414 kc.	VYW	Winnipeg, Man.	2396 kc.
KGHC			KIUK	San Bernardino, Cal.	1712 kc.	WCK	Belle Island, Mich.	2414 kc.
KGHG	Las Vegas, Nev.	2474 kc.	KNFA	Jefferson City, Mo.	1674 kc.	WEY	Boston, Mass.	1630 kc.
KGHH	Palo Alto, Cal.	1674 kc.	KNFB	Clovis, N.Mex.	2414 kc.	WKDT	Detroit, Mich.	1630 kc.
KGHM	Reno, Nev.	2474 kc.	KNFC	Idaho Falls, Idaho	2458 kc.	WKDU	Cincinnati, Ohio	1706 kc.
KGHN	Hut-kinson, Kans.	2450 kc.	KNFD	SS Gov. Stevens, (Wash.)	2490 kc.	WMDZ	Indianapolis, Ind.	2442 kc.
KGHO	Des Moines, Iowa	1682 kc.	KNFE	SS Gov. J. Rogers, (Wash.)	2490 kc.	WMJ	Buffalo, N.Y.	2422 kc.
KGHP	Lawton, Okla.	2466 kc.	KNFF	Duluth, Minn.	2382 kc.	WMO	Highland Park, Mich.	2414 kc.
KGHQ	Chinook Pass, W.	2490 kc.	KNFG	Leavenworth, Kans.	2422 kc.	WMP	Framingham, Mass.	1666 kc.
KGHR	(Mobile) in Wash.	2490 kc.	KNFH	Olympia, Wash.	2490 kc.	WNFP	Niagara Falls, N.Y.	2422 kc.
KGHS	Spokane, Wash.	2414 kc.	KNFI	Garden City, Kans.	2474 kc.	WPDA	Tulare, Cal.	2414 kc.
KGHT	Brownville, Tex.	2382 kc.	KNFL	Mt. Vernon, Wash.	2414 kc.	WPDB	Chicago, Ill.	1712 kc.
KGHU	Austin, Tex.	2442 kc.	KNFJ	Pomona, Cal.	1712 kc.	WPDC	Chicago, Ill.	1712 kc.
KGHV	Corpus Christi, Tex.	2382 kc.	KNFK	Bellingham, Wash.	2490 kc.	WPDD	Chicago, Ill.	1712 kc.
KGHW	Centralia, Wash.	2414 kc.	KNFL	Shuksan, Wash.	2490 kc.	WPDE	Flint, Mich.	2442 kc.
KGHX	Santa Ana, Cal.	2490 kc.	KNFM	Compton, Cal.	2490 kc.	WPDF	Louisville, Ky.	2442 kc.
KGHY	Whittier, Cal.	1712 kc.	KNFN	Waterloo, Iowa	1682 kc.	WPDG	Chicago, Ill.	2466 kc.
KGHZ	Little Rock, Ark.	2406 kc.	KNFO	Storm Lake, Iowa	1682 kc.	WPDH	Youngstown, Ohio	2458 kc.
KGJX	Pasadena, Cal.	1712 kc.	KNFP	Everett, Wash.	2414 kc.	WPDJ	Richmond, Ind.	2442 kc.
KGJL	Albuquerque, N.M.	2414 kc.	KNFR	Skykomish, Wash.	2490 kc.	WPKI	Columbus, Ohio	2430 kc.
KGKZ	Des Moines, Iowa	2466 kc.	KNFS			WPKL	Milwaukee, Wis.	2450 kc.
KGKZ	Seattle, Wash.	2414 kc.	KNFT			WPKM	Lansing, Mich.	2442 kc.
KGKZ	Minneapolis, Minn.	2430 kc.	KNFU	Mobile in State of Wash.	2490 kc.	WPKN	Dayton, Ohio	2430 kc.
KGKZ	St. Louis, Mo.	1706 kc.	KNFV			WPKO	Auburn, N.Y.	2382 kc.
KGKZ	San Francisco, Cal.	2466 kc.	KNFW			WPKP	Akron, Ohio	2458 kc.
KGKZ	Kansas City, Mo.	2422 kc.	KNFX	Alpowa Camp, Wash.	2490 kc.	WPKR	Philadelphia, Pa.	2474 kc.
KGKZ	Santa Fe, N.Mex.	2414 kc.	KNFY	Ilwaco, Wash.	2490 kc.	WPKS	Rochester, N.Y.	2422 kc.
KGKZ	Vallejo, Cal.	2422 kc.	KNFZ	Holls Crossing Camp, Wash.	2490 kc.	WPKT	St. Paul, Minn.	2430 kc.
KGKZ	Oklahoma City, Okla.	2450 kc.	KNGA	Satus Pass Camp, Wash.	2490 kc.	WPKU	Kokomo, Ind.	2490 kc.
KGKZ	Omaha, Neb.	2466 kc.	KNGB	Yakima, Wash.	2490 kc.	WPKV	Pittsburgh, Pa.	1712 kc.
KGKZ	Beaumont, Tex.	1712 kc.	KNGC	Vancouver, Wash.	2490 kc.	WPKW	Charlotte, N.C.	2458 kc.
KGKZ	Sioux City, Iowa	2466 kc.	KNGD	Walla Walla, Wash.	2490 kc.	WPKX	Washington, D.C.	2422 kc.
KGKZ	Los Angeles, Cal.	1712 kc.	KNGE	Cleburne, Tex.	2490 kc.	WPKY	Detroit, Mich.	2414 kc.
KGKZ	San Jose, Cal.	2466 kc.	KNGF	Sacramento, Cal.	1712 kc.	WPDZ	Atlanta, Ga.	2414 kc.
KGKZ	Davenport, Iowa	2466 kc.	KNGH	Dodge City, Kans.	2422 kc.	WPEA	Fort Wayne, Ind.	2490 kc.
KGKZ	Tulsa, Okla.	2450 kc.	KNGI	El Centro, Cal.	2474 kc.	WPEB	Syracuse, N.Y.	2382 kc.
KGKZ	Portland, Ore.	2442 kc.	KNGJ	Duncan, Okla.	2490 kc.	WPEC	Grand Rapids, Mich.	2442 kc.
KGKZ	Honolulu, T.H.	1712 kc.	KN GK	Rapid City, S. Dak.	2450 kc.	WPEF	Memphis, Tenn.	2466 kc.
KGKZ	Minneapolis, Minn.	2430 kc.	KNGL	North Platte, Neb.	2490 kc.	WPEG	Arlington, Mass.	1712 kc.
KGKZ	Bakersfield, Cal.	2414 kc.	KNGM	Portable, Okla.	2450 kc.	WPEH	New York, N.Y.	2450 kc.
KGKZ	Salt Lake City, Utah	2406 kc.	KNGN	Shreveport, Pa.	2430 kc.	WPEI	New York, N.Y.	2450 kc.
KGKZ	Denver, Colo.	2442 kc.	KNGO	Wenatchee, Wash.	2490 kc.	WPEJ	Somerville, Mass.	1712 kc.
KGKZ	Wichita, Kans.	2450 kc.	KNGP	Spokane, Wash.	2490 kc.	WPEK	E. Providence, R.I.	1712 kc.
KGKZ	Fresno, Cal.	2414 kc.	KNGQ	Muskogee, Okla.	2450 kc.	WPEL	New Orleans, La.	2430 kc.
KGKZ	Houston, Tex.	1712 kc.	KNGR	Salina, Wash.	2450 kc.	WPEM	W. Bridgewater, Mass.	1666 kc.
KGKZ	Topeka, Kans.	2422 kc.	KNGS	Salina, Kans.	2414 kc.	WPEP	Woonsocket, R.I.	2466 kc.
KGKZ	San Diego, Cal.	2490 kc.	KNGT	Brownwood, Tex.	2458 kc.	WPEQ	Kenosha, Wis.	2450 kc.
KGKZ	San Antonio, Tex.	2482 kc.	KNGU	Portable, Los Angeles	1712 kc.	WPER	Saginaw, Mich.	2442 kc.
KGKZ	Chanute, Kans.	2450 kc.	KNGV	Lodi, Calif.	2414 kc.	WPEW	Lexington, Ky.	1706 kc.
KGKZ	Des Moines, Iowa	2466 kc.	KNGW	Ephrata, Wash.	2490 kc.	WPEX	Portable (in Mass.)	1666 kc.
KGKZ	Klamath Falls, Ore.	2442 kc.	KNGX	Mobile, Wash.	2490 kc.	WPEY	Northampton, Mass.	1666 kc.
KGKZ	Wichita Falls, Tex.	2458 kc.	KNGY	Green Bay, Wis.	2382 kc.	WPEZ	Newton, Mass.	1712 kc.
KGKZ	Phoenix, Ariz.	2430 kc.	KNHZ	Ada, Okla.	1658 kc.	WPF	Muskegon, Mich.	2442 kc.
KGKZ	El Paso, Tex.	2414 kc.	KNIA	Redwood Falls, Minn.	2406 kc.	WPF	Reading, Pa.	2442 kc.
KGKZ	Tacoma, Wash.	2414 kc.	KNIB	Fort Smith, Ark.	1712 kc.	WPF	Jacksonville, Fla.	2442 kc.
KGKZ	Santa Barbara, Cal.	2414 kc.	KNIC	Denton, Tex.	2430 kc.	WPF	Baltimore, Md.	2414 kc.
KGKZ	Coffeyville, Kans.	2450 kc.	KNID	Prescott, Ark.	2430 kc.	WPF	Columbus, Ga.	2414 kc.
KGKZ	Waco, Tex.	1712 kc.	KNIE	Fargo, N. Dak.	2442 kc.	WPF	Hammond, Ind.	1712 kc.
KGKZ	Salem, Ore.	2442 kc.	KNIF			WPF	Hackensack, N.J.	2430 kc.
KGKZ			KNIG			WPF		
KGKZ			KNIH			WPF		
KGKZ			KNII			WPF		

"WHEN TO LISTEN IN"  
Appears on page 575

For Television Stations see Page 570

# SHORT WAVE LEAGUE



## HONORARY MEMBERS

- Dr. Lee de Forest
- John L. Reinartz
- D. E. Replogle
- Hollis Baird
- E. T. Somerset
- Baron Manfred von Ardenne
- Hugo Gernsback

*Executive Secretary*

## Keeping the Short Wave Club "Alive"

● IN the last two articles, we have discussed the essential details which those about to start a club will find valuable, while the second article in the December issue covered the teaching of code to club members, lectures, the club transmitting and receiving station, etc.

In the present discussion, we will confine our thoughts to such important factors as keeping the club *alive*, and what the club's officers can do to promote this spirit.

The old saying, "All work and no play makes Jack a dull boy," is quite applicable to short-wave clubs—and if you are really interested in having a good, wide-awake club, you will have to add a dash of pleasure to the club's activities now and then.

The club may be so fortunate as to

have a dramatic coach among its members, and not only a lot of fun, but also financial aid for the club can be obtained by staging a play occasionally. In some cases, the manager of the local movie theater will be glad to cooperate with the club and arrange matters so that the club members can sell specially printed tickets for the performance on a certain night. The percentage of profits and other details will have to be worked out in each case with the local theater manager.

In some cases, dramatic organizations in adjacent towns have staged a particularly successful play, and you can arrange with them to produce the play in your town. The club can share in the profits in return for their work in publicizing the show, and other assistance which they may render, such as transporting the scenery and costumes, etc.

Several times during the year, arrangements can be made to transport the club's members by bus or otherwise, to visit some commercial radio station, particularly a short-wave station. In other cases, a prominent Ham may have a particularly fine station in operation, and by pre-arrangement with the owner, he will invariably be very glad to receive a visit from the club's members.

As mentioned in the previous articles, do not forget the club's members like to hear an out-of-town speaker once in a while, and an effort should be made by the officers of the club to contact an expert on short waves to give a talk before the club. Sometimes you may have to send a car for the speaker, even a distance of fifteen miles or so, but it will repay you handsomely in renewed spirit among the club members, as experience has richly proved.

A novelty feature, which has apparently received much more recognition in

## Here's Your Button

The illustration herewith shows the beautiful design of the "Official" Short Wave League button, which is available to everyone who becomes a member of the Short Wave League.

The requirements for joining the League are explained in a booklet, copies of which will be mailed upon request. The button measures  $\frac{3}{4}$  inch in diameter and is inlaid in enamel—3 colors—red, white, and blue.



Please note that you can order your button **AT ONCE**—SHORT WAVE LEAGUE supplies it at cost, the price, including the mailing, being 35 cents. A solid gold button is furnished for \$2.00 prepaid. Address all communications to SHORT WAVE LEAGUE, 99-101 Hudson St., New York.

Europe than it has in America, is the "hidden" transmitter hunt. For this stunt, a certain short-wave transmitter is put into operation at a given time, and those participating in the "hunt," use special sets fitted with loop or other directive aerials, and eventually, of course, they succeed in locating the transmitter. There are many other variations of this interesting short-wave "stunt," which live club directors will be able to develop themselves. For instance, in addition to the "hidden" transmitter hunt, other complications may be added, such as trick code combinations, rapid changes in wavelength, and other wrinkles which will help to arouse and sustain the interest of the short-wave "hunters."

Experience with clubs in general has shown that advantage should be taken of all of the important holidays, when theater parties (and dances) held in the club's quarters can be arranged, and do not forget to notify the Y.L.'s (young lady operator) as well as potential Y.L.'s—and that field, of course, is as broad as a house, and includes all the "eligible" young ladies in town—or as many as the club can provide cake and coffee for.

One thing that the writer has noted about short-wave clubs in general is that the organizations tend to be too clannish at times—not intentionally, of course. In other words, if the club

*(Continued on page 562)*

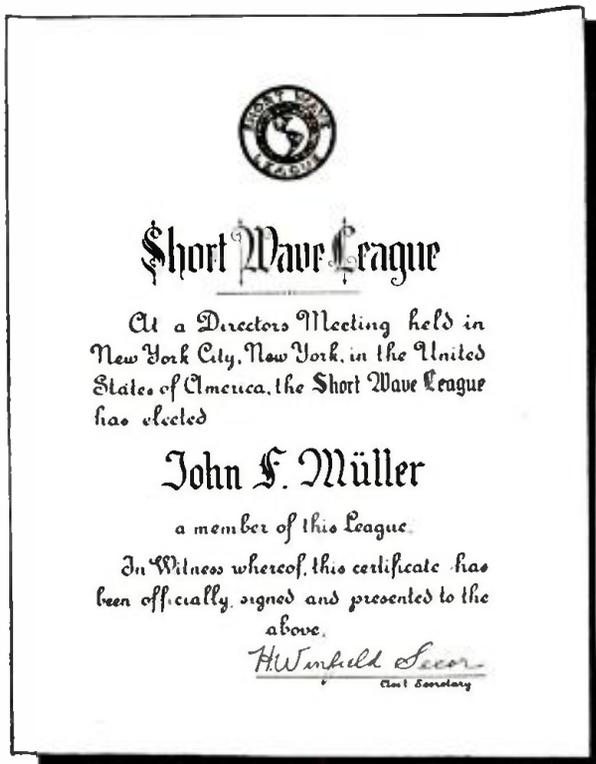

This is the handsome certificate that is presented FREE to all members of the SHORT WAVE LEAGUE. The full size is 7 $\frac{1}{4}$ " x 9 $\frac{1}{2}$ ".

See page 576 how to obtain certificate.

# Short Wave

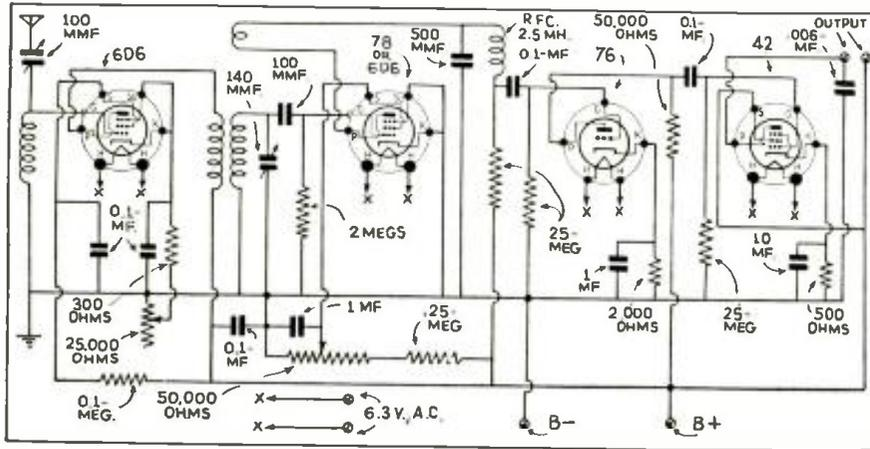

4-tube 6.3 volt receiver.

## EDITED BY GEORGE

● Because the amount of work involved in the drawing of diagrams and the compilation of data, we are forced to charge 25c each for letters that are answered directly through the mail. This fee includes only hand-drawn schematic drawings. We cannot furnish "picture-layouts" or "full-sized" working drawings. Letters not accompanied by 25c will be answered in turn on this page. The 25c remittance may be made in

me this information in the next issue of the *Question Box!*

(A) Once again we print the coil data for 2- and 3-winding coils, covering a range of from 15 to 200 meters. It is given in pictorial form, and we suggest that our readers save this data because it can be used in just about every set described in *Short Wave Craft*.

## 4-TUBE T.R.F. RECEIVER

James Kiggin, Lynchburg, Va.

(Q) Kindly print a diagram of a 4-tube regenerative receiver, using a 6D6, a 78, a 76, and a 42. Also show how 3:1 ratio transformers may be used. Also employ only one plug-in coil. I would also like to

antenna coil is a 2.5 mh. R.F. choke commonly used in S-W receivers.

## T.R.F. STAGE FOR DOERLE RECEIVER

Chas. Yorker, Salem, Mass.

(Q) I would greatly appreciate your printing a diagram of a T.R.F. stage which can be added to the 2-tube Doerle band-spread receiver described in the May, 1934 issue.

(A) The tuned R.F. diagram is shown, using standard 4-prong 2-winding coils and a 140 mmf. condenser for tuning. Band-spread is really not necessary because a nonregenerative R.F. stage tunes rather broadly. The output terminals will connect directly to the antenna and ground posts of your receiver.

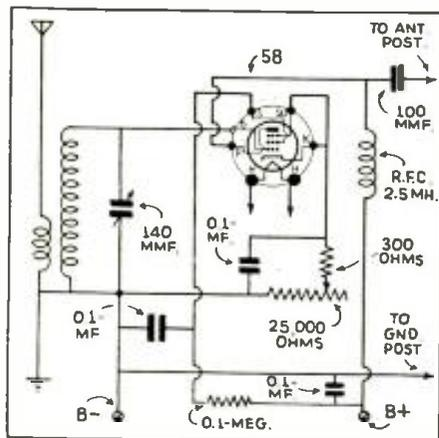

T.R.F. stage diagram.

## 25-CYCLE POWER SUPPLY

D. Gluch, Crowland, Ont.

(Q) I would like to know whether or not a 25Z5 tube will work in receivers on 25-cycle power, as well as on 60-cycle.

(A) The results would be approximately the same on either 25 or 60 cycles, except for the amount of hum experienced. A 25-cycle supply will require considerably greater filtering than the 60-cycle supply.

## POWER SUPPLY DIAGRAM

David K. McNish, Jr., Huntington, West Va.

(Q) I would appreciate it if you would publish a diagram of a "power supply" unit delivering 300 volts, with a 6.3 volt filament winding for the tubes.

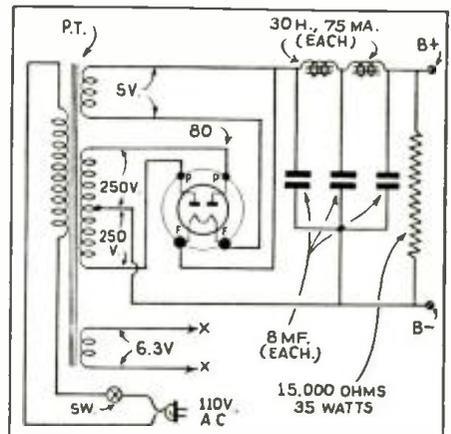

Power supply for Short-Wave receivers.

have you supply me with coil data.

(A) The 4-tube diagram shown comprises an untuned R.F. stage inductively coupled to a regenerative detector with two stages of resistance-coupled audio amplification, resistance-coupling being preferred to transformer-coupling. The

## COIL DATA

Ralph Peer, Syracuse, N.Y.

(Q) I have built the 3-tube "electrified" Doerle receiver which was described in the May, 1935 issue. All I need is the coil data; would you be kind enough to give

(A) The power supply diagram will be found on this page. If you wish to obtain various "B" voltages, the 15,000-ohm bleeder should have four or five sliders which may be adjusted to the desired voltages. Each tap on the divider should be by-passed to the "B" negative with a condenser ranging from 1/4 to 1 mf.

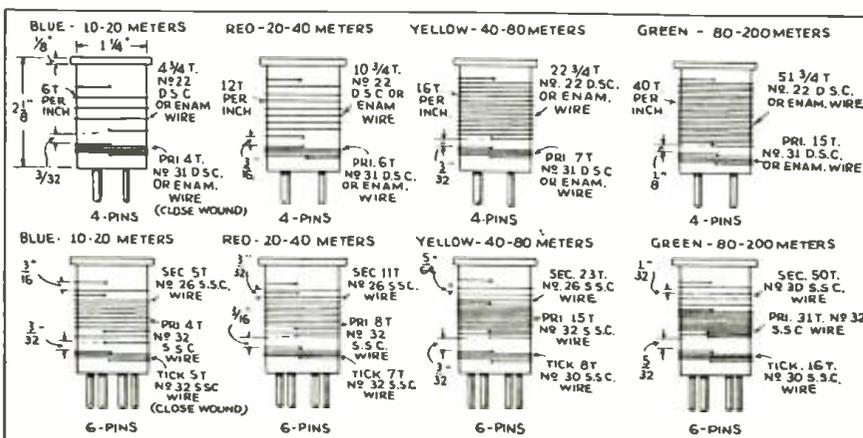

Complete coil data for 2 and 3 winding coils.

## OBTAINING VERIS

Arthur Anderson, St. Paul, Minn.

(Q) I am very much interested in your "Trophy Contest" and have had considerable trouble in obtaining verification cards. I have written to a number of stations and have received no reply. Please outline the correct procedure in obtaining veris, and where can I purchase an *International Postal Reply Coupon*.

(A) There is no reason why you should not obtain "verification" cards, provided you go about the thing properly. When receiving a station, make a note of the following: The time, date, frequency or wavelength, the character of the program received, together with any other data which may be the result of your observation. Send this, together with an *International Postal Reply Coupon* to the address of the station; this is given in each issue of *Short Wave Craft*. Make your report interesting and complete, and of some value to the station management.

# QUESTION BOX

## W. SHUART, W2AMN

the form of stamps or coin.  
Special problems involving considerable research will be quoted upon request. We cannot offer opinions as to the relative merits of commercial instruments.  
Correspondents are requested to write or print their names and addresses clearly. Hundreds of letters remain unanswered because of incomplete or illegible addresses.

### 2-TUBE CONVERTER

L. C. Browning, Newark, N.J.  
(Q) I have a broadcast receiver which is very sensitive, and I would like to add a converter to it in order to receive short-wave programs. This converter should use a "57" detector and a "56" oscillator. The coils should be 2-winding, 4-prong affairs, and the output of the converter should connect to the antenna and ground posts.  
(A) We are pleased to print the diagram, and you should obtain excellent results with it, providing your receiver really is sensitive. The diagram shown is one in which the two 140 mmf. variable

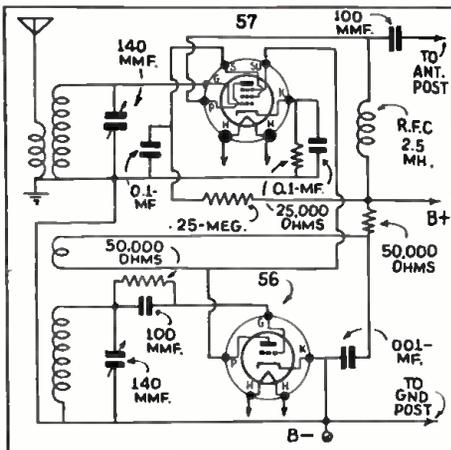

2-tube short-wave converter.

condensers are operated individually, and not ganged.

### WHAT TYPE AUDIO TRANSFORMER?

Roy C. Foss, Chicago, Ill.  
(Q) In an article in the July, 1935 issue of *Short Wave Craft* there was a self-powered amplifier with an input transformer not designated. Could this be a 3 1/2 to 1 Thordarson standard amplifier transformer? If not, please give the characteristics.  
(A) Any good make of transformer between 2:1 and 5:1 ratio will serve as the input transformer.

### 2-TUBE E. C. RECEIVER

William C. Baker.  
(Q) Would you please show a diagram in the *Question Box* of a short-wave receiver using Na-Ald band-spread coils? This set should use a "58" electron-coupled detector, and a "56" resistance-coupled audio amplifier. The coils are of the 5-prong variety.  
(A) We are pleased to print the 5-prong band-spread coil connections in a 2-tube receiver using a "58" and a "56." The conventional tickler or small winding, is con-

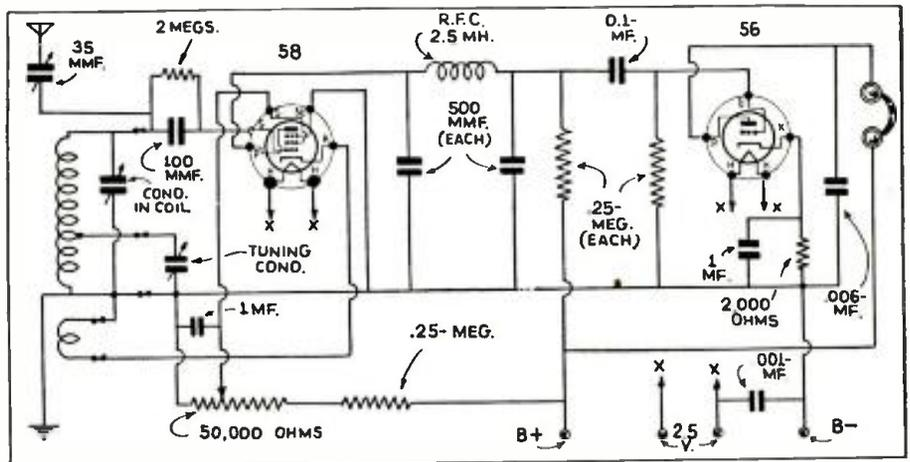

Electron-coupled detector and one stage of resistance-coupled audio amplification.

nected in the cathode circuit. The cathode of the tube is connected to the end of the tickler which is nearest to the grid coil.

### ANTENNA TRANSFORMER

Paul Davis, Racine, Wis.  
(Q) I have recently constructed a doublet antenna having a length of 40 feet in each half. The lead-in and transformer have been quite a puzzle to me. I am told that a suitable transformer can be constructed to match a given lead-in or feeder system to the antenna; also a transformer should be used to couple the lead-in to the receiver. Please let me have your suggestions.

(A) It is impossible to build a transformer which will match any feeder to your antenna, unless you wish to receive on one particular frequency. For general reception, no transformer is needed. The transformer which couples the lead-in to the receiver will depend upon the type of lead-in. These can be purchased more cheaply than they can be built.

### AUDIO AMPLIFIER DIAGRAM

S. Boorshstein, Detroit, Mich.  
(Q) Please publish a diagram of an amplifier using a "57" and a 2A5 tube, and which has its own power supply. This power supply should be capable of running a receiver as well as the amplifier.  
(A) The "57" and 2A5 amplifier is quite a high-gain affair, and we have shown the circuit with sufficient decoupling to render the amplifier stable in operation. The power supply will also furnish voltages for a receiver.

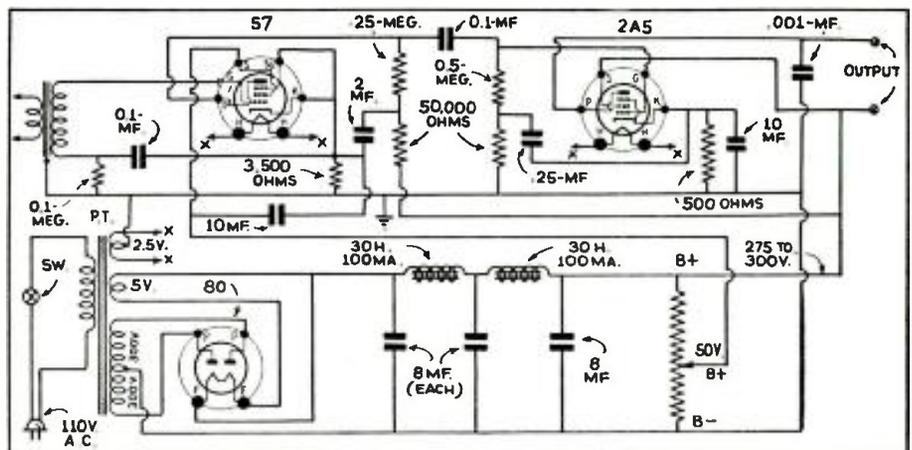

High-gain audio-frequency amplifier having 3 watts output.

### 1-TUBE POCKET SET

James Shivel, Hendersonville, Tenn.  
(Q) Please print a diagram in your *Question Box* of the 1-tube pocket set which was described in the December, 1934, issue of *Short Wave Craft*. This was a

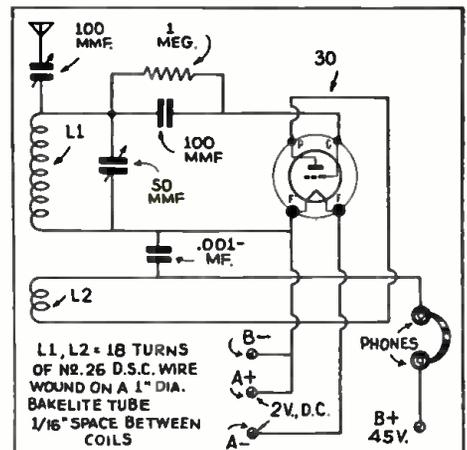

The famous "1-tube Pocket Set."

super-regenerative set.  
(A) The 1-tube pocket set sure did become famous, because nearly every one that built this set received foreign stations without an antenna! We are pleased to print the diagram again, and wish you success with it.

# Short Wave Scout News

## Dr. Alan Smith, Reports From Chester, Vt.

- NEW stations heard and logged here in the last month include:  
 YNDA, Managua, Nicaragua. Heard several evenings on 8590 kc. around 9 p.m.  
 XEFT, Vera Cruz, Mexico. Heard on 6120 kc., best after W2XE and COCD sign off. I have their veri and they say they have a special DX program on Saturdays from 6:30 to 7:30 p.m.  
 TG2X, Guatemala City, "The Voice of the National Police," heard on 5940 kc. around 9 p.m.  
 HRN, Tegucigalpa, Honduras, on 5875 kc. heard with good signal. They have a daily schedule of 8-10 p.m., with program of appreciation to listeners who report to them, every Sunday night.  
 YV4RC, 6375 kc., Caracas, is on daily "sked" with good signal and announces as "Ecos de Avila."  
 TIPG, 6410 kc., San Jose, Costa Rica, is on daily every evening.  
 SPW, Warsaw, Poland, 13,635 kc., tested from Oct. 1 to Oct. 15, being heard here on two days around noon, signing off at 12:30 p.m. They usually use telegraphy on same frequency.  
 TFI, Reykjavik, Iceland, 12,235 kc., was heard one Sunday, originating a program for CBS.  
 YV8RB, 5880 kc., located at Barquisimeto, Venezuela, is heard every evening.  
 Veris received this month: XEFT, TIPG, HJ4ABA, W10XF (the ground station of the stratosphere balloon), DOA1 (S.S. Europa), FNSK (S.S. Normandie), H11J.

## Charles Guadagnino, Detroit, Mich., Reports

- HERE are some of the stations heard:  
 YVQ, Maracay, Venezuela, 6.67 meg., broadcasting every Saturday night from 8:00 to 8:30 p.m. E.S.T.  
 PRADO, Rio Bamba, Ecuador, 6.62 meg., broadcasts on Thursday 9:00 to 11:30 p.m.  
 HICK, Quito, Ecuador, 5.89 meg., heard between 8 p.m. and 11 p.m. E.S.T.  
 LSX, Buenos Aires, Argentina, 10.35 meg., heard testing with New York between 6 p.m. and 11:30 p.m., E.S.T.  
 PRF5, Rio de Janeiro, Brazil, 905 meg., broadcasting from 4:45 p.m. to 5:45 p.m. Address: Postoffice Box 709, Rio de Janeiro, Brazil.  
 CEC, Santiago, Chile, 10.6 meg., broadcasts Thursday and Sunday 8:30 to 9 p.m.  
 XBJQ, Mexico City, Mexico, 11 meg., heard broadcasting 8 p.m. to 11 p.m., E.S.T.  
 COCD, Havana, Cuba, 6.13 meg., heard irregularly 7 p.m. to midnight.  
 TYA, Paris, France, 12.2 meg. heard working the "Normandie."

## A. B. Rice of Richmond, Va., and his trophy



Above—A. B. Rice of Richmond, Va., and the Short Wave Scout Trophy which was recently awarded him. Mr. Rice in a recent letter says: "It was with much pleasure that I received the beautiful trophy awarded by your magazine. . . . The trophy has been greatly admired, and I will always prize it very highly. . . . I am very pleased to know that I have been appointed 'Official Listening Post' for Richmond, and will endeavor to furnish you with reports at regular intervals as to the results obtained on short-wave reception."

## J. C. Storer's Listening Post Report

● I SURELY want to thank all those nice fellows who sent me their SWL cards. We are again enjoying Boundbrook's 16-meter programs, as DJE has faded out in this season. PHI and GSG still come in very good in this band.  
 19 meters has not been very good; only W8XK coming in as usual.  
 PMA and SUV have been heard early in the morning; quite good.  
 On the 25 meters the best has been 2RO at all times. The English and German stations on this wavelength were poor. CEC is coming in R9 for the last few days and it seems that they give daily broadcasts, except Sundays, at 7:00 p.m. E.S.T.  
 TFK, the new station in Iceland, has been heard for about ten consecutive nights, testing phone with England.  
 The new station XBQQ in Mexico is "pounding in" fine every evening. The same with W4XB of Miami Beach, Fla.  
 New stations heard are:  
 YNBA—8620—Managua, Nicaragua.  
 H13C—Voz de Rio Dulce—La Romana, D.R. on 6900 kes.  
 YV4RC—6375—Ecos Avila—Caracas.  
 HJ1ABK—7150—Barranquilla, Colombia. Just inaugurated.  
 YV5AM—7100—Ecos del Llano—San Juan de los Morros, Venezuela, just received today their verification. Will officially inaugurate this month.  
 YV8RB—5880—La Voz de Lara—Barquisimeto, Venezuela, has already inaugurated and is coming in R9 at all times.  
 VP3BG—7200—Georgetown, British Guiana. Broadcasts commercial programs of the Empire Bar every Tuesday at 8 p.m. E.S.T.  
 T18W—7550—Ecos del Pacifico—Punta Arenas, Costa Rica. Every evening from 7 to 10 p.m., E.S.T.

I am using a G. E. "V" doublet antenna.  
 Juan Cloquell Storer,  
 José de Diego St., No. 1,  
 P. O. Box 194, Arecibo, Puerto Rico.

## Report from Our "Ace" Dial-Twister in Illinois, Edward G. Schmeichel, 12th Trophy Winner

● RECEPTION at this "Post" during the past month has been excellent on all frequencies. Stations from the four corners of the earth have been received with good volume, and very fine programs. I am enclosing a few tips which may be of aid to all listeners. These tips are up to the minute and will be of benefit to all listeners.  
 PMA—Bandoeng, Java, 19.35 megs., is now operating on a regular schedule Tuesday, Thursday, and Saturday mornings from 10—10:30 a.m., E.S.T. They have a loud, clear signal and are heard very nicely. For a real treat, try for them on the above schedule.  
 YV2RC—Caracas, Venezuela, 5.80 megs., has moved to this frequency and are heard daily from 6—10 p.m., E.S.T., with tremendous volume, and crystal-clear signals. They announce in English, and use a 6-note chime at every 15-minute interval. They previously were on 6.11 megs.  
 DJI—Berlin, Germany, is a new German station operating daily from 12—2 p.m., E.S.T., on a frequency of 14.41 megs. They are heard very clear, and no difficulty should be experienced in hearing them.  
 DJB—Berlin, Germany, 15.20 megs., has again returned to the fold, and are now operating daily from 9—11:30 a.m., E.S.T. They have a strong signal since their aerial is "beamed" toward North America. They request reports and send very attractive QSL cards.  
 RIM—Tashkent, U.S.S.R., is heard every Saturday morning at 8:30 a.m., E.S.T., and earlier phoning RKI Moscow. They are heard very loud and clear, and reports of reception should be sent to Comite de Radio-diffusion et Radiofication, Petrova 12, Moscow, U.S.S.R. As a matter of fact all stations heard from the U.S.S.R. provinces, including Siberia, should be sent to this address. They verify all reports.  
 (Continued on page 567)

## Hi! Special Xmas Greetings to "S.W.C." from Australia

All readers of Short Wave Craft are cordially invited to listen-in to a farewell program from VK2ME-JME-JLR given to this post as follows: Dec. 29, 1935. VK2ME will give a Farewell Program to Oliver Amlic, members of the International 6000-12,500 Mile Club, and greetings to all Short Wave Craft readers, time 6:45 to 7:15 a.m., Eastern Standard Time. VK3ME will give the same Farewell Program of a different nature to the same party on Dec. 26, 1935, time 6:45 to 7 a.m., Eastern Standard Time. VK3LR will also give a Farewell Program to same party on Dec. 30, 1935, time 6:45 to 7:15 a.m. Eastern Standard Time, and greetings to Short Wave Craft readers.  
 Both the writer and each station would appreciate a report of reception on these transmissions. This post will finish his work in this zone of Australia on the three main Australian stations December 1935; from January to October 23, 1935, this post has cleared 260 reports, or veris on these three Australian stations, or 360 hours. Hope to get 365 veris, and 500 hours in this zone, ending December, 1935, and hope to win the first Australian Trophy for this work with only a "three-tube" receiver. If the trophy is received, readers of Short Wave Craft will be able to see it as a photo will be sent to the Editor of Short Wave Craft.  
 The Australian "farewell" programs will be heard in every country in the world, it is hoped, I wish all readers of Short Wave Craft a Merry Christmas and a Happy New Year.  
 Oliver Amlic,  
 Philadelphia, Pa.

## A Neat "QSL" Card

**BRECKSVILLE, OHIO.**  
 ROUTE 2, BOX 124, UNITED STATES OF AMERICA

**OFFICIAL - LISTENING - POST**  
 OF SHORT WAVE CRAFT

MEMBER-INTERNATIONAL SHORT WAVE CLUB

STATION JYT Heard Here 5:30 AM 10/3, 1935  
 READABILITY QSA5 VOLUME R7 QUALITY GOOD FADING SLIGHT  
 STATIC SOME INTERFERENCE NONE COMPLETION FAIR  
 PROGRAM MUSICAL SELECTIONS  
 REMARKS I NEED YOUR VERI. FOR THE S.W.C. CONTEST  
 Please Verily. Best Regards. Edward N. Heiser

One of our trophy winners, Edward N. Heiser of Brecksville, Ohio, has designed this interesting "QSL" card, on which he has incorporated the insignia of the Short Wave League, and also the fact that his station is an "Official Listening Post" of Short-Wave Craft.

Keep An  
Allied Catalog  
By Your Side-  
It Pays!

***"We're doing our Radio Buying***



**100% from ALLIED's catalog"**

**1**

"We're tough customers. We know what we want, the kind of service we want and what price we want to pay. That means we know real value when we see it.

**2**

We've been around—we've done plenty of shopping—and we're through experimenting. Now we've found the right answer for every single one of our radio needs.

**3**

We're doing our radio buying 100 per cent from ALLIED. We know that only ALLIED can give us the quality, the low prices and the real service that we want. That's why we keep an ALLIED Catalog handy—It pays!"

**WRITE FOR**

**YOUR COPY**

**FREE**

Send this coupon now!

ALLIED RADIO CORPORATION  
833 W. Jackson Blvd.  
Chicago, Ill. Dept. E

Send me your FREE 1936 Catalog—Radio's Leading Supply Guide

Name.....  
Address.....  
City..... State.....

**Allied Radio**  
CORPORATION  
833 W. JACKSON BLVD., CHICAGO  
*"EVERYTHING IN RADIO UNDER ONE GREAT ROOF"*

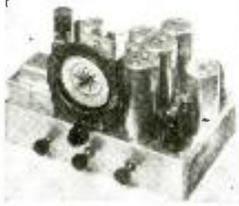

## ALL-WAVE PATHFINDER 6 TUBE SUPER HETERODYNE Featuring ALL METAL TUBES

With glass tubes if specified

Uses 1—6A8, 2—6K7, 1—6J7, 1—6F6, 1—5Z4. Individual Coils for each Band. Positive Contact Band

Selector Switch, with Monel metal contacts. Pre-selector Stage on all Bands. Crowe Micro Master Band Spread Dial. Covers complete spectrum from 16 to 550 meters.

COMPLETE KIT OF PARTS  
Not wired, without tubes and speaker

**\$21.50**  
8-Inch Dynamic Speaker \$2.95

MAIL  
ORDERS  
FILLED



FREE  
CIRCUIT  
ON REQUEST

167 GREENWICH ST.

Dept. S-12

NEW YORK, N. Y.

## MUTER DE LUXE TUNING SELECTOR

Reduces  
Static

Increases  
Selectivity

Increases  
Volume

Reduces  
Interference



## "BIG AJAX"

## FOR QUIET FOREIGN RECEPTION

Big Ajax—reduces static and interference. Ends forever the nuisance of mangled, noise-ridden short wave reception—install Big Ajax between your antenna and receiver.

Here's an accurate, impedance-matching, tuning selector for coupling a doublet antenna to any receiver. Its easily adjusted switches correct many reception troubles, greatly increasing volume and improving selectivity.

### READ WHAT THIS USER SAYS ABOUT BIG AJAX

"Gave Big Ajax a thorough tryout last night and this morning and find same is all you claim it to be. I have a fine receiver of a renowned manufacturer and Big Ajax even improves both selectivity and sensitivity. Brought in VK3ME and VK3LR, Melbourne, Australia, both with volume and clearness under adverse climatic conditions."

P. D. BROWN,  
Atlanta, Ga.

It's got a noise reduction shield that takes out man-made static, like an All-American Half Back takes out an opposing End. Hook it up between your antenna and your set and learn what quiet foreign reception is really like.

Your jobber has them—get one today. Or mail the coupon NOW and we'll send it postpaid for \$2.50. It's guaranteed to improve reception or your money will be refunded. PRICE \$2.50.

## MAIL THIS COUPON!

THE MUTER COMPANY

1255-P South Michigan Ave, Chicago, Ill.

Please RUSH me one of your "BIG AJAX"  I am enclosing \$2.50  
 I will pay mailman \$2.56. It must be satisfactory in every way.

Name .....

Address .....

City ..... State .....



The MUTER COMPANY

1255-P S. Michigan Av.  
CHICAGO, ILL.  
U.S.A.

## Improved 3-Tube "Doerle"

(Continued from page 521)

In the audio portion of the receiver, we have two stages of resistance-capacity coupled amplification; a single 19, which is a twin triode, serves for the two stages. Tremendous amplification is obtained with this tube lineup, and even the weakest stations can be brought in with full earphone volume. The stronger stations will operate a magnetic speaker. However, no power output stage is used, and the best results would be obtained with the use of earphones, rather than a speaker.

### Has R.F. Stage

The radio frequency and detector stages are tuned with a two-gang 140 mmf. condenser assembly, allowing single dial tuning. Padding in the R.F. stage is accomplished through the loading effect obtained by adjusting the small condenser connected across the interwound winding of the antenna coil. This is the same winding that is used as primary or R.F. plate coil in the detector circuit. The entire receiver is built on a commercially available, stamped and drilled chassis. This chassis has six tube holes, but only five of them are used.

Looking at the front of the receiver, we see the large airplane type tuning dial in the center. This dial can be of the "dual-ratio" type if band-spread is desired. The small knobs along the bottom of the panel are used as follows: From left to right, on-and-off switch, antenna trimmer, throttle condenser for regeneration control, and filament rheostat. In the rear view, we have the two six prong-3 winding plug-in coils on either side of the chassis. Behind the left-hand plug-in coil is the 34-R.F. amplifier. Behind the right-hand coil, is the regenerative detector; the "19" is between the two plug-in coils. For smoothness in operation, regeneration is controlled through the use of a "throttle" condenser.

The underneath view of the receiver shows the various resistors and by-pass condensers. Note the absence of transformers. Through the use of resistance coupling, quite a saving is brought about in the cost of construction, and the tone quality is all that could be expected of any good short-wave receiver. The particular chassis used, measures 10½ inches long, 7 inches deep, and it fits into a cabinet which is finished in black crackle enamel, to match the front panel. Building receivers on metal chassis, and using metal cabinets, not only enhances the appearance of the receiver, but increases the efficiency considerably. It also simplifies tuning because serious body capacity effects are eliminated.

Standard plug-in coils are used. These have three windings, and cover a range from 15 to 200 meters. On the plug-in coils, the small winding at the base of the coil is used as the antenna coupling coil in the R.F. stage, and as the tickler or feedback coil in the detector stage. The largest winding is used as the grid coil in both cases. The interwound winding is used in the R.F. stage as the trimming coil, and in the detector stage, as the plate coupling coil of the R.F. stage. In connecting up these coils, remember that the top of the largest winding always connects to the grids. The top of the interwound winding in the detector coil connects to the plate of the R.F. tube, and the bottom of the tickler winding goes to the plate of the detector tube.

Any antenna having a length approximating 75 feet, or over, will give satisfactory results. The length of the antenna should be considered directly from the receiver to its farthest end. If a doublet is used, the one set of the antenna coil indicated by the dotted line, is not grounded. In other words, the connections marked "1," "2" and "3," are connected as follows: No. 1 to the antenna, and Nos. 2 and 3, shorted, i.e., with an antenna and ground combination. With a doublet, the connection between "2" and "3" is eliminated, and the two leads of the feeders or lead-in's connect to the terminals "1" and "2." For

Please mention SHORT WAVE CRAFT when writing advertisers

complete coil data, see the Question Box.

**Parts List for "3 Tubes Equal 4"**

- 1-2-gang 140 mmf. condenser.
- 2-140 mmf. variable condensers, Hammarlund.
- 4-.1 mf. by-pass condensers, Cornell-Dubilier.
- 1-100 mmf. mica condenser, Cornell-Dubilier.
- 1-.006 mf. mica condenser, Cornell-Dubilier.
- 1-3 mex. 1/2 watt resistor, I.R.C.
- 2-50,000 ohm resistors, 1/2 watt, I.R.C.
- 2-250,000 ohm resistors, I.R.C.
- 1-2.5 mh. R.F. choke, Hammarlund.
- 2 sets of 4, 6 prong plug-in coils, Na-Ald.
- 2-4-prong wafer sockets, Na-Ald.
- 2-6-prong wafer sockets, Na-Ald.
- 1-15 ohm rheostat.
- 1-4 inch airplane type dial.
- 1 metal Chassis and Cabinet, Radio Trading Co.
- 1-type 34 tube, Aero.
- 1-type 30 tube, Aero.
- 1-type 19 tube, Aero.
- 3-45 volt "B" batteries, Burgess.
- 2-1 1/2 volt dry cells, Burgess.

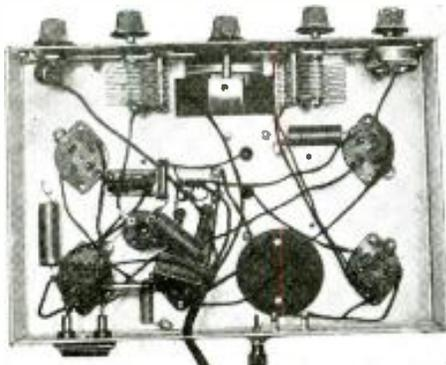

Bottom-view of 3-Tube Doerle.

**11 Tube Receiver**

(Continued from page 534)

Victor Division, RCA Mfg. Co. Inside the receiver, a terminal strip with jumpers is provided in order to change for operation either from batteries or A.C. power line.

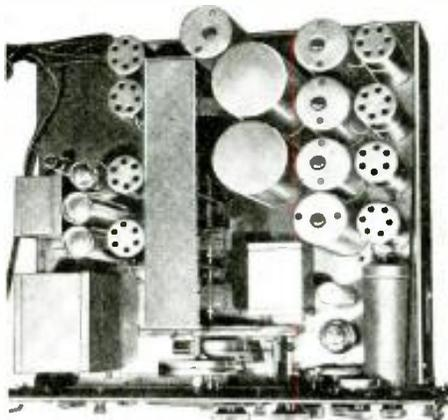

This view shows the chassis.

**New 1936 Allied Radio Catalog**

● THE new "Streamlined" Allied Radio Catalog for 1936 is "packed full" of data on the latest radio apparatus of interest to every amateur and set-builder. The main sections of this snappy new catalog are devoted to metal tubes, all-wave, short-wave, battery and auto sets; also new public-address sound equipment, new service test equipment and tools, short-wave receiving and transmitting apparatus, together with thousands of standard replacement and set-building parts. Every "Ham" and "Fan," will want a copy of this valuable book. Ask for Catalog No. 510, Service Department, Short Wave Craft, 99-101 Hudson St., New York City.

*A gift that will bring joy  
to any man or boy  
For a Merry Christmas*

SEND FOR EITHER OF THESE EXCELLENT RECEIVERS TODAY!

**IMMEDIATE DELIVERY GUARANTEED!**

**FULTONE V**  
3-Tube Set  
**NEW FIVE-IN-THREE SET**  
6D6-6F7-12A7  
**ALL-ELECTRIC**



**BUILT-IN LOUD SPEAKER  
ENTIRELY SELF-CONTAINED**

**1936 MODEL  
NOW!! WITH FULL  
B-A-N-D-S-P-R-E-A-D**

**OF ALL HAM BANDS AND  
FOREIGN STATION  
BANDS AT NO EXTRA  
COST!!**

Screen grid RF stage—Screen grid regenerative detector—High gain first audio tube—Power pentode output—Voltage rectifier FIVE tube performance from THREE new type tubes—Self contained humless power supply—operates on 110 volts AC or DC—Triple winding coils—Velvet smooth, large airplane vernier dial—Full loud speaker volume—Tuning range —9% to 62% meters.

We're proud of it—and we know you will be too! Order your 1936 Fultone V today and enjoy real reception. Try it yourself for five days—full cash refund if you want it.

**COMPLETE FULTONE V THREE TUBE RECEIVER** KIP of all necessary parts including large airplane dial, crystal finished metal chassis and panel with all holes, four coils 9% to 200 meters, and complete easily followed wiring and tuning instructions ..... **\$6.95**  
(Not wired, less tubes, cabinet, loud speaker and broadcast coils)  
Three matched guaranteed tubes..... \$2.20  
Metal Cabinet for above..... 1.25  
Loudspeaker to fit in set..... 1.45  
200 to 625 meter Broadband and Long Wave coils.  
Two coils..... 1.25  
Laboratory wired and tested..... 1.50

**SPECIAL COMBINATION OFFER**

Complete Fultone V 3-Tube receiver kit, not wired, but with 3 tubes, Two Broad-band coils, Loudspeaker and Cabinet..... **11.45**  
Laboratory Wired and Tested..... \$1.50 extra

**ROYAL "PR-SIX"**  
6-Tube Communications Receiver



- ▶SIX ALL STEEL TUBES  
6K7 - 6C5 - 6K7  
6C5 - 6F6 - 5Z4
- ▶REAL Continuous Bandspread
- ▶FULL RANGE 9% to 625 Meters
- ▶FIVE Tuning Sections
- ▶"TWIN-MASTER" Control
- ▶Humless Power Supply (AC only)
- ▶FREE FIVE DAY TRIAL

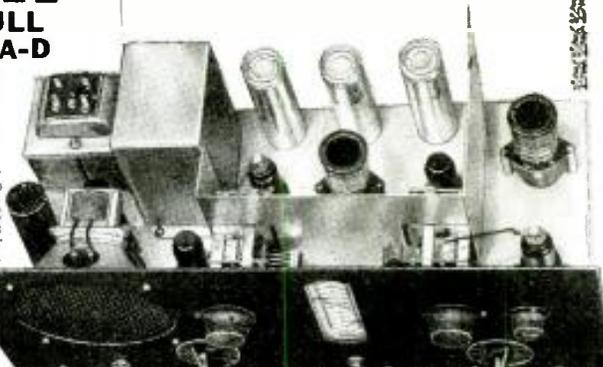

**ISOLATED REGENERATOR TUBE**

This sensational new feature alone makes Royal's new professional receiver the outstanding Communications Type receiver of today! Twenty other ROYAL features will convince you that this is the only set for you! Read pages 406 and 125 of the November issue of Short Wave Craft for complete description. Available with either metal or glass tubes. Please state your choice when ordering.

**Complete "PR-SIX" Receiver**

with built-in power supply and large dynamic speaker. Complete with SIX real STEEL Tubes, all coils 9% to 625 meters, and attractively finished heavy steel cabinet, Laboratory wired and tested, ready to plug in and operate! **\$31.45**

**Order direct for immediate shipment by mail,  
or if in New York—**

**Call At Our New Large Salesroom**

12 West Broadway (Between Barclay and Vesey Streets)

- **LARGE STOCK**
  - **DEMONSTRATIONS**
- (We are one of the few with enough confidence in our products to cheerfully demonstrate)

Send for new large catalog

**HARRISON RADIO CO.**

Dept. C-1, New York City  
142 Liberty Street

### Practical 5-Meter Antenna Design

(Continued from page 535)

chief radio man for all of the hotels under the management of Ralph Hitz, we were able to secure free access to the roof of the Hotel New Yorker. This roof is some forty-four stories, or approximately six hundred feet above the street. Our receiving and transmitting equipment was placed in a large motor room on the forty-third floor and the antennas, themselves, were approximately one hundred twenty-five feet above this point. It is difficult to imagine any place where local interference would be quite as bad as in this location. For the purpose of studying the means for reducing local noise, resulting from the use of noise-reducing antenna systems, it is doubtful that a better location could be found.

Our first antenna was a simple half-wave dipole, as shown in Fig. 1. This antenna was tied to the end of an 8-foot stick and it was stuck out from one of the

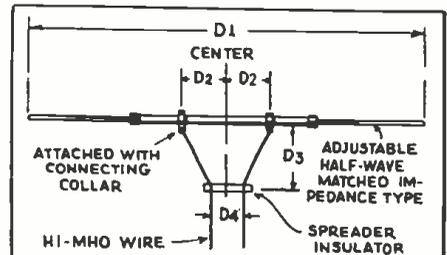

FR. MC.	W. L. MET	D1	D2			D3
			430	440	475	
56	5.357	8'3"	13.068	13.167	13.8	29.7
57	5.263	8'0"	12.67	12.768	13.54	28.8
58	5.172	7'11"	12.54	12.635	13.3	28.5
59	5.085	7'10"	12.418	12.5	13.16	28.2
60	5.0	7'8 1/2"	12.21	12.3	12.95	27.75

HI-MHO WIRE IN ALL LINES (LIGHT WEIGHT FOR LESS THAN 50 FT. - HEAVY WEIGHT FOR LONGER LINES)

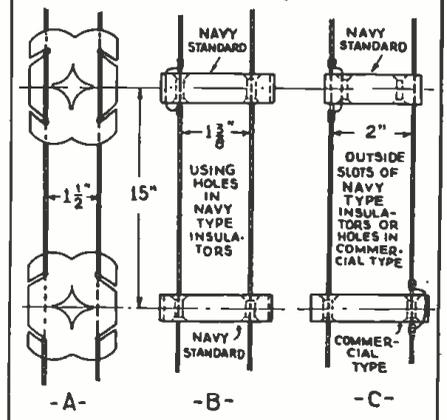

Correct dimensions for various radiators and reflectors.

supporting members of the hotel's huge Neon sign. The antenna proper was approximately level with the window and the room where our receiver was installed; and the lead from the antenna to the receiver was approximately twenty-five feet long. In order to determine the effect of introducing long lengths of transmission line, the antenna circuit was opened and various additional lengths were introduced. No variation in signal intensity was noticed.

Our next move was to the matched impedance type of antenna, shown in Fig. 2. No particular difference was noticed between this antenna and the arrangement shown in Fig. 1, so far as signal strength was concerned, but the system shown in Fig. 1 was a very much better system for eliminating interference.

### ROLAND'S 100% 5 Tube Bandspread Receiver

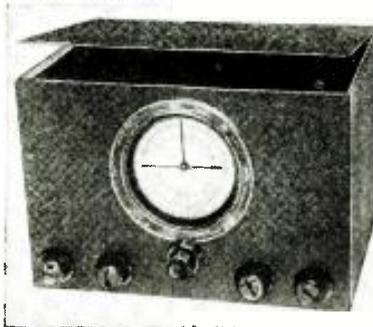

MODEL R 1000

Our Engineering Dept. has now perfected our short wave receiver to provide 100% bandspreading on all bands from 15-200 meters. This has been accomplished with the new dual ratio airplane dial with its 125-1 ratio bandspread pointer.

You may now use this receiver for your daily communication work and log your stations accurately for repeat tuning. For the short wave fan these new features will aid in separation of the foreign and domestic stations on all congested bands.

Phone jacks with speaker cutout switch are mounted on front panel for easy accessibility. Complete shielding of all stages to eliminate R.F. and audio feedback. A highly sensitive regenerative circuit using a tuned R.F. stage with a newly perfected system for equalizing both stages, makes this an ideal short wave receiver for both ham and short wave fan.

Tubes employed are the newly developed 6.3 volt types: 6D6, 6F7, 76, 42 and 80. Set is mounted on a black wrinkled heavy steel chassis. Chassis wired and tested with 8 coils without cabinet, speaker, power supply, and tubes

Cabinet for above ..... \$ 1.75  
 Five Sylvania set tested tubes ..... 3.50  
 6" short wave dynamic speaker ..... 2.00  
 Short wave hum free power supply ..... 4.95  
 Complete kit of parts for set and power supply, less speaker and tubes..... 14.75

No. R 2000, same receiver as No. R 1000, but complete with Pack and Speaker in Cabinet, wired and tested, with 5 tubes, ready to operate.....\$23.25  
 Can also be obtained A.C.-D.C.

### ROLAND RADIO CO.

1340 E. 9th St.,

Dept. S-1-36,

Brooklyn, N. Y.

\$11<sup>75</sup>

### HERE At Last!

#### THE PATTERSON PR-16

#### 16 TUBE SUPER HET

The patience of the many thousands of amateurs—experimenters—and professional operators who have been waiting for this model—is gratefully acknowledged. In case you haven't seen the specs on this most advanced all-wave receiver—check some of these.

- \*Three stage push-pull audio.
- \*18 1/2 watts audio output. Less than 2% distortion.
- \*Beat frequency oscillator for CW reception.
- \*16 tube superhet.
- \*Crystal filter can be cut in as a series or parallel filter.
- \*Five band range. Full 8 to 550 meters.
- \*Dial shutter — Patterson camera type.
- \*Audio channel flat = 2 db from 50 to 10000 cycles.
- \*12" dynamic speaker.
- \*AVC and manual volume control.
- \*Six months guarantee—you can't go wrong.

Write for descriptive catalog material on this and other models. Also a complete group of amateur transmitters.

We are also making immediate delivery on Sargent, RME-69, Silver, Hammarlund, RCA, Hallicrafters Super Skyriders, Bretnik, etc.



PR-16, complete with 16 tubes, metal cabinet, speaker, less crystal.....\$ 95.70  
 PR-16G, same as PR-16 above, but with crystal .....\$101.70

### W 22 G MARINE W 22 G RADIO COMPANY

124-11 101st Avenue  
 Richmond Hill, N. Y.

# FACTORY TO YOU

## LATEST MODEL REMINGTON TYPEWRITERS

BRAND NEW, latest model Remington Portable for only 10¢ a day! Here is your opportunity to get a perfect writing machine at an amazingly low price direct from the factory. Every essential feature of large office typewriters—standard 4-row keyboard, standard width carriage, margin release, back spacer, automatic ribbon reverse. Act now, while this special opportunity holds good. Send coupon TODAY for details.



10¢ A DAY

your 10-day trial period and see how easy expert typing can be. We also will send you FREE a sturdy carrying case of 3-ply wood covered with heavy Du Pont fabric. Mail coupon for full details—NOW.

**You Don't RISK a Penny**  
 We send you the Remington Portable, Model 5, direct from the factory with 10 days' free trial. If you are not satisfied, send it back. We pay shipping charges both ways.

#### FREE Typing Course and Carrying Case

With your new Remington you will receive FREE a complete simplified home course in Touch Typing. Follow instructions during

Remington Rand Inc., Dept. 214-1  
 205 East 42nd St., New York, N. Y.  
 Please tell me, without obligation, how I can get a New Remington Portable, plus Free Typing Course and Carrying Case, for 10¢ a day. Send Catalogue.

Name .....

Address.....

City.....State.....

Please mention SHORT WAVE CRAFT when writing advertisers

**SELECT YOUR HOLIDAY GIFTS from this LIST of REAL SHORT WAVE VALUES**

**WE GUARANTEE SATISFACTORY RESULTS ON ALL OF OUR PRODUCTS**

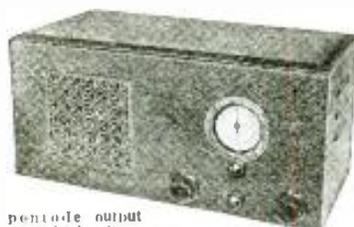

**EILEN HG-36**  
5-Tube Bandsread Receiver

A POWERFUL, CUSTOM-BUILT, TUNED RADIO FREQUENCY regenerative short wave receiver that WILL PRODUCE RESULTS. See editorial description pages 471 and 488 December issue of SWC.

Uses 6D6-6C6-76-12-81 hi-gain tubes as Tuned RF amplifier-Tuned screen-grid regenerative detector-powerful 2 stage audio frequency amplifier with pentode output stage-high voltage rectifier and built in power supply. Operates entirely from 105 to 130 volt AC lighting socket. Entirely self-contained. Dimensions 10x7 1/2 x 8 1/2.

Uses special dual ratio, double scale, multi-colored, bandsread, illuminated airplane type dial of great beauty. Positively no backlash. Continuous bandsread from 302 to 600 meters. Any of the AMATEUR BANDS or foreign SW bands may be spread over from 80 to 100% of the bandsread scale.

Automatic jack for phones—volume control—built-in high fidelity dynamic speaker—hum free—connections for doublet or single wire antenna—beautiful, black shrivel finish metal chassis and cabinet—selectivity, sensitivity, and tonal qualities that will amaze you.

<b>HG-36 KIT</b> of all necessary parts, un-wired, 4 coils for 9 to 200 meters, & instructions (less tubes, speaker, cabinet, & BC coils) Beautiful metal cabinet.....	<b>\$14.95</b>
5 Matched Areturus tubes.....	2.85
<b>SPECIAL:</b> Complete kit, cabinet & 5 tubes, less BC coils & un-wired	<b>\$17.95</b>
Labor for wiring & testing, ready to use, extra.....	2.00
2 Broadcast band coils, if desired.....	1.25

An unusual value for the SW fan or the AMATEUR who wishes a REALI-CABLE COMMUNI-CATIONS RE-CEIVER. Send for literature.

**IF METAL-GLASS TUBES** (6K7 - 6J7 - 6C5 - 6F6 - 5Z11 are preferred over the glass type, add \$1.00.

**EILEN 6A SHORT WAVE**  
4-TUBE RECEIVER

A midget in size—A giant in performance The new, sensational, 1936 Eilen 6A receiver is truly a masterpiece in design. Its unusual design, conforming to the best in modern engineering theory, has all of the latest up-to-the-minute features. **FULL 6 TUBE PERFORMANCE.**

Uses 6K7 (metal-glass)—6F7 (twin 2 in 1)—6C5 (metal-glass)—12A7 (twin 2 in 1) hi-gain tubes as aperiodic RF amplifier, screen grid regenerative detector, **POWERFUL 3 stage audio amplifier with pentode output stage, rectifier & built-in power supply. Hum-free. Completely self-contained. Operates entirely from 105 to 130 volt AC or DC light socket.**

**BAND SPREAD TUNING TRIMMER—smooth regeneration control—built in hi-quality loudspeaker—automatic**

headphone jack—large, airplane vernier tuning dial—large 3 winding low-loss inductances—selectivity, sensitivity, and volume that will amaze you. Heavy, black shrivel finish metal chassis and cabinet. Foreign speaker reception under fair conditions. **ORDER YOURS TODAY! YOU'LL NEVER REGRET IT!**

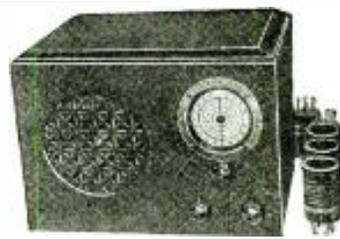

<b>EILEN 6A KIT</b> of all necessary parts, un-wired, with 4 coils for 10-200 meters, & instructions (less tubes, speaker, cabinet, & BC coils)	<b>\$7.95</b>
Beautiful cabinet.....	1.15
4 Matched Areturus tubes.....	1.45
Special loudspeaker.....	1.25
2 Broadcast band coils.....	1.25
<b>SPECIAL:</b> Complete kit, cabinet, tubes, speaker, 1 BC coil & instructions, un-wired.....	<b>\$12.95</b>
Labor for wiring & testing, ready to use, extra.....	1.50



**EILEN 5A**  
SHORT WAVE  
4-tube RECEIVER

The finest, low-priced, SW receiver on the market. The sensitivity, volume, unusual beauty, and hum-free reception obtainable from this set make it an outstanding value. Uses 6D6-6D6-76-12A7 (twin 2 in 1) tubes as aperiodic amplifier, screen grid regenerative detector, 2 stage audio amplifier with pentode output tube, rectifier and built-in power supply. Operates entirely from the 105 to 130 volt AC or DC light socket. Hum-free.

See article p. 343 October issue of SWC.

**BAND SPREAD TRIMMER—Large, airplane type vernier dial—tremendous headphone volume—operates a speaker on many stations—large 3 winding coils for selectivity and efficiency—so simple that even a beginner can operate it—heavy, black shrivel finish metal chassis and cabinet.**

So simple that even a beginner can operate it. Owners report dozens of foreign SW stations with loudspeaker volume. You can do the same under fair conditions.

**IF METAL-GLASS TUBES** are preferred over the glass type, add \$1.00. AMATEUR Model 5A-AB same as 5A except designed especially for 20-10-80-160 M bands. \$1.00 extra.

<b>5A KIT</b> of all necessary parts, un-wired, including 4 coils for 9-200 meters & instructions (less tubes, cabinet & BC coils).....	<b>\$7.45</b>
4 matched Areturus.....	\$2.85
Beautiful cabinet.....	1.25
2 BC band coils.....	1.25
<b>SPECIAL:</b> Complete kit, cabinet, tubes, & BC coil.....	<b>\$11.45</b>
Labor for wiring & testing, ready to use, extra.....	1.50



**EILEN HF-35**  
SW 3-tube  
TRANSMITTER

SEE FEATURE ARTICLE pages 474 and 475 of Dec. issue of SWC. A POWERFUL and well designed amateur band transmitter that you can be proud to own. **CRYSTAL CONTROL-TRI-TUBE OSCILLATOR-DOUBLE-CLASS C RF POWER AMPLIFIER-TRIPLE-T METERS-EILEN TRANSMITTING DIALS—BUILT-IN AN-**

**TENNA TUNING SYSTEM—35 WATTS OUTPUT ON 20-10-80-160 meter bands. Extremely beautiful appearance. Heavy, black shrivel finish metal shelving and cabinet. Highest quality of parts used.**

<b>KIT</b> of all parts, un-wired, instructions and 3 coils for any 1 band, (less tubes, crystal, holder, and power supply, un-wired)	<b>\$23.95</b>
3 Raytheon tubes 50-16-16.....	\$2.15
Eilen quartz crystals 80-160 or 40 M.....	1.95
Eilen crystal holder.....	2.95
Eilen crystal holder.....	1.00
Wired and tested, extra.....	3.00
3 Coils for additional bands, per set.....	1.45
HV-475 power supply KIT (un-wired) for above, in beautiful metal cabinet to fit directly under HF-35, less tube @ \$13.95.....	
Wired and tested, extra \$1.50; Areturus tube, extra \$6.50.....	



**EILEN DC3**  
2-Tube Receiver

A powerful battery operated receiver designed to produce loudspeaker volume. Uses 32-30-53 tubes as screen-grid reg. detector, and 2 stage audio amplifier with pentode output. Black shrivel finish metal construction.

<b>DC3 KIT</b> of necessary parts, un-wired, with 4 coils for 10-200 meters & instructions (less tubes, batteries, speaker, cabinet, & BC coils).....	<b>\$5.95</b>
Beautiful cabinet.....	\$1.25
3 Areturus tubes.....	\$2.05
2 Broadcast band coils.....	1.25
<b>SPECIAL:</b> Complete kit, cabinet, tubes, & BC coil (less speaker, un-wired).....	<b>\$10.45</b>
With built-in loudspeaker, extra.....	1.45
Labor for wiring, ready to use.....	1.50

**ALL ELECTRIC 3-tube SW RECEIVER**

The original, popular, All-Electric model, which has been praised by thousands. Owners have reported as high as 35 foreign countries with this set. Uses 6F7 (twin 2 in 1)—76-12A7 tubes as screen grid regenerative detector, 2 stage audio amplifier, rectifier & built-in power supply. Hum-free. Operates from 105 to 130 V AC or DC light socket. Vernier dial.

<b>KIT</b> of parts, (un-wired), 4 coils for 10-200 meters & instructions (less tubes, cabinet, & BC coils).....	<b>\$5.95</b>
Cabinet.....	\$1.25
2 Areturus tubes.....	2.15
3 BC band coils.....	1.25
<b>SPECIAL:</b> Complete kit cabinet, tubes & BC coil (un-wired).....	<b>\$9.65</b>
Labor for wiring & testing, extra.....	1.50

FREE Catalogue of SW receivers, transmitters, transceivers, and accessories. Send for your copy. Prompt Shipment. 36 hour service. Telegraph orders rushed to you. 20% deposit on COD orders. **QUALITY—VALUE—HONESTY—SERVICE.**

**EILEN RADIO LABORATORIES, DEPT. SC 1, 136 LIBERTY STREET, NEW YORK, N. Y.**

**Coupling to the Receiver**

Wherever the low impedance Giant Killer Cable type of transmission line was employed, the coupling to the receiver was in the form of a two-turn coupling coil. With receivers in which the regular National Midget Coil Forms support the tuning winding, the making of such a coupling coil is a very simple matter. Number 14, solid, enamel wire is wound into a self-supporting coil, with its two ends projecting. The diameter is such as to permit it to fit snugly into the coil form. The turns may be spaced the same distance as the diameter of the wire. When such a coupler is employed, the coupling between the line is variable and it permits the operator to control both the sensitivity and the selectivity. It requires no changing, after finding the optimum position, unless more than ordinary sensitivity and selectivity are required for a specific purpose. Such a coil forms a fairly close match for the low impedance transmission line of G-K cable, used in our work.

The third type of vertical dipole was the system employing the so-called Picard type of antenna shown in Fig. 3. This type of antenna has been designed to provide a suitable impedance match between the low impedance, current-fed dipole and a high

impedance transmission line, such as a spaced pair. This system, when used with the "Picard" transformers commercially available, is not suitable for use with a low impedance, twisted pair transmission line. It is capable of satisfactory performance only when it is used in locations where both the antenna and the transmission line are free from local interference.

**Vertical Half-Wave Collectors**

So many fellows were securing satisfactory results from other forms of antennas, that we decided to try some of the units they were employing. Our first attempt is shown diagrammatically in Fig. 4, and is made of a half-wave collector, fed in "Zep" fashion and tuned by the variable condensers shown in the diagram. This arrangement was found to be very satisfactory for signal pickup but it did not have the noise-reducing property found in connection with Fig. 5. Then, too, the spaced pair used in connection with Fig. 4 made the running of the transmission line a comparatively difficult mechanical problem. The arrangement shown in Fig. 5 enabled us to use a very light, 8-foot aluminum tube, which we were able to insert in the top of the 16-foot bamboo pole and thus get the collector, itself, well above all surrounding objects.

Giant Killer Cable of random length was used for the transmission line and one side was connected to the ground and the other side connected to the antenna post of the receiver, through the variable condenser shown. This arrangement, as well as the one shown in Fig. 6 was suggested by George Shuart, W2AMN.

In using the arrangement shown in Fig. 6, it is well to observe that the top of the antenna proper was some thirty feet below the top of the antenna shown in Fig. 5. There was no noticeable difference in either signal pickup or noise reduction. However, it would seem that under ordinary conditions the arrangement shown in Fig. 6 would be the more desirable. It is well to observe, however, that when the lead-in is taken from the top of the antenna and run off on a 45 degree angle, as is done in this case, the 8-foot antenna must be of fairly heavy material to withstand the strain.

We next went to the beam array, shown in Fig. 7, and it will be observed that this type of antenna is the conventional type in which two radiators and two reflectors are employed. The radiators are cut to ninety-five percent of half of the wavelength at which it is desired to operate, while the reflectors are cut to ninety-seven percent. Both radiators and reflectors are

Please mention SHORT WAVE CRAFT when writing advertisers

# NEW Sets for OLD! AT 1/3 THE COST

A sensational new idea now makes it possible for you to own a custom built radio at a fraction of the cost of a factory built model of equal performance! Why discard your present radio when the cabinet and much of the equipment can be utilized in an up-to-the-minute circuit which brings you superlative world-wide all-wave reception? Other features include: automatic volume control, highest sensitivity and selectivity, etc. Your own radio serviceman is undoubtedly a Tobe Modernization Engineer. Tear out this ad and ask him about it. You'll be amazed when he gives you a price for modernizing your receiver. If he cannot—write for name of the nearest Tobe Modernization Engineer.

## SERVICEMEN! DEALERS!

If you have not already done so, get a copy of Zeh Bouck's book on this new phase of radio servicing. Nearly 1000 servicemen have already entered this field. Write today for Book and Free Merchandising Plan and Sales Promotion Kit.

Tobe Deutschmann Corp., Dept. SW-16  
Canton, Massachusetts

I am a  customer  serviceman  
 Send me name of nearest Tobe Modernization Engineer. I own a 19..... receiver.  
 I enclose 25c for Zeh Bouck's Book and Free Sales Promotion Kit.

Name.....  
Address.....  
City..... State.....

# CABINETS

for ALL STAR SR. & JR.



with hinge cover finished to match the ALL STAR SET.

Our Low Price **\$3.95**

We do not supply panel, dial or knobs for ANY MAKE RECEIVER. Send drawing, blue print or kit complete description for estimate.

Dealers and Jobbers: Write for special prices.  
**KORROL MFG. CO., Inc.** Dept. S-1  
232 GREENWICH ST. NEW YORK CITY



# ACME PHONES PROVIDE

Superior performance at remarkably low cost. Sturdy construction—Lightweight—The most phone for the money.

**ACME SPECIALTY CO.**

2000 MENDEL ST., CHICAGO, ILL.

# LEARN RADIO

225 Graduates Placed in the Last Four Years  
At the oldest, largest and best equipped privately owned radio operating school in the East. Western Electric and RCA tube transmitters; 225 licensed graduates placed in past four years in broadcasting, shipping, police radio, aviation, service work, etc. Course prepares for all U.S. Government Telegraph and Telephone licenses. Send for 40-page catalog. Investigate. New classes every eight weeks from Sept. 9th. Open all year around.  
**MASS. RADIO SCHOOL** 18 Boylston St., BOSTON  
R. F. TROP, Treas.—EST. 1899—G. R. Entwistle, Pres.  
One of America's leading Radio Schools

spaced a half wavelength apart and the radiators are spaced a quarter of a wavelength from the reflectors. The high impedance transmission line employed, in this case, was tuned with a pair of variable condensers, as shown. A very much simpler arrangement which accomplishes the same result is illustrated in Fig. 8. Here the same general dimensions for the radiator and reflector portions are employed and the quarter-wave matching section is made up of two pieces of regular stranded enamel antenna wire, spaced two and a quarter inches apart.

One very important point in the construction of antennas such as shown in Fig. 8, is the quarter-wave matching section. The total distance ABCD must be exactly half of a wavelength.

## The Latest Antenna

Since moving from the Hotel New Yorker, to the Forty Wall Street Building, where our equipment is located more than nine hundred feet above the street, we have run into several problems which our experience at the Hotel New Yorker did not cover. The tower in which we now have our station is a very ornate affair and we find ourselves in a position where there is practically no roof space. Therefore, we cannot avail ourselves of the advantages of beams and all of our antenna activity must be conducted with comparatively simple units. The arrangement shown in Fig. 9, is, if we forget about the reflectors indicated by the dotted line, essentially the same as Fig. 8, except for the fact that the half-wave radiators are disposed one above the other, instead of being parallel and a half a wave apart.

This type of antenna is two half-wave vertical elements, with a quarter-wave matching arrangement, fed by a low impedance transmission line. In this case, each of the radiators, themselves, are actually ninety-five percent of a half wavelength long and they are about two and a half inches apart at the center.

The arrangement it is necessary for us to make for using an antenna of this nature, is to provide ourselves with several 8-foot lengths of two by two inch sticks. The antenna and its supporting members are attached to these sticks, as shown in Fig. 10 and then the sticks, themselves, are pushed out the window, for a distance of at least nine feet, which is more than a half wavelength away from the building itself, which is copper-covered.

For simplicity of construction, we arranged to use a very light aluminum tube for the upper radiator and a length of copper sash cord for the lower radiator and the matching section. The insulators for supporting the matching section, are permanently fastened to the outside two by two, as is the 8-foot sash cord, which forms the lower half of the antenna. The outside antenna insulator is provided with a suitable length of aluminum tubing, into which the 8-foot section may be slid. This type of antenna has resulted in a very marked increase in our signal strength and because the transmission line used with it is a twisted pair, the reduction in noise is very apparent and its simplicity would seem to suggest that it will become very popular among 5-meter station owners.

## All-Wave Set Modernization Book

● ZEH BOUCK, whose name is known to short-wave fans and hams up and down the land, is the author of a popular new book entitled, "8,000,000 Jobs for the Service Man," this book being sponsored by the Tobe Deutschmann Corp. It gives detailed information on the changes necessary for converting the average broadcast receiver into a modern "all-wave" set. This book also tells how you can make money by modernizing old broadcast receivers, and includes photos, diagrams and methods of getting business, etc. The complete merchandising plan, including Zeh Bouck's book is obtainable at 25c. Ask for book and plan No. 511, Service Department, Short Wave Craft, 99-101 Hudson St., New York City.

# Guaranteed RADIO TUBES at New LOW PRICES!

Complete Stock Ready for Immediate Shipment

Order from this page—Remit 20% with order, balance C. O. D. All prices are F. O. B. FACTORY, Newark. Shipments go forward express or parcel post. No order for less than \$3.00 accepted.

## DEALER'S NET PRICE LIST

Guaranteed for 6 Months Licensed by R.C.A.

METAL SHIELDED TUBES					
Type	Net Price	Type	Net Price	Type	Net Price
6K7	\$ .85	6H6	\$ .73	6E5	\$ .85
6A8	.98	5Z1	.98	2Z5-MG	.85
6J7	.85	6P6	.85	4B-MG	.85
6C5	.73	6L7	.98	Balast Unit	.65

## REGULAR TUBES

Type	Net Price	Type	Net Price	Type	Net Price
00A	\$ .56	46	\$ .44	9X	\$ .41
01A	.26	47	.40	99 8d1	.56
1V	.56	48	1.13	WD11	.56
10	.50	49	.44	WD12	.56
12A	.31	50	1.13	1A6	.56
19	.44	53	.56	1C6	.68
20	.44	55	.44	2A3	.56
22	.56	56	.31	2A5	.44
24A	.40	57	.40	2A6	.41
26	.26	58	.40	2B6	1.13
27	.51	59	.56	2A7	.56
30	.31	71A	.31	2B7	.56
31	.31	75	.44	5Z3	.40
32	.56	76	.31	6A1 (1a)	.56
33	.41	77	.41	6A6	.56
34	.56	78	.44	6A7	.56
37/51	.40	79	.56	6B7	.56
36	.40	80	.26	6C6	.41
37	.31	81	.50	6D6	.40
38	.40	82	.40	6E7	.68
39/14	.40	83	.40	6Z1 (81)	.56
40	.31	83V	.68	12A5	.90
41	.40	81	.56	12A7	.90
42	.44	85	.44	12Z3	.44
43	.41	89	.41	25Z5	.41
45	.31	99V	.41	PZ11	.68

## MAJESTIC TYPE TUBES

Type	Net Price	Type	Net Price	Type	Net Price
2A7S	\$1.01	75R	\$ .77	3-8-51S	\$ .83
2B7S	1.01	6F7S	.86	558	.77
28-4S	1.19	6Y5	.86	568	.59
2Z2-G81	.83	6Z1	.59	578	.79
6A7S	1.01	6Z5	.86	588	.79
6B7S	.95	24S	.59	6E7	.79
6C7	.86	25-25S	1.22	8A8	.77
6D7	.79	27S	.36		

## SPECIAL PURPOSE TUBES

Type	Description	Net Price	Type	Description	Net Price
182B	Sparton type	\$.68	1H1	Raytheon type 125	
183	Sparton type	.68		mill rec.	\$1.13
484	Sparton type	.68	213	Full wave rectifier	.26
485	Sparton type	.68	216B	Half wave rectifier	.90
586	Sparton type	1.13		Neon Tuning Lamps (single contact)	.85
401	Kellogg type	.90		Neon Tuning Lamps (double contact)	.59
403	Kellogg type	1.13	866	Heavy Duty	1.50
686	Sparton type	.68			

## CHARGER BULBS

Type	Net Price
6/10 amp trickle charger bulbs (tungar type)	\$1.65
2 amp charger bulb with wire (tungar type)	1.80
2 amp charger bulb without wire (tungar type)	1.80
5 and 6 amp charger bulbs (tungar type)	3.75
15 amp charger bulbs (tungar type)	7.50

## TELEVISION TUBES, PHOTO ELECTRIC CELLS, CRATER TUBES, CATHODE RAY TUBES

1" sq. cathode television tube	\$2.85
1 1/2" sq. cathode television tube	3.85
1" sq. cathode reflectron window type 50-60 mils.	2.85
Cold cathode crater tube crater size .010 to .250	5.75
Photo electric cells (potassium type) 2 1/2" length overall	1.75
Photo electric cells (potassium type) 4" length overall	5.90
Photo electric cells (caesium type) 3 1/2" length overall	3.90
Photo electric cells (caesium type) 4 1/2" length overall	5.90
Photo electric cells (caesium type) 868 type	3.90

Specifications and quotations on TRANSMITTER TUBES, CRATER TUBES, GLOW LAMPS, HIGH VACUUM TYPE CATHODE RAY TUBES, suitable for television and standard oscillographic uses. SUBMITTED ON REQUEST.

**ARCO TUBE COMPANY**  
227 Central Avenue Newark, N. J.

Please mention SHORT WAVE CRAFT when writing advertisers

## World-Wide S-W Review

(Continued from page 525)

and volume possible to be realized. An unusual feature of this set is the way in which the grid-leak is connected. Instead of returning the grid-leak to the cathode circuit in the usual way, it is connected to the screen-grid, at a high positive potential.

While this gives the required positive bias to the grid circuit, for grid-detection, the bias is unusually high, even though a 5 meg. grid-leak is employed. This method of connecting the detector is an interesting wrinkle for experimentally inclined readers to try. The remainder of the circuit is quite normal, except for the group of power line jacks for 110, 150 and 220 volt lines. A 5-prong plug inserted into one of these jacks changes the circuit for that particular voltage by changing filament connections.

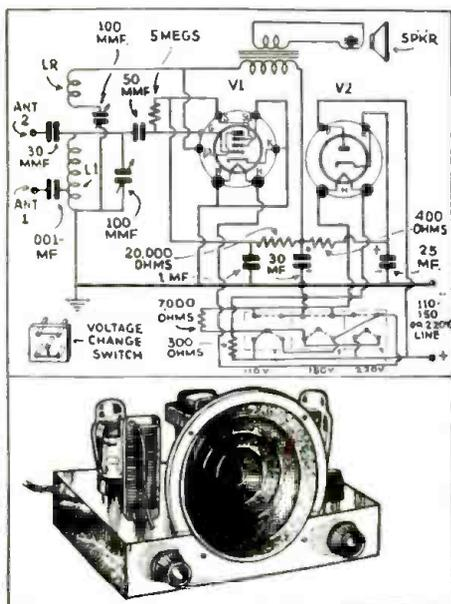

Circuit and appearance of A.C.-D.C. set.

### Call Letters for Your Transmitter Panel

● THE Tri-Dot metal call letters provide distinction to the appearance of your transmitter. As can be seen in the photograph, these letters are heavy, sharp-face Gothic style with a bright metal finish. The overall height is 5"; width, 10½"; width of 5 letters, 8½"; letter height, 1¾", furnished with a drilled bracket for mounting on top of transmitter. A wall model is also made, which is equipped with a chain arranged for convenient hanging. (No. 330.)



Dandy "Call Letter" sign for your panel.

### Correction

Inadvertently, credit was not given to the manufacturers of the earphones shown in the photograph on Page 462 of the December issue of *Short Wave Craft*. This was "The Ham and Fan Band-Spread 2." These phones were the new crystal type manufactured by the Brush Development Company.

# BEST BY TEST IN 5 & 10 METER EQUIPMENT

## Universal 5 & 10 Meter 2 Tube Receiver

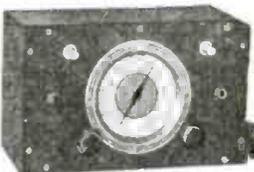

Here again Raco triumphs in introducing a complete A.C.-D.C. operated 5 & 10 meter receiver only. This extremely efficient receiver is recommended to the amateur beginner as well as the professional ham. The super regenerative circuit consists of 1-12A7 Audio & Rectifier 1-76 Detector Tubes. Due to perfect layout and circuit design absolutely no hum is encountered when listening in on the latest dope and signals.

Complete Kit of parts, not wired, **7.95**  
 Wired and Assembled.....\$2.00  
 Crystallized Cabinet.....1.00  
 Kit of 2 Matched tubes.....1.25  
 Wiring diagram with each Kit.

## 3 Tube (Battery Operated) Transceiver



**Raco Presents**  
 This powerful portable unit coupled combination super regenerative Transceiver for the 56 to 60 m.c. This unit is capable of maintaining communication up to 100 miles depending on localities. Tubes used are 1-19 Det. and Class B Oscillator, 1-30 Amplifier, and 1-19 Class B Modulator and Output. Batteries required are 2 No. 6 dry cells and 3-45 volt B Batteries, 1-22½ volt C Battery. The result of years of experience in circuit and layout design have been incorporated in this so-called "Raco".

Complete Kit of parts not wired, less cabinet, tubes and batteries **10.95**  
 Wired and Assembled.....\$3.00  
 Crystallized Cabinet.....1.50  
 Kit of 3 Tubes.....1.65  
 Wiring Diagrams with each Kit.

## All Electric 2 Tube Transceiver



For the ham or beginner looking for a permanent installation, completely A.C. operated, we recommend this 3-in-1 balanced combination transmitter and receiver. The tubes used are 1-8A6 dual purpose and 1-80 rectifier tube. Absolutely humless when working on 5 or ten meter bands. Extremely sensitive, and extraordinary long range tuning and receiving. Range on 5 meters, 25-50 miles on 10 meters, 50-75 miles.

Complete Kit of parts (including both 5 & 10 meter coils). Not wired, less cabinet and tubes **8.95**  
 Wired & Assembled.....\$2.00  
 Black Crystallized Cabinet... 1.50  
 Kit of 2 Tubes... 1.10

## 1 Tube (No. 19 Tube) Transceiver

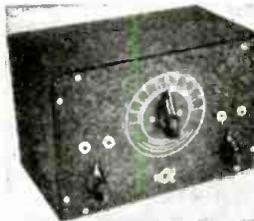

An inexpensive 1 tube 5 and 10 meter transceiver. This extremely efficient transceiver is recommended for the short-wave enthusiast who is interested in exploring the fascinating 5 & 10 meter bands. This circuit utilizes the type 19 two-tube, and is exceedingly sensitive since the super regenerative principle is employed when the receiving position is switched on. Batteries required are two 1½ volt dry cells and 90 to 135 I supply. Tuning ranges are on 5 meters, one to 20 miles, on ten meters, 20 to 50 miles, depending on locality.

Complete Kit with 5 meter coil. Not wired, less cabinet, 10 meter coils, tubes and batteries **\$4.75**  
 Shielded Crystallized Cabinet.....\$.75  
 1-10 meter coil......50  
 1-R. C. A. D. C. matched tube......65  
 Wired and tested..... 1.50  
 Wiring diagrams with each Kit.

Radio Constructors Labs.



136 Liberty St. New York, N.Y. Dept. S-1

## LEARN TO SEND AND RECEIVE CODE



Whether you want to enter radio as a career, or merely add another valuable and fascinating ability to your avocational repertoire, TELEPLEX will help you!

Learn to send and receive code signals. Like operators on ships at sea and at commercial and amateur land stations. Intercept distress signals, news flashes, bulletins, and dozens of other kinds of interesting radio communications. TELEPLEX teaches you to receive code exactly the way the world's best operators do—by sound. Copper tape, running through a machine, operates an automatic key which sends messages to you, at any speed you desire. As you improve in speed, the machine sends faster, gradually preparing you for top-speed amateur and commercial signals. With the MASTER TELEPLEX you learn to send by sending, and the signals you send are repeated back to you, exactly as you sent them, thus enabling you to correct your own errors. We furnish a complete course, lend you the improved MASTER TELEPLEX and give you personal instruction with a MONEY BACK GUARANTEE. Send for our new TELEPLEX FOLDER **SI** today, IT'S FREE!

TELEPLEX CO., 76 Cortlandt St., New York

## Good Results Demand Good Instruments



Model 325 Voltmeter Portable A.C. or D.C.

TRIPLETT manufactures a complete line of electrical instruments for radio, electrical and general industrial purposes both standard and custom built—For better short wave work, write for catalogue.

TRIPLETT ELECTRICAL INSTRUMENT CO. 281 Harmon Drive Bluffton, Ohio



ELECTRICAL INSTRUMENTS

Please mention SHORT WAVE CRAFT when writing advertisers

## A.C.-D.C.-5 BAND-SWITCH—15-550 METER—4-METAL-TUBE RECEIVER



Only RACO can give you such value. No more tuning in coils. No more groping for that elusive coil socket. Easy to tune. All band switching done by the new RACO all wave unit. Covers all broadcast, police, amateur, and foreign short wave bands. The new all metal tubes used are 2-6KT7, the new metal-glass tubes used are 1-MG13 1-MG123Z5 in a perfectly symmetrical layout for high efficiency. The latest in laboratory design—switch coils—metal tubes—built in dynamic speaker—phone jack.

Complete Kit of parts. Not wired, less tubes, including dynamic speaker and crystallized cabinet **\$10.95**  
 Wired and assembled.....\$2.50  
 Kit of 2 All-Metal Tubes and 2 metal-glass tubes.....\$2.35  
 Wiring diagram and instructions with each kit.

RADIO CONSTRUCTORS LABS 136 Liberty St., Dept. 2-1, New York

## Mail us your order for the world's most reliable and accurate Balancing or Grid Condenser

**XL VARIO DENSER in 4 ranges**  
 Mod. N. Cap. 1.2 to 20 MMF.  
 Mod. G1. Cap. 20 to 100 MMF.  
 Mod. G5. Cap. 100 to 500 MMF.  
 Mod. G10. Cap. 500 to 1000 MMF.  
 and the **XL PUSH POST** (best spring type Binding Post)



Mod. N \$1.00 ea. Mod. G \$1.50 ea.  
 No Corrod Navy Type (Brass Base Bak. Top) 28c ea.  
 Type B (Aluminum Base, Bakelite Insulated Top) 15c.  
 Type M (All Aluminum Body) at 10c each.  
 For quick connections and positive contact at all times.  
**X. L. RADIO LABORATORIES**  
 Dept. 5.W.1, 1224 Belmont Ave., Chicago, USA.



**YOU CAN BUILD IT** **9 to 175 Meters** **RADIO "SILVER"** **HIGH-FREQUENCY SUPERHETERODYNE** **AND SAVE MORE THAN 50%**

Join the hundreds of DXers who have already seized this exceptional opportunity to own the most sensational communication receiver of the year—at a tremendous saving!

If you want real proof of what it has done in actual short wave contacts, listen to the W. A. C. Boys sing its praises over the air... and read this letter which is typical of scores that are pouring in from the four corners:

"All contacts, with very few exceptions, have been 100%... all on phone on the 20 meter band... South America, Cuba, Haiti, West Indies, Mexico, Canada, East, West and South coasts of the U. S. have been made within the past three days. The permanent logging band spread works perfectly, and makes schedules easier. The parallel crystal works perfectly in cutting QRM and background noise level is negligible. Have tried receiver on all bands and find it works perfectly, and with more than enough volume on all stations. Foreign broadcast stations come through effortlessly, with beautiful quality. I notice absolutely no image (repeat spots) which is certainly great, after the performance of my former receiver. Congratulations on the perfect engineering design, beautiful appearance and marvellous performance." —Charles F. Grover (W9FJ), Engineer WFD, Police Dept., Chicago Ill.

**START FOR AS LITTLE AS \$7.30 BUY THE PARTS AS YOU BUILD!**

The 32-page "HOW TO BUILD IT" Book (sent for 10c) tells the whole story of this amazing 10-Tube Superhet. You can build and align it in a few hours... or you can buy its standard parts from your local jobber as you build. If you haven't already got many of them.

**SEND 10c** (stamps or coin) **for 32-page Book "HOW TO BUILD IT"**

Address: **R-S MERCHANDISING COMMITTEE** 1711 Roscoe St., Chicago, Ill., U. S. A.

**SPONSORED BY:** Biller Piezo Electric Co., Crowe Name Plate and Mfg. Co., Hammarlund Mfg. Co., Chicago Trans-former Corp., Vastley Div. of F. R. Mallory Co., Jensen Radio Mfg. Co., Sprague Products Co., Continental Carbon Co., Ghmit Mfg. Co., Readrite Meter Works, Raytheon Production Corp., Alladin Radio Industries, Inc., Steri Box & Display Corp., Filtermatic Mfg. Co., McMurdo Silver Corp.

**YOUR RADIO WITHOUT A HEADPHONE ATTACHMENT**

frequently becomes a nuisance because it keeps the family and neighbors awake. You can easily correct this condition by using

**CANNONBALL HEADSETS**

The favorite set of "Hams!"

The phones are built with very heavy bar magnets which greatly increase their efficiency.

Write for illustrated circular S-1

**C. F. CANNON COMPANY** SPRINGWATER, N.Y.

**INSTRUCTOGRAPH THE PRACTICAL CODE TEACHER**

To learn the code or increase speed, you want to study the most practical way. With the Instructograph, you can study more easily than at a school or by listening to Short Wave. You can practice when and where you like—regardless of schedules or interference. Book of Instructions, showing how to study to best advantage, comes with each Instructograph sold or rented. Write today for free folder and price list.



**INSTRUCTOGRAPH COMPANY, Dept. SW-1** 912 Lakeside Place, Chicago, Ill. Representatives for Canada: Radio College of Canada, Ltd., 863 Bay St. Toronto

**RADIO COURSES**

**RADIO OPERATING:** Prepare for Gov't License Exam. ● **RADIO SERVICING:** Including Short Wave ● **AMATEUR CODE** ● New Course in **ELECTRONICS:** Day and Evening Classes.

Booklet Upon Request

**NEW YORK YMCA SCHOOLS** 4 W. 64th St. N. Y. City

**It's a Cinch to Try Out the New Circuits**

(Continued from page 531)

course, is at the option of the builder; while the experimenter is naturally expected to use what he has on hand, experimental apparatus is usually of a high degree of perfection. In hooking up circuits, stranded wire is a nuisance, due to its becoming frayed, and I find the handiest possible wire to use is solid "push-back". So much for that part of it.

No technical drawing of connections is possible, as this would involve a specific tube, but a picture-drawing is given, along with a detailed explanation to follow, so no slip-up should occur in wiring.

The four and five six-prong sockets are marked, but the seven-prong socket bears no marking at all. But examination of the socket will show you that there are two holes in one end, larger than the rest. By turning the socket over, and locating the two terminals directly connected with these two holes, which are the HEATER connections, you will be able, by following the directions given here, to mark the other terminals so as to be able to wire it into the unit. In order to make the wiring easier, all three sockets are shown in Fig. 2. These drawings show the TOPS of the sockets—and the following explanation applies to the BOTTOMS of the sockets, as, of course, the wiring is done from the bottom.

Turning the seven-prong socket over, as above, you will "read" from left to right, or clock-wise. The first terminal immediately to the left of the left heater prong is the plate, and following towards the right in immediate sequence are: Suppressor grid, Control grid, Screen grid and Cathode.

There are on the five-six prong socket two unmarked terminals. One of these, to the immediate right of the plate terminal, is the screen-grid, and the other, immediately adjacent to the Grid, is the Suppressor Grid. The four-prong socket is plainly marked, and with the aid of Fig. 2, no difficulty in wiring should be met with.

Assuming that the sockets and binding posts have all been properly mounted, and the correct terminals located, the actual wiring may now be done. The first wire to be laid is the control grid cap, from the tip jack in the center to binding post number 5. This is a direct and straight connection. Binding posts 4 and 6 are connected to the filament-heater prongs, all wires in parallel. Binding post number 9 connected to the three plates. Number 2 terminates the two suppressors. Number 1, connected to the three control-grid terminals, marked "G", serves as grid connection, as well as screen-grid for 24's, 30's, etc. No. 3 is soldered to the "K" (Cathode) prongs of the two sockets bearing such markings. The pentode screens, on the six and seven-prong sockets, are connected to binding post No. 7. Number 8 may be connected to Number 3, to serve as a double connection for resistor and condenser individual connection, or to number 9, to give double connection to the plate circuits. In the event that double posts are used, and such is highly recommended, only eight in all will be necessary for this one unit.

Wiring of the coil unit is practically identical with that of the forementioned, except that three binding posts are omitted, as there is no control grid cap to be considered, nor any seven-prong sockets. Binding post No. 1 goes to one side of the heater and filament circuit, the side adjacent to its corresponding post, and the opposite side of the heater circuit goes to No. 4. No. 2 is connected to the grid terminals, and the suppressor grid terminal of the five-six-prong socket, which is the terminal immediately adjacent to the grid prong, is also connected to this post. Post No. 3 goes to "K" on the five-prong socket; post No. 5 to the two plate terminals; and No. 6 connects with the screen-grid terminal. Double posts here would be especially beneficial. You now have two units which, with a few

**MOTOR DRIVEN Craftsman Tools COMPLETE—READY TO RUN**

**ELECTRIC HANDY-LATHE**

PRICE

**\$757**



Ship. weight 10 lbs.

**WITH BUILT-IN MOTOR**

Length of Bed, 15 inches; height to spindle, 2 inches, is supplied with face plate as well as spur center for handling all types of work. This lathe is furnished with a built-in Induction Motor, mounted on the head-stock, so that the drive wheel acts directly on the three-speed pulley. **NO BELT REQUIRED.** In shifting to the various speeds it is only necessary to lift the motor with the left hand and slide it forward or back as desired. A finger-tip switch is located conveniently on top of the motor. Finished in gray and green enamel and comes complete with motor, cord and plug cap, and special wrench. Operates on alternating current only, 110 volts, 60 cycles.

**ELECTRIC GRINDER**

PRICE

**\$349**



Ship. weight 4 lbs.

Comes supplied with 2 genuine Aloxite grinding wheels, one coarse grinder, and one fine grinder. It is driven with a

dependable induction type high speed inner fan cooled motor with the grinding wheels mounted at opposite ends of the motor shaft. This motor does not interfere with radio reception, and has a heavy ground steel shaft and large bronze bearings, having thick felt oil-retaining washers behind them, constantly lubricating the shaft and bearings and provided with oil holes for re-oiling. Complete with cord and plug cap. Operates on alternating current only, 110 volts, 60 cycles.

**ELECTRIC SCROLL AND JIG SAW**

PRICE

**\$469**

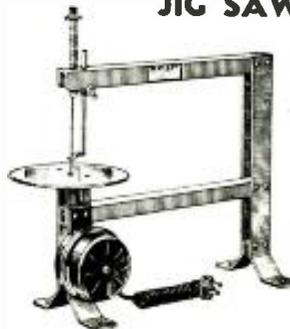

Ship. weight 10 lbs.

This is an entirely new type of saw, powered by a fan-cooled, induction motor geared directly to saw blade for maximum power.

Blade stroke 3/4". Made of channeled steel, has 12" throat that handles work up to 24" long, 6 1/2" round work table, adjustable hold down shoe with guide roller to support and steady saw blade. Cord, plug and 1 blade included. Built-in motor operates on alternating current only, 110 volts, 60 cycles.

**Our Old Customers Know That Our Merchandise Is Sold on a Strict Money-Back Guarantee**

All Shipments will be forwarded by Express Collect if not sufficient postage included with your order.

**WELLWORTH TRADING CO.** 506 Palmolive Bldg., Dept. S. W. 136, Chicago, Ill.

Please mention SHORT WAVE CRAFT when writing advertisers

fixed condensers and resistors, a tuning condenser or two, scrap panels and a couple of potentiometers, along with some good wire, will enable you to experiment with any R.F. or A.F. amplifier, detector, wavemeter, frequency meter or rectifier making use of, either singly or in combination, any coil, condenser or tube. All of the technical points of construction of the actual units have been given due consideration, and I believe I have made everything clear. The business-like appearance of the aluminum shelves as shown in the photos may be duplicated by yourself, or do as I did—turn it over to the wife. Due credit should here be given to her for her good work with a pencil eraser, in giving it the much desired "whorl", or chased, effect, and with a scribe in scratching in the "V". The whole unit, minus the sockets, was given a coat of clear lacquer, to prevent marring and fingerprinting.

You will find in Fig 4 the circuits of two "time-tried and true" one-tube receiving sets. The numbers of the binding posts are given on coils, and tubes, and the values of external parts are marked, so no confusion will arise. These two sets will give you an idea as to how the unit is used.

**Parts List**

- 1 Piece Aluminum 4 3/4 x 9.
- 1 piece Aluminum 6 1/2 x 3 1/2.
- 1 piece Bakelite 1 x 6.
- 1 piece Bakelite 1 x 3 1/2.
- 15 Old style Metal Binding Posts.
- 2 I.X. (four-prong) Sockets.
- 2 "Universal" 5-6 prong Sockets.
- 1 "Universal" Short and Long Prong Socket.
- 1 Insulated Tip Jack for Grid Cap Lead.
- Mounting Screws, Wire, etc.

**Talking On One-Half Meter**

(Continued from page 527)

to the oscillator. The plate current of the oscillator should not be allowed to exceed 5 milliamperes. Remember these 955 Acorn tubes are not 210's! Don't try to light flashlight bulbs with the output. When the antenna is connected to the oscillator there should be only the slightest sign of increase in the plate current. If the coupling is too close, the tube will stop oscillating and the plate current will rise to a value far too high and the plate of the tube will become red hot. *This condition should be carefully avoided!*

**Antenna Details**

The antenna used in experiments was a single wire as shown in the photo; this proved to work very fine. The feeder was a single wire tapped on to the antenna slightly "off center"; for complete details see the antenna table. Probably the most interesting part of this *ultra* short-wave business is the *antenna*. Many types of directional antennas may be used. With a sharply concentrated beam antenna, this transmitter and receiver covered distances up to over one-half mile. And under favorable conditions communication probably could be held over even greater distances. For best results the receiving and transmitting antennas should be identical.

This apparatus has been operated successfully and affords an opportunity for the experimenter to build and operate a really practical transmitter and receiver operating between one-half and one meter.

**Antenna Data**

Antenna length	Tapped off center
1 meter, 20 inches	2.8 inches
3/4 meter, 15 inches	2.1 inches
1/2 meter, 10 inches	1.4 inches

**New Sets for the S-W "Fan."**

In the next and following issues new receivers for general S-W "broadcast" reception will be described, with full "constructional" details.

FOR BETTER RADIO

*Use*

**Hammarlund**

**I.F. TRANSFORMERS**  
AIR-TUNED • VARIABLE COUPLING



- 1** CONTINUOUS VARIATION OF BAND WIDTH — EXTREME SELECTIVITY TO HIGH FIDELITY
- 2** PANEL OR INDIVIDUAL CONTROL — POSITIVE COIL SPRING ACTION
- 3** IMPREGNATED THREE PIE LITZ COILS • ISOLANTITE CORES — HIGH GAIN
- 4** FOR ANY I.F. AMPLIFIER WITH SCREEN GRID TUBES — 175 AND 465 KC TYPES
- 5** ONLY 2" x 2" x 5"
- 6** GUARANTEED STABILITY



Write Dept. SW.1 for FREE NEW CATALOG of Condensers, Transformers, Chokes, Sockets, Coils and technical data on receiving and transmitting equipment. Attach 10c for New 32-page Manual of most popular Short-Wave Receivers, with illustrations, diagrams and parts lists.

**Hammarlund Manufacturing Co.**  
424-438 W. 33rd St., New York

**Attention—**

**Amateurs and Radio Experimenters!**



At last the dream of thousands has been realized. W.2-C.V.E. Experimental Laboratory is introducing to the radio amateur fraternity a new plug-in coil known as the *Uno All-Wave Coil*.

This unit alone will take the place of all the necessary coils required to cover the entire amateur bands. No switches, no soldering, and no alteration to your present receiver is required to adapt this unit. It is plugged-in, in the ordinary way, and by turning the dial it is equipped with, you are ready to tune in, any particular frequency required. The *Uno All-Wave Coil* will permit you to monitor your signals, or to work duplex, by listening in to the second harmonic of your transmission; it will also enable you to listen in to commercial stations and broadcasting abroad. All the tuning is done with your own tuning condenser in your set, while the unit will furnish the frequency required for each set of the tuning knob.

It is also provided with padding condensers to make up for any minor off-balance from time to time, and is available with 4, 5, or 6 prongs. It has many advantages over the ordinary plug-in coils now on the market, for economy and efficiency, and above all is available for Super-het with 465 K.C. intermediate. **\$10.00**

Watch following issues for list of distributing houses.  
**UNO ALL-WAVE COIL CO.**  
11 Mollineux Place Dept. S-1 Roosevelt, N. Y., U. S. A.

**IDEAL! The FIRST FULLY SEALED AND INSULATED RESISTORS**

IRC INSULATED Resistors bring you EVERY advantage of the famous Metallized resistance principle PLUS full, high voltage insulation. No danger of shorts or opens. Smaller—lighter—vibration-proof — moisture-proof — BOTH color coded AND marked with range and value. Featured by leading jobbers.

**International Resistance Co.**  
Philadelphia, Pa. — Toronto, Canada

*Metallized IRC INSULATED*

**MONEY CAN BUY THE BEST CONDENSERS**

**PAPER ELECTROLYTIC OIL**

Write for general catalog No. 128 on complete line today.

**CORNELL-DUBILIER CORPORATION**  
4376 BRONX BOULEVARD  
NEW YORK

*The Cream of Radio Books*

**Principles of Radio**

By KEITH HENNEY

Considered "the best combination of theory and application for all radio experimenters that has yet appeared."

Second Edition, \$3.50

**Short Wave Wireless Communication**

By A. W. LADNER and C. R. STONER

A self-contained treatise, not restricted to short waves alone, but including wherever necessary principles common both to short and long waves.

Second Edition, \$3.75

**Elements of Radio Communication**

By the late JOHN H. MORECROFT

"The whole story of radio, simply as well as accurately treated."

Second Edition, \$3.00

**ON APPROVAL COUPON**

John Wiley & Sons, Inc.  
440 Fourth Ave., New York City

Kindly send me the following books. I agree to return their price within 10 days after their receipt or return the books postpaid.

Henney     Ladner-Stoner     Morecroft

Name .....

Address .....

Employed by.....SWC-36

**The SENSATION of the Short Wave Field the 1936 SUPER SKYRIDER**

- All Metal Tubes
- Iron Core I.F.'s
- Controlled Crystal Filter
- Duo - Micro Band Spread

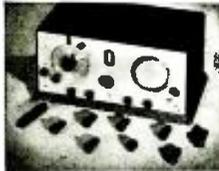

WRITE FOR FULL DETAILS

**the Hallicrafters**  
3001-U Southport Ave., Chicago

**DON'T READ THIS IF YOU ARE A MILLIONAIRE**

HUNDREDS OF AMATEURS AND SHORT WAVE LISTENERS ARE PURCHASING ON OUR

**EASY PAYMENT PLAN**

WE ARE MAKING IMMEDIATE DELIVERY ON NATIONAL—HAMMARLUND PATTERSON—RCA—BREITUNG SKYRIDER—RME—SILVER AND OTHER CUSTOM BUILT RECEIVERS

DOWN PAYMENTS AS LOW AS \$15.00

SEND 5c FOR COMPLETE DETAILS

**DELAWARE RADIO SALES CO.**

403 DELAWARE AVE., WILMINGTON, DEL.

ATTN.: WILLARD WILSON-W3DQ EST. 1920

**Be a TELEVISION EXPERT**

LEARN TELEVISION WITH RADIO NOW!

Here's opportunity! Get ready for the best paid jobs in Radio as Television sweeps the country. Train at big-time broadcasting station. Get actual experience over our Television Station W9XAL and commercial station W9XBY. Write today for free folder and literature showing actual photos of Television broadcasting, opportunities, etc.

**FIRST NATIONAL TELEVISION, INC.**  
Dept. B-1, Power & Light Bldg., Kansas City, Mo.

**How Waves Are Propagated**

(Continued from page 520)

used, the multiple-dipole transmits equally well along an axis at right angles to the point of the array, i.e., it transmits in front of and behind the array, as shown by the full line and dotted arrows in Fig. 4.

Fig. 5 shows one of the simplest reflector-antenna arrays which utilizes one aerial wire or rod and one similar size reflector rod, spaced one-fourth wavelength behind it. The radiation is shown for this simple reflector type. Fig. 6 shows how greater directional activity is obtained by using an aerial array of four wires or rods, using a reflector system spaced one-fourth wavelength behind it. The individual rods or wires comprising the antenna are spaced one-half wavelength apart, as shown in the diagram. As the wave pattern in Fig. 6 shows, most of the energy is concentrated in the elongated lobe and only a small fraction of the total energy radiated from this highly directive antenna is wasted in the four auxiliary lobes, as shown. By using various arrangements of the aerial and reflector arrays, and by suitably phasing or staggering the phased relation of the currents in the antennas and the reflectors also, or by spacing them in suitably spaced groups, as shown in a paper prepared by G. C. Southworth of the American Telephone & Telegraph Co., the predominating lobe or directive wave pattern may be caused to become much sharper. In other words, by using this principle, antenna patterns can be arranged so that the wave may be sharply beamed or directed toward Europe, etc.

Fig. 7 shows one form of directive aerial in which a doublet is placed at the focus of a parabolic reflector made from a series of wires or rods held in an insulated frame made in the shape of a parabola. The direction of the concentrated beam or wave is indicated in Fig. 7.

The inverted "L" aerial and the peculiar vertical wave pattern around a transmitting aerial of this type are shown in Fig. 8.

It should be mentioned at this point, perhaps, that very little of the wave energy penetrates into the ground and the more conducting the ground happens to be, the more it acts like a true reflector. The horizontal radiation pattern for the inverted "L" aerial is also shown in Fig. 8.

(To be concluded)

**Noise-Reducing Aerial**

(Continued from page 533)

tenna System here illustrated the switch serves to throw into the circuit, in the same way that a wave change switch on a short-wave receiver would do, another section of the set transformer which is matched for short waves.

The length of transmission line between the antenna transformer and the set transformer is not critical and can be extended up to 300 feet without loss of efficiency and without noise pick-up.

The antenna should be as high as possible. If it is feasible to run the antenna from the end of the building out to a pole or tree beyond, such an arrangement would be more desirable than having the antenna run over the roof of the building, because of the greater effective height. The full length of the antenna should be employed whenever possible, and best reception in all cases will result. If the distance between the two supports is greater than 60 feet, the 60-foot antenna should be used with insulators at each end and a length of regular antenna wire or guy wire employed to make up the additional distance required. In no case should either the 17-foot section or the 43-foot section be increased in length. If it is impossible to install the entire 60 feet of antenna, the reduction in length should be made from the 43-foot section and not the 17-foot section.

Best reception is obtained when the lead-in does not exceed 150 feet.

**DATAPRINTS**

Just the CONSTRUCTION

Information

You Need

To Build

Electrical

Apparatus

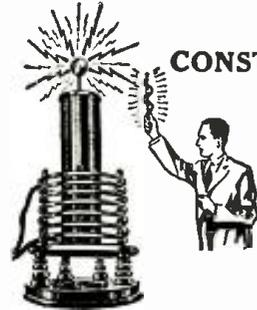

**TESLA OR OUDIN COILS**

Dataprint containing data for constructing this 3 ft. spark Oudin-Tesla coil. Requires 1 K.W. 20,000 volt transformer as "exciter"; see list below. Includes condenser data. . . . \$ .75

- 8 inch spark, data for building, including condenser data; requires 1/2 K. W. 15,000 volt transformer; see list below. . . . . 0.50
- Violetta type, high frequency coil data; 110 volt A.C. or D.C. type; 1" spark; used for "violet ray" treatments and "Experiments". . . . . 0.50
- How to operate Oudin coil from a vacuum tube oscillator . . . . . 0.50
- 3 inch spark Tesla coil; operates on Ford ignition coil . . . . . 0.50
- 3 inch spark Oudin coil; 110 volt A.C. "Kick-Coll" . . . . . 0.50
- 20 Tricks with Tesla and Oudin Coils . . . . . 0.50

**TRANSFORMER DATA**

- 1 k.w. 20,000-volt transformer data, 110-volt, 60-cycle primary. Suitable for operating 3 ft. Oudin coil . . . . . 0.50
- 1/2 k.w. 15,000-volt transformer data, 110-volt, 60-cycle primary. Suitable for operating 8-inch Oudin coil . . . . . 0.50
- Electric Welding Transf. (2 K.W. 110 Vt. Prim. 18 Vt. Sec. Other Sec. Vt. data given) . . . . . 0.50
- Induction Coils—1 to 12 inch spark data . . . . . 0.50
- ARTIFICIAL FEVER Apparatus . . . . . 0.75

(Low, Medium & High Power Data Given)

**SLIDE RULE**

MIDGET

Metal 4" Dia. Price \$1.50.

Case 50c extra



This rule solves any problem in multiplication, division, addition, subtraction, and proportion; it also gives roots and powers of numbers, sines, cosines, tangents and cotangents of all angles; also logs of numbers. Adds and subtracts fractions. Approved by colleges.

10" Dia. 27" Scale "Special" Rule. \$2.75. Multiplies and Divides, but has no "Trig" Scales.

**TELEPHONE** — Records Voice or "Code" signals on steel wire by magnetic. Code can be recorded "fast" and translated "slow." Construction data (special) . . . . . \$0.50

**MAGNET COIL DATA**

- Powerful battery electro-magnet; lifts 40 lbs. . . . . 0.50
- 110 Volt D.C. magnet to lift 25 lbs. . . . . 0.50
- 110 Volt D.C. 300 lb. Lift electromagnet . . . . . 0.50
- 110 Volt D.C. solenoid; lifts 2 lb. through 1 in. . . . . 0.50
- 110 Volt D.C. solenoid; lifts 6 lb. through 1 in. . . . . 0.50
- 12 Volt D.C. solenoid; lifts 2 lb. through 1 in. . . . . 0.50
- A. C. Solenoid, powerful, 110-volt, 60-cycle . . . . . 0.50
- MOTOR—1/16 H.P., 110 volt A.C., 60 cycle (suitable for driving 12" fan, etc.)—Data . . . . . 0.50
- 60 or 1,200 cycle Synchronous motor Data . . . . . 0.50

**MISCELLANEOUS DATAPRINTS**

- Electric Furnace Regulator . . . . . \$0.50
- Treasure Locator . . . . . 0.50
- Water Turbines . . . . . 0.50
- 20 motor circuits—book-ups . . . . . 0.35
- 20 practical telephone hook-ups . . . . . 0.35
- 100 mechanical movements for inventors . . . . . 0.50
- Polarized Relay—Ultra Sensitive . . . . . 0.50
- Electro-medical coil (shocking coil) . . . . . 0.50
- Water Wheels—How to Build and Light your house . . . . . 0.50
- 20 Electric Bell circuits . . . . . 0.50
- Public Address System . . . . . 0.50
- Electric chime ringer; sets any clock . . . . . 0.50

20 "Electrical Tricks" for LODGES and PARTIES . . . . . \$0.50

How to Fry Eggs on Cake of Ice Electrically. \$0.50  
"Rewinding" Small Motor Armatures . . . . . 0.50

"ENGINEERING SERVICE BY MAIL"  
(20% off on orders for \$3.00 or more. No C.O.D.)

**The DATAPRINT COMPANY**  
Lock Box 322 RAMSEY, N. J.

## Solar Phenomena and Their Effects on S-W's

(Continued from page 519)

been seen on the sun. This may account for the fact that *invisible* sunspots and activity surrounding them may be causing the strong terrestrial effect, the spots themselves being hidden underneath clouds of hydrogen and calcium gases, which in themselves are also a manifestation of solar activity. These clouds are called flocculi, and some of them are prominent in an eruptive state. During periods when disturbed radio conditions obtained and where it was possible to observe the sun through a device called the spectrohelioscope, these flocculi were always in evidence.

The sunspots move across the surface of the sun by virtue of its rotation, as pointed out by Mr. Richey, and in some of his research work, as well as that made by many astronomers, successive photos have been taken, showing the movement of a spot or a group of spots across the surface of the sun as it rotates. As mentioned previously, a strong sunspot disturbance, which resembles a veritable whirlpool of incandescent gases in the sun's surface, causes streamers to be shot forth from the sun in the region surrounding these sunspots, some of the streamers extending more than a million miles in length, as recorded by the camera. These streamers can be likened to the jets of water caused by a revolving lawn spray, and it will be seen that as the sun rotates, and providing the streamers are pointed at the right angle to intercept the earth, the earth will be swept by one of these streamers and the speed of the sun's rotation is such that the streamer, would sweep across the earth's disc in about thirty seconds.

Sunspots, in many cases, last for only a day or two, but every once in a while one will persist as long as two hundred days. In one case, in 1840-41, one lasted eighteen months. To see a sunspot with the naked eye, it must measure approximately thirty thousand miles across, and the largest sunspot ever recorded, measured one hundred and fifty thousand miles in breadth. The birth of a sunspot is generally preceded and accompanied by eruptive prominences composed mostly of sheets of hydrogen and calcium flames, extending up to high altitudes, ranging from a few thousand to millions of miles. These activities apparently give rise to streams of electrified gas particles which are shot off from the sunspot region and are expelled or driven away from the sun by the pressure of light radiation. Calculations and observations of the commencement of magnetic storms with the incidence of the passage of spots across a vertical line in the center at the sun show that these streams of electrified particles may reach an average velocity of about one thousand miles per second. In other words, in about twenty-six hours such a stream of particles could traverse the ninety-three million miles, separating the earth and sun.

So far as the effect of the sunspots on short-wave transmission is concerned, these seem to recur on about a twenty-seven-day cycle. Recently solar activity of this nature has been noticed to be on the increase. The effect or presence of severe magnetic storms on the earth have been noted for many years, and the conclusion that practically all magnetic storms are caused by some change in solar activity or the presence of sunspots has been believed for some time. Even though the spot or spots are not always visible, due to being hidden under clouds of incandescent gases, still the effect and relation between them and magnetic storms, is quite positive and measurable.

With regard to the effect of streams of electrified particles radiated by the sun, and in addition to its effect on the earth's magnetic field as it sweeps across the earth, it also appears to increase the ionization of the "E" layer in the ionosphere and decreases the ionization in the "F" layers. It apparently raises the temperature of the gases at great heights, which increases the

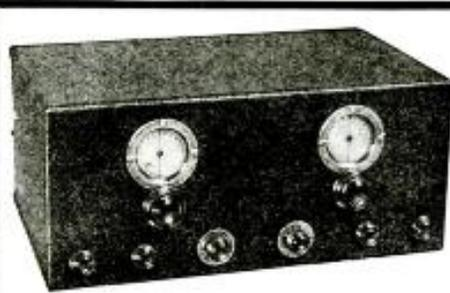

**Sargent Model 20**  
9 Tube Receiver

- One Stage Pre-Selection
- A.V.C. and Manual Volume Control
- Continuous Band Spread, Calibrated for Amateur Bands
- Coil Switching—No Plug-in Coils
- Built-in, Hum-free Power Supply
- Headphone Jack
- Excellent Broadcast Band Reception
- Ideal for Shipboard Work
- Razor-edge Selectivity
- Fractional Microvolt Sensitivity
- Outperforms Receivers selling for 3 times its price.

## Radio Operators, Amateurs — Look at This One!

15 to 1500 Meters  
Not a "Skip Band" Receiver

### MARINE TUNING RANGE

A true Communication-type super-het that covers all of the wavelengths that you really want. Has all of the popular short wave features such as band spread, beat oscillator, etc., that are absolutely necessary to efficient short wave reception. In addition it covers the ship telegraph wavelengths as they should be covered. The tuning band of the receiver, 510 to 1500 meters, is beaked near 600 meters, giving the highest efficiency possible. This receiver also covers the 800 meter compass wave and the airplane beacons from 900 to 1500 meters.

Due to special design of our coil unit, this extension of wave coverage is obtained without any reduced efficiency at short waves, and if we were to design the set for short waves only, we could not improve it. For those not wanting the ship telegraph wavelengths, this same receiver is also put out with a tuning range of 15-550 meters.

Model 20 prices given below include an 8" Jensen speaker unit and a complete set of tubes. For speaker cabinet, finished to match receiver add \$3.25 net to these prices.

This will be the outstanding receiver of the 1936 season. ORDER YOURS TODAY.

### Amateur Net Prices

Model 20-MA, 15-1500 Meters, complete,	\$67.50
less speaker cabinet	
Model 20-SA, 15-550 Meters, complete,	\$59.50
less speaker cabinet	

### IMMEDIATE DELIVERY

**E. M. SARGENT CO.**

212 Ninth St. Dept. 5 Oakland, Calif.

## Good News!

Your order for the Patterson PR-16 shipped promptly \$95.70 complete or with crystal filter \$101.70. Shipped prepaid on ten day trial. You need send but \$5 with order. Write for full information.

### IN STOCK too:

SUPER-SEVENS complete prepaid	\$ 49.50
METAL TUBE SUPER SKYRIDERS complete prepaid	79.50
SILVER 5Ds complete prepaid	109.80
BREITING 12s complete prepaid	93.00
RCA ACR-136s complete	69.50
RME-69s	118.80
HROs	167.70

All receivers shipped on ten day trial. You can trade in your receiver or buy on time payments.

### HENRY RADIO SHOP

211-215 North Main St. Butler, Missouri



**You cannot make a better investment than to have in your home a GOLD SHIELD PROFESSIONAL MODEL Carbon Sun Lamp SAVES DOCTOR'S BILLS**

Everyone in your family needs the health giving VIOLET RAYS. This is a large CHROMIUM plated lamp using standard carbons, emitting rays of ultra violet and infra red.

If SUN TAN is desired, order accordingly. CURES COLDS, RHEUMATISM AND MANY OTHER AILMENTS.

Complete with screen and goggles... **\$7.50**

**WONDERFUL VALUE!**  
GOLD SHIELD PRODUCTS CO.,  
17 W. 60th St. N. Y. City

## SEND FOR THE LATEST

and complete authorized information on testing the new Octal Metal tubes, the new Octal analyzer plug with Dual grid cap and 9 wire endle, plug and socket and associate adapter, the new Octal sockets, the new Octal grid clips, etc.

NOW the new "Tuning Fork" clip is available in every type of socket including the new Octal types. Life tests are now approaching 2,000,000 perfect contacts without failure.

**ALDEN PRODUCTS CO.**  
Dept. SW-1 715 Centre St.  
BROCKTON, MASS.

## BLAN CHASSIS

Have you noticed BLAN equipment mentioned in various radio magazine articles lately? Most of the leading authors and research engineers use BLAN parts, because BLAN is dependable and can furnish anything from a setscrew to a speaker.

**BLAN THE RADIO MAN**  
175 GREENWICH ST. NEW YORK, N.Y.



## BUD TUNING DIALS

For EVERY Amateur Purpose

A large moulded bakelite fluted knob with skirt mounted on a nickel silver dial plate with circular finish. Numerals and divisions etched in black enamel. Made in clockwise and counter clockwise rotation.

No. 711—1 1/2" Dia. 0-100 in 180°	Price \$1.00
No. 712—1 3/4" Dia. 100-0 in 180°	Price \$1.00
No. 713—2" Dia. 0-100 in 180°	Price \$1.25
No. 714—2 1/4" Dia. 100-0 in 180°	Price \$1.25
No. 715—3" Dia. 0-100 in 180°	Price \$1.75
No. 716—4" Dia. 100-0 in 180°	Price \$1.75

**40% DISCOUNT TO AMATEURS**

NEW 1936 Catalog describing numerous new items for the amateur user sent to you upon receipt of 3c postage stamp.

## BUD RADIO, Inc.

1937 E. 55th St., Cleveland, Ohio



## Brush Type A' Phones

meet every headphone requirement. Response 60 to 19,000 cycles. Brush phones operate from any normal source... give greater volume from weak signals. No magnets to cause diaphragm chatter. Will handle excessive volume without overloading. Specially designed cases minimize breakage. Weight... 6 ounces. Now available at the new low price... only \$9.00 list.

Data Sheet No. 10 gives full headphone information and circuit diagrams. Free on request. Send for your copy today.

## The BRUSH DEVELOPMENT COMPANY

1887 E. 60th St. CLEVELAND, O.

MICROPHONES • WIRE STANDS • TUBES • HEAD PHONES • LOUD SPEAKERS

**ELECTRICAL BOOKS**  
shipped  
**FREE**

**10**  
BIG BOOKS

**A-C-RADIO TELEVISION**  
EVERY ELECTRICAL SUBJECT COVERED

Here's great news for anybody interested in Electricity. BRAND NEW edition of Applied Electricity brought right down to date with every NEW Electrical subject fully covered. 10 big Volumes and all shipped FREE for examination. See special offer below.

**For Beginners and Experts**

Over 3000 pages—hundreds of illustrations—the most complete work of its kind ever published. Dynamos, motors, power stations, radio, television, everything electrical explained clearly so anyone can understand them.

**BIG FIELD! Big Demand! Big Pay!** Men who understand electricity are urgently needed right now in thousands of industries. Autos, airplanes, machine shops—practically every industry depends on electricity and men who know this subject make big money. Pleasant, fascinating work, easy to learn and do. Send coupon for a set of these books for FREE examination.

**FREE** S. Gerzaback's famous Radio Encyclopedia (latest edition) given free with these electrical books if you send NOW. Invaluable in any Radio work. Covers whole Radio field.

American Technical Society, Drexel at 58th St., Dept. E 145, Chicago

Send for 10 days' free use. BRAND NEW 10 volume set of Electrical Engineering. Include free membership in the American Technical Society and S. Gerzaback's Encyclopedia. I will pay the few cents delivery charge on the books. If I wish I may return them in 10 days and owe you nothing, but if I keep them I will send \$2.00 after 10 days, then \$3.00 a month until the special price of only \$29.50 is paid.

Name.....  
Address.....  
City..... State.....

Attach letter stating age, occupation and name and address of employer and at least one business man as reference.

**Newark's ★★★ Program**

Deferred Payment plan on all Short-Wave sets. Write for Catalog No. 101.

★★★ THORDARSON No. T6878 Plate and Fil. Transformer, 600-0-600 V. at 200 M. A. 2 1/2 V. at 10 amp., 5 V. at 3 amp., 7 1/2 V. at 3 amp. \$2.45

★★★ THORDARSON No. T6877 Heavy Duty choke. 15 henries at 250 M. A. \$1.95

★★★ THORDARSON No. T1998B Choke. 18 henries at 200 M. A. 190 Ohms—2200 Volt insulation \$1.25

★★★ NEWARK Oil filled—Oil impregnated Filter Condensers.

2 mfd. 2000 V. DC \$1.50  
4 mfd. 2000 V. DC \$2.25  
8 mfd. 2000 V. DC \$2.75  
9 mfd. 3000 V. DC \$7.25

★★★ NEW LOW PRICES ON RCA TUBES

852 \$16.40 866 \$2.25

**NEWARK ELECTRIC COMPANY**  
"Faster Service—Better Bargains"  
226 W. Madison St. Dept. S, Chicago, Ill.

**A NEW BOOK—Second Edition of FUNDAMENTALS OF RADIO**  
(426 pages 6"x9", 430 figures)

By Professor R. R. RAMSEY, Ind. Univ.  
Revised, enlarged, repaged, reprinted, New cover.

New subjects Multi-electrode Tubes; A, B and C amplifiers; and Cathode Ray Television. Radio theory and practice brought up to May 1935. Problems and questions on each chapter. It still can be said that "Ramsey manages to provide that missing fact which seems to be hidden in other books." Everything new and enlarged but the price. You cannot afford to miss this book.

**EXPERIMENTAL RADIO**

By the same author. You have heard of the original radio manual of experiments. Get it. Prices: Fundamentals \$3.50; Experimental \$2.75 post paid.

Your check, postal order or C.O.D. brings 'em  
**RAMSEY PUBLISHING CO.** Bloomington, Indiana

**Low Prices On Short Wave Parts**

4-prong S.W. Coils 12 to 180 meters, 4 coils to set..... \$ 98  
6-prong S.W. Coils 12 to 180 meters, 4 coils to set..... 1.19  
2 1/2 m. H. P. Choke, 4 pies wound on ceramic piston form..... .49  
Pilot 30 hys. 45 mls. bakelite cased filter chokes..... .29  
P. P. Input by P. P. Output 47" transformers, each..... .45  
Grossing-Victor Power Transformer—Model R-32..... 1.00  
8 mfd Elec condensers—cardboard—450 V.W. Guaranteed..... .29

Write for bargain bulletin. Distributors of all nationally known radio parts and test equipment for amateur and serviceman. No order too small to ship. We ship to all parts of the world.

**M. SCHWARTZ & SON**  
710-712 Broadway Schenectady, N. Y.

collision frequency and serves to reduce the ionic density. Layer height measurements point to great turbulence existing at these heights. The increase in the ionization of the "E" layer apparently increases the daylight intensity of the long waves, while the general turbulence and reduced ionization, together with increased collisions in the "F" layers, probably explains the increase in attenuation of the short waves, as pointed out by Mr. Richey.

One of the most interesting and valuable observations about sunspot activity is that they occur in fairly regular cycles, the average cycle being 11.13 years, sunspot activity obtaining its maximum at this period, after which it slowly declines for a little more than five years, then slowly works back toward its maximum. Since 1788, the interval between the major maxima has varied from 7.3 to 17.1 years. Sometimes, for periods as long as two hundred days, no sunspots will be observed, but at other times, there may be whole years during which the sun is never without them. The maximum number of sunspots, observed per day, under the same conditions, may vary from twenty-five to fifty, or more, depending upon the magnifying properties of the observing instrument.

Other phenomena have been observed which show a close connection with the occurrence of severe magnetic storms and high sunspot activity. Two interesting correlating phenomena are the occurrence of polar aurora and large electric currents oscillating back and forth in the earth's crust.

So important is the effect of sunspot activity on short-wave transmission, that the engineers of the Bell Telephone Laboratories have made a special study of these effects and also have an instrument known as a Spectroheliograph located at Deal, N.J., for making observations of the sun. These observations, plus a careful study of past records of sunspot and magnetic storm activity, make it possible to predict possible future occurrences of such disturbances. While not much can be done about a really violent storm, steps can often be taken to minimize their effect. The origin of the majority of the disturbances causing a change in the normal behavior of terrestrial magnetism and radio transmission, therefore, lies in the sun and sunspot activity, and not in some cosmic agency affecting simultaneously both the sun and the earth. This is borne out by the fact that so many disturbances have recurred on a synodic rotation period (a rotation period as seen from the earth) and not a sidereal period (a period of rotation as would be seen from a fixed point in space) of the sun.

**New Line Filter**  
(Continued from page 533)

covered cord and terminal plug coming out of the filter, is placed in the 110-volt A.C. supply. The cord from the set is coiled up and tied with a piece of twine, and this acts as an extra choke in the circuit.

The filter can be installed in a few minutes by anyone, and complete instructions and simple hook-up diagram come with it. A ground clip on the Lynch Filteradio is connected to the ground post of the receiving set, or to any convenient part of the chassis, by means of a short piece of wire. At the same time, another piece of wire is run from the ground post on the set to a water pipe or other good ground. The receiver is turned on and a program tuned in, keeping the volume well down. Then the line balancer is adjusted to a spot where the least interference noise is found. Changing from one station to another, or even shifting from one band to another, should have no effect on the setting of the line balancer.

The improvement produced by the use of the device can be checked by switching an electric light on and off rapidly, with the device first in the circuit, and then cut out. In some cases, a further improvement may be noted by reversing the attachment plug from the receiver where it is plugged into the filter.

**Why gamble?—**  
**INVEST in a genuine**  
**DOERLE**



**2-TUBE BATTERY RECEIVER**  
**15 to 200 Meters**

One of the most popular members of the Doerle Set family. Employs but two tubes, yet gives the performance of a set having three tubes. Uses a type 30 as regenerative detector and a type 19 twin triode (actually 2 tubes in one) as two stages of resistance-coupled audio. The world-famous reputation of the entire Doerle line, is behind this remarkable set. Requires two No. 6 dry cells and two 45 volt "B" batteries for operation. All parts and workmanship fully guaranteed. Employs a set of four 5-prong ribbed plug-in coils. These coils are interchangeable with the new 5-prong bandspread coils. Ship. wt., 10 lbs. List Price \$15.75.

No. 5009-K Doerle 2-tube Battery Receiver Kit, not wired, but including Coils, less Tubes, Batteries and cabinet. **YOUR PRICE \$7.66**

- Set of 2 Matched Tubes.....\$1.00
- Metal Cabinet for above......90
- Set of 4 Bandspread Coils..... 2.35
- No. 5006-K Doerle 3-tube Battery Receiver Kit, not wired but with 3 Coils and Metal Cabinet, less Tubes and Batteries. Ship wt., 10 lbs. List Price—\$23.75
- YOUR PRICE \$12.46**
- Set of 3 Matched Tubes.....\$1.80

We will wire and test any of these kits at an additional charge of \$1.50.

125 to 1 Bandspread Dial for the 3-tube set \$1.75 extra

**RADIO TRADING CO.**  
101-A Hudson St. N. Y. C.

**STOPPANI COMPASS**

A Precision Instrument made in Belgium. Purchased by the U. S. Government at more than \$30.00 each. Ideal for Radio Experimenters Laboratory, also may be used as a Galvanometer for detecting electric currents in radio circuits. Ruby, jeweled, solid bronze. 4 inches square, fitted in a hardwood case. Also used by hunters and surveyors. Our price prepaid \$4.50 each

**Gold Shield Products Co., 17 West 60th St., N. Y. City**

## Radio Amateur Course

(Continued from page 537)

of the coil which is not connected to the plate. The condenser "NC," which is the neutralizing condenser, is then adjusted to feed an amount of R.F. from the plate circuit back to the grid, equal to the amount of R.F. fed from grid to plate, due to the internal capacity of the tube. This external feed-back method of feeding back R.F. 180 degrees out of phase, cancels the plate-to-grid feed-back within the tube.

### Push-Pull With Triodes

In figure 4-B, we have *push-pull* amplification, using triodes, each operating 180 degrees out of phase, making neutralizing possible by just connecting small, variable condensers between the plate of one tube and the grid of the other. In other words, one tube furnishes the neutralizing voltage for the other.

In Figures 5-A and 5-B, we have R.F. amplifiers using screen grid tubes which require no neutralizing. One is a *push-pull* circuit, and the other is a *single-ended* affair. As we said before, in Class "B" and "C" amplifiers, both *audio* and *radio* frequency grid current flows during either a portion or all the positive half-cycle of the exciting voltage. Now, this grid current can be utilized for biasing R.F. amplifiers by inserting a resistor in series with the grid return, the same as we have in an oscillator where bias is obtained with a grid leak. We can also obtain bias by the cathode method as shown in Figure 5-B. Grid-leak bias is never used in audio frequency, Class "B" amplifiers. Screen-grid voltage in amplifiers, such as shown in Figures 5-D and 5-C, can either be obtained directly from a separate power supply or obtained through a voltage-dropping resistor as indicated at "R," dropping the plate voltage to a sufficient value for the screen.

### Frequency Multipliers

Radio frequency amplifiers can be used for *frequency multiplication*. For instance, we can feed a 3500 kc. signal into the grid of any one of the "single-ended," Class "B" or "C" R.F. amplifiers shown in the various diagrams; then by tuning the plate circuit to 7,000 kc. and taking power out of this circuit, we have doubled the frequency of the original exciting signal. Class "B" amplifiers are not well suited for frequency doubling, because there is less second harmonic present in the output circuit. A Class "C" amplifier is a very fine *frequency multiplier* where the even order of harmonics are to be obtained. A *push-pull* amplifier does not make a good second harmonic amplifier or frequency doubler because the push-pull output circuit tends to cancel out the even order of harmonics. The push-pull amplifier can be used as a frequency multiplier where the odd order of harmonics are desired. For instance, the 3rd, 5th, etc.

Push-pull amplifiers are generally used where *frequency tripling* is required. Through the use of the new pentode tubes, such as the 2A5, 42, 802, and 23, an oscillator and frequency multiplier can be combined within a single tube. In Figure 6, we have a pentode oscillator and multiplier. The crystal is connected between the cathode and the grid. A tuned circuit is inserted between the cathode and the "B" negative and is tuned to a frequency about midway between the crystal frequency and its second harmonic. This will cause the crystal to oscillate; then the plate circuit can be tuned to twice or even three times the crystal frequency, with a fair amount of power output. It can also be tuned to four times the crystal frequency, but the power output and plate efficiency are so low that it is of no particular value.

### For the HAM!

In the next issue—All about the 5 meter M.O.P.A. that's now making history—"on the air"! It uses 3 type 89 Receiver tubes. W2AMN describes its construction.

## H. G. Cisin's 2-Tube Metal Tube AIR SCOUT



All Electric ALL WAVE  
Only Set of its kind in the world

Pat. Pending U. S. Serial No. 592,586. Operates on A.C. or D.C. Self-Contained Power Supply.

POWERFUL—W. C. Angell, Jr. of Providence, R.I., logged 12 foreign stations the first week. Many Air Scout owners report reception from Spain, England, Germany, Rome and even Australia and Japan. Broadcast reception on indoor aerial. Police calls, amateurs, code, weather reports, airplane and Trans-Atlantic phone conversations. Speaker on strong stations.

COMPLETE ASSEMBLED KIT, all necessary parts, instructions, picture diagram and all four short wave coils, less tubes, long wave unit, broadcast coils and earphone, ready to wire. **\$3.95**

Set of 2 Matched Metal Tubes... \$2.50  
Broadcast Coils... 1.45  
Special Long Wave Unit W. Coil... .85  
Earphone (Single)... .85  
Total... **\$5.70**

SPECIAL COMBINATION OFFER—Assembled Kit, not wired, \$3.40  
2 metal tubes, 6 coils, including Long Wave Unit, earphone, ready to use, \$1 extra.  
Above, Custom-Built, Wired and Laboratory Tested, ready to use, \$1.75 extra. Loud Speaker (extra), \$1.65.

## H. G. CISIN'S AIR SCOUT SIGNAL SET

"THE IDEAL X'MAS GIFT FOR THE BOY"  
THREE ENTERTAINING AND INSTRUCTIVE INSTRUMENTS IN ONE!

It gives 22 diving submarine signals used in Navy.  
It flashes, like a railroad telegraph sounder.  
The Air Scout Signal Set comes in a compact, portable black crystalline metal case, with suitable key. International Code Signals are printed on plate alongside key. Convenient switch changes from buzzer, to light or to sounder. Can be connected to similar instrument for code communication between friends. Ideal practicing code or for sending messages. Full instructions included. Use two ordinary flash light batteries. **COMPLETE READY TO USE (less batteries) \$1.25 (Two for \$2.)**

H. G. CISIN, Chief Engineer, Allied Engineering Institute, Dept. S-23, 98 Park Place, New York, N. Y.

## NEW METAL TUBE PROFESSIONAL THREE-TUBE AIR SCOUT



All Electric ALL WAVE

AIR SCOUT

Superlative Performance

- Foreign, Short Wave and Regular Broadcast
- 10 to 550 Meters
- Loud Speaker Operation
- Band Spread
- Self-Contained Power Supply
- Three Powerful All Metal Tubes
- Calibrated Dial
- Newly Invented Coil Shield
- A.C. or D.C. Interchangeable
- Earphone Jacks

COMPLETE ASSEMBLED KIT, all parts, 4 coils 10 to 200 meters, diagram, less speaker, tubes, Broadcast Coil, and earphone, ready to wire. **\$6.95**

Kit of 3 Matched All Metal Tubes... \$3.50  
Broadcast Coil (single)... .55  
Earphone... .85  
Total... **\$12.25**

SPECIAL COMBINATION OFFER—Assembled Kit, not wired, 3 metal tubes, 6 coils, including broadcast, earphone, **\$10.95**

Above Custom-Built, Wired and Laboratory Tested, ready to use \$1.75 extra. Loud Speaker (extra), \$1.65.

Over 130,000 People Find Each Issue of **EVERYDAY SCIENCE AND MECHANICS** of Intense Interest!

EVERYDAY SCIENCE AND MECHANICS is the finest scientific—technical—mechanical—construction magazine in the field. Up-to-the-minute with news flashes of scientific events. Dozens of constructional articles and many popular experiments. Ideas from which you can make things to sell.

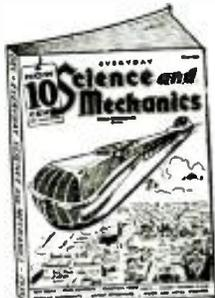

A MOST OF INTERESTING SUBJECTS COVERED  
Woodworking—Photography—Magic—Patents and Inventions—Book Reviews—Metal-Working—Chemistry—Engineering—Microscopy—Electrical Experiments—Household Helps—Astronomy—Prize Contests—and other subjects.

Edited by HUGO GERNSBACK

Over 150 Illustrations

10c the copy

Get your copy today! On all newsstands  
Everyday Science and Mechanics  
99-C Hudson St., New York, N. Y.

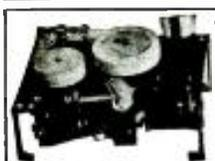

### "HAM" SPECIAL Standard Teleplex

A highly efficient code teacher using heavy specially prepared waxed paper tape, having two rows of perforations. Write for Free folder "S.W." DEALERS—correspondence invited with dealers for protected territories. We are the originators of this type instrument. **TELEPLEX CO., 76 Cortlandt St., New York City**

Instrument, with tapes prepared by expert and complete course of lessons: all for **\$11.95**

### Reduce Noise On ALL WAVES

LYNCH HI-FI ASSEMBLED ALL-WAVE ANTENNA  
All ready to hang. Saves 90% of installation time. Amazing results. **\$6.75** List

Write for folder  
If dealer cannot supply order direct

LYNCH FILTERADIO  
Cuts out objectionable noise from the radio. Has. Easy to install. Sample **\$5.00** List

Arthur H. Lynch, Inc., 227 Fulton St., N. Y. PIONEER OF NOISE-REDUCING AERIALS

## INTERNATIONAL DX 3-Tube AC-DC Short-Wave Set



EXCELLENT FOREIGN RECEPTION

Many owners report listening EUROPEAN, ASIAN, AUSTRALIAN, SOUTH AMERICAN, etc., stations.

- Complete kit of parts for the set and power supply, 3 controls, 4 special coils for 14 to 200 m., with speaker outlet and wiring diagram. EXTRAS: □ WIRED & TESTED 1.75 □ SPEAKER & direct drive, sound transmitting AIRPLANE DIAL assembly 1.75
- with 3 Tubes—6D6, 76 and 12A7 2.25. □ With 3 Tubes—6K7, 6C5 metal and 12A7 glass 3.25. □ Phone-outlet with automatic speaker cutoff 0.50. □ Band spread 0.75.
- Sensitivity control 0.75. □ One broadcast coil 200-500 m. 0.75
- Two broadcast coils 200-600 m. 1.25. □ Crackle-finished metal cabinet 1.95

KIT **5.95**

Not wired, less speaker, airplane dial, cabinet, tubes, headphones, sensitivity control and broadcast coil.

## INTERNATIONAL DXDX AC-DC 5-TUBE REGENERATIVE RECEIVER

The RECEPTION & RANGE on the lower bands, obtainable with this receiver, surpasses, moderately stated, many large superhets. Verified Reports.  
□ Complete kit include all parts for the set and power supply, 5 controls, 4 coils for 14 to 200 m., with speaker outlet and wiring diagram. EXTRAS: □ Custom built & TESTED 2.95. □ ROLA dynamic speaker & direct drive sound transmitting AIRPLANE DIAL assembly 3.75. □ Set of 5 metal and glass tubes 4.50. □ Two broadcast coils 1.25. □ Phone-outlet with automatic speaker, cutoff 0.50. □ Band Spread 0.75. □ Metal cabinet 2.50.

KIT **12.75**

Not wired, less speaker, dial, tubes, headphones, sensitivity control and cabinet.

2 volt or 6 volt battery models at same prices as above. Use advertisement as order blank. Check items you want. **EXPERIMENTAL RADIO LABS., 168 Washington St., New York, N. Y.**

## ONE TUBE RADIO ONLY \$1.25 POST PAID



1 TUBE KIT  
Haven't you always wanted a Real, Powerful Radio Receiver, all your own? A Short and Long Wave set that will actually bring in many foreign stations from all parts of the World, police calls, airplanes, amateurs, etc., as well as your local stations. ACE Radios give GUARANTEED RESULTS! Thousands now in use. Amazing performance!

NOW, the world famous ACE Construction Kits are priced so low that anyone can afford one! For only \$1.25 we send you, postpaid, every part needed to build a powerful one tube receiver with heavy, attractive metal chassis-panel. Not a feeble crystal set! Works on two inexpensive dry batteries. Later, you can change your set into the Two Tube Battery or All-Electric set at special low cost! You get a valuable radio education by wiring it yourself from our clear diagrams. It's easy for even a child! Just a few simple connections. Wavelengths range 15 to 600 meters. For more power and volume buy the TWO TUBE receiver Kit—Not wired. Less tubes, Batteries and Phones. **\$2.00**

ALL ELECTRIC Two tube house current set. No batteries needed. Works on 105-125 volt AC or DC. Complete construction kit. Not wired. Less Tubes and Phones—only **\$3.00**  
Kits wired—75c extra. Tubes 75c each. Double phones—\$1.25

**ORDER NOW!** Not a toy or an attachment!!  
**ACE RADIO LABORATORIES**  
1619 Broadway Dept. C-1 New York City

**SA, OM!!**

**HARRISON HAS SUM  
FB XMAS BARGAINS!**

Grab yourself a few of these before they're all gone! There won't be any more shortly at anywhere near our special price!

**Western Electric**

211-D — **\$4.90**

Brand new, genuine, first grade, Western Electric Fifty Watters. Standard characteristics. Over 100 Watts output!! An FB tube for any Ham! Regular selling price is \$17.50. Harrison offers them at the sensational price of only \$4.90. Unconditionally Guaranteed for 30 Days (broken glass or burnt out filament the only exceptions)! Safe, prompt shipment to any part of the world. Broadcast Stations supplied.

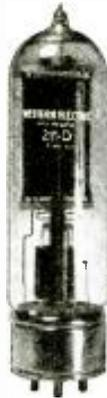

**HEAVY DUTY**  
**866** Mercury Vapor Rectifier Tubes  
Fil. 2.5 Volts, 5 Amps.  
Inverse Peak—7500 Volts  
DC Current 600 MA.  
A fully guaranteed tube at a low price **98c**

**New Low Prices**  
**RCA—De Forest**  
**Xmitting Tubes**  
866—\$2.25  
8520—16.40  
All other types in stock

VISIT OUR NEW  
**LARGE SALESROOM**  
AT  
**12 WEST BROADWAY**  
(Between Barclay and Vesey St.)  
Send for **FREE HAM BULLETIN**

**HARRISON RADIO CO.**  
12 West Broadway Dept. C-1 New York City

UNCONDITIONAL GUARANTEE ON ALL OUR RADIO SUPPLIES  
**UNCLE DAVE'S**  
24 HOUR SERVICE. **RADIO SNACK** SERVICE  
350 BROADWAY, ALBANY, N. Y., U.S.A.

Just a few left **GENTLE SPRAGUE AMPLIFIERS**, uses 3 tubes, 3 1/2 watts output, less tubes, speaker and mike \$ 2.95  
**PEERLESS** 3-tube Professional AM receiver, wired and tested, with tubes, power supply and 2 sets of coils for 15 to 200 meters special \$15.75  
**PEERLESS** 2-tube **LOUDSPEAKER** AM receiver, wired and tested with tubes, power supply and 1 set of coils for 15 to 200 meters special \$12.75  
Weston 1 mil meters with volt-ohm-ma scale, net special, each \$ 6.00  
Weston 0-150 volt AC meters, special Cable Address "Uncle Dave's" Long Distance Phone 4-5746 Include 20¢ deposit with O.A. orders Prices F.O.B. Albany Foreign Trade Solicited Send for new Ham Catalog—just out!

**ELIMINATE Line Noise** with the **NEW MILLER LINE FILTER**  
J. W. MILLER COMPANY  
5717 So. Main St. • Los Angeles, Calif.

**RADIOS..SAVE UP TO 50%**  
DEAL DIRECT, Factory Prices. Many models to select from. AC-DC, All-wave, Farm, Car and new metal Tube Models. Your name and address on postcard bring you NEW 1936 page 1936 Bargain Catalog in colors FREE. Get details of 30-DAY TEST Plan and Agent-User proposition. Goldentone Radio Co., Dept. 222 8780 Grand River, Detroit, Mich.

**RADIO ENGINEERING**  
RCA Institutes offers an intensive course of high standard embracing all phases of Radio. Practical training with modern equipment at New York and Chicago schools. Also specialized courses and Home Study Courses under "No obligation" plan. Catalog. Dept. SW-36.  
**RCA INSTITUTES, Inc.**  
75 Varick St., New York. 1354 Merchandise Mart, Chicago  
Recognized Standard in Radio Instruction Since 1909

**Keeping the Short Wave League Club "Alive"**

(Continued from page 545)

wishes to attract new members and really grow into a flourishing organization, it would be a very good idea to publicize the club's activities in the local newspapers, bulletin boards about town, etc. Why not stage a short-wave "DX" performance, for the benefit of the laymen or those who are unfamiliar with what short waves are really doing today.

The technical experts of the club should hook up a first-class receiver, or at least the best the club can afford, together with a good-size amplifier, and let the folks hear some foreign stations roll in! In connection with such a demonstration now and then, a popular lecture could be very well given by one of the club's members qualified to do so. Lantern slides may be used to illustrate the lecture or pictures clipped from magazines, such as *Short Wave Craft* for example, can be very nicely projected on a screen by means of the well-known Reflectoscope or post-card projector.

Even though the club is small at the beginning, it will always prove a very good asset to have a library. Magazines, as well as the latest books on short waves and radio in general can be purchased through the club's funds, and magazine subscriptions may often be contributed as gifts by some of the club's members or friends of the club. If the club is in a small town and where the mayor is not so busy, he might appreciate being invited to one or more of the club's meetings. And do not forget the local M.D.—many physicians, through their thorough college training, which includes physics and mathematics, have become regular radio enthusiasts, and some of the liveliest clubs we know of have several M. D.'s and other professional men as regular members, and they often own and enjoy Ham stations in the bargain.

**5-Meter Transceiver Uses Midget Tubes**

(Continued from page 523)

on the tube, compatible with good sensitivity, in order that you will cause no undue interference with other 5-meter receivers. The antenna which gave best results was a "doublet," measuring eight feet long, with a "twisted pair" feeder about three and a half feet long. The length of the feeder is determined by watching the plate current of the oscillator. For a given frequency the plate current should show a slight increase when the feeders are connected. The feeders can be tuned with a condenser if the proper length cannot be readily determined. During tests we worked over distances of seven to eight miles and under favorable conditions ten to twenty miles may be covered with little difficulty.

**Parts List for Transceiver**

- 1—50,000-ohm 1/2-watt resistor, I.R.C.
- 1—1 meg. 1/2-watt resistor, I.R.C.
- 1—.5 meg. variable resistor (Pot.), Electrad.
- 1—.0001 mf. mica condenser, Aerovox.
- 1—.004 mf. mica condenser, Aerovox.
- 1—.006 mf. mica condenser, Aerovox.
- 1—1mf. by-pass condenser, Sprague.
- 1—.1 mf. by-pass condenser, Sprague.
- 1—shield interruption-frequency transformer, National.
- 2—Isolantite coil assemblies (5-meter), National.
- 1—15 mmf. Isolantite variable condenser, National.
- 1—transceiver transformer; 3 windings.
- 1—midget choke, 30 henry A.C.-D.C. type.
- 1—0.25 MA meter, Triplett.
- 1—panel and shelf; see text. Blan.
- 1—carrying case; see text. Blan.
- 2—type XL "midget" tubes, Hivac. (Types 30's may be used as substitutes.)
- 1—double-pole, double-throw, send-receiving switch.
- 1—3-volt midget battery, Burgess type T2FL.
- 2 midget 45-volt batteries, Burgess type X30FL.

**"COSMAN 4" 5-Band 4-Tube Receiver**



The year's outstanding inexpensive short-wave receiver. Provides Band Spread tuning of any signal; Uses two of the new Metal tubes; Built-in Dynamic Speaker; 17-550 meter tuning range; 5-Band switch coil assembly—no plug-in coils; 17 Airplane Dial; Hammarlund Tuning condenser; Built-in power supply and numerous other features found only in higher priced receivers. Uses four tubes; 2-6KT's; 1-13 and 1-25Z5. A.C.-D.C. Operation.  
Complete kit of parts and instructions. **\$10.50**  
Not wired, less tubes and cabinet..... \$2.50  
Wired and tested. Extra..... \$2.25  
4 Matched Sylvania tubes..... 2.25  
All Metal Crystallized Cabinet for "Cosman 4"..... 1.50  
Send For Our New 1936 Catalogue.  
**TRY-MO RADIO CO., INC.**  
85 CORTLANDT ST. NEW YORK CITY

**What more useful HOLIDAY GIFT**  
can you give your relatives or friends than a large and good looking **SPORTS BINOCULAR**

A real high-power field glass that enables you to enjoy such sporting events as Football, Prize Fights, Wrestling Matches, Horse Racing, Baseball-Games, etc. Most useful on Auto Trips, Hunting, Outings, Beaches, etc. It's a real buy at a fraction of its worth.



PARCEL POST PREPAID **\$1.50** 5 1/2" long, extended to 6 1/2". Lenses nearly two inches in diameter, Black crackle finish. Carrying strap.

Supply limited—ORDER NOW!  
Money back guarantee. You can't lose!  
**GOLD SHIELD PRODUCTS CORP.**  
17 West 60th St. Dept. S. New York City

**RADIO'S LIVEST MAGAZINE**  
Edited by HUGO GERNSBACK  
RADIO-CRAFT is devoted to general Radio in all its phases, to Radio Servicing and to the advanced set builder and Radio Technician. Kinks show simple ways out of difficult problems. The latest radio equipment is illustrated and described.  
RADIO-CRAFT is fully illustrated with photographs, diagrams and sketches. Each issue contains over 150 illustrations. 15c for Sample Copy.  
**8 Months for \$1.00**  
**RADIO-CRAFT**  
99C Hudson Street New York, N. Y.

**Short Wave League Members**  
IDENTIFY THEMSELVES WITH THE ORGANIZATION  
In order that fellow members of the LEAGUE may be able to recognize each other when they meet, we have designed this button, which is sold only to members and which will give you a professional appearance. If you are a member of the LEAGUE, you cannot afford to be without this insignia of your membership. It is sold only to those belonging to the LEAGUE and when you see it on another, you can be certain that he is a member. See Page 576.  
Lapel Button, made in bronze, gold filled, not plated, prepaid..... **35c**  
Lapel Button, like one described above, but in solid gold, prepaid..... **\$2.00**

# FREE S-W DATA SERVICE

Joseph Calcaterra, Director

Short Wave Craft Data Service,  
99 Hudson Street,  
New York City, N. Y. SWC-136

Please send to me, without charge or obligation, the catalogs, booklets, etc., the numbers of which I have circled below.

2 3 4 5 25 76  
28 57 73 74 75

My radio connection is checked below:

- Short-Wave Set Builder
- Short-Wave Experimenter
- Short-Wave Listener
- Service Man operating own business
- Service Man for manufacturer
- Service Man for jobber
- Service Man for dealer
- Service Man for servicing company
- Dealer
- Jobber
- Experimenter
- Professional Set Builder
- Amateur Set Builder
- Licensed Amateur
- Station Operator
- Radio Engineer
- Laboratory Technician
- Public Address Worker
- Manufacturer's Executive
- Student

My age is \_\_\_\_\_ years.

I have been interested in radio for \_\_\_\_\_ years.

I buy approximately \$ \_\_\_\_\_ .00 of radio material a month. (Please answer this question without exaggeration or not at all.)

(Please Print Name and Address)

Name \_\_\_\_\_

Address \_\_\_\_\_

City \_\_\_\_\_ State \_\_\_\_\_

**AVOID DELAY.** The catalogs and booklets listed are now in stock and will be sent promptly as long as the supply lasts. Only the items listed are available. Please make your selection from the current issue of *Short Wave Craft*, and use the coupon in ordering the items.

● THE catalogs, booklets, and folders listed in this department contain a wealth of information and data which will help you in your short-wave work.

These catalogs, booklets, and folders may be obtained by *Short Wave Craft* readers (without the trouble and expense usually involved in writing individual letters to the various organizations which publish them) through arrangements which have been made by *Short Wave Craft* magazine with the publishers of the literature listed.

To obtain any of the material listed in this department, simply draw a circle around each Booklet Number on the coupon, corresponding to the numbers of the items you would like to have, fill in the rest of the coupon and mail it to the *Short Wave Craft Data Service*.

A complete stock of these catalogs and other literature is kept on hand and will be sent to you promptly, as long as the supply lasts. There is no limitation on the number of items you may ask for, but to avoid waste, please do not ask for material in which you are not interested or of which you already have a copy.

Only the literature listed in this issue is available. Please do not ask for catalogs which are not listed. Do not include letters asking for information from other departments with your request for catalogs as that will cause delay in answering your inquiries.

2. HAMMARLUND 1936 CATALOG. Short wave fans and set builders will find a flock of

new low-loss parts such as variable condensers, coil forms, sockets, transformers, chokes, shields, and other precision products especially designed for short-wave and ultra-short-wave work described in this catalog. Information on short-wave sets is included.

3. THE HAMMARLUND SHORT-WAVE MANUAL. No short-wave fan who is interested in short-wave set design should be without this 16-page manual, which contains constructional details, wiring diagrams and lists of parts of the day. A circular giving a description and 12 of the most popular short-wave receivers of list of contents of this manual is available free of charge to *Short Wave Craft* readers.

4. THE HAMMARLUND "COMET PRO" SHORT-WAVE SUPERHETERODYNE. This receiver is still holding its own as one of the leading short-wave receivers available for professional operators and advanced amateurs, for work on 15- to 250-meter code and phone reception. It is especially adapted for laboratory, press, police, airport and steamship use.

5. ELECTRAD 1936 VOLUME CONTROL AND RESISTOR CATALOG. No short-wave set can function properly unless the volume controls and resistors are of the best. This catalog of resistors features the latest developments in the resistor art. Fundamental volume and tone control circuit diagrams are given.

25. LYNCH NOISE-REDUCING ANTENNA SYSTEMS. No use trying to get world-wide short-wave reception if your aerial picks up more noise than signals. This folder, by Arthur H. Lynch, gives complete instructions on how to build noise-reducing antenna systems for short-wave reception and contains a special supplement covering Ham Antenna Design for transmitting and receiving on the amateur bands as well as the ultra-high frequencies.

28. LYNCH SUPER-FILTASTATS FOR AUTO RADIO INSTALLATIONS. It isn't necessary to put up with ignition noise in auto radio installations. The new Lynch Super-Filtastats eliminate ignition noise without the necessity of using the conventional suppressors.

57. RIBBON MICROPHONES AND HOW TO USE THEM. How do your phone signals sound to the fellow at the receiving end? If they sound as though you're talking with a bunch of marbles in your mouth, the chances are a good microphone, properly hooked up, would help "to beat the band." This folder describes the Amperite Velocity Ribbon Microphone and gives information and circuit diagrams on how to connect up the microphone.

73. HOW TO ELIMINATE RADIO INTERFERENCE. You'll get much more enjoyment out of short-wave programs if you cut out the noise interference. This handy folder gives complete information on the Sprague Interference Analyzer and how to use it to locate and eliminate radio interference.

74. SPRAGUE ELECTROLYTIC AND PAPER CONDENSER CATALOG. You can't very well build a short-wave set without fixed condensers for filtering and by-passing. You'll find complete specifications of all the condensers you'll need for building or improving your short-wave set in this catalog. A description of the Sprague Capacity Indicator, for making tests on condensers, is included.

75. SPRAGUE TEL-U-HOW CONDENSER GUIDE. If you are ever puzzled regarding the proper kind, capacity and voltage of condenser to use in any given place, you should have a copy of this free chart which gives data on just that very subject. This folder also gives valuable hints on how to locate radio troubles due to defective condensers and includes helpful data on condenser calculations.

76. FACTS YOU SHOULD KNOW ABOUT CONDENSERS. If you have any wrong ideas or notions as to the effect of certain condenser characteristics on the filtering efficiency or suitability of a condenser for a given application, this little folder will straighten you out.

**ALL FOR 10¢** **DICTIONARY OF RADIO DEFINITIONS**  
**5 FAMOUS EAGLE RADIO CIRCUITS**  
**AND VALUABLE INFORMATION**

Cannot Be Obtained Under One Cover Elsewhere!  
Complete Symbols used in Radio Circuits. Frequently used Formulae. Proper Grid-bias for 28 Standard Tubes. Complete RMA Color Code. International Morse Code. Diagrams and Technical Data for building 4 FAMOUS EAGLE ALL-WAVE SETS and AC-DC MIDGET HOOK-UP. Dictionary of Radio Definitions. All Radio Terms defined and explained. Characteristic chart of New Metal Tubes, etc.  
**DON'T HESITATE—WRITE NOW!**  
Enclose 10¢ in stamps or coin, which only covers the cost of handling and mailing this valuable technical data.  
**EAGLE RADIO Dept. S-1, 84 Cortlandt St., New York City**

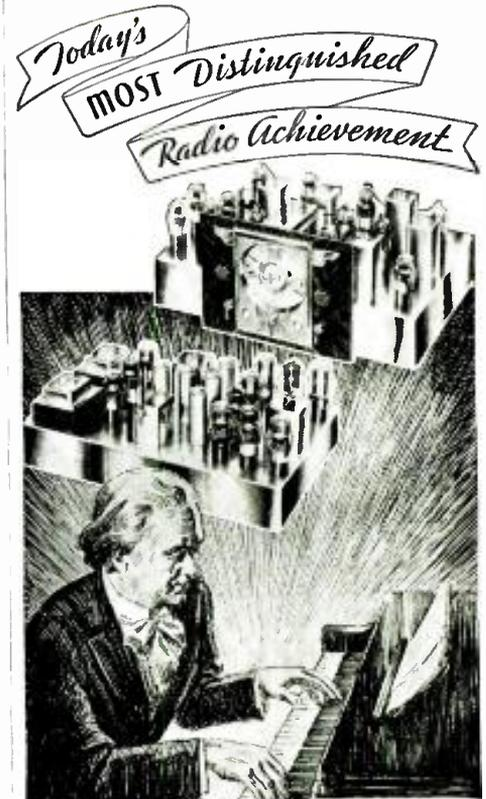

## CUSTOM BUILT ROYALE 24-TUBE Radio

THIS super radio-musical instrument was created for those discriminating and exacting few who insist on the finest, most beautiful, most precisely built radio obtainable. A set of rare distinction, musically and artistically perfect, the Royale offers over 100 features... assuring a luxurious and idealized type of brilliant, sparkling, guaranteed world-wide performance... heretofore unattainable. It is today's only "aged" radio... offers 6 tuning ranges... 4½ to 2400 meters... etc.

This 24-tube achievement outperforms other receivers. Assures Unlimited Scope Full Fidelity. Audio range is 20 to 16,000 cycles per second... 40 watts undistorted output. Fully guaranteed for 5 years... absolute satisfaction assured.

The 30-day FREE Trial Offer enables you to try the Royale in your own home, without obligation. Write for literature now or mail coupon TODAY.

**ROYALE RADIO CRAFTERS**  
(Division Midwest Radio Corporation)  
Dept. 205G, Cincinnati, Ohio.

Without obligation, send me literature describing Custom-Built 24-Tube 6-Tuning Range, Royale Radio... and details of your 30-day Free Trial Plan.

Name \_\_\_\_\_  
Street \_\_\_\_\_  
Town \_\_\_\_\_ State \_\_\_\_\_

Please mention SHORT WAVE CRAFT when writing advertisers

## Learn Code RIGHT With The SYSTEM That Made The Champion



**TED McELROY**  
World's Champion Radio Operator. Speed 69 wpm.

**CHAMPION McELROY** says: "My speed is the result of **CANDLER** training. It taught me to read code as easily as I read print. Beginners who wish to learn code **RIGHT**; and those who want real speed, will save themselves much time and discouragement by taking the **CANDLER SYSTEM**."

**FREE**—Copy of article by Champion McElroy: "**HOW I LEARNED TO HANDLE CODE**" also **BOOK OF FACTS** containing valuable help if you want to learn code **RIGHT**. A card will do. No Obligation.

Candler System Co. Dept. S-1, Asheville, N. C.

## ANNOUNCING!!

### OUR "EASY PAYMENT PLAN" NOW

Radio Amateurs and Shortwave Listeners, living in any part of the U. S. A., may buy modern, standard shortwave receivers on extremely easy terms. We now offer our really "EASY PAYMENT" Plan for the Radio Amateur and Experimenter, so you and your friends may purchase a really good receiver out of your budget. Our plan enables you to equip your station with the latest type receivers, thus greatly increasing your interest and pleasure in Amateur Radio.

**JUST THINK**—for only a few dollars down the choice of the finest receivers on the market. You can equip your station with that fine new receiver you thought you couldn't afford. Really, O.M., you can't afford NOT to buy your new set—our plan works so well for you.

**WHY WAIT?** Every day you put off ordering, you are without good reception that much longer. Every day is doing it—buying up-to-date equipment. Get "On The Air," O.M. Write us for further information on our really "EASY PAYMENT PLAN."

### HINDS and EDGARTON

19 S. Wells St., Chicago, Illinois  
W9APY Randolph 5208 W9WR

### Regent 5-Tube 5 Band 15-550 Meter Switch Receiver

This new improved "Regent" completely eliminates the use of plug-in coils. Independent tuning of the five separate bands is accomplished by means of a five-band switch. No more groping around for the proper coils. A great distance getter that will fulfill the requirements of every radio experimenter or amateur. Uses 2-58's, 1-80 and 2-2A5's. All controls on front of cabinet. Complete kit of parts including speaker, airframe dial, blueprints, and all accessories unwired, less cabinet and tubes



Cabinet..... \$12.50  
Labor for wiring and testing (Extra)..... 1.50  
Set of 5 Matched Sylvania or R.C.A. Tubes..... 3.50  
Write for our latest catalog or circular

**TRY-MO RADIO CO., INC.**  
85 Cortlandt St. New York City  
This is our only address

### QUALITY RADIO SUPPLIES

1936 Catalog featuring hundreds of new items—x-mitting and transceiver parts—television and short wave equipment, apparatus and items of interest to all in the radio industry. Send 10c in stamps or coins to cover the cost of handling and mailing.

**INSULINE CORP. OF AMERICA**  
25 Park Place Dept. S-1 New York, N. Y.

### SPECIAL

FOR THIS MONTH

Send \$1.00 (\$1.25 Canada and foreign) and we will send you **SHORT-WAVE CRAFT** for eight months. **DO IT NOW.**

### SHORT WAVE CRAFT

99-101 Hudson Street New York

## Latest TUBE DEVELOPMENTS

### New 6A3 Audio Amplifier



The New 6A3 Audio Amplifier Tube

and the two grids are connected together, with a single grid and plate terminal in the base of the tube.

These tubes are said to be more uniform than the older type of 2A3.

● THE 6A3 is the latest addition to the tube family and it is designed to replace the 2A3 in high fidelity audio amplifiers. The new tube requires 6.3 volts for the heater instead of the 2½ which the 2A3 required.

The elements of the tubes are duplicated; in other words, there are two triodes within the envelope and they are connected in parallel internally. The two plates are connected together

### Sylvania Type 6A3 Output Triode

#### CHARACTERISTICS

Filament Voltage A.C. or D.C.	6.3 Volts
Filament Current	1.0 Ampere
Maximum Overall Length	5¾"
Maximum Diameter	2 1/16"
Bulb	ST-16
Base	Medium 4-Pin

#### Operating Conditions and Characteristics:

<i>Class A Amplifier (One Tube)</i>	
Filament Voltage	6.3 Volts
Plate Voltage	250 Volts Max.
Grid Voltage	-15 Volts
Plate Current	60 Ma.
Plate Resistance	800 Ohms
Mutual Conductance	5250 micro-mhos
Amplification Factor	4.2
Load Resistance	2500 Ohms
Power Output (with 5% 2nd Harmonic)	3.3 Watts

#### Push-Pull Class A Amplifier (Two Tubes)

<i>Fixed Bias</i>	
Filament Voltage	6.3 6.3 Volts
Plate Voltage	325 325 Volts Max.
Grid Voltage	-68 -68 Volts
Plate Current per Tube	35 35 Ma.
Plate to Plate Load Resistance	3000 5000 Ohms
Power Output	15 10 Watts
Total Harmonic Distortion	2.5% 5%

### The "SG3" Transmitter

(Continued from page 539)

- 1—Isolantite coil forms (5-prong); National.
- 2—Crystal, 80 or 40 meters or one for each.
- 3—Small standoff insulators; National.
- 4—Closed circuit jacks.
- 5—0-100 MA meter Triplett.
- 6—Type "89" tubes.

#### Coil Data

##### Receiving Parts Transmitter

xtal	80 meters	amp. grid	amp. plate
20T.	osc. plate	54-T.	26-T.
xtal	40 meters	amp. grid	amp. plate
9T.	osc. plate	26-T.	12-T.
xtal	20 meters	amp. grid	amp. plate
Use	osc. plate	16-T.	6-T.
40m	6-T.		
coil			

All coils close-wound with No. 22 D. C. C. wire. Amp. grid coil No. 30 D. C. C. wire. Amplifier coils are both center-tapped.

## 6 Copies of SHORT WAVE CRAFT 70c PREPAID

For a limited time only, and as long as they last, we will send you six back numbers of **SHORT WAVE CRAFT** assorted, your choice, for 70 cents.

The usual price for six copies would be \$1.50 and most publishers charge a higher price for back numbers over one year old.

We can supply all copies except the following: June-July, Aug.-Sept., Oct.-Nov., 1930; Dec.-Jan., 1931; Dec.-Jan., May, June, Sept., Nov., 1932; Jan., Feb., March, May, June, July, 1933; Dec., 1934.

If you do not specify copies we will use our own judgment in sending assorted numbers to fill your order. Note we cannot exchange the copies for ones that have been sent to you.

Practically every copy of **SHORT WAVE CRAFT** contains important information that you should have. Here is a chance to get those copies.

As we have only a small supply of back numbers on hand, this offer will be withdrawn as soon as they have been sold.

We accept U.S. stamps, U.S. coin, or money order. Rush your order today.

### SHORT WAVE CRAFT

99-101 Hudson Street New York, N. Y.

SHORT WAVE CRAFT 1-36

99-101 Hudson Street, New York, N. Y.

Gentlemen: I enclose herewith 70c. for which you are to send me six back number copies of **SHORT**

**WAVE CRAFT** as follows:

Name .....

Address .....

City..... State.....

## ELECTRIC DRILL

### CAPACITY

1/4" DRILL

Weight 4½ lbs.

PRICE \$5.97



This Utility Drill is built for intermittent service, always ready for instant use, and will accommodate straight shank drills up to 1/4 inch. Weighs only 4½ pounds, and has a convenient on-and-off switch mounted on the motor body. The three-jaw chuck has a capacity up to 1/4 inch. Furnished complete with 10 feet of heavy duty rubber covered cord, and plug cap. Operates on alternating current only. 110 volts, 60 cycles. Ship. weight 5 lbs.

Shipped by Express Collect if not sufficient postage included.

MONEY-BACK GUARANTEE

### WELLWORTH TRADING CO.

506 Palmolive Bldg. DEPT. SWC 136 CHICAGO, ILLINOIS

### PATENTS — TRADE MARKS

All inventions submitted held confidential and given personal attention by members of the firm.

Form "Evidence of Conception" and instructions

"How to Establish Your Rights"—Free

LANCASTER, ALLWINE & ROMMEL

PATENT LAW OFFICES 475 Bowen Bldg. Washington, D. C.

Please mention **SHORT WAVE CRAFT** when writing advertisers

# A 3-Tube Preselector

(Continued from page 534)

In the design of a preselector several factors must be considered. It should have sufficient selectivity to completely eliminate image response at high signal frequencies as well as have noticeable gain at those same frequencies. Two stages of radio frequency amplification are necessary to accomplish this. Quick change from one band to another makes coil switching, rather than plug-in coils, desirable but the coils and the coil switch must be of low loss design with short leads from coils to switch, if any gain is to be realized at high frequencies.

Proper shielding as well as the correct layout of parts must be considered to prevent oscillation or unstable operation without resort to critical sensitivity controls or adjustments.

The unit should contain its own power supply so that it can be used with any type of receiver, by simply connecting it to the antenna post of the receiver and connecting the antenna to the preselector. If the unit were to receive its power from the receiver, more or less complicated connections would be necessary, which in some cases would disturb the balance and sensitivity of the receiver.

The Miller Preselector is shown as an

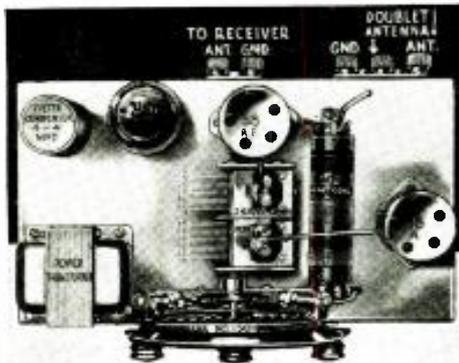

Top view of the preselector chassis.

example of good design and fills all the requirements of an ideal preselector. The circuit diagram is given here. Three sets of coils are used to cover the range of frequencies from 1500 to 25,000 kc. As most all-wave receivers operate satisfactorily on the broadcast band of 550 to 1500 kc., coils for those frequencies are not provided, but provision is made for the inclusion of broadcast or other long-wave coils by an extra contact on the coil switch.

A five-contact three-circuit switch is used. The (A) contact or position cuts out the preselector by connecting the antenna direct to the receiver. This position is used when working on the broadcast band. It can also be used to check the gain in both volume and selectivity when the preselector is in circuit. A signal tuned in on the receiver that is barely audible, can be brought up to full room volume when the preselector is switched and tuned to the signal frequency. Also a reduction of noise in relation to signal is noticed, due to the increase in selectivity. If, when the signal was tuned in on the receiver, it had interference due to image response, this interference will be completely eliminated when the preselector is switched on.

The (B) position connects the coils for the 75- to 200-meter band, the (C) position the 35- to 75-meter coils, and the (D) position the 12- to 35- meter coils. The extra position is either connected to the (A) contact or used for a set of coils on some other frequency.

The coils have been designed to provide high and uniform gain throughout their range. The antenna coils are inductively coupled to the first grid coil and are not grounded so that a doublet antenna can be used. The plate of the first R.F. tube, which can be either a type 58 or 6D6, de-

pending on the heater voltage, is inductively coupled to the second grid coil. The second tube is a duplicate of the first and its plate is parallel-fed and capacity-coupled to the antenna post of the receiver to be used. A special Miller choke is used, which provides good coupling efficiency at all frequencies to practically any type of antenna circuit used in all-wave receivers.

The coils are mounted one above and one below the chassis at right angles to each other, providing good shielding as well as short leads to the switch and tuning condensers, which are two-gang .00035 m.f. The trimmers originally mounted on the tuning condensers are not used and are bent wide open to provide as low a minimum capacity as possible. Separate trimmers are used on each coil and are mounted close to the coil switch. These trimmers are 50 mmf. maximum capacity and are adjusted to as low a capacity as possible to make the circuits track.

A shield is shown in the bottom view of the chassis, between the R.F. coil and the band-change switch, and is bent so that it also shields the trimmers TC3 and TC4 from each other. Without this shield, the unit may oscillate at some positions on the dial.

The resistors shown in the circuit diagram are all one-watt carbon and the bypass condensers have a 400-volt rating. The .002 mf. condenser from plate of second R.F. tube to the receiver antenna post must be a good mica condenser.

The power supply provides full 250 volts to the plates of the tubes and uses a type 80 rectifier tube. A single 15 henry choke and two 4 mf. condensers in the same can, adequately filter the output. The power transformer can have either a 2½-volt or a 6.3-volt winding for the heaters, depending on which type of tubes are used.

The wiring to the various parts is not critical, states Ralph O. Gordon of the J. W. Miller Co., except for the coil to switch and trimmer condenser connections, which should be as short and direct as possible, keeping the wires well separated. The preselector antenna lead from the binding post to the coil switch should be a stiff piece of bus bar kept well away from the second R.F. coil circuits.

The unit is mounted on a metal chassis 10½ inches wide, 6 inches deep, and 2¼ inches high. A 4-inch airplane-type dial gives plenty of band-spread and the tuning is sharp but not at all critical.

## \$200.00 "Cover Title" Contest Winners in Next Issue.

● THE prize awards to the successful contestants in our *Cover Title* Contest will be published in the February issue. Thousands of titles were submitted to the judges, and the editors were agreeably surprised by the large number of entries received, and we know that all of our readers will be on "tiptoe" until they learn the name of the first prize winner. The first prize is the magnificent, new 18-tube Midwest receiver, as announced in the previous issue of this magazine. If you like this contest and have some suggestions for a future contest in *Short Wave Craft*, send them to the Editor, care of this publication.

**WANTED** —Fully experienced Radio Service Expert. "Screw driver mechanics" need not apply. Must be fast, accurate and thoroughly familiar with all types of modern radio work. A real opportunity for the right man. State qualifications in detail. Box 101, c/o Bulletin.

## Could You Fill This Service Job?

Under improved business conditions, dozens of good-paying opportunities will soon be popping up in radio. Your future depends on whether or not you are qualified to grasp them. Will they go to other fellows—or will you MAKE them come to you!

Sprayberry Training is designed NOT for beginners but for men already in the service business who recognize the need for keeping up-to-date. It is for men who know that, to get better-than-average jobs, they have to be better-than-average workmen. It is sound, practical business and technical training—at a price within the reach of all. Investigate!



**LET ME HELP YOU BUILD A REAL SERVICE BUSINESS**

**F. L. SPRAYBERRY** 2548 University Place, N.W. Washington, D.C.  
Without obligation, send me details on your advanced Service training.

Name.....  
Street.....  
City..... SW1-36

**SPRAYBERRY'S PRACTICAL MECHANICS OF RADIO SERVICE**

## Radio's Latest Developments WHOLESALE RADIO'S New 1936 CATALOG!

196 Pages Crammed With Bargains at Lowest Wholesale Prices  
Get your copy now! Over 50,000 items! Every latest radio development, every last minute improvement. Newest sets from 2-24 tubes, parts, tubes, kits, tools and accessories; Short Wave and X'mitting Equipment; Nationally known lines. Quality approved parts for all radio construction kits. Buy from the World's Largest Stock at Lowest WHOLESALE Prices and save Money. Send coupon for your FREE copy of radio's latest, greatest Bargain Book.

**RUSH THIS COUPON FREE!**  
Parts can be supplied for any kit described in this magazine  
Wholesale Radio Service Company  
100 Sixth Ave., Dept. SW-16, New York, N.Y.  
 Please rush FREE copy of your new 196 Page Catalog for 1936, listing over 50,000 items.  
Name.....  
Address.....  
City..... State.....

**AMERICAN MICROPHONE CO.**  
A California Corporation  
Microphones of Quality  
Condenser, Carbon, & Crystal Microphones.  
New catalogue available upon request.  
1915 South Western Avenue, Los Angeles, Calif.

Please mention SHORT WAVE CRAFT when writing advertisers



the new price of **15¢** makes  
**SHORT WAVE LISTENER**  
 the leading short-wave fan magazine

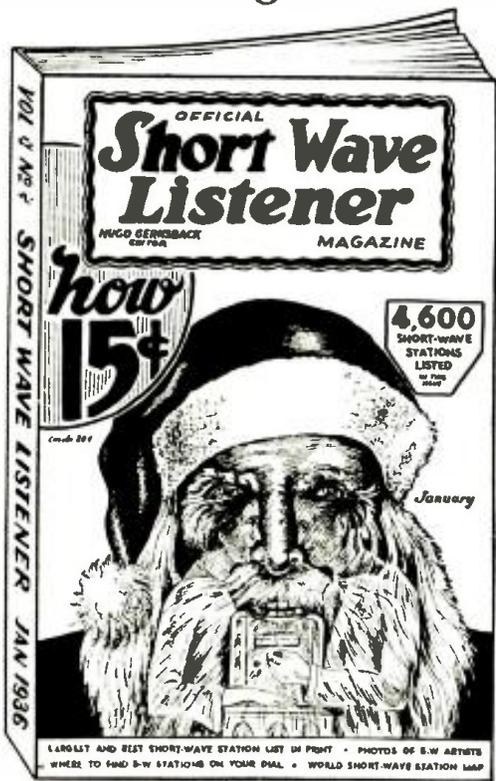

WE ARE happy to present to the thousands of short wave fans this magazine which enthusiastic readers of SHORT WAVE CRAFT have urged us to publish. It is the most complete book of its kind ever published.

**4600  
 SHORT WAVE STATIONS**

It contains the largest listing of short wave stations in the world, a much larger list than the list published monthly in SHORT WAVE CRAFT, or any other magazine. There are so many short wave stations, which normally cannot be included in any monthly magazine list, but frequently you hear these calls and then you wish to know from where they originate. THE OFFICIAL SHORT WAVE LISTENER gives you this information, besides a great deal more which you must have.

It is totally different in get-up and contents from any other short-wave fan magazine.

It contains a great variety of material, all of which is essential to the short-wave listener.

IT IS NOT A TECHNICAL MAGAZINE. It is designed for the short-wave listener only. The January, 1936, issue, now on all newsstands, contains the material you find listed below.

**ASK YOUR NEWS DEALER  
 FOR A COPY OF THIS NEW  
 SHORT-WAVE MAGAZINE**

*Features in the January Issue*

How to Obtain Verifications. Short Wave "Map" of the World. Latin-American S-W Stations by H. S. Bradley. Latest Reports from Short-Wave Listeners. How to Listen to Police Calls. New "Catches" Among S-W "Foreigners". Hints for Improving S-W Listening. "Grand List" S-W Stations of the World. The Listener Asks—"Questions and Answers". "Best" S-W Station List. Silvery Trophy Cup for "Best Listening Post" Photo. Up-to-date List of "Police Calls."

From this you will see that the magazine has been designated as a companion magazine to SHORT WAVE CRAFT.

**P. S.** —If you cannot get the magazine at your newsstand due to sell-out, send 15c in cash, stamps, or money order, and we will send the magazine to you direct, prepaid.

If you are now a reader of SHORT WAVE CRAFT magazine, you will not wish to be without THE OFFICIAL SHORT WAVE LISTENER MAGAZINE. It will help you tremendously in your short wave logging at all times, and will give you priceless and invaluable information, such as you cannot get anywhere else. THE OFFICIAL SHORT WAVE LISTENER MAGAZINE, in other words, is a necessity.

**OFFICIAL SHORT WAVE LISTENER MAGAZINE**  
 99 HUDSON STREET  
 NEW YORK, N.Y.

Please mention SHORT WAVE CRAFT when writing advertisers

**An All-Electric Amplifier and Power Supply**

(Continued from page 532)

and can recommend its operation most highly. As a matter of fact, it can be used with almost any earphone receiver, including the small battery sets and it gives excellent volume and tone quality. It can also be used for many other purposes where a small but effective amplifier is required.

Actually it adds two powerful (self-contained power supply) audio stages to the original receiver. In the first stage, the 6C6 tube is coupled to the receiver by resistance-coupling. The 75,000-ohm grid resistor is replaced by a 75,000-ohm potentiometer which serves as a *volume control*. The 6C6 tube is also coupled to the output stage by resistance-coupling. The 43 type pentode tube is used in the output stage. The rectifier is a 25Z5 tube which provides rectified current for the 6C6 and the 43 tubes and also for the dynamic speaker field. A small choke bypassed at either end by electrolytic condensers provides more than sufficient filtering to eliminate hum when the amplifier is used on A.C. The standard Universal A.C.-D.C. circuit is employed so that the amplifier will work just as well on *alternating* current as on *direct* current. The filaments of the three tubes are connected in series and the 300-ohm limiting resistor is contained in the line cord. By connecting the .01 mf. cartridge condenser and the 75,000-ohm variable resistor in series between the plate of the 43 and ground, an excellent *tone control* is obtained.

In constructing the *all-electric* amplifier a metal chassis is used similar to the one used in making the sets previously described. The only component mounted on top of the chassis is the choke, CH-1. The three six-prong sockets are secured to the chassis and the small fixed resistors and fixed condensers are soldered in place beneath the chassis during the wiring. In the amplifier illustrated, the entire outfit has been mounted in a small cabinet with the volume control, tone control, and dynamic speaker fastened to the front panel of the cabinet.

The wiring is so easy to do that it is hardly necessary to go into any detail regarding this. It is suggested, however, that the filaments be wired in first with the other wiring following in natural sequence. All ground returns may be connected directly to any portion of the metal chassis. This eliminates the use of a single ground return wire reducing the amount of wiring and resulting in a better-looking job.

The *all-electric* amplifier is the easiest thing in the world to connect up and use. First of all, the line cord is plugged into an A.C. or D.C. source. If used on direct current, it may be necessary to reverse the plug before the amplifier will operate as it only works in the one way on direct current. After the tubes have had a chance to warm up, place a hand on the flexible input wire and a distinct audio hiss will be heard. Now, put the receiver into operation and attach the input wire to one of the earphone jacks. Experiment will show which is the correct wire; as soon as the right one is attached, the amplifier works.

**List of Parts for Amplifier**

- C1—.01 mf. cartridge condenser
- C2—.01 mf. cartridge condenser
- C3—.01 mf. cartridge condenser
- C4—10 mf. 25 volt cartridge electrolytic condenser
- C5, C6—dual electrolytic condenser, 8 mf. each section
- C7—.2 mf. cartridge condenser
- R1—75,000-ohm Electrad potent. with switch.
- R2—10,000-ohm, 1-watt IRC Resistor
- R3—¼ meg., ½ watt IRC Resistor
- R4—1 meg. ½ watt.
- R5—600-ohm wire-wound resistor
- R6—75,000-ohm Electrad rheostat
- R7—300-ohm, 50-watt line cord
- CH1—300-ohm, 20-henry choke
- V1—6C6 tube
- V2—43 tube
- V3—25Z5 tube
- 3—6-prong sockets
- 1—screen grid clip
- 1—5" Dynamic speaker output transformer for 43 tube.
- 1—metal chassis, hardware.

**Short Wave Scout News**

(Continued from page 548)

HRN—Tegucigalpa, Honduras, 5.87 meg. is a new Honduras station heard in the evenings with strong signals. Every Sunday evening at 8:30 p.m., E.S.T.

XBHQ—Mexico City, Mexico, D.F., 11.00 meg. This is a new station which is putting a very strong signal into this part of the country. They are heard from 5—12 p.m., E.S.T. daily. They request reports to be sent to P.O. 2825, Mexico, D.F.

OPL—Leopoldville, Belgian Congo, can be heard daily at 11:45 a.m., E.S.T., calling station ORG at Bruxelles. OPL is on 20.04 meg, and is heard well when conditions prevail. A man with a low gruff voice calls out "Allo Bruxelles," and then converses in Belgian.

VWY—Poona, India, 17.54 meg. This station calls London daily between 7:30 and 8:00 a.m., E.S.T., every day, and when no calls are ready for them they immediately close down. They are heard very well in this part of the country, and are very clear. They use English entirely, and when closing down they announce as "V-W-Y."

JVT—Tokio, Japan, 6.75 meg, is now heard on mornings from 5—8 a.m., E.S.T., with very good volume. This station replaced the famous JVM. However, JVM is used to broadcast the "Overseas" program which is broadcast every Monday and Thursday from 4—5 p.m., E.S.T. on 10.74 meg.

TG2X—Guatemala City, Central America, 5.94 meg., is a new station heard in Guatemala. They are slightly higher in frequency than HJ4BE and are heard in the evenings from 8—12 p.m., E.S.T. They identify themselves as "Los Voz del Nacional Policiano," or in English, Voice of the National Police.

TYA—Paris, France, 12.22 meg., can be heard calling the ship Normandie daily from 1—3 p.m., E.S.T. Call Normandie in English.

YVQ—Maracay, Venezuela, 6.67 meg. This station which is a phone station is now broadcasting musical programs every Saturday night from 8—9 p.m., E.S.T. They announce in English after every selection.

PHI—Huizen, Holland, 11.74 meg. This station is now operating on this frequency, and is heard with very good volume and excellent program merit. This station was previously on 17.77 meg. They will verify all reports, and English is used freely. They broadcast from Wednesday to Monday inclusive from 8—10:30 a.m., E.S.T.

LSN-3—Buenos Aires, Argentina, is a new station which was heard on 9.88 meg., relaying broadcast station LR1. They are at Buenos Aires, and reports should be sent to LR1. They broadcast an English program.

ZBW—Hong Kong, China, 8.75 meg. This station is heard quite well when conditions prevail from 5—7 a.m., E.S.T. They will be heard much better as winter pushes in. Reports of reception should be sent to Miss Betty Billing, Hong Kong Broadcasting Service, Post Office Box 200, Hong Kong, China.

PLP—Bandoeng, Java, 11.00 meg., is heard every Sunday morning from 5—9 a.m., E.S.T., broadcasting music, and announcing in English. They are the best-heard station on Sunday morning, and broadcast in parallel with PMN also at Bandoeng, on 10.26 meg.

ETB—Addis Ababa, 12.27 meg., was heard on Sunday, Oct. 13, 1935, at 1:00 p.m., E.S.T., calling the United States. They were heard until 1:35 p.m., E.S.T., frequency 12.275 kilocycles.

ZLT—Wellington, New Zealand, can be heard on 11.05 meg., calling and speaking to VLZ of Australia at 12:30 a.m., E.S.T. in the mornings.

Edward G. Schmeichel,  
2939 South Loomis St.,  
Chicago, Ill.

**Official Listening Post, Richmond, Va., Reports**

Call	Location	K.C.	Remarks
COCH	Havana, Cuba	9.428	Very good
EAQ	Madrid, Spain	9.860	Loud and clear
DIQ	Germany	10.400	Special for Denmark
HBP	Geneva, Switzerland	7.799	Very good
HLB	Geneva, Switzerland	9.995	Fading at times
RNE	Moscow, Russia	12.000	Fair-to-good—QRM
CT1GO	Paredo, Portugal	6.198	Very poor
HAT4	Budapest, Hungary	9.125	Talk and Music
HKY	Bogota, Colombia	8.795	Music—good
HHH	Dominican Republic	6.800	Good—QRM times
RNE	Moscow, Russia	12.000	Very good
RADIO	Colonial Paris, France	11.890	Very weak
2R0	Rome, Italy	11.810	Fair
2R0	Rome, Italy	9.635	Good
DJD	Berlin, Germany	11.770	Good
TIEP	San Jose, Costa Rica	6.710	Very good
W7BC1	Washington State	20 Mts.	W6BJ
T12R	Costa Rica	20 Mts.	CQ
HLB	Geneva, Switzerland	9.995	Good
HBP	Geneva, Switzerland	7.799	Good
CRCX	Bowmanville, Ont., Can.	6.090	Very good
WMA	Lawrenceville, N.J.		Working England
LU6AP	Argentina	20 Mts.	Working W3BPH
EAQ	Madrid, Spain	9.860	Very good

WCG	New York	10,500	Testing
HPF	Panama City		Calling WNC
WQP-			
WCG	New York		Testing HBJ
HBJ	Geneva, Switzerland		Testing WCG
HP5J	Panama City, Panama	9.590	Very good
ORK	Brussels, Belgium	10,330	Very good
WEN-			
WEA	New York		Special to DIQ
			A. B. Rice,
			Richmond, Va.

**Ohio Report from E. M. Heiser Brecksville, Ohio—Time is E.S.**

Date	Time	Call	K.C.	Location	Remarks
Sept. 21	7:20 p.m.	HJ4ABA	11,700	Columbia, S.A.	Very loud and clear
21	7:30	EAQ	9,860	Spain	Very loud. Some noise
21	7:35 a.m.	GSC	9,580	England	Very loud
22	8:45	LSL	21,160	Argentina, S.A.	Very loud
22	8:50	PHI	17,775	Holland	Very loud, clear and steady
22	7:00 p.m.	DJD	11,770	Germany	Very, very loud
22	7:15	GBS	12,150	England	Very loud. Working WMA
22	7:20	GSC	9,580	England	Very, very loud and clear
22	7:25	DJA	9,560	Germany	Very loud
22	7:25	DJN	9,540	Germany	Louder than DJA
22	7:30	GSB	9,510	England	Very, very loud
Oct. 17	7:10	EAQ	9,860	Spain	Steady, but weak
17	7:20	WIXAL	6,040	U.S.	Very loud, but bad whistle
18	7:20	2R0	9,635	Italy	Fair, faded
21	7:50	CRCX	6,090	Canada	Very loud and clear

Edward M. Heiser,  
Route 2, Box 124, Brecksville, Ohio.

**Report From Walter A. Jasiorkowski, 964 West Manitoba St., Milwaukee, Wis.**

● ALTHOUGH conditions during the month of October were not exactly excellent, 140 short-wave broadcasters were logged.

**Europe**

SPW, Warsaw, Poland, 13.635 meg.; a new 10-kilowatt station heard testing the first two weeks of October from 11:30 a.m. to 12:30 p.m. with music. Announcements were made by a man, who spoke in Polish, and a woman, who announced in French, English, and German. Reports were requested sent to "Polskie Radio," Warszawa (Warsaw), Poland.

**Central America**

XEFT, Vera Cruz, Mexico, 6.121 meg.; "La Voz de Vera Cruz." This 20-watter will dedicate a special program to us and the Milwaukee Journal, Nov. 15, 11:30 p.m., since ours was the first report the station had received regarding their short-wave transmissions. They relay XEFT daily 7:30 p.m., to 12:30 a.m.

XEUW, Vera Cruz, Mexico, 6.028 meg.: although they announce their frequency as 6.02 meg., the station is actually heard on 6.028 meg. relaying XEU, and both stations at times relay XEW, 7 p.m. to 12:30 a.m.

XBHQ, Mexico City, Mexico, 11.00 meg.; owned and operated by the Bank of Mexico, this 500-watter is heard daily 4 p.m. to 1 a.m. relaying various long-wave stations. Ricardo Bravo of the old XETE, and operator of Amateur Station X1Q, is chief engineer.

YNLF, Managua, Nicaragua, 5.91 meg.; this 100-watter can't make up its mind; heard irregularly 7 to 11:30 p.m. anywhere between 5.88 and 5.99 meg., but lately has settled on 5.91 mc.

TG2X, Guatemala City, Guatemala, 5.94 meg.; "La Voz de Policia Nacional," heard irregularly between 7 and 12 midnight.

TGW, Guatemala City, Guatemala, 6.00 meg.; "Radiodifusora Nacional"; power 200 watts, heard Sundays 2 to 4 a.m.

HRN, Tegucigalpa, Honduras, 5.875 meg.; "La Voz de Honduras" is a new one heard daily 8-10 p.m. and Sundays with an English program 10-10:30 p.m.

HRP1, San Pedro Sula, Honduras, 6.038 meg.; this station was heard once on that frequency calling various Latin stations at midnight. Their broadcast schedule is irregular, 7 to 9 p.m.

TIPG, San Jose, Costa Rica, 6.41 meg.; "La Voz de La Victor"; broadcasts daily 6 to 11:15 p.m. with 1 kw. power.

HP5J, Panama City, Panama, 9.61 meg.; "La Voz de Panama"; this station is poor here and is not received on its announced frequency of 9.59 meg. Broadcasts daily 7 to 10:30 p.m.

**Lafayette 5 METER Superhet Receiver**



**6 Tubes**

- ★ Using New 954 Acorn Pentode Tubes in R.F. and Autodyne Detector stages.
- ★ Reduced Thermal Noises, Low Noise Level, Increased Sensitivity.

Lafayette engineers offer another scoop in presenting this 5 meter receiver in which the noise level is practically negligible due to the use of the acorn pentode type 954 tubes. Ample gain is provided for reception of all but the weakest signals on loud speaker, while new type high-reduction, noiseless diodes are used. Here is a job that will appeal to every amateur, particularly those accustomed to the use of super-regenerative receivers in which "rush" is an outstanding and annoying noise characteristic.

SWY 21934—Lafayette 5 meter "Acorn" Superhet receiver complete in cabinet less tubes, power supply and speaker **\$26.50**

BRANCHES AT  
CHICAGO—901 W. Jackson Blvd.  
ATLANTA—430 W. Peachtree St.  
NEWARK, N.J.—219 Central Ave.  
BRONX, N.Y.—342 E. Fordham Rd.

**CLIP & MAIL TODAY**

Wholesale Radio Service Co., Inc.,  
100 Sixth Ave., Dept. SWX-16, N.Y. City  
I enclose \$..... for order described in attached letter. Check here if interested in our Special New Ham Catalog. It's FREE

Name .....

Address .....

City ..... State .....

**30-15,000 CYCLES ±1 DB**  
**Alloy Core MULTIPLE COIL**  
**Hum-Free Construction**  
**AUDIO TRANSFORMERS** Each Net \$3.75  
**In Hum-Free Alloy Cases**  
Single or Push-Pull High and Low Equalizers in Alloy Case Each net \$1.50 Hum-Proof Alloy Case... .75  
Filament Transformers, Modulation, Special Coils wound to order. 24 Hour Service.  
**ALLOY TRANSFORMER CO.**  
1355 Liberty St., New York City

**ARE YOU AN AMATEUR ? A DEALER ? A SERVICEMAN OR WE STOCK EXPERIMENTER**

**A COMPLETE LINE OF STANDARD RADIO EQUIPMENT**  
1936 catalog on request to those living in Ohio, Pennsylvania, W. Virginia only  
**CAMERADIO**  
601-3 GRANT ST., PITTSBURGH, PA. 30 TWELFTH ST. WHEELING, W.VA.  
Established 1919

**RADIO ENGINEERING**,  
broadcasting, aviation and police radio, servicing, marine radio telegraphy and telephony, Morse telegraphy and railway accounting taught thoroughly. Engineering course of nine months' duration equivalent to three years of college grade work. All expenses low. Catalog free. School established 1874.  
Dodge's Institute, Turner St., Valparaiso, Ind.

Please mention SHORT WAVE CRAFT when writing advertisers

# Stop!— GREATEST

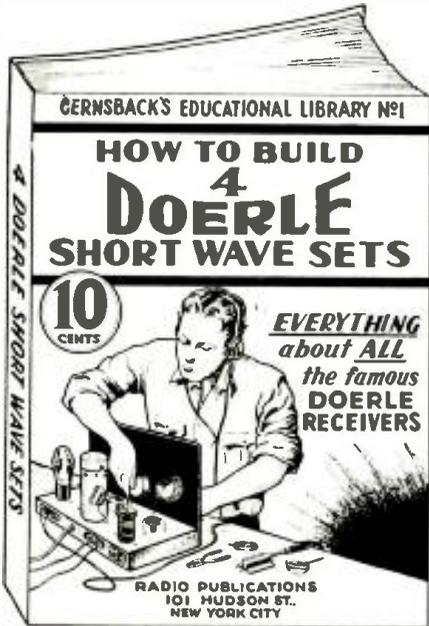

LITERALLY thousands of readers have built the now famous DOERLE Short Wave Radio Receivers. So insistent has been the demand for these receivers that all available literature, including back numbers of SHORT WAVE CRAFT, have long been exhausted.

For the thousands of readers who wish to build any, or all of the many approved DOERLE Short Wave sets, this book has been specially treated.

### HOW TO MAKE FOUR DOERLE SHORT WAVE SETS

Contains EVERYTHING that has ever been printed on these famous receivers. Four of the most popular sets are described herein. These are the famous sets that appeared in the following issues of SHORT WAVE CRAFT: "A 2-Tube Receiver that Reaches the 12,500 Mile Mark," by Walter C. Doerle (Dec., 1931-Jan., 1932). "A 3-Tube Signal Gripper," by Walter C. Doerle (November 1932). "Doerle 2-Tube" Adapted to A. C. Operation," (July 1933). "The Doerle 3-Tube Signal-Gripper Electrified," (August 1933) and "The Doerle Goes 'Band-Spread,'" (May, 1934).

Due to a special arrangement with SHORT WAVE CRAFT, we now present a complete set as well as compact 32-page book with stiff covers, printed on an extra heavy grade of paper, with numerous illustrations. Nothing has been left out. Not only are all the DOERLE sets in this book, but an excellent power pack if you wish to electrify any of the DOERLE sets. It is also described. A wealth of detail is presented in this book despite its ridiculously low price—and, believe it or not, it contains over 15,000 words of legible new type. Everything has been brought up to date: it isn't merely a reprint of what was printed originally, but any improvements on the original sets that were made by readers and various laboratories have been incorporated in this most up-to-date book.

And at the extraordinary price of 10c you cannot possibly go wrong. Despite its low cost, our usual guarantee goes with this book as well.

**IF YOU DO NOT THINK THAT THIS BOOK IS WORTH THE MONEY ASKED FOR IT, RETURN IT WITHIN TWENTY-FOUR HOURS AND YOUR MONEY WILL BE INSTANTLY REFUNDED.**

There has never been such a wealth of data published in a low-priced radio book of this type in the history of the radio publishing business.

Take advantage of the special offer we are making and use the coupon below.

**RADIO PUBLICATIONS**  
101 Hudson Street  
New York, N. Y.



RADIO PUBLICATIONS (No. 1) SW-1-36  
101 Hudson Street  
New York, N. Y.

Please send immediately your book HOW TO MAKE FOUR DOERLE SHORT WAVE SETS, for which I enclose 10c (coin or U. S. stamps acceptable). Book is to be sent prepaid to me.

Name \_\_\_\_\_  
Address \_\_\_\_\_  
City \_\_\_\_\_ State \_\_\_\_\_

### West Indies

CO9JQ, Camaguey, Cuba, 8.10 megas.; broadcasts irregularly 8 to 10 p.m. with 150 watt power, should be on 8.665 megas.

CO9GC, Santiago de Cuba, 6.15 megas.; this station not often heard because of its wavelength, which coincides with that of W8XK. Heard here 6 to 8:30 p.m.

HI1J, San Pedro Macoris, D.R., 5.865 megas.; heard irregularly between 6 and 9 p.m. on its normal frequency; this station was formerly on 5.78 and gives its power as 42 watts.

HI1A, Santiago de los Caballeros, 6.16 megas.; another one of those Latins with the ethereal wanderlust has settled on 6.16 megas. but should be on 6.188 megas.; this 50-watter heard here irregularly 5:40 to 10:30 p.m.

### South America

HJ1ABC, Quibdo, Colombia, 6.008 megas.; "La Voz de Choco"; heard irregularly 8 to 11 p.m.

HJ1ABJ, Santa Marta, Colombia, 6.006 megas.; "La Voz de Santa Marta"; daily except Sundays 6 to 11 p.m. Announced power as 600 watts.

HJ4ABC, Pereira, Colombia, 6.08 megas.; this station is now heard daily 7 to 9:30 p.m. but interference is noted from W9XAA.

HJ4ABD, Medellin, Colombia, 5.76 megas.; originally on 6.06 megas, this station shifted to 5.76 and is heard daily 6 to 11 p.m.

HJ4ABJ, Ibague, Colombia, 6.46 megas.; "Ecos del Combeina," heard daily 8 to 10:30 p.m.

HJ2ABD, Bucaramanga, Colombia, 5.98 megas.; this is a new station heard testing between 10 p.m. and 1 a.m.

HJ5ABC, Cali, Colombia, 6.155 megas.; daily 7 to 10 p.m.; styled "La Voz de Colombia," uses chimes similar to those used by NBC.

YV2RC, Caracas, Venezuela, 5.80 megas.; a change from 6.112 megas. was made early in October.

YV8RB, Barquisimeto, Venezuela, 5.88 megas.; "La Voz de Lara"; this one is heard daily now, 6 to 10:30 p.m.

HC1T, Ambato, Ecuador, 7.27 megas.; heard broadcasting irregularly at 10 p.m.

HC2CW, Guayaquil, Ecuador, 8.30 megas.; "Ondas del Pacifico"; this station was originally heard on 8.62 megas. but slipped down to 8.30 and is heard daily 8 to 11 p.m.

HC1B, Quito, Ecuador, 8.46 megas.; "La Voz de los Andes" also got the "bug" and shifted to 8.16 megas. from 8.214; heard daily ex. Mondays 7:30 to 11 p.m.

PRA8, Pernambuco, Brazil, 6.05 megas.; "A Voz do Norte" which is supposed to be on 6.04 is now on 6.05 daily 4:30 to 8:30 p.m.

CFE, Santiago de Chile, 10.67 megas.; this 2-kilowatt now broadcasts daily 7-7:15 p.m. and also Thursdays and Sundays 8:30 to 9 p.m.

### Asia

JVN, Tokio, Japan, 10.66 megas.; now broadcasts daily 12 to 1 a.m. with English announcements; fairly good here.

JVM, Tokio, Japan, 10.74 megas.; broadcasts Thursdays and Mondays 4 to 5 p.m. simultaneously with JVP, 7.51 megas.; received here well.

JVT, Tokio, Japan, 6.75 megas.; now broadcasting mornings 2:15 to 7:40 a.m. in place of JVM; fairly good here.

JVII, Tokio, Japan, 14.60 megas.; heard testing several times at 9 p.m. but very weak.

P.P. Bandoeng, Java, 11.00 megas.; and PMN, Bandoeng, 10.26 megas., are both heard Sunday mornings 4:30 to 8 a.m.

ZRW, Hongkong, China, 8.75 megas.; extremely weak here, this station shows signs of improving as winter approaches; heard irregularly 5 to 8 a.m.

### North America

KIO, 11.68 megas., and KKH, 7.52 megas., Kahuku, Hawaii; these stations were as strong as "locals," relaying special programs to CBS Monday nights.

### Frank Hogler, Brooklyn, N.Y., Reports

HAS3—15.370 and HAT4—9,125 kc., Budapest, Hungary, is heard fine lately, Sundays 9 to 10 a.m. and 6 to 7 p.m. E.S.T., respectively.

HRL—9595 kc., Geneva, Switzerland, is heard broadcasting to Australia around midnight, Sundays.

KTO—18,450 kc., Manila, Philippines, was heard calling and testing with Tokyo, Japan, around 6:15 to 7 p.m. E.S.T.

Most South American stations are coming in fine, as soon as it gets dark; that's around 5.500 kc. to 7.400 kc.

Frank Hogler,  
222 Wyckoff Ave.,  
Brooklyn, N.Y.

### "Listening In" at Freeport, Pa.

TIGP, 6.40 meg., puts in a very nice signal schedule, 8:30 p.m. to 11:30 p.m., E.S.T.

DJC, 6.02 meg., and HJ3ABH, 6.01 meg., cause heterodyne whistles on each other. At times neither one can be heard on account of their wave-lengths being about the same.

YVQ, 6.67 meg., is heard very well Saturdays; schedule is 8 to 8:30 p.m. Saturdays, but they may be heard before, and after the said time.

HIH, 6.81 meg., is operating on a new schedule. Daily 7:30 to 9:00 p.m. Sundays 3 to 4 a.m. and 4:15 to 6:00 p.m.

TIRCC, the only Catholic stations in Costa

# Look!! 10c BOOKS

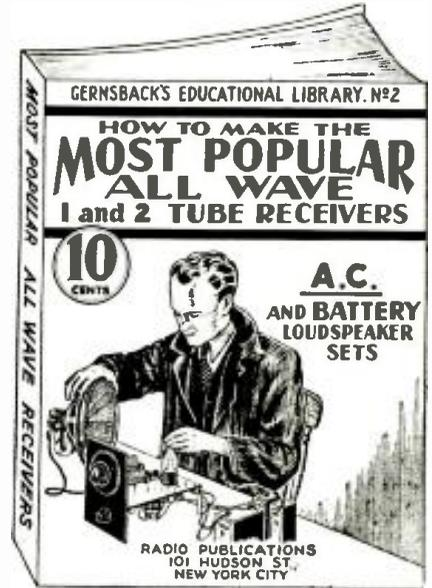

THERE has been a continuous demand right along for a low-priced book for the radio experimenter, radio fan, radio Service Man, etc., who wishes to build 1- and 2-tube all-wave sets powerful enough to operate a loudspeaker. Sets of this type are always intensely popular with all classes of people who not only wish to amuse themselves to see how good a set they can build with a single or two tubes, but frequently such sets are important for special purposes, particularly where a good little set is required and where space is at a premium. For the thousands of readers who wish to build such sets, this book has been especially published.

### HOW TO MAKE THE MOST POPULAR ALL-WAVE 1 and 2-TUBE RECEIVERS

This book contains a number of excellent sets some of which have appeared in past issues of RADIO-CRAFT, and have been highly successful. These sets are not toys but have been carefully engineered. They are not experiments. To mention only a few of the sets the following will give you an idea.

● The Megadyne 1-Tube Pentode Loud-speaker Set, by Hugo Gernsback. ● Electrifying The Megadyne. ● How To Make a 1-Tube Loud-speaker Set, by W. P. Chesney. ● How To Make a Simple 1-Tube All-Wave Electric Set, by W. Green. ● How To Build a Four-In-Two All-Wave Electric Set, by J. T. Bernsley, and others. Not only are all of these sets described in this book, but it contains all of the illustrations, hookups, etc.—the book, in fact, contains everything. Nothing at all has been left out. A wealth of important detail is presented in this book that will make you wonder how we can do it at the price.

And believe it or not, the book contains over 15,000 words of new legible type. The book is thoroughly modern and up-to-date. It isn't just a reprint of what was printed before. All the latest improvements have been incorporated into the sets.

Remember that this book sells at the extraordinary low price of ten cents; you can not possibly go wrong in buying it. Despite its low cost, our usual guarantee goes with this book as well!

**IF YOU DO NOT THINK THAT THIS BOOK IS WORTH THE MONEY ASKED FOR IT, RETURN IT WITHIN TWENTY-FOUR HOURS AND YOUR MONEY WILL BE INSTANTLY REFUNDED.**

There has never been such a wealth of data published in a low-priced radio book of this type in the history of the radio publishing business.

Take advantage of the special offer we are making and use the coupon below.

**RADIO PUBLICATIONS**  
101 Hudson Street  
New York, N. Y.



RADIO PUBLICATIONS (No. 2) SW-1-36  
101 Hudson Street  
New York, N. Y.

Please send immediately your book "HOW TO MAKE THE MOST POPULAR ALL-WAVE 1- AND 2-TUBE RECEIVERS," for which I enclose 10c (coin or U. S. stamps, acceptable). Book is to be sent prepaid to me.

Name \_\_\_\_\_  
Address \_\_\_\_\_  
City \_\_\_\_\_ State \_\_\_\_\_

Please mention SHORT WAVE CRAFT when writing advertisers

Save \$1.98

Just as Long as the Supply  
Of This Book Lasts!

**THE ONE AND ONLY  
ENCYCLOPEDIA on  
SHORT WAVES**

By C. R. Leutz and R. B. Gable

384 Pages — Over 345 Illustrations  
Bound handsomely in red linen. Stiff covers. Size 6x9"

"SHORT WAVES" is written by Leutz and Gable, two foremost radio authorities. You will remember Charles R. Leutz as one of the pioneers in radio, also designer and manufacturer of the famous LEUTZ Transoceanic Receivers. Mr. Robert Gable owned and operated one of the finest low power broadcasting stations in the country. He is well known as an experimenter and research worker in scientific fields.

Considering the value of this book for data alone, its cost should really be more than originally asked. But when you see the illustrations in the book you will marvel at how this book could be sold for ONE DOLLAR. It originally sold for \$2.98.

The book is printed on a very expensive super-calendered paper. It contains 384 pages with over 345 photographic illustrations and diagrams. The supply of these books is not expected to last long. Once they are gone no additional copies will be available. **ORDER NOW**—be sure to tell your friends about this remarkable book value. Send the coupon today for your copy of "SHORT WAVES" by Leutz and Gable.

345 Photographic  
Illustrations  
  
384 Pages

This book  
originally sold  
for \$2.98

"SHORT WAVES" is the most important and comprehensive volume of short-waves ever published. This book has EVERYTHING on short-waves—it literally contains a complete education on short-waves.

Partial Contents of  
"SHORT WAVES"

- HISTORICAL REVIEW
- SHORT WAVE PROPAGATION
- COMMERCIAL RADIO TELEPHONY AND TELEGRAPHY
- SHIP TO SHORE RADIO TELEPHONY
- DIRECTIONAL ANTENNAE TELEVISION
- AIRCRAFT RADIO EQUIPMENT
- SHORT WAVE BROADCAST RECEIVERS
- ULTRA SHORT WAVES (Medical and Surgical Applications)
- AMATEUR SHORT-WAVE EQUIPMENT

Don't forget that this comprehensive volume is sold on a MONEY-BACK GUARANTEE. If you are not satisfied with it, return it within three days for refund. Use the coupon below for ordering your copy of "SHORT WAVES" by Leutz and Gable.

**RADIO PUBLICATIONS**  
103 Hudson St. New York, N. Y.

MAIL COUPON TODAY!

RADIO PUBLICATIONS, Dept. SWC-I-36  
103 Hudson Street, New York, N. Y.

(Gentlemen: Enclosed you will find my remittance of One Dollar (\$1) (cash, money order or new U. S. stamps) for which send me One Copy of "SHORT WAVES" by Leutz and Gable. I understand this book may be returned to you within three days if I am not completely satisfied and my money refunded.)

NAME .....

ADDRESS .....

CITY ..... STATE .....

(include 15c extra to cover mailing charges; 25c foreign countries)

Rica, on 6.55 meg., and HI4D, 6.61 meg. interfere with each other very much.

CO9GC, 6.15 meg., is always heard very good. HJ4ABD, 6.05 meg., and W8XA1, 6.06 meg., interfere with each other sometimes, mostly at from 6 to 7 p.m. 2V8XAL cannot be heard; covered up entirely by HJ4ABD.

HIZ, on 6.31 meg., is heard very well. Tune for them on Saturdays, 10:40 to 11:40 p.m.

YV2RC is operating on 5.80 meg. The change is for the better; their old wavelength was pretty crowded; the new wavelength is heard fine.

IQA, Italy, on 14.6 meg. may be heard around 3 p.m. sending music for Buenos Aires.

A new Mexican station, XBJQ, is operating on about 11.12 meg.

Radio Coloniale on 15.25 meg. is now coming in fine.

HAS3, 15.37 meg., and HAT4, are heard fairly well on Sundays.

2RO, Rome, Italy, on 9.61 meg., now broadcasts a "news" bulletin every night at 6 p.m., except Sundays.

RIM, 15.25 meg., has been phoning almost every morning until 7 a.m.

RKI, 15.04 meg., has been relaying programs to N.B.C. on Sundays, irregular.

YVR, 18.30 meg., may be heard phoning DFB, 17.52 meg., at about 10 a.m., nearly every morning.

DJE on 17.76 meg., is being heard better now that the weather is getting colder.

VK2ME, 9.59 meg., is very fine till 8:30 a.m. Sundays.

Angelo Centanino,  
Box 516,  
Freeport, Pa.

Report from Rhode Island

● THE stations heard on 19 meter band are: PCJ, Holland; GSF, England; HVJ, Vatican City, Italy; 2RO, Rome, Italy; DJB, Germany; WNC, Hialeah, Fla.

On 25 meters, RNE, Russia; W8XK, Pittsburgh, Pa.; W2XE, New Jersey; GSE, and GSD, England.

On 31 meters, EAQ, Madrid, Spain; W3XAU, Philadelphia, Pa.; 2RO, Rome, Italy; DJA, Germany; GSB, England; VK2ME, Sydney, Australia; CTIAA, Lisbon, Portugal; HHL, Switzerland; TIRA, Costa Rica.

On 49 meters, CJRO, Winnipeg, Can.; VE9HX, Halifax, Nova Scotia; W9XF, Illinois; W9XAA, Chicago, Ill.; H54ABC, Colombia, S.A.; HJ4ABB, Colombia, S.A.

Spencer E. Lawton,  
15 Hillside Ave.,  
Westerly, R.I.

News from Tulsa, Okla.

● LISTENING here at this post has been very good for the past month. All of the European "locals" heard daily if tuned for. I wish to say in particular that GSB 9.51 mc. and GSD 11.75 mc. may be heard extra good here at 2:15 a.m., E.S.T. for an hour or two, especially GSB. Also DJA at 1:30 a.m., E.S.T., may be heard fairly good sometimes. ORK Brussels, heard a number of times on 10.33 mc. at 2:30 p.m., good signal, HAT4, Budapest, heard on Sundays at 6 to 7:00 p.m., E.S.T. EAQ, Madrid, Spain, is now heard on the air as late as 9:30 p.m., E.S.T. RIO, Bakou, U.S.S.R., phone heard at 11:00 p.m. to 12:00 midnight. They call Moscow at this time. TYA, Paris, 12.22 mc. irregular during the day, calling the S.S. Normandie.

Asia

JVF, Nazaki, Japan, 15.61 mc., 9:00 p.m., E.S.T.—Good signal.

JVM, Nazaki, Japan, 10.74 mc., 11:30 p.m., E.S.T.—Good signal.

JVN, Nazaki, Japan, 10.66 mc., 12:05 a.m., E.S.T.—Good signal.

KTO, Manila, P.I., 16.24 mc., 6:55 p.m., E.S.T.—Fair signal.

PJE, Bandoeng, Java, 18.83 mc., 7:30 p.m., E.S.T.—Fair signal.

Australia

VK2ME, Sydney, on 9.59 mc. Sunday morning 12:00 to 2:00 a.m., E.S.T.

VLK, Sydney, on 10.52 mc. heard most any time after 1:00 a.m., E.S.T.

VK3LR, Melbourne, 2:00 a.m. and irregular after 12:00 a.m., E.S.T.

Africa

SUV, Cairo, Egypt, 10.04 mc. irregular during the afternoon.

North America

WVD, Seattle, Wash., irregular during the evenings and early a.m. It is on 8.66 mc. Strong signal. This station is a U.S. Army signal station. XBJQ, a new station in Mexico City, heard on 11.00 mc. The address of this station is P.O. Box 2825.

WIOXL, ground station of "stratosphere" flight, was picked up here on about 47 meters at 5:45 p.m., E.S.T., one afternoon.

CO9JQ, Camaguey, Cuba, on 8.65 mc. A new Cuban station, received very good.

South America

HP5J, Panama City, 5.59 mc.; YV5RMO, Maracaibo, Ven.

HJ4ABE, Medellin, Colombia.

CEC, Santiago, Chile.

LSN-LSX, HJB and others received O.K.

Wade Chambers,  
Tulsa, Okla.

"Pleased"

with the Hi-Fidelity  
of the Model 1750—the  
Reproducer with the New



It's What OTHERS say  
that COUNTS!

Read the following letter:

Pass Christian, Miss., Oct. 14, 1935  
"Gentlemen:  
Recently I received one of your new No. 1750 Para-Curve Reproducers and I am more than pleased with its Hi-Fidelity performance. Please rush 1 Model 1750 to match a new Philco Model 650X."  
Eldridge A. Helwick.

\$17<sup>50</sup>  
LIST

Write for complete catalog, dealer's discount and name of nearest distributor. Wright-DeCoster distributors are always anxious to cooperate with you.

**WRIGHT-  
DECOSTER,  
Inc.**

2257 University Ave.,

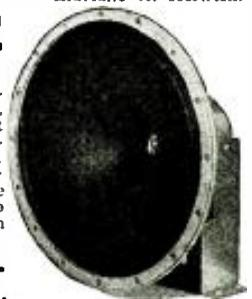

Model 1750  
12" Reproducer  
St. Paul, Minn.

**PHILA.'S  
SHORT WAVE  
HEADQUARTERS**

We carry a complete line of parts for all the new short wave circuits appearing in this magazine and other periodicals.



**IN STOCK  
THE NEW  
PATTER-  
SON  
PR-16  
10 TUBE  
SUPERHET**

— ALSO —  
National HRO Sargent Marine All Wave Model New Silver 9 to 200 meter super. All Star Jr. & Sr.  
Browning 35 Hammarlund Thordarson Triplett & Dayrad Service Instruments

**M & H Sporting Goods Co.**  
512 MARKET ST. PHILADELPHIA

**ASTATIC**

**THE QUALITY CRYSTAL  
MICROPHONE**



Noted for quality, dependability, ruggedness and performance. A professional microphone at an amateur price and fully guaranteed. Modernize your transmitter. See your jobber today!

Licensed under Brush Development Co. patents.

**ASTATIC MICROPHONE LAB., Inc.**  
YOUNGSTOWN, OHIO

"Pioneer Manufacturers of Quality Crystal Devices"

Please mention SHORT WAVE CRAFT when writing advertisers

### Police Radio Alarm Stations

(Continued from page 544)

WPFL	Gary, Ind.	2470 ke.
WPFM	Birmingham, Ala.	2382 ke.
WPFN	New Bedford Mass.	1712 ke.
WFFO	Knoxville, Tenn.	2474 ke.
WFFP	Clarksburg, W.Va.	2490 ke.
WFFQ	Clarksburg, W.Va.	2490 ke.
WFFR	Johnson City, Tenn.	2470 ke.
WFFS	Asheville, N.C.	2474 ke.
WFFT	Lakeland, Fla.	2442 ke.
WPFU	Portland, Me.	2422 ke.
WPFV	Pawtucket, R.I.	2466 ke.
WPFW	Bridgeport, Conn.	2466 ke.
WFFX	Palm Beach, Fla.	2442 ke.
WFFY	Yonkers, N.Y.	2442 ke.
WPFZ	Miami, Fla.	2442 ke.
WPGA	Bay City, Mich.	2466 ke.
WPGB	Port Huron, Mich.	2466 ke.
WPGC	S. Shenectady, N.Y.	1658 ke.
WPGD	Rockford, Ill.	2458 ke.
WPGF	Providence, R.I.	1712 ke.
WPGG	Pindlay, Ohio	1596 ke.
WPGH	Albany, N.Y.	2414 ke.
WPGI	Portsmouth, Ohio	2430 ke.
WPGJ	Utica, N.Y.	2414 ke.
WPGK	Cranston, R.I.	2466 ke.
WPLG	Binghamton, N.Y.	2442 ke.
WPGN	South Bend, Ind.	2490 ke.
WPGO	Huntington, N.Y.	2490 ke.
WPGP	Muncie, Ind.	2442 ke.
WPGQ	Columbus, Ohio	1596 ke.
WPGS	Mineola, N.Y.	2490 ke.
WPGT	New Castle, Pa.	2482 ke.
WPGU	Cohasset, Mass.	1712 ke.
WPGV	Boston, Mass.	1712 ke.
WPGW	Mobile, Ala.	2382 ke.
WPGX	Worcester, Mass.	2466 ke.
WPGZ	Johnson City, Tenn.	2474 ke.
WPHA	Fitchburg, Mass.	2466 ke.
WPHB	Nashua, N.H.	2422 ke.

WPHC	Massillon, Ohio	1596 ke.
WPHD	Staubenville, Ohio	2458 ke.
WPHE	Culver, Ind.	1634 ke.
WPHF	Richmond, Va.	2450 ke.
WPHG	Medford, Mass.	1712 ke.
WPHI	Charleston, W.Va.	2490 ke.
WPHJ	Fairmont, W.Va.	2490 ke.
WPHK	Wilmington, Ohio	1596 ke.
WPHL	Portable in Ohio	1682 ke.
WPHM	Orlando, Fla.	2442 ke.
WPHN	Tampa, Fla.	2466 ke.
WPHO	Zanesville, Ohio	2430 ke.
WPHP	Jackson, Mich.	2466 ke.
WPHQ	Parkersburg, W.Va.	2490 ke.
WPHS	Culver, Ind.	1634 ke.
WPHT	Cambridge, Ohio	1596 ke.
WPHU	Jasko, Ind.	1634 ke.
WPHV	Bristol, Va.	2450 ke.
WPHY	Elizabethton, Tenn.	2474 ke.
WPHZ	Oil City, Pa.	2482 ke.
WPSP	Harrisburg, Pa.	1674 ke.
WQFA	New Haven, Conn.	2466 ke.
WQFB	Macon, Ga.	2414 ke.
WQFC	Gainesville, Fla.	2466 ke.
WQFD	Columbia City, Ind.	1534 ke.
WQFE	Seymour, Ind.	1634 ke.
WQFF	Manassas, Pa.	2482 ke.
WQFG	Roanoke, Va.	2450 ke.
WQFH	Lynchburg, Va.	2450 ke.
WQFI	Petersburg, Va.	2450 ke.
WQFJ	Onconter, N. Y.	2414 ke.
WQFK	Clearwater, Fla.	2466 ke.
WQFM	Wilkes-Barre, Pa.	2442 ke.
WQFN	Winter Haven, Fla.	2442 ke.
WQFO	Lancaster, Ohio	2430 ke.
WQFP	Springfield, Ill.	1610 ke.
WQFQ	Lafayette, Ind.	2442 ke.
WQFR	Portable, N. Y.	1658 ke.
WQFS	Hibbing, Minn.	2382 ke.
WQFT	Portable, Ohio	1596 ke.
WQFU	Sharon, Pa.	2482 ke.
WQFV	Augusta, Ga.	2414 ke.
WRBH	Cleveland, Ohio	2458 ke.
WRDQ	Toledo, Ohio	2474 ke.
WRDR	Grosse Pt. Village, Mich.	2414 ke.
WRDS	E. Lansing, Mich.	1642 ke.
W1XAO	Boston, Mass.	1712 ke.

### Television Stations

(Continued from page 544)

2000-2100 kc.	
VE9AU	London, Ont., Can.
VE9DS	Montreal, Que.
W2XDR	Long Island City, N.Y.
W6XAN	Jackson, Mich.
W9XK	Iowa City, Iowa
W9XAK	Manhattan, Kans.
W9XAO	Chicago, Ill.
W6XAH	Bakersfield, Calif.
2750-2850 kc.	
W3XAK	Portable
W9XAP	Chicago, Ill.
W2XBS	Bellmore, N.Y.
W9XAL	Kansas City, Mo.
W9XG	W. Lafayette, Ind.
W2XAB	New York, N.Y.
VE9AR	Saskatoon, Sask., Can.
VE9ED	Mt. Joli, Que., Can.
42000-50000, 60000-86000 kc.	
W2XAX	New York, N.Y.
W6XAO	Los Angeles, Calif.
W9XD	Milwaukee, Wis.
W2XBT	Portable
W2XF	New York, N.Y.
W3XE	Philadelphia, Pa.
W3XAD	Camden, N.J.
W10XX	Portable & Mobile (Vicinity of Camden)
W2XDR	Long Island City, N.Y.
W6XAN	Jackson, Mich.
W9XAT	Portable
W2XD	New York, N.Y.
W2XAG	Portable
W1XG	Boston, Mass.
W9XK	Iowa City, Iowa
VE9BZ	Vancouver, B.C., Can.
VE9DS	Montreal, Que., Can.
VE9AU	London, Ont., Can.
VE9RC	Quebec, Que., Can.
VE9AG	Walkerville, Ont., Can.

# NOW READY!

Volume Two (1935 Edition)

## of the Official Short-Wave Radio Manual

There has been tremendous progress and a great boom in short waves in the past year, and the art has made such rapid progress that no single book, up to now, has been able to keep up with this progress. The 1935 OFFICIAL SHORT WAVE RADIO MANUAL fills this need, and it fills it completely. All the progress made in short waves, whether it is in set building, whether it is in radio servicing, whether it is in new models, whether it is in new short wave discoveries, all are faithfully reported and chronicled in this great 1935 volume. Similar to last year's volume, the new book has been edited by Hugo Gernsback, Editor of SHORT WAVE CRAFT and H. W. Secor, Managing Editor. Here are the star features of the book:

### 29 ★ FEATURES

- ★ 1—Short-Wave Beginners' Section—Items of new simplified circuits for 1, 2 and 3 tube receivers, including famous "Doerle" and "Oscillone," etc.
- ★ 2—Short Wave Receivers—All types discussed with diagrams and pictures—The best types only, which have "stood the test" of actual operating service. Full details for constructing them, etc.—"Band-Spreading" the Doerle, 5-tube T.R.F. Receivers, etc.
- ★ 3—Battery Short-Wave Receivers—1, 2, & 3 tube sets—all the way up to special 5-tube superheterodyne, designed especially for battery operation.
- ★ 4—"5-Meter" Department—All the latest "dope"—including newest transmitters, "Long Line" oscillators, improved "high sensitivity" receivers, 5-meter transceivers, hook-ups, etc.
- ★ 5—Short-Wave "Artificial Fever" Apparatus—also newest therapeutic and other allied applications of ultra short waves.
- ★ 6—Short-Wave Experimenter's Section—filled with Short-Wave Kinks, Short-cuts, etc., of interest to every experimenter.
- ★ 7—Ultra Short Waves—Newest circuits, apparatus, and results obtained in this field.
- ★ 8—Commercial "Short-Wave" and "All-Wave" Receivers—Full Servicing Data for "Set-Owners" and "Service-men."
- ★ 9—How to build "Power Supply" Units for Short-Wave Receivers.
- ★ 10—Latest Short-Wave Converters—With servicing data on Commercial Models.
- ★ 11—The Short-Wave Antenna—including latest "Noise-Reduction" types, Transposed Lead-in systems, shielded cable, Double-Doublers, etc.
- ★ 12—Short-Wave Superheterodynes—From 3 to 11 tube—Latest descriptions and diagrams including commercial all-wave varieties.
- ★ 13—Phone Transmitters for Amateur Stations—How to build them.
- ★ 14—"Skip" Distance—Heavily loaded layer, etc.—explained; physics of Short Waves.
- ★ 15—Super-Regenerative Short-Wave Receivers—latest circuits, etc.
- ★ 16—Recording "Foreign" and "Domestic" Short-Wave programs. All systems in use.
- ★ 17—"High Fidelity"—How to obtain it in Short-Wave Receivers.
- ★ 18—The best Short-Wave Questions and answers of the Year.
- ★ 19—The best Short-Wave "Kinks" of the year.
- ★ 20—Foreign Short-Wave Review—Novel circuits, apparatus, etc.
- ★ 21—Tubes for Short-Wave purposes—including tables of latest tubes for Short-Wave transmitters and Receivers.
- ★ 22—Short-Wave Transmitters—All about the new "Long Lines" Oscillators and others.
- ★ 23—Multi-Purpose Tubes—How to use them on Short Wave—Sets in which 2 tubes equal 4, etc.
- ★ 24—"Audio Amplifiers" for Short-Wave Receivers. Circuits, etc.
- ★ 25—"Band-Spread"—How to spread the stations over the dial for easier tuning.
- ★ 26—Plug-less "Mono-Coil" Receivers—How to build efficient switch-type coils to eliminate plug-in coils. "Clip-Coil" Receivers, etc.
- ★ 27—Boosters, Pre-amplifiers and Beat Oscillators—How they work, with constructional data, diagrams, etc.
- ★ 28—Portable Short-Wave Receivers and Transmitters—Transmitter Power supply from Ford Coils, etc.

#### AND FOR SERVICE MEN

★ 29—Every short-wave diagram, every short-wave set, whether in other words, that has been manufactured in the commercial set line, will be found in this special enlarged section.

OVER 240 BIG PAGES

Size 9x12 Inches—Flexible Looseleaf Leatherette Binder

OVER 1000 ILLUSTRATIONS

99 HUDSON STREET SHORT WAVE CRAFT NEW YORK, N.Y.

MAIL COUPON AT LEFT FOR YOUR COPY



\$2.50

SHORT WAVE CRAFT  
99 Hudson Street  
New York, N. Y. SWC-1-36

Gentlemen: I enclose herewith my remittance of \$2.50 for which please send me one copy of the 1935 OFFICIAL SHORT WAVE RADIO MANUAL. (Send remittance, check or money order. Register letter if it contains cash or currency.)

Name .....

Address .....

City ..... State .....

Please mention SHORT WAVE CRAFT when writing advertisers

# INVALUABLE

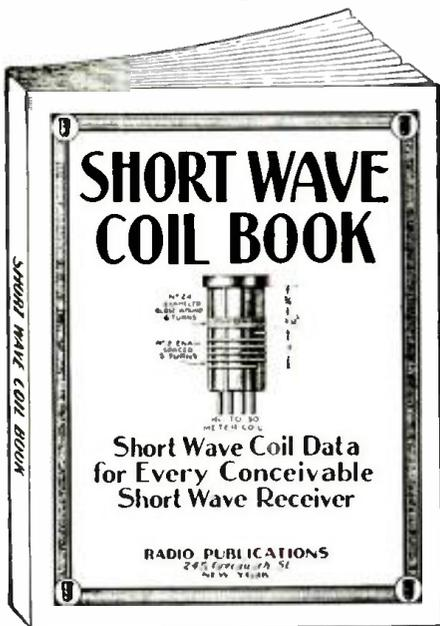

## SHORT WAVE SET BUILDERS MUST HAVE THIS BOOK

● FOR the first time, it is now possible for the experimenter and short wave enthusiast to obtain the most exhaustive data on short wave coil winding information that has ever appeared in print.

● As every experimenter who has ever tried to build a short wave set knows only too well by experience, the difference between a good and a poor receiver is usually found in the short wave coils. Very often you have to hunt through copies of magazines, books, etc., to find the information you require. The present data has been gotten up to obviate all these difficulties.

● Between the two covers of this book you now find every possible bit of information on coil winding that has appeared in print during the past two years. Only the most modern "dope" has been published here.

● No duplication. Illustrations galore, giving not only full instructions how to wind coils, but dimensions, sizes of wire, curves, how to plot them, by means of which any coil for any particular short wave set can be figured in advance, as to number of turns, size of wire, spacing, etc.

● There has never been such data published in such easy accessible form as this.

● Take advantage of the special offer we are making today, as due to increasing costs, there is no question that the price will increase soon.

**RADIO PUBLICATIONS**  
97 HUDSON STREET  
NEW YORK, N. Y.

Radio Publications  
97 Hudson Street.  
New York, N. Y.

1-36

Please send immediately your Short Wave Coil Book, for which I enclose 25c herewith (coin, U. S. stamps or money order acceptable). Book is to be sent prepaid to me.

Name .....

Address .....

City and State .....

## Short Waves and Long Waves

(Continued from page 529)

I wish to advise you of the results I have received with it.

The first station I received with it was COC, Havana, Cuba; DJC, Berlin, Germany; I2RO, Rome, Italy; HP5B, Panama City, Panama; GSA, Daventry, England; YV2RC, Caracas, Venezuela; CJRX, Winnipeg, Canada; YV5RMO, Maracibo, Venezuela; XEBT, Mexico City, Mexico; WOB, Lawrenceville, N.J.; W1XAL, Boston, Mass.; W2XE, New York; W9XAA, Chicago, Ill.; CRCX, Bowmanville, Canada; W3XAL, Bound Brook, N.J.; W8XK, Pittsburgh, Pa. on two bands. W2XAF, W3XAU on two bands, W9XF, Chicago, Ill.; and many Spanish stations which I could not identify.

Not bad, eh? More luck to your magazine, and wish you would have more like it. And thanks for printing descriptions of such excellent sets as the Doerle.

AMBROSE McMULLEN,  
567 Querbes Ave.,  
Montreal, Quebec, Canada.

(Fine business, Ambrose, and your Doerle D.C. 2-tuber is certainly performing in fine shape. We presume that by this time you have rolled up quite an astonishing "log" of foreign as well as home stations.—Editor)

## 2.5 and 5-Meter Superhet

(Continued from page 533)

receiver unit is built onto a copper-plated chassis measuring only 11x7½x9 inches. No power supply is included, as the same receiver chassis is designed for operation either on a 6-volt storage battery and dry "B" batteries or an A.C. power supply unit delivering 6.3 volts for the filament and up to 300 volts for the plate.

To simplify the arrangement of the parts and to eliminate trimming and aligning troubles, separate controls are provided for the radio frequency and detector stages, according to its designer, Frank Lester, W2AMJ, engineer of the Wholesale Radio Service Co. While the R.F. stage does not provide a great deal of amplification, it does decidedly improve the signal to noise ratio, and more important, it eliminates receiver radiation and dead-spots in the detector tuning due to antenna absorption. Tiny plug-in coils, only one-half inch in diameter, are provided for the two and one-half and five-meter bands.

## Long Distance on 7.5 Meter Waves

● IT has recently been reported that communications have been held between Washington, D.C. and battleships off the coast of California on 7.5 meters. This is probably the longest ultra high-frequency actual QSO (contact) that has taken place. This only goes to show that one never can tell just what is going to happen on these ultra short waves. It seems that each day brings new developments, tending to outlaw the quasi-optical theory, i.e., the rule that ultra short wave transmitting and receiving stations should be erected so as to be within sight of one another. It is reported that the 7 meter television station in Berlin has been picked up in America. The 7 meter harmonic of the B.B.C. 14 meter wave station in England was heard in Buenos Aires, S.A., a distance of about 7000 miles, according to one report. Just how far these ultra short waves can be relied upon for regular long distance transmission can only be ascertained after more extensive tests.

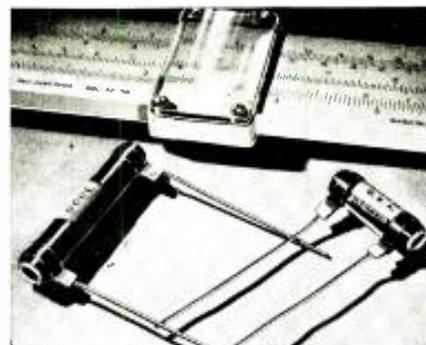

## PYROHM Jr. RESISTORS

Genuine wire-wound vitreous-enamel resistors. Most compact. 5, 10, 15 and 20 watt ratings. All resistance values. For midjet sets and crowded assemblies. For stay-put servicing.

Crack-proof refractory tubing. Adequate heat dissipation. Quality resistance wire. Space wound under tension. Wire ends brazed to lugs. Pigtailed soldered to terminal bands. Heavy vitreous enamel coating. Permanent seal against moisture and damage.

**DATA** Send for new catalog covering complete condenser and resistor line. Also largest listing of exact duplicate replacements. Sample copy of Research Worker included.



## "CHI-RAD"

More for your old S.W. receiver in a trade at Chi-Rad

Panels, Racks, Chasses and Cabinets. We specialize in S.W. Supplies of every description

Get a copy of "The Morse Code" free on request at our store.

**CHICAGO RADIO APPARATUS COMPANY, Inc.**

Amateur Sta. W9RA-W9PST  
415 South Dearborn Street  
(Near Van Buren Street)

Est. 1921 CHICAGO

**NEW LOW PRICE**  
on  
**AMPERITE**  
CURRENT AND VOLTAGE  
**REGULATORS**

Amperite replacements for AC-DC sets now LIST \$1.25. Amperite 3-40 can replace AC-DC set regulators 50x3, 500, and 5B. Also new low price on replacements for 2-Volt Battery Sets, List \$1.40

Write for CHART CV.  
**AMPERITE Co.** 561 BROADWAY NEW YORK

## QUICK WAY to make money in RADIO

Modern receivers are demanding men with modern training for service work. New training method and service equipment offer starts you earning almost at once. Up to \$3 an hour easy in a short time. Write today for FREE book of details.

**Radio Training Association of America**  
Dept. S.W.C.-61  
4525 Ravenswood Ave., Chicago

Please mention SHORT WAVE CRAFT when writing advertisers

# Here are the Six Best SHORT-WAVE RADIO BOOKS!

Without doubt you will have to go a long way to buy better books on short waves than you find on this page. Each book is written by a well-known authority on short waves . . . each book has been carefully illustrated with photographs and diagrams to

make the study of this field of radio much simpler. The volumes on this page are the finest books on short-waves which are published anywhere today. Order one or more copies today . . . find out for yourself how fine they are. Prices are postpaid.

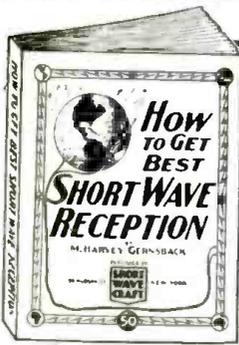

## How to Get Best Short-Wave Reception

By M. HARVEY GERNSBACK

This book tells you everything you ever wanted to know about short-wave reception. The author, a professional radio listener and radio fan for many years, gives you his long experience in radio reception and all that goes with it. Why is one radio listener enabled to pull in stations from all over the globe, even small 100 watters, 10,000 miles away, and why is it that the next fellow, with a much better and more expensive equipment, can only pull in the powerful stations that any child can get without much ado? The reason is intimate knowledge of short waves and how they behave. Here are the chapters of this new book:

1. What are Short-Wave receiver or converters?
2. How to tune and when to listen in on the short wave.
3. How to identify short-wave stations.
4. Seasonal changes in short-wave reception.
5. Types of receivers for short-wave reception.
6. Aerial systems for short-wave receivers.
7. Verifications from short-wave stations.

The book makes excellent reading matter. There are many tricks in short-wave reception that even some of the "old-timers" do not know. Be sure to get it.

40 Illustrations, 72 Pages. **50c**  
Stiff, flexible covers

## HOW TO BUILD AND OPERATE SHORT-WAVE RECEIVERS

THIS is the best and most up-to-date book on the subject. It is edited and prepared by the editors of SHORT WAVE CRAFT, and contains a wealth of material on the building and operation, not only of typical short-wave receivers, but short-wave converters as well. Dozens of short-wave sets are found in this book, which contains hundreds of illustrations, actual photographs of sets built, hookups and diagrams galore.

This book is sold only at a ridiculously low price because it is our aim to put this valuable work into the hands of every short-wave enthusiast.

We know that if you are at all interested in short waves you will not wish to do without this book. It is a most important and timely radio publication.

150 Illustrations, 72 Pages. **50c**  
Stiff, flexible covers

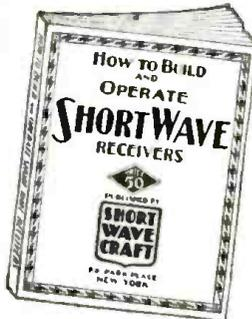

## THE SHORT-WAVE BEGINNER'S BOOK

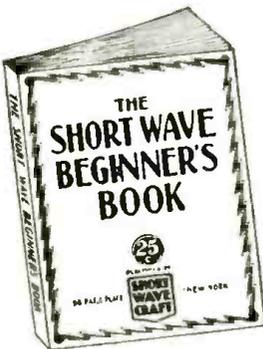

HERE is a book that solves your short wave problems—leading you in easy stages from the simplest fundamentals to the present state of the art as it is known today. It is the only low-priced reference book on short waves for the beginner. The book is profusely illustrated—it is not "technical." It has no mathematics and no technical lexicon. It also gives you a tremendous amount of important information, such as time conversion tables, all about aerials, noise elimination, all about radio tubes, data on coil windings and other subjects.

### Partial List of Contents

Getting Started in Short Waves—the fundamentals of electricity. Symbols, the Short Hand of Radio—how to read schematic diagrams. Short-Wave Coils—various types and kinds in making them. Short-Wave Aerials—the points that determine a good aerial from an inefficient one. The Transposed Lead-in for reducing Static. The Beginner's Short-Wave Receiver—a simple one tube set that anyone can build. How to Tune the Short-Wave Set—telling the important points to get good results. Audio Amplifiers for S-W Receivers. Learning the Code—for greater enjoyment with the S-W set. Wave Length to Kilocycle Chart. Wire Chart—to assist in the construction of coils.

75 Illustrations, 40 Pages. **25c**  
Stiff, flexible covers

## 101 SHORT-WAVE HOOKUPS

Compiled by the Editors of SHORT WAVE CRAFT

EACH and every hook-up and diagram illustrated is also accompanied by a thorough explanation of what the particular hook-up accomplishes, what parts are required, coil-winding information, values of resistors, etc., in fact, everything you want to know in order to build the set or to look up the data required.

To be sure, all of the important sets which have appeared in print during the past five years are in this valuable book. Sets such as the Doerle, Dinsmore, the "19", Twinline, (Oscillodyne, Denton, "Stand-By", Magadone, Triplex 2, (Oscillodyne, Denton, "2-Tube Super-Short", "Mystery", "Loop" Receiver, "Doerle" 2-tube Battery, "Doerle" 3-tube Battery, "Doerle" 2-tube A.C., "Doerle" 3-tube A.C., Doerle "Signal Gripper", "Duo H.P.", 4-tube Receiver, The Sargent 9-33 Tapped Coil Receiver, Globe-Griper 2, The 2-Tube "Champ"—2 Tubes Equal 3, Ham-Band "2-Tube Peer-Wave", Wyeth All-Way 6, Denton "Economy" 3, 2-Tube "Regenerative-Oscillodyne" will be found here, with full descriptions. In many cases, we have also included a picture hook-up for those who do not wish to follow the regular symbolic hook-up, but wish to have a regular wiring diagram. This is a very handy volume, especially for those "fans" who wish to study the best sets in the short-wave art. Iron one tube up to ten tubes.

100 Illustrations, 72 Pages, **50c**  
Stiff, flexible covers

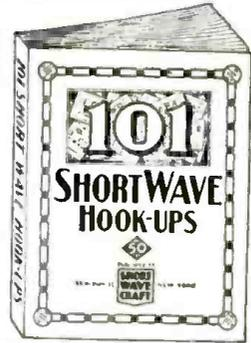

## HOW TO BECOME AN AMATEUR RADIO OPERATOR

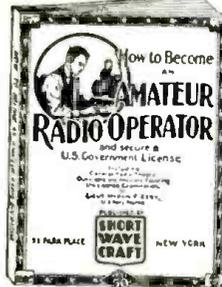

WE chose Lieut. Myron F. Eddy to write this book because his experience in the amateur field has made him prominent in this line. For many years he was instructor of radio telegraphy at the R.C.A. Institute. He is a member of the I.R.E. (Institute of Radio Engineers), also the Veteran Wireless Operators' Association.

If you intend to become a licensed code operator, if you wish to take up phone work eventually—this is the book you must get.

### Partial List of Contents

Ways of learning the code. A system of sending and receiving with necessary drill words is supplied so that you may work with approved methods. Concise, authoritative definitions of radio terms, units and laws. Brief descriptions of commonly used types of radio equipment. This chapter gives the working terminology of the radio operator. Graphic symbols are used to indicate the various parts of radio circuits. General radio theory particularly as it applies to the beginner. The electron theory is briefly given, then waves—their creation, propagation and reception. Fundamental laws of electric circuits, particularly those used in radio are explained and typical basic circuits are analyzed. Descriptions of modern receivers that are being used with success by amateurs. You are told how to build and operate these sets. Amateur transmitters. Diagrams with specifications are furnished so construction is made easy. Power equipment that may be used with transmitters and receivers, rectifiers, filters, batteries, etc. Regulations that apply to amateur operators. Appendix which contains the International "Q" signals, conversion tables for reference purposes, etc.

150 Illustrations, 72 Pages, **50c**  
Stiff, flexible covers

## TEN MOST POPULAR SHORT-WAVE RECEIVERS

—HOW TO MAKE AND WORK THEM

THE editors of SHORT WAVE CRAFT have selected ten outstanding short-wave receivers and these are described in the new volume. Each receiver is fully illustrated with a complete layout, pictorial representation, photographs of the set complete, hookup and all worth-while specifications. Everything from the simplest to the set to a 5-tube R. F. receiver is presented. Complete lists of parts are given to make each set complete. You are shown how to operate the receiver to its maximum efficiency.

### CONTENTS

The Doerle 2-Tube Receiver That Reaches the 12,500 Mile Mark, by Walter C. Doerle.  
2-R.F. Pentode S-W Receiver having two stages of Tuned Radio Frequency, by Clifford E. Denton and H. W. Secor.  
My de Luxe S-W Receiver, by Edward G. Ingram.  
The Binneweg 2-Tube 12,000 Mile DX Receiver, by A. Binneweg.  
Build a Short-Wave Receiver in your "Brief-Case," by Hugo Gernsback and Clifford E. Denton.  
The Denton 2-Tube All-Wave Receiver, by Clifford E. Denton.  
The Denton "Stand-By," by Clifford E. Denton.  
A COAT-POCKET Short-Wave Receiver, by Hugo Gernsback and Clifford E. Denton.  
The S-W PEN-TOD-L, by G. C. Cain, M. E.  
Louis Martin's Idea of A GOOD S-W RECEIVER, by Louis Martin.

75 Illustrations, 40 Pages, **25c**  
Stiff, flexible covers

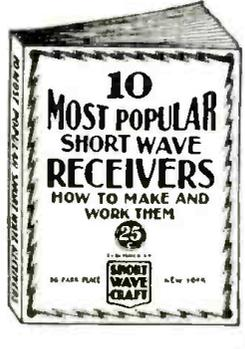

All the books shown on this page are published exclusively by

## SHORT WAVE CRAFT

99-101 Hudson Street, New York, N. Y.

CLIP-MAIL

SHORT WAVE CRAFT, 99-101 Hudson Street, New York, N. Y. SW-1-36

Gentlemen: I enclose herewith my remittance for the amount of \$..... for which you are to send me, postpaid, the books checked below.

- |   |   |
|---|---|
| <input type="checkbox"/> How to Get Best Short-Wave Reception..... 50c each         | <input type="checkbox"/> How to Become an Amateur Radio Operator..... 50c each                          |
| <input type="checkbox"/> 101 Short-Wave Hook-ups..... 50c each                      | <input type="checkbox"/> Ten Most Popular Short-Wave Receivers. How to Make and Work Them..... 25c each |
| <input type="checkbox"/> How to Build and Operate Short-Wave Receiver..... 50c each | <input type="checkbox"/> The Short Wave Beginner's..... 25c each  |

Name.....  
Address.....  
City..... State.....

(Send remittance in form of check or money order. If letter contains cash or unused U. S. Postage Stamps, register it.)

## OVERSEAS READERS!

These books can be obtained from the following houses:

**GREAT BRITAIN**  
Gorrings  
9a, Green Street, Leicester Square  
London, England

**FRANCE**  
Editions Radio  
42 Rue Jacob  
Paris

**AUSTRALIA**  
McGill's  
183-195, 218 Elizabeth St.  
Melbourne, C. I

Please mention SHORT WAVE CRAFT when writing advertisers

### Short Wave Scouts

(Continued from page 530)

- WEST INDIES AND CENTRAL AMERICA  
 COH—9,428 kc.—Short Wave Station COH, Calle B No. 2 Vedado, Havana, Cuba.  
 COC—6,010 kc.—Short Wave Station COC, Box 98, Havana, Cuba.  
 COCD—6,130 kc.—La Voz Del Aire, S. A., Box 2291, Havana, Cuba.  
 XECR—7,380 kc.—Secretaria de Relaciones Exteriores, Mexico City, D. F. Mexico.  
 HHD—6,482 kc.—La Voz de Quisqueya, Santo Domingo, Dominican Republic.  
 HHH—6,814 kc.—Radiodifusora HHH, San Pedro de Macoris, Dominican Republic.  
 HIX—5,980 kc.—Santo Domingo, Dominican Republic.  
 CEC—10,630 kc.—Compania Internacional de Radio S. A., Santiago, Chile.  
 HJIABE—6,115 kc.—Station HJIABE, Laboratorios Fuentes, Cartagena, Colombia.  
 HJ2ABC—5,890 kc.—Estacion La Voz de Cucuta, Cucuta, Colombia.  
 HJ4ABA—11,710 kc.—Ecos de la Montana, Medellin, Colombia.  
 HJ4ABE—5,925 kc.—La Voz de Antioquia, Medellin, Colombia.  
 HJ5ABE—14,480 kc.—Cia Radiodifusora Colombiana, Apartado 50, Cali, Colombia.  
 HP5B—6,030 kc.—Estacion Radiodifusora, Miramar, Apartado 919, Panama City, Panama.  
 HP5J—9,590 kc.—Servicio Publico de Radio, S.A., Panama City, Panama.  
 OAXID—5,780 kc.—All American Cables, Inc., Casilla 2336, Lima, Peru.  
 PRADO—6,619 kc.—Apartado 98, Riobamba, Ecuador.  
 YV2RC—6,112 kc.—Broadcasting Caracas, Caracas, Venezuela.  
 YV3RC—6,150 kc.—Caracas, Venezuela.  
 YV5RMO—5,650 kc.—Apartado de Correos 211, Maracaibo, Venezuela.  
 YV6RV—6,520 kc.—Por Radiodifusora La Voz de Carabobo, Valencia, Venezuela.  
 HJ1ABG—6,042 kc.—Barranquilla, Colombia.  
 TTPG—6,410 kc.—Estaciones La Voz de la Victoria, Apartado 225, San Jose, Costa Rica.  
 EAQ—9,860 kc.—Box 951, Madrid, Spain.  
 DJD—11,760 kc.—Berlin, Germany.  
 DJB—15,200 kc.—Same as above.  
 DJC—6,546 kc.—Same as above.  
 DJN—9,540 kc.—Same as above.  
 DJE—17,760 kc.—Same as above.  
 HAT4—9,125 kc.—Budapest Radiolabor., Budapest, Hungary.  
 HBL—9,595 kc.—League of Nations, Geneva, Switzerland.  
 HHP—7,799 kc.—Same as above.  
 2RO—9,635 kc.—Ente Italiano Avdizioni Radiofoniche, Via Montello 5, Rome, Italy.  
 2RO—11,810 kc.—Same as above.  
 ORK—10,330 kc.—I.N.R., 1A, Rue de Baston, Bruxelles, Belgium.  
 PHI—17,770 kc.—Eindhoven, Holland.  
 RNE—12,000 kc.—Radio Centre, Solyanka 12, Moscow, U. S. S. R.  
 Radio-Coloniale—11,715 kc.—98 Bis Blvd. Haussmann, Paris, 8, France.  
 DJQ—15,280 kc.—Berlin, Germany.  
 DJA—9,560 kc.—Berlin, Germany.  
 HBJ—14,535 kc.—Radio-Suisse S.A., 12, Quai de la Poste, Geneva, Switzerland.  
 VK2ME—9,590 kc.—Amalgamated Wireless Ltd., Sydney.  
 3LR—9,580 kc.—Postmaster-General's Dept., Lyndhurst, Victoria.  
 QPM—10,140 kc.—Leopoldville, Belgian Congo.

### TROPHY CONTEST RULES

(Continued from page 530)

The judges of the contest will be the editors of SHORT WAVE CRAFT, and their findings will be final. Trophy awards will be made every month, at which time the trophy will be sent to the winner. Names of the contesting SCOUTS not winning a trophy will be listed in Honorable Mention each month. From this contest are excluded all employees and their families of SHORT WAVE CRAFT magazine. Address all entries to SHORT WAVE SCOUT AWARD, 99-101 Hudson St., New York City.

### \$20.00 Prize Monthly for Best Set

THE editors are looking for "new" receiving circuits—from 1 to 5 tubes preferably. A \$20.00 monthly prize will be awarded to the best short-wave receiver submitted. The closing date for each contest is 75 days preceding date of issue (Dec. 15 for the March issue, etc.). In the event of a tie, an equal prize will be given to each contestant so tying. Address all entries to: Editor, SHORT WAVE CRAFT, 99 Hudson St., New York City.

# CLASSIFIED

Advertisements are inserted at 5c per word to strictly amateurs, or 10c a word to manufacturers or dealers. Each word in a name and address is counted. Cash should accompany all orders. Copy for the February issue should reach us not later than December 5th.

<p><b>BOOKS</b></p> <p>ARMY-NAVY GIVES FREE radio operators' training for service on aircraft, ships. Salary, expenses paid. Information pamphlet, how to apply, 29c. Continental, Box 341, Dept. 4, Indianapolis, Ind.</p>	<p>FOR SALE GROSS TWENTY-five watt transmitter, Denton six-tube superheterodyne receiver used three months. Inquire W4BVZ, Needham Crow, New Bern, North Carolina.</p> <p>100035 VARIABLE CONDENSERS—3 for \$1.00. W8RW, Bluffton, Ohio.</p>	<p>PATENTS, REASONABLE TERMS. Book and advice free. L. F. Randolph, Dept. 711, Washington, D. C.</p> <p><b>QSL—CARDS—SWL</b></p> <p>QSLs, SWLs, DIFFERENT, PHOTO type. Attractive. Very Reasonable. Samples? (Stamps). W8ESN—1827 Cone, Toledo, Ohio.</p>
<p><b>GENERATORS</b></p> <p>TWENTY PRACTICAL AND LOW cost changes converting old generators into new generators and motors 100-500 watt capacity, d c or a c current, with 6 to 100 volts, for radio operation, power, light, or welding. Also instructions for rewinding armatures, 350 definitions of electrical terms, etc. All in new, revised book with simplified instructions and illustrations. Postpaid by thousands. Only \$1.00 postpaid. Autopower, 411 S. Hoyle Ave., Chicago.</p>	<p>SW3 COMPLETE, SACRIFICE. P. T. Blanchard, Gunnison, Mississippi.</p> <p><b>INSTRUCTION</b></p> <p>RADIO ENGINEERING, BROADCASTING, aviation and police radio, Serjeant, Marine and Morse Telegraphy taught thoroughly. All expenses low. Catalog free. Dodge's Institute, Colt St., Valparaiso, Ind.</p>	<p>QSL CARDS, NEAT, ATTRACTIVE, reasonably priced, samples free. Miller, Printer, Ambler, Pa.</p> <p>QSLs, SWLs, SAMPLES! 200 TWO colors \$1.00. W3AUB, Tupelo, Miss.</p> <p>SNAPPY QSL'S SAMPLES? W3SIF, Spring Road, Hinsdale, Ill.</p> <p><b>RADIO ENGINEERING</b></p> <p>CUSTOMBUILDERS OFFERS YOU a new service. Any radio equipment built to your specifications. Write for details—no obligation. Custombuilders, Dept. A, 113 West 57th, New York City.</p>
<p><b>"HAM" OFFERS AND WANTS</b></p> <p>SALE TRADE READRITE MODEL 710 Tester \$8.50. New Allstar Jr., tubes speaker \$19.75. Sears Roebuck 1935 World's Fair model 2 band box battery Radio \$12.75. Crosley Banbox Jr., Bat. Radio \$3.50. All Good, Maynard Ogle, Gatlinburg, Tenn.</p>	<p><b>MISCELLANEOUS</b></p> <p>OHM'S LAW CALCULATOR—Lightning Slide Rule; solves all problems of Voltage, Current and Resistance, Power, Wire Sizes, etc. Range: 1 micro-amp. to 1000 amps.; 1 micro-volt to 10,000 volts; 1 micro-ohm to 10 meg-ohms; 1 micro-watt to 10 megawatts; wire sizes 0 to 36 B. &amp; S. gauge. Introductory price \$1.00 prepaid. The Dataprint Co., Box 322, Ramsey, N.J.</p>	<p><b>SHORT WAVE COMPONENTS</b></p> <p>4 BAKELITE PLUG-IN COILS, wound on tube bases .30, tall forms .50, six prong .75. Noel, 728 Birch, Scranton, Pa.</p> <p><b>SHORT WAVE RECEIVERS</b></p> <p>BUILD IT YOURSELF SHORT WAVE Superheterodyne, Automatic Volume Control, Beat oscillator, Crystal filter, 20 watts output. Diagram, coil winding data and instructions. Price 25 cents. Link Laboratories, Box 497, Kirksville, Mo.</p>
<p>FOR SALE SILVER MARSHALL, all-wave superheterodyne, also National power pack, Gross, Eagle receiver, two 815 power amplifier, Wand National, Patterson, Skyriider, Hallierafter or Scott receiver, Glenn Watt, Chanute, Kas.</p>	<p><b>PATENTS &amp; INVENTIONS</b></p> <p>PRACTICAL, USEFUL INVENTIONS may now be safely marketed without patenting expense. Complete information free. Chartered Institute of American Inventors, Dept. 92, Washington, D. C.</p>	<p>BLUEPRINT "HOW TO BUILD 18 Long Distance Crystal Receivers"—recond 2100 miles; "Scrubbers Data" year; 25c. Laboratories, 151-A Liberty, San Francisco.</p>

1936  
**RADIO BARGAIN**  
 CATALOG No. 31  
 THE HOUSE OF INTELLIGENT SERVICE  
 MANAGED BY MEN WITH 30 YEARS RADIO EXPERIENCE  
**RADIO TRADING CO.**  
 HUDSON STREET  
 NEW YORK CITY  
 OFFICIAL DOERLE  
 SHORT-WAVE RECEIVERS

See pages 560 and 574 for our other "ads."

## FREE—Just Out!

### NEW 1936 BARGAIN BUYING GUIDE

64 Illustrated Pages—Two Colors

For Radio Servicemen, Dealers, Experimenters and Short-Wave Fans.

Contains modern glass and metal-tube receivers at unbeatable prices. Complete Public Address Systems from 6 watts up to 10 watts—all high quality, guaranteed systems—at prices which will amaze you. Latest type all-metal and glass tube testers and other test equipment. Complete information on the famous 3-Tube Doerle DeLuxe A.C. Short-Wave Receiver and many other interesting short-wave equipment. This catalog carries a large array of modern radio equipment of interest to all classes of radio servicemen, experimenters and fans. Many items found in no other catalog are listed and illustrated in this Radio Bargain Guide.

You can increase the value of your dollar by buying at the low prices contained in this buying guide. This bargain catalog will show you how to save money by buying economically. Why not start saving now? Don't delay. Write today for your free copy. You are not obligated in any way.

WRITE TODAY—send postcard or letter. Buying guide sent by return mail. IT'S ABSOLUTELY FREE.

**RADIO TRADING CO.**  
 101A Hudson St. New York, N. Y.

**New D. C. Multiple Meter**

0-.1-1-10-100-1,000 VOLTS  
 0-.001-.01-.1-1-10 AMPERES  
 0-50,000-5,000,000 OHMS

A beautiful walnut case, decimal scale, precision meter for the ENGINEER, EXPERIMENTER and SERVICE MAN. ONLY \$14.95. For details write.

**SCHOOLEY ENGINEERING CO.,** Terril, Iowa

**OXFORD SPEAKERS**

—give you ALL there is in radio. High piccolo, low organ; pure tones, no distortion. And they're durable. Write for prices.

**OXFORD-TARTAK RADIO CORP.**  
 350 D' W. HUDSON ST., CHICAGO, ILL.

Please mention SHORT WAVE CRAFT when writing advertisers

# The DOERLE

## 5-TUBE DELUXE

### A.C. SHORT WAVE RECEIVER

#### Features CONTINUOUS BANDSPREAD

*on All Bands!*

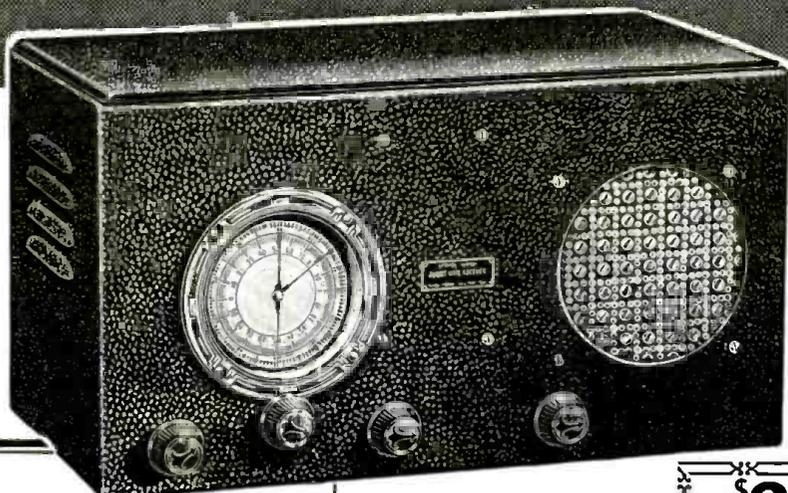

- ★ USES DOUBLET OR STANDARD ANTENNA.
- ★ 8 LOW-LOSS PLUG-IN COILS.
- ★ RANGE 15 to 200 METERS.
- ★ MICROMASTER BANDSPREAD DIAL.
- ★ MAGNAVOX DYNAMIC SPEAKER.
- ★ BEAUTIFUL CRACKLE CABINET
- ★ HEADPHONE RECEPTION IF DESIRED.
- ★ SENSITIVE REGENERATIVE CIRCUIT.
- ★ TONE CONTROL.

### NATION-WIDE TESTIMONIALS PRAISE THIS SET!

Dear Sirs:

Just a line or so to give you an idea of what my Doerle A.C. 5 has done in during a 2 weeks listening test. All of the G and D stations were received also THE1, W50F, PHA10, HJAB, W8XAL, W2NE, W8XK, CHD, Y2RC, CHX, CQC, HJABB, HJABB, Y2RMO, Y2RC, W8CT, CT1AA, WEXAL, W8XAA, W1XAZ, EAQ, WEGW, HJ2BL, HJ2AB, KEB, HJL, HJ2H, HJ2BL, W2NE, Y2RC, HJZ, JYK, FYA, Y2RC, QAAAD, RNE, PHL, RKL, WNC, YBA, COH, PRF5, WQN, XERT, W2XAF, LSL, 1210, HRM, JYS, UK3LR. All stations come in with strong carriers with a QSA4-5-R9 plus.

FRANCES KMETZ,  
213 Linden St., Allentown, Pa.

Gentlemen:

Here is a list of Short-Wave stations I have received in a short time with my "Doerle AC5," with a very poor aerial for short-wave work. EAQ—MADRID, SPAIN; W1XAZ—Springfield, Mass.; W2XAL—Schenectady, N.Y.; COH—Havana, Cuba; CQC—Havana, Cuba; VEGW—Bowmanville, Ontario, Canada; CT1AA—Lisbon, Portugal; PRF5—Rio De Janeiro, Brazil; HJABB—Barranquilla, Col., S.A.; PHA10—Riohamba, Ecuador, S.A.; HJL—Berlin, Germany; XERT—Mexico City, Mexico; Y2RMO—Maracaibo, Venezuela, S.A.; CHD—Winnipeg, Canada; W2XAF—New York, N.Y.; W8XK—Pittsburgh, Pa.; HJ2H—Panama City, Panama; FYA—Paris, France; GSC-GSI—Baventy, England; EAQ—Madrid, Spain, and COH—Havana, Cuba, come in every night on the loud speaker regardless of weather conditions. This is the third and best receiver I have owned in the short time I have been interested in Short Waves.

EMERALD H. DELBRIEGE,  
Rose-Mary Dahlin Gardens,  
Martins Ferry, Ohio.

Original Letters Plus Others May Be Seen At Our Office

**\$27.51**  
READY TO OPERATE  
*Less 2 Pearl coils—\$1.75 extra*

EVERYBODY'S talking about the new 5-Tube Doerle Deluxe Short-Wave Receiver. If you are interested in short-waves, avail yourself of this opportunity to listen to this remarkable set with no obligation to buy it unless you are absolutely satisfied with its performance. Use the coupon below for fast service.

#### USES ANY TYPE AERIAL

Regardless of what type aerial you have, this receiver makes provisions for using it. Either the standard inverted-L type or noise-free doublet type may be utilized. This means that this receiver can be used in ALL localities.

#### SENSITIVE REGENERATIVE CIRCUIT

Two tuned stages, regenerative detector, three A.F. stages with powerful 41 pentode output and perfectly matched dynamic speaker—all these features contribute to the great power and fine performance of this receiver. A special antenna-trimming scheme permits perfect alignment of both antenna and detector tuning circuits without affecting the setting of the tuning dial.

#### CONTINUOUS BAND-SPREAD

Continuous bandspread on the entire range from 15 to 200 meters is ob-

# FREE

64 page Buying Guide for the Radio Serviceman, Dealer and Experimenter. Contains thousands of well illustrated items, with public address equipment, short-wave receivers, standard American and European broadcast receivers, Automobile sets, radio parts, etc., etc.

DO NOT DELAY WRITE TODAY

Send post card or letter. Buying Guide sent by return mail. It's Free.



Send COUPON TODAY

## 5-DAY FREE TRIAL

tained through the use of a very ingenious dial having a ratio of 125 to 1 and two pointers. Furthermore, two knobs are provided, making possible fast and slow tuning. No longer are the foreign broadcast stations crowded on two or three scale divisions of the dial. They are now spread out over a goodly portion of the dial thereby greatly simplifying tuning.

#### 8-LOW-LOSS PLUG-IN COILS

The use of plug-in coils is still the most efficient method of changing from one band to another. That is why they are used in this Doerle receiver. 8 coils are provided to cover the range of from 15 to 200 meters in 4 bands, viz: 20, 40, 80 and 160 meter bands. These coils are of the 3-winding 6-prong type and are used 2 at a time. Wound on ribbed bakelite forms and designed especially for the Doerle receiver, they are highly efficient.

#### EXQUISITE WORKMANSHIP

All parts are mounted on a single, cadmium-plated chassis and contained in a large, handsomely-finished black crackle cabinet. The dial and speaker grill are practically the same diameter and are symmetrically centered on the front panel of the cabinet, thereby presenting a professional and dignified appearance.

Provisions are made for using headphones if desired with switch to cut out the dynamic speaker. A tone control is provided which not only varies the tone but helps materially to reduce back ground hiss.

#### FAMOUS FOR DX RECEPTION

Hundreds of testimonials in our files attest to the superlative performance of this world-famous receiver. Several of these testimonials are printed on this page. Set measures 17 1/2" x 8" x 8 1/2" high. Net weight 23 lbs., shipping weight 35 lbs. Designed for 110-120 volt, 50-60 cycle A.C. operation. No. 5000—Doerle 5-Tube Deluxe A.C. Short-Wave Receiver complete with a matched tubes and 8 coils. Completely wired and tested (NOT SOLD IN KIT FORM).  
Your price.....\$27.51  
Set of 2 broadcast coils \$1.75 additional. Add \$2.50 for 110 volt 25 cycle model or 220 volt 60 cycle model.

**RADIO TRADING CO., 101A HUDSON ST., NEW YORK**

Gentlemen: I enclose \_\_\_\_\_ dollars, \_\_\_\_\_ cents, for your new Doerle 5-tube Deluxe Short-Wave receiver on a five day free trial basis. If, at the end of five days after receipt of radio, I am not perfectly satisfied, I will write you for return shipping instructions. Upon receipt of the radio, you will refund me the full purchase price. I agree to pay express charges one way, and you the other.

C.O.D. SHIPMENT. I enclose \_\_\_\_\_ dollars, \_\_\_\_\_ cents deposit, balance of \_\_\_\_\_ dollars, \_\_\_\_\_ cents C.O.D.

PRINT Name \_\_\_\_\_ Address \_\_\_\_\_ Town \_\_\_\_\_ State \_\_\_\_\_

# RADIO TRADING CO., 101A Hudson St., New York City

Please mention SHORT WAVE CRAFT when writing advertisers

Index to Advertisers

**A**

Ace Radio Laboratories.....561  
 Acme Specialty Co.....554  
 Aerovox Corporation.....569  
 Alden Products Co.....561  
 Allied Engineering Institute.....549  
 Allied Radio Corp.....567  
 Alloy Transformer Co.....565  
 American Microphone Co.....560  
 American Technical Society.....571  
 Amperite Co.....554  
 Arco Tube Company.....569  
 Astatic Microphone Laboratory.....559

**B**

Blan, the Radio Man.....559  
 Brush Development Co., The.....559  
 Bud Radio Inc.....575  
 Burstein-Applebee Co.....575

**C**

Cameradio Co.....567  
 Candler System Co.....564  
 Cannon, C. F., Company.....566  
 Chicago Radio Apparatus Co., Inc.....571  
 Classified Advertisements.....573  
 Cornell-Dubilier Corporation.....557  
 Coyne Radio & Electrical School.....515

**D**

Dataprint Company.....558  
 Delaware Radio Sales Co.....558  
 Deutschmann, Tole, Corp.....554  
 Dodge's Institute.....567

**E**

Eagle Radio Co.....563  
 Eilen Radio Laboratories.....553  
 Everyday Science & Mechanics.....561  
 Experimental Radio Labs.....561

**F**

First National Television, Inc.....558

**G**

General Winding Co.....575  
 Goldentone Radio Co.....562  
 Gold Shield Products Co.....559, 560, 562

**H**

Hallcrafters, The.....558  
 Hammarlund Manufacturing Co.....557  
 Harrison Radio Company.....551, 562  
 Henry Radio Shop.....559  
 Hinds & Edgerton.....564

**I**

Instructograph Company.....556  
 Insuline Corp. of America.....564  
 International Correspondence Schools.....575  
 International Resistance Co.....557

**K**

Korrol Mfg. Co., Inc.....554

**L**

Lancaster Allwine & Rommel.....564  
 Lynch, Arthur H., Inc.....561

**M**

M. & H. Sporting Goods Co.....569  
 Marine Radio Company.....552  
 Massachusetts Radio School.....554  
 Midwest Radio Corp.....Back Cover  
 Miller, J. W., Co.....562  
 Muter Company, The.....550

**N**

National Company, Inc.....Inside Back Cover  
 National Radio Institute.....513  
 Newark Electric Co.....560  
 New York Y.M.C.A. Schools.....556

**O**

Oxford-Tartak Radio Corp.....573

**R**

Radio Constructors Labs.....555  
 Radio Craft.....562  
 Radio Publications.....516, 568  
 Radio Trading Co.....560, 573, 574  
 Radio Training Assn. of America.....571  
 Ramsey Publishing Co.....560  
 RCA Institutes, Inc.....562  
 Remington-Rand, Inc.....552  
 Roland Radio Co.....552  
 Royale Radio Crafters.....563  
 R-S Merchandising Committee.....556

**S**

Sargent, E. M., Co.....559  
 Schwartz, M. & Son.....560  
 Schooley Engineering Co.....573  
 Short Wave Coil Book.....571  
 Short Wave League.....562, 576

Short Wave Listener Magazine.....566  
 Short Wave Manual.....570  
 Short Waves.....569  
 Sprayberry, F. L.....565

**T**

Teleplex Co.....555, 561  
 Thor Radio Corp.....550  
 Triplett Electrical Instrument Co.....555  
 Try-Mo Radio Co., Inc.....562, 564

**U**

Uncle Dave's Radio Shack.....562  
 Uno All-Wave Coil Co.....557

**W**

Wellworth Trading Company.....556, 564  
 Wholesale Radio Service Co., Inc.....565, 567  
 Wiley, John, & Sons, Inc.....558  
 Wright-DeCoster, Inc.....569

**X**

X.L., Radio Laboratories.....555

**When To Listen In**  
 by M. HARVEY GERNSBACK  
 (All Schedules Eastern Standard Time)

**ETHIOPIA**

● The station at Addis Ababa in Ethiopia is now the center of attention for S-W fans. This station originally built for telegraphy is now employed to send special "broadcasts" of news, etc., using telephony. The power of the transmitter is 12 kw. (It was raised to this figure from 3.5 kw. a year ago.) The call letters are ETA and ETB. The station operates normally on 18270 and 11955 kc. using the call ETA and on 7620 kc. using the call ETB. The 11955 kc. channel has been heard up to 7 p.m.

**CARACAS**

YV2RC at Caracas, Venezuela has now settled down on 5800 kc., now being heard very well indeed and we thank the management for the special broadcast dedicated to the SHORT WAVE LEAGUE.

**POLAND**

SPW at Warsaw, a commercial phone and telegraph station has been heard since Oct. 1st, sending a special Sunday broadcast from 11:30 a.m.-12:30 p.m. Announcements are in Polish and English. There are 2 announcers, one a man, the other a woman. The frequency employed is 13635 kc. (22 meters); SPW is rated at 20 kw. power.

**ROME**

In addition to its regular broadcasts, 2RO is now sending out a daily news bulletin in English from 6-6:15 p.m. on its 49 meter band transmitter. This is followed by one in Spanish on 9635 kc.

**MEXICO**

There is a new Mexican station at Vera Cruz. It is XEFT. Address is 28 Ave., Independencia, Vera Cruz. The frequencies used are either 9600 or 6120 kc. XBJQ at Mexico City on 11200 kc (approximate) is operated by the National Bank, P.O. Box 2825. It is supposed to be on daily from 5:30-6:30 p.m. and 10:30 p.m.-12 m.

**JAVA**

PMA (19345 kc. and PLV (9415 kc.) are still broadcasting from 10-10:30 a.m. on Tues., Thur. and Sat.

YDA at Tandjongpriok is expected back on the air on either 6040 or 6120 kc. by the time this appears in print. YDA may also operate in the 19 and 25 meter bands.

**DAVENTRY**

The English stations will be operating as follows in December. The stations used are subject to sudden change however so listen to the announcer for the waves being used. Trans. 1, 5:30-6:30 am on GSD and GSB; 6:30-7:30 am on GSD and either GSF or GSB. Trans. 2, 6-8:45 a.m. (Sun. 6:30-8:45 a.m.) on GSF and either GSG or GSE. Trans. 3, 9-10:30 a.m. on GSD and GSB; 10:30 a.m.-12 noon on GSB and either GSD or GSA. Trans. 4, 12.15-2.15 pm. on GSI, GSD and GSB; 2.15-4 p.m. on GSD, GSB and GSL; 4.15-5.45 p.m. on GSB and GSA. Trans. 5, 6-8 pm. on GSC and GSA. Trans. 6, 10-11 pm. on GSL and either GSC or GSA.

QUALITY APPARATUS FOR Short Waves

**GEN-WIN POLICE AND SHORT WAVE ADAPTER**  
 Convert your broadcast set into a short-wave set tuning from 80 to 200 meters. Get exciting police alarms from stations thousands of miles away. Airplane communications while planes are in flight. Amateur phone and international code communications. The biggest thrill and fun for so little money. Installed in a jiffy. Plug directly into the detector tube socket. Specify the detector tube in your set, or if uncertain as to detector tube, advise make and model number of set when ordering.

No. 190—for 30, 40, 50, 12A, 200A or 201A Detector Tube	Price \$1.39
No. 191—for 32 or 34 Detector Tube	1.39
No. 200—for 27, 37 or 56 Detector Tube	1.39
No. 201—for 24, 35, 51, 36, 49 or 44 Detector Tube	1.39
No. 206—for 57, 58, 77, 78, 676 or 610 Detector Tube	1.49

**GEN-WIN SILVER PLATED SHORT WAVE COILS**  
 This new short wave coil kit features silver plated wire, space wound turns on ribbed form, riddled with slip rings for easy handling. Tests made by the U. S. Bureau of Standards have proven conclusively that coils wound with silver plated wire will increase the gain and sensitivity of any short wave receiver, which means that you will hear more stations and louder signals with these coils. Wax-length range (16-225 meters using either a 00014 or 00015 mid. condenser for tuning. Wiring diagram included free with coils. Separately 10c.

No. 4048R—4 prong—Set of 4 coils (16-225 meters)	Price \$1.19
No. 4048B—4 prong—Broadcast coil (200-550 meters)	38
No. 4088R—6 prong—Set of 4 coils (16-225 meters)	1.59
No. 4088B—6 prong—Broadcast coil (200-550 meters)	.48

**GEN-WIN ALL-WAVE COIL KIT—Range 25 to 550 Meters**  
 A newly developed all-wave coil kit comprising a 3 circuit tuner and an R.F. coil, both having tapped secondaries, which permits you to enjoy **SHORT WAVE AND BROADCAST PROGRAMS.** By means of a simple shorting-switch arrangement, a portion of the secondary coils may be cut out of the circuit thereby making it resonant to the higher frequencies in lower wave lengths. Kit may be had for use with either 00035 or 00035 mid. condenser. Specify which when ordering. Wiring diagram included free with coils. Separately 10c. All Wave Tuner (as illustrated) .75  
 All Wave R. F. Coil

**GENERAL WINDING COMPANY**  
 254 W. 31st St. Dept. I-S NEW YORK, N. Y.

**BIG 1936 WHOLESALE CATALOG FREE**

164 pages—Radio, Electrical and Refrigeration Equipment at lowest net prices. A catalog of great value to every dealer, service man and amateur. Complete sets, parts, amateur and commercial apparatus. Write today.

**BURSTEIN-APPLEBEE CO.**  
 1012-14 McGee St. Kansas City, Mo.

**A HAPPY NEW YEAR TO YOU!**

Enroll with **INTERNATIONAL CORRESPONDENCE SCHOOLS**

AND OBTAIN AN EDUCATION ON **RADIO** THAT WILL INSURE 1936 as your **HAPPY NEW YEAR**

**INTERNATIONAL CORRESPONDENCE SCHOOLS**  
 Box 2880-C, Scranton, Penna.  
 Send me—free—information on subject checked:  
 Radio Operator  Radio Service Man  
 Electrical Engineer

Name.....  
 Address.....

Please mention SHORT WAVE CRAFT when writing advertisers



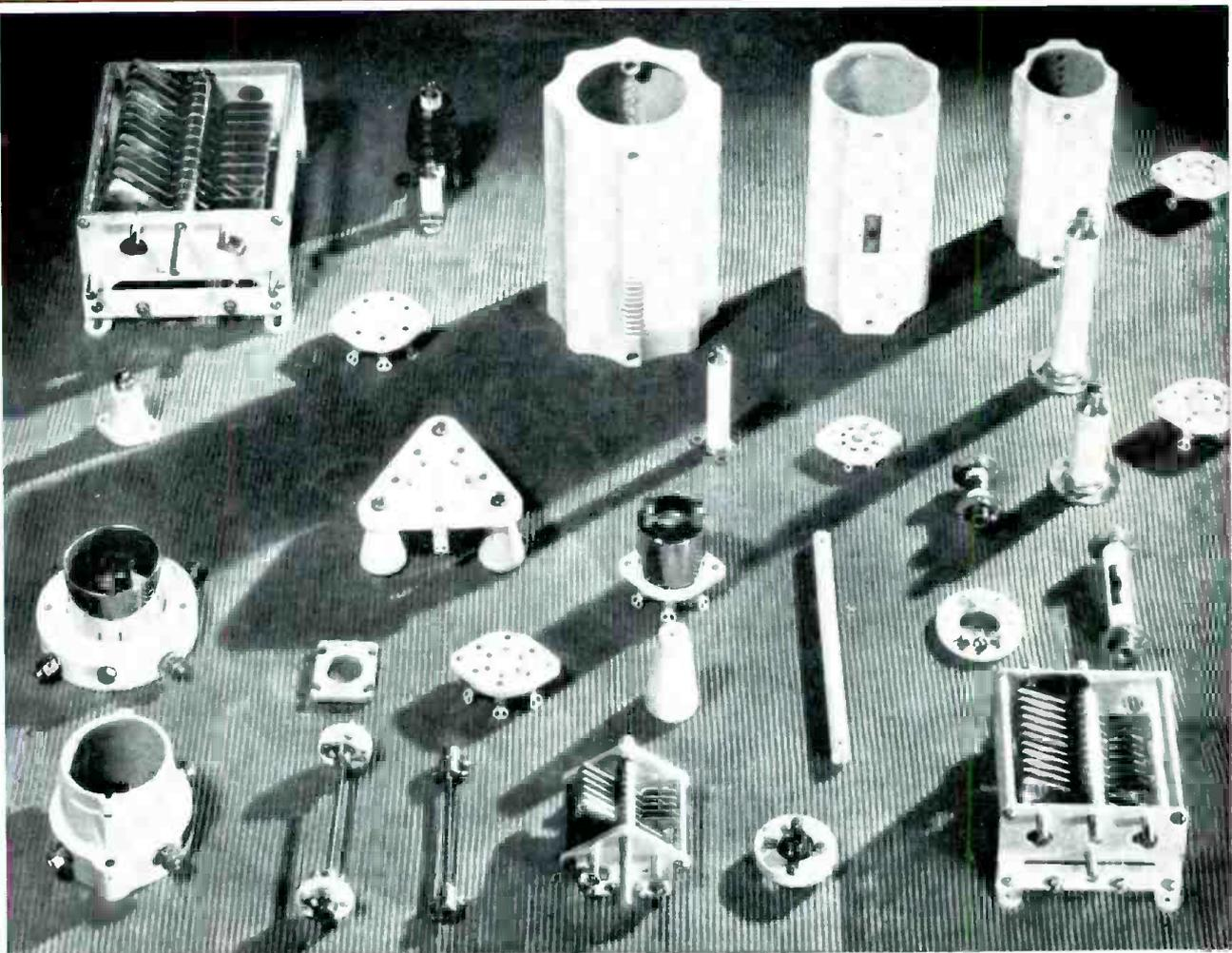

National offers a thoroughly engineered part for nearly every radio purpose. The entire line cannot be compressed into our twenty-page catalogue, much less a single page. But look over the group above. Transmitting condensers from the little 1000 volt TMS in the foreground to the 12,000 volt TMA at the rear. Low loss ceramic coil forms for every amateur band. Low loss sockets for nearly every tube type, from acorns to power pentodes. Flexible couplings from the little TX-12, which will work around a corner, to the big fellows for heavy condensers, high voltages, and low-losses. Strain insulators, spreaders, lead-ins for the antenna: stand-offs, chokes, dials for the rig. National has what it takes.

**NATIONAL**  
61 SHERMAN STREET



**COMPANY**  
MALDEN, MASS.

only  
**MIDWEST**

Gives You an

**18-TUBE Radio**  
(for Metal or Glass Tubes)

SIX TUNING RANGES

4½ to 2400 METERS

FULL SCOPE  
HIGH FIDELITY

PUSH BUTTON TUNING

ROBOT EAR

and Scores of Other  
Features for

**\$59.50**  
with New  
GIANT  
THEATRE-  
SONIC  
SPEAKER

SAVE UP TO **50%**

Direct FROM MIDWEST  
LABORATORIES

No middlemen's profits to pay. You buy at wholesale price, direct from Laboratories... saving 30% to 50%. You can order your 1956 Midwest radio from the new 40-page catalog with as much certainty of satisfaction as if you were to come yourself to our great laboratories.

You save 30% to 50%... you get 30 days FREE trial... as little as \$5.00 down puts a Midwest radio in your home. You are triply protected with a One-Year Guarantee, Foreign Reception Guarantee and Money-Back Guarantee.

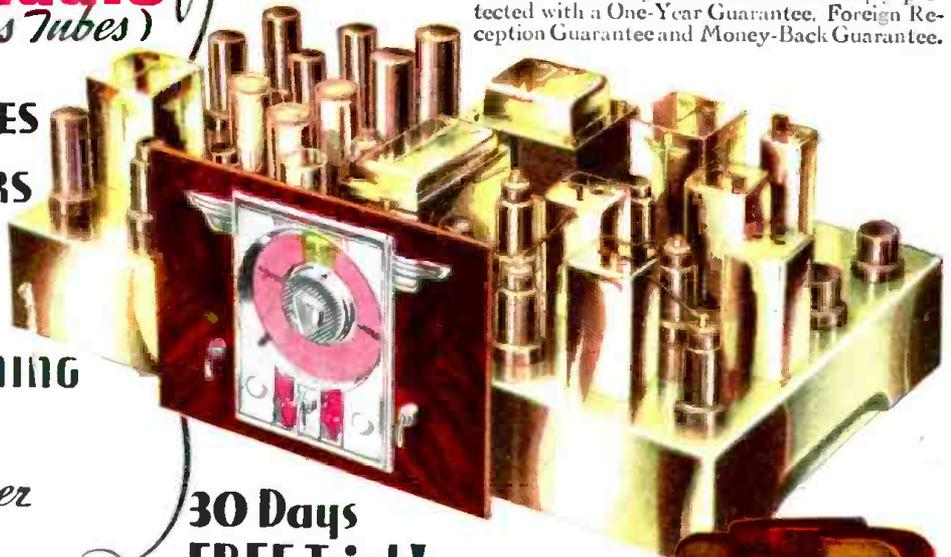

**30 Days  
FREE Trial!**

**GUARANTEED FOREIGN RECEPTION**

This super radio will out-perform \$200 and \$300 sets on a side by side test. It is so powerful, so amazingly selective, so delicately sensitive that it brings in distant foreign stations with full loud speaker volume, on channels adjacent to powerful locals. The 18 tubes permit of advanced circuits, make it possible to use the tremendous reserve power, and to exert the sustained maximum output of the powerful new tubes.

**80 SENSATIONAL ADVANCEMENTS**

Scores of marvelous Midwest features, many of them exclusive, explain Midwest glorious tone realism, super performance and thrilling worldwide 6-band reception. They prove why nationally known orchestra leaders like Fred Waring, George Olsen, Jack Denny, etc., use a Midwest in preference to more costly makes. Pages 12 to 21 in FREE catalog illustrate the new Midwest features. Study them before you make up your mind.

**PUSH BUTTON TUNING**

Simply pushing Silencer Button silences set between stations. Beautiful tuning lights automatically indicate when station is properly tuned. Release button... and station comes in perfectly. Pressing Station Finder Button (Midwest's exclusive ROBOT EAR) automatically determines proper dial position for bringing in extremely weak stations.



GINGER ROGERS AMAZED AT MIDWEST PERFORMANCE

Hollywood, California.  
"Your Midwest is a wonderful instrument. The tone quality is delightful and it surpasses any set I have ever owned. I have heard stations from all over the world. I got a thrill the first time I tuned in on the booming of 'Big Ben'."  
GINGER ROGERS



**TERMS AS LOW AS \$5.00 DOWN**

ONCE again Midwest demonstrates its leadership by offering the world's most powerful Super De Luxe 18-METAL Tube 6-Tuning Range radio. It is a master achievement... today's most highly perfected, precisely built, laboratory adjusted set. It is a radio-musical instrument that will thrill you with its marvelous super performance... glorious new acousti-tone... crystal-clear "concert" realism... and magnificent foreign reception. Before you buy any radio, write for FREE 40-page 1936 catalog. Learn about the successful Midwest Laboratory-To-You policy that saves you 30% to 50%... that gives you 30 days FREE trial.

**SIX TUNING RANGES**

This exclusive engineering triumph puts Midwest radio years ahead of ordinary sets and makes them the "World's Greatest Radio Values." Now, it is easy to make the nations of the world parade before you. You can switch instantly from American programs to Canadian, police, amateur, commercial, "secret," experimental, airplane and ship broadcasts... to the finest and most fascinating programs from Europe, Africa, Asia, Australia, South America... 12,000 miles away.

**ACOUSTI-TONE V-SPREAD DESIGN**

(U. S. Patent No. 96750)

The V-Front Dispersing Vanes established a new radio style overnight. They spread the beautiful lace-work of the "highs" throughout the room in a scientific manner... directing the High Fidelity waves uniformly to the ear. Now, get complete range of audible frequencies from 50 to 16,000 cycles... achieving glorious new acousti-tone... assuring life-like crystal-clear "concert" realism.



Send for FREE 40-page four-color catalog. It pictures the complete line of beautiful 1936 Midwest Acousti-Tone V-Spread consoles... and chassis... in four colors.

**MAIL COUPON TODAY!**

**FOR FREE 30-DAY TRIAL OFFER and 40-PAGE FOUR-COLOR FREE CATALOG**

MIDWEST RADIO CORP.,  
Dept. 14P, Cincinnati, Ohio

Without obligation on my part, send me your new FREE catalog, complete details of your liberal 30-day FREE trial offer, and FREE Miniature Rotating 18-tube Dial. This is NOT an order.

User-Agents  
Make Easy  
Extra Money

Check Here  
for  
details

Name \_\_\_\_\_

Address \_\_\_\_\_

Town \_\_\_\_\_ State \_\_\_\_\_

Check here, if interested in a Midwest All-Wave Battery Radio

**MIDWEST RADIO CORP.**

DEPT. 14P CINCINNATI, OHIO U.S.A.

Established 1920 Cable Address MIRACO All Codes