

SERVICE

THE TECHNICAL JOURNAL OF THE TELEVISION-RADIO TRADE

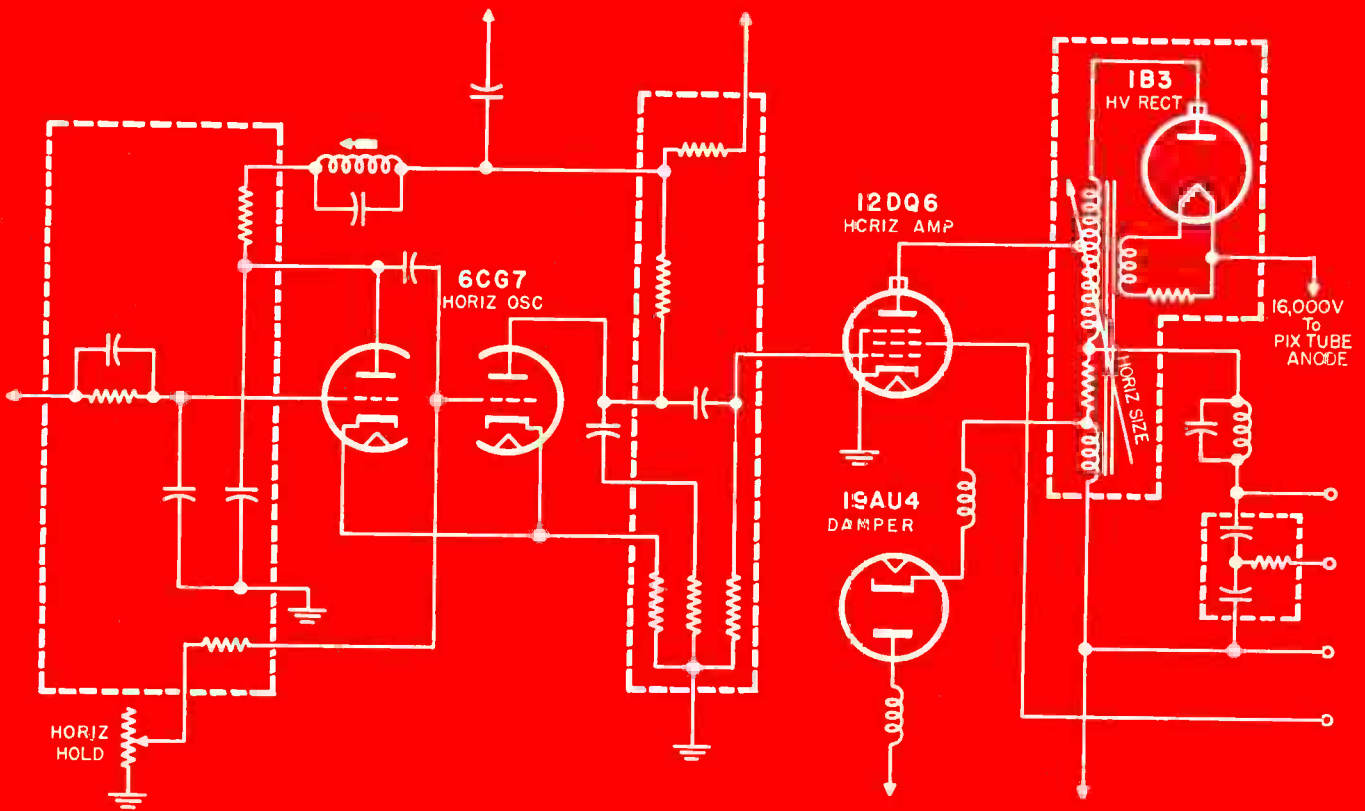

Horizontal oscillator-amplifier, damper and hv rectifier circuitry of plated-circuit TV chassis using printed-circuit component assemblies.

See circuit analysis, this issue

25 SAR 6-28-56 MR
L DILLON
814 WATER ST
MEADVILLE, PA
2-59

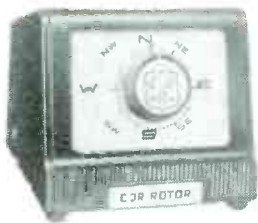

AR-22



TR-2



TR-4

5-star feature...

1

the best color TV picture

the growth of color TV means an even greater demand for CDR Rotors for pin-point accuracy of antenna direction.

2

a better picture on more stations

CDR Rotors add to the pleasure of TV viewing because they line up the antenna perfectly with the transmitted TV signal giving a BETTER picture... and making it possible to bring in MORE stations.

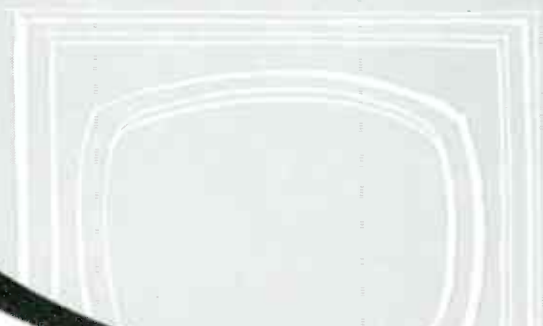

CDR ROTORS

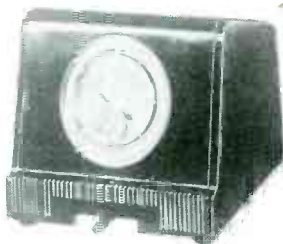

TR 11 and 12

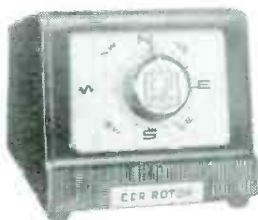

AR 1 and 2

3

tested and proven dependable

thousands and thousands of CDR Rotors have proven their dependability over years of unflinching performance in installations everywhere in the nation. Quality and engineering you know you can count on.

4

pre-sold to your customers

the greatest coverage and concentration of full minute spot announcements on leading TV stations is working for YOU... pre-selling your customers.

5

the complete line

a model for every need... for every application. CDR Rotors make it possible for you to give your customer exactly what is needed... the right CDR Rotor for the right job.



CORNELL-DUBILIER
SOUTH PLAINFIELD, N. J.



THE RADIART CORP.
CLEVELAND 13, OHIO

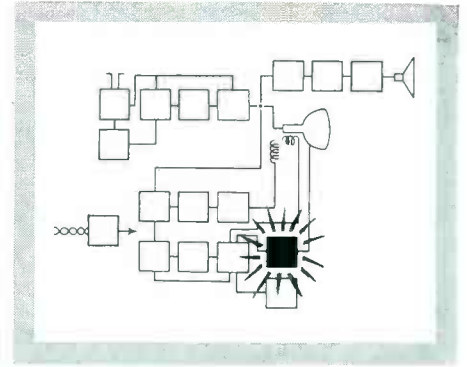
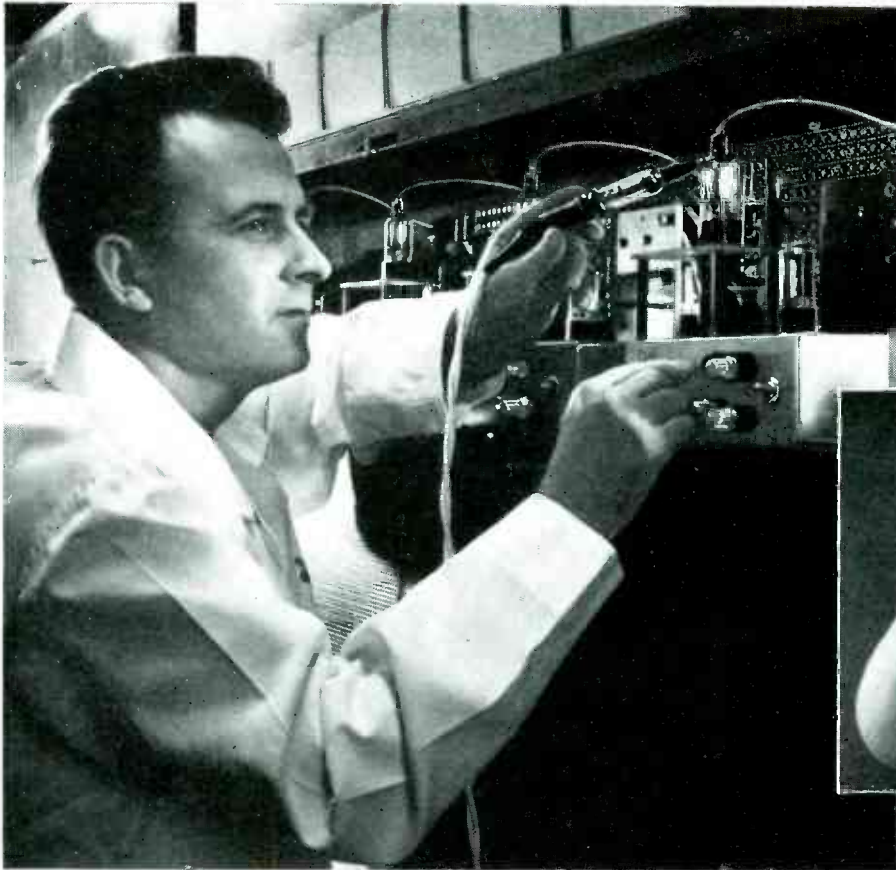

ABOVE: A General Electric technician checks rectifier tubes during special flyback life test.

ABOVE: Tungsten "lightning rod" in G-E high-voltage rectifier tubes shields the filament from electrostatic pull of high anode voltages. Shorts, broken filaments are sharply reduced.

"Lightning rod" in G-E high-voltage rectifier tubes minimizes filament pull-out, adds hours of service!

High-voltage rectifier tubes handle high anode voltages. These create an electrostatic pull on the fragile filament, and can cause it to short or break. In General Electric's service-designed 1B3-GT and 1X2-A/B, a tungsten post shields the filament . . . cuts filament-to-plate shorts and pull-out . . . enables you to install long-life tube performance in your customers' sets.

Other special design features of G-E high-voltage rectifier tubes further help you build customer goodwill. A highly adhesive filament coating cuts arc-overs, extends tube life. Bulbs are ringed with conductive material to prevent bulb-charging, a condition which

causes streaking of the television-viewer's picture.

After manufacture, tubes receive a 100% flyback test and a dynamic flyback life test—both at the maximum ratings met in big-screen set operation. You can install Types 1B3-GT and 1X2-A/B with confidence their superior performance and long service life will bring customer satisfaction.

There are General Electric tubes with the same business-building high quality for every socket in every set you service. Phone your G-E tube distributor today! *Electronic Components Division, General Electric Company, Schenectady 5, New York.*

Progress Is Our Most Important Product

GENERAL  **ELECTRIC**

161-1A2

SERVICE, FEBRUARY, 1957 • 1

Two Great Names
get together . . .

Plasti-Kote
and Argos

To bring Spray Paint to
The Electronics Industry

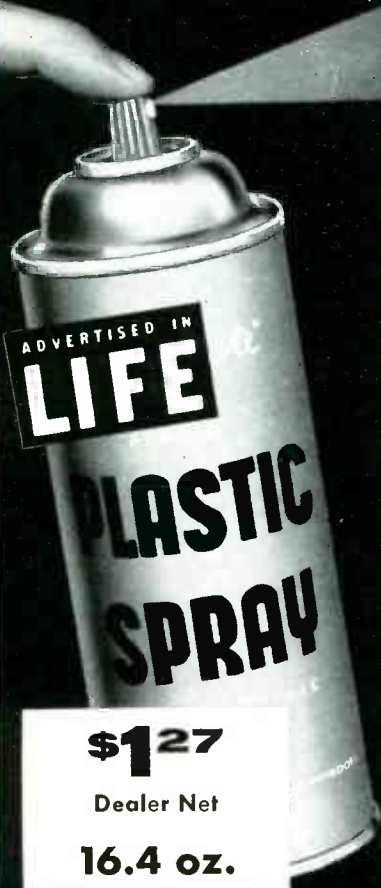

\$1.27

Dealer Net

16.4 oz.

Developed by electronic engineers
for electronic experts—with the
highest dielectric strength—800
volts/mil.

The new Plasti-Kote X-11 acrylic
spray is the best ever developed
for coating terminals, rust proofing
antennas and other electronic uses.

Ask your Argos parts distributor now!

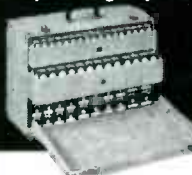

Brought to you
by the makers
of the famous
"tube caddy"

Reg. TM
Argos
PRODUCTS COMPANY

310 MAIN STREET • GENOA, ILLINOIS

Vol. 26 No. 2

SERVICE

FEBRUARY, 1957

The Technical Journal of the Television-Radio Trade
Including RADIO MERCHANDISING and TELEVISION MERCHANDISING
Registered U. S. Patent Office

COVER CIRCUIT

TV Horiz-Osc/HV Rectifier Section of PW Packaged-Assembly Chassis
(Motorola TS-422A-00) 15

FEATURES

Editorial Lewis Winner	11
Radio-B-W/Color-TV Servicing in Oakland, Calif. Ernest Copley	12
Packaged Electronic Circuit Printed-Wiring TV Chassis (Cover; With Complete Diagram) Bernard Schlacter	15
How the 3-Gun Color-TV Tube Operates Ken Kleidon	18
This Month in SERVICE	21
Troubleshooting Horizontal-Output HV-Rectifier Circuits in the Horizontal Sweep System (Circuit-Chart Analysis) Jesse Dines	24
Microwave System Field Servicing by Independent Service Engineers (Service Engineering) George Vass	28
Transistor Chassis Repair . . . Auto-Radio Intermittent-Electrolytic Tests . . . Radio IF Replacements (Service Helps)	30
Latest Developments in Color/B-W TV Picture Tubes and Miniatures Audio Transistors	32
All-Band VHF-Antenna Fringe-Area Installations Jack Darr	35
Transistor-Amp Portable-Phono Circuitry . . . Tape-Recording Repair Tips . . . 4-Speed Player Servicing (Audio Installation . . . Service)	37
Commercial Sound Cables Frank Timmons	54

CIRCUIT DIAGRAMS

Motorola TS-422A-00 PW Chassis Power Supply 15	Spartan 24U213 Sweep System 25
Motorola TS-422A-00 Cascode-Pentode Tuners 16	Magnavox CT/CU/CM4401B Sweep 25
Motorola TS-422A-00 (Complete Circuit) 17	Delco Transistor (1N278 PNP) Radio Output 30
RCA KCS81E Horizontal Sweep 25	Intermittent Electrolytic Test Setup 30

DEPARTMENTS

Service Engineering 28	Audio Developments 48-51
Tube-Transistor News 32	Association News 52
TV Antenna Digest 35	Ten Years Ago in SERVICE 52
Audio Installation and Service 37	Bench-Field Tools 53
Industry News 38	Instruments 56
Catalogs and Books 43	Components 57
TV Parts . . . Accessories 46	Personnel 64

Index to advertisers 63

Entire Contents Copyright 1957, Bryan Davis Publishing Co., Inc.

Second-Class mail privileges authorized at New York, N. Y.; additional entry at the Post Office, Norwalk, Conn. . . . Subscription price: \$2.00 per year (\$5.00 for 3 years) in the U.S.A. and Canada; 25 cents per copy. \$3.00 per year in foreign countries; 35 cents per copy.



EDITOR and PUBLICATION DIRECTOR

Lewis Winner

- Associate Editor: **David E. Pearsall II**
- Assistant Editor: **Robert D. Wengenroth**
- Editorial Assistant: **Arnold Gewirtz**
- Editorial Assistant: **Howard Jennings**
- Art Director: **Anthony R. Aliffi**
- Supervisor, Circuit Diagrams:
Michael D. Bellezza
- Editorial Production: **Astrid Kelly**

CIRCULATION DEPARTMENT

- Circulation Manager: **A. Goebel**
- Ass't Circulation Mgr.: **A. Kiernan**

ADVERTISING DEPARTMENT

- Advertising Mgr.: **Aaron L. Lafer**
- Pacific Coast: **Leo Sands**, Dist. Mgr.
535 Ramona St.
Palo Alto, Calif.
Tel.: DAvenport 5-3716

Published Monthly by
Bryan Davis Publishing Company, Inc.
 52 Vanderbilt Ave., New York 17, N. Y.
 Tel.: MUrray Hill 4-0170
 B. S. Davis, Pres. Lewis Winner, Vice-Pres.



LOOKING?
for the right dual-control replacement

You'll find it's
ALWAYS IN STOCK at your
Centralab Fastatch[®]
distributor

- With Centralab's unique Fastatch system, your distributor can afford to carry a *complete line* of dual-concentric replacements for all popular TV, radio, and auto sets.
- Each Fastatch control unit is factory assembled, tested, and guaranteed.
- Ask your Centralab distributor's salesman or counterman about Fastatch duals. Or send coupon for bulletin 42-218.



A DIVISION OF GLOBE-UNION INC.
 934B East Keefe Avenue, Milwaukee 1, Wisconsin B-5622

Send me Fastatch bulletin 42-218.

Name: _____

Company: _____

Address: _____

City: _____ Zone: _____ State: _____





Here's your first line of defense
against one of TV's biggest service problems

Sylvania Deflection Tubes

—upgraded and triple-tested for dependable
performance in TV's hardest working
deflection systems

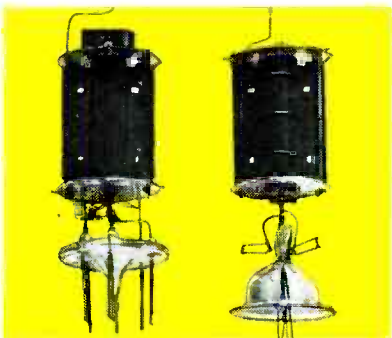

Notice how much more rugged the Sylvania wafer stem mount looks (left). That's because the wafer stem results in shorter construction with more points of support and heavier, sturdier leads.

If you haven't yet tried these new Sylvania deflection tubes—you're in for a pleasant and profitable surprise.

They've been carefully redesigned and thoroughly tested to meet the challenge of hard-working deflection systems, tightly engineered circuits and the "runaway" conditions which often result when components age and change in value.

Sylvania's wafer stem construction minimizes the effects of electrolysis resulting from gases driven off by high tube operating conditions. The wafer stem provides wider

spacing between leads and permits the use of heavier lead wires.

The wafer stem adds mechanical ruggedness to these tubes by providing three-point support and reduces internal arcing by increasing the spacing between the plate pigtail lead and the tube mount.

These improvements were made as the result of thorough testing and experimentation to determine points of breakdown in earlier types. Now, these tests serve as important quality control measures for the production of these new deflection types.



SYLVANIA

SYLVANIA ELECTRIC PRODUCTS INC.
1740 Broadway, New York 19, N. Y.
In Canada: Sylvania Electric (Canada) Ltd.
Shell Tower Building, Montreal

LIGHTING • RADIO • ELECTRONICS • TELEVISION • ATOMIC ENERGY



Test No. 1—Static Life Test



The static life test operates the tube under dc circuit conditions near maximum plate and screen dissipations and dc cathode current. Characteristics are con-

trolled for maximum and minimum values and is considered at the end of its life when characteristics drop below or rise above specified limits.

Test No. 2—TV Life Test



Sylvania deflection tubes are testing in stock models of representative TV manufacturers. Tests are conducted at accelerated line voltages so that tubes are operated at a considerably high level. These

accelerated conditions of 130-volt line increase failure rate 2.37 times to provide important design and production information which results in better quality and dependability for you.

Test No. 3—Dynamic Life Test



These dynamic life test racks enable Sylvania to approximate TV set operating conditions which can be controlled. Thus, an operating standard is established

against which all deflection tubes can be tested.

Look for and specify Sylvania's new deflection tubes in the new carton.

Learn how you can earn this famous course in COLOR TV SERVICING

Sylvania has just taken another step in its continuing effort to help the independent radio and TV service dealer. Your Sylvania Distributor can tell you how you can earn the popular Radio-Television Training Association's Color TV Technician course. RTTA is one of the most respected names in home study training methods—has trained thousands in the fundamentals of black-and-white TV and is now doing the same in color servicing.

A Sylvania Exclusive!

When you earn RTTA's color course offered by Sylvania you get a special supplementary lesson in full color. It's a Sylvania extra which serves as a capsule survey of color television which will help you with lesson details.

See your Sylvania Distributor or mail the coupon below and find out how you can start learning color TV right away.



Sylvania Electric Products Inc.
Dept. B62N
1740 Broadway, New York 19, N. Y.

Please send me full details on how I can earn the RTTA home-study course in color TV

Name _____

Service Co. _____

Address _____

City _____

State _____

Right from the carton...

Right for the set!



No guessing...
No fussing...
No wasting
precious time and effort.

CLAROSTAT

Right from the "RTV"* green carton, you get the right replacement control matched to original specifications.



Ask your Clarostat distributor
for "RTV"* Replacements!



* Reg. U. S. Pat. Off.

Controls and Resistors
CLAROSTAT MFG. CO., INC. • DOVER, NEW HAMPSHIRE

In Canada: CANADIAN MARCONI CO., LTD., Toronto 17, Ont.

FULL **C** **O** **L** **O** **R** TV



MODEL U-98—first and finest fully automatic rotator. Eye-appealing decorator colors—Ivory, Forest Green and Standard Mahogany Grain. Retail **\$44.25**

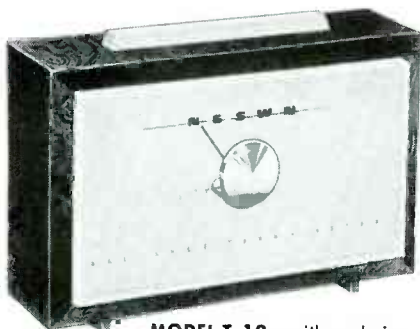

MODEL T-12—with exclusive Tenna-Teller Pointer—highly accurate. Striking, modern design. Forest Green and Ivory or Standard Mahogany. Retail . . . **\$34.25**
Decorator Colors priced \$2.00 extra.

demands reliable



DON'T ASK VIEWERS TO PUT UP WITH A 'STAY-PUT' ANTENNA!

- TV authorities admit the higher sensitivity of color.*
- Viewers won't tolerate weak, washed out color!
- Maximum directivity with ALLIANCE TENNA-ROTOR is the best insurance for top antenna performance—for FULL COLOR!

Wherever you find Color TV, it will pay you to recommend Alliance!

- Every color TV buyer is a potential Tenna-Rotor sale . . . even in metropolitan areas. Because the "**fringe**" area for color is closer to the transmitter!
Viewers who might tolerate black and white TV that's "so-so", will **not** put up with irritating, "ghosty" color. And independent interviews **at point of sale** show that color TV customers find it **easy** to say Yes to Alliance Tenna-Rotor!

*Practically all TV authorities agree "color is critical"—more sensitive than black and white. "Chromatic gradation" with color that's ghosty, is harder on the eyes than black and white. Many recommend properly installed outdoor antennas with rotators, to improve directivity of the antenna, to help overcome interference and reduce annoying effects caused by the higher sensitivity of color, and the normal characteristic of **color** to "drop out" quicker.

Ride the Trend to Color . . .

and soak up those extra profits with Alliance! Tie in with the longest and strongest TV campaign in TV accessory history! Remember . . . Poor color is worse than no color . . . and Alliance Tenna-Rotor is the sensible answer!

THE ALLIANCE
MANUFACTURING COMPANY, INC.

(Division of Consolidated Electronics Industries Corp.)

ALLIANCE, OHIO

In Canada—ALLIANCE MOTORS, Schell Avenue, Toronto 10



Here's why Electronic Equipment is Safeguarded Best — when Protected by BUSS Fuses

To make sure BUSS fuses will give dependable electrical protection under all service conditions . . . BUSS fuses are tested in a sensitive electronic device. Any fuse not correctly calibrated, properly constructed and right in all physical dimensions is automatically rejected.

That's why BUSS fuses blow only to protect—and not needlessly. Equipment receives maximum protection

against damage due to electrical faults—yet, it is not put out of operation by needless fuse blows.

Most important, the dependability of BUSS fuses helps you avoid costly, unnecessary callbacks and helps safeguard your reputation for quality and service.

Why settle for anything less than BUSS quality fuses? To meet service

needs, a complete line of BUSS fuses is available, plus a companion line of fuse clips, blocks and holders.

For more information on BUSS and FUSETRON Small Dimension fuses and fuseholders . . . Write for bulletin SFB. Bussmann Mfg. Co. (Div. of McGraw Electric Co.), University at Jefferson, St. Louis 7, Mo.

***BUSS fuses are made to protect
—not to blow, needlessly***



Makers of a complete line of fuses for home, farm, commercial, electronic, automotive and industrial use.

S257

the world's finest mast at today's lowest prices!

... because only Channel Master
manufactures telescoping masts
in its own steel tubing mill.

CHANNEL MASTER[®] **new SUPER-MAST**

Packed with new features that reduce installation
time...cut costs...deliver sturdier antenna support—
with the greatest convenience and safety.

NEW! EXCLUSIVE! DUAL T-NUT CLAMP

—saves time, cuts costs

Dual Clamp has 2 T-Nuts to accommodate standout insulator and locking
bolt. Eliminates nuisance and cost of additional nut buckle straps.

NEW! EXCLUSIVE! FREE TURNING GUY RING AND BEARING FOR EACH SECTION

—can never bind or jam

Extra large square guy ring for greater stability.

COMPLETELY INTERLOCKED

Can't pull out! Each mast section has swaged neck, expanded bottom.

Can't slip down! Each mast section rests on a heavy-duty cotter "plat-
form" pin. Bottoms are notched to automatically align locking-bolt holes.

Can't twist or turn! Sections are securely locked in place by a sturdy
L-Bolt with man sized lever that makes it easier to tighten without tools.

EASY TO TAKE DOWN!

Both the Dual T-Nut Clamp and Guy Rings are positioned below each joint.
This allows the mast to be completely collapsed without removing the
clamp or the standout insulator, and without jamming.

see your **CHANNEL MASTER** distributor

**Now Channel Master offers
you the widest selection in TV wire.**

- New UHF Tubular Transmission Wire
- New 4-Conductor Rotor Wire
- New Low Priced Addition to VHF Flat Ribbon Transmission Line
- New Hank Packaging—50', 75', 100'



HOT-DIPPED GALVANIZED
ZINC-COATED Inside and Out

Available
in 20, 30,
40, and 50
foot models.
All models
are 16 gauge
for top 2
sections.
Also Available
Straight-Away
telescoping mast
for economy
installations.

CHANNEL MASTER EXTENDS MASSIVE NATIONAL ADVERTISING CAMPAIGN

MILLIONS OF AMERICANS WILL CONTINUE TO
READ AND REMEMBER CHANNEL MASTER LARGE
SIZE ADS IN AMERICA'S LEADING PUBLICATIONS.



CHANNEL MASTER CORP. ELLENVILLE, N. Y.
the world's largest manufacturer of television antennas and accessories

copyright 1957 Channel Master Corp.

®-Trade Mark Reg. U.S. Pat. Off.

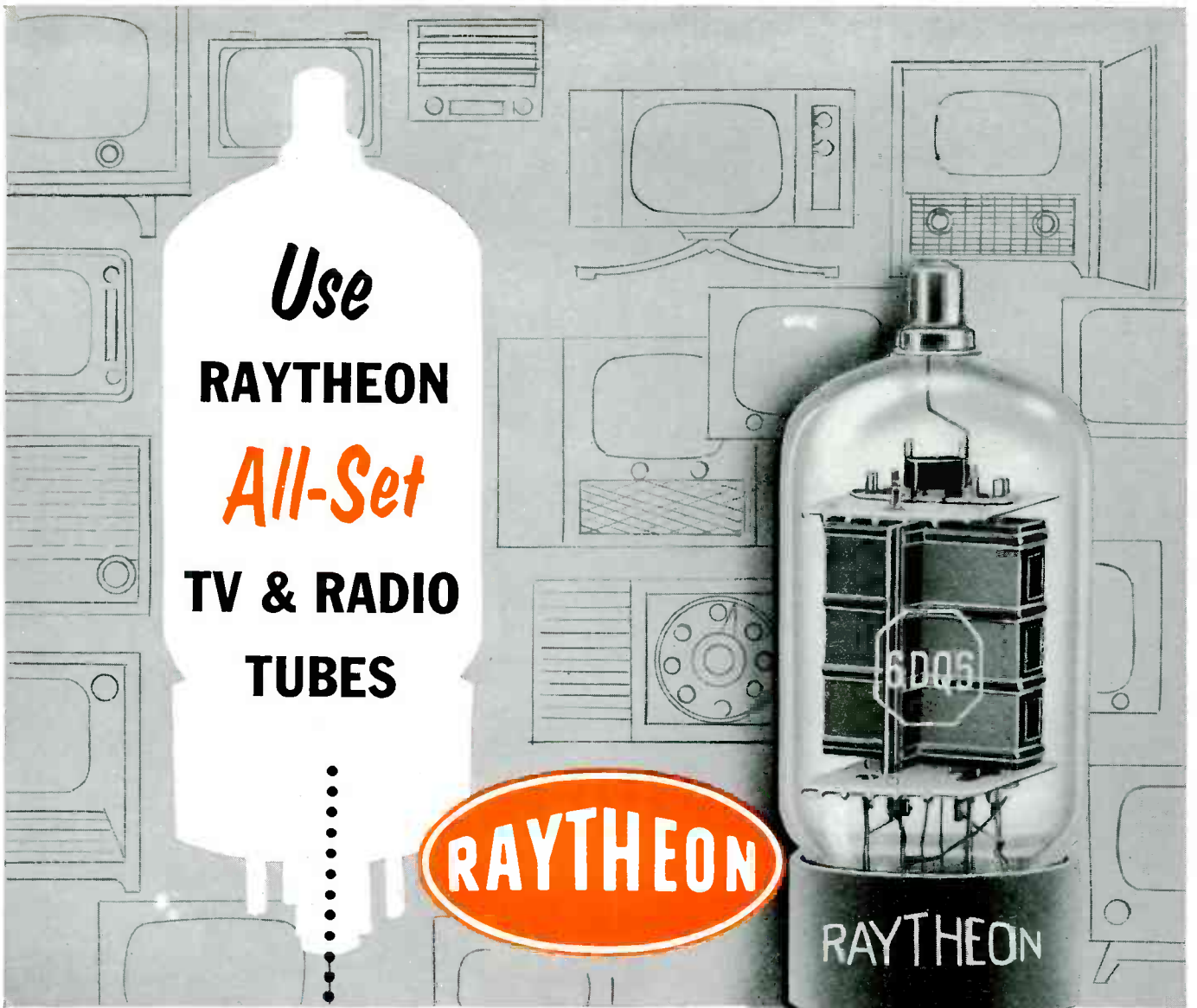

for all set replacement work!

You'll save yourself trouble if you standardize on Raytheon "All-Set" Tubes for replacement work.

Here's why:

Raytheon "All-Set" Tubes are designed to give perfect service in many makes and models of receivers because Raytheon sells Tubes to almost

every set manufacturer. To satisfy the many and varying needs of so many manufacturers, these tubes must combine top quality performance and dependability. This successful combination makes Raytheon "All-Set" Tubes tops for replacement.

Always use Raytheon "All-Set" Tubes to satisfy your "all-set" customers.

TV-Radio service is your business . . . serving you is ours



RAYTHEON MANUFACTURING COMPANY

Receiving and Cathode Ray Tube Operations

Newton, Mass. • Chicago, Ill. • Atlanta, Ga. • Los Angeles, Calif.

Raytheon makes all these { Receiving and Picture Tubes, Reliable Subminiature and Miniature Tubes, Semiconductor Diodes and Transistors, Nucleonic Tubes, Microwave Tubes.



Excellence in Electronics

SERVICE

The Technical Journal of the Television-Radio Trade

The New Look In Test Equipment

THE ADVENT OF COLOR-TV, printed-wiring chassis, packaged electronic circuits, miniaturized radio and TV models,^{*} modules and transistors, has brought about the development of a new family of instruments with many operational and application features.

Particularly noteworthy in all designs, even in the most complex equipment, is the simplicity of control that has been achieved. This has been accomplished through the use of not only novel circuit arrangements, but unique mechanical and electrical advancements that have made many functions completely automatic. For color-TV, we now have color-convergence pattern generators with automatic synchronization and stabilizer systems. Also available are signal generators with automatic output-level control.

In color-bar generators there are simplified controls for the expanded values of chroma now required because of the use of vestigial color-sideband-type reception. Some instruments now provide up to -6 db for chroma control, and in addition include a -15 db chroma output to check color lock on a weak burst signal. Color-bar generators also offer (G-Y)/90° test signals to take care of the (G-Y) color detectors now being used extensively.

THE INCREASING DEMANDS ON TIME, calling for not only speed, but marked accuracy in repair work, have also prompted the development of a number of specialty-type instruments that can quickly localize troubles. Some of these instruments have taken the form of in-circuit testers and others as equipment-extension accessories that can extend the usefulness of test gear now in the shop. To illustrate, the recently-developed marker-adders have made it possible to increase substantially the effectiveness of sweep generators in alignment work.

In using sweep generator traces for alignment, it is important to know exactly where you are on the frequency scale. Most generators come with a calibrator crystal which can provide specific marker points at predetermined frequencies. These frequencies are accurate because of the

crystals used. But, even with this aid, it has been found difficult to interpolate exactly the frequency you want to know. It is much more convenient to have an adjustable marker that can be set to a specific frequency that may be required. Signal generators separated from the sweep generator have been used for this purpose by linking to the external marker point on the sweep equipment. However, there is a serious disadvantage to this procedure. In mixing the marker frequency with the sweep frequency, the marker frequency passes through the test section of the receiver, as well as the sweep frequency. Thus, the response curve traced will be invalidated by the presence of the marker signal; it will tend to fill in the slots made by the traps. These disadvantages can be overcome by adding a marker after passing a test signal through the set. In this way, the marker serves to put a pip on the screen at the predetermined frequency, without in any way interfering with the performance of the set by its presence. Such adding must be done electronically, so that no mutual interference takes place. This is the job done by the marker-adder.

TUBE AND TRANSISTOR testers have also undergone quite a change in their design.

The increasing use of tubes and semiconductors, and the exacting requirements that must be met, have made it mandatory for test instruments to be not only more accurate, but easier and quicker to use than ever before. Accordingly, manufacturers have engineered instruments that are not only extremely efficient, but have streamlined function controls to expedite tests.

THE SOARING AUDIO and commercial sound activity have also accented the need for improved test gear.

Here, too, industry has come through by developing a variety of versatile instruments that can check for all types of problems, such as wow, flutter, phasing and intermodulation distortion.

THE MODERN NEW-LOOK INSTRUMENTS[°] offer Service Men a grand opportunity to increase their business through speedier and more dependable service in the home and on the bench.—L.W.

^{*}Analyses of these new developments will appear in the March issue of SERVICE. Watch for this important report.

by ERNEST COPLEY, Foothill Television Service Co.

Radio-B-W/COLOR-TV Servicing in Oakland,

WE ARE a 2-shop operation, with a 6-man team of Service Men, covering the Berkeley to San Leandro territory in California, an area with a population approaching 1-million.¹

While all of us make outside calls when necessary, one of our men is a bench-repair specialist. Five of us regularly work on television sets, while one of the crew specializes in radio sets and record changers.

Our business was established six years ago. We handle over 400 service calls each month during which period we use approximately 1500 tubes. A charge of \$4.50 is made for service calls. There is a minimum charge of \$12.50 when sets are brought to the shop. This fee includes pick up and

delivery. Service calls are made as late as 9:30 P.M.

Receivers brought to the shop are plugged in and turned on and allowed to warm up sufficiently so that all tubes can be critically tested. We find that by checking *hot* tubes it is possible to find those which can cause trouble. Besides checking for shorts and transconductance, all applicable tube types are tested for grid emission with a set of portable grid circuit testers. These tests have served to minimize the callback problem.

After the tubes have been checked, the set is turned over to our bench specialist who diagnoses the trouble, makes out his report and calls the customer to quote the cost of repairs. We

never urge the customer to give us a go-ahead. Instead, we let the customer decide for himself. If the answer is *no*, the set is put back in its cabinet and returned with the minimum shop fee assessed. When we bring in an old model TV set and we find the repair costs to be excessive, we recommend that the customer buy a new set.

We do our own color work and have acquired a complete complement of test equipment to do the job right. We do not farm out any color-TV servicing as many shops in this area still do.

Our chief bench man, John Miller, teaches TV servicing two nights each week at East Contra Costa Junior

RIGHT: LETTER and return card used by Foothill shop to determine whether or not service rendered was satisfactory. Comments have proved very helpful in developing business. BELOW: DIRECT-MAIL BOOKLET that has been found to be very effective as a promotional circular.

HOW TO MAKE THE MOST OF YOUR TELEVISION SET

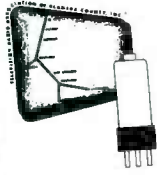

PRESENTED AS A PUBLIC SERVICE BY THE Foothill Television Service Co. Telephone ER 5-3722

HOW TO MAKE THE MOST OF YOUR TELEVISION SET

"What is the best distance to sit from the screen?" is one of the questions most frequently asked by people buying a television set for the first time. There is no one correct answer for everybody.

While the average distance for most viewers is from 8 to 12 feet, let your eyes tell you what the distance should be. Just as when you go to the movies, don't sit too far from the screen. When you prefer the convenience of the home, a little experimentation with members of the family will soon find the favored spot for watching with pleasure.

How much light should be left on? Is another question that is often asked.

In the evening, keep one light burning, a 40 or 75 watt bulb is sufficient. It should be shielded, of course, and should be located on either side of the tube wall. If you are watching a picture on one wall, for instance, the light should be on either the north or south wall. In the daytime, reduce available light with shades or Venetian blinds.

Annual dusting permits fused with glass (which causes reflections) above the set, and don't put dust-trapping objects on the top of the set.

The size of your set is all important and simple facts of life. Be sure to purchase a set that will fit in the room you intend to use it in.

To keep the screen clean, wipe the outside with a dampened lint-free cloth. If fingerprints, smudges or stains appear, clean with a soft, dry cloth. Annual tube tests should be inspected at regular intervals for convenience which require special test areas, wires need cleaning every six weeks.

Periodically, you will find the cabinet that has one or two extra pieces of the foreign TV should not have the electrical rigging that is visible to or ready for use as possible when in use.

The electrical rigging under the hood has the word "Warning" set against it. Don't touch it.

A television set is a complex mechanism. For example, the one. Annual 25¢ service fee covers 1000 hours of use, and during service is more than 2000 hours. (Some models of sets have a 1000-hour warranty.) Many service calls are made for repairs for sets that are working more than a year, under, and "Call your service man."

IN THE PUBLIC INTEREST THE TELEVISION-RADIO ASSOCIATION OF ALABAMA COUNTY HAS ESTABLISHED THE FOLLOWING CODE OF ETHICS

of the Television and Radio Association of Alabama County, Inc. is to assist in serving the public and the trade with competent workmanship, with forthright, truthful information and honest values, and to avoid any misrepresentation or subterfuge in the solicitation or the performance of the work we do by:

- Setting clearly in advance the price of goods sold, or a reasonable estimate of work to be performed and probable time of completion.
- Handling articles and services sold, actual work performed, all parts replaced and any return.
- Behaving to the customer, when practicable, all defective parts that have been replaced.
- Co-operating with customer and manufacturer in promptly obtaining existing warranties.
- Setting clearly when new, rebuilt or used merchandise is sold or is replaced.
- Accepting responsibility for work performed, assuming liability for damage caused, and being prepared to make good on all promises made.
- Refraining from deceptive advertising claims.

We Specialize in Complete Electronic Service

TELEVISION
RADIO - HOME AND AUTO
PUBLIC ADDRESS SYSTEMS
RECORD CHANGERS
PHONOGRAPHS
HI-FI

Foothill Television Service Co.
1275-1280 4TH ST. OAKLAND COUNTY
3319 FOOTHILL BLVD OAKLAND
Telephone
REReg 3-4215 REReg 3-7722

WALNUT CREEK BRANCH
1330 BARDWAY WALNUT CREEK
Telephone
TE 966-8424

FOOTHILL TELEVISION SERVICE CO.
3359 Foothill Blvd., Oakland 1, California
PHONE ER 5-3722
AUTHORIZED DEALER RCA • EMERSON • STRONBERG-CARLSON • MOTOROLA

DEAR FRIEND:

WE WISH TO THANK YOU FOR CALLING US IN TO SERVICE YOUR TELEVISION RECEIVER.

WE WANT TO BE SURE THAT OUR WORK HAS BEEN ENTIRELY SATISFACTORY... THAT YOUR SET IS WORKING PROPERLY... AND THAT OUR FACTORY-APPROVED SERVICEMAN WAS COURTEOUS.

BECAUSE PROFESSIONAL MEN NEVER TAKE ETHICAL SERVICE FOR GRANTED... AND BECAUSE IT IS THROUGH THE RECOMMENDATIONS AND SUGGESTIONS OF OTHER SATISFIED CLIENTS LIKE YOU THAT WE HAVE GROWN... WOULD YOU KINDLY CHECK THE POSTAGE-PAID REPLY CARD ENCLOSED AND DROP IT IN THE MAIL AT YOUR CONVENIENCE?

CORDIALLY,
Ernest S. Copley
FOOTHILL TELEVISION SERVICE CO.
(MEMBER OF THE NATIONAL ASSOCIATION OF BROADCASTING ENGINEERS)

DETERMINE YOUR SERVICEMAN

Circle one
 I AM NOT SURE
 I AM SURE

DO NOT REPAIR MY TELEVISION SET TO MY SATISFACTION

Circle one
 YES
 NO

IF YOU WOULD BE SO KIND AS TO REPLY TO THIS MAILING, PLEASE PRINT YOUR NAME AND ADDRESS.

NAME _____
ADDRESS _____
CITY _____ STATE _____ ZIP _____

▶
CHECKING tubes in a set brought in for a shop estimate.



California

College. One night is devoted to black and white TV servicing and the other to color servicing.

Miller took up radio almost 20 years ago at Samuel Gompers Technical School in San Francisco and studied electrical engineering for four years at the University of California after serving in the navy during the war.

Robert Hendrickson, who specializes in radio and record changers, teaches electronics at the junior college. The rest of us have had extensive experience in servicing TV receivers, radios, intercoms and industrial electronic equipment.

TV Antenna Installations

Most of our customers have outdoor antennas. Reception of channels 4 and 5, located on the other side of San Francisco bay, is generally excellent. Sometimes, these signals are too strong, especially for old model TV sets, so it often becomes necessary to install attenuator pads in the

(Continued on page 41)

¹Main store is at 3359 Foothill Blvd., in Oakland and the branch operation is a mile down the street.

The staff consists of John Miller, Ron Croft, Arnold Braaten, Robert Hendrickson, Ed and Ernest Copley.

▶
DIAGNOSING TV troubles prior to calling the customer to give an estimate of repair cost. In this checkup tubes are first tested for shorts, electrical merit and grid emission.



(Above)
THE TV bench-repair setup in the Foothill TV service shop.



(All photos by Cyril Glunk)

television's most dramatic

indoor antenna

Snyder
PHILADELPHIA

IMPERIAL

Directronic® 10-D

Twenty Dollars

*the ultimate in beauty
and performance*

Handsome cabinet in choice of traditional walnut, contemporary blond or smart ebony tones. Four-section extendable gold tone staff with 360° Roto-Tilt adjustment; the exclusive Snyder 12-position Directronic® Beam Selector For black & white and color, all channels. 10-day money back guarantee. Insured by the world's largest and oldest insurance company.

Another Antenn-gineered Original

by **Snyder**



PATENTS
PENDING

SNYDER Manufacturing Company
PHILADELPHIA • LOS ANGELES • TORONTO
EXPORT: ROBURN, NEW YORK

Packaged Electronic Circuit Printed-Wiring TV Chassis



Complete Analysis of 16-Tube Receiver Featuring 17 Circuit Assemblies and Metal Strap-Connected Panel-Chassis

[See Front Cover and Page 17 for Complete Circuit Diagram]

FOR THE FIRST TIME in TV receiver design, it has become possible to combine a completely printed-wiring circuit chassis with packaged electronic circuits.¹

In engineering this chassis, all of the circuits, except the high-voltage transformer, *vo* transformer, tuner, speaker and the customer controls, were placed on two *pw* panels. These controls were not included as part of the *pw* panels because of cabinet styling considerations.

The two *pw* panels have been so constructed that they can be supported by a metal chassis pan, which also supports the horizontal and vertical output transformers. Connections are made between the two panels by means of metal straps called *interpanel connectors*. These connectors are also used to make contact to the high-voltage assembly. The tuner, yoke and customer controls are connected to the rest of the set by plug-in. Thus, any

By **BERNARD SCHLACTER**, Senior Development Engineer, Motorola, Inc.

major section of the television set can be removed from the cabinet and from the rest of the set without unsoldering connections, if that section requires servicing.

The two plated-wiring panels consist of an *I* and *H* panels. The *I* panel contains a three-stage 40-mc *if*, video amplifier, audio *if*, audio amplifier, audio output and the major portion of the low-voltage power supply. The *H* panel contains the horizontal sweep, *afc* circuitry, vertical sweep, sync and the remainder of the power supply.

Res-caps² are used throughout to reduce space consumption and simplify the location of a specific resistor or capacitor which may be suspected of being faulty. In this chassis, there are 17 res-cap circuits, which contain

97 carbon resistors and ceramic capacitors normally found in a conventionally wired chassis.

The tuner is a pentode type with a 3BC5 *rf* stage and a 5U8 mixer-oscillator. Switch wafers, which contain the tuned circuits for the antenna, *rf* and oscillator coils, are plug-in to the tuner chassis base. By removing the tuner shaft, these plug-in wafers can be removed and replaced in case of clip contact damage or other failures.

The tuner is insulated mounted to the tuner mounting bracket and can be removed from the cabinet by removing two rear self-tapping screws and unplugging the tuner cable leads from the main chassis. This tuner cable contains two filament, B+, *agc*, and the mixer output coupling leads.

The *agc* fed to the tuner is applied to both the *rf* stage and the mixer stage when the area selector switch is in the local position. This has been found to minimize cross modulation in a very strong signal area. With the area selector switch in the suburban and fringe position, this *agc* line is grounded so that a minimum of noise from the tuner is contributed to the weaker incoming signals.

The *if* is a three-stage stagger-tuned 40-mc system, aligned in a *lo-hi-jack* arrangement for a 3.5-mc band width. The coupling from the

(Continued on page 16)

¹Terminology adopted by RETMA standards committee to define capacitor and resistor assemblies manufactured as a packaged encapsulated circuit.

BELOW: POWER SUPPLY diagram for Motorola packaged-circuit printed-wiring chassis.

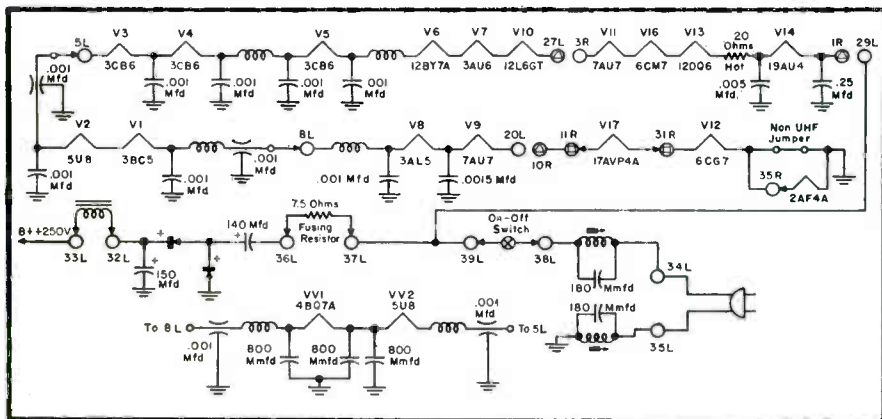

Printed-Wiring TV Chassis

(Continued from page 15)

tuner output cable capacity is part of the coupling network.

Full *agc* is applied to the first and second *if* stages in the *local-suburban* position of the area selector switch, but when this switch is placed in the *fringe* position only half of the available *agc* voltage is applied to these two stages, so that on a very fringe signal the noise does not develop sufficient second-detector volts to bias back the *if* and reduce picture-tube contrast.

The video amplifier has a 3.8-mc bandwidth. The audio *if* take-off (4.5-mc) is from the plate of the video amplifier through a 2.2-mmfd capacitor in a res-cap unit, into a limiter tube; the limiter drives an unbalanced ratio detector. To align the ratio detector primary and secondary, test points are provided at the edge of the panel. Video-*if* alignment test points are also provided on the edge of the I panel near the third *if* coil can. One half of a 7AU7 is used as an audio amplifier. A drop across a 33,000-ohm plate load resistor is used as the bias for the audio-output stage because of the *dc* coupling between these two stages. The audio-output stage also acts as a self-regulating dropping resistor for dissipating the power required to drop the B+ (265 v) down to 135 v.

When high total capacity is required in a res-cap, *hi-K* dielectric ceramics are used, and conversely when a very low value or temperature-compensating type capacities are necessary, a *low-K* dielectric must be used.

In the *if* strip, grid-coil damping resistors which require low capacities, and *agc*, cathode or other high capacity *bypass* capacitors have been combined in a single res-cap unit. It was found possible to combine these *low* and *hi-K* ceramic dielectrics into a single plate by reducing stray internal capacities between critical points.

In the audio *if* res-cap a total of 16,500 mmfd is used for the various *bypass* and coupling capacitors, but the grid-leak resistor of this stage is also included as one of the resistors; this grid requires only about 30 mmfd capacity across it to maintain high

(Continued on page 62)

LEFT: CASCODE (A) and pentode (B) type tuners designed for Motorola pw chassis. The cascode tuner is included in those chassis having a continuous tuning uhf system.

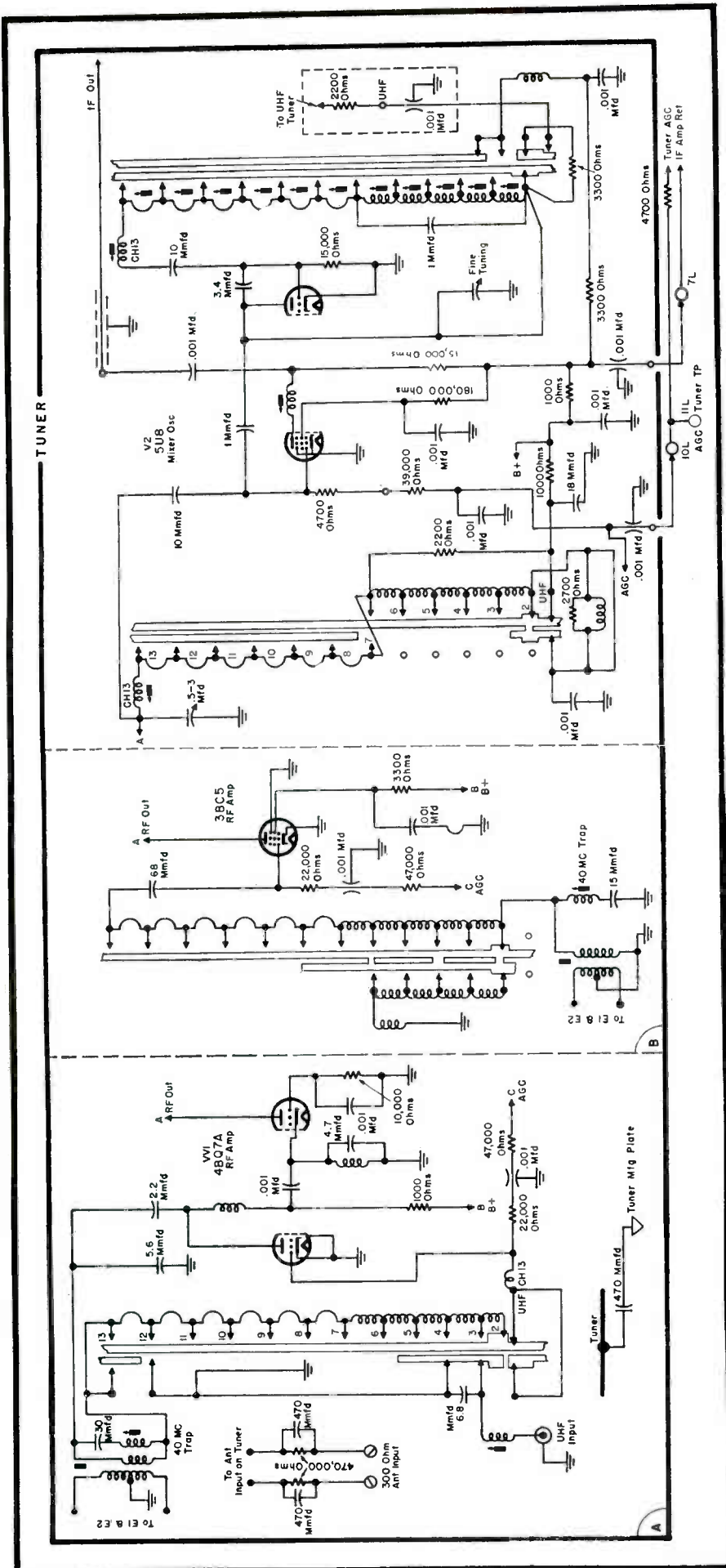

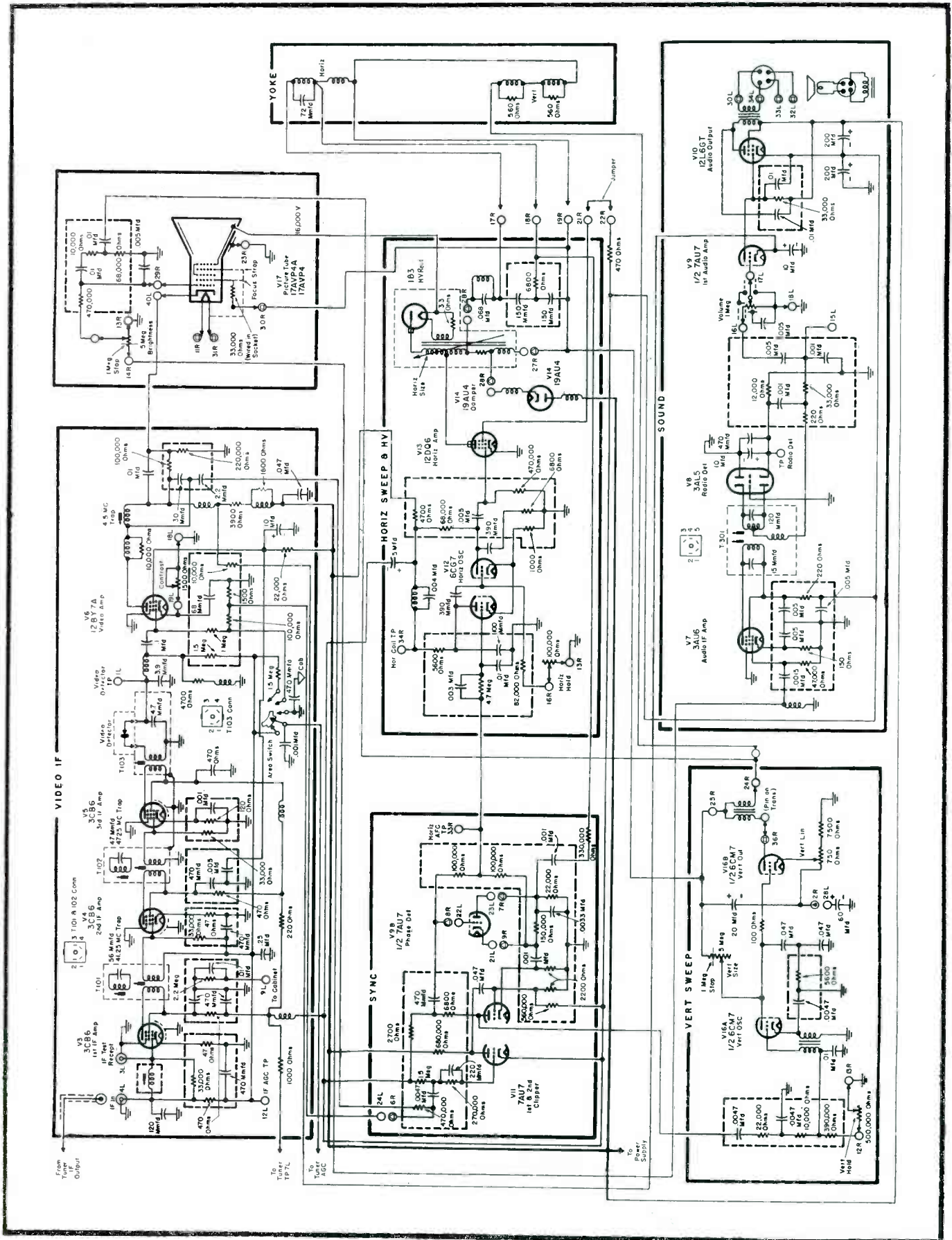

COMPLETE CIRCUIT DIAGRAM of the 16-tube printed-wiring TV chassis with packaged electronic assemblies; Motorola chassis TS-422A-00.

How the 3-Gun COLOR-TV

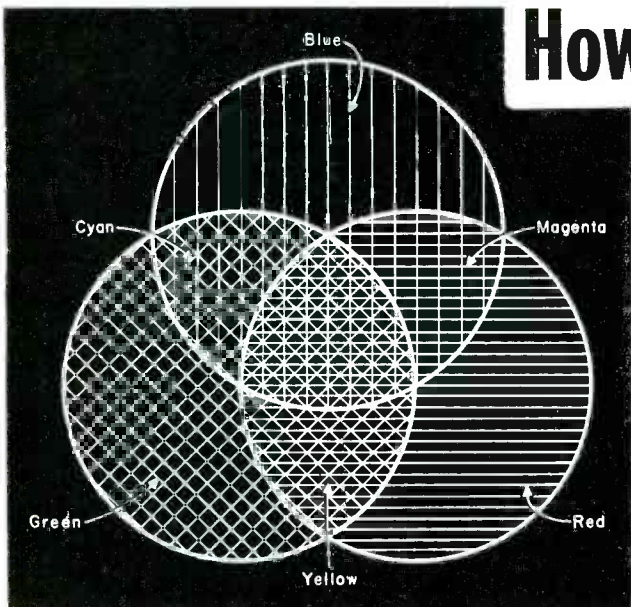

Simplified Explanation Using Novel Black and White Pattern Charts to Illustrate Color Reproduction

THE COLOR-TV picture tube is the heart of the color set. This tube, performing the final function in the reproduction of the televised scene, converts the electrical signal impulses into the color light variations necessary to construct a television picture in full color.

Due to the compatibility aspects of color, one of the requirements of a color receiver is that it must be capable of receiving a b-w transmission and reproducing pictures in black-and-white, as well as color.

Color picture tubes now in use are of the three-gun type, and contain exactly what its name implies: three electron guns. There are actually three separate picture tubes in one enve-

The black and white color-bar method, (Figs. 1 and 2) designed to illustrate all of the colors that one would see in a color-bar pattern on the screen of a 3-gun tube, was developed by the author and is being considered as an industry standard to define color patterns in black and white drawings.

lope, with three individual electron guns as well as three separate phosphor screens. Each electron gun has a filament, cathode, control grid, screen grid, focus electrode and a corresponding phosphor screen similar to a black-and-white picture tube. Each of the three separate picture tubes functions and operates similar to a monochrome picture tube. The

phosphor screen represents the only difference between the three picture tubes; the screens are coated with green, red and blue phosphors, the three primary colors necessary to produce white light, as well as all other colors. A b-w picture tube phosphor screen, when excited by the tube's electron beam, produces varying degrees of white light. In the three-gun color tube, we have three separate phosphor screens, arranged in a regular sequence, which when excited by three corresponding electron beams, produce varying degrees of white light, as well as any combination of color light.

White light is a combination of all colors; however, it has been found

ABOVE—FIG. 1: THREE-CIRCLE DIAGRAM illustrating how combinations of basic colors develop supplementary colors. See Fig. 2, below, for detailed analysis.

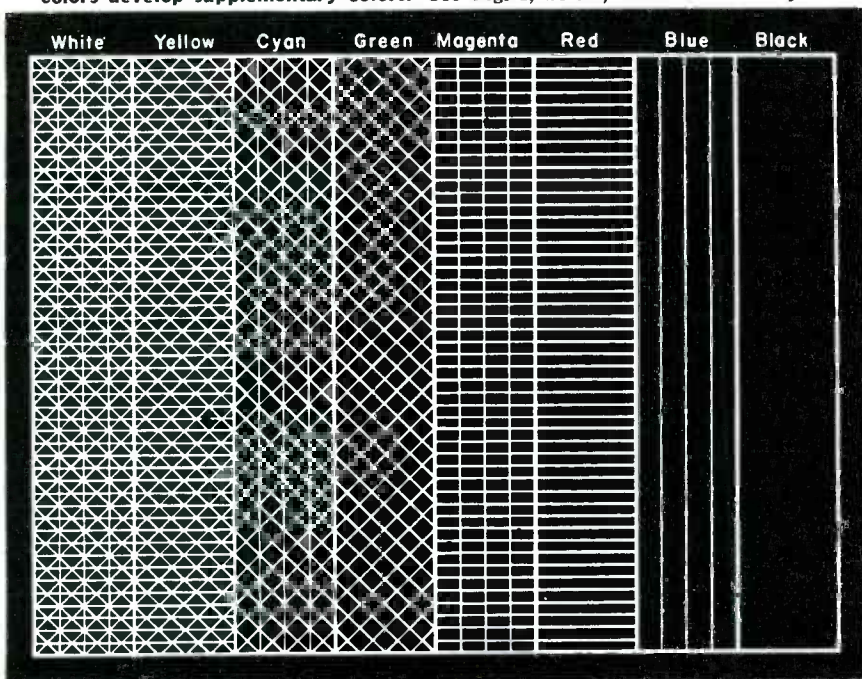

LEFT—FIG. 2: COLOR-BAR PATTERN. Blue is represented by vertical lines; red by horizontal lines, and green by diagonal lines. There are three times as many horizontal lines in the magenta bar as there are vertical lines and there are twice as many diagonal lines in the yellow bar as there are horizontal lines. This follows the luminance signal composition: $Y = .6G + .3R + .1B$.

BELOW—FIG. 3: CONDUCTION period of each gun necessary to produce the color-bar pattern at left is shown here.

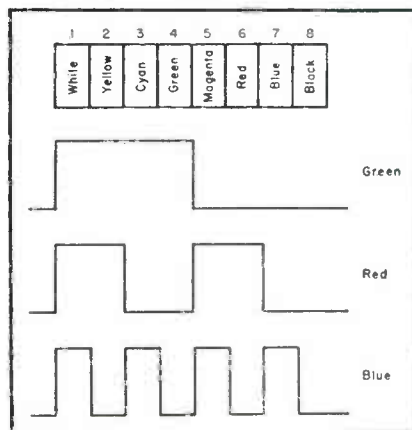

Tube Operates

by **KEN KLEIDON**

National Color Television Manager
Hycon Electronics, Inc.

that white light can be obtained by the addition or mixture of three primary colors such as green, red and blue. Three slide projectors can be used to illustrate how white is produced. In place of clear slides which would allow the white light of the projector tube to appear on the screen, green, red and blue filters, representing the three primary colors of a color picture tube, are used. Each filter allows only the appropriate color to reach the viewing screen. As an example, the red filter allows only the red portion of the white light to be projected on the screen. When the projectors are so positioned that each color overlaps on the viewing screen the colors resolve into pure white. To illustrate further how this result is obtained, the drawing, shown in Fig. 1, has been prepared. Here we find a combination of horizontal, vertical and diagonal lines in the center of circles, with green represented by diagonal lines, red by horizontal lines and blue by vertical lines. It will be noticed that other colors result when two of the three primary colors overlap. When green and red colors overlap, we have yellow, witness the combination of horizontal and diagonal lines. When green and blue colors are mixed together, a greenish-blue color (*cyan*) is obtained; *cyan* is represented by the combination of the vertical and diagonal lines. When red and blue colors are added together, a bluish-red color (*magenta*) results; this color is represented by the combination of the vertical and horizontal lines.

With the three-projector arrangement, a variety of other colors can be produced by individually varying the brightness of the three primary col-

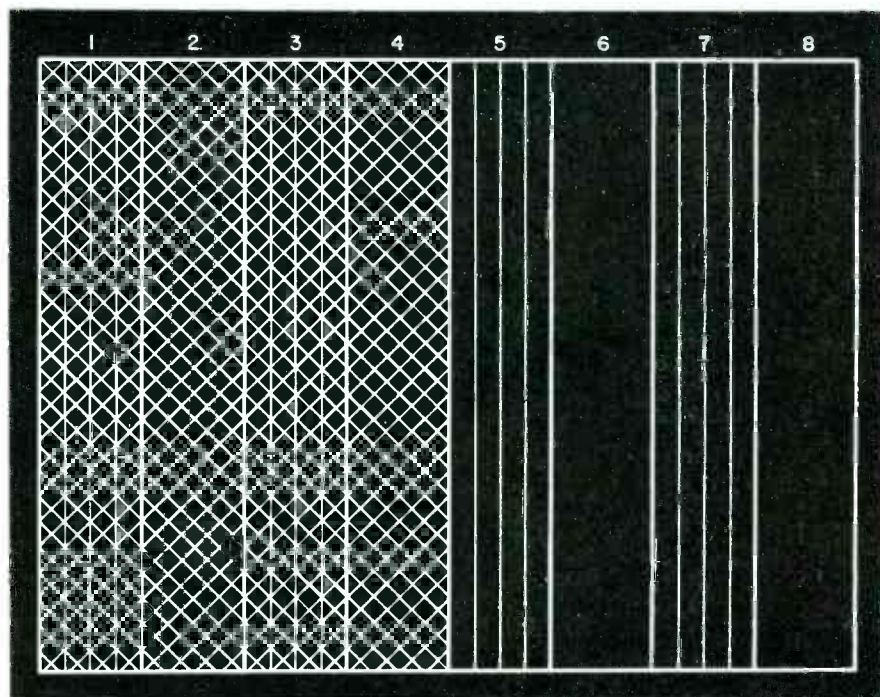
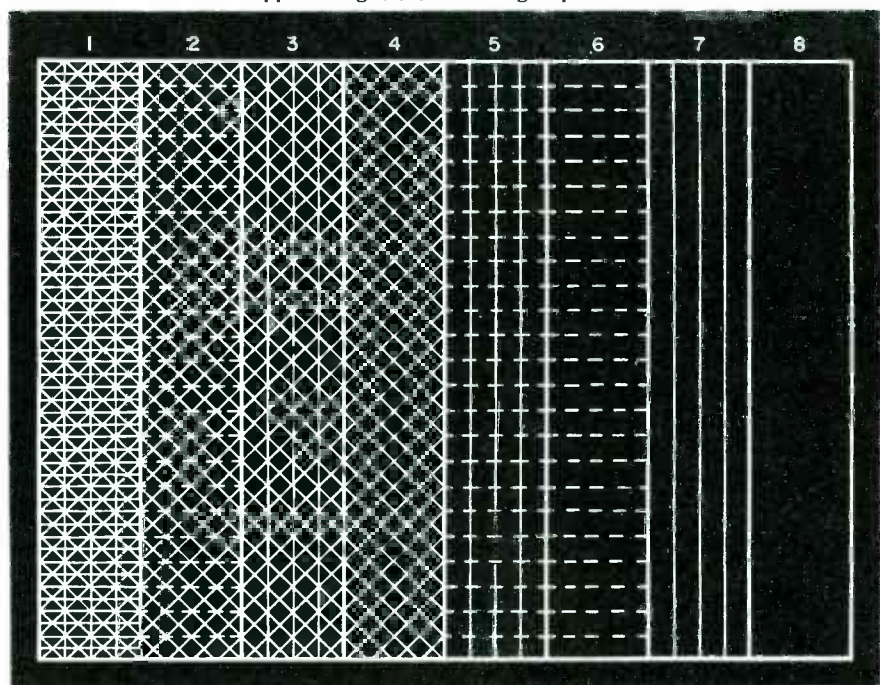

FIG. 4: COLOR-BAR diagram illustrating how picture tube can be used to locate defective section in chassis. Here the color red is missing.

ors. This can be accomplished by varying the input voltage to the projectors which will change the brightness output of the light bulb. As an example, Fig. 1 illustrates that yellow is observed when green and red are mixed together. If the input line voltage to the green projector was reduced, the brightness of the green color would be reduced accordingly. Mixing red and green with a reduced brightness will produce an orange color. Likewise, reducing the bright-

ness of the color red and mixing with green will produce a greenish-yellow color. Thus, we find that the three projectors can be described as representing the three electron guns in a three-gun color picture tube, with the amount of light being projected from each projector being equivalent to the number of electrons emitted from each electron gun. The filters, used in conjunction with the projected image, represent the phosphor dot
(Continued on page 60)

FIG. 5: ANOTHER SERVICE problem is illustrated in this color-bar diagram. Horizontal lines (red) are in white bar, but missing in yellow, magenta and red bars. Dotted horizontal lines, representing luminance signal, cause yellow, magenta and red to appear brighter than in Fig. 4 pattern.





65 ma—#205G1



75 ma—#206G1



100 ma—#206G1



150 ma—#201G1

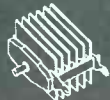

200 ma—#207G1



250 ma—#208G1

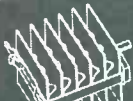

300 ma—#202G1

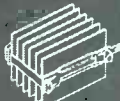

350 ma—#209G1

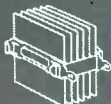

400 ma (compact)—#210G1

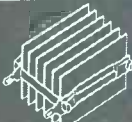

400 ma—#203G1

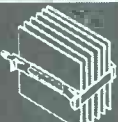

500 ma (compact)—#211G1

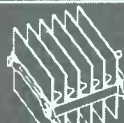

500 ma—#204G1

For dependable replacement

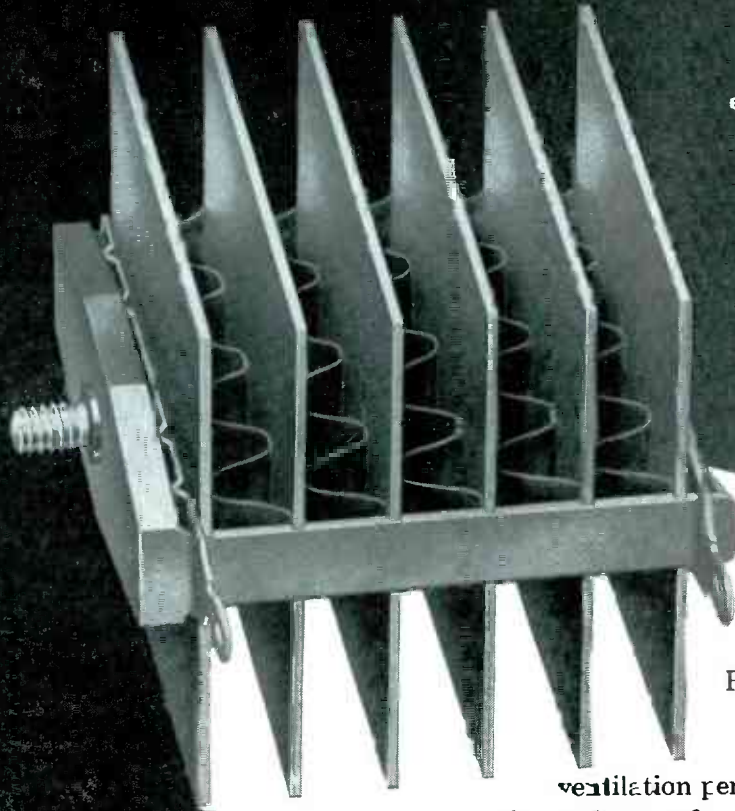

easy to install, efficient in operation, RCA

Selenium Rectifiers...

popular choice of servicemen on the go!

Service technicians appreciate easy-to-install RCA Selenium Rectifiers with modern open design features. RCA's full surface ventilation permits greater heat dissipation, reduces chance of center-core hot spots. One-piece assembly-yoke with molded mounting stud prevents twisting or squeezing stack during installation. They go in faster, operate cooler, more efficiently. Customers appreciate that kind of service!

On your very next selenium rectifier replacement, choose from RCA's comprehensive line, including the smaller sizes for any given current. In 12 types, ratings from 65 Ma to 500 Ma.

Now available through your RCA Distributor!

RCA SELENIUM RECTIFIERS



SELENIUM RECTIFIERS

RADIO CORPORATION OF AMERICA
COMPONENTS DIVISION, CAMDEN, N. J.



THIS MONTH IN SERVICE

SEMICONDUCTORS AND AUDIO IN SPOTLIGHT AT ANNUAL IRE CONVENTION--The growing semiconductor family will receive headline attention at the forthcoming national convention of the Institute of Radio Engineers, which will be held for the first time at the Coliseum in New York City, March 18-21. . . . Not only will new applications of germanium and silicon transistors be disclosed, but the use of silicon diodes and detectors in new circuitry will also be examined. In one group of talks experts will cover the progress achieved in transistors, particularly in the high-frequency regions, which now makes it possible to use them in video circuitry. Typical TV receivers using these hf transistors will be described in a special report.

AUDIO, where transistors found their greatest potential in the early days, continue to be a vital application area for the semiconductors. Developments have advanced so that it is now possible to build very high-power amplifiers with transistors throughout. One such amplifier, a 50-watt model, will be detailed at the IRE meeting.

PHONO PICKUP preamps have also become large users of transistors because of their ability to insure inputs with low-hum and low-noise level, freedom from microphonics, expanded response and low distortion. . . . In an audio session at the New York conclave, several transistor preamps will be reviewed. One model, to be described, features the use of transistors and a high-gain double-triode voltage-amplifier tube that serves to bring the input level of the preamp up to the required input sensitivity of power amplifiers. . . . In developing transistor-input circuits for either inductive or capacitive pickups, it is necessary to consider noise factors: At present, there are three kinds--white noise, inverse-frequency surface noise and inverse-frequency leakage noise. During the IRE talks, these noise factors and their relation to pickup design and application, will be analyzed.

COMPONENTS will also be on parade at the New York conference. Among the new products that will be displayed and commented on will be ceramic filter and close-tolerance temperature-compensating ceramic capacitors, and subminiature metallized paper capacitors.

SERVICE will be in booth 4512 (fourth floor) at the Coliseum. Hope we'll be seeing you!

MICROWAVES; RADIO'S NEW WORK HORSE--The microwave portion of the rf spectrum (890 to 13,000 mc) is rapidly becoming one of radio's most useful communication mediums. . . . In addition to furnishing links to broadcasters and public agencies to protect life and property, microwave nets are now being used by a widening variety of industrial and other business purposes. . . . Microwaves have become so vital because they are not affected by weather and man-made interference. In turn, their straight-line directivity permits the same channel to be used by parallel systems transmitting different kinds of information. Since transmitter energy can be concentrated and pointed, microwaves require comparatively little transmitter power. . . . Today, microwave systems are used to handle police, fire, highway maintenance, special emergency, conservation, civil defense and general administrative matters. Microwave links also serve to control traffic and helps in the operation of state highways; witness their present use on turnpikes in Pennsylvania, New Jersey and Ohio. The increasing popularity of microwaves has developed an active field for independent service engineers. . . . The vast opportunities that obtain here are revealed in an exclusive report in this issue on page 28.

TV SERVICEMEN TO RECEIVE NATIONAL TRIBUTE DURING WEEK IN MARCH--The nation's TV Service Men will once again receive a rousing salute during National Television Servicemen's Week, March 25-30. An intensive program in the consumer and trade press and on the air has been set up to call attention to this annual event. . . . Commenting on the campaign, a spokesman for the company sponsoring the week said that few people are aware of the impressive growth of TV servicing. He pointed out that in 1946, when the first commercial TV sets were introduced, there were fewer than 20,000 qualified TV Service Men in the country. Thus, while the number of receivers has multiplied more than 4,000 times, the corps of experts now available has expanded only six times. This growth, the company specialist added, has not only placed a responsible burden on the service industry, but as TV sets have increased in complexity, with the advent of color, the Service Man has found it necessary to exercise a higher order of skill in the performance of his work.

TV Alignment Is Easy

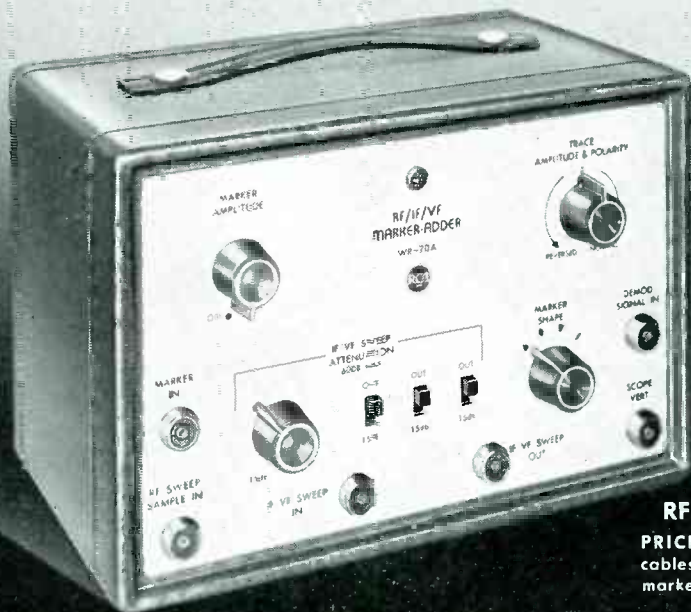

**RCA WR-70A
RF/IF/VF MARKER-ADDER**

PRICE...\$97.50,* with four coaxial cables for connection to sweep and marker generators, and to oscilloscope.

...when you use the new

RCA WIDE-RANGE MARKER-ADDER

The RCA WR-70A Marker-Adder is designed for use in rf, if, and video sweep-frequency alignment of both color and black-and-white TV receivers. When used with alignment instruments such as the RCA WR-59C TV Sweep Generator, the WR-89A TV Calibrator, and an oscilloscope, the WR-70A produces narrow and distinct markers of high amplitude. Response-curve distortion is virtually eliminated, thereby simplifying trace-shape and frequency identification.

Note these important features:

Front-panel control provides instant choice of four different marker shapes, permitting use of type of marker best suited to response curve being observed.

- Eliminates distortion of marker or of the sweep curve by the marker due to overloading of the TV receiver circuits because the marker is added to the sweep-response signal *after the sweep signal is taken out of the receiver*. The marker signal does not go through the rf, if, or vf channels of the receiver.
- Marker "suckout" by receiver circuits is eliminated—enables simple and precise alignment of traps.
- Provides very high-Q markers—high in amplitude, narrow in width.
- Front-panel control of marker shape, amplitude, and polarity; sweep-trace amplitude, and polarity—greatly simplifies black-and-white or color-TV alignment procedure.
- Electron-tube regulator circuit for all B+ voltages provides steady trace display on CRO.

*user price (optional)

SEE YOUR RCA DISTRIBUTOR FOR DETAILS...NOW!



TEST EQUIPMENT

® Radio Corporation of America, Components Division, Camden, N. J.

FRONT PANEL SWITCH PROVIDES INSTANT SELECTION OF FOUR DIFFERENT MARKER SHAPES



Narrow-band marker for S-curve observation

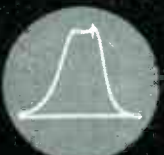

Wide-band marker for tuner alignment



Negative-going marker for trap adjustment

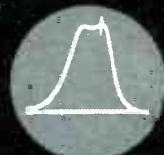

Positive-going marker for peak alignment

IN GLAMOROUS NEW YORK CITY—ALL EXPENSES PAID PLUS \$100 CASH

WIN A WEEKEND AT THE WALDORF FOR 2

IN THE PYRAMID TWIST-MOUNT CAPACITOR CONTEST

TOTAL—147 WONDERFUL PRIZES—PLUS A PRIZE TO EVERY ENTRANT . . . SERVICEMEN, ENTER NOW! YOU CAN'T LOSE!

IT'S EASY TO WIN ANY ONE OF THESE WONDERFUL PRIZES:

GRAND PRIZE: Weekend at New York's fabulous Waldorf Astoria Hotel for 2, guest of Pyramid. Air transportation from your home to New York and return. Weekend of entertainment including a visit to the famous Gaslight Club, dinner at the Waldorf's Starlight Roof, and breakfast at the Waldorf. Air transportation by CAPITAL Airlines Viscount.

1st PRIZE: One 4-drawer steel file cabinet plus your choice of 50 sets of PHOTOFACT folders. Value: \$120.45.

FIVE 2nd PRIZES: 5 CR-30 PRECISION Cathode Ray Tube Testers. dlr. net \$109 ea.

TEN 3rd PRIZES: 10 CRA-2 PYRAMID Capacitor-Resistor Analyzers. dlr. net \$92.50 ea.

TWO 4th PRIZES: 2 SW-54 NATIONAL Short Wave Receivers. dlr. net \$59.95 ea.

TEN 5th PRIZES: 10 JENSEN professional speaker units consisting of a D-30 lifetime driver unit and RT-20 rectangular horn. dlr. net \$44.40 per set.

FIFTEEN 6th PRIZES: 15 TW CHANNEL MASTER 7 element "traveling wave" TV antennas, Model 350. dlr. net \$33 ea.

EIGHTEEN 7th PRIZES: 18 PYRAMID Pyra-Pak kits consisting of \$69.95 in Pyramid capacitors, metal tool box and tool kit. dlr. net \$29.95.

THIRTY-FIVE 8th PRIZES: 35 PYRAMID gift certificates entitling you to \$10. (dlr. net) of Pyramid capacitors at your distributor.

9th PRIZE: WALCO twin-point diamond phono needle. dlr. net \$30. For G.E. Var. Rel. Cartridge.

FIFTY 10th PRIZES: 50 WALCO needles for G.E. twin-point sapphires. \$3.50 dlr. net.

AND to all entrants a kit of 5 bypass and coupling capacitors featuring the Pyramid type IMP.

It's easy to win any one of 147 big prizes—just follow these simple rules: Identify the unnamed Pyramid T-M capacitor in the TV set schematic appearing on this page. Give the Pyramid stock number, name and model number of TV set. Then mail your entry to Pyramid. Use coupon on this page or obtain additional blanks from your distributor. A different schematic will appear in these servicemen's magazines for 4 months. Prizes will be awarded on a points-earned basis as follows: 5 points for Contest No. 1; 10 points for Contest No. 2; 15 points for Contest No. 3; 20 points for Contest No. 4; and 10 points each contest for neatness. Possible perfect score: 90 points. However it is not necessary to achieve a perfect score to be declared a prize winner.

So act quickly... send in your entries early each month... you can't lose.

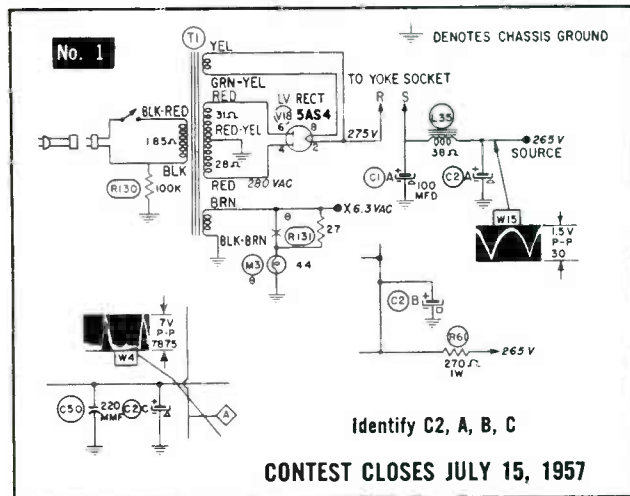

A PHOTOFACT STANDARD NOTATION SCHEMATIC © Howard W. Sams & Co., Inc.

JUDGES: M. Harvey Gernsbeck, editorial director, Radio-Electronics
Oliver Read, D.Sc., publisher, Radio & Television News
Howard W. Sams, chmn. board, Howard W. Sams & Co., Inc.



HELPFUL HINTS

The unidentified capacitor in each entry will be a Pyramid Twist-Mount. All schematics are of TV sets made in the U. S. by a known manufacturer within the past 2 years.

Schematics for reference may be those published by the TV set manufacturers, Howard Sam's Photofacts, or by any other accepted publisher. You may enter as often as you like but be sure to include a box top (showing stock number) of any Pyramid Twist-Mount Capacitor, with your letterhead or business card with each entry.

WHO MAY ENTER

Any Radio-TV serviceman or employee of a Radio-TV service company may enter. Officers, employees, (members of their families) of Pyramid Electric Co. or its advertising agency are not eligible to enter the contest. All entries are limited to residents of the continental U. S. over 21 years of age.

All entries become the property of Pyramid Electric Co., none will be returned and the decisions of the judges are final. In case of ties, duplicate prizes will be awarded. This contest is subject to all federal, state and local laws and regulations.

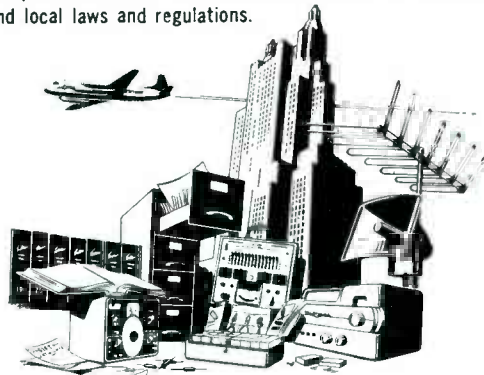

MAIL THIS ENTRY BLANK NOW!

Pyramid Twist-Mount Contest, Dept J
Pyramid Electric Co.
P.O. Box 655, Tyler Park Station, North Bergen, New Jersey

Entry No. (1) (2) (3) (4)—(check one)—Is: Pyramid stock No. _____

Twist-Mount values _____

Set manufacturer's name _____ TV set model No. _____

I enclose a box top (indicating stock number) of any Pyramid Twist-Mount Capacitor together with my business card or letterhead or my employer's.

Contestant's name _____ Position _____

Contestant's address _____

City _____ Zone _____ State _____

Employer's Firm name _____

Employer's address _____

City _____ Zone _____ State _____

My jobber's name and address _____

ENTER AS OFTEN AS YOU LIKE—FOR ADDITIONAL ENTRY BLANKS
SEE YOUR JOBBER.

Capacitors, Selenium Rectifiers—for original equipment, for replacement
PYRAMID ELECTRIC COMPANY North Bergen, New Jersey

Troubleshooting Horizontal-Output HV Rectifier

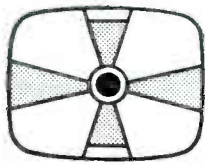
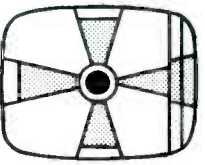
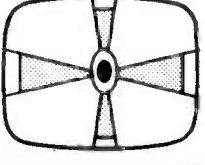
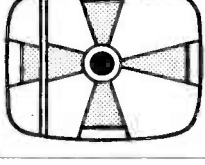
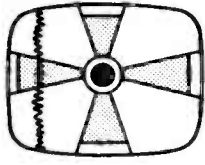
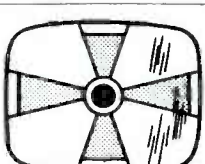
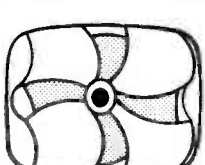
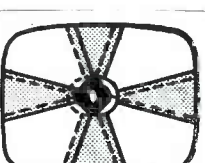
Picture Trouble	Visual Indication	Cause	Remedy
Picture width increases or decreases.		Increase caused by decrease in resistance of horizontal output tube screen and cathode resistors; width coil inductance too high. Opposite of this results in picture width decrease. <i>(See circled numbers 1, 2 and 3 in Figs. 1, 2 and 3 at right)</i>	Width coil should be readjusted or replaced; screen or cathode resistors should be replaced.
Foldover and stretching at right.		Horizontal output tube coupling capacitor and grid-leak resistor decreases in value. Horizontal drive control has been set for minimum capacity or resistance. <i>(See circled numbers 4, 5 and 6 in Figs. 1, 2 and 3 at right)</i>	Horizontal drive control should be reset. Coupling capacitor or grid-leak resistor should be replaced.
Compression in center; stretching at right of picture.		Horizontal output tube cathode bypass capacitor leaky or shorted. <i>(See circled number 7 in Figs. 1, 2 and 3 at right)</i>	Cathode bypass capacitor should be replaced.
A) One, two, or three drive lines at left of picture. B) Slight foldover at picture left-center.		Horizontal drive control is misadjusted; improperly-shaped horizontal trace at horizontal output tube input due to faulty coupling network. <i>(See circled number 6 in Figs. 1, 2 and 3 at right)</i>	Horizontal drive control should be readjusted. Components at input circuit of horizontal output tube should be checked.
Barkhausen oscillations; one or more vertical lines at left of picture.		Leakage inductance contributed by flyback transformer and when horizontal output tube screen goes positive, with respect to plate. <i>(See circled numbers 8 and 9 in Figs. 1, 2 and 3 at right)</i>	Resistance or choke should be inserted in series with horizontal output tube plate or screen. All controls should be readjusted. Horizontal output and oscillator tubes should be replaced. Ion trap should be inserted and adjustments made around horizontal output tube. Better shielding should be provided for the <i>hv</i> cage.
Snivets; dark streaks at right of raster.		Oversuppression of horizontal output tube suppressor grid resulting in spurious oscillation radiation and pickup by front end of receiver. <i>(See circled number 10 in Figs. 1, 2 and 3 at right)</i>	One should substitute 6DQ6 for 6BQ6 or 6CU6 and rewire socket connections of a 6BG6 or 6CD6. Antenna lead should be redressed. Remedies suggested for Barkhausen oscillation should be followed.
An <i>ac</i> hum in picture; 120-cps modulation.		Leakage between filament and cathode of horizontal-output tube; open screen-grid bypass capacitor; improper filtering in <i>lv</i> supply or open bypass capacitor in B+ or filament line. <i>(See circled numbers 10 and 11 in Figs. 1, 2 and 3 at right)</i>	Horizontal-output tube and bad component in low-voltage supply or screen grid should be replaced.
Horizontal jitter.		Feedback from plate lead of horizontal-output tube (or from yoke hot lead) to horizontal oscillator or <i>afc</i> circuit. <i>(See circled number 12 in Figs. 1, 2 and 3 at right)</i>	Trouble lead should be rerouted to provide better shielding for horizontal output, horizontal oscillator and <i>afc</i> stages.

Note: In this troubleshooting report, it has been assumed that the horizontal oscillator and *afc* circuits are operating properly and that the horizontal-output and *hv* rectifier tubes are o.k. Blooming or no raster, erratic and intermittent vertical jagged lines at left of pix, white streaks flashing through pix and popping sounds, and blooming or no raster accompanied by excessive arcing around *hv* capacitor, represented by circuit troubles in circled-number areas 1, 2, 4, and 13 to 18 in Figs. 1, 2, and 3 at right, will be analyzed in a subsequent report. ^oAuthor of *Servicing TV Sweep Systems*.

FIGS. 1, 2 AND 3 (RIGHT): The horizontal sweep circuit used in RCA KCS81E is illustrated in Fig. 1. In Fig. 2 appears the circuit of the sweep system employed in Spartan chassis 24U213, while Fig. 3 shows the sweep circuit included in Magnavox CT/CU/CMU401B models.

Circuits in the Horizontal Sweep System

by JESSE DINES*

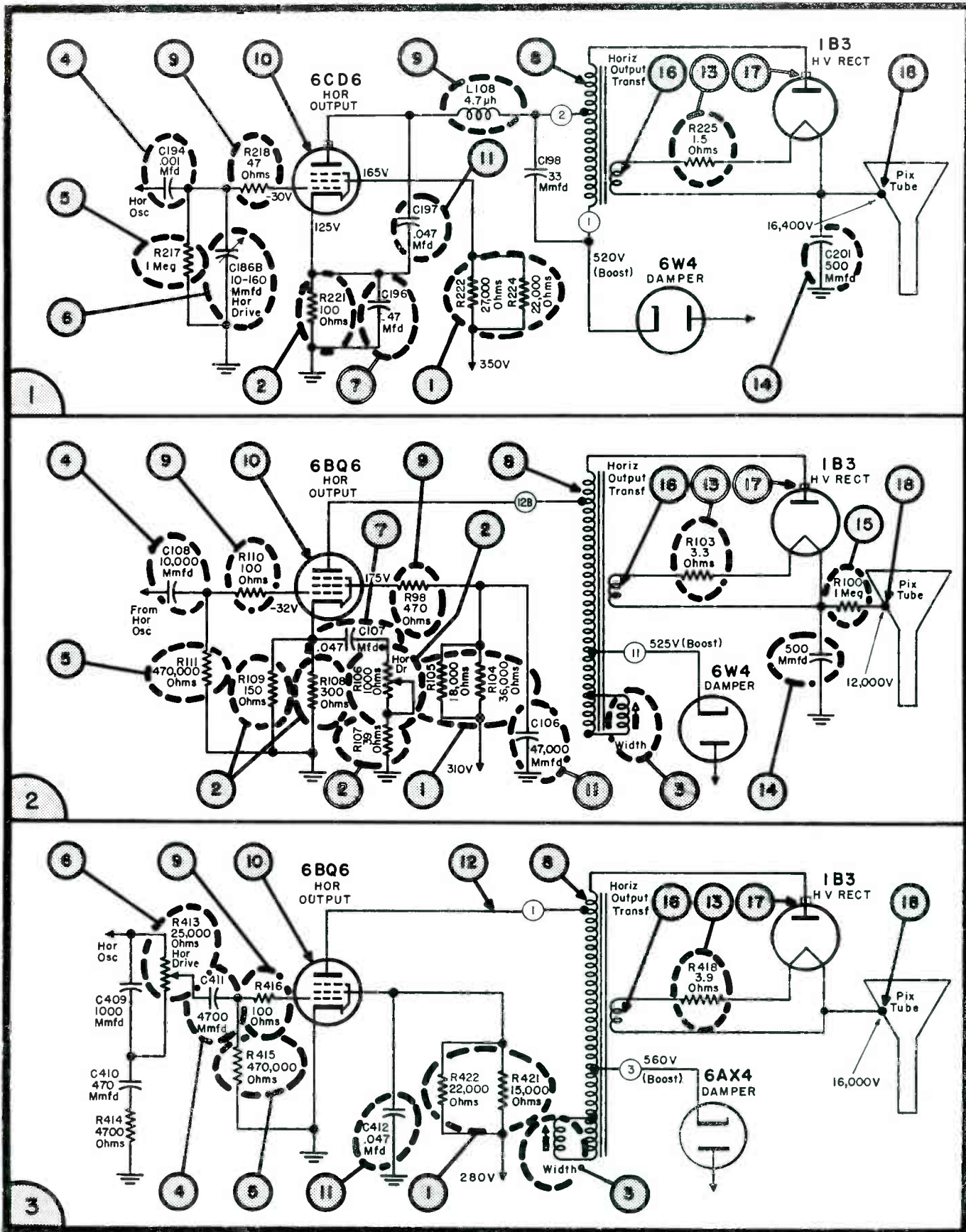

OPEN LETTER TO THE SERVICING INDUSTRY



Statement of RCA Policy

January 2, 1957

The radio-television-electronics industry has just completed its greatest year in history.

In 1956, the industry contributed more than \$11 billion to the national economy and now, after only ten short years, it has achieved fifth place in American manufacturing.

Servicing, a primary factor in customer satisfaction, has been one of the major elements in this phenomenal growth. In fact, the electronics industry has reached its present high level largely because of the outstanding performance of the servicing profession. Reflecting the importance of its contribution, the servicing profession last year achieved a \$2.8 billion volume—one quarter of the entire electronics industry's gross income.

The rapid expansion of the electronics industry has been characterized, like other fast-growing industries, by many new developments and changing conditions. Some of these activities have created a feeling of uncertainty and confusion in some segments of the servicing profession.

As a timely contribution toward clearing up this uncertainty and confusion, RCA's fundamental policies with regard to servicing are herewith reaffirmed and amplified:

1. RCA believes that full customer satisfaction depends on a vigorous and healthy independent service industry and, therefore, RCA will continue to make available to the servicing profession the information and knowledge it acquires in its own operations.

2. RCA believes in the free competitive system in the operation of its factory service business. In this, independent service organizations must have equal opportunity to compete with RCA factory service for consumer service arrangements on RCA Victor television sets. It is our further belief that in any plan under which the original price of the television receiver includes service through the warranty period, dealers must have full freedom to provide their own service or provide the service through independent service organizations or RCA factory service. In the exercise of this choice the dealer must not be restricted to "captive service."

3. RCA believes in, and plans to continue, its service organization's program for procuring replacement parts and other material on a basis that is fair and competitive with the independent service dealers.

4. RCA believes that good customer service requires broad distribution of replacement parts. It will continue its long established policy of making all repair and replacement parts available to the service industry through all of its distributors.

5. RCA believes in supporting every forward-looking industry-

wide program aimed at increasing the respect of the consuming public for this vital arm of the American distribution system. RCA will continue to recognize the independent service industry in its advertising program and printed literature.

Historically, RCA has operated on a basis of cooperation with the independent service profession. When we pioneered television immediately after World War II, we not only developed our own servicing facilities, but also encouraged the growth of the entire servicing profession by inaugurating a program of education and training for independents.

Virtually everything that we learned, and our technical "know how," were made available to servicemen throughout the country. This information was given without charge to 175,000 servicemen through 3,500 seminars and training sessions in 247 cities. Since the introduction of color television, RCA has conducted 2,000 color clinics in more than 150 cities for more than 100,000 service technicians. In addition, our knowledge and experience on color television servicing have been made available to thousands of other servicemen through seminars, lectures, demonstrations and printed material.

This program of cooperation has contributed immeasurably to the tremendous growth of the entire servicing profession.

Today, independent servicemen handle the great bulk of the electronics industry's servicing requirements. For example, more than 90 per cent of all RCA Victor television sets are maintained by independent service technicians, with less than 10 per cent being handled by the RCA Service Company.

We believe that the importance of the RCA Service policy lies in the contributions it makes to the entire servicing industry. It has helped sell the public on the need to buy good service. It has helped raise standards throughout the industry to their present high level.

Cooperation and mutual understanding of the problems common to the manufacturer, distributor, dealer and serviceman are essential. This is the basis upon which we all can continue to win and merit the public acceptance that is so vital to our success.

A handwritten signature in cursive script, reading "Frank M. Folsom".

Frank M. Folsom, President

RADIO CORPORATION OF AMERICA

GUIDE AUTRONIC-EYE[®]

TRAINING COURSES MEAN MORE BUSINESS FOR YOU!



Courses for experienced service technicians provide latest repair information—enable you to do the job faster and more efficiently.

Quick, accurate circuit diagnosis and repair to factory specifications boosts your profits. That's why so many qualified auto technicians attend these Guide training courses at no cost other than transportation and living expenses.

The Guide Lamp diploma, awarded only to those who successfully complete the course, is proof that you're equipped to give more and better service to more people—and that means business.

If you're an auto radio service dealer, come yourself, or send your technicians. There's one of 30 GM Training Centers near you. Apply through your local United Motors Service Division Distributor or write

GUIDE LAMP DIVISION • GENERAL MOTORS CORP. • ANDERSON, INDIANA

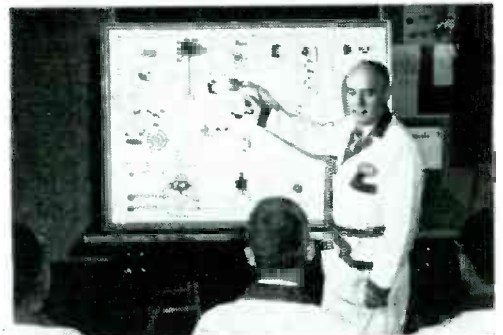

Jumbo-size operational panel of Guide's Autronic-Eye Circuit puts all parts out front for better, more efficient instruction.



Thirty modern GM Training Centers offer newest equipment and latest service techniques. There's one nearby . . . no matter where you live.

**BLINKY MEANS
BUSINESS!**

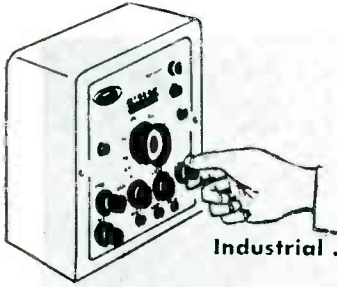

FIELD AND SHOP NOTES

Industrial . . . Commercial . . . Institutional

Communications . . . Audio . . . Television Installation . . . Maintenance . . . Repair

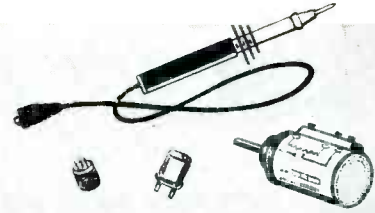

Microwave-System Field

Servicing by Independent Service Engineers

by **GEORGE VASS**

*Product Service Section
General Electric Communications Dept.*

◀ **CHECKING FREQUENCY** of radio equipment at the main Indiana toll road communications center near South Bend, now being serviced by independent authorized microwave service engineers.

A NEW CHALLENGE has recently been placed in the hands of independent mobile service stations; the servicing of microwave systems. Several¹ have already proven that independent service organizations are capable of meeting the challenge. For example, one service company in Hammond, Indiana,² is maintaining the Indiana toll road communication system, while another independent in Denver, Colorado,³ is maintaining the Public Service Company of Colorado's system. In many cases the user's mobile *vlf* equipment is directly controlled by microwave and the service for such systems are contracted for as a package.

It, therefore, becomes obvious that the independent mobile service station must be encouraged to enter the field of microwave to insure his share of mobile service and installations in the regions where he operates.

They have found that the best communication service possible is at the local level by local business men. Accordingly, the doors to microwave service should be opened to the independent service organization to compete for the business available in the area. The opened door, however, must lead to the user's satisfaction, profitable results for both the user and

the service organization, and insurance to the user that such service is the best type available to him.

The independent *service engineer* may feel there are many apparent obstacles which must be overcome. For example, there is engineering training required to become familiar with the various phases of microwave. The distances involved in some systems would appear to present a problem; however, all obstacles thus far faced have been overcome through the joint efforts of the manufacturer, the *service engineer* and the user.

Many of the obstacles can be eliminated during early stages of system planning and installation. Consider the very first obstacle that faces the manufacturer and ultimate user after it is decided that a microwave system can be beneficial and economically sound for some particular user. Will the terrain, over which the microwave system is proposed, be adaptable for reliable and economical communications? Who better can answer the question than local personnel familiar, not only with the

surrounding area, but also familiar with the demand requirements of good communication service? Demands such as road accessibility, power requirements, and the other factors which influence the selection of communication base station locations can only be resolved at the local level. It, therefore, becomes obvious that the local communication *service engineer* and his experience can be beneficial from the initial conception and planning of the microwave system. The question of frequency propagation in the microwave ranges are no longer a mystery to the average *service engineer*. He has already, in most cases, cut his teeth on 450-mc mobile equipment, and the jump to still higher frequencies is no longer an obstacle. The *service engineer* already familiar with *vlf* surveys for coverage purposes can, with only a little additional training and effort, complete the necessary requirements for microwave surveys. While this type of work in the past has been performed only by larger service organizations, the knowledge accumulated and published by them and the simplification of such work makes it possible for the local *service*

(Continued on page 45)

¹Authorized General Electric service stations.

²Mead Electric Company.

³Radio Specialists Company.

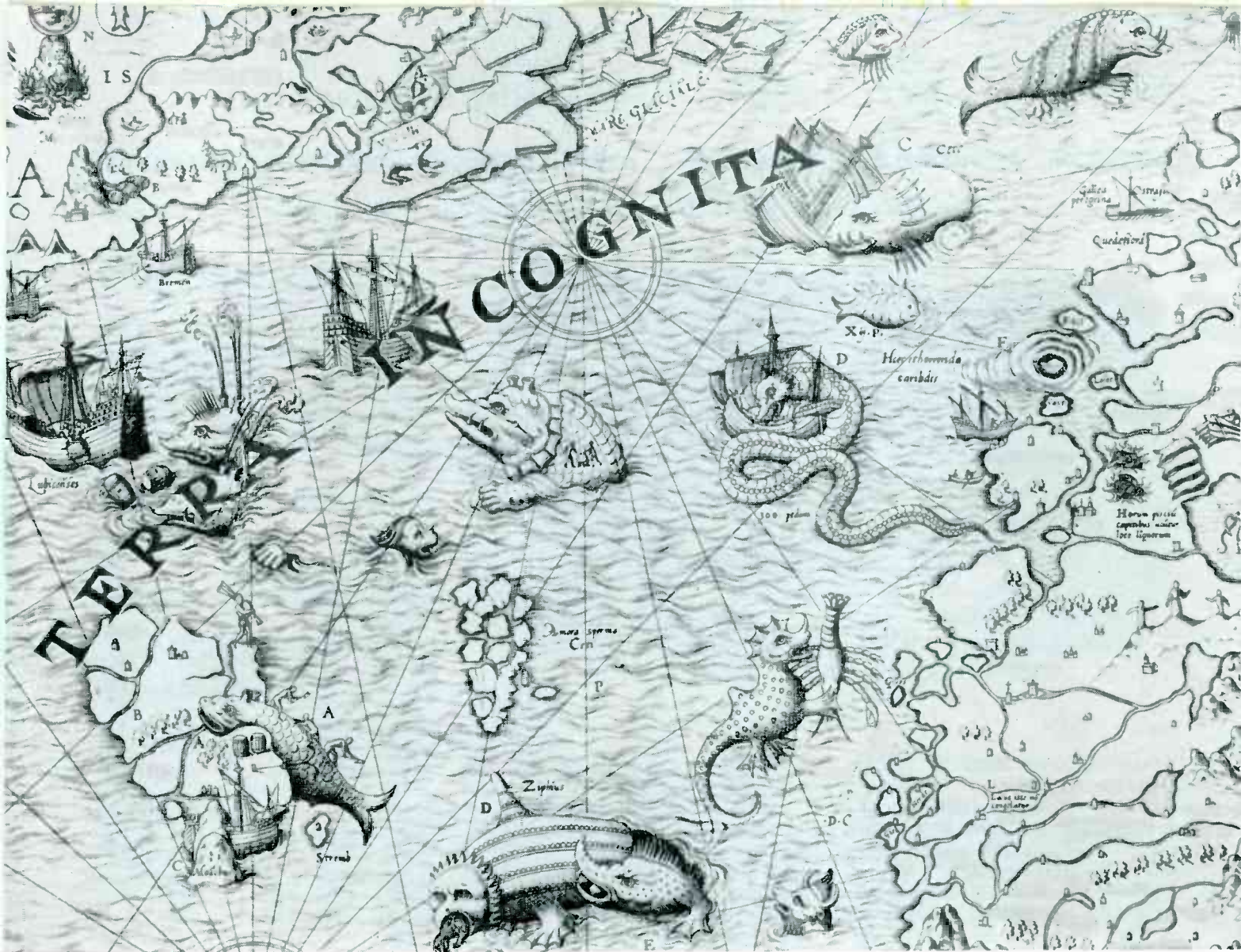

An UNKNOWN WORLD Awaits Us, Too

TERRA INCOGNITA — the Unknown World. This was the challenge to men of earlier centuries . . . to venture into the mysterious, unexplored regions of the Earth. They met the challenge and found new lands.

While no continents or uncharted seas remain for us to discover, an unknown world awaits us too. The challenge to men of our times is to venture still farther into the unexplored realms of scientific knowledge. Today's scientists are opening new worlds as truly as did Magellan and Columbus. Helping them speed their discoveries are the men who design and build Remington Rand Univac® electronic computing systems. Univac recognizes the importance of the contributions of their engineers and technicians in this new age of discovery. They are important men . . . and Univac treats them accordingly.

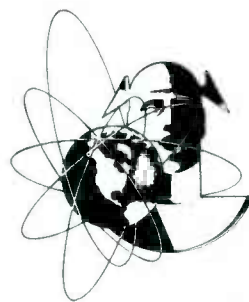

IMMEDIATE OPENINGS FOR:

FIELD LOCATION ENGINEERS with a college degree in a scientific or engineering field and experience in electronics. Extensive electronic background may substitute for some college. Many opportunities for rapid advancement.

FIELD LOCATION TECHNICIANS with technical school background and preferably some experience in electronics. These positions can lead to full engineering responsibility.

Send Complete Resumé to
Remington Rand Univac

DIVISION OF SPERRY RAND CORPORATION

at any one of these four plant locations

D. A. BOWDWIN Dept. PF-28 2300 W. Allegheny Ave. Philadelphia, Pa.	FRANK KING Dept. NF-28 Wilson Avenue South Norwalk, Conn.	CAL BOSIN Dept. YF-28 315 Fourth Ave. New York City
---	--	--

J. N. WOODBURY, Dept. SF-28, 1902 W. Minnehaha Ave., St. Paul W4, Minn.

Converter Transistor Replacement . . . Troubleshooting Transistor Circuits ‡ . . .

Intermittent Auto Radio Electrolytic Cures ‡ . . . Radio Chassis IF Transformer Replacements

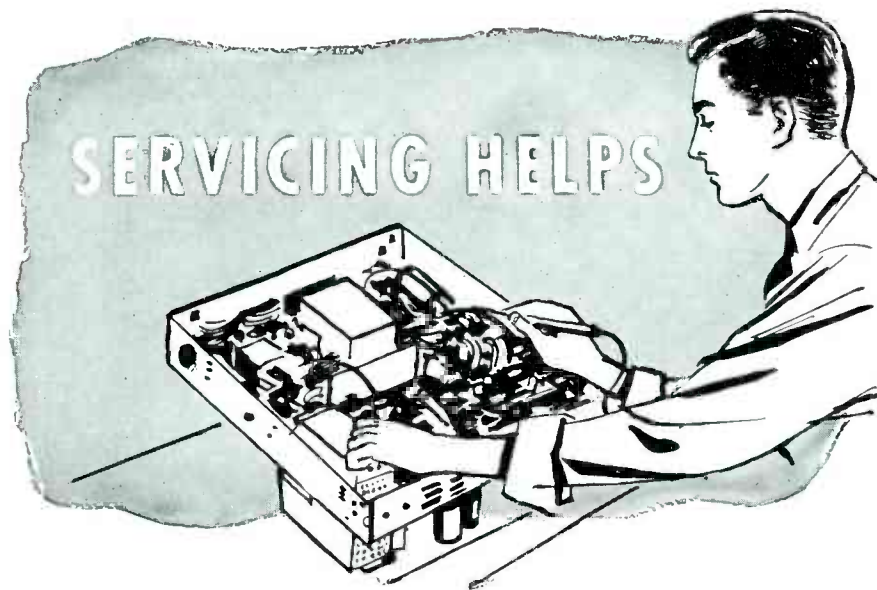

WHEN REPLACING a 2N172 converter transistor in Motorola 56T1 radios, it may be necessary to change the original oscillator coil (24B635394) to a revised oscillator coil (24K636690), and add a germanium diode.

These revisions will be necessary only if the sensitivity of the set is low, or high frequency reception is low after replacing a converter transistor. Before making these revisions, one should check the set's wiring for a gain adjusting resistor (R_{10}) wired across the primary of the first *if* transformer. If this resistor is in the circuit, it should be disconnected and one should recheck for sensitivity; if removal did not appreciably improve sensitivity, the oscillator coil will have to be changed and a germanium diode wired from the top of the tank circuit to a +9 volt source.

In some cases, when a converter transistor is replaced, the gain of the converter stage may be high enough to cause the set to squeal, whistle or be unstable in operation. When this occurs, a gain-adjusting resistor will have to be wired across the primary of the first *if* transformer.

If the sensitivity and operation of the set are normal after replacing a converter transistor, none of the foregoing changes will be necessary.

The gain-adjusting resistor will not be found in all sets. This resistor is wired across the primary of the first *if* transformer during production to

help eliminate unstable operation of extremely high-gain sets.

If a set being serviced is found to be unstable in operation (squeals or whistles), a gain-adjusting resistor may have to be added to help eliminate this condition. The value of the resistor that should be used to attain maximum gain without unstable operation is determined by trying several resistors of the 10% $\frac{1}{2}$ -w type ranging from 68,000 to 120,000 ohms. As

‡Based on field notes in *Testing Tips* prepared by Delco Radio service department.

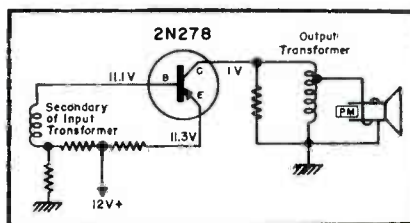
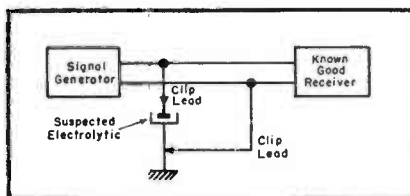

FIG. 1: TYPICAL DELCO radio output transistor circuit employing a pnp 2N278.

FIG. 2: SIGNAL-GENERATOR setup designed to detect intermittent electrolytics.



the resistor lowers the gain, the trial should start with the 120,000-ohm resistor jumped across the primary of the first *if*. Then results should be checked. If the 120,000-ohm resistor did not eliminate the instability, the next lower value should be tried and values decreased until a value is found that eliminates the unstable condition.

Troubleshooting Transistor Circuits

WHAT IS COMMON practice in troubleshooting vacuum-tube radios can cause new troubles in working with transistor circuits.

In troubleshooting transistor circuits one should not use the *click* signal check involving grounding of the grid to produce a sound indicating that the circuit is operating. This technique cannot be applied on a *pnp* transistor in a negative battery ground circuit without ruining the transistor. This transistor has a normal forward bias from emitter to cathode of .2 volt. When the base is grounded, the bias is changed to 11.3 volts and the transistor will burn up in a matter of a few microseconds.

One must also remember that the transistor is a low-impedance device, and therefore the impedance from collector to emitter is relatively low. A large increase in this impedance with a signal in the circuit will produce a high collector voltage. If this voltage exceeds the rating of the collector the transistor will be ruined. Therefore the speaker must be connected in the circuit at all times when the radio is *on*, because if large signal voltages are present and the speaker is disconnected, this voltage rating will be exceeded and the transistor will be destroyed.

Intermittent Auto-Radio Electrolytic Cures

PROBABLY ONE of the toughest intermittent troubles to diagnose is an intermittent electrolytic. This is true because most electrolytics, especially in auto-radios, are securely fastened to the chassis and therefore cannot be moved around in an effort to produce the intermittent condition. An intermittent electrolytic will cause inter-

(Continued on page 40)



A NEW FRONTIER FOR TECHNICIANS

RCA offers an opportunity for you to apply your technical skill to its Missile Test Project at Patrick Air Force Base, Florida—"Launching Site of the Satellite."

Here at the world's longest missile testing range, extending from Florida far across the South Atlantic, you can enjoy improved status with the recognized leader in Electronics. Unprecedented growth opportunities are offered in various phases of data acquisition, transmission and processing, including Radar—Communications—Optics—Computers—Timing—Telemetry.

At RCA's Missile Test Project you will enjoy technical advancement

combined with famous Florida living. Your family will appreciate the ideal climate—allowing year 'round outdoor activities—and pleasant social surroundings.

Immediate assignments are available in Florida, the Bahama Islands, and aboard tracking ships in the South Atlantic. Attractive home leave policy and salary differential make the Bahama Islands and tracking ship assignments especially attractive for single men.

Let the Missile Test Project become *your* symbol of the future. Join in our assault on the frontier of space!

For complete information about this new and challenging field, write to:

Personnel Manager, Dept. N-34B
RCA Service Company, Inc.
Missile Test Project
P. O. Box 1226
Melbourne, Florida



RADIO CORPORATION of AMERICA

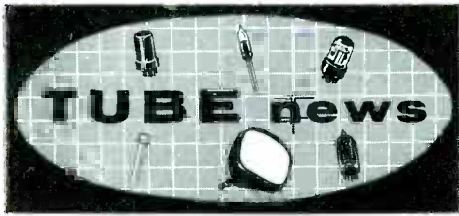

Latest Developments In COLOR and B-W TV Picture Tubes and Miniatures, Series-String Tubes and Audio Transistors

A ROUND ALL-GLASS bulb and a new technique of glass sealing have been developed for the 3-gun color-TV tube!

Featuring the same design of internal assemblies, including the aperture mask employed in the metal-

envelope types, the all-glass bulb version is expected to become available during the middle of 1957. Both metal and glass versions will be produced thereafter.

One of the problems solved in development of the new glass envelope

was the assembly of its two sections. This was accomplished by sealing the halves together with a glass flux which first melts at a relatively low temperature and then, when cooled, becomes as much a part of the bulb as the original glass.

Wide-Angle TV Picture Tube²

FOR B-W TV a 17-inch aluminized tube with 110° deflection has been made available to the renewal market.

Designated 17BVP4, the tube features a 1 1/4" neck and electrostatic focus.

Triode-Tetrodes for B-W/Color-TV¹

A 9-PIN MINIATURE 450-milliamperre heater tube containing a medium-mu triode and a sharp-cutoff tetrode intended for application in black-and-white and color-TV receivers has been announced.

The tube (6CQ8) is useful as a combined oscillator and mixer tube in tuners of TV receivers which utilize 40-mc *if*. The triode unit of the tube is not only useful as a *vhf* oscillator, but also as an *rf* amplifier, phase splitter, sync clipper and sync separator. The tetrode unit can also serve as a sound or video intermediate frequency amplifier tube.

General-Purpose TV Miniatures²

TWO 9-PIN triode-pentodes with 600-ma heaters for use in both color and b-w TV receivers are now available.

The tubes, designated 6AW8A and 6BA8A, have identical pentode sections. The two tubes permit a wider range of B+ supply voltage (120 volts and up) than their prototypes (6AW8 and 6BA8), a plate dissipation rating of 3.25 watts, reduced sync pulse clipping and minimized white compression.

Featuring a transconductance of 9000 *μmhos*, they are intended for use as video amplifiers. Both tubes can, in addition, serve as video and sound-*if* and *agc* amplifiers.

The triode section of the 6AW8A has a *mu* of 70 and finds usage in sync-separator, sync amplifier, sync-clipper and phase inverter circuits.

¹RCA ²Sylvania ³Raytheon

DON'T PASS UP PRINTED CIRCUIT REPAIRS!

EVERYTHING YOU NEED IS IN THE...

GE PRINTED CIRCUIT REPAIR KIT

Now you can repair any printed circuits or printed circuit wiring. This kit contains silicone resin and solvent, pure silver print, solder and tools... plus the G-C Printed Circuit Service Manual. Used and recommended by leading set manufacturers. Ask for G-C No. 680.

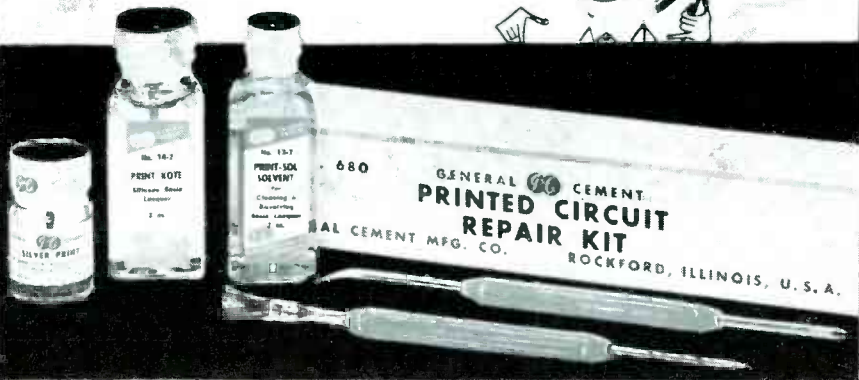

ALWAYS USE THESE G-C CHEMICAL SERVICE AIDS!

G-C RADIO-TV SERVICE CEMENT No. 30-2	G-C PLI-O-BOND CEMENT No. 43-2	G-C RADIO SERVICE SOLVENT No. 31-2	G-C SPRA-KOAT ACRYLIC SPRAY No. 8665	G-C DE-OX-ID CONTACT CLEANER No. 19-1	G-C SPRA-KLEEN CLEANER-LUBRICANT No. 8666	G-C CREME-O-WAX POLISH No. 95-2	G-C SPRA-KOAT RUF-KOAT No. 60-12



GENERAL CEMENT MFG. CO.

Division of Textron Inc. • 400 South Wyman Street • Rockford, Illinois

Send 10c for Your G-C Printed Circuit Service Manual... PLUS G-C CATALOG

The 6BA8A triode unit has a μ of 18, and can be used in low-frequency oscillator circuits.

TV-Tube Replacements¹

A NUMBER of *vhf* and *uhf* tubes, which include diodes, triodes, tetrodes and pentodes for series-string chassis, have been designed for b-w TV replacement purposes.

One, the 283, a filamentary diode, has been developed for use as the high-voltage rectifier to supply power to the anode of the picture tube; it is intended primarily for use in flyback type power supplies. The tube differs from the 1B3GT by incorporating higher filament ratings, which in many cases will permit the tube to be operated directly from the flyback transformer without the use of a filament-dropping resistor.

Another replacement, the 3AF4A, a heater-cathode type medium- μ triode of miniature construction, has been designed for use as a local oscillator in *uhf* receivers. Internal lead inductance is reduced by employing double connections to the plate and grid. Except for heater ratings the 3AF4A is identical to the 6AF4A, and has a 450-milliamper heater rating.

Also available now is a 4DT6, a heater-cathode type sharp-cutoff miniature pentode for use as an FM detector in TV receivers. The 4DT6 has been so designed that grid 1 and grid 3 can each be used as independent sharp cutoff control electrodes and connected in delay, gain-controlled amplifier and mixer circuits. Except for heater characteristics the 4DT6 is identical to the 3DT6 and 6DT6. The 4DT6 has a 450-milliamper heater rating.

Another heater-cathode type twin pentode miniature, 6BU8, now available, has been designed with separate plates and number 3 grids, but a common screen, number 1 grid and cathode.

One section can be used as a sync separator and sync clipper, while the other section is used to generate *agc* voltage in TV receivers.

For use as a combined horizontal phase detector and reactance tube, a miniature double-diode high- μ triode (8CN7) has been designed. It features a separate cathode for the diode and triode sections. Except for heater characteristics the 8CN7 is identical to the 6CN7, and has a 225-milliamper heater rating.

Audio High-Power Transistors¹

A NEW alloy-junction transistor, 2N270, intended particularly for use

in large-signal *af* applications, such as single-ended or double-ended power output stages and high-gain class A driver stages of radio receivers and *af* amplifiers, has been developed. This transistor, of the germanium *pn-p* type, has flexible leads and is hermetically sealed in an insulated metal case having a length of .375" and a maximum diameter of .360."

In class A amplifier service, a single 2N270 can deliver a maximum-signal power output of approximately 60 milliwatts with a power gain of 34 db. In class B push-pull arrange-

ment, two 2N270's can deliver a maximum-signal power output of approximately 500 milliwatts with a power gain of 32 db.

The current transfer ratio of this transistor has been found to be nearly constant over the full range of the output-signal swing, even when the peak output-signal current reaches the peak collector current rating. This feature minimizes distortion at high power outputs, especially when low supply voltages are employed.

One of our many satisfied customers.

W. J. COUCH & COMPANY
PLUMBING, HEATING & ELECTRICAL DEPARTMENT

Jullietta, Tenn.
November 20nd 1956

Mr. Fred Rogers
Rogers Electronic Corp.
43-49 Bleecker Street
New York 12, N. Y.

Dear Mr. Rogers:

This letter to advise concerning the HVO transformer you sent us thru Randolph and Holt to be used in a Sparton Model 50TM21, Chassis 23V5.

This transformer was immediately installed in this set and has been giving splendid service ever since. It was an exact replacement and the only thing that we would suggest is that the original had a pair of fuse clips on it to mount a 1/4 amp. slo blow fuse as per attached rough sketch.

Many thanks for this splendid service and we will probably use several of these.

Yours very truly,

W J Couch and Company,

By *Robert L Couch Sr.*
Robert L Couch Sr.

No other manufacturer can offer it's customers replacement service of any flyback for any model TV set.

Only Rogers component parts are Hermetically sealed in Plastic containers for insured working installation.

This Personalized Service available through Authorized Rogers Dealers!

8CN7-hb

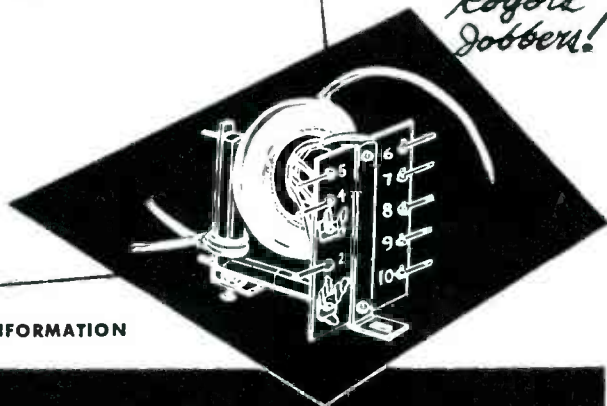
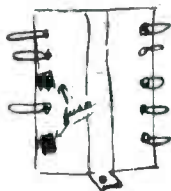

WRITE FOR COMPLETE INFORMATION

ROGERS

ELECTRONIC CORP.

43-49 Bleecker Street New York 12, N. Y.

SPRAGUE SALUTES

the INDEPENDENT

PARTS DISTRIBUTOR

HERE'S TO THE MAN

- • • who assures you—the independent service dealer—a complete, fresh selection of the finest replacement parts in the world.
- • • who offers a priceless wealth of unbiased information whenever you ask for it.
- • • who supports you in all his relations with the independent parts manufacturer.
- • • who stands alone . . . serving no other boss than you, one of the thousands of well-established independent service dealers.
- • • who, as an independent parts distributor, is able to supply you with ALL the exact replacement parts for ALL the sets you are asked to service.

don't be vague...insist on

SPRAGUE[®]

world's largest capacitor manufacturer

SPRAGUE RESEARCH IS CONSTANTLY PRODUCING NEW AND BETTER CAPACITORS FOR YOU

All-Band VHF TV-Antenna Fringe-Area Installations

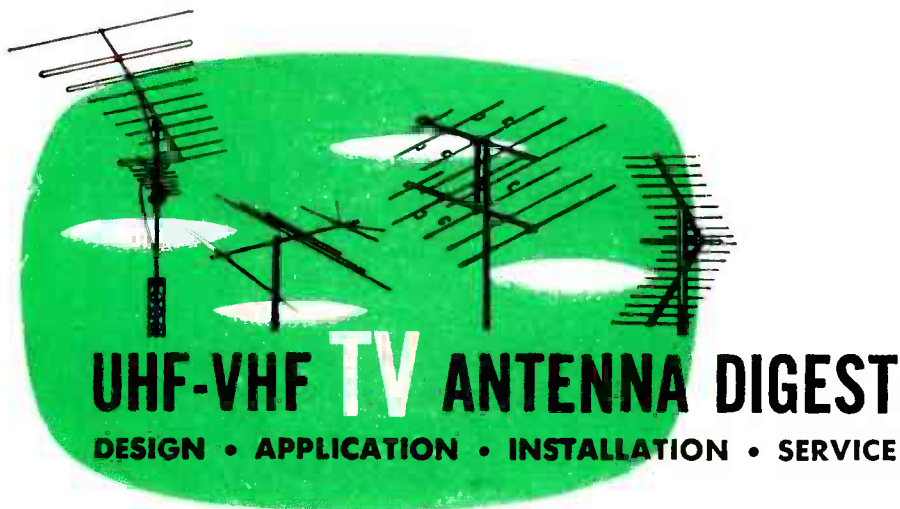

THE TV SERVICE MAN working in the fringe areas faces many unusual problems. In the past, signals from but one station were usable and single-band yagis were able to take care of this situation. Now, however, more stations use high power and more efficient transmitting antennas and their coverage has increased substantially. Thus, set owners are

by JACK DARR

now in the receiving range of many stations.

This condition has developed a new market for *all-channel* high-gain antennas and rotators, too.

In selecting a site and an antenna for a job, the location of the station's tower must be carefully considered to avoid such problems as co-channel interference. Such interference can cause feed-through of unwanted signals which develop lines, streaks and sound chatter.

In the Ozark mountain area† five years ago, there was but one telecaster; a 48-kw, channel-6 station, 78 miles away. At present, the channel-6 station has a 100 kw power and is south of our location; to the east, there is a 100-kw channel-4 station

and another, on channel 11 operating on 316 kw about 90 airline miles away. To the north there is a 25-kw channel-5 station 70 miles away, while to the southeast, 95 miles away, we have a channel-7 station operating on 150 kw. The latter station provides intermittent signals, due to the pattern of the transmitting antenna, which is oriented away from us, and the mountainous terrain. Shadowed locations, which are the rule rather than the exception in Ozark areas, make it necessary to study receiving sites very carefully. Some locations have reported that they can receive strong signals from all directions, even including the erratic channel 7. Others have said that they are completely shadowed to the south, open to the east; some are just the opposite.

Until one is thoroughly familiar with an antenna and its performance, it has been found that the best procedure is to take measurements with a field-strength meter at each location, to determine exactly what signal strength can be found, and what stations will give satisfactory pictures at this location. In this way, the

(Continued on page 58)

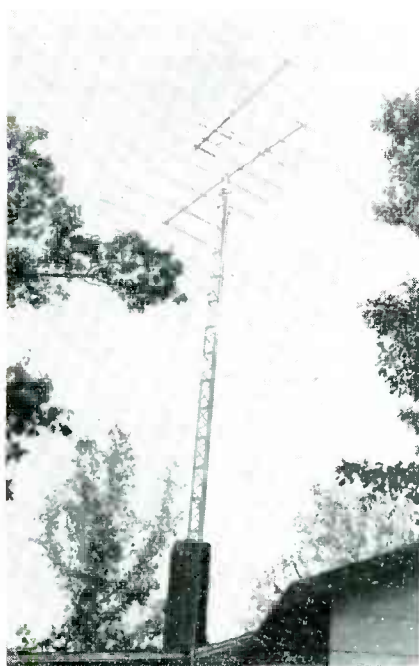

FIG. 2: MODERN BROAD-BAND 2-section antenna installation. Long antenna below covers low channels, while the smaller antenna above covers the high channels. The two are tied together by a matching network. The tower was used here primarily to clear an obstruction to the south.



FIG. 1: TALL TOWER used on house to clear obstruction behind house.

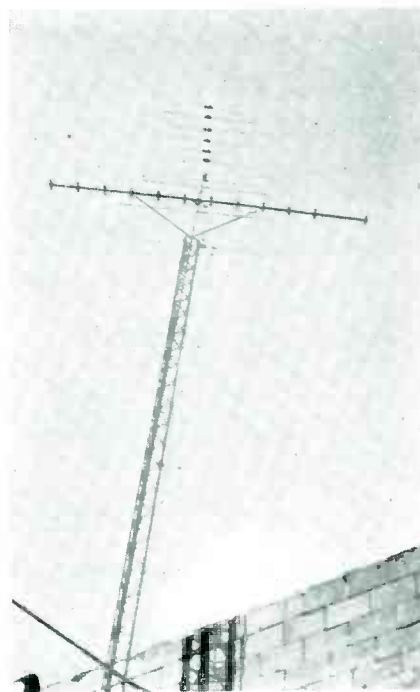

FIG. 3: ANTENNAS used for shop tests. Below is a channel 6 yagi, and above, an all-channel. This setup permits two separate leadins so that two TV sets may be tested simultaneously.

†Mena, Arkansas.

"I cut testing time in half"
 ... "doubled our tube sales" *



"Adds to my income and saves me unprofitable call-backs"

"We have two... one for the shop and one for house calls."

"Paid for itself several times. Really indispensable."

"Best tube tester I've ever owned. Simple to operate. Saves time."

"Makes lots of money for us. Wonderful instrument."

"Serves my purpose best for speed and dependability."

B&K MODEL 500
DYNA-QUIK
 DYNAMIC MUTUAL CONDUCTANCE TUBE TESTER

FASTEST SELLING TUBE TESTER
 IN THE WORLD

Tests over 95% OF ALL POPULAR TV TUBES — IN SECONDS

- Accurately makes each tube test in seconds
- Checks average TV set in minimum minutes
- Tests each tube for shorts, grid emission, gas content, leakage, and dynamic mutual conductance
- Ingenious life test detects tubes with short life expectancy.
- One switch tests everything. No multiple switching. No roll charts.
- Shows tube condition on "Good-Bad" scale and in micromhos. Large 4 1/2-inch plastic meter has two highly accurate scales calibrated 0-6000 and 0-18,000 micromhos
- Automatic line compensation is maintained by a special bridge that continuously monitors line voltage.
- Built-in 7-pin and 9-pin straighteners are mounted on the panel.

* NAMES ON REQUEST



Makers of Dyna-Quik, CRT, Dyna-Scan and Calibrator
B & K MANUFACTURING CO.
 3726 N. Southport Ave. • Chicago 13, Illinois

One extra tube sale on each of 5 calls a day pays for the Model 500 in 30 days

Enthusiastic comments like those above* come from servicemen all over the country. *Actual experience shows an average of close to 2 additional tube sales per call.*

Instead of the "trial and error" method of substitution testing, the Dyna-Quik 500 quickly detects weak or inoperative tubes. Cuts servicing time, saves costly call-backs, shows each customer the true condition and life expectancy of the tubes in the set, and makes more on-the-spot tube sales. Helps keep customer good-will, give a better service guarantee, and make more profit.

The B&K Dyna-Quik 500 measures *true dynamic mutual conductance*. Completely checks tubes with laboratory accuracy under actual operating conditions right in the home... *in a matter of seconds*. Saves time and work in the shop, too. Simple to operate. Easily portable in luggage-type case. Weighs only 12 lbs. **NET, \$109⁹⁵**

See Your B&K Distributor or Write for Bulletin No. 500-S

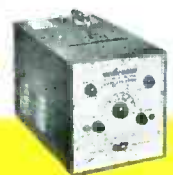

Model 1000 DYNA-SCAN
 Picture and Pattern Video Generator. Complete Flying Spot Scanner. Net, \$199.95



Model 400 CRT
 Cathode Rejuvenator Tester Tests and repairs TV picture tubes. Net, \$54.95

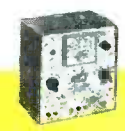

Model 750 CALIBRATOR
 Designed to check and adjust test instruments with laboratory accuracy. Net, \$54.95

THE DEVELOPMENT of higher power transistors has made it possible to build portable phonos that can produce up to 200-milliwatts output at a fairly low distortion level. In one such model, designed recently, a 3-stage amplifier using 2N109 alloy-junction transistors was included for use with medium-output crystal or ceramic pickups operated from a 9-volt supply.

The amplifier circuit features a preamp, driver, and class B output stage.

Volume and tone controls for the amplifier were placed in the second stage so that they could also serve as bias resistors. To reduce the sensitivity of the control at low-volume settings it was found necessary to use a log-taper pot as the volume control. The tone-control circuit, using a linear potentiometer, was so designed that its adjustment can vary the high-frequency rolloff point as well as the amount of high-frequency attenuation.

To obtain the highest possible efficiency and power output, the output stage is operated under substantially class B conditions. The driver transformer has a primary-to-secondary impedance ratio of 3,000 to 5,000 ohms. Although it was recognized that a transformer having a higher primary impedance would provide more gain, the additional cost of such a transformer was considered unjustified because the available gain was found to be more than adequate for the pickup used. Bias voltage for the output stage is obtained from a tap on a decoupling network for the first two stages. Here, a 33-ohm resistor is used in the common emitter circuit to minimize crossover distortion and stabilize the operating point for the output stage. To minimize



AUDIO

INSTALLATION AND SERVICE

Phono • Tape • PA
Cartridges • Needles • Amplifiers • Speakers

Circuitry Features of Portable Phono Transistor Amplifiers With Class-B Output† . . . Tape Repair Hints . . . How Four Speed Players Operate . . . Phono Turntable Speed Checks

ringing which tends to occur in a class-B stage, when the output current switches from one half of the circuit to the other, a .04-mfd capacitor was placed across the output-transformer primary. The value of this capacitor is not critical and it may be made to serve a double purpose by the choice of a value which will reduce the effects of any high-frequency resonances in the pickup.

At normal listening levels for speech and music (approximately 50 milliwatts) the amplifier was found to draw about 22 milliamperes, representing a power consumption of .198 watt. The amplifier will operate satisfactorily, although with reduced output, at reduced battery voltage. The total battery drain will, of course, depend upon the current drawn by the turntable motor. A typical 45-rpm, 6-volt motor draws 30 milliamperes.

High Hum Level Cures

THE WINDING direction of the motor windings in relation to the winding direction of the power transformer windings has a definite relation to hum. In the RCA 7-TR-2/3 and 7-TRC-1 tape models, residual hum

†Based on copyrighted application notes prepared by the semiconductor division of RCA.

level can sometimes be reduced by interchanging either the leads to the motor or the primary leads of the power transformer. Least hum does not always coincide with leads connected according to the colors indicated on the schematic diagrams.

Tape Takeup Drive Slippage

SEVERAL INSTANCES of insufficient tape takeup tension in RCA tape chassis have been found to be the result of a separation in the main drive pulley. This is a dual pulley in which the nylon pulley is held to the
(Continued on page 48)

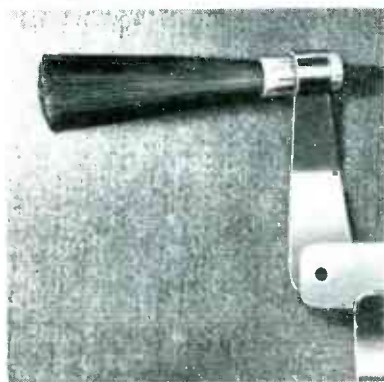

STATIC-RESISTANT record brush, made of sable hair, which fastens on phono arm. (The Duotone Co., Inc., Keyport, N. J.)

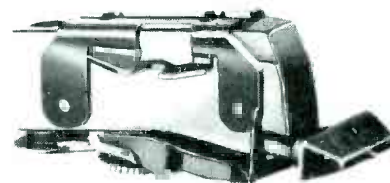

THREE-SPEED, dual-needle (twin-lever) dual-voltage crystal cartridge. Said to offer five-volt output with response to 10,000 cps. (W9; Shure Brothers, Inc., Evanston, Ill.)

SERVICEMEN SEE New Source of Income

WITH AMAZING
SSST! Steam Iron
CLEANER

Steam Irons
Need Cleaning
Too!

- ★ Removes clogging scale.
- ★ Safe odorless easy to use.
- ★ Perfect for hard water areas.
- ★ Tested and recommended by appliance manufacturers.

Nationally Advertis-
ed in Parents,
Living, etc.
JOBBER! Still a
few choice territories
available.

Resale \$1 (Full
year supply)



ORDER TODAY
from your jobber,
or write direct for
name of nearest
dealer.

FAST CHEMICAL PRODUCTS CORP.
65 Page Avenue Yonkers, N. Y.

HICKOK

Model 675



PROFESSIONAL
TV ENGINEERS'
5" SCOPE

- Illuminated Calibrated Screen.
- Flat response through 3.58 MC.
- New circuit technique eliminates band-width switching.
- Low capacity probe furnished.
- Includes New HICKOK Service-Instruction Warranty

THE HICKOK ELECTRICAL INSTRUMENT CO.
10521 Dupont Ave. • Cleveland 8, Ohio

INDUSTRY NEWS

BRAND NAME SURVEY

THE FOURTH ANNUAL electronic component brand name survey will be conducted during February by Brand Name Surveys, Chicago, Ill.

Questionnaires will be mailed to more than 20,000 radio and TV Service Men throughout the U.S., who will be asked to indicate brand preferences, as well as the reasons for their choice.

MIKE PLANT MOVES

THE PACIFIC COAST plant of American Microphone in Pasadena, Calif., will be closed on March 2, and equipment and key personnel will be moved to Elgin, Ill.

Move was said to be dictated by need for a centralized location, as well as closer liaison with the central research and development lab of the Elgin National Watch Co., parent company. New warehousing facilities will be established at Burbank, Calif.

ANTENNA MAKER OPENS FAR WEST WAREHOUSE

ANOTHER WAREHOUSE, the sixth, has been opened by the Snyder Manufacturing Company, located at 1612 Broadway in Seattle, Wash.

The Seattle warehouse and office is under the direction of Milton Schindler, west coast sales manager.

COLOR-TV MEETINGS

CONTINUING THEIR west-coast series of color-TV meetings, Simpson Electric Co. has announced that Bob Middleton will demonstrate applications of color-bar generators, white-dot generators, wide-band oscilloscopes, and related equipment in a number of Texas cities during the month of February. Meetings will be held subsequently in Denver and Salt Lake City.

25th ANNIVERSARY CELEBRATION

THE 25TH ANNIVERSARY of the Amphipol Electronics Corp., founded in 1932 by Arthur J. Schmitt, will be celebrated during 1957. Ads and trade show exhibits will be keyed to the occasion. Letterheads, catalogs and all metered mail will incorporate anniversary insignia.

Q and A Meeting



AT A CORNELL-DUBILIER question and answer session held recently in Union City, New Jersey, under sponsorship of Nidisco of Jersey City, N. J. Left to right: Bill Shaffer, mgr, Nidisco Hackensack store; Tony Moletti, mgr, Nidisco Richfield store; Ray Leary, sales mgr, C-D jobber div; Jack Newman, vice-pres, Nidisco chain; Olaf Ingemann, pres, Nidisco chain; Hy Steinberg, C-D rep, N. Y. area; Joe Mihalic, purchasing agent, Nidisco chain, and Tony Weiss, mgr, main store, Jersey City.

You need a special tool
for a special job . . .

Lenk

"PRINTED CIRCUIT" SOLDERING GUN

for
Printed Circuits
and Miniaturized
Components



\$6⁹⁸
LIST



Fast Soldering

Exclusive "Controlled Heat" produces proper amount of heat for quick, easy soldering.

Prevents Damage

Exclusive "Controlled Heat" reduces possibility of damage to delicate printed circuits or miniaturized components.

Pin-Points the Work

Precision-designed tip pin-points the tip onto the work quickly and accurately.

Lightweight — Comfortable

Exclusive "Easy Grip" handle and lightweight (only 1 lb. approx.) reduce fatigue.



Printed Circuit photograph
courtesy of Electralab, Inc.

Write for name of nearest Jobber
The LENK MANUFACTURING CO.
30 Cumington Street Boston 15, Mass.

for
WEAK
"SYNC"

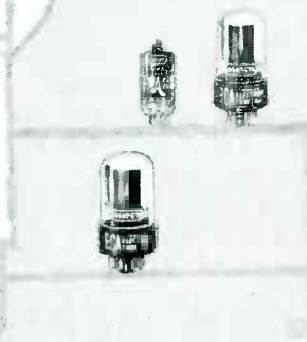
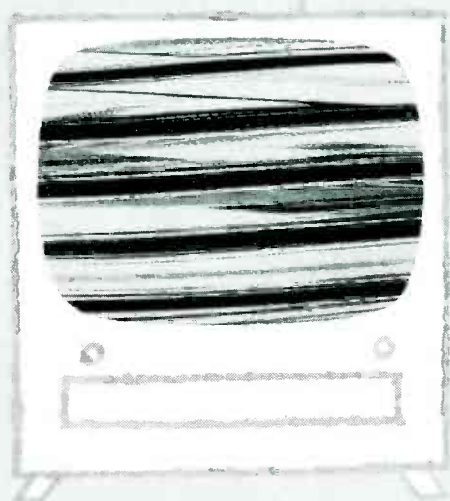

give that set a "shot" with

RCA TUBES

When the picture symptom is "unstable sync"—check into that sync separator, sync amplifier, video if, and video amplifier, and use *RCA Tubes* when you replace.

Designed and built to some of the tightest electrical tolerances in the tube business, RCA Tubes are the answer for replacement types that *fit the circuit*. Take the RCA-12AU7 and 6SN7-GTB, as examples. In these types, plate current cutoff characteristic is extremely uniform from tube to tube. And stability is excellent—even under wide variations in heater voltages. When you replace—go 100 per cent with "RCA's", and watch your bench-time drop. When you order—tell your distributor "RCA only" and watch your profits grow.



RECEIVING TUBES

Radio Corporation of America

® Tube Division

Harrison, N. J.



Have What You Need
... Right On The Job!



New HUMI-KUP*

2-SET TV
Coupler
Caddy*

6 Humi-Kups... all mast mounting hardware in handy carrying case. Everything for quick, profitable installations.

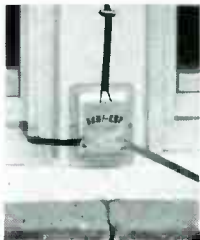

EXCLUSIVE!
Hermetically
Sealed

Positively water and weather proof... use anywhere outdoors or indoors.

New
Low Price

ONLY
\$1.95 EACH
DEALER NET

Humi-Kup, first hermetically sealed 2-set coupler now at a NEW LOW PRICE... now available in ultra handy COUPLER CADDY in three different models. Fast Service, bigger profit... designed for the serviceman.

NEW FONO-MAGIC

A compound of special rubber and carbide... eliminates turntable slipping-dragging. Makes automatic changers cycle properly.



Only
\$1.95
DEALERS NET

Trolmaster and Kleentrol Solvent

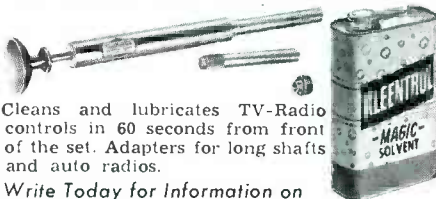

Cleans and lubricates TV-Radio controls in 60 seconds from front of the set. Adapters for long shafts and auto radios.

Write Today for Information on
These Servicemens' Designed Products

R-Columbia
PRODUCTS CO., INC.
Highwood, Illinois

Servicing Helps

(Continued from page 30)

mittent buzz in the output of the radio.

Since there are connections inside the electrolytic that could become loose or develop a high resistance, some way of making such an internal defect show up would be of great value. One method that can be used features the use of a known good receiver connected up to a signal generator; see circuit on p. 30. The signal generator should be set for an *rf*-unmodulated frequency, say 1,000 kc, and the radio tuned to this frequency. The signal generator output should be adjusted to at least 1,000 microvolts; if in doubt, maximum output. The volume control of the known good radio should be at maximum.

Clip Leads for Checking

Clip leads should be used to connect the suspected electrolytic between the leads going from the signal generator to the good radio. The suspected electrolytic does not have to be disconnected from its radio.

Tapping the suspected electrolytic will cause any intermittent condition to develop noise in the output of the known good radio.

IF Transformer Replacements

WHEN REPLACING *if* transformers in Motorola 56T1 home radio models care should be taken to assure use of proper replacement types. Some sets use *if*'s that require an external 390-mmf capacitor (C_5 , C_6 and C_{11}), wired across the primary of the transformer; other sets use *if*'s that have the capacitor built into the base of the transformer, and do not require the use of an external capacitor. When replacing *if*'s, one should check the set's circuit to determine if it uses internal or external capacitor type *if*'s.

Use of Lower Tolerance Capacitors

When replacing the external 390-mmf micas, 390-mmf 3% 500 v capacitors should be used in place of the originally specified 10% units. These capacitors are replaceable only in those sets that use external capacitor type *if*'s. The tolerance has been lowered to insure proper range of the *if* transformers.

NEW RETMA HEADQUARTERS

RETMA has announced that its headquarters operations have been consolidated and removed to 1721 De Sales St., N.W., Washington, D. C.

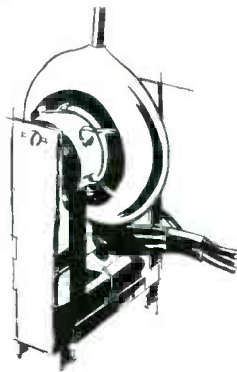

HVO-63 replaces Zenith part S-19408

ONLY MERIT

... always first with the latest

exact replacement

exceed original equipment specifications to eliminate call-backs... and no electrical or mechanical changes are necessary.



HVO-66 replaces part 24K736488 in 85 Motorola models and chassis



MDF-85 for G.E. RLD-041 & 045



HVO-62 replaces Magnavox part 360580-1, 360604-1, 360610-1



BC-359 sub-miniature IF output transformer for printed circuits—455KC



MDF-84 for G.E. RLD-025

MERIT

MERIT COIL AND TRANSFORMER CORP.
4427 N. Clark St., Chicago 40, Ill.

Servicing in Oakland

(Continued from page 13)

antenna transmission line. To prevent channel 4 from interfering with channel 5 we sometimes install a shorted stub across the receiver antenna terminals. The stub consists of a 6" piece of 300-ohm transmission line trimmed to the correct length by clipping it down step-by-step with diagonal cutters; sometimes the stub ends up being only 3" long.

Reception of channel 9, KQED, the San Francisco non-commercial community station, is generally excellent. Channel 13, on the other hand, while over 3000' above sea level on Mt. Diablo, does not come through as well because of intervening mountains, and requires special attention on antenna installations. San Francisco also has a *uhf* station, KSAN on channel 32, which delivers a good signal.

Since we are in the heart of the tremendous San Francisco metropolitan area with a population in excess of 3,000,000, we seldom encounter difficulty in obtaining spare parts. Our jobbers give us excellent service.

A satisfied customer is our best advertisement. To find out if we satisfy our customers, after each service call we mail a letter with a return reply card inquiring as to the reaction to our services. Most customers mail the cards back and most replies are favorable.

Besides word-of-mouth advertising we use direct mail and newspaper advertising. We have a mimeograph and an addressing machine and a mailing list of over 2,500.

Our firm is a member of the Television Radio Association of Alameda County. I am the editor of the association's official organ, *TV Flashes*, and John Miller is a former president.

While we have concentrated on TV and our business is excellent, we plan to expand into industrial electronics including two-way sales and service.

New Distribution Center



NEW distributor division building of P. R. Mallory and Co., Inc., at 1302 E. Washington St., Indianapolis, Ind. Building houses over 22,000 square feet of floor space and employs 77 persons.



BEST FOR COLOR TEST!

There's just one way to test the new color TV sets... WITH NTSC COLOR PATTERN. That's what Hycón's Model 616 Color Bar/Dot Generator offers... *all* standard colors, sequences and patterns easily selected and graphically shown in *actual color* right on the control panel. For color TV, get ready... GET HYCON!



**MODEL 622
5" OSCILLOSCOPE**

with automatic triggered sweep, first really new scope development in years. Fewer adjustments, no sync problems.

"Where Accuracy Counts"
Hycón ELECTRONICS, INC.
A Subsidiary of Hycón Mfg. Company
1030 SOUTH ARROYO PARKWAY
PASADENA, CALIFORNIA

MAIL,
please,
for Catalogs
616 and 622

HYCON ELECTRONICS, INC. Dept. S-10
P. O. Bin D Pasadena, California
Please send me the new model 616 and 622 catalogs.

Name _____
Address _____
City _____ State _____

...for faster, more profitable
servicing of RCA products



ALWAYS USE **RCA** SERVICE PARTS

One simple formula sums up success in your business . . . faster service equals more profits!

Here are a few of the many thousands of RCA SERVICE PARTS available through your RCA Distributor. Like all of their kind, they are identical mechanical and electrical duplicates of original parts used in RCA Victor TV, Radios and Phonographs. Factory-Tailored, they fit exactly right. This means faster replacement, less time on the bench, and restored top performance. RCA SERVICE PARTS are distinguished by the name your customers know, respect, and trust to do the job right!

Next time you "call" for an RCA Victor TV, Radio, or Phonograph . . . contact your RCA Distributor for Factory-Tailored, RCA SERVICE PARTS —and keep your servicing on the go—profitably!



SERVICE PARTS

Radio Corporation of America, Components Division, Camden, N.J.

RCA PRODUCTS AND RCA SERVICE PARTS — made for each other!

CATALOGS—BOOKS

TELEMATIC INDUSTRIES, INC., 16 Howard Ave., Brooklyn 21, N. Y., has released a 16-page booklet, *Hints for Speedier Servicing*, detailing the common faults found in picture-tube and sync circuits; how to recognize them and how to fix them quickly and economically.

MICROTRAN COMPANY, INC., 145 E. Mineola Ave., Valley Stream, N. Y., has published a 20-page transformer catalog listing a line of miniaturized transistor driver and output transformers.

THE HICKOK ELECTRICAL INSTRUMENT Co., 10521 Dupont Ave., Cleveland 8, O., has announced publication of a folder describing their model 660 white dot-bar-color display generator.

RECOTON CORP., 52-35 Barnett Ave., L. I. City 4, N. Y., has released its new 6th edition of the *Recoton Reference Guide* and *B Section*, with cartridge-to-phonoto-phoneneedle data.

HEXACON ELECTRIC Co., 594 W. Clay Ave., Roselle Park, N. J., has released catalog 144 showing an expanded line of 40 stock sizes and shapes. Various shapes of plug and screw tips are illustrated and the tip diameter and length, style of tip point and size of tip point are given.

HOWARD W. SAMS AND Co., INC., 2201 East 46th St., Indianapolis 5, Ind., has published a 286-page book on *Metallic Rectifiers* by Leonard R. Crow. Book presents theory, principles, and applications of the three most commonly used metallic rectifiers; the copper-oxide, the magnesium-copper sulfide, and the selenium. Also presented are rectifier circuits, applications of power rectifiers and small current rectifiers, instrument rectifiers, and rectifiers used as electrical valves. Priced at \$3.00.

COMMERCIAL ENGINEERING of the RCA Tube Division has released a new edition of the *RCA Receiving Tube Manual*. The manual (RC-18) contains technical data on more than 575 receiving tubes, including types for black-and-white and color television and series-string applications. In addition, more than 75 picture tubes, including color types, are treated. . . . Section on electron tube applications has been expanded to include a description of TV applications such as timer circuits, video amplifiers, sync circuits, *age* circuits, and deflection systems. Other sections include information on generic tube types, interpretation of tube data, and electron-tube installation. . . . Section on circuits covers such typical applications as superhet, superregenerative, and short-wave receivers. Copies may be obtained from RCA tube distributors, or by sending 75 cents to Commercial Engineering, Tube Division, RCA, Harrison, N. J.

IF YOU WANT BIGGER ANTENNA BUSINESS
IN 1957 . . . YOU'RE SURE TO WANT THE

Snorkle

the finest, most beautiful
of all rear fin antennas

Made by TENNA . . .
the world's largest maker
of auto antennas

THE TENNA
FOR DUAL OR SINGLE
REAR MOUNT
INSTALLATION

Available in both
dress-up and
"active" models



Packed in
lovely
display
carton.

The "Snorkle" is a 3 section, rear fin antenna, beautifully chrome plated to enhance the beauty of any car. Complete with special mounting adapters to fit every mounting need. Die cast base unit is heavily chrome plated to match antenna mast. Equipped with 15 ft. shielded cable with built-in 75MMF condenser to assure strong, clear signal, 33° angle harmonizes with speed lines of modern automobiles. Extends to 27", collapses to 10".

MODEL	DESCRIPTION
TRMD	Single "Dress-Up" (no cable)
TRM-27	Single Rear "Active" 15 ft. cable
TRMT-A	Dual Rear "Active" 15 ft., 6 ft. and 1 ft. cables
TRMT	Dual Rear, One "Active", 15 ft. cable

The **TENNA** Manufacturing Co.

CLEVELAND 25, OHIO

YOU'RE SERVING YOUR COUNTRY AND SERVING YOURSELF...

WHEN YOU'RE A TECHNICIAN WITH RCA SERVICE COMPANY

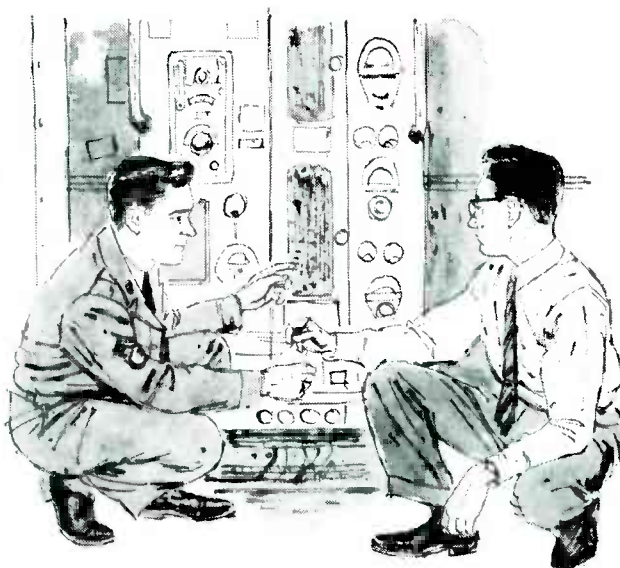

Why RCA for your next (and best) position as a technician? Because you value the opportunity to serve your country on projects like RCA's . . . vital to free world military supremacy. Because new and advanced challenges appeal to you far more than routine work. Because you're happy and satisfied only when your sense of accomplishment is strong.

What fields of technical work does RCA open for you? Instructing—Field Engineering—Equipment Maintenance—Equipment Installation—Test and Repair—Technical Writing—Factory Field Support.

What locations can you choose with RCA?

You may choose work with RCA at Alexandria, Va.; Cocoa Beach, Fla.; Cherry Hill, N.J.; or Tucson, Ariz.

Talk to RCA Engineering Management in Person!

Will an RCA representative be near *you* in the next 60 days?

Here is our partial schedule . . .

March 18, 19—Milwaukee
March 20, 21—Ft. Worth
March 23, 24—St. Louis
March 25, 26—Kansas City

March 28, 29—Chicago
April 1, 2—Denver
April 5—Salt Lake City
April 8, 9—Columbus

April 10—Winston-Salem
April 11, 12—Detroit
April 13, 14—Dallas
April 17, 18—Atlanta

To arrange confidential interview when we are in one of the above cities—or in a mutually-convenient area—send your resume, today, to:

Mr. James Bell, Employment Manager, Dept. Y-11B
RCA Service Company, Inc.
Cherry Hill, Camden 8, N.J.



RCA SERVICE COMPANY, INC.

Service Engineering

(Continued from page 28)

engineer to become competitive in microwave survey work.

It has often been quoted, and observed, that the initial way communication equipment is installed will reflect upon the subsequent performance of the equipment. This is as true for microwave equipment as it is for the other types of communication equipment such as *vhf* or *uhf* mobile. It becomes a type of insurance to the user and to the manufacturer to involve the *service engineer*, who will eventually service the system in the initial installation. The user knows that the man he is going to rely on to maintain his system is not only familiar with it from its conception, but actually was responsible for its installation. Hence, any *confidence* obstacle may easily be overcome. To the *service engineer*, it is on-the-job training; he is actually paid his full rate as he learns the basic fundamentals of microwave; the fundamentals which develop into skill as the system progresses. We have encouraged this type of training by providing our own communication engineers and microwave specialists, to supervise the installation and add the personal teaching that is necessary in understanding some of the microwave system's particular complexities. During the period of the *service engineer's* paid training, he has the opportunity to save the user and the manufacturer some of the hidden installation costs. Microwave installations involve site clearing, road building, station construction, tower erection, building power wiring, audio or end device wiring and emergency power. All of these are common to various *vhf* installations. The local *service engineer* has had experience in most of these phases and is familiar with local tradesmen best suited to perform this necessary work. For example, the power wiring must conform not only to the National Electrical Code, but also to local laws and union regulations. The *service engineer* can save valuable installation time by acting as the consultant on such matters and add the insurance necessary so that when the work is done all standards will be met and the work accomplished will be acceptable.

The benefits of local knowledge are hard to overestimate. Without it, up to several weeks may be required for orientation of the manufacturer's representatives from some distant loca-

(Continued on page 63)

... another
MALLORY
service-engineered
product



New Mallory "Gems" pace setters in paper capacitors

Next time you replace paper tubulars, make sure you use these new Mallory capacitors. They give you a lot of extra value features—without extra cost.

Soldering iron heat can't loosen leads. Wires are permanently attached in the plastic end seal... can't work loose from heating or vibration.

Moistureproof construction, using a protective case of high grade mica-filled bakelite, ends worries about premature shorts due to high humidity.

True center construction protects the foil element from deformation during assembly... assures uniform quality in each capacitor.

Get your stock now, from your local Mallory distributor. Ask for Mallory "Gems"—you'll agree they're a gem of a capacitor!

P. R. MALLORY & CO. Inc.
MALLORY

P. R. MALLORY & CO. Inc., INDIANAPOLIS 6, INDIANA

- Capacitors
- Controls
- Vibrators
- Switches
- Resistors
- Rectifiers
- Power Supplies
- Filters
- Mercury Batteries

Your **ERIE** Distributor Has
"PAC" Replacement Modules

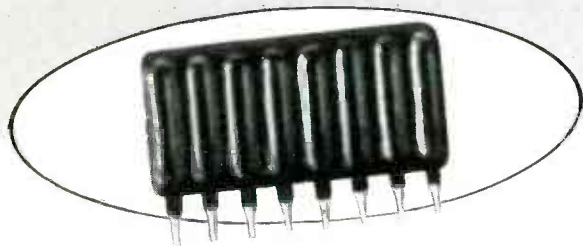

for Servicing 1957 Auto Radios

PAC is a group of interconnected capacitors and resistors, combined in a single-insertion unit. Several popular 1957 model automobile and truck radios employ this new concept in component packaging. When servicing these auto radios, a complete PAC (Pre Assembled Circuit) module can be quickly and easily replaced.

*Your ERIE Distributor has PAC Replacement Modules in stock.
 See him for complete information and prices.*

ERIE ERIE ELECTRONICS DISTRIBUTOR DIVISION
 ERIE RESISTOR CORPORATION
 Main Offices: ERIE, PA.
 Factories: ERIE, PA. • LONDON, ENGLAND • TRENTON, ONTARIO

NEW! RAM® X-CHECKER®

SERVICE-ENGINEERED!

- helps solve a multitude of TV-electronic problems
- from the Voice of Authority in sweep components



The new RAM X-CHECKER is a substitution box allowing easy substitution or insertion of a resistor or capacitor, or a series combination of both, in an electronic circuit. The resistance substitution range is from 0 to 2500 ohms. The capacitance substitution range is from 20 to 450 mmfd. Both ranges are continuously variable and the values may be read directly from the scale calibration. Accuracy of the calibration is 10%. Dissipation of the resistor is 2 watts. Typical uses are:

- to eliminate sound bars on screen due to insufficient filtering action of 4.5 mc trap
- to correct lack of picture detail due to insufficient h-f response of video amplifier stage
- to correct insufficient raster width
- to correct improper magnitude of AGC or AFC pulse from flyback circuit
- to correct improper horizontal linearity, brightness or width
- to determine value of burned illegible resistors or capacitors
- to read unfamiliar codes
- to compensate for deterioration of parts
- to determine values in lab breadboard circuits
- to substitute directly for faulty components

\$7.95 NET See it at your local distributor or write to Ram for local wholesale source.



RAM ELECTRONICS SALES CO. • Irvington, N. Y.

Canadian Sales Division: Teleequipment Mfg. Co., Ltd, London, Ontario.
 Export Dept: Dage Corp., 219 E. 44 St., New York, N. Y.

TV PARTS... ACCESSORIES

VHF-BAND-REJECT FILTERS

SHARP-CUTOFF, high-attenuation vhf band-reject filters have been developed by Entron, Inc., 4902 Lawrence St., Bladensburg, Md.

Units are said to improve band-edge response of broad-band filters or amplifiers and, because of their narrow bandwidth, eliminate narrow band co-channel interference. Traps are also claimed to remove adjacent channel interference to color-TV signals.

Series is available in two bandwidth ranges: *HQT*, with a peak attenuation greater than 70 db and a 30 db bandwidth of 200 kc; *HQF*, with a peak attenuation greater than 90 db and a 30 db bandwidth of 400 kc. Various connector types are available, matched to maintain minimum *vswr*.

REPLACEMENT FLYBACKS

FOUR EXACT REPLACEMENT flyback transformers have been introduced by Chicago Standard Transformer Corp., 3501 W. Addison St., Chicago 18, Ill.

Models replace Raytheon numbers 12E25423 and 12E25424; Airline, Coronado, Raytheon and Truetime numbers C-201-19817, -1, -2, -3 and C-201-19533-1; Airline and Raytheon parts 201-22396, -1 and 201-22382, -1, and Philco 32-8677, -1, -2. Complete information available in bulletin 524.

FERRITE DEFLECTION YOKE CORES

FERRITE FULL ROUND deflection yoke cores, series T, for b-w and color-TV picture tube assemblies, have been introduced by Allen-Bradley Co., 136 W. Greenfield Ave., Milwaukee 4, Wis.

In color-TV, the yoke is said to provide improved convergence and color purity.

For the 110° picture tubes full-round flared yokes have been designed. Yokes are said to make possible a weight reduction of 30% over cylindrical cores heretofore used.

Flared ferrite yoke cores are made as a full 360° ring, then *cracked* into two mated halves, which are rejoined and mechanically held together for shipping.



for just **27¢** per day—



PHOTOFACT—the world's finest TV-radio service data comes to you... keeps you right up-to-the-minute on new model releases... is delivered automatically by your Parts Distributor as each new Folder Set is issued. Yes, for just 27¢ per day...

PHOTOFACT can help you double your repair output



Exclusive PHOTOFACT features help you solve any service problem faster...help you earn more

PHOTOFACT offers you complete coverage on over 30,000 TV, Radio, Amplifier, Tuner and Changer models. And PHOTOFACT is a current service—keeps you right up with late model production—brings you these exclusive features...

Full Schematic Coverage: Famous "Standard Notation" uniform symbols are used in every schematic. Diagrams are large, easy to read and handle. Wave forms and voltages are shown right on the schematic for fast analysis. Transformer lead color-coding and winding resistances appear on the schematic. Schematics are keyed to parts lists and to parts on chassis photos.

Full Photographic Coverage: Photos of all chassis views are provided for each model; all parts are numbered and keyed to the schematic and parts lists for quicker parts identification and location.

Alignment Instructions: Complete, detailed alignment data is standard and uniformly presented in all Folders. Alignment frequencies are shown on radio photos adjacent to adjustment number—adjustments are keyed to schematic and photos.

Tube Placement Charts: Top and bottom views are shown. Top view is positioned as seen from back of cabinet. Blank pin or locating key on each tube is shown. Charts include fuse location for quick service reference.

Tube Failure Check Charts: Shows common trouble symptoms and tubes generally responsible for such troubles. Series filament strings are schematically presented for quick reference.

Complete Parts Lists: Detailed parts list is given for each model. Proper replacement parts are listed (with installation notes where required). All parts are keyed to chassis photos and schematics for quick reference.

Field Service Notes: Each Folder includes time-saving tips for servicing in the customer's home. Gives valuable hints for quick access to pertinent adjustments, safety glass removal, special advice covering the specific chassis, etc.

with PHOTOFACT by your side, you solve your service problems in just minutes...you SERVICE MORE SETS AND EARN MORE DAILY...

The regular monthly issues of Sam's PHOTOFACT provide you with up-to-the-minute service data on new models as they are produced, for as little as 27¢ per day! And this includes the "bonus" schematic service on new models hot off production lines to give you *immediately* the essential data you need.

With a current PHOTOFACT library at your fingertips, you can actually *double* your repair output, because *you save valuable time on every job.* YOU EARN MORE DAILY.

Learn how easy it is to sign up with your Parts Distributor to receive all Sams' PHOTOFACT Sets regularly as published each month. Learn for yourself how a small investment of only 27¢ per day can mean GREATER income for you.

SPECIAL OFFER: If you return the coupon below and indicate your interest in receiving PHOTOFACT regularly each month, we will arrange to have delivered to you, ABSOLUTELY FREE, a valuable and attractive Wall Holder for the "Index to Photofact Folders" as well as the latest copy of the Index. Be sure to give your Distributor's name.

HOWARD W. SAMS & CO., INC.
2207 E. 46th St., Indianapolis 5, Indiana

I am interested in receiving all new PHOTOFACT Sets regularly as published each month. Send full details (I understand there is no obligation on my part, and that I will receive without charge, the latest "Index to Photofact", along with Wall Holder).

I am a Service Technician: full time; part time.

My Distributor is: _____

Name: _____

Address: _____

City _____ Zone _____ State _____

NEW! UNIVERSITY PORTABLE SOUNDCASTING

POWRPAGE

**PROJECTS VOICE BETTER
BOOSTS SALES HIGHER**

The University Powrpage is ideal for sporting events, coaching, boating, picnics, civil defense, auctions... literally anything requiring portable soundcasting. The voice is projected clearly, distinctly... with a lightweight, self-contained University POWRPAGE. *Goodbye to shouting...* just press button and talk! No tubes... no waiting for warm-up. Exclusive built-in POWRSAVER circuit. Two different design types for almost every need.

PORTABLE POWRPAGE MODEL PP-1 Only 7½ lbs. Uses seven standard flashlight cells. Unit stands free or hangs from any convenient structure. Press-to-talk switch on microphone and long 11 ft. cable give you complete freedom of movement. Completely weather-proof. *Greatest power and voice clarity in portable soundcasting!*

PISTOLGRIP POWRPAGE MODEL PP-2 Where maximum compactness and freedom of action are desired. Entire unit weighs only 4¼ lbs. Uses six ordinary "pencil" batteries that fit inside the slim, easy-grip handle, or may be powered directly from the 6 or 12 volt D.C. of car or boat ignition system. Completely weatherproof.

See your distributor. For literature and further information write Desk W-22, University Loudspeakers, Inc., 80 So. Kensico Ave., White Plains, N. Y.



MODEL PP-1
\$69.75 User Net
(less batteries)

MODEL PP-2 \$65.00 User Net
(less batteries)

Audio

(Continued from page 37)

metal pulley by the bronze bushing. In the instances mentioned the bushing has loosened in the metal pulley and moved endways slightly. This allowed the nylon pulley to slip on the bushing and resulted in insufficient tape takeup tension.

If the nylon pulley shows any indication of being loose, it is recommended that the dual pulley assembly be removed and the bushing tapped back into position. The pulley should then be placed on a flat surface and the small diameter end peened slightly. This should hold the bushing tightly in place and prevent further slippage.

Turntable Cycling

IF THE turntable in RCA RP-197/RP-198 series should be rotated in a reverse direction when the mechanism is out of cycle, the trip pawl on the cycling gear will be pushed into a position where it will not engage the projection on the turntable hub. When this happens the mechanism will not go into cycle when the off-on-rej control lever is pushed to the rej position.

To correct this condition it is necessary to turn the cycling gear by hand so that it will engage the teeth of the turntable hub. The turntable will then be able to turn the cycling gear through the complete cycle in a normal manner.

Four-Speed Players

A NUMBER of phonos now being made feature four-speed mechanisms de-

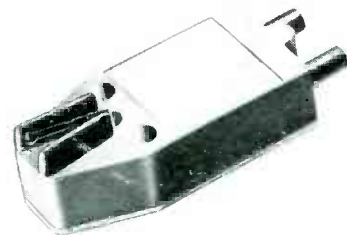

PHONO pickup designed as a direct replacement for cartridges employed in many Sears-Roebuck Silvertone record players. Pickups used in these models were Sonotone models that are no longer being made. (Model 430: Astatic Corp., Conneaut, O.)

¹In December, 1956, SERVICE, this cartridge was inadvertently described as an auto-record player component.

LISTEN

University sounds better



SERVICE AIDS & ACCESSORIES

Precision Engineered for Better Reception.



"GOLD-DOT" SERIES

Handsome, self-service Counter Racks. 36 assorted Types and Sizes.

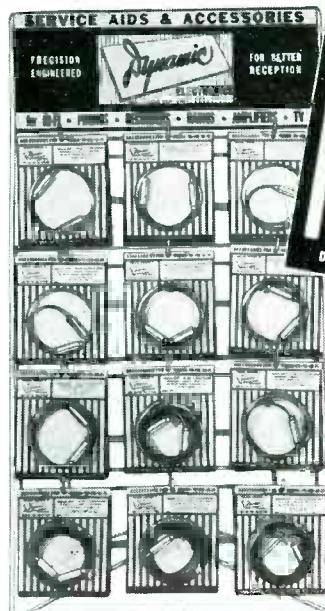

Stock and Display the finest and most distinctive line of...

Dynamic "GOLD-DOT" FLEX-E-COUPLERS

Shielded and insulated Connecting Cables, Jumper Cords and Feed thru Couplers. Engineered for fast temporary or permanent noise free and Positive Couplings for Audio Amplifiers, Pre-amps, Phonos, Record Changers, Recorders, Radios, Tuners, and all Hi-Fi requirements. Precision made of the finest shielded low capacity Cable with insulated shield covered Connectors.

DYNAMIC ELECTRONICS-NEW YORK, INC., FOREST HILLS, NEW YORK

signed to play, in automatic sequence, a stack of 7", 10" or 12" records, or 10" and 12" records intermixed. Three types of pickups and three types of motors are used.

Record Separation

In the RCA 205 series, record separation is accomplished by movement of a finger in the center spindle. This finger directly separates records having a 3/4" centerhole and actuates the knives and shelves of the centerpost used for the playing of records having a 1 1/2" centerhole.

The tripping method used is the acceleration or velocity type in which the trip lever causes a trip pawl to engage a projection on the turntable hub and start the mechanism into cycle. If the record being played causes the pickup arm to move inward at a constant rate without acceleration, a point will be reached where a constant-diameter trip is effected.

A well is provided on the record changer for storage of the centerpost when it is not in use. The centerpost may be firmly secured, after placing it in the well, by pushing down. The shelves of the centerpost will engage with projections on the inner diameter of the well.

The operation of the 16 2/3-45 speed centerpost is unusual. In the out-of-cycle position (playing), the records with 1 1/2" centerhole rest upon the protruding shelves of the centerpost (knives are retracted).

When the mechanism goes through cycle, the record push-off finger in the
(Continued on page 50)



POWER AMPLIFIER which has an EF86 voltage amplifier direct-coupled to a 6SN7GTB cathode-coupled phase inverter, which drives a pair of ultra-linear connected push-pull EL34 output tubes operated with fixed bias. Rated power output is said to be 60 watts (130w peak). Uses a GZ34 rectifier with indirectly-heated cathode which, it is claimed, eliminates high starting voltage on the electrolytics and delays B+ until amplifier tubes warm up. (Model HF60; Eico, 84 Withers St., Brooklyn 11, N. Y.)

Simpson...the most Complete Line of VOM's

Select the one that fits your needs!

MODEL

260
world's most popular!

Over half a million Model 260's have been sold to date! 20,000 Ohms per volt. You'll find it wherever quick, accurate, electrical checks are needed. It's so handy, so dependable, so sensibly priced! Ask your jobber. Price, including Adjust-A-Vue Handle, only ... **\$43.95**

Carrying Cases from **\$7.75**

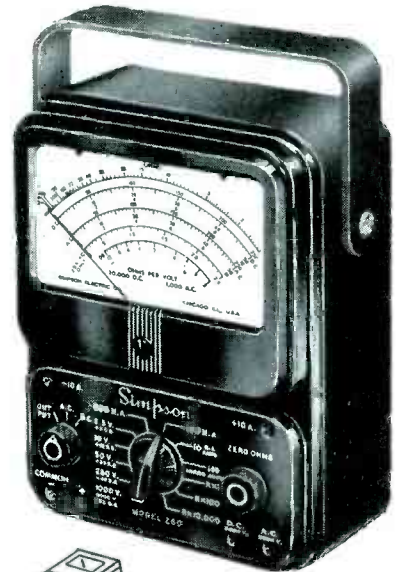

MODEL **262**

Deluxe!

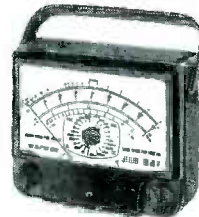

the new VOM with a 7" meter

20,000 Ohms per volt DC and 5,000 Ohms per volt AC sensitivity ... 33 ranges ... compact 7" case with Adjust-A-Vue Handle ... **\$59.50**

Carrying Case ... **\$ 9.95**

MODEL **269**

100,000 Ohms per volt!

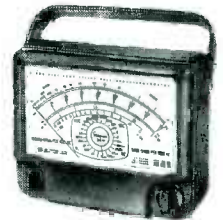

Most sensitive VOM available!

A Volt-Ohm-Microammeter with a big 7" meter in a compact 7" case ... 33 ranges ... Adjust-A-Vue Handle ... **\$88.00** price complete ...

Carrying Case ... **\$ 9.95**

NEW!

- MIDGETESTER Model 355—New shirt-pocket size Volt-Ohmmeter \$34.95
- MODEL 240—Small VOM; 14 ranges; up to 3000 volts AC or DC \$28.95
- MODEL 230—Small VOM; 12 ranges; up to 1000 volts AC or DC \$27.95
- ROTO RANGER Model 221—25 Separate meters at turn of a switch \$75.00
- LABORATORY STANDARD—For instrument calibration. Price on application.

Simpson ELECTRIC COMPANY

World's Largest Manufacturer of Electronic Test Equipment

5200 W. Kinzie St., Chicago 44, Ill. • ESTEbrook 9-1121
In Canada: Bach-Simpson, Ltd., London, Ontario

QUAM

Adjust-a-Cone®

SPEAKERS

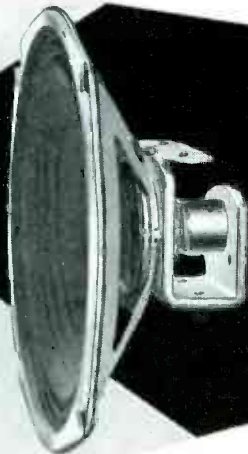

are the
SAME PRICE
but they
COST LESS

They cost less because they fit right . . . the first time . . . and they work right . . . the first time.

With Quam Adjust-a-Cone Speakers there are no callbacks—caused by defective or non-fitting speakers—to eat up your profits.

Remember: a guarantee does not pay for your time or protect your reputation and customer goodwill . . . so use Quam, the "no-callback" speaker.

*ask for QUAM,
the quality line,
for all your speaker needs*

QUAM-NICHOLS COMPANY

232 EAST MARQUETTE ROAD • CHICAGO 37, ILLINOIS



UNIDIRECTIONAL DYNAMIC microphone designed for use with low-gain public address systems and tape recorders. (Unidyne; Shure Brothers, Inc., 222 Hartrey Ave., Evanston, Ill.)

porting all but the bottom record. When the shelves retract the bottom record falls to the turntable.

Careless placement or removal of the centerpost on the center spindle may result in bending of the center spindle. The centerpost should be placed on or removed from the center spindle with a *straight vertical motion*. The word *front* should always face to the front of the record changer.

Correcting Incorrect Turntable Speed

IN CHECKING TURNTABLE speed one should use a stroboscope disc that has been cemented to a 10- or 12-inch phono record to make it more rigid and increase its useful life.

Turntable speed should be checked with the needle in the record groove, using a fluorescent or neon lamp. When the two rows of dots for the speed under test appear to move in

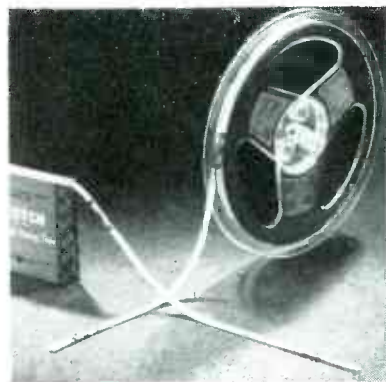

PLASTIC LEADER and timing tape said to have an anti-static coating that, it is claimed, reduces noise as the tape passes over the playback head. For tape speeds of 15 ips there are indicator arrows every 15 inches; plaid sections are printed every 7½ inches. Leader and timing tape is ¼" wide by 150' long. (No 43-P; Minnesota Mining and Manufacturing Co., 900 Fauquier Street, St. Paul 6, Minn.)

Audio

(Continued from page 49)

¼" center spindle pushes against the actuator slide. This slide actuates two pairs of pivot levers. One pair of these levers pull the shelves inward; downward projections of pivot levers extend through long slots of knives and engage in short slots of the shelves. The other pair of levers push the separator knives outward; downward projections of pivot levers en-

gage small holes in knives—long slot of shelves allow freedom of movement.

Two small coil springs push outward on the shelves and thus return them to the normal outward position. A formed metal spring extending up into the nose cap returns the slide to its normal position.

In the normal position the stack of records is supported by the shelves. During cycle the separator knives are extended first and then the shelves are retracted. The knives extend into the opening between the bottom record and the one adjacent, thus sup-

opposite directions, the turntable speed is within specified limits. If the speed is at the top or the bottom tolerance limit, one of the two rows of dots for the speed under test will appear to be stationary and the changer turntable speed is within factory specifications.

If the two rows of dots both appear to be moving counterclockwise, the turntable speed is below specified tolerance. To service such a changer in Magnavox phonos, the following five steps should be taken:

(1) Motor should be tapped with a screwdriver handle while motor is running. Motors used in Magnavox models are equipped with a self-aligning bearings and any misalignment should be corrected in this way. One should not, under any conditions, disassemble the motor.

(2) In the next step, the turntable should be removed and engagement checked between rubber idler wheel and motor pulley. If rubber wheel is dragging on step of next larger pulley diameter, pulley should be pressed all the way down. If this does not alter the condition, idler wheel height should be readjusted by turning the stop nut under the speed-change cam until the idler pulley is centered on each step of drive pulley as speed selector is adjusted.

(3) Next, one must check position of the neoprene washer inside turntable hub. If it is not properly seated in the groove provided, it should be repositioned and if necessary a small amount of *lubriplate* should be used to hold it in place while the turntable is reinstalled.

(4) Now the turntable should be rotated by hand with the changer out of cycle and with the idler wheel disengaged from the motor pulley. If the turntable appears to bind at the center bushing (this is evident if the clip on top of the turntable is rubbing it) the turntable should be removed. Then the ball race should be removed from the record spindle exposing one or more neoprene washers. One of these washers should be removed and the ball race and the turntable reassembled; then the turntable speed can be checked. Ordinarily, removal of one of the neoprene washers will provide required turntable bearing clearance, although in some cases two washers may have to be removed.

(5) Finally, the ball race under the turntable should be lubricated if necessary with a light machine oil. Also this same lubricant should be applied to the inside of turntable hub if it appears dry.

Cartridge replacements are a "Snap" with Sonotone



Sonotone 1P and 2T mount the same way, take the place of up to 12 different models in other cartridge lines

Time is money to you, so why be slowed down by handling a variety of different cartridges that mount various ways? Sonotone Ceramic 1P (single-needle) and 2T (turn-over) are all you need for over 90% of quality replacement jobs. They're a cinch to install in almost any arm — let you do the job *the same quick, easy way time after time.*

Stick to the Sonotone 2-model line and you'll find you cut installation time to an absolute minimum. Your customers will applaud for another reason — Sonotone cartridges, leader in the field, in virtually every case give *better* response than original equipment... enhancing your reputation for quality work.

New standard of the phono industry

In more than half the quality phonographs made today by leading manufacturers, you'll find one of these Sonotone cartridges. All the more reason why you should standardize on Sonotone.

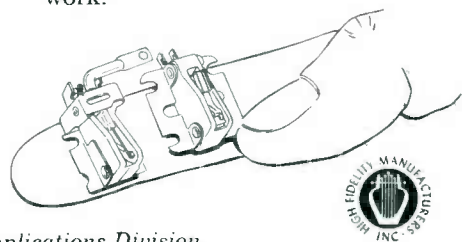

Electronic Applications Division

SONOTONE CORPORATION

ELMSFORD, N. Y.

In Canada, contact Atlas Radio Corporation, Ltd., 50 Wingold Avenue, Toronto

ASSOCIATIONS

TESA, Buffalo, N. Y.

IRVING J. TONER has been reelected president of TESA of Greater Buffalo, N. Y. Other officers elected include: *Pascal P. Pratt*, vice-president; *Homer G. Johnson*, secretary; *Ralph D'Agostino*, treasurer, and *George Leffler*, sergeant-at-arms.

Directors named were: *Al Szalav*, *Nick Mitri*, *Ed Danaher*, *Joe Miller*, and *Joe Adams*.

Newly elected officers were installed at the annual banquet held at Chestnut Lodge.

TSA, Detroit, Mich.

AN ALL-COLOR 2-day service clinic, sponsored by the Television Service Association of Michigan, was held recently in the Fort Shelby Hotel, Detroit, Mich.

Displays on color sets and components were offered by 20 manufacturers. A number of the exhibits featured demonstrations.

Subjects covered by industry experts were *antennas for color*, *troubleshooting color*, *new tubes for color*, *color circuitry development* and *color transmission*.

**Time
for
Replacement?**



Specify

**OXFORD
SPEAKERS**

"Put the right shoe on the right foot" by demanding the most exact replacement speakers . . . OXFORD.

Proven for replacement and preferred for original equipment,

OXFORD offers you the best from 2" to 15" . . . a streamlined, complete line of speakers constantly improved over more than twenty-five years of speaker leadership.

TIME for REPLACEMENT . . . specify OXFORD SPEAKERS . . . you'll be glad you did.

OXFORD Components, Inc.

Subsidiary of Oxford Electric Corp.

556 West Monroe Street • Chicago 6, Illinois

In Canada: Atlas Radio Corp., Ltd., Toronto

Export: Roburn Agencies, New York City



CSEA, California

THE CSEA STATE BILL licensing Service Men and service shop operators has been revised and submitted to committee in Sacramento for a hearing.

The proposed measure notes that a license may be granted without an examination if one has actually been engaged in the installation and servicing of domestic radio or television receiving sets for not less than twelve months prior to the effective date of the bill, and shall apply for a license within six months of the effective date of the bill. Applicants who do not take a test will have to show if their qualifying experience was gained as an employee, or while self-employed.

In a section on disciplinary proceedings, the bill states that the administrator may suspend or revoke the license of any licensed person for any cause for disciplinary action, such as gross incompetence, violation of any provision of the bill, conviction of a criminal offense involving moral turpitude, conviction of a felony arising out of servicing electronic devices, fraudulent misstatements or misrepresentations in applicant's application, and aiding and abetting any person or persons to work without a license.



AT FIRST '57 MEETING of the Radio and Television Guild of Long Island, *Chris Stratigos* (left) and *Ralph Milne* (center), the new president and vice president, respectively, with outgoing president *Murray Barlowe*.

TEN YEARS AGO IN SERVICE

STANDARDIZATION OF BASIC designs, components and circuits for phono, auto-radio, FM and TV chassis was recommended by the engineering department of RETMA. The plan provided for drive-pulley simplification, phono-record dimension control, auto-radio signal measurements, 21.25-21.9 mc channels for TV, 300-ohm TV antenna inputs, color-coded wiring and streamlined diagram symbols for tubes and switches, which would include voltage information at key points. . . . Associations were notified by manufacturers that they would supply speakers explaining the new program and its effect on servicing operations. . . . The first of a series of two-week television courses were announced by the receiver division of G.E. . . . A pocket-size Ohm's law calculator was produced by Olmito. . . . Aluminum-foil-base voice coils were announced by G.E. . . . The first complete list of miniature tubes, involving 40 types announced by RCA, were detailed in a special chart in SERVICE.

BENCH-FIELD TOOLS

PRE-INSULATED CONNECTOR

A SPRING-TYPE insulated connector, *Scotchlok Type R*, to prepare solderless, insulated splices in one step without tools, has been introduced by Minnesota Mining and Manufacturing Co., 900 Fauquier St., St. Paul 6, Minn.

Connector is said to provide a vibration-resisting pig-tail splice that will hold regardless of thermal or mechanical changes and meet requirements for high and low voltage building and fixture wiring. Unit consists of a cone-shaped coil spring within a steel shell.

PISTOL-TYPE WIRE-WRAPPER

HAND-HELD pistol-type wire-wrapping tools, powered by either air or electricity, designed to speed electrical connections in radio, TV and other electronic chassis, have been developed by Ingersoll-Rand, 11 Broadway, New York 4, N. Y.

Skimmed wire is inserted in a loading groove, which can be set to six different positions for wire insertion from any angle. A notch in the winding bit anchors wire and bit is then placed over terminal lug. Wire-to-terminal connection is made by pressing trigger which shoots connecting wire around terminal about 6 times per second under high tension. Winding bits and sleeves are interchangeable and can be changed without tools.

CONTACT PRESERVATIVE CLEANER

A CONTACT PRESERVATIVE and cleaner, *Cramolin*, said to contain a chemical compound that is attracted by metal surfaces, has been announced by Caig Laboratories, 46 Stanwood Rd., New Hyde Park, N. Y.

Compound is claimed to be fungus-proof.

WATER DEMINERALIZER

A WATER DEMINERALIZER, *Water Master*, supplying small quantities of mineral-free water to steam irons, has been developed by Ion Exchange Products, 9349 S. Cottage Grove Ave., Chicago 19, Ill.

Preparation is claimed to eliminate sputtering and poor steaming.



"See! I told you we'd get that boy next door over with a **JENSEN NEEDLE.**"

ask the
"Man-on-the-Roof"
 why he prefers
South River

EAVE MOUNT model EM-48
 One piece construction of heavy gauge, embossed steel. Hot-Dip galvanized to prevent corrosion. Unique design of lower bracket give extra strength and rigidity. Extended lip supports mast during installation. 48" spread permits generous spacing between brackets for excellent mechanical mast support. Both 3" embossed steel upper bracket and lower bracket have new "reversed" U bolt and clamp feature for Spintite fastening. Also available with 60" spread: EM-60
 Write for New 1957 Catalog

SOUTH RIVER
 METAL PRODUCTS CO., INC.
 South River, New Jersey

pioneer & outstanding producer of finest line of antenna mounts

New! COLOR & BLACK & WHITE LAB & TV SERVICE 5" SCOPE

KIT \$79.95
Factory Wired \$129.50

#460

- Flat from DC to 4.5 mc to reproduce 3.58 mc sync burst and oscillator signals in color TV sets.
- V amplifier direct-coupled and push-pull thru-out; gradual roll-off beyond 4.5 mc, useful at 10 mc.
- High V sensitivity: 25 mv/in.
- Choice of direct coupling (DC) or capacitive coupling (AC).
- 4-step frequency-compensated attenuator in both AC and DC positions.
- Built-in calibrator permits peak-to-peak voltage measurement.
- **Automatically syncs** anything visible on the screen.
- **Pre-set TV V & H sweep positions** (30 cps & 7875 cps).
- Edge-lit lucite engraved graph screen with dimmer control; filter; standard bezel fits standard photographic equipment.
- 5UP1 CRT.

Prices 5% Higher on West Coast

EICO Write for Name of Distributor & FREE New 1957 CATALOG S-2

84 Withers St. • Bklyn 11, N. Y.

NOW IN STOCK AT YOUR NEIGHBORHOOD DISTRIBUTOR—ORDER NOW!

BEST BUY IN HI-FI
Grommes **KITS**

THE Little Jewel
MUSIC LOVERS AMPLIFIER KIT
 Featured by LIFE as the best buy in the field. Power Output: 10 Watts. Freq. Response: ± 1DB, 20 to 20,000 CPS. With 3 inputs: Radio, Magnetic and Crystal Phono and Microphone. Charcoal and Gold Finish. With tubes and instructions. Wt.: 9 lbs. **\$2495**
 LJK KITNet

61-PGK 20 Watt AMPLIFIER KIT
 Single unit amplifier with built-in pre-amp. and all controls. Wt.: 20 lbs. Complete with instructions. **\$5950**
 61-PGKNet

See your Hi-Fi Dealer or write . . .

Grommes Div. of Precision Electronics, Inc.
 Dept. S-2, 9101 King Ave., Franklin Park, Ill.

Send complete Kit details. Send Kit.
 COD (\$5 enclosed). Postpaid. (Full payment enclosed. Enclose name of Dealer. (If any.)

Name
 Address
 City Zone State

10-day money back guarantee on all Kits.

BEST BUILT



YET

That's our claim—backed up by a solid majority of independent set makers who use them. Built to one standard of quality—Blue Chip Quality—Magic Mirror Aluminized Picture Tubes mirror twice the light to create a picture twice as bright. Tell your supplier you'd rather have Tung-Sol!

Blue Chip Quality

 **TUNG-SOL®**

Magic Mirror Aluminized
PICTURE TUBES

TUNG-SOL ELECTRIC INC., Newark 4, N. J. Sales Offices:
Atlanta, Ga., Columbus, Ohio, Culver City, Calif., Dallas,
Tex., Denver, Colo., Detroit, Mich., Irvington, N. J., Melrose
Park, Ill., Newark, N. J., Seattle, Wash.

Commercial Sound

Basic Types of Lines and Installation

by **FRANK TIMMONS**

Product Engineer, Belden Manufacturing Company

COMMERCIAL SOUND SYSTEMS require a number of carefully designed cable networks that must be fed to assorted components to insure maximum performance. Basically, cables are designed for input and output use, and for connection to power and control sources. Almost all of these cables are of a shielded construction.¹

High-Impedance Patching

For high-fidelity service there are cables that can be used for short length (3' to 6') patching in high-impedance circuits between record player, radio tuner and tape recorder output terminals and power amplifier input terminals.

For application in long runs between preamps and power amps, when using low-impedance balanced circuits, special cables are also available. In such applications, the shield drain wire has been found effective permitting shield termination and providing low circuit noise level.

Cables for High and Low-Impedance Microphones

Cables for high-impedance microphones designed for long life in rough service, can deliver small voltages with minimum loss directly from microphones or high-impedance units directly to tube grids.

This cable not only has low capacitance per foot, copper braid shield and a high insulation resistance, but a minimum diameter.

Shields, fabricated for optimum coverage and minimum weight, together with greatest flexibility or limpness, are designed for long, noise-free life in flexing service.

Low-impedance microphone cables can be used to feed low voltages in a balanced-to-ground circuit from the microphone to the amplifier-input transformer.

They can be used in runs far longer than high-impedance cable, due to circuit balance and transposition of the conductors. Rubber or polyethylene insulation is in their construction.

The polyethylene conductor insulation and vinyl jacket over shield has been found to provide the highest insulation resistance and nominal capacitance per foot. Cables with rubber conductor insulation and rubber jacket over the shield can be used where flexing service and physical abuse are more severe.

These cables are also designed with more than two conductors for control circuits and special arrangements.

To insure long service life with low noise level, copper braid shields of high coverage are employed in all types. Alternate designs, using spiral-served shields of conductive

¹The development of the served or wrapped-type shield has been found to offer a considerable saving in time as compared to the tedious process of making connections with the braided type shield. However, these served shields are not suitable for cables which require considerable flexing; therefore they are not applicable to microphone cables as such, but can be used in stationary applications.

Cables

System Requirements

cotton with spiral stranded drain wire, have been found very practical, too, since they afford cable limpness.

For low-impedance balanced circuits suitable for low noise, long-run applications, special audio cables are available. Classed as broadcast type, they feature small cable diameter, high shield coverage, solid conductors for ease of termination and balanced design for low noise level. They are designed for installation in fixed position; not for continued flexing.

For interconnecting power supplies to electronic equipment where voltages used are at or below 1000 volts and where shielding is essential, special cabling must be used. For this purpose shielded multiple-conductor types have been designed.

They may be employed in some installations to supply power to, and signals away, from isolated equipment, when used with proper terminal equipment.

These cables are often used to supply power to equipment, conduct control impulses and to convey signals back from remote and isolated devices. Proper impedance matching and balanced circuits are necessary in these applications.

Unshielded output cables have been designed for application in delivery of audio power from amplifier to speaker only. They are fully adequate when adjacent cables are in service, where crosstalk voltages do not interfere.

Shielded (using tinned copper braid) output cables have the widest application range. Shielded output cables have been found to reduce induction and crosstalk voltages to a minimum and permit the same cables (in some applications) to be used for talk-back to the control point. Tinned copper (spiral wrapped) shields are widely accepted for their higher shield coverage, lower shield weight, lower diameter and ease of shield termination.

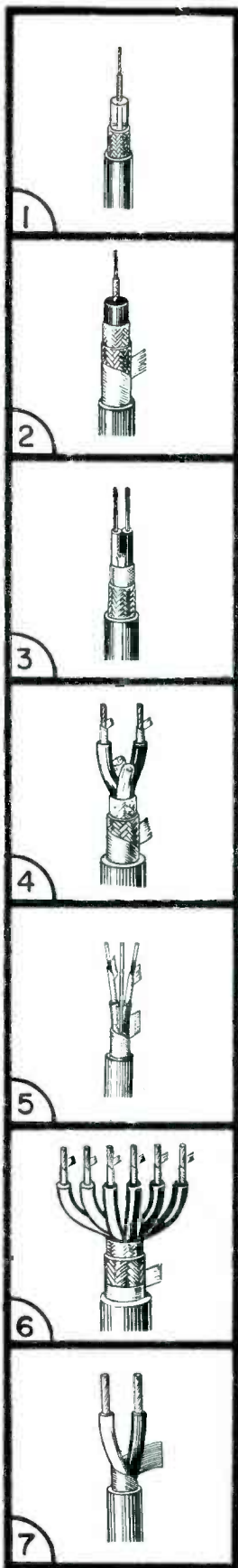

SEVEN TYPES of cables specially designed for commercial sound application: Types shown in 1, 2, 3 and 4 are for microphone use and for high and low-impedance applications; the cable shown in 5, a special broadcast audio type, can be used for long runs between preamps and power amps; a shielded multiple-conductor cable, shown in 6, serves to interconnect power supplies where shielding is necessary, and 7 illustrates a commercial sound output cable.

BEST FOR



EVERY SET

All Tung-Sol radio, TV or Hi Fi tubes are engineered to one standard of quality—Blue Chip Quality. Whether they're for famous set makers or leading service dealers, Tung-Sol Tubes are identical in design and performance. Tell your supplier you'd rather have Tung-Sol!

Blue Chip Quality

TUNG-SOL[®]
RECEIVING TUBES

TUNG-SOL makes All-Glass Sealed Beam Lamps, Miniature Lamps, Signal Flashers, Picture Tubes, Radio, TV and Special Purpose Electron Tubes and Semiconductor Products.

for service and lab. work

Heathkit PRINTED CIRCUIT OSCILLOSCOPE KIT FOR COLOR TVI

① Check the outstanding engineering design of this modern printed circuit Scope. Designed for color TV work, ideal for critical Laboratory applications. Frequency response essentially flat from 5 cycles to 5 Mc down only 1½ db at 3.58 Mc (TV color burst sync frequency). Down only 5 db at 5 Mc. New sweep generator 20-500,000 cycles, 5 times the range usually offered. Will sync wave form display up to 5 Mc and better. Printed circuit boards stabilize performance specifications and cut assembly time in half. Formerly available only in costly Lab type Scope. Features horizontal trace expansion for observation of pulse detail—retrace blanking amplifier—voltage regulated power supply—3 step frequency compensated vertical input—low capacity nylon bushings on panel terminals—plus a host of other fine features. Combines peak performance and fine engineering features with low kit cost!

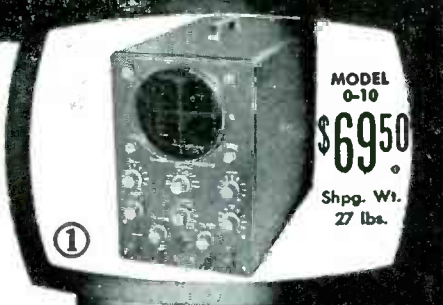

MODEL
0-10
\$6950.
Shpg. Wt.
27 lbs.



MODEL
TS-4
\$4950.
Shpg. Wt.
16 lbs.

Heathkit TV SWEEP GENERATOR KIT ELECTRONIC SWEEP SYSTEM

② A new Heathkit sweep generator covering all frequencies encountered in TV service work (color or monochrome). FM frequencies too! 4 Mc—220 Mc on fundamentals, harmonics up to 880 Mc. Smoothly controllable all-electronic sweep system. Nothing mechanical to vibrate or wear out. Crystal controlled 4.5 Mc fixed marker and separate variable marker 19-60 Mc on fundamentals and 57-180 Mc on calibrated harmonics. Plug-in crystal included. Blanking and phasing controls—automatic constant amplitude output circuit—efficient attenuation—maximum RF output well over .1 volt—vastly improved linearity. Easily your best buy in sweep generators.

Heath
COMPANY
A SUBSIDIARY OF DAYSTROM, INC.
BENTON HARBOR 11, MICH.
WRITE FOR FREE CATALOG
...COMPLETE INFORMATION

INSTRUMENTS

TRANSISTOR TESTER

A TRANSISTOR TESTER, TC-1, has been announced by Century Electronics Co., Inc., 111 Roosevelt Ave., Mineola, N. Y. Unit is used with *com* scales in various ranges and is said to check transistors in or out of set for current gain, leakage, opens or shorts; also crystal diodes for forward to backward current.

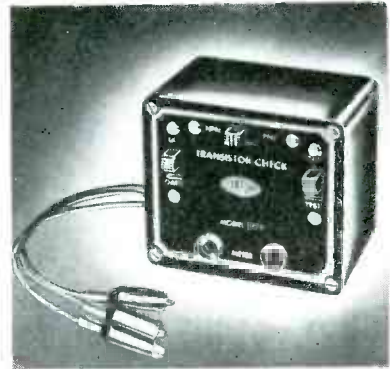

CORE MAGNET METER MOVEMENT

A CORE-MAGNET meter movement, said to assure linearity for 100° of scale arc, has been introduced by the Phaostron Instrument and Electronic Co., 151 Pasadena Ave., South Pasadena, Calif.

It is claimed that sensitivities as low as 20 *ua* are available with coil resistance of 3000 ohms. Structural features include sintered rings and pole faces, precision die cast brackets, and shock-mounted jewel assemblies. Movement is available in a 2½" round, clear plastic case.

VOLTAGE-REGULATED MULTI-BIAS SUPPLY

A VOLTAGE-REGULATED multi-bias supply, 230, for single and multiple bias substitution in b-w and color-TV alignment, has been developed by Precision Apparatus Co., Inc., 70-31 84th St., Glendale 27, N. Y.

Unit provides four simultaneous bias voltages to substitute for *acc*, *agc*, *chroma*, etc. Each output is individually adjustable and filtered from a voltage-regulated source. Three of the controls are variable from 0 to -15 v; the fourth from 0 to -150 v.



FROM A "CAT'S WHISKER" TO A COLISEUM!

Crystal sets to satellites... only decades away from the first primitive experiments looms today's giant 12 billion dollar radio electronics industry. Now, all 4 floors of New York City's Coliseum are needed to display one year's growth!

The purpose of *The Radio Engineering Show* is to bring new and stimulating ideas in radio-electronics to engineers. To achieve this more than 200 papers will be presented by 22 professional groups at the Convention's 55 technical sessions. Over 800 new ideas in radio-electronics engineering will also be presented by 834 exhibitors representing more than 80% of the productive capacity of the industry.

Yes, it's big in size, big in scope. Whatever your special interests, attending this Convention can cut weeks off your "keeping informed" time. Plan now to be there.

Save time; a whole year's productive effort seen in days! See all that's new in radio electronics products, developments, and engineering—meet the men responsible! Hear the best technical papers about your specialty! Meet old friends, make new ones, enjoy association and social events!

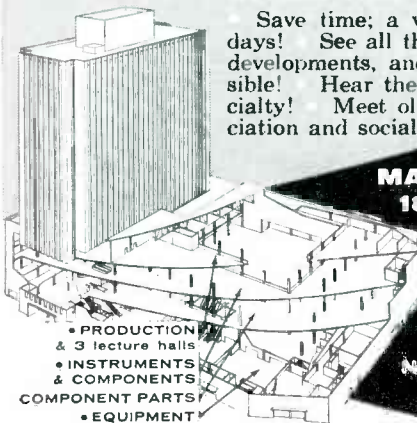

MARCH
18-21

The IRE National
Convention
Waldorf Astoria Hotel
and The Radio Engineering Show
Coliseum

New York City

IRE Members \$1.00
Non-members \$3.00



The Institute of
Radio
Engineers

1 East 79th Street, New York 21, N. Y.



THE MOST COMPLETE LINE OF

COLOR TELEVISION HARNESSSES AND EXTENSIONS

EBY now makes available, harnesses and extensions to facilitate servicing of all makes Color TV Receivers. A complete service kit is also available . . .

56-12H	CRT Extension	5.35 List
56-6H	Deflection Extension	2.70 List
49-9H	Deflection Extension	2.02 List
AC-4	Hi Voltage Extension	1.44 List
K-312	Color Service Kit	11.00 List

Laminated and Molded

EBY SALES CO. of N. Y.
130 LAFAYETTE ST.
NEW YORK 13, N. Y.

HORIZONTAL-MOUNTED PW COIL FORMS

HORIZONTAL - MOUNTED printed - wiring coil forms, (2270 and 2271), have been developed by the Cambridge Thermionic Corp., 445 Concord Ave., Cambridge 38, Mass.

The 2270-form is 3/4" long overall and mounts on .5"x.2" mounting centers; 2271 is 13/16" long overall and mounts on .7"x.2" centers. Both units are made with 3/8" *od* internally-threaded ceramic tubing, silicone impregnated, are slug tuned by a powdered iron core and have four solder terminals and two silicone fibreglass collars.

COMPONENTS

WRAP-AROUND SELENIUM RECTIFIERS

A 65-MIL selenium rectifier, featuring a metal *wrap-around* design, has been introduced by the components division of Federal Telephone and Radio Co., 100 Kingsland Rd., Clifton, N. J.

Unit has its individual cells placed flat against each other like pages in a book instead of being placed on a center shaft with an air space between cells. *Wrap-around* construction is said to provide thermal coupling to the chassis, which acts as a heat sink, eliminating necessity for air cooling, permitting mounting flexibility.

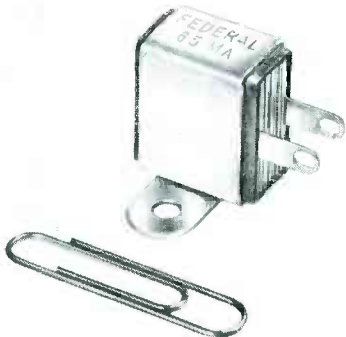

TRANSISTOR-MATCHED LOOPSTICKS

ELEVEN TRANSISTOR matched *Loopsticks*, said to feature electrical adjustability, compactness, maximum signal transfer and increased selectivity, have been announced by Suprex Electronics Corp., 4-6 Radford Pl., Yonkers, N. Y.

Each unit is packed with installation instructions, including nine suggested circuits and a summary of transistor receiver design.

FERRITE CORE CHOKES

A SET OF HIGH-Q ferrite core choke coils, with 14 inductances from 150 *uh* to 1 *mh*, has been announced by the National Co., 61 Sherman St., Malden 48, Mass.

Chokes are intended for use in networks and filters at frequencies from 50-1500 kc; may also be used as resonant elements in *if* and *rf* circuits.

SERVICE MEN KNOW THERE IS JUST ONE

HUSH

Reg. U.S. Pat. Off.

Chemically engineered for tuners and switching mechanism



Hush comes in a 6 oz. pressure can with sufficient pressure to reach all contacts to wash-away that dirt, leaving clean and positive contacts, protected with a lasting lubricant film.

\$2.25 net

Hush also available in 2 oz., 8 oz. and 32 oz. containers.

See your distributor or write to

CHEMICAL ELECTRONIC ENGINEERING, INC. Matawan, New Jersey

EVER-QUIET

Reg. U.S. Pat. Off. Pend.

Since 1949 the Original Volume Control and Contact Restorer

EVER-QUIET is a free-flowing liquid that leaves no powder residue. Scientifically designed to seep around the shaft and penetrate the control or potentiometer, cleaning the contacts and leaving a safe protecting film. Harmless to metals, wire or carbon. Will not affect inductance, capacitance or resistance.

2-Ounce Bottle with Handy Dispenser (32 oz. sizes available) only 59c



The Most Popular Line In America!

TRIO

Sharpshooter

TV ANTENNAS

808's

Conicals

SINGLE CHANNEL Yagi's

MULTI CHANNEL Yagi's

T

R

I

U

Manufacturing Company ILLINOIS

EXPORT SALES DIV., SCHEEL INTERNATIONAL INC., 5909 N. Lincoln Ave., Chicago, U.S.A. Cable Address: HARSCHEEL

Another Sencore Time-Saver

SENCORE FILAMENT CHECKER

MODEL FC-4



- ★ COMPLETELY NEW
- ★ MORE VERSATILE
- ★ LOWER COST

Quickly finds any open filament. Especially handy for servicing series filament TV sets and radios; only checker that checks all actals, locals, 7 and 9 pin miniatures automatically.

Continuity and voltage tester — no switches, merely plug in test leads.

AT LEADING DISTRIBUTORS EVERYWHERE
Mfg by



SERVICE INSTRUMENTS CORP.
171 OFFICIAL RD., ADDISON, ILL.

Only **\$2.95**
DEALER NET WITHOUT LEADS \$2.75

POPULAR SENCORE PRODUCTS

- Transistor Tester
- Leakage Checker
- Filament Tester
- Voltage Regulator
- Bias Supply

TV Antennas

(Continued from page 35)

set owner can be told just what stations he will be able to get. This will avoid the biggest headache of all; customer dissatisfaction. The one thing which has been found to be a cause of trouble is overselling performance. It is best to be absolutely frank with the prospective user, explaining the performance limitations of any type of antenna. Service Men understand the many vagaries of a transmitted TV signal, but the customer does not. It is far better to take a few minutes to explain this in advance demonstrating the actual performance of the antenna, so that the user will know that there will be times when he is unable to get a given station, through neither the fault of his set nor the antenna. While there will be a certain number of unreasonable people, as usual, the majority will be quite easy to convince, if the proper explanation is made.

In this area, most Service Men have abandoned the house-top antenna entirely. Now, the antenna must be moved to get reception from the necessary direction; so, in most cases we use 30-foot telescoping

masts, set at the side of the house on the ground, instead of the fixed ten-footer set atop the house. The ground-mounted mast may be turned by hand, to permit pickup of the different stations, if the guy wires are fastened to floating guy rings provided with this type of mast.

Rotators represent the ideal solution to insure all-direction pickup. Installation of a rotator is simple; the mast can be lowered, the rotator installed, and the mast raised again.

Height-Signal Relation

As far as the extreme heights, once thought essential, actual experiments in this area have shown that there is no usable gain in signal strength above 30' from the ground, 20' to 30' having been found to be the best heights. Therefore, very tall towers are used only where the added height is necessary to clear obstructions. An example of such an installation appears in Fig. 1 (p. 35); although it is not visible in the photo, the ground behind the house rises sharply. A 50' tower atop the house was necessary to clear this level. Once the tower was installed, good pictures were obtained, even though a much higher mountain between the house and the station was about a mile away.

Another home installation is shown in Fig. 2 (p. 35). Here a 36' tower was used to get clearance of a rise in the ground to the southward.

Smaller Antenna Installation

In some locations, excellent results can be obtained with smaller antennas of the type shown in Fig. 3 (p. 35). The lower antenna is a channel-6 yagi pointed south; the upper one is a multi-band model pointed east. Dual leadins are used in this installation at the shop of the author of this report. Signals from three stations are available; channel 6 (south) and channels 4 and 11 (east). This installation also provides the convenience of two leadins, so that two sets may be tested simultaneously. The tower was used here to clear another rise of ground to the south and also to get above the downtown noise.

Antennas for Shadowed-Area

In the most elaborate installation possible and in an extremely bad location at the bottom of a deep valley,

KESTER

FASTER ACTING

EASIER TO USE

LONGER LASTING

THE BEST

Absolutely non-corrosive and non-conductive, KESTER "RESIN-FIVE" CORE SOLDER contains an activated type of resin that gives you that fast, positive action on all your jobs . . . including the most difficult.

KESTER SOLDER COMPANY
4248 Wrightwood Avenue • Chicago 39, Illinois
Newark 5, New Jersey • Brantford, Canada

SOLDER

shadowed from *all* sides, where practically no TV signals were available, it was found necessary to take the antennas up to the signal. Atop the mountain, where signal strength was found to be very high, long yagi antennas for each channel were installed. The signals from these were combined in a matching network and filter system and fed to the house over an open-wire leadin. In this case, the leadin was over 1,100' long. For another home, on the other side of this mountain, a set of antennas, mounted not over 100' from the original setup, was installed. The leadin to this receiver was almost 1,000' in length.

Although this is quite a long line, it was not found necessary to use boosters; the signals at the bottom of the line were of ample strength to provide snow-free pictures from three of the four stations received; the fourth was the unreliable channel 7. A disadvantage of this type of installation is that adjacent channel signals cannot be fed through the filters; 4 and 5 may be used, as they are not actually adjacent. In this case, both 5 and 6 happened to be on the same network, so that there was no loss of programs.

The advent of color-TV has developed another installation problem; most of the broad-band antennas have a bandpass sufficient to pass color signals, but there are many whose gain is entirely too low for fringe applications. Once again, only by field-testing on location can one determine the effectiveness of the antenna. One should remember that color demands a very strong signal at all times.

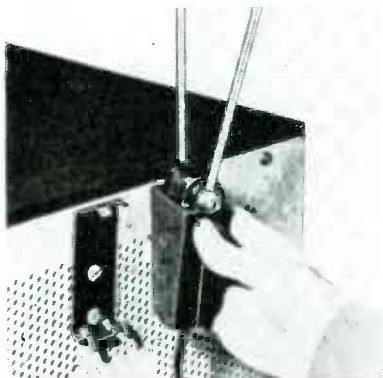

INDOOR 3-section dipole TV antenna, that it is said can be used as both a top-mount and a built-on antenna for uhf-vhf. Has bracket for back mounting claimed to fit most G.E., RCA, Hoffman, Sylvania, Westinghouse, Admiral, Dumont, Hallicrafters, Sonora, Wells Gardner, Zenith and Motorola receivers. (V-8 Universal; The Radion Corp., 1130 W. Wisconsin Ave., Chicago, Ill.)

Model TF-56MO*



Ward Tear Drop Mount

**... the replacement antenna
with original equipment styling**

Here's the fast-selling style leader of them all... a new antenna designed for new car styling. Looks like the original equipment models, and combines smart appearance with finest reception!

- ★ Easy, quick installation
- ★ Mounts completely from outside of car
- ★ Angle adjustment to 35° in all positions
- ★ 3 sections extend to 56" from 22"
- ★ Heavy chrome plating throughout
- ★ 54" lead-in

Order your WARD Tear Drop Mounts today. Replace old antennas with these finest, newest models with that sales-appealing original equipment look. Write now.

* This model fits newest 1957 cars as is. For Ford, order Adapter Pad No. C-62 available in bulk.

LIST PRICE \$4.28
Individual Shipping Wt. 1-lb.

**Ward
PRODUCTS CORP.**

DIV. OF THE GABRIEL COMPANY

1148 EUCLID AVE. • CLEVELAND 15, OHIO

IN CANADA, ATLAS RADIO CORPORATION • 50 WINGOLD AVE • TORONTO, ONTARIO

3-Gun Color-TV Tubes

(Continued from page 19)

screen of the picture tube, while the brightness levels or the amount of light variation from the projectors represent intensity variation of the electron beam. By varying the intensity and with the proper mixtures of the three primary colors, almost all the colors found in nature can be reproduced by this method.

If the projectors were positioned so that each color overlapped entirely,

only white would be produced. The white developed by the mixing of the three colors depends on the brightness level of each color, as well as the color of the filter used in each projector. If the correct filters are used and the input line voltage to each projector adjusted, a true white will be obtained. If then, the input line voltage to each projector was reduced the same amount, the bright-

ness of each color would also be reduced the same amount and a grey rather than a white would be observed; this serves to illustrate how a color picture tube operates to produce a black-and-white picture.

As noted earlier, in a three-gun color picture tube, the green, red and blue phosphor dot screens are arranged in a regular sequence. But, the phosphors do not overlap; they are arranged in a triangle. The mixing of the color light is actually accomplished in the human eye. By observing a color-bar pattern on a picture tube through a magnifying glass, the mixing qualities of the eye are revealed. If the magnifying glass is placed over the white bar in Fig. 2* (p. 18), three individual color dots (green, blue and red) will be observed. When the magnifying glass is removed, the human eye blends the three colors together and we have the illusion of white.

In the Fig. 2 color-bar pattern, horizontal, vertical and diagonal lines again represent the three primary colors as in Fig. 1. The color bar sequence, from left to right, is white, yellow, cyan, green, magenta, red, blue and black. This method of representing various colors in a black and white drawing, using diagonal, horizontal and vertical lines, also details the brightness characteristic of each color. There are approximately three times as many horizontal lines contributing to the brightness of the magenta bar as there are vertical lines and there are approximately twice as many diagonal lines in the yellow bar as there are horizontal lines. This follows the luminance signal composition; $Y = .6G + .3R + .1B$.

An analysis of one horizontal scanning line in the center of the screen will serve to illustrate how the three electron beams function to produce the various colors. The first bar on the left is white, and, as illustrated in Fig. 2, this is produced by the combination of all three primary colors; green (diagonal lines), red (horizontal lines), and blue (vertical lines). All three electron guns must be conducting to produce white. The second bar (yellow) shows diagonal lines representing green and horizontal lines representing red, yellow being produced by the conduction of the green and red electron guns. The blue electron gun is prevented from operating during the scanning of the second or yellow bar. The third bar

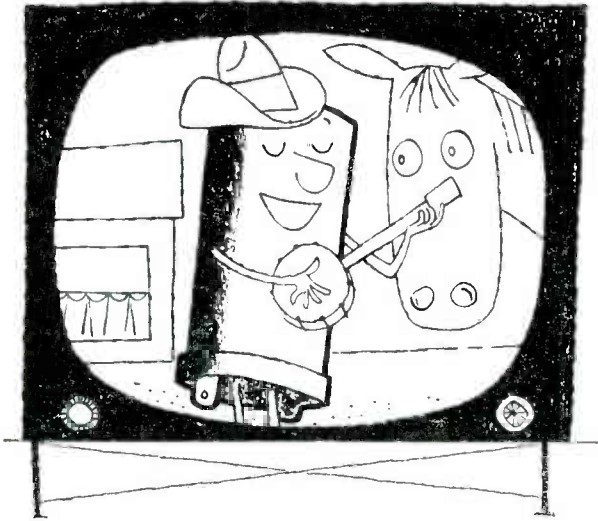

TV's most popular twist-prong electrolytic... C-D's type "UP"

Specified by the industry's leading TV set manufacturers—adopted by "service-wise" technicians, the C-D "UP" is first-choice for wide range twist-prong replacement service—rugged, dependable service-life under conditions of high temperature and high voltage surges. (With a special "UPE" unit for selenium rectifier circuits.) Stock and service problems are "down" with "UP". Ask your nearby C-D Distributor for catalog, or write Cornell-Dubilier Electric Corporation, South Plainfield, N. J.

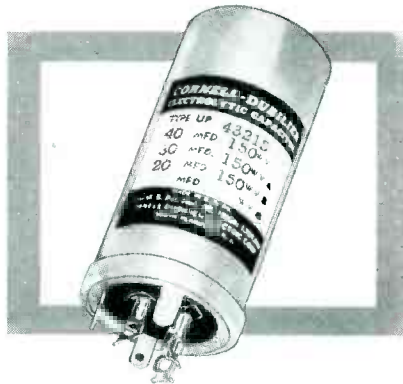

Cornell-Dubilier capacitors

South Plainfield, N. J.; New Bedford, Worcester & Cambridge, Mass.; Providence & Hope Valley, R. I.; Indianapolis, Ind., Sanford, Fuquay Springs & Varina, N. C.; Venice, Calif., & subsidiary, The Radiart Corporation, Cleveland, Ohio.

*Based on pattern produced on Hycon 616 color bar/dot generator on a normal-operating color receiver.

(cyan) is produced by the conduction of the green and blue electron guns represented by diagonal and vertical lines. The red electron gun is not conducting at this time. The fourth bar, represented in Fig. 2 reveals that the red and blue electron guns are cut off and only the green electron gun is conducting, as only diagonal lines appear. The next color bar (magenta) shows horizontal and vertical lines, illustrating that the red and blue electron guns are conducting and that the green electron gun is cut off. The sixth bar (red) shows that only the red electron gun is conducting. The seventh color bar illustrates the color blue by virtue of vertical lines. Only the blue electron gun is conducting during the scanning period of the seventh bar and the green and red electron guns are cut off. The eighth bar does not indicate any lines whatsoever and represents black. Neither of the three electron guns are conducting.

Fig. 2 illustrates that the green electron gun conducts during color bars 1, 2, 3 and 4, and is not conducting during bars 5, 6, 7 and 8. The red electron gun is operating when bars 1, 2, 5 and 6 are being scanned and prevented from operating during the scanning of bars 3, 4, 7 and 8. The blue electron gun is conducting during the 1, 3, 5 and 7 color-bar period and not conducting during bars 2, 4, 6 and 8. Therefore, the on time of each electron gun varies. This is shown in Fig. 3 (p. 18); the conduction period of each electron gun necessary to produce the color bar pattern of Fig. 2 is illustrated here.

The color picture tube is also an important and readily available piece of service test equipment; it can furnish a great deal of servicing data. Information on the face of the color picture tube will enable one to locate a defective section or stage. A typical example of the use of a picture tube to locate a defective section or stage is illustrated in the color bar pattern in Fig. 4 (p. 19), where we find that the color red is missing. A comparison of the color bar pattern of Fig. 2 with that of Fig. 4 will reveal the absence of horizontal lines which represent red. Horizontal lines are missing from the white, yellow, magenta and red bars, which leaves cyan in place of white, green in place of yellow, blue in place of magenta and black in place of red. The red electron gun is not conducting, due possibly to an open filament or a component failure in the cathode, control grid or screen grid circuits.

A slightly different service trouble is illustrated in the color bar pattern of Fig. 5 (p. 19). Horizontal lines

representing red are presented in the white bar, but missing in the yellow, magenta and red bars. However, dotted horizontal lines representing the luminance signal (equivalent to the monochrome video signal), are shown in the three bars. Since white is produced, all three electron guns must be conducting as previously mentioned. Therefore, the trouble must be in those circuits handling only the red color video signal. The luminance signal is present in the color bar pattern, represented by dotted horizontal lines, which would cause the yellow, magenta and red bars to appear

brighter in Fig. 5, than in Fig. 4. If the receiver employs *I* and *Q* type demodulators, the red adder, red output and red-*dc* restorer stages would be the possible source of the trouble. If *B-Y* and *G-Y* demodulators are employed, the *R-Y* matrix stage is probably at fault and if a *R-Y* demodulator is used, the *R-Y* signal path to the red grid of the picture tube is possibly open.

Analyzing the face of the picture tube and using a color-bar generator when trouble develops will prove to be a time-saving asset for efficient color service.

IF YOU REPAIR SMALL APPLIANCES...

... you'll want this new, different and complete Manual of parts and service.

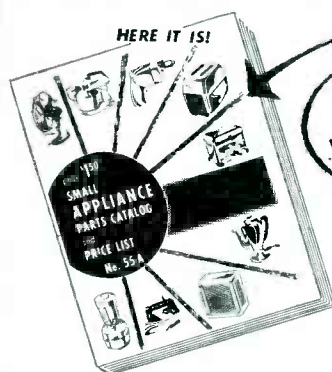

HERE IT IS!
THE PARTS CATALOG YOU HAVE ALWAYS WANTED... NOTHING ELSE LIKE IT



HERE is the newest and best approach to cataloging ever compiled. No other catalog even remotely compares to it in efficiency and completeness. Months of painstaking study and research have gone into making this the best possible method of presenting fast moving parts for your ordering convenience. The catalog is designed to be **current for at least 4 years** and complete, new confidential price supplements will be issued annually.

Catalog contains no prices—you can use it as a counter book. Price supplement is separate.

Parts are grouped by type of appliance and by classification of item rather than by manufacturer.

STILL AVAILABLE

Every appliance repair shop needs this handy catalog. Regularly priced at \$1.50 . . . but for a limited time only it's yours for only 25c—stamps or cash (no check please) to cover cost of mailing.

128 PAGES!

SEND 25c NOW FOR YOUR COPY—OUR SUPPLY IS LIMITED

DON'T DELAY!

Fill In and Mail This Coupon NOW!

To Company in Your Area and be sure of obtaining YOUR copy

ELECTRIC SWEEPER Service Co. 2034 Euclid Avenue Cleveland 15, Ohio	ELECTRA-CRAFT Appliance Co. 348 West 42nd Street New York 36, N. Y.	WOODALL ELECTRIC Service Co. 1024 Boulevard, N. E. Atlanta 6, Georgia
--	---	---

To cover postage and handling we herewith send you 25c for which we are to receive copy of Catalog No. 55A without delay. For each additional catalog we are enclosing \$1.25 extra. Remember—just one free catalog to each organization.

Company
Address
City Zone State
Type of Business
Signed Title

Printed-Wiring TV Chassis

(Continued from page 16)

audio *if* gain and tune a take-off coil. Thus, here too, it was necessary to combine a *hi* and *low-K* material into a single plate.

The sync feed is taken off of the plate of the video amplifier through a 10,000-ohm resistor and is carried across to the *H* panel via one of the interpanel connectors. The sync clipper and separator is a two section

(7AU7) clipper. The vertical sync is fed into an integrator network from the plate of the second clipper, while the horizontal sync is fed push-pull to the phase detector tube.

All of the shaping and biasing components necessary for the *afc* tube are located in one res-cap unit, on the *H* panel, but the tube itself is located on the *I* panel, thus using

three more interpanel connectors. Two interpanel connectors are for *B+* and *B++*, and two others are for the filaments.

Interpanel Test Points

Since the chassis is a 600-ma series string type, these interpanel connectors represent convenient test points for checking continuity of the filament string to determine, more rapidly, the location of the tube with an open filament.

Vertical/Horizontal Oscillators

The vertical oscillator ($\frac{1}{2}$ of 6CM7) is a blocking-oscillator type and drives the other half of the tube as an output stage. The horizontal oscillator (6CG7) is a multivibrator type. Both the horizontal output tube (12DQ6) and the damper (19AU4) are on the *pw* panel and connections are made to the horizontal output transformer by plug-in interpanel connectors.

High-Voltage Assembly

The high voltage assembly includes the transformer and a 1B3 high voltage rectifier mounted to a one piece molded base. Horizontal size adjustment is obtained by varying the gap between the two halves of the core. The assembly and shield are designed to withstand a supply of 25 kv, although this chassis uses 17 kv for an aluminized 17" picture tube.

To comply with the new FCC regulations regarding spurious radiation from a television receiver into the *ac* line, a pair of traps have been built into the chassis and located on the *ac* interlock assembly.

AVAILABLE FOR THE FIRST TIME!

An Assortment Of The Most Popular

Hi-Voltage ELMENCO

SILVERED MICA CAPACITORS

Used In All TV Circuits

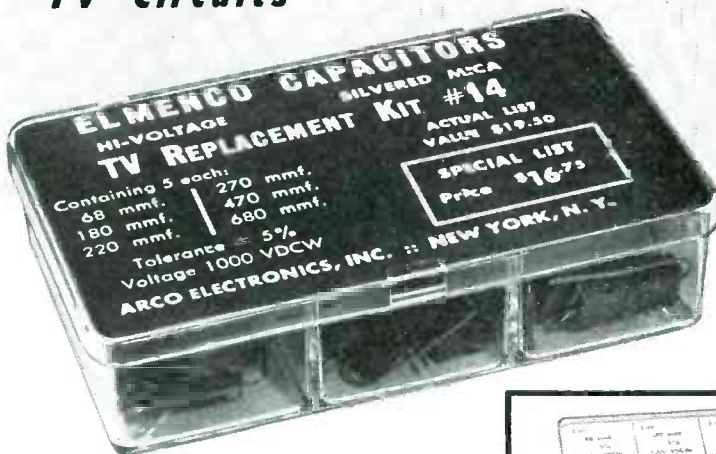

CONTAINS 5 EACH OF

- 68 mmf.
- 180 mmf.
- 220 mmf.
- 270 mmf.
- 470 mmf.
- 680 mmf.

Actual List Value \$19.50

SPECIAL LIST PRICE

\$16.75

- All Silvered Mica
- All 1000 Working Volts
- All $\pm 5\%$ Tolerance
- All Capacities, Tolerance and Voltages Imprinted On Each Unit
- Handy Compact Plastic Container

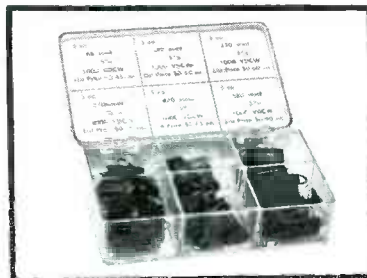

NOW AVAILABLE AT YOUR LOCAL DISTRIBUTOR or write

ARCO 64 WHITE STREET NEW YORK 13, NEW YORK

REMEMBER — ELMENCO REPLACES BUT IS NEVER REPLACED



New Ad-Agency V-P



BURTON BROWNE (right), president of Burton Brown Advertising, congratulating Robert E. Abbott, whom he has appointed vice-president and general manager of the agency. Abbott has been an account executive, creative director and assistant to Browne since 1952.

ADVERTISERS IN SERVICE
FEBRUARY, 1957

	Page
Alliance Manufacturing Co., Inc.	7
Allied Radio Corp.	63
American Television and Radio Co.	64
Arco Electronics, Inc.	62
Argos Products Co.	2
Astron Corp.	Inside Back Cover
B&K Manufacturing Co.	36
Bussmann Manufacturing Co.	8
Centralab, A Div. of Globe-Union, Inc.	3
Channel Master Corp.	9
Chemical Electronic Engineering, Inc.	57
H. G. Cisin	63
Clarostat Manufacturing Co., Inc.	6
Cornell-Dubilier Electric Corp.	Inside Front Cover, 60
Dynamic Electronics-New York, Inc.	48
Eby Sales Co. of New York	57
Electra-Craft Appliance Co.	61
Electric Sweeper Service Co.	61
Electronic Instrument Co., Inc. (EICO)	53
Erie Resistor Corp.	46
Fast Chemical Products Corp.	38
General Cement Manufacturing Co.	32
General Electric Co., Electronic Components Div.	1
General Motors Corp., Guide Lamp Div.	27
Heath Co.	56
The Hickok Electrical Instrument Co.	38
Hycon Electronics, Inc.	41
Institute of Radio Engineers	56
Jensen Industries, Inc.	53
Kester Solder Co.	58
Lenk Manufacturing Co.	38
P. R. Mallory and Co., Inc.	45
Merit Coil and Transformer Corp.	40
Oxford Components, Inc.	52
Precision Electronics, Inc.	53
Pyramid Electric Co.	23
Quam-Nichols Co.	50
The Radiart Corp.	Inside Front Cover, 60
Radio Corp. of America, Components Div.	20, 22, 42
Radio Corp. of America, Tube Div.	26, 39, Back Cover
Ram Electronics	46
Rathen Manufacturing Co.	10
RCA Service Co., Inc.	31, 44
R-Columbia Products Co.	40
Remington Rand Univac, Div. of Sperry-Rand Corp.	29
Rogers Electronic Corp.	33
Howard W. Sams and Co., Inc.	47
Service Instruments Corp.	58
Simpson Electric Co., Inc.	49
Snyder Manufacturing Co.	14
Sonotone Corp.	51
South River Metal Products Co., Inc.	53
Sprague Products Co.	34
Sylvania Electric Products, Inc.	4, 5
Tenna Manufacturing Co.	43
Trio Manufacturing Co.	57
Tung-Sol Electric, Inc.	54, 55
University Loudspeakers, Inc.	48
Ward Products Corp.	59
Winegard Co.	64
Woodall Electric Service Co.	61

Service Engineering

(Continued from page 45)

tion. The purchasing of installation material or parts at the local level is a good example. In many cases, the local *service engineer* can supply the demand from his own local stock, and if not, will know exactly where it can be purchased locally at the best price. Without this type of assistance, there are often costly delays of waiting or searching for material. The local *service engineer* is therefore exchanging knowledge for knowledge as he receives his microwave training on a paid basis.

System distance, considered by many to be the obstacle that limits the independent *service engineer's* advance into the field of microwave, is on the contrary, an aid to growth. It permits the opportunity for expansion into other areas—an expansion which is in business on a paying basis the day it is made. Or, it provides for strengthening independents as two or more independents may well combine to share in the service of a long system. The combination of independent service shops for mutual aid has been growing and will continue to grow. For example, during the floods in New England, service stations in New York City lent both manpower and equipment to the service stations in New England that were affected by the flood. Combined service of microwave systems tends to strengthen the bonds between independent service organizations and at the same time offers the user excellent facilities along his complete system. This becomes *very* important when the user has a large mobile *vhf* application. The readily available service in cities or states along his line are important to him. The facility available to him can be top notch, yet the price is reasonable as he shares the cost with other *vhf* users.

The initial trend in the microwave industry was for the user's self service, or service by his own employees, or direct service by the manufacturer, or limited to the large service companies only. The smaller service organizations only subcontracted for the *vhf* mobile portion; only recently have they commenced to wrestle with the full challenge.²

The nature of communication *service engineers* is such that they relish a challenge. This, coupled with the fact that microwave servicing opens the door to their expansion growth, and resulting profit, are the motivating factors behind the independent mobile *service engineers* moving into the microwave field.

²*It is difficult to predict at this time the number of independent service organizations interested in the microwave field. However, enough interest has been shown to substantiate a study and to prepare written training courses on microwave equipment and their application. George A. Svitek, national service manager of the G. E. Communication Products Department, is in the process of developing the GESS's who have shown interest in the microwave business.*

NEW SPEED
TV SERVICING SYSTEM

FIND TUBE — CURE TROUBLE
With H. G. Cisin's NEW 1957
TV TUBE LOCATOR

Just off the press. Vol. 2 has copyrighted Trouble Indicating Tube Location Guides for over 5000 TV models of the 45 leading makes from Admiral to Zenith. 1957, 1956, 1955 Models
Vol. 2..... Only \$1.50 Postpaid

TV TUBE LOCATOR—Vol. 1 contains similar Location Guides for over 3000 TV models from 1947 to 1954.
Vol. 1..... Only \$1 Postpaid

These two volumes are a "Must" for every TV service bench. A storehouse of TV tube servicing information.

Each TV TUBE LOCATION volume shows not only location and type of all tubes, but also actually indicates the exact location of the particular tube or tubes which must be replaced. Picture tube types are given on all guides and where series string heaters are used, this fact is noted.

SPECIAL FEATURE: Over 135 common TV troubles listed, with explicit directions for locating the defective tubes which cause each fault.

Guaranteed Money Back in 5 Days if Not Satisfied!

ABSOLUTELY FREE with each order for both LOCATOR volumes: H. G. Cisin's "TV & RADIO TUBE SUBSTITUTION GUIDE." Gives direct replacements of set and picture tubes. Most valuable servicing aid! ACT NOW—get all three books postpaid at cost of only two.

RUSH COUPON NOW!

H. G. CISIN, CONSULTING ENGINEER

Amagansett, N. Y. Dept. S-35

Enclosed find \$..... RUSH following:

Vol. 1 Vol. 2 Both Vols.

Include FREE book with both volumes.

Name.....

Address.....

City..... Zone..... State.....



BUILD YOUR OWN

NEW knight-kit
FLYBACK CHECKER KIT
Helps You Earn More

only \$19.50

Race through TV deflection circuit repairs—boost your profits! This new Flyback and Yoke Tester checks all standard types of horizontal output transformers, deflection yokes, linearity and width coils. Positively indicates shorted turns for any coil with "Q" greater than 1, and inductance between .003 and 2 henries. Determines continuity of any circuit with resistance from zero to .5 meg. Checks much wider range of inductances than any other unit. Big 4 1/2" meter; 6S4-A pulsed oscillator circuit. Complete with case, all parts and test leads. Shpg. wt., 5 1/2 lbs.

Model 83 Y 118. Net only \$19.50

Net F.O.B. Chicago



FREE 356-PAGE ALLIED CATALOG

Lists dozens of other low-cost quality Knight-Kit test instruments, plus the world's largest selection of parts and equipment for service work. Write for FREE copy.

ALLIED RADIO

ALLIED RADIO, Dept. 23-B-7

100 N. Western Ave., Chicago 80, Ill.

Send Kit No. 83 Y 118. \$ enclosed

Send FREE 356-Page ALLIED Catalog.

Name.....

Address.....

MORE INCOME IN 1957 FOR INDEPENDENT TV TECHNICIANS!



Receiver . . .
precision-engineered
"for those who want the
finest" . . . is a non-
competitive line.

**GENEROUS COMMISSIONS
THRU EXCLUSIVE
PROFITABLE TV
TECHNICIAN FRANCHISES
NOW AVAILABLE**

You can recommend ATR with the pride
and assurance of your own know-how
and the reputation and craftsmanship
of AMERICAN TELEVISION & RADIO

- ✓ . . . as original sets
- ✓ . . . as replacement sets
- ✓ . . . as the No. 1 set in two-set homes
- ✓ . . . and for special chassis installations
(without cabinet)



UNEQUALLED
IN
PERFORMANCE

UNMATCHED
IN QUALITY
CONSTRUCTION

UNSURPASSED
IN
BEAUTY

FOR FULL INFORMATION —
WRITE TODAY FOR COLORFUL
BROCHURE SHOWING THE
NEW LINE OF ATR TV SETS

ALSO MANUFACTURERS OF DC-AC INVERTERS,
"A" BATTERY ELIMINATORS, AUTO RADIO VIBRATORS



PERSONNEL

MAX E. MARKELL has been named manager of equipment sales of the RCA Components Division.

MARIE-LOUISE GAIROARD is now president of Kraenter and Co., Inc., Newark, N. J. Joseph R. Zelenka has been appointed vice president and general manager, and Robert D. Fleischer, sales manager.

WILLIAM R. ANTON and George Avalon have been appointed vice president in charge of sales and vice president in charge of manufacturing, respectively, of Permo, Inc., 6415 N. Ravenswood Ave., Chicago 26.

J. RICHARD KRAPFEL has been promoted to product sales manager of electronic components for the parts division of Sylvania Electric Products, Inc. Krapfel has been district sales manager in the parts division sales office in Chicago.

JAMES B. IRWIN has been appointed sales manager of The Radix Wire Company, 26260 Lakeland Boulevard, Cleveland 32, O. Irwin was formerly sales manager of Eastern Insulated Wire Corp.



Irwin



Jatis

JOSEPH P. JATIS is now manager of two-way radio service training of Motorola's communications and electronics division. In this new post Jatis will be responsible for all of the service clinics held throughout the U. S. each year, as well as the service classes held at Motorola's factory in Chicago.

JULIUS DORFMAN has been named manager of special tubes sales for Raytheon Manufacturing Company's receiving and cathode-ray tube operations.

BRENTON T. MORSE has been elected vice president and treasurer of Krylon, Inc.

GARTH J. HEISIG has been named director of TV engineering for Motorola, Inc. William Hinton is now assistant to Heisig.

WALTER GOODMAN has been appointed sales manager of the products line division of the Jerrold Electronics Corp., Philadelphia, Pa.

GEORGE BEAVER has been appointed field service engineer for the Chicago region by The Magnavox Co. His office will be in the Chicago Merchandise Mart.



Easy Does it WITH Winegard

Most Winegard antennas are so easy to install that you can put them up in minutes. Without a helper, too! All of which means more time for you to put in on skilled service instead of on rooftops.

Only Winegard makes a complete, factory-assembled antenna installation. You get the whole package—nothing else to buy! Not a kit, but a completely assembled unit that opens easily as an umbrella. No loose parts. Nothing to put together. Nothing to attach. Fold it open—nail it up. (Special screw-type nails included!) Clip lead-in to terminals . . . and you're done!

There's a Winegard model for every area and every customer.

Nationally advertised in SATURDAY EVENING POST and other leading magazines.

"Minute-Mount" Model

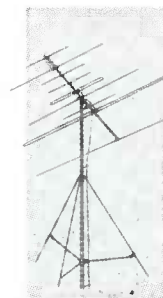

for fringe areas. A high-gain antenna with patented "Electro Lens" focusing and 10' aluminum fold-out tower. Factory-assembled and ready for installation. Complete, including lead-in, insulators, lightning arrester, ground wire and ground rod — \$44.95 retail.



See your Jobber, or write:

Winegard Co.

3000 Scotten Blvd., Burlington, Iowa

*Pat. No. 2700105

ASTRON *"Staminized"* CAPACITORS HAVE . . .

long life

**NO CALL-BACK CONSTRUCTION
ASSURED BY 10 INDIVIDUAL
PRODUCTION TESTS**

plus **100% FINAL INSPECTION**

Long life in capacitors is important to you as a serviceman. Complete confidence in the components you use is a necessity, because your business is built on reputation.

Astron considers the serviceman's reputation to be prime importance. That is why each capacitor is manufactured under Astron's "Staminized" system.

Astron's "Selected Purchasing" guarantees that only the very finest of raw materials are chosen. Astron's special production techniques are supplemented by continuous inspection under strict quality controls. Production tests are made right on the production line . . . 10 separate tests in all. A 100% final inspection is made before any capacitor can be shipped.

You can put your trust in Astron . . . your assurance of top performance . . . every time.

There is an Astron "Staminized" Capacitor built especially to fill the specific, exacting replacement requirements of any job you tackle.

Remember, your reputation is our business, too. Build it, guard it, protect it . . . Buy Astron!

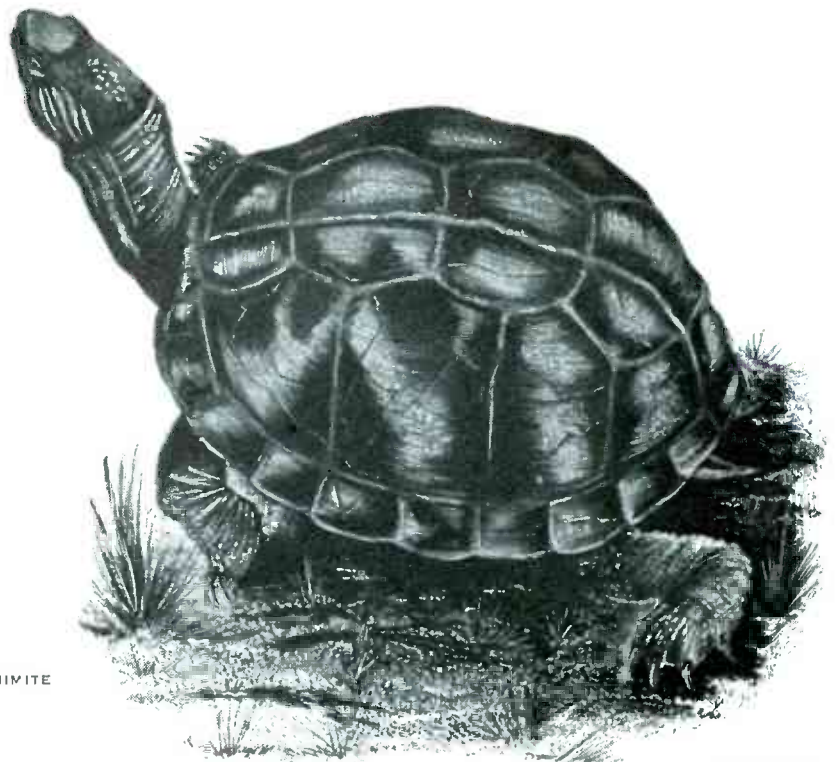

*Trade-Mark



SAFETY MARGIN "SM" MINIMITE

BLUE•POINT® MOLDED
PLASTIC PAPER TUBULAR



Free Servicing Aid . . .
Save time, use handy Astron pocket-sized Replacement
Catalog and Pricing Guide (AC-4D) . . . Write today!

ASTRON
CORPORATION
255 GRANT AVENUE EAST NEWARK, N. J.

Export Division: Rocke International Corp., 13 East 40th St., N. Y., N. Y. In Canada: Charles W. Pointon, 6 Alinga Ave., Toronto 10, Ontario

The Keynote of the 3rd Annual
NATIONAL TELEVISION SERVICEMEN'S WEEK

is **YOU!**



Once again, RCA salutes its partners in the great electronic industry—*you*, the TV servicemen—whose neighborhood is America, whose business is America's entertainment! This year, RCA's salute to you is carried over network radio and TV, including March 16th TV Emmy Awards program and March 23rd Perry Como show; in the March 25th issue of Life, and the March 23rd issues of the Saturday Evening Post and TV Guide; in local newspapers; via displays, streamers and mailings, in every town and city from coast to coast. All America joins with us in a tribute to you—the men who help keep the nation's TV "rollin'!"

*REGISTERED WITH U.S. CHAMBER OF COMMERCE, MARCH 25 TO 30

EXTRA! EXTRA! To Dealers Who Can Qualify here is the most powerful identification program that RCA has ever offered:

be an **AUTHORIZED RCA ELECTRON TUBE DEALER**
for Prestige...for Profit

See your RCA Distributor salesman today, and get all the facts.



RADIO CORPORATION of AMERICA

Tube Division

Harrison, New Jersey

