

APRIL, 1956

SERVICE

THE TECHNICAL JOURNAL OF THE TELEVISION-RADIO TRADE

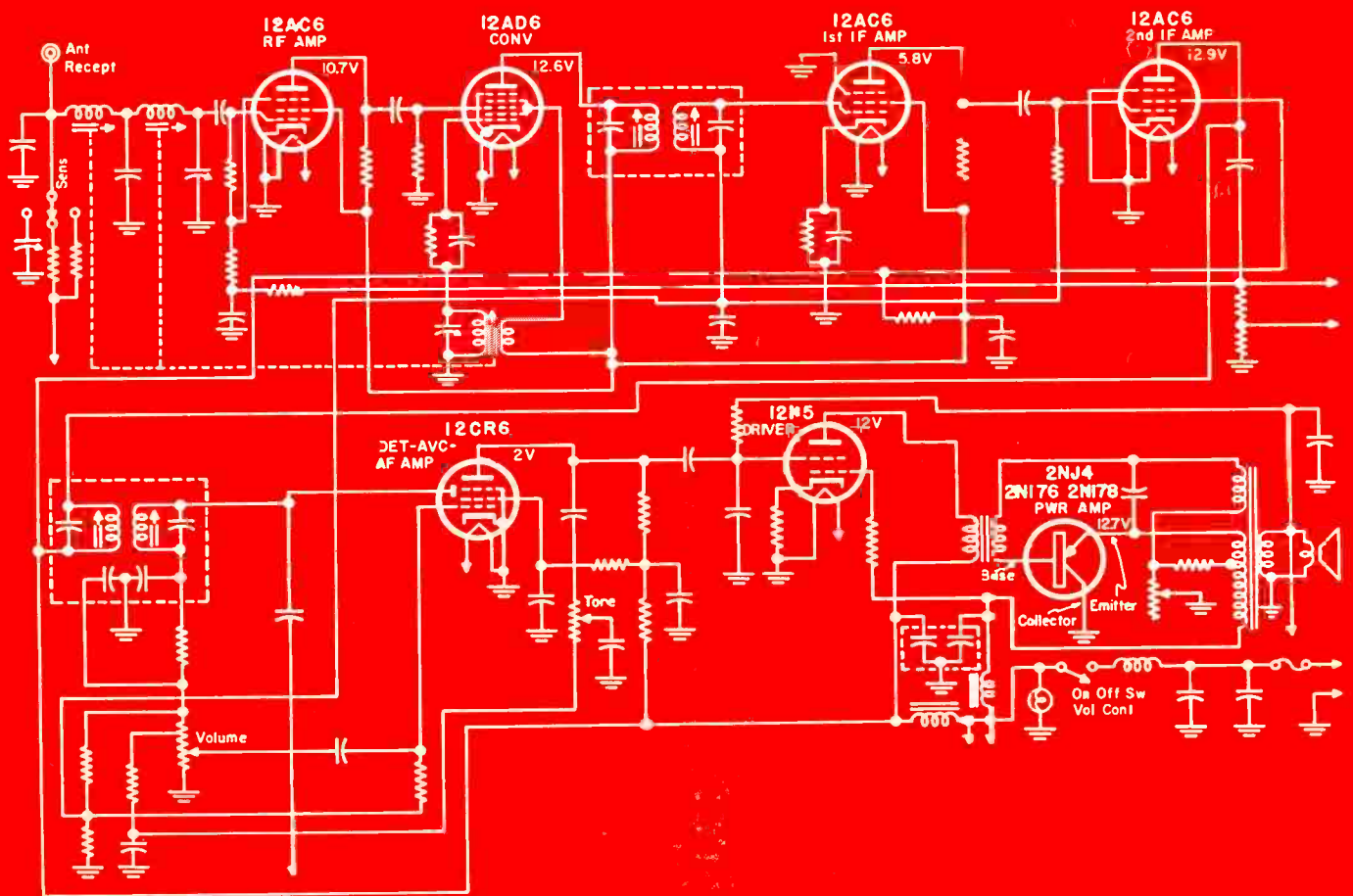

Search-tuned auto radio using transistor power amp and 12-v car-battery for B supply. See circuit analysis, this issue

R TURSE
CLARKEW LANE,
POMPTON LAKES, N
25 SAR 9-6-55



RADIART features
 the complete line of
COMMUNICATION VIBRATORS
 in 6 Volt and 12 Volt Series

These Ten Types Offer Complete Replacement for ORIGINAL Communication Equipment.

Old No.	New No.	
	6 volt	6/12 volt
5515	5715	6715
5518	5718	6718
★	5721	6721
★	5722	6722
★	5725	6725
5605	5805	6805
5620	5820	6820
5621	5821	6821
5622	5822	6822
★	5824	6824

For Specific Applications See Latest Radiart Vibrator Guide

Again because of SUPERIOR ENGINEERING and CONSISTENTLY INCREASED QUALITY, Radiart offers you communication vibrators that are DEPENDABLE! The RIGHT vibrator... for EACH application! See for yourself... You're RIGHT WITH RADIART.

SUBSIDIARY OF



THE **RADIART** CORPORATION
 CLEVELAND 13, OHIO

TV ANTENNAS • AUTO AERIALS • VIBRATORS • ROTORS • POWER SUPPLIES

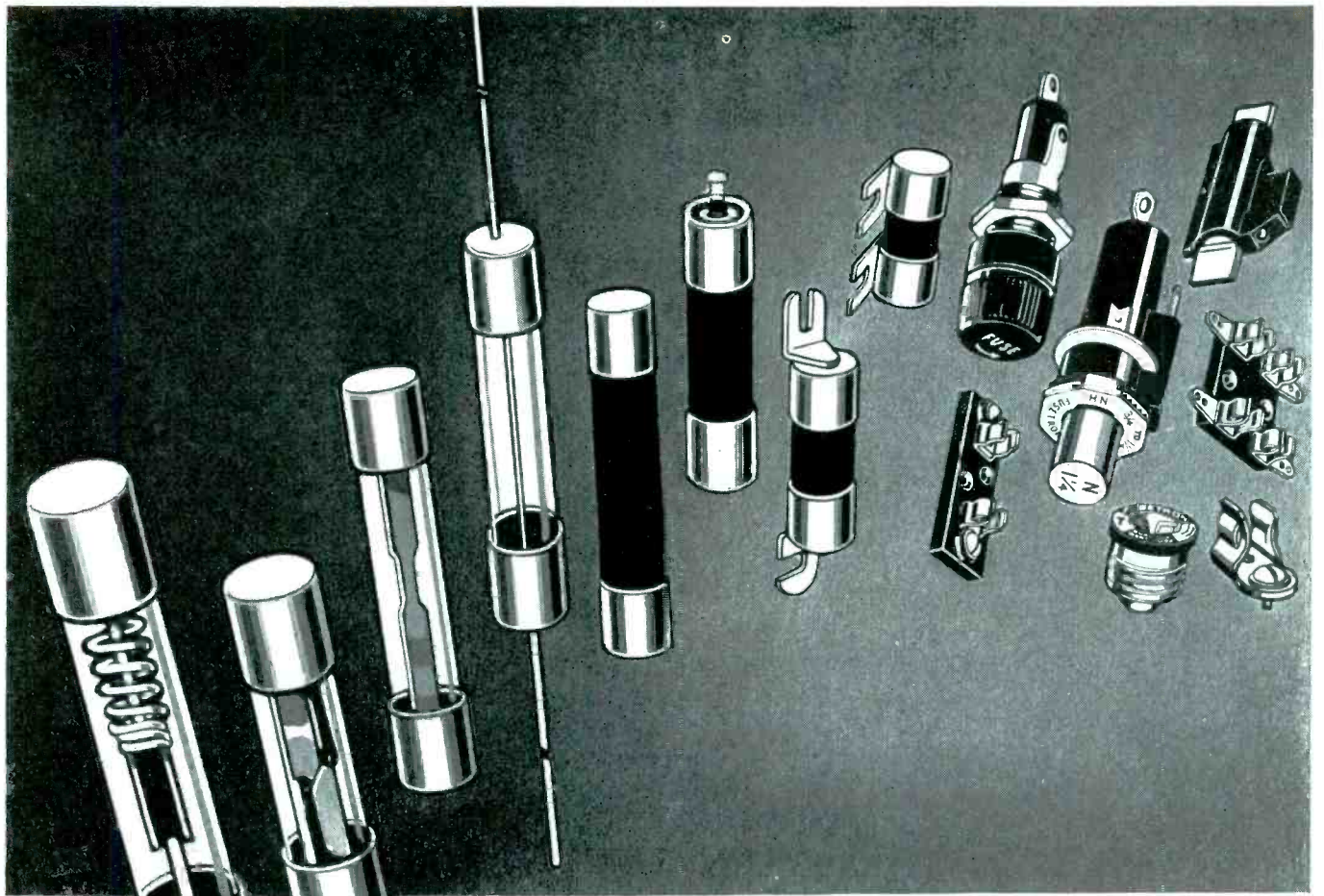

You'll quickly find the right fuse for the job everytime—when you turn to BUSS Fuses

The complete BUSS fuse line includes: standard types, dual-element (slow blowing), renewable and one-time types — available in all standard sizes, and many special sizes and designs. Plus a companion line of fuse clips, blocks and holders.

Simplify your purchasing, stock handling and records — by standardizing on this one, reliable source for fuses.

BUSS Trademark is your assurance of "trouble-free" protection

BUSS fuses are electronically tested to make sure they will operate as intended under all service conditions. A sensitive device auto-

matically rejects any fuse not correctly calibrated, properly constructed and right in all physical dimensions.

And in sales and service — it is just good business to handle BUSS fuses. They are the known brand of fuses — accepted by the trade and consumer as the finest available. Handling established, quality items like BUSS fuses helps maintain your reputation as a reliable sales and service organization.

For more information on BUSS and FUSETRON small dimension fuses and fuseholders, write for bulletin SFB.

MAKERS OF A COMPLETE LINE OF FUSES FOR
HOME, FARM, COMMERCIAL, ELECTRONIC,
AUTOMOTIVE AND INDUSTRIAL USE.



BUSSMANN MFG. CO.

(Div. of McGraw Electric Co.)

UNIVERSITY AT JEFFERSON, ST. LOUIS 7, MO.

S-156

NEW!

Technician's Quickie bench

"GREATEST TIME-SAVER SINCE THE TUBE CADDY"

**Speeds Repairs On the Spot
Increases Profit Per Call
Builds Customer's Satisfaction**

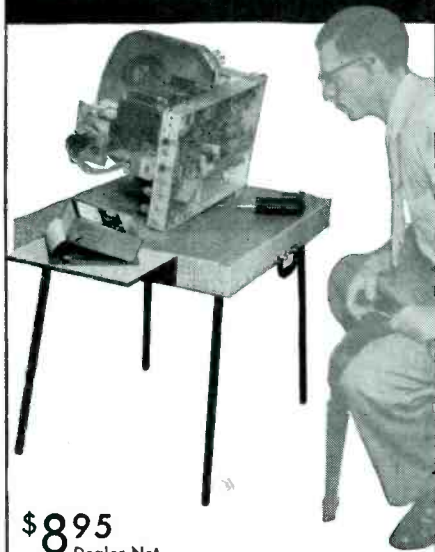

\$895
Dealer Net

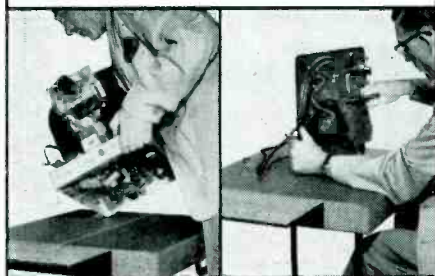

STRONG
with "Craftsmanship in Cabinets."

VERSATILE
use for any repairs.

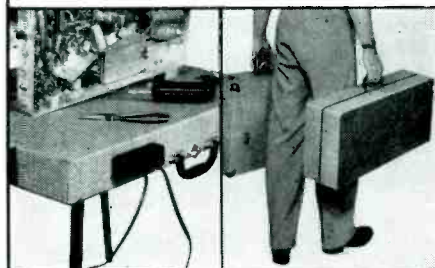

EXTRA GADGETS
can easily be added. Not incl.

CARRIES EASILY
only 26x11x6 1/4"
Can fit under arm.

**ASK YOUR PARTS DISTRIBUTOR
OR WRITE FOR FOLDER**

Argos
PRODUCTS COMPANY
310 MAIN STREET - GENOA, ILLINOIS

Vol. 25 No. 4



APRIL, 1956

Trade Mark

Including SERVICE—A Monthly Digest of Radio and Allied Maintenance: RADIO MERCHANDISING and TELEVISION MERCHANDISING. Registered U. S. Patent Office.

COVER CIRCUIT

Transistorized Car Radio (Motorola 6TAS8) 14

FEATURES

Editorial	Lewis Winner	11
A Field Report on a Small Town Drive-In Auto Radio Service Shop Donald L. Govoni		12
Search-Tuned Transistor-Powered Car Radio (With Complete Circuit) Albert Arnold and Tim Alexander		14
Servicing Printed Wiring TV Chassis	Alan Lytel	17
A Technical Progress Report on Auto Radios	Eli Cohen	18
Behind the Controls of the 'Scope for B-W and COLOR-TV Applications G. S. Ryant		20
Troubleshooting Transistorized Radios (With Complete Circuits) Ken Kleidon		22
SERVICE . . . The National Scene		24
Checking H-F Communications Receivers (Service Engineering) G. A. Svitek		26
Dual Selenium Rectifier Horizontal AFC (Service Helps)		34
COLOR-TV Picture Tube Developments (Tube News)		38
Probing for Wow and Flutter in Tape Recorders and Phonos	Leo Sands	44
Parasitic Amplifier Oscillation (Audio Installation and Service)		46
Fringe . . . Community-TV Antenna Installation Tips		56
Circuit Diagrams In This Issue		63

DEPARTMENTS

News	32
Auto-Radio Antenna Developments	41
Catalogs and Bulletins	42
Ten Years Ago in SERVICE	42
Association News	43
Latest in Audio	53
Personnel	55
TV Antenna-Accessory Developments	56
TV Parts . . . Accessories	58
Components	59
Instruments	61
Bench-Field Tools	62
Index to Advertisers	63

Entire Contents Copyright 1956, Bryan Davis Publishing Co., Inc.

Second-Class mail privileges authorized at New York, N. Y.; additional entry at the Post Office, Norwalk, Conn

Subscription price: \$2.00 per year in the U.S.A. and Canada; 25 cents per copy. \$3.00 per year in foreign countries; 35 cents per copy.



EDITOR and PUBLICATION DIRECTOR

Lewis Winner

Associate Editor: David E. Pearsall II
Assistant Editor: Robert D. Wengenroth
Editorial Assistant: Eli Cohen

Art Director: Anthony R. Aliff

Supervisor, Circuit Diagrams:
Michael D. Bellezza

Ass't Supervisor, Circuit Diagrams:
Norman Cohen

Editorial Production: Astrid Kelly

CIRCULATION DEPARTMENT

Circulation Manager: A. Goebel

Ass't Circulation Mgr.: A. Kiernan

ADVERTISING DEPARTMENT

Advertising Mgr.: Aaron L. Lafer

Business Mgr.: F. W. Boyd

Mid-West Mgr.: Stuart J. Ostern
333 N. Michigan Ave.
Chicago 1, Ill.
Tel.: DEarborn 2-3507

East-Central Rep.: James C. Munn
2253 Delaware Dr.
Cleveland 6, O.
Tel.: ERievew 1-1726

Pacific Coast Rep.: Brand & Brand
1052 W. 6th St.
Los Angeles 17, Cal.
Tel.: MADison 6-1371

Published Monthly By

Bryan Davis Publishing Company, Inc.
52 Vanderbilt Ave., New York 17, N. Y.
Tel.: MURray Hill 4-0170

B. S. Davis, Pres. F. W. Boyd, Sec'y



Simpson...the most Complete Line of VOM's

Select the one that fits your needs!

MODEL
260
world's most popular!

Over half a million Model 260's have been sold to date! 20,000 Ohms per volt. You'll find it wherever quick, accurate, electrical checks are needed. It's so handy, so dependable, so sensibly priced! Ask your jobber. Price, including Adjust-A-Vue Handle, only ...

\$38.95

Carrying Cases from **\$6.75**

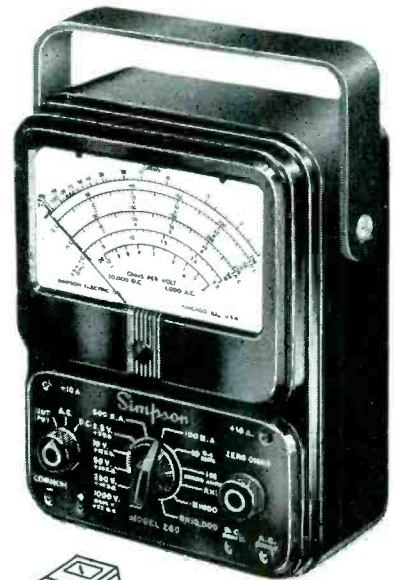

MODEL **262**

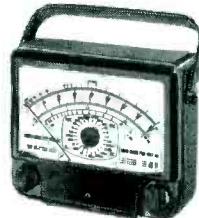

the new VOM with a 7" meter

20,000 Ohms per volt DC and 5,000 Ohms per volt AC sensitivity ... 33 ranges ... compact 7" case with Adjust-A-Vue Handle ...

\$59.50

Carrying Case ... **\$ 9.95**

NEW!



MIDGETESTER Model 355—New shirt-pocket size Volt-Ohmmeter **\$29.95**

MODEL 240—Small VOM; 14 ranges; up to 3000 volts AC or DC **\$26.35**

MODEL 230—Small VOM; 12 ranges; up to 1000 volts AC or DC **\$24.95**

ROTO RANGER Model 221—25 Separate meters at turn of a switch **\$75.00**

LABORATORY STANDARD—For instrument calibration. Price on application.

MODEL **269**

100,000 Ohms per volt!

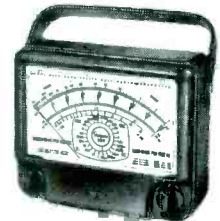

Most sensitive VOM

available! A Volt-Ohm-Microammeter with a big 7" meter in a compact 7" case...33 ranges... Adjust-A-Vue Handle ...

\$88.00

Carrying Case ... **\$ 9.95**

Simpson ELECTRIC COMPANY

World's Largest Manufacturer of Electronic Test Equipment

5200 W. Kinzie St., Chicago 44, Ill.

ESTebrook 9-1121

In Canada: Bach-Simpson, Ltd., London, Ontario

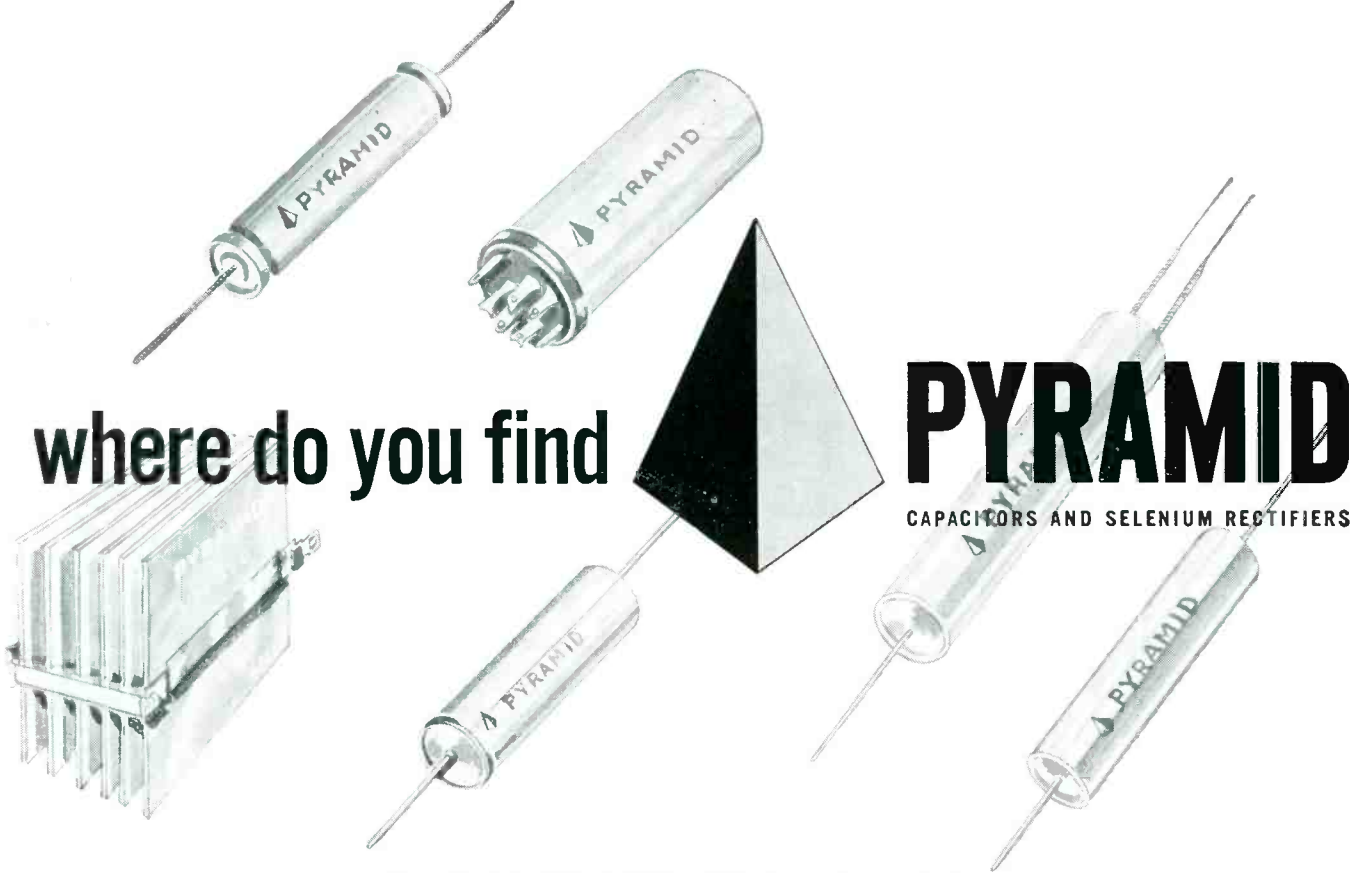

where do you find

PYRAMID

CAPACITORS AND SELENIUM RECTIFIERS

SEE US AT THE PARTS SHOW . . . Booth 213

In the electronic products of all these leading brand manufacturers—where their presence testifies to PYRAMID'S high standards of quality and service.

Admiral **Magnavox**



Motorola

CROSLEY

Packard-Bell

DU MONT

RAYTHEON

Emerson



SYLVANIA

hallicrafters

Westinghouse

Hoffman

ZENITH

AND you find PYRAMID as a participant in Howard Sams PHOTOFACT—the bible of radio-television-sound field servicing—which guarantees accurate replacement with PYRAMID parts and testifies to the immediate availability of PYRAMID Capacitors and rectifiers throughout the country.

Howard W. Sams

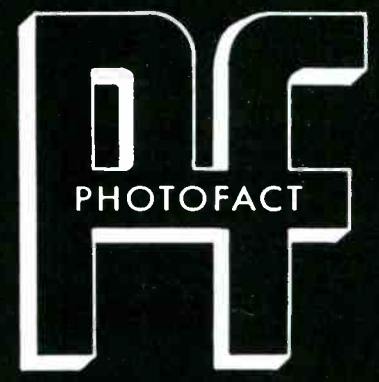

PYRAMID ELECTRIC CO.
North Bergen, New Jersey

THE BIG NAME IN CAPACITORS AND SELENIUM RECTIFIERS TODAY...

NOW YOU CAN SELL THE OUTDOOR MARKET

Snyder PHILADELPHIA **7-D**

TENNA-TUNER

FOR USE WITH

Outdoor Antennas

Featuring

The Self-Contained 6-POSITION

Directronic[®] BEAM SELECTOR

GUARANTEED BETTER **TV** PIX

REDUCES / ELIMINATES

- ADJACENT CHANNEL INTERFERENCE
- CO-CHANNEL INTERFERENCE
- LOCAL ELECTRICAL DISTURBANCES
- GHOSTS
- SNOW EFFECTS

9.95

SNYDER

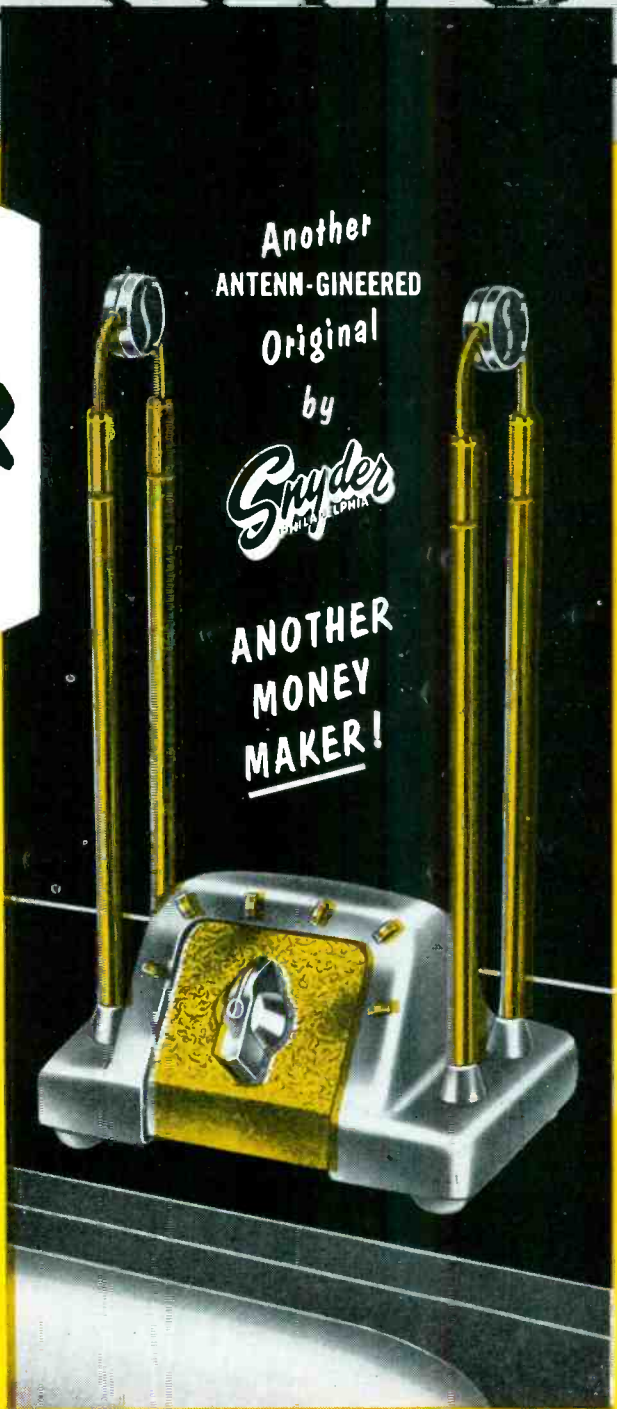

SNYDER MFG. CO., PHILADELPHIA 40, U. S. A.
BELLEVUE TUBE MILL, INC., PHILADELPHIA
SYNDER ANTENN-GINEERS, LTD., TORONTO 14, CANADA
WORLD EXPORT: ROBURN AGENCIES, INC., N. Y.

Philco breaks National Campaign to replace "Tired" Picture Tubes



Don't let a
'Tired' Picture Tube
spoil half of your TV enjoyment



Now, Get a better picture than ever before!
PHILCO Star Bright 20
ALUMINIZED PICTURE TUBE
Bond plus Warranty

Regardless of the make or model of your TV set, you will get the best picture ever when you change to the Philco Star Bright 20/20. And it's the only TV picture tube made that gives you double protection with both bond and warranty.



Bonded to be built with all new picture making parts. To the same rigid standards as tubes in newest Philco TV sets. Plus full year warranty.

Authorized Philco Service Dealer now. Ask about his allowance for your old picture tube.

Millions of TV Set owners get the call to action—to phone you immediately for a new picture tube

TV Guide, Saturday Evening Post, newspapers and TV commercials are ready to break the big replacement story and sell the Philco Star Bright 20/20 Aluminized Picture Tube for you. Be sure to have stock on hand when your phone starts ringing. Then you'll be ready to move into the homes of television owners and cash in on the greatest campaign of its kind ever to hit the public.

Invest in your future in Color TV Service and equip your shop **FREE** during the fabulous

**PHILCO SHARE
AND PROFIT**
Dividend Opportunity

That's right, you can earn **FREE** color and B/W Test Equipment and Parts and Accessories by concentrating your radio and TV parts on Philco. With each purchase you get **SHARE** and **PROFIT** stamps, redeemable for the dividends of your choice at your Philco Distributor. They build **EXTRA 100% PROFITS** because they cost you nothing. See your Philco Distributor now for full details.

Now, an Exclusive Double Edged Selling Tool...

Bond plus Warranty

ON EVERY

PHILCO®

Star Bright 20/20



Sharon Kay Ritchie
Miss America 1956

**SUPER ALUMINIZED! CLEAREST,
MOST LIFELIKE PICTURE POSSIBLE**

Regardless of the make or model of a TV set, a Philco Star Bright 20/20 Aluminized Picture Tube gives your customers a clearer, brighter, more lifelike picture than ever before . . . and builds confidence in you.

**PHILCO PICTURE TUBE
BOND**
Bonded by a leading Indemnity Co. to be built with all new picture making parts, to the same rigid standards of tubes in the newest Philco TV models.

**PHILCO PICTURE TUBE
WARRANTY**
Covers the picture tube for one full year. Combined with the new Philco bond, it offers the purchaser guarantees never before matched in television history.

Yes, Philco gives you a double-edged selling exclusive to boost your replacement tube business. In addition to the one year warranty, the Philco Star Bright 20/20 Aluminized Picture Tube is BONDED to have all new picture making components. This bond protects your customers against counterfeit tubes and assures a picture tube that's built to the same rigid standards as those in original TV receiving equipment. The Philco Star Bright 20/20 is the only picture tube made that is backed by such a bond.

PHILCO CORPORATION

ACCESSORY DIVISION

PHILADELPHIA 34, PA.



Model 7100

Philco puts you in the color service business with this one compact instrument

PHILCO Universal COLOR BAR and DOT BAR Generator

It's new . . . highly efficient . . . designed to provide the widest possible variety of functions in the minimum amount of space. PHILCO MODEL 7100 is used to

completely trouble-shoot circuits associated with color reproduction and make accurate convergence adjustments in any color television receiver on the market.

damaged, weather-worn, obsolete!

6 out of 10 need replacement now!

replace them with
CHANNEL MASTER
TV ANTENNAS

**FIVE ALL-CHANNEL FAVORITES —
TOPS FOR REPLACEMENT!**

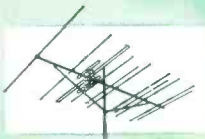

SUPER RAINBOW
model no. 331
Still the most sensitive all-channel antenna made! Other popular Rainbow models also available.

"K.O." model no. 1023
(broad band)
Knocks out "venetian blinds" with the highest front-to-back ratios ever recorded!



TRAILBLAZER model no. 335
Extra elements provide extra performance at no extra cost!

New LANCER model no. 337
Popular fringe-area installation — new rugged powerful design. Also available: Super Lancer, and new economy "Challenger" model.



SUPER FAN model no. 313A
The finest of Fan-antennas — superior both electrically and mechanically!

Here's the greatest profit opportunity in TV today!

The "Golden Age" of antenna replacement is here! Time has finally caught up with millions of older TV antennas that no longer provide good reception.

A national survey shows that 65% of all TV set-owners in established areas are not getting the picture quality they *should* be getting. **THEY NEED NEW ANTENNAS!** And you can profit in a big way by replacing now with a powerful, new CHANNEL MASTER installation!

YOUR BEST REPLACEMENT BUY is Channel Master, America's most widely advertised and merchandised antenna line. Channel Master provides you with the most advanced electrical designs, the soundest construction, the easiest, fastest installation.

See your Channel Master distributor



CHANNEL MASTER CORP.

ELLENVILLE, N. Y.

WORLD'S LARGEST MANUFACTURER OF TV ANTENNAS AND ACCESSORIES



65 ma—#205G1



75 ma—#200G1



100 ma—#205G1



150 ma—#201G1



200 ma—#207G1



250 ma—#208G1

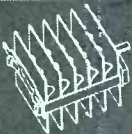

300 ma—#202G1

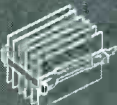

350 ma—#209G1

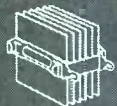

400 ma (compact)—#210G1

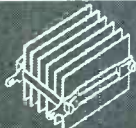

400 ma—#203G1

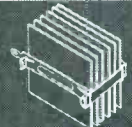

500 ma (compact)—#211G1

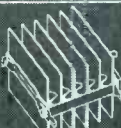

500 ma—#204G1

For dependable replacement

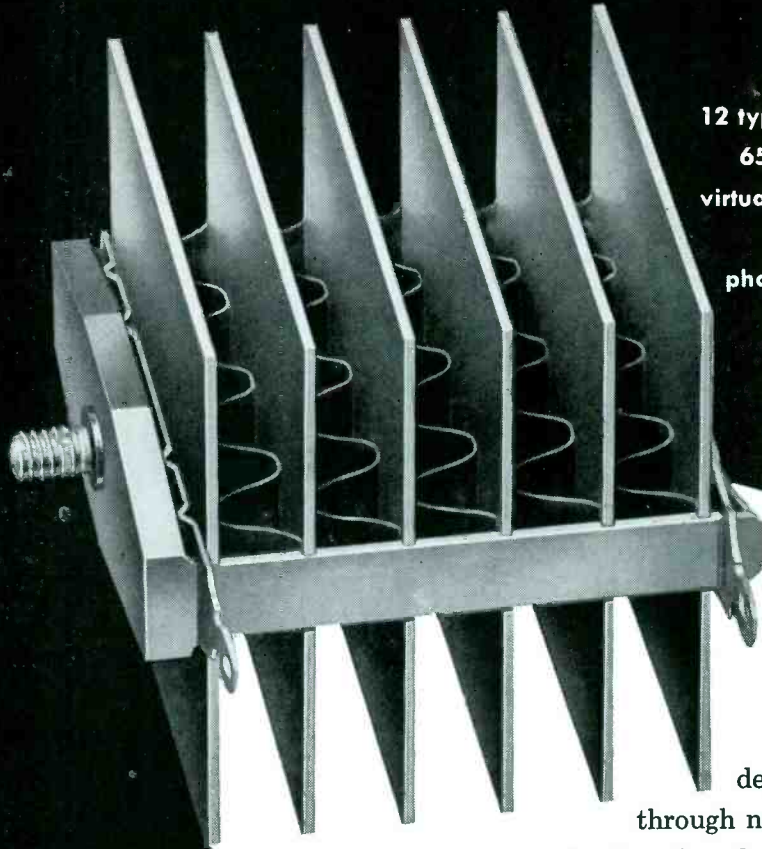

12 types—ratings from
65 ma to 500 ma—meet
virtually all your replacement
requirements in radio,
phonograph, hi-fi, and TV sets.

RCA SELENIUM RECTIFIERS
are manufactured to give
long and dependable
performance. This
dependability is made possible
through new, advanced design, careful
selection of production material, and thorough
quality control in manufacture. The new,
open design permits greater heat dissipation
. . . no possibility of center "hot spots."

RCA SELENIUM RECTIFIERS are a
dependable replacement line because they are
. . . cool in operation . . . sturdy in
mechanical construction . . . efficient
in electrical operation . . . easy-to-install.

Now available through your RCA distributor!

RCA SELENIUM RECTIFIERS



RADIO CORPORATION OF AMERICA
ELECTRONIC COMPONENTS

HARRISON, N.J.

"2300 RAYTHEON TUBES PERFORMANCE TESTED WITHOUT ONE FAILURE"

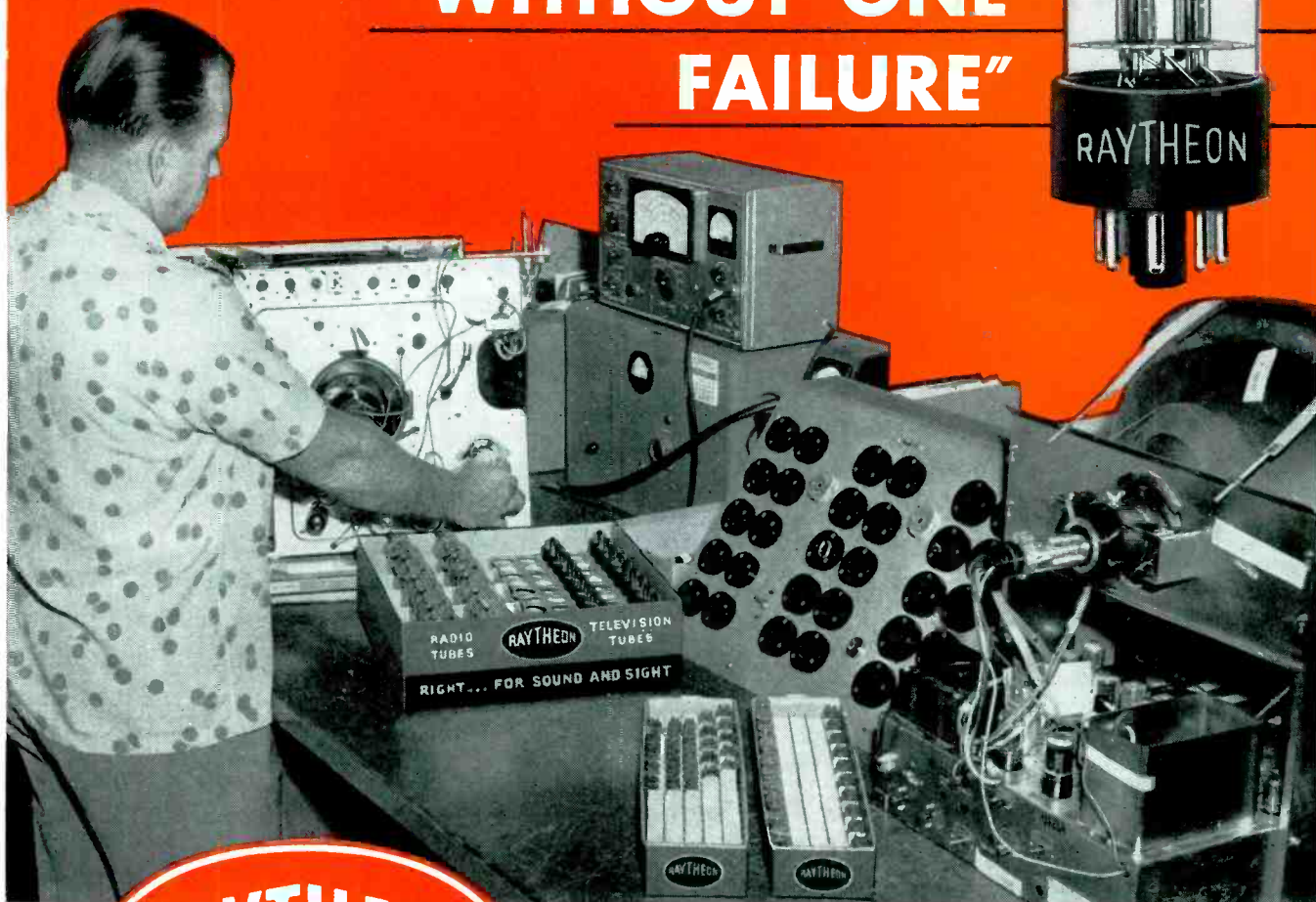

RAYTHEON RECEIVING TUBES for replacement
pass every test for performance and quality
at **HOWARD W. SAMS & CO., INC.**

The results of this thorough, impartial test of regular production Raytheon Tubes provide potent evidence that Raytheon Tubes are tops in quality and performance. Here's what the report says:

"Raytheon tubes were substituted in basic chassis, representing several hundred models. In these tests 2300 Raytheon tubes were tried in 230 different circuit applications with no apparent tube performance failure. Conditions were arranged to simulate fringe area as well as prime signal area, when testing tube types in RF, IF, Video,

Sync, Vertical Oscillator and Horizontal Oscillator Circuits. Low Voltage Rectifiers, High Voltage Rectifiers, Vertical and Horizontal Oscillator, and Horizontal Output Tube types were also checked under low line voltage conditions. No types were found incapable of providing satisfactory results in these circuits, after adjustments of service controls."

What more can we add to this conclusive proof that Raytheon Receiving Tubes are truly **RIGHT . . . FOR SOUND and SIGHT.**



RAYTHEON MANUFACTURING COMPANY

Receiving and Cathode Ray Tube Operations

Newton, Mass. • Chicago, Ill. • Atlanta, Ga. • Los Angeles, Calif.

Raytheon makes all these { Receiving and Picture Tubes, Reliable Subminiature and Miniature Tubes, Semiconductor Diodes, Power Rectifiers and Transistors, Nucleonic Tubes, Microwave Tubes



Visit Raytheon Booth No. 4 at the **ELECTRONICS PARTS DISTRIBUTORS SHOW** May 21-24—Badges issued only in advance
—No registration at the show.

SERVICE

The Technical Journal of the Television-Radio Trade

Color-TV Activity Booming

ON THE THREE MAJOR FRONTS—broadcast, tube manufacture and receiver production—color-TV is really pouring it on now.

No longer are color programs on a hit and miss basis; they're not only on daily schedule, but for many hours. In Chicago, in the million-dollar all-color studios of WNBQ, a 10-hour a day deal has been set for color. The station will carry every live local program in color, along with all of the network color shows and films. Elsewhere, equally bold plans are being made for packages of local color programs. Nationally, many stations and chains have announced that they'll join the color parade, that should drive the total number of color air-hours monthly to over 100.

THE EXTENSIVE PROGRAMMING PLANS have sparked picture tube and set production. Practically every tube plant equipped to turn out three-gun tubes—which will be the only types used this year in commercial models—has announced that they'll push production to meet demands of all of the leading set makers.

One manufacturer is so optimistic about the color snowball that he has contracted to buy thousands of tubes from other plants, even though he plans to make over 200,000 tricolors in his own factory, and use them in color sets he'll produce.

To meet the huge demands for color tubes, glass-envelope manufacturers are dismantling their pilot plants, which have served to meet the past light needs, and preparing to erect special factories devoted exclusively to color-TV bulb production.

TV CHASSIS ENGINEERS have been burning the midnight oil designing completely new lines of simplified sets for the color rush. Some models, as noted earlier in these columns, will feature a number of printed-wiring boards with startling circuit innovations, that will provide excellent color quality and stability.

THE COLOR MARCH has also stimulated marked activity in the instrument camp. To leading cities across the nation, the test equipment makers are sending their top field engineers to hold clinics on the newest techniques in color instrumentation.

COLOR-TV is today an important factor in our industry. During the coming months its progress will be outstanding. You'll find exclusive field reports on these developments every month in SERVICE.

Heightened Need For Special Instruments

THE SOLID ARRIVAL of color-TV and transistors, plus the expanding market for b-w TV, audio, auto radio and communications gear, has accented the importance of test equipment in the shop. Without a suitable complement of the proper instruments, one cannot possibly perform satisfactory service of any type today.

TRANSISTORS have underscored this point very effectively. Because of the low battery voltages used by transistors, *vtvms* must be used to measure circuit voltages. A regulation 1000 ohm-per-volt meter cannot be used because its high internal resistances load down the circuit under test and true readings go out the window. The high-capacity low-working voltage (25v) electrolytics used in transistor sets, also pose a test problem. Special capacity checkers, which do not apply voltages across the capacitors, must be used for these tests.

COLOR-TV test requirements are extremely critical, too. Horizontal deflection and sync problems, acute in most color chassis, require accurate use of special types of gear to localize the difficulties and indicate the solutions.

EVEN IN AUDIO, an assortment of test equipment is vital. As an example, the irritating problem of parasitic oscillation can only be tracked down with a 'scope.

THE RIGHT INSTRUMENT, used properly, cannot only help solve the most stubborn problem effectively, but speedily; insurance against expensive call-backs.

Banner Year For Sound Trucks

THIS IS A ROARING ELECTION YEAR throughout the country. And mobile sound will be king. The demand for microphones, amplifiers, phonos, speakers and even tape, will be greater than ever. Tape will emerge as a dominant tool in the field sound kit, supplying packaged political talks, sound effects and music, all wrapped up in a reel.

THERE WILL BE PLENTY of action on deck for the sound man during the months ahead.

Auto Radio's Bright Progress Report

SIGNIFICANT ADVANCEMENTS have been achieved during the past two decades by the auto-radio industry. The variety of striking changes that have taken place are revealed for the first time in this issue in a series of exclusive field reports.

You'll find these timely articles on pages 12 to 16, and 18, 19, 26 and 41.—L. W.



Above: Auto-antenna installation in drive-in garage of the TV and radio shop operated by George A. Holmes and Donald L. Govoni.

Right: Entrance to the drive-in of auto-radio section of shop.

A Field Report On a Small-Town

LOCATED ABOUT ONE-HALF MILE from the center of Plymouth, a few hundred feet from a new highway, our shop specializes in auto-radio repair and services suburban towns that can be quickly reached by the through-way road.

Shop in Owned Building

We operate in our own building, on the ground floor of a three-apartment dwelling that we purchased some time ago. The unit which we now occupy originally housed a grocery store. It has been completely converted to accommodate mobile and fixed maintenance, repair and installation facilities.

The auto-radio repair section of our shop features a drive-in at the rear of

the building. Next to this drive-in compartment is our service shop. On the other side of the drive-in section is a waiting room, which also serves as a showroom.

The centralized location of the drive-in makes it possible to use that arrangement for loading and unloading during inclement weather.

The auto-radio workbench is located at the rear of the drive-in garage. It is equipped with a battery eliminator vacuum-tube voltmeter, signal generator, tube checker, and various parts.

Shop Hours

Our doors are open from 8:30 A.M. to 9 P.M. each day except Sundays

and holidays. All house calls are made during the day.

There is always someone in the shop to receive calls and do bench work, and make auto-radio repairs on the set in the car, where practical.

Other Activities

In addition to our auto-radio activities, we repair radios, TV sets and phonos.

Home TV servicing consists of tube changes, minor repairs and adjustments for which we get a minimum service charge, plus cost of parts at list price.

Sets taken to our shop are charged for at an hourly rate; we have a policy

Below: Repairing TV chassis on bench in the Holmes-Govoni shop. Right: Assortment of instruments used for auto radio, TV, radio and phono repair: TV-FM sweep generator, signal generator, tube checker, sweep and audio generator, vtvm, capacitor checker, 'scope and picture-tube substituter.

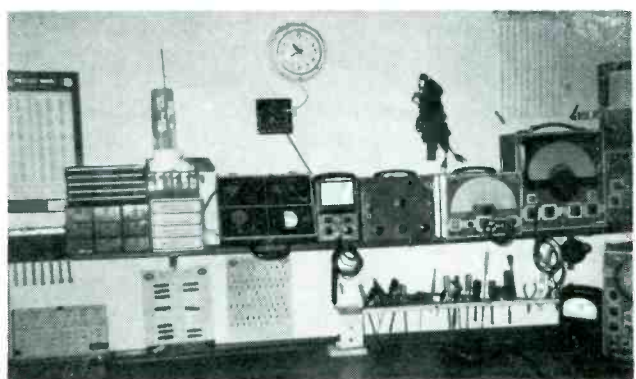
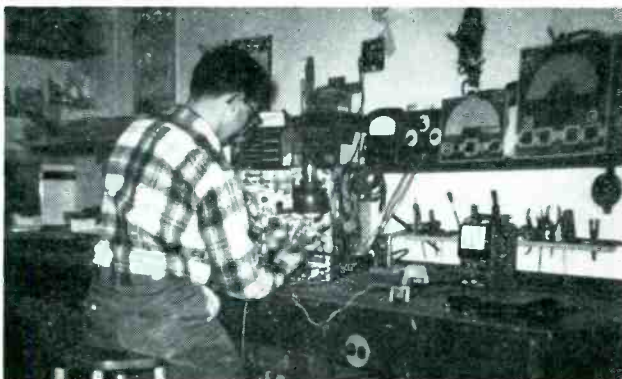



Interior view of truck used for TV and radio repair calls. Materials and instruments carried include tube caddy, tube checker, sound powered phones, antenna-installation kit, leadin and guy wire, antennas, roof and ladder hooks.



(Above)

Component and picture-tube stock carried in shop: Speakers, selenium rectifiers, panel lights, resistors, capacitors, phono cartridges, switches, controls, transformers, vibrators, antennas, antenna mounts, and fuses.

Drive-In AUTO-RADIO Service Shop

by DONALD L. GOVONI*

of air testing each set at least 2 hours after being repaired. We have found that many call-backs are eliminated by this method.

TV Antenna Work

TV antenna installations represent another active project in our shop. Two men equipped with sound-powered phones are sent out on each call. This practice has been found to speed up work.

Assembly in Shop

Where practical, new-installation antennas are put together in our garage and transported completely assembled to the job.

This procedure has been found very sound, particularly during the cold days, of which we have plenty in this part of the country.

Management Control

Any small business must have an efficient bookkeeping and purchasing system.

We have schooled ourselves in this direction; to be sure we're on the right track we call on an accountant and a bookkeeper once a month to check our set of books.

Incidentally a substantial part of our business, among those we know

in town, is conducted on a billing basis. Others are asked to pay on delivery. Detailed bills for repairs and material are presented at every call whether it be a shop or house assignment.

Rental Service

Because we are located in an area surrounded by beaches and are close to numerous fine lakes, a number of summer resorts and developments have sprung up during the past few years. Most people on vacation are

anxious to have a television set and we accommodate them by renting them trade-in chassis that we have rebuilt. Rentals are made by the day, week, month or season.

We keep these chassis in perfect operating order; when we find that it is no longer practical to maintain the set, it is discarded. Business of this type is often more profitable than selling these trade-ins outright.

Although service is our main business, this set rental operation has become a very profitable proposition.

Color-TV Plans

Now that color-TV has come of age, we are making plans to capitalize on the market, by renting or selling color receivers, and establishing a special color installation and repair service. To familiarize ourselves with component and chassis developments, we attend every meeting and clinic session put on by the distributors in this area. And, of course, we constantly search for and read every circuitry-report article published in technical journals. We believe this approach is a wise investment in time and effort.

Inventory of auto-radio, TV, radio and audio tubes. Completely stocked tube caddies used on calls are also shown.

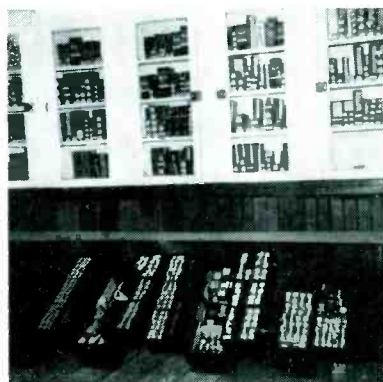

*Samoset TV and Radio, Plymouth, Mass.

Search-Tuned

Design-Repair Analysis of Motor-Control

4 - Watt Tube - Transistor Auto Chassis

Powered Directly From 12-V Car Battery

In Motorola's car radio-engineering test lab; Albert Arnold (seated) pointing out a feature in search tuner used in 6TAS8 chassis to coauthor, Tim Alexander. Transistor powered receiver is on bench alongside, undergoing a performance test.

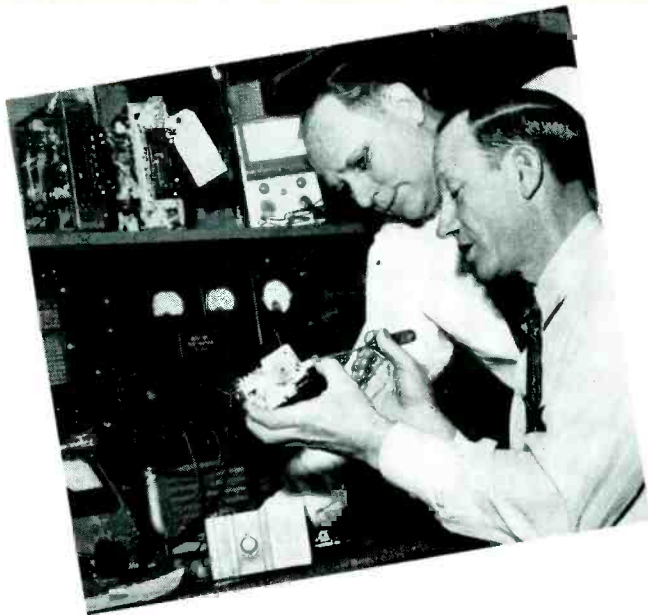

THE DEVELOPMENT of the power transistor has pointed the way to a new concept in auto radio design.

The transistor is inherently a power amplifier, yet it has the unique advantage of operating at low voltage.

Basically, the transistor as engineered into the car radio^o developed in our labs, permits the receiver to operate directly from the 12 volts *dc* supplied by the battery, without the necessity of converting the *dc* voltage to a high voltage *ac* with its accompanying rectifier circuitry.

The Transistor Output Stage

The power transistor is mounted on an aluminum heat radiator (commonly called a heat sink) on the outside of the radio chassis. The purpose is to radiate the heat developed at this junction. The heat sink was designed for a maximum ambient temperature of 60° C, so that the temperature at the transistor will not rise above its maximum rated temperature of 90° C. The collector is the transistor case. It is mounted on the outside of the chassis; at a ground potential to eliminate accidental shorting.

The circuit evolved is known as common emitter with grounded collector. (The three elements of the power transistor are base, emitter and collector.) The audio signal from the driver transformer is applied effectively between the base and emitter due to the low impedance path of a 200-mfd capacitor (C_{25}) and because of the high impedance offered by the tertiary winding on the output transformer. A 500-ohm resistor (R_{25}) is

adjusted so that an emitter current of 480 *ma* is flowing in the circuit. A biasing network consisting of the 500-ohm resistor and a 27-ohm unit (R_{23} and R_{20}) is tapped onto the primary to provide better response at 100 cycles.

The necessary driving power for the transistor is derived from a special tube, developed for operation from a 12-volt plate supply. This new tube, a 12K5, which effectively operates as a triode, also has an auxiliary grid next to the cathode that operates at a positive potential. This space charge grid acts as a virtual cathode that serves as the actual cathode for the remainder of the tube. A high transconductance in proportion to plate potential is possible because of the proximity of the virtual cathode to the control grid. The driver transformer matches the 800-ohm plate impedance of the 12K5 with the 10-ohm input impedance of the transistor. Negative feedback comes from secondary of the output transformer applied to the grid of the 12K5 through a 2.2-megohm resistor, thereby reducing distortion in the output.

A 12CR6 serves as a detector, automatic volume control and first audio amplifier. The first audio amplifier is resistance coupled and has an *avc* voltage applied to the control grid through a 3.3-megohm resistor.

This feature, known as *volumetric control*, tends to hold the sound level more constant despite changes in signal strength at the antenna. This control system is important in poor signal

^o Motorola 6TAS8

areas, such as under bridges, viaducts and near tall buildings. With the exception of a .5-mfd capacitor (C_{20}), from the tone control centertap to ground, the volume and tone-control circuits using 1-megohm variables (R_{17A} and $17B$) are the standard types used in auto radios. The .5-mfd capacitor was necessary to prevent variations in stopping accuracy resulting from various settings of the tone control. A 10,000-ohm resistor (R_{21}) and .1-mfd capacitor (C_{22}) serve as a filter for the automobile breaker point noise. The secondary of the *if* transformer is coupled to the diode of the 12CR6. The diode load is formed by the volume control in parallel with a pair of 5.6 and 8.2-megohm resistors. The tapped voltage at the 8.2 megohm resistor supplies the *avc* voltage for the first and second *if* and the first audio stages. In conventional high-voltage radios, the maximum-developed *avc* voltage is applied to the various stages without any detrimental effect. But in a low-voltage radio with only 12 *v* on the plate of the tubes, strong signal distortion and even grid blocking occurs if maximum *avc* voltage is used. Maximum *avc* can be used safely only at the grid of the *rf* stage.

If and Rf Stages

It was found after exhaustive tests with the present tubes available that an additional *if* stage would be required because of the increased loading effect of the trigger circuits. The first *if* is resistance coupled to the second *if*, which in turn is transformer

See Front Cover and Page 16 For The Complete Circuit Diagram

TRANSISTOR-POWERED Car Radio

coupled to the detector. A decoupling network composed of an 82-ohm resistor (R_{12}) and .5-mfd capacitor (C_{12}) stabilizes the circuit. Three 12AC6s, used as *if* and *rf* amplifiers, were especially designed for low-voltage operation characteristics. (The *if* resonant frequency is 262.5 kc.)

The converter, a 12AD6, is another low-voltage operation tube. It was found that by placing the tickler winding of the oscillator in the screen circuit, oscillation could be maintained with battery voltages as low as 9 v *dc*. The conversion of the tube was also improved. *Avc* voltage is not applied to the converter tube because of the strong signal overload distortion.

The *rf* amplifier is resistance coupled to the *rf* stage and is unique in its circuitry. The *avc* voltage is applied to the suppressor grid. With the application of strong signals to the antenna, the *rf* tube is cut off. The signal is series fed to the converter tube through the suppressor grid to plate capacitance.

Double-Tuned Antenna Circuit

The antenna circuit is double tuned. This type of circuitry has been found to produce excellent selectivity, eliminate cross modulation and power-line hum modulation. It produces good image and *if* rejection; there is a very apparent lack of tweets across the band. A .01-mfd capacitor

by **ALBERT ARNOLD** and **TIM ALEXANDER**

Chief Engineer, Distributor Auto Radio
Motorola, Inc.

National Service Director

(C_3) provides a low impedance path to ground for high-frequency motor noises.

Search Tuning Circuitry

The receiver stopping sensitivity is controlled by a switch providing three levels of sensitivity, while receiver is search tuning. A 6.8-mmfd capacitor (C_2) on the switch in the high position to ground is used to compensate for the switch capacity, so that the set sensitivity is essentially not affected by the different switch settings when the receiver is on station.

The search section of the receiver is composed of a trigger tube (12AE6), relay tube (12K5), sensitive relay (E_3), clutch solenoid (E_4), motor reversing switch (E_6), mute switch (E_7) and drive motor (E_8).

When the search bar is depressed the switch (E_7) and the reversing switch (E_6) are mechanically engaged. The action of E_7 is to mute the speaker and close relay E_3 . The switch (E_6) provides the desired direction of the motor with a 330-ohm resistor, 470-mmfd capacitor (C_{30}) and L_5 and L_6 serving as a

motor noise filter. The relay (E_3) is held closed by the current drawn through the 12K5. The current in the relay tube is sufficient to hold the relay closed, but not great enough to actually pull in the relay. With the relay closed the speaker is muted, the clutch solenoid and motor are actuated, and the sensitivity switch is grounded, so that the sensitivity of the radio can be controlled during sweeping operation only.

To stop the tuner on station, the E_3 relay is deenergized by an electronic triggering circuit actuated by an incoming signal.

The incoming signal develops a voltage in the primary and secondary of the second *if* transformer. The *if* signal in the secondary of the second *if* transformer is coupled through a 100-mmfd capacitor to the grid of the trigger tube, developing a voltage across the 5.6-megohm resistor (R_{28}). The incoming signal causes the trigger tube to conduct, which in turn produces a negative-going pulse at the grid of the 12K5 of sufficient duration and amplitude so as to reduce the current flow through the tube, allowing the relay to be de-

Top and underside views of transistorized auto radio.

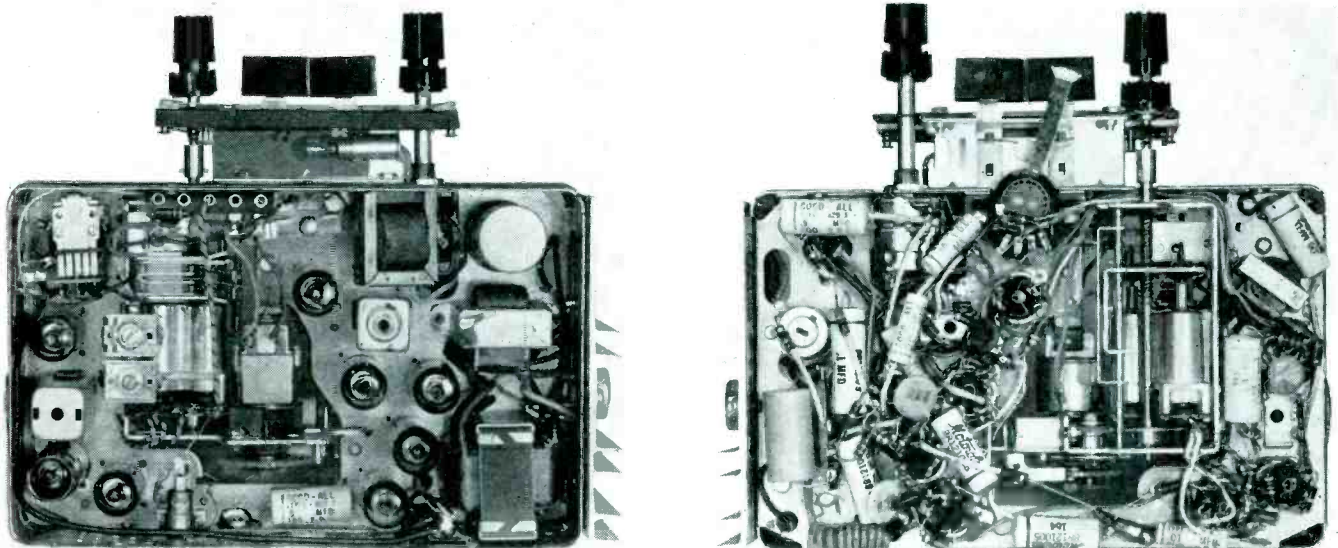

(Below)

Fig. 1. Complete circuit diagram of Motorola 6TA58 search-tuned auto radio using power transistor in audio output stage and 12-v car battery to provide both filament and plate power.

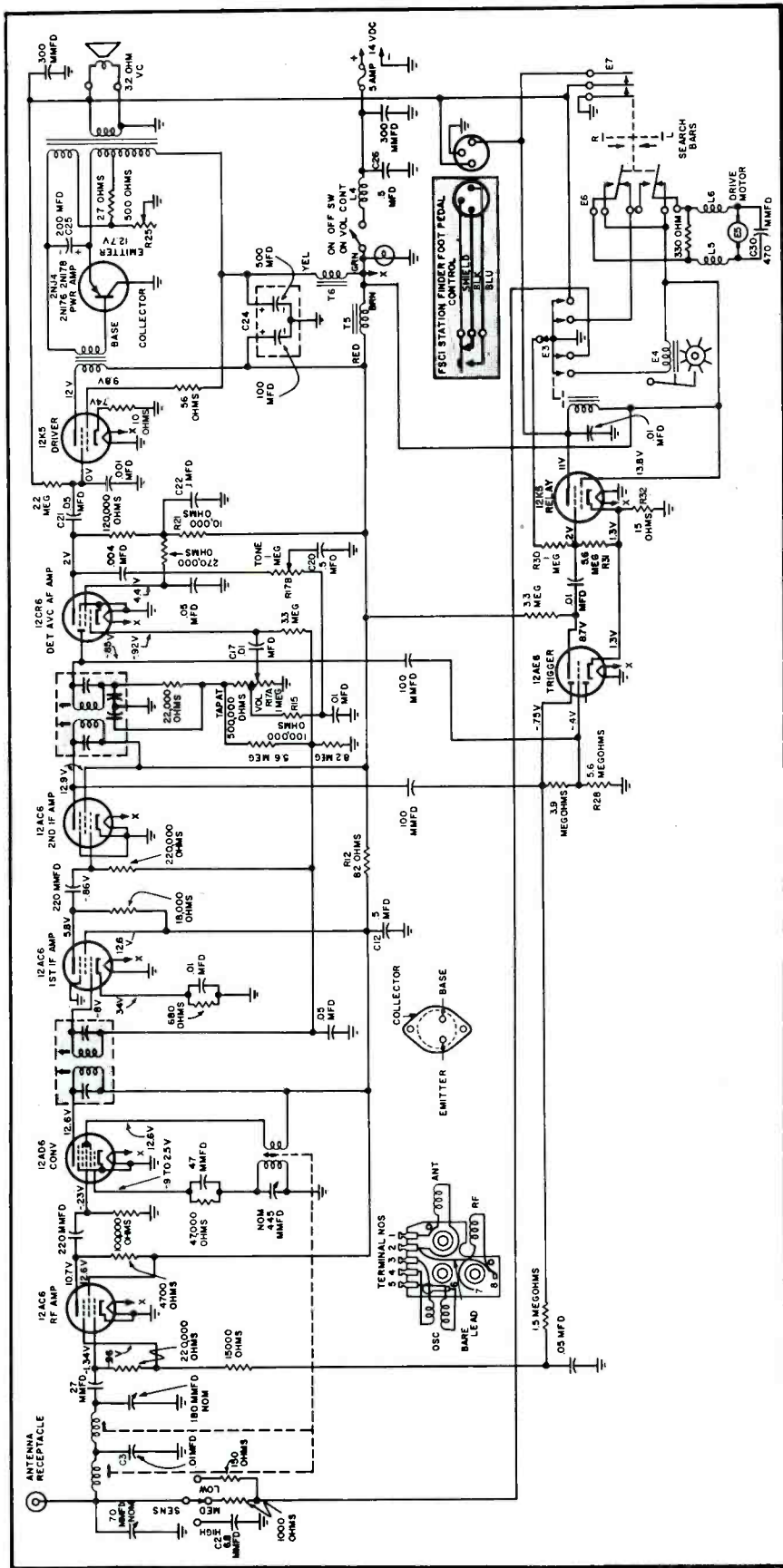

energized. The relay will now remain in this position until search bars are again depressed.

The purpose of the trigger circuit is to take input signals of various amplitudes and trigger the relay tube, so that the stopping accuracy will be the same on all stations regardless of the signal strength. The grid of the trigger tube is tied back to the *avc* line and a portion of the *avc* voltage is used to vary the bias in proportion to the strength of the incoming signals. With a strong incoming signal, the bias voltage is high and the triggering does not take place until the tuner gets very near the resonant frequency of the station providing the incoming signal. At this point, the *if* signal is great enough to overcome the bias and the trigger tube is allowed to conduct, stopping the tuner. Likewise on a weak incoming signal, the *avc* voltage is small and the bias on the trigger tube is small; therefore a smaller amount of *if* signal will stop the tuner very close to the resonant peak of the incoming signal. The circuit is so designed that the *if* signal voltage is high enough to overcome the bias and stop the tuner, only when the tuner has reached the carrier frequency of the station. The positive feedback for the trigger tube holds off the *avc* voltage at the grid of the trigger tube and greatly increases the stopping accuracy of the receiver for weak incoming signal levels. Due to the fact that current is always present in the relay tube, a 1-megohm resistor (R_{m1}) is placed in parallel with the 5.6 megohm grid-leak resistor (R_{m2}) when the tuner is on station. This prevents the amplified *af* signal, which is present at all times in the trigger circuit, from modulating the relay, causing possible relay buzz.

Since this radio is connected directly to the twelve-volt system of the automobile, certain undesirable noise frequencies are present on this input. The inductance (L_1) and .5 mfd and 300-mmfd capacitors are primarily for the elimination of interference caused by the high voltage of the ignition system. A pair of chokes (T_5 and T_6) and 100/500-mfd electrolytic (C_{21}) are required to filter out the low-frequency ripple caused by the distributor rotor.

Troubleshooting Techniques

To check out the various stages a standard *rf* generator and a signal tracer can be used. If the *rf* and *if* amplifier stages are good and the search tuning mechanism is operating

(Continued on page 37)

Left: Circuit of horizontal-oscillator and horizontal control plated-board unit used in RCA KCS-97 chassis. Right: Soldering aids developed for pw repair (Courtesy General Cement.)

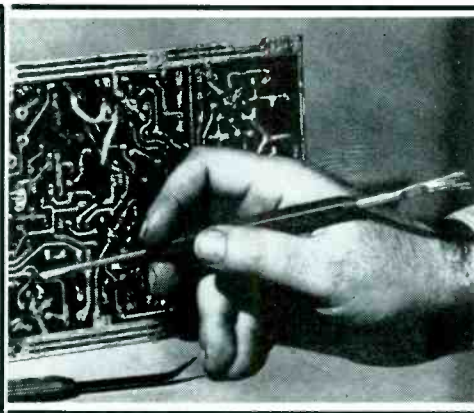
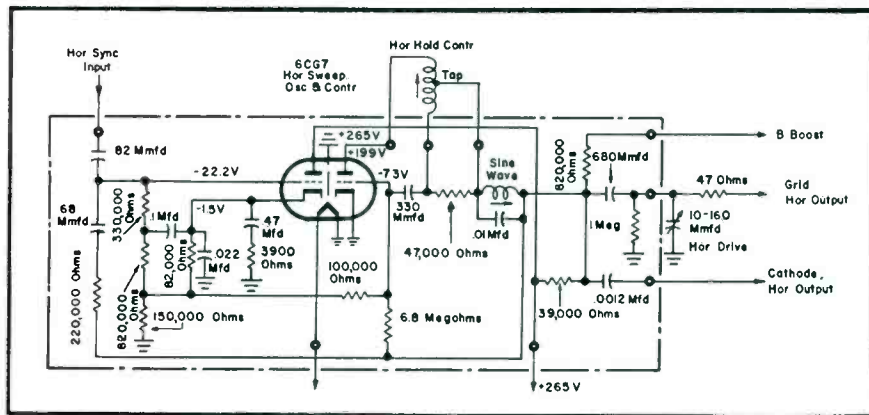

Servicing PRINTED-WIRING TV Chassis

by ALAN LYTEL
Engineering Department, RCA

PLATED OR PRINTED-WIRING boards, now being used in a substantial number of radio, TV and audio chassis, have many unusual constructional and circuitry characteristics that must be carefully analyzed before troubleshooting.

In its raw state, the pw board consists of a plastic sheet plated with copper. A master of the desired circuit is impressed on the copper by one of several processes, and excess copper can be removed by a number of techniques, including etching. Holes are punched in the copper-clad board through which component leads are placed; the whole board with components mounted, is then dip-soldered. The wiring is then given a protective coating of a special varnish.

To simplify TV chassis layout, designers have developed five basic units carrying signal and low-power circuits:

- (1) Sound (if, detector, audio)
- (2) Video amplifier (video amplifier and output; sometimes this board includes a sync stage)
- (3) Picture if (picture if strip and detector)
- (4) Horizontal circuit (oscillator and control)
- (5) Vertical circuit (oscillator, output and sync)

The circuits included in one of these boards* are illustrated above.

Circuit tracing on printed-boards is easier than on conventionally-wired chassis since the leads are easy to see and to trace, the parts are always in the same spot on each board, and a drawing or layout of a given board simplifies location of the individual

components. Because the boards are translucent, a light (low-wattage) can be held underneath the board to help pinpoint the wiring and components.

Measurements for the capacitors, resistors, and coils can be made from the component side of the board.

Magnifying glasses have been found very handy, serving to detect very small cracks across the thin copper-foil that are actually large enough to break the circuit. On the wiring side of the board it is necessary to use a pointed probe to break through the varnish coating to make measurements. Since some tube sockets are mounted on the component side and some are mounted on the wiring side, one must remember that the pin numbering is different. The key-way can be located from the missing lug hole when viewing a tube socket through the board.

Small breaks sometimes occur because of rough handling, or inexperienced hands can damage the wiring

Technique that has been found effective in removing tube socket mounted on wire side of a pw board.

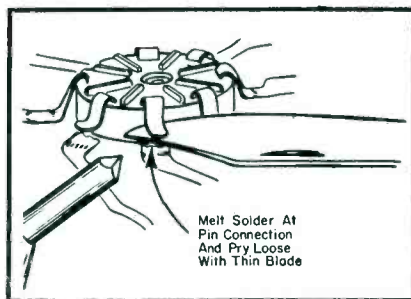

when replacing components. A small break, about 1/16" can be repaired by a simple solder joint. The wiring on both sides of the break should be cleaned and heated with an iron; solder (using a small iron—less than 35 watts) is used to mate the two sections. One must be careful of excess solder which can short parallel printed connections and cause trouble.

Silver, conductive paint can be used for repairs also. If the break is rather large, or where portions of the wiring have come free from the board, a section of tinned wire should be used to make repairs. One should not attempt to glue wiring back into place when it has become loose.

There are several methods that can be used to remove components. Smaller parts, if their leads are long enough, can be cut. The damaged part can then be discarded and the remaining leads used to mount the new part. The old leads can be bent into small loops and used to connect to the leads of the replacement, then being soldered in place.

If the leads are not long enough, another procedure can be applied. The component can be cut out with diagonal cutters and crushed with a pair of long nose pliers. The broken component can then be removed. If this is done with care there will be enough extra lead to allow small loops to be made for the new part.

Care should be taken to see that the copper foil, which is very thin, is not damaged. If too much pressure is applied the copper may separate from the base material.

For the same reason manufacturers have coated the wiring with a protective varnish, namely to prevent corrosion.
(Continued on page 31)

*RCA KCS-97.

Comparison of Circuitry, Components and Tubes Used in Car Sets Produced Since the Early '40s

A Technical Progress

WITH OVER 25 - MILLION radio-equipped cars slated to do vacation traveling during the coming months, and some thirty per cent in need of repairs and replacement components and accessories, the Service Man has a husky job ahead. A number of the sets that will be tagged for service will be the pre-war capacitor-tuned superhets; many will feature the newer signal-seeking tuning systems.

The most noticeable trend in the design of auto radios has been the reduction in size without any sacrifice in performance. This has been brought about through the change-over from standard octal tubes to 7- and 9-pin miniatures, miniaturization of *if* transformers, permeability rather than capacitor tuning, and the use of plated circuitry.

The basic car radio, past and present, consists essentially of the same input, detector and output stages, as illustrated in Fig. 1. Capacitor tuning of the antenna, *rf* amplifier, and converter has given way almost entirely to permeability tuning in current

models. This step has been taken because slug tuning requires less space, is better adapted to pushbutton station setting, and is ideal for search tuners.

Although realignment of capacitor-tuned radios requires only conventional tools, a core-alignment device is necessary for handling the adjustment of slug tuned sets. This normally consists of two 4" long wooden strips, each bonded for at least half its length with rubber. By handling these strips in *chopstick* fashion, the rubber surfaces may be used to rotate the core.

Adjustment of the antenna trimmer takes on increasing importance for sets having search tuning. The sensitivity of these models to received signals governs the stopping of the tuner drive motor. With the trimmer away from its optimum setting, strong signals alone may be detected, while

weaker stations are bypassed. The length of antenna withdrawn can also be critical. If the sensitivity of the set is not sufficient to detect broadcast signals, the tuner motor may rotate continuously without stopping.

The *rf* stage of some car radios includes an *if* or *image* trap. This is a series resonant *lc* circuit between the plate of the *rf* tube and ground, which has been incorporated to offset *if* feedback. With fairly high-gain *rf* stages, it is possible for some of the *if* voltage to be fed back to the input stage and amplified. This voltage, when applied to the converter grid, would tend to *zero beat* with the local oscillator and produce a modulation of the *if* output at an audible frequency. The trap shunts any *if* voltage to ground. In some sets the *if* trap is tunable; in others it is untuned.

Tube development, particularly over the past five years, has played

Fig. 1. Block diagram of basic auto-radios with innovations. Typical design for pre-war sets is shown at top. Post-war chassis design to '50 is illustrated in center portion of illustration, while diagram at bottom shows trends in the '51 to the present period. Some of the features shown in any row will be found in present-day models.

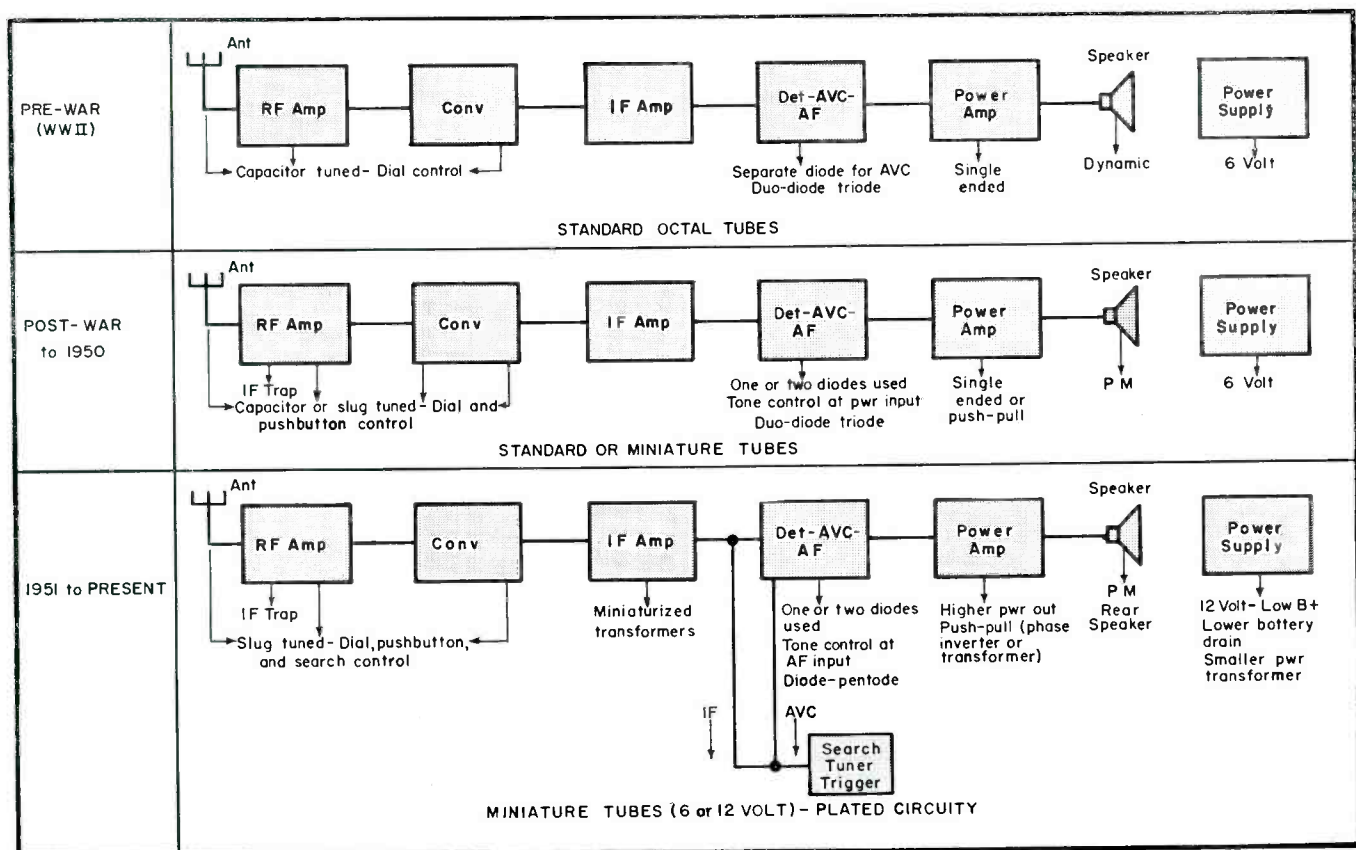

by ELI COHEN

Report on AUTO RADIOS

a large role in the design of current automobile receivers. The 7-pin miniature 6AQ5, for example, has proved a perfect replacement for the 6V6 octal type in the power output stage. New tubes such as the 6CR6 and the 12CR6 (diode-pentode) enable the use of much lower plate and screen voltages.† A typical audio amplifier, employing the pentode section of the 6CR6, can be operated with 40 volts at its plate and 10 volts at its screen.

Variations in the basic detector-*avc*-*af* circuit are related to its association with search tuning and power amplifier. Two typical circuits are illustrated in Figs. 2 and 3. The first probably the more conventional basic circuit, utilizes both diodes of a 12AV6 duo-diode triode, feeding a single-ended power amplifier. One diode is the detector; the other provides the *avc* signal. Inverse feedback in this type of circuit is usually applied from the output transformer to the power amplifier or audio amplifier.

The circuit of Fig. 3, used in conjunction with a search tuner trigger and a double-ended power amplifier, utilizes two 12AV6 duo-diode triodes. Only one diode of each tube is used, however; one for detection and the other for *avc*. One triode and associated components comprise the audio amplifier, and the other is used as an inverter to feed one of the push-pull output tubes. The *if* output and the *avc* signal are fed to the tuning trigger tube. In some receivers, a coupling transformer is used instead of the phase-inverter circuit. The transformer offers greater balance, whereas the phase inverter reduces bulk while still providing good frequency response.

The relatively recent change to the 12-volt ignition system has brought about new developments in tubes and components, especially in the power supply. The 12X4 (the 12-volt equivalent of the 6X4) is the most commonly used rectifier tube in 12-volt sets. Twelve-volt vibrators are more efficient than the 6-volt units, cutting the car battery drain almost in half. A typical 6-volt vibrator draws from

6 to 7 amperes, whereas a 12-volt unit draws from 3 to 4 amperes.

Transformers which step up 12 volts chopped *dc* to 300 volts *ac* need less total windings. This design modification has led to a reduction in transformer size and more conservative ratings.

A source of breakdown in 12-volt systems is the high starting voltage. The power supplies must be checked for 16-volt vibrator starting, and for 1% maximum ripple.

The increasingly popular rear-seat speaker represents another key trend. When servicing a receiver with provision for both speakers, a shorting bar should be placed into the rear speaker receptacle; otherwise, the radio will have no audio output.

Signal-seeking radios utilize a reversible *dc* motor which, when energized, drives the tuning cores through the entire broadcast band. The motor is shut off when a signal of sufficient strength triggers the control circuit. The complete schematic diagram for one such unit is shown in Fig. 4.

The trigger circuit consists of a relay and both halves of a 12AU7 twin

(Continued on page 36)

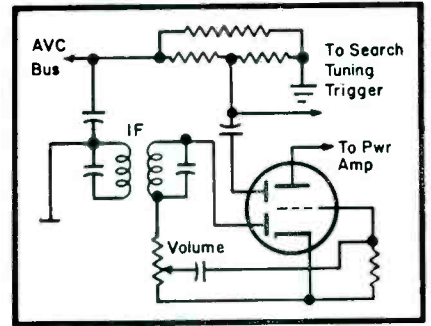

Figs. 2 (above) and 3 (below) Typical detector-*avc*-*af* auto-radio stages are illustrated in these diagrams. Circuit above utilizes separate diode section for *avc*; feeds single-ended power output stage. Circuit below has *avc* diode as part of inverter tube; feeds push-pull output. (Motorola 69MF and 910, respectively)

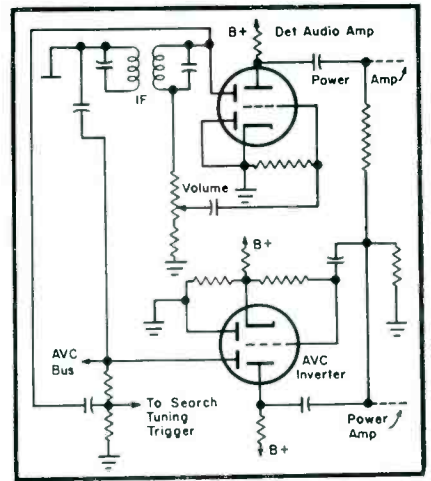
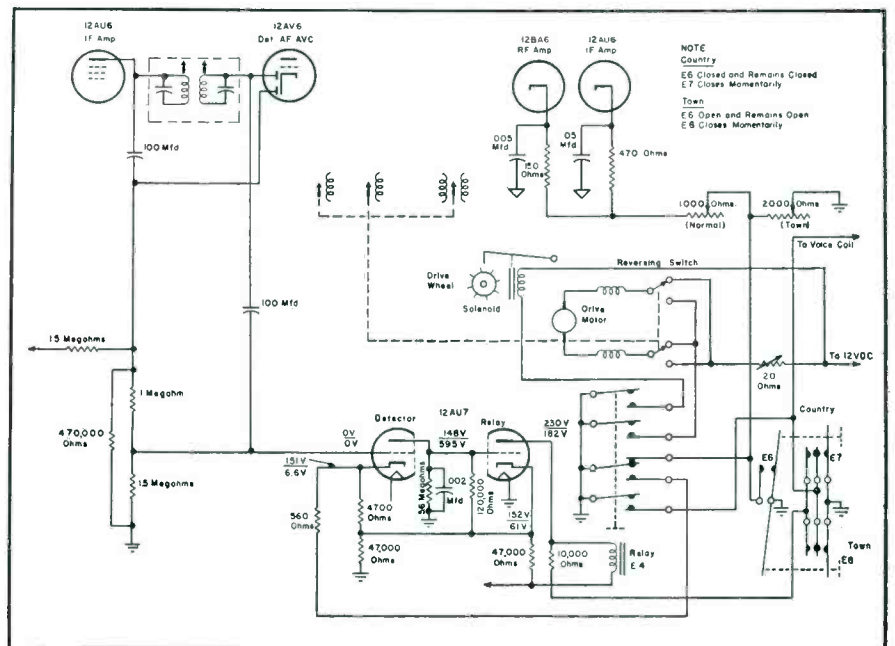

Fig. 4. Basic trigger circuit diagram for a search tuning system. Slug-drive motor and clutch-engaging solenoid are energized by relay when search button is depressed. Relay is held closed by 12AU7 until combined *if* and *avc* signal from approaching station cuts off second half of tube. Two sensitivity potentiometers provide separate sensitivity levels for town or country reception. (Motorola 69MF)



†See complete analysis of Motorola 6TAS8 transistor-output chassis, featuring use of these tubes, this issue, p. 14.

Behind the Controls of the 'Scope for

Design Features	Circuit Action	Performance Factors
Low-frequency compensation network. (1)	At lower operating frequencies, the reactance of the capacitor rises, and the series resistor becomes partially effective as an added plate load, thereby increasing the low-frequency gain.	The values of R and C are both semi-critical in this application, and the low-frequency response will be unsatisfactory unless both are correct. See circuit at right; circle (1).
High-frequency compensation network for vertical preamplifier. (2)	Provides an increasing value of plate-load impedance at higher operating frequencies to obtain the same gain as in the mid-band region.	Both series and shunt peaking are utilized to secure maximum gain from the stage. The damping resistor is required across the series peaking coil to obtain the desired flat response. See circuit at right; circle (2).
Compensated vertical-input step attenuator. (3)	Provides control of pattern size vertically, without frequency or phase distortion of waveform.	The trimmer capacitors permit one to compensate the attenuator steps. The fixed capacitors operate to maintain a constant input capacitance on each step, so that low capacitance and capacitance-divider probes can be used properly. See circuit at right; circle (3).
Wide-band/narrow-band switch. (4)	An operating control which provides a choice of plate-load impedance of 2700 or 27,000 ohms. The low impedance provides flat frequency response at reduced gain to 5 mc, while the high impedance provides high gain at a bandwidth of 500 kc.	The 'scope is most useful in alignment of low-gain circuits when the narrow-band setting is used. However, reproduction of color burst, etc., requires the use of the wide-band setting. See circuit at right; circle (4).
Cathode-follower vernier vertical-gain control. (5)	Provides continuous control of vertical gain in between the steps of the coarse attenuator.	The cathode follower is an electronic impedance transformer which permits the use of a continuous control without frequency or phase distortion. A loss in signal level is the price which is paid for the facility. See circuit at right; circle (5).
Paraphase inverter driving amplifier. (6)	This section of the vertical amplifier converts the single-ended input to double-ended output, with a simultaneous stepup of signal level.	Double-ended output is required to obtain a sharply focussed trace, free from astigmatic distortion at the screen edges. See circuit at right; circle (6).
Push-pull output vertical amplifier. (7)	The output stage provides ample driving voltage to the crt vertical deflection plates.	The push-pull arrangement not only eliminates screen-edge distortion, but also minimizes non-linearity of vertical deflection. See circuit at right; circle (7).
Blanking generator and amplifier. (8)	Provides a suitable retrace blanking voltage to crt grid.	Eliminates visibility of the flyback, which is otherwise a spurious portion of the display. See circuit at right; circle (8).
Horizontal-function selector switch, which permits operator to choose mode of sync and horizontal deflection. (9)	Alignment applications require the use of sine-wave horizontal deflection, while troubleshooting applications require the use of sawtooth deflection, with choice of + or - sync.	The horizontal function switch enables one to apply an external signal voltage to the horizontal amplifier for applications such as lissajous frequency determinations, phasable sine-wave sweep voltage, etc. See circuit at right; circle (9).
Horizontal amplifier section. (10)	Provides stepup of the horizontal-deflection voltage, with inverted action for double-ended output.	Double-ended output also required from the horizontal amplifier to eliminate screen-edge distortion. The frequency response of the horizontal amplifier is considerably less than that of the vertical amplifier. See circuit at right; circle (10).
Sawtooth deflection generator. (11)	Generates a sawtooth deflection voltage from the dc plate supply, for horizontal beam deflection.	Frequency of the sawtooth voltage is variable over a wide range. Both R and C are varied, to maintain a linear sawtooth. See circuit at right; circle (11).
Cathode-ray tube for display of waveforms. (12)	Has a medium-persistence screen for use in general servicing applications.	Short-persistence or long-persistence screens can be substituted for special applications. See circuit at right; circle (12).
Low-and-high voltage power supply. (13)	Provides plate-supply voltage for the small tubes, and 1100 volts for acceleration of the crt beam.	Elaborate filtering is provided to minimize hum voltage to the amplifiers and the crt. Current drain is relatively low to the crt, but high to the amplifiers. See circuit at right; circle (13).

‡From a field report submitted by Robert C. Middleton, Chief Field Engineer, Simpson Electric Company.

B-W and COLOR-TV Applications

by G. S. RYANT

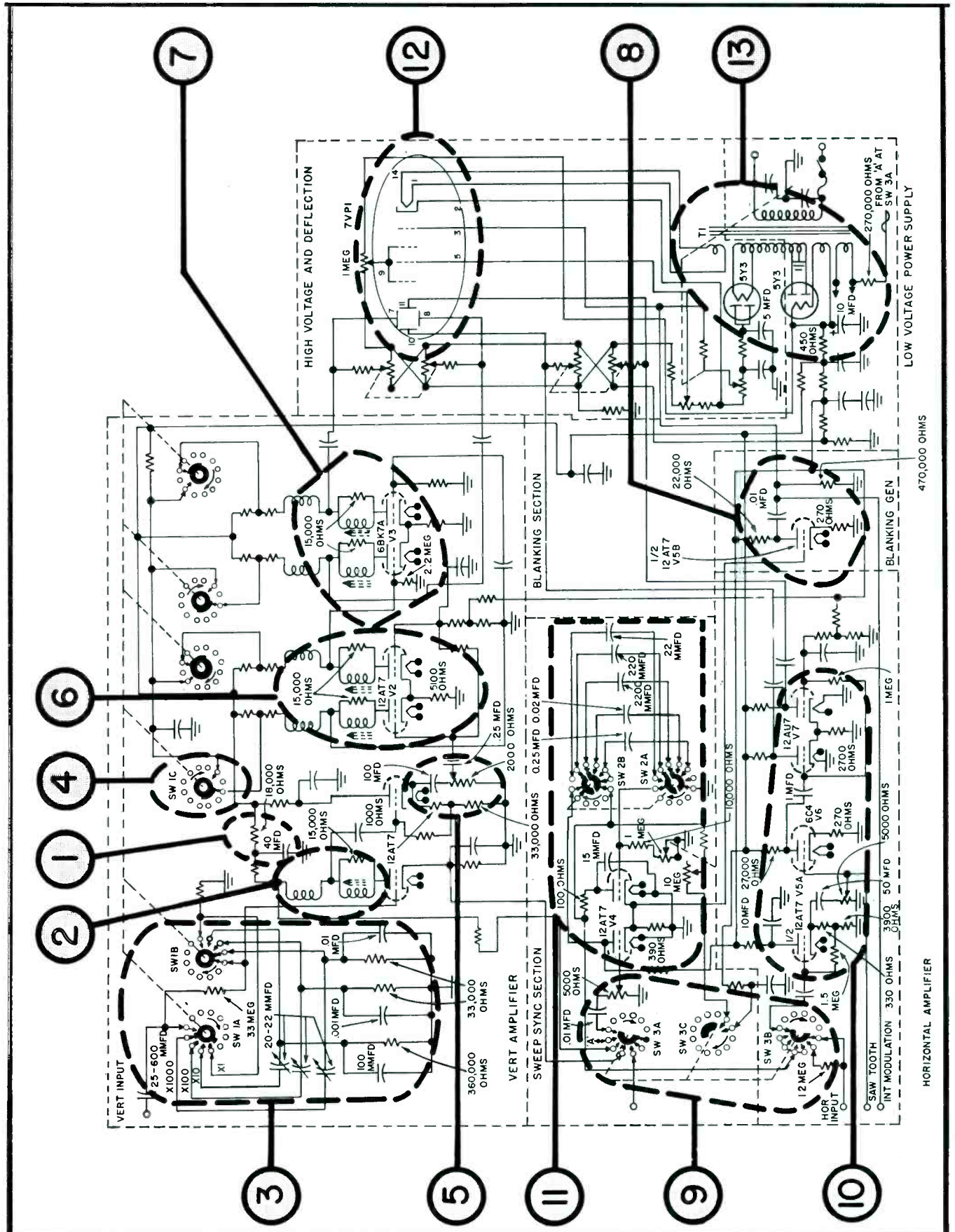

Circuit arrangement of typical 'scope than can be used for b-w and COLOR-TV work. Numerical references are analyzed in table at left.

Troubleshooting TRANSISTORIZED RADIOS

By KEN KLEIDON

Raytheon Manufacturing Company, Television and Radio Operations

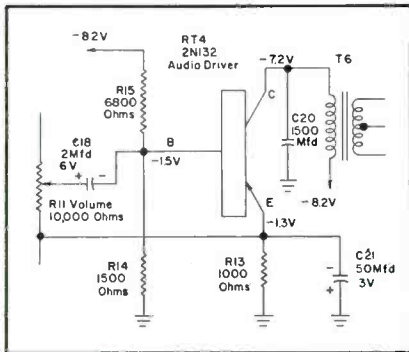
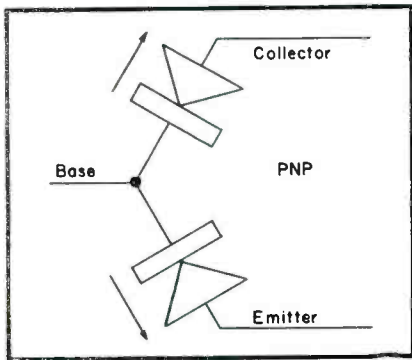

Fig. 1. Audio transistor circuit with typical voltage readings measured with a vtvm.

Fig. 2. Basic equivalent circuit for a pnp transistor.



	1	2	3	4	5
Emitter	900	460	900	930	940
Base	600	1,220	1,270	1,220	1,300
Collector	2,420	480	3,000	1,100	3,500

- Condition 1: All transistors in circuit, positive meter lead connected to chassis.
- Condition 2: All transistors in circuit, negative meter lead connected to chassis.
- Condition 3: All transistors in circuit except stage being measured, positive meter lead connected to chassis.
- Condition 4: All transistors in circuit except stage being measured, negative meter lead connected to chassis.
- Condition 5: All transistors out of circuit, either meter lead connected to chassis.

Fig. 3. Resistance measurements from emitter, base and collector to ground for circuit shown in Fig. 1, under different conditions.

TRANSISTORS differ from tubes in numerous ways and because of these differences, new techniques and procedures must be applied when servicing transistor radios.

A transistor is a very efficient device, and due to its low power drain and low operating potentials, low voltage batteries are used to supply all the required power for operation. Transistor radios normally require a battery potential of 6 and 9 v. Because of this low battery voltage a vtvm should be used to measure the circuit voltages. If, for example, a 1000 ohm-per-volt meter was used to measure voltages in a transistor radio, the 10-volt range would be used to check the battery and collector voltages and the 3-volt range would probably be used to check the base and emitter voltages. The internal resistance of the meter on these ranges would be 10,000 and 3,000 ohms, respectively. This type meter would load down the particular circuit under test and a true reading would never be obtained. The base current of a transistor is in the order of 10 microamperes and the base-emitter bias is generally about 1 to 2 volts; therefore, measuring the base voltage with such a meter on the low-voltage scale will upset the bias, the transistors conductivity will change and the readings will be incorrect.

Voltage readings in a transistor radio will vary with the strength of the signal being received, the battery voltage and type voltmeter being used. The voltage readings indicated in Fig. 1 were measured with a vtvm, no signal input and with a battery voltage of 9. The supply voltage of -8.2 is coupled through a filter network, which drops .8 v, from a 9-volt battery. Voltage readings will also vary with a change of transistors. This is due to the non-uniformity of present-day transistors. The conductivity varies from one transistor to another (same type and manufacturer) and, therefore, the voltage readings will differ.

Voltage measurements at the base and emitter circuits, unless they can be interpreted correctly, are not of

too much value, except to determine if a voltage is present. The voltage readings will be in the order of 1 to 2, and it is difficult to determine whether a 5 or 10 per cent difference might be the cause of trouble. One important point to remember for a pnp type transistor is that the base voltage will always be greater in magnitude than the emitter voltage. This is necessary to provide bias for the stage.

Transistor radios use the npn and pnp transistors and some radios use both types in the same chassis. For this reason, the transistors used should be checked, as the voltage polarity is dependent on the type used. If pnp-type transistors are employed, the voltage readings will be negative and if npn-type transistors are used, the voltage readings will be positive with respect to chassis.

When checking voltages, one must be careful to avoid accidental shorting of the circuit to chassis, especially the collector circuit, as damage to the transistors may result. Also, the practice of deliberately shorting a circuit to chassis to determine if voltage is present, or to listen for a click in the speaker must be avoided. If the collector circuit shown in Fig. 1 was momentarily shorted to chassis, the action of the inductance of the primary transformer winding in the collector circuit would develop a potential many times greater than the battery voltage. This voltage would be applied to the collector and cause excessive conduction which could cause permanent damage to the transistor.

Battery replacement will be one of the major service remedies for transistor radios. When a transistor radio is presented for service, the battery should be the first component checked as it can easily be checked by measuring the voltage at the battery cable connections. Since the battery voltage decreases with use and age, it is a good practice to measure the battery voltage before checking other circuits. If the battery voltage is low, all other voltage readings will be proportionately lower. The battery voltage should, however, only be checked

First Complete Field Report on Instrumentation and Tool Requirements . . . Test Procedures . . . Battery and Component Replacements

with the receiver turned on after at least five minutes of operation. Batteries have a tendency to reactivate when not in use and a true test of the batteries' capabilities cannot be determined until sufficient current has been drawn from the battery. If the battery is found to be *dead*, the receiver should be checked for a short circuit before the replacement battery is installed.

The old rule-of-thumb advocating battery replacement if a 10 per cent drop in battery voltage is detected, does not apply to transistor radios. Battery replacement should be performed when one finds the sound output to be muffled or distorted with a decrease in total output. If a series of batteries are used (say, four 1½-volt batteries in series), all the batteries should be replaced at the same time. When installing a replacement battery, or series of batteries, one must observe the battery polarity and check carefully before operating the receiver. Damage to the transistors or other components in the receiver may result because of incorrect battery polarity. The same applies if a substitute battery is used for bench service.

Caution must also be observed when using an ohmmeter to check continuity and resistance readings in a transistor radio. Every ohmmeter has an internal battery and the battery voltage will vary from one meter to another. It is important to know the voltage of this battery before attempting service, as damage to the transistors and other components could result due to excessive voltage being applied to the circuit by the ohmmeter. If an ohmmeter is placed across the emitter resistor (R_{13} in Fig. 1) to check the resistance, the emitter capacitor C_{21} , may be damaged if the internal battery voltage of the ohmmeter exceeds the voltage rating of the electrolytic capacitor; this capacitor is rated at only 3 volts. Even though the meter battery voltage is sufficiently low, damage may also result to the capacitor due to excessive reverse current caused by placing reverse voltage across the capacitor. This may easily be done by placing the ohmmeter lead connected to the positive terminal of the battery to the emitter. It is important to know the

(Continued on page 28)

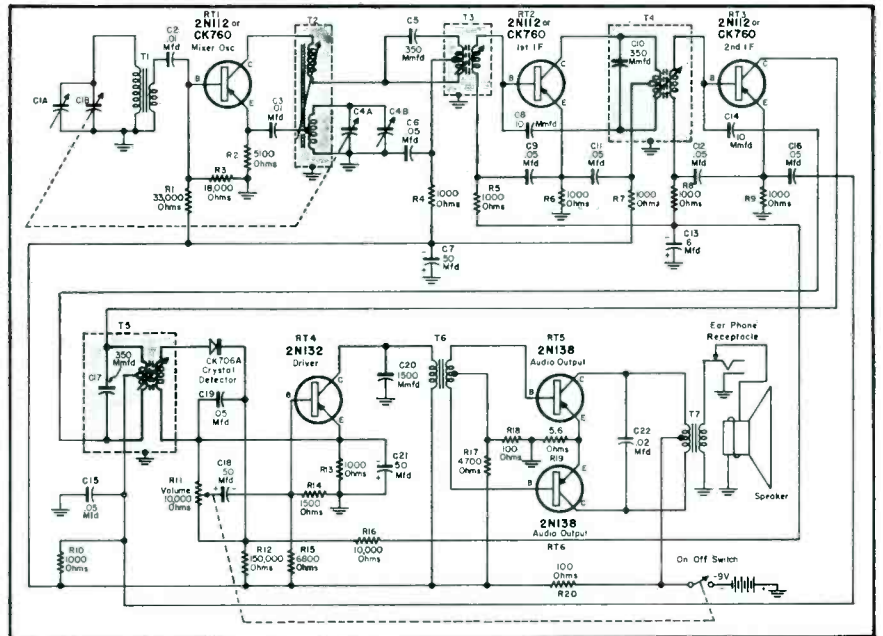
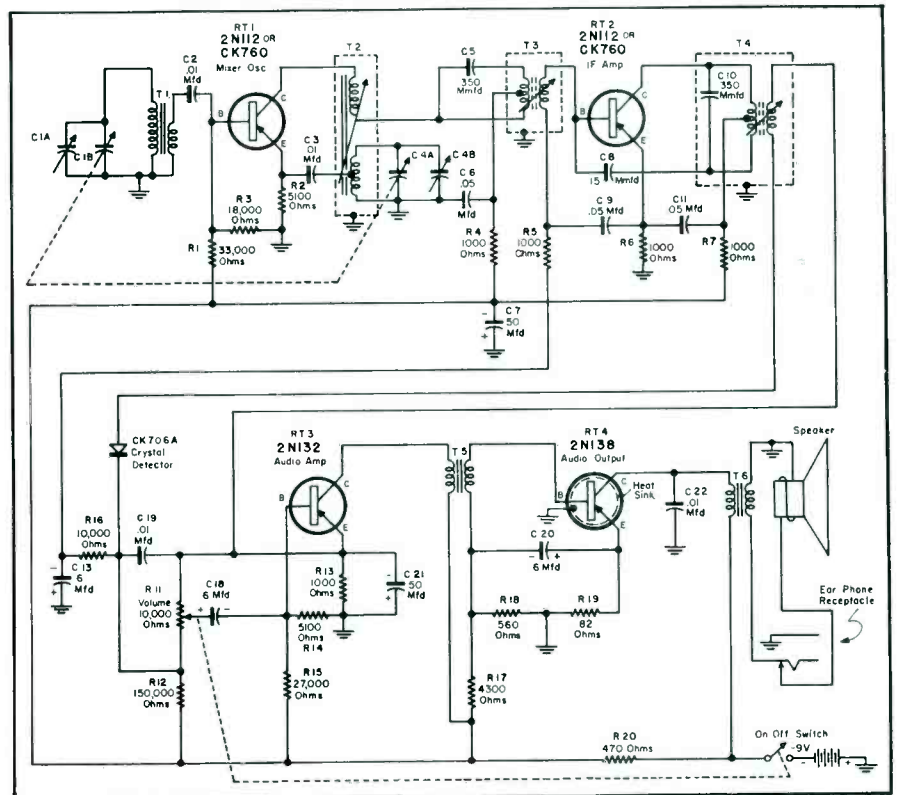

Fig. 4. Schematic of Raytheon T-150 transistor portable radio. The difference between this model and the T-500 are the use of two if amplifiers rather than one, one audio amplifier rather than two, an autodyne circuit (which replaces the oscillator and converter stages) and a 9-v battery in place of a total of 6 v.

Fig. 5. Another Raytheon transistor portable radio. This, the model T-100, is similar to the model T-150, except that only one if amplifier stage is used and a single ended class A output stage is employed in place of the push-pull output. The single-ended stage provides 25 milliwatts output and a heat sink is used to obtain the rated output; the heat sink is simply a metal clip around the transistor to dissipate the heat. The heat sink must be in place as damage to the output transistor may result. Rated battery life is 100 hours; the reduced battery life is due to the class A output stage which draws more current than the push-pull stage operated as class AB.



SERVICE... The National Scene

ANNUAL MARKET SEEN FOR 10-MILLION PICTURE-TUBE REPLACEMENTS -- The average of almost 7-million TV receivers that has been sold every year since '50, indicating that every month another half-million sets pass their fifth anniversaries, is creating a sharp replacement demand for picture tubes, that should send replacement requirements up to at least 10-million a year. . . . So reported the replacement sales manager of a leading tube maker recently. . . . He felt that we are approaching the point when replacement picture-tube sales will be more important, from a volume standpoint, than tubes produced for new chassis. . . . Pointing out that since the replacement cost of a picture tube represents so substantial an outlay of money, the marketing expert said that it was important that Service Men insist on top brands for replacements. In his opinion, as much care should be shown in specifying a replacement picture tube, as was originally shown in buying the set.

IMPROVED TRANSISTORS WITH MARKED INCREASE IN GAIN UNVEILED -- A number of recently-developed extremely high-gain power transistors, were shown for the first time at the annual IRE convention, along with their unique application possibilities. With one such hi-powered unit, a pn_p type, it was found possible to build a miniaturized amplifier, about the size of an ordinary pencil eraser, with a gain of 70 db, or a power gain of 10-million. . . . With the availability of these high-power transistors considerable effort has been put into the development of straight audio amplifiers, with outputs on the order of ten watts and higher. The push-pull class-B amplifier has been found to provide the best utilization of the transistor's capabilities in this direction. . . . With supply voltages of approximately 12 volts, now commonly used for automotive applications*, it has been found that the new transistors are excellent, but the common base connection is not usable because of low power gain. The common emitter amplifier, instead, has been found to represent a better choice, offering higher power gain.

MODULAR RADIOS AND TV CHASSIS SCHEDULED FOR EARLY APPEARANCE--Receivers featuring machine-made modules--unitized vertically-stacked ceramic-wafer units, which include all the resistive, capacitive and inductive elements--have been designed and will soon be on the production line. . . . Numbers of the modules, each the equivalent of from six to twenty-eight resistor, capacitor and inductance components, have been included in several portable models and complete TV receivers. . . . The new trend has generated tremendous interest among parts manufacturers; as a result many research and development projects have been set up, and new types of assembled components have been evolved. In one plant, engineers have come up with packaged r-c building-block units containing rows of capacitors and resistors; the latter of the cold-molded composition type and the former ceramic-dielectric tubulars. Resistances range from 5 ohms to 50 megohms; capacitance values from 10 to 5100 mmfd. . . . Modular-equipped receivers and instruments will require new concepts in repair and maintenance. An exclusive report on the principles that will obtain will appear soon in SERVICE.

TYPICAL TV SERVICE SHOP DISPLAYED BY ASSOCIATION AT FAIR--To further understanding between the consumer and TV Service Men, an upper New York State association set up a service shop at an annual midwinter fair, and stocked it complete with tools, test equipment, components and bench. A large wall card featured the names of all member shops. Another sign urged set owners to deal with association members for their ethical practices and technical ability. In another sign display, featuring a series of large cards, defective components were mounted and the faults and effects on set operation were clearly defined. . . . To illustrate techniques used by members to locate troubles, a videometer was used to inject a cross hatch or dot pattern on the screen of an activated TV receiver, which in turn was picked up and displayed on a 'scope. Association members were in constant attendance to answer questions. . . . Twenty-four member shops participated in the exhibit, in cooperation with local distributors.

*A striking illustration of the application of such a unit appears in the Motorola auto set described in this issue on pages 14 to 16.

Always insist on

WARD
FIBERGLAS
AUTO AERIALS

Dura-ramic



WARD

**AUTO
AERIALS...**

for:

- ★ **Top quality**
- ★ **Customer acceptance
for over 20 years**
- ★ **Reliable performance**
- ★ **Easiest installation**

For every radio installation you make, a WARD AERIAL tops it off with the most dependable, acceptable and popular antenna you can buy . . . yet it costs no more than an ordinary aerial.

Here's the *complete* top-quality line for every requirement:

- EIGHT BALL—ever-popular favorite
- MAJORETTE—the economy model
- PHANTOM—disappearing antenna
- TWIN REAR MOUNT—midget 8-ball twins
- MIDGET PHANTOM—twin rear mounts
- SKY QUEEN—smartly styled side mount
- LONG RANGER—longer, for extra signal
- CONTINENTAL—flex-angle side mount for all foreign cars
- DURA-RAMIC®—the original Fiberglass aerial in full colors to complement the car. Can't fade, rust, warp, break or corrode.

Order your WARD AERIALS now. Keep a few on hand all the time. Keep your customers satisfied with the . . . *World's Finest!*

WARD

PRODUCTS CORPORATION
DIVISION OF THE GABRIEL CO.

1148 EUCLID AVE. • CLEVELAND 15, OHIO

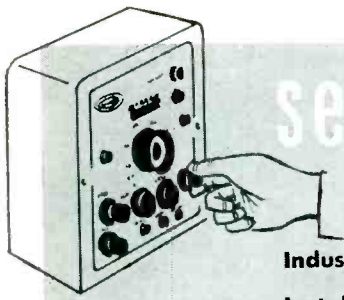

service engineering

FIELD AND SHOP NOTES

Industrial . . . Commercial . . . Institutional Communications . . . Audio . . . TV
Installation . . . Maintenance . . . Repair

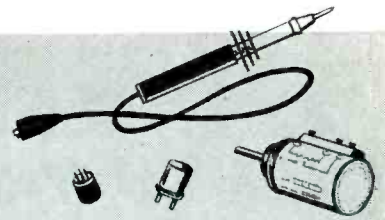

Checking High-Frequency Communications Receivers

by **GEORGE A. SVITEK**, Communications Training Counselor
General Electric Company

IN TROUBLESHOOTING a dead audio circuit in 450-470 mc receivers, it is best to remove first the 6AL5. Audio signals should appear. If they do not (or come on weakly), then the 12AX7 is probably defective. If there is no control of the squelch, then the 6AL5 should be replaced. It is also possible under conditions of no squelch that the gain of the noise amplifier (6BH6) is low. Replacing it should correct the trouble. If none of these changes corrects the difficulty, then troubleshooting with a *vtm* having 1 meg or more resistance at probe should be attempted. Under conditions of no-audio, pin 2 (12AX7) reads about 13 v, pin 3 about 36. This corresponds to *squelch on, audio off*. When the receiver is enabled, pin 2 becomes about 36 v, pin 3 about

40 v; this condition is *audio on, squelch off*.

If the 6BH6, 6AL5 and 12AX7 are good and the squelch circuit is behaving normally, then trouble is indicated in the 6AQ5 output transformer or the speaker connections.

In addition to the foregoing troubleshooting, a regular routine of preventive maintenance should be carried out on the receiver, as well as the transmitter.

In establishing routine preventive maintenance, certain readings should be taken periodically from the receiver and recorded for future comparison. These would include B+ and filament voltage, oscillator current, and in particular, *first limiter noise current*. B+ is nominally 190 v and filament is 6 or $12.6 \pm 10\%$

with a battery voltage of 6.6 or 13.2 v $\pm 10\%$. In a mobile, with a good battery, if B+ is less than 170 v the vibrator should be checked; if as low as 162 v the vibrator should be replaced.

Importance of Antenna

There is one source of trouble found in 2-way combinations; a source sometimes overlooked until the last, and yet it is common to both the transmitter and receiver. We refer, of course, to the antenna. Many of the possible troubles can be eliminated before they occur if the necessary care is taken during installation. The common defects in antennas are usually damaged elements, cracked or shorted insulators, and shorts or opens in the associated transmission line. Many reports have disclosed that unsatisfactory operation has been traced directly to a drop in the center conductor of solid line such as RG17/U. Such a drop results in an open con-

(Continued on page 60)

Fig. 1. Six possible ways that a mobile set can be mounted in a car.

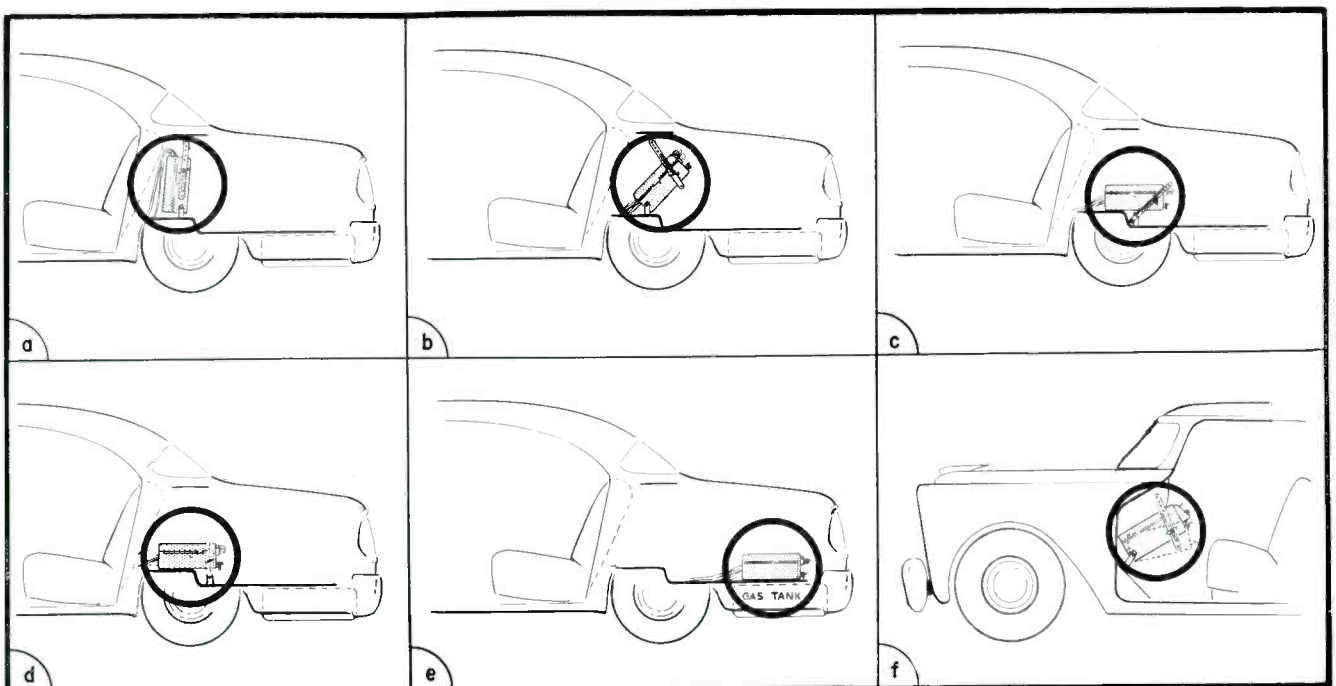

abacus



昨日之最好者

honorable ancestor of the UNIVAC

In theory many centuries have gone into the development of the Univac®. Only recently, at Remington Rand Univac, has it achieved product perfection. The tremendous strides forward in the past few years are due to the imagination and creative genius of the scientists and engineers of Univac. Recognized leaders in the field of electronic computer systems, they are the men *who set the standards for others to follow*. You can become a member of this team

... where ambition and professional skill find their reward in limitless opportunities in an expanding organization.

Immediate openings for:

FIELD LOCATION ENGINEERS with a college degree in a scientific or engineering field and experience in electronics. Extensive electronic background may substitute for some college. Many opportunities for rapid advancement.

FIELD LOCATION TECHNICIANS with technical school background and preferably some experience in electronics. These positions can lead to full engineering responsibility.

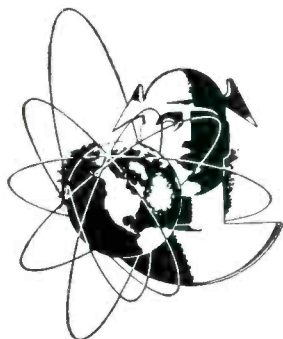

Send complete resumé to

Remington Rand Univac

DIVISION OF SPERRY RAND CORPORATION

AT ANY ONE OF THESE THREE PLANT LOCATIONS

MR. D. A. BOWDOIN
Dept. AP-32
2300 W. Allegheny Ave.
Philadelphia, Pa.

MR. KURT PINKE
Dept. AS-32
1902 W. Minnehaha Ave.
St. Paul W4, Minn.

MR. FRANK KING
Dept. AN-32
Wilson Avenue
South Norwalk, Conn.

© Registered in U. S. Patent Office

Troubleshooting Transistorized Radios

(Continued from page 23)

battery voltage and polarity of the meter leads. The black meter lead does not necessarily indicate that the negative terminal of the meter battery is wired to this lead. Using a voltmeter or referring to the meter diagram will determine which lead represents the negative or positive terminal of the internal battery of the ohmmeter.

Another important consideration is that high frequency transistors (type CK759, CK760, 2N111 and 2N112)

are rated at a maximum of 12 volts. Connecting an ohmmeter across a transistor could permanently damage the transistor if the meter battery voltage is greater than 12 volts.

The electrolytics used in transistor radios (C_{38} and C_{21} in Fig. 1), are high-capacity types with low working voltages. The same methods used to check electrolytics in TV and radio receivers will apply to these type capacitors; however, capacity checkers which apply a voltage across the ca-

pacitor to be checked must be avoided. The low working voltage of the electrolytics as well as the other capacitors, which have a working voltage of only 25 volts, prohibit the use of such capacity checkers.

Due to the nature of a transistor, crystal diode action will be experienced when attempting to check resistance readings with the transistors in the circuit. A basic equivalent circuit for the *pn*p type transistor is illustrated in Fig. 2 (p. 22). For the *pn*p type transistor the diode action is between base and emitter and between base and collector. The diode action would be opposite for a *npn* type transistor. The arrows in Fig. 2 represent the low-impedance path. If an ohmmeter were placed across resistor R_{14} in Fig. 1, with the positive meter lead at the base, the diode action of the transistor would affect the meter reading, as the low impedance of the transistor from base to emitter in series with resistor R_{13} would parallel resistor R_{14} . Also, if an ohmmeter is placed across resistor R_{15} , with the positive meter lead at the base, the low impedance of the transistor from base to collector, in series with the primary winding of T_6 , would parallel resistor R_{15} . Reversing the meter leads, negative meter lead at the base, will bias the transistor to the point where the impedance of the transistor is quite high and will not affect, to any great extent, the meter reading. The primary winding resistance of T_6 could, however, be checked without any effects from the transistor, as the impedance between collector and base would be quite high.

Because of the diode action of a transistor, it will be advisable to remove the transistors from the circuit before checking ohmmeter readings. In some transistor radios, sockets will be provided for the transistors and in other radios the transistors will be soldered in place. However, all the transistors should be removed from their sockets before accurate ohmmeter measurements can be made. If the transistors are removed to make ohmmeter checks, one should be sure the transistors are replaced in the same socket or resoldered in the same circuit from which they were removed.

Approximate or close resistance measurements can be made if the ohmmeter is used correctly, without removing the transistors from the circuit. It is important, when checking resistance readings with the transistors in the circuit, to observe the battery polarity of the ohmmeter. When checking a radio using *pn*p-type trans-

Now Available! NEW...

VACO®

Hollow Shaft NUT DRIVERS in Color

Nothing else like them anywhere! Choice of 28 types and sizes! New plastic kit at right contains 7 most popular drivers in self-standing bag for service work or bench use.

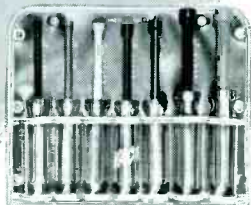

No. K7 Self-Standing Service Kit
Stands Up! Hangs Up! Folds Up!

Stands upright for easy accessibility. May be hung flat on wall or may be folded. Each driver fits in individual holder marked for size, color.

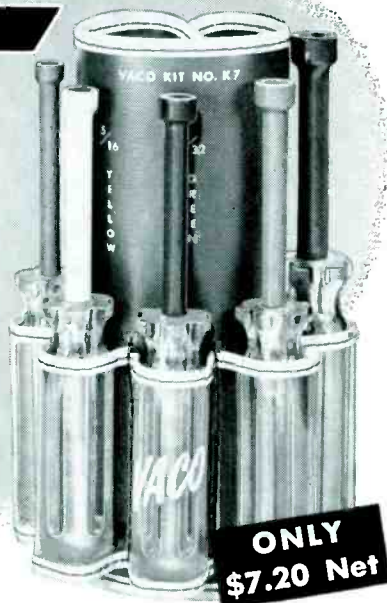

Check These 6 Important VACO Features

NEW! Each size color-keyed!

NEW! All-hollow shafts

NEW! Extra large VACO Comfordome Handles!

NEW! Extra hard long wearing sockets!

NEW! Shafts insulated from handle to tip!

NEW! Available in 4 shaft lengths and 7 Hex sizes!



THIS COUPON WORTH \$1.20

Coupon only valid for use as stated below. Not valid in states where prohibited.

Name.....
Street.....
City..... Zone..... State.....

VACO PRODUCTS COMPANY
317 E. Ontario St., Chicago 11, Ill.
In Canada: Vaco-Lynn Products Co., Ltd., Montreal 1, Que.

Take this coupon to your jobber. It is worth \$1.20 when filled in and used to purchase one VACO K 7 Kit. If your jobber cannot supply you, write direct.

istors, the positive lead should be connected to chassis to measure resistance readings of the emitter and collector, and the negative lead to chassis to measure the base resistance readings. The opposite meter lead connections will apply when *npn*-type transistors are employed. The chart shown in Fig. 3 (p. 22) illustrates the resistance measurements from emitter, base and collector to ground for the circuit of Fig. 1 under different conditions. This chart clearly indicates the transistor effect on ohmmeter readings; chart was compiled from actual measurements on a model T-150 Raytheon transistor radio.

Checking resistance readings from B- to chassis, if a short circuit is suspected, will also require removing all transistors from the radio for an accurate check. The resistance readings will vary from one receiver to another, and will also vary if the transistors are not removed when the meter leads are reversed.

When soldering or unsoldering in a transistor radio, one must use great caution. Transistors are equivalent to crystal diodes as far as heat is concerned; excessive heat can easily damage a transistor. When soldering a transistor lead or soldering a component to a terminal on which a transistor lead is wired, the heat to the transistor should be dissipated in some manner. Either the transistor lead should be grasped with a pair of long nose pliers or a piece of aluminum or copper placed against the lead to draw off the heat. If this is not done, the heat from the soldering iron will travel through the lead to the body of the transistor and may cause permanent damage. In those receivers where sockets are provided for the transistors, the transistors should be removed from the socket before soldering to the socket pins, for the same reason. When attempting any soldering in a transistor radio, a low-wattage small-diameter tip iron is suggested. Heat may also damage other components, such as $\frac{1}{4}$ watt resistors; therefore, it is important to dissipate the heat to these components in the same manner.

The transistor, due to its construction, is practically service free. Unless the transistor is damaged by excessive voltage or heat, its life should outlast that of a tube. Because of the long-life expectancy of the transistor, unlike tubes, the first components checked when trouble is experienced with a tube radio, the transistors should be checked only as a last resort. If a transistor is suspected of

(Continued on page 30)

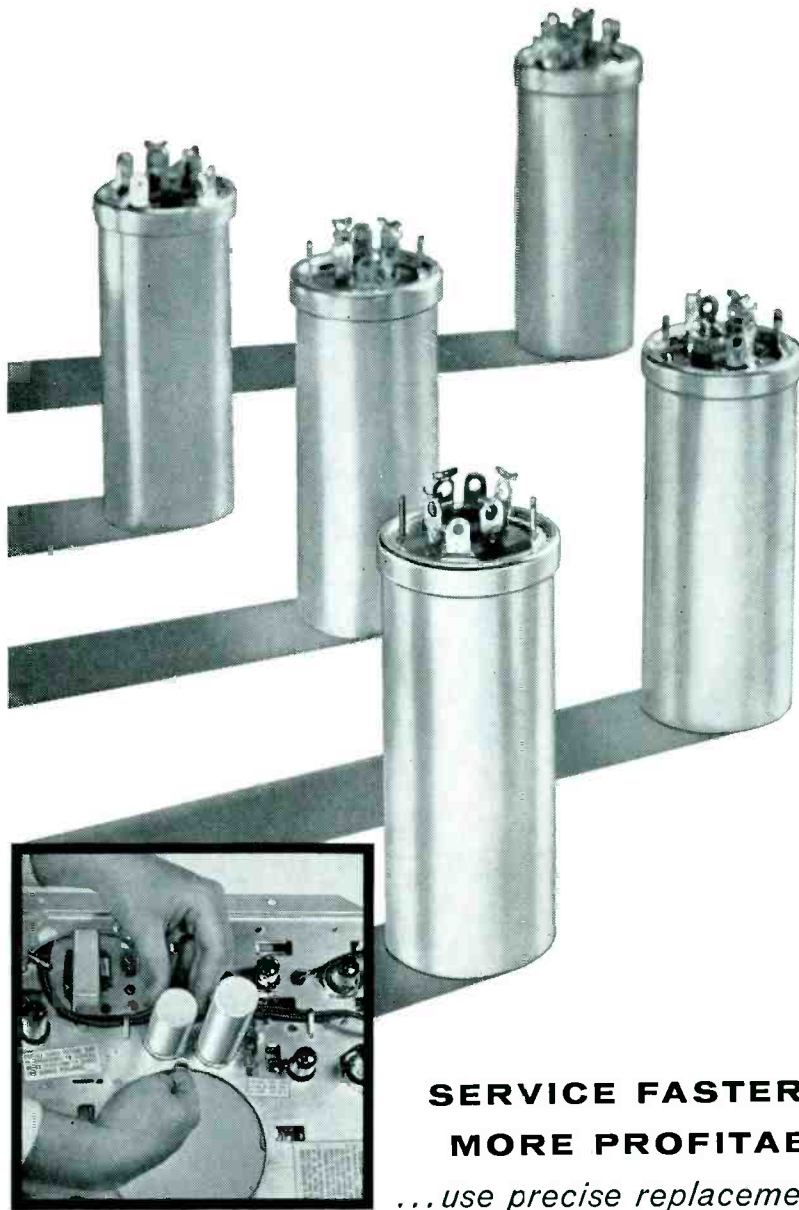

**SERVICE FASTER,
MORE PROFITABLY**

...use precise replacement

RCA SERVICE PARTS

These electrolytic capacitors are exact replacements for the units originally built into RCA VICTOR TV SETS. Mechanically and electrically they fit...exactly right! Like all RCA SERVICE PARTS, they mean faster replacement—less time on the bench. More, too, they help give assurance that *top performance* will be restored.

Stringent manufacturing controls in the production of RCA electrolytic capacitors assure extremely low leakage currents and the ability to handle very heavy ripple currents—*without deterioration*. They have excellent self-healing properties—*for long service life*, and maintain capacitance values under severe variations in temperature.

So, next time you "call" for an RCA Victor radio, phonograph, or TV set, contact your RCA distributor for fit-right, install-fast RCA SERVICE PARTS and *keep your servicing on the go—profitably!*



SERVICE PARTS

® RADIO CORPORATION OF AMERICA, HARRISON, N. J.

RCA VICTOR PRODUCTS • RCA SERVICE PARTS—made for each other!

Troubleshooting Transistorized Radios

(Continued from page 29)

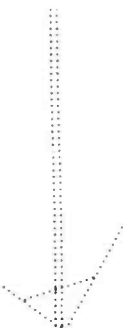

MERIT, first in exact and universal replacement transformers, yokes, coils—the only manufacturer of transformers, yokes and coils who has complete production facilities for all parts sold under their brand name.

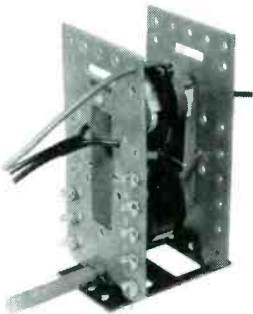

HVO-49 FOR EXACT REPLACEMENT IN AIRLINE, RAYTHEON, TRUETONE. Another in the complete MERIT line of exact and universal replacements—the only single source for all your transformer and coil requirements.

Merit

MERIT COIL & TRANSFORMER CORP.
4427 NORTH CLARK STREET
CHICAGO 40, ILLINOIS



being defective, substitution will be the only reliable check. Checking the resistance readings between the transistor elements with an ohmmeter will indicate only a shorted or open transistor. If the ohmmeter battery voltage is high, damage to the transistor may result; therefore, this method is not recommended.

When inserting a transistor in its socket, one must make sure that the transistor's leads line up with the socket holes, and that the transistor is not inserted incorrectly. Application of the audio and *rf* type transistors are illustrated in Figs. 4 and 5 (p. 23). The audio transistors (CK-721, CK-722, 2N132 and 2N138) have equal spacing between the leads and the *rf* transistors (CK-759, CK-760, 2N111 and 2N112) have unequal spacing. The base lead is always the center or middle lead, regardless of the type transistor. The audio transistors have a red dot on the body of the transistor adjacent to the collector lead, for identifying purposes. The red dot must line up with the dimple provided on the socket or paint dot on the chassis when inserted into the socket. The collector on the *rf* type transistor is that lead which has the greatest spacing from the base lead and is an easy method of identifying the collector lead. If the transistors are soldered in place, extra care should be used to make sure the transistor is correctly replaced. If a transistor is incorrectly inserted into its socket or incorrectly soldered into place, damage to the transistor may result due to excessive voltage being applied to the emitter.

If a transistor substitution is made, especially in the *rf* or *if* circuits, realignment may be required. This may be due to the difference in operating characteristics from one transistor to another. For this reason, it is not recommended that transistors be rearranged from one socket to another.

Similar Socket Uses

Both the audio and *rf* transistors may use the *rf* transistor socket in some radios. The audio transistor leads will then be bent slightly to accommodate the different spacing of the socket pins. The audio transistor socket, due to the equal spacing between the socket pins, may be wired with the emitter and collector pins reversed. Checking the socket will reveal the method of wiring.

Another important consideration when servicing is component replacement. The majority of transistor radios incorporate miniature components. A number of 5 per cent resistors, as well as critical tolerance capacitors, especially in the oscillator circuit, will be found and must be replaced with exact duplicate parts. Replacement transformers also require special treatment due to the low secondary impedance. Speakers also fall into this classification; those used in our chassis have a voice coil impedance of 15 ohms.

As mentioned previously, the battery should be the first component checked when a transistor radio is presented for service. If the battery proves to be in working order, the trouble can be isolated by using a signal generator and listening to the speaker. Circuit tracing from the base of the output stage back through the receiver to the antenna should reveal quickly which stage is not functioning properly. When injecting an audio signal to the base of an audio transistor, a high capacity electrolytic must be used. The negative lead of the capacitor should be connected to the base. A .1 or .5-mfd capacitor should be used when injecting the signal to the base of the *if* or *rf* stages. To inject a signal to the antenna coil, one should connect a loop of wire (approximately 3 turns) to the generator and couple close to the coil.



**DON'T JUST SAY
CAPACITORS**

Ask For Sprague By
Catalog Number

Know what you're getting . . .
get exactly what you want.
Don't be vague . . . insist on
Sprague. Use complete radio-
TV service catalog C-610. Write
Sprague Products Company,
61 Marshall Street, North
Adams, Massachusetts.

SPRAGUE®

WORLD'S LARGEST CAPACITOR MANUFACTURER

Printed-Wiring Servicing

(Continued from page 17)

rosion which would eat away the thin foil. Service Men should also coat the repaired parts and new soldered connections. One must first examine the job to see if there is any excess solder which can cause trouble. If there is none, the area should be coated with a good silicone resin.*

Soldering aids developed for *pw* repair include a soldering brush, solvent for removing the protective coating found on the boards, coating for re-application to new areas, and silver paint for repair to the wiring.

Socket Removal Procedures

Large parts require a different approach to their replacement. Fig. 3 (p. 17) illustrates the way to remove a tube socket mounted on the wiring side of the board. The soldering iron is applied to each lug, one at a time, to melt the solder. A brush can be used to remove some of the solder after which a small blade serves to pry the lug away from the wiring. One must be careful to pry up only the lug, and not the printed wiring. The blade should be placed *between* the lug and the wiring.

After all of the lugs soldered on the wiring side of the board have been freed from the wiring, the iron should be applied to the grounding lug on the *component* side of the board. Then the socket should be pulled slowly from the board as the center lug is freed.

Ground connections are made under the tube socket and to the center lug; it is important to make sure that these grounds are undamaged before proceeding further. Then the board should be cleaned of excess solder and the socket replaced with the same type. One should avoid using any other type of socket.

When the tube sockets are mounted on the component side of the board, the iron can be applied to all lugs including the ground lug, each being bent up from the copper wiring. The lugs should be cut as close as possible to the board, applying the iron again to the ground lug, and removing the socket. After the board is cleaned the new socket can be placed in position; if the fit seems tight the holes may be enlarged slightly.

Modifications of these methods can be followed to other components such as ratio-detector transformers, *if* cans, and other parts.

*For example, *General Cement Print-Kote*.

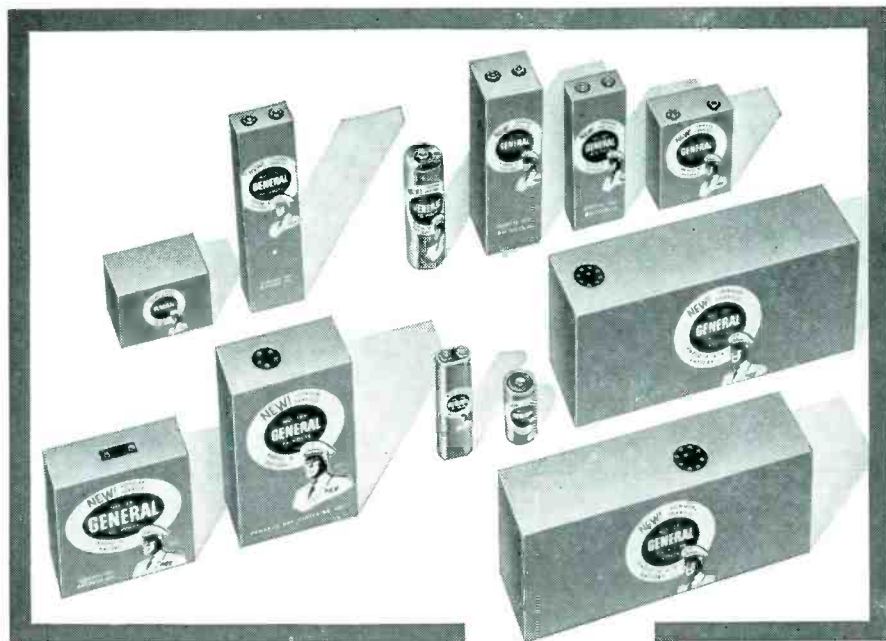

It takes only **12** General BATTERIES to cover 91% of the big-demand, high- turnover Portable Radio Batteries

Contact your jobber or write direct for the *new* General Catalog NC5 with full information on the General line of batteries for portable, personal and pocket radios.

Find out all about the 12 most popular replacement radio batteries . . . including batteries for the new cordless transistor types now just coming into the market.

General is ready for the market . . . has batteries for all types of popular and newly designed sets . . . for example
4-Volt Mercury #696 90-Volt Carbon Zinc #176



FAST DELIVERY FROM 11 CONVENIENT SHIPPING POINTS:

Boston, Mass.; Silver Spring, Md.; Cleveland, Ohio; Atlanta, Georgia; Dubuque, Iowa; Memphis, Tenn.; Dallas, Texas; Denver, Colo.; Los Angeles, Cal.; San Francisco, Cal.; Portland, Oregon.

General

DRY BATTERIES, INC.

13000 ATHENS AVE., CLEVELAND 7, OHIO
BOulevard 2-0030









EXPORT OFFICE: 431 5th Ave., New York 16, New York
IN CANADA: General Dry Batteries, Ltd., Toronto 4, Canada

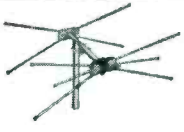

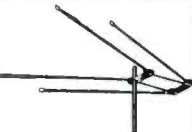
TELCO VHF-UHF ANTENNAS

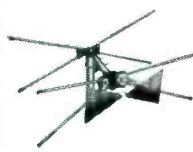
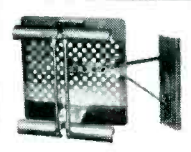
Cover the Mass Market—109 Styles Available
For Every TV Installation

WRITE for your TELCO Catalog or ask your supplier. FREE!

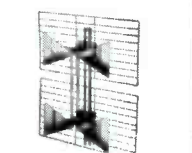
 TELCO ALL-STAR CONICAL A-210	 TELCO MASTER LINE CONICAL A-8700	 TELCO SCOUT 1 CONICAL A-130	 TELCO MITY-V A-9098
 TELCO "STANDARD" GOLDEN HALO A-9000	 TELCO CONICAL UHF- VHF BOW TIE A-8981	 TELCO WINDOW CAN-TENNA A-9058	 TELCO "KING SIZE" GOLDEN HALO A-9020
 TELCO GOLDEN SWITCH-O-MATIC A-8140	 TELCO HI-LOW DIPOLE A-250	 TELCO UHF 16-ELEMENT YAGI A-325	 TELCO UHF DOUBLE BOW TIE A-9004

TELCO ELECTRONICS MFG. CO. Division of General Cement Mfg. Co.

901 Taylor Avenue • Rockford, Illinois

House Current Anywhere

with

Trav-Electric CONVERTERS

Enjoy house current anywhere in car, truck, boat. Just plug into cigarette lighter and operate any A.C. electric tool or appliance, up to 125 watt load. Built for both 6 and 12 volt batteries. List. from \$11.95.

SUMMER SALES Booster

(See chart below). Trav-Electric's peak months are in summer. They help sell phonographs, small radios, electric shavers, etc. For use at beach, camp, picnic. Let Trav-Electric change summer slump into summer sales.

**"101"
USES**

Trav-Electric SALES WILL FILL THE LOW SPOTS

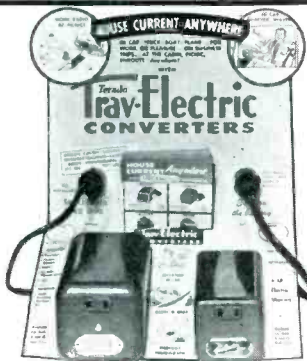
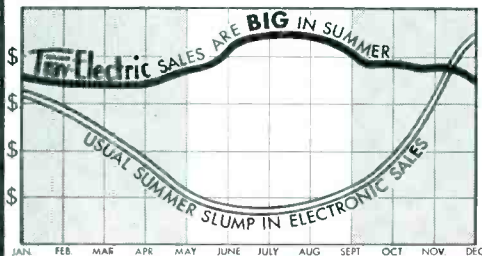

Free

DEALER DISPLAY

(Small—8" x 5" on Counter)

FREE LITERATURE

ORDER NOW

Receive free dealer display, free literature and two models from stock, as shown above, at quantity discount. Shipped direct through your favorite jobber. Order now. . . . Be ready for summer sales.

Write for Particulars

TERADO Company

Designers & Mfrs. of Electronic Equipment
Since 1927

1066 RAYMOND AVE.
ST. PAUL 14, MINN.

NEWS

HOFFMAN OFFERS DOUBLE SERVICE DATA COVERAGE

Subscribers to Hoffman Electronics service data will hereafter receive a bound, indexed book containing schematics, parts lists, tuner data and general service notes on sets at the end of each year.

Bound volume is in addition to the regular mailings of service data at time of set releases. New plan will give Service Men both working and file copies of all Hoffman service data.

• • •

ASTRON BUYS SKOTTIE ELECTRONIC CORP.

Astron Corp., East Newark, N. J., has announced acquisition of Skottie Electronic Corp., Inc., Peckville, Pa. Purchase includes plant buildings and production facilities.

Skottie manufactures disc and tubular ceramic capacitors and subminiature units designed for transistorized and printed circuits.

• • •

UNITED CATALOG OPENS WEST COAST OFFICE

United Catalog Publishers, Inc., have announced the opening of a west coast sales office at 9015 Wilshire Blvd., Beverly Hills, Calif.

Office is headed by Charles H. Mitchell of C. H. Mitchell Co.

• • •

WESTINGHOUSE ADDING TUBE WAREHOUSE

A 120,000-square foot warehouse is being built for the tube division of the Westinghouse Electric Corp., Elmira, N. Y.

Warehouse will handle incoming materials and finished products of the plant; present warehousing areas will be made available for expanded manufacturing operations. Customer service department will also be housed in the new structure.

• • •

NEUTRODE TV TUNER CONFERENCE



Discussing recently developed Neutrode TV tuner developed by Standard Coil Products Co., Inc.: J. R. Johnson (left) technical adviser to company president Glen E. Swanson, and C. A. Swanson, general sales manager.

SPRAGUE SALUTES INDEPENDENT SERVICE MEN THROUGH WINDOW-SIZED POSTERS

Sprague Products Co. has made available to Service Men through their local parts distributors, window-sized 22" x 17" blow-ups of its recent advertisement entitled *Sprague Salutes the Independent Service Dealer*.

The 2-color ad was written to promote the well-deserved patronage, respect, and confidence from the community served by the neighborhood independent Service Man.

Posters may be obtained from all Sprague distributors, or by letterhead request to Sprague Products Company, North Adams, Mass., for poster RP-15.

LESCARBOURA AD AGENCY EXPANDS

Austin C. Lescarboura and Staff, the Adshop, Croton-on-Hudson, N. Y., has expanded into Lesbarboura Advertising, Inc.

The corporation is headed by the original agency's founder, *Austin C. Lescarboura*. His son *Stanley*, partner since '46, has become vice president and treasurer. The corporation has been joined by *Fred P. Donati*, former ad manager of Aero-vox, as secretary.

MMM TAPE RECORDING LECTURE-DEMONSTRATION

High fidelity tape-recording practices were featured in a recent lecture-demonstration by Pat Cafferty, sales engineer for Minnesota Mining and Manufacturing Co., at Federated Purchaser, Mountainside, N. J.

Subjects covered included types of magnetic tape, recording techniques, proper maintenance of equipment, tape storage and demagnetization.

MUELLER TO EXPAND

Mueller Electric Company, 1583 East 31st Street, Cleveland, Ohio, has announced the breaking of ground for an additional 6,000 square feet of production floor space.

NEDA NUMBERED BATTERIES

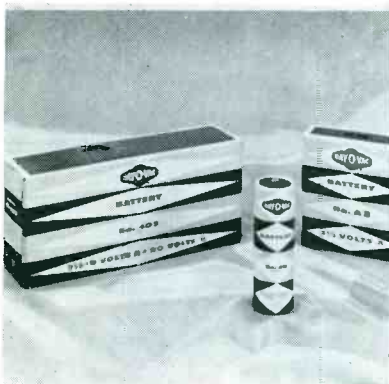

Several of complete line of eighty-seven Ray-O-Vac batteries that will hereafter carry standardized numbers set up by (NEDA). Numbering system announcement was made at start of Ray-O-Vac's 50th anniversary.

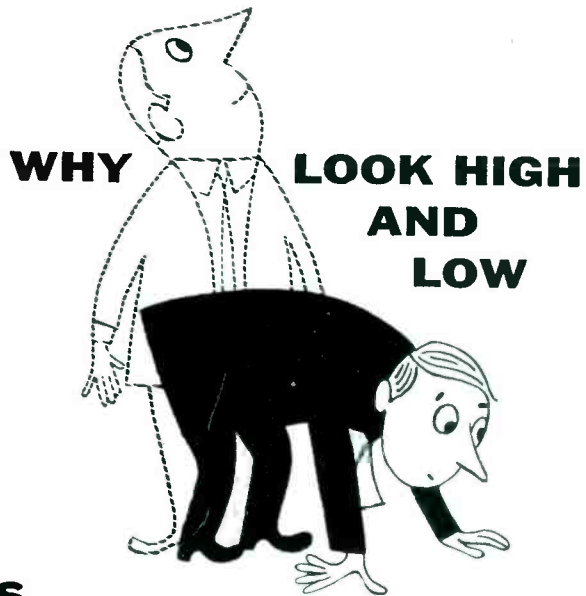

C-D IS THE ONLY COMPLETE LINE OF ELECTROLYTICS

No matter what you need in electrolytic capacitors—*C-D has it*. Every type, shape and rating . . . all of consistent high quality proven by outstanding field performance. C-D capacitors are always reliable . . . and readily available—because Distributors *who know*, carry the complete Cornell-Dubilier line.

Free! TV Capacitor "Replacement Guide"—and C-D Twist Prong Cross Index from your C-D Distributor. He's listed in your local Classified Telephone Directory.

C-D's "UP" twist prong

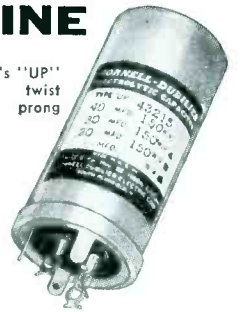

There are more C-D capacitors in use today than any other make.



CONSISTENTLY DEPENDABLE CORNELL-DUBILIER CAPACITORS

PLANTS IN SOUTH PLAINFIELD, N. J.; NEW BEDFORD, WORCESTER AND CAMBRIDGE, MASS.; PROVIDENCE AND HOPE VALLEY, R. I.; INDIANAPOLIS, IND.; SANFORD AND FUQUAY SPRINGS, N. C.; SUBSIDIARY: THE RADIART CORPORATION, CLEVELAND, O

ON TUNE-UP PROGRAM DRIVE

Lioness model appearing in nationwide TV and radio tune-up program urging Service Men to get the lion's share of the service business by promoting local tune-up programs in conjunction with national G.E. five-ring Circus of Values sales program. National magazine ad schedule has been initiated to promote tune-up plans. Ads emphasize that a three-year-old set can be made as good as new by replacing all weak tubes and old picture tubes. As every radio, TV set and record player needs a periodic tune-up for continued peak performance, ads tell the set owner the advantages of contacting his local Service Man and inquiring about a special-price tune-up plan now in effect.



SERVICING HELPS

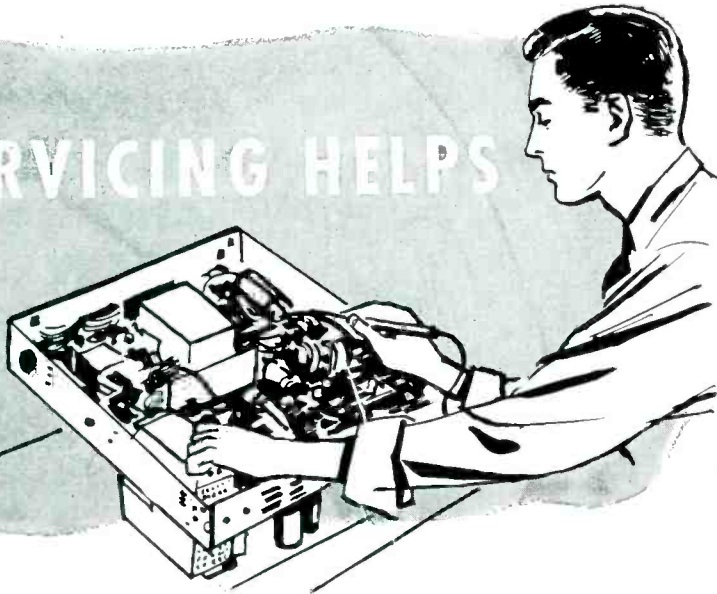

Dual-Selenium Rectifier Horizontal AFC Installation ‡ . . .

Electrolytic Capacitor Rotation

DUAL SELENIUM RECTIFIERS are now being used as a horizontal phase detector in TV chassis to replace the 6AL5s.

In a line of TV chassis, developed by Admiral, the horizontal automatic-frequency control circuit is a balanced duo-diode system, and the common lead of the dual rectifier is connected to a negative sawtooth voltage of 15 v which is obtained from the horizontal deflection yoke. To the positive (cathode) side, negative sync pulses of 15-v amplitude are applied, and 15-v of positive sync is applied to the negative (anode) side. Each rectifier conducts during the horizontal retrace time. The degree of conduction depends upon the phase relationship between the sync and sawtooth volt-

ages. The *dc* path for each rectifier is through a separate 100,000-ohm resistor and then through a common 4.7-megohm resistor. The polarity and amplitude of the voltage developed across this 4.7-megohm resistor will depend upon the frequency or phase relationship of the incoming sync versus the horizontal oscillator frequency. This voltage developed is the *afc* voltage and is applied to the horizontal oscillator to control its frequency.

The rectifier has a rated forward current of 1.5 milliamps at a voltage drop of one volt. Peak inverse volt-

age is 60; peak surge current is 80 milliamps.

In the Admiral circuit typical operating conditions are: inverse voltage, 25; average current through each unit, 50 microamps, and peak current, .8 milliamp.

Typical shunt capacities of the rectifiers range from 80 to 120 mmfd, as compared to about 3 mmfd in the 6AL5. This increased capacity, it has been found, offers no disadvantage in the Admiral circuit because all sources of voltage to the rectifier unit are of relatively low *ac* impedance. The finite back resistance of the rectifiers is high enough so that no circuit compensation is necessary.

The dual selenium rectifier as used by Admiral consists basically of an aluminum base, a layer of selenium, a dielectric barrier and a layer of Wood's metal. These are approximately 3/32" in diameter and are stacked as two rectifiers in series. The total length is less than 3/16". Pig-tail leads are attached and come out as the anode (negative) common and cathode (positive) leads.

For corrosion, humidity, and mechanical protection, the entire unit is encapsulated in an epoxy resin. Stable operation is said to be obtained under temperature extremes from -50° C to well over +100° C.

Besides being able to withstand high ambient temperatures, it has been found, this rectifier develops practically no heat of its own. It has a dissipation of under one milliwatt, compared to just under two watts from the tube counterpart, the 6AL5/3AL5.

The absence of heaters eliminates power line leakage which could affect

(Continued on page 54)

‡From notes prepared by Alfred F. Augustine, Admiral Corp. engineering department.

Horizontal phase detector, with selenium rectifiers, in Admiral TV chassis.

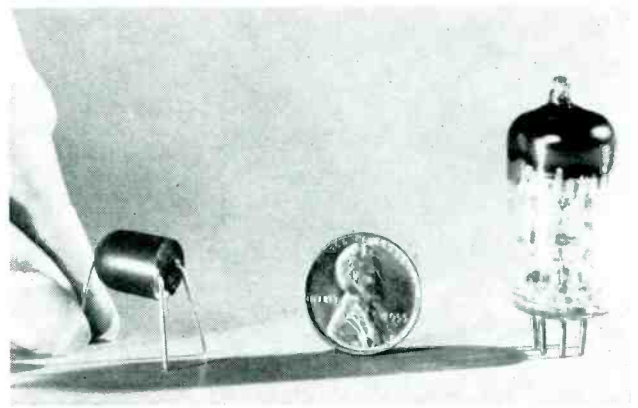
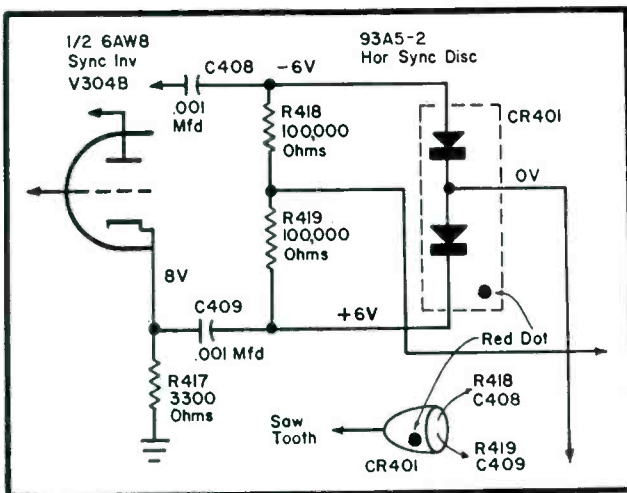

Selenium rectifier (left) which consists of a small piece of selenium metal encased in a protective plastic covering, now being used as a horizontal phase detector in Admiral TV chassis, replacing the 6AL5 tube.

DOUBLE PLAY
for
more
sales

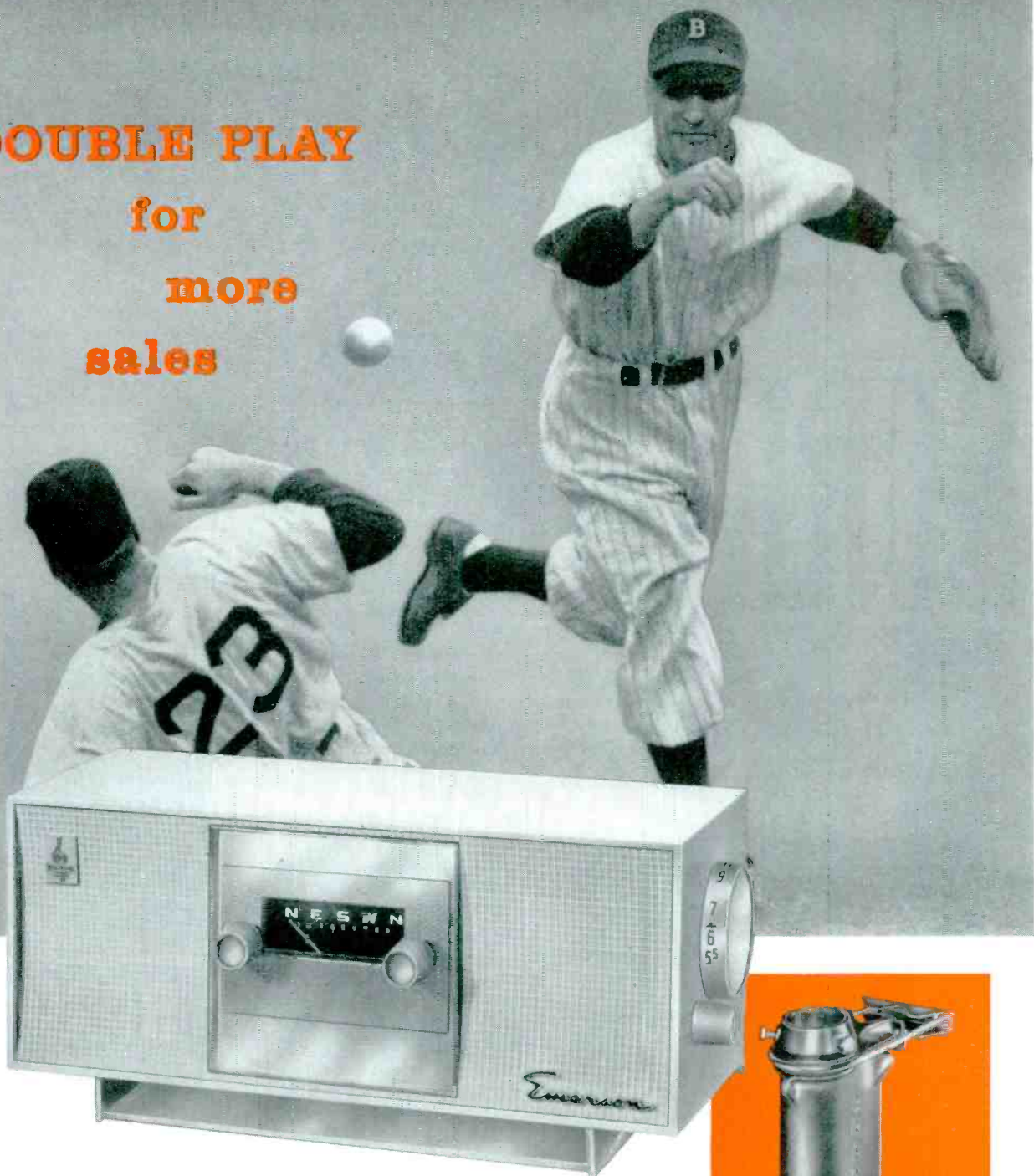

EMERSON-BRACH RADIO-ROTATOR

An exceptionally fine radio coupled with the most scientifically engineered TV rotator on the market today!

This combination is the most practical idea ever presented to the industry and consumer. The rotator control unit is actually housed in the radio cabinet thus eliminating the need for two appliances in the living room. The radio, with its improved superheterodyne circuit, is among the finest ever produced by the Emerson electronic research department.

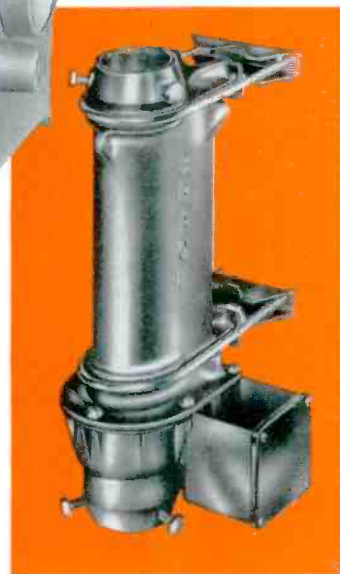

The rotator by BRACH features: flexible worm drive; built-in thrust ball bearing; built-in guy rings with attached guy wire thimble; high rotating torque; automatic drainage and high starting torque motor.



BRACH MANUFACTURING CORP.
DIVISION OF GENERAL BRONZE CORP.
200 Central Avenue
Newark, N. J.



Visit us at Booth #684, Electronic Parts Distributor Show, May 21, 1956 Chicago

to be SURE!

buy
VOKAR

the original-
equipment
VIBRATOR



Leading manufacturers of original-equipment auto-radios specify Vokar vibrators as components for installation on the production-line. Why? They're sure Vokar quality never varies —will always contribute to top performance demanded of today's radios.

You too can depend on Vokar vibrators—for sure starts, longer life, silent operation. For all replacement jobs, buy Vokar Imperial or Quality Brand vibrators to be sure of satisfied customers.

Now is the time to stock up on 12-volt vibrators—**ONLY TWO VOKAR IMPERIALS ARE NEEDED TO FILL ALL REPLACEMENTS!**



VOKAR—preferred by leading manufacturers of auto-radios.

VOKAR

VOKAR CORPORATION
DEXTER 2, MICHIGAN

Progress Report on Auto Radio

(Continued from page 19)

triode. When either search button is depressed, the relay is energized, lowering the bias on the trigger tube. Conduction of the tube holds the relay closed. The relay shorts the output to ground and energizes the motor and a solenoid. The solenoid engages a clutch which allows the motor to drive the tuning shaft.

When the tuner approaches a station, the *if* signal (combined with the *avc* signal) causes increased conduction (during the positive swing) of the trigger detector through the relay tube's grid resistor, cutting off the relay tube. This deenergizes the relay, stopping the motor and disengaging the clutch.

The relay tube must be cut off 2.5 kc before the station, because the tuner coasts 2.5 kc after the relay is deenergized. The *avc* voltage controls the cut-off point.

The sensitivity selected determines whether the set will respond to strong or weak signals. The operator's choice depends upon the reception in the area in which he happens to be driving.

Printed-Wiring Chassis

As in the case of other electronic equipments, plated circuits have advanced into the design of auto radios. They have introduced the problems of fragility and close work. When servicing such a set, extreme caution must be exercised not to expose the circuits to heat, such as might occur through the use of an incandescent lamp. It is normally better to remove a set of this type for examination rather than

try to hold a lamp close to the mounted chassis.

Plated Circuit Repair Tools

When replacing components on a plated circuit, a small soldering iron (40 watts maximum) should be used. The iron should be applied for as short a time as possible. Since all leads are very thin, excessive heat can burn or loosen them from their base material. Damaged leads may be replaced with jumpers on regular hook-up wires, provided their length is identical to the lead being replaced and is kept taut.

DON'T JUST SAY CAPACITORS

Ask For
Sprague
By Catalog
Number

Know what you're getting . . . get exactly what you want. Don't be vague . . . insist on Sprague. Use complete radio-TV service catalog C-610. Write Sprague Products Company, 61 Marshall Street, North Adams, Massachusetts.

SPRAGUE®

WORLD'S LARGEST
CAPACITOR MANUFACTURER

THE NEW No-Noise TUNER TONIC

Volume Control and Contact Restorer with PERMA-Film

2 oz. bottle. Net to servicemen

\$1.00



Cleans, lubricates, protects . . . not a carbon-tet solution. Still available in the new 6 oz. spray can.

Net to servicemen—\$2.25



Also available in 8 oz. bottles and quart cans.

At your nearest distributor.

with PERMA-FILM

Cleans, lubricates, restores all tuners including wafer type. Won't change or affect capacities, inductance or resistance. Won't harm insulations or precious metals, nor attack plastics. For television, radio and FM. Eliminates all noise, oxidation and dirt indefinitely.

Non-toxic, 6 oz. aerosol non-inflammatory can. Net to servicemen

\$3.25

EXTRA economical because a small amount does the job!

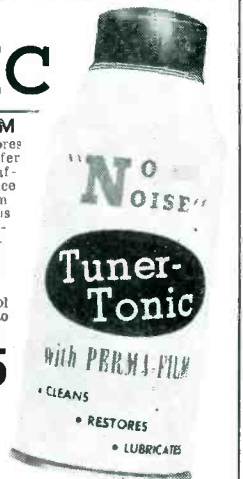

ELECTRONIC CHEMICAL CORP.

813 Communipaw Avenue

Jersey City 4, N. J.

Transistor Car Radio

(Continued from page 16)

properly, the problem is obviously located in the power output stage. In reverse, if the output stage checks out along with the other two stages, the problem in all probability can be located in the tuning circuits.

In either case these are the two new areas where an unexpected problem can arise.

Here are a few service hints to cover the transistor and search tuning circuitry.

The transistor can be expected to give unusually long trouble-free life. However, a coarse check may be made with an ohmmeter. This check primarily measures the ability of the transistor to conduct current in one direction, and to resist current flow in the opposite direction. The resistance in the conduction direction is very low in relation to the resistance in the non-conduction direction. A closer check on the condition of the transistor is determined by its gain. The gain should be over 20. To check the gain, the following procedure should be followed:

Gain Checks

The *dc* voltage drop across the 1500 and 10-ohm resistors should be measured.

The values obtained should be substituted into the following equation: The *dc* voltage drop across the 10-ohm resistor should be divided by the *dc* voltage drop across the 1500-ohm resistor; the results obtained should be multiplied by 110.

Gain =

$$\frac{\text{dc voltage drop across 10-ohm resistor}}{\text{dc voltage drop across 1500-ohm resistor}} \times 110$$

If the search tuning mechanism is not operating the following preliminary checks can be made:

The motor should be checked first; then the search selector switch (E_7), relay (E_8), switch contacts of E_8 relay (to see if they are defective or dirty) and the motor reversing switch (E_9), to see if it's inoperative.

If the tuner sweeps normally, after the search bar is depressed and released, but doesn't select station, two troubles might be present:

Low B+ at relay (E_3) and motor choke coils (L_5 and L_6).

If tuner sweeps but stops the instant either search bar is depressed and released, one should check for a defective 12K5 relay tube, defective 15-ohm resistor (R_{30}), a short to ground of pin 2 of the 12K5 relay

PAYS ITS WAY every day

**TESTS and
REPAIRS
TV PICTURE
TUBES**



**Makes Customers Happy
— Creates New Profits**

Servicemen now earn new servicing dollars in minutes and build satisfied customers—with B&K Deluxe Portable CRT 400.

Spots and corrects picture tube troubles in a few minutes, right in the home, without removing tube from set! Restores emission, stops leakage, repairs inter-element shorts and open circuits. Grid cut-off reading indicates picture quality customer can expect. Life-test checks gas content and predicts remaining useful tube life. Cuts operating costs, eliminates tube transportation. Also saves money on TV set trade-in reconditioning. Profits start the very first day.

**DELUXE CRT 400
with 4½" Plastic Meter**
Weights only 5 lbs. mounted in rugged, luggage style, carrying case covered with handsome, durable leatherette.
Size: 11 x 7½ x 5". Net \$54⁹⁵



ECONOMY CRT 200

Every serviceman can cash in on picture tube repairs with this low priced quick profit maker. Performs most of the functions of the CRT 400. Has 3" meter. In leatherette carrying case.
Size: 11 x 7½ x 5"
Weights 5 lbs. Net \$39⁹⁵

Send for Bulletin 104-S

Made by the Makers of the DYNA-QUIK Tube Tester

B & K MANUFACTURING CO.
3726 N. Southport Ave. • Chicago 13, Illinois



**PROVEN IN
THE FIELD
EVERY DAY
BY OVER
20,000
SERVICEMEN**

tube, defective relay (E_8) contacts, and defective 100-mmfd coupling capacitor.

If tuner does not sweep after either search bar is depressed and the motor does run, one should check the motor coupling spring, solenoid (E_1), control clutch, and for defective or dirty relay contacts.

It is also important to check the antenna connection and make sure that the antenna trimmer is properly adjusted. If the tuner sweeps normally it should stop only on strong stations when the sensitivity control is

in its minimum position, on strong and medium powered stations with the control in its mid position, and on all stations within the range of the radio with the control in its maximum position. If the tuner does not stop as noted, it is necessary to check the *rf*, converter, *if* and detector tubes, antenna trimmer for proper adjustment, poor or insufficient antenna, low sensitivity and defective 12AE6 trigger and 12K5 relay tubes.

If the tuner stops only on strong stations when operated with either

(Continued on page 40)

COLOR-TV Picture Tube Developments

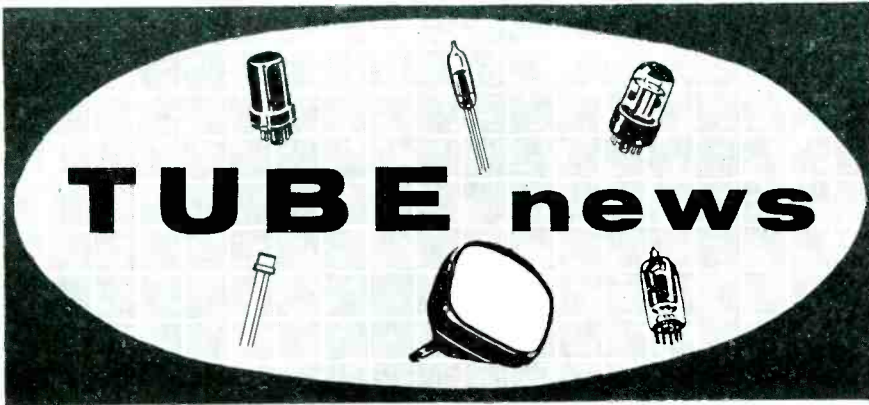

ALTHOUGH THE outward appearance of the tricolor shadow-mask 21-inch round metal picture tube* with its two-piece metal envelope has not been appreciably altered, improvement in performance has been obtained by processing and optical design changes.

An ideal shadow-mask tube should have a phosphor screen completely covered by tangent phosphor dots of uniform diameter. Each of the electron beams should have perfect landing, or be in perfect register with the corresponding phosphor dots, and should have the same diameter as the dots. These ideal conditions were not always achieved with early tricolor tubes because of various electrical and mechanical factors. (1) Radial misregister caused by changes in the effective center of deflection of the deflecting yoke with deflection angle; (2) misregister caused by mechanical distortions of the bulb and mask-frame assembly during processing; (3) effects of the earth's magnetic field; (4) degrouping of the electron beams of a trio with respect to the phosphor dots when dynamic convergence is applied; (5) non-uniform phosphor dot size due to variation of light intensity on the optical lighthouse exposure, and (6) misregister caused by warpage of the aperture mask due to the heating effect of electron bombardment.

Tests Set Up to Study Problems

Various tests have been made to determine the individual contribution and relative importance of each of the foregoing factors.

The discovery of a constant radial misregister in yoke and mechanical

†Based on IRE annual-convention report prepared by R. B. Janes, L. B. Headrick and J. Evans of the RCA tube division.

*21AXP22.

distortion tests suggested that a correction might be made on the optical lighthouse so that the phosphor-dot pattern would conform more closely with the beam-landing pattern obtained, when conventional deflecting yokes are used. The design and construction of a lighthouse construction lens, it was found, served to minimize uniform radial misregister.

By improvements on the deflecting yoke it was found possible to reduce spacing between horizontal and vertical deflection centers. Most yokes include some provision for shielding the low-frequency vertical-deflection field and the high-frequency horizontal-deflection field. A change in the

Silicon power rectifiers, 1N503 through 1N526, said to be capable of operating with high reverse voltages and low reverse currents. This feature, together with a low forward voltage drop, enables the rectifier to deliver large power to the load with relatively little dissipation. Available in three different configurations. Smallest unit is capable of handling 1/3 amp without additional heat radiator, and features pigtail construction for printed wiring application. Second type features screw-type mounting in a small cylindrical package and is capable of carrying 1 amp. Third has a hexagon base screwstud mounting and is capable of handling 1 1/4 amp.
(CBS-Hytron)



materials used for this shielding reduced the spacing between deflection centers, and improved horizontal-vertical registry, without producing any undesirable change in other characteristics of the yoke.

By a change of spacings in the lighthouse photographic process, electron-beam degrouping has been corrected to some extent. The effects of the earth's magnetic field have also been off-set somewhat by shifting the light source in the optical lighthouse.

Although the new optical system is more efficient and provides more uniform radiation intensity over the entire screen surface than a conventional system, it has been found that it is less efficient than direct exposure to a radiation source of suitable shape, radiation distribution, and equivalent brightness. Such sources are being made experimentally and investigated for efficiency, stability and life.‡

Wide-Angle Color Tubes**

THREE-COLOR picture-tube research has disclosed that slit apertures between the wires of a grill can serve as lens elements to focus the electron currents in the three beams onto the appropriate phosphor areas. In the presence of an accelerating field between such a focusing mask and the screen, secondary electrons emitted at the mask as well as high-velocity electrons back-scattered by the screen may be drawn back to the screen, with resulting color dilution and contrast reduction. The addition of a second mesh or grill electrode has been found to eliminate the need for an accelerating field ahead of the phosphor screen, making it possible to avoid color dilution and contrast reduction arising from back-scattered and secondary electrons. Tests have shown that in tubes with flat line phosphor screens and two-wire grills on slightly curved supports, defects introduced by the focusing mask structure can be held small even for an over-all deflection of 90°. Essentially the viewing screen assembly consists of two closely spaced grills mounted less than an inch from a phosphor screen.

Fastening of grill wires to a frame has been done by an electroplating

(Continued on page 40)

**From IRE annual-convention paper by E. G. Ramberg, H. B. Law, H. S. Allwine, D. C. Darling, C. W. Henderson, and H. Rosenthal of RCA Laboratories.



FROM DELCO RADIO come the **speakers** with highest performance. You trust them...so do your customers!

Engineering skills of Delco Radio and General Motors combine to offer a full line of speakers for home and auto radios, phonographs, TV, and Hi-Fi. National advertising behind the Delco Wonder Bar Radio develops a bigger service market for you! For fast service call your UMS-Delco Electronics Parts Distributor.

14 Standard Models: Designed and built to R.E.T.M.A. standards with heavily plated metal parts and Alnico-V magnets. Precision felted cones give uniform response over full operating frequency range. All are fully dustproof and dependable.

Dual-Purpose Hi-Fi Model 8007: A superior speaker for custom-built audio systems and for replacements in AM, FM, TV and phonograph sets. Size 8", 50 to 12,500 CPS frequency range; Alnico-V magnet; 10-watt power rating; 4.1 v.c. impedance; 1 $\frac{3}{16}$ " voice coil.

DELCO



RADIO

DIVISION OF GENERAL MOTORS, KOKOMO, INDIANA



A GENERAL MOTORS PRODUCT — A UNITED MOTORS LINE
Distributed by Electronics Distributors Everywhere

A complete line of original equipment service parts from the
WORLD LEADER IN AUTORADIO

SERVICE, APRIL, 1956 • 39

by
every
test

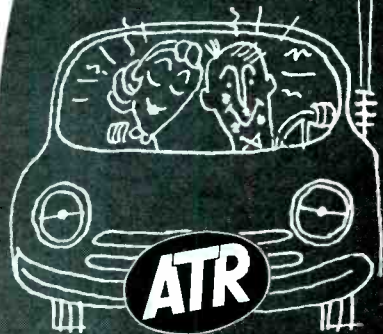

is **BEST!**



ATR AUTO
RADIO
VIBRATORS

Have Ceramic Stack Spacers

**A COMPLETE LINE
OF VIBRATORS**

Designed for Use in Standard Vibrator-Operated Auto Radio Receivers. Built with Precision Construction, featuring Ceramic Stack Spacers for longer lasting life. Backed by more than 22 years of experience in Vibrator Design, Development, and Manufacturing.

Free



"A" Battery Eliminators, DC-AC Inverters, Auto Radio Vibrators



✓ NEW MODELS

✓ NEW DESIGNS

✓ NEW LITERATURE

See your jobber or write factory

AMERICAN TELEVISION & RADIO CO.

Quality Products Since 1931

SAINT PAUL 1, MINNESOTA—U. S. A.

Transistor Car Radio

(Continued from page 37)

search bar, one should check for low sensitivity, proper adjustment of antenna trimmer, poor or insufficient antenna, *rf*, converter, *if* and detector tubes, defective *if* coupling capacitor and defective 12AE6 trigger tube.

Additional Tuner Checks

Lastly, if tuner sweeps normally but stops either before or after the station, one should check input voltage of radio with radio installed in car, value of 100,000-ohm bias resistor (R_{15}), *if* 100-mmf coupling capacitor for leakage, sticky relay contacts, sticky control clutch, tension spring of control clutch, *if* alignment, and binding gears in search unit.

The 12-volt car-battery powered auto radio using a transistor power-amplifier output.



Tube News

(Continued from page 38)

process. Wire vibration, it has been found, can be prevented by using tightly stretched high tensile strength wires. Also of importance is the avoidance of voltage fluctuations between the grills which tend to set up sustained vibrations.

Phosphor screens for experimental tubes have been printed after first determining the location of the phosphor elements by direct exposure of the electron beam on an appropriate sensitive surface.

Delta as well as in-line gun mounts have been employed. An experimental gun constructed with 5/16" cylinders and a convergence angle of 36° has proved effective.

Tubes have been built in 16" round and 21" rectangular cones and satisfactory experiments performed with deflection angles up to 70°.

TRANSMITTER

and

RECEIVER

ENGINEERS

College graduates with 4 years experience for challenging development work on new and unique communications systems. Experience should include one or more of the following:

RF CIRCUITS

HF OR VHF RECEIVERS
AND TRANSMITTERS

AUTOMATIC ANTENNA COUPLERS

FREQUENCY SYNTHESIZERS

*You are invited to mail
your complete resume
to the address below.*

Scientific Staff Relations

HUGHES

RESEARCH AND DEVELOPMENT
LABORATORIES

Culver City, Los Angeles County, California

AUTO RADIO ANTENNAS ... ACCESSORIES

DELCO DUAL AUTO ANTENNA

A dual chrome-plated auto antenna developed for rear deck installation designed by Delco has been introduced through the United Motors Service of General Motors. Antenna packed in a green and yellow display carton, is supplied with mounts, extension leads, clips and necessary fasteners. Base assembly has been designed for top mounting, which provides installation in restricted space often found in rear fender applications. The masts extend to 30" and are of three section design with built-in anti-rattlers.



NEMCO ANTENNA FENDER ADAPTERS

Contour adapters for '56 rear fender antenna installations, have been announced by the National Electronic Manufacturing Co., 186 Granite St., Manchester, N. H.

Adapters provide form-fitting surface for mounting antennas: NA631 is for Plymouth models; NA632 for DeSoto and Chrysler; NA633 for Dodge; and NA634 for Buick, Chevrolet and Studebaker Hawk.

Also available is a 100" telescopic rear mount 4-section antenna, NP82, with a 15' lead-in cable.

Another Nemco auto-radio product is a Gold-Tenna Twin Kit, NT 5300, for rear mounting; consists of two one-section 27" fiberglass antennas plated in simulated gold, one 22' coax cable harness and five cable clips. Also adapted to '56 contour rear fender mounting by use of contour adapters included in kits.

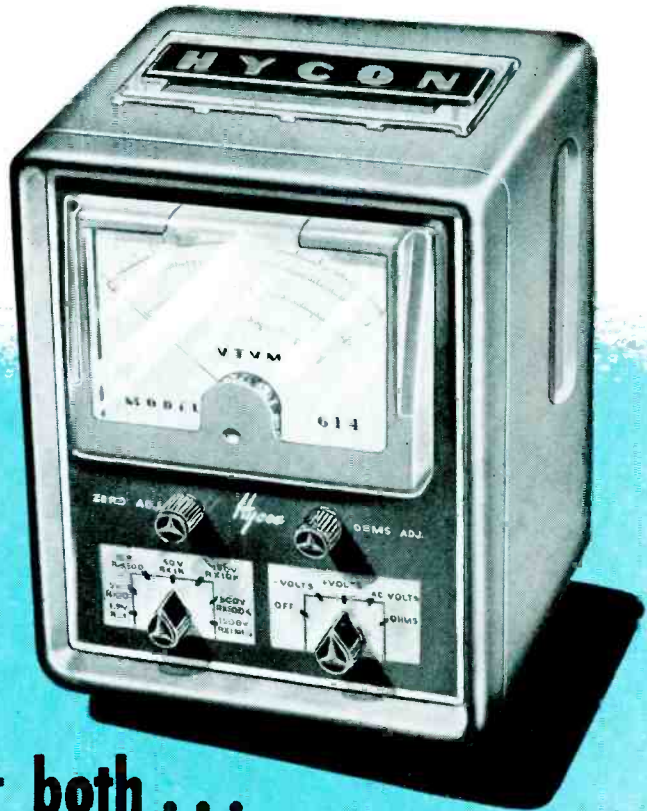
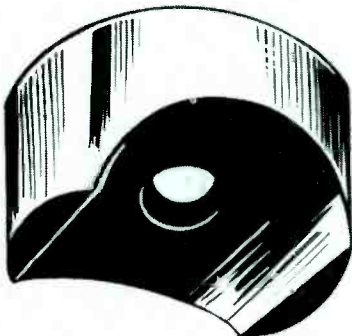

Get both ...
TOP CONVENIENCE
... LOWEST COST

You *expect* accuracy in a VTVM. Hycon's Model 614 offers economy, too ... plus versatility you'd never look for in an instrument of its price. Response to 250 MC (with accessory probes) ... 21 ranges (28 with p-p scales) ... electrostatic and electromagnetic shielding ... and a real convenience for the user: **TEST PROBES STOW INSIDE THE CASE.**

Another Hycon test help ...



**MODEL 617
3" SCOPE**

... gives you a full 3" of undistorted trace on special flat-face CRT. Laboratory accuracy, field ruggedness.

"Where Accuracy Counts"
Hycon ELECTRONICS, INC.

A Subsidiary of Hycon Mfg. Company
321 SOUTH ARROYO PARKWAY
PASADENA, CALIFORNIA

**Send
TODAY
for latest
catalogs**

HYCON ELECTRONICS, INC., Dept. S
P. O. Box 749
Pasadena, California

Send the latest catalogs on Model 614 and Model 617.

Name

Address

City State

the 1956

**BURGESS
PORTABLE
RADIO
BATTERY
PROMOTION**



POWERFUL FRESH!

Here's a power-packed promotion that's fresh as a spring breeze, designed to help you build record sales in the 1956 Portable Battery season. See your distributor for full information on America's most complete portable battery line.

*freshest
idea of
the year!*



Window Display Card

Here is a brand new card—big enough to make a real eye-catching display. Increases battery sales.



Replacement Battery Stickers

Put one of these on every battery you sell, or in the radio set, and you've increased your chances for repeat business on both the Burgess battery and radio repair set. These handy little stickers have a place for the battery number.

See your Burgess Distributor for Full Information



New Window Banner

Big attractive window or counter banner directed to the portable battery customer. Fresh new theme ties-in with other Burgess sales aids to increase sales impact in your store. Free!

Modern picture chart, replacement guide and cross reference chart all combined into one attractive wall chart! Clear photos of most popular sets now in use make it easy for your customer to order the right battery—and prompts him to buy on impulse! Complete replacement guide to all brands and models, with up to date cross reference chart included, puts all pertinent information right at your fingertips, in one place! This is the "stickiest" and most effective merchandising idea to be introduced since Burgess first introduced the illustrated set chart. Ask your jobber for yours. It's Free!

CATALOGS — BULLETINS

THE TRIPLETT ELECTRICAL INSTRUMENT CO., Bluffton, Ohio, has published a booklet, *Scope Connections*, by Vern L. Walker, covering elementary data on scope functions and use in servicing. Copies are available from Triplett at \$2 each.

TUBE DIVISION, RCA, Harrison, N. J., has issued a revised edition of the 28-page booklet, *RCA Receiving Tubes for AM, FM, and Television Broadcast*, giving characteristics of more than 600 RCA receiving tubes. TV pix tube information is presented in a chart which lists and describes 75 types. Priced at twenty-cents per copy.

MINNESOTA MINING AND MANUFACTURING CO., 900 Fauquier St., St. Paul, Minn., has released a bulletin, *Sound Talk 31*, covering the effect of coating thickness on frequency response, optimum recording conditions, bias and audio-recording currents and their effects on high and low-frequency response of tapes with various oxide coating depths. Four charts are included.

ELECTRO-VOICE, INC., Buchanan, Mich., has issued a 5-page bulletin, 222, with data on high fidelity power amplifiers, amplifiers with controls, and music control centers with preamplifiers.

NATIONAL ELECTRONIC MANUFACTURING CO., 186 Granite St., Manchester, N. H., has published a '56 auto antenna brochure covering its complete line for the car radio market.

INTERNATIONAL RESISTANCE CO., 401 N. Broad St., Philadelphia 8, Pa., has issued a 12-page catalog bulletin *C-la*, with data on construction, features, types, ratings, terminations and leads, coating, insulation and windings of tubular and flat power wire-wound resistors.

TRIAD TRANSFORMER CORP., 4055 Redwood Ave., Venice, Calif., has released an auto-radio replacement guide, AR-56, listing recommended Triad replacement transformers for nearly 500 auto radio models, including several 12-v models.

THE GENERAL ELECTRIC tube department, Schenectady, N. Y., has released a quick selection chart (*ETD-1163-A*) listing G.E. 600-milliamperere series-string receiving type tubes. The chart classifies the 48-tube types according to elements; lists typical service, heater voltages, maximum plate and screen dissipation ratings; and gives average characteristics.

TEN YEARS AGO IN SERVICE

PRODUCTION OF FM AND FM/AM SETS on a wide scale, which it was estimated would bring 2-million chassis into the field before the close of the year, stimulated tremendous interest in outdoor FM antennas and prompted announcements of a variety of FM antennas and accessories. Service Men began schooling themselves in the basics of FM receivers and antennas and learning all about techniques that must be followed to install properly outdoor FM antennas and twin leads to get maximum reception. . . . The FM trend alerted associations who set up day and night clinics under the direction of antenna and receiver engineering reps. A number of set makers sent field engineers across the country to address associations in those cities where FM broadcasting was most active. . . . The boom in FM and its impact on the service industry was covered in an exclusive report in *SERVICE*. . . . Issue also featured highlights of the annual May Parts Show. . . . A window display, featuring the returning Service Man theme, was announced by the radio tube division of Sylvania Electric. . . . Hytron Radio and Electronics Corp. purchased Air King Products Co., Inc., Brooklyn, N. Y. . . . J. M. Lang was appointed manager of the tube division of the G.E. electronics department.

Associations

TESA, Kansas

TELEVISION ELECTRONIC SERVICE Association of Kansas, Inc., an affiliate of NATESA, has been incorporated under the laws of Kansas. At the present time the organization consists of state headquarters and three chapters: Wichita, Salina and Midwest.

Officers of the state group are *William Nichols*, president, and *E. A. Redmon*, secretary.

President of the Salina chapter is *John Doud*; *Melton Shelton* is secretary.

Harry Wright is president of the Midwest chapter and *Ralph Renfro* secretary. This chapter, formed recently, is expected to have more than 50 charter members. Plans have been made for educational meetings and group advertising.

The Salina chapter has appointed a committee to investigate the possibilities of setting up a licensing plan for members and non-members.

The Wichita chapter, which recently has been reactivated, will elect its officers soon.

* * *

TSA, Seattle, Wash.

AT A RECENT MEETING of the King County Television Service Association the following officers were elected for '56: *Bob Kelly*, president; *Harold Hart*, vice president, and *Clayton Faller*, secretary.

* * *

ETA, Jamestown, N. Y.

AT THE ANNUAL ELECTION meeting of the Electronic Technicians' Association of Jamestown the following officers were reelected for '56: *Herm Seehausen*, president; *George Carlson*, secretary, and *Kerm Johnson*, treasurer. *Gordon Atkins* was elected vice president.

* * *

Eau Claire, Wisc.

DURING THE RECENT National TV Servicemen's Week the engineering staff of WEAU and WEAU-TV, Eau Claire, held open house during the evenings for association members and others in the Eau Claire area. Visitors were shown latest b-w and color-TV equipment used by the station and familiarized with the operations and problems encountered by the broadcaster. *T. Jorgenson*, chief engineer of the stations, conducted the tours.

* * *

RTA, Akron, O.

THE AKRON RADIO TECHNICIANS' Association has elected *John Kranshan*, president; *William Arnold*, vice president; *John Reitz*, secretary, and *Jack Brenn*, treasurer.

* * *

At City Hall presentation of special service ethics placque to *Victor Blanc* (left) district attorney in Philadelphia, by association heads, during recent TV Servicemen's Week. *William Poole*, president of the Philadelphia Radio Service Men's Association, made presentation. Observing, from left, are: *Albert M. Hass*, president, Television Contractors Association; *Ray Cherrill*, president, Northeast Television Dealers Association, and *Harrison Neel*, president of the Television Service Dealers Association.



A-M-P

terminals

your best
connection
for
dependability
and
quality

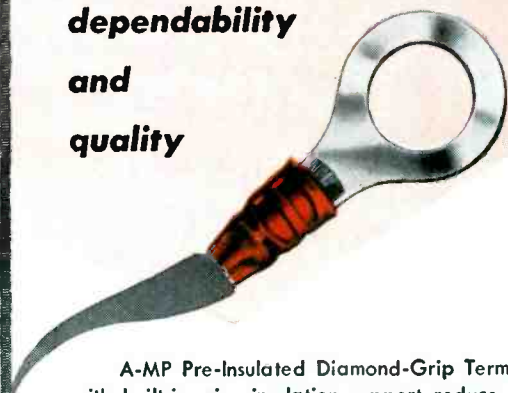

A-M-P Pre-Insulated Diamond-Grip Terminals with built-in wire insulation support reduce your maintenance cost... because they insure perfect electrical connections under the most exacting conditions. You don't have to worry about replacement.

The A-M-P Pre-Insulated Diamond-Grip Terminal is not affected by heat or cold, and vibration won't cause broken strands. Moreover, PIDG colored insulation shows you at a glance which wire size it accommodates and which tool connects it. No errors... no loss of time... and a lot of saving!

API branch warehouses in major cities stock popular A-M-P terminals and tools for maintenance and repair purposes. An API representative can prepare a Custom Fitted Kit containing just the items you need. Contact your nearest API office.



api

*TRADE MARK

AMERICAN PAMCOR, Inc.
Subsidiary of Aircraft-Marine Products, Inc.
181 Hillcrest Ave., Havertown, Pa.

Atlanta, Ga.
Boston, Mass.
Chicago, Ill.
Cleveland, O.
Dallas, Texas
Detroit, Mich.
Hawthorne, Cal.
Maplewood, N. J.
Philadelphia, Pa.
Pittsburgh, Pa.
St. Louis, Mo.
San Francisco, Cal.

Below: Method devised to check record player for wow and flutter. Right: Checking tape for wow or flutter defects.

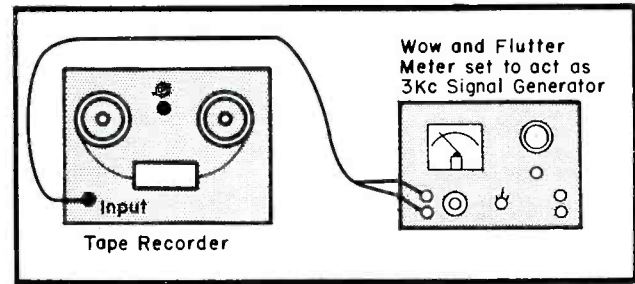
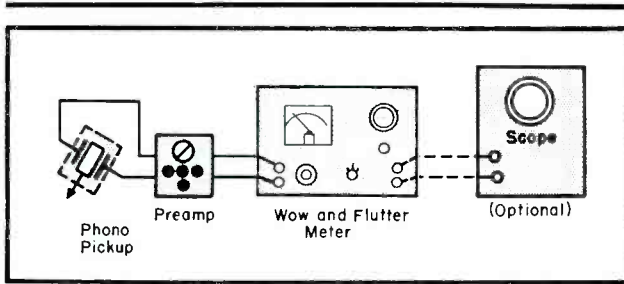

Probing For WOW and FLUTTER In Tape Recorders and Phono Players

by LEO SANDS

IN SPITE OF FINE AMPLIFIERS and elaborate loudspeaker systems, many disc and tape reproducing systems fail to provide satisfactory results.

The problem does not obtain because of deficiencies in the amp or speaker. Both can be designed or adjusted to favor certain frequencies over others; thus, reproduction can be modified to suit individual tastes and to compensate for the widely differing frequency responses of recordings and pickup devices. The defects appear because undesired variations in speed are introduced at the record player or tape recorder, and these variables cannot be compensated for or filtered out in the amplifying system.

These speed variations, known as *flutter* and *wow*, have existed for a long time in record players. However, with the advent of 33 $\frac{1}{3}$ and 45 record players and the campaign to sell better audio, *flutter* and *wow* have become acute problems.

Many older record players (and some new ones) just were not properly designed or built to provide quality sound. With many kinds of records, particularly dance music, they may get by; but, with piano records or during sustained passages, the results are usually horrible.

When all standard records were of the 78 variety, the problems were fewer. First, the frequency response was much narrower and flaws were not as glaring. In fact, most listeners were content because they didn't know there was anything better.

Radio set owners, in the early days, were accustomed to limited frequency

response and lots of boom-boom. When a record player was plugged in or if the radio was combined with a phono, the average listener set the tone control to attenuate the highs. The distortion was so bad that *wow* and *flutter* went unnoticed. Besides, the higher-speed record players suffered less from these maladies, because minute speed variations were smaller in relation to speed of rotation and thus had less effect on reproduced frequency.

Professional 33 $\frac{1}{3}$ Records

The *lp* record was not new from the standpoint of its 33 $\frac{1}{3}$ speed; this has been the standard speed for professional sound transcriptions for many years. Records on the market 14 years earlier were played at 33%. In '34, several manufacturers introduced radio-phonos with two speed record players capable of handling both 78 and 33 $\frac{1}{3}$ records. However, the resulting sounds were often miserable due to *wow* introduced by the record turntables.

Back in '28, when talking pictures were new, many of the sound systems installed in theatres left much to be desired. Although the frequency range of the systems in those days was more limited than it is today, the primary irritants were *wow* and *flutter*. The old sound-on-disc theatre sound systems used 16-inch discs recorded at 33 $\frac{1}{3}$ rpm. On the larger theatre sound systems, the results were pretty good. But on some of the systems made by the smaller companies, piano reproduction particularly was,

almost unbearable, even to a non-critical ear.

The bigger professional sound systems sounded better because unusual control devices were built into the players. An electronically-regulated constant-speed motor, not dissimilar to modern devices used in precise manufacturing operations, and a mechanical filter arrangement contributed toward eliminating *flutter* and *wow*. Most of the smaller sound systems used a flywheel to filter out some of the speed variations.

At 78 the situation is not so difficult, as explained. But at 33 $\frac{1}{3}$ we have a tough problem to resolve. The turntable, motor and other mechanical parts must be manufactured to much closer tolerances and must be more carefully assembled. There can be considerable difference in performance between two supposedly identical record changers, turntables or players. Both, designed to be alike, can become damaged or fall out of adjustment somewhere along the line. Perhaps it had not been properly checked.

In many instances, high-priced radio-phonos and hi-fi assemblies initially delight the dealer, the installer and the customer. But several days later, irritated customers often report that something has happened: "Liberace sounds like he has the shakes." Or perhaps the voice says: "Stokowski sounds like Spike Jones." *Flutter* and *wow* rear their ugly heads.

To detect *wow* and *flutter*, a number of manufacturers have even fitted

their production lines with special instruments. Generally these instruments are cumbersome, rack-mounted devices abounding with knobs and levers.

Recently, portable *wow* and *flutter* meters have been developed for service shop use. With one of these⁹ it is possible to read directly the percentage of *wow* and *flutter* present in the output of a phono record changer, player or turntable, as well as that of a tape recorder.¹

This *wow* and *flutter* meter is actually an FM receiver with a vacuum-tube voltmeter reading demodulated output. It measures the frequency modulation introduced by the mechanism of a record player or tape machine, expressed as a percentage of an arbitrary carrier frequency (3 kc). To check a record player, a tone record (such as the 33 $\frac{1}{3}$ Dubbings D-100) is placed on the turntable and the pickup is set on the unmodulated 3,000-cycle section of record. If a crystal pickup is used, its output is fed directly to the input of the meter. A preamp must be used when the output of the pickup is less than .1 volt rms, as is the case with variable reluctance pickups.

The *wow* and *flutter* meter is tuned to the recorded frequency by means of a tuning knob; proper tuning is indicated by a magic-eye tube. The *eye* will not close unless there is a proper input signal within the range of 2800 to 3200 cps. *Flutter* and *wow* can be measured separately, or the value of both *flutter* and *wow* combined can be read on the meter, by turning a selector switch. Another switch is used for changing range; 3%, 1% and .3% full-scale.

When frequency modulation of the test signal occurs at the rate of .5

(Continued on page 51)

⁹Donner model 28 *wow* and *flutter* meter.

¹It has been suggested that a *flutter* meter is useful in checking *wow* and *flutter* content of electronic organs, particularly the Hammond, which uses a motor-driven tone wheel system. *Wow* is often encountered when the organ is operated from a farm lighting plant or other non-utility power source whose frequency is not constant.

Fig. 3. Testing tape recorder for *wow* or *flutter*.

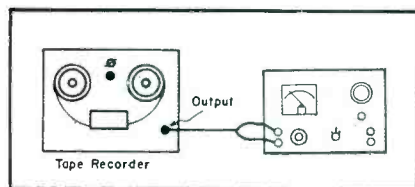

Your Future in Microphones...TODAY!

A S T A T I C

FUTURA

DYNAMIC MICROPHONES

Vogue 988



for Hand



for Lavalier

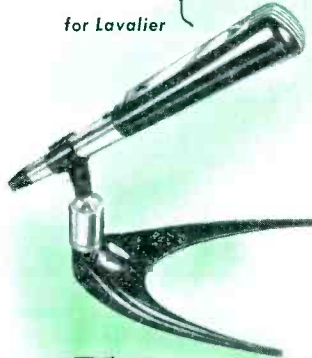

Tempo 888

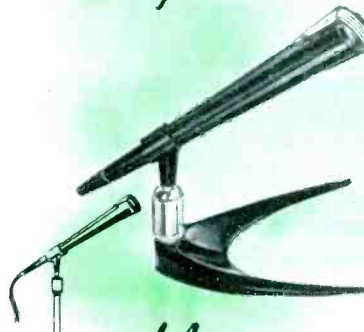

for Stand

Metro 788

High Fidelity Dynamic Professional Microphones, Specifically Designed for Telecasting, Broadcasting, Recording, Public Address and Communications

Here is a dramatic new concept in microphone design . . . the incomparable "FUTURA" series! Striking beauty, all-around versatility, and electronic engineering of the highest quality are combined in each of these slender, distinctive instruments. Never before has any one series of microphones brought so many startling "firsts" to the industry!

FIRST with high fashion-styling . . . non-reflecting satin black finishes . . . brushed chrome or gold trim . . . subtle color touch for a new note of smartness.

FIRST with Astatic "quick connect" adaptors to permit permanent cable installation . . . take the mike to the cable!

FIRST with diaphragm made of DuPont "Mylar", newest and strongest of plastic films, to provide the ultimate in shockproof, weatherproof construction.

For Complete Information & Specifications, Write Today for Our New Illustrated Catalog, No. S-438!

THE **Astatic** CORPORATION, CONNEAUT, OHIO

KNOWN THE WORLD OVER

IN CANADA: CANADIAN ASTATIC LIMITED, TORONTO, ONTARIO

Export Sales Representative: 401 Broadway, New York 13, N. Y. Cable—ASTATIC, New York

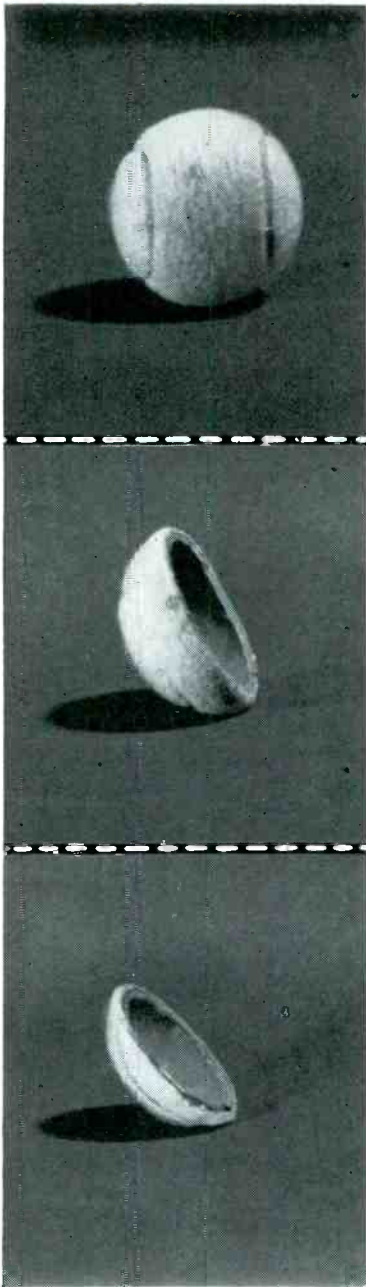

Want to cut each call your salesman makes right down to 1/3 the time? Sell more phonograph needles, sell them faster? Duotone lets your salesman perfect the fastest service yet. With an automatic inventory-control system on stub of each Duotone needle package. Retailer tears off, keeps stubs. Your salesman picks up stubs for reorder as fast as a professional tennis player picks up a ground ball. Sensational! (A sensational package all around — the only package with a testing area for used needles, too.) Better find out about Duotone Automatic Selling Plan. Gives your salesman an easy win over any competition.

THE DUOTONE COMPANY

Keyport, N. J.

MANUFACTURER SUPPLIER

Audio

(Continued from page 47)

ative. This plate resistance, in conjunction with the circuit capacitance, causes a high-frequency rolloff, the frequency of which is dependent upon the relative values of resistance and capacitance. If either resistance or capacitance changes, the position of the roll-off changes and this is just what happens during an audio waveform, due to fluctuation of plate resistance.

This could be a cause of intermodulation, if the rolloff occurs in the audio band. To illustrate, suppose two tones are being reproduced, such as a lower one in the region of 200 cycles and a higher one near the upper end, say 10,000 cycles. Due to the change in high-frequency rolloff at different points on the 200-cycle waveform, the amplification of the 10,000-cycle wave will be varied, and this is a form of intermodulation.

This is one reason why feedback amplifiers should have their response extended well beyond the audio range. Intermodulation of audio frequencies cannot occur then, but the response of the over-all amplifier still changes at different points on the waveform; sometimes at one point on the waveform the peak goes so high as to start oscillation.

Then one of two things can happen, following the pattern of the single-tube variety of parasitic oscillation. Either the oscillation will build up and take over so as to become continuous; or as the audio waveform changes the operating condition again the parasitic oscillation will die out, and the result will be a burst of oscillation at a certain point on the audio waveform. In either case the cure is similar.

The oscillation occurs because the amplifier does not really have a sufficient margin of stability. It would not require very much more feedback to make the amplifier go into continuous oscillation. Reducing the amount of

Fig. 5. An alternative position for the phase shift capacitor met on some amplifiers.

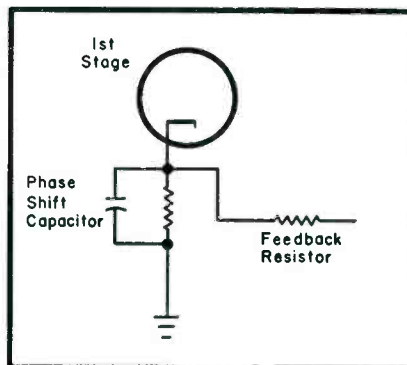

HUSH

Reg. U.S. Pat. Off.

**Chemically engineered
for tuners and switching
mechanism**



6 oz.
Spray
can

\$2.25
net

Hush comes in a 6 oz. pressure can with sufficient pressure to reach all contacts to wash-away that dirt, leaving clean and positive contacts, protected with a lasting lubricant film. Hush does not affect inductance, capacitance or resistance. Hush also available in 2 oz., 8 oz. and 32 oz. containers.

Free literature available.

See your distributor
or write to

**CHEMICAL ELECTRONIC
ENGINEERING, INC.**

Matawan, N. J.

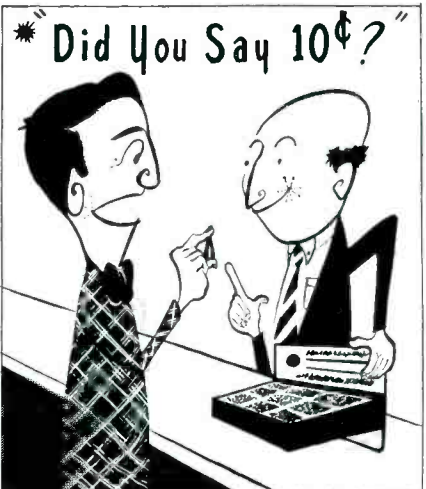

**"YES, I Said 10c for These
Vital Items of Electronic
Test Equipment."**

*Famous headline by courtesy of Model Tobacco Co. In this day of high-priced, high-powered electronic test equipment, Mueller Clips still sell for pennies!

Simple and efficient, they do the most vital job of all—completing the all-important circuit. Our new miniature clips—particularly the "Mini-gator"—do the job in the tightest spots you can find in today's miniaturized equipment.

Send to factory for FREE CATALOG and FREE "MINI-GATOR" (miniaturized) test clip.

MUELLER ELECTRIC CO.

1573Y E. 31st St., Cleveland 14, Ohio

feedback by raising the value of the feedback resistor is a certain way to cure this kind of parasitic oscillation, but this may not be too desirable because it reduces the available feedback in the amplifier; this means that its capability of reducing distortion, increasing damping factor, and the other things for which feedback is applied, are also cut down. So the better approach is to try and increase the margin of stability without cutting down the amount of feedback.

Phase-Shift Capacitor Value Changes

This can usually be achieved by modifying the value of phase-shift capacitors in the circuit. Most feedback amplifiers use a small phase-shift capacitor somewhere in the feedback network, or in some part of the amplifier. It may be across part of the feedback resistor as shown in Fig. 4 (p. 47), or across the cathode resistor of the input stage as at Fig. 5. In other amplifiers it may be combined with a resistance across one of the plate coupling resistors as at Fig. 6.

One must determine which of these arrangements is used to achieve high-frequency stability in the amplifier under consideration, and then experiment with changes in the value of capacitor. However, one should not be too drastic in these changes. Suppose the value connected is a 68-mmfd capacitor. Then one should try the effect of a 47 or a 100-mmfd unit; one of these should show an improvement and the other a deterioration in the condition. It may be that one of them will effect a complete cure; if not, a little further change in the direction which shows improvement should be tried. If the change from 68 to 100 shows an improvement but does not quite stop the oscillation, a 120 or 150-mmfd capacitor should be installed.

It is important to realize the critical nature of the operation of high feed-
(Continued on page 50)

Fig. 6. Another alternative arrangement for obtaining the necessary phase shift capacitor. Here both the resistor and capacitor may have critical values.

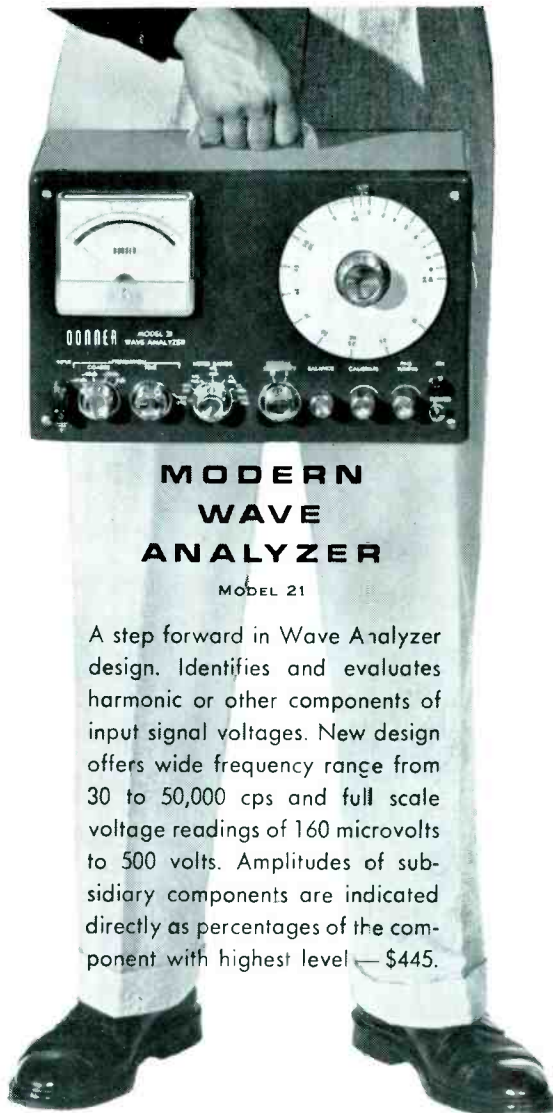
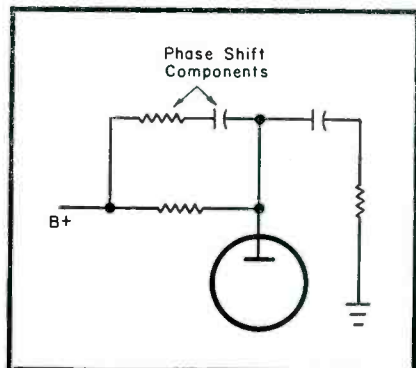

MODERN WAVE ANALYZER

MODEL 21

A step forward in Wave Analyzer design. Identifies and evaluates harmonic or other components of input signal voltages. New design offers wide frequency range from 30 to 50,000 cps and full scale voltage readings of 160 microvolts to 500 volts. Amplitudes of subsidiary components are indicated directly as percentages of the component with highest level — \$445.

ADVANCED INSTRUMENTATION



WOW AND FLUTTER METER

MODEL 28

An all new instrument for measuring phenomena that can be expressed as frequency or phase modulation of an audio frequency. Completely portable. Meets all applicable requirements of the IRE, SMPTE and ASA — \$295.

DONNER SCIENTIFIC COMPANY

2860 7th Street, Berkeley 10, California
all prices f.a.b. Berkeley, California

Write for specification sheets on the above instruments and the complete Donner line of advanced instrumentation

NEW!

A more durable easier-to-use SERVICEMAN'S CARRYING CASE

- more durable
- more compact

TNT
TUBE'N TOOL
TOTE BOX



Holds As Many As 250 Tubes and a Complete Set of Tools!

"Terrific", say radio-TV servicemen. "Best-designed carrier ever made!" Extra rugged, extra roomy — holds all your tools and up to 250 tubes, standing upright for easy identification. Removable tray with compartment and side pockets keep everything in view. A real time and temper saver, built by men in the know, and priced to save you money. Model 55. 19 3/8 x 9 3/8 x 14 1/4".



Really Rugged!

- Supports 350 lbs.
- Tough 1/4" plywood throughout
- Leatherette lined and covered
- Tough, top-grain cowhide corners
- Metal bottom studs
- Lifetime handle
- Positive draw bolt lock and key

Manufacturers
of
**LEATHER
GOODS**
Since 1926

Write for information, prices, catalog sheets
... on complete line of TNT Tote Boxes.

MASTRA COMPANY
2104 Superior Ave., Cleveland 14, Ohio

Canadian Distributor
TENATRONICS LTD., New Market, Ontario

Audio

(Continued from page 49)

back amplifiers. For this reason a drastic change such as, for example, from 68 to 220 mfd could well jump from one region of instability clear into another, while there may be a stable region somewhere in between.

If you find that trial of various capacitors between these values (using the same example) results in instability all the way, but that the best value for minimizing it is somewhere in the middle, then another approach is necessary to eliminate this parasitic oscillation. You can settle for the value that produces the minimum effect; you will then have to change the feedback to completely eliminate it.

It may not be necessary to reduce the total amount of feedback employed. Most feedback amplifiers use a long loop and a short loop. A typical amplifier of this type is illustrated in Fig. 7. Having obtained the best results possible by changing the phase-shift capacitor value, you can try altering the distribution of long loop and short loop feedback, again only changing resistor values by small intervals. The resistance value of R_1 might be lowered and R_2 increased. Each should be changed by one step in the 10% preferred value range. This may well finish off the parasitic oscillation entirely. If not, but some improvement is shown, a second step in

Fig. 7. Adjusting distribution of total feedback between inner and outer loops, by means of R_1 and R_2 , will help where no value of phase shift capacitor (not shown here) succeeds. This is a simple single ended job, intended for inexpensive high quality low power, but the same method is applicable to more complicated amplifiers of similar type, using push-pull output arrangements.

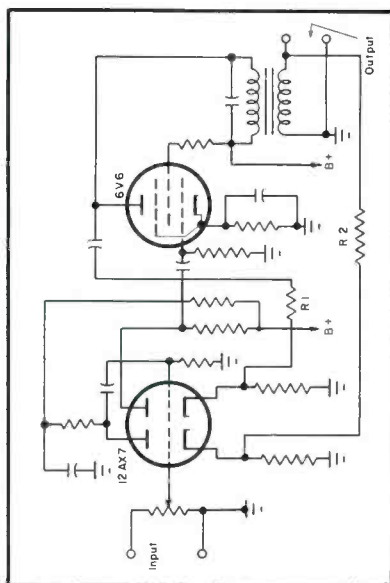

Quickly locates
"TOUGH DOGS"
Senco
Tube
and
Capacitor



Leakage Checker
Model LC-2

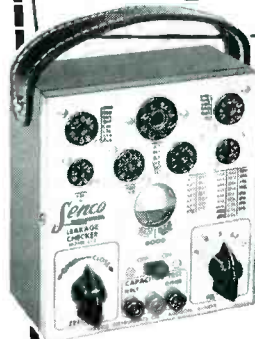

Dealer Net

\$19.95
Kit

Complete with
test leads.
Simple to
operate.

\$24.95
wired

"Two Testers In One"

Now—checks 70 critical tube types

- Quickly locates tubes with gas, grid to cathode or heater to cathode leakage, and grid emission in RF, IF and AGC Circuits.
- Only type tester that finds all tubes causing picture overload, low sensitivity, poor sync, etc.
- Checks all capacitors for leakage with voltage applied.

At Leading Distributors!

Mfg by

SERVICE INSTRUMENTS
COMPANY

171 OFFICIAL ROAD • ADDISON, ILL.

DON'T JUST SAY CAPACITORS

Ask For Sprague By
Catalog Number

Know what you're getting . . .
get exactly what you want.
Don't be vague . . . insist on
Sprague. Use complete radio-
TV service catalog C-610.
Write Sprague Products Com-
pany, 61 Marshall Street,
North Adams, Massachusetts.

SPRAGUE®

WORLD'S LARGEST
CAPACITOR MANUFACTURER

New SUPEREX

7" LOOPSTICK®

List
2.25



KING SIZE
Loopstick outper-
forms them all. "Q"
up to 425. . . like add-
ing another stage of IF. Meets
the most severe requirements.

SUPEREX YONKERS,
N. Y.

the preferred value range should be tried.

The foregoing procedure is applicable to any amplifier that shows this trouble. However, if the amplifier is one that has been clear of this trouble in times past, but has suddenly developed it, the approach should be somewhat different. Obviously some condition in the amplifier must have changed for the parasitic oscillation to start up. Perhaps a resistor value has changed somewhere or a tube has deteriorated. All Service Men are familiar with the procedure for checking tubes and resistor values; but in testing out an audio amplifier in which this kind of trouble appears, the important thing to realize is that *comparatively small changes in components can be responsible for setting up this condition.* So, if you find a resistor specified as a close tolerance value that has changed appreciably, even though it may not be more than 10%, this could well be the cause of the trouble, and the resistor should be replaced with a new component, after checking that its value is within tolerance. Replacing any tubes that may be off their rating, and any close tolerance resistors and capacitors that may have drifted, will usually restore such an amplifier to its normal operating condition.

Wow and Flutter

(Continued from page 45)

to 10 cps, the phenomenon is called *wow*. Above 10 and up to 300 cycles, it is called *flutter*. Phono record players more often suffer from *wow*, whereas tape and wire recorders are more subject to *flutter*. However, both *flutter* and *wow* plague all types of reproducers.

The output of a typical low-priced record player often contains about .2% of *wow* and 1% *flutter*. However, many of the better playback turntables show as little as .5% combined *wow* and *flutter*. High-priced professional tape recorders have less than .1% *wow* and .2% *flutter*. Many of the lower-priced tape recorders are unsatisfactory for high-fidelity music reproduction in spite of the advertised frequency response characteristics, because of relatively high *flutter* in the output. However, during speech reproduction, the *flutter* may go unnoticed.

To check tape recorders, a standard 3,000-cps tape is used, if available; otherwise, a 3,000-cps signal is recorded on a length of blank tape. When a test tape is made, the 3,000-

(Continued on page 52)

Give customers "hi-fi satisfaction" —profitably!

THE BRILLIANT NEW "3" SERIES SONOTONE CERAMIC

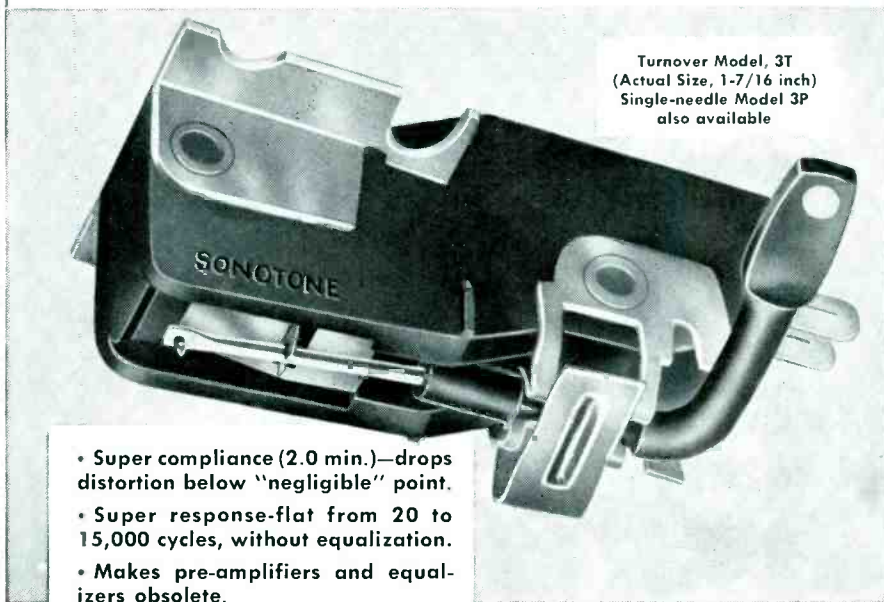

If you've followed the development of ceramic cartridges since Sonotone pioneered them in 1946, you know of their enormous advances.

Now Sonotone presents the "3" Series, which sets utterly new standards of performance and opens the door to profitable "hi-fi" business for you.

The Sonotone "3" Series ceramic cartridge can be used as a replacement in nearly any phonograph circuit. It delivers a brilliance and clarity of sound which will be noticed and commented upon by delighted customers. Because these cartridges deliver a whopping 0.5 volts (roughly 50 times as much as most velocity types), they do not need preamplification and equalization circuits. And naturally the non-magnetic structure eliminates motor hum.

There are two basic models, a turnover (3T-S) for all record speeds and a single-needle model (3P-1S) for 33 and 45 rpm records. They have standard 1/2 or 5/8 inch mounting centers and fit any of the widely used tone arms. Prices begin at \$12.50 list (sapphire needles).

Use the brilliant new Sonotone Series "3" on your next replacement job. You'll find yourself on the way to profitable "hi-fi" business.

SONOTONE®

CORPORATION, ELMSFORD, N. Y.



Write Department CS-46 for free cartridge replacement chart

In Canada—Atlas Radio Corp., Ltd., 50 Wingold Ave., Toronto

KESTER

KESTER SOLDER COMPANY
4248 Wrightwood Avenue • Chicago 39, Illinois
Newark 5, New Jersey • Brantford, Canada

Absolutely non-corrosive and non-conductive, KESTER "RESIN-FIVE" CORE SOLDER contains an activated type of resin that gives you that fast, positive action on all your jobs . . . including the most difficult.

SOLDER

AMPLIFIERS for Public Address

Backed by the world's greatest performance record for power at low cost!

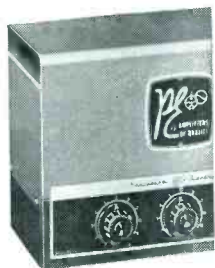

3 Popular Sizes

10, 15 and 30-watt power output. Available with phonograph top or as a complete portable ready-to-use system including microphone, speaker and case. Engineered for top performance and easy operation. A model for every need.



Send for FREE New Catalog!



PRECISION ELECTRONICS, INC.
9101-S King Ave., Franklin Park, Ill.

Name _____

Address _____

City _____ Zone _____ State _____

106-55



"I will not dance — not until you get a JENSEN NEEDLE for that machine!"

Wow and Flutter

(Continued from page 51)

cps cycle tone can be obtained from the flutter meter itself. The tape is then played back to the meter; wow and flutter are read in the same manner as with records.

The meter consists of a limiting-type tuned amplifier which feeds a signal of constant amplitude to a discriminator. The magnitude of frequency modulation present in the signal is indicated by a *vum* calibrated in per cent. Although the amplifier within the meter is tuned to 3 kc, a 1-kc signal may be used in lieu of 3 kc; the limiting amplifier generates a third harmonic (3 kc), which serves the same purpose as if a 3-kc signal were used. However, about 5 volts of 1000-cycle signal must be furnished for proper operation.

Scope may be connected to the output of the meter to obtain visual indication of the character of the wow and flutter. Usually the scope pattern can be used to identify such troubles as faulty gears, defective drive wheels (flat spots), bent shafts, worn bearings, eccentric capstans, etc.

In addition to checking of sound reproducing devices, the wow and flutter meter can be used for measurement of variations in the speed of other types of mechanical, optical and magnetic recording, reproducing and information-storing equipment.

Service Men using flutter meters can determine what makes and types of record and tape players are superior and what it takes to iron out flutter and wow. He will be substituting precise electronic methods for the fallible human ear.

Miniaturized phono cartridge which (top left and top right) consists of a miniature nylon case, 1/4" x 3/4", enclosing a ceramic generating element to which synthetic sapphire or natural diamond tips are directly connected. Three mounting mechanisms (lower left) are available: Fixed mount for single speed machines and turnover, and turnover mounts for multiple speed machines. Can be mounted into tone arm having standard 7/16", 1/2", or 5/8" mounting centers. (Power Point; Electro-Voice, Inc., Buchanan, Mich.)



Latest in Audio

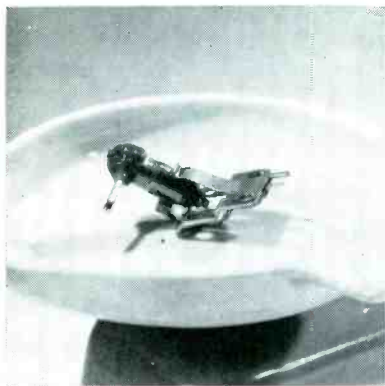

(Above)

Turnover throwaway type ceramic phono cartridge with both osmium and sapphire needles. Snap-in action said to locate automatically the single needle replacement in proper alignment. Cartridges available with one, two or three-mill size tip features. (American Microphone, affiliate of Elgin National Watch Co., Elgin, Ill.)

(Below)

Remote speaker with 4" speaker, a four-position switch and volume control. Supplied with 35' of three-conductor wire. With the remote speaker both remote speaker and TV speaker can be cut off; speaker at TV set can operate while the remote speaker becomes inoperative; both TV set speaker and the remote speaker can operate simultaneously; and remote speaker can operate while the TV set speaker will become inoperative. (Sutton Electronic Co., Inc., 426 W. Short St., Lexington, Ky.)



(Left)

Subminiature pm speaker (1 1/2" in diameter by 15/16" deep) designed primarily for transistorized circuitry. Magnet is Alnico 5; voice coil impedance is 10 ohms. Total weight of the unit is 1 7/8 ounces. (Argonne Electronics Manufacturing Corp., 27 Thompson St., New York 13, N. Y.)

(Right)

12-watt compound diffraction projector with two coaxially-mounted diffraction horns that work from opposite sides of a single diaphragm. Acoustical application of optical slit diffraction principle is said to give 120° sound distribution up to 10,000 cps. (Model 847CDP; Electro-Voice, Inc., Buchanan, Mich.)



There are many reasons why you should use

QUAM

Adjust-a-Cone®

SPEAKERS

- Adjust-a-Cone® Suspension
- U-Shaped Pot
- Heavier Magnetic Structures
- Factory packaged
- Universal Mounting Brackets
- Baked Aluminum Finish
- Listed in Counterfacts and Photofacts

but it all comes down to this...

*ask for QUAM, the quality line,
for all your speaker needs*

QUAM-NICHOLS CO.

232 East Marquette Road
Chicago 37, Illinois

Your customer can hear the Quality that is built into every Quam Speaker

**what
you want ...**

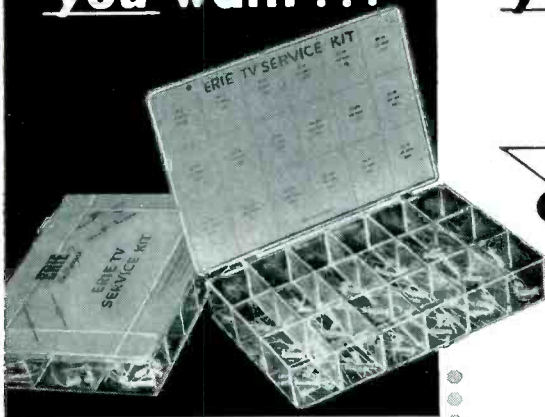

HERE'S WHAT YOU GET

- ① 63 High Stability ERIE Disc or Tubular Ceramicons
- ② 18 Popular Values
- ③ Handy, Convenient 18 Section Plastic Storage Case
- ④ Exceptional Value

ERIE Disc and Ceramicon Service Kits are also available

**when
you want it
with an**

**ERIE
CERAMICON®
TV SERVICE
KIT**

HERE'S WHAT YOU SAVE

REGULAR PRICE
63 Piece ERIE Ceramicon Assortment \$15.00
18 Section Plastic Case 1.75
Total Value \$16.75
YOU PAY \$10.65
YOU SAVE \$ 6.10

**ORDER NOW
From Your
ERIE
DISTRIBUTOR**



ERIE ELECTRONICS DISTRIBUTOR DIVISION
ERIE RESISTOR CORPORATION
Main Offices: ERIE, PA.
Factories: ERIE, PA. • LONDON, ENGLAND • TRENTON, ONTARIO

for service and lab. work

**Heathkit
PRINTED CIRCUIT
OSCILLOSCOPE KIT
FOR COLOR TV!**

① Check the outstanding engineering design of this modern *printed circuit* Scope. Designed for color TV work, ideal for critical Laboratory applications. Frequency response essentially flat from 5 cycles to 5 Mc down only 1½ db at 3.58 Mc (TV color burst sync frequency). Down only 5 db at 5 Mc. New sweep generator 20-500,000 cycles, 5 times the range usually offered. Will sync wave form display up to 5 Mc and better. Printed circuit boards stabilize performance specifications and cut assembly time in half. Formerly available only in costly Lab type Scope. Features horizontal trace expansion for observation of pulse detail — retrace blanking amplifier — voltage regulated power supply — 3 step frequency compensated vertical input — low capacity nylon bushings on panel terminals — plus a host of other fine features. Combines peak performance and fine engineering features with low kit cost!

**Heathkit TV
SWEEP GENERATOR KIT
ELECTRONIC SWEEP SYSTEM**

② A new Heathkit sweep generator covering all frequencies encountered in TV service work (color or monochrome). FM frequencies too! 4 Mc — 220 Mc on fundamentals, harmonics up to 880 Mc. Smoothly controllable all-electronic sweep system. Nothing mechanical to vibrate or wear out. Crystal controlled 4.5 Mc fixed marker and separate variable marker 19-60 Mc on fundamentals and 57-180 Mc on calibrated harmonics. Plug-in crystal included. Blanking and phasing controls — automatic constant amplitude output circuit — efficient attenuation — maximum RF output well over .1 volt — vastly improved linearity. Easily your best buy in sweep generators.



**Heath
COMPANY**
A SUBSIDIARY OF DAYSTROM, INC.
BENTON HARBOR 11, MICH.
WRITE FOR FREE CATALOG
...COMPLETE INFORMATION

Servicing Helps

(Continued from page 34)

the *afc* voltage and show up in the picture as a bending or weaving.

The selenium rectifier adapts readily into printed circuit wiring, or to the conventional wired-in chassis.

Electrolytic Capacitor Rotation

ELECTROLYTICS installed in radio and TV sets require periodic use to keep them in good working condition. However, many fail to realize that the same constant reforming technique is required for electrolytics in stock. The shelf life of such capacitors is about six months.

It is therefore extremely important that the stock be used up on a first-bought, first-used basis. If reformation is necessary, the capacitors should be connected to the *B+* supply from any TV or radio set that will deliver a voltage as high as they are to be used on. A current-limiting resistor should be placed in series during the reforming process to limit the current to not more than about 5 milliamperes.

Let us suppose that 450 v is the *B+* supply. Even with a shorted capacitor, the resistor should limit the current to 5 ma; 5 ma is 5×10^{-3} ampere. Thus, the ohmage is $450 / (5 \times 10^{-3}) = 90 \times 10^3 = 90,000$ ohms. Since the wattage dissipated is I^2R , $W = (5 \times 10^{-3})^2 \times 90 \times 10^3 = 2.25 \times 10^{-3}$ or well under a half watt. Therefore, one should reform for about 10 hours or so, depending upon the voltage drop across the resistor; less than 10% of the total *B+* should appear across the resistor.

NEDA TRIBUTE



Harry Resnick (right), president of the Channel Master Corp., accepting a plaque, in behalf of his brothers Joe and Lou Resnick, founders and owners of the company, from NEDA's board chairman, Aaron Lippman, in recognition of: "their personal integrity and unflinching efforts to advance the interests of the electronics industry." The occasion of the presentation was a testimonial dinner given in honor of the Resnicks for their service to the Ellenville community by community leaders, friends, neighbors, business associates, and employees.

PERSONNEL

RICHARD A. KLEINE is now sales manager of the Rohn Manufacturing Co., Peoria, Ill.



Richard A. Kleine



R. D. Gawne

RUSSELL D. GAWNE has been appointed general sales manager of General Cement Manufacturing Co., Rockford, Ill. Formerly sales manager of the G-C Electronics division, Gawne will now be in charge of sales for the parent company as well as all divisions; others include Telco Electronics and Television Hardware Manufacturing Co.

ALBERT COUMONT, formerly service coordinator and staff assistant to the parts division of RETMA, has joined the Sprague Products Co., North Adams, Mass.

ARTHUR Z. ADELMAN has rejoined the Leon L. Adelman Co., 25 Chittenden Ave., New York 23, N. Y., after a tour of duty with the United States Army.

EDWARD BERLIANT is now president of the newly formed Ebcor Electronics Co., Inc., 87 Merrick Road, Baldwin, N. Y., engaged in packaging and distribution of Dow-Corning silicone products marketed under the trade names of *Silikone* and *Sil-Lube*. Company also manufactures marine radiotelephone antennas, antenna conversion kits, test equipment, tools, pin straighteners and other Service Man aids. . . . ROBERT M. KUHN will serve as vice president.

W. ROPP TRIPLETT, has been named president of the Triplett Electrical Instrument Co., Bluffton, O.; he was formerly general manager. . . . RAY L. TRIPLETT, founder, has resigned as president to become chairman of the board of directors.

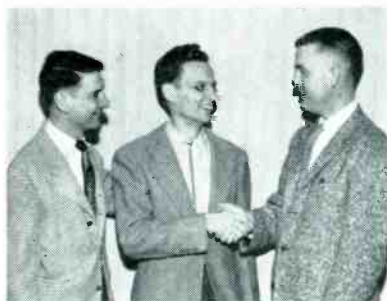

W. Ropp Triplett (center) receiving congratulations on becoming prexy from Norman Triplett (right), sales manager, and M. Morris Triplett, vice president in charge of engineering.

Time for REPLACEMENT?

Specify
OXFORD
SPEAKERS

Speakers is our prime business and we supply more of the BEST manufacturers of original equipment. Since we have quality replacement speakers for any and every application . . . you will actually better the original sound with OXFORD SPEAKERS.

Why wait . . . find out TODAY why more and more servicemen are switching to OXFORD SPEAKERS . . . when it's time for replacement!

Our latest catalog is available . . . write today!
...at better jobbers!

OXFORD ELECTRIC CORPORATION

Distributor Sales Division

556 West Monroe Street, Chicago 6, Ill.

In Canada: Atlas Radio Corp., Ltd., Toronto

Export: Roburn Agencies, New York City



J. P. BROCKI has been appointed TV service manager of the TV and broadcast receiver division of Bendix Aviation Corp.

LEE BALLENGEE, JR., has joined CBS-Hytron, 32 Green St., Newark 2, N. J., as eastern district sales manager. . . . HERBERT L. REICHERT is now midwest regional manager for CBS-Hytron Sales Corp., 4935 W. Fullerton Ave., Chicago, Ill.

JAMES H. CARMINE has retired as president of Philco Corp., Philadelphia 34, Pa. . . . JAMES M. SKINNER, JR., will succeed him.

HAROLD F. COOK is now director of advertising and market research of Tung-Sol Electric. R. M. ANDREWS has been named manager of ad and sales promotion for electronic products; E. G. HAZELTINE, manager of ad and sales promotion for automotive products, and G. A. MORGAN, manager of market research.



Left to right: H. F. Cook, R. M. Andrews, E. G. Hazeltine and G. A. Morgan.

FRINGE . . . COMMUNITY-TV Antenna Installation Tips

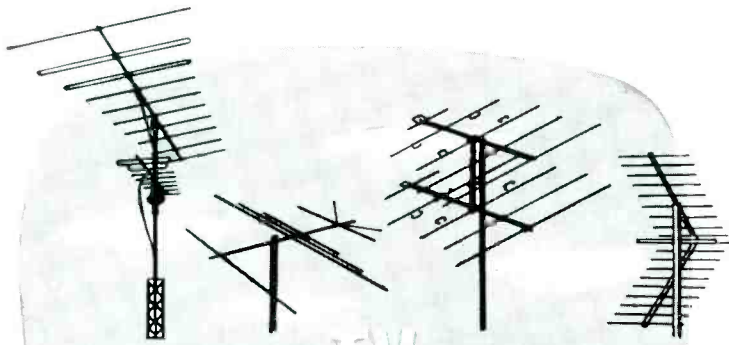

UHF-VHF ANTENNA DIGEST

DESIGN • APPLICATION • INSTALLATION • SERVICE

ANTENNAS located in a diffraction zone (where the signal is diffracted from the curve of the earth and the signal decreases rapidly with distance) which may be from 40 to 80 miles away from the transmitter, are the key to more gain. Also, tests have revealed that receiver output increases rapidly with increased elevation of the antenna, at least up to several hundred feet. It is in this area that we find medium fringe and community-TV installations.

At greater distances the signals available through diffraction around the earth become extremely weak, and reception might be expected to be non-existent. But tests have indicated that signals do exist at distances far greater than one would expect. The

zone in which this occurs is known as the *scatter* or *radio twilight zone*.

In the scatter region (distances greater than 120 miles) experiment has shown that very little is gained by increasing antenna elevation above 5 wavelengths. However, increasing the *gain* of the receiving antenna works essentially as well as it does in zones nearer to the transmitter.

The variation of signal strength between day and night is due largely to the variation of moisture gradient. In the early evening on a still, clear night the ground and the air near the ground may cool off much more rapidly than the air high above the

**Based on NCTA-conference analysis report prepared by Lester C. Smith, chief engineer Spencer-Kennedy Labs.*

ground. Thus the moisture content near the ground may increase more rapidly than the moisture content at higher elevation.

At times, when a brisk wind is blowing, the air is thoroughly mixed, and the refraction gradient index will most probably resemble that of the standard atmosphere. As a consequence, reception may be expected to be only moderately good during times of a brisk wind.

Ionospheric reflection must also always be considered in DX TV reception. The frequencies used for TV are so high that reflection by the ionosphere, the phenomenon so important between 2 to 20 mc, is quite uncommon. Very long distance reception sometimes observed is not usually due to ionospheric reflection, but more likely due to super-refraction. During periods of extremely high sun-spot activity, brief moments of long distance reception due to ionospheric reflection can occur on lower channels.

Another installation factor to consider are obstacles such as mountain ridges or peaks between the transmitter and receiver, so located that the signal strength at the ridges is very high. One will find that at particular locations in the shadow of this ridge, the signal strength will be somewhat higher than one would expect without the obstacle. This phenomenon has been described as *obstacle gain* or *knife-edge* (Continued on page 63)

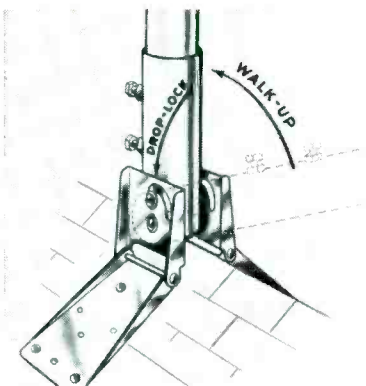

Roof mounting device with walk-up drop-lock feature which enables one to walk the antenna mast from a horizontal position to a vertical position in the mounting, without the necessity of removing and replacing any bolts or nuts which hold the mast socket. As the mast is elevated to a vertical position device allows mast to drop and lock at that point. (South River Metal Products Co., Inc., 377-379 Turnpike, South River, N. J.)



High to low-channel vhf crystal-controlled converter for community-TV. Unit is said to supply over 33-db gain through a low-noise grounded-grid amplifying circuit. Up to 1 volt rms maximum output available at either of two 75-ohm outlet fittings. A third 75-ohm fitting handles input from high channel yagi antenna. (Model MVC; Blonder-Tongue Lab. Inc., 526-536 N. Ave., Westfield, N. J.)

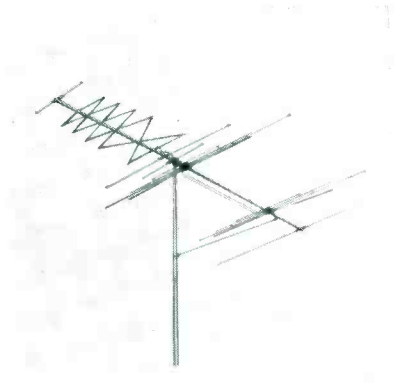

Antenna said to be custom-designed to reject co-channel interference on channel specified. Rear section incorporates a poly-phase dipole with reflector custom-cut to pick up the offending channel in phase opposition to the forward section. The resultant signals are combined in a harness. (Shut-Out Helix: JFD Manufacturing Co., Inc., 6101 16 Ave., Brooklyn 4, N. Y.)

how long would it take you to solve this service problem?

SYMPTOM: Sound bars in the picture. Bars vary in intensity and position according to the audio being transmitted. Need for alignment has been established.

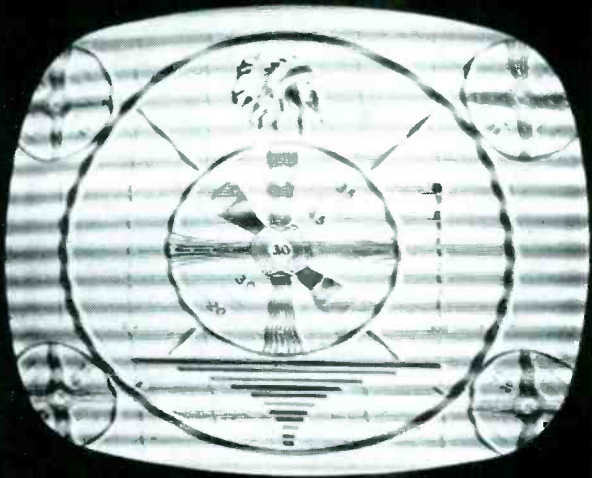

Valuable time can be spent searching for alignment points, adjustments and frequencies if you are relying on hit-or-miss methods or incomplete service data. With a **PHOTOFACT Folder** by your side you have all the information in just minutes. Here's why:

ALIGNMENT INSTRUCTIONS						
SWEEP INDICATION	SWEEP GENERATOR FREQUENCY	MARKER GENERATOR FREQUENCY	CHANNEL	CONNECT SCHEME	ADJUST	REMARKS
To tune and fine tune of tube Low	43.5 MC	42.25 MC	Between any two channels	Vert. amp. thru detector (Fig. 1)	A1 A2 A3 A4	Adjust for response curve similar to Fig. 1. Adjust A1 to place 41.25 MC marker to 1/2 inch. Adjust A2 to place 47.25 MC to 1/2 inch. A3 to place 42.25 MC marker on frequency scale of curve. Adjust A4 to 1/2 inch at 70% on half frequency side of response curve.
Not used	44.0 MC	42.5 MC		Use VTVM DC probe to point \odot Contin. to chassis	A5	Adjust for maximum deflection.
	42.35 MC				A6	

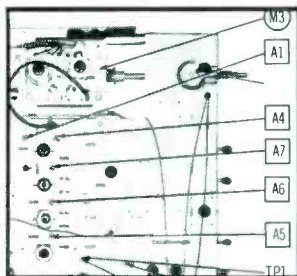
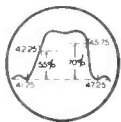

In just seconds, you find the complete Alignment Instructions. It's in *every* PHOTOFACT Folder, in the form of an easy-to-use chart*, with step-by-step instructions. It gives frequencies, adjustments, connection points for oscilloscope or VTVM, dummy antenna and detectors required, and oscilloscope response curves with marker frequencies and placement. Whenever possible, instructions are given for using either an oscilloscope or a VTVM.

Adjustments called for in the alignment chart are readily located by reference to chassis photographs* with call-outs keyed to alignment chart and Standard Notation Schematic*. In minutes, you make the video IF alignment and eliminate the sound bars.

To eliminate the buzz, you can either follow the alignment chart for a complete sound IF alignment or, as advised in the Field Servicing notes on this model, merely adjust the ratio detector, A-11. For speedy reference to this adjustment as well as to other service adjustments and picture tube removal or safety glass cleaning, see the Servicing In the Field* notes. They save you even more time.

SERVICING IN THE FIELD
SOUND IF DETECTOR BUZZ ADJUSTMENT
 To eliminate sound IF detector buzz, adjust the ratio detector secondary slug (A11) located on top of chassis. (See tube placement chart).

From start to finish, you solve your service problems in just minutes... you service more sets and earn more daily with PHOTOFACT by your side!

MONEY BACK GUARANTEE!
 Got a tough repair? Try this—at Howard W. Sams' own risk: see your Parts Distributor and buy the proper PHOTOFACT Folder Set covering the receiver. Then use it on the actual repair. If PHOTOFACT doesn't save you time, doesn't make the job easier and more profitable for you, Howard W. Sams wants you to return the complete Folder Set direct to him and he'll refund your purchase price promptly. **GET THE PROOF FOR YOURSELF—TRY PHOTOFACT NOW!**

free 
 Send for Sams' INDEX TO PHOTOFACT FOLDERS—your guide to virtually any receiver model ever to come into your shop; helps you locate the proper PHOTOFACT Folder you need to solve any service problem on any model. You'll want this valuable reference guide. Send coupon now.

*One of 32 features found exclusively in PHOTOFACT—the world's finest service data covering over 20,000 TV and radio models

HOWARD W. SAMS & CO., INC.
 Howard W. Sams & Co., Inc.
 2207 E. 46th St., Indianapolis 5, Ind.

Send FREE Index to PHOTOFACT Folders
 I am a Service Technician

Name _____
 Address _____
 City _____ Zone _____ State _____

New!

the mosley 4-Set TV Coupler

IDEAL FOR:

- HOMES
- 4-UNIT DWELLINGS
- MOTELS
- STORES

LIST PRICE
\$6.25



The new Mosley Type 904, 4-Set TV Coupler is especially designed for metropolitan television areas . . . *the major multi-set market!*

A bridging type resistive circuit distributes the signal equally to each output and provides effective isolation between sets to eliminate interaction. Signal transfer is excellent due to the constant impedance design.

The Mosley 4-Set Coupler will serve in a multitude of uses where it is neither necessary nor economically feasible to use amplifying distribution systems. Its low cost will appeal to your customers and the simplicity of installation means extra profits . . . *for you!*

AT YOUR PARTS JOBBER

MOSLEY ELECTRONICS, Inc.
8622 St. Charles Rock Rd., St. Louis 14, Missouri

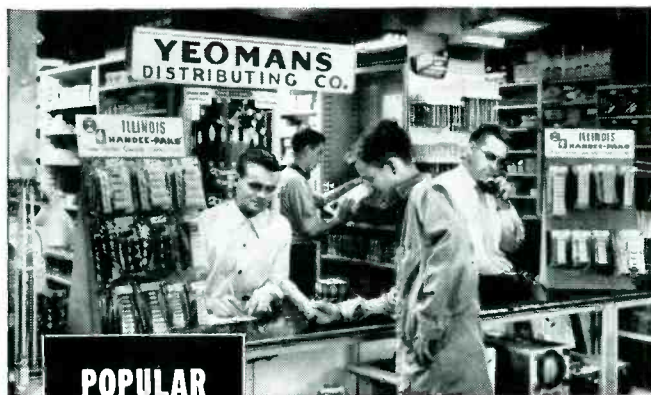

**POPULAR
WITH
SERVICEMEN**

ILLINOIS "HANDEE-PAK" CAPACITOR KITS

Servicemen go for the new ILLINOIS "HANDEE-PAK" Capacitor Kit assortments because they take up little room in the service kit—are easily identified and since they are hermetically sealed in polyethylene bags, the capacitors are always factory fresh and clean! Each PAPER CAPACITOR KIT is made up of 10 assorted new Type ITC Ceramic Cased Paper Capacitors of the capacity and voltage ratings most used by servicemen. The ELECTROLYTIC KITS consist of 5 popular types.

LOOK FOR THEM ON THE NEW JOBBER COUNTER RACKS

New ILLINOIS "HANDEE-PAKS" are available at most better jobbers—carry a few "HANDEE-PAKS" in your service kit. They are the ultimate in packaging, convenience and reliability.



ILLINOIS CONDENSER CO.
1616 N. THROOP STREET CHICAGO 22, ILLINOIS

TV Parts . . . Accessories

RAM FLYBACK AND 90° DEFLECTION YOKE REPLACEMENTS

Two flyback replacement transformers, X128 and X129, have been announced by RAM Electronics Sales Co., S. Buckhout St., Irvington, N. Y.

X128 is for replacement of RCA flybacks 78201, 78810, 79145, 79736, 79879 and 100860; X129 for Admiral flybacks 79C60-2,-3,-4 and -5.

Two 90° deflection yokes, Y90F12/47 and Y90F19/43, designed, it is claimed, to eliminate pin-cushioning and edge-to-edge focusing and featuring a vinyl insulator between horizontal and vertical coils for longer life, have also been introduced by RAM.

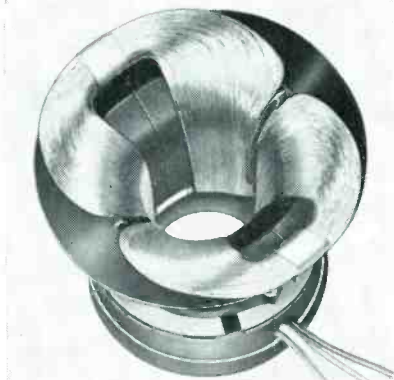

RAYPAR REPLACEMENT TRANSFORMERS

A line of replacement transformers for TV sets has been announced by Raypar, Inc., 7800 W. Addison St., Chicago, Ill.

INTERNATIONAL TV REMOTE CONTROL

A TV remote control tuner, *it*, that allows viewer to switch channels and fine-tune the TV picture automatically, has been introduced by International TV Remote Control Co., 2310 S. La Cienega Blvd., Los Angeles 34, Calif.

FTR HIGH-CURRENT DENSITY SELENIUM RECTIFIERS

A line of high current density selenium rectifiers for TV receiver applications, said to be substantially smaller and lighter than conventional selenium stacks with the same ratings, has been developed by the Federal Telephone and Radio Co., 100 Kingsland Rd., Clifton, N. J.

The length of a 350 ma (output *dc*) high-current density model is 2"; conventional type would be 2½". Cell size of new type is 1¼" square; conventional cells are 1¾" square.

Shown at left below is one of the new rectifiers compared to a rectifier of conventional size.

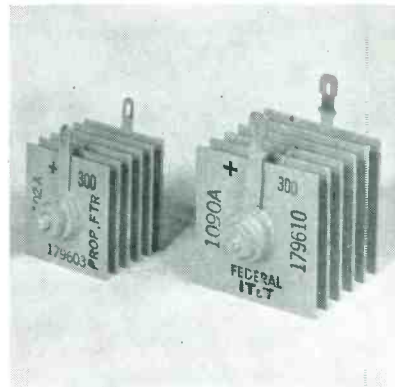

When . . . You Change Your Address

► Be sure to notify the Subscription Department of SERVICE at 52 Vanderbilt Avenue, New York 17, N. Y., giving the old as well as the new address, enclose address labels from your last SERVICE copy, and do this at least four weeks in advance.

► The Post Office Department does not forward magazines unless you pay additional postage, and we cannot duplicate copies mailed to the old address.

► We ask your cooperation.

COMPONENTS

COLMAN 6-VOLT DROPPING RESISTOR

A 6-volt dropping resistor, permitting installation of 6-volt accessories in 12-volt auto electrical systems, has been introduced by Colman Tool and Machine Co., P. O. Box 7026, Amarillo, Tex.

Resistor works with 6-volt equipment drawing from 2.5 to 9 amps.

CLAROSTAT INDIVIDUAL LOUDSPEAKER VOLUME CONTROLS

Two individual loudspeaker controls, CM17084 and CM17083 (series 43), for drive-in theatre installations using RCA, Motiograph or International equipment, have been introduced by the Clarostat Manufacturing Co., Inc., Dover, N. H.

CM17084 is a rheostat with tapered winding. Left hand terminal is a dummy; can be used as a tie point if needed. When control is rotated to full *ccw* position, wiper arm leaves the winding, making it an *off* position.

CM17083 is a 50-ohm linear rheostat with *off* position in full *ccw* rotation; also has a dummy left hand terminal. Both controls have $\frac{1}{8}$ " round 2" shaft and $\frac{3}{8}$ " mounting bushing.

IRC 2-WATT RHEOSTAT POT

A 2-w rheostat potentiometer, 2W, for use on outdoor movie speaker controls, test and measuring instrument controls, has been announced by International Resistance Co., 401 N. Broad St., Philadelphia 8, Pa.

Resistance (alloy wire) element is said to be uniformly wound.

Further details in bulletin A-3.

AEROVOX PRINTED WIRING RIGHT-ANGLE TUBE SOCKETS

Right-angle tube sockets with silver-plated contacts for printed-wiring assemblies, have been introduced by Pacific Coast Div., Aerovox Corp., 2724 S. Peck St., Monrovia, Calif.

Available in four 7 and 9-pin versions; A for general-purpose applications; AX for special applications requiring extra rigidity; B same as A, but with tube shield; and BX, same as AX, but with tube shield.

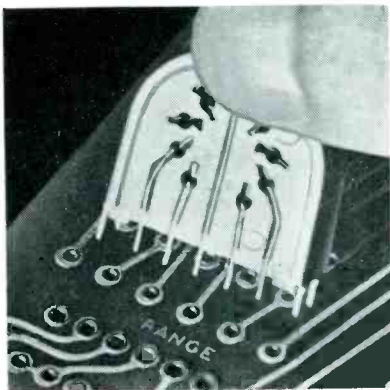

Ask "The Man on the Roof" why he prefers

South River



How valuable is a Serviceman's time? 5¢ a minute?
... 7¢ a minute? ... 10¢ a minute?

South River's New Ratchet Type Chimney Mount Saves 10 Minutes Per Installation!

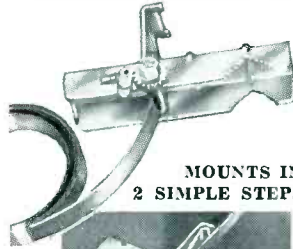

1. Encircle chimney with banding and thread through slotted shaft.



2. Tighten banding with wrench.



RATCHET GUY WIRE TIGHTENER

Eliminates turn-buckles! Fastens to wall or roof with screws. Extra space between tightening shaft and base permits large tightening capacity. Same-sturdy construction as ratchet chimney mount.

It's the fastest, simplest, most convenient ever manufactured!

Mounting is factory assembled with band attached. No assembly of eyebolts, banding, banding clips, nuts, etc., is necessary for chimney mounting.

South River's New Ratchet Type Chimney Mount is 8 WAYS BETTER:

1. Heavy gauge steel construction.
2. Banding naturally unwinds for easy mounting. No troublesome watchspring effect!
3. Embossed and welded for extra rigidity and strength!
4. Ratchet of aircraft type aluminum, forged and heat-treated for maximum toughness and strength.
5. Fine ratchet teeth insure positive tightening of banding.
6. Banding is factory assembled to mounting.
7. Zinc plated, golden iridite finish.
8. Available with galvanized banding (Model RT) or stainless steel banding (Model RT-ST).



HIGH STRENGTH ALUMINUM GUY CABLE, HIGHLY CORROSION RESISTANT

Special 56S Alclad alloy. 7 strands, 17 gauge specially tempered and normalized. Special tight weave. Will not rust or stain. Specifically for guying use. Breaking strength: approx. 500 lbs. pull. Boxed in 100 ft. coils or ten 100 ft. coils, interconnected, 1000 ft. to box.

South River

METAL PRODUCTS CO., INC.

South River, New Jersey

PIONEER MANUFACTURER AND OUTSTANDING PRODUCER OF THE FINEST LINE OF ANTENNA MOUNTING ACCESSORIES

WRITE FOR OUR NEW 1956 CATALOG

GUARDIAN SWITCHING RELAY

A totally-enclosed switching device, *Reloid*, actuated by a plunger that combines functions of relay and solenoid, has been announced by Guardian Electric Manufacturing Co., 1621 W. Walnut St., Chicago 12, Ill.

Three contact leads are equipped with AMP or Douglas type terminals; coil has two AMP terminals. Available for any voltage from 6 to 115, *ac* or *dc*. Contacts are rated up to 8 amps at 115 v, non-inductive. Standard contact combination is single pole, double break. Measures 2 11/32" x 1 7/32" x 1 7/32".

TRU-OHM VITREOUS RESISTORS

Small vitreous axial-lead resistors, said to be capable of continuous operation at 300°C and same power dissipation as larger counterparts, have been developed by Tru-Ohm Products, division of Model Engineering and Manufacturing Co., 2800 N. Milwaukee Ave., Chicago, Ill.

Units are constructed of ceramic cores with alloy caps with integral leads pressed on. Core assembly is wound to proper resistance; junction of resistance element is silver brazed and coated with vitreous enamel which is fired at high temperature. Available in 3, 5 and 10 w sizes.

EICO 84 Withers St., Brooklyn 11, N. Y. S-4

SAVE ME 50% on precision instruments — send **FREE CATALOG** on EICO's 46 models in factory-wired and kit form.

My Name
 Address
 City Zone State

NEW! COLOR
 and Black-&-White
 DC to 5 MC LAB & TV
 5" OSCILLOSCOPE

#460
 Factory-wired
 and tested \$129⁵⁰
 Also available as kit \$79⁹⁵

• Features DC Amplifiers!

Flat from DC-4.5 mc, usable to 10 mc. VERT. AMPL.: sens. 25 rms mv/in.; Z 3 megs; direct-coupled & push-pull thruout; K-follower coupling bet. stages; 4-step freq-compensated attenuator up to 1000:1. SWEEP: perfectly linear 10 cps-100 kc (ext. cap. for range to 1 cps); pre-set TV V & H positions (30 & 7875 cps); auto. sync. ampl. & lim. PLUS: direct or cap. coupling; bal. or unbal. inputs; edge-lit engraved lucite graph screen; dimmer; filter; bezel fits std photo equipt. High intensity trace CRT. 0.06 usec rise time. Push-pull hor. ampl., flat to 400 kc, sens. 0.6 rms mv/in. Built-in volt. calib. Z-axis mod. Sawtooth & 60 cps outputs. Astig. control. Retrace blanking. Phasing control.

BEFORE you buy ANY instruments—get the **FACTS** on the money-saving, high-precision EICO line. Fill in coupon for **FREE** catalog & name of your nearby distributor.

EICO 84 Withers St., Brooklyn 11, N. Y.
 Prices 5% higher on West Coast

Service Engineering

(Continued from page 26)

nection at the antenna. The probability of such a defect occurring would be considerably reduced, if care in installation is taken to insure that the braid is held firmly in the connector, and that all of the slack has been removed before cutting the center conductor.

When the line is terminated in a pure resistive load we would expect, if nothing was wrong, to obtain a standing wave ratio of 1:1 or better. Usually we find that the *swr* is somewhat above this, in the neighborhood of 2:1. Should the *swr* increase substantially higher, then one can expect to find a defect in the antenna.

As noted previously one should bring into play the *act of isolation*, for should we terminate the line in a resistive load and find the *swr* to be in the neighborhood of 1:1, then we know the problem is in the antenna.

ANTENNA TECHNICAL FORUM



At recent technical forum conducted for TV Consumers Association of New Jersey by Brach Manufacturing corp.; Les Dooner, senior project engineer of Brach, demonstrating rotator to members of the group. At right is Jack Keough in charge of Brach sales promotion program, and Jerome Berger, plant manager.

SERVICE will be in

Display Room 611

At the Electronics Parts Show

Conrad Hilton Hotel

In Chicago, May 21 to 24

IT'S HERE! THE CATALOG YOU'VE BEEN WAITING FOR!

2 years in preparation BY APPLIANCE MENT FOR APPLIANCE MENT

128 Pages!

ELECTRA-CRAFT Appl. Co.

348 West 42nd Street, New York 36, N. Y.

To cover postage and handling we herewith send you 25c for which we are to receive copy of Catalogue No. 55A without delay, which illustrates and describes parts of over 72 small appliance manufacturers.

Company
 Address
 City Zone State
 Type of Business
 Signed Title

DON'T DELAY!

Fill In and Mail This Coupon NOW! and be sure of obtaining YOUR copy

KENCO KATE SAYS

"NO INSTALLATION PROBLEMS when you use KENCO MOUNTS"

KENCO 6" and 12" Aluminum Snap-in Wall Brackets

Made of heavy gauge high strength aluminum alloy. Snap-in feature eliminates holding of mast while applying hardware. Carriage bolts thruout for easy installation. Full thread hex head lag screws permit use of ratchet or speed wrench.

Available with Stainless Steel Hardware (optional at slight extra cost).

For information on the complete Kenco line write Dept. S.

KENWOOD ENGINEERING CO., INC.
 Kenilworth, New Jersey

F. C. C. LICENSE QUICKLY!

Correspondence or Residence Preparation for FCC Examinations. Results Guaranteed.

Our *specialty* is preparing you to pass FCC license examinations. Beginners get 2nd class license in 8 weeks, 1st class in 4 additional weeks. Students with background often finish more rapidly.

Here's proof! A few of our recent graduates, the class of license they got, and how long it took them:

Class of License	Weeks
Irvin Gemora, 5008 Pembridge, Baltimore.....1st	8
W. C. Goodall, 500 Forest Bl., Indianapolis.....1st	10
Dick Johnson, 1756 P St., N.W., Washington.....1st	9
Robert LaVoy, 247 Rochelle Rd., Toledo, O.....1st	11
John Marquet, RFD 1, Hummelstown, Pa.....1st	14
P. Martinez, 1013 N. Alvarado, Los Angeles.....1st	13
Jack Sanders, 118 Nagle, Harrisburg, Pa.....1st	11
Brent Shriver, 158 E. 136, Hawthorne, Cal.....2nd	5
J. Yeardeley, 500 Lynn Pl., Falls Church, Va.....1st	13

Learn by Mail or in Residence

Correspondence training from Washington, D. C. DAY and EVENING resident classes held in Hollywood, Calif., and Washington, D. C. Enter any course you choose.

OUR GUARANTEE If you should fail the FCC exam after finishing our course, we guarantee to give you additional training at NO ADDITIONAL COST. Read details in our free booklet.

FCC-TYPE EXAMS FCC-type tests are used throughout the Grantham course. Constant practice with these FCC-type tests helps you prepare for the actual FCC examination.

Write for our free booklet, telling how you can get your commercial FCC license quickly. There is no obligation and no salesman will call.

Grantham School, Desk. 9
 821 19th Street, N.W. OR 5910 Sunset Blvd.
 Washington, D. C. Hollywood 28, Calif.

INSTRUMENTS

B&K TUBE TESTER FLOOR STAND

A floor stand, for use with the Dyna-Quik 500 tube tester, has been made available by B&K Manufacturing Co., 3726 N. Southport Ave., Chicago 13, Ill.

Unit, it is said, makes a one-piece permanent tube tester and vendor. Stand may be purchased by itself or with Dyna-Quik 500 installed. Has six drawers that hold more than 600 separated tubes. Supplied with lock. Measures 22 $\frac{1}{2}$ " wide x 14 $\frac{1}{2}$ " deep x 41 $\frac{1}{2}$ " high.



TRICRAFT TUBE ANALYZER

A tube analyzer, 200, said to check standard octal, loktal, 7 and 9-pin miniature and TV picture tubes for emission gas, shorts, opens, microphonics and filament continuity, has been introduced by Tricraft Products Corp., 1535 N. Ashland, Chicago 22, Ill.

Elements are checked independently; no elements are tied together during test.

DONNER SINE WAVE GENERATOR

A sine wave generator, 1200, which is said to generate pure sinusoids from 1 cps to 1 mc (plus overlap) in 6-decade ranges, for communications, audio and lab testing, has been introduced by the Donner Scientific Co., 2829 Seventh St., Berkeley 10, Calif.

Distortion is claimed to be less than .1% for any frequency or amplitude. Output impedance of 600 ohms is constant for any setting of amplitude control. Signal, 0 to 8 v rms, contains no dc component. Stable amplitude, freedom from drift and calibration accuracy are said to be assured by a fully regulated power supply and generous negative feedback. Uses frequency-generator circuit requiring two tubes, etched circuits and miniaturized components.



from the VOICE OF AUTHORITY IN SWEEPS . . .

SPOT and FIX TV FAULTS FAST!

FREE RAM BOOK SHOWS HOW!

Typical latest field-proven servicing data you'll find in your RAM book:



FAULT: "Ringing."
CAUSE: Incorrect value of balancing R-C network across one-half of H. Yoke winding.
(A): H. Yoke current wave-form. Obtained by connecting scope across 10-ohm resistor inserted in series.

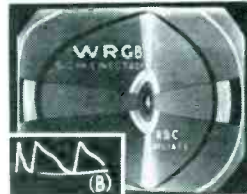

FAULT: Picture compression and stretching.
CAUSE: Capacitance value of boost capacitor (connected to linearity coil) too low.
(B): H. Yoke current wave-form. Leaky boost capacitor could cause similar effect.



FAULT: Picture stretching at left and compression at right.
CAUSE: 0.02 mf boost capacitor (connected to linearity coil) used instead of 0.1 mf capacitor.
(D): H. Yoke current wave-form.

For over 10 years, RAM has specialized and pioneered in sweeps exclusively. RAM designs them, makes them, counsels TV set manufacturers on them, field-services them, educates Servicemen on them — leads the industry.

No one but RAM can bring you such proven data — as shown here and in the RAM Manual. In manufacturing know-how and field experience, you can depend on RAM for . . .

THE VOICE OF AUTHORITY IN SWEEPS

Send coupon today — get the BEST information from the FOREMOST manufacturer now!



RAM ELECTRONICS SALES CO. • Irvington, N. Y.

Canadian Sales Division: Tequipment Mfg. Co., Ltd., Ontario

Export Dept: Dage Corp., 219 E. 44 St., New York, N. Y.



TELCO TELEVISION HARDWARE AT YOUR DISTRIBUTOR

WRITE for your TELCO Catalog or ask your supplier. FREE!



TELCO TV STAND-OFF
All-aluminum; wood-screw; 3 $\frac{1}{2}$ " long.
No. 8027-A



TELCO MAST STRAP STAND-OFF
Alum. screw-eye; 9" strap; 3 $\frac{1}{2}$ " long.
No. 8253-A



TELCOE-Z KANT-STRIP MAST STAND-OFF
In-line 7 $\frac{1}{2}$ "; galv. strap.
No. EZ-8258



TELCO GROUND ROD
Heavy copper plated; 4" long; 3/8" dia.
No. 8929

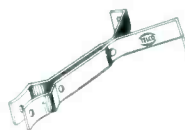

TELCO SNAP-IN CHIMNEY MOUNT
Fits masts to 1 $\frac{3}{4}$ " dia.
No. 8610



TELCO TV PLASTIC PLIERS
Rugged; insulated, shock-proof.
No. 8387

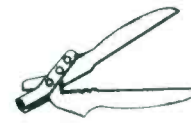

TELCO 300-OHM LEAD-IN TOOL
Slot, strip, cut; crimp lugs.
No. 9220



TELCO DUPLEX LINE CONNECTOR
Connects two leads to TV set.
No. 8221



TELCO GALV. STEEL ANTENNA MASTS
Hot dipped; 1 $\frac{1}{4}$ " OD x 5' crimped end.
No. 9013



TELCO DELUXE UNIVERSAL SWING BRACKET
All aluminum; fits 1 $\frac{1}{4}$ " masts.
No. 8000



TELCO 6-PACK LIGHTNING ARRESTORS
Six for quick, handy use.
No. 8642-6P



TELCO 2-SET TV COUPLER
Couple two sets to one antenna.
No. 8920

TELEVISION HARDWARE MFG. CO.

Division of General Cement Mfg. Co., 901 Taylor Avenue • Rockford, Illinois

don't do it
the hard way!

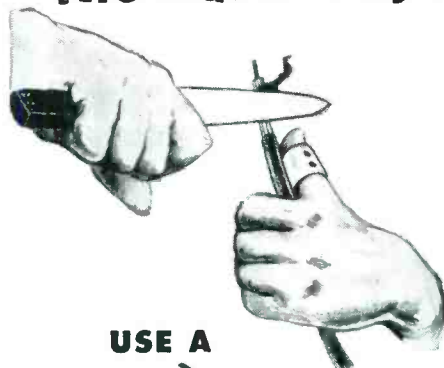

USE A



ROTARY CABLE STRIPPER Model S-1

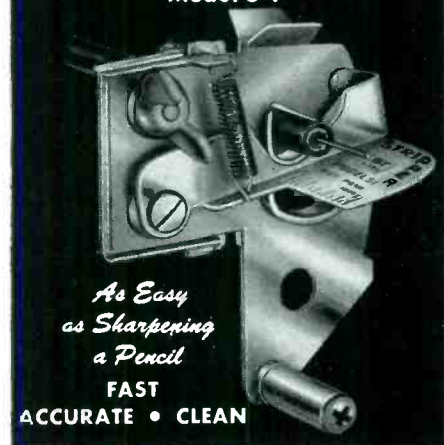

As Easy
as Sharpening
a Pencil

FAST
ACCURATE • CLEAN

and Practically **AUTOMATIC**

- Cuts and strips the outer covering of coax cable without injuring the shielding.
- Cuts the shielding without pulling, fraying or unbraiding.
- Cuts and strips the inner insulation and . . .
- Measures just the right length of lead desired.
- Ideal for stripping all insulated wire and cable — as well as non-metallic tubing.

— and its **ONLY \$3⁷⁵** LIST

A Must For Your Kit —
Get One Today
at your Parts Distributor.

BLONDER-TONGUE LABORATORIES, INC.
Dept. JD-8, Westfield, New Jersey



Manufacturers of TV Cameras,
TV Amplifiers, Boosters,
UHF Converters, TV Accessories
and Originators of the Masterline
and 'Add-A-Unit'
Master TV Systems.

INSTRUMENTS

SECO INTERMITTENT CHECKER

An intermittent checker, *Monitron*, which sounds an alarm (audio tone) in case of a break in signal path, has been developed by Seco Manufacturing Co., 5015 Penn. Ave. S., Minneapolis, Minn.

A dual electron-ray indicator tube serves to monitor signal level independently of alarm circuits; an indicator lamp also lights in channel under test in which failure occurs. Unit is said to trace signals and localize intermittent problems on any steady-signal carrying circuit, monitor two different circuits simultaneously, and make point-to-point gain measurements.

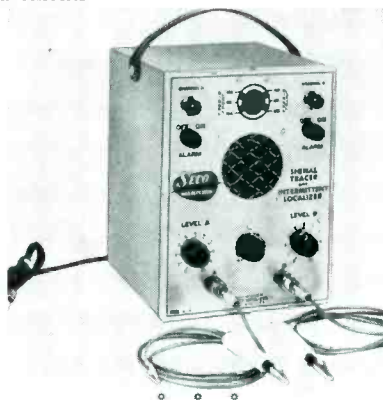

PHAOSTRON VOM

A *vom*, 666, said to be fused to prevent most common burnouts and instrument damage through misuse, has been developed by Phaostron Instrument and Electronic Co., 151 Pasadena Ave., South Pasadena, Calif.

An overload signal light warns operator of overloads or incorrect polarity. Two jacks are used for all measurements. *Ac* current ranges are from 1.5 ma to 15 amp; *dc* current from 50 microamps to 15 amps; *dc* voltage from 1.5 to 1500 at 20,000 ohms/volt; *ac* voltage from 1.5 to 1500 at 2000 ohms/volt; db from -10 to +50; and resistance from .25 ohm to 10 megohms.

FUTURAMIC SIGNAL TRACER PROBE

A signal tracer probe, 262, for use on 20,000 ohms/volt *vom*'s to permit checking of *ac* waveform voltages in horizontal and vertical-oscillator circuits, drive voltage to horizontal output tube, sweep-circuit output, local oscillator operation, sync circuit signals, *if* output and audio signals, has been introduced by Futuramic Co., 2500 W. 23rd St., Chicago.

VIDAIRE PIX TUBE SHORT REMOVER-REJUVENATOR

A picture-tube short remover and rejuvenator, *Vitalyzer VL-55*, has been announced by Vidaire Electronics Manufacturing Corp., Lynbrook, N. Y.

Unit is claimed to remove cathode-to-filament and cathode-to-grid shorts and rejuvenate weak pix tubes. Picture tube does not have to be removed from cabinet.



10 Volt Line
Adjuster . . .



At All Distributors



BENCH-FIELD TOOLS . . .

WALSCO COLOR-TV INTERLOCK CHEATER

An interlock cheater to prevent grounding of color-TV sets' high-voltage supplies and protect against tube damage while servicing, has been announced by WalSCO Electronics Corp., 3602 Crenshaw Blvd., Los Angeles 16, Calif.

One advantage is feature which is said to permit insertion of a high-voltage probe.



R-COLUMBIA SHAFT ADAPTER FOR CLEANER-LUBRICATOR

A shaft adapter for the TrolMaster control cleaning and lubricating tool, permitting use on controls with shafts up to 7" long, has been developed by R-Columbia Products Co., Inc., 305 Waukegan Ave., Highwood, Ill.

Further details in bulletin 22.

ADVERTISERS IN SERVICE

APRIL, 1956

	Page
Acme Electric Corp.	63
American Pamcor, Inc.	43
American Television & Radio Co.	40
Argos Products Co., Inc.	2
The Astatic Corp.	45
B & K Mfg. Co.	37
Blonder-Tongue Labs, Inc.	62
Brach Mfg. Corp.	35
Div. General Bronze Corp.	
Burgess Battery Co.	42
Bussmann Mfg. Co.	1
Channel Master Corp.	8
Chemical Electronic Engineering Co.	48
Cornell-Dubilier Electric Corp.	33
Inside Front Cover,	
Delco Radio Div. General Motors Corp.	39
Donner Scientific Co.	49
Duotone Co.	48
Electra-Craft Co.	60
Electronic Chemical Corp.	36
Electronic Instrument Co., Inc.	60
Erie Resistor Corp.	54
General Cement Mfg. Co.	32, 61
General Dry Batteries, Inc.	31
Grantham School	60
The Heath Co.	54
Hughes Research & Development Labs.	40
Hycor Electronics, Inc.	41
Illinois Condenser Corp.	58
Jensen Industries, Inc.	52
Kenwood Engineering Co., Inc.	60
Kester Solder Co.	52
P. R. Mallory & Co., Inc.	33
Inside Back Cover	
Mastra Co.	50
Merit Coil & Transformer Corp.	30
Mosley Electronics, Inc.	58
Mueller Electric Co.	48
Oxford Electric Corp.	55
Perma-Power Co.	62
Philco Corp.	6, 7
Precision Electronics	52
Pyramid Electric Co.	4
Quam-Nichols Co.	53
The Radiart Corp.	33
Inside Front Cover,	
Radio Corporation of America	9, 29, Back Cover
Ram Electronic Sales Co.	61
Raytheon Mfg. Co.	10
Remington-Rand Div. Sperry Rand Corp.	27
Howard W. Sams & Co., Inc.	57
Service Instruments Co.	50
Simpson Electric Co.	3
Snyder Mfg. Co.	5
Sonotone Corp.	51
South River Metal Products Co.	59
Sprague Products Co.	30, 36, 50
Superex Electronics Corp.	50
Telco Electronics Mfg. Co.	32
Television Hardware Mfg. Co.	61
Tenna Mfg. Co.	47
Terado Co.	32
Triplett Electrical Instrument Co.	64
Vaco Products Co.	28
Vokar Corp.	36
The Ward Products Corp.	25

TV Antennas

(Continued from page 56)

diffraction. Even though the diffraction mechanism is only moderately efficient, the path from the transmitter to the ridge may be almost line-of-sight, and the path from the ridge to the receiving antenna also may be almost line-of-sight so that the chief loss of signal is due to the diffraction loss over the sharp edge.

There is also an extreme super-refraction or trapping condition. At times the index of refraction varies with elevation at such a rapid rate that the waves are bent even more than the curvature of the earth and are actually bent towards the ground. In this instance, the signal may travel from the transmitter to the receiver in a series of hops. Since the transmitter's energy is largely prevented from escaping and is confined within a layer near the earth, strong (and usually interfering) signals may be propagated for extreme distances.

Grounding Notes

GROUNDING in TV antenna systems to underground gas piping should be avoided. It is true that many pipe lines and local distribution systems are insulated with coats of tar or Fiberglas, but the whole system may be charged with a low *dc* voltage, to prevent electrolytic action on the pipes. If a TV ground connection were made to such a system, not only would the possibility of trouble in the TV system obtain, but grounding of the gas pipe could cause electrolytic damage; a hole in the pipe could result, with the resultant fire hazard.

In areas where lightning damage is quite frequent, one should interconnect a number of grounds in the area, to prevent sideflash between several grounding systems.

Circuit Diagrams In This Issue

Motorola Transistor Car Radio; Basic Circuitry	Cover
Motorola Transistor Car Radio; Model 6TAS8 (Complete Circuit)	16
RCA HO Printed-Wiring Board; Model KCS-97	17
Basic Auto Radio Design Changes from Prewar to Present	18
Motorola Auto Radio Det/AVC/AF Stages; Model 69MF and 910	19
Motorola Trigger Circuitry for Search Tuning; Model 69MF	19
Scope for B-W and Color-TV Applications (Complete Circuit)	21
Audio Transistor Circuit with VTVM Readings	22
PNP Transistor Equivalent Circuitry	22
Raytheon Transistor Portable; Model T-150 (Complete Circuit)	23
Raytheon Transistor Portable; Model T-100 (Complete Circuit)	23
Admiral Selenium Rectifier Horizontal Phase Detector	34
Wow-Flutter Test Setups for Tape and Phono	44
Push-Pull Audio Illustrating Parasitic Oscillation Troubles	46
Phase-Shift Capacitor for Feedback Amplifier	47
Alternate Amp Arrangement for PS Capacitors	49
Single-Ended Output with Feedback-Loop Adjustments	50

THE HANDIEST TESTER YOU CAN HAVE IN YOUR KIT

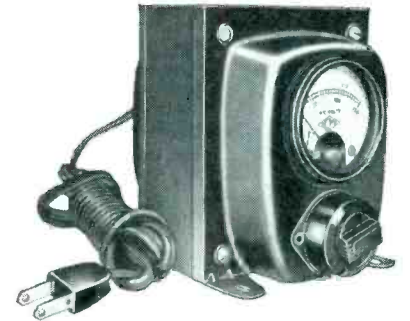

THE ACME ELECTRIC T-8394 VOLTAGE ADJUSTOR

Smart service men, who like to save time and make more money by doing so, are using the Acme Electric T-8394M Voltage Adjustor on every service call. With this unit, varying voltage conditions ranging from 95 to 125 volts input can be simulated. Under these varying voltage conditions defective components that function properly at normal voltage, but cause trouble at low voltage or over voltage can be located and replaced.

And, in thousands of instances, service customers have insisted on buying this handy unit from the service man so that they may maintain a normal voltage at the set and enjoy top TV reception.

Furnished complete: primary cord and plug; secondary receptacle; accurate meter indicates output voltage; control switch regulates secondary voltage. Compact, inexpensive.

See this at your dealers.

ACME ELECTRIC CORPORATION
474 WATER STREET CUBA, NEW YORK

Acme ACME **Electric**
TRANSFORMERS

No one piece of equipment can do more for you. As the electronic field expands your tube tester must do more. TRIPLETT TUBE TESTERS meet this demand. More heater voltages including 3.15, 4.2 and 4.7 volts for 600 mill series string heaters. Quickly locating the bad tubes saves time. Tube sales can be a profitable business in itself.

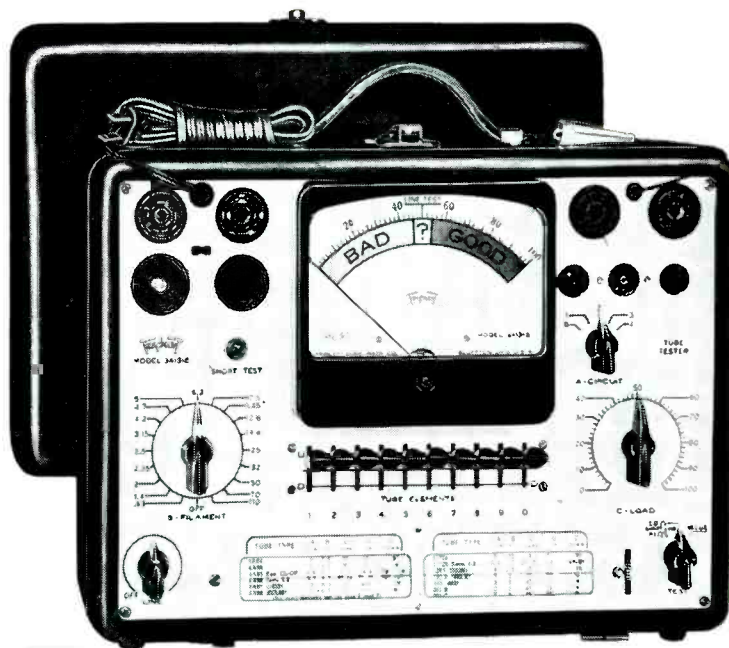

80% OF YOUR SERVICE JOBS CAN BE COMPLETED

WITH A TRIPLETT TUBE TESTER







**NEW
UNIQUE
AND ONLY \$79.50**

*The first
low priced
tube tester
to provide*

**DUAL SENSITIVITY
SHORT TEST**

Triplet model 3413-B combines provision for conventional short test (0.25 megohms) with high sensitivity leakage test (2.0 megohms)—will test series string tubes without adapter.

Model 3413-B is a money-saver on original cost—a profit maker because it's faster, more versatile, more flexible operation for more tests in less time. This tester does a better job today and tomorrow—and here's why:

-  New, longer roll chart includes all tubes up to the moment.
-  Triplet automatically furnishes revised, up-to-date roll charts regularly if you promptly return registration card. (Included with tester.)
-  Flexibility of switching allows you to set up to test *any new tube*.
-  Tests TV picture tube by means of BV Adapter (\$4.50) without removing tube from set.
-  Reads BAD—?—GOOD direct on big 6-inch meter.
-  Short tests (neon) each element with single flip of switch.

And for the ultimate in laboratory quality testing examine

MODEL 3423 MUTUAL CONDUCTANCE TUBE TESTER \$199.50

Proportional Mutual Conductance testing of *all* radio and TV tubes plus selenium rectifiers, crystal diodes, pilot lamps, thyratrons, transistors, etc., by a new patented circuit.

*At leading Parts Distributors everywhere,
see the finest and most complete line of test equipment by*

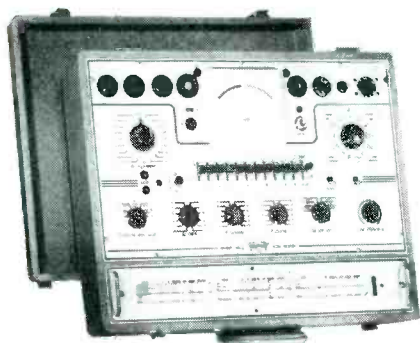

TRIPLETT

**ELECTRICAL INSTRUMENT COMPANY
BLUFFTON, OHIO**

another
MALLORY
service-engineered
product



Control
Replacements
are speedy
and sure...
with

Midgetrols[®]

You'll like Mallory Midgetrols . . . for the way they save your time. Need a line switch? You can attach it instantly, without taking the control apart. Need a tailor-made shaft? In seconds you can cut the round, tubular shaft and insert a split-knurl or flatted tip.

Your customers will like their performance. The extra-smooth surfaced carbon element, manufactured by a special Mallory process, assures long life and noise-free operation.

See your local Mallory distributor. He's ready to supply you with Midgetrols in the exact resistance values and tapers to fit all popular TV and radio sets.

P. R. MALLORY & CO. Inc.
MALLORY

P. R. MALLORY & CO. Inc., INDIANAPOLIS 6, INDIANA

• Capacitors • Transformers • Inductors • Controls • Switches
• Resistor • Doctor Supplies • Filament • Mercury Batteries



THE BRIGHTEST PICTURE

*...any way
you look*

RCA Silverama

**SUPER-ALUMINIZED
PICTURE TUBES**

Designed with a super-phosphor that develops greater light—and aluminized by an exclusive “advanced-technique” process that sharpens image contrast, does away with “mottling”, increases picture “snap”—RCA SILVERAMA Picture Tubes are setting unparalleled records for superior performance. And RCA is telling this story to your customers across the nation—through the most dynamic consumer advertising campaign in the history of picture tubes.

Your RCA Tube Distributor can help you make this far-reaching advertising effort pay off for you NOW—with the most complete selection of sales promotion material ever created to sell picture tubes. Ask him for the facts. Let him show you how 25 types of RCA SILVERAMA Picture Tubes can handle over 110 replacement types for YOU. Be convinced that RCA SILVERAMA makes the brightest picture—any way you look.



PICTURE TUBES

RADIO CORPORATION OF AMERICA
HARRISON, N. J.

Ask your RCA Tube Distributor for your copy of the new RCA Picture Tubes Booklet (Form KB-106).



Nationwide Consumer Advertising

See RCA's hard-hitting consumer ads on SILVERAMA in LIFE, POST, and TV GUIDE. Watch RCA's dramatic commercials on top TV programs like MILTON BERLE, MARTHA RAYE, and NBC Spectaculars.

