

# SERVICE

VOL. 24

THE TECHNICAL JOURNAL OF THE TELEVISION-RADIO TRADE

In This Issue: AUDIO FORUM

APRIL  
1955

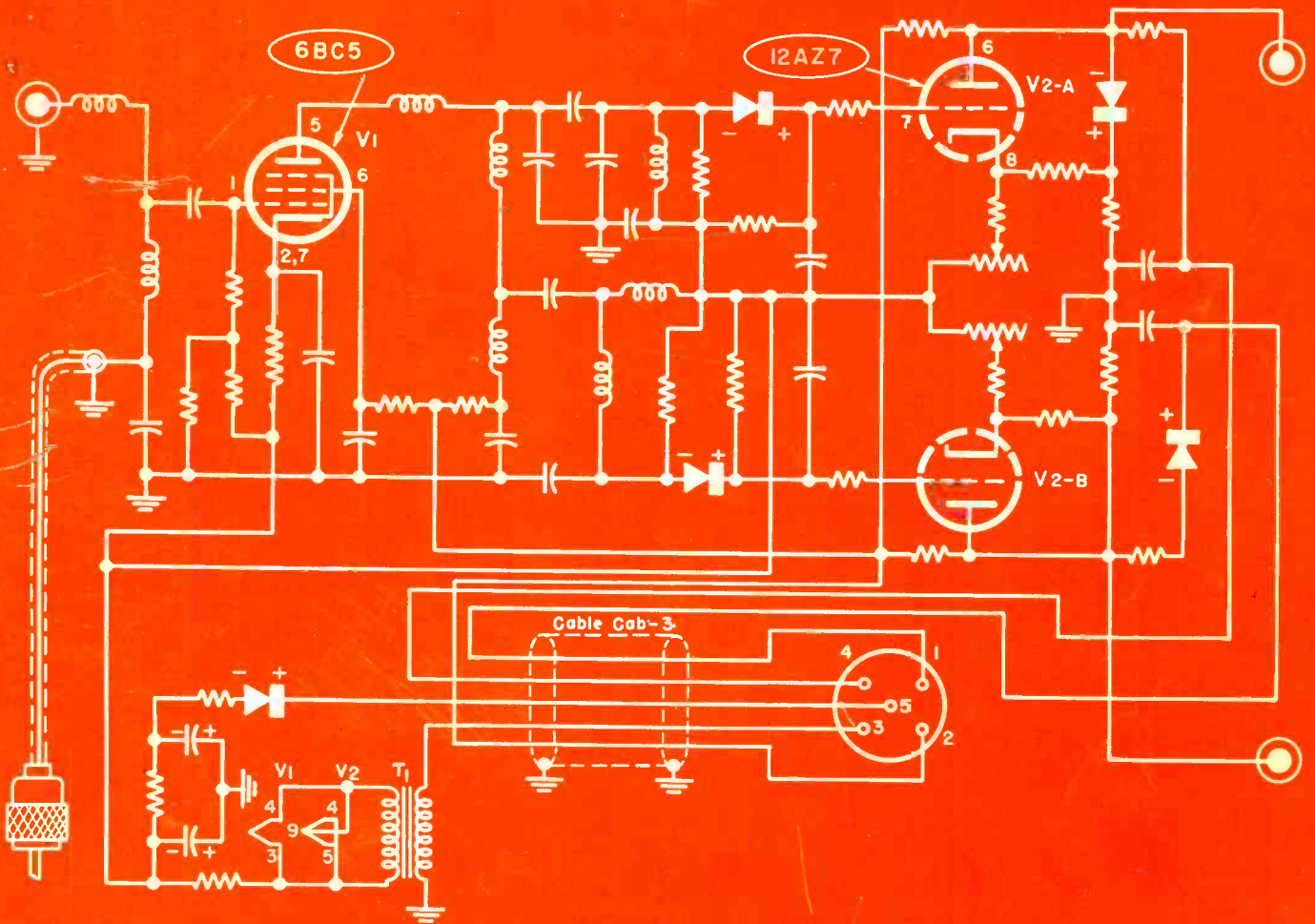

TV vht distribution-system amp designed to hold output to 1 1/2 db change when signal at amp input varies 20 db.

[See circuit analysis, this issue]

AL BROWDY  
1962 S STEARNS DR  
LOS ANGELES 34, CAL  
2-57

25 SAR 11-18-54

a complete **NEW** line!

# RADIART SEAL-VENT Communication Vibrators

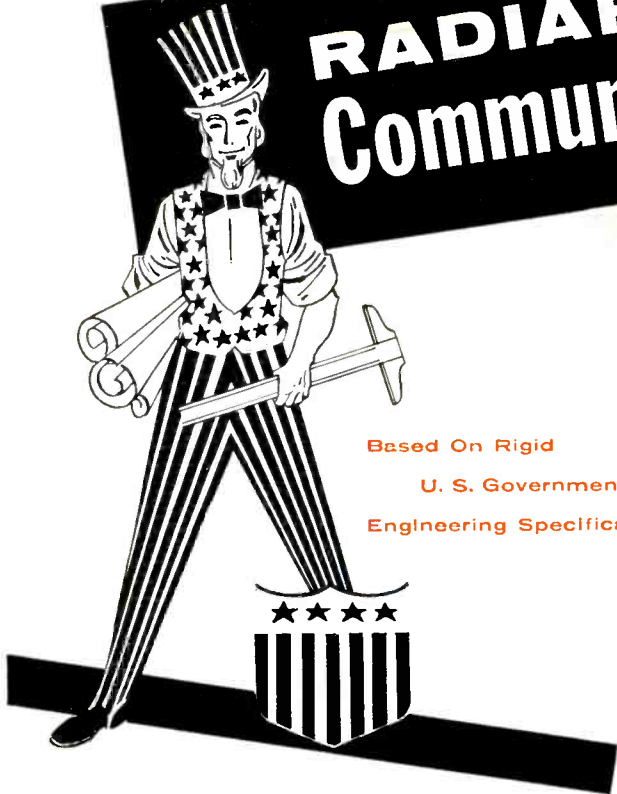

Based On Rigid  
U. S. Government  
Engineering Specifications

NOW... RADIART makes available to commercial users of communications equipment, a new line of vibrators based upon experience of producing over 2 million similar units to the exacting requirements of U.S. Signal Corps Specifications.

These Eight Types Offer Complete Replacement for ORIGINAL Communication Equipment:

Old No.	New No.
5515	<b>5715</b>
5518	<b>5718</b>
★	<b>5721</b>
★	<b>5722</b>
5605	<b>5805</b>
5620	<b>5820</b>
5621	<b>5821</b>
5622	<b>5822</b>

**It's ready now!**

**The new 1955**

**Radiart Vibrator  
Replacement Guide**



THE **RADIART** CORPORATION  
CLEVELAND 13, OHIO

TV ANTENNAS • AUTO AERIALS • VIBRATORS • ROTORS • POWER SUPPLIES

# NEW BETTER WAY

## To Stock, Sell and Service

### PHONO-CARTRIDGE REPLACEMENTS



## NOW SEALED-IN-PLASTIC

This is a big step ahead in cartridge merchandising and servicing! For greater protection and convenience, E-V Replacement Cartridges now come in individual new sealed-in-plastic Blister-Paks, with full model identification, interchangeability chart, and instructions—in colorful display box.

### \$70,000,000 CARTRIDGE REPLACEMENT MARKET

The exclusive new Blister-Pak in the E-V Basic 6 Preferred Types makes it easier to take E-V cartridges along on a service call for immediate replacement. Advanced engineering by E-V assures finer reproduction, longer record and needle life, easy installation, and more satisfied customers.

### NEW E-V MODEL 47 DUAL-SLIDE CARTRIDGE FOR 78, 33-1/3, 45 RPM

Here is a unique new innovation in replacement cartridges! The dual-slide, dual needle Model 47 shown on the Blister-Pak at right makes it possible to replace hundreds of different specialized types with a single general-purpose cartridge—with design and operating features found only in wide range custom built cartridges.



### NEW PACKAGING... NEW MERCHANDISERS

**Make Cartridge Replacements  
Easier and More Profitable than Ever!**

Colorful new 2-drawer metal display-dispenser makes it easier for service-dealers to stock and sell phono-cartridge replacements. Your E-V Distributor is ready to supply you with these merchandisers and other E-V sales aids.

SIZE  
6x13x9 3/4"



## FREE HANDY NEW QUICK-ANSWER Cartridge Interchangeability Guide

This complete, up-to-date cartridge interchangeability guide SA9 is available FREE to service-dealers. A simple turn of the wheel gives you the exact replacement for all current cartridges. Get it now from your E-V Distributor or write to Electro-Voice.

# Electro-Voice®

# BAFFLES 3<sup>rd</sup> GENERATION

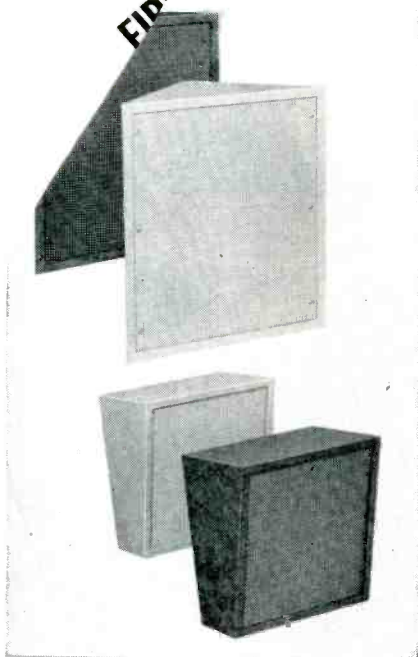

Baffles are *seen* as well as *heard*. Use Argos baffles and you improve any installation.

Corner baffles \$11.25 and \$15.50, list; wall baffles \$3.95 to \$7.85, list.

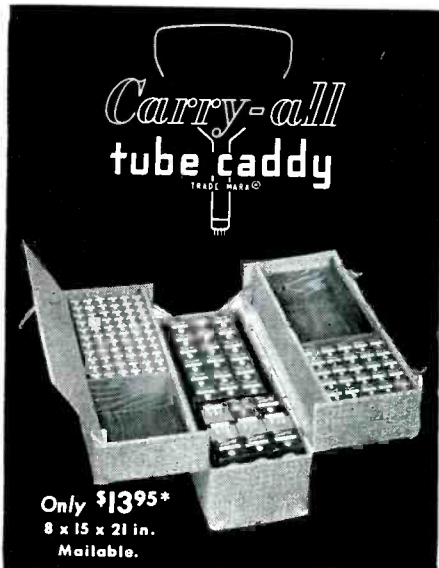

Most time-saving case ever designed for the TV technician. Carries up to 262 tubes, plus tools . . . tells the customer, "Now here is an efficient serviceman."

\*Dealer Net. Others \$8.85 to \$14.95  
ASK YOUR PARTS DISTRIBUTOR



**LEWIS WINNER**  
Editor

**D. E. PEARSALL II**  
**F. WALEN**  
Assistant Editors

Including *SERVICE—A Monthly Digest of Radio and Allied Maintenance*; RADIO MERCHANDISING and TELEVISION MERCHANDISING. Registered U. S. Patent Office.

Association News .....	28
Audio Service Notes (For Phonos... Amps) .....	52
PA in Stadiums. By Norman Crowhurst .....	42
Ser-Cuits (Broad-Band VHF Distribution Amp with AGC; Cover). By M. W. Percy .....	20
Service...The National Scene .....	37
Service Engineering (6-12 V Portable Power Supply Design-Application). By Maxwell Alberts .....	34
Servicing Helps (Printed Circuit Repair Notes). By T. L. Gilford .....	30
Streamlined Test Bench Design (Basic Plans to Expedite Repairs). By George F. Steeg .....	18
Ten Years Ago .....	29
The AAC Audio Forum:	
Speaker Loading .....	46
The Role of Acoustics in Music Listening .....	50
The Final Stages in a Community TV Installation. By T. C. Masters .....	22
The TV Spurious Radiation Problem (Report on Comments by W. R. G. Baker and FCC Commissioner Webster at IRE Symposium) .....	17
Tube News (Transistor Noise Measurements). By A. M. Kelwood .....	33
UHF-VHF TV Antenna Digest (Double Diamond Phasing for VHF Antennas). By Ralph Peters .....	40
UHF-VHF TV Antenna-Accessory Review .....	41
Views and News. By Lewis Winner .....	15

## CIRCUITS

ATR Combination 6-12 V DC Input Vibrator Pack .....	34
Blonder-Tongue MAGC Automatic Gain Control (Cover) .....	20
Blonder-Tongue MLA VHF Distribution Amplifier .....	21
Four-Speaker System for Remote Audio Installation .....	46
Pierce Electron-Coupled Dual-Crystal Beat-Frequency Oscillator .....	30
Three-Speaker Crossover Network .....	46
Transistor, Tube, Diode Flip-Flop Circuitry .....	33

## COVER

Automatic Gain Control for VHF Distribution Amp (Blonder-Tongue MAGC) .....	20
---	----

## Index to Advertisers

.....	63
-------	----

## Manufacturers

Catalogs and Bulletins .....	58
Components and Equipment for Service Engineering .....	35
Instruments .....	43
Jots and Flashes .....	63
News .....	44
New Parts . . . Tools .....	54
On Book Row .....	4
Personnel .....	59
Rep Talk .....	45
TV Parts . . . Antennas . . . Accessories .....	53



Entire Contents Copyrighted 1955, Bryan Davis Publishing Co., Inc.

Published monthly by Bryan Davis Publishing Co., Inc.

52 Vanderbilt Avenue, New York 17, N. Y.

Telephone: MURRAY HILL 4-0170

Bryan S. Davis, Pres. F. Walen, Sec. B. Block, Adv. Mgr. A. Goebel, Cir. Mgr.  
**East. Rep.: Jerome J. Brookman, 299 Madison Ave., New York 17, N. Y. Tel.: MU 7-6530**  
**Mid-West Mgr.: Stuart J. Osten, 333 N. Michigan Ave., Chicago 1, Ill. Tel.: DEarborn 2-3507**  
**East-Central Rep.: James C. Munn, 2253 Delaware Dr., Cleveland 6, O. Tel.: ERievew 1-1726**  
**Pacific Coast Rep.: Brand & Brand, 1052 W. 6th St., Los Angeles 17, Cal. Tel.: MADison 6-1371**

Entered as second-class matter June 14, 1932, at the Post Office at New York, N. Y., additional entry at the Post Office, Norwalk, Conn., Oct. 22, 1954, and under the Act of March 3, 1879. Subscription price: \$2.00 per year in the U.S.A. and Canada; 25 cents per copy. \$3.00 per year in foreign countries; 35 cents per copy.

Editorially approved by HOWARD SAMS Photofact Reporter\*—

Feature "invisible" conversion for over

14,000,000

TV sets with Standard Coil tuners in use today.

Buy the set owners' goodwill and loyalty by selling them "invisible" conversion with Standard Coil UHF strips in their Standard Coil tuner.

Strip conversion is "designed in" conversion developed by the same engineers who designed the tuners used in the sets. And—no extra box, no extra wires, no extra tuning knobs—and the absolute minimum of interference.

And Standard Coil "invisible" conversion is simple to install and easy to align. Capitalize on the steady demand for UHF conversion. This is all that's needed for each channel converted (actual size).

\*Vol. 3, No. 2—page 35 and following

**Standard**—COIL PRODUCTS CO., INC.

CHICAGO • LOS ANGELES • BANGOR, MICH. • NO. DIGHTON, MASS.

Export Agent: *Rocke International Corporation, 13 E. 40th Street, New York City*

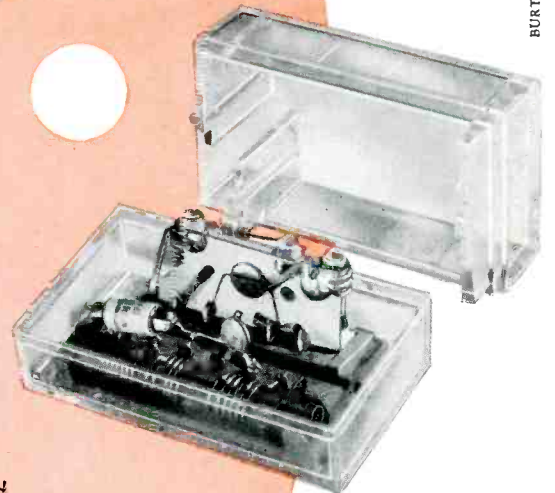

BURTON BROWNE ADVERTISING

# On Book



## RADELCO

## PRESENTS

### TWO BRAND NEW ANTENNAS

### To help you to Bigger Sales!

**RADELCO**

## Nautilus

**WITH BEAUTIFUL  
STREAMLINED  
MOUNTING BASE**

The Radelco Nautilus provides the first basic change in antenna design in a decade... and its beauty will endure as long as automobiles retain their present streamlined design of flowing movement.

**MOUNTS EITHER  
FRONT OR REAR**

Available in two models for either front or rear mounting. Model NT-3 is for front installation with a 4 ft. lead-in cable. Model NT3-15 is for rear installation with a 15 ft. lead-in cable and 75 MMF Ceramic Condenser.

Model	Sec.	Lead	List
NT-3	3	4 ft.	\$6.15
NT3-15	3	15 ft.	8.65



**RADELCO**

## Fire Ball

**ALL CHROME  
DUAL REAR MOUNT  
ANTENNA SET**

The Radelco Fireball antenna enhances the appearance of any car... old or new! Mounts easily on rear deck or the rear flat surfaces of all cars. The Fireball comes complete with 15 ft. lead-in cable with T-Connector and 75 MMF Ceramic Condenser. Cable clips included. Packed in self-selling counter display. Packed 10 sets to a master carton.

Model	Sec.	Lth.	List
FBD-35	3	35"	\$11.70



## RADELCO MANUFACTURING COMPANY

7580 GARFIELD BLVD.

CLEVELAND 25, OHIO

THE RADIO AMATEUR'S HANDBOOK... 32ND EDITION: A 27-chapter volume, with revised sections on *vlf* and *hf* transmitters and *vlf* techniques. Also contains revised tube tables and base diagrams for 67 new miniature types, 26 crystal diodes, 19 rectifiers, 17 transistors and 32 other types, plus a complete listing of electrostatic cathode-ray tubes. Included are five chapters on basic radio theory, three covering basic experimental data, and fifteen on advanced theory and constructional details for transmitters, receivers, transmission lines, antennas, power supplies, single-sideband, FM and AM, keying and microwave techniques. — 768 pages, 6½" x 9½", priced at \$3.00; American Radio Relay League, Inc., West Hartford 7, Conn.

\* \* \*

TV REPAIR QUESTIONS AND ANSWERS — FRONT ENDS... BY SIDNEY PLATT: First in a series featuring questions and answers on the repair of each section of the TV receiver, covered in the sequence that the signal travels. Chapters cover antennas and transmission lines, plus front ends. Contains 135 practical questions and answers, and follow-through discussions; also lists safety precautions, variations and other information. Volume can be used as a bench reference or as background material.—Paper bound, priced at \$2.10; John F. Rider Publisher, Inc., 480 Canal St., New York 13, N. Y.

\* \* \*

WIRELESS AND ELECTRICAL TRADER YEAR BOOK: RADIO, TELEVISION AND ELECTRICAL APPLIANCES 1955... 26TH EDITION: Comprehensive reference text on industry in England. Includes condensed specifications of nearly 300 current commercial British TV receivers and information on vacuum and picture tube base connections, with over 300 base diagrams. Provides alphabetical and territorial lists of radio and electrical wholesalers; association members are indicated. Has a listing of *if* values of radio receivers marketed during the past seven years. Other data includes specifications of current radio receivers (over 250 models), and a directory of trade associations, wholesalers' directory, and classified buyers guide.—304 pages, 5½" x 8¾"; Trader Publishing Co., Ltd., Dorset House, Stamford St., London, S.E. 1, England.

# Row

**BIGGER PROFITS IN TV . . .** BY RAY A. SNYDER AND DONALD B. SHAW: A practical guide for the Service shop. Features sample problems and examples of accounting procedures, business records, shop tickets and labor costs. Titles of chapters include: *Keeping Business Records; How To Figure Your Profit; What is Your Labor Worth; Credit and Collections; and Legal Angles of Business.*—132 pages, 5¼" x 8", priced at \$1.50; Howard W. Sams and Co., Inc., 2201 E. 46th St., Indianapolis 5, Ind.

\* \* \*

**SONICS . . .** BY THEODORE F. HUETER AND RICHARD H. BOLT: An exposition of analysis, testing, and processing of materials and products by the use of mechanical vibratory energy, or sound and ultrasound. With the unity of sonics as their keynote, authors cover the fundamental physics of vibration and sound, design principles of electroacoustic and fluid-dynamic transducers, and special techniques for testing and processing.—456 pages, priced at \$10.00; John Wiley and Sons, Inc., 440 Fourth Ave., N. Y. 16, N. Y.

\* \* \*

**BASIC ELECTRICITY . . .** BY HOWARD W. SAMS STAFF: A training manual offering a practical approach to beginning studies in the field of electricity. Text material is laid out in 35 lessons; each is illustrated and explained. Many questions and problems are presented to aid one in grasping fundamental laws and relationships. Typical lessons are: *Ohm's law, Kirchhoff's laws, Watts' law, magnetism, generators, motors, transformers, lighting.*—264 pages, 8½" x 11", priced at \$5.00; Howard W. Sams and Co., Inc.

\* \* \*

**TAPE RECORDER MANUAL . . .** BY JOHN F. RIDER STAFF: A 310-page manual containing the official service and adjustment information on the products of thirteen tape-recorder manufacturers. Includes schematics, tube layout, operating voltages, photographic views of the components on the chassis, complete parts list, etc. Also, mechanical details in the form of step-by-step adjustment information, exploded views of the assembly, and service guide to both electrical and mechanical troubles.—Priced at \$4.50.

# Why Fuss?

(when replacing selenium rectifiers)

don't be  
a  
plodder



be a  
"plugger"\*



\* Use the Sarkes Tarzian CC-1 Plug-In Conversion Chassis to modernize old TV sets.

All Sarkes Tarzian Replacement Rectifiers plug into Conversion Chassis CC1. See your distributor.

Sarkes  
Tarzian

"Plug-In"  
SELENIUM RECTIFIERS

# Why —

## YOU CAN SAVE TIME AND TROUBLE BY STANDARDIZING ON BUSS FUSES!



Whatever your fuse requirements may be — you can turn to BUSS and select the right fuse for the job.

The complete BUSS line includes fuses in any size from 1/500 up, plus a companion line of fuse clips, blocks and holders.

You'll find that relying on this one, dependable source for fuses helps to simplify your buying, stock handling and records — and results in profit-saving efficiency.

Every BUSS fuse is electronically tested to assure "trouble-free" protection.

To make sure that BUSS fuses will operate properly under all service conditions — every BUSS fuse normally used by the Electronic Industries is electronically tested. A sensitive device automatically rejects any fuse not correctly calibrated, properly constructed and right in all physical dimensions.

Capitalize on the BUSS trademark.

You don't have to explain why you sell or install BUSS fuses because — millions upon millions of BUSS fuses used in homes, on farms and in industry over the past 40 years have established their ready acceptance. Handling quality products, like BUSS fuses, helps you maintain your reputation for quality and service.

For more information on BUSS and Fusetron small dimension fuses and fuse holders . . . Write for bulletin SFB.

Makers of a complete line of fuses for home, farm, commercial, electronic and industrial use.



**BUSSMANN MFG. CO.** (Div of McGraw Electric Co.)  
University at Jefferson, St. Louis 7, Mo.





**G-C LUMINOUS LITE-KOAT KIT**  
Coat dials, switches, etc., with this long-life, non-poisonous "glow in the dark" coating.  
No. 184-0 NET \$1.95

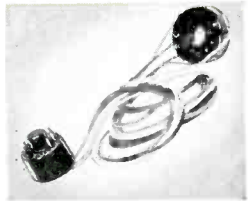

**G-C PICTURE TUBE EXTENSION**  
Extends picture tube leads from chassis to tube when servicing set. Complete, 48 inches.  
No. 8856 NET \$1.50



**G-C ELEC., RESISTOR CEMENT**  
Ideal for resistors, appliances, etc. Heat-proof, hardens like porcelain.  
No. 27-2 2-oz. bottle NET \$0.39



**G-C SILVER PRINT**  
Pure silver compound used to repair printed circuits. Handy for touch-up, labs, etc.  
No. 21-2 Troy oz. NET \$4.65



**G-C DE-OX-ID KIT**  
Handy contact cleaner for switches, controls, relays. Kit contains 2 oz. De-Ox-Id and needle-type injector.  
No. 8460 NET \$0.99

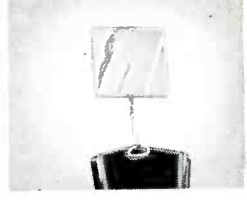

**G-C TV PORTO MIRROR**  
Heavy chrome plated mirror for adjusting TV sets. Rubber lined spring clamp.  
No. 8198 NET \$2.58



**G-C STRIP-X**  
Removes insulating enamel from wires for easy soldering. Simply dip and wipe!  
No. 26-2 2 oz. bottle NET \$0.39



**G-C CREME-O-WAX POLISH**  
White, non-staining polish for furniture, TV and radio cabinets. Dries to hard gloss.  
No. 95-16 16-oz. bottle NET \$0.66



**G-C CABINET REPAIR KIT**  
Contains 10 shades of shellac sticks, stains, varnish, brushes, everything for cabinet repairs. Easy to use.  
No. 901 NET \$4.50

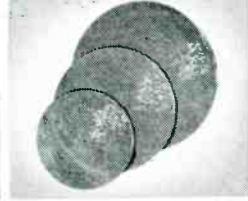

**G-C RECORD TURNTABLE FELT**  
Ready-cut replacements, center hole.  
No. 1292 7 7/8" dia. NET \$0.30  
No. 1293 9 7/8" dia. .42  
No. 1294 11 7/8" dia. .51

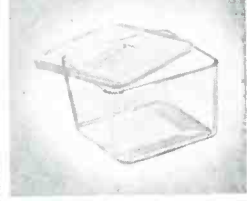

**G-C PLASTIC STOCK BOX**  
Handy, covered polystyrene box for stocking screws, nuts, resistors, capacitors, etc. 4x4x2 1/2".  
No. 8022 NET \$0.36



**G-C 1/2" JEWEL SIGNAL LIGHT**  
Miniature screw base jewel in red, green, blue, amber, opal, clear (specify) 7/16" mtg. hole.  
No. 7910 NET \$0.27



**GENERAL**



**CEMENT**

*Ask For These*  
**RADIO-TV SERVICE AIDS**  
*... at Your Jobber*



**G-C FUSE CONNECTOR**  
Regular type used on car radios, etc. 2 1/2" long x 3/8" dia. For 1/4" fuses.  
No. 1749 NET \$0.15

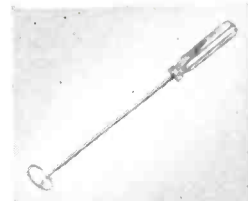

**G-C INSPECTION MIRROR**  
Get into those hard-to-reach corners, inspect coils, connections, etc.  
No. 5090 NET \$0.33

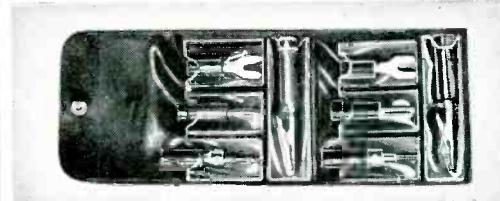

**G-C TEST LEAD PLUG INTERCHANGE KIT**  
Easy to switch alligator clips, banana plugs, spade lugs, phone tips. Fitted plastic case holds one each in red and black.  
No. 7743 NET \$1.95

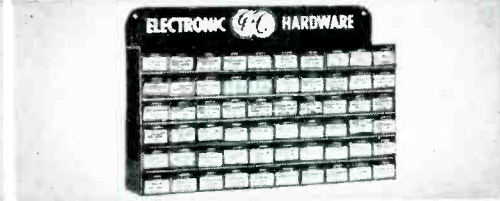

**G-C ELECTRONIC HARDWARE LAB**  
Contains 60 most popular items in G-C 50 Line, each in hinged cover box. Good looking steel rack (9" x 13 1/2" x 2 1/2") for bench or wall mounting included in kit without charge.  
No. 3660 NET \$19.50

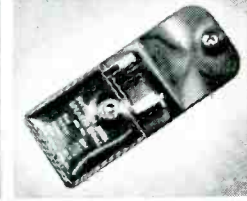

**G-C SWEDISH STEEL SHIMS**  
Leatherette kit includes 16 high grade shims for speaker repair. Sizes: .004", .006", .008", .010".  
No. 701 NET \$0.54

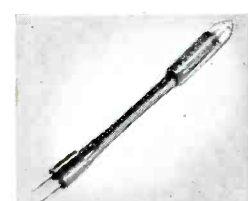

**G-C NE-O-LITE TESTER**  
Neon glow lamp circuit tester for many uses. 60 V. AC to 550 V. AC-DC.  
No. 5100 NET \$0.36

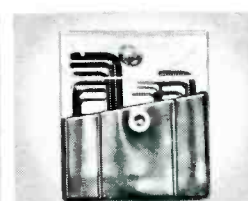

**G-C ALLEN-BRISTO WRENCH KIT**  
Complete kit for both hex and spline type screws. Leatherette case, 12 wrenches.  
No. 5028 NET \$1.09

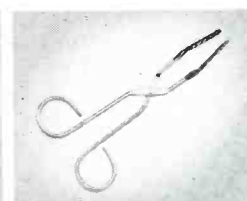

**G-C TUBE & PARTS EXTRACTOR**  
Originally designed for Signal Corps. Spring steel, cadmium plated. Prongs rubber cushioned.  
No. 5092 NET \$0.99



**G-C MINIATURE TUBE PULLER**  
Suction, vacuum principle tool prevents tube breakage, burned fingers. Easy to use, saves time.  
No. 5093 for 7-pin tubes NET \$1.08  
No. 8106 for 9-pin tubes 1.08



**G-C UHF HOLLOW LINE CAPS**  
Seals round and oval hollow line ends. Easy to slip cap over end of line, eliminates heat sealing.  
No. H8912 Box of 8 NET \$0.30

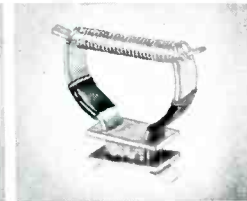

**G-C BO ELIMINATOR**  
Eliminates Barkhausen Oscillation in horizontal sweep output tubes. Easy to install and adjust.  
No. 8749 NET \$0.75



**G-C BEAM-O-CENTER**  
Beam adjuster fits in back of tube yoke coil to center picture. Bakelite housing. Easy adjusting.  
No. 8956 NET \$1.05

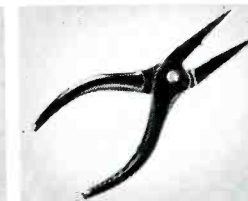

**G-C TV HIGH VOLTAGE PLIERS**  
Insulated long nose pliers made of high impact Bakelite. Absolutely shock-proof.  
No. 8387 NET \$0.99

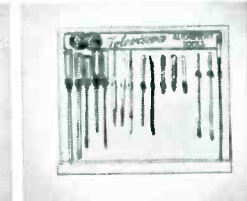

**G-C ALIGNMENT BENCH KIT**  
Includes 16 most needed tools in handy stand-up bench rack.  
No. 8281 NET \$7.74

**GENERAL CEMENT MFG. CO.**

901 Taylor Ave. • Rockford, Illinois

**FREE!** Postcard brings you big G-C Catalog.

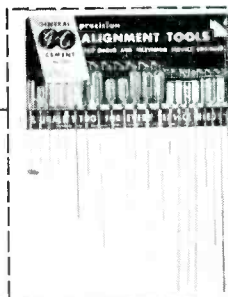

**G-C ALIGNMENT TOOL KIT**  
No. 9200 NET \$13.95

**G-C ALIGNMENT TOOL KIT**  
No. 9201 NET \$14.95

*Ask Your Jobber*  
*for the*  
**GENERAL CEMENT**  
**SPECIALS OF THE MONTH**



# WHO'S THE ONE YOU TALK TO

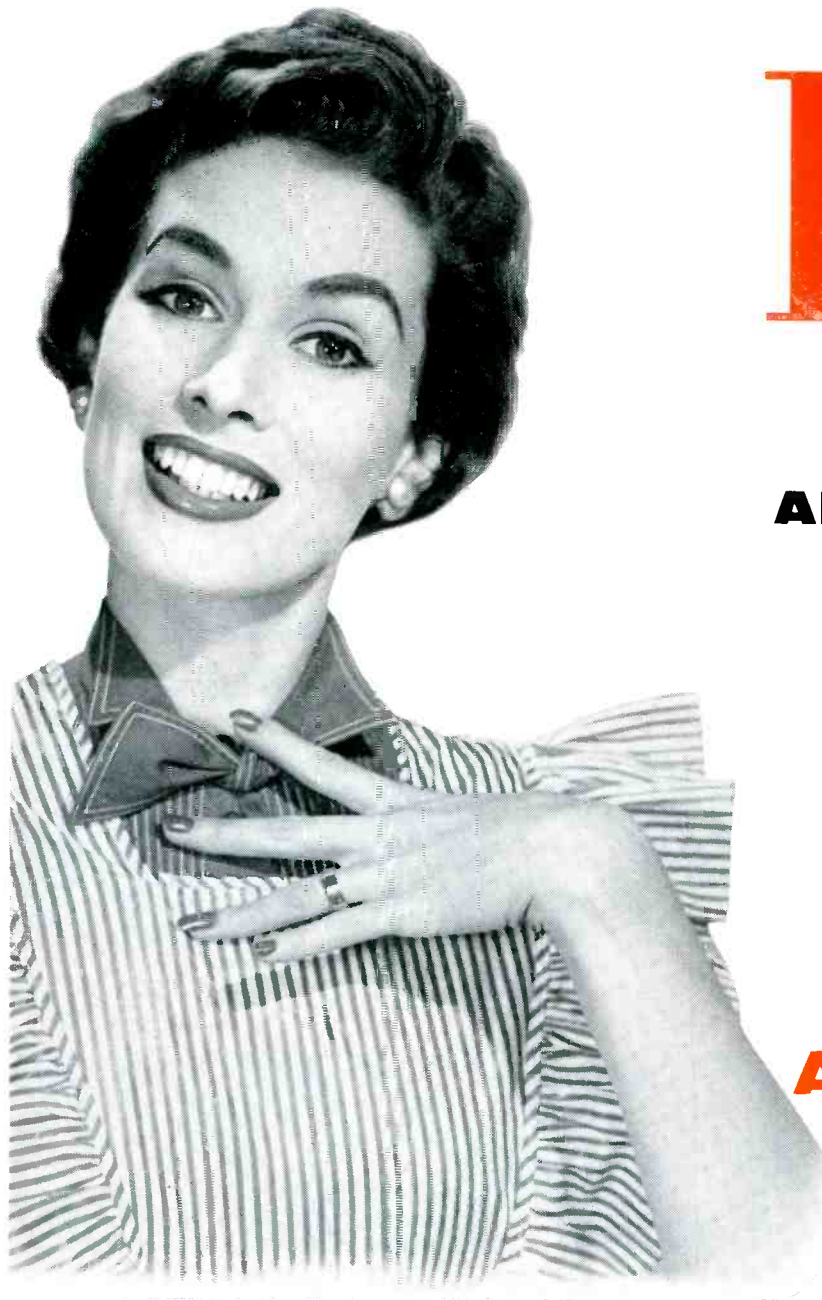

# It's a

## **AND WOMEN BUY**

A Crossley, Incorporated survey shows that this Seal influences 53% of *all* women in their purchases of everything from raisins to refrigerators . . .

and . . . *CBS TUBES* have the Good Housekeeping Guaranty Seal! When you

# SO-O-O-O ADVERTISES

CBS is the *first and only tube* manufacturer to address its advertising to women.



CBS tubes will be consistently advertised throughout the year in Good Housekeeping and Life, reaching 17,171,419 readers every time an advertisement appears!

**CBS-HYTRON** Main Office: Danvers, Massachusetts • A DIVISION OF CBS . . . THE COLUMBIA BROADCASTING SYSTEM, INC.

A member of the CBS family: CBS Radio • CBS Television • Columbia Records • CBS Laboratories

**ON MOST SERVICE CALLS ?**

# Woman...

**... BY THIS SEAL**

install CBS tubes you leave no question in your customer's mind about the quality of the tubes you supply. Keep *your* customers happy — with CBS tubes, the tubes with the *Good Housekeeping Guaranty Seal* on the carton.



## ... CBS TO WOMEN

*And it's women you talk to on most service calls.*



*Quality products through **ADVANCED-ENGINEERING***

### **CASH IN WITH THIS NEW CBS TUBE SALES PROMOTION KIT!**

Ask your distributor for special offer, or mail coupon *today.*

CBS-Columbia • CBS International • and CBS-Hytron

**CBS-HYTRON, Danvers, Mass.**

Please rush me the new CBS TUBE SALES PROMOTION KIT, PA-70, containing:

- 1. Three Truck Posters
- 2. Metal Frame for Truck Posters
- 3. Window Display with three-dimension Giant CBS Tube Carton
- 4. New Inside/Outside Decal

I enclose \$2.00 to cover the cost of this kit.

Name.....  
(please print name and address)

Street.....

City.....State.....

# CHANNEL MASTER

steers you to the  
greatest  
conical values  
ever offered!

the New  
**"MAVERICK"**

Never before such  
a complete line  
of conicals at such  
fabulous **LOW PRICES!**

Low-priced conicals? Here is the **LOW-EST-PRICED**, fullest conical line you've ever seen—a complete series of 22 different models. Checked out and approved by the Channel Master laboratory, every "MAVERICK" antenna provides outstanding Broad Band reception wherever conical antennas find application. Available both "Super-sembed" and non-assembled, the "MAVERICKS" are, without doubt, today's most sensational antenna buy.

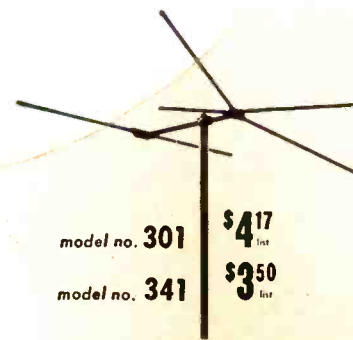

model no. 301 \$4<sup>17</sup><sub>list</sub>  
model no. 341 \$9<sup>50</sup><sub>list</sub>

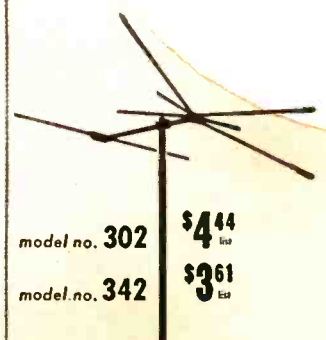

model no. 302 \$4<sup>44</sup><sub>list</sub>  
model no. 342 \$9<sup>61</sup><sub>list</sub>

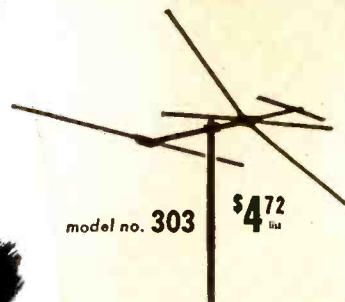

model no. 303 \$4<sup>72</sup><sub>list</sub>

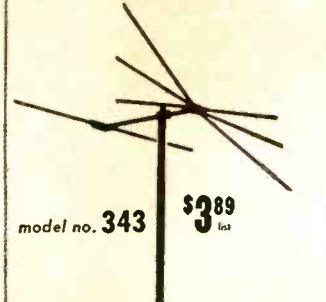

model no. 343 \$9<sup>89</sup><sub>list</sub>

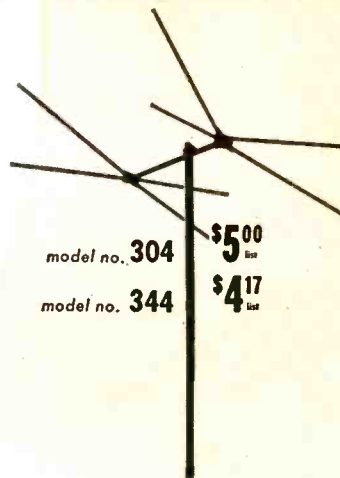

model no. 304 \$5<sup>00</sup><sub>list</sub>  
model no. 344 \$4<sup>17</sup><sub>list</sub>

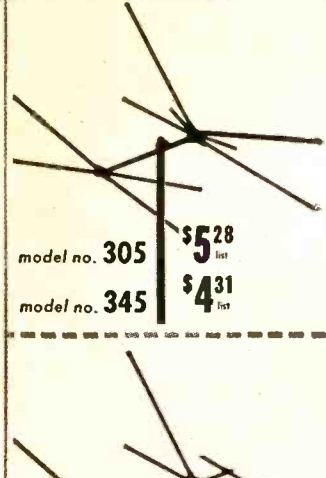

model no. 305 \$5<sup>28</sup><sub>list</sub>  
model no. 345 \$4<sup>31</sup><sub>list</sub>

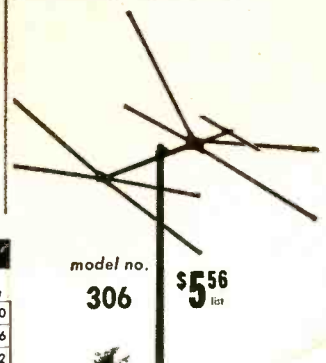

model no. 306 \$5<sup>56</sup><sub>list</sub>

## "MAVERICK 300"

model no.	desc.	pack'd list
301	1-Bay 6	\$4.17
301-2	2-Bay 3	8.75
301-8	2-Bay 1	9.31
302	1-Bay 6	4.44
302-2	2-Bay 3	9.31
302-8	2-Bay 1	9.86
303	1-Bay 6	4.72
303-2	2-Bay 3	9.86
303-8	2-Bay 1	10.42
304	1-Bay 6	5.00
304-2	2-Bay 3	10.42
304-8	2-Bay 1	10.97
305	1-Bay 6	5.28
305-2	2-Bay 3	10.97
305-8	2-Bay 1	11.53
306	1-Bay 6	5.56
306-2	2-Bay 3	11.53
306-8	2-Bay 1	12.08
301-3	Conn. Rods	.56

## "MAVERICK 340"

model no.	desc.	pack'd list
341	1-Bay 6	\$3.50
341-2	2-Bay 3	7.36
341-8	2-Bay 1	7.92
342	1-Bay 6	3.61
342-2	2-Bay 3	7.64
342-8	2-Bay 1	8.19
343	1-Bay 6	3.89
343-2	2-Bay 3	8.19
343-8	2-Bay 1	8.75
344	1-Bay 6	4.17
344-2	2-Bay 3	8.75
344-8	2-Bay 1	9.31
345	1-Bay 6	4.31
345-2	2-Bay 3	9.03
345-8	2-Bay 1	9.58
341-3	Conn. Rods	.56

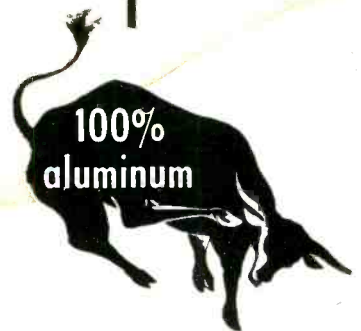

# "MAVERICK 300"

12 different models

Extra "sleeve" on element provides 400% greater strength where it is needed most.

Conical "head."

The **first** and **only** full line of conical antennas completely *"Super-sembled"*

No hardware, no tools, no tightening—pops open, ready for the mast!

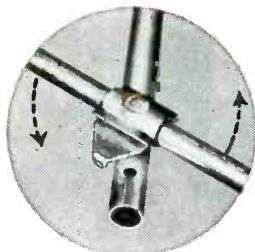

Director bracket.

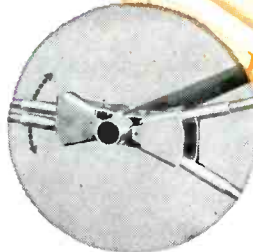

Bracket of X-type reflector.

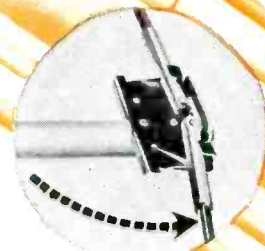

Bracket of straight-bar reflector.

# "MAVERICK 340"

10 different models

Features

**"NOTCH-LOCK"**

Clamp Plate  
Elements can't turn  
or twist loose!

This exclusive feature, until now, has been available only in much higher-priced models.

**NON-ASSEMBLED\***

**This quality line carries the lowest price-tags ever seen on conical antennas!**

- Installs in a matter of minutes. • Most popular conical arrangements.
- Finest materials; durable, rugged construction.

**\* Extra Preassembly Feature!**

On all models with straight-bar reflectors, the reflector element is completely preassembled for snap-open installation.



**CHANNEL MASTER CORP.**  
ELLENVILLE, N. Y.

WORLD'S LARGEST MANUFACTURER OF TELEVISION ANTENNAS

Write for complete technical literature

Copyright 1955, Channel Master Corp.

# BATTERY BUSINESS IS BIG BUSINESS

## here's how to win your share

Over 15 million portables in the USA today make this business of selling batteries a big business. Get your share by letting RCA give selling power to your battery selling plans. Remind your customers that RCA Batteries are radio-engineered for extra listening hours . . . manufactured to the highest performance standards of the greatest name in radio. Your RCA Battery Distributor is ready now to supply you with fresh, full-powered RCA Batteries. And, remember, when you place your order, ask about RCA's profit-building battery selling aids. They're available with your purchase of fast-selling RCA Batteries.



**FREE!** "This Business of Selling Batteries" (Form 4F303), filled with business tips, selling hints, and promotional ideas. Get your free copy from your RCA Battery Distributor or write directly to RCA Commercial Engineering, Section D44N Harrison, New Jersey.



**RADIO CORPORATION  
of AMERICA**

**RADIO BATTERIES HARRISON, N. J.**

Ask "The Man on the Roof"  
why he prefers

*South River*



Take **CHIMNEY BANDING** for instance...



*Why take this?*

The troublesome watchspring effect—Some servicemen have to put up with banding that has a tight spiral "set". Bands of this kind can easily be spotted by their reluctance to stay put. Placement around the chimney is difficult and time consuming.



*You can have this?*



This is the "free-opening" South River Band. Remove the retaining tape and you'll see it naturally unwinds for easy placement around the chimney. That's South River's way of making things easier for the man-on-the-roof.



**NEW!**

**Hi-Strength Aluminum Guy Cable Equivalent to 6-18 Steel Wire  
Highly Resistant to Atmospheric Corrosion**

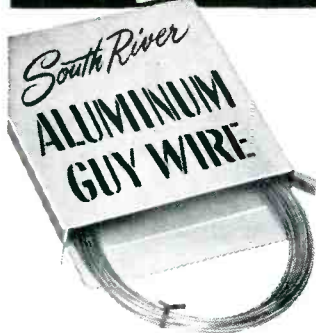

◀ This 7-strand aluminum guy cable of 17 ga. Alclad 56S alloy is specially made for TV guying purposes. It should not be confused with converted clothesline types of cable. Our particular cable has a "tight" twist that gives maximum strength, minimum wind resistance and ice load, does not "basket" when bent. Grey Alclad finish.

Available in 100 ft. coils individually boxed, or ten 100 ft. coils, interconnected and packed 1000 ft. to the box.

Also . . . for **Lightning Protection**; our EC Aluminum Ground Wire. High conductivity #8 gauge. Packaged 100 ft. per coil. ▶



*South River* **METAL PRODUCTS CO., INC.**  
South River, New Jersey

PIONEER MANUFACTURER AND OUTSTANDING PRODUCER OF THE FINEST LINE OF ANTENNA MOUNTING ACCESSORIES

WRITE FOR OUR 1955 CATALOG

In Canada: A.T.R. ARMSTRONG, LTD., TORONTO



"Your Raytheon program\* has gone far toward the needed understanding between customer and dealer..." says Bailey Root of ROOT TELEVISION

One need only glance at these pictures of ROOT TELEVISION'S modern, efficient looking operation and competent staff of technicians to realize that here is a well organized, dependable, profitable Radio-TV service business.

We're proud that they are Raytheon Bonded dealers, and happy that we could play a part in their success story. Why not ask your Raytheon Tube Distributor if you can qualify for the Raytheon Bond that helps thousands of Service Dealers throughout the country gain prestige and profit? If you can qualify, it's yours for the asking.

\*The RAYTHEON Bonded Electronic Technician Program



"Let ROOT get to the root of your trouble"

**Root** television

317 MONMOUTH STREET • NEWPORT, KENTUCKY  
 • CO Inland 5864  
 • AX tel 5555

Raytheon Manufacturing Co.,  
 55 Chapel Street  
 Newton 58, Massachusetts

Gentlemen:

We have just received our 1955 Raytheon Bond Certificate for which we extend a most gratified "Thank you".

As one T.V. - service dealer we appreciate the effort which your entire organization has put forth over the past years in behalf of we dealers. We for one, feel that your program has gone far toward the needed understanding between customer and dealer. You are setting a perfect example for other tube and part manufacturers to follow. Keep up the good work.

Yours very truly,

*Bailey S. Root*  
 Bailey S. Root

BSR/bb



**RAYTHEON MANUFACTURING COMPANY**

Receiving and Cathode Ray Tube Operations  
 Newton, Mass., Chicago, Ill., Atlanta, Ga., Los Angeles, Calif.

*Excellence in Electronics*

RAYTHEON MAKES ALL THESE:

RECEIVING AND PICTURE TUBES • RELIABLE SUBMINIATURE AND MINIATURE TUBES • SEMICONDUCTOR DIODES AND TRANSISTORS • NUCLEONIC TUBES • MICROWAVE TUBES



**Operation Confusion on Plus or Minus Road**

NO TERM has bewildered the Service Man so much as *tolerance*. Service Men have been told that it is absolutely essential that tolerances, as specified, must be followed religiously, when selecting a replacement. And yet, repeatedly, it has been found that following this recommendation led to trouble and caused a number of problems that could only be corrected by installing a component whose tolerances usually varied substantially from the original design.

The situation has always prevailed, even in the early days of the three-tuber. But with the advent of the complex sight-sound chassis, the problem really has become grave. With up to four times as many tubes and supplementary circuitry to go wrong, it has become increasingly important to know how and when to choose the right component, with the correct plus or minus values.

Those who produce quality parts for replacement adhere, with scrupulous care, to the recommended designs for receivers; and they deliver an excellent product, perfectly tailored for the job. The tolerances indicated are absolutely correct. These manufacturers are extremely proud of their ability and the painstaking care taken in the production of their components. So they, too, have been riled to learn that a number of their parts, *all* conforming to prescribed tolerances, just don't fit the need when used as replacements.

Who then is to blame for this dilemma? Anyone of a number of persons, and all are at the plant of the set maker.

In making a decision involving special tolerances, or ratings, or product type, a ring of personnel must be consulted: Design, production and quality control engineers, plus those in purchasing, sales and management.

It is up to them to decide if close or broad tolerances are necessary for correct performance, critical operating conditions or frequency response. They must be sure that allowances are made where drift is inevitable. And larger dissipation ratings must be chosen to minimize change of value with temperature. It must be also decided if it is wise to use parts with certain tolerances, perhaps very close, rather than resort to more complicated circuitry to avoid their use.

But, in too many labs and on too many benches, component values, tolerances and ratings are chosen with little consideration for field results. There are receiver

engineers who refuse to follow solid fundamentals in their designs. Or all too often, the inclusion of some special component with vague tolerances is approved, because it provides the basis for a sales pitch. Also, there is often a lack of adequate coordination of responsibility; engineering personnel are not always sufficiently coherent in conveying information to those who have to make decisions. Regretfully, too, engineers competent to make these important decisions are relegated to other assignments; management doesn't always weigh too carefully the relative importance of component selection to overall design.

The basic problem of tolerance control appears among resistors and capacitors. It is generally known that a variety of engineering factors determine the choice of paper, ceramic or electrolytic capacitors. Paper and ceramics hold their values well, whereas some electrolytics are subject to deterioration. And for precision applications, ceramics represent an excellent choice.

Tubes and types must also be studied closely, for their behavior can serve as a barometer of value changes that can be tolerated. In many labs, though, programs call for casual specification of tubes, without any serious thought to the absolute values of complementary components required. And when these chassis, designed so ineptly, must be repaired, Service Men find themselves buried in trouble; usually the remedies are known only to the plant's engineering staff, who have had to devise a long list of production changes so that the sets might operate.

Everyone concerned with the production of a chassis should certainly be well versed with the varied characteristics of components before final selections are made. In some companies, it is essential that everyone in design, purchasing and management possess this knowledge. But, in too many quarters, there are only a few levels where such polished professional talent must obtain, and decisions are arrived at loosely.

The problem is acute in black and white TV; in color the picture is frightening. But, there is no reason why this bleak situation must continue. Manufacturers can readily adopt a firm coordinated engineering-management policy that will eliminate all of the current confusion on plus or minus road, so that Service Men might select and install replacement components, as specified, with confidence, and know that both he and his customers will be consistently sure of top-flight performance.—L. W.



*Extra Sales... Extra Profits with*

# PHILCO AUTOMATIC ANTENNA ROTOR

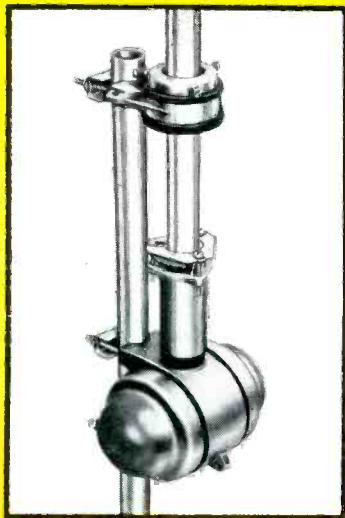

## Super Pin-Point Reception

There's sales magic in the Philco name . . . especially when it appears on this top quality, customer-satisfying Automatic Antenna Rotor. Precision-designed for accuracy, ruggedly built for long, trouble-free life . . . the Philco AP-2 Rotor outmodes all other antenna rotating devices.

The Philco AP-2 permits pin-point adjustment with sharp separation . . . turn the knob to the desired position and antenna revolves to the exact location chosen . . . automatically. It locks firmly and *will not drift or stray*. Accuracy is not affected by changes in line voltage.

### **IT SELLS ITSELF!**

Thousands of satisfied purchasers everywhere have found the Philco AP-2 a perfect answer for better pictures, and Service Dealers have found the Philco AP-2 Automatic Antenna Rotor the perfect answer for new sales volume . . . greater profits.

Order your stock of the AP-2 from your Philco Distributor now.

Don't forget—every AP-2 you sell means more Philco Share and Profit stamps—Free—More new merchandise to sell at a clear 100% profit. Ask your distributor about the 1955 Share and Profit program at once. *There's money in it for you.*

**PHILCO CORPORATION Accessory Division**

Philadelphia 34, Pa.

PHILCO TUBES  
IMPROVE THE  
PERFORMANCE OF  
ANY TV OR  
RADIO RECEIVER



# The TV Spurious Radiation Problem

As Viewed by Industry and Government

Specialists During IRE Interference Symposium

WITH THE increasing use of electronic devices, there exists increasing interference between services. The growing seriousness of the situation points up the clear necessity for consideration of the interference problem as one in which the interfered service as well as the interfering service has a distinct responsibility to seek a solution. This philosophy should be adopted by the FCC.

In the past, the FCC has issued dockets and notices of rule making which have come as a surprise and shock to the industry. In the light of this past experience, this important recommendation is made: We should establish a joint consulting group comprising members of the FCC and industry, this group to be supported by appropriate joint industry and FCC task forces as the occasion arises. Such a proposal is preeminently sound. It would bring together the policy requirements of the FCC and the vast technical and economic resources of the industry, and would result in rules which would have the immediate acceptance of the entire industry. This proposal was made to the FCC in a

## The Problem of Interference†

report on *Interference*; December 30, 1954. This proposal is not entirely new. An approach to it was actually tried in Washington in September, 1950, at which time committees of RETMA met unofficially with representatives of the FCC. At that time radiation limits were established for FM and TV receivers, which limits later became industry standards. Unfortunately, this good beginning was not followed through.

Wholehearted efforts have been made by RETMA in attempting to seek practical and equitable solution to the two current major interference problems. It must be recognized that RETMA is a voluntary association of electronics equipment manufacturers and has not, does not wish, nor could in any manner have policing power over its members or the industry broadly. It has been extremely successful in a number of recognized instances in setting up recommended standards and practices in technical areas. Notable, were the NTSC stand-

ards for monochrome and color television.

The interference problems mentioned are, of course, spurious radiation from radio and television receivers and other electronic devices and interference to television receivers due to authorized transmissions in the 41-46 mc band (which embraces the standardized if band of a TV receiver).

The efforts made by the industry through the RETMA engineering department to solve these problems includes years of work by the engineering staffs of member companies, including recognized technical authorities in this field. The tangible results of this work are evidenced by a number of standards covering *radiation rating of television and FM broadcast receivers*<sup>1</sup>, *good engineering practice regarding if rejection of television receivers*,<sup>2</sup> and *intermediate frequencies*.<sup>3</sup>

RETMA proposed standard of good engineering practice on the limits of radiation from TV broadcast receivers

(Continued on page 61)

<sup>1, 2, 3</sup> RETMA Standards REC-129B, 140 and 109, respectively.

†From a report by **W. R. G. Baker**, Director of Engineering, RETMA, and Vice President, General Electric.

At the IRE symposium on spurious radiation in the Waldorf-Astoria, New York City, left to right: FCC Commissioner E. M. Webster, W. R. G. Baker, G.E. and RETMA; Axel Jensen, (Bell Labs); A. V. Loughren, (Hazeltine); Ralph Bown, (Bell Labs., symposium chairman); G. C. W. Browne, (Controller of Telecommunications Division, Dept. of Transport, Canada); Edward W. Allen, Jr., (chief engineer, FCC); Edward S. White, (chief engineer, Warwick Manufacturing Co.); L. E. Coffey (engineer-in-charge, inductive interference, Department of Transport, Canada), and ye ed. White and ye editor represented the IRE professional groups on receivers and broadcast transmission (as group chairmen), co-sponsors of the symposium.



# Streamlined Test

## A Basic Plan For a Service Bench to Improve Overall Shop Efficiency

MOST PRESENT-DAY service benches are outgrowths of earlier radio benches. While these benches are fine for radio, many are finding that these work tables leave something to be desired when used to service the ever-growing television chassis. Evidence of this is found in the assortment of mobile setups now available, which include trollies or carts for test equipment to allow greater ease and flexibility in service.

### The Bench Pattern

To improve overall shop efficiency, the bench shown in Fig. 1 was developed; actually it *grew* as conditions arose, and now serves to reduce handling of chassis, expedite trouble-shooting, and maintain or improve the economy with which shop floor space is used.

The system still takes the chassis to the test equipment as is done with the conventional bench. This is done by means of a wheeled dolly designed to fit between the work tables, as disclosed in the illustration. The work table and the dolly are the fundamental units of the system, and they may be as simple or as elaborate as cost, flexibility, and space require.

Since this system was originally conceived, there have appeared completely-packaged table-rack-dolly setups<sup>1</sup> which are equally as effective as the combination built in our shop. They offer a number of conveniences, such as rack support for test gear, power outlets, and tool housings, plus structural features that can't always be duplicated in hand-made items.

Accordingly, this report can be used either as a guide in planning a service-bench layout using fabricated units, or some of the tables can be built.

### The Work Tables

The work tables can be specially constructed, or standard kitchen work tables can be used. The dimensions shown are only approximate, and are offered as guides only. Each installation will differ according to individual preferences, and available space and materials. The deeply shaded area on

the tables represents space set aside for basic test equipment. This will probably include at least a 'scope and a *vum*. Provision has been made for a capacitor checker or other medium-sized instrument. The remaining bench area (roughly 8" front to back) can be used for tools, parts, and other odds and ends in immediate use. The drawer provides tool storage which can be locked if tools are issued or are personal property. The additional shelves (or drawers) can be used for storage of parts, either for the shop as a whole or for use at the one test position.

### Dolly Features

The dolly can be constructed of 2x2's and plywood, suitably braced. The two shelves serve to beef up the dolly, and can have other functions also. In sets using separate chassis and picture tube, the tube can be placed on the shelf, keeping necks and metal cones away from accidental contact.

If the shelf is made low enough, the separate pix tube can be left in a table model cabinet, or the space can be used for cabinet stowage.

### Defective Part Bin

A strip of lath around the lower shelf makes it a handy trash bin, keeping bits and pieces off the floor and

keeping defective parts with the chassis. The portion of the dolly projecting beyond the work table edge allows space for service notes, and furnishes greater flexibility in placing the chassis in position.

### Typical Table Arrangement

The illustration shows a possible arrangement for two. Tables 1 and 3 are the main work tables; the major portion of work will be performed with dollies in spaces A and C. Table 2 is the alignment table, and alignments (by either man) would be done at B. The method can be extended to any number of work tables, and obviously there must be more than one dolly for each work table. As in the illustration, the setup should include a table set aside to hold alignment equipment (generators, jigs, power supply, etc.)

Since the alignment table will not be in frequent use, its position may be chosen to provide for the occasional left-hander and to allow intermittents to be evenly distributed among the positions.

### Intermittent Checking

Intermittents still present a problem with this system, but at least they are more easily moved. For instance, if the man working at position 1 hits an intermittent, he can pull it out of space A and let it cook in space B. When the trouble shows up in space B, the intermittent can be serviced with minimum disturbance from the work in space A and no moving of test equipment.

### Roll-Away Virtues

After repair, the set may be rolled away from the work table for test run in some convenient part of the shop. This serves to free the test equipment for other work, while allowing return of the chassis for additional work with a minimum of effort and set-up time.

### Bench Advantages

From this description it can be seen that the bench layout can materially reduce time and labor involved in handling chassis. The dolly provides a convenient work table for stripping the set. Once on the dolly, the chassis

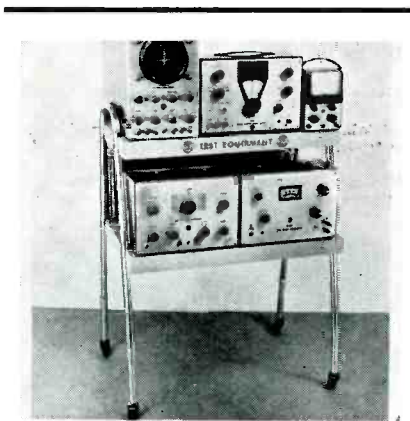

A recently designed mobile table that serves to hold a complement of test equipment for servicing TV receivers. Table, which is fitted with ball-bearing casters and constructed with a polished aluminum frame and a pair of wood-framed shelves (providing eight square feet), is said to be capable of supporting several hundred pounds. (Port-a-Rack; RCA.)

<sup>1</sup>Similar to equipment developed by the Baumker Manufacturing Co.

# Bench Design

by GEORGE F. STEEG

**Expedites Handling of Chassis Before, During and After Troubleshooting**

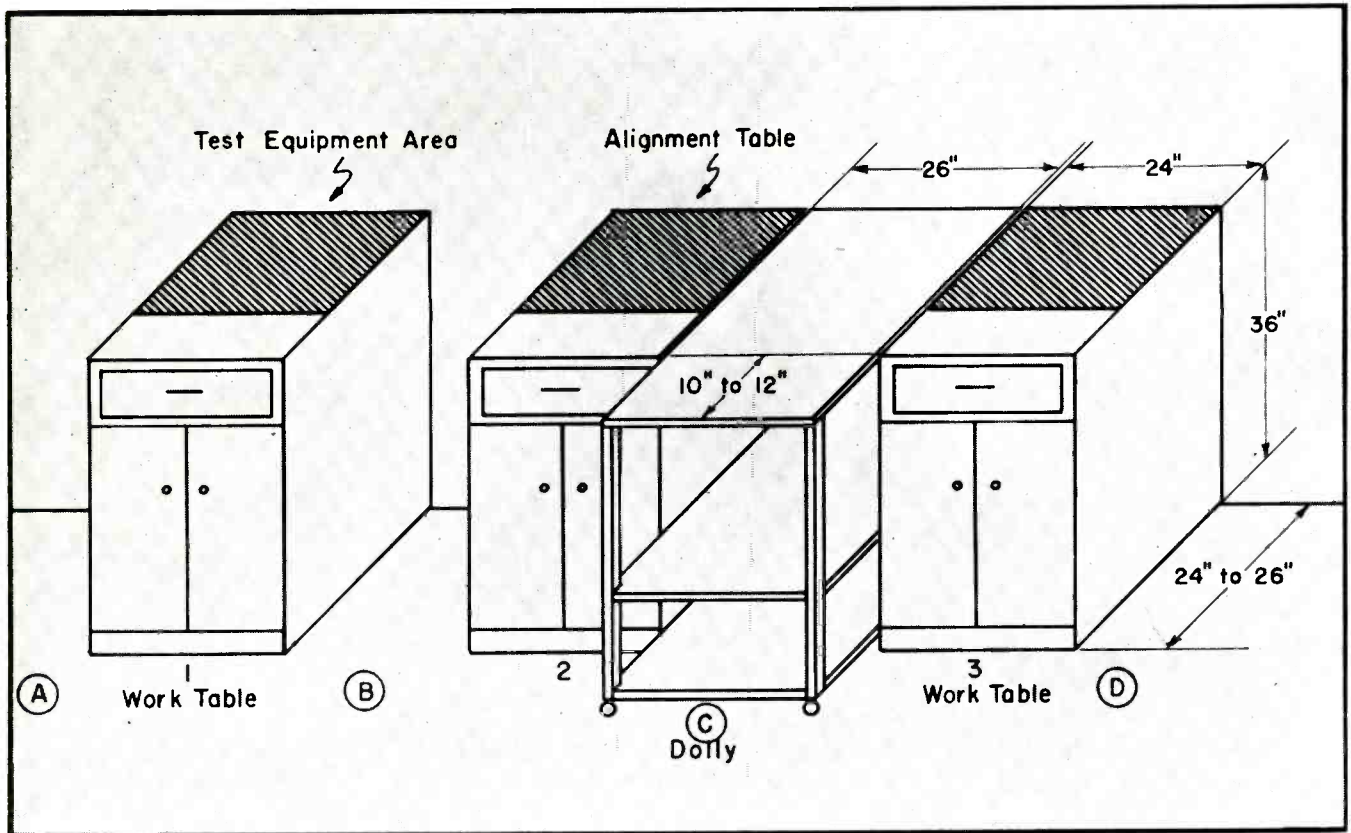

Fig. 1. Test bench layout designed to facilitate service operations; arrangement shown for use by two Service Men.

remains there until ready for its cabinet or the completed rack. In addition, neat and accessible storage of tools, parts, and equipment help speed up the actual servicing operation. The ease with which chassis can be moved during the service operation makes the system extremely flexible.

Flexibility may also be increased by designing the work tables to meet special needs or to utilize one's special abilities. Finally, this system requires less space for a given number of Service Men and chassis than the conventional bench.

These work tables are less in depth by the width of the usual over-the-bench test equipment shelf. This arrangement serves to free wall space for charts, price lists, or shelves (out of the way of tipped chassis) for manuals and parts storage.

Even though the dollies take up space when not in use, and the cost of tables and dollies may be more than the cost of a conventional bench, it is imperative that a more efficient chas-

sis-handling system be employed in the shop. This system has been found to be an answer to the problem of speedy and efficient handling of the volume of sets passing through today's active shops. Gradual installation of or conversion to this system is readily accomplished because of its unit nature, and once in use Service Men will wonder how they ever got along without it.

## Import of Tools and Instruments

Of course, it is important to remember that this, or any system cannot be fully effective unless one has a complete complement of quality tools and test gear.

An inadequate supply of tools can prove disastrous. Not only is it necessary to have the standard assortment, but a number of specialty items, which can facilitate bench work.

For instance, there is now available an extension cord reel (15") provid-

<sup>2</sup>Hykon Manufacturing Co. <sup>3</sup>Plomb Tool Co.; <sup>4</sup>Proto Grab-All. <sup>5</sup>Donari Co.

ing light and power up to 200' from the source.<sup>2</sup>

Reel features 30 a, 110 v collector ring for continuous current, while reel is 200' of 14-2 wire and is furnished with 10' of 12-2 plug-in cord.

Another handy item to have around is a retrieving and holding tool. One such tool<sup>3</sup> features four spring steel grippers and a flexible casing.

When top of tool is pressed, a cable that passes through outer casing pushes the four grippers out of the casing at the bottom. Grippers expand outward to grab objects; a spring between cap and finger bar pulls cable back in casing until grippers have a firm hold on the object.

Also very useful are all-rubber drill bit holders. There's one made that holds 13 bits from 1/16" through 1/4" by 64ths.

Bits are held in flexible rubber pockets, and the holder slips on and off the drill cord.

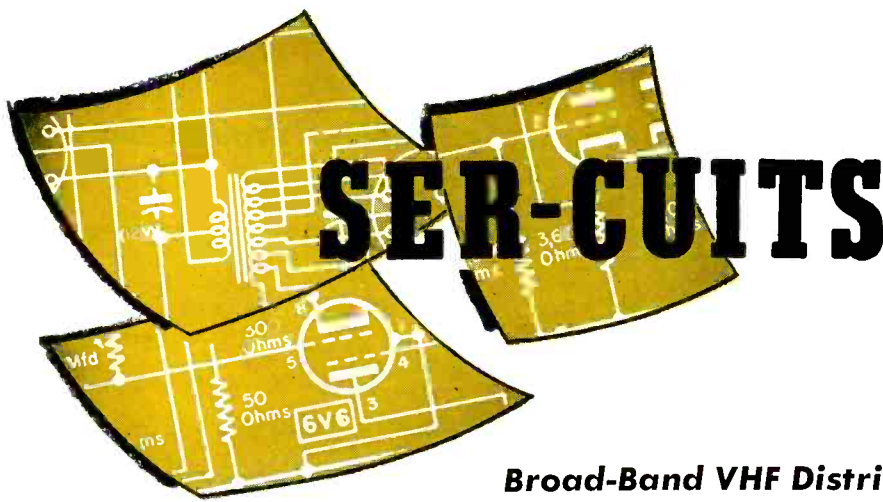

[See Front Cover]

### Broad-Band VHF Distribution Amplifier with AGC

THE MOUNTING CONSTRUCTION of apartment houses and the increased installation of TV receivers in such dwellings, as well as schools, offices and commercial establishments, has upped the interest in master distribution systems, and introduced a scaling need for high-gain amplifiers with some form of *agc*. To simplify installation of such equipment, lab studies have revealed that this gear should have a single input and a single output, so that it could be inserted in any TV system line, or serve as an antenna preamp.

Recently, such an amplifier, with a separate *agc* unit, was evolved<sup>1</sup>. Internal duplexers at input and output were built into the amp to permit all channels in a single line to be handled internally, via a three-tube low-band and a four-tube high-band amplifier. These amplifiers have cascade in-

puts directly followed by pentode amplifiers, to take advantage of the ease of gain control afforded by pentodes. In the field, a gain of at least 37 db (70 times) has been achieved by these circuits at *vhf* frequencies.

To permit increased output it was felt that the 12BY7, originally designed as a power video amplifier tube, could be used. An investigation proved that with proper circuitry, the 12BY7 would operate very well up through 216 mc, providing an undistorted output of 1.25 volts *rms* in each of the *vlf* bands. It was found that with this arrangement, it is possible to obtain a theoretical total of about 2 *v* of *rf* signal from a single composite unit, provided the channels employed are equally distributed in the low and high bands of the *vlf* spectrum.

The use of pentodes was found to permit maximum band-pass flatness

with varying settings of the gain control. Partially unbypassed cathode resistors are employed to minimize any change of frequency with different gain settings. Two gain controls have been incorporated; one for the high band and one for the low band.

To reduce the requirements or demands on the *B+* filtering circuit, the plates of the pentodes are supplied from unfiltered *B+*; gain of the pentodes is relatively independent of plate supply voltage. This arrangement was found to avoid addition of hum to the supply. Less current is drawn through the *B+* filter resistor, improving regulation of the *B+* supply.

In developing the amplifier, it was found that double-tuned coupling between tubes provided greater gain and higher selectivity than staggered single-tuned circuits. The automatic-gain control draws power from the amplifier. It is capable of maintaining constant output levels as low as .5 *v* and as high as 1.25 *v*, in either *vlf* band.

In operation, the output of the amplifier flows into the *agc* unit through a low-pass filter, on which is tapped the grid of a 6BC5.

The output of this tube is then amplified, the plate supplying a high and

(Continued on page 57)

<sup>1</sup>Blonder-Tongue Masterline M.L.A. and M.A.G.C.

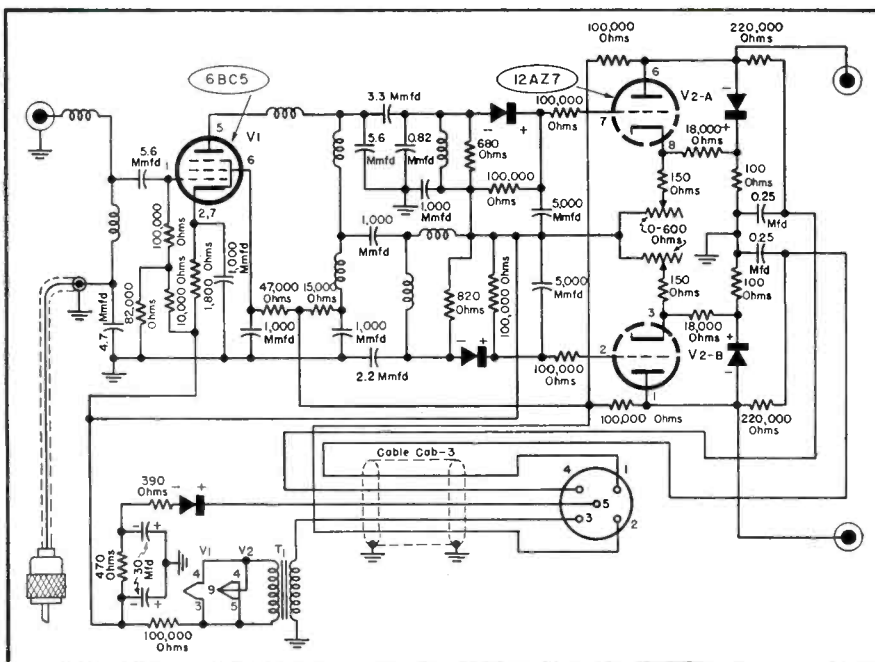

(Left)

Fig. 1. Automatic gain control for a 20-db input variation, when used with amplifier shown in Fig. 2. Circuitry of rectifiers in plate of 12AZ7, as shown in cover diagram, has been revised, and now appears as indicated in this schematic.

(Right)

Fig. 2. Schematic of *vlf* broad-band amplifier which can be used with *agc* unit, illustrated in Fig. 1, or independently if signal fluctuation is not a problem.

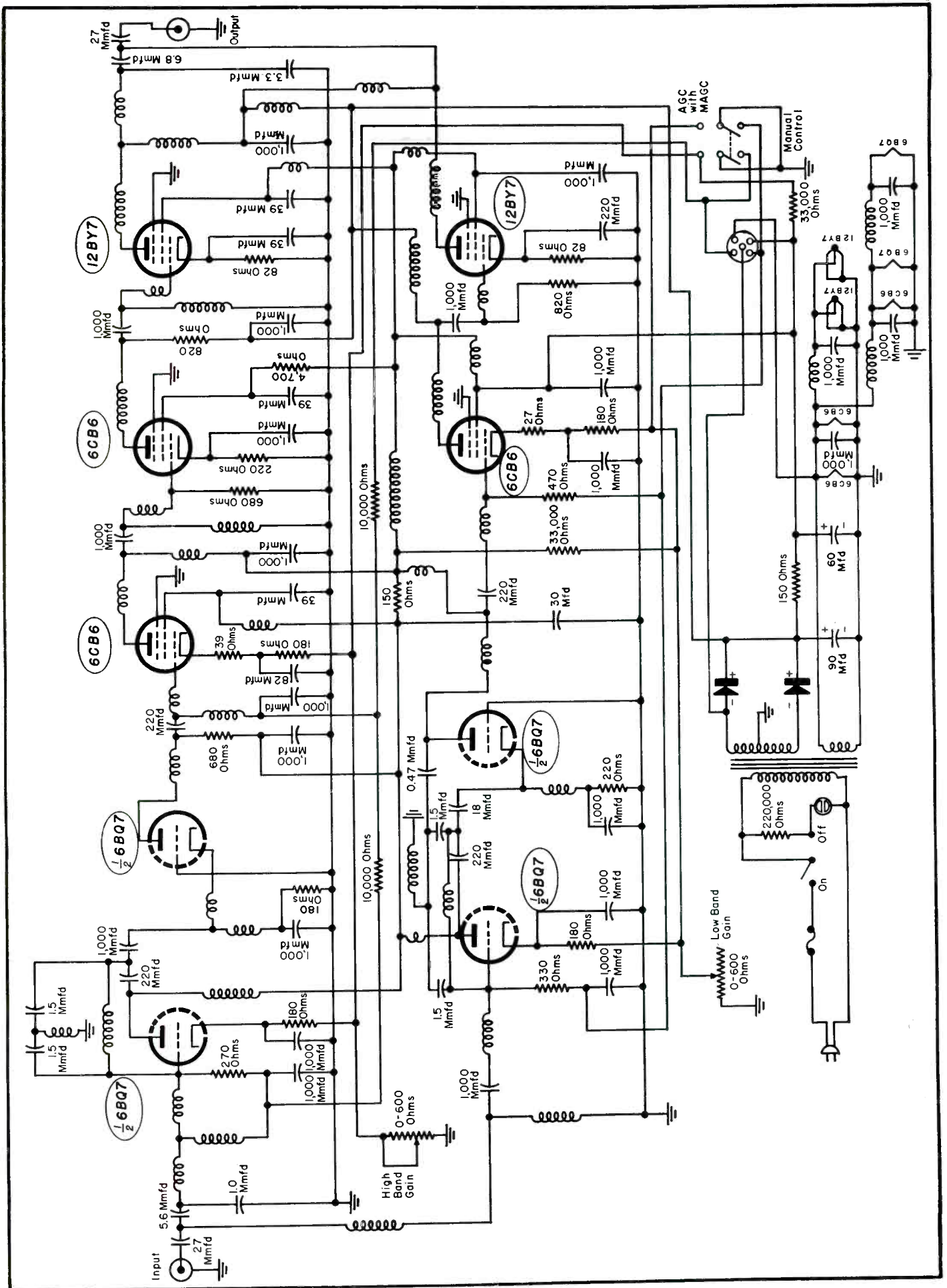

# The Final Stages in a Community TV Installation

by T. C. MASTERS, Chief Engineer, Television Signal Service

## Securing Messenger Cable to Pole . . . Matching Transformers . . . Tapoff Design and Applications

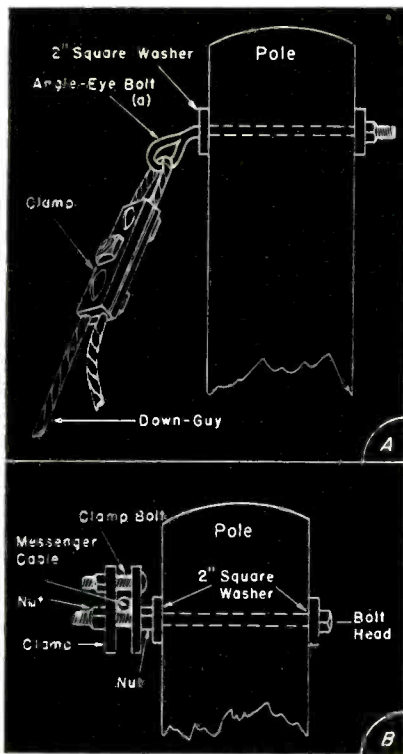

Two METHODS can be used for securing the messenger cable to the pole. A drive hook\* can be driven into the pole itself, or a *C-span-clamp* may be clamped directly to the main cable messenger, and the drop lashed off there. The latter method is preferred, because the house drop strand is then connected directly to the main messenger, providing an excellent ground for the drop. The main messenger strand must be grounded at every fifth pole with a standard 8' ground rod and No. 6 bare copper ground wire. These precautions, together with the use of the 4' rod at the house end, insures excellent protection against lightning damage, and provides a solid selling feature which can be discussed at great length with nervous-type subscribers.

Inside the house, the coax cable is terminated in a matching transformer, 75 to 300 ohms, which is mounted on the baseboard directly above the point of entry of the coax. A 6' piece of ordinary twinlead, with an alligator-type connector, can then be used to reach the TV receiver. This permits the set to be quickly disconnected for cleaning or service work.

The next operation involves the connection of the drop cable to the main distribution cable. There are several units available for this purpose; and each has some desirable features. The most popular items are

those which can be installed without cutting the main cable; these are much less likely to cause future troubles.<sup>1</sup> One tap-off makes use of  $\frac{1}{2}$ -watt resistors as isolating components, and the other uses capacitors. The isolating resistors or capacitors perform two major functions. They introduce several db of isolation between the TV set and the cable, thus preventing radiating sets from feeding back interference into the main lines, and also reduces the high signal levels present in the main lines, down to the proper levels for good set performance.

In most cases about 500-600 microvolts will be found sufficient for good stable performance; this level is maintained at the TV set, while signal levels in the main cable will run up as high as several thousand microvolts. The output of a 36-db amplifier with 1-db input (1 db referred to 1,000 microvolts), will be around 63,000 microvolts. If the drop is connected at the output of an amplifier, a high ohmic value resistor should be used; 3900, 2200, 1500, 1000, 820, 680, 441 and 220-ohm re-

sistors, used at 100' to 150' intervals along the cable from a line amplifier, have proven effective for proper isolation. If capacitors are used, they should be included in the next step following the 1,000-ohm resistor, beginning with a 1.5-mmfd unit, followed by 2.2, 3.3, 4.7, and 6.8 mmfd. If the signal level in the cable is such that a larger capacitor is necessary to obtain adequate readings at the set, then another line amplifier should be installed, although for best results, line amplifier spacings should be figured accurately, according to footage of cable, losses, etc.

There is one exception: When the end of a cable run has been reached, a 75-ohm resistor, which will give an effective 6-db isolation, can be used. In this case, it is necessary to remove the customary 75-ohm terminating resistance and replace it with one of 150 ohms. The 75-ohm isolating resistor is connected directly to the cable, thus placing it in series with a drop load or matching transformer of 75-ohms impedance, for a resultant of 150 ohms. The two 150-ohm loads are then in parallel, giving an effective terminating impedance of 75 ohms; this is an absolute necessity for all cable-runs at the extreme end, to prevent reflections, ghosts, and other difficulties.

One advantage of using capacitors as isolating components is that they

(Above, left)

Pole-hardware used for attaching messenger cables and guy wires to utility poles. The bolts are  $\frac{5}{8}$ ", heavily galvanized; all hardware is also galvanized or coated to prevent weathering. The 3-bolt clamps are used for clamping guy wires and holding the messenger cables to the poles. The angle-eye bolt (a) is used for attaching downguys to poles. Straight or thimble-eye bolts are used when cable goes away from pole at right angles.

(Continued on page 56)

\*Hubbard 1316.

<sup>1</sup>Possibly the best known of these are the RCA MI-6929A, Entron Fastee and B-T-L types.



...for leading TV receiver  
manufacturers

...for you

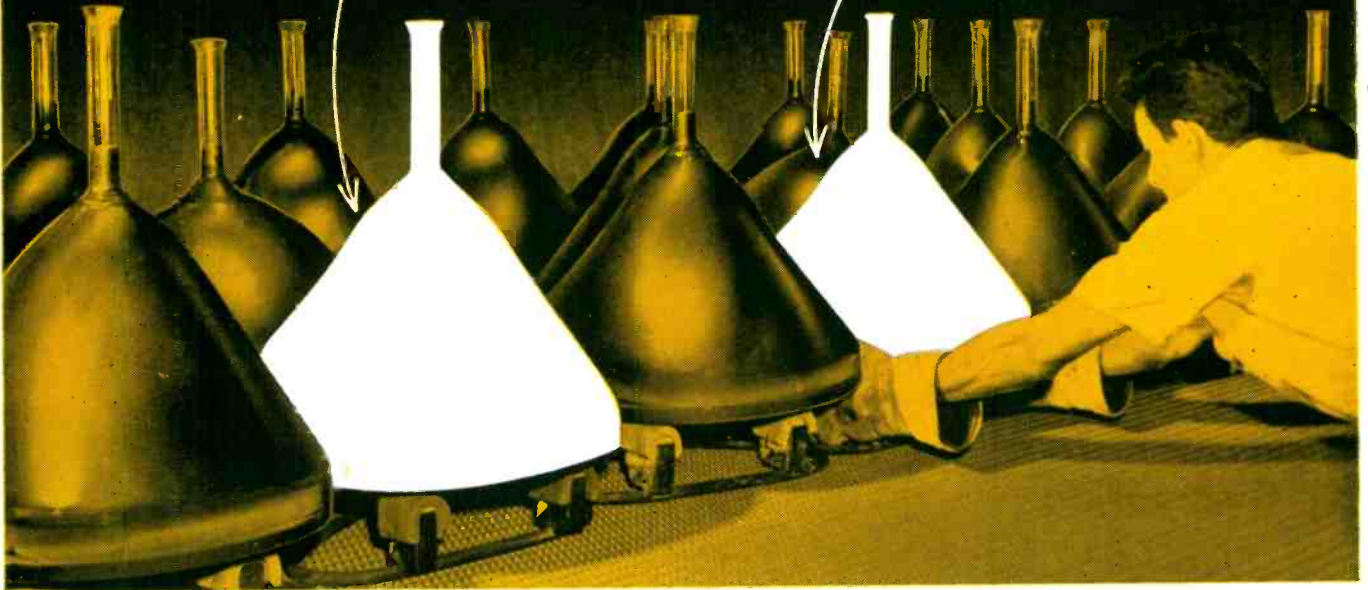

At Du Mont there is only one

*Standard of Quality...*

You take no chances with quality when you use Du Mont picture tubes. *Every* Du Mont picture tube is manufactured to the same exacting quality standards

— whether it's for a leading television receiver manufacturer to be used as initial equipment, or for you to be used as a replacement.



Trade-marks

**ADVERTISE QUALITY —  
FOR QUALITY PROFIT!**

Look for the Initial Quality Picture Tube tag packed with every Du Mont picture tube. Use it to show your customers that you have provided the finest quality components with your service.



Allen B. Du Mont Laboratories, Inc., Clifton, N. J. Replacement Sales, Cathode Ray Tube Division

# ANNOUNCING

# a NEW **FINCO**®

## MODEL

# F-4

(PAT. PEND.)

with exclusive

# FIDELITY\* PHASING

\* Dictionary: the highest degree of accuracy in the reproduction of a signal

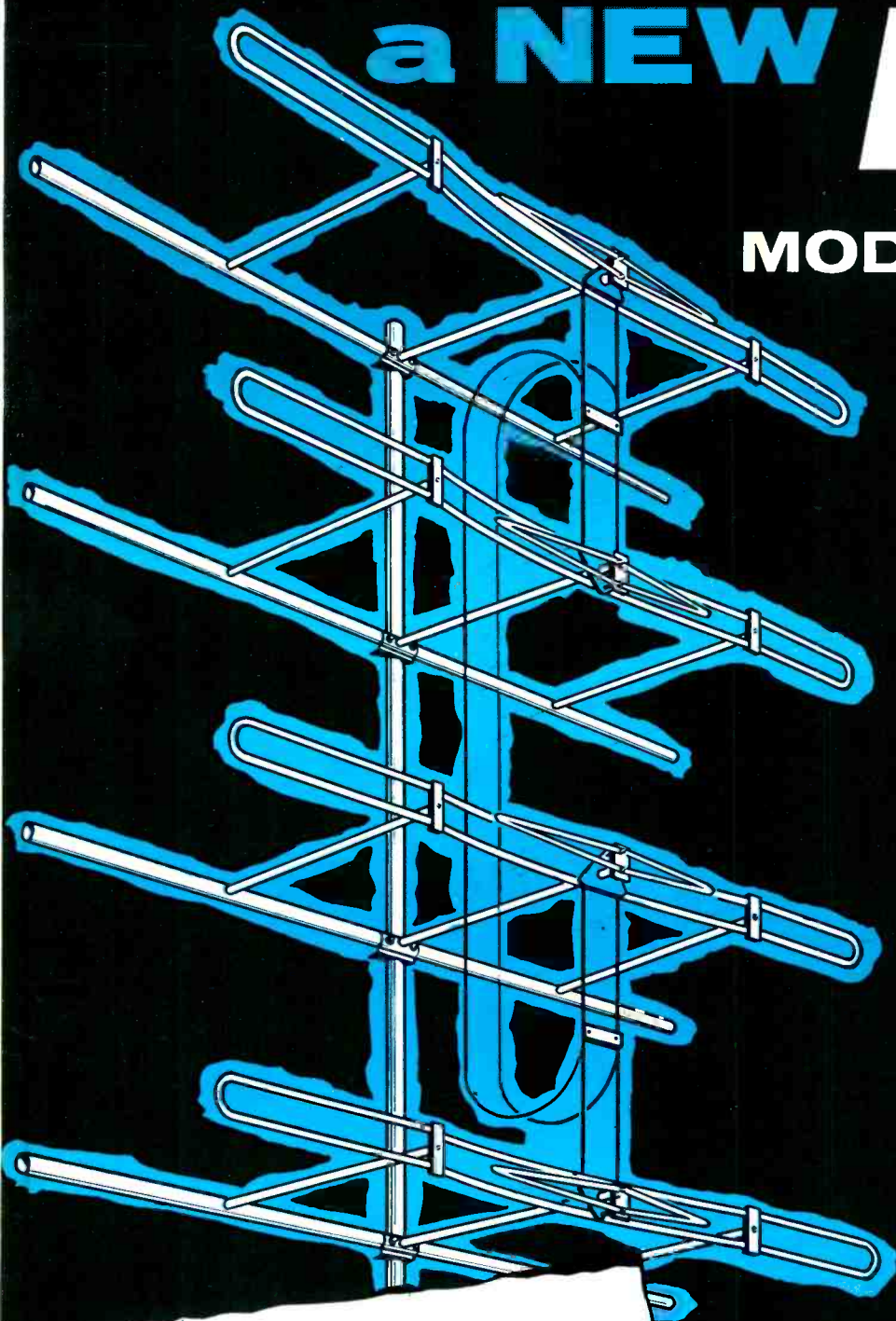

**Now!**

**Finest Performance  
Ever Achieved  
on LOW-BAND**

**Plus +**

**Acknowledged  
FINCO Superiority  
on HIGH-BAND!**

**"We will stake  
our reputation  
on this!"**

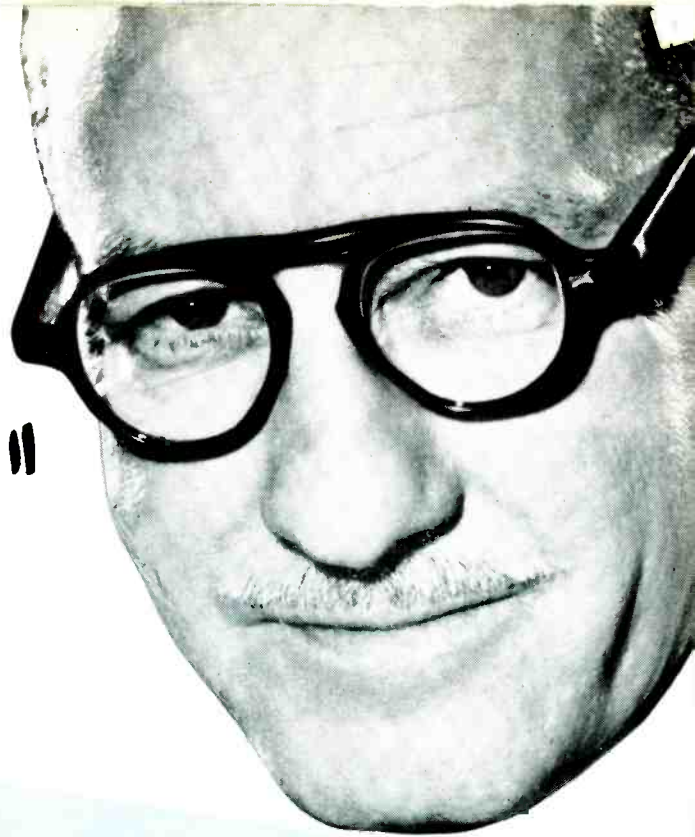
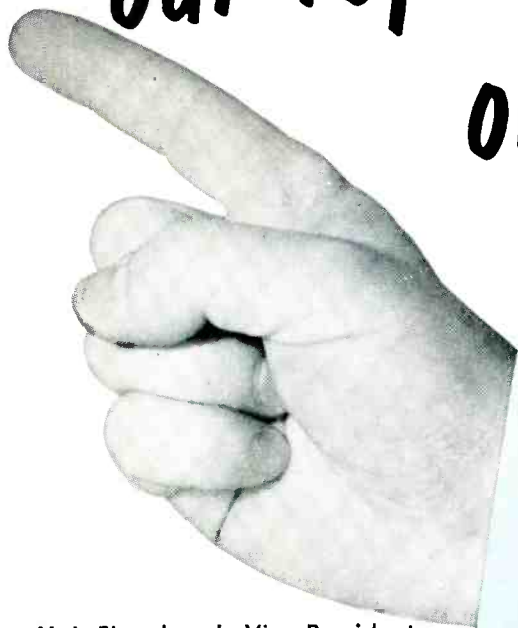

M. L. Finneburgh, Vice-President,  
The Finney Company,  
speaking for the entire  
FINCO organization:

**"The new Finco Model F-4 (pat. pend.) is  
the closest approach to perfection yet con-  
ceived in TV antennas. The F-4 gives the  
greatest combined performance ever  
achieved in the Super Fringe Area... on  
both Low and High-band. Upon this, we  
stake our reputation."**

**NEW!**

**SENSATIONAL LOW PRICE  
FIDELITY PHASING  
LOW AND HIGH-BAND SUPREMACY  
ENGINEERED FOR COLOR  
UNCONDITIONAL WRITTEN WARRANTY  
FREE TESTING ANTENNA TO QUALIFYING DISTRIBUTORS**

**WRITE, WIRE  
OR PHONE  
TODAY!**

**The FINNEY Company**

Dept. S-45

4612 St. Clair Avenue  
Cleveland 3, Ohio

*Ready to install!*

# 6 NEW G-E

You can put top quality in more TV sockets,

## X-RAYS PROVE STRONGER TUBE CONSTRUCTION

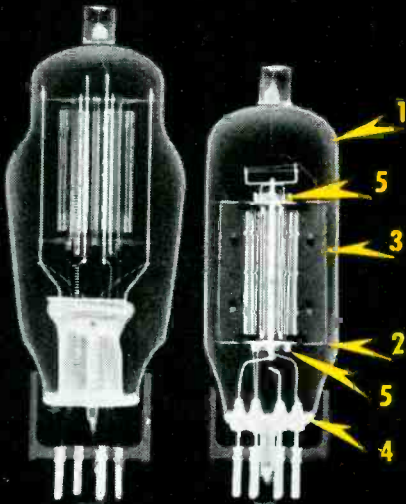

OLD 6BG6-G      NEW 6BG6-GA

1. New bulb is straight-side, much smaller and sturdier.
2. Bottom mica, as well as top, now contacts the glass all around, for greater rigidity.
3. Redesigned, more shock-resistant structure.
4. Button-stem base gives shorter and better-separated leads; improves heat conduction.
5. New beam shields mask off stray electron bombardment from micas and bulb.

## NEW SERVICE-DESIGNED 6BG6-GA

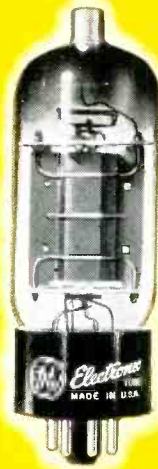

● X-ray pictures at left explain why the new tube is stronger throughout, also more compact. (Note that new straight-side bulb is "necked down" at bottom to take the same diameter base as prototype, so the same ring-clamps can be used when installing.)

Tube performance is much improved. Internal structure and micas have been redesigned to cut down inter-electrode leakage, reducing the chance of horizontal TV-picture shrinkage. The new beam shields, which mask off stray electron bombardment, further increase operating stability.

And every 6BG6-GA is high-voltage seasoned—is pulse-treated at absolute max voltage ratings, among other checks!

## NEW SERVICE-DESIGNED 6CD6-GA AND 25CD6-GB



● Prototypes gave arc-over trouble, causing horizontal TV-picture streaking. In the new sweep tubes, brand-new mica design corrects this fault.

Also, plate area has been increased for greater dissipation. Ratings are higher:

	6CD6-GA and 25CD6-GB	PROTOTYPES
Plate positive-pulse voltage	7000 v	6600 v
Plate dissipation	20 w	15 w

New tubes are high-voltage seasoned. Every 6CD6-GA and 25CD6-GB gets an arc-over test at absolute max ratings!

More compact and sturdier than prototypes, with same base diameter. All of the new construction features shown in the X-ray picture of the 6BG6-GA, apply also to Types 6CD6-GA and 25CD6-GB.



*Electronic*  
TUBES

**NOW 14 G-E SERVICE-DESIGNED TUBES . . . SPECIALLY DEVELOPED, BUILT, AND TESTED TO OUT-PERFORM AND OUTLAST THE TYPES THEY REPLACE!**

- |             |             |             |               |
|-------------|-------------|-------------|---------------|
| NEW 1B3-GT  | NEW 6AX4-GT | NEW 6BX7-GT | NEW 6SN7-GTB  |
| NEW 5U4-GA  | NEW 6BG6-GA | NEW 6CD6-GA | NEW 12SN7-GTA |
| NEW 5Y3-GT  | NEW 6BQ6-GA | NEW 6J6     | NEW 25BQ6-GA  |
| NEW 6AV5-GA |             |             | NEW 25CD6-GB  |

**SEE YOUR G-E DISTRIBUTOR FOR NATIONALLY-ADVERTISED G-E SERVICE-DESIGNED TUBES!**

# SERVICE-DESIGNED TUBES!

build more customer goodwill, than ever before!

**NEW SERVICE-DESIGNED  
6J6**



**NEW SERVICE-DESIGNED  
6SN7-GTB**



**NEW SERVICE-DESIGNED  
6AV5-GA**



**X-RAYS SHOW WHY  
TUBE LIFE IS INCREASED**

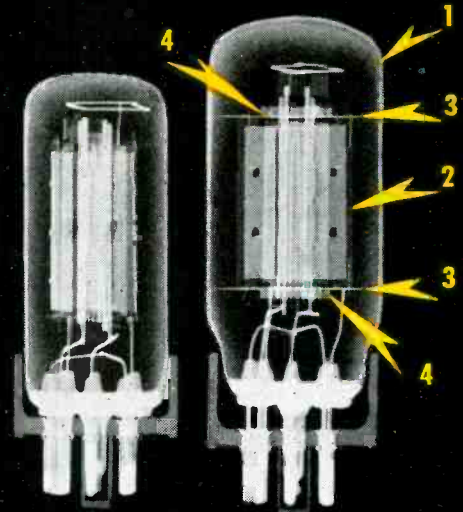

**OLD 6AV5-GT NEW 6AV5-GA**

1. New bulb is much larger, radiates more heat. Tube runs cooler and gives longer service.
2. Redesigned plate has larger area, reducing internal operating temperature of tube.
3. Redesigned micas cut down on high-voltage arcing.
4. New beam shields mask off stray electron bombardment from micas and bulb. Help stabilize tube performance.

● **6J6** . . . Whisper-quiet! Microphonics are cut 'way down! The prototype, used in many head-end TV circuits, was subject to microphonic disturbance when jarred or shaken. This caused picture jitter . . . in some sets, audio noise.

Redesigned tube elements and structure now give servicemen a whole new deal on this much-used type. With Service-Designed 6J6's, technicians can satisfy their most critical customers.

● **6SN7-GTB** . . . Shows that G-E design improvement is a never-ending process! A brand-new model of the popular 6SN7-GTA, with all the latter's superior performance . . . plus a 600-ma heater with "series-string" warm-up time.

Completely interchangeable with the 6SN7-GTA. Also, because of its "series-string" heater, a tube that's universally adaptable for servicing old or new sets.

● The prototype 6AV5-GT had a tendency to run hot, which shortened tube life. X-ray pictures at right show important improvements in G-E's new 6AV5-GA that add up to more hours of service.

The new tube operates safely at high temperatures, withstands high pulse plate voltages, and is sturdy in construction. All these advantages are integral in the 6AV5-GA's new design.

Also—like other Service-Designed Tubes—the 6AV5-GA is high-voltage seasoned. *Every tube* is pulse-tested at absolute max voltage ratings.

Your can count on 6AV5-GA dependability and long life! Install this tube to improve still further your standing with your customers!

● G-E SERVICE-DESIGNED TUBES cost no more than others . . . yet give far superior service. Fully interchangeable with prototypes, they perform better, and tube life is longer. You *gain* when you install them, because they enhance your reputation as a TV service technician.

You *save* in fewer customer call-backs—in reduced tube inventory needs, due to the fact that G-E SERVICE-DESIGNED TUBES give top performance in

all television chassis, regardless of the make.

Now 14 types are available, covering a wide range of sockets. G-E SERVICE-DESIGNED TUBES—a popular success from the start—are nationally advertised. TV owners know about them, ask for them. *Profit* by selling and installing these proved high-quality tubes, obtainable only from your G-E tube distributor! *Tube Department, General Electric Company, Schenectady 5, New York.*

*Progress Is Our Most Important Product*

**GENERAL  ELECTRIC**

# Associations

## ARTSNY, New York City

A SERIES OF LECTURES featuring talks on color and b-w TV test equipment, tubes in color TV and audio has been scheduled for the Spring and early Summer meetings of the Associated Radio Television Servicemen of New York, in the Central Commercial High School auditorium.

It is expected that copies of the lectures will be available for all who attend.

\* \* \*

## NATESA, Chicago

FRANK MOCH, president of the National Alliance of Television and Electronic Service Associations appeared recently before the House Ways and Means Committee in Washington, D. C. to urge the committee to oppose the repeal of section 452 of the Internal Revenue Code.<sup>1</sup>

Moch told the legislators that . . . "Ours is an industry in a state of constant flux. We are continuously faced with tremendous problems, as is every radically new endeavor. Because of its peculiarities, our industry has not, and probably never will achieve the stability enjoyed by most other enterprises. Because of constant changes in design and other factors it is almost impossible to gauge the cost of business except in retrospect."

Pointing out that we are, at the moment, facing another major change in our industry, color TV, the association prexy said that the ". . . possibilities of predetermining actual costs of service with something so new is impossible, and yet we must, of necessity, establish service rates on service contracts, otherwise the speed with which this phase will be accepted by the public will suffer. Repeal of section 452 would thus place us under double jeopardy; on the one hand we would assume unpredictable risks as to cost, and on the other hand, much needed income would be taken as taxes even though it would not be profit."

\* \* \*

## RTG, Long Island, New York

A COMPLETE report on the licensing conference held in Albany, New York, recently, was published by the Radio and Television Guild of Long Island in their monthly edition of the *Guild News*. The story, prepared by *Chris Stratigos*, featured highlights of the remarks made by the district attorney of Kings County, the president of RETMA, and the chairman of the RETMA committee on technical education. According to the lawyer, some form of licensing should be put in effect. The trade association representatives pointed out that no such controls were necessary, since educational programs of the type now in force, and codes and self-policing practices now in effect are doing an excellent job of control and will continue to do so.

*Joseph Forman*, speaking for the Empire State Federation of Electronic Technicians Associations, took a positive stand in favor of licensing; he urged, however, that the servicing profession should be represented on an official committee during the formative planning of the licensing program.

<sup>1</sup>This section permits businesses to defer payment of taxes on income collected on contracts or work that extends over a period of time, until the work has been completed and it is definitely determined just what portion of the money is actual profit. Prior to the enactment of this section, TV service operators paid, in many instances, more than 50% tax on the sum collected even though they may have eventually suffered a loss.



## HIGH PASS FILTER eliminates TV interference

*The model 114-330 High Pass Filter is an inexpensive accessory providing clearer, sharper pictures for any tv set. It effectively rejects all signals at frequencies below 50 mc, including communication-type, diathermy and heat-transmitting interference, and industrial or ignition interference • Circuits are double-shielded in the 114-330 to prevent pick-ups of signals by the Filter itself. Mounting/grounding strap bleeds off rf interference direct to chassis ground. Easily attached to chassis of any tv set.*

Lists at only \$5.45!

AMERICAN PHENOLIC CORPORATION

chicago 50, illinois

In Canada: AMPHENOL CANADA LIMITED, Toronto



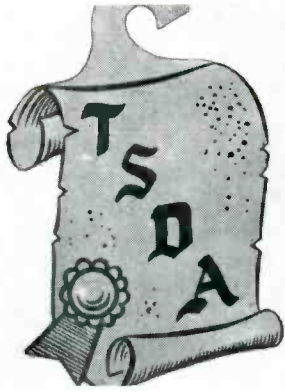

Knob hanger designed by Television Service Dealers Association of Philadelphia. The reverse side of display contains following message: "As a member of the Television Service Dealers Association, we are pledged to give you the best possible TV service at a fair price, and are backed by the high standards set by this mutual association of reliable and honest dealers. . . . The Television Service Dealers Association protects you from unethical service practices. For further information call . . ."

#### ETA, Jamestown, New York

HERMAN SEEHAUSER has been elected president of the Electronic Technician's Association of Jamestown, New York.

Others now serving as officers include Lawrence Savanson, vice president; George Carlson, secretary; and Kermit Johnson, treasurer.

As a feature of a recent meeting, members toured the receiver plant of Sylvania.

\* \* \*

#### TSDA, San Mateo County, Calif.

A STATE CHARTER has been granted to the Television Service Dealers Association of San Mateo County, California.

W. D. Haines is now serving as temporary chairman, and A. F. Blumenthal is co-chairman, while E. Mitchell is secretary-treasurer.

#### TEN YEARS AGO

SEVEN COMPONENTS were cited as the basic causes of set failures in a report by Frank Mansfield of Sylvania. In order of importance they were noted as: tubes, capacitors, power supplies, tuning systems, *if* and *rf* coils and filters. Humidity was called the major cause of component breakdown. . . . At a meeting and equipment demonstration, sponsored by Harrison Radio, Jamaica, N. Y., Roy Goodwin, manager of the RCA test and measuring division, discussed test equipment and predicted that except for television, no new or startling test equipment was expected at the end of the war. Art Lieb-scher of RCA demonstrated a plastic case meter and an audio chanalyst. . . . Captain Albert Gofjstein returned to his duties as general manager and chief engineer of American Television and Radio Co., St. Paul, Minn., after more than three years of military service. . . . Jack Davis was appointed chief engineer of the auto radio division of Galvin Manufacturing Corp.; Gus L. Mydlit became assistant chief engineer. . . . Don G. Mitchell, vice president in charge of sales, Sylvania Electric Products, Inc., was elected to the board of trustees. . . . Charley Golenpaul completed his 15th year as distributor sales manager of Aerovox. . . . Ben Miller became general sales manager of United Transformer Corp.

#### QUESTION:

Why buy TWO when ONE will do?

#### ANSWER:

## Insist on AEROVOX TWIST-PRONG ELECTROLYTICS

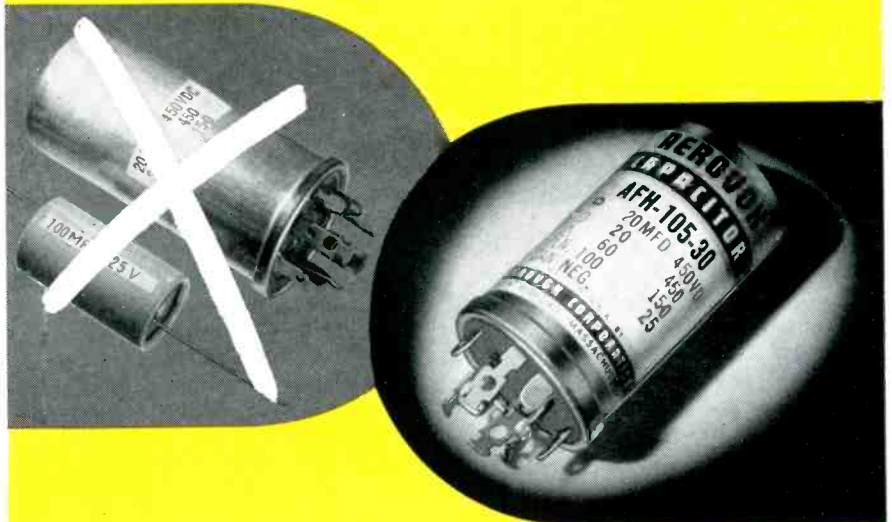

Here's the reason: A popular TV replacement calls for a 4-section unit rated at 20-20/450, 60/150, 100/25. In the absence of such a number, some capacitor lines recommend TWO units in combination — 20-20/450 60/350, list price \$5.05, plus a tubular electrolytic 100/25, list price \$1.35, for a total of \$6.40.

By contrast, AEROVOX offers the identical part number — an AFH-105-30, rated at 20-20/450, 60/150, 100/25, list price \$4.25

Why buy TWO when ONE will do? Why \$6.40 list when you can get a single-unit replacement for \$4.25 — and cut your labor by half? Lastly, you avoid trouble in TV chassis where tight fits are a problem.

With more extensive listings (actually 290 to 345 more numbers than those of any one of five competing brands\*), AEROVOX Type AFH Twist-Prong Electrolytic Capacitors meet more requirements with single, economical units in place of multiple-unit makeshifts.

#### Consult AEROVOX Listings!

Take full advantage of those more extensive listings of ALL types of capacitors. Ask your AEROVOX distributor — or write us.

\*Details on written request.



## AEROVOX CORPORATION

DISTRIBUTOR SALES DIVISION,  
NEW BEDFORD, MASS.

In Canada: AEROVOX CANADA, LTD., Hamilton, Ont.  
Export: Ad. Auriema., 89 Broad St., New York, N. Y. • Cable: Auriema, N. Y.

# Transistorized Portable Printed-Circuit Board Repair Notes<sup>1</sup>

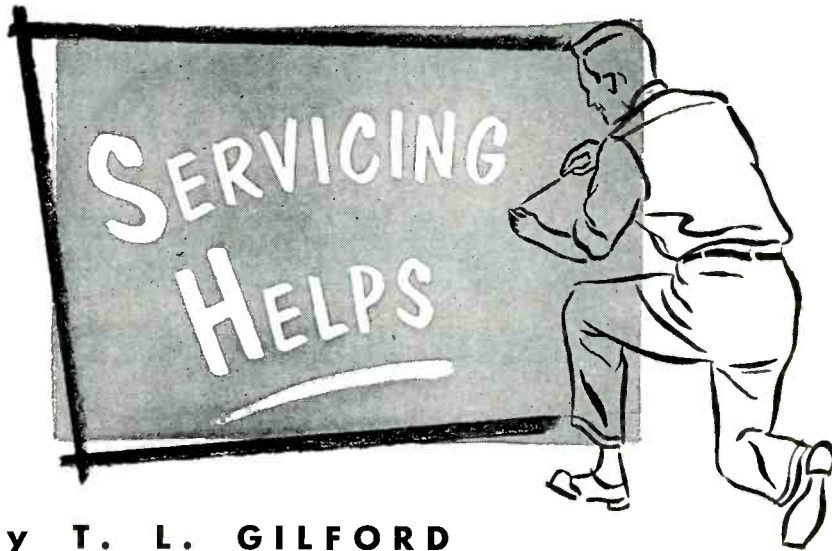

by T. L. GILFORD

ALL OF THE CIRCUIT components of the Regency TR-1 transistorized portable are assembled by inserting leads or tabs through holes in a phenolic plastic circuit board, on the reverse side of which is the interconnecting circuit wiring in the form of a photoetched copper layer. All of the lead wires which extend through holes in the printed-circuit conductor *straps* are clipped off close to the board by a special machine and the board solder dipped to produce all of the soldering of connections in a single operation.

While the bond between the laminated plastic board and the copper

foil, representing the wiring of the circuit, is sufficiently strong to resist the careful time and temperature controlled factory solder dip, it can be easily damaged by overheating during servicing operations. The printed circuit wiring of this chassis is similar to that used in recent radio and TV receiver design, except that the miniature construction of this set has necessitated closer spacing of conducting strips than in other printed circuits. This increases the hazard of shorts between circuits by solder *bridges* when making repairs.

If replacement of components or other servicing operations, which would require the application of a soldering iron to the printed-circuit board, should become necessary the

following precautions should be observed:

A small (low wattage) soldering iron having a small point or wedge should be used. This should be of the *pencil* type having a rating of not more than 35 watts.

Since the copper foil, being metal, expands to a greater extent than the underlying plastic board, the bond between them can be broken and the circuit *arched* away from the board if heat is applied for too long a period. The iron should be applied for the shortest possible time to effect softening of the solder and removal of the old part or attachment of the new.

Only low-temperature solder of small diameter and having a rosin flux core should be used. This type is known as 60/40, since it is composed of 60% tin and 40% lead. The ordinary solder which has a higher melting point and has a composition of 40% tin and 60% lead should not be used.

A small fine wire brush, as used for cleaning suede shoes, is helpful in brushing away surplus solder and in removing solder bridges between circuits.

With the exception of replacement of transformers, transistors or the oscillator coil, repairs can be effected without unsoldering the component leads of the printed circuit side of the board. This repair can be made by cutting the defective unit (resistor or capacitor) in half with diagonal pliers. Then each half of the unit should be cut or crushed until only its connecting leads remain. Now a small loop should be made in each lead of the replacement component and these loops slid over the leads of the part removed. A secure solder connection should now be made, using as little solder and as short a time as possible. Too much heat may cause the original lead to fall out of the board.

To summarize, one should use as little heat as possible, remove excess solder quickly and completely, and never attempt repairs with a large soldering iron.

## Hints on Sylvania Portables<sup>2</sup>

WHEN SOUND is distorted in the Sylvania 433 portables, the 3V4 will probably be found faulty; replace.

Often, one will find that the set will play on *dc*, but not on *ac*. Usually this

(Continued on page 60)

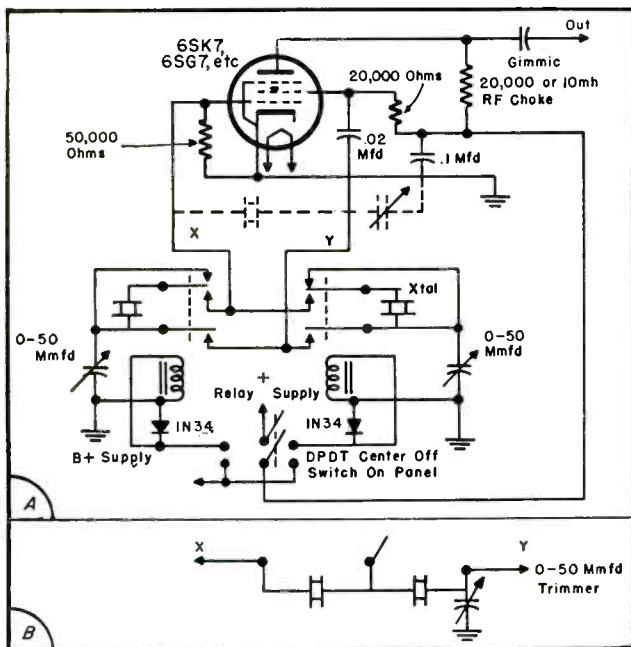

Fig. 1. Dual-crystal (Pierce electron-coupled) beat-frequency oscillator. To clarify position of crystals and associated trimmer, they are shown dotted; they are switched into this position electrically by relays. If arrangement of the receiver permits placement of the *bfo* immediately adjacent to control switch and allows room for adequate shielding in that position, the simplified crystal-switch circuit shown in *b* can be used. However, if the leads between crystal, tube and switch are more than 2" long, or come within about 2" of any if component ahead of the injection circuit, this direct-switching circuit could be a source of trouble.



Sylvania "600 ma" Tubes

# 99.7 proof\*

FOR SERIES-STRING TV



*In a 15-tube series string, analysis proved that 99.7% of all probable combinations of Sylvania types operated within 2% of the heater-current design center. Sylvania's tight heater-current limit is one of the most important contributions to tube performance for series string operation.*

## Best for Service In **4** big ways

WHEN YOU SERVICE TV SETS using series-string-heater tubes, don't take chances on call backs. Here are four big reasons why only Sylvania "600 ma" tubes give you the uniform, dependable performance that insures customer satisfaction.

**1. Less heater voltage variations**—even distribution of tube voltages

throughout the series string insures better tube life.

**2. Less heater burn-outs**—heater burn-outs are reduced because the controlled heater warm-up of 11 seconds is uniform from tube to tube throughout the circuit.

**3. Less time for normal set operation**—controlled heater warm-up brings set to normal operation in less than half the time.

**4. More uniformity**—because Sylvania makes everything but the bulb, quality is controlled from raw materials straight through to finished product.

Write for this handy reference guide to Sylvania tubes for series string television. It's both a brochure and wall chart! Write Department D38N.

**All Sylvania TV PICTURE TUBES now have heaters specially controlled for series string operation!**



# SYLVANIA

Sylvania Electric Products Inc.  
1740 Broadway, New York 19, N. Y.  
In Canada: Sylvania Electric (Canada) Ltd.  
University Tower Bldg., St. Catherine St.  
Montreal, P. Q.

LIGHTING • RADIO • ELECTRONICS • TELEVISION • ATOMIC ENERGY

# DOUBLE YOUR SALES

## SNYDER

### Directronic®

INDOOR TV ANTENNAS

### 3-D

9<sup>95</sup>

### 5-D

12<sup>95</sup>

BLACK
WHITE
COLOR
AM/FM
VHF/UHF

6-POSITION  
BEAM  
SELECTOR

8-POSITION  
**PUSH BUTTON**  
BEAM SELECTOR

# SNYDER

SNYDER MFG. CO., PHILADELPHIA 40, U.S.A.  
 BELLEVUE TUBE MILL, INC., PHILADELPHIA  
 SNYDER ANTENN-GINEERS, LTD., TORONTO 14, CANADA  
 WORLD EXPORT: ROBURN AGENCIES, INC., N.Y.  
 VAN DER HOUT ASSOC., LTD., NEW TORONTO, CANADA

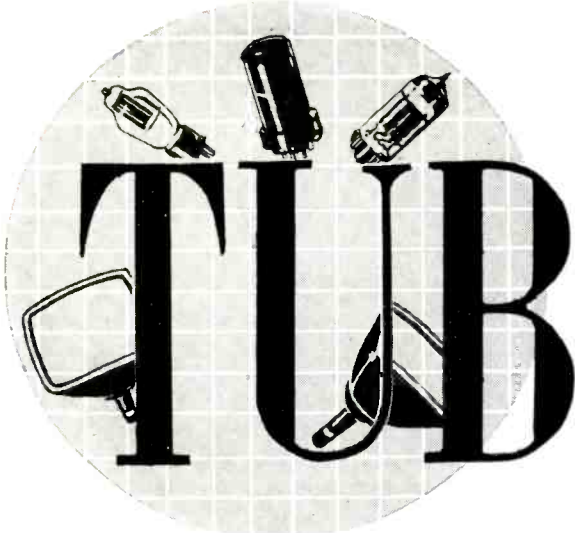

# TUBE

## News

by A. M. KELWOOD

(Right)

An interesting array of three types of flip-flop circuits, illustrating transition from complete tube system (top), to one using diodes and tubes (center) and only transistors. The latter circuit, a direct-coupled saturation flip-flop, employs a surface-barrier type of transistor, said to allow operation at 50 mc and higher. Only .018 watt is consumed in this circuit, while the diode and tube arrangement (recirculating flip-flop) uses 8.25 watts. In contrast the all-tube circuit (Eccles-Jordan) requires 13.4 watts. The transistor circuit has been incorporated in a computer module, which contains all of the elements required for addition, subtraction, multiplication and division. (Philco)

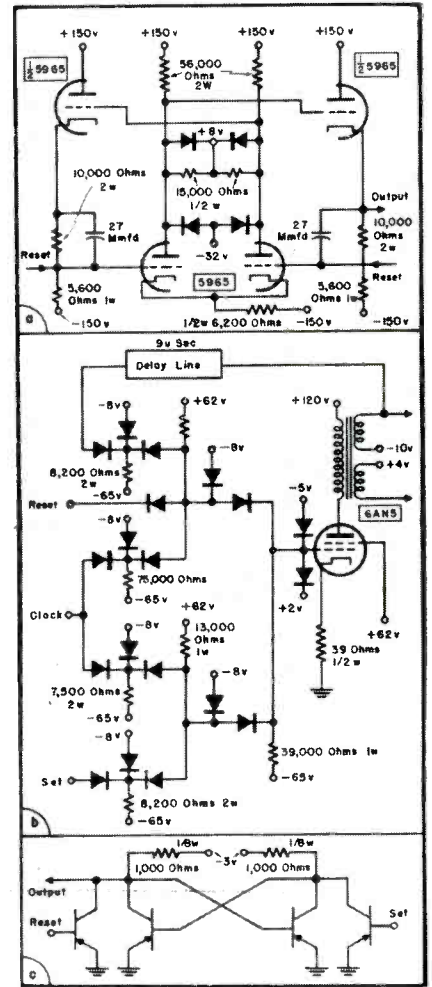

THE NOISE generated in a transistor is one of its basic characteristics and the accurate measurement of this quantity is of considerable importance in the development, manufacture, and application of transistor devices.

Transistor noise, unlike thermal and shot noise, has a frequency characteristic such that the noise power per unit bandwidth varies approximately inversely with frequency. Because of this type of variation it has been standard practice to specify *noise figure* for transistors at an audio frequency (for example 1,000 cps) for a bandwidth of 1 cps. Recent data have shown, however, that the inverse frequency is due to the presence of unwanted impurities and this has encouraged the measurement to be made for wider bandwidths which aids in the practical measurement.

In the basic method used to measure noise figure, a calibrated audio noise generator is matched to the input of the transistor through the emitter input resistance. A power indicating meter is coupled to the collector circuit via a 1,000-cycle filter with a

narrow bandwidth. The output noise power is measured with the noise source turned off. With the noise source then turned on, its output level is adjusted so that the output noise power is doubled.

The reading of the calibrated noise source then corresponds to the noise power produced by the transistor under test. The ratio of this power to the computed thermal power for the same narrow bandwidth yields the noise figure of the device.

It has been found that there are three disadvantages in this manual method: (1) Time consumed in the measurement process; (2) Possibilities of gain and bandwidth changes introducing errors; (3) The method does not yield continuous readings and makes optimization of parameters for low noise figure difficult to achieve.

This problem has been solved by a transistor noise figure meter which automatically performs the foregoing

†From a report by D. D. Grieg and S. Moskowitz, Electronic Research Associates, Inc., presented at annual IRE convention.

measurement many times per second and displaying the results on a direct-reading meter.

The basic elements for accomplishing this consist of an audio thermal noise source, noise source control circuit, power indicating meter, calibrated in noise figure values, low noise synchronous switching device and output comparison circuit with feedback connection to the noise control circuit.

The switching device synchronously connects and disconnects the noise generator to the input of the transistor or transistor amplifier under test. The output comparison circuit compares the values of noise power for these two conditions and supplies a negative feedback voltage to control the output level of the noise source via a control circuit. This feedback voltage is reduced to zero for the condition of noise generator power equal to the internal transistor noise. Since the output power of the noise generator for these conditions is directly propor-

(Continued on page 57)

# Service Engineering

## field and shop notes

by MAXWELL ALBERTS

PORTABLE VIBRATOR-TYPE supplies that derive their input from 6 or 12-volt batteries are useful not only on the bench, but particularly in the field as a reliable 110-v source to power tube testers, tape or disc equipment, field strength meters and test gear.

An excellent example of such a versatile unit is illustrated in Fig. 1. Originally developed for the Signal Corps,<sup>1</sup> it features four input current ratings: 6.6 amperes at 6.3 v dc for 15-watt output; 15 amperes at 6.3 v dc for a 50-watt output; 2.5 amperes at 12.6 v dc for a 15-watt output; and 7 amperes at 12.6 v dc for a 50-watt output.

### Theory of Operation

In this vibrator pack the actuating coil in the vibrator and the primary of the transformer are in separate circuits. The actuating coil is in series with a single driver contact. When a power switch is closed, the actuating coil is energized and pulls the vibrating reed away from the driver contact. This opens the driver contact and breaks the circuit through the actuating coil. The reed then springs back, closes the driver contact, and again energizes the actuating coil. The electrical and physical dimensions of

the components in the circuit (especially the physical dimensions and weight of the vibrating reed) are such that the reed repeats this cycle and vibrates at a rate of 60 cps.

### Interrupter Contacts

When the reed is pulled in toward the actuating coil, the contacts that are connected to pin 6 of the vibrator are closed. This completes a dc circuit through the upper section of transformer  $T_1$ , and a pulse of current flows during the interval that the contacts are closed. When the reed is released, it breaks this circuit and springs back to the opposite contacts that are connected to pin 1 of the vibrator. This completes a dc circuit through the lower section of  $T_1$ , and a pulse of current flows during the interval that the contacts are closed. These paired contacts are commonly referred to as the power or interrupter contacts.

Regardless of the polarity at the clip leads, current flows through the primary of  $T_1$ , first in one direction and then in the opposite direction as the vibrator closes the alternate pairs of

## Portable Vibrator Power Supplies for 6.3/12.6 V Inputs.\*

power contacts. These alternating pulses produce an alternating output in the secondary of  $T_1$ . Since the reed vibrates at approximately 60 cps, the output frequency is approximately 60 cps. The output voltage waveform is essentially square wave.

### Input Circuit

The input circuit extends from the upper clip lead through  $S_1$ , section C of  $S_2$ , terminal 3 of socket  $X_1$ , the actuating coil, driver contact, the reed, and fuse  $F_1$  or  $F_2$ , to the lower clip lead. The circuit is closed when the power switch is set at *on*, and is interrupted 60 times per second by the making and breaking of the driver contact. When the vibrator pack is used with a 6-volt storage battery, an *input-voltage* switch is set at 6 v and the entire input voltage is applied across the actuating coil. When a 12-volt storage battery is used, the *input-voltage* switch is set at 12 v and a 9-ohm resistor ( $R_3$ ) is inserted in the circuit in series with the actuating coil;  $R_3$  is a voltage-dropping resistor which drops the voltage applied to the coil to approximately 6.

There are two branch circuits through the primary of  $T_1$ ; one  
(Continued on page 57)

\*Based on notes in Signal Corps instruction book.  
<sup>1</sup>By American Television and Radio Co.

Fig. 1. Circuit of a combination 6-12 volt dc input vibrator pack, designed to provide 110 v output.

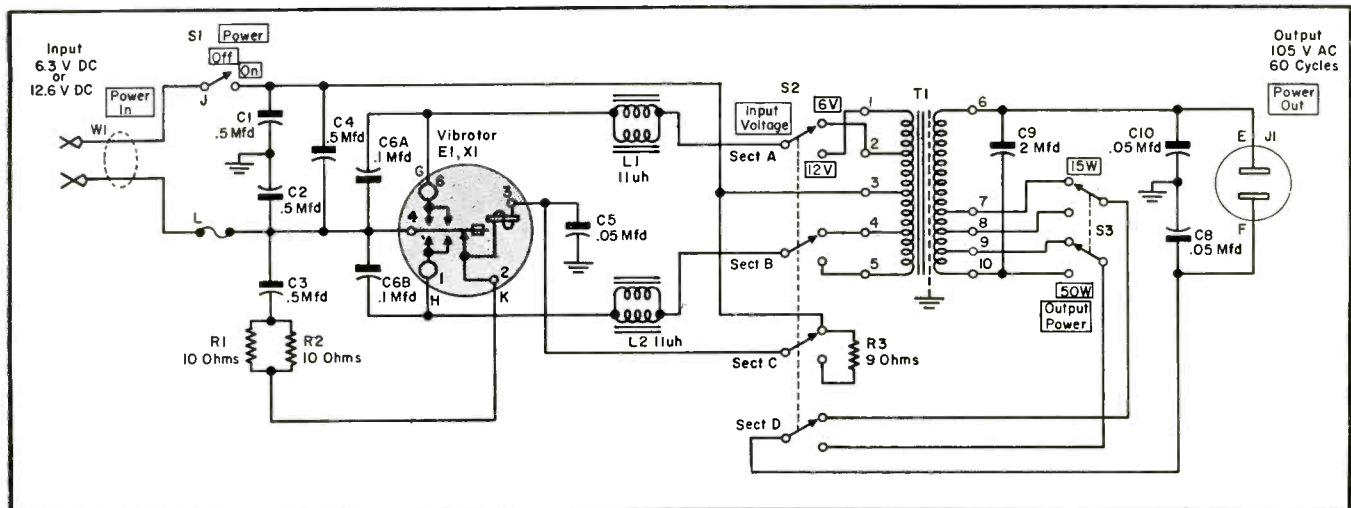

# Components . Equipment for Service Engineering



Servus-Fone telephone and music system, for drive-in restaurants. In operation patron parks his car at serving station, consults an illuminated menu, presses a convenient button on a two-way speaker-microphone and gives order to the drive-in's switchboard operator. When operator receives call a switchboard light indicates the position of the car and stays on until acknowledged. Orders are relayed to the kitchen in the sequence received. When the speaker-microphone is not being used for placing orders, it automatically plays music from sound equipment. An automatic multiple speed record changer plays up to four hours of music without manual change. System includes dual speech amplifiers and a complete music amplifier. (Motiograph, Inc., 4407 West Lake Street, Chicago 24, Ill.)



Low-cost voltage amplifier intended for use as a preamp ahead of electronic instruments. May be also used as a voltage amplifier. Unit is a direct-coupled two stage amp having an output—through a capacity network. Time constant of output network is suitable to permit satisfactory operation at frequencies down to 1 cps. Complete with built-in power supply. Has a gain of 200 or more at frequencies between 1 and 30,000 cps; gain is approximately 100 at 100,000 cps and 50 at 200,000 cps. Has a peak-to-peak voltage output up to 10 volts with less than 2½% distortion, 30 volts with 6% and over 50 volts at saturation. Input impedance at low frequencies is 100,000 ohms. Output impedance is approximately 20,000 ohms; amplifier load impedance should be at least 100,000 ohms in order to realize maximum gain. (Model 3400-A; Electro Products Laboratories, 4503 N. Ravenswood Ave., Chicago 40, Ill.)



Portable Wheatstone bridge available as completely gasketed units; feature is said to eliminate infiltration of wire or other metal particles to switch assemblies. Ratio dial settings of bridges are: .001; .01; 0.1; 10; 100; 1000; M10; M100; M1000; ¼; 1/9. Decade knobs have steps of 1, 10, 100, 1000 ohms. Coils are bifilar wound on ceramic cores, oven aged and varnish-impregnated. Indicating galvanometer is moving coil type with a dial having fifteen millimeter divisions each side of zero. Sensitivity of galvanometer is one micro-ampere per millimeter. (Type RN; Industrial Instruments, Inc., Cedar Grove, N. J.)

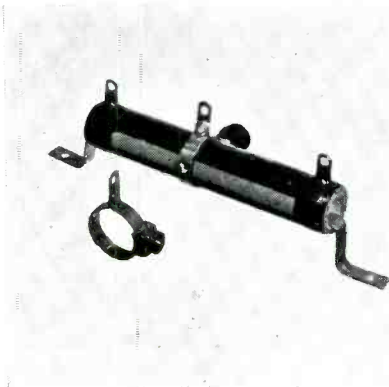

Adjustable wire wound resistor. Featured is an adjustable slider band, which can be loosened and tightened by a knurled plastic nut or a hexagon nut as desired. Available sizes include nominal core diameters of 5/16", 9/16", ¾", and 1½", ranging in nominal wattages from 10 watts to 200 watts. (Resistors, Inc.—J. J. Cerny—5226 West 26th St., Chicago 50, Ill.)

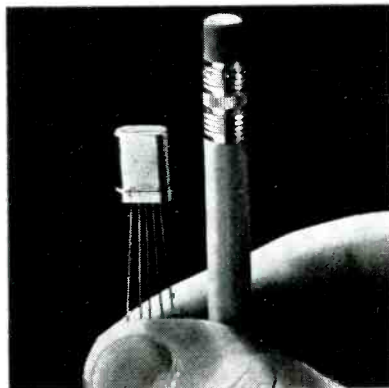

Tiny spdt shock-resistant relay, housed in transistor case half-an-inch high. Relay weighing .035 ounce, has a one-quarter ampere contact rating (non-inductive) and a 26.5-volt dc rating. Sensitivity is 100 milliwatts and it can be adjusted down to approximately 40 milliwatts. (Neomite; Elgin-Neomatic, Inc., Los Angeles division of Elgin National Watch Co., Elgin, Ill.)



Wheatstone and fault locating bridge. As a Wheatstone bridge, resistance within a zero to 1.2-megohm range can be measured directly. In the field, instrument can also be used as a continuity checker. (Electro-Measurements, Inc., 4312 S. E. Stark St., Portland 15, Oregon)

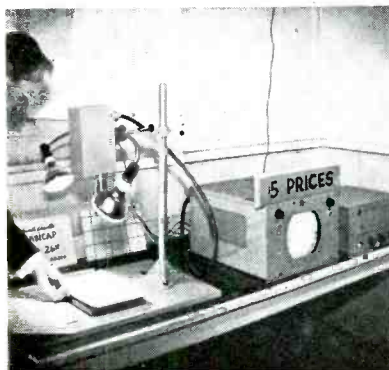

(Left)  
Closed-circuit TV camera in service at race track. Camera is focused on price information which is transmitted instantly to monitors at pay-off windows. Odds are shown on nearby screen. (Kay Lab, San Diego, Calif.)

(Right)  
Voltmeter designed for measurement of ac voltages from .001 to 300 full scale in the frequency ranges from 20 cps to 2 mc. Input impedance of 10 megohms and 25 mmfd said to minimize errors due to loading of the circuit under test. Separate terminals are brought out from input and output of the amplifier section of the instrument. (Model 202A; Shasta Division, Beckman Instruments, Inc., P. O. Box 296, Station A, Richmond, Calif.)



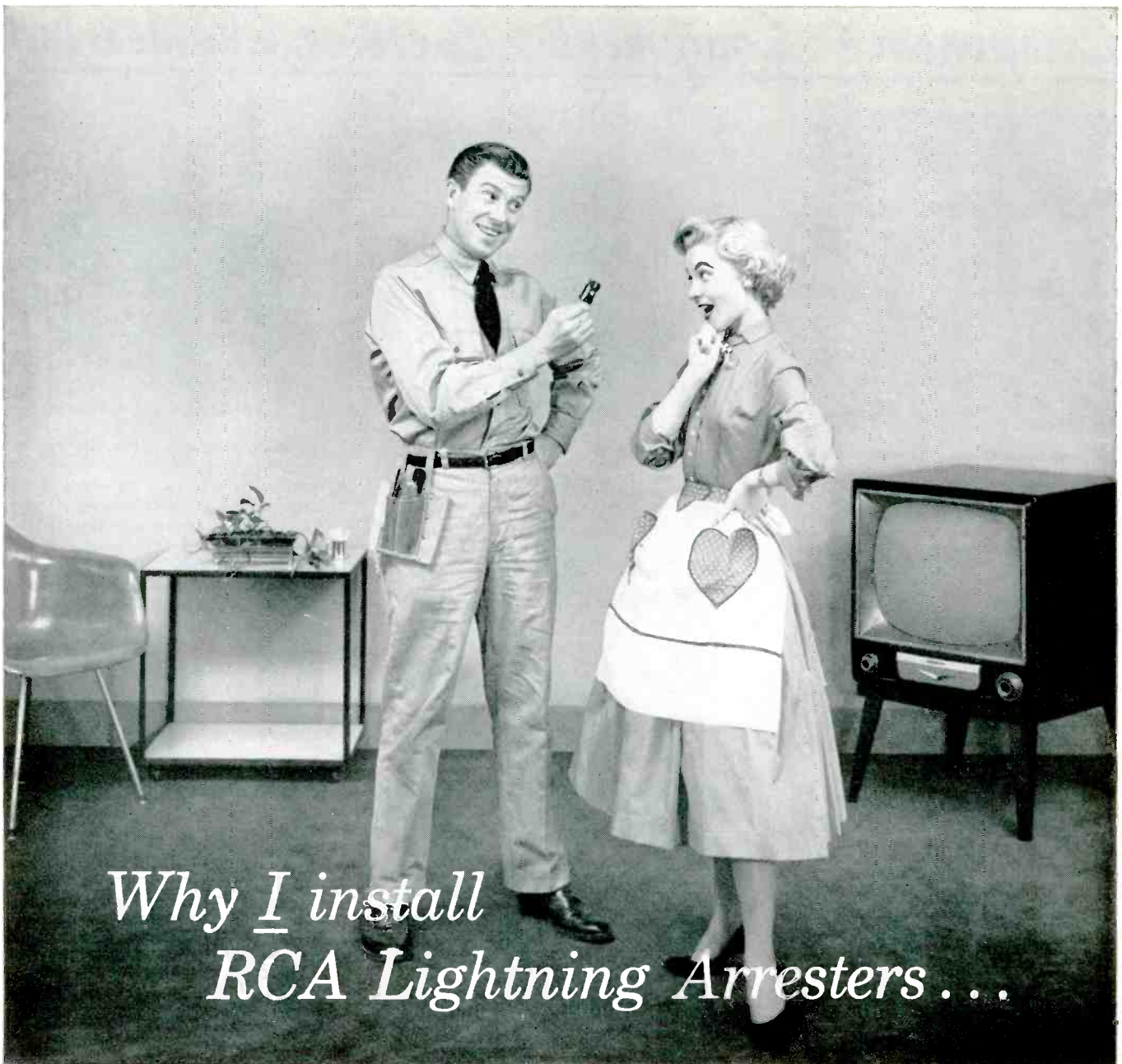

*Why I install  
RCA Lightning Arresters...*

- Available for UHF and VHF
- UHF Model has only 1 db (approx.) loss at 800 mc
- Easy to install
- Positive contact assured by narrow clamping bite
- Strap or screw type construction
- RCA quality throughout

My customers know they're getting their money's worth when I install an RCA Lightning Arrester. The "best VHF and UHF lightning arresters to come down the line," both types are listed by Underwriters' Laboratories, Inc. See your local RCA Tube Distributor. Stock up TODAY!



**RADIO CORPORATION of AMERICA**  
ELECTRONIC COMPONENTS

HARRISON, N. J.

# SERVICE... *The National Scene*

CALIFORNIA ASSOCIATIONS CAMPAIGNING AGAINST OVERCHARGE OPERATORS-- A sweeping series of drives to curb shop owners who hike their bills and install parts that are not necessary have been instituted by associations in the San Francisco, Oakland and neighboring Bay areas. . . . Spurred on by a sudden burst of complaints from set owners, adverse newspaper publicity and BBB criticism, association heads have rallied Service Men to combat the plaguing problem by advertising their association membership and strict adherence to codes. . . . The effort has brought in scores of new members who have been able to prove that they were toeing the line in their pricing and servicing practices. . . . And in communities without any associations, new groups were being formed with the rigid rules and regulations of the older organizations being adopted as a basic pattern. . . . A number of the association members also signed an industry code of ethics prepared by the Better Business Bureau and joined the bureau to reemphasize their position as ethical service shops.

DETROIT LOOKS TO LICENSING--TSA, in Detroit, who originally opposed any form of licensing, has helped draft a TV service measure, which will be introduced to the City Council soon. . . . Complete membership of the association has accepted the ordinance. . . . Three forms of licenses would be issued, as the bill stands now: Apprentice and technician, advanced technician and service dealer, with fees ranging from \$1.00, to \$2.50 to \$25.00 for the three grades. . . . A board of examiners would pass on applications. And such a board would consist of a service dealer, an advanced technician, a staff member from a radio-TV school holding membership in the Institute of Radio Engineers, a radio-TV parts distributor and a member representing the general public.

WESTERN NEW YORK ASSOCIATION ADVOCATES LICENSING--Members of the Buffalo, New York, association have announced that state licensing appears to be the only remedy to broad unethical practices that still prevail. . . . Commenting on these views, the association prexy said that a small number of inscrupulous opportunists, who are ill-equipped, ill-manned and improperly financed have compounded confusion upon confusion. Licensing, he felt, represents the only direction that can be taken to eliminate these operators. Obviously, it was noted, there are thousands and thousands of well-qualified Service Men; otherwise so many millions and millions of TV sets would not be performing so well.

COLOR TV COMES OF AGE . . . THEME OF DISPLAY AT CONVENTION--Focal point of a booth at the recent IRE convention was a display of color TV tubes and test equipment under the banner--Color Television Comes of Age. In operation was a 21-inch color tube, new color bar and dot generators, and assorted parts used in a color chassis. . . . Experts at the booth reported that there are now over 180 TV stations equipped to rebroadcast network color programs and 46 of these stations are also equipped to originate some colorcasts locally. It was noted, too, that industry is expected to produce between 100,000 and 200,000 color sets within the next 9 months.

FERRITES HAILED FOR CONTRIBUTIONS TO COMPONENT PROGRESS--Improvements in ferrites have developed an intense interest in the design of new parts using this unique material. . . . Now available is a new high-efficiency ferrite, called W-02, that has been found to be excellent for flyback transformers. The formulation is now being used in such transformers installed in color receivers, since it saves up to two tubes in the horizontal-driving circuit and shows no slump under high-temperature conditions. . . . And thanks to a new circuit arrangement, it has been found possible to use ferrites in a rod antenna that is omnidirectional. This has made it possible to make up small experimental antennas, surrounded by electrostatic shielding to eliminate stray interference fields, that could be included in handles of portables, or in some cars on the dashboard. . . . It has also been found that at uhf, ferrite beads on wires are essentially resistors having no dc drop. This behavior has been utilized to improve the effectiveness of discoidal feed-through capacitors, by replacing the ceramic insulators with ferrite elements.

# *SERVICE... The National Scene*

OVER 35,000,000 TV SETS NOW IN OPERATION--According to a report recently issued by the Federal Communications Commission, there are over 35,000,000 TV sets in the field, and about 5,000,000 of these are equipped to receive the ultra-highs. It was also revealed that only about 20 per cent of the chassis now being made are all-wave models. . . . Another study has disclosed that approximately 20 per cent of the receivers installed are in post-freeze TV zones, compared with 11 per cent a year ago. And over 50 per cent of the sets sold during the past year went into post-freeze areas.

NEW TECHNIQUE FOR HIGH-DEFINITION BLACK-WHITE TV--A system which will double the maximum number of vertical and horizontal picture elements was described at the recent annual convention of the IRE. It differs from the conventional approach in that both large and small-size picture elements are used; a large-size picture element was noted as corresponding to the standard conventional-size picture element. These large-size picture elements are subdivided into the vertical and horizontal directions to form four small-size picture elements. . . . Two conventional fields are required to complete the picture in those areas where the conventional large-size picture elements are used. Eight fields are required to complete the picture in areas where small-size picture elements are used, since four times as much information is being displayed. For the large dots, a standard short-decay phosphor must be used, and for the small dots, a long-decay phosphor must be used to minimize objectionable flicker. . . . A special picture tube, required in this new approach, would have interspersed these long-decay and short-decay phosphors and a means for separately exciting them. A focus-grid tube with interleaved phosphors and two guns, one for exciting the long-decay phosphor and the other for exciting the short-decay phosphor might be used in the new tube. . . . The new system requires the transmission of three signals, in addition to the conventional video and sync signals. They are a high-frequency phase-synchronizing signal to assure the proper gating phase for displaying the interspersed small-size picture elements at the receiver, a 7.5-cycle sync pulse to assure the correct field order and a signal to tell the receiver whether to display large or small size picture elements. The phase-sync signal is transmitted as a burst during the horizontal retrace time like the color burst. The frequency of this burst is one-half the frequency used for gating. The picture element size-selecting signal is transmitted during the active scan. . . . It was reported that this method is applicable to closely-viewed large screens, because of the higher definition. Fortunately, most of the system complications occur at the transmitter, and here, it was said, they can be readily resolved.

STATEWIDE GROUP FORMED IN MINNESOTA--A statewide association, devoted to management, and known as the Minnesota Television Service Engineers, has been formed in Minneapolis. . . . The group has set up definition standards for service and service personnel. A cooperative arrangement has been made with the Department of Labor, Bureau of Apprenticeship, along with the Minnesota Industrial Commission, to set up an apprenticeship training plan for Service Men.

DRIVE TO PUT MORE RADIOS IN HOME--A \$100,000 fund has been established by set manufacturers and the Radio Advertising Bureau to promote the sale of kitchen, bedroom, portable and table model radios. Broadcasters will participate with spot announcements. . . . The campaign is expected to boost sales by at least 50 per cent. The tentative schedule for the promotions are: Portables, May 15-June 15 . . . Bedroom and kitchen sets, September 1-October 1 . . . Old radio roundup, October 1-November 1.

N. Y. STATE '54 HURRICANE DAMAGE TO TV ANTENNAS CLOSE TO \$20,000,000--Insurance underwriters have estimated that policyholders in New York State collected at least \$20,000,000 for damage to TV antennas and masts arising from the hurricanes in '54!-- L. W.



150 field tests have proved to  
WARD jobbers:

- \* Good VHF picture at as far as 200 miles on several channels
- \* Excellent results at 100 miles
- \* Good results in areas where no other antenna was able to bring in a picture
- \* More compact—25%—75% less stacking distance
- \* Channel 2-13 response as much as 40% better than any comparable antenna
- \* Unique superior snap-lock bracket
- \* Original WARD design all aluminum supplemented spring pressure bracket—eliminates possibility of intermittent contact

TRY ONE—you'll find why the Invader is superseding all fringe and super-fringe antennas.

WARD Model TVS 356 2 bay and stacking harness \$39.95 list

WARD Model TVS 357 4 bay stacking kit (feed harness only) \$3.95

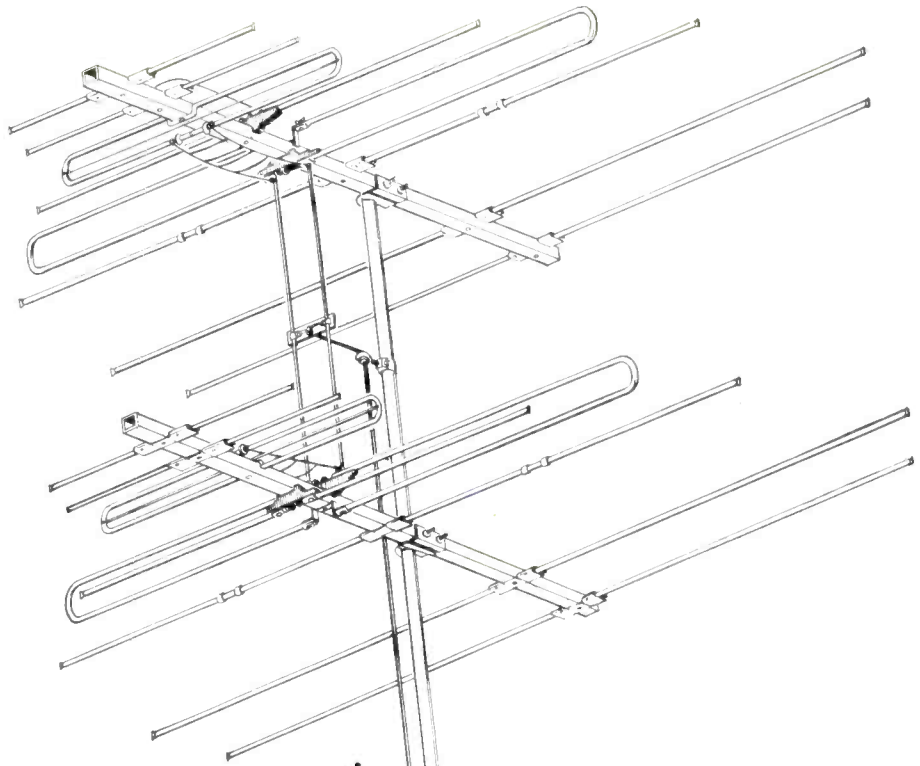

# THE INVADER\* CONQUERS

sweeps all other fringe and super-fringe antennas before it

\* an original WARD design

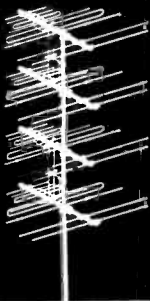

flat type Uni-plane  
Yagi for fringe  
area VHF and  
primary signal  
area UHF.

\*Documental testimonials in our files

**WARD** Products Corp., Cleveland 15, Ohio

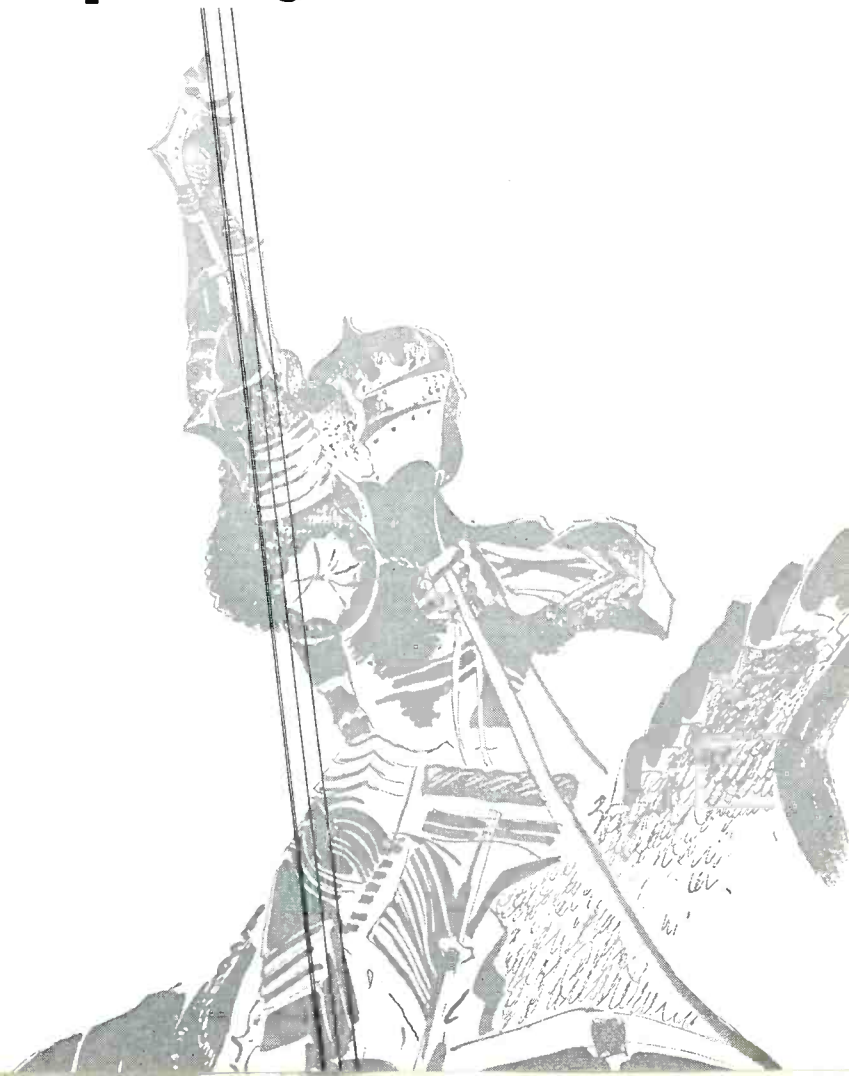

## Double Diamond Phasing for VHF Antennas†

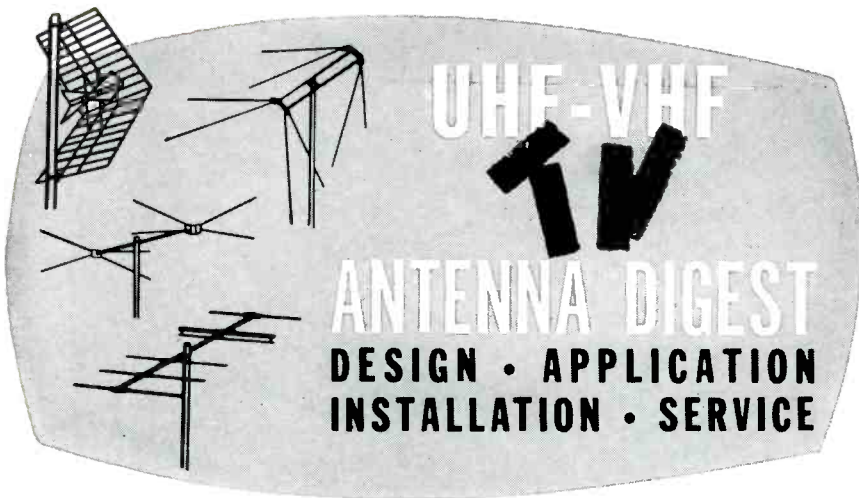

by RALPH PETERS

WITH THE ADVENT of more sensitive receiving sets and increased power output of many stations, fringe and deep-fringe area set owners have found that they can receive more than the one station they had to be content with in the early days. But, the improvement has brought along a number of problems, too, in the form of multiple reception headaches such as co-channel interference, *venetian blind* effects, etc. For this condition, the antenna must not only offer a high gain, but broad banding, extremely high front-to-back ratio (no rear or side pick up), and less than 1½-db gain variation.

A number of antennas, such as yagi-conicals, tri-pole models, and colinear adaptations, have been evolved to meet these requirements.

Recently, another type, using a *double-diamond phasing* concept,<sup>1</sup> was developed.

One of the main problems in designing a broad-band antenna is to determine the best way to obtain maximum response on the low *vlf* (channels 2-6) and the high *vlf* bands (channels 7-13), using a dipole that is cut to a specific physical length. The problem becomes somewhat simpler when we realize that the length of a half-wave dipole tuned to mid-frequency on the low *vlf* band is about 3 times the length of a half-wave dipole tuned to mid-frequency on the high *vlf* band. In other words, a low-band dipole is the equivalent of three high-band dipoles connected end to end.

This brings up another situation. Fig. 1 indicates the current direction and distribution of a half-wave dipole on the low band, and Fig. 2 shows the current direction and distribution when using the same half-wave dipole on the high band. It will be noted that the current in the center half-

wave of Fig. 2, is traveling in the opposite direction to the currents in the outer half-wave. Thus, one of the outer half-waves and the inner half-wave cancel each other, leaving us with an antenna that has approximately ⅓ the effectiveness that it should have on the high band. However, if the phase or direction of current flow of the center half-wave could be reversed, then all three half-waves would be in phase. The results would then be additive rather than subtractive, and we would have about three times the efficiency of a single half-wave antenna. The resultant waveform would appear as in Fig. 3.

Several methods of achieving this phase reversal are now in common use, but they are variations of the method of using colinear dipoles with quarter-wave phase-reversing stubs, as shown in Fig. 4. In Fig. 5, we have essentially the same phase reversing stubs as in Fig. 4, but they are shaped a bit differently. Fig. 6 accomplishes the same results using two extra high-band dipoles to obtain the required phase-reversal. One of the high-band dipoles being out of phase with the center half-wave of the driven dipole merely cancels itself and the center half-wave, while the other extra high-band dipole adds its in-phase current. Thus, we have the same results, regardless of which method of phase-reversal we use; those results are a single half-wave dipole on the low-band and three in-phase colinear half-wave dipoles on the high-band.

In studying this condition, it was found phase-reversal stubs are frequency sensitive devices since they can only be cut physically to one length. It

(Continued on page 60)

†Based on a report prepared by Elliott March, vice president, T-V Products Co.

<sup>1</sup>T-V Products Mighty Mo.

Below: Figs. 1, 2, 3, 4 and 5. Fig. 1 shows current distribution of half-wave dipole. Fig. 2 illustrates the third harmonic content of a half-wave dipole. A half-wave low-band dipole with phase-reversing stubs for high-band colinear operation appears in Fig. 3. Three half-wave dipoles in phase are shown in Fig. 4. And in Fig. 5, current direction and distribution is illustrated.

Right: Figs. 6 and 7. In Fig. 6 at (a) is a low-band and half-wave dipole with a pair of high-band phase-reversal dipoles. Current distribution on both high and low band is illustrated in (b), and in (c) we have a current-distribution pattern, resulting from addition of currents in (b). The double diamond phasing principle is shown in Fig. 7.

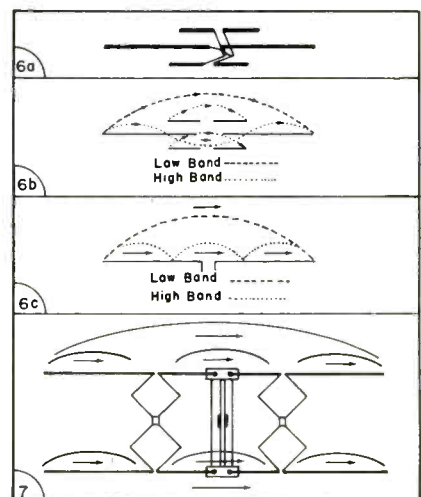
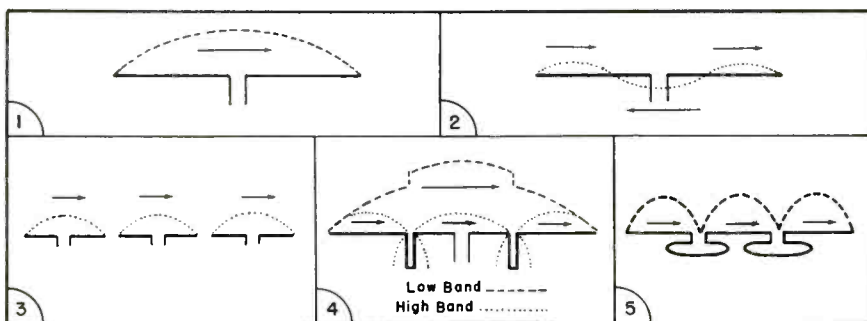

# UHF / VHF TV Antenna-Accessory Review

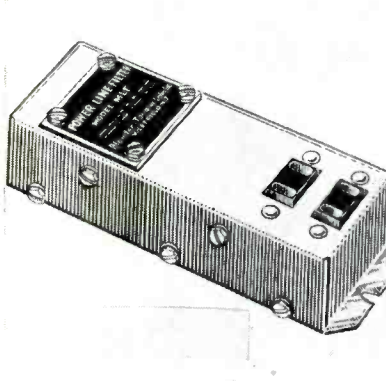

Power line filter that mounts inside a radiation-proof housing, said to provide more than 60-db isolation in the vhf and uhf ranges; eliminates the possibility of ac interference in the TV distribution system. Included are two ac output receptacles and one BX input connector. (Model MLF; Blonder-Tongue Labs, Inc., 526-536 North Ave., Westfield, N. J.)

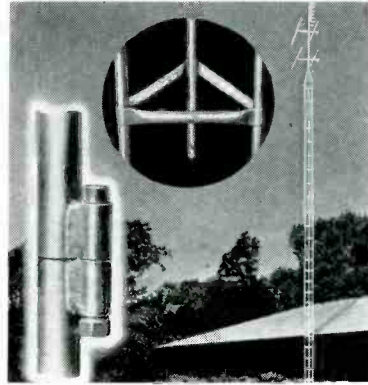

Towers produced with a durable zinc finish bonded to steel by electro-plating. Features lateral load-bearing joints and the gird-around cross ties, producing a tower that, it is claimed, stands free up to 50' high and is safe in gales up to 80 mph. (Kuehne Manufacturing Co., TV Tower Division, Mattoon, Illinois.)

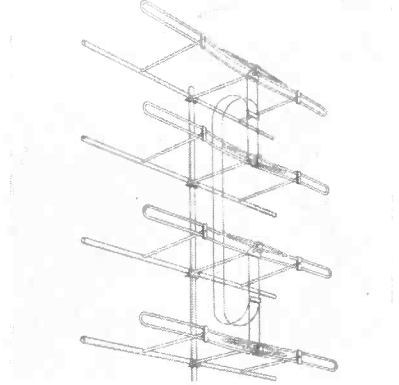

Antenna featuring fidelity phasing, claimed to produce in-phase colinear currents without reversing harness. Employs four driven, low-band, in-phase folded dipoles, plus twelve driven high-band in-phase folded elements. All aluminum construction. Completely preassembled. (Finco model F-4; The Finney Co., Cleveland, O.)

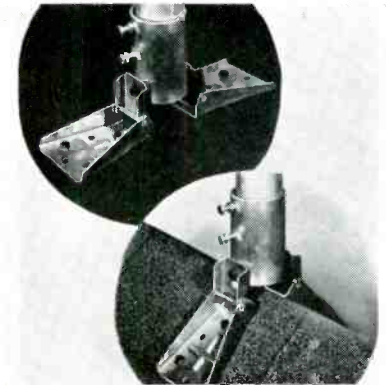

Aluminum universal mast mountings. Three heavy-duty models, to fit masting of all sizes, are available. Made of high-temper. alloy aluminum. Features thick sleeve walls and embossed rib construction for greater strength. Has self-locking feature, that it is claimed, permits mast to be self-supporting when swung into a vertical position. Free-swiveling joints permit installation on flat surfaces or peaks of any angle. Twin set-screws, each with full-threaded T-Nut and locking nut, grip the mast. Three models are available; Model No. 9046 for masting from 1 1/4" to 1 1/2" od; model No. 9047 for masting from 1 1/2" to 1 3/4" od; and extra-heavy duty mount for masting from 2" to 2 1/4". (Channel Master Corp., Ellenville, N. Y.)

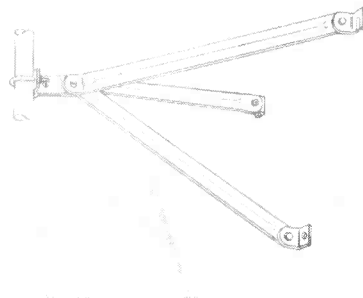

An 18" adjustable aluminum-alloy wall bracket. To mount installer drives two lag screws on 16" centers to approximately 1/4" of the wall. Pivoted drop slot feet permit hanging of the bracket on these screws which are then tightened. Adjustment to desired distance from the wall is then made by raising or lowering the tripod leg before lagging it to the wall. Pivots are spring loaded by heavy lock washers. Assembled and available in combination with a 3" upper bracket and 18" lower tripod spider. (Kenco Spider; Kenwood Engineering Co., Inc., Kenilworth, N. J.)

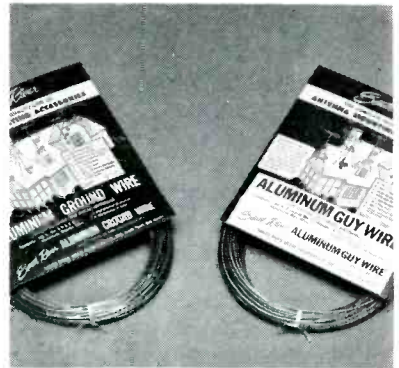

Aluminum stranded guy cable and ground wire. Cable is 7 strand, 17-gauge wire with a breaking strength of about 500 pounds, and is said to be equivalent in strength to 6/18 steel wire. One thousand feet of the cable weighs 13 3/4 pounds. Cable is said to be non-corrosive and non-staining. Inner core is made of 565 alloy. Available in 100' boxes, 100' coils and 100' interconnected coils. Ground wire is No. 8 gauge dead soft aluminum electrical conductor wire. Available in 100' boxes, 100' coils, and 100' interconnected coils. (South River Metal Products, Inc., South River, N. J.)

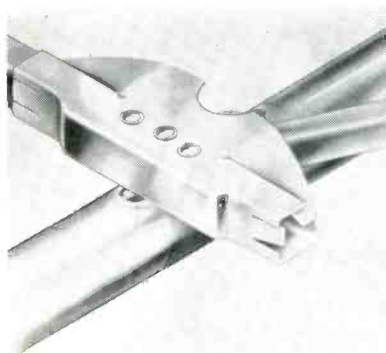

(Left)  
Auto-lock clip designed to expedite rooftop installation of antennas. (Technical Appliance Corp., Sherburne, N. Y.)

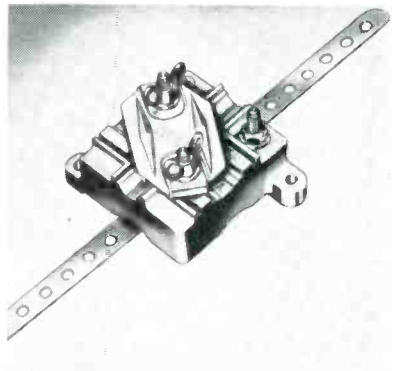

(Right)  
Hermetically-sealed universal lightning arrester for vhf. Uses low-loss printed circuits. Can also be used for vhf and FM. Accommodates flat, tubular, oval, foam and open types of wire. (Type ULA, LaPointe Electronics Inc., Rockville, Conn.)

# PA In STADIUMS

by NORMAN CROWHURST

## Determining Speaker Levels—Matching Requirements in Arena Installations

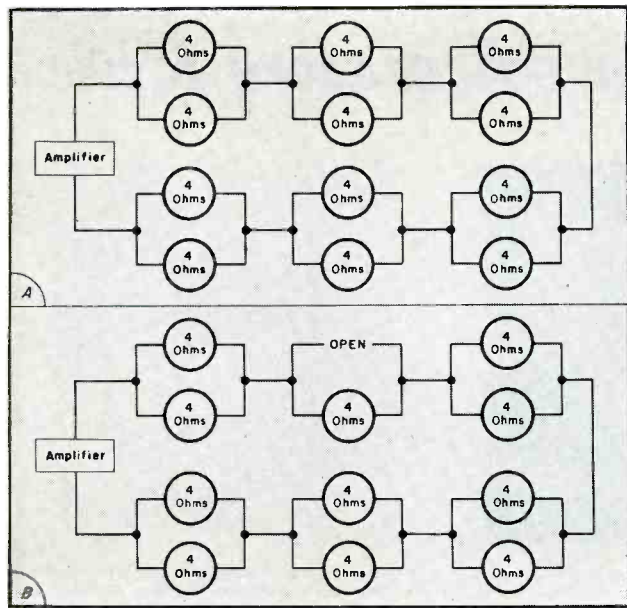

Left: Figs. 1a and 1b.

A series-parallel array of twelve speakers. In a the speakers (4-ohm units) are arranged so that a load of 12 ohms obtains. An amplifier of 60-watt output would then deliver five watts to each. Should one speaker open, as shown in b, the overall impedance will rise to 14 ohms. Assuming a mismatch drops the output to 56 watts, ten speakers will receive four watts, while the speaker complementary to the one that has opened, would receive 16 watts, or four times its normal power.

WHEN PLANNING for a commercial public-address installation, it is particularly important to decide just what level the speakers are to be operated at and the number of units that are to be matched into an amplifier.

In ball parks or other large stadiums the problem is quite large because of the number of speakers that have to be used. During one installation<sup>1</sup>, it was necessary to use 21 high-pressure units located on home plate, fed from a 50-watt amplifier and matched so as to receive a peak power of almost  $2\frac{1}{2}$  watts per unit. And 24 units along two sides, parallel with the stand configuration, each had a 50-watt amplifier to themselves and so matched that each speaker received a peak power of approximately 2 watts. Finally speakers in the outfield, 12 in number, were fed by another 50-watt amplifier, being matched in such a way that each unit received about 8 watts.

The remaining speaker lines to departmental groups, etc., were fed, via a constant voltage system, in such a way that individual speakers on each line could be adjusted to suit the conditions there. For instance, a loudspeaker installed in the cafeteria, where dishwashing was taking place, required a considerably higher level than one feeding say a hospital department where everything was quiet. By using a constant-voltage distribution system and different transformers to match the loudspeaker to the constant voltage line, it was found that the total power from the amplifier feeding the line could be distributed correctly among the loudspeakers.

In any *pa* assignment one must remember that the method of connect-

ing up loudspeakers depends to some extent upon the purpose for which the installation is made. In a huge permanent installation there is no doubt that the best method is to use a constant-voltage system throughout. However when, as was the case during this stadium installation, well over 100 loudspeakers were being used in the overall installation, and these loudspeakers were from various sources brought in for the specific purpose, it may not be practical to use constant-voltage distribution everywhere. This may obtain because transformers are not immediately available for the different voice coil impedances and power ratings that may be required.

### Permanent-Installation Factors

In a permanent installation the correct voice coil impedances could be specifically ordered together with transformers for the power ratings required in different parts. But for an installation of the type used here, which was only required for one week, after which it had to be dismantled and most of the equipment returned, it was necessary to give careful thought to distribution-system planning to make the best use of the facilities at hand. In this installation, constant voltage was used for approximately half of the whole installation, and various methods of series-parallelism of the units were used effectively.

The important factors to bear in mind when using series-parallel connection are:

(1)—One must be sure that the total load built up by a series-parallel arrangement matches correctly the

amplifier, so that the full rated power of the amplifier is available. This calculation can be made simply by applying the rules used to calculate series and parallel resistances.

(2)—The method of connection must distribute the power in the correct proportions, so that each unit receives an equal amount of power, or power in proportion to the requirements of the case, where it may be desired to feed more power to some units in the group than to others.

(3)—It is also very advisable, in series-parallel connected groups, that all units be of the same type and with the same horn loading or acoustic matching according to whatever type of mounting is provided for the unit. This obtains because loudspeakers do not really operate at their best in series arrangements.

Series operation of loudspeakers tends to destroy the correct damping of the individual units. However, by using identical units, all the speaker's resonances will occur at the same point, providing a cumulative load for the amplifier; or a true replica or multiple of each individual loudspeaker's impedance. In this way the response delivered to every loudspeaker in a group will be uniform. But, if loudspeakers of different types are connected together in a series arrangement, the response from individual loudspeakers can differ very considerably due to interaction between their various impedance characteristics.

(4)—A final point that requires careful consideration in the practical layout of a series-parallel system is the safety factor. In any system there

(Continued on page 48)

<sup>1</sup>Crowhurst, Norman, *PA for Stadiums*, SERVICE; May, 1954.

# New Instrument Developments



(Left)

Small dc 'scope combining linear sweep with dc amplifier for color-TV restorer circuits. Features provisions for ac coupling; vertical and horizontal expansion of trace; automatic astigmatism control circuit; linear time base and sweep (return trace automatically blanked), and vertical or horizontal operation. Frequency range dc to 500 kc; sensitivity better than 50 mv. (Midgetscope 534; Radio City Products Co., Inc., Centre and Glendale Sts., Easton, Pa.)



(Right)

Picture tube tester, for checking 10" to 30" tubes. Utilizes emission method; also tests for interelement leakage, shorts and open elements; uses own power. Checks tube whether in or out of set. Features single master control. (Model 102; Century Electronics Co., 11 Roosevelt Ave., Mineola, N. Y.)



Picture tube rejuvenator, designed to meter cathode activity during rejuvenation. Available in either kit or factory wired form. For electrostatic and electromagnetic picture tubes. Can be used without removing tubes from the set. Detects open or shorted elements and leakages as high as 3 megohms between elements. Has metered circuit said to remove particle shorts between cathode and heater. Features a current limiter to prevent cathode ribbon burnout. (Multiphase Rejuva-Tube; Central Electronics, Inc., 1247 W. Belmont Ave., Chicago 13, Ill.)



Signal generator for if-rf alignment, signal tracing, audio test and marker generator applications. Unit features frequency range from 150 kc to 145 mc on fundamentals in 6 bands: 11 to 435 mc on calibrated harmonics. Has Colpitts rf oscillator; turret-mounted slug-tuned coils; fine and coarse 3-step attenuators; rf output of 100,000 microvolts; af output to 10 v. Uses 12AU7 and 12AV7. Output impedance is 50 ohms. Supplied with shielded output cable. Available as kit, or wired. (Model 324; Electronic Instrument Co., Inc., 84 Withers St., Brooklyn 11, N. Y.)



TV sweep generator (kit) offering all-electronic sweep without moving parts. Unit is claimed to provide deviation controllable from 0 to 40 mc, depending on base frequency. Also features output frequency on fundamentals from 3.6 to 220 mc in four bands, two-way blanking, and output impedance of 50 ohms. Markers available from three sources. Crystal oscillator produces 4.5 mc and multiples thereof. Variable oscillator covers 19 to 60 mc, and up to 180 mc on harmonics. Provision is made for use of external marker. Calibrated for vhf and uhf channels. (Model TS-4; Heath Co., Benton Harbor, Mich.)

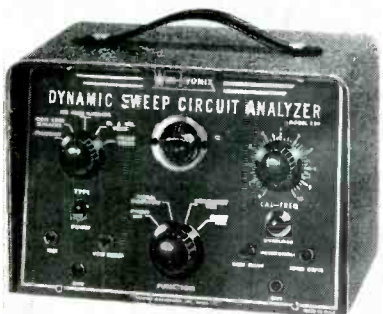

(Left)

Sweep circuit analyzer for troubleshooting horizontal and vertical deflection circuits. Provides 60 cycles vertical sawtooth, 15-kc horizontal sawtooth and deflection-transformer drive for both vertical and horizontal sweep-circuit checking by signal substitution. Also provides for positive test for flyback transformers and yokes using oscillating neon indicator in conjunction with dc amp. (Model 820; Winston Electronics, Inc., 4312 Main St., Philadelphia 27, Pa.)

(Right)

Capacitor tester that, it is said, discloses open, shorted, or intermittent capacitors and leaky electrolytics. Also shows circuit continuity and ac and dc voltages; will indicate leakage of over 300 megohms; checks capacitors at 150 v. (Capacitest; Barjay Co., 145 W. 40th St., New York 18, N. Y.)



the  
complete  
line!



**Cornell-Dubilier  
Communication  
Vibrators**

Based on  
Rigid U.S. Government  
Engineering Specifications

NOW... Cornell-Dubilier makes available to commercial users of communications equipment a new line of vibrators based upon the experience of producing over two million similar units to the exacting requirements of U.S. Signal Corps specifications.

These Eight Types Offer Complete Replacement for ORIGINAL Communications Equipment:

old	new
5515	<b>5715</b>
5518	<b>5718</b>
—	<b>5721</b>
—	<b>5722</b>
5605	<b>5805</b>
5620	<b>5820</b>
5621	<b>5821</b>
5622	<b>5822</b>



CONSISTENTLY DEPENDABLE  
**CORNELL-DUBILIER**  
SOUTH PLAINFIELD, NEW JERSEY

ROTORS · CAPACITORS · VIBRATORS · ANTENNAS · CONVERTERS

**JERROLD FORMS COMMUNITY OPERATIONS DIVISION**

Jerrold Electronics Corp., 23rd and Chestnut Sts., Philadelphia, Pa., has announced the formation of a community operations division. William H. Miller has been named manager; Robert J. Tarlton, manager of community constructions; Barbara Loomis, planning supervisor; Claire Ostroff, field management representative; and Earl Fletcher, engineering supervisor.

**CHANNEL MASTER ADDS DISTRIBUTORS**

Channel Master Corp., Ellenville, N. Y., has added three distributors to handle the company's complete line of products: R and R Supply Co., 605 E. Second, Roswell, N. M.; Straits Distributors, Inc., 144 Ridge St., Sault Ste. Marie, Mich.; and Thurow Distributors, Inc., 566 Balough Rd., Daytona Beach, Fla.

**CLAROSTAT FUZOHM DISPLAY CARD-KIT**

A display card kit, GL-1, with a dozen 7.5-ohm Fuzohm resistors, individually packed in plastic bags, is now available from Clarostat Manufacturing Co., Inc., Dover, N. H. The 7.5-ohm value is standard in TV and other equipment using this protective resistor.

**CENTRALAB IN INDUSTRY-ON-PARADE TV SERIES**

Centralab division of Globe-Union, Inc., Milwaukee, Wisc., was selected recently by the National Association of Manufacturers to appear in its Industry-On-Parade TV series.

Featured in a special film are scenes of the company's printed electronic circuit and ceramic manufacturing facilities and an explanation of the manufacture of a number of CRL electronic components. The film has been scheduled by the NBC-TV network for local stations.

**IRC BUYS HYCOR**

The International Resistance Co., 401 N. Broad St., Philadelphia, Pa., has purchased the Hycor Companies of California and Puerto Rico. Management of the new subsidiaries will continue operations independently. Hycor's major products include magnetic and audio devices and precision resistors.



(Left)

Monte Cohen (left), old-time ship wireless operator and industry pioneer and new president of General Instrument Corp., receiving Marconi Medal of Achievement from Veteran Wireless Operators Association president William J. McGonigle during VWOA's 30th anniversary dinner in New York City. Award was in recognition of Cohen's outstanding achievement in the radio-TV field.

(Right)

Miss Marilee, secretary to the editor of Techni-Talk, who has been selected as G.E.'s TV Service Maid, to help promote TV Service Month, April 19 to May 19. Dealers handling G.E. tubes will be listed in a TV service directory to be published in a national weekly.



# Rep Talk

DONALD HANKINS, 161 Mass Ave., Boston, Mass., has been appointed New England rep for Browning hi-fi tuners. . . . Wayne Woodruff has been named industrial sales manager of Frank A. Emmet Co., 2836 Pico Blvd., Los Angeles 6, Cal., and Elmer Watrous is now in the customer relations section of the sales department. Norman Theobald has joined Emmet, as jobber-sales manager. . . . A. William Christopher, Jr., has been appointed field rep for the electronics systems division of Sylvania Electric Products, Inc., 4700 Parkside Ave., Philadelphia, Pa. . . . Clear Beam Antenna Corp. has appointed Fred A. Rosenwasser Sales, 1581 Coventry Rd., Cleveland 18, Ohio, to rep in western Pennsylvania, West Virginia and eastern Ohio. . . . Mid-Lantic chapter of The Reps has announced the following committee chairmen for '55: George G. Scarborough, board of governors; Samuel A. Jeffries, industry relations; Wilfrid Graham, publicity and advertising; Samuel K. Macdonald, membership; Frank Perna, entertainment; Henry Cordray, new industry; Charles H. Stratton, welfare; Wilmer S. Trinkle, charity and Kenneth Randall, by-laws. . . . Jerome Bresson, 75 Patterson St., New Brunswick, N. J., will represent Centralab in southern New Jersey, Camden and Philadelphia metropolitan area. . . . Film Capacitors, Inc., 3400 Park Ave., New York 56, N. Y., has named Al Denburg, 1312 Ditmars Ave., Brooklyn, N. Y., as factory sales rep for metropolitan New York and northern New Jersey. . . . Dale G. Weber Co., 234 Sherlock Bldg., Portland, Ore., has been appointed industrial and jobber rep in Washington, Oregon, Montana, Idaho and Alaska for International Rectifier Corp. . . . Vidair Electronics Manufacturing Corp., has named the following reps: Charles S. Polacheck, 1500 E. Fairy Chasm Rd., Milwaukee, Wisc., (Minnesota, N. and S. Dakota, and western Wisconsin); John Zimmer, 21 E. Bloomington St., Iowa City, Ia., (Iowa, Missouri, Kansas, eastern Nebraska and southern Illinois); and Eugene L. Park, Jr., P. O. Box 336, Feasterville, Pa., (Delaware, District of Columbia, Maryland and southern New Jersey, and eastern Pennsylvania and Virginia). . . . L. E. Septer, P. O. Box 16, Bloomington, Ind., is now a rep for the Electronic Components Division of the Stackpole Carbon Co. in Indiana. . . . Robert B. Nieman, 38 E. Ash St., Lombard, Ill., has been appointed Cincinnati district sales rep for the Jefferson Electric Co. . . . Marty Bettan Sales (metropolitan New York), and John Mustico (Mid Atlantic states), have become sales reps for Seco Manufacturing Co., Minneapolis, Minn. . . . Radio Receptor Co., Inc., has named the following reps for its semi-conductor division: Victoria Sales Co., 7522 N. Sheridan Rd., Chicago, Ill., (northern Illinois, including Chicago), and Gates Co., Salt Lake City, Utah, (Utah, Wyoming, New Mexico, Colorado and parts of Texas, Idaho, Montana and Nebraska).

# QUIET...

Controls should be adjustable but not really variable. That's why Clarostat controls—composition-element and wire-wound alike—are designed, manufactured, and quality-controlled for QUIET operation, insuring maximum listening and viewing pleasure. Satisfy your customers with QUIET controls. ▀ Details in latest Clarostat catalog.



All tapers, taps and choice of field-attached shafts and switches.



Popular 3/16" dia. size has become the universal replacement choice.



Dual controls in all types, combinations, single or concentric shafts.

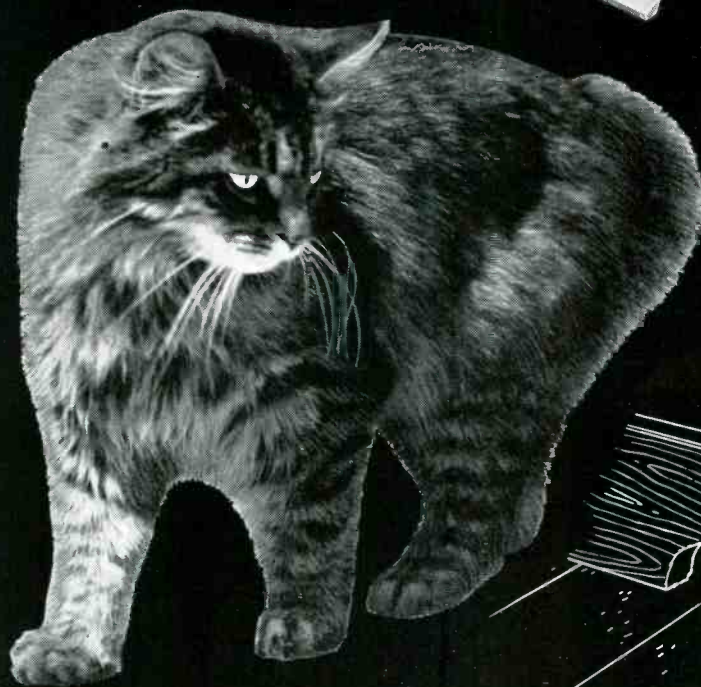

## CONTROLS and RESISTORS

CLAROSTAT MFG. CO., INC., DOVER, NEW HAMPSHIRE  
In Canada: Canadian Ma-coni, Co., Ltd., Toronto 17, Ont.

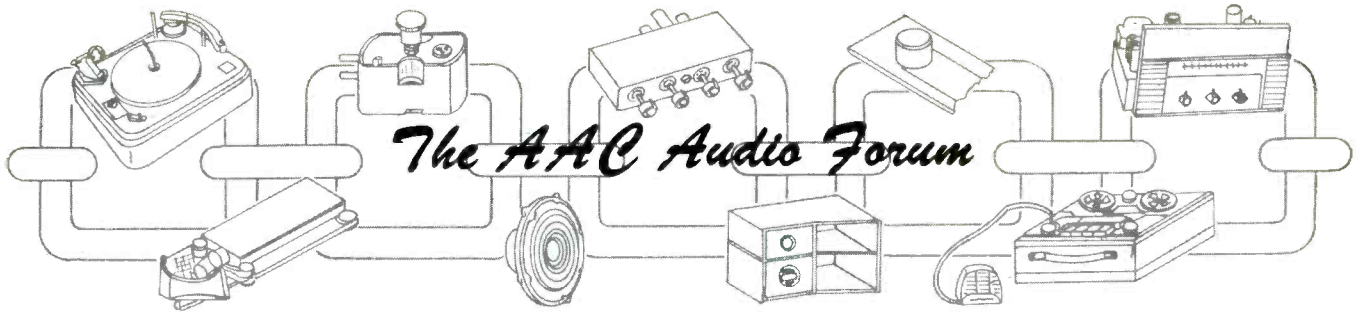

## Part IX of a Series of System-Component Evaluation and Progress Reports

### Speaker Loading†

THE MODERN SPEAKER has now been developed to the point where, by the use of two or three horn-loaded speakers, a close approach to reproduction of the original sound is possible.

As a piston sloshing up and down in the middle of a lake fails as an effective pump, so a cone-type loudspeaker sloshing the air in a room has been found to fail as an efficient sound generator. But when we insert a cylinder around the piston, the pump becomes effective; and when we match properly a horn to the cone, the speaker becomes efficient. Simultaneously, distortion is reduced, because the horn reduces diaphragm excursion for a given sound level output.

Apparently, in the present state of the art, the horn-loaded speaker is limited in frequency response to ranges indicated in Table I; p. 50.

While the fully horn-loaded corner-speaker system, it is felt, represents

†Based on data prepared by the lab staff of Klipsch and Associates.

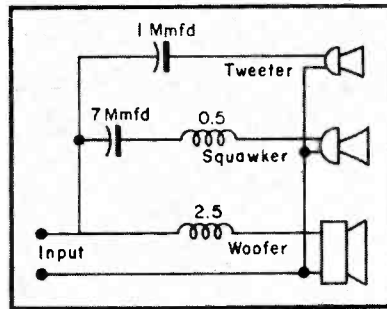

Fig. 1. Typical 3-way crossover network. (From Klipsch data sheet for Shorthorn corner horn loudspeaker system.)

the closest approach to true reproduction the state of the art affords today, the system has been found to be expensive; the corner-horn back-loaded direct-radiation type of woofer has been found to be by far the most popular.

In the choice of elements for new or replacement speakers, one should follow these rules, for the types indicated:

- (1) *Corner Horn*: The larger, the better, up to about 36" high. Half-inch plywood is just as good as heavier material, if it

is properly braced and free of vibrations and rattles.

- (2) *Woofer Motor or Driver*: A heavy magnet here is more important than a large cone; a good 12" cone will have a two pound or larger alnico V slug, while a 15" cone will have an alnico slug weighing from three to five pounds. Twelve-inch speakers normally weigh from eight to twelve pounds, the 15" type usually weighs twenty - five pounds or more. In the main, lighter units of high efficiency have been found to develop dragging voice coils, due to the small air gaps necessary when skimping on magnetic material.
  - (3) *Squawker*: This unit supplies that all-important *middle range* often neglected in *hi-fi* speakers. It need not be costly. Small straight-axis horns usually have a cut-off, due to a taper, of 500 cycles.
  - (4) *Tweeters*: Usually tweeters are built complete with horn. Small 3/4" diameter diaphragm types
- (Continued on page 50)

Figs. 1 and 2. A 4-speaker system that can be used for remote installation, recently introduced by Magnavox. Designed for rectangular or corner-type cabinets, the speakers can be connected up as illustrated in Fig. 2; the original hookup of these speakers in Magnavox phono models (to amplifier models 128 and 132) is shown in Fig. 1. The speaker system consists of a pair of 12-inch and a pair of 5-inch cone-type speakers with a crossover network and 30' of two-conductor cable. Frequency response is said to be 40 to 15,000 cps; peak power output 20 w.

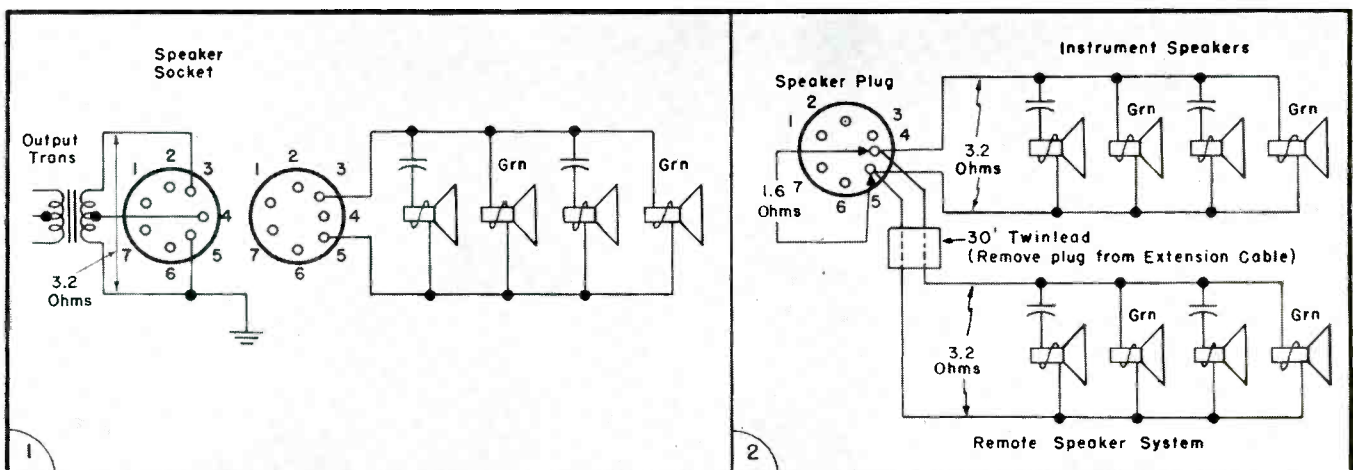



# Latest in Audio



Disc-type phono cartridge interchangeability guide. Turn of wheel shows E-V model that can replace crystal or ceramic phono-cartridge. A spec table shows tracking force, frequency response, voltage output, application rpm, needle number and list prices. (Electro-Voice, Inc., Buchanan, Mich.)

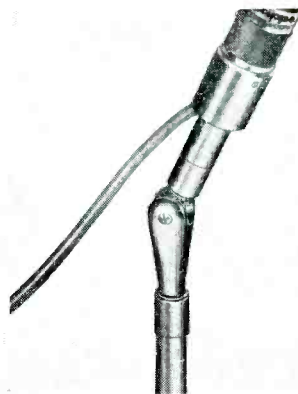

Universal microphone swivel styled to match modern studio equipment. Can be adjusted to any angle on any standard floor or desk stand. Has a  $\frac{5}{8}$ -27 female thread on one end and  $\frac{5}{8}$ -27 male thread on the other. (Model SFM; Frank L. Capps and Co., Inc., 20 Addison Place, Valley Stream, N. Y.)

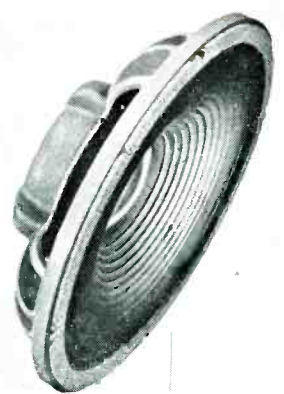

Extended range 12" speaker, with depth of  $3\frac{5}{8}$ ". Speaker can be mounted between studding, flush with the surface of wall or partition. Usable frequency response range, when used as a direct radiator and enclosed with an adequate baffle, claimed to extend from 20 to 15,000 cps. Power input is 20 watts; impedance, 16 ohms. (Model 123; James B. Lansing Sound, Inc., Los Angeles, Calif.)

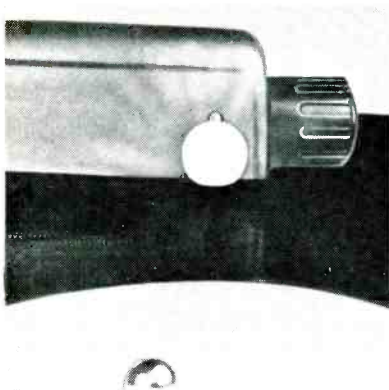

Radioactive device, said to make records dust-resistant, which clips on tone arm of record player. Styled in shape of a tiny ball of pearlescent plastic. It is 9 mm in diameter and said to weigh less than 1/50th of an ounce. Contains a small amount of radioactive material compounded with pure gold and silver. Unit item, it is claimed, ionizes the air at record surface, neutralizing the electric charges. (SE-9; Robins Industries Corp., 41-08 Bell Boulevard, Bayside 61, N. Y.)

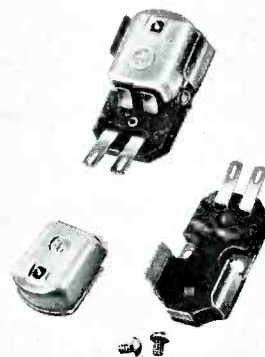

Miniature cartridges for use with 78 (available with either diamond or sapphire styli) and  $33\frac{1}{3}$  and 45 rpm (available only with diamond styli). When purchased separately, a clip type universal adapter is packaged with each cartridge. Adapter is said to permit installation of cartridges in all standard makes of changers and tone arms. Adapter can be permanently mounted by two 3-48 screws also provided. Silverplated contacts on the cartridges and adapter clip. (Models 220 and 240; Pickering.)

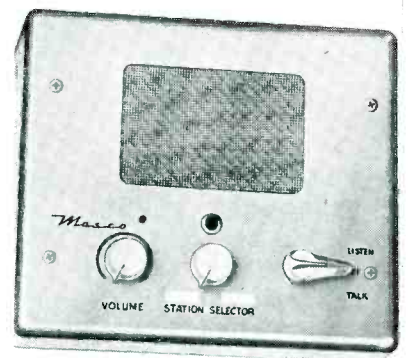

Flush-mounted door answering intercom system. Consists of a master or a portable master and a remote door station. All power is off until master talk-listen switch is operated to talk or listen. Instant heating tubes said to take only two seconds to put the unit in operation. Remote door station is designed for flush mounting on a door frame or a wall. It incorporates a push button for operating bell, buzzer or chime. Master units contain a selector switch for front and rear doors, volume control, talk-listen switch and pilot light. (Electronic Buller; Mark Simpson Manufacturing Co., Inc., 32-28 49th St. Long Island City 3, N. Y.)

(Left)

High compliance crystal cartridge said to have an output of 3.5 volts. (Model 28; Astatic Corp., Conneaut, O.)

(Right)

Three-speed ( $7\frac{1}{2}$ ,  $3\frac{3}{4}$  and  $1\frac{7}{8}$ ) tape recorder which features push-button control with straight-line slot threading. Frequency response at the  $7\frac{1}{2}$  ips speed is rated at 30 to 12,000 cps; 7,500 and 4,500 cps maximum response is provided at  $3\frac{3}{4}$  and  $1\frac{7}{8}$  ips speeds, respectively. The  $1\frac{7}{8}$  ips speed provides six hours of dual track recording on 1800', 7" diameter reel. A 6" x 9" oval speaker is built in. Outputs include a 3.2-ohm jack for external speaker and a hi-Z jack for feeding an external hi-fi amplifier; hi-Z jack bypasses the unit's output stage. (Model RT-75; Bell Sound Systems, Inc., 555 Marion Road, Columbus 7, Ohio.)

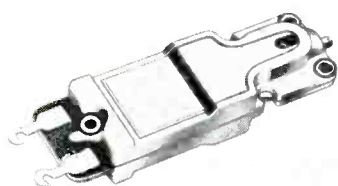

**OXFORD Speakers**  
*Guarantee*  
*Quality Sound*

Better sound from **OXFORD SPEAKERS**... complete line from 2" to 15"... for all replacement needs... **ORDER TODAY!**

 **OXFORD ELECTRIC CORPORATION**  
 3911 South Michigan Avenue • Chicago 15, Illinois  
 EXPORT — ROBURN AGENCIES, NEW YORK CITY IN CANADA — ATLAS RADIO CORP. LTD. TORONTO

## Stadium PA System

(Continued from page 42)

is usually much more likelihood of an open than of a short. This being the case, a completely parallel-connected system as used for constant-voltage line distribution, is inherently safer because there is less likelihood of a short occurring across the line than of an individual unit becoming open; and if a unit does open the parallel connection insures that only that particular unit goes out of commission. In a completely series-connected circuit any

unit going open terminates the service given by the whole loop. If a unit shorts, there is no trouble and just that one unit drops out of service; but this is a far rarer fault. In the event that one unit opens in a series chain, the only way to locate the fault is to inspect each unit in turn until the defective connection is found.

Therefore, the best installation method to follow in a series-parallel connection is to use at least two units in

parallel at each stage. For example, if there are 12 units on a line, these can be connected as six series groups of two in parallel; the resultant impedance will then be three times the impedance of an individual unit, and the matching to the amplifier should be arranged so that it will deliver full power into this impedance. In the event that any one unit opens, its partner will then receive approximately four times its normal power. The two units connected in parallel will generally be reasonably close together, so that if the remaining unit delivered twice the normal power, general sound distribution would be approximately correct. However, quadrupling the power from a unit, which is a partner to one that fails, does insure that coverage will be provided for the unit that failed, if both units serve adjacent areas.

This was the method adopted at the stadium installation described earlier.<sup>1</sup> For three of the larger groupings it proved quite successful, and in fact no failures were detected due to open circuits.

Someone will probably ask: If the parallel connection approach is better than a series connection, why not parallel all of a loudspeaker group, rather than use any series connection at all? The best answer to this probably appears in the following arithmetical example. Let us suppose, that in the groups of 24 loudspeakers used to feed the side stand sections at the stadium, parallel connection had been used. These were 4-ohm speakers, so that the total impedance connected in parallel would have been  $\frac{1}{6}$  of an ohm. The line feeding the speakers was several hundred feet in length, and of necessity must be a few ohms in resistance unless an extremely heavy wire, of the type normally used for an arc welding plant, were used. Obviously this would not be a practical distribution system for public address. In this case, assuming that the connecting wires produced a resistance of 2 ohms, a 50-watt amplifier would only deliver about 1/12 of its 50 watts to the loudspeakers, while the remaining 11/12 would be dissipated in the connecting wires.

Certainly connection to the speaker system should be arranged so that the bulk of the power delivered by the amplifiers reaches the voice coils of the loudspeakers, and is not dissipated in the connecting wires. Using paralleled pairs in 12 series groups, the 4-ohm units would build up instead to an impedance of 24 ohms; in this case a total series loss of 2 ohms would only dissipate 1/12 of the total power

and 11/12 would reach the desired destination.

Of course, it is much simpler to use a constant-voltage distribution system everywhere, where this is possible; but it should not be necessarily assumed that the constant-voltage distribution system would be more efficient. In the case just mentioned 11/12 of the total power went to the voice coils. This is quite a high efficiency for a speaker-matching transformer; so it is doubtful whether more than 11/12 of the total power delivered by the amplifier would reach the individual units in a constant-voltage line system, because of the losses in the matching transformers.

To summarize then, provided the impedance at which distribution is made is kept reasonably high compared to the resistance losses in the wire system, the constant voltage and series-parallel connection are equally efficient. The great advantages of the constant-voltage method are that it is more versatile, when it is required to distribute different amounts of energy in different places, and that peculiar response effects do not arise from using different types of units together. It was for this reason that constant voltage distribution was adopted, in all cases, for the lines feeding the departments located under the stands in the stadium installation.<sup>3</sup>

#### AUDIO PLANT OPEN HOUSE



At a two-day product exhibition of Electro-Voice, Inc., in the Buchanan American Legion Hall. Top: Informal discussion about E-V's new phono-cartridge packaging (l to r)—Phil Costanza, Warren Radic, Grand Rapids, Mich.; Web Soules, manager, E-V distributor sales division; Jerry Murphy, Electronic Supply, Battle Creek, Mich.; Larry LeKashman, E-V vice president, sales; and Warner Gardner, Gardner Radio Supply, Manistee, Mich. Bottom: Ev Leedom (left) manager, E-V advertising and sales promotion for Electro-Voice, demonstrating one of several hi-fi loudspeaker exhibits to (l to r) George Fisher, Al Kester Jr., and Melvin Ebersold, all from Commercial Sound and Hi-Fi, South Bend, Ind.

**Dictate Reports Accurately-Promptly!**

**make your car,  
boat or plane  
a "rolling  
office"**

with



**INVERTER**

for changing your storage battery current to A. C. Household ELECTRICITY

*Anywhere . . .*

in your own car!!

ATR INVERTERS . . . especially designed for operating standard 110 volt A. C. . . .

- TAPE RECORDERS
- WIRE RECORDERS
- DICTATING MACHINES
- ELECTRIC RAZORS

for

- EXECUTIVES
- SALESMEN
- PUBLIC OFFICIALS
- POLICEMEN
- FIREMEN
- OUTDOOR MEN
- REPORTERS
- FIELD INSPECTORS
- DOCTORS
- LAWYERS, ETC.

*See your jobber or write factory*

NEW MODELS ✓ NEW DESIGNS ✓ NEW LITERATURE  
"A" Battery Eliminators, DC-AC Inverters, Auto Radio Vibrators

**AMERICAN TELEVISION & RADIO Co.**

*Quality Products Since 1931*

SAINT PAUL 1, MINNESOTA — U. S. A.

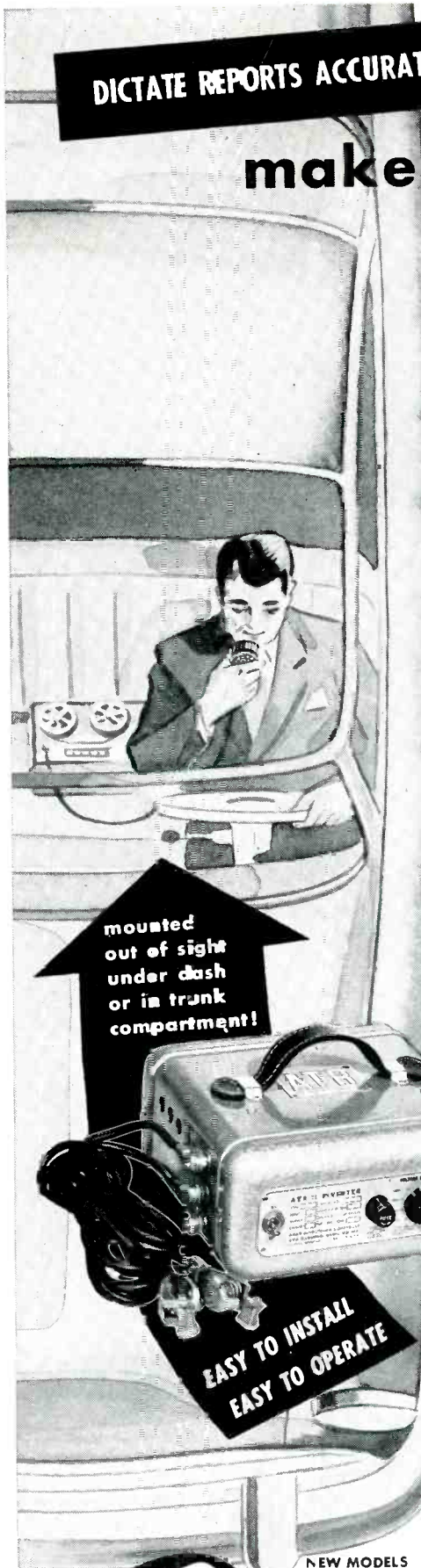



*Something Big's  
in the News!*

Can't tell you yet...  
but what Walco will  
unveil at the Parts Show  
will make your phonograph  
needle sales spiral.

Watch this magazine for  
later developments (and we do  
mean developments!) Watch  
WALCO for bigger and  
better needle profits.

Write for a full-size print of the  
Walco cutie above, suitable  
for framing, plus informa-  
tion on how you can up your  
needle sales and profits.

**NEEDLES FOR EVERY  
PHONOGRAPH BY**

# Walco

Trade Name of Electrovox Company, Inc.  
60-S Franklin Street, East Orange, N. J.

## Audio Forum

(Continued from page 46)

have been found to have a smoother and more extended range than units with large diaphragms.

- (5) *Crossover Network*: One type is shown in Fig. 1; p. 46. Unless some special consideration,

relative to a peculiarity of response of one or more driver units is involved, it will be found that the 6 db-per-octave slope of the network illustrated will be superior to steeper slopes.

### The Role of Room Acoustics in Music Listening††

THE TERM HI-FI is usually applied to the broadcast or recording and reproduction of music in such a manner as to provide a satisfying listening experience. Noise, distortion, and non-uniform frequency-response characteristics introduced by electrical and electro-mechanical elements in the transmission system, especially transducers, have long proved to be the primary factors which detract from full listening enjoyment. Recently, with the advent of magnetic recording, FM broadcasting, quiet disc record materials, feedback record cutters, and wide-range pickups and loudspeakers, equipment factors have become potentially less important than the influence of room acoustics on the quality of broadcast or reproduced music. Recent enthusiasm for binaural

and stereophonic recording and broadcasting techniques, designed to provide a considerable increase in realism over customary single-channel methods, has been found to place greater emphasis on the significance of the room as an essential link in the electroacoustic transmission system, which carries music from its source to the listener.

Rooms in which recorded music or other signals are normally reproduced, whether they be large motion picture theatres or small living rooms, are usually relatively dead; carpeting, drapes, and upholstered furniture introduce a considerable amount of acoustic absorption, which may or may not be uniformly distributed in frequency. The frequency-response characteristic of a reproducing system may require adjustment to suit the room in which the loudspeaker is located and the same system may sound quite different in different acoustical environments.

Since listening rooms usually have a short reverberation time, compared

††From a report delivered at the annual IRE convention in New York City by **John A. Kessler**, Acoustics Lab, MIT.

	Fully horn-loaded system	Semi-loaded base (combined horn and direct radiation); horn squawker and tweeter	Semi-loaded; 2-way
<b>Woofers</b>	4 octaves; typically 60-800, except in best corner type, which may cover 30-500 cps	4 octaves; 60-1000 cps*	4 octaves; 60-1000 cps*
<b>Squawker (Midrange)</b>	3 octaves; typically 600-6000 or 500-5000 cps	2 octaves; 1000-5000 cps	3 or 4 octaves; 1000-8000 or
<b>Tweeter</b>	1½ octaves; typically 5000-15000 cps	1½ octaves; 5000-15000 cps	500-8000 cps**

\*Depending on type of horn loading, size, and use of corner, some response may occur below 60 cps.

\*\*A combined squawker-tweeter must have a large diaphragm, say 1½" to 2" diameter to pump enough air at 500 or 1,000 cps, which precludes its smooth response above 5,000 cps. Typically such horn squawker-tweeters are designed to provide a *presence peak* at about 7,500 cps to compensate for the deficiency in actual upper range.

Table I: Frequency response ranges of horn-loaded speakers.

with that of a concert hall, the manipulation of reverberant effects for dramatic or aesthetic purposes can be carried out in the original recording process. Following the principles of *liveness*<sup>1</sup>, considerable variations in acoustical perspective can be effected, even in single-channel systems, and the transmission can be made to convey to the listener strong implications as to the acoustical environment from which the music originated. For example, listeners have been conditioned to associate a string quartet with a relatively small room and a short reverberation time; at the other extreme, one associates Gregorian chant with a large stone cathedral, and with a correspondingly large proportion of reverberant sound to direct sound. Between these two extremes, for live concerts or for reproduced music, the relative acceptability of various acoustical conditions, and even the perceptibility of particular changes in the acoustical environment, have not been well established.

#### Acoustic Flaw Isolation

In concert halls and in motion picture theaters, acoustic flaws which cause disturbance or annoyance have proved to be easier to isolate by existing test methods than have positive acoustic merits. The nature of the listening process can provide a rather broad tolerance to acoustical conditions so long as intrusive acoustic flaws are eliminated. The establishment of statistically-reliable preference limits for various acoustic factors will require the development and application of improved psycho-physical test procedures.

<sup>(1)</sup> As outlined by J. P. Maxfield and W. J. Albersheim in their report on *An Acoustic Constant of Enclosed Spaces Correlatable with Their Apparent Liveness*: Journal of Acoustical Society; 1947.

The AAC Audio Forum is being presented as a service to industry, in cooperation with the Audio Activities Committee (through its Promotion and Public Relations Subcommittee) of the Sales Managers' Club, Eastern Division, who have arranged for members of the audio industry to contribute authoritative data on all phases of audio in which they are most expert. Comprehensive reports feature technical and merchandising information on amplifiers, preamps, speaker enclosures, speakers, turntables, record changers, cartridges, needles, arms and accessories, recording discs and tapes and accessories, tape recorders, special output transformer kits and tuners.



**"The jack of all trades  
is master of none . . ."**

*That's why*

# QUAM

*Adjust-a-Cone*<sup>®</sup>

## REPLACEMENT SPEAKERS

are **EXACT REPLACEMENTS**

Each one is designed to do a specific job—and to do it as well—or better—than the original speaker.

QUAM speakers are built for quality—not compromise. They are exact replacements—every one of them—with the right magnet, the right power handling capacity, and the right size to do the job you—and your customers—want them to do.

**FREE** The QUAM catalog listing over 100 exact replacement speakers.

*ask for QUAM, the quality line for all your speaker needs*

**QUAM-NICHOLS COMPANY**

232 East Marquette Road • Chicago 37, Illinois

Below: AM-FM tuner with separate tuning knobs and output terminals, which can be used for stereophonic reception. (National Co., Inc.)

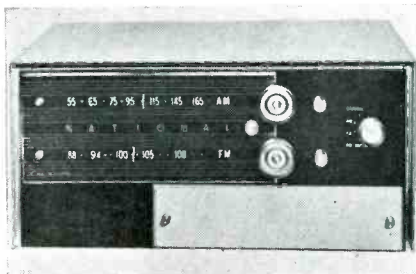

Below: Dual-carriage tone arm for playing binaural or stereophonic records. The play-in grooves of the two sections of such records are designed to establish initial synchronization between the two halves. (Livingston Electronic Corp.)

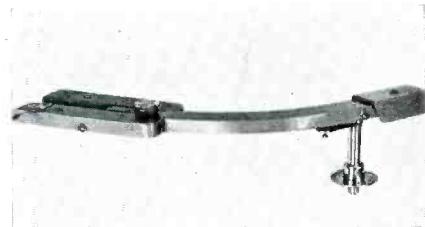

Use the complete line...

# ERIE DISC CERAMICONS®

Erie Disc Ceramicons are available at Distributors in four classes as standard stock:—High Stability General Purpose Ceramicons in a wide range of values, (5mmf to 1800 mmf) with 10% capacity tolerance,—Hi-K By-Pass and Coupling Ceramicons from 470 mmf to .02 mfd GMV,—Hi-K Dual Ceramicons,—High Voltage Ceramicons rated at 1500, 3000, and 6000 Volts, DC. Working. Characteristic of all classes is smallness of size graduating with increase in capacity value. For complete listing of styles and values available write for D-54 Catalog which includes all Erie Distributor products, or ask your nearest Erie Distributor.

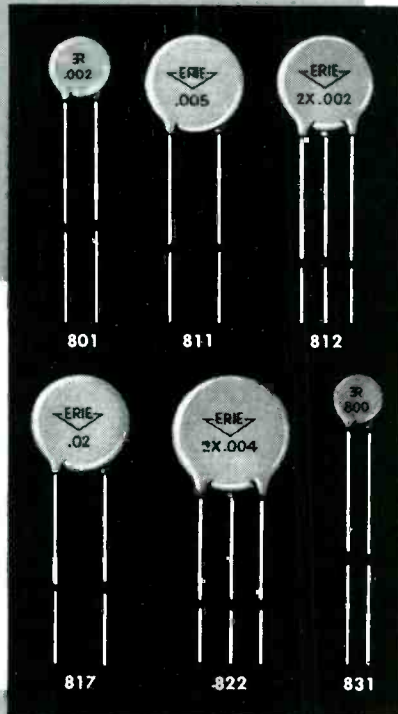

ERIE ELECTRONICS DISTRIBUTOR DIVISION

ERIE RESISTOR CORPORATION

Main Offices: ERIE, PA.

Factories: ERIE, PA. • LONDON, ENGLAND • TRENTON, ONTARIO

## Audio Service Notes

SLIPPING OF 45-RPM records on Admiral phonos may be due to the fact that the 45-rpm adapter nibs may be deformed, may not fit tight enough in the record, or may be cocked. The records should be checked to see that they are not warped. If records have the fibre-type 45-rpm adapter, they should be replaced with the plastic type. The plastic type adapter will fit in the record better and will have sharper nibs.

Needle pressure may be too great for this type of record. The tone arm weight should be removed.

### Erratic Trip Action

ERRATIC TRIP action may be caused by failure of the trip slider return spring to return the trip slider to its proper position as the changer goes through cycle. The trip slider return spring should be checked for proper tension, and the trip slider checked for sticking or binding.

### Eliminating Hum In Audio Amp Models

IF HUM IS NOTICED in the Magnavox 300 series chassis, used in conjunction with the AMP135, the following suggestions should be followed:

- (1) Shielded audio leads from TV-Phono switch in the TV chassis should be dressed away from filter choke and close to chassis pan.
- (2) Amplifier ac plug should be reversed. This will have no noticeable effect if lead dress in step (1) is incorrect.
- (3) If hum is still objectionable, one should try a new 6T8 in the TV chassis.

Tune-A-Port speaker cabinet with a baffle-board that is adjustable from outside via knob control. Accommodates 12" or 15" single, coax or triaxial speaker systems; has a sound enclosure of 10,000 cubic inches. Constructed of 3/4" mahogany veneer stock. (Standard Wood Products Corp., 47 W 63 St., N. Y. 23.)

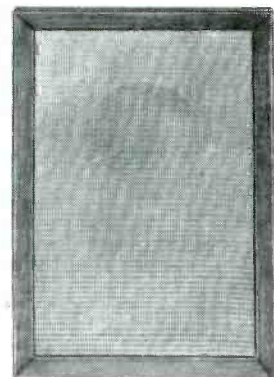

"Ah, they must have gotten a  
JENSEN NEEDLE"

## NEW! ATLAS CJ-30 COBRA-JECTOR INDESTRUCTIBLE FIBER-GLASS ALL WEATHER WIDE ANGLE DISPERSION

List \$40.00  
NET \$24.00

Complete with Driver.

Weatherproof Line Matching Transformer as shown, Net \$5.10.

New versatile all-purpose projector—excellent for paging & talk-back, intercom, marine, and industrial voice & music systems. Penetrating articulation assures wide angle intelligible coverage even under adverse sound conditions. "ALNICO-V-PLUS" magnetic assembly. Double-sealed against all weather. Omni-directional mounting bracket. Quick, easy installation. An amazing "power package"—Specify the CJ-30 for the "tough" jobs!

Input Power (continuous).....15 watts  
Input Impedance.....8 ohms  
Response .....250-9000 cps  
Dispersion .....120° x 60°  
Dimensions: .....Opening, 14" x 6"  
Overall Length, 14"



WRITE FOR COMPLETE CATALOG  
ATLAS SOUND CORP.

1442—39 St., Bklyn. 18, N. Y.  
In Canada:  
Atlas Radio Corp., Ltd., Toronto, Ont.

# TV Parts... Accessories

## PERMATEX AVIATION PLASTIC CLEANER

A non-scratching plastic and plexiglass cleaner, *Permatex Aviation Plastic Cleaner*, for cleaning TV receiver screens, has been introduced by Permatex Co., Inc., Ave. Y and 18th St., Brooklyn, N. Y.



## VIDAIRE EXTENSION KIT

A picture-tube extension kit, packaged in a pocket-size lucite case, has been announced by Vidair Electronics Manufacturing Corp., 576 W. Merrick Rd., Lynbrook, N. Y.

Three items are included in kit: anode extension, *AE-1*, rated for a minimum of 25,000-v breakdown; yoke extension, *YE-1*, for many late type TV receivers; and socket extension, *SE-3*, six wire, for all picture tubes.



## COPPERWELD GROUND RODS-CLAMPS

Non-rusting ground rods and clamps, packed in cardboard tubes that serve as a bin for rods and container for clamps, have been announced by Copperweld Steel Co., Glassport, Pa.

The rods feature a chamfered end to prevent mushrooming, and a body of molten-welded copper covering to provide protection against rusting. Has stiff steel core to make driving easier.

Supplied in six sizes:  $\frac{3}{8}$ " x 4';  $\frac{3}{8}$ " x 6';  $\frac{3}{8}$ " x 8';  $\frac{1}{2}$ " x 5';  $\frac{1}{2}$ " x 6';  $\frac{1}{2}$ " x 8'.

Also available is a line of guy strand, grounding wire and solid antenna wire which also features molten-welding of copper to steel core. Strand supplied in 100', 200', 250', 500' and 1000' coils or spools. Furnished in two sizes: No. 14 and 18. Ground wire is available in No. 8 and 10 in lengths ranging from 50' to 500'

for your most complete  
**EXACT REPLACEMENT  
FLYBACK COVERAGE**

## LOOK TO STANCOR

... whenever you need a flyback. The chances are you'll find a STANCOR exact replacement for the job!

There are 7 Admiral exact replacements that give you

**96% ADMIRAL  
EXACT REPLACEMENT  
FLYBACK COVERAGE**

There are 5 Muntz exact replacements that give you

**98% MUNTZ  
EXACT REPLACEMENT  
FLYBACK COVERAGE**

There are 10 RCA exact replacements that give you

**87% RCA  
EXACT REPLACEMENT  
FLYBACK COVERAGE**

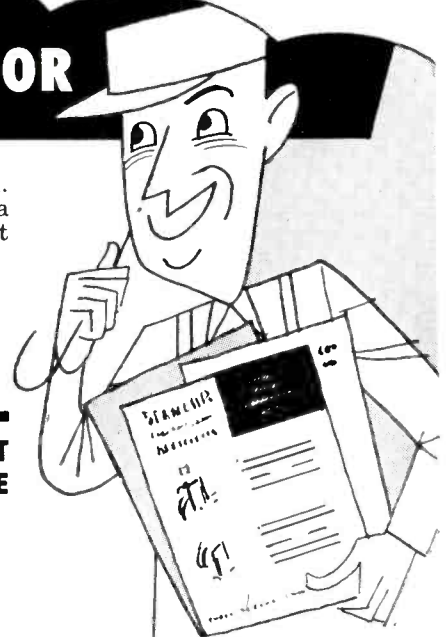

**FREE** Reference library of STANCOR bulletins listing replacement applications for new STANCOR flybacks... from your Chicago Standard distributor

**STANCOR** transformers are listed in Photofact Folders Counterfacts File-O-Matic Radio's Master



## CHICAGO STANDARD TRANSFORMER CORPORATION

3588 ELSTON AVENUE • CHICAGO 18, ILLINOIS

**EXPORT SALES:**  
Roburn Agencies, Inc.  
431 Greenwich Street  
New York 13, N. Y.

## GENERAL INSTRUMENT TUNERS

Three TV tuners for *vhf* and *uhf*, designed to meet proposed FCC limits for radiation, have been announced by General Instrument Corp., Elizabeth, N. J.

One model, No. 100, a *vhf* tuner, less than 4" long, 3" wide and 3" high, has either 12 (for *vhf*) or 13 (for use with *uhf*) detent positions, and is available for pentode or cascode amp design. Another tuner, model 200, is a dual preselector *uhf* tuner, 1 5/16" deep, 3 3/8" wide, and slightly over 3" high. Model 400, which is a combination of types 100 and 200, provides *uhf*, *vhf* service.

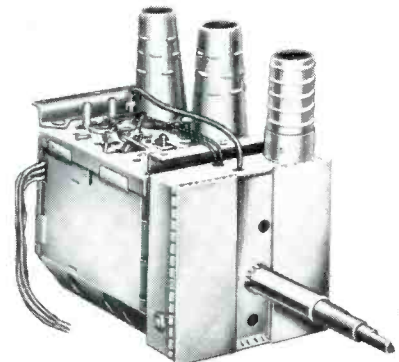

# CASH IN on Multiple TV installations

for motels, apartments, clubs

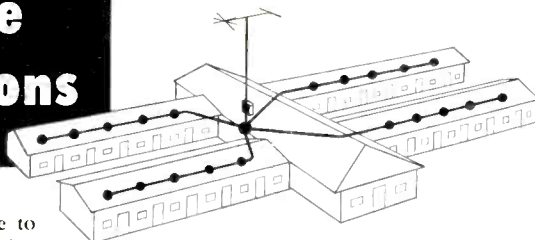

Sell terrific "come-hither" value to motels, tourist courts, apartment houses, and clubs, by equipping every room with the finest television reception! Sell the single-antenna system that does away with a roof full of costly, dangerous, unsightly separate antennas. Sell the ease of adding receivers without additional roof work.

The Jerrold TV *Multi-Outlet* System feeds snow-free signals to twenty or more sets from one antenna, with full signal strength at every receiver and with no interaction between sets. Heart of the system is the indoor-mounted 5-tube Jerrold ABD-1 Distribution Amplifier, which distributes the sharpest picture attainable in any area, on low-noise coax cable to individual line-tap impedance matchers in each TV-equipped room.

Jerrold engineering simplifies every step of your installation, from the antenna to the receivers. *You save outdoor time and equipment*, and you boost your repeat-service market on individual receivers!

The farsighted motel and apartment owner is going more and more to Jerrold *Multi-Outlet* television. Will you be there when he buys?

Write for free illustrated literature to help you sell.

**JERROLD ELECTRONICS CORPORATION**

1407 S. 26th Street

Philadelphia 46, Pa.

# JERROLD

for service and lab. work

**Heathkit**

## PRINTED CIRCUIT OSCILLOSCOPE KIT FOR COLOR TV!

① Check the outstanding engineering design of this modern *printed circuit* Scope. Designed for color TV work, ideal for critical Laboratory applications. Frequency response essentially flat from 5 cycles to 5 Mc down only 1½ db at 3.58 Mc (TV color burst sync frequency). Down only 5 db at 5 Mc. New sweep generator 20-500,000 cycles, 5 times the range usually offered. Will sync wave form display up to 5 Mc and better. Printed circuit boards stabilize performance specifications and cut assembly time in half. Formerly available only in costly Lab type Scope. Features horizontal trace expansion for observation of pulse detail — retrace blanking amplifier — voltage regulated power supply — 3 step frequency compensated vertical input — low capacity nylon bushings on panel terminals — plus a host of other fine features. Combines peak performance and fine engineering features with low kit cost!

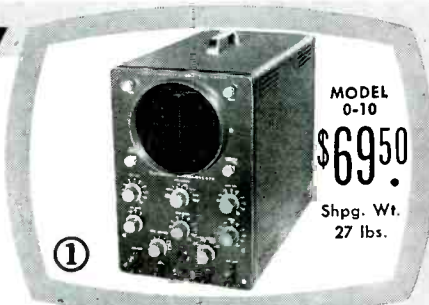

MODEL  
0-10  
**\$69.50**  
Shpg. Wt.  
27 lbs.



MODEL  
TS-4  
**\$49.50**  
Shpg. Wt.  
16 lbs.

**Heathkit TV**

## SWEEP GENERATOR KIT ELECTRONIC SWEEP SYSTEM

② A new Heathkit sweep generator covering all frequencies encountered in TV service work (color or monochrome). FM frequencies too! 4 Mc — 220 Mc on fundamentals, harmonics up to 880 Mc. Smoothly controllable all-electronic sweep system. Nothing mechanical to vibrate or wear out. Crystal controlled 4.5 Mc fixed marker and separate variable marker 19-60 Mc on fundamentals and 57-180 Mc on calibrated harmonics. Plug-in crystal included. Blanking and phasing controls — automatic constant amplitude output circuit — efficient attenuation — maximum RF output well over .1 volt — vastly improved linearity. Easily your best buy in sweep generators.

**Heath**  
COMPANY  
A SUBSIDIARY OF DAYSTROM, INC.  
BENTON HARBOR 11, MICH.

WRITE FOR FREE CATALOG  
... COMPLETE INFORMATION

# Tools . Parts

## SNYDER AUTO ANTENNAS

Two rear-mount communications antennas for autos, *HR-1* and *HR-2*, which can be adapted to AM auto-radio, auto-telephone or short wave communications, have been introduced by Snyder Manufacturing Co., 22nd and Ontario Sts., Philadelphia, Pa.

*HR-1*, which is cadmium plated and fitted with a tapered, heavy-duty steel spring has 96" spring tempered steel mast; cable is 12' long. *HR-2* includes a stainless steel 96" mast, chrome-plated adjustable die-cast swivel ball joint with bakelite insulator mounting plate, plus a 15' length of cable.



\* \* \*

## PRIMAX SOLDERING GUN

A soldering gun, *Primax*, said to reach soldering heat in less than six seconds, has been announced by Paul C. Roche Co., Inc., 11 Park Pl., New York 7, N. Y.

Gun features unbreakable plastic handle; alloy tip, said to be restored to operating condition by wiping. Has balanced grip and trigger control. Available for 110 or 220 vac.

\* \* \*

## G-C SPRING WINDER

A spring winder, *Speedex*, that it is claimed, can turn out any type of spring, number of coils, or diameter or pitch desired, using any size wire, has been developed by General Cement Manufacturing Co., Rockford, Ill.

Unit designed to produce either compression or extension springs. Winder fastens to bench.

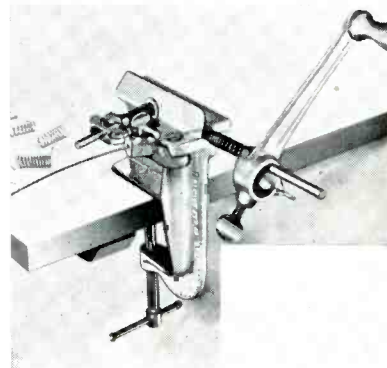



**GENERAL SCIENTIFIC SYTE-AYDE**

A three-way illumination kit, *Syte-Ayde*, with four light transmitting rods—two straight (3½" and 6" long) and two bent to 90° angles, has been announced by General Scientific Equipment Co., 2700 W. Huntingdon St., Philadelphia 32, Pa.

Unit is powered by flashlight batteries and has three 1.5 power mirrors, ½", ¾" and 1¼" in diameter, supplied with clips which fit rod ends.

\* \* \*

**CLAROSTAT MINIATURIZED SWITCH**

A miniaturized rotary selector switch, series *BH*, available in single pole (up to 12 positions), two pole (6 positions), three pole (4 positions) and four pole (3 positions), has been developed by Clarostat Manufacturing Co., Inc., Dover, N. H.

Switch features enclosed construction; mounts with ⅜" bushing and ¼" shaft and can be had in shorting or non-shorting types. Measures ¾" diameter by 13/16" overall for body and terminals.



\* \* \*

**BEAVER CONTACT CLEANER-LUBRICATOR**

A cleaner-lubricator, *Contact*, for TV tuners, motors, relays, solenoids and other moving parts, has been introduced by Beaver Laboratories, Inc., 86-51 Palo Alto Ave., Hollis 23, N. Y.

*Contact* is said to deposit a coating of durable hard-bonded dry lubricant which resists corrosives, heat and cold.

\* \* \*

**OHMITE FUSE RESISTOR**

A 7.5-ohm fuse resistor, *No. FR-7.5*, designed as a replacement in TV receivers, has been announced by the Ohmite Manufacturing Co., 3675 Howard St., Skokie, Ill.

It is furnished with 1½" timed wire leads plus a separate plug-in mounting strip. Can be soldered to the strip for plug-in mounting or directly into the circuit under the chassis.

Both resistor and mounting strip are packaged in a clear plastic bag for convenient handling. Further details in bulletin 146.

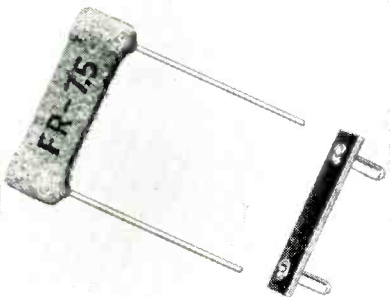

more than 5 years

**HUMIDITY — SHELF TEST**

**ELMENCO STEATITE PAPER TUBULARS**

Tests performed on ELMENCO STEATITE PAPER TUBULAR CAPACITORS which had been aged for more than five years — subject to ALL normal atmospheric variations — revealed that 65% still met original RETMA specifications and all units were still satisfactory for use in most by-pass circuits.



**OFTEN IMITATED— STILL UNMATCHED**

**FOR YOU MR. MANUFACTURER:**

— A quality component at competitive prices. . . . low cost assurance of a dependable product.

**FOR YOU MR. DISTRIBUTOR:**

— A widely-accepted brand name component backed by national advertising and promotional aids. When your customer asks for ELMENCO, have them on hand. No fear of deterioration on your shelves. **They all move fast and stay good.**

**FOR YOU MR. SERVICEMAN:**

— Money in the bank!! Put **ELMENCO STEATITES** in a circuit and you can forget them. No call backs, no worries of replacement failure. And you can still use those units you bought months ago with complete confidence. **ELMENCO REPLACES BUT IS NEVER REPLACED.**

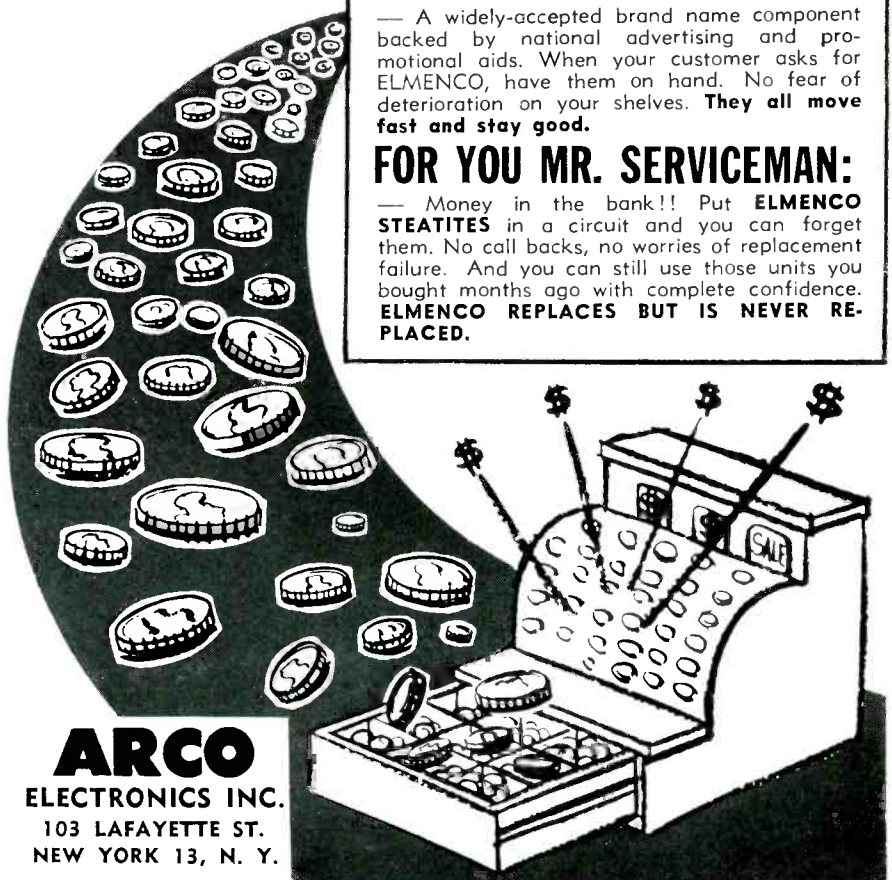

**ARCO ELECTRONICS INC.**  
103 LAFAYETTE ST.  
NEW YORK 13, N. Y.

WEST COAST BRANCH—ARCO CAPACITORS INC., 5281 WEST PICO BOULEVARD, LOS ANGELES, CALIF.

## Community TV

(Continued from page 22)

have a smaller impedance to the higher frequencies; the drop-cable, being coax, attenuates the high channels much more than the low. Thus, at the end of a 100' drop, all channel-strengths will be equalized (approximately), if the proper capacitor is used.

If the subscriber has never used TV before, the subject of set placement should be discussed carefully and with tact.

As unobtrusively as possible, one should point out to a subscriber (especially if female) the advantages of locating the receiver where a minimum of direct light will fall upon the screen, space for viewers will be available, and maximum convenience for tuning will obtain. In most cases, these suggestions will be appreciated, if presented diplomatically. If possible, where the family has never operated a TV set before, a few minutes spent in outlining the various functions of the tuning controls, holds, contrast and brightness, will pay off, producing a highly satisfied customer.

### Additional System Installation Notes

If the site chosen for the antennas is high enough to be subject to attack by ice-storms during the winter, extra special precautions must be taken in the erection and guying of the towers. A firm, heavy foundation must be laid, preferably of concrete, and the towers should be guyed at least every twelve feet, using four-guy wires at each station. The modern heavy duty tower will bear a tremendous load of ice, if it is maintained in a straight position; if a bending or buckling strain is allowed on it, it will very likely fail. Therefore, allowances should be made for this when designing the tower installation.

When attaching the antenna, if some provision cannot be made for freeing the pulley in icy weather, so that the antenna can go down without taking the tower with it, the end of the antenna should be secured with a light rope, which will break, dropping the antenna, if overloaded, but saving the tower. (Although we have not had an opportunity to make operating tests on this method, the use of some material such as *soil-heating cable*<sup>2</sup>, to thaw out the antenna suspension pulleys, permitting them to run freely, has been contemplated. Even a small electric light bulb that would keep the pulleys ice-free, or perhaps a cardboard or metal box over the pulley itself, would be very helpful.)

<sup>2</sup> G. E.

# "Really Built"

## JONTZ Kwick-Up Telescoping Masts

Jontz Kwick-up telescoping masts are available in 3 lines: The De Luxe 100 series, made from hot-dipped galvanized 16 gauge tubing. The Standard 200 series, made of 16 gauge tubing rolled from galvanized strip. The Standard 300 series made of 18 gauge tubing rolled from galvanized strip with 1 1/4", 16 gauge top.

- Mast sections will not pull apart with the exception of the top section which enables easier antenna mounting.
- New type locking device for faster erection and locking without tools.
- Revolutionary new guy ring eliminates all strain, tension, and friction on the next section to be erected.
- Newly designed companion base assures definite locking, will not turn in the wind.

Sell the Line that is "Really Built" to do the job Available at better jobbers everywhere

### JONTZ MANUFACTURING CO.

1101 East McKinley, Mishawaka, Indiana

IN CANADA: Active Radio & TV Distributors  
60 Spadina Ave. • Toronto, Canada

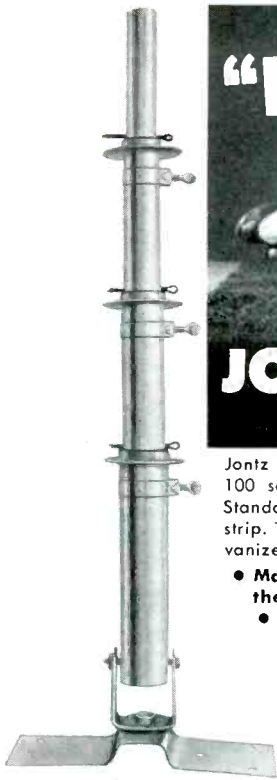

The new Model TV-50

# GENOMETER

A versatile all-inclusive GENERATOR which provides ALL the outputs for servicing:  
A.M. Radio • F.M. Radio • Amplifiers • Black and White TV • Color TV

## 7 Signal Generators in One!

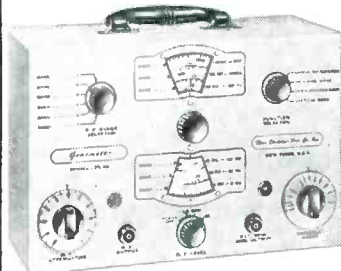

- ✓ R. F. Signal Generator for A.M.
- ✓ R. F. Signal Generator for F.M.
- ✓ Audio Frequency Generator
- ✓ Bar Generator
- ✓ Cross Hatch Generator
- ✓ Color Dot Pattern Generator
- ✓ Marker Generator

R. F. SIGNAL GENERATOR: Generates Radio Frequencies from 100 Kilocycles to 60 Megacycles on fundamentals and from 60 Megacycles to 180 Megacycles on powerful harmonics.

VARIABLE AUDIO FREQUENCY GENERATOR: Provides a variable 300 cycle to 20,000 cycle peaked wave audio signal (also fixed 400 cycle sine wave).

**BAR GENERATOR:** Projects an actual Bar Pattern on any TV Receiver Screen. Pattern will consist of 4 to 16 horizontal bars or 7 to 20 vertical bars.

**CROSS HATCH GENERATOR:** Projects a crosshatch pattern on any TV picture tube. Pattern consists of non-shifting, horizontal and vertical lines, interlaced.

**DOT PATTERN GENERATOR (FOR COLOR TV):** The Dot Pattern projected on any color TV Receiver tube by the Model TV-50 will enable you to adjust for proper color convergence.

**MARKER GENERATOR:** The Model TV-50 includes all the most frequently needed marker points. 189 Kc., 262.5 Kc., 456 Kc., 600 Kc., 1000 Kc., 1400 Kc., 1600 Kc., 2000 Kc., 2500 Kc., 3579 Kc., 4.5 Mc., 5 Mc., 10.7 Mc., (3579 Kc. is the color burst frequency).

Comes absolutely complete with shielded leads and operating instructions. Only

**\$47<sup>50</sup> NET**

## SHIPPED ON APPROVAL NO MONEY WITH ORDER — NO C. O. D.

Try it for 10 days before you buy. If completely satisfied send \$11.50 and pay balance at rate of \$6.00 per month for 6 months.—**No Interest or Finance Charges Added.** If not completely satisfied, return to us, no explanation necessary.

MOSS ELECTRONIC DISTRIBUTING CO., INC.  
Dept. D-116, 3849 Tenth Ave., New York 34, N. Y.

Please rush one Model TV-50. I agree to pay \$11.50 within 10 days after receipt and \$6.00 per month thereafter.

NAME .....

ADDRESS .....

CITY ..... ZONE ..... STATE .....

## Tube News

(Continued from page 33)

tional to noise figure, the power indicating meter can be calibrated to read directly in noise figure values.

Since a common amplifier and filter is utilized in the instrument and the characteristics of these elements do not change during the fraction of a second switching time, the measurement made by the instrument has been found to be independent of gain and bandwidth change. The accuracy of the instrument reduces to a dependency on the calibration of the indicating meter, stability and accuracy of the comparison circuit, and inherent noise introduced by the circuit elements. All of these parameters can be controlled by careful circuit design.

## Ser-Cuits

(Continued from page 20)

low-band splitting circuit (with double-tuned selectivity) feeding each high and low-band detector where a voltage proportional to the sum of the signals in each band, independently, is produced. The outputs of these detectors are separately amplified in *dc* amplifiers, the cathodes of which are operated at  $-115$  v. A plate-load resistor goes to  $+150$  volts and the cathode bias resistor (*agc* level control) is adjusted to hold the plate voltage between 0 and  $-4$ , when the *agc* circuit is operating under the recommended conditions; in this instance, the input to the amplifier is between 14,000 and 140,000 mv in either high or low band.

Since the plate voltage of the *dc* amplifier circuit in the *agc* unit would tend to go highly positive with weak input signals at the amp, below 14,000 microvolts, a catcher diode has been provided to clamp the plate voltage at 0, should it attempt to rise positively.

The *agc* unit will regulate its amp, permitting only a  $1\frac{1}{2}$ -db change in the output when the signal at the input to the amp varies 20 db.

The combination of the amplifier and its *agc* control has been found effective not only in the face of the foregoing conditions covering broadcast signal fluctuations and *ac* line variations, but also as a means of compensating for substantial differences in cable attenuation in long line TV systems, due to temperature changes.

This amplifier combination can be used to continue or expand any TV system, by inserting it in the cable line and adjusting the signal level controls. To offer resistor isolation and capacitor blocking for any TV set connected to a cable, a spliceless cable tapoff has been designed.<sup>2</sup>

<sup>2</sup>B-T.

# C-D's CUB BEST-BAR NONE

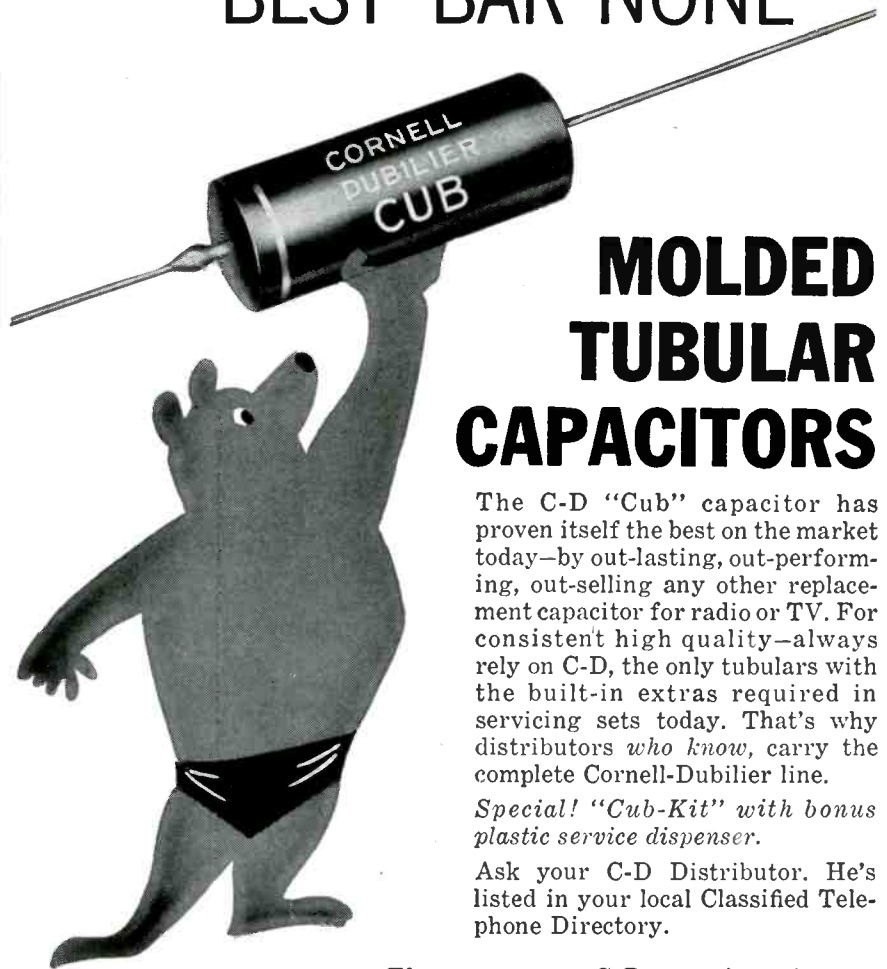

## MOLDED TUBULAR CAPACITORS

The C-D "Cub" capacitor has proven itself the best on the market today—by out-lasting, out-performing, out-selling any other replacement capacitor for radio or TV. For consistent high quality—always rely on C-D, the only tubulars with the built-in extras required in servicing sets today. That's why distributors *who know*, carry the complete Cornell-Dubilier line.

*Special! "Cub-Kit" with bonus plastic service dispenser.*

Ask your C-D Distributor. He's listed in your local Classified Telephone Directory.

*There are more C-D capacitors in use today than any other make*



## CONSISTENTLY DEPENDABLE CORNELL-DUBILIER CAPACITORS

PLANTS IN SOUTH PLAINFIELD, N. J.; NEW BEDFORD, WORCESTER AND CAMBRIDGE, MASS.; PROVIDENCE AND HOPE VALLEY, R. I.; INDIANAPOLIS, IND.; SANFORD AND FUGUAY SPRINGS, N. C.; SUBSIDIARY: THE RADIART CORPORATION, CLEVELAND, O.

## Service Engineering

(Continued from page 34)

through the upper half, the other through the lower half. One branch extends from the upper clip lead through  $S_1$ , terminal 3 (the center tap) of  $T_1$ , terminal 1 of  $T_1$ , when the *input-voltage* switch is at 6 v, or terminal 2 of  $T_1$  when the switch is at 12 v, *rf* choke coil  $L_1$ , pin 6 of the vibrator and its paired power contacts, the reed, and fuse  $F_1$  or  $F_2$ , to the lower clip lead. The other branch is similar except that it extends from terminal 3 of  $T_1$  to terminal 4 or 5 of  $T_1$ , *rf* choke coil  $L_2$ , pin 1 of the vibrator and its paired power contacts, and back through the reed and fuse  $F_1$  or  $F_2$  to the lower clip lead. Cur-

rent flows alternately in the upper and lower sections of the transformer when the reed makes contact with the upper and lower power contacts of the vibrator. This occurs 60 times per second for each pair of contacts. For 12-v operation, the *input-voltage* switch is set at 12 v and current flows through the complete upper and lower halves of the transformer primary as each pair of power contacts is closed. For 6-v operation, the switch is set at 6 v and current flows through approximately half of each upper and lower half of the transformer primary. The step-up turns ratio for 6-v operation is approximately twice that for 12-v operation. Therefore, the output voltage at the secondary of  $T_1$  for both types of operation is almost the same; 100 to 110 v.

For **SATISFIED CUSTOMERS**

and **PROFITS too!**

INSTALL

**Mosley**

TV ANTENNA  
ACCESSORIES



**Wall-Thru**

Cat. No. 625  
List Price \$1.95

- New, improved tube is semi-flexible – bends without breaking for easy insertion into wall openings drilled out of line!
- Neat, Convenient, Efficient! Appeals to ALL TV Owners because it's Practical!
- A Sure-Fire Profit Maker For TV Installers!

Ask your Parts Jobber or write direct for your  
Free copy of the new MOSLEY Catalog 54-55.

**MOSLEY ELECTRONICS, Inc.**

8622 St. Charles Rock Rd., St. Louis 14, Missouri

**DO YOU WANT TO TRAVEL  
FOR A LEADING  
COMPONENT MANUFACTURER?**

Nationally known company needs personable, bright young men with good TV training to travel, making talks before groups of service technicians, etc. Please give full resumé of experience and education in first letter. Single men 21 to 28 preferred.

**HARRY P. BRIDGE ADVERTISING**

Attention WALTER J. WERBOS, Vice President

1201 Chestnut Street Philadelphia 7, Pa.

At the Electronic Parts Show  
Conrad Hilton Hotel  
In Chicago, May 16 to 19  
SERVICE will be in  
Display Room 659

## Catalogs-Bulletins

INTERNATIONAL RECTIFIER CORP., 1521 E. Grand Ave., El Segundo, Cal., has released 4-page bulletin *GD-2*, listing ratings and specifications on diodes that can be used in *uhf* mixers, for meter protection and general applications. Also incorporates an interchangeability and replacement chart.

\* \* \*

PHILCO CORP. has issued their '55 parts and accessories catalog, with data on over 24,000 components. Features technical reference information. All items have been catalogued by part number. Catalog holders will receive quarterly supplements containing all price changes.

\* \* \*

MUELLER ELECTRIC Co., 1573 E. 31st St., Cleveland 14, Ohio, has released catalog sheet, *172*, describing small insulated alligator clips for use in miniaturized and sub-miniaturized equipment.

\* \* \*

VOKAR CORP., Dexter, Mich., has published a 20-page *Vibrator Replacement Guide (108)*, containing detailed operating data and base diagrams on sync and non-sync vibrators. Features cross-referenced replacement sections listing car and radio part numbers, and Vokar and original equipment manufacturers' codes for 6 and 12-v auto radios built since '39.

\* \* \*

MERIT COIL AND TRANSFORMER CORP., 4427 N. Clark St., Chicago, Ill., has released an auto-radio replacement guide, No. 3, describing replacements for all model cars up to and including '55; features information on vibrator transformers, speaker outputs, and *if* and *rf* transformers.

\* \* \*

CBS-HYTRON, Danvers, Mass., has issued an 8-page *Substitution Chart for TV Picture Tubes*. Contains basing diagrams and substitution information for electromagnetically deflected tubes, regardless of make, including aluminized types: indicates directly interchangeable types and substitutes requiring a minimum of service changes. Index lists picture tubes by substitution group, giving best choice of substitute type.

\* \* \*

FRANK L. CAPPS AND Co., 20 Addison Pl., Valley Stream, N. Y., has announced an 8-page brochure, *Technical Information on Condenser Microphones*. Details construction of condenser mikes and operational theory, as well as characteristic charts.

\* \* \*

ALTEC LANSING CORP., 161 6th Ave., New York 13, N. Y., and 9356 Santa Monica Blvd., Beverly Hills, Cal., has issued a 36-page engineering catalog, containing technical data on AM-FM tuners, transcription arms, broadcast, *pa* microphones, amplifiers and preamps, power supplies, control consoles, speakers, horns, cabinets and matching transformers.

\* \* \*

TELEX, INC., Telex Park, St. Paul 1, Minn., has released an illustrated catalog sheet, with specs and applications of miniature jack and plug combinations which can be installed in dictating machines, tape recorders and miniature radios.

\* \* \*

RECOTON CORP., 52-35 Barnett Ave., L. I. City 4, N. Y., has prepared a 4-page brochure with a technical report on their turnover cartridge, including a circuit of a preamp designed for the pickup.

# Personnel

W. WALTER JABLON has been appointed sales manager of Radio City Products Co., Inc., and its affiliate, Reiner Electronics Co., both of Easton, Pa.



W. Walter Jablon



A. R. Andrews



Robert Raynor

A. R. ANDREWS has been promoted to vice president and general sales manager of Pyramid Electric Co., 1445 Hudson Blvd., Tenafly, N. J. Andrews formerly headed a rep. firm in Syracuse, and handled Pyramid products.

ROBERT RAYNOR has been named sales promotion manager of the newly formed merchandising department of Clear Beam Antenna Corp. and Tempo TV; he will continue as Clear Beam sales manager.

GRADY L. ROARK, formerly marketing manager of the G.E. tube department, has been named manager of a new unit, tube sales, with headquarters at Schenectady. The new operation will serve as a central sales service organization for tubes, and radio and TV components, including test equipment, such as 'scopes, marker generators and sweep generators.



G. L. Roark



N. P. Marshall



Matthew D. Burns

NELSON P. MARSHALL has been appointed general sales manager of Sola Electric Co., 4633 W. 16th St., Chicago 50, Ill. . . . PAT J. MORRISSEY is now field sales manager.

MATTHEW D. BURNS has been elected a vice president of Sylvania Electric Products, Inc.; he is general manager of electronic tube operations.

WILLIAM R. CROTTY has been promoted to manager of radio and TV sales of the electronic division of Erie Resistor Corp., Erie, Pa. . . . JOSEPH T. ZURAVLEFF succeeds Crotty as manager of the Chicago district sales office. . . . GEORGE K. EGELSTON is now sales rep in that office.

WILLIAM O. HAMLIN, formerly technical editor of the Sylvania News, has joined CBS-Hytron as supervisor of technical information service.



(Left)  
William O. Hamlin



(Right)  
Al C. Olsson

AL C. OLSSON has been appointed manager of the New York district office of Burgess Battery Co., Freeport, Ill.



**BURGESS**  
Portable Radio  
**BATTERY**  
sales promotion  
has more

**"LASTING POWER"**

ORDER THESE HANDY  
SALES AIDS FROM YOUR  
**BURGESS**  
DISTRIBUTOR!  
**NOW!**

It's Here! Another outstanding sales promotion designed to keep cash registers ringing during the soon-to-arrive Portable Radio Season! Burgess Promotion Kits are free! They're designed to help you, Mr. Dealer, to sell more batteries, TO MAKE MORE PROFITS! Get all the advantages of planned ordering! Contact your distributor!

Original Handy Wall Chart shows "at a glance" the correct Burgess battery for use in each portable radio listed!



Retail Price and Reference Data Chart has "at a glance" answers for all your battery questions.



Cross Reference Chart—shows right Burgess battery to use when replacing other brands!



**Keep Sales**  
**Alive in**  
**'55!**



12" x 27"  
Attractive Window or Counter Banner directed to the portable battery customer! A hard-hitting salesman and many other useful selling tools in this FREE kit!



No. F6A60  
Your Burgess distributor has full information! Contact him today!



No. C5

No. 21R



No. XX45



No. N60

these are the books that  
**SAVE TV SERVICE TIME**

**NEW  
VOL. 5**

HOWARD W. SAMS'

**"Television Tube  
Location Guide"**

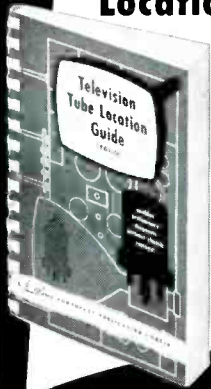

latest  
volume  
in this  
invaluable  
series of  
"Tube  
Location  
Guides"

**FIND THE TROUBLE—REPLACE TUBES  
WITHOUT REMOVING THE CHASSIS**

Latest volume in the series used daily by thousands of TV technicians. It's the only book that shows the *position and function* of all tubes in hundreds of recent TV sets. Helps save your servicing time. Most often, an operational check of the set in the customer's home gives you the clue to the trouble. Generally, a tube failure is the cause. This handy Guide makes trouble diagnosis and tube replacement fast and easy, *without removing the chassis!* Each TV model has its own clear, accurate tube placement diagram. All new diagrams covering 1953 and 1954 TV models. Over 200 pages. Indexed for fast reference; 5½" x 8½"; handy "open-flat" plastic binding. Pays for itself on just one job.  
ORDER TGL-5. Only.....\$2.00

**OWN THEM ALL—THEY  
HELP YOU EARN MORE**



**VOL. 4.** Shows location and function of all tubes in hundreds of 1951-1952 TV models. 192 pages. 5½" x 8½". Fully indexed for quick reference.  
ORDER TGL-4. Only.....\$2.00

**VOL. 3.** Gives tube positions in hundreds of 1950-1951 TV sets. Solves tube failure troubles in minutes. 192 pages; 5½" x 8½".  
ORDER TGL-3. Only.....\$2.00

**VOL. 2.** Includes hundreds of tube placement charts for 1949-1950 TV models. Big, legible charts. 208 pages; 5½" x 8½".  
ORDER TGL-2. Only.....\$2.00

**VOL. 1.** Shows location and function of tubes in TV models made in 1948-1949. Not duplicated in other volumes. 208 pages; 5½" x 8½".  
ORDER TGL-1. Only.....\$2.00

**Carry Them ALL in Your Tube Caddy**

**HOWARD W. SAMS & CO., INC.**

Order from your Parts Jobber today, or write to HOWARD W. SAMS & CO., INC., 2207 E. 46th St., Indianapolis 5, Ind.  
My (check) (money order) for \$..... enclosed. Send the following books:  
 TGL-5 (\$2.00)                       TGL-4 (\$2.00)  
 TGL-3 (\$2.00)                       TGL-2 (\$2.00)  
    TGL-1 (\$2.00)

Name.....  
Address.....  
City..... Zone... State.....  
(priced slightly higher outside U.S.A.)

**TV Antennas**

(Continued from page 40)

was also noted that since current always takes the path of least resistance, it would still take that path even if more than one path were offered to it. It was therefore decided to see what would happen if current were given two paths in which to flow for phase-reversal; current was allowed to take its own path every time a channel selector switch was tuned. This was accomplished by the addition of an aluminum conductor which electronically connected the upper and lower diamonds. In Fig. 7, this design is illustrated. Here we have an antenna that has two half-wave dipoles on the low-band, and six half-wave dipoles on the high-band.

A pair of diamond-shaped phase-reversing elements with a lower Q than the average stub were incorporated in a model; the net result was found to be a broader bandwidth serving to increase the overall coverage of the antenna.

**Screen Reflector**

After the dipole system had been developed, the *ddp* engineers concentrated on a reflector system. A single bar reflector was rejected since it was found that this type of reflector functioned effectively only on one frequency. A screen-type of reflector, on the other hand, it was found, is not frequency sensitive, non-resonant and has an optimum gain of approximately twice that of a single bar reflector. A screen reflector that had about 70 square feet of area was designed for the *ddp* antenna. This screen, it was felt, is large enough to provide maximum reflection on the low-band and, as the screen is not frequency sensitive, is more than adequate for the high-band. Screen elements were spaced less than one-tenth wavelength apart; this close spacing, plus the fact that the ends of the screen elements were joined together, was found to provide a screen that appeared as a solid sheet of aluminum to the oncoming signal.

**Driven Element Spacing**

Finally, for best reflector action, it was decided to space the driven elements so that they were a quarter-wave from the screen on the low-band, and three quarter-waves from the screen on the high-band. The stacking harness that is used to stack two single-bay antennas to make one stacked unit, provides half-wave stacking on the low-band, and three half-waves stacked on the high band.

*It's got the  
Rotor Industry  
in a spin!*  
**RMS  
ROTOR QUEEN**  
only **1995** list  
list

(all the  
quality features of  
high priced  
rotors...  
and more)

Radio  
Mdses Sls,  
Inc.  
N. Y. 62

Liberal  
trade Discounts

See us at the Chicago Show—Booth 128

**RED LINE  
INSULATED  
Nails & Staples**  
For Cable and Twin-Lead  
Safe, Long Lasting  
Installations  
See your Jobber or write us.  
M. M. Rhodes & Sons Co. Taunton, Mass.

**WHEN YOU CHANGE  
YOUR ADDRESS**

Be sure to notify the Subscription Department of SERVICE at 52 Vanderbilt Avenue, New York 17, N. Y., giving the old as well as the new address, and do this at least four weeks in advance. The Post Office Department does not forward magazines unless you pay additional postage, and we cannot duplicate copies mailed to the old address. We ask your cooperation.

**Servicing Helps**

(Continued from page 30)

will be due to a bad selenium rectifier; replacement is best check for this trouble.

To remove vertical jitters on Sylvania 511 (chassis 527), one should remove R<sub>205</sub>, a 2.2-meg resistor, from pin 1 of the 5AN8 sync clipper tube and replace with a 390,000-ohm ½-watt resistor.

don't be vague...

insist  
on  
SPRAGUE

ATOMS®



SPRAGUE

NORTH ADAMS, MASS.

don't  
be  
vague...

insist on  
SPRAGUE  
BLACK  
BEAUTY®



TELECAP®  
tubulars

SPRAGUE

NORTH ADAMS, MASS.

## Spurious Radiation

(Continued from page 17)

applies to all magnetic and conductive radiation from a television receiver falling between the frequencies of 15 kc and 50 mc. RETMA has also established several task forces to study and recommend standards of spurious radiation for all types of electronic apparatus in addition to radio and television receivers.

It should be obvious, even to the most critical person, that these standards, proposed standards and studies are evidence and even proof that the industry is not only cognizant of the problem, but sincerely wishful of obtaining a solution to it. If the problem were simple, it would have been completely solved long ago. It is, however, not of a nature which can be solved by decree. The problem, if solved for the best public interest, is bi-lateral and requires deep study and compromise.

Many of the problems upon which the FCC must ultimately rule—the spurious radiation problem is a good example—are complex and abstruse and can be solved only after a searching study of all of the factors and only when the technical state of the art and its economy permits. Earlier action is bound to impair the economic health of some of our very important industries. Joint studies will often-times set in motion the step by step processes whereby proper answers are bound to result. The proper answers are, of course, the ones which permit the continued healthy growth of the industry and simultaneously protect the best balanced interests of all.

### Economic Considerations

This point should be *stressed*: There is an economic consideration which cannot be overlooked in applying the rule of public interest to the solution. It is paramount in our contention that in the case of interference created to one service by spurious radiation from another, both the interfering and interfered services have a responsibility. It is not in the public interest to place the entire burden for correction of a problem on either one of these services.

For example, there are practical limits to which spurious radiation can be reduced in any given piece of equipment. In the case of mass-produced low-cost equipment, such as radio and television receivers, these limits, of necessity, must be considerably higher than would be the case for lower quantity, more special-

(Continued on page 62)

Get this  
Cabinet **FREE**

Sprague Ceramikit



WITH A BASIC ORDER OF  
CERAMIC CAPACITORS

● NOW . . . stock ceramics so you can find 'em when you want 'em . . . have your own neat and complete cabinet . . . at the cost of the capacitors alone.

● Sprague has pre-stocked these handsome, blue, heavy-gauge steel CERAMIKIT cabinets with its famous Ceramite capacitors. Ratings and quantities are based on popularity. No dogs! Stand-up indexes separate reusable plastic boxes. Catalog numbers and ratings can be seen at a glance.

● Whether you use many ceramics, or just a few, there's a Ceramikit sized and priced just right for you. Kit CK-2 is a two-drawer model holding 150 capacitors in 27 different ratings. Kit CK-3 is a single-drawer unit holding 75 capacitors in 12 different ratings. Remember there's not a dog in either Ceramikit.

● Kits interlock so You Can Build With Sprague as you buy your Ceramikits. Use the extra cabinets for handy indexed stocking of all your small parts.

● See your distributor *now* about Ceramikits, or get complete information in Sheet M-711 from the Sprague Products Company, Marshall Street, North Adams, Massachusetts.



CK-2  
150 Assorted  
Capacitors  
\$38.00 LIST

CK-3  
75 Assorted  
Capacitors  
\$19.25 LIST

don't be vague... insist on

SPRAGUE

Sprague Products Co. is the Distributors'  
Division of the Sprague Electric Co.

# KESTER

A stack of Kester Solder cans is the central focus. The top can is labeled "KESTER RESIN-FIVE SOLDER" and "ALLOY 50/50 062". Surrounding the cans are four cartoon characters holding signs that read: "FASTER ACTING", "EASIER TO USE", "LONGER LASTING", and "THE BEST".

**KESTER SOLDER COMPANY**  
4248 Wrightwood Avenue • Chicago 39, Illinois  
Newark 5, New Jersey • Brantford, Canada

# SOLDER

Absolutely non-corrosive and non-conductive, KESTER "RESIN-FIVE" CORE SOLDER contains an activated type of resin that gives you that fast, positive action on all your jobs . . . including the most difficult.

FCC are the proposed rules governing restricted radiation devices and the proposed rules for setting up a procedure for type acceptance and type approval of two-way radio equipment.

Another outstanding example of a case wherein cooperation could have been employed with excellent effect, involves, the standardized *if* for television.

The FCC in its allocation plan for the *uhf* channels took cognizance of the existence of the industry standard *if* of 41.25 mc and protected it from interference in the plan. The FCC, however, continues to permit operation, and actually has licensed additional operation of high power transmitters near this frequency causing interference to thousands of TV receivers. Certainly this matter would be high on the agenda of a consulting group.

The coordination proposed between the two engineering departments and preferably under the direct supervision of a coordinating committee of FCC and industry representatives, can be of lasting benefit to the public, to the industry, to the FCC, and to the proper and advantageous use of the radio spectrum. Industry can help compensate for the lack of funds and manpower which bars the FCC from complete consideration of the problems. The establishing of close-knit technical consultation between industry and the FCC through the creation of a joint group will provide a solution distinctly in the best balanced interests of the public, industry, and government.

### The Commission's View

COMMENTING ON how the play of free competition could work towards a reduction of radiation without interruption by government, Federal Communications Commissioner *E. M. Webster* said the job is up to management, not the engineers.

Noting that the scientists can do anything, and they have provided a host of solutions to the problem, the government spokesman said that radiation is actually a policy issue that must be resolved by those in charge of a company. The conference was told that it was the executive who should travel to Washington and discuss bluntly the situation, reviewing the problems of cost and its relation to competition and receiver sales. A panel of radio-TV set presidents should come to the Commission's office, emphasized Webster, to tell their story. Such a representative body, he felt, could provide an immediate solution to TVI.

## Spurious Radiation

(Continued from page 61)

ized equipment. If this were not so, the cost to the public would not only be burdensome to the extent that it would limit the growth of the broadcast service but, in some cases, prohibitive. Furthermore, on a percentage basis, the number of actual cases of TV interference which have been experienced would not seem to warrant an FCC decree substantially increasing the cost to the public of *all* television receivers. This question obviously requires critical and penetrating study of all factors.

After years of work RETMA has established what it believes are practical limits for radio and television receivers, and a proposed standard dealing with radiation between 15 kc and 50 mc. As indicated, work currently is going forward on proposed standards for other electronic devices. If the amount of radiation which exists from a piece of equipment complying with these standards does interfere with some service, then this service should feel some responsibility for inquiring into whether it should take steps to assist in resolving the problem. This could be accomplished in various ways, including judicious

choice of transmitter or receiver locations, receiver design, transmitter power and the specific frequencies used. This philosophy warrants serious consideration by the FCC in discharging its rule-making responsibility.

From the standpoint of interference to TV receivers by authorized radiation in the standard *if* band, we also feel that there is a joint responsibility. Mass-produced, low-cost television receivers, which are definitely a public necessity as an information media, as well as playing a recognizably important role as an entertainment media, and as such are in the public interest, can be designed to have a certain immunity to such interference. There is, however, a practical limit beyond which the costs become excessive, as in the associated problem of emissions of spurious radiation. The FCC should institute rule making which will protect TV receivers designed in accordance with the RETMA standard.<sup>2</sup> The FCC could help tremendously in this respect by proper and judicious assignment of services in the standard *if* band and by rules regarding transmitter powers and locations.

Two current examples where the public interest calls for maximum cooperation between RETMA and the



## ADVERTISERS IN SERVICE

APRIL, 1955

	Page
Aerovox Corp.	29
American Phenolic Corp.	28
American Television & Radio Corp.	49
Arco Electronics Inc.	55
Argos Products Co., Inc.	2
Atlas Sound Corp.	52
Harry P. Bridge	58
Burgess Battery Co.	59
Bussmann Mfg. Co.	6
<b>CBS-Hytron (Div. Columbia Broadcasting System)</b>	<b>8, 9</b>
Channel Master Corp.	10, 11
Chicago Standard Transformer Corp.	53
H. G. Cisin	63
Clarostat Mfg. Co., Inc.	45
<b>Cornell-Dubilier Electric Corp.,</b> <b>Inside Front Cover, 44, 57</b>	
Allen B. DuMont Laboratories, Inc.	23
Electro-Voice, Inc.	1
Erie Resistor Corp.	52
The Finney Co.	24, 25
General Cement Mfg. Co.	7
General Electric	26, 27
The Heath Co.	54
Jensen Industries, Inc.	52
Jerrold Electronics Corp.	54
Jersey Specialty Co., Inc.	64
Jontiz Mfg. Co.	56
Kester Solder Co.	62
<b>P. R. Mallory &amp; Co., Inc. Inside Back Cover</b>	
Mosley Electronics, Inc.	58
Moss Electronic Dist. Co., Inc.	56
Oxford Electric Corp.	48
Philco Corp.	16
Quam-Nichols Co.	51
Radelco Manufacturing Co.	42
<b>The Radiart Corp. Inside Front Cover, 44, 57</b>	
Radio Corp. of America	12, 36, Back Cover
Radio Merchandise Sales, Inc.	60
The Radion Corp.	64
Raytheon Mfg. Co.	14
M. M. Rhodes & Sons Co.	60
Howard W. Sams & Co., Inc.	60
Snyder Mfg. Co.	32
South River Metal Products Co., Inc.	13
Sprague Products Co.	61
Standard Coil Products Co., Inc.	3
Sylvania Electric Products, Inc.	31
Sarkes Tarzian, Inc. Rectifier Div.	5
Walco-Electrovox Co., Inc.	50
<b>The Ward Products Corp. Div. the</b> <b>Gabriel Co.</b>	<b>39</b>

## JOTS AND FLASHES

FIFTEEN MAJOR categories of exhibits, including components and equipment handled by parts jobbers and sold by manufacturers through distributors on a national basis, will be on display at the Electronic Parts Distributors Show, at the Conrad Hilton, May 16-19. On view will be the latest in coils; transformers; power supplies; relays; switches; capacitors; resistors; antennas; towers and masts; amplifiers and tuners; speakers and audio accessories; microphones, pickups and phono mechanisms; public address, intercom and ham equipment; tape recorders and enclosures; converters, motors and vibrators; wire and solder; tubes and rectifiers; test equipment and instruments; batteries and chassis, and hardware, components and tools. . . . A radio-frequency bridge to measure resistance in a junction-type transistor has been developed by *Anthony Hlavacek* and *Ge Yao Chu* of Sylvania. The bridge will make it possible to determine whether a transistor meets certain necessary performance standards; heretofore this could not be measured and could not be determined until the transistor had been applied directly to a circuit. . . . A color TV camera tube, *Tricolor Vidicon*, that generates simultaneously red, green and blue signals is under development and has been successfully tested by scientists and engineers of RCA. The heart of the tube is an intricate color-sensitive target applied to the face of the tube by an evaporation technique. The target, a rectangle whose diagonal measurement is 1½", consists of nearly 900 vertical strips of alternating red, green and blue color filters, covered by three sets of semi-transparent conducting signal strips. . . . *Nathan Chirelstein*, chairman of the board of Allied Electric Products, Inc., died recently. . . . *Frank M. Folsom*, president of RCA, was recently presented with a good citizenship award for 1955 for outstanding contributions to science, statesmanship and public welfare by the Philadelphia chapter, Sons of the American Revolution. . . . *Si Holzman*, JFD field engineer, recently conducted a series of antenna and rotator engineering talks and demonstrations in Canada, under the auspices of Canadian Electric Supply Co. . . . *Amplitel, Inc.*, is now located at 342 W. 40 St., N. Y. C. . . . *Lou Selsor*, distributor sales manager of Jensen Manufacturing Co., and *Jim Cody*, executive vice president of Burton Browne Advertising, recently attended the southwest electronics conference at Brackettsville, Texas. . . . Radio Receptor Co. is now making transistors which are .2" square and ⅛" thick. Prices of transistors have been reduced substantially, it has been reported. . . . Aerovox Corp. has merged Acme Electronics, Inc., which was acquired by the parent company two years ago, with the Pacific Coast division of Aerovox. . . . *Gus Snyder*, partner in Snyder Manufacturing Co., Philadelphia, returned recently from Europe where he visited the Utrecht International Trade Fair in Holland, and electronic plants in Paris, London and Germany. . . . *Kendrick K. Lippitt*, Taco vice president in charge of engineering, and *Robert T. Leitner*, one of Taco's project engineers, recently addressed meetings of the IRE and AIEE in Canton, N. Y., and Binghamton, N. Y., on communication antennas. . . . *Joseph H. Gillies* has been appointed vice president in charge of manufacturing for Philco. He will also continue to serve as vice president and general manager of the government and industrial division.

**NEW! NEW! NEW!**  
**TROUBLE-INDICATING**  
**TUBE LOCATION GUIDES**

## RCA TV MODELS

1947 TO 1955

**FIND and FIX TV TUBE TROUBLES**  
**THIS EASY WAY**  
**WITHOUT REMOVING CHASSIS**

**RCA TV MODELS**—Newest Cisin service aid. The only book containing tube guides of hundreds of RCA sets from earliest to latest models.

Shows position of all tubes and also by a novel copyrighted method indicates the effect of each tube on the operation of the TV set. Eliminates old-style fine-print function names such as AGC Gate, Sync Clip, Vert. Mult. Instead tells plainly what each tube actually does. Tubes affecting picture are marked "P", sound "S", contrast "C", horiz. sweep "H", etc.

**RCA TV MODELS**—Size 8½" x 5½"—Fits Every Tube Caddy—A "must" for every TV Service Bench. **Only \$1**

### Vol. 4—TV TROUBLE TRACER

Just Off Press!

Contains **TITLG** (Trouble Indicating Tube Location Guides) of hundreds of 1954-55 TV models from Admiral to Zenith. Also has section on how to read color coded molded resistors, capacitors and r.f. chokes. All **TV TROUBLE TRACER** volumes also contain over 40 illustrations of picture faults caused by defective tubes, 40 **SYMPTOM-CAUSE-REMEDY** Instruction Charts. Pix faults and **TITLG** indexed for rapid reference. **Only 50¢**

### Vol. 3—TV TROUBLE TRACER

—Contains hundreds of **TITLG** models covering 1953-54 TV sets and includes valuable practical data on TV antennas. **Only 50¢**

### Vol. 2—TV TROUBLE TRACER

—Gives tube positions and purpose by means of **TITLG** of hundreds of 1950-52 TV models. Includes safety rules for changing tubes. **Only 50¢**

### Vol. 1—TV TROUBLE TRACER

—Contains hundreds of **TITLG** of older TV models. **Only 50¢**  
Trouble Indicating Tube Location Guides in Volumes 1, 2, 3 and 4 are all different.

**Carry the Complete Set**  
**in Your Tube Caddy!**

**H. G. CISIN, PUBLISHER**

Order from your Jobber today, or if not stocked, write to:

**HARRY G. CISIN, Dept. S 26**  
**AMAGANSETT, N. Y.**

Enclosed find \$..... Send

RCA TV MODELS **TITLG**  
 TV TRACER, Vol. 1  TV TRACER, Vol. 3  
 TV TRACER, Vol. 2  TV TRACER, Vol. 4

Name .....

Address .....

City.....Zone..... State.....

MAKE

**\$44<sup>40</sup>**

**PROFIT**

PER WEEK

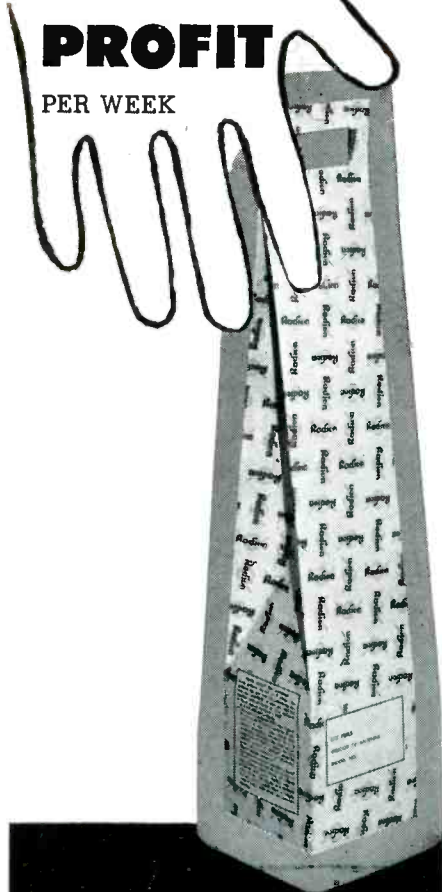

WITH THE NEW

**Radion  
PROFIT-PAK  
CARTON**

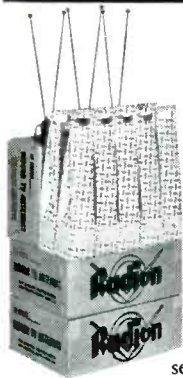

**SELL  
only**

**12**

QTA-3 antennas in new self-merchandising carton. (\$3.70 minimum profit on each)

Contact your distributor today.

**Radion**

THE RADION CORPORATION  
Dept. S, 1130 W. Wisconsin Ave., Chicago 14



W. Walter Watts (right), RCA executive vice president, electronic products, presenting 14-inch symbolic electronic statuette to Robert Hester of Mission, Kansas, during the recent 75-station NBC telecast of Peter Pan, launching National Television Servicemen's Week. Hester was chosen to represent Service Men because of the location of his business near the TV geographic center of the U. S. Sixty-two stations of the network carried the ceremony in color and 13 stations in black and white. To make the star-studded colorcast and the statuette presentation ceremony available to the maximum number of viewers, RCA arranged for the placement of 21-inch color receivers in key cities throughout the nation. Nearly 4,000 per- throughout the nation.



At a symposium of replacement sales executives and engineers of Raytheon, discussing the decade ahead, where it was forecast that by 1965, there will be a twofold increase in the sales of receiving tubes, TV picture tubes, and semiconductors such as transistors and diodes. Left to right: F. E. Simmons; E. I. Montague; N. B. Krim, vice-president and general manager of receiving and cathode ray tube operations; Charles F. Adams, Jr., president; F. E. Anderson, distributor sales head; and J. A. Hickey.

CBS-Hytron plant at Danvers, Mass., which prompted American Association of Nurserymen, Inc., to issue its national Plant America Award to Hytron for "achievement in industrial landscaping and beautification contributing to employee and civic pride in our American heritage."



Still Time for You to Win

**A FREE TRIP**

to Bermuda or Trinidad  
in Jersey Specialty's

**TIME-OF-YOUR-LIFE  
CONTEST!**



• THOUSANDS OF ENTRIES pouring in from all parts of the country!

• DISTRIBUTORS REPORT tremendous interest shown by dealers!

• DISTRIBUTORS' ORDERS for No. 2080 hundred foot TV wire coils flooding JSC plant now running full blast to meet orders from all over the country.

**DEALERS! DEALERS!**

Rush Your Letter to JSC Today! Coupons mailed to you on receipt of your letter for free wire. Important, coupons redeemed at your wholesale distributor. Write today (your distributor has full details).

**Jersey Specialty  
Co., Inc.**  
Burgess Place  
Mountain View, N. J.



P. R. MALLORY & CO. INC.  
**MALLORY**  
APPROVED PRECISION PRODUCTS

P. R. MALLORY & CO. INC.  
**MALLORY**  
APPROVED PRECISION PRODUCTS

P. R. MALLORY & CO. INC.  
**MALLORY**  
APPROVED PRECISION PRODUCTS

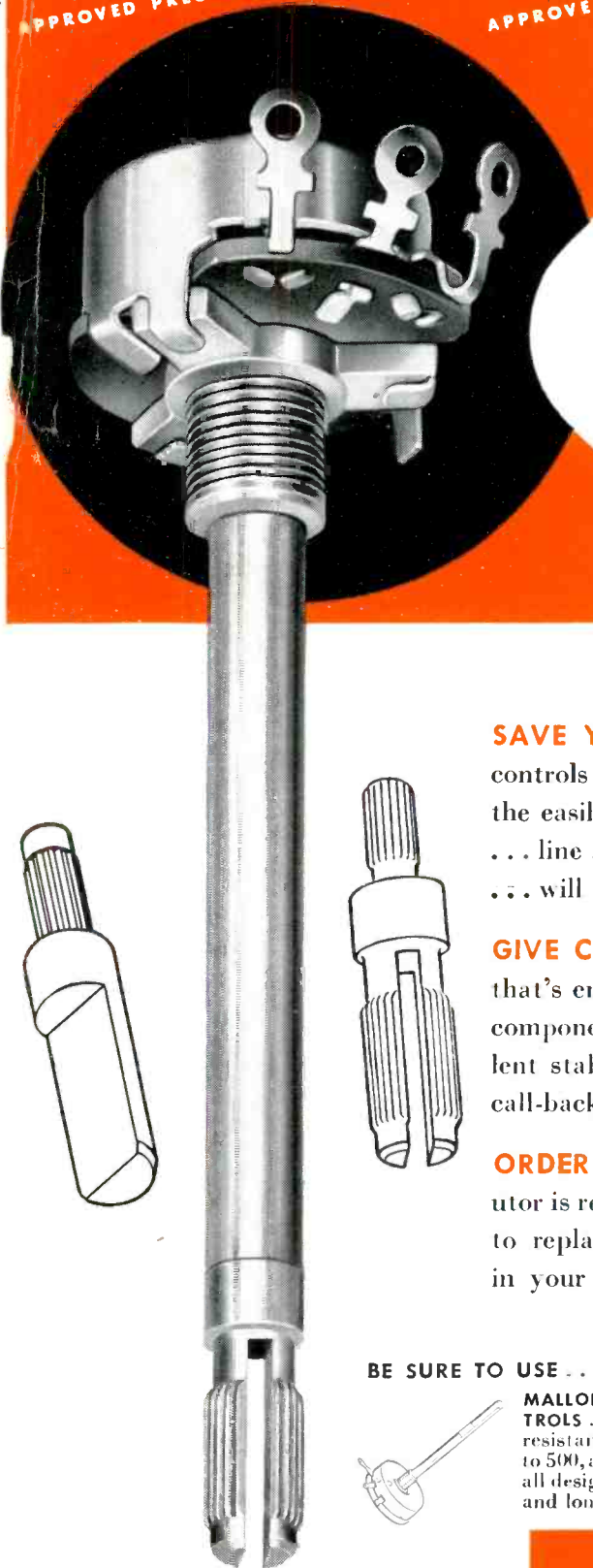

The simplest — and best  
— control replacements  
you can install

**SAVE YOURSELF TIME** with Mallory Midgetrols®—the carbon controls designed for *both* you and your customers. Features like the easily-cut tubular shaft that fits split-knurl or flatted knobs . . . line switches that you attach without disassembling the unit . . . will save valuable minutes of your shop work.

**GIVE CUSTOMERS THE BEST** with Midgetrols—the control that's engineered to equal or exceed the performance of original components. Their precise tapers, noise-free operation and excellent stability add up to the kind of performance that prevents call-backs . . . builds customer good-will.

**ORDER YOUR STOCK TODAY.** Your nearby Mallory distributor is ready to supply you with a Control Kit that will equip you to replace controls in 90 per cent of the radio and TV sets in your area.

**BE SURE TO USE . . .**

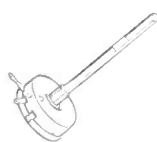

**MALLORY WIRE WOUND CONTROLS . . .** a wide selection of resistance, wattages from 2 to 500, and variety of tapers . . . all designed for cool operation and long life.

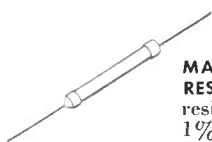

**MALLORY DEPOSITED CARBON RESISTORS . . .** high stability resistors with tolerances of 1% or 10% . . . at cost substantially lower than wire wounds.

P. R. MALLORY & CO. INC.  
**MALLORY**

CAPACITORS • CONTROLS • VIBRATORS • SWITCHES • RESISTORS  
RECTIFIERS • POWER SUPPLIES • FILTERS • MERCURY BATTERIES  
**APPROVED PRECISION PRODUCTS**

**P. R. MALLORY & CO. Inc., INDIANAPOLIS 6, INDIANA**

# For dependable output from TV power supplies



**... USE RCA TUBES  
with built-in quality!**

To meet the ever-increasing demand for higher currents in the low-voltage supplies of modern TV receivers, RCA is making available the new, outstanding 5U4-GB. This tube is a heavy-duty version of the top-quality RCA 5U4-G which is highly recommended for applications where the increased ratings of the 5U4-GB are not required. The 5U4-GB features more plate area for better heat conduction, increased plate thickness for more uniform heat dissipation—and new button stem construction to reduce leakage and electrolysis. Result—a reserve operating capability which assures you top performance in high-current TV power supplies.

*Here's another example of how  
RCA safeguards your servicing  
profits by "building-in" extra  
quality where you need it!*



**RADIO CORPORATION of AMERICA**  
ELECTRON TUBES  
HARRISON, N.J.

**Your First Choice for TV circuits . . . dependable RCA Tubes.**